

# MARKS PUBLISHED FOR OPPOSITION

The following marks are published in compliance with section 12(a) of the Trademark Act of 1946. Applications for the registration of marks in more than one class have been filed as provided in section 30 of said act as amended by Public Law 772, 87th Congress, approved Oct. 9, 1962, 76 Stat. 769. Opposition under section 13 may be filed within thirty days of the date of this publication. See rules 2.101 to 2.105.

A separate fee of two hundred dollars for opposing each mark in each class must accompany the opposition.

## SECTION 1.— INTERNATIONAL CLASSIFICATION

The short titles associated below with the international class numbers are terms designed merely for quick identification and are not an official part of the international classification. The full names of international classes are given in section 6.1 of the trademark rules of practice.

The designation "U.S. Cl." appearing in this section refers to the U.S. class in effect prior to Sep. 1, 1973 rather than the international class which applies to applications filed on or after that date. For adoption of international classification see notice in the OFFICIAL GAZETTE of Jun. 26, 1973 (911 O.G. TM 210).

### Application in more than one class

SN 75-163,780. BAUER NIKE HOCKEY INC., ST-JEROME, QUEBEC, CANADA, FILED 9-10-1996.



OWNER OF U.S. REG. NO. 1,050,773 AND OTHERS.  
THE MARK CONSISTS OF THE STYLIZED LETTER "B"  
AND THE WORD "BAUER".

#### CLASS 9—ELECTRICAL AND SCIENTIFIC APPARATUS

FOR HOCKEY HELMETS; IN-LINE SKATING HELMETS; AND FACE GUARDS, VISORS, CAGES, AND MASKS FOR SUCH HELMETS (U.S. CLS. 21, 23, 26, 36 AND 38).

#### CLASS 18—LEATHER GOODS

FOR ALL-PURPOSE SPORTS BAGS, FANNY PACKS, AND DUFFEL BAGS (U.S. CLS. 1, 2, 3, 22 AND 41).

#### CLASS 25—CLOTHING

FOR CLOTHING FOR USE IN PLAYING HOCKEY AND FOR IN-LINE SKATING, NAMELY, PANTS, JERSEYS, SOCKS, STOCKINGS, UNDERWEAR, CAPS, HATS, T-SHIRTS, RINK SUITS, GYM SUITS, JOGGING SUITS, SPORTS SHORTS, COMPRESSION SHORTS, TIGHTS, RACING SHIRTS, WARM-UP JACKETS, SHOWER SANDALS, INSOLES, LINERS FOR ICE SKATES, ROLLER SKATES, IN-LINE ROLLER SKATES, AND SPORTS SHOES, JERSEYS, SOCKS AND STOCKINGS SPECIFICALLY DESIGNED AND CONSTRUCTED FOR THE PRACTICE OF HOCKEY, SUSPENDERS SPECIFICALLY DESIGNED FOR USE WITH HOCKEY PANTS, GARTER BELTS FOR HOCKEY STOCKINGS (U.S. CLS. 22 AND 39).

#### CLASS 28—TOYS AND SPORTING GOODS

FOR SPORTS ARTICLES AND REPLACEMENT PARTS THEREFOR, NAMELY, ICE SKATES, HOCKEY SKATES, ROLLER SKATES, IN-LINE ROLLER SKATES, ICE SKATE BLADES, IN-LINE SKATE CHASSIS, WHEELS, AND BRAKES; HOCKEY STICKS, HOCKEY STICK SHAFTS, HOCKEY GOALTENDER STICKS, HOCKEY STICK REPLACEMENT BLADES, HOCKEY PUCKS, AND HOCKEY BALLS; HOCKEY GOAL NETS; SPORTS BAGS SPECIFICALLY DESIGNED TO CARRY HOCKEY EQUIPMENT; SKATE BLADE GUARDS, AND SKATE BLADE PROTECTIVE JACKETS; BODY PROTECTIVE ARTICLES AND EQUIPMENT SPECIFICALLY DESIGNED FOR THE PRACTICE OF ICE HOCKEY, ROLLER HOCKEY, STREET HOCKEY, RINGETTE, FIELD HOCKEY, DECK HOCKEY, AND BALL HOCKEY, NAMELY, THROAT PROTECTORS, BODY PADS, SHOULDER PADS, ELBOW PADS, GLOVES, PANTS COMPRISING BODY PROTECTIVE PADDING AND GUARDS, GIRDLES COMPRISING BODY PROTECTIVE SHIN GUARDS, WRIST SLASH GUARDS, CHEST PROTECTORS, ARM PADS, HIP PADS, LEG GUARDS, KNEE PADS, ANKLE PADS, ANKLE GUARDS, CHIN PROTECTORS, NECK GUARDS, TEETH GUARDS, GOAL PADS, TRAPPER GLOVES, BLOCKERS, ATHLETIC SUPPORTERS AND CUPS, JOCKSTRAPS, AND PELVIC PROTECTORS; BODY PROTECTIVE ARTICLES FOR IN-LINE SKATING, NAMELY, KNEE AND ELBOW PADS, WRIST GUARDS, AND GUARD GLOVES (U.S. CLS. 22, 23, 38 AND 50).

RUSS HERMAN, EXAMINING ATTORNEY

SN 75-447,943. ORANGE PERSONAL COMMUNICATIONS SERVICES LIMITED, BRADLEY STOKE, BRISTOL BS12 4QJ, UNITED KINGDOM, FILED 3-10-1998.

### THE FUTURE'S BRIGHT, THE FUTURE'S ORANGE

OWNER OF ERPN CMNTY TM OFC REG. NO. 000736355,  
DATED 3-5-2000, EXPIRES 1-30-2008.  
OWNER OF U.S. REG. NO. 920,090.

**CLASS 9—ELECTRICAL AND SCIENTIFIC APPARATUS**

FOR TELEPHONES, MOBILE TELEPHONES, VIDEO TELEPHONES, TELEPHONE HANDSETS AND ACCESSORIES FOR THE AFOREMENTIONED, NAMELY, BATTERIES, BATTERY CHARGERS, CONNECTOR CABLES; ELECTRICITY MAINS ADAPTERS FOR USE WITH TELEPHONES, ADAPTERS WHICH ALLOW USE OF TELEPHONES THROUGH AUTOMOBILE CIGARETTE LIGHTER SOCKETS; DESK TOP BATTERY CHARGING STANDS, DESK OR CAR MOUNTED UNITS INCORPORATING A LOUDSPEAKER TO ALLOW A TELEPHONE HANDSET TO BE USED HANDS-FREE; IN-CAR TELEPHONE HANDSET CRADLES; BAGS AND CASES SPECIALLY ADAPTED FOR HOLDING OR CARRYING PORTABLE TELEPHONES AND THEIR ACCESSORIES AS AFOREMENTIONED; RADIO PAGING APPARATUS; PAGING APPARATUS; RADIO TELEPHONE APPARATUS; COMPUTERIZED PERSONAL ORGANIZERS; ANTENNAS; SATELLITE TRANSMITTERS AND RECEIVERS FOR USE IN THE PROVISION OF A MOBILE TELEPHONE SERVICE; BLANK AND PRE-RECORDED MAGNETIC CARDS FOR USE IN CONNECTION WITH MOBILE TELEPHONES AND RADIO PAGERS; MODEMS; COMPUTER KEYBOARDS; MICROPROCESSORS FOR USE IN ANY OF THE AFOREMENTIONED TELECOMMUNICATIONS EQUIPMENT; COMPUTER PROGRAMS FOR USE IN CONNECTION WITH THE OPERATION OF ANY OF THE AFOREMENTIONED GOODS (U.S. CLS. 21, 23, 26, 36 AND 38).

**CLASS 16—PAPER GOODS AND PRINTED MATTER**

FOR DESK ORGANIZERS, LETTER TRAYS, PEN AND PENCIL HOLDERS, FILE ORGANIZERS, AGENDAS, ADDRESS BOOKS, APPOINTMENT BOOKS, BUSINESS CARDS, CALENDER DESK PADS, DESK CALENDERS, POCKET CALENDERS (U.S. CLS. 2, 5, 22, 23, 29, 37, 38 AND 50).

**CLASS 37—CONSTRUCTION AND REPAIR**

FOR INSTALLATION, MAINTENANCE AND REPAIR OF TELECOMMUNICATIONS APPARATUS AND SYSTEMS, TELEPHONES, MOBILE TELEPHONES AND TELEPHONE HANDSETS, PAGING APPARATUS, RADIO PAGING APPARATUS, RADIO TELEPHONE APPARATUS, COMPUTERIZED PERSONAL ORGANIZERS, COMPUTERS, SATELLITE TRANSMITTERS AND RECEIVERS (U.S. CLS. 100, 103 AND 106).

**CLASS 38—COMMUNICATION**

FOR MOBILE TELEPHONE SERVICES, DATA SERVICES, NAMELY, SENDING AND RECEIVING FACSIMILES, ELECTRONIC MAIL, VOICE MAIL, DATA COLLECTION AND STORAGE, NAMELY, THE COLLECTION AND STORAGE OF DATA IN ELECTRONIC MEMORY SUBSEQUENT TO VIEWING OR TRANSMISSION (U.S. CLS. 100, 101 AND 104).

HENRY S. ZAK, EXAMINING ATTORNEY

SN 75-729,669. CANADIAN HOME PUBLISHERS, TORONTO, ONTARIO M5V 2Z4, CANADA, FILED 6-15-1999.

**HOUSE & HOME**

PRIORITY CLAIMED UNDER SEC. 44(D) ON CANADA APPLICATION NO. 1013153, FILED 4-26-1999, REG. NO. TMA533248, DATED 9-25-2000, EXPIRES 9-25-2015. SEC. 2(F).

**CLASS 16—PAPER GOODS AND PRINTED MATTER**

FOR MAGAZINES IN THE FIELD OF HOME DECORATING, HOUSE STYLES, HOME IMPROVEMENT, HOME MAINTENANCE, LANDSCAPING, AND GARDENING (U.S. CLS. 2, 5, 22, 23, 29, 37, 38 AND 50).  
FIRST USE 0-0-1986; IN COMMERCE 0-0-1986.

**CLASS 41—EDUCATION AND ENTERTAINMENT**

FOR ENTERTAINMENT IN THE NATURE OF AN ONGOING TELEVISION PROGRAM ON THE SUBJECT OF HOME DECORATING, HOUSE STYLES, HOME IMPROVEMENT, HOME MAINTENANCE, LANDSCAPING AND GARDENING (U.S. CLS. 100, 101 AND 107).

FIRST USE 9-0-1998; IN COMMERCE 9-0-1998.  
LINDA E. BLOHM, EXAMINING ATTORNEY

SN 75-776,613. YELLO STROM VERWALTUNGSGESSELLSCHAFT MBH, 76131 KARLSRUHE, FED REP GERMANY, FILED 8-16-1999.

**YELLO**

PRIORITY CLAIMED UNDER SEC. 44(D) ON FED REP GERMANY APPLICATION NO. 39910326.0, FILED 2-23-1999, REG. NO. 39910326, DATED 7-19-1999, EXPIRES 2-28-2009.  
OWNER OF U.S. REG. NO. 1,994,903.

**CLASS 7—MACHINERY**

FOR ELECTROMECHANICAL DEVICES FOR THE PREPARATION OF DRINKS, NAMELY BLENDERS FOR HOUSEHOLD AND RESTAURANT USE, AND NON-REFRIGERATED BEVERAGE PREPARATION AND DISPENSING MACHINES FOR HOT, COLD AND FROZEN BEVERAGES; ELECTRICAL FOOD PROCESSORS; POWER-OPERATED TOOLS, NAMELY, AUGERS, BEETLES, BLOWLAMPS, BLOWTORCHES, BURNISHERS, CHAINSAWS, CHISEL BITS FOR POWER-OPERATED TOOLS, DRILLS, EDGING SHEARS, ELECTRIC KNIVES, ELECTRIC KNIFE SHARPENERS, ENGRAVERS, POWER GRINDERS, HAMMER DRILLS, HEDGE CLIPPERS, MILLING CUTTERS, MACHINE-TOOL PAPER PERFORATORS, PLANES, RASPS, SANDERS, SAWS, SCRAPERS, SCREWDRIVERS, GAS-OPERATED SOLDERING IRONS, ROTARY HAMMER DRILLS, ELECTRIC SHEARS, RIVETING MACHINES, DRILL PRESSES, BAND SAWS, POWER PLANERS, SCROLL SAWS, MULTISPEED DRILLS, ELECTRIC RECIPROCATING SAWS, ELECTRIC HELICAL CUTTERS, ANGLE GRINDERS, ORTHOGENIC GRINDERS, FLEX SHAFT GRINDERS, MOULD GRINDERS, SHEET SANDERS, DISC SANDERS, BELT SANDERS, DISC POLISHERS, ELECTRIC SPANNERS, FIX TORQUE SPANNERS, ELECTRIC SCREWDRIVERS, ELECTRIC TAP SCREWDRIVERS, ELECTRIC FLOOR POLISHERS, ELECTRIC HEDGE TRIMMERS, ELECTRIC JIG SAWS, ROUTERS, WOOD BLADE GRINDERS, ELECTRIC CIRCULAR SAWS, ELECTRIC CARVING MACHINES; ELECTRIC GRINDING WHEELS; PNEUMATIC HAND TOOLS, NAMELY, AIR PICKAXES, AIR SHOVELS, AIR DRILLS, AIR SCALE BREAKERS, AIR CHIPPERS, AIR NAIL GUNS, AIR SPANNERS, AIR GRINDERS, AIR SCREWDRIVERS, AIR JIG SAWS, AIR POLISHERS, AIR BELT GRINDERS, AIR RIVETING MACHINES, ANGLE AIR GRINDERS, COMPRESSED AIR PUMPS, POWER-OPERATED ABRASIVE WHEELS; HEAT SINKS FOR USE IN MACHINES; EMISSION CONTROL EQUIPMENT, NAMELY, EMISSION REDUCTION UNITS FOR MOTORS AND ENGINES, NAMELY, CATALYTIC CONVERTERS, INDUSTRIAL ROBOTS (U.S. CLS. 13, 19, 21, 23, 31, 34 AND 35).

**CLASS 9—ELECTRICAL AND SCIENTIFIC APPARATUS**

FOR ELECTRIC SOLDERING IRONS; ELECTRIC ARC WELDERS; SOUND RECORDING EQUIPMENT, NAMELY AUDIO CASSETTE RECORDERS, AUDIO TAPE RECORDERS, AUDIO MIXERS, AUDIO SPEAKERS, DIGITAL AUDIO TAPE RECORDERS, CD RECORDERS, COMPUTER SOFTWARE TO CONTROL AND IMPROVE COMPUTER AND AUDIO EQUIPMENT SOUND QUALITY, BLANK INTEGRATED CIRCUIT CARDS FOR RECORDING, TRANSMITTING AND REPRODUCING SOUND AND IMAGES IN MOBILE TELEPHONE SERVICES, MICROPHONES, TELEPHONE ANSWERING MACHINES; ELECTRONIC EFFECT PEDALS FOR USE WITH SOUND AMPLIFIERS; ELECTRONIC SOUND PICKUP FOR GUITARS AND BASSES; ELECTRONIC TESTING EQUIPMENT, NAMELY, SOUND LEVEL METERS; STEREO TUNERS; PHOTO TELEGRAPHY EQUIPMENT, NAMELY CELLULAR PHONES WITH PHOTOTELEGRAPHIC ABILITY, FACSIMILE MACHINES, FIBER OPTIC CABLES, SLOW SCAN TV DEVICES, COMPUTER SOFTWARE FOR PHOTOTELEGRAPHIC PURPOSES; AUDIO AND VIDEO EQUIPMENT, NAMELY, PHOTOGRAPHIC CAMERAS, DIGITAL CAMERAS, MOTION PICTURE FILM CAMERAS, MOTION PICTURE DIGITAL CAMERAS, CAMCORDERS, VIDEO CAMERAS, SECURITY CAMERAS; OPTICAL FIBERS SOLD AS COMPONENT OF FIBER OPTIC CABLES; OPTICAL INSPECTION APPARATUS FOR INDUSTRIAL USE; OPTICAL FILTERS; OPTICAL LENSES; OPTICAL MIRRORS; OPTICAL SCANNERS; TELEVISIONS; TELEPHONES; REMOTE CONTROL EQUIPMENT FOR USE WITH TELEPHONES, RADIOS, TELEVISIONS, STEREOS, AUDIO TAPE RECORDERS AND PLAYERS, PHONOGRAPH RECORD PLAYERS, CD PLAYERS, DIGITAL AUDIO TAPE RECORDERS AND PLAYERS, VIDEO CASSETTE RECORDERS, DIGITAL VIDEO RECORDERS, DVD RECORDERS AND PLAYERS AND VIDEO CAMERAS, AND FOR USE WITH HEATING, VENTILATING AND AIR-CONDITIONING APPARATUS; EQUIPMENT, NAMELY, COMPUTER HARDWARE AND SOFTWARE FOR THE REMOTE CONTROL OF HOUSEHOLD AND GARDEN EQUIPMENT AND DEVICES; EQUIPMENT, NAMELY, COMPUTER HARDWARE AND SOFTWARE FOR THE REMOTE DIAGNOSIS OF MALFUNCTIONS, INCLUDING REMOTE DIAGNOSIS, FOR THE TRANSMISSION OF DATA RELATING TO SUCH MALFUNCTIONS AND FOR REMEDYING SUCH MALFUNCTIONS OF HOUSEHOLD AND GARDEN EQUIPMENT AND DEVICES; RADIO EQUIPMENT, NAMELY RADIO RECEIVERS, RADIO TELEPHONES, RADIO TRANSMITTERS, AND RADIOS INCORPORATING TELEPHONES; WIRELESS TELECOMMUNICATIONS EQUIPMENT, NAMELY TELEPHONES, TELEGRAPHS, SATELLITE NAVIGATIONAL SYSTEMS, NAMELY GPS, PERSONAL DIGITAL ASSISTANTS, ELECTRONIC ORGANIZERS AND AMATEUR RADIOS; MAGNETIC TAPE DRIVES FOR DATA PROCESSING; ELECTRICAL MEASURING EQUIPMENT, NAMELY AEROMETERS, ALTIMETERS, ALCOHOLMETERS, AMMETERS, APERTOMETERS, BAROMETERS, BATHROOM SCALES, DENSIMETERS, DENSITOMETERS, DOSIMETERS, DYNAMOMETERS, ERGOMETERS, GAS METERS, GASOMETERS, GAS SENSORS FOR MEASURING GAS CONCENTRATION LEVELS, HYDROMETERS, HYGROMETERS, KITCHEN SCALES, MICROMETERS, OHMMETERS, POLARIMETERS, PRESSURE GAUGES, PYROMETERS, SACCHAROMETERS, SALINOMETERS, SULPHITOMETERS, THERMOSTATS, THERMOMETERS NOT FOR MEDICAL USE, VARIOMETERS, VISCOSIMETERS, VOLTMETERS, WATER METERS; COMPUTER HARDWARE; MICROPROCESSORS; MICROCHIPS; SEMICONDUCTOR DEVICES; COMPUTER PERIPHERAL EQUIPMENT; COMPUTER FAX MODEM CARDS; COMPUTER MICE; ELECTRICAL WIRES; ELECTRIC CABLES; COMPUTER CABLES; BACKUP DRIVES FOR COMPUTERS; COMPUTER KEYBOARDS; COMPUTER MONITORS; COMPUTER PRINTERS; ETHERNET CABLES; EXTERNAL MODEMS MAGNETIC TAPE DRIVES TYPEFACE FONTS RECORDED ON MAGNETIC MEDIA; COMMUNICATIONS TECHNOLOGY PRODUCTS, NAMELY, COMMUNICATIONS SERVERS; CD-ROM DRIVES; COMPUTER TELEPHONY SOFTWARE, DVD MACHINES; PHOTOCOPYING MACHINES; ELECTROSTATIC COPYING MACHINES AND THERMAL COPYING MACHINES; CD PLAYERS; CASSETTE TAPE PLAYERS; PHONOGRAPH RECORD

PLAYERS; VIDEO TAPE RECORDERS, VIDEO CAMERAS; RADIO, TELEVISION AND ELECTRONIC TRANSMITTERS; VIDEO GAME SOFTWARE; VIDEO OUTPUT GAME MACHINES FOR USE WITH TELEVISIONS, VIDEO GAME ACCESSORIES, NAMELY, DISCS AND CARTRIDGES; VIDEO GAME JOYSTICKS; VIDEO GAME INTERACTIVE CONTROL FLOOR PADS AND MATS; VIDEO GAME DATA CARRIERS; VIDEO GAME INTERACTIVE REMOTE CONTROL UNITS; CURRENT CLOSERS; CURRENT STRENGTH METERS; CURRENT BREAKERS; CURRENT LOSS INDICATORS; CURRENT TRANSFORMERS; COMMUTATORS; ACETYLENE REGULATORS; POWER ATTENUATORS; CIRCUIT BOARDS; CIRCUIT BREAKERS; CONDUCTIVE FIBERS; TELEFAX MACHINES; TELECOPIERS; ELECTRICAL TEMPERATURE INDICATORS, NAMELY ELECTRICAL; DIGITAL THERMOMETERS NOT FOR MEDICAL USE; AUDIO AMPLIFIERS; SOUND REPRODUCTION EQUIPMENT, NAMELY AUDIO CASSETTE PLAYERS, AUDIO TAPE PLAYERS, AUDIO MIXERS, AUDIO SPEAKERS, CD PLAYERS, DIGITAL AUDIO TAPE PLAYERS, PHONOGRAPH RECORD PLAYERS; COMPUTER SOFTWARE TO CONTROL AND IMPROVE COMPUTER AND AUDIO EQUIPMENT SOUND QUALITY, BLANK INTEGRATED CIRCUIT CARDS FOR REPRODUCING SOUND IN MOBILE TELEPHONE SERVICES; TELEPHONIC TRANSMISSION EQUIPMENT, NAMELY TELEPHONE TRANSMITTERS, TELEPHONE WIRES, TELEPHONE RECEIVERS; MEASURING DEVICES AND INSTRUMENTS, NAMELY, LASERS FOR MEASURING PURPOSES AEROMETERS ALTIMETERS ALCOHOLMETERS, AMMETERS; APERTOMETERS, BAROMETERS, BATHROOM SCALES, BEVELS, CONTROLLED VOLUME PUMPS, DENSIMETERS, DENSITOMETERS, DOSIMETERS, DYNAMOMETERS, ELECTRICITY METERS, ELECTRICITY CONSUMPTION METERS, ERGOMETERS, FUEL PUMPS FOR SERVICE STATIONS, GAS DETECTORS FOR DETECTING THE PRESENCE OF GAS, GAS SENSORS FOR MEASURING GAS CONCENTRATION LEVELS, GAS METERS, GASOMETERS, HYDROMETERS, HYGROMETERS, KITCHEN SCALES, LASERS FOR MEASURING PURPOSES, MEASURING CUPS, MEASURING SPOONS, METERED GASOLINE PUMPS; MICROMETERS, OHMMETERS, POLARIMETERS, PRESSURE GAUGES AND PRESSURE THROUGHFLOW MEASURING INSTRUMENTS, PYROMETERS, RESIDUAL GAS ANALYZERS, SACCHAROMETERS, SALINOMETERS, SLIDE RULES, SULPHITOMETERS, TAPE RULERS, THEODOLITES, THERMOCOUPLES, THERMOSTATS, VARIOMETERS, VISCOSIMETERS, VOLTMETERS, ELECTRICITY SWITCHBOXES; ELECTRIC ACCUMULATORS, ELECTRIC CONVERTERS, ELECTRIC DISTRIBUTION BOXES; ELECTRIC SWITCHES; ELECTRIC MOTION SENSITIVE SWITCHES; ELECTRICAL CONDUCTORS; ELECTRICAL CONTROLLERS; ELECTRICAL DISTRIBUTION CONSOLES; ELECTRICAL TRANSFORMERS; ELECTRICITY CONDUITS; RHEOSTATS; GALVANOMETERS; POWER DISTRIBUTION EQUIPMENT, NAMELY, STATIC VOLTAGE REGULATORS; THYRISTORS; VOLTAGE REGULATORS FOR ELECTRIC POWER; VOLTAGE SURGE PROTECTORS; VOLTAGE SURGE SUPPRESSORS; VOLTMETERS; HEAT CONTROL EQUIPMENT, NAMELY AIR-CONDITIONERS FOR USE IN COMPUTERS AND FOR USE IN HEATING, COOLING AND VENTILATING APPARATUS; REFRIGERATED CIRCULATORS, HEATING CIRCULATORS, IMMERSION CIRCULATORS; ELECTRICAL METERS, ELECTRIC COUNTERS, NAMELY ADDING MACHINES; TIME RECORDING EQUIPMENT, NAMELY CHRONOGRAPHS FOR USE AS SPECIALIZED TIME RECORDING APPARATUS, FOOD TIMERS, MAGNETICALLY ENCODED TIME CARDS, TIME CLOCKS, SOFTWARE AND HARDWARE USED FOR SPECIALIZED TIME MEASUREMENT AND TIME RECORDING AND FOR CALCULATING TELEPHONE, ELECTRICITY, GAS, SOLAR AND WATER USAGE, USED FOR CALCULATING THE SPEED, THE ADVANCE AND THE SETTING OF MACHINE TOOLS; AND USED FOR COUNTING HOURS OF OPERATION, AND CHRONOGRAPHS FOR USE AS SPECIALIZED TIME RECORDING APPARATUS; MECHANICAL OR ELECTRIC EGG TIMERS; ELECTRICAL TIME SWITCHES, ELECTRICAL SIGNALING, CONTROL AND COUNTING EQUIPMENT, NAMELY PAGERS, LASER POINTERS, AND DIRECTIONAL SIGNALS USED FOR RAILWAY TRAFFIC, ACCESS CONTROL EQUIPMENT, NAMELY, ELECTRIC AND ELECTRONIC ALARM DEVICES AND SYSTEMS, PARTICULARLY

SECURITY ACCESS SYSTEMS, INFRARED PASS-KEY SYSTEMS, AND PERSONAL IDENTIFICATION DEVICES; CLIMATE CONTROL EQUIPMENT, NAMELY, HEAT EXCHANGERS, AND AIR CONDITIONERS; CIRCUIT CONTROL EQUIPMENT, NAMELY, CIRCUIT BREAKERS AND SWITCH BOXES, RELAYS, CONTACTS, AND DISTRIBUTION CABINETS; EMISSION CONTROL EQUIPMENT NAMELY, ELECTROSTATIC EMISSION CONTROL DEVICES, NAMELY, ELECTROSTATIC PRECIPITATORS FOR REDUCING PARTICULATE EMISSION IN INDUSTRIAL APPLICATIONS; ENERGY CONSUMPTION CONTROL EQUIPMENT, NAMELY, ELECTRIC RECORDING AND MEASURING EQUIPMENT FOR ELECTRICITY, GAS, SOLAR, AND WATER CONSUMPTION; METERING DEVICES FOR USE IN CONJUNCTION WITH ELECTRICITY, GAS, LIQUIDS, AND HEAT, ELECTRONIC LOAD INDICATORS; FIRE CONTROL EQUIPMENT, NAMELY FIRE TRUCKS, FIRE ALARMS, SMOKE ALARMS AND DETECTORS, MOTION CONTROL EQUIPMENT, NAMELY, ELECTRIC RECORDING AND MEASURING EQUIPMENT FOR VIBRATIONS, SEISMIC AND METEOROLOGICAL DATA, AND ELECTRICAL MOTION SENSORS; PEST CONTROL EQUIPMENT, NAMELY, ELECTRONIC DEVICES UTILIZING ULTRASONIC AND/OR ELECTROMAGNETIC TECHNOLOGY FOR PEST CONTROL; POLLUTION CONTROL EQUIPMENT, NAMELY, ELECTRIC RECORDING AND MEASURING EQUIPMENT FOR AIR, WATER AND SOIL POLLUTION, AND TREATMENT, DEVICES AND THEIR COMPONENTS FOR THE IDENTIFICATION AND LOCALIZATION OF LEAKS IN TANKS AND CONTAINERS HOLDING SOLID, LIQUID AND GASEOUS SUBSTANCES, LEAKAGE DETECTORS FOR USE IN POWER PLANTS, AND STATIC VOLTAGE REGULATORS, TEMPERATURE CONTROL EQUIPMENT, NAMELY, SOLAR COLLECTORS, TRAFFIC CONTROL EQUIPMENT, NAMELY, TRAFFIC LIGHTS, NEON SIGNS, ACTUATED AND PRE-TIMED ELECTRICAL CONTROLLERS, VEHICLE AND PEDESTRIAN SIGNALS, SYSTEM MASTER SWITCHES, TRAFFIC CONTROL EQUIPMENT COMPRISING DISPLAY MONITORS, COMPUTERS, AND SOFTWARE; AUTOMATED PAPER AND COIN MONEY SORTING MACHINES, AND COMPUTER SOFTWARE FOR USE IN COUNTING CURRENCY AND MAINTAINING INVENTORY INFORMATION RELATING TO SUCH CURRENCY DEPOSITED INTO GAMING, AMUSEMENT AND VENDING MACHINES, VEHICLE COUNTING HARD- AND SOFTWARE, NAMELY, COUNTING SYSTEMS COMPRISED OF COUNT PANELS, GROUND LOOPS, VEHICLE DETECTION DEVICES, PHOTO ELECTRIC SENSORS, AND PASSIVE INFRARED SENSORS FOR REGULATING VEHICLE AND TRAFFIC FLOW, PRODUCT AND MERCHANDISE COUNTING HARD AND VEHICLE LOCATING, TRACKING AND SECURITY SYSTEM COMPRISED OF AN ANTENNA AND RADIO TRANSMITTER TO BE PLACED IN A VEHICLE, TRANSMITTERS OF ELECTRONIC SIGNALS, SURVEYING APPARATUS AND INSTRUMENTS, NAMELY SURVEYING CHAINS, SURVEYORS LEVELS; ELECTRICAL EQUIPMENT FOR THE RECEIPT, RECORDING, TRANSMISSION, PROCESSING, OUTPUT AND REPRODUCTION OF DATA, LANGUAGE, TEXT, SIGNALS, SOUND AND PICTURES, NAMELY BLANK MAGNETIC DATA CARRIERS, BLANK TAPES FOR STORAGE OF COMPUTER DATA, COMPUTER SOFTWARE TO AUTOMATE DATA WAREHOUSING DATA COMPRESSION SOFTWARE DATA PROCESSORS, SIGNAL PROCESSORS, MOBILE DATA RECEIVERS, PRERECORDED MAGNETIC DATA CARRIERS FEATURING COMPUTER COMMUNICATIONS SOFTWARE FOR CONNECTING COMPUTER NETWORK USERS AND GLOBAL COMPUTER NETWORKS, COMPUTER COMMUNICATIONS SOFTWARE TO ALLOW CUSTOMERS TO ACCESS UTILITY RECORDS AND ACCOUNT INFORMATION AS WELL AS BANK ACCOUNT INFORMATION AND TO TRANSACT BANK BUSINESS, ELECTRICAL CIRCUITS FOR USE IN AMUSEMENT GAME MACHINES FOR REPRODUCING MUSIC, SPEECH AND SPECIAL EFFECTS, COMPUTER SOFTWARE TO ENHANCE THE AUDIO-VISUAL CAPABILITIES OF MULTIMEDIA APPLICATIONS, NAMELY; FOR THE INTEGRATION OF TEXT; AUDIO, GRAPHICS; STILL IMAGES AND MOVING PICTURES; DATA PROCESSING EQUIPMENT AND COMPUTERS; COMPUTER SOFTWARE, NAMELY, GENERAL DATABASE MANAGEMENT SOFTWARE; DATABASE MANAGEMENT SOFTWARE FOR USE BY FINANCIAL ADVISORS AND ENERGY, ENVIRONMENT AND

WASTE MANAGEMENT CONSULTANTS; COMPUTER SOFTWARE FOR APPLICATION AND DATABASE INTEGRATION; SPREADSHEET SOFTWARE FOR USE BY BUDGET ANALYSTS AND ENERGY, ENVIRONMENT OR WASTE MANAGEMENT CONSULTANTS; COMPUTER SOFTWARE USED TO BACKUP OR ARCHIVE DATA STORED ON LOCAL DISC DRIVES; COMPUTER SOFTWARE USED TO CONNECT VARIOUS COMPUTERS INTO A COMPUTER NETWORK; NETWORK MANAGEMENT COMPUTER SOFTWARE; COMPUTER SOFTWARE FOR DOMESTIC ENERGY MANAGEMENT AND ENVIRONMENTAL CONTROL, NAMELY, ELECTRIC RECORDING, MEASURING AND CONTROL EQUIPMENT FOR ELECTRICITY, GAS, WATER AND SOLAR CONSUMPTION; COMPUTER SOFTWARE FOR DOMESTIC AND HOUSEHOLD FUNCTIONS, NAMELY, COMPUTER SOFTWARE TO CONTROL THERMOSTATS, AIR CONDITIONING AND HEATING UNITS, FURNACES LIGHT SWITCHES GARAGE DOOR OPENERS HOUSEHOLD AND KITCHEN APPLIANCES, WATER HEATERS, WASTE WATER PURIFICATION UNITS, VAPORIZERS, HUMIDIFIERS, DEHUMIDIFIERS, IRRIGATION SPRINKLERS, AIR CLEANERS, AIR PURIFICATION UNITS, ELECTRIC FANS, FILTERS FOR AIR CONDITIONERS AND FURNACES, BARBECUE GRILLS, FIREPLACES, SPAS IN THE NATURE OF HEATED POOLS, POOLS, AND SAUNAS; COMPUTER SOFTWARE AND COMPUTER HARDWARE FOR THE ELECTRONIC COMMUNICATION BETWEEN HOUSEHOLDS AND ENERGY SUPPLIERS AS TO QUANTITY, AND TIME OF ELECTRICITY, GAS, WATER AND SOLAR CONSUMPTION AS WELL AS WITH RESPECT TO MALFUNCTIONS AND DEFECTS REGARDING ELECTRICITY, GAS, WATER AND SOLAR INSTALLATIONS; FACILITIES MANAGEMENT SOFTWARE, NAMELY, SOFTWARE TO CONTROL ENVIRONMENTAL, ACCESS AND SECURITY SYSTEMS RELATED TO BUILDINGS; LIGHTING EQUIPMENT AND SYSTEMS, NAMELY ELECTRIC LIGHT DIMMERS, ELECTRIC LIGHT SWITCHES, FIBER OPTIC LIGHT AND IMAGE CONDUITS, LIGHTING BALLAST, MOTION SENSITIVE SECURITY LIGHTS; HELMET SAFETY LIGHTS; HEAVY CURRENT ENGINEERING EQUIPMENT, NAMELY ELECTRICAL CONDUITS AND CABLES, ELECTRICAL SLIDING WIRES AND CABLES, ELECTRIC CONNECTORS, ELECTRIC SLIP RINGS, ELECTRIC DISTRIBUTORS NOT FOR VEHICLES, ELECTRIC CURRENT COLLECTORS FOR SLIDING WIRES AND CABLES, CONTROL STATIONS COMPRISING ELECTRICAL APPARATUS AND SWITCHBOARDS FOR OPERATING, CONTROLLING AND HEIGHT ADJUSTING HEAVY CURRENT ENGINEERING EQUIPMENT, TEMPERATURE CONTROLLERS, ELECTRICAL HEATING WIRES AND CABLES AND PARTS THEREFORE, FOR USE IN THE FIELDS OF CONDUCTION, TRANSFORMATION, STORAGE, REGULATION AND CONTROL; APPARATUS AND INSTRUMENTS FOR LIGHT CURRENT ENGINEERING, NAMELY REGULATORS, CABLES, JUNCTION BOXES, TELEGRAPH WIRES FOR COMMUNICATION ENGINEERING, HIGH-FREQUENCY ENGINEERING AND AUTOMATIC CONTROL ENGINEERING IN THE FIELDS OF TELECOMMUNICATIONS, HIGH FREQUENCY AND REGULATION; BATHROOM SCALES, KITCHEN SCALES; ELECTRICITY METERS; ELECTRICITY CONSUMPTION METERS; HOUSEHOLD AND BUSINESS ALARM SYSTEMS; AUTOMATED SECURITY GATES AND CONTROLLERS, PERSONAL SECURITY ALARMS, ELECTRONIC LOCKS, ELECTRONICALLY OPERATED HIGH SECURITY LOCK CYLINDERS; PHONOGRAPH RECORD PLAYERS, LOUDSPEAKERS, VIDEO MONITORS, FILM PROJECTORS, SLIDE PROJECTORS, VIDEO CASSETTE RECORDERS, DIGITAL VIDEO RECORDERS, DVD RECORDERS AND PLAYERS, FILMS, NAMELY, CINEMATOGRAPHER FILMS, DOUBLE-EIGHT FILMS AND CASSETTES, BLANK VIDEO CASSETTES, BLANK VIDEOTAPES AND VIDEO PLATES, BLANK AUDIO CASSETTES, BLANK AUDIO COMPACT DISCS, BLANK VIDEO COMPACT DISCS, BLANK DDS, BLANK LASER DISCS AND BLANK INTERACTIVE MULTIMEDIA COMPACT DISCS, BLANK MAGNETIC DATA CARRIERS; PRERECORDED DATA CARRIERS WITH COMPUTER PROGRAMS FOR USE IN ACCOUNTING, IN CUSTOMER SERVICES, IN THE OPERATION OF ENERGY PRODUCTION AND DISTRIBUTION FACILITIES, AS WELL AS PROGRAMS FOR USE IN TELECOMMUNICATIONS, PROGRAMS FOR USE IN DATABASE MANAGEMENT AND PROGRAMS FOR THE COLLECTION, EDITING, ORGANIZ-



ING, MODIFYING, TRANSMISSION, STORAGE AND SHARING OF DATA AND INFORMATION; DATA PROCESSORS; BLANK DISKETTES, BLANK INTEGRATED CIRCUIT CARDS, BLANK TAPES FOR STORAGE OF COMPUTER DATA; PRERECORDED COMPACT DISCS, DVD'S AUDIO TAPES AND DISCS AND VIDEO TAPES AND DISCS AND INTERACTIVE MULTIMEDIA COMPACT DISCS, FEATURING TEXT, SOUND AND IMAGES RELATING TO AND FEATURING SPORTS AS WELL AS CULTURAL, HISTORICAL, SCIENTIFIC, TECHNOLOGICAL, LIFESTYLE AND SOCIAL ISSUES AND INFORMATION AND CURRENT EVENTS, POLITICS, ECONOMICS, THE MEDIA, FASHION AND TRAVEL; VENDING MACHINES AND PARTS AND FITTINGS FOR COIN-OPERATED VENDING MACHINES; CASH REGISTERS, CALCULATORS; FIRE EXTINGUISHERS (U.S. CLS. 21, 23, 26, 36 AND 38).

#### **CLASS 11—ENVIRONMENTAL CONTROL APPARATUS**

FOR LIGHTING EQUIPMENT, NAMELY, ELECTRIC LIGHTING FIXTURES, LIGHT BULBS, ELECTRIC LIGHT TUBES, FLUORESCENT ELECTRIC LIGHTING TUBES, LAMPS AND LIGHT BULBS, ELECTRIC TRACK LIGHTING UNITS, FLASHLIGHTS, FLARES, FLOODLIGHTS, INFRARED LAMPS AND LIGHTING FIXTURES, LAMPS, LIGHT DIFFUSERS, LIGHT REFLECTORS; HEATING EQUIPMENT, NAMELY, ELECTRIC AND STEAM RADIATORS FOR HEATING BUILDINGS, SOLAR HEATING PANELS, ELECTRICALLY OR CHEMICALLY ACTIVATED HEATING PADS AND CUSHIONS NOT FOR MEDICAL PURPOSES, HEAT SINKS FOR USE IN HEATING, COOLING AND VENTILATING APPARATUS; COOKING EQUIPMENT, NAMELY, MICROWAVE OVENS FOR COOKING, COMMERCIAL AND DOMESTIC COOKING OVENS AND COMMERCIAL AND DOMESTIC COOKING GAS OVENS AND COMMERCIAL AND DOMESTIC COOKING STOVES; ELECTRIC PRESSURE COOKERS; REFRIGERATING EQUIPMENT, NAMELY, REFRIGERATED SHIPPING CONTAINERS, REFRIGERATORS; DRYING EQUIPMENT, NAMELY, CLOTHES DRYERS, ELECTRIC HOT AIR HAND DRYERS, HAND HELD ELECTRIC HAIR DRYERS, STATIONARY HAIR DRYERS FOR COMMERCIAL AND DOMESTIC USE; VENTILATING EQUIPMENT, NAMELY, VENTILATING FANS FOR COMMERCIAL, INDUSTRIAL AND DOMESTIC USE, VENTILATING LOUVERS; AIR CONDITIONING UNITS FOR DOMESTIC USE; ELECTRICAL CABINETS USED TO CONTROL TEMPERATURE AND HUMIDITY FOR HEATING AND PROOFING FOOD GOODS; CHILLERS, NAMELY, WALK-IN COOLERS AND WATER COOLERS; HEAT EXCHANGERS; PUMPS FOR REFRIGERATION, ELECTRIC ROASTERS, DEEP FRYERS, AND NON-ELECTRIC GRIDDLES, BATH TUBS, HEAT PUMPS, AND THERMOSTATIC VALVES FOR HEATING INSTALLATIONS, WATER PURIFICATION UNITS, HEAT REGISTERS (U.S. CLS. 13, 21, 23, 31 AND 34).

#### **CLASS 12—VEHICLES**

FOR ANTI-THEFT ALARMS FOR VEHICLES; VEHICLE PERFORMANCE WARNING ALARM SYSTEMS, TURN SIGNALS FOR VEHICLES (U.S. CLS. 19, 21, 23, 31, 35 AND 44).

#### **CLASS 21—HOUSEWARES AND GLASS**

FOR COOKING EQUIPMENT, NAMELY, POTS AND METAL PANS; NON-ELECTRIC ROASTERS, AND GRIDDLES (U.S. CLS. 2, 13, 23, 29, 30, 33, 40 AND 50).

#### **CLASS 28—TOYS AND SPORTING GOODS**

FOR STAND ALONE VIDEO GAME MACHINES (U.S. CLS. 22, 23, 38 AND 50).

#### **CLASS 35—ADVERTISING AND BUSINESS**

FOR BUSINESS MANAGEMENT; ENERGY USAGE MANAGEMENT (U.S. CLS. 100, 101 AND 102).

#### **CLASS 39—TRANSPORTATION AND STORAGE**

FOR PUBLIC UTILITY SERVICES, NAMELY, DISTRIBUTION OF ELECTRICITY, HEAT, WATER, NATURAL AND PROPANE GAS TO INDUSTRIAL CUSTOMERS; PUBLIC UTILITY SERVICES NAMELY THE TRANSMISSION OF ELECTRICITY, HEAT, NATURAL AND PROPANE GAS TO INDUSTRIAL CUSTOMERS; CONSULTATION REGARDING PUBLIC UTILITY SERVICES (U.S. CLS. 100 AND 105).

#### **CLASS 42—SCIENTIFIC, COMPUTER AND LEGAL SERVICES**

FOR TECHNICAL CONSULTATION IN THE FIELD OF ENERGY AND ENERGY USAGE MANAGEMENT AND ORGANIZATION; TECHNICAL ADVICE REGARDING POWER GENERATION AND DISTRIBUTION PLANTS; TECHNICAL AND ECOLOGICAL CONSULTANCY SERVICES IN THE FIELD OF ENERGY (U.S. CLS. 100 AND 101).

DORITT L. CARROLL, EXAMINING ATTORNEY

SN 75-808,223. PROLYSIS LIMITED, OXFORDSHIRE OX5 1PF, UNITED KINGDOM, FILED 9-27-1999.

## **PROLYSIS**

OWNER OF UNITED KINGDOM REG. NO. 2206293, DATED 4-28-2000, EXPIRES 8-18-2009.

#### **CLASS 1—CHEMICALS**

FOR CHEMICALS AND BIOCHEMICALS FOR USE IN ANTI-BACTERIAL SCREENING AND TESTING; DIAGNOSTIC PREPARATIONS FOR SCIENTIFIC RESEARCH; ASSAY KITS COMPRISED OF REAGENTS FOR SCIENTIFIC USE (U.S. CLS. 1, 5, 6, 10, 26 AND 46).

#### **CLASS 5—PHARMACEUTICALS**

FOR CHEMICALS AND BIOCHEMICALS FOR USE AS ANTI-BACTERIAL AGENTS (U.S. CLS. 6, 18, 44, 46, 51 AND 52).

#### **CLASS 35—ADVERTISING AND BUSINESS**

FOR BUSINESS MANAGEMENT SERVICES, NAMELY, PROJECT MANAGEMENT; BUSINESS AND MANAGEMENT CONSULTANCY (U.S. CLS. 100, 101 AND 102).

#### **CLASS 42—SCIENTIFIC, COMPUTER AND LEGAL SERVICES**

FOR INFORMATION IN THE FIELDS OF THE CHEMICAL, PHARMACEUTICAL AND BIOTECHNICAL INDUSTRIES; CONSULTANCY AND ADVISORY SERVICES IN THE FIELDS OF THE CHEMICAL, PHARMACEUTICAL AND BIOTECHNICAL INDUSTRIES; RESEARCH LABORATORY SERVICES IN THE FIELD OF CHEMISTRY AND BIOCHEMISTRY; ASSAY SERVICES, NAMELY ANTIBACTERIAL AGENT ASSAYING; ANTI-BIOTIC ANALYSIS; DESIGN, RESEARCH AND DEVELOPMENT FOR OTHERS OF PHARMACEUTICAL PRODUCTS (U.S. CLS. 100 AND 101).

LINDA ESTRADA, EXAMINING ATTORNEY

SN 75-977,258. WHOLE FOODS MARKET IP, L.P., AUSTIN, TX. FILED 5-2-1997.



OWNER OF U.S. REG. NOS. 1,557,320 AND 1,961,586. NO CLAIM IS MADE TO THE EXCLUSIVE RIGHT TO USE "FOODS MARKET", APART FROM THE MARK AS SHOWN.

SEC. 2(F) AS TO "WHOLE FOODS MARKET".

#### CLASS 5—PHARMACEUTICALS

FOR BABY FOOD, ALL FREE OF ARTIFICIAL INGREDIENTS AND PRESERVATIVES (U.S. CLS. 6, 18, 44, 46, 51 AND 52).

#### CLASS 29—MEATS AND PROCESSED FOODS

FOR FROZEN BOXED DINNERS CONSISTING PRIMARILY OF MEAT, FISH, POULTRY OR VEGETABLES, SOUPS, FRUIT SAUCES, POTATO AND FRUIT-BASED CHIPS, FROZEN FRUITS, PROCESSED TOMATOES, TOMATO SAUCE AND PASTE, CHILI, FROZEN POTATO DISHES, PROCESSED BEANS, BEAN DIP, DRIED FRUIT, PROCESSED NUTS, TRAIL SNACK MIX CONSISTING PRIMARILY OF PROCESSED FRUITS, PROCESSED NUTS AND/OR RAISINS, NUT BUTTERS, JAMS, MARMALADE, FRUIT SPREADS, OLIVE OIL, COOKING OIL, MARGARINE, CANNED TUNA, MILK, HALF AND HALF, CREAM CHEESE, CHEESES, SOY-BASED AND RICE-BASED FOOD BEVERAGES USED AS A MILK SUBSTITUTE, CHEESE, YOGURT, PROCESSED VEGETABLES AND PROCESSED FRUITS, ALL FREE OF ARTIFICIAL INGREDIENTS AND PRESERVATIVES (U.S. CL. 46).

#### CLASS 30—STAPLE FOODS

FOR PROCESSED CEREALS, PROCESSED GRAINS, PASTA, MACARONI AND CHEESE, GRANOLA, READY TO EAT CEREAL-BASED FOOD BAR, RICE-BASED FOOD BARS, WHEAT-BASED FOOD BARS, PROCESSED POPCORN, CORN-BASED CHIPS, FLOUR-BASED CHIPS, CHEESE FLAVORED PUFFED CORN SNACKS, CONFECTIONERY CHIPS FOR BAKING, PRETZELS, CRACKERS, SALAD DRESSING, MAYONNAISE, KETCHUP, MUSTARD, RELISH, HOT SAUCE, SPICES, NATURAL SWEETENERS, HONEY, EXTRACTS USED AS FLAVORING, COFFEE, PASTA SAUCE, MARINADES, CHOCOLATE SYRUP, CHOCOLATE CHIPS, BARBECUE SAUCES, VINEGAR, CHEESE SAUCE, SALSA, PIZZA, CEREAL-BASED SNACK FOODS, RICE-BASED SNACK FOODS, WHEAT-BASED SNACK FOODS, WHOLE GRAIN AND DRY FRUIT BAR, CANDY, FROZEN YOGURT, FROZEN FRUIT BARS, ICE CREAM, SORBET, COOKIES, FROZEN BOXED DINNERS CONSISTING PRIMARILY OF PASTA OR RICE, WAFFLES AND PROCESSED HERBS, ALL FREE OF ARTIFICIAL INGREDIENTS AND PRESERVATIVES (U.S. CL. 46).

#### CLASS 31—NATURAL AGRICULTURAL PRODUCTS

FOR UNPROCESSED CEREALS, UNPROCESSED POPCORN, UNPROCESSED FRUIT, UNPROCESSED VEGETABLES, UNPROCESSED HERBS, UNPROCESSED BEANS AND RICE, UNPROCESSED GRAINS FOR EATING, AND PET FOOD, ALL FREE OF ARTIFICIAL INGREDIENTS AND PRESERVATIVES, AND PESTICIDES (U.S. CLS. 1 AND 46).

#### CLASS 32—LIGHT BEVERAGES

FOR FRESH AND CONCENTRATED FRUIT JUICES, FRESH AND CONCENTRATED VEGETABLE JUICES, FRESH AND CONCENTRATED FRUIT AND VEGETABLE JUICE COMBINATIONS, SOFT DRINKS, SPORTS DRINKS, ALOE VERA DRINKS, SPARKLING WATER, AND BOTTLE DRINKING WATER, ALL FREE OF ARTIFICIAL INGREDIENTS AND PRESERVATIVES (U.S. CLS. 45, 46 AND 48).

JOHN DALIER, EXAMINING ATTORNEY

SN 75-982,109. NORDEA BANK FINLAND ABP, HELSINKI, FINLAND, FILED 2-12-2001.

## SOLO

PRIORITY CLAIMED UNDER SEC. 44(D) ON FINLAND APPLICATION NO. T200002609, FILED 8-16-2000, REG. NO. 223447, DATED 4-15-2002, EXPIRES 4-15-2012.

OWNER OF U.S. REG. NO. 2,252,393.

#### CLASS 35—ADVERTISING AND BUSINESS

FOR TRADE FINANCE SERVICES, NAMELY, PROVIDING FOREIGN TRADE INFORMATION FOR CORPORATE CUSTOMERS AVAILABLE VIA A GLOBAL COMPUTER NETWORK; BUSINESS MANAGEMENT CONSULTATION; BUSINESS RESEARCH; MARKET RESEARCH; PROVIDING BUSINESS STATISTICAL INFORMATION; MANAGEMENT CONSULTING SERVICES IN THE FIELD OF ELECTRONIC COMMERCE (U.S. CLS. 100, 101 AND 102).

#### CLASS 36—INSURANCE AND FINANCIAL

FOR CASH MANAGEMENT FOR CORPORATE CUSTOMERS AVAILABLE VIA A GLOBAL COMPUTER NETWORK; BANKING; ELECTRONIC BANKING SERVICES VIA A GLOBAL COMPUTER NETWORK; PC BANKING; AUTOMATED TELEPHONE BANKING, NAMELY, PROVIDING BANK ACCOUNT INFORMATION BY TELEPHONE; ELECTRONIC FILE TRANSFER, NAMELY ELECTRONIC FUNDS TRANSACTIONS AND ELECTRONIC DEBIT TRANSACTIONS; FINANCIAL ANALYSIS AND CONSULTATION IN THE NATURE OF RATES OF EXCHANGE; FINANCIAL INFORMATION PROVIDED BY ELECTRONIC MEANS; FINANCIAL MANAGEMENT; FINANCIAL PLANNING; FINANCIAL PORTFOLIO MANAGEMENT; FINANCIAL RESEARCH; FINANCIAL SERVICES IN THE NATURE OF AN INVESTMENT SECURITY; FINANCIAL GUARANTEE AND SURETY SERVICES (U.S. CLS. 100, 101 AND 102).

#### CLASS 38—COMMUNICATION

FOR TELECOMMUNICATION GATEWAY SERVICES, NAMELY PROVIDING A TELECOMMUNICATIONS CONNECTION BETWEEN FINANCIAL INSTITUTIONS AND BANKING CUSTOMERS VIA A GLOBAL ELECTRONIC NETWORK (U.S. CLS. 100, 101 AND 104).

ALEXANDER L. POWERS, EXAMINING ATTORNEY

SN 76-007,970. MAX-PLANCK-GESELLSCHAFT, 14476 GOLM, FED REP GERMANY, FILED 3-23-2000.

## CACTUS COMPUTATIONAL TOOLKIT

PRIORITY CLAIMED UNDER SEC. 44(D) ON ERPN CMNTY TM OFC APPLICATION NO. 1522317, FILED 2-23-2000, REG. NO. 1522317, DATED 6-29-2001, EXPIRES 2-23-2010.

OWNER OF U.S. REG. NO. 2,105,834.

NO CLAIM IS MADE TO THE EXCLUSIVE RIGHT TO USE "COMPUTATIONAL TOOLKIT", APART FROM THE MARK AS SHOWN.

### CLASS 9—ELECTRICAL AND SCIENTIFIC APPARATUS

FOR COMPUTER SOFTWARE SOLD ONLY TO SOFTWARE DEVELOPERS FOR USE IN BUILDING APPLICATION SOFTWARE IN THE FIELD OF NATURAL SCIENCES (U.S. CLS. 21, 23, 26, 36 AND 38).

### CLASS 16—PAPER GOODS AND PRINTED MATTER

FOR COMPUTER SOFTWARE HANDBOOKS AND MANUALS (U.S. CLS. 2, 5, 22, 23, 29, 37, 38 AND 50).

### CLASS 42—SCIENTIFIC, COMPUTER AND LEGAL SERVICES

FOR COMPUTER SOFTWARE DESIGN AND DEVELOPMENT FOR OTHERS, PROVIDING TEMPORARY USE OF ON-LINE NON-DOWNLOADABLE SOFTWARE FOR PARALLEL COMPUTATION FOR SCIENTIFIC APPLICATIONS (U.S. CLS. 100 AND 101).

ESTHER BELENKER, EXAMINING ATTORNEY

SN 76-050,666. HANDELSBANKEN VARUMARKES AB, STOCKHOLM, SWEDEN, FILED 5-17-2000.



OWNER OF ERPN CMNTY TM OFC REG. NO. 001299445, DATED 3-19-2001, EXPIRES 9-6-2009.

THE STIPLING SHOWN IN THE DRAWING INTENDED TO INDICATE SHADING.

THE MARK CONSISTS OF HUMAN FIGURES INSIDE THREE SQUARES.

### CLASS 36—INSURANCE AND FINANCIAL

FOR INSURANCE SERVICES, NAMELY, INSURANCE BROKERAGE, INSURANCE ADMINISTRATION, INSURANCE UNDERWRITING IN THE FIELD OF PENSION INSURANCE, LIFE INSURANCE AND HEALTH INSURANCE, FINANCIAL SERVICES NAMELY FINANCIAL MANAGEMENT, FINANCIAL PLANNING, FINANCIAL INVESTMENT IN THE FIELD OF PENSION FUNDS AND SECURITIES (U.S. CLS. 100, 101 AND 102).

### CLASS 41—EDUCATION AND ENTERTAINMENT

FOR CONDUCTING SEMINARS AND WORKSHOPS ON INSURANCE, FINANCIAL AND LEGAL MATTERS (U.S. CLS. 100, 101 AND 107).

### CLASS 42—SCIENTIFIC, COMPUTER AND LEGAL SERVICES

FOR LEGAL SERVICES; LEGAL INSURANCE CONSULTATION (U.S. CLS. 100 AND 101).

ESTHER BELENKER, EXAMINING ATTORNEY

SN 76-066,625. PALM, INC., SANTA CLARA, CA. FILED 6-9-2000.

## THINAIR SERVER

NO CLAIM IS MADE TO THE EXCLUSIVE RIGHT TO USE "SERVER", APART FROM THE MARK AS SHOWN.

### CLASS 9—ELECTRICAL AND SCIENTIFIC APPARATUS

FOR COMPUTER SOFTWARE, NAMELY A MIDDLEWARE PLATFORM THAT PERMITS THE REAL-TIME EXCHANGE OF DATA BETWEEN WIRELESS COMMUNICATION DEVICES AND DATA SOURCES (U.S. CLS. 21, 23, 26, 36 AND 38).

FIRST USE 12-1-1999; IN COMMERCE 12-1-1999.

### CLASS 35—ADVERTISING AND BUSINESS

FOR ELECTRONIC RETAILING OF COMPUTER SOFTWARE, MIDDLEWARE AND SERVERS OVER A GLOBAL COMPUTER NETWORK THAT ENABLE THE REAL-TIME EXCHANGE OF DATA BETWEEN WIRELESS COMMUNICATION DEVICES AND DATA SOURCES; AND LICENSING OF SOFTWARE, MIDDLEWARE AND SERVERS THAT ENABLE THE REAL-TIME EXCHANGE OF DATA BETWEEN WIRELESS COMMUNICATION DEVICES AND DATA SOURCES (U.S. CLS. 100, 101 AND 102).

FIRST USE 9-8-1999; IN COMMERCE 9-8-1999.

### CLASS 42—SCIENTIFIC, COMPUTER AND LEGAL SERVICES

FOR COMPUTER SERVICES, NAMELY, DEVELOPMENT, MODIFICATION, INSTALLATION OF SOFTWARE, MIDDLEWARE THAT ENABLES THE REAL-TIME EXCHANGE OF DATA BETWEEN WIRELESS COMMUNICATION DEVICES AND DATA SOURCES; AND TECHNICAL SUPPORT FOR SOFTWARE THAT ENABLES THE REAL-TIME EXCHANGE OF DATA BETWEEN WIRELESS COMMUNICATION DEVICES AND DATA SOURCES (U.S. CLS. 100 AND 101).

FIRST USE 12-1-1999; IN COMMERCE 12-1-1999.

VIVIAN MICZNIK FIRST, EXAMINING ATTORNEY

SN 76-091,773. CASHFAC LIMITED, LONDON, ENGLAND, FILED 7-17-2000.

## CASHFAC

PRIORITY CLAIMED UNDER SEC. 44(D) ON ERPN CMNTY TM OFC APPLICATION NO. 16785802, FILED 5-26-2000, REG. NO. 001678580, DATED 7-4-2001, EXPIRES 5-26-2010.

**CLASS 9—ELECTRICAL AND SCIENTIFIC APPARATUS**

FOR BLANK COMPACT DISCS FOR RECORDING; AUTOMATIC VENDING MACHINES, FIRE EXTINGUISHERS; CASH REGISTERS, CALCULATORS, COMPUTERS AND COMPUTER SOFTWARE, NAMELY, SOFTWARE FOR FACILITATING FINANCIAL TRANSACTIONS IN THE FIELD OF ACCOUNTING AND BANKING, SOFTWARE FOR FACILITATING ELECTRONIC FINANCIAL SETTLEMENTS, SOFTWARE FOR MANAGING LIQUIDITY, SOFTWARE FOR PROCESSING BANKING TRANSACTIONS, SOFTWARE FOR MONITORING COMPLIANCE FOR THE FINANCIAL INDUSTRY, SOFTWARE FOR MANAGING BANK ACCOUNTS, SEARCH ENGINE SOFTWARE, SOFTWARE FOR FACILITATING SECURE BUSINESS TO BUSINESS FUNDS TRANSFERS, SOFTWARE FOR CONNECTING BETWEEN COMPUTER DATABASES AND THE INTERACTION BETWEEN MARKETING, PRODUCTION AND ACCOUNTING DATABASES, AND SOFTWARE MANUALS AND INSTRUCTIONAL AND MAINTENANCE MANUALS IN ELECTRONIC FORMAT SOLD THEREWITH AS A UNIT (U.S. CLS. 21, 23, 26, 36 AND 38).

**CLASS 16—PAPER GOODS AND PRINTED MATTER**

FOR PAPER, CARDBOARD AND GOODS MADE FROM THESE MATERIALS, NOT INCLUDED IN OTHER CLASSES, NAMELY PRINTED COMPUTER MANUALS, A SERIES OF HANDBOOKS IN THE FIELD OF FINANCE AND ONLINE FINANCIAL TRANSACTIONS, TEACHING AND INSTRUCTIONAL MATERIALS, NAMELY, A SERIES OF BROCHURES AND NEWSLETTERS IN THE FIELD OF FINANCE AND ONLINE FINANCIAL TRANSACTIONS, BOOKBINDING MATERIAL, NAMELY, BOOKBINDING TAPE AND WIRE; MOUNTED AND UNMOUNTED PHOTOGRAPHS; STATIONERY; ADHESIVES FOR STATIONERY OR HOUSEHOLD PURPOSES—ARTISTS' MATERIALS, NAMELY, PAINT BRUSHES; TYPEWRITERS, INSTRUCTIONAL AND TEACHING MATERIALS, NAMELY, WORKBOOKS DIRECTED TO PENSION ACCOUNTS, LAW, FLEXIBLE CAR PLANS, SHARE SAVINGS, NICHE BANKING, FLEXIBLE BENEFITS ACCOUNTS, TRUST ACCOUNTS; AND PLAYING CARDS (U.S. CLS. 2, 5, 22, 23, 29, 37, 38 AND 50).

**CLASS 35—ADVERTISING AND BUSINESS**

FOR ADVERTISING FOR OTHERS, NAMELY, DIRECT MAIL AND INTERNET ADVERTISING FOR OTHERS; BUSINESS MANAGEMENT CONSULTATION FOR SPECIALIST TECHNOLOGY SERVICES, ACCOUNTING SERVICES FOR CASH PROCESSING (U.S. CLS. 100, 101 AND 102).

**CLASS 36—INSURANCE AND FINANCIAL**

FOR LIFE, FIRE, PROPERTY, ACCIDENT, ANNUITY, AUTOMOBILE, CASUALTY, BUSINESS, DISABILITY AND TERM INSURANCE UNDERWRITING, COMPUTERIZED ELECTRONIC BANKING SERVICES; NAMELY, MONEY TRANSFER SERVICES; DIRECT BANKING PROCESS SERVICES; BUSINESS TO BUSINESS CASH SETTLEMENT SERVICES; BILL PAYMENT SERVICES AND BANKING ACCOUNT MANAGEMENT SERVICES; PROVISION OF INFORMATION RELATING TO BANKING ACCOUNTS; PROVISION OF STATEMENTS OF BANKING ACCOUNTS; REAL ESTATE MANAGEMENT SERVICES AND CHARITABLE FUND RAISING; SPONSORING COMMUNITY FESTIVALS FEATURING A VARIETY OF ACTIVITIES, NAMELY SPORTING EVENTS, LIVE MUSICAL PERFORMANCES, ART EXHIBITIONS, FLEA MARKETS, ETHNIC DANCES AND THE LIKES (U.S. CLS. 100, 101 AND 102).

**CLASS 38—COMMUNICATION**

FOR TELECOMMUNICATION SERVICES, NAMELY, PERSONAL COMMUNICATION SERVICES; ELECTRONIC TRANSMISSION OF DATA AND DOCUMENTS VIA COMPUTER TERMINALS (U.S. CLS. 100, 101 AND 104).

**CLASS 41—EDUCATION AND ENTERTAINMENT**

FOR COMPUTER SOFTWARE EDUCATION TRAINING SERVICES; ARRANGING AND CONDUCTING SEMINARS AND WORKSHOPS IN THE FIELD OF COMPUTER PROGRAMMING AND FINANCIAL TRANSACTIONS (U.S. CLS. 100, 101 AND 107).

**CLASS 42—SCIENTIFIC, COMPUTER AND LEGAL SERVICES**

FOR PROVIDING ON LINE INFORMATION IN THE FIELD OF COMPUTER PROGRAMMING, MAINTENANCE, INSTALLATION AND UPDATING OF COMPUTER PROGRAMS; COMPUTER SOFTWARE PROGRAMMING SERVICES FOR OTHERS; INSTALLATION, MAINTENANCE AND UPDATING OF COMPUTER SOFTWARE; COMPUTER CONSULTATION AND TECHNICAL SUPPORT SERVICES, NAMELY, TROUBLESHOOTING OF COMPUTER HARDWARE AND SOFTWARE PROBLEMS VIA THE INTERNET, TELEPHONE AND IN-PERSON CONSULTATIONS (U.S. CLS. 100 AND 101).

JASON TURNER, EXAMINING ATTORNEY

SN 76-108,316. EADS DEUTSCHLAND GMBH, OTTOBRUNN, FED REP GERMANY, FILED 8-11-2000.

**NEMISYS**

PRIORITY CLAIMED UNDER SEC. 44(D) ON FED REP GERMANY APPLICATION NO. 30032489.8, FILED 4-27-2000, REG. NO. 30032489, DATED 6-9-2000, EXPIRES 4-30-2010.

**CLASS 9—ELECTRICAL AND SCIENTIFIC APPARATUS**

FOR ELECTRONIC CONTROL UNITS FOR MISSILES, COMPRISING SENSORS, ACTIVATORS, MICROPROCESSORS, AND ELECTRONIC GUIDANCE DEVICES, NAMELY, TARGET HOMING HEADS FOR MISSILES (U.S. CLS. 21, 23, 26, 36 AND 38).

**CLASS 13—FIREARMS**

FOR MISSILES; GUIDED AND UNGUIDED ROCKETS; WARHEADS FOR MISSILES; DETONATORS FOR MISSILE WARHEADS, EXPLOSIVES, PARTS FOR THE ABOVE-MENTIONED GOODS (U.S. CLS. 2 AND 9).

**CLASS 37—CONSTRUCTION AND REPAIR**

FOR REPAIR AND MAINTENANCE OF MISSILES AND THEIR PARTS (U.S. CLS. 100, 103 AND 106).

**CLASS 42—SCIENTIFIC, COMPUTER AND LEGAL SERVICES**

FOR ENGINEERING SERVICES; FURNISHING TECHNICAL EXPERT OPINIONS, CONSULTING AND ENGINEERING DATA FOR OTHERS IN THE FIELD OF MISSILES (U.S. CLS. 100 AND 101).

DAVID H. STINE, EXAMINING ATTORNEY

SN 76-136,393. GESCO INDUSTRIES INC., BRAMPTON, ONTARIO, CANADA, FILED 9-28-2000.



PRIORITY CLAIMED UNDER SEC. 44(D) ON CANADA APPLICATION NO. 1068904, FILED 7-27-2000, REG. NO. TMA587058, DATED 8-13-2003, EXPIRES 8-13-2018.  
NO CLAIM IS MADE TO THE EXCLUSIVE RIGHT TO USE ".COM", APART FROM THE MARK AS SHOWN.

**CLASS 19—NON-METALLIC BUILDING MATERIALS**

FOR FLOOR COVERING PRODUCTS, NAMELY, LAMINATE FLOORING, WOOD FLOORING AND CERAMIC TILE (U.S. CLS. 1, 12, 33 AND 50).

**CLASS 27—FLOOR COVERINGS**

FOR FLOOR COVERING PRODUCTS, NAMELY CARPETS AND CARPET CUSHIONING (U.S. CLS. 19, 20, 37, 42 AND 50).

**CLASS 35—ADVERTISING AND BUSINESS**

FOR BUSINESS MARKETING CONSULTATION SERVICES, NAMELY, CONSULTING OPERATORS OF RETAIL STORES SPECIALIZING IN THE SALE OF FLOOR COVERING PRODUCTS IN THE ADVERTISING, MERCHANDISING AND MARKETING OF THOSE PRODUCTS (U.S. CLS. 100, 101 AND 102).  
WON TEAK OH, EXAMINING ATTORNEY

SN 76-164,894. E4E, INC., SANTA CLARA, CA. FILED 11-13-2000.

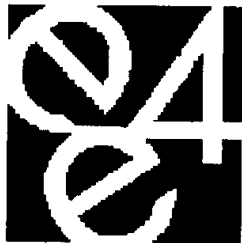

**CLASS 35—ADVERTISING AND BUSINESS**

FOR CUSTOMER RELATIONSHIP MANAGEMENT SERVICES; ACQUISITION OF TECHNOLOGY COMPANIES, ELECTRONIC COMMERCE COMPANIES, GLOBAL COMPUTER NETWORK BASED COMPANIES AND EXCHANGES, AND INFRASTRUCTURE SERVICE PROVIDERS FOR OTHERS (U.S. CLS. 100, 101 AND 102).

**CLASS 36—INSURANCE AND FINANCIAL**

FOR FINANCIAL INVESTMENT IN THE FIELD OF TECHNOLOGY COMPANIES, ELECTRONIC COMMERCE COMPANIES, GLOBAL COMPUTER NETWORK BASED COMPANIES AND EXCHANGES, AND INFRASTRUCTURE SERVICE PROVIDERS; FINANCIAL ANALYSIS AND CONSULTATION SERVICES FOR TECHNOLOGY COMPANIES, ELECTRONIC COMMERCE COMPANIES, GLOBAL COMPUTER NETWORK BASED COMPANIES AND EXCHANGES, AND INFRASTRUCTURE SERVICE PROVIDERS (U.S. CLS. 100, 101 AND 102).  
ALICE BENMAMAN, EXAMINING ATTORNEY

SN 76-210,012. NORDEA BANK FINLAND ABP, HELSINKI, FINLAND, FILED 2-12-2001.

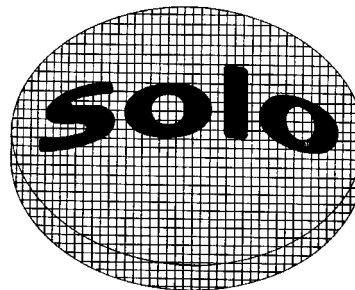

PRIORITY CLAIMED UNDER SEC. 44(D) ON FINLAND APPLICATION NO. T199903400, FILED 10-25-2000, REG. NO. 218663, DATED 9-15-2000, EXPIRES 9-15-2010.  
OWNER OF U.S. REG. NO. 2,252,393.  
THE MARK CONSISTS OF THE WORD SOLO IN BLACK STYLIZED LETTERS ON TOP OF A RAISED OVAL IN THE COLOR YELLOW.

**CLASS 9—ELECTRICAL AND SCIENTIFIC APPARATUS**

FOR AUTOMATED TELLER MACHINES; AUTOMATIC BANK NOTE DISPENSERS, NAMELY, AUTOMATIC PAPER MONEY SORTING MACHINES; BANK CARDS INCORPORATING DATA CARRIERS; MAGNETICALLY ENCODED DEBIT CARDS; MAGNETIC ENCODED CARD READERS FOR CREDIT CARDS; COMPUTER TERMINALS FOR USE WITH CREDIT CARDS AND DEBIT CARDS; MAGNETICALLY ENCODED CREDIT CARDS FOR ELECTRONIC FUNDS TRANSFER AND FINANCIAL TRANSACTIONS; APPARATUS FOR PAYMENTS WITH MAGNETIC MEMORY CARDS, NAMELY, COMPUTER TERMINALS; APPARATUS FOR RECEIVING, CASH PAYMENTS, NAMELY, AUTOMATIC TELLER MACHINES; AUTOMATIC PAYMENT MACHINES, NAMELY, AUTOMATED BANKING MACHINES; ELECTRONIC IDENTIFICATION CARDS FOR USE IN PAYING FOR SERVICES; MACHINE READABLE DEVICES, CONSISTING OF DISKETTES, MAGNETIC TAPES AND BAR CODE CARRIERS FOR CASHLESS PAYMENT SYSTEMS; MAGNETIC AND ENCODED PAYMENT CARDS; PAYMENT INCORPORATING DATA CARRIERS; EQUIPMENT TELECOMMUNICATION AND INTERACTIVE COMMUNICATION, NAMELY COMPUTERS, TELEPHONES, RADIOS AND TELEVISIONS; COMPUTER COMMUNICATIONS SOFTWARE TO ALLOW CUSTOMERS TO ACCESS INFORMATION AND TRANSACT BANKING BUSINESS; COMPUTER E-COMMERCE SOFTWARE FOR VERIFYING AND FACILITATING ON-LINE RETAIL SALES AND BUSINESS TO BUSINESS TRANSACTIONS; COMPUTER E-COMMERCE SOFTWARE TO ALLOW USERS TO PERFORM ELECTRONIC BUSINESS TRANSACTIONS VIA A GLOBAL COMPUTER NETWORK EXCLUDING COMPUTERS AND PERSONAL COMPUTER TERMINALS (U.S. CLS. 21, 23, 26, 36 AND 38).

**CLASS 35—ADVERTISING AND BUSINESS**

FOR TRADE FINANCE SERVICES, NAMELY PROVIDING FOREIGN TRADE INFORMATION FOR CORPORATE CUSTOMERS AVAILABLE VIA A GLOBAL COMPUTER NETWORK; BUSINESS MANAGEMENT CONSULTATION; BUSINESS RESEARCH; MARKET RESEARCH; PROVIDING BUSINESS STATISTICAL INFORMATION; MANAGEMENT CONSULTING SERVICES IN THE FIELD OF ELECTRONIC COMMERCE (U.S. CLS. 100, 101 AND 102).

**CLASS 36—INSURANCE AND FINANCIAL**

FOR CASH MANAGEMENT FOR CORPORATE CUSTOMERS AVAILABLE VIA A GLOBAL COMPUTER NETWORK; BANKING ELECTRONIC BANKING SERVICES VIA A GLOBAL COMPUTER NETWORK; PC BANKING; AUTOMATED TELEPHONE BANKING, NAMELY PROVIDING BANK ACCOUNT INFORMATION BY TELEPHONE; ELECTRONIC FILE TRANSFER, NAMELY ELECTRONIC FUNDS TRANSACTIONS AND ELECTRONIC DEBIT TRANSACTIONS; FINANCIAL ANALYSIS AND CONSULTATION IN THE NATURE OF RATES OF EXCHANGE, FINANCIAL INFORMATION PROVIDED BY ELECTRONIC MEANS; FINANCIAL MANAGEMENT; FINANCIAL PLANNING; FINANCIAL PORTFOLIO MANAGEMENT; FINANCIAL RESEARCH; FINANCIAL SERVICES IN THE NATURE OF AN INVESTMENT SECURITY; FINANCIAL GUARANTEE AND SURETY SERVICES (U.S. CLS. 100, 101 AND 102).

**CLASS 38—COMMUNICATION**

FOR TELECOMMUNICATION GATEWAY SERVICES, NAMELY PROVIDING A TELECOMMUNICATIONS CONNECTION BETWEEN FINANCIAL INSTITUTIONS AND BANKING CUSTOMERS VIA A GLOBAL ELECTRONIC NETWORK (U.S. CLS. 100, 101 AND 104).  
ALEXANDER L. POWERS, EXAMINING ATTORNEY

SN 76-210,324. MARKETFIRST SOFTWARE, INC., MOUNTAIN VIEW, CA. FILED 2-12-2001.

**CLASS 35—ADVERTISING AND BUSINESS**

FOR PROVIDING INFORMATION IN THE FIELD OF AUTOMATED MARKETING CAMPAIGNS THAT COMBINE ONLINE STRATEGIES AND TACTICS AND ANALYSIS THEREOF; BUSINESS CONSULTING AND BUSINESS MARKETING CONSULTATION; DATA PROCESSING SERVICES (U.S. CLS. 100, 101 AND 102).  
FIRST USE 10-3-1999; IN COMMERCE 10-3-1999.

**CLASS 41—EDUCATION AND ENTERTAINMENT**

FOR PROVIDING EDUCATIONAL SERVICES IN THE NATURE OF CLASSES, SEMINARS, WORKSHOPS AND INDIVIDUAL TUTORING, PRESENTED IN PERSON AND THROUGH ELECTRONIC COMMUNICATIONS MEANS, DEALING WITH MARKETING FOR BUSINESSES AND MARKETING AUTOMATION; COMPUTER EDUCATION TRAINING; ARRANGING AND CONDUCTING EDUCATIONAL CONFERENCES AND DEMONSTRATIONS; AND DISTRIBUTION OF EDUCATIONAL COURSE MATERIAL IN CONNECTION THEREWITH (U.S. CLS. 100, 101 AND 107).  
FIRST USE 10-3-1999; IN COMMERCE 10-3-1999.

**CLASS 42—SCIENTIFIC, COMPUTER AND LEGAL SERVICES**

FOR COMPUTER CONSULTATION; COMPUTER SYSTEMS ANALYSIS; COMPUTER SERVICES, NAMELY, PROVIDING SEARCH ENGINES FOR OBTAINING DATA ON A GLOBAL COMPUTER NETWORK, LOCAL AREA NETWORKS AND WIDE AREA NETWORKS (U.S. CLS. 100 AND 101).  
FIRST USE 10-3-1999; IN COMMERCE 10-3-1999.  
STACY WAHLBERG, EXAMINING ATTORNEY

SN 76-283,207. REUTERS S.A., GENEVA, SWITZERLAND, FILED 7-3-2001.



OWNER OF ERPN CMNTY TM OFC REG. NO. 002232585, DATED 8-20-2002, EXPIRES 5-24-2011.  
OWNER OF U.S. REG. NOS. 1,795,247 AND 2,521,527.

**CLASS 9—ELECTRICAL AND SCIENTIFIC APPARATUS**

FOR PRE-RECORDED AUDIO AND VIDEO COMPACT DISCS FEATURING FINANCIAL DATA; READ-ONLY MEMORY COMPACT DISCS FEATURING FINANCIAL DATA; COMPUTER OPERATING PROGRAMS; COMPUTER PROGRAMS FOR USE IN TRADING STOCKS AND BONDS; COMPUTER SOFTWARE RELATING TO THE COLLECTION AND DISTRIBUTION OF DATA, FINANCIAL EXCHANGES, SHARE DEALING, STOCK DEALING, FINANCIAL TRANSACTIONS AND NEWS AGENCIES; BLANK MAGNETIC ENCODED CARDS; USER INTERFACES FOR COMPUTERS; TELEPRINTERS; TELEVISION APPARATUS, NAMELY, TELEVISIONS, TELEVISION SCREENS; TELECOMMUNICATION APPARATUS AND INSTRUMENTS, NAMELY, FACSIMILE MACHINES; COMPUTERS; COMPUTER KEYBOARDS; COMPUTER PERIPHERAL DEVICES; PRINTERS FOR USE WITH COMPUTERS; MODEMS; COMPUTER MICE; COMPUTER TERMINALS; DOWNLOADABLE COMPUTER SOFTWARE AND ELECTRONIC PUBLICATIONS IN THE NATURE OF MAGAZINES AND NEWSLETTERS FOR USE IN EMAIL STOCK TRADING, SUPPLIED ONLINE FROM DATABASES OR FROM FACILITIES PROVIDED ON A GLOBAL COMPUTER NETWORK; COMPUTER SOFTWARE FOR CONNECTING COMPUTERS TO LOCAL DATABASES AND/OR GLOBAL COMPUTER NETWORKS; TELECOMMUNICATIONS APPARATUS, NAMELY, MODEMS, TELEPHONES FOR CONNECTING COMPUTERS TO LOCAL DATABASES AND/OR GLOBAL COMPUTER NETWORKS; COMPUTER SOFTWARE FOR SEARCHING DATA IN THE FIELD OF INVESTMENTS (U.S. CLS. 21, 23, 26, 36 AND 38).

**CLASS 35—ADVERTISING AND BUSINESS**

FOR TAX ESTIMATES, NAMELY, TAX ANALYSIS; BUSINESS SERVICES PROVIDED ON-LINE FROM A COMPUTER DATABASE AND/OR A GLOBAL COMPUTER NETWORK, NAMELY, ADVERTISING SERVICES IN THE NATURE OF DISSEMINATION OF ADVERTISING FOR OTHERS VIA AN ON-LINE ELECTRONIC COMMUNICATIONS NETWORK, DISSEMINATION OF ADVERTISING MATTER, BUSINESS APPRAISALS, BUSINESSES INFORMATION IN THE FIELD OF STOCKS, BONDS AND PERSONAL FINANCE, BUSINESS INVESTIGATIONS, COMMERCIAL INFORMATION AGENCIES, ECONOMIC FORECASTING, RENTAL OF OFFICE MACHINERY AND EQUIPMENT, BUSINESS RESEARCH, PROVIDING STATISTICAL INFORMATION, ADVERTISING AND PROMOTION SERVICES AND INFORMATION SERVICES RELATING THERETO IN THE NATURE OF PROMOTING THE SERVICES OF STOCKBROKERS THROUGH THE DISTRIBUTION OF PRINTED ADVERTISING AND PROMOTIONAL MATERIALS, BUSINESS INFORMATION SERVICES IN THE NATURE OF COMPILATION OF ADVERTISEMENTS FOR USE BY OTHERS AS WEB PAGES ON A GLOBAL COMPUTER NETWORK (U.S. CLS. 100, 101 AND 102).

**CLASS 36—INSURANCE AND FINANCIAL**

FOR FISCAL ASSESSMENTS; STOCK EXCHANGE PRICE QUOTATIONS; ELECTRONIC FUNDS TRANSFERS; FINANCIAL AND STOCK MARKET INFORMATION IN THE NATURE OF ECONOMIC, MONETARY AND STOCK EXCHANGE INFORMATION, CURRENCY TRADING INFORMATION; PROVIDING FINANCIAL INFORMATION ON BONDS, WARRANT BONDS, COMMERCIAL SALES, AND EXCHANGE AND INVESTMENT TRUSTS; PROVIDING ON-LINE FINANCIAL AND INSURANCE INFORMATION VIA COMPUTER DATABASES AND/OR A GLOBAL COMPUTER NETWORK; AND FINANCIAL ANALYSIS RELATING TO THE FOREGOING, BUT SPECIFICALLY EXCLUDING INVESTMENT ADVISORY, INVESTMENT SUPERVISORY AND INVESTMENT MANAGEMENT SERVICES, NAMELY BUYING, SELLING, MAINTENANCE AND MANAGEMENT OF FUNDS AND INVESTMENTS FOR OTHERS, ASSET MANAGEMENT, SECURITIES LENDING, INVESTMENT ADVISER OPERATIONS, BROKER-DEALER OPERATIONS, FUND INVESTMENT SERVICES, MARKET-MAKING, UNDERWRITING AND DISTRIBUTING MUTUAL FUND SHARES, PRIVATE PLACEMENT OF INVESTMENT FUNDS, INVESTMENT BANKING AND CORPORATE FINANCE SERVICES (U.S. CLS. 100, 101 AND 102).

STACY WAHLBERG, EXAMINING ATTORNEY

**CLASS 9—ELECTRICAL AND SCIENTIFIC APPARATUS**

FOR TELECOMMUNICATIONS AND DATA COMMUNICATIONS INSTALLATIONS, APPARATUS, AND INSTRUMENTS, NAMELY, CORDLESS, MOBILE, CELLULAR, WIRELESS, SATELLITE AND DIGITAL TELEPHONES, SPEAKERPHONES, PAGERS, PERSONAL DIGITAL ASSISTANTS; INTEGRATED AND PRINTED CIRCUITS; TELEPHONE SYSTEMS, COMPRISED OF A HANDSET AND CONSOLE UNIT; TELEPHONE DIALERS; TELEPHONE STATION MESSAGE DETAIL RECORDERS; MOBILE TELECOMMUNICATION EQUIPMENT COMPRISING A CONTROL TELEPHONE UNIT, TRANSCEIVER AND ANTENNA; MOBILE TELEPHONES AND COMPONENT PARTS THEREOF; BATTERY POWER PLANTS FOR USE IN PROVIDING AND MANAGING ENERGY SUPPLY REQUIREMENTS IN THE TELECOMMUNICATIONS INDUSTRY; CLOCK RADIO TELEPHONES; COMPUTERS; LIGHTWAVE DATA LINKS, NAMELY, TRANSMITTERS AND RECEIVERS; MODEMS; TELEPHONE INSTALLATION APPARATUS, NAMELY, PHONE MOUNTS, DUAL OUTLET ADAPTORS, TELEPHONE OUTLETS, MODULAR JACKS, WIRE JUNCTIONS AND PLUG-IN CONVERTERS; INTERACTIVE TELEVISION UNITS FOR ACQUISITION OF INFORMATION FROM DATA BASES; TELECOMMUNICATIONS SWITCHING APPARATUS; COMPUTER PERIPHERALS; FACSIMILE MACHINES; DOCUMENT SCANNER, NAMELY, FOCUSING LENSES, IMAGE DETECTORS, MEMORY UNITS, CIRCUIT BOARDS AND INTERFACE UNITS; VOICE AND DATA TRANSMITTING, CARRYING AND RECEIVING EQUIPMENT, NAMELY, TELECOMMUNICATION CARRIERS, CENTRAL OFFICE AND REMOTE TERMINALS, CHANNEL BANKS, ELECTRONIC PLUG-INS AND PAIR-GAIN APPARATUS; NETWORK MULTIPLEXER; DATA COMMUNICATION MULTIPLEXERS AND CONCENTRATOR; VIDEOTEX TERMINALS AND ELECTRIC EMERGENCY CALL UNITS; TELEPHONE ANSWERING MACHINES; VIDEOPHONES; VIDEO TELECONFERENCING PRODUCTS, NAMELY, SWITCHES, MODEMS, SPEAKERS AND VIDEO DISPLAY TUBES; COMPUTER HARDWARE, AND FIRMWARE USED FOR ACCESSING THE INTERNET AND FOR A CELLULAR TELEPHONE NETWORK; COMPUTER HARDWARE, NAMELY BASE TRANSCEIVERS AND CONTROLLERS FOR A CELLULAR TELEPHONE NETWORK, SWITCHES, ROUTERS, MODEMS, ANTENNAS, WAVE GUIDES, MULTIPLEXERS, ACCESS CONCENTRATORS; COMPUTER SOFTWARE FOR DATA PROCESSING; COMPUTER SOFTWARE FOR SWITCHING TELEPHONE CALLS OVER TELECOMMUNICATIONS NETWORKS, FOR REMOTE CONTROL OF MOBILE NETWORKS, AND FOR ACCESSING THE INTERNET; MICROPROCESSORS; MICROPROCESSOR BASED COMMUNICATORS, NAMELY, WRITING STYLI AND TABLETS; ELECTRONIC APPARATUS, NAMELY MODEMS, SMART CARDS AND DATA CARDS FOR SCRAMBLING, DESCRAMBLING, ENCODING AND DECODING OF VOICE, DATA, IMAGE AND VIDEO TRANSMISSION; COMPUTER KEYBOARDS; COMPUTER HARDWARE AND SOFTWARE USED FOR PROCESSING ELECTRONIC MONEY TRANSACTIONS; FLOOR DUCTS FOR HOUSING ELECTRIC CABLES; ELECTRICAL CABLES, COAXIAL CABLES, FIBER OPTIC CABLES, COMPUTER CABLES, TELEPHONE CABLES, COPPER CABLES FOR RECORDING, STORING, TRANSMISSION, RECEIVING AND REPRODUCING OF DATA, SOUND, IMAGES AND VIDEO; TRANSCEIVERS AND CONTROLLERS FOR TELECOMMUNICATIONS EQUIPMENTS; AUDIO VISUAL APPARATUS AND INSTRUMENTS FOR RECORDING, TRANSMISSION PROCESSING AND REPRODUCTION OF SOUND OR IMAGES, NAMELY, RADIO, TELEVISION AND WIRELESS RECEIVING APPARATUS AND INSTRUMENTS; SOUND RECORDING AND SOUND REPRODUCING APPARATUS AND INSTRUMENTS AND TAPES AND CASSETTES THEREFORE; VIDEOTAPE RECORDERS AND TAPES THEREFORE; SOUND AMPLIFIERS; STEREOPHONIC UNITS; PUBLIC ADDRESS SYSTEMS; LOUDSPEAKERS; HEADPHONES; GRAMOPHONE RECORDS AND PRE-RECORDED MAGNETIC TAPES AND CASSETTES THEREFORE FOR TAPE RECORDERS; ENCODED CARDS, NAMELY, MAGNETICALLY ENCODED DEBIT CARDS, MAGNETICALLY ENCODED CREDIT CARDS AND MAGNETICALLY ENCODED TELEPHONE CARDS; SMART CARDS FOR STORING VALUE OR DATA; ELECTRONIC PUBLICATIONS DOWNLOAD-

SN 76-286,951. CHINA MOBILE (HONG KONG) LIMITED, HONG KONG, FILED 7-18-2001.

**MONTERNET**

PRIORITY CLAIMED UNDER SEC. 44(D) ON HONG KONG APPLICATION NO. 2001/04723-0, FILED 3-22-2001, REG. NO. 14958, DATED 3-22-2001, EXPIRES 3-22-2008.

PRIORITY CLAIMED UNDER SEC. 44(D) ON HONG KONG APPLICATION NO. 2001/04723-0, FILED 3-22-2001, REG. NO. 14857, DATED 3-22-2001, EXPIRES 3-22-2008.

ABLE FROM THE INTERNET, NAMELY, ADVERTISING MATERIALS, MAPS, NEWSPAPERS, MAGAZINES AND INSTRUCTIONAL MATERIALS RELATING TO BUSINESS, COMMERCIAL, FINANCIAL, TELECOMMUNICATIONS, TRANSPORTATION AND TRAVELING, EDUCATION, ENTERTAINMENT, SPORTING AND CULTURAL ACTIVITIES, SCIENCE AND TECHNOLOGY, LEGAL SERVICES, MEDICAL AND HEALTHCARE SERVICES, FOOD AND BEVERAGE SERVICES, PERSONAL AND SOCIAL SERVICES AND SECURITY SERVICES; TESTING APPARATUS, NAMELY, PROBES FOR TESTING INTEGRATED CIRCUITS; SIGNALING APPARATUS, NAMELY, SIGNAL TRANSMITTERS, SIGNAL RECEIVERS AND SIGNAL PROCESSORS; MONITORING APPARATUS, NAMELY, BATTERY CHARGE MONITORS, TELEPHONE MONITORING EQUIPMENT, MONITORS FOR RECORDING TELECOMMUNICATIONS SIGNALS; CALCULATORS; PRE-RECORDED CD ROMS, DISCS, TAPES, CARDS AND WIRES, ALL BEING ELECTRONIC, MAGNETIC, ELECTRO-MAGNETIC, OPTICAL AND/OR ELECTRO-OPTICAL DATA CARRIERS ALL CONTAINING TELECOMMUNICATIONS INFORMATION; PARTS AND FITTINGS FOR ALL THE AFORESAID GOODS (U.S. CLS. 21, 23, 26, 36 AND 38).

#### **CLASS 16—PAPER GOODS AND PRINTED MATTER**

FOR PRINTED MATERIAL, NAMELY INSTRUCTIONAL AND TEACHING MANUALS, INSTRUCTION CARDS, BOOKS, PAMPHLETS AND USER GUIDES ALL FEATURING INFORMATION IN THE FIELDS OF TELECOMMUNICATIONS, COMPUTERS, AND COMPUTER APPLICATIONS (U.S. CLS. 2, 5, 22, 23, 29, 37, 38 AND 50).

#### **CLASS 35—ADVERTISING AND BUSINESS**

FOR BUSINESS ADVISORY, CONSULTANCY, RESEARCH AND INFORMATION SERVICES RELATING TO DATABASES AND THE INTERNET PROVIDED ONLINE; COMPILATION OF BUSINESS AND COMMERCIAL INFORMATION; RESEARCH, EDITING AND PUBLICATION OF BUSINESS AND COMMERCIAL INFORMATION; PROMOTING THE GOODS AND SERVICES OF OTHERS BY PREPARING AND PLACING ADVERTISEMENTS IN AN ELECTRONIC FORM ACCESSED THROUGH THE INTERNET; BILLBOARD ADVERTISING, OUTDOOR ADVERTISING, RADIO ADVERTISING, TELEVISION ADVERTISING AND E-MAIL ADVERTISING; DATA PROCESSING; PRODUCTION, PREPARATION AND PRESENTATION OF ADVERTISING MATTER; COMPILATION OF BUSINESS DIRECTORIES; MARKET ANALYSIS AND RESEARCH; COMPILATION OF BUSINESS DATA; TRANSCRIPTION OF DATA; PREPARATION OF BUSINESS REPORTS; PROVIDING SALES PROMOTION ADVICE AND CONSULTANCY; COMPUTERIZED DATABASE MANAGEMENT SERVICES; COMPILATION OF ADVERTISEMENTS FOR USE ON WEB PAGES; BUSINESS INFORMATION, ADVERTISING AND PROMOTIONAL SERVICES PROVIDED ON-LINE FROM A COMPUTER DATABASE OR BY MEANS OF WEB PAGES ON THE INTERNET; INTEGRATED TRACKING AND MANAGEMENT OF COMMERCIAL TRANSACTIONS ON THE INTERNET; COMPUTERIZED DATABASE MANAGEMENT RELATING TO COMPILATION AND SYSTEMIZATION OF INFORMATION INTO COMPUTER DATABASE; TELEPHONE ANSWERING SERVICES AND MESSAGE HANDLING SERVICES; BUSINESS MANAGEMENT OF PROMOTIONAL AND INCENTIVE SCHEMES (U.S. CLS. 100, 101 AND 102).

#### **CLASS 38—COMMUNICATION**

FOR TELECOMMUNICATIONS SERVICES, NAMELY, THE ELECTRONIC TRANSMISSION OF VOICE, DATA, INFORMATION, VIDEO AND FACSIMILE; LOCAL, LONG DISTANCE, AND INTERNATIONAL VOICE, TEXT, FACSIMILE, VIDEO AND DATA TELECOMMUNICATIONS SERVICES; FRAME RELAY TELECOMMUNICATIONS SERVICES; VIRTUAL NETWORK TELECOMMUNICATIONS SERVICES; ELECTRONIC DATA TRANSMISSION PACKET SERVICES; COMPUTER AIDED TRANSMISSION OF MESSAGES AND IMAGES; AUDIO AND VIDEO TELECONFERENCING SERVICES; PRIVATE LINE VOICE, TEXT, FACSIMILE, VIDEO AND DATA TELECOMMUNICATIONS SERVICES; INTEGRATED SERVICES DIGITAL NETWORK TELECOMMUNICATIONS SERVICES, KNOWN AS ISDN SERVICES; TELECOM SERVICES; E-MAIL SERVICES; WIRELESS APPLICATION PROTOCOL SERVICES, KNOWN AS WAP SERVICES; MOBILE PHONE ASSISTED DATA INFORMATION AND IMAGE TRANSMISSION; CHAT-ROOM, WAP GAMES AND ON-LINE GAMES, LOCATION SERVICES; EXPERT, PROFESSIONAL AND SCIENTIFIC CONSULTANCY SERVICES ALL RELATING TO TELECOMMUNICATIONS EQUIPMENT, NETWORKS AND SYSTEMS; PROVIDING USER ACCESS TO THE INTERNET; PROVIDING TELECOMMUNICATIONS ACCESS AND CONNECTIONS TO THE INTERNET OR DATABASES; AUDIO AND VIDEO BROADCASTING SERVICES; WIRELESS TRANSMISSION OF VOICE, DATA AND FACSIMILE, TRANSMISSION OF DATA AND OF INFORMATION BY ELECTRONIC MEANS, COMPUTER, CABLE, RADIO, RADIOPAGING, TELEPRINTER, TELELETTER, ELECTRONIC MAIL, FAX MACHINE, TELEVISION, MICROWAVE, LASER BEAM AND SATELLITE; INFORMATION AND ADVISORY SERVICES RELATING TO TELECOMMUNICATIONS AND BROADCASTING PROVIDED ONLINE OR BY WAP, CMNET, GSM, GPRS, 3G AND PLMN MEANS; ELECTRONIC DATA INTERCHANGE SERVICES; LEASING AND RENTAL OF TELECOMMUNICATIONS APPARATUS, INSTALLATIONS, INSTRUMENTS, AND SIGNALING APPARATUS, NAMELY MOBILE, CELLULAR, WIRELESS, SATELLITE, AND DIGITAL TELEPHONES, PAGERS, PERSONAL DIGITAL ASSISTANTS, ELECTRONIC MAIL BOXES; TELECOMMUNICATIONS RESELLER SERVICES, NAMELY, PROVIDING LONG DISTANCE TELECOMMUNICATIONS SERVICES AND TELECOMMUNICATIONS AIR TIME BROKERAGE SERVICES (U.S. CLS. 100, 101 AND 104).

#### **CLASS 42—SCIENTIFIC, COMPUTER AND LEGAL SERVICES**

FOR EXPERT, PROFESSIONAL AND SCIENTIFIC CONSULTANCY SERVICES, TESTING SERVICES, RESEARCH AND DEVELOPMENT SERVICES, DESIGN AND INSPECTION SERVICES, ALL RELATING TO THE INTERNET, BY MEANS OF DESIGN, DEVELOPMENT, CUSTOMIZATION, INTEGRATION AND UPGRADING OF COMPUTER SOFTWARE, COMPUTER HARDWARE CONSULTANCY, RECOVERY OF COMPUTER DATA, COMPUTER SOFTWARE MAINTENANCE, COMPUTER SOFTWARE SECURITY, COMPUTER SYSTEM ANALYSIS; LEASING OF ACCESS TIME TO COMPUTER DATABASES; RENTAL AND LEASING OF COMPUTERS AND COMPUTER DATA PROCESSING APPARATUS; COMPUTER PROGRAMMING; COMPUTER NETWORK DESIGN AND INSTALLATION SERVICES FOR OTHERS; INSTALLATION AND MAINTENANCE OF COMPUTER SOFTWARE; SYSTEMS INTEGRATION SERVICES; DESIGNING WEB SITES FOR OTHERS, NAMELY, DESIGN DRAWING AND COMMISSIONED WRITING, ALL FOR THE COMPILATION OF WEB PAGES ON THE INTERNET; COMPUTER SERVICES, NAMELY, COMPUTER PROGRAMMING, COMPUTER SOFTWARE DESIGN, DEVELOPMENT, CUSTOMIZATION, INTEGRATION AND UPGRADING; EDITING AND SYSTEMIZATION OF DATA IN COMPUTER DATABASES; OPERATING ELECTRONIC INFORMATION NETWORKS; WEB-SITE DESIGN, HOSTING AND MAINTENANCE SERVICES; TESTING SERVICES, RESEARCH AND DEVELOPMENT SERVICES, DESIGN AND INSPECTION SERVICES, ALL RELATING TO TELECOMMUNICATIONS EQUIPMENT, NETWORKS, AND SYSTEMS (U.S. CLS. 100 AND 101).

SCOTT OSICK, EXAMINING ATTORNEY



SN 76-294,506. GOLD HORSE UNLIMITED, LLC, SCOTTS-DALE, AZ. FILED 8-6-2001.



NO CLAIM IS MADE TO THE EXCLUSIVE RIGHT TO USE "BODY", APART FROM THE MARK AS SHOWN.

**CLASS 41—EDUCATION AND ENTERTAINMENT**

FOR INSTRUCTION IN THE FORM OF CLASSES, SEMINARS, WORKSHOPS AND SUPERVISED PRACTICE SESSIONS IN THE FIELD OF PHYSICAL THERAPY, SPECIFICALLY THEORY AND PHYSICAL EXERCISES AND TECHNIQUES TO BE USED TO RESOLVE BLOCKAGES AND ENERGY AND TENSION IN THE BODY THROUGH THE USE OF VIBRATION, BREATHING, AND BODY PRESSURE POINTS (U.S. CLS. 100, 101 AND 107).

**CLASS 42—SCIENTIFIC, COMPUTER AND LEGAL SERVICES**

FOR PHYSICAL THERAPY, SPECIFICALLY THE PHYSICAL EXERCISES AND TECHNIQUES USED IN ORDER TO RESOLVE BLOCKAGES OF ENERGY AND TENSION IN THE BODY THROUGH THE USE OF VIBRATION, BREATHING AND BODY PRESSURE POINTS (U.S. CLS. 100 AND 101).

KHANH LE, EXAMINING ATTORNEY

**CLASS 9—ELECTRICAL AND SCIENTIFIC APPARATUS**

FOR COMMUNICATION EQUIPMENT, NAMELY, TELEPHONE SETS, TELEPHONE SWITCHES, ROUTERS, FACSIMILE MACHINES, MODEMS, DIGITAL DATA TRANSMISSION APPARATUS, NAMELY, MULTIPLEXERS, ASYNCHRONOUS TRANSFER MODE, ATM, SWITCHES AND ELECTRONIC BRANCH EXCHANGES; RADIO AND TELEVISION TRANSMITTERS AND RECEIVERS, AND RADAR TRANSMITTERS; ELECTRIC WIRES; COMMUNICATION CABLES AND OPTICAL FIBERS; ELECTRONIC COMPUTERS AND DATA PROCESSING EQUIPMENT, NAMELY, COMPUTER PROGRAMS, MONITORS, KEYBOARDS, PRINTERS, SCANNERS, MAGNETIC DISC UNITS, AND PERIPHERALS AND TERMINALS FOR USE IN DATA PROCESSING SYSTEMS; CASH REGISTERS AND DISPENSERS; SEMICONDUCTOR DEVICES, NAMELY, INTEGRATED CIRCUITS, SEMICONDUCTOR MEMORIES, AND MICROPROCESSORS; ELECTRIC AND ELECTRONIC PARTS AND COMPONENTS, NAMELY, RELAYS, CONNECTORS, SWITCHES, AND BATTERIES; PRE-RECORDED SOUND-RECORDED AND IMAGE-RECORDED OPTICAL DISCS, MAGNETO-OPTICAL DISCS, MAGNETIC DISCS, AND MAGNETIC TAPES FEATURING AUDIO AND VIDEO USED FOR INSTRUCTION AND EDUCATION IN THE FIELD OF COMPUTER EDUCATION AND USED FOR ENTERTAINMENT IN THE NATURE OF COMPUTER GAMES; AND VIDEO OUTPUT GAME MACHINES ADAPTED OR USED WITH TELEVISION RECEIVERS (U.S. CLS. 21, 23, 26, 36 AND 38).

**CLASS 16—PAPER GOODS AND PRINTED MATTER**

FOR PRINTED MATTER, PRINTED PUBLICATIONS, NAMELY, BOOKS AND NEWSLETTERS IN THE FIELD OF INFORMATION TECHNOLOGY, PAPER STATIONERY, WRITING INSTRUMENTS, TYPEWRITERS, TYPEWRITER RIBBONS, AND INKING RIBBONS FOR COMPUTER PRINTERS (U.S. CLS. 2, 5, 22, 23, 29, 37, 38 AND 50).

SN 76-310,016. FUJITSU LIMITED, KAWASAKI-SHI, KANAGAWA 211-8588, JAPAN, FILED 9-7-2001.

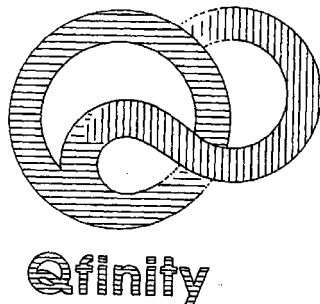

**CLASS 41—EDUCATION AND ENTERTAINMENT**

FOR COMPUTER EDUCATION, INSTRUCTION AND TRAINING FOR COMPUTER OPERATION AND COMPUTER PROGRAMMING, PROVIDING ENTERTAINMENT INFORMATION, EDITING AND DUBBING OF VIDEOTAPES AND DISCS, AND PROVIDING ON-LINE COMPUTER GAMES (U.S. CLS. 100, 101 AND 107).

**CLASS 42—SCIENTIFIC, COMPUTER AND LEGAL SERVICES**

FOR COMPUTER PROGRAMMING FOR OTHERS, COMPUTER SOFTWARE DESIGN FOR OTHERS, INSTALLATION AND SETUP OF COMPUTER SOFTWARE, MAINTENANCE AND UPDATING OF COMPUTER SOFTWARE, REMOTE CONTROLLING AND SUPERVISING OF COMPUTER SYSTEMS AND NETWORKS, COMPUTER SYSTEMS ANALYSES, CONSULTANT SERVICES IN THE FIELD OF COMPUTER HARDWARE AND SOFTWARE, PROVIDING INFORMATION REGARDING THE DESIGN, DEVELOPMENT AND MAINTENANCE OF COMPUTER SOFTWARE, RENTAL AND LEASING OF COMPUTERS, SERVERS AND COMPUTER SOFTWARE, TRANSLATION OF LANGUAGES VIA A GLOBAL COMPUTER NETWORK, AND RESEARCH AND DEVELOPMENT SERVICES FOR OTHERS IN THE FIELD OF COMPUTER HARDWARE AND SOFTWARE, COMMUNICATION SYSTEMS, AND SEMICONDUCTOR DEVICES (U.S. CLS. 100 AND 101).

CATHERINE FAINT, EXAMINING ATTORNEY

PRIORITY CLAIMED UNDER SEC. 44(D) ON JAPAN APPLICATION NO. 2001-053165, FILED 6-12-2001, REG. NO. 4586650, DATED 7-19-2002, EXPIRES 7-19-2012.

THE DRAWING IS LINED FOR THE COLORS RED AND BLUE.

SN 76-332,734. SCHNEIDER ELECTRIC INDUSTRIES SA, RUEIL-MALMAISON, FRANCE, FILED 11-2-2001.

SN 76-333,781. LARKIN INDUSTRIES, INC., BIRMINGHAM, AL. FILED 11-5-2001.



## TRANSPARENT READY

PRIORITY CLAIMED UNDER SEC. 44(D) ON FRANCE APPLICATION NO. 013099528, FILED 5-10-2001, REG. NO. 013099528, DATED 5-10-2001, EXPIRES 5-10-2011.

### CLASS 9—ELECTRICAL AND SCIENTIFIC APPARATUS

FOR DATA PROCESSING APPARATUS, NAMELY, OBJECT LINKING EMBEDDING PROCESS CONTROL AND OPERATING SOFTWARE AND SOFTWARE COMPRISING GENERAL PURPOSES SPREADSHEETS FOR COLLECTING DATA ON EITHER AN INTRANET OR INTERNET CONNECTED PERSONAL COMPUTER TO A PROGRAMMABLE LOGIC CONTROLLER (U.S. CLS. 21, 23, 26, 36 AND 38).

### CLASS 37—CONSTRUCTION AND REPAIR

FOR ELECTRICAL REPAIRS AND INSTALLATION SERVICES OF POWER AND CONTROL EQUIPMENT, NAMELY CIRCUIT BREAKERS, MOTOR DRIVES, HEATING APPARATUS, SOLENOIDS, ELECTRICAL SWITCHES, SWITCHBOARDS, ELECTRICAL PROXIMITY AND INDUCTIVE SENSORS FOR PROGRAMMABLE LOGIC CONTROLLER SYSTEMS, I/O MODULES, AND INTEGRATED CIRCUIT CARDS (U.S. CLS. 100, 103 AND 106).

### CLASS 38—COMMUNICATION

FOR TELECOMMUNICATIONS SERVICES PROVIDED ON COMPUTER NETWORKS, NAMELY, PROVIDING TELECOMMUNICATIONS CONNECTIONS TO A LOCAL AREA NETWORK OR A GLOBAL COMPUTER NETWORK FOR MONITORING AND CONTROL SERVICES FOR INDUSTRIAL MACHINES AND PROCESSES; ELECTRONIC TRANSMISSION OF MESSAGES AND DATA; PROVIDING ON-LINE CHAT ROOMS FOR TRANSMISSION OF MESSAGES AMONG COMPUTER USERS CONCERNING THE OPERATION, MONITORING AND CONTROL OF AUTOMATION INDUSTRIAL CONTROL SYSTEMS AND CONCERNING ENGINEERING AND RELATED TECHNICAL SUBJECTS; RADIO BROADCASTING SERVICES; ELECTRONIC MAIL SERVICES; PROVIDING MULTIPLE USER DIAL-UP AND DEDICATED ACCESS TO THE INTERNET AND ON-LINE HELP SITES (U.S. CLS. 100, 101 AND 104).

### CLASS 42—SCIENTIFIC, COMPUTER AND LEGAL SERVICES

FOR BUILDING MONITORING SERVICES; COMPUTER AIDED ELECTRONIC INTERNET SERVICES, NAMELY, PROVIDING TEMPORARY USE OF NON-DOWNLOADABLE SOFTWARE FROM WORLD WIDE WEB SITES THAT TRANSMITS PROGRAMMABLE LOGIC CONTROL SOFTWARE VIA THE INTERNET (U.S. CLS. 100 AND 101).

ELIZABETH J. WINTER, EXAMINING ATTORNEY

THE DRAWING OF THE MARK IS LINED FOR THE COLOR BLUE OF THE SHADE PMS 300. SEC. 2(F).

### CLASS 7—MACHINERY

FOR KITCHEN MACHINERY, NAMELY, KITCHEN VENTILATION HOOD MOTORS AND KITCHEN VENTILATION FAN MOTORS (U.S. CLS. 13, 19, 21, 23, 31, 34 AND 35).

FIRST USE 2-1-1985; IN COMMERCE 2-1-1985.

### CLASS 9—ELECTRICAL AND SCIENTIFIC APPARATUS

FOR PRE-WIRED MASTER CONTROL PANELS FOR KITCHEN VENTILATION EQUIPMENT (U.S. CLS. 21, 23, 26, 36 AND 38).

FIRST USE 2-1-1985; IN COMMERCE 2-1-1985.

### CLASS 11—ENVIRONMENTAL CONTROL APPARATUS

FOR KITCHEN VENTILATION PRODUCTS, NAMELY, KITCHEN VENTILATION HOODS AND KITCHEN VENTILATION FANS; INSTALLATIONS FOR LIGHTING, COOKING, DRYING, AND VENTILATION, NAMELY, KITCHEN VENTILATION HOODS AND KITCHEN VENTILATION FANS AND LIGHTED KITCHEN VENTILATION HOODS (U.S. CLS. 13, 21, 23, 31 AND 34).

FIRST USE 2-1-1985; IN COMMERCE 2-1-1985.

ROBERT COGGINS, EXAMINING ATTORNEY

SN 76-339,088. WEBSTER, GLENN DAVID, SURBITON, SURREY KT6 6JD, UNITED KINGDOM, FILED 11-17-2001.



OWNER OF UNITED KINGDOM REG. NO. 2270244, DATED 3-22-2001, EXPIRES 5-16-2011.

**CLASS 9—ELECTRICAL AND SCIENTIFIC APPARATUS**

FOR ABACUSES, AMUSEMENT APPARATUS AND COMPUTER AND VIDEO GAMING EQUIPMENT, NAMELY, JOYSTICKS, GAME PADS, LIGHT GUNS, DANCE MATS, SKATEBOARD SIMULATORS, STEERING WHEELS, ACCELERATOR AND BRAKE PEDALS, TO BE USED WITH TELEVISIONS TO PLAY A COMPUTER GAME; GAME CODE CARDS, MEMORY CARDS, DIGITAL CAMERAS FOR USE WITH COMPUTER GAMES; TALKING MACHINES; COIN OR COUNTER OPERATED COMPUTER GAME MACHINES; ENTERTAINMENT SOFTWARE AND SOFTWARE PROGRAMS; NAMELY, ELECTRONIC GAMES SOFTWARE, GAMES CARTRIDGES, CONSOLE GAME DISCS, VIDEO GAME INFORMATION AND SOFTWARE DOWNLOADABLE FROM THE INTERNET, SOFTWARE FOR FACILITATING GAME PLAY VIA NETWORKS AND THE INTERNET; NOTEBOOK COMPUTERS; ELECTRONIC NOTICE BOARDS; POCKET CALCULATORS; MOUSE MATS; VIDEO GAME CARTRIDGES; VIDEO CASSETTES; PRE-RECORDED TAPES FEATURING CINEMATOGRAPHIC AND TELEVISION FILMS, CINEMATOGRAPHIC AND TELEVISION PROGRAMS AND ANIMATED FILMS AND PROGRAMS, THE SUBJECT MATTER OF WHICH IS DRAMA, COMEDY, HORROR AND CHILDREN'S ENTERTAINMENT; PHOTOGRAPH SLIDE TRANSPARENCIES; MOTION PICTURE FILMS FEATURING ANIMATION; VIDEO DISCS AND VIDEO TAPES WITH RECORDED ANIMATION CARTOONS; EXPOSED CAMERA FILM; CARTOON SEQUENCES RECORDED ON DISC, FILM AND/OR TAPE; ANIMATED CARTOONS IN THE FORM OF CINEMATOGRAPHIC FILMS; ANIMATED CINEMATOGRAPHIC FILMS; ANIMATED CINEMATOGRAPHIC FILMS PREPARED FOR EXHIBITION; FLASH MEMORY CARDS BEARING SOUND AND/OR VIDEO RECORDING; ELECTRONIC GAMES CONSOLES; ELECTRONIC GAMES SOFTWARE AND ELECTRONIC GAMES ADAPTED FOR USE WITH TV, VIDEO SCANNERS, VDUS, VIDEO MONITORS, BOOKS RECORDED ON DISC; BOOKS RECORDED ON TAPE; BABY ALARMS; LIFE BUOYS; SNORKELS; SWIMMING GOGGLES AND MASKS; SWIMMING FLOTATION SAFETY AIDS ADAPTED FOR INCORPORATION INTO BATHING SUITS; TELESCOPES; DOG WHISTLES; ELECTRIC DOOR CHIMES; ELECTRIC DOOR BELLS; VENDING MACHINES; CELL PHONES; CELL PHONE ACCESSORIES; NAMELY EAR PIECES, CLIP ON COVERS, BELT HOOKS, AERIALS, BATTERIES AND CELL PHONE CHARGERS; PAGERS; CASSETTE PLAYERS; RECORDERS; RADIOS; CLOCK RADIOS; CD PLAYERS; RECORD PLAYERS, ELECTRONIC TRANSISTORS; TELEPHONE RECEIVERS, PORTABLE STEREOPHONIC TAPE, MINI DISC AND CD PLAYERS ADAPTED FOR USE WITH HEADPHONES; PRE-RECORDED AUDIO CASSETTES; PRE-RECORDED DVDS; AUDIO DIGITAL DISCS AND AUDIO DISCS ALL FEATURING MUSIC AND/OR NARRATION; JUKEBOXES FOR COMPUTERS; MUSICAL JUKEBOXES; SAFETY REFLECTIVE PRODUCTS, NAMELY BANDS TO BE WORN ON THE BODY, AND HELMET SKIRTS; SAFETY ARTICLES MADE FROM REFLECTIVE MATERIALS FOR USE ON ANIMALS, NAMELY, LEADS, COLLARS, BOOTS AND DOG COATS; PROTECTIVE HELMETS FOR CYCLISTS AND MOTORCYCLISTS; EYE SHADES; ANTI-DAZZLE SHADES; ANTI-DAZZLE SPECTACLES; ANTI-GLARE GLASSES; SUNGLASSES; SPECTACLE CASES; EYEGLASS FRAMES; READING GLASSES; EYEGLOSS CHAINS; CONTACT LENSES AND CONTAINERS, HOLDERS AND CASES; TOYS IN THE FORM OF PHOTOGRAPHIC CAMERAS CAPABLE OF TAKING A PHOTOGRAPH; FUNCTIONING TOY COMPUTERS; FUNCTIONING TOY TELEPHONES; FUNCTIONING WALKIE-TALKIES; LIFE BELTS AND LIFE JACKETS; ANTI-INTRUSION ALARMS, NAMELY, INTRUDER DETECTORS AND INTRUDER DETECTING SENSORS (U.S. CLS. 21, 23, 26, 36 AND 38).

**CLASS 16—PAPER GOODS AND PRINTED MATTER**

FOR COMIC STRIPS, CHILDREN'S MAGAZINES, MAGAZINES FEATURING ANIMALS, ANIMATED CHARACTERS, CARTOONS, ADULT HUMOR, GAMES AND PUZZLES; STATIONERY, NAMELY, LETTER-HEAD, PARTY STATIONERY; WRITING PADS; PENCIL SHARPENERS; DRAWING BOOKS; SCRAPBOOKS; COLORING BOOKS; PENCILS; CRAYONS; FELT TIP PENS; ERASING PRODUCTS, NAMELY ERASERS, ERASING PENS, LIQUID CORRECTION FLUID, BLACKBOARD ERASERS; ART MATERIALS, NAMELY, ART PAPER, CANVASSES, PAINT BRUSHES, ARTISTS' PALETTES AND TRAYS, EASELS, ARTISTS' BOARDS, ARTISTS' CHARCOALS, CALENDARS; DISPOSABLE DIAPERS; MODELING MATERIALS, NAMELY MODELING WAX, PLASTICS FOR MODELING, MODELING CLAY; BOOKS, NAMELY COMIC BOOKS, GAME BOOKS, CHILDREN'S BOOKS, PUZZLE BOOKS, JOKE BOOKS, NOVELS, BIOGRAPHIES, EDUCATIONAL BOOKS, BOOKS IN THE FIELD OF DOMESTIC PETS, ANIMAL WELFARE AND ANIMALS, BOOKLETS; GRAPHIC PRINTS; DRAWING BOARDS; DRAWING PADS, DRAWING PENS, DRAWING PINS AND DRAWING SETS COMPRISED OF DRAWING RULERS, PENCIL SHARPENERS AND TRACING PAPERS; FOUNTAIN PENS, PENS; BOXES OF PENS; CHILDREN'S PAINT BOXES, PAPER TABLECLOTHS; PAPER LINENS; PAPER MATS; PAPER NAPKINS; MUSICAL GREETING CARDS; GREETING CARDS; POSTERS; PHOTOGRAPHS; PICTURES; POSTCARDS; BLACKBOARD; CHALK; WRAPPING PAPER; PARTY STREAMERS; ADVERTISEMENT BOARDS OF PAPER OR CARDBOARD; BOXES OF CARDBOARD OR PAPER; COASTERS OF PAPER, MATS FOR BEER GLASSES; FLAGS OF PAPER; AQUARIUM HOODS; INDOOR AQUARIUMS; TOILET PAPER AND FACE TOWELS OF PAPER; DISPOSAL DIAPERS AND NAPKIN PANTS; NOVELTY PAPER HATS; PHOTOGRAPHIC ALBUMS; ALMANAC; BIBS OF PAPER; SONG BOOKS; PRINTED PLASTIC BAGS FOR HOUSEHOLD USE; HOLOGRAMS AND COLORED PAPER HATS (U.S. CLS. 2, 5, 22, 23, 29, 37, 38 AND 50).

**CLASS 25—CLOTHING**

FOR CLOTHING, NAMELY APRONS, BABIES' CLOTH DIAPERS, BONNETS, BABIES' PANTS, BABY SLEEP SUITS, BATH ROBES, BATHING CAPS, BATHING SUITS, BOOTIES, BIKINIS, BATHING TRUNKS, BELTS, BIBS, LINGERIE, BRAS, CAMISOLES, PANTIES, VESTS, UNDERPANTS, PETTICOATS, SLIPS, UNDERWEAR, NIGHTWEAR, PAJAMAS, NIGHT-SHIRTS, NIGHTIES, HOSIERY, SOCKS, PANTYHOSE, STOCKINGS, HATS, CAPS, BERETS, COATS, RAIN COATS, JACKETS, SUITS, WAISTCOATS, TROUSERS, DUNGAREES, BLOUSES, T-SHIRTS, TOPS, SHIRTS, SHORTS, CLAM-DIGGERS, SHOES, BOOTS, SNEAKERS; SLIPPERS, SKIRTS, JUMPERS, JERSEYS, CARDIGANS, BODY WARMERS, FLEECEES, SWEATSHIRTS, GLOVES, MITTENS, TIES, TRACK SUITS, TRACK SUIT TROUSERS, CYCLING SHORTS, LEGGINGS, BRA TOPS, LEOTARDS, FOOTBALL BOOTS, SKI BOOTS, FLIP-FLOPS, DRESSES, CULOTTES, SCARVES, COSTUMES FOR USE IN ROLL-PLAYING GAMES; AND CARNIVAL HATS (U.S. CLS. 22 AND 39).

**CLASS 28—TOYS AND SPORTING GOODS**

FOR TOY FIGURES AND ACCESSORIES FOR USE THEREWITH, NAMELY, PLAY FOOD, PLAY BONES, PLAY FISH; DOLLS, DOLLS' CLOTHING AND ACCESSORIES, NAMELY, PLAY BAGS, BELTS, TIES, BRIEF CASES, FOOTWEAR, HATS, CELL PHONES, UMBRELLAS, COMPUTERS, SKIS AND BOOTS, SNOW BOARDS, MAKE-UP, MAKEUP BAGS, JEWELRY AND MIRRORS; PARTY FAVORS IN THE NATURE OF CRACKERS; HAND-HELD COMPUTER GAMES; PLAY ARTICLES, NAMELY, INFLATABLE SWIMMING POOLS; SKI GEAR, NAMELY, SNOW BOARDS, AND SKIS, KNEE GUARDS FOR ATHLETIC USE; TOY SOAP BUBBLE WAND AND SOLUTION SETS; CHRISTMAS TREE DECORATIONS, NAMELY, BAUBLES AND GARLANDS; TOY VEHICLES; CHILDREN'S AND INFANTS' MULTIPLE ACTIVITY TOYS; PLUSH TOYS; TEDDY BEARS; STUFFED TOYS; RIDE-ON TOYS; PUSH TOYS;

PULL TOYS; RADIO-CONTROLLED TOYS; MECHANICAL TOYS; TOY CONSTRUCTION SETS; BUILDING TOYS; WIND-UP TOYS; WATER SQUIRTING TOYS; MUSICAL TOYS; INFANT TOY RATTLES; JIGSAW PUZZLES; BOARD GAMES; PARLOR GAMES; SPINNING TOPS; ROCKING HORSES; TOY MODELS; MODEL KITS; TOY MOBILES; TOY KALEIDOSCOPES; SWINGS, SLIDES, CLIMBING FRAMES; CHESS BOARDS AND PIECES; CHESS SETS; DOMINOES; TOY SCOOTERS; TOY SPORTING EQUIPMENT, NAMELY FOOTBALLS, BASEBALLS, BASEBALL BATS; BASEBALL GLOVES, HOCKEY STICKS AND PUCKS; SOCCER BALLS; BASKETBALLS; VOLLEYBALLS; PARTY FAVORS IN THE NATURE OF PARTY POPPERS AND STREAMERS; SWIMMING COLLARS IN THE FORM OF INFLATABLE SWIMMING AIDS POSITIONED AROUND THE NECK FOR BUOYANCY PURPOSES; COLORED PAPER HATS, COLORED SPRAY STRING AND PARTY BLOWERS; TOY MASKS AND FACE MASKS, PLAY BALLOONS; FANCY DRESS COSTUMES BEING CHILDREN'S PLAYTHINGS; PUPPETS; CLOTHING FOR TOY FIGURES; TOYS FOR DOMESTIC PETS; KITES AND KITE REELS; PUNCH BAGS; INFLATABLE TOYS; POOL TOYS; SURFBOARDS; SAIL BOARD COVERS; SCUBA FLIPPERS AND FINS; BEACH BALLS; SKATE BOARDS; ROLLERSKATES; INLINE SKATES; TOY DOGS, CATS, HUMAN CHARACTERS AND ANIMALS; TOY CAMERAS NOT CAPABLE OF TAKING A PHOTOGRAPH; ARM FLOATS FOR BATHING AND SWIMMING, WATER WINGS; KALEIDOSCOPES; ARCADE GAMES; AUTOMATIC, COIN, TOKEN AND COUNTER OPERATED AMUSEMENT GAMING MACHINES; ELBOW PADS AND GUARDS FOR ATHLETIC USE; AND PLAYING CARDS (U.S. CLS. 22, 23, 38 AND 50).

#### **CLASS 31—NATURAL AGRICULTURAL PRODUCTS**

FOR ALL FOODSTUFFS FOR ANIMALS/PET FOODS; ANIMAL BEVERAGES; NON-MEDICATED ADDITIVES FOR ANIMAL FEED; DOG BISCUITS/BISCUITS FOR ANIMALS; CAT LITTER (U.S. CLS. 1 AND 46).

#### **CLASS 41—EDUCATION AND ENTERTAINMENT**

FOR MUSICAL ENTERTAINMENT SERVICES IN THE NATURE OF LIVE POP CONCERTS; ENTERTAINMENT SERVICES IN THE NATURE OF THEATER SHOWS; ENTERTAINMENT IN THE FORM OF AMUSEMENT PARK RIDES; ENTERTAINMENT IN THE NATURE OF ONGOING DRAMA AND COMEDY TELEVISION PROGRAMS AND TELEVISION PROGRAMS FEATURING ANIMALS; ENTERTAINMENT IN THE NATURE OF ONGOING CHILDREN'S TELEVISION PROGRAMS; FILM PRODUCTION; PRODUCTION OF ANIMATED SHOWS; PRODUCTION OF ANIMATED CARTOONS AND ANIMAL FEATURE FILMS, CINE FILM CLIPS, ANIMATED PROGRAMS FOR USE IN TELEVISION AND CABLE; PRODUCTION OF TELEVISION DRAMA AND COMEDY SHOWS; PRODUCTION OF TELEVISION SHOWS FEATURING ANIMALS; PRODUCTION OF CHILDREN'S TELEVISION PROGRAMS; ENTERTAINMENT SERVICES, NAMELY, PROVIDING AN ON-LINE COMPUTER GAME; PUBLICATION OF ONLINE PUBLICATIONS, NAMELY CHILDREN'S BOOKS AND MAGAZINES, PUZZLE BOOKS, GAME BOOKS, JOKE BOOKS, COMIC BOOKS, COMIC STRIPS, EDUCATIONAL BOOKS OR MAGAZINES, BOOKS OR MAGAZINES FEATURING ANIMATED CHARACTERS, BOOKS OR MAGAZINES FEATURING ANIMALS; PROVISION OF DIGITAL MUSIC, NOT DOWNLOADABLE; PROVIDING PARTICIPATION-TYPE ENTERTAINMENT IN AN AMUSEMENT AND ENTERTAINMENT PARK, NAMELY CHILDREN'S COSTUMED ENTERTAINMENT; LIVE STAGE PRESENTATIONS FEATURING MUSIC; ARRANGING AND CONDUCTING OF EVENTS, NAMELY, SPORTING COMPETITIONS AND CULTURAL FAIRS; ANIMAL TRAINING SERVICES; ANIMAL TRAINING COURSES AND ANIMAL EDUCATION; EDUCATION SERVICES, NAMELY CONDUCTING PROGRAMS IN THE FIELDS OF NUTRITION AND ROAD SAFETY; AND EDUCATIONAL COURSES FOR TEA-

CHERS, PARENTS, PRESCHOOL AND SCHOOL CHILDREN IN THE FIELDS OF NUTRITION AND ROAD SAFETY (U.S. CLS. 100, 101 AND 107).

THEODORE MCBRIDE, EXAMINING ATTORNEY

SN 76-339,089. WEBSTER, GLENN DAVID, SURREY KT6 6JD, UNITED KINGDOM, FILED 11-17-2001.



OWNER OF UNITED KINGDOM REG. NO. 2270245, DATED 3-22-2001, EXPIRES 5-16-2011.

#### **CLASS 9—ELECTRICAL AND SCIENTIFIC APPARATUS**

FOR ABACUSES, AMUSEMENT APPARATUS AND COMPUTER AND VIDEO GAMING EQUIPMENT, NAMELY, JOYSTICKS, GAME PADS, LIGHT GUNS, DANCE MATS, SKATEBOARD SIMULATORS, STEERING WHEELS, ACCELERATOR AND BRAKE PEDALS, TO BE USED WITH TELEVISIONS TO PLAY A COMPUTER GAMES; GAME CODE CARDS, MEMORY CARDS, DIGITAL CAMERAS FOR USE WITH COMPUTER GAMES; TALKING MACHINES; COIN OR COUNTER OPERATED COMPUTER GAME MACHINES; ENTERTAINMENT SOFTWARE AND SOFTWARE PROGRAMS; NAMELY, ELECTRONIC GAMES SOFTWARE, GAMES CARTRIDGES, CONSOLE GAME DISCS, VIDEO GAME INFORMATION AND SOFTWARE DOWNLOADABLE FROM THE INTERNET, SOFTWARE FOR FACILITATING GAME PLAY VIA NETWORKS AND THE INTERNET; NOTEBOOK COMPUTERS; ELECTRONIC NOTICE BOARDS; POCKET CALCULATORS; MOUSE MATS; VIDEO GAME CARTRIDGES; VIDEO CASSETTES; PRE-RECORDED TAPES FEATURING CINEMATOGRAPHIC AND TELEVISION FILMS, CINEMATOGRAPHIC AND TELEVISION PROGRAMS AND ANIMATED FILMS AND PROGRAMS, THE SUBJECT MATTER OF WHICH IS DRAMA, COMEDY, HORROR AND CHILDREN'S ENTERTAINMENT; PHOTOGRAPH SLIDE TRANSPARENCIES; MOTION PICTURE FILMS FEATURING ANIMATION; VIDEO DISCS AND VIDEO TAPES WITH RECORDED ANIMATION CARTOONS; EXPOSED CAMERA FILM; CARTOON SEQUENCES RECORDED ON DISC, FILM AND/OR TAPE; ANIMATED CARTOONS IN THE FORM OF CINEMATOGRAPHIC FILMS; ANIMATED CINEMATOGRAPHIC FILMS PREPARED FOR EXHIBITION; FLASH MEMORY CARDS BEARING SOUND AND/OR VIDEO RECORDING; ELECTRONIC GAMES CONSOLES; ELECTRONIC GAMES SOFTWARE AND ELECTRONIC GAMES ADAPTED FOR USE WITH TV, VIDEO SCANNERS, VDUS, VIDEO MONITORS, BOOKS RECORDED ON DISC; BOOKS RECORDED ON TAPE; BABY ALARMS; LIFE BUOYS; SNORKELS; SWIMMING GOGGLES AND MASKS; SWIMMING FLOTATION SAFETY AIDS ADAPTED FOR INCORPORATION INTO BATHING SUITS; TELESCOPES; DOG WHISTLES; ELECTRIC DOOR CHIMES; ELECTRIC DOOR BELLS; VENDING MACHINES; CELL PHONES; CELL PHONE ACCESSORIES; NAMELY EAR PIECES, CLIP ON COVERS, BELT HOOKS, AERIALS, BATTERIES AND CELL PHONE CHARGERS; PAGERS; CASSETTE PLAYERS;

RECORDERS; RADIOS; CLOCK RADIOS; CD PLAYERS; RECORD PLAYERS, ELECTRONIC TRANSISTORS; TELEPHONE RECEIVERS, PORTABLE STEREPHONIC TAPE, MINI DISC AND CD PLAYERS ADAPTED FOR USE WITH HEADPHONES; PRE-RECORDED AUDIO CASSETTES; PRE-RECORDED DVDS; AUDIO DIGITAL DISCS AND AUDIO DISCS ALL FEATURING MUSIC AND/OR NARRATION; JUKEBOXES FOR COMPUTERS; MUSICAL JUKEBOXES; SAFETY REFLECTIVE PRODUCTS, NAMELY BANDS TO BE WORN ON THE BODY, AND HELMET SKIRTS; SAFETY ARTICLES MADE FROM REFLECTIVE MATERIALS FOR USE ON ANIMALS, NAMELY, LEADS, COLLARS, BOOTS AND DOG COATS; PROTECTIVE HELMETS FOR CYCLISTS AND MOTORCYCLISTS; EYE SHADES; ANTI-DAZZLE SHADES; ANTI-DAZZLE SPECTACLES; ANTI-GLARE GLASSES; SUNGLASSES; SPECTACLE CASES; EYE-GLASS FRAMES; READING GLASSES; EYEGLASS CHAINS; CONTACT LENSES AND CONTAINERS, HOLDERS AND CASES; TOYS IN THE FORM OF PHOTOGRAPHIC CAMERAS CAPABLE OF TAKING A PHOTOGRAPH; FUNCTIONING TOY COMPUTERS; FUNCTIONING TOY TELEPHONES; FUNCTIONING WALKIE-TALKIES; LIFE BELTS AND LIFE JACKETS; ANTI-INTRUSION ALARMS, NAMELY, INTRUDER DETECTORS AND INTRUDER DETECTING SENSORS (U.S. CLS. 21, 23, 26, 36 AND 38).

#### **CLASS 16—PAPER GOODS AND PRINTED MATTER**

FOR COMIC STRIPS, CHILDREN'S MAGAZINES, MAGAZINES FEATURING ANIMALS, ANIMATED CHARACTERS, CARTOONS, ADULT HUMOR, GAMES AND PUZZLES; STATIONERY, NAMELY, LETTER-HEAD, PARTY STATIONERY; WRITING PADS; PENCIL SHARPENERS; DRAWING BOOKS; SCRAPBOOKS; COLORING BOOKS; PENCILS; CRAYONS; FELT TIP PENS; ERASING PRODUCTS, NAMELY ERASERS, ERASING PENS, LIQUID CORRECTION FLUID, BLACKBOARD ERASERS; ART MATERIALS, NAMELY, ART PAPER, CANVASSES, PAINT BRUSHES, ARTISTS' PALETTES AND TRAYS, EASELS, ARTISTS' BOARDS, ARTISTS' CHARCOALS, CALENDARS; DISPOSABLE DIAPERS; MODELING MATERIALS, NAMELY MODELING WAX, PLASTICS FOR MODELING, MODELING CLAY; BOOKS, NAMELY COMIC BOOKS, GAME BOOKS, CHILDREN'S BOOKS, PUZZLE BOOKS, JOKE BOOKS, NOVELS, BIOGRAPHIES, EDUCATIONAL BOOKS, BOOKS IN THE FIELD OF DOMESTIC PETS, ANIMAL WELFARE AND ANIMALS, BOOKLETS; GRAPHIC PRINTS; DRAWING BOARDS; DRAWING PADS, DRAWING PENS, DRAWING PINS AND DRAWING SETS COMPRISED OF DRAWING RULERS, PENCIL SHARPENERS AND TRACING PAPERS; FOUNTAIN PENS, PENS; BOXES OF PENS; CHILDREN'S PAINT BOXES, PAPER TABLECLOTHS; PAPER LINENS; PAPER MATS; PAPER NAPKINS; MUSICAL GREETING CARDS; GREETING CARDS; POSTERS; PHOTOGRAPHS; PICTURES; POSTCARDS; BLACKBOARD; CHALK; WRAPPING PAPER; PARTY STREAMERS; ADVERTISEMENT BOARDS OF PAPER OR CARDBOARD; BOXES OF CARDBOARD OR PAPER; COASTERS OF PAPER, MATS FOR BEER GLASSES; FLAGS OF PAPER; AQUARIUM HOODS; INDOOR AQUARIUMS; TOILET PAPER AND FACE TOWELS OF PAPER; DISPOSAL DIAPERS AND NAPKIN PANTS; NOVELTY PAPER HATS; PHOTOGRAPHIC ALBUMS; ALMANAC; BIBS OF PAPER; SONG BOOKS; PRINTED PLASTIC BAGS FOR HOUSEHOLD USE; HOLOGRAMS AND COLORED PAPER HATS (U.S. CLS. 2, 5, 22, 23, 29, 37, 38 AND 50).

#### **CLASS 25—CLOTHING**

FOR CLOTHING, NAMELY APRONS, BABIES' CLOTH DIAPERS, BONNETS, BABIES' PANTS, BABY SLEEP SUITS, BATH ROBES, BATHING CAPS, BATHING SUITS, BOOTIES, BIKINIS, BATHING TRUNKS, BELTS, BIBS, LINGERIE, BRAS, CAMISOLES, PANTIES, VESTS, UNDERPANTS, PETTICOATS, SLIPS, UNDERWEAR, NIGHTWEAR, PAJAMAS, NIGHT-SHIRTS, NIGHTIES, HOSIERY, SOCKS, PANTYHOSE, STOCKINGS, HATS, CAPS, BERETS, COATS, RAIN COATS, JACKETS, SUITS, WAISTCOATS, TROUSERS, DUNGAREES, BLOUSES, T-SHIRTS, TOPS, SHIRTS, SHORTS, CLAM-DIGGERS, SHOES, BOOTS, SNEAKERS; SLIPPERS, SKIRTS, JUMPERS, JERSEYS, CARDIGANS, BODY WARMERS, FLEECEES, SWEATSHIRTS, GLOVES, MITTENS, TIES, TRACK SUITS, TRACK SUIT TROUSERS, CYCLING SHORTS, LEGGINGS, BRA TOPS, LEOTARDS, FOOTBALL BOOTS, SKI BOOTS, FLIP-FLOPS, DRESSES, CULOTTES, SCARVES, COSTUMES FOR USE IN ROLL-PLAYING GAMES; AND CARNIVAL HATS (U.S. CLS. 22 AND 39).

#### **CLASS 28—TOYS AND SPORTING GOODS**

FOR TOY FIGURES AND ACCESSORIES FOR USE THEREWITH, NAMELY, PLAY FOOD, PLAY BONES, PLAY FISH; DOLLS, DOLLS' CLOTHING AND ACCESSORIES, NAMELY, PLAY BAGS, BELTS, TIES, BRIEF CASES, FOOTWEAR, HATS, CELL PHONES, UMBRELLAS, COMPUTERS, SKIS AND BOOTS, SNOW BOARDS, MAKE-UP, MAKEUP BAGS, JEWELRY AND MIRRORS; PARTY FAVORS IN THE NATURE OF CRACKERS; HAND-HELD COMPUTER GAMES; PLAY ARTICLES, NAMELY, INFLATABLE SWIMMING POOLS; KNEE GEAR, NAMELY, SNOW BOARDS, AND SKIS, KNEE GUARDS FOR ATHLETIC USE; TOY SOAP BUBBLE WAND AND SOLUTION SETS; CHRISTMAS TREE DECORATIONS, NAMELY, BAUBLES AND GARLANDS; TOY VEHICLES; CHILDREN'S AND INFANTS' MULTIPLE ACTIVITY TOYS; PLUSH TOYS; TEDDY BEARS; STUFFED TOYS; RIDE-ON TOYS; PUSH TOYS; PULL TOYS; RADIO-CONTROLLED TOYS; MECHANICAL TOYS; TOY CONSTRUCTION SETS; BUILDING TOYS; WIND-UP TOYS; WATER SQUIRTING TOYS; MUSICAL TOYS; INFANT TOY RATTLES; JIGSAW PUZZLES; BOARD GAMES; PARLOR GAMES; SPINNING TOPS; ROCKING HORSES; TOY MODELS; MODEL KITS; TOY MOBILES; TOY KALEIDOSCOPES; SWINGS, SLIDES, CLIMBING FRAMES; CHESS BOARDS AND PIECES; CHESS SETS; DOMINOES; TOY SCOOTERS; TOY SPORTING EQUIPMENT, NAMELY FOOTBALLS, BASEBALLS, BASEBALL BATS; BASEBALL GLOVES, HOCKEY STICKS AND PUCKS; SOCCER BALLS; BASKETBALLS; VOLLEYBALLS; PARTY FAVORS IN THE NATURE OF PARTY POPPERS AND STREAMERS; SWIMMING COLLARS IN THE FORM OF INFLATABLE SWIMMING AIDS POSITIONED AROUND THE NECK FOR BUOYANCY PURPOSES; COLORED PAPER HATS, COLORED SPRAY STRING AND PARTY BLOWERS; TOY MASKS AND FACE MASKS, PLAY BALLOONS; FANCY DRESS COSTUMES BEING CHILDREN'S PLAYTHINGS; PUPPETS; CLOTHING FOR TOY FIGURES; TOYS FOR DOMESTIC PETS; KITES AND KITE REELS; PUNCH BAGS; INFLATABLE TOYS; POOL TOYS; SURFBOARDS; SAIL BOARD COVERS; SCUBA FLIPPERS AND FINS; BEACH BALLS; SKATE BOARDS; ROLLERSKATES; INLINE SKATES; TOY DOGS, CATS, HUMAN CHARACTERS AND ANIMALS; TOY CAMERAS NOT CAPABLE OF TAKING A PHOTOGRAPH; ARM FLOATS FOR BATHING AND SWIMMING, WATER WINGS; KALEIDOSCOPES; ARCADE GAMES; AUTOMATIC, COIN, TOKEN AND COUNTER OPERATED AMUSEMENT GAMING MACHINES; ELBOW PADS AND GUARDS FOR ATHLETIC USE; AND PLAYING CARDS (U.S. CLS. 22, 23, 38 AND 50).

#### **CLASS 31—NATURAL AGRICULTURAL PRODUCTS**

FOR ALL FOODSTUFFS FOR ANIMALS/PET FOODS; ANIMAL BEVERAGES; NON-MEDICATED ADDITIVES FOR ANIMAL FEED; DOG BISCUITS/BISCUITS FOR ANIMALS; CAT LITTER (U.S. CLS. 1 AND 46).

**CLASS 41—EDUCATION AND ENTERTAINMENT**

FOR MUSICAL ENTERTAINMENT SERVICES IN THE NATURE OF LIVE POP CONCERTS; ENTERTAINMENT SERVICES IN THE NATURE OF THEATER SHOWS; ENTERTAINMENT IN THE FORM OF AMUSEMENT PARK RIDES; ENTERTAINMENT IN THE NATURE OF ONGOING DRAMA AND COMEDY TELEVISION PROGRAMS AND TELEVISION PROGRAMS FEATURING ANIMALS; ENTERTAINMENT IN THE NATURE OF ONGOING CHILDREN'S TELEVISION PROGRAMS; FILM PRODUCTION; PRODUCTION OF ANIMATED SHOWS; PRODUCTION OF ANIMATED CARTOONS AND ANIMAL FEATURE FILMS, CINE FILM CLIPS, ANIMATED PROGRAMS FOR USE IN TELEVISION AND CABLE; PRODUCTION OF TELEVISION DRAMA AND COMEDY SHOWS; PRODUCTION OF TELEVISION SHOWS FEATURING ANIMALS; PRODUCTION OF CHILDREN'S TELEVISION PROGRAMS; ENTERTAINMENT SERVICES, NAMELY, PROVIDING AN ON-LINE COMPUTER GAME; PUBLICATION OF ONLINE PUBLICATIONS, NAMELY CHILDREN'S BOOKS AND MAGAZINES, PUZZLE BOOKS, GAME BOOKS, JOKE BOOKS, COMIC BOOKS, COMIC STRIPS, EDUCATIONAL BOOKS OR MAGAZINES, BOOKS OR MAGAZINES FEATURING ANIMATED CHARACTERS, BOOKS OR MAGAZINES FEATURING ANIMALS; PROVISION OF DIGITAL MUSIC, NOT DOWNLOADABLE; PROVIDING PARTICIPATION-TYPE ENTERTAINMENT IN AN AMUSEMENT AND ENTERTAINMENT PARK, NAMELY CHILDREN'S COSTUMED ENTERTAINMENT; LIVE STAGE PRESENTATIONS FEATURING MUSIC; ARRANGING AND CONDUCTING OF EVENTS, NAMELY, SPORTING COMPETITIONS AND CULTURAL FAIRS; ANIMAL TRAINING SERVICES; ANIMAL TRAINING COURSES AND ANIMAL EDUCATION; EDUCATION SERVICES, NAMELY CONDUCTING PROGRAMS IN THE FIELDS OF NUTRITION AND ROAD SAFETY; AND EDUCATIONAL COURSES FOR TEACHERS, PARENTS, PRESCHOOL AND SCHOOL CHILDREN IN THE FIELDS OF NUTRITION AND ROAD SAFETY (U.S. CLS. 100, 101 AND 107).

THEODORE MCBRIDE, EXAMINING ATTORNEY

SN 76-350,468, TECHNICAL RESEARCH CENTRE OF FINLAND, 02044 VTT, FINLAND, FILED 12-18-2001.

**VTT**

PRIORITY CLAIMED UNDER SEC. 44(D) ON FINLAND APPLICATION NO. T200102007, FILED 6-20-2001, REG. NO. 226083, DATED 12-31-2002, EXPIRES 12-31-2012.

**CLASS 9—ELECTRICAL AND SCIENTIFIC APPARATUS**

FOR SCIENTIFIC APPARATUS AND INSTRUMENTS, NAMELY RADIO FREQUENCY FILTERS, SENSORS BASED ON MICRO MECHANICS AND RADIO FREQUENCY TECHNOLOGY, OSCILLATORS; NAUTICAL APPARATUS AND INSTRUMENTS INCLUDING NAVIGATIONAL EQUIPMENT AND DIVING APPARATUS, NAMELY COMPASSES, BEARING COMPASSES, GPS, RADARS, ECHO SOUNDERS, NAVIGATIONAL BUOYS, CHART CORRECTORS, SEXTANTS, GPS CHART PLOTTERS, BINOCULARS, WHISTLES, DIVING COMPUTERS, BELTS FOR DIVING, AIR TANKS AND REGULATORS, DIVING HELMETS, GLOVES, MASKS, SNORKELS, AND STABILIZING JACKETS; ELECTRIC APPARATUS AND INSTRUMENTS, NAMELY VOLT-METERS, ELECTRICAL CIRCUITS, CIRCUIT BOARDS AND SWITCHES, BOTH TOUCH AND MOTION SENSITIVE; PHOTOGRAPHIC APPARATUS AND INSTRUMENTS, NAMELY CAMERAS, DIGITAL CAMERAS AND VIDEO CAMERAS, PROJECTORS; OPTICAL APPARATUS AND INSTRUMENTS, NAMELY PHOTOCOPYING MACHINES, MICROSCOPES AND SPECTROPHOTOMETERS, WEIGHING APPARATUS AND INSTRUMENTS, NAMELY SCALES, MEASURING APPARATUS AND INSTRUMENTS, NAMELY MULTICHANNEL AND ARRAY DETECTORS, GAUGES AND

LED SPECTROMETERS, GAS FLOW METERS AND MASS SPECTROMETERS; SIGNALING APPARATUS AND INSTRUMENTS, NAMELY SIGNAL WHISTLES, SIGNAL BELLS AND SIGNAL LIGHTS; SUPERVISION APPARATUS AND INSTRUMENTS, NAMELY, ALARM BOXES, ANTI-INTRUSION ALARMS, BURGLAR ALARMS AND DETECTORS; LIFE-SAVING APPARATUS AND INSTRUMENTS, NAMELY BULLET-PROOF VESTS, FIRE ALARMS AND DETECTORS, LIFE BELTS, LIFE SAVING RAFTS, LIFE-BUOYS, LIFEJACKETS, LIFE NETS, AND TEACHING APPARATUS AND INSTRUMENTS, NAMELY PROJECTORS AND WIDE SCREEN PROJECTORS; APPARATUS FOR RECORDING, TRANSMISSION OR REPRODUCTION OF SOUND OR IMAGES, NAMELY TELEVISIONS, CAMERAS, VIDEO CAMERAS, VIDEO AND TAPE RECORDERS, CD AND DVD PLAYERS, LOUDSPEAKERS, RADIOS, MOBILE PHONES AND DIGITAL RECORDERS; MAGNETIC, ELECTRIC, OPTICAL DATA CARRIERS AND RECORDING DISCS BOTH BLANK AND PRE-RECORDED DEALING WITH MOBILE COMMUNICATIONS TECHNOLOGY, INFORMATION SYSTEM APPLICATIONS, TELECOMMUNICATIONS AND NETWORK TECHNOLOGIES, SAFETY AND RELIABILITY RESEARCH, SENSOR TECHNOLOGY, ENVIRONMENTAL ISSUES FOCUSING ON FOREST CHEMICALS, PRINTING PROCESSES, MINERAL REFINEMENT, DEVELOPING AND RESEARCHING BIOMOLECULES, CELL FACTORY, PROCESS TECHNOLOGY, BUILDING TECHNOLOGY, FOOD DESIGN, MICROBIOLOGY, RESEARCHING ENERGY PRODUCTION, NEW ENERGY TECHNOLOGIES, NUCLEAR ENERGY, ENGINE TECHNOLOGY AND ENERGY IN TRANSPORTATION, CONTROLLING FACTORS RELATED TO THE OPERATING RELIABILITY AND SERVICE LIFE OF VARIOUS PRODUCTS, FINDING MATERIAL SOLUTIONS FOR DIFFICULT OPERATING CONDITIONS, PROMOTING AND DEVELOPING OF ENVIRONMENTALLY FRIENDLY PRODUCTS AND PRODUCTION METHODS, AS WELL AS DEVELOPING MODELS FOR EXPLOITING NEW TECHNOLOGIES FOR THE MANAGEMENT OF GOODS AND INFORMATION FLOWS; COMPUTER SOFTWARE FOR USE IN DATA BASE MANAGEMENT, FOR USE AS A SPREADSHEET, FOR WORD PROCESSING, FOR COMPUTER AIDED DESIGN; ELECTRONIC PUBLICATIONS, NAMELY BOOKS, MAGAZINES, MANUALS, BROCHURES AND RESEARCH REPORTS FEATURING MOBILE COMMUNICATIONS TECHNOLOGY, INFORMATION SYSTEM APPLICATIONS, TELECOMMUNICATIONS AND NETWORK TECHNOLOGIES, SAFETY AND RELIABILITY RESEARCH, SENSOR TECHNOLOGY, ENVIRONMENTAL ISSUES FOCUSING ON FOREST CHEMICALS, PRINTING PROCESSES, MINERAL REFINEMENT, DEVELOPING AND RESEARCHING BIOMOLECULES, CELL FACTORY, PROCESS TECHNOLOGY, BUILDING TECHNOLOGY, FOOD DESIGN, MICROBIOLOGY, RESEARCHING ENERGY PRODUCTION, NEW ENERGY TECHNOLOGIES, NUCLEAR ENERGY, ENGINE TECHNOLOGY AND ENERGY IN TRANSPORTATION, CONTROLLING FACTORS RELATED TO THE OPERATING RELIABILITY AND SERVICE LIFE OF VARIOUS PRODUCTS, FINDING MATERIAL SOLUTIONS FOR DIFFICULT OPERATING CONDITIONS, PROMOTING AND DEVELOPING OF ENVIRONMENTALLY FRIENDLY PRODUCTS AND PRODUCTION METHODS, AS WELL AS DEVELOPING MODELS FOR EXPLOITING NEW TECHNOLOGIES FOR THE MANAGEMENT OF GOODS AND INFORMATION FLOWS RECORDED ON FLOPPY DISKS, CDS, DVDS AND MP-3S; CALCULATING MACHINES, NAMELY CALCULATORS; DATA PROCESSING EQUIPMENT, NAMELY COMPUTERS, PRINTERS, KEYBOARDS, MODEMS, LOUDSPEAKERS, Mouses, REMOTE CONTROLS, SCANNERS AND MASS STORAGE MEMORIES; FIRE-EXTINGUISHING APPARATUS, NAMELY FOAM EXTINGUISHERS AND FIRE-EXTINGUISHING BLANKETS; PARTS AND EQUIPMENT TO ALL THE AFORESAID GOODS (U.S. CLS. 21, 23, 26, 36 AND 38).

**CLASS 16—PAPER GOODS AND PRINTED MATTER**

FOR PRINTED MATTER, NAMELY NEWSPAPERS, MAGAZINES, CATALOGS, CIRCULARS, BOOKS, MANUALS, RESEARCH REPORTS, POSTERS AND CALENDARS COVERING SUBJECT MATTERS IN THE FIELD OF MOBILE COMMUNICATIONS TECHNOLOGY, INFORMATION SYSTEM APPLICATIONS, TELECOMMUNICATIONS AND NETWORK TECHNOLOGIES, SAFETY AND RELIABILITY RESEARCH, SENSOR TECHNOLOGY, ENVIRONMENTAL ISSUES FOCUSING ON FOREST CHEMICALS, PRINTING PROCESSES, MINERAL REFINEMENT, DEVELOPING AND RESEARCHING BIOMOLECULES, CELL FACTORY, PROCESS TECHNOLOGY, BUILDING TECHNOLOGY, FOOD DESIGN, MICROBIOLOGY, RESEARCHING ENERGY PRODUCTION, NEW ENERGY TECHNOLOGIES, NUCLEAR ENERGY, ENGINE TECHNOLOGY AND ENERGY IN TRANSPORTATION, CONTROLLING FACTORS RELATED TO THE OPERATING RELIABILITY AND SERVICE LIFE OF VARIOUS PRODUCTS, FINDING MATERIAL SOLUTIONS FOR DIFFICULT OPERATING CONDITIONS, PROMOTING AND DEVELOPING OF ENVIRONMENTALLY FRIENDLY PRODUCTS AND PRODUCTION METHODS, AS WELL AS DEVELOPING MODELS FOR EXPLOITING NEW TECHNOLOGIES FOR THE MANAGEMENT OF GOODS AND INFORMATION FLOWS; PHOTOGRAPHS BOTH MOUNTED AND UNMOUNTED; STATIONERY; INSTRUCTIONAL AND TEACHING MATERIAL IN THE FIELDS OF MOBILE COMMUNICATIONS TECHNOLOGY, INFORMATION SYSTEM APPLICATIONS, TELECOMMUNICATIONS AND NETWORK TECHNOLOGIES, SAFETY AND RELIABILITY RESEARCH, SENSOR TECHNOLOGY, ENVIRONMENTAL ISSUES FOCUSING ON FOREST CHEMICALS, PRINTING PROCESSES, MINERAL REFINEMENT, DEVELOPING AND RESEARCHING BIOMOLECULES, CELL FACTORY, PROCESS TECHNOLOGY, BUILDING TECHNOLOGY, FOOD DESIGN, MICROBIOLOGY, RESEARCHING ENERGY PRODUCTION, NEW ENERGY TECHNOLOGIES, NUCLEAR ENERGY, ENGINE TECHNOLOGY AND ENERGY IN TRANSPORTATION, CONTROLLING FACTORS RELATED TO THE OPERATING RELIABILITY AND SERVICE LIFE OF VARIOUS PRODUCTS, FINDING MATERIAL SOLUTIONS FOR DIFFICULT OPERATING CONDITIONS, PROMOTING AND DEVELOPING OF ENVIRONMENTALLY FRIENDLY PRODUCTS AND PRODUCTION METHODS, AS WELL AS DEVELOPING MODELS FOR EXPLOITING NEW TECHNOLOGIES FOR THE MANAGEMENT OF GOODS AND INFORMATION FLOWS (U.S. CLS. 2, 5, 22, 23, 29, 37, 38 AND 50).

**CLASS 35—ADVERTISING AND BUSINESS**

FOR DATA PROCESSING SERVICES; PROCESSING OF INFORMATION RELATING TO MOBILE COMMUNICATIONS TECHNOLOGY, INFORMATION SYSTEM APPLICATIONS, TELECOMMUNICATIONS AND NETWORK TECHNOLOGIES, SAFETY AND RELIABILITY RESEARCH, SENSOR TECHNOLOGY, ENVIRONMENTAL ISSUES FOCUSING ON FOREST CHEMICALS, PRINTING PROCESSES, MINERAL REFINEMENT, DEVELOPING AND RESEARCHING BIOMOLECULES, CELL FACTORY, PROCESS TECHNOLOGY, BUILDING TECHNOLOGY, FOOD DESIGN, MICROBIOLOGY, RESEARCHING ENERGY PRODUCTION, NEW ENERGY TECHNOLOGIES, NUCLEAR ENERGY, ENGINE TECHNOLOGY AND ENERGY IN TRANSPORTATION, CONTROLLING FACTORS RELATED TO THE OPERATING RELIABILITY AND SERVICE LIFE OF VARIOUS PRODUCTS, FINDING MATERIAL SOLUTIONS FOR DIFFICULT OPERATING CONDITIONS, PROMOTING AND DEVELOPING OF ENVIRONMENTALLY FRIENDLY PRODUCTS AND PRODUCTION METHODS, AS WELL AS DEVELOPING MODELS FOR EXPLOITING NEW TECHNOLOGIES FOR THE MANAGEMENT OF GOODS AND INFORMATION FLOWS (U.S. CLS. 100, 101 AND 102).

**CLASS 41—EDUCATION AND ENTERTAINMENT**

FOR EDUCATIONAL SERVICES, NAMELY CONDUCTING CLASSES, SEMINARS, CONFERENCES AND WORKSHOPS IN THE FIELDS OF MOBILE COMMUNICATIONS TECHNOLOGY, INFORMATION SYSTEM APPLICATIONS, TELECOMMUNICATIONS AND NETWORK TECHNOLOGIES, SAFETY AND RELIABILITY RESEARCH, SENSOR TECHNOLOGY, ENVIRONMENTAL ISSUES FOCUSING ON FOREST CHEMICALS, PRINTING PROCESSES, MINERAL REFINEMENT, DEVELOPING AND RESEARCHING BIOMOLECULES, CELL FACTORY, PROCESS TECHNOLOGY, BUILDING TECHNOLOGY, FOOD DESIGN, MICROBIOLOGY, RESEARCHING ENERGY PRODUCTION, NEW ENERGY TECHNOLOGIES, NUCLEAR ENERGY, ENGINE TECHNOLOGY AND ENERGY IN TRANSPORTATION, CONTROLLING FACTORS RELATED TO THE OPERATING RELIABILITY AND SERVICE LIFE OF VARIOUS PRODUCTS, FINDING MATERIAL SOLUTIONS FOR DIFFICULT OPERATING CONDITIONS, PROMOTING AND DEVELOPING OF ENVIRONMENTALLY FRIENDLY PRODUCTS AND PRODUCTION METHODS, AS WELL AS DEVELOPING MODELS FOR EXPLOITING NEW TECHNOLOGIES FOR THE MANAGEMENT OF GOODS AND INFORMATION FLOWS; TRAINING SERVICES IN THE FIELDS OF MOBILE COMMUNICATIONS TECHNOLOGY, INFORMATION SYSTEM APPLICATIONS, TELECOMMUNICATIONS AND NETWORK TECHNOLOGIES, SAFETY AND RELIABILITY RESEARCH, SENSOR TECHNOLOGY, ENVIRONMENTAL ISSUES FOCUSING ON FOREST CHEMICALS, PRINTING PROCESSES, MINERAL REFINEMENT, DEVELOPING AND RESEARCHING BIOMOLECULES, CELL FACTORY, PROCESS TECHNOLOGY, BUILDING TECHNOLOGY, FOOD DESIGN, MICROBIOLOGY, RESEARCHING ENERGY PRODUCTION, NEW ENERGY TECHNOLOGIES, NUCLEAR ENERGY, ENGINE TECHNOLOGY AND ENERGY IN TRANSPORTATION, CONTROLLING FACTORS RELATED TO THE OPERATING RELIABILITY AND SERVICE LIFE OF VARIOUS PRODUCTS, FINDING MATERIAL SOLUTIONS FOR DIFFICULT OPERATING CONDITIONS, PROMOTING AND DEVELOPING OF ENVIRONMENTALLY FRIENDLY PRODUCTS AND PRODUCTION METHODS, AS WELL AS DEVELOPING MODELS FOR EXPLOITING NEW TECHNOLOGIES FOR THE MANAGEMENT OF GOODS AND INFORMATION FLOWS; INTERNET BASED TRAINING IN THE FIELD OF COMPUTER APPLICATION AND SIMULATION; ELECTRONIC PUBLISHING SERVICES, NAMELY PUBLICATION OF TEXT, IMAGES AND GRAPHIC WORKS OF OTHERS ON FLOPPY DISKS, CDS, DVDS, MP-3S AND ON-LINE FEATURING SUBJECT MATTERS DEALING WITH MOBILE COMMUNICATIONS TECHNOLOGY, INFORMATION SYSTEM APPLICATIONS, TELECOMMUNICATIONS AND NETWORK TECHNOLOGIES, SAFETY AND RELIABILITY RESEARCH, SENSOR TECHNOLOGY, ENVIRONMENTAL ISSUES FOCUSING ON FOREST CHEMICALS, PRINTING PROCESSES, MINERAL REFINEMENT, DEVELOPING AND RESEARCHING BIOMOLECULES, CELL FACTORY, PROCESS TECHNOLOGY, BUILDING TECHNOLOGY, FOOD DESIGN, MICROBIOLOGY, RESEARCHING ENERGY PRODUCTION, NEW ENERGY TECHNOLOGIES, NUCLEAR ENERGY, ENGINE TECHNOLOGY AND ENERGY IN TRANSPORTATION, CONTROLLING FACTORS RELATED TO THE OPERATING RELIABILITY AND SERVICE LIFE OF VARIOUS PRODUCTS, FINDING MATERIAL SOLUTIONS FOR DIFFICULT OPERATING CONDITIONS, PROMOTING AND DEVELOPING OF ENVIRONMENTALLY FRIENDLY PRODUCTS AND PRODUCTION METHODS, AS WELL AS DEVELOPING MODELS FOR EXPLOITING NEW TECHNOLOGIES FOR THE MANAGEMENT OF GOODS AND INFORMATION FLOWS, ENTERTAINMENT IN THE NATURE OF SCIENCE EXHIBITIONS, ON-LINE SCIENCE AND TECHNOLOGY REPORTS, PROVIDING COMPUTER AND ON-LINE GAMES, MUSIC CONCERTS, STAGE SHOWS AND FESTIVALS; SPORTING AND CULTURAL ACTIVITIES, NAMELY IN THE NATURE OF BALL GAMES, DANCE PERFORMANCES, THEATER AND ART EXHIBITIONS, PROVIDING ON-LINE BOOKS, MANUALS, EDUCATIONAL MATERIAL, JOURNALS, RESEARCH REPORTS AND BROCHURES IN THE FIELDS OF MOBILE COMMUNICATIONS TECHNOLOGY, INFORMATION SYSTEM APPLICATIONS, TELECOMMUNICATIONS AND NETWORK TECHNOLOGIES, SAFETY AND RELIABILITY RE-

SEARCH, SENSOR TECHNOLOGY, ENVIRONMENTAL ISSUES FOCUSING ON FOREST CHEMICALS, PRINTING PROCESSES, MINERAL REFINEMENT, DEVELOPING AND RESEARCHING BIOMOLECULES, CELL FACTORY, PROCESS TECHNOLOGY, BUILDING TECHNOLOGY, FOOD DESIGN, MICROBIOLOGY, RESEARCHING ENERGY PRODUCTION, NEW ENERGY TECHNOLOGIES, NUCLEAR ENERGY, ENGINE TECHNOLOGY AND ENERGY IN TRANSPORTATION, CONTROLLING FACTORS RELATED TO THE OPERATING RELIABILITY AND SERVICE LIFE OF VARIOUS PRODUCTS, FINDING MATERIAL SOLUTIONS FOR DIFFICULT OPERATING CONDITIONS, PROMOTING AND DEVELOPING OF ENVIRONMENTALLY FRIENDLY PRODUCTS AND PRODUCTION METHODS, AS WELL AS DEVELOPING MODELS FOR EXPLOITING NEW TECHNOLOGIES FOR THE MANAGEMENT OF GOODS AND INFORMATION FLOWS (U.S. CLS. 100, 101 AND 107).

#### **CLASS 42—SCIENTIFIC, COMPUTER AND LEGAL SERVICES**

FOR SCIENTIFIC AND INDUSTRIAL RESEARCH; SCIENTIFIC AND PROFESSIONAL CONSULTANCY SERVICES; TECHNICAL AND ENGINEERING EXPERTISE, CONSULTANCY, TESTING AND LABORATORY SERVICES IN THE FIELD OF MOBILE COMMUNICATIONS TECHNOLOGY, INFORMATION SYSTEM APPLICATIONS, TELECOMMUNICATIONS AND NETWORK TECHNOLOGIES, SAFETY AND RELIABILITY RESEARCH, SENSOR TECHNOLOGY, ENVIRONMENTAL ISSUES FOCUSING ON FOREST CHEMICALS, PRINTING PROCESSES, MINERAL REFINEMENT, DEVELOPING AND RESEARCHING BIOMOLECULES, CELL FACTORY, PROCESS TECHNOLOGY, BUILDING TECHNOLOGY, FOOD DESIGN, MICROBIOLOGY, RESEARCHING ENERGY PRODUCTION, NEW ENERGY TECHNOLOGIES, NUCLEAR ENERGY, ENGINE TECHNOLOGY AND ENERGY IN TRANSPORTATION, CONTROLLING FACTORS RELATED TO THE OPERATING RELIABILITY AND SERVICE LIFE OF VARIOUS PRODUCTS, FINDING MATERIAL SOLUTIONS FOR DIFFICULT OPERATING CONDITIONS, PROMOTING AND DEVELOPING OF ENVIRONMENTALLY FRIENDLY PRODUCTS AND PRODUCTION METHODS, AS WELL AS DEVELOPING MODELS FOR EXPLOITING NEW TECHNOLOGIES FOR THE MANAGEMENT OF GOODS AND INFORMATION FLOWS; TECHNICAL AND STRUCTURAL PLANNING AND CONSULTANCY IN THE FIELDS OF MOBILE COMMUNICATIONS TECHNOLOGY, INFORMATION SYSTEM APPLICATIONS, TELECOMMUNICATIONS AND NETWORK TECHNOLOGIES, SAFETY AND RELIABILITY RESEARCH, SENSOR TECHNOLOGY, ENVIRONMENTAL ISSUES FOCUSING ON FOREST CHEMICALS, PRINTING PROCESSES, MINERAL REFINEMENT, DEVELOPING AND RESEARCHING BIOMOLECULES, CELL FACTORY, PROCESS TECHNOLOGY, BUILDING TECHNOLOGY, FOOD DESIGN, MICROBIOLOGY, RESEARCHING ENERGY PRODUCTION, NEW ENERGY TECHNOLOGIES, NUCLEAR ENERGY, ENGINE TECHNOLOGY AND ENERGY IN TRANSPORTATION, CONTROLLING FACTORS RELATED TO THE OPERATING RELIABILITY AND SERVICE LIFE OF VARIOUS PRODUCTS, FINDING MATERIAL SOLUTIONS FOR DIFFICULT OPERATING CONDITIONS, PROMOTING AND DEVELOPING OF ENVIRONMENTALLY FRIENDLY PRODUCTS AND PRODUCTION METHODS, AS WELL AS DEVELOPING MODELS FOR EXPLOITING NEW TECHNOLOGIES FOR THE MANAGEMENT OF GOODS AND INFORMATION FLOWS; PRODUCT RESEARCH AND DEVELOPMENT SERVICES; DESIGN FOR OTHERS AND OPERATION OF MOBILE COMMUNICATIONS TECHNOLOGY, INFORMATION SYSTEM APPLICATIONS, TELECOMMUNICATIONS AND NETWORK TECHNOLOGIES, SAFETY AND RELIABILITY RESEARCH, SENSOR TECHNOLOGY, ENVIRONMENTAL ISSUES FOCUSING ON FOREST CHEMICALS, PRINTING PROCESSES, MINERAL REFINEMENT, DEVELOPING AND RESEARCHING BIOMOLECULES, CELL FACTORY, PROCESS TECHNOLOGY, BUILDING TECHNOLOGY, FOOD DESIGN, MICROBIOLOGY, RESEARCHING ENERGY PRODUCTION, NEW ENERGY TECHNOLOGIES, NUCLEAR ENERGY, ENGINE TECHNOLOGY AND ENERGY IN TRANSPORTATION, CONTROLLING FACTORS RELATED TO THE OPERATING RELIABILITY AND SERVICE LIFE OF VARIOUS PRODUCTS, FINDING MATERIAL SOLUTIONS FOR DIFFICULT OPERATING CONDITIONS, PROMOTING AND DEVELOPING OF ENVIRONMENTALLY FRIENDLY PRODUCTS AND PRODUCTION METHODS, AS WELL AS DEVELOPING MODELS FOR EXPLOITING NEW TECHNOLOGIES FOR THE MANAGEMENT OF GOODS AND INFORMATION FLOWS; COMPUTER PROGRAMMING FOR OTHERS; MAINTENANCE OF COMPUTER SOFTWARE; UPDATING AND DEVELOPMENT OF COMPUTER SOFTWARE FOR OTHERS; ADMINISTRATION AND LICENSING OF INDUSTRIAL PROPERTY RIGHTS AND CONSULTANCY RELATING THERETO (U.S. CLS. 100 AND 101).

ING MATERIAL SOLUTIONS FOR DIFFICULT OPERATING CONDITIONS, PROMOTING AND DEVELOPING OF ENVIRONMENTALLY FRIENDLY PRODUCTS AND PRODUCTION METHODS, AS WELL AS DEVELOPING MODELS FOR EXPLOITING NEW TECHNOLOGIES FOR THE MANAGEMENT OF GOODS AND INFORMATION FLOWS FOR OTHERS; OPERATION AND ANALYSIS OF COMPUTER SYSTEMS FOR OTHERS IN THE FIELDS OF MOBILE COMMUNICATIONS TECHNOLOGY, INFORMATION SYSTEM APPLICATIONS, TELECOMMUNICATIONS AND NETWORK TECHNOLOGIES, SAFETY AND RELIABILITY RESEARCH, SENSOR TECHNOLOGY, ENVIRONMENTAL ISSUES FOCUSING ON FOREST CHEMICALS, PRINTING PROCESSES, MINERAL REFINEMENT, DEVELOPING AND RESEARCHING BIOMOLECULES, CELL FACTORY, PROCESS TECHNOLOGY, BUILDING TECHNOLOGY, FOOD DESIGN, MICROBIOLOGY, RESEARCHING ENERGY PRODUCTION, NEW ENERGY TECHNOLOGIES, NUCLEAR ENERGY, ENGINE TECHNOLOGY AND ENERGY IN TRANSPORTATION, CONTROLLING FACTORS RELATED TO THE OPERATING RELIABILITY AND SERVICE LIFE OF VARIOUS PRODUCTS, FINDING MATERIAL SOLUTIONS FOR DIFFICULT OPERATING CONDITIONS, PROMOTING AND DEVELOPING OF ENVIRONMENTALLY FRIENDLY PRODUCTS AND PRODUCTION METHODS, AS WELL AS DEVELOPING MODELS FOR EXPLOITING NEW TECHNOLOGIES FOR THE MANAGEMENT OF GOODS AND INFORMATION FLOWS AND TELECOMMUNICATION SYSTEMS AND NETWORKS FOR OTHERS; LEASING OF COMPUTERS AND COMPUTER SOFTWARE AND ADP DATABASES FOR USE IN THE FIELDS OF MOBILE COMMUNICATIONS TECHNOLOGY, INFORMATION SYSTEM APPLICATIONS, TELECOMMUNICATIONS AND NETWORK TECHNOLOGIES, SAFETY AND RELIABILITY RESEARCH, SENSOR TECHNOLOGY, ENVIRONMENTAL ISSUES FOCUSING ON FOREST CHEMICALS, PRINTING PROCESSES, MINERAL REFINEMENT, DEVELOPING AND RESEARCHING BIOMOLECULES, CELL FACTORY, PROCESS TECHNOLOGY, BUILDING TECHNOLOGY, FOOD DESIGN, MICROBIOLOGY, RESEARCHING ENERGY PRODUCTION, NEW ENERGY TECHNOLOGIES, NUCLEAR ENERGY, ENGINE TECHNOLOGY AND ENERGY IN TRANSPORTATION, CONTROLLING FACTORS RELATED TO THE OPERATING RELIABILITY AND SERVICE LIFE OF VARIOUS PRODUCTS, FINDING MATERIAL SOLUTIONS FOR DIFFICULT OPERATING CONDITIONS, PROMOTING AND DEVELOPING OF ENVIRONMENTALLY FRIENDLY PRODUCTS AND PRODUCTION METHODS, AS WELL AS DEVELOPING MODELS FOR EXPLOITING NEW TECHNOLOGIES FOR THE MANAGEMENT OF GOODS AND INFORMATION FLOWS; COMPUTER PROGRAMMING FOR OTHERS; MAINTENANCE OF COMPUTER SOFTWARE; UPDATING AND DEVELOPMENT OF COMPUTER SOFTWARE FOR OTHERS; ADMINISTRATION AND LICENSING OF INDUSTRIAL PROPERTY RIGHTS AND CONSULTANCY RELATING THERETO (U.S. CLS. 100 AND 101).

CAROLYN CATALDO, EXAMINING ATTORNEY

SN 76-384,084, REGO-FIX AG, 4456 TENNIKEN, SWITZERLAND, FILED 3-7-2002.

## **POWRGRIP**

PRIORITY CLAIMED UNDER SEC. 44(D) ON SWITZERLAND APPLICATION NO. 08847/2001, FILED 9-7-2001, REG. NO. 494312, DATED 2-5-2002, EXPIRES 9-7-2011.

#### **CLASS 6—METAL GOODS**

FOR GOODS OF COMMON METAL, NAMELY IRON AND STEEL AND THEIR ALLOYS (U.S. CLS. 2, 12, 13, 14, 23, 25 AND 50).



**CLASS 7—MACHINERY**

FOR PRECISION CLAMPING TOOLS FOR POWER-OPERATED MACHINES TOOLS WHICH ARE SOLD AS COMPONENT PARTS OF POWER OPERATED MACHINE TOOLS AND SEPARATELY, NAMELY CLAMPS USED ON TURNING MACHINES, MILLING MACHINES DRILLING MACHINES FOR THE CLAMPING OF CUTTING TOOLS LIKE DRILLS, MILLING CUTTERS AND REAMERS FOR USE IN MACHINING APPLICATIONS (U.S. CLS. 13, 19, 21, 23, 31, 34 AND 35).

**CLASS 40—MATERIAL TREATMENT**

FOR CUSTOM CONSTRUCTION OF IRON AND STEEL, IRON ALLOY, AND STEEL ALLOY GOODS, NAMELY TOOL HOLDING AND WORK HOLDING SYSTEMS AND ASSOCIATED CLAMPING DEVICES FOR USE IN MACHINING APPLICATIONS (U.S. CLS. 100, 103 AND 106).

**CLASS 42—SCIENTIFIC, COMPUTER AND LEGAL SERVICES**

FOR DEVELOPMENT OF NEW PRODUCTS FOR OTHER IN THE FIELD OF TOOLS FOR USE IN MACHINING APPLICATIONS (U.S. CLS. 100 AND 101).  
MARY BOAGNI, EXAMINING ATTORNEY

**CLASS 38—COMMUNICATION**

FOR TELECOMMUNICATIONS RESELLER SERVICES, NAMELY, PROVIDING LONG DISTANCE TELECOMMUNICATION SERVICES; TELECOMMUNICATIONS ROUTING AND JUNCTION SERVICES; PROVIDING TELECOMMUNICATIONS CONNECTIONS TO A GLOBAL COMPUTER NETWORK (U.S. CLS. 100, 101 AND 104).

**CLASS 41—EDUCATION AND ENTERTAINMENT**

FOR CONDUCTING EDUCATIONAL CONFERENCES, CONVENTIONS AND TRADE SHOWS IN ALL AREAS OF BUSINESS, COMMERCE, ENTERTAINMENT, EDUCATION, HEALTH AND SCIENCES; CONDUCTING CONFERENCES, CONVENTIONS AND TRADE SHOWS FOR EDUCATIONAL AND CULTURAL PURPOSES (U.S. CLS. 100, 101 AND 107).

**CLASS 42—SCIENTIFIC, COMPUTER AND LEGAL SERVICES**

FOR TECHNICAL CONSULTING FOR EXHIBITIONS; DESIGNING, CONSTRUCTING, INSTALLING AND DECORATING TRADE FAIR AND EXHIBIT STANDS (U.S. CLS. 100 AND 101).  
PAUL F. GAST, EXAMINING ATTORNEY

SN 76-384,236. KÖLNMESSE GMBH, 50679 KÖLN, FED REP GERMANY, FILED 3-19-2002.

SN 76-391,784. REED ELSEVIER INC., NEWTON, MA. FILED 4-8-2002.



OWNER OF FED REP GERMANY REG. NO. 30145833, DATED 10-25-2001, EXPIRES 7-31-2011.

**CLASS 16—PAPER GOODS AND PRINTED MATTER**

FOR PRINTED MATTER, NAMELY, MAGAZINES, BROCHURES AND NEWSLETTERS REGARDING TRADE FAIRS, CONFERENCES, CONVENTIONS AND EXHIBITIONS (U.S. CLS. 2, 5, 22, 23, 29, 37, 38 AND 50).

**CLASS 35—ADVERTISING AND BUSINESS**

FOR ORGANIZING, ARRANGING, PROMOTING AND CONDUCTING OF TRADE FAIRS AND EXHIBITIONS FOR ECONOMIC AND ADVERTISING PURPOSES; ORGANIZATION AND BUSINESS CONSULTATION SERVICES TO TRADE SHOW EXHIBITIONS; ADVERTISING SERVICES FOR OTHERS; PREPARING ADVERTISEMENTS FOR OTHERS; PUBLIC RELATIONS SERVICES FOR TRADE FAIRS AND EXHIBITIONS (U.S. CLS. 100, 101 AND 102).

**CLASS 37—CONSTRUCTION AND REPAIR**

FOR CONSTRUCTION OF READY TO USE FAIR STANDS; HANDY-CRAFT SERVICES, NAMELY INSTALLATION OF ELECTRICITY, PLUMBING, GAS AND WATER INSTALLATIONS AND CLEANING OF FAIR STANDS (U.S. CLS. 100, 103 AND 106).

**REED****CLASS 35—ADVERTISING AND BUSINESS**

FOR PERSONNEL PLACEMENT AND RECRUITMENT SERVICES; ON-LINE PERSONNEL PLACEMENT AND RECRUITMENT SERVICES; EMPLOYMENT AGENCIES; EMPLOYMENT COUNSELING, HIRING, RECRUITING, PLACEMENT, STAFFING AND CAREER NETWORKING SERVICES; EMPLOYMENT OUTPLACEMENT SERVICES; CAREER PLACEMENT; PERSONNEL RELOCATION; PROVIDING EMPLOYMENT LISTINGS, CAREER DEVELOPMENT AND CAREER OPPORTUNITIES TO OTHERS VIA A GLOBAL COMPUTER NETWORK; PROVIDING ON-LINE INFORMATION AND INTERACTIVE DATABASES IN THE FIELDS OF EMPLOYMENT, RECRUITING, JOBS, CAREERS, PERSONAL ISSUES RELATED TO CAREERS AND WORK LIFE, JOB RESOURCES, JOB LISTINGS AND RESUMES; POSTING OF RESUMES AND MATCHING RESUMES WITH EMPLOYMENT OPPORTUNITIES LISTED BY EMPLOYERS, ALL THROUGH A GLOBAL COMPUTER NETWORK; EMPLOYMENT SERVICES, NAMELY, PROVIDING SENIOR-LEVEL JOB POSTINGS, NETWORKING OPPORTUNITIES, CAREER MANAGEMENT TOOLS AND INFORMATION ON RECRUITMENT, EMPLOYMENT, AND EMPLOYEE RETENTION ISSUES FOR EXECUTIVES VIA A GLOBAL COMPUTER NETWORK; AND ON-LINE JOB BOARDS (U.S. CLS. 100, 101 AND 102).

**CLASS 41—EDUCATION AND ENTERTAINMENT**

FOR PROVIDING ON-LINE INFORMATION AND NEWS IN THE FIELD OF EMPLOYMENT TRAINING; CAREER COUNSELING; PROVIDING CAREER INFORMATION VIA THE INTERNET; PROVIDING ON-LINE INFORMATION AND ADVICE ON RESUME CREATION (U.S. CLS. 100, 101 AND 107).  
JULIA HARDY COFIELD, EXAMINING ATTORNEY

SN 76-419,127. THE CLASSICS CHICAGO, INC., CHICAGO, IL. FILED 6-10-2002.

SN 76-440,180. PHOENIX X-RAY SYSTEMS + SERVICES GMBH, WUNSTORF, FED REP GERMANY, FILED 8-14-2002.

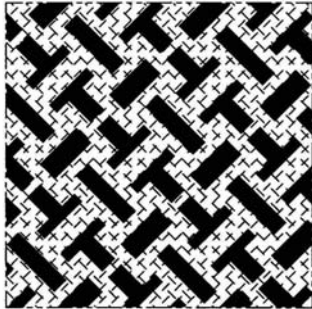

THE LINING SHOWN IN THE DRAWING IS A FEATURE OF THE MARK.

THE MARK CONSISTS OF A REPEATING PATTERN OF THE LETTER "T" AND RECTANGLES. THE DOTTED LINE OUTLINING THE DESIGN IS NOT A FEATURE OF THE MARK BUT IS USED TO INDICATE THE REPEATING NATURE OF THE DESIGN ON PACKAGING OR ON THE GOODS, WHICH MAY TAKE ANY SHAPE.

**CLASS 18—LEATHER GOODS**

FOR HANDBAGS, POCKETBOOKS, WALLETS, BACKPACKS AND COSMETIC BAGS SOLD EMPTY; UMBRELLA (U.S. CLS. 1, 2, 3, 22 AND 41).

**CLASS 25—CLOTHING**

FOR SHOES, BOOTS, SNEAKERS, BELTS AND SCARVES (U.S. CLS. 22 AND 39).  
JERI J. FICKES, EXAMINING ATTORNEY

---

SN 76-425,477. DREAMWELL, LTD., LAS VEGAS, NV. FILED 6-25-2002.

**MOISTUREBAN**

**CLASS 20—FURNITURE AND ARTICLES NOT OTHERWISE CLASSIFIED**

FOR MATTRESSES (U.S. CLS. 2, 13, 22, 25, 32 AND 50).

**CLASS 24—FABRICS**

FOR MATTRESS PADS; FABRIC FOR THE MANUFACTURE OF MATTRESSES AND MATTRESS PADS (U.S. CLS. 42 AND 50).  
SONYA STEPHENS, EXAMINING ATTORNEY



NO CLAIM IS MADE TO THE EXCLUSIVE RIGHT TO USE NANO FOCUS, APART FROM THE MARK AS SHOWN.

**CLASS 9—ELECTRICAL AND SCIENTIFIC APPARATUS**

FOR X-RAY SYSTEMS FOR NON-DESTRUCTIVE TESTING IN SCIENCE AND INDUSTRY, NAMELY X-RAY APPARATUS WITH IMAGE RESOLUTION IN THE MICROMETER AND SUBMICROMETER OR NANOMETER RANGE, X-RAY TUBES WITH FOCAL SPOTS IN THE MICROMETER AND SUBMICROMETER/NANOMETER RANGE FOR NON-DESTRUCTIVE TESTING; IMAGE PROCESSING AND CONTROL SOFTWARE FOR NON-DESTRUCTIVE TESTING WITH X-RAY SYSTEMS AND X-RAY TUBES; IMAGE PROCESSING AND CONTROL SOFTWARE FOR THE X-RAY ANALYSIS AND INSPECTION OF MEDICAL, BIOLOGICAL AND PATHOLOGICAL PREPARATIONS AND SPECIMEN (U.S. CLS. 21, 23, 26, 36 AND 38).  
FIRST USE 9-17-2001; IN COMMERCE 9-17-2001.

**CLASS 10—MEDICAL APPARATUS**

FOR ROENTGEN SYSTEMS FOR ANALYSIS AND INSPECTION OF MEDICAL, BIOLOGICAL AND PATHOLOGICAL PREPARATIONS AND SPECIMEN, NAMELY X-RAY APPARATUS WITH IMAGE RESOLUTION IN THE MICROMETER AND SUBMICROMETER/NANOMETER RANGE, X-RAY TUBES WITH FOCAL SPOTS IN THE MICROMETER AND SUBMICROMETER/NANOMETER RANGE FOR ANALYSIS AND INSPECTION OF MEDICAL, BIOLOGICAL AND PATHOLOGICAL PREPARATIONS AND SPECIMEN ALL FOR MEDICAL USE (U.S. CLS. 26, 39 AND 44).  
FIRST USE 9-17-2001; IN COMMERCE 9-17-2001.  
SUSAN STIGLITZ, EXAMINING ATTORNEY

---

SN 76-459,393. ACCESSORY NETOWRK GROUP LLC, NEW YORK, NY. FILED 10-15-2002.

**CLASS 18—LEATHER GOODS**

FOR WALLETS, TRAVEL BAGS, TOTE BAGS, BACKPACKS, KNAPSACKS, DUFFLE BAGS, BELT BAGS, ROLL BAGS, BOOK BAGS, GYM BAGS, ATTACHE CASES, BRIEFCASES AND LUGGAGE (U.S. CLS. 1, 2, 3, 22 AND 41).

**CLASS 25—CLOTHING**

FOR HATS, CAPS, SCARVES, GLOVES, MITTENS, T-SHIRTS AND TOPS, VESTS, AND BELTS (U.S. CLS. 22 AND 39).

NICHOLAS ALTREE, EXAMINING ATTORNEY

SN 76-467,114. SPEEDWAY MOTORSPORTS, INC., CONCORD, NC. FILED 11-6-2002.



OWNER OF U.S. REG. NOS. 1,264,512, 2,590,928 AND OTHERS.

NO CLAIM IS MADE TO THE EXCLUSIVE RIGHT TO USE MOTORSPORTS, INC. WITH RESPECT TO CLASSES 21 AND 41 ONLY, APART FROM THE MARK AS SHOWN.

THE LINES IN THE DRAWING ARE A FEATURE OF THE MARK AND DO NOT INDICATE COLOR.

SEC. 2(F) AS TO "SPEEDWAY MOTORSPORTS".

**CLASS 6—METAL GOODS**

FOR METAL KEY RINGS, METAL LICENSE PLATES AND METAL IDENTIFICATION TAGS (U.S. CLS. 2, 12, 13, 14, 23, 25 AND 50).

**CLASS 12—VEHICLES**

FOR REDUCED-SIZE AND FULL-SIZE AUTOMOBILES FOR RACING IN OVAL TRACK AND ROAD COURSE COMPETITIONS (U.S. CLS. 19, 21, 23, 31, 35 AND 44).

**CLASS 14—JEWELRY**

FOR JEWELRY, NAMELY, LAPEL PINS, CHARMS AND BELT BUCKLES OF PRECIOUS METAL (U.S. CLS. 2, 27, 28 AND 50).

**CLASS 16—PAPER GOODS AND PRINTED MATTER**

FOR PAPER GOODS AND PRINTED MATERIALS, NAMELY POSTERS, BUMPER STICKERS, DECALS, WALL CALENDARS, WINDOW STICKERS, COLLECTIBLE TRADING CARD SETS AND COLLECTIBLE TRIVIA CARD SETS, BROCHURES AND BOOKS ABOUT AUTOMOBILE RACING (U.S. CLS. 2, 5, 22, 23, 29, 37, 38 AND 50).

**CLASS 20—FURNITURE AND ARTICLES NOT OTHERWISE CLASSIFIED**

FOR PLASTIC NOVELTY LICENSE PLATES AND PLASTIC KEY RINGS (U.S. CLS. 2, 13, 22, 25, 32 AND 50).

**CLASS 21—HOUSEWARES AND GLASS**

FOR HOUSEWARES AND GLASSWARE, NAMELY DRINKING GLASSES, CUPS, MUGS; INSULATING SLEEVE BEVERAGE HOLDERS MADE OF RUBBER, PLASTIC OR FOAM AND PLASTIC WATER BOTTLES SOLD EMPTY (U.S. CLS. 2, 13, 23, 29, 30, 33, 40 AND 50).

**CLASS 24—FABRICS**

FOR CLOTH FLAGS, TOWELS AND CLOTH PENNANTS (U.S. CLS. 42 AND 50).

**CLASS 25—CLOTHING**

FOR CLOTHING, NAMELY SWEATSHIRTS, WARM-UP SETS, SHORTS, SHIRTS, SPORT SHIRTS, GOLF SHIRTS, T-SHIRTS, SUSPENDERS, SWEATERS, JACKETS, HEADBANDS, CAPS, VISORS, STRAW HATS, SOCKS AND INFANT SETS, NAMELY, BABY BIBS NOT OF PAPER (U.S. CLS. 22 AND 39).

**CLASS 28—TOYS AND SPORTING GOODS**

FOR TOYS, NAMELY, MINIATURE CARS AND TRUCKS MECHANICALLY AND ELECTRICALLY OPERATED; PLAYING CARDS (U.S. CLS. 22, 23, 38 AND 50).

**CLASS 41—EDUCATION AND ENTERTAINMENT**

FOR ENTERTAINMENT SERVICES IN THE NATURE OF ORGANIZING AND CONDUCTING MOTOR VEHICLE RACES AND EXHIBITIONS (U.S. CLS. 100, 101 AND 107).

WILLIAM VERHOSEK, EXAMINING ATTORNEY

SN 76-471,810. THOMAS COOK UK LIMITED, PETERBOROUGH PE3 8SB, UNITED KINGDOM. FILED 12-3-2002.



PRIORITY CLAIMED UNDER SEC. 44(D) ON ERPN CMNTY TM OFC APPLICATION NO. 2,896,892, FILED 10-18-2002, REG. NO. 2896892, DATED 7-27-2004, EXPIRES 10-18-2012.

NO CLAIM IS MADE TO THE EXCLUSIVE RIGHT TO USE "TRIPS", APART FROM THE MARK AS SHOWN.

THE ENGLISH TRANSLATION OF THE WORD CULTURA IN THE MARK IS "CULTURE".

**CLASS 16—PAPER GOODS AND PRINTED MATTER**

FOR PRINTED MATTER, NAMELY, BOOKS IN THE FIELD OF TRAVEL; PRINTED PUBLICATIONS, NAMELY PERIODICALS IN THE FIELD OF TRAVEL; DIARIES; CALENDARS; PERSONAL ORGANIZERS; POSTERS; WRITING INSTRUMENTS; DECALOMANIAS; MAPS; PRINTED WALL CHARTS; PRINTED TICKETS; PRINTED TIMETABLES; TRAVELERS' BLANK CHECKS; GUIDE BOOKS; PAPER IDENTIFICATION TAGS FOR LUGGAGE (U.S. CLS. 2, 5, 22, 23, 29, 37, 38 AND 50).

**CLASS 35—ADVERTISING AND BUSINESS**

FOR ARRANGING FOR THE TRANSPORTATION OF GOODS BY AUTOMOBILE, TRUCK, BUS, RAIL AND BOAT (U.S. CLS. 100, 101 AND 102).

**CLASS 36—INSURANCE AND FINANCIAL**

FOR MONEY EXCHANGE SERVICES; ELECTRONIC FUNDS TRANSFER; CREDIT, DEBIT, CHECK GUARANTEE AND CHARGE CARD SERVICES; AUTOMATED BILL PAYMENT SERVICES; INSURANCE SERVICES, NAMELY INSURANCE BROKERAGE AND UNDERWRITING SERVICES IN THE FIELD OF TRAVEL AND ACCIDENT INSURANCE; PROVIDING FINANCIAL INFORMATION IN THE FIELD OF MONEY AND CASH TRANSFER (U.S. CLS. 100, 101 AND 102).

SN 76-473.004. NORTHGATE INFORMATION SOLUTIONS UK LIMITED, HEMEL HEMPSTEAD, HERTFORDSHIRE, HP2 7HU, UNITED KINGDOM, FILED 11-27-2002.

**CLASS 39—TRANSPORTATION AND STORAGE**

FOR TRANSPORTATION OF PERSONS AND GOODS BY AIR; TRAVEL AGENCY SERVICES, NAMELY, MAKING RESERVATIONS AND BOOKINGS FOR TRANSPORTATION AND TOURS; ARRANGING AND ORGANIZING VACATIONS AND TOURS FOR OTHERS; PROVIDING TRAVEL AND TOURIST INFORMATION OVER COMPUTER NETWORKS AND THE INTERNET (U.S. CLS. 100 AND 105).



**CLASS 43—HOTEL AND RESTAURANT SERVICES**

FOR TRAVEL AGENCY SERVICES, NAMELY, MAKING HOTEL RESERVATIONS FOR OTHERS (U.S. CLS. 100 AND 101).  
CAROLINE WOOD, EXAMINING ATTORNEY

PRIORITY CLAIMED UNDER SEC. 44(D) ON UNITED KINGDOM APPLICATION NO. 2304981, FILED 7-10-2002, REG. NO. 2304981, DATED 7-10-2002, EXPIRES 7-10-2012.

SN 76-472.400. CARING AMBASSADORS PROGRAM, INC., DUNWOODY, GA. FILED 12-3-2002.

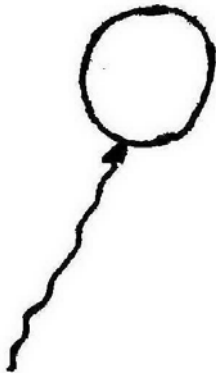

**CLASS 9—ELECTRICAL AND SCIENTIFIC APPARATUS**

FOR COMPUTER PROGRAMS FOR USE IN DATABASE MANAGEMENT AND CUSTOMER RELATIONSHIP MANAGEMENT; COMPUTER PROGRAMS FOR USE IN DATABASE MANAGEMENT FOR USE IN CONNECTION WITH HUMAN RESOURCE AND PAYROLL SYSTEMS, AND BUSINESS PROCESS OUTSOURCING AND INFORMATION TECHNOLOGY MANAGED SERVICES; COMPUTER PROGRAMS FOR DATABASE MANAGEMENT FOR USE BY LOCAL GOVERNMENT AND POLICE AUTHORITIES; COMPUTER SOFTWARE FOR USE IN DATABASE MANAGEMENT FOR USE IN CONNECTION WITH HUMAN RESOURCE AND PAYROLL SYSTEMS, BUSINESS PROCESSING OUTSOURCING AND INFORMATION TECHNOLOGY MANAGED SERVICES; COMPUTER SOFTWARE FOR DATABASE MANAGEMENT FOR USE BY LOCAL GOVERNMENT AND POLICE AUTHORITIES; COMPUTER DISCS FEATURING COMPUTER PROGRAMS FOR USE IN DATABASE MANAGEMENT AND CUSTOMER RELATIONSHIP MANAGEMENT; COMPUTER DISCS FEATURING PROGRAMS FOR DATABASE MANAGEMENT FOR USE IN CONNECTION WITH HUMAN RESOURCE AND PAYROLL SYSTEMS, BUSINESS PROCESS OUTSOURCING AND INFORMATION TECHNOLOGY MANAGED SERVICES; MAGNETIC MEDIA BEARING COMPUTER PROGRAMS FOR USE IN DATABASE MANAGEMENT (U.S. CLS. 21, 23, 26, 36 AND 38).

THE MARK CONSISTS OF A BALLOON TETHERED TO A STRING.  
SEC. 2(F).

**CLASS 35—ADVERTISING AND BUSINESS**

FOR PROMOTING PUBLIC AWARENESS OF THE NEED FOR EMPLOYERS TO ESTABLISH HEALTHCARE SUPPORT GROUPS (U.S. CLS. 100, 101 AND 102).  
FIRST USE 0-0-1997; IN COMMERCE 0-0-1997.

**CLASS 35—ADVERTISING AND BUSINESS**

FOR COMPUTER DATA PROCESSING (U.S. CLS. 100, 101 AND 102).

**CLASS 44—MEDICAL, BEAUTY AND AGRICULTURAL SERVICES**

FOR SUPPORT SERVICES, NAMELY, PROVIDING HEALTHCARE AND WELLNESS INFORMATION TO INDIVIDUALS WITH A LIFE-CHANGING OR LIFE-THREATENING DISEASE AND TO HELP THESE INDIVIDUALS TAKE AN ACTIVE ROLE IN THEIR HEALTHCARE AND IN HELPING OTHERS WITH THEIR DISEASES (U.S. CLS. 100 AND 101).  
FIRST USE 0-0-1997; IN COMMERCE 0-0-1997.  
ALICIA COLLINS, EXAMINING ATTORNEY

**CLASS 37—CONSTRUCTION AND REPAIR**

FOR INSTALLATION, REPAIR AND MAINTENANCE OF COMPUTERS AND COMPUTER NETWORKS; MAINTENANCE AND UPDATING OF COMPUTER HARDWARE; INSTALLATION OF COMPUTER HARDWARE (U.S. CLS. 100, 103 AND 106).

**CLASS 40—MATERIAL TREATMENT**

FOR CUSTOM CONSTRUCTION OF COMPUTERS (U.S. CLS. 100, 103 AND 106).

**CLASS 41—EDUCATION AND ENTERTAINMENT**

FOR TRAINING SERVICES RELATING TO COMPUTER SYSTEMS, COMPUTER SOFTWARE AND PROGRAMMING; TRAINING SERVICES RELATING TO PERSONAL DEVELOPMENT; TRAINING SERVICES RELATING TO PROFESSIONAL SKILLS INCLUDING PRESENTATION SKILLS, CUSTOMER CARE AND CONSULTANCY SKILLS (U.S. CLS. 100, 101 AND 107).

**CLASS 42—SCIENTIFIC, COMPUTER AND LEGAL SERVICES**

FOR COMPUTER SYSTEMS ANALYSIS; COMPUTER CONSULTATION; DESIGN OF COMPUTER HARDWARE AND SOFTWARE FOR OTHERS; COMPUTER TIMESHARING; CONSULTATION IN THE FIELD OF COMPUTER HARDWARE AND COMPUTER SOFTWARE; COMPUTER PROGRAMMING FOR OTHERS; PROVISION OF WEBSITE HOSTING, NAMELY, HOSTING THE WEBSITES OF OTHERS ON A COMPUTER SERVER FOR A GLOBAL COMPUTER NETWORK; COMPUTER SUPPORT, NAMELY TECHNICAL SUPPORT SERVICES, NAMELY, TROUBLE-SHOOTING FOR COMPUTER HARDWARE AND SOFTWARE PROBLEMS, AND PROVIDING BACK-UP COMPUTER PROGRAMS AND FACILITIES; PROVISION OF WEBSITES, NAMELY DESIGNING AND IMPLEMENTING WEBSITES FOR OTHERS, MANAGING WEBSITES FOR OTHERS, DISPLAYING THE WEBSITES AND IMAGES OF OTHERS ON A COMPUTER SERVER, HOSTING THE WEBSITES OF OTHERS ON A COMPUTER SERVER FOR A GLOBAL COMPUTER NETWORK, PROVIDING CUSTOMIZED ON-LINE WEB PAGES FEATURING USER-DEFINED INFORMATION, WHICH INCLUDES SEARCH ENGINES AND ON-LINE WEB LINKS TO OTHER WEBSITES; DESIGNING AND IMPLEMENTING COMPUTER PORTALS SO AS TO PROVIDE CUSTOMIZED ON-LINE WEB PAGES FEATURING USER-DEFINED INFORMATION, WHICH INCLUDES SEARCH ENGINES AND ON-LINE WEB LINKS TO OTHER WEBSITES; INSTALLATION, REPAIR AND MAINTENANCE OF COMPUTER SOFTWARE; COMPUTER SOFTWARE DEVELOPMENT; COMPUTER SOFTWARE DESIGN FOR OTHERS (U.S. CLS. 100 AND 101).  
GINA FINK, EXAMINING ATTORNEY

SN 76-478,367. DAKOCYTOMATION DENMARK A/S, 2600 GLOSTRUP, DENMARK, FILED 12-26-2002.

---

**DAKO**

PRIORITY CLAIMED UNDER SEC. 44(D) ON DENMARK APPLICATION NO. VA200202659, FILED 6-28-2002, REG. NO. VR200202506, DATED 7-11-2002, EXPIRES 7-11-2012.  
OWNER OF U.S. REG. NOS. 1,220,474, 2,123,042 AND OTHERS.

**CLASS 1—CHEMICALS**

FOR CHEMICALS USED IN INDUSTRY AND SCIENCE, NAMELY CHEMICAL REAGENTS AND DIAGNOSTIC PREPARATIONS FOR USE IN RESEARCH LABORATORIES AND FOR USE IN INDUSTRY; DIAGNOSTIC REAGENTS FOR MEDICAL RESEARCH USE; DIAGNOSTIC PREPARATIONS AND REAGENTS FOR SCIENTIFIC OR RESEARCH USE (U.S. CLS. 1, 5, 6, 10, 26 AND 46).  
FIRST USE 1-0-1978; IN COMMERCE 1-0-1978.

**CLASS 5—PHARMACEUTICALS**

FOR PHARMACEUTICAL AND VETERINARY PREPARATIONS FOR HUMANS AND ANIMALS FOR DIAGNOSIS OF CANCER; CHEMICAL REAGENTS AND DIAGNOSTIC PREPARATIONS FOR CLINICAL OR MEDICAL LABORATORY USE AND FOR VETERINARY PURPOSES; MEDICAL DIAGNOSTIC REAGENTS; CLINICAL MEDICAL REAGENTS (U.S. CLS. 6, 18, 44, 46, 51 AND 52).  
FIRST USE 1-0-1978; IN COMMERCE 1-0-1978.

**CLASS 9—ELECTRICAL AND SCIENTIFIC APPARATUS**

FOR DIAGNOSTIC APPARATUS AND INSTRUMENTS, NOT FOR MEDICAL PURPOSES, NAMELY, APPARATUS FOR STAINING OF TISSUE OR CELL BASED SAMPLES FOR DIAGNOSTIC OR SCIENTIFIC USE, APPARATUS FOR DETECTION OF TISSUE AND/OR CELL BASED SAMPLES AND SCIENTIFIC APPARATUS FOR HIGH-SPEED CELL AND/OR BEAD SORTING AND ANALYSIS; BIOINFORMATICS-ENABLED DIAGNOSTIC SOFTWARE (U.S. CLS. 21, 23, 26, 36 AND 38).  
FIRST USE 7-1-2002; IN COMMERCE 7-1-2002.

**CLASS 10—MEDICAL APPARATUS**

FOR DIAGNOSTIC APPARATUS AND INSTRUMENTS FOR MEDICAL USE, NAMELY, APPARATUS FOR STAINING OF TISSUE OR CELL BASED SAMPLES FOR DIAGNOSTIC OR MEDICAL USE, APPARATUS FOR DETECTION OF TISSUE OR CELL BASED SAMPLES AND APPARATUS FOR HIGH-SPEED CELL AND/OR BEAD SORTING AND ANALYSIS, ALL FOR MEDICAL PURPOSES (U.S. CLS. 26, 39 AND 44).  
FIRST USE 7-1-2002; IN COMMERCE 7-1-2002.

**CLASS 42—SCIENTIFIC, COMPUTER AND LEGAL SERVICES**

FOR MEDICAL RESEARCH SERVICES (U.S. CLS. 100 AND 101).  
FIRST USE 1-0-1978; IN COMMERCE 1-0-1978.

**CLASS 44—MEDICAL, BEAUTY AND AGRICULTURAL SERVICES**

FOR MEDICAL SERVICES IN THE NATURE OF MEDICAL ANALYSIS AND DIAGNOSIS (U.S. CLS. 100 AND 101).  
FIRST USE 1-0-1978; IN COMMERCE 1-0-1978.  
JOHN SCHUYLER YARD, EXAMINING ATTORNEY

---

SN 76-478,735. CAMBRIDGE INSTITUTE FOR BETTER VISION, INC., TOPSFIELD, MA. FILED 12-20-2002.

**THE PROGRAM FOR BETTER VISION**

NO CLAIM IS MADE TO THE EXCLUSIVE RIGHT TO USE "PROGRAM", APART FROM THE MARK AS SHOWN. SEC. 2(F).

**CLASS 9—ELECTRICAL AND SCIENTIFIC APPARATUS**

FOR PRE-RECORDED AUDIO TAPES FEATURING VISION ENHANCEMENT AND EYE EXERCISE PROGRAMS (U.S. CLS. 21, 23, 26, 36 AND 38).  
FIRST USE 3-14-1988; IN COMMERCE 3-14-1988.

**CLASS 16—PAPER GOODS AND PRINTED MATTER**

FOR PRINTED INSTRUCTIONAL MATERIAL, NAMELY, PAMPHLETS AND CHARTS USED FOR VISION ENHANCEMENT AND EYE EXERCISE INSTRUCTION (U.S. CLS. 2, 5, 22, 23, 29, 37, 38 AND 50).

FIRST USE 3-14-1988; IN COMMERCE 3-14-1988.  
JERI J. FICKES, EXAMINING ATTORNEY

SN 76-478,796. SOCIETE ANONYME DES BAINS DE MER ET DU CERCLE DES ETRANGERS A MONACO, MC 9800 MONTE CARLO, MONACO, FILED 12-24-2002.

**CASINO DE MONACO**

PRIORITY CLAIMED UNDER SEC. 44(D) ON MONACO APPLICATION NO. 23610, FILED 7-1-2002, REG. NO. 02.23234, DATED 9-30-2002, EXPIRES 7-1-2012.

NO CLAIM IS MADE TO THE EXCLUSIVE RIGHT TO USE CASINO, APART FROM THE MARK AS SHOWN.

THE ENGLISH TRANSLATION OF CASINO DE MONACO IS CASINO OF MONACO.  
SEC. 2(F).

**CLASS 9—ELECTRICAL AND SCIENTIFIC APPARATUS**

FOR ELECTRIC APPARATUS AND INSTRUMENTS, NAMELY COMPUTERIZED VIDEO GAMES FOR GAMING PURPOSES, INTERACTIVE VIDEO GAMES OF VIRTUAL REALITY COMPRISED OF COMPUTER HARDWARE AND SOFTWARE, MACHINES FOR PLAYING GAMES OF CHANCE, COMPUTER SOFTWARE GAMES, SOFTWARE FOR USE IN GAMING MACHINES AND GAMING EQUIPMENT, GAMING EQUIPMENT NAMELY GAMING MACHINES, SLOT MACHINES, KENO AND POKER MACHINES, COIN CHANGERS, COIN ACCEPTERS FOR SEPARATING GOOD COINS FROM COUNTERFEITS; PHOTOGRAPHIC APPARATUS; CONTROLLING AND SIGNALING APPARATUS USED IN CASINOS; APPARATUS FOR RECORDING, TRANSMISSION, REPRODUCTION OF SOUND OR IMAGES, NAMELY RADIO APPARATUS, VIDEO SCREEN, VIDEO CAMERAS; CALCULATORS, DATA PROCESSING EQUIPMENT, NAMELY COMMUNICATION SERVERS, COMMUNICATION SOFTWARE FOR CONNECTING GLOBAL COMPUTER NETWORKS, COMPUTER CAMERAS, COMPUTER GAME SOFTWARE, COMPUTER ECOMMERCE SOFTWARE TO ALLOW USERS TO PERFORM ELECTRONIC BUSINESS TRANSACTIONS VIA A GLOBAL COMPUTER NETWORK AND COMPUTERS; FIRE EXTINGUISHERS (U.S. CLS. 21, 23, 26, 36 AND 38).

**CLASS 16—PAPER GOODS AND PRINTED MATTER**

FOR PRINTED MATTER, NAMELY BLANK OR PARTIALLY PRINTED POSTCARDS, PRINTED INVITATIONS, PRINTED MENUS, PRINTED PAPER SIGNS, MENU BOARDS, PRINTED TIMETABLES, BOOKS, MAGAZINES, CATALOGUES FEATURING CASINO, HOTEL AND INTERNATIONAL NEWS, TOURISM; BOOKBINDINGS; PHOTOGRAPHS, STATIONERY; ADHESIVES TAPES FOR STATIONERY OR HOUSEHOLD PURPOSES; ARTISTS' MATERIALS, NAMELY PENCILS, PENS, BRUSHES, PAINT BRUSHES; TYPEWRITERS AND OFFICE REQUISITES, NAMELY TYPEWRITER TYPING ELEMENTS, RUBBER BANDS, STAPLERS; PRINTED INSTRUCTIONAL, EDUCATIONAL, AND TEACHING MATERIALS USED IN HOTELS AND CASINOS FOR TEACHING DIFFERENT GAMES; PLASTIC MATERIALS FOR PACKAGING, NAMELY BAGS FOR PACKAGING, TUBS FOR CONSUMER PRODUCTS, PLASTIC FILMS USED AS PACKAGING FOR FOOD, ENVELOPES, POUCHES FOR MERCHANDISE PACKAGING; PRINTERS' TYPE; PRINTING BLOCKS (U.S. CLS. 2, 5, 22, 23, 29, 37, 38 AND 50).

**CLASS 28—TOYS AND SPORTING GOODS**

FOR GAMES AND PLAYTHINGS, NAMELY PLAYING CARDS, BOARD GAMES, CARD GAMES, COIN-OPERATED VIDEO GAMES, DISPOSABLE TICKET SETS FOR PLAYING GAMES OF CHANCE, HAND HELD UNITS FOR PLAYING ELECTRONIC AND VIDEO GAMES, LOTTERY GAMES, DOMINOS, PARLOR GAMES, EUROPEAN ROULETTE, AMERICAN ROULETTE, VIDEO POKER, POKER GAME AND BOULE GAME; GYMNAS-TIC AND SPORTING ARTICLES, NAMELY GOLF BAGS AND BALLS, SPORT BALLS, PLAY SWIMMING POOLS, SWIMMING EQUIPMENT, GYMNAS-TIC APPARATUS, GYMNAS-TIC TRAINING STOOLS, PORTABLE SUPPORT STRETCHING FOR DANCE AND OTHER EXERCISES AND TENNIS EQUIPMENT; DECORATION FOR CHRISTMAS TREES (U.S. CLS. 22, 23, 38 AND 50).

**CLASS 41—EDUCATION AND ENTERTAINMENT**

FOR ORGANIZING COMMUNITY SPORTING AND CULTURAL ACTIVITIES; PROVIDING CASINO SERVICES WITHIN A HOTEL RESORT ENVIRONMENT; TRAINING FOR THE PERSONNEL EMPLOYED IN CASINOS IN THE USE AND OPERATION OF SLOT MACHINES AND CINEMA EQUIPMENT; CONDUCTING EDUCATIONAL ENTERTAINMENT EXHIBITS IN THE NATURE OF COOKING DEMONSTRATIONS; ENTERTAINMENT SERVICES IN THE NATURE OF OPERA, NAMELY, ORGANIZING, PRODUCING AND PRESENTING LIVE MUSICAL, ORCHESTRAL AND OPERATIVE SHOWS; ORGANIZING SPORTING EVENTS IN THE NATURE OF CAR RACING, TENNIS TOURNAMENTS, GOLF TOURNAMENTS, AND SWIMMING COMPETITIONS (U.S. CLS. 100, 101 AND 107).

ALICE BENMAMAN, EXAMINING ATTORNEY

SN 76-480,972. BEST SOFTWARE, INC., IRVINE, CA. FILED 1-8-2003.

**best**  
software

insights for the life of your organization™

OWNER OF U.S. REG. NOS. 2,229,346, 2,582,484 AND OTHERS.

NO CLAIM IS MADE TO THE EXCLUSIVE RIGHT TO USE SOFTWARE, APART FROM THE MARK AS SHOWN.

**CLASS 9—ELECTRICAL AND SCIENTIFIC APPARATUS**

FOR COMPUTER SOFTWARE FOR USE IN ACCOUNTING, PAYROLL, TAX PREPARATION, GENERATING OFFICE REPORTS AND MANUALS, ELECTRONIC FILING AND FACSIMILE TRANSMISSION, HUMAN RESOURCES AND PERSONNEL MANAGEMENT, FINANCIAL MANAGEMENT AND PLANNING, BUDGET FORECASTING AND ANALYSIS, COMPUTER NETWORK MANAGEMENT, OFFICE ADMINISTRATION, FILE MANAGEMENT, ASSET MAINTENANCE, MANAGEMENT AND RECONCILIATION, MANAGEMENT REPORTING, TRACKING AND ACCOUNTING OF ASSETS AND ASSET ACTIVITY, AND BOOKKEEPING, REAL ESTATE PROPERTY MANAGEMENT, LEASE MANAGEMENT, MESSAGING AND WORKFLOW MANAGEMENT, PROPERTY TAX CALCULATION, ASSESSMENT AND RECORD-KEEPING, PREPARING, PAYING, MANAGING AND ADMINISTERING PROPERTY TAXES AND TAX APPEALS AND USER MANUALS THEREFOR, SOLD AS A UNIT WITH THE COMPUTER SOFTWARE; COMPUTER SOFTWARE TO ALLOW EMPLOYEES AND MANAGERS TO VIEW AND UPDATE PERSONAL INFORMATION USING AN INTERNET BROWSER (U.S. CLS. 21, 23, 26, 36 AND 38).

**CLASS 35—ADVERTISING AND BUSINESS**

FOR CONSULTING SERVICES IN THE FIELDS OF AUTOMATED TAX PREPARATION AND ELECTRONIC FILING OF TAX RETURNS; ELECTRONIC TAX FILING SERVICES; PROVIDING INFORMATION ONLINE AND VIA THE INTERNET IN THE FIELDS OF ACCOUNTING, TAX TREATMENT, TAX PREPARATION AND FILING, BUSINESS MANAGEMENT, HUMAN RESOURCES AND SOFTWARE PRODUCT MARKETING (U.S. CLS. 100, 101 AND 102).

**CLASS 36—INSURANCE AND FINANCIAL**

FOR PROVIDING EMPLOYEE INSURANCE BENEFIT INFORMATION ONLINE VIA THE INTERNET; PROVIDING INFORMATION ONLINE AND VIA THE INTERNET IN THE FIELD OF FINANCIAL ASSET MANAGEMENT; AND FINANCING SERVICES, NAMELY FINANCING THE SOFTWARE PURCHASE OF OTHERS; ELECTRONIC TAX PAYMENT PROCESSING SERVICES (U.S. CLS. 100, 101 AND 102).

**CLASS 41—EDUCATION AND ENTERTAINMENT**

FOR EDUCATIONAL SERVICES, NAMELY CONDUCTING CLASSES AND SEMINARS IN THE FIELDS OF AUTOMATED TAX PREPARATION AND FILING, FILING OF FINANCIAL AND REGULATORY REPORTS, AND THE USE OF COMPUTERS AND COMPUTER PROGRAMS IN THE FIELDS OF ACCOUNTING, HUMAN RESOURCES, BUSINESS MANAGEMENT AND FINANCE (U.S. CLS. 100, 101 AND 107).

**CLASS 42—SCIENTIFIC, COMPUTER AND LEGAL SERVICES**

FOR MAINTENANCE OF COMPUTER SOFTWARE, UPDATING OF COMPUTER SOFTWARE OF OTHERS; TECHNICAL SUPPORT SERVICES, NAMELY TROUBLESHOOTING OF COMPUTER SOFTWARE PROBLEMS; COMPUTER CONSULTING (U.S. CLS. 100 AND 101).

AISHA CLARKE, EXAMINING ATTORNEY

SN 76-483,354. JORDAN OUTDOOR ENTERPRISES, LTD., COLUMBUS, GA. FILED 1-21-2003.

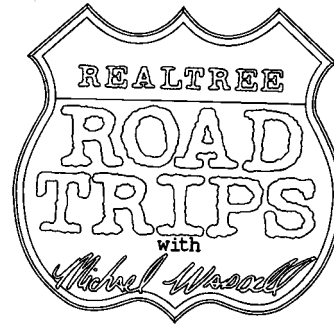

THE NAME MICHAEL WADDELL IDENTIFIES A LIVING INDIVIDUAL WHOSE CONSENT IS OF RECORD.

**CLASS 9—ELECTRICAL AND SCIENTIFIC APPARATUS**

FOR PRE-RECORDED VIDEO IN THE NATURE OF VIDEOTAPES AND DVDS FEATURING LIVE GAME HUNTING (U.S. CLS. 21, 23, 26, 36 AND 38).

FIRST USE 6-0-2004; IN COMMERCE 6-0-2004.

**CLASS 41—EDUCATION AND ENTERTAINMENT**

FOR ENTERTAINMENT SERVICES, NAMELY PROVIDING A TELEVISION SHOW FEATURING LIVE GAME HUNTING (U.S. CLS. 100, 101 AND 107).

FIRST USE 7-0-2003; IN COMMERCE 7-0-2003.

HEATHER THOMPSON, EXAMINING ATTORNEY

SN 76-491,591. PARRILLADA LAS VACAS GORDAS, INC., MIAMI BEACH, FL. FILED 2-20-2003.

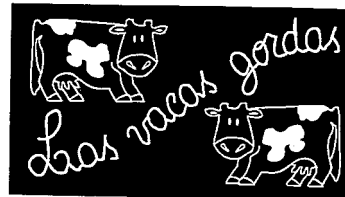

THE MARK IS SPANISH FOR "THE FAT COWS."

**CLASS 25—CLOTHING**

FOR T-SHIRTS, SHORTS, PANTS, SKIRTS, JACKETS, BELTS, SOCKS, SWEATSHIRTS, LEATHER JACKETS, LEATHER PANTS AND LEATHER SKIRTS (U.S. CLS. 22 AND 39).

**CLASS 29—MEATS AND PROCESSED FOODS**

FOR CHEESE SPREADS AND DIPS, VEGETABLE-BASED SPREADS AND DIPS, MEAT-BASED SPREADS AND DIPS, BEAN DIP, MEATS AND SOUPS (U.S. CL. 46).

**CLASS 30—STAPLE FOODS**

FOR SAUCES, SEASONINGS AND MARINADES (U.S. CL. 46).

MICHAEL SOUDERS, EXAMINING ATTORNEY

SN 76-493,229. ALLEN'S ALL-STARS, INC., MIAMI, FL.  
FILED 2-14-2003.

## ALL-STARS CONTRACTING

NO CLAIM IS MADE TO THE EXCLUSIVE RIGHT TO USE "CONTRACTING", APART FROM THE MARK AS SHOWN.

### CLASS 35—ADVERTISING AND BUSINESS

FOR ADVERTISING, NAMELY, PROMOTING THE GOODS AND SERVICES OF OTHERS THROUGH THE DISTRIBUTION OF PRINTED, VIDEO AND AUDIO PROMOTIONAL MATERIALS; PROVIDING ADVERTISING SPACE IN AN ON-LINE BUSINESS DIRECTORY AND PROMOTING THE GOODS AND SERVICES OF OTHERS BY PLACING ADVERTISEMENTS IN AN ON-LINE BUSINESS DIRECTORY AND ON-LINE BUSINESS DIRECTORIES FEATURING ELECTRICAL WORK, HEATING/AIR CONDITIONING INSTALLATION AND REPAIRS, PLUMBING, CARPENTRY, MASONRY, ROOFING, PAINTING, LANDSCAPE DESIGN AND MAINTENANCE, ARCHITECTURAL SERVICES, POOL CONSTRUCTION AND MAINTENANCE, GENERAL CONTRACTING, KITCHEN AND BATH CONSTRUCTION AND REPAIRS, HOME SECURITY, LOCKSMITH, MARBLE AND TILE INSTALLATION AND REPAIRS, FLOORING INSTALLATION AND MAINTENANCE, WINDOW AND DOOR INSTALLATION AND REPAIRS, FENCE AND GATE INSTALLATION AND REPAIRS, CARPETING AND DRAPERY INSTALLATION AND CLEANING, PEST CONTROL, AND REAL ESTATE MANAGEMENT SERVICES (U.S. CLS. 100, 101 AND 102).

### CLASS 37—CONSTRUCTION AND REPAIR

FOR CONSTRUCTION AND REPAIR OF HEATING AND AIR CONDITIONING UNITS, SWIMMING POOLS, KITCHEN AND BATHROOMS, WINDOWS, DOORS, FENCES AND GATES, PLUMBING, MASONRY, ROOFING INSTALLATION SERVICES, CARPENTRY CONTRACTOR SERVICES, AIR CONDITIONING CONTRACTOR SERVICES, PAINTING CONTRACTOR SERVICES, INSTALLATION OF SECURITY SYSTEMS, INSTALLING AND REPAIRING MARBLE AND FLOOR TILE, INSTALLING CARPET, CARPET CLEANING, INSTALLING DRAPERY, DRAPERY CLEANING AND PEST CONTROL (U.S. CLS. 100, 103 AND 106).

GIANCARLO CASTRO, EXAMINING ATTORNEY

SN 76-494,252. VITA ZAHNFABRIK H. RAUTER GMBH & CO. KG, D-79713 BAD SACKINGEN, FED REP GERMANY, FILED 3-3-2003.

**1M1**

SEC. 2(F).

### CLASS 5—PHARMACEUTICALS

FOR DENTAL RESTORATIVE MATERIALS OF A SPECIFIC TOOTH COLOR (U.S. CLS. 6, 18, 44, 46, 51 AND 52).

FIRST USE 2-0-1998; IN COMMERCE 2-0-1998.

### CLASS 10—MEDICAL APPARATUS

FOR ARTIFICIAL TEETH OF A SPECIFIC COLOR (U.S. CLS. 26, 39 AND 44).

FIRST USE 2-0-1998; IN COMMERCE 2-0-1998.

BARBARA A. LOUGHRAN, EXAMINING ATTORNEY

SN 76-494,254. VITA ZAHNFABRIK H. RAUTER GMBH & CO. KG, D-79713 BAD SACKINGEN, FED REP GERMANY, FILED 3-3-2003.

**3L2.5**

SEC. 2(F).

### CLASS 5—PHARMACEUTICALS

FOR DENTAL RESTORATIVE MATERIALS OF A SPECIFIC TOOTH COLOR (U.S. CLS. 6, 18, 44, 46, 51 AND 52).

FIRST USE 2-0-1998; IN COMMERCE 2-0-1998.

### CLASS 10—MEDICAL APPARATUS

FOR ARTIFICIAL TEETH OF A SPECIFIC COLOR (U.S. CLS. 26, 39 AND 44).

FIRST USE 2-0-1998; IN COMMERCE 2-0-1998.

BARBARA A. LOUGHRAN, EXAMINING ATTORNEY

SN 76-494,255. VITA ZAHNFABRIK H. RAUTER GMBH & CO. KG, D-79713 BAD SACKINGEN, FED REP GERMANY, FILED 3-3-2003.

**5M2**

SEC. 2(F).

### CLASS 5—PHARMACEUTICALS

FOR DENTAL RESTORATIVE MATERIALS OF A SPECIFIC TOOTH COLOR (U.S. CLS. 6, 18, 44, 46, 51 AND 52).

FIRST USE 2-0-1998; IN COMMERCE 2-0-1998.

### CLASS 10—MEDICAL APPARATUS

FOR ARTIFICIAL TEETH OF A SPECIFIC COLOR (U.S. CLS. 26, 39 AND 44).

FIRST USE 2-0-1998; IN COMMERCE 2-0-1998.

BARBARA A. LOUGHRAN, EXAMINING ATTORNEY

SN 76-494,304. VITA ZAHNFABRIK H. RAUTER GMBH & CO. KG, D-79713 BAD SACKINGEN, FED REP GERMANY, FILED 3-3-2003.

**4R1.5**

SEC. 2(F).

### CLASS 5—PHARMACEUTICALS

FOR DENTAL RESTORATIVE MATERIALS OF A SPECIFIC TOOTH COLOR (U.S. CLS. 6, 18, 44, 46, 51 AND 52).

FIRST USE 2-0-1998; IN COMMERCE 2-0-1998.

### CLASS 10—MEDICAL APPARATUS

FOR ARTIFICIAL TEETH OF A SPECIFIC COLOR (U.S. CLS. 26, 39 AND 44).

FIRST USE 2-0-1998; IN COMMERCE 2-0-1998.

BARBARA A. LOUGHRAN, EXAMINING ATTORNEY



SN 76-494,371. PRESTACIONES UNIVERSALES, S.A. DE C.V., 06600 MEXICO, D.F., MEXICO, FILED 2-25-2003.

## SI VALE

OWNER OF MEXICO REG. NO. 593,922, DATED 7-30-1998, EXPIRES 7-31-2008.

OWNER OF MEXICO REG. NO. 589,395, DATED 7-30-1998, EXPIRES 7-31-2008.

OWNER OF MEXICO REG. NO. 589,394, DATED 7-30-1998, EXPIRES 7-31-2008.

THE ENGLISH TRANSLATION OF "SI VALE" IS "YES, IT'S WORTH IT".

### CLASS 16—PAPER GOODS AND PRINTED MATTER

FOR PAPER, NAMELY, WRITING PAPER; CARDBOARD; PRINTED MATTER, NAMELY, GENERAL FEATURE MAGAZINES; BOOKBINDING MATERIALS, NAMELY, BOOKBINDINGS, BOOKBINDING WIRE, BOOKBINDING TAPE; PHOTOGRAPHS; STATIONERY; ADHESIVES FOR STATIONERY OR HOUSEHOLD PURPOSES; ARTISTS' MATERIALS, NAMELY, PASTELS, PENCILS, PENS; ARTIST'S BRUSHES; TYPEWRITERS; OFFICE REQUISITES, NAMELY LABELING MACHINES, ENVELOPE SEALING MACHINES; PRINTED INSTRUCTIONAL AND TEACHING MATERIAL IN THE AREA OF SALE OF GOODS OR RENDERING OF SERVICES BY MEANS OF COUPONS; PLASTIC MATERIALS FOR PACKAGING, NAMELY, PLASTIC BAGS; PRINTING TYPE; PRINTING BLOCKS; SPECIALTY SAFETY PAPER AND BOND PAPER FOR PRINTING COUPONS (U.S. CLS. 2, 5, 22, 23, 29, 37, 38 AND 50).

### CLASS 35—ADVERTISING AND BUSINESS

FOR ADVERTISING, NAMELY, PROMOTING THE SALE OF THE GOODS AND SERVICES OF OTHERS THROUGH THE DISTRIBUTION OF COUPONS FOR PURCHASES (U.S. CLS. 100, 101 AND 102).

### CLASS 36—INSURANCE AND FINANCIAL

FOR MEANS OF PAYMENT TO PURCHASE GOODS OR SERVICES, NAMELY, CREDIT CARD SERVICES, DEBIT CARD SERVICES, ESTABLISHING FUNDED ACCOUNTS USED TO PURCHASE GOODS AND SERVICES ON THE INTERNET (U.S. CLS. 100, 101 AND 102).  
ALICIA COLLINS, EXAMINING ATTORNEY

SN 76-494,552. VITA ZAHNFABRIK H. RAUTER GMBH & CO. KG, D-79713 BAD SACKINGEN, FED REP GERMANY, FILED 3-3-2003.

## 2M3

SEC. 2(F).

### CLASS 5—PHARMACEUTICALS

FOR DENTAL RESTORATIVE MATERIALS OF A SPECIFIC TOOTH COLOR (U.S. CLS. 6, 18, 44, 46, 51 AND 52).

FIRST USE 2-0-1998; IN COMMERCE 2-0-1998.

### CLASS 10—MEDICAL APPARATUS

FOR ARTIFICIAL TEETH OF A SPECIFIC COLOR (U.S. CLS. 26, 39 AND 44).

FIRST USE 2-0-1998; IN COMMERCE 2-0-1998.

BARBARA A. LOUGHRAN, EXAMINING ATTORNEY

SN 76-495,148. PARK LI MANAGEMENT SIMULATIONS, INC., DBA MANAGEMENT SIMULATIONS, NORTHFIELD, IL. FILED 3-6-2003.

## CAPSTONE

OWNER OF U.S. REG. NOS. 2,245,268 AND 2,593,024.

### CLASS 9—ELECTRICAL AND SCIENTIFIC APPARATUS

FOR COMPUTER GAME SOFTWARE AND INSTRUCTION MANUALS SOLD AS A UNIT (U.S. CLS. 21, 23, 26, 36 AND 38).

FIRST USE 0-0-1985; IN COMMERCE 0-0-1985.

### CLASS 41—EDUCATION AND ENTERTAINMENT

FOR PROVIDING AN ON-LINE COMPUTER GAME FOR EDUCATIONAL PURPOSES AND INSTRUCTIONAL MANUALS SOLD AS A UNIT (U.S. CLS. 100, 101 AND 107).

FIRST USE 0-0-1985; IN COMMERCE 0-0-1985.

### CLASS 42—SCIENTIFIC, COMPUTER AND LEGAL SERVICES

FOR PROVIDING TEMPORARY USE OF ON-LINE NON-DOWNLOADABLE SOFTWARE THAT ENABLES USERS TO PERFORM BUSINESS MANAGEMENT TECHNIQUES IN THE CONTEXT OF IMAGINARY FACT PATTERNS IN THE FIELD OF BUSINESS MANAGEMENT EDUCATION AND INSTRUCTIONAL MANUALS SOLD AS A UNIT (U.S. CLS. 100 AND 101).

FIRST USE 0-0-1985; IN COMMERCE 0-0-1985.

JENNIFER CHICOSKI, EXAMINING ATTORNEY

SN 76-495,149. PARK LI MANAGEMENT SIMULATIONS, INC., DBA MANAGEMENT SIMULATIONS, NORTHFIELD, IL. FILED 3-6-2003.

## CAPSTONE

OWNER OF U.S. REG. NOS. 2,245,268 AND 2,593,024.

### CLASS 9—ELECTRICAL AND SCIENTIFIC APPARATUS

FOR COMPUTER GAME SOFTWARE AND INSTRUCTION MANUALS SOLD AS A UNIT (U.S. CLS. 21, 23, 26, 36 AND 38).

FIRST USE 0-0-1985; IN COMMERCE 0-0-1985.

### CLASS 41—EDUCATION AND ENTERTAINMENT

FOR PROVIDING AN ON-LINE COMPUTER GAME FOR EDUCATIONAL PURPOSES AND INSTRUCTIONAL MANUALS SOLD AS A UNIT (U.S. CLS. 100, 101 AND 107).

FIRST USE 0-0-1985; IN COMMERCE 0-0-1985.

**CLASS 42—SCIENTIFIC, COMPUTER AND LEGAL SERVICES**

FOR PROVIDING TEMPORARY USE OF ON-LINE NON-DOWNLOADABLE SOFTWARE THAT ENABLES USERS TO PERFORM BUSINESS MANAGEMENT TECHNIQUES IN THE CONTEXT OF IMAGINARY FACT PATTERNS IN THE FIELD OF BUSINESS MANAGEMENT EDUCATION AND INSTRUCTIONAL MANUALS SOLD AS A UNIT (U.S. CLS. 100 AND 101).

FIRST USE 0-0-1985; IN COMMERCE 0-0-1985.  
JENNIFER CHICOSKI, EXAMINING ATTORNEY

SN 76-500,244. WESTPOINT STEVENS INC. I, LAS VEGAS, NV. FILED 3-25-2003.



SN 76-497,460. CUSSANO, SOPHIE, 78000 VERSAILLES, FRANCE, FILED 3-14-2003.

**SALESLAB**

OWNER OF FRANCE REG. NO. 023183946, DATED 9-13-2002, EXPIRES 9-13-2012.

**CLASS 35—ADVERTISING AND BUSINESS**

FOR CONSULTATION IN THE FIELD OF BUSINESS ORGANIZATION AND MANAGEMENT; ORGANIZING EXHIBITIONS TO HELP COMPANIES TO DEVELOP THEIR PROFICIENCY IN SALES AND MARKETING (U.S. CLS. 100, 101 AND 102).

**CLASS 41—EDUCATION AND ENTERTAINMENT**

FOR EDUCATIONAL SERVICES, NAMELY CONDUCTING SEMINARS, CONFERENCES AND CONVENTIONS IN THE FIELDS OF SALES AND MARKETING (U.S. CLS. 100, 101 AND 107).

BARNEY CHARLON, EXAMINING ATTORNEY

**CLASS 20—FURNITURE AND ARTICLES NOT OTHERWISE CLASSIFIED**

FOR BED PILLOWS, DECORATIVE PILLOWS (U.S. CLS. 2, 13, 22, 25, 32 AND 50).

**CLASS 27—FLOOR COVERINGS**

FOR BATH RUGS (U.S. CLS. 19, 20, 37, 42 AND 50).  
SHARI SHEFFIELD, EXAMINING ATTORNEY

SN 76-499,417. MEDPOINT COMMUNICATIONS, INC., EVANSTON, IL. FILED 3-21-2003.

**INTELLIVENT****CLASS 38—COMMUNICATION**

FOR TELECOMMUNICATIONS SERVICES IN THE NATURE OF PROVIDING ONLINE WEB CONFERENCING; PROVIDING VIDEO-ON-DEMAND TRANSMISSION SERVICES IN THE NATURE OF MULTIMEDIA AND VIDEO PRESENTATIONS ELECTRONICALLY TRANSMITTED VIA A GLOBAL COMPUTER NETWORK (U.S. CLS. 100, 101 AND 104).

**CLASS 42—SCIENTIFIC, COMPUTER AND LEGAL SERVICES**

FOR GRAPHIC DESIGN SERVICES; WEB SITE DESIGN SERVICES FOR OTHERS; AUDIOVISUAL SUPPORT SERVICES, NAMELY, TECHNICAL SUPPORT SERVICES IN THE NATURE OF TROUBLESHOOTING OF AUDIO VISUAL COMPUTER HARDWARE AND SOFTWARE PROBLEMS (U.S. CLS. 100 AND 101).

TONJA GASKINS, EXAMINING ATTORNEY

SN 76-503,535. PERFORMFIT, INC., PARKTON, MD. FILED 4-2-2003.

**LIFE LADDER****CLASS 9—ELECTRICAL AND SCIENTIFIC APPARATUS**

FOR PRERECORDED AUDIO TAPES, VIDEO TAPES, AUDIO CASSETTES, VIDEO CASSETTES, DVDS, AND COMPACT DISCS FEATURING FITNESS AND WORK-OUT EXERCISES WITH INSTRUCTIONS (U.S. CLS. 21, 23, 26, 36 AND 38).

**CLASS 28—TOYS AND SPORTING GOODS**

FOR EQUIPMENT FOR EXERCISE, FITNESS AND STRETCHING, NAMELY, PERSONAL EXERCISE MATS, DUMBBELLS, RESISTIVE TUBING, MEDICINE BALLS, AEROBICS EXERCISE STEPS, PERSONAL EXERCISE CONES AND JUMP ROPES (U.S. CLS. 22, 23, 38 AND 50).

**CLASS 41—EDUCATION AND ENTERTAINMENT**

FOR EDUCATION SERVICES, NAMELY CONDUCTING TRAINING PROGRAMS, CLASSES, SEMINARS, CONFERENCES AND WORKSHOPS IN THE FIELDS OF EXERCISE, NUTRITION AND PHYSICAL FITNESS AND DISTRIBUTING COURSE MATERIALS IN CONNECTION THEREWITH; PERSONAL TRAINER SERVICES; PHYSICAL FITNESS INSTRUCTION SERVICES (U.S. CLS. 100, 101 AND 107).

TRACY FLETCHER, EXAMINING ATTORNEY

SN 76-503,592. SJ BERWIN, LONDON, WC1X 8XF, UNITED KINGDOM, FILED 4-2-2003.

## SJ BERWIN

OWNER OF ERPN CMNTY TM OFC REG. NO. 000848614, DATED 6-16-2000, EXPIRES 6-12-2008.

OWNER OF U.S. REG. NOS. 2,353,340, 2,382,323 AND OTHERS.

THE MARK DOES NOT IDENTIFY A PARTICULAR LIVING INDIVIDUAL.

### CLASS 16—PAPER GOODS AND PRINTED MATTER

FOR PRINTED MATTER AND PRINTED PUBLICATIONS, NAMELY, NON-FICTION BOOKS, BOOKLETS, GUIDES, LEAFLETS, BROCHURES, MANUALS, PAMPHLETS, AND NEWSLETTERS ALL IN THE FIELD OF LAW, NAMELY, LEGAL RESEARCH, LEGAL RIGHTS, LEGAL ADVICE, LEGAL GUIDANCE AND LEGAL SERVICES; PRINTED INSTRUCTIONAL, EDUCATIONAL, TEACHING AND GUIDANCE MATERIALS IN THE FIELD OF LAW, NAMELY, LEGAL RESEARCH, LEGAL RIGHTS, LEGAL ADVICE, LEGAL GUIDANCE AND LEGAL SERVICES (U.S. CLS. 2, 5, 22, 23, 29, 37, 38 AND 50).

### CLASS 42—SCIENTIFIC, COMPUTER AND LEGAL SERVICES

FOR LEGAL SERVICES; LEGAL RESEARCH; LEGAL ADVICE; TECHNICAL CONSULTATION AND RESEARCH, ALL IN THE AREAS OF CONTRACT, TORT, INTELLECTUAL PROPERTY, TRADEMARKS, COPYRIGHT, UNFAIR COMPETITION, PASSING OFF, PATENTS, REGISTERED AND UNREGISTERED DESIGNS, DOMAIN NAMES, COMMERCE AND TECHNOLOGY INCLUDING ELECTRONIC COMMERCIAL LAW, PHARMACEUTICALS AND BIOTECHNOLOGY, COMPETITION; AND ANTI-TRUST LAW; EUROPEAN UNION LAW; LITIGATION, ENVIRONMENTAL PLANNING, MEDIA, SPORT, INFORMATION TECHNOLOGY, EMPLOYMENT, PROPERTY, COMMERCIAL PROPERTY, PROPERTY FINANCE, CONSTRUCTION, PLANNING, REAL ESTATE, COMPANY, BANKING AND FINANCE, TAX, PENSIONS; BANKRUPTCY AND INSOLVENCY, CORPORATE, SECURITIZATION; INVESTMENT FUNDS, FINANCIAL SERVICES, PRIVATE EQUITY, VENTURE CAPITAL, LEGAL ASPECTS OF INFRASTRUCTURE, PUBLIC LAW AND HUMAN RIGHTS, CHARITIES; ARBITRATION AND MEDIATION, CONCILIATION SERVICES, NAMELY ALTERNATIVE DISPUTE RESOLUTION SERVICES; AND CONSULTATION SERVICES THEREFOR (U.S. CLS. 100 AND 101).

ALICE BENMAMAN, EXAMINING ATTORNEY

SN 76-505,186. HET FRIESCH PAARDEN-STAMBOEK, 9205 BZ DRACHTEN, NETHERLANDS, FILED 4-9-2003.

## FPS

### CLASS 35—ADVERTISING AND BUSINESS

FOR ASSOCIATION SERVICES, NAMELY PROMOTING THE INTEREST OF PUREBRED FRIESIAN HORSE BREEDERS, OWNERS AND ENTHUSIASTS; MAINTAINING A WORLDWIDE STUD BOOK REGISTRY; MAINTAINING A WORLDWIDE REGISTRY OF PUREBRED FRIESIAN HORSES AND THEIR PEDIGREE; LICENSING OF PUREBRED FRIESIAN HORSES; PROVIDING INFORMATION ABOUT THE PURCHASE AND SELECTION OF PUREBRED FRIESIAN HORSES THROUGH THE MAINTENANCE OF A RESOURCE DATABASE; ISSUANCE OF BREEDING CERTIFICATES (U.S. CLS. 100, 101 AND 102).

FIRST USE 0-0-1879; IN COMMERCE 9-0-1984.

### CLASS 41—EDUCATION AND ENTERTAINMENT

FOR ISSUANCE OF ACHIEVEMENT CERTIFICATES; TRAINING AND APPOINTING JUDGES FOR THE INSPECTION OF PUREBRED FRIESIAN HORSES; EDUCATING OTHERS IN CONNECTION WITH THE PURCHASE, SALE AND REGISTRATION OF PUREBRED FRIESIAN HORSES THROUGH SEMINARS, WORKSHOPS, WEB SITES AND PUBLICATIONS; PUBLISHING INFORMATIVE LITERATURE ABOUT FRIESIAN HORSES; ADVANCING THE STUDY, BREEDING AND EXHIBITING OF PUREBRED FRIESIAN HORSES THROUGH THE USE OF SEMINARS, WORKSHOPS, WEB SITES AND PUBLICATIONS (U.S. CLS. 100, 101 AND 107).

FIRST USE 0-0-1879; IN COMMERCE 9-0-1984.

### CLASS 42—SCIENTIFIC, COMPUTER AND LEGAL SERVICES

FOR INSPECTION OF PUREBRED FRIESIAN HORSES (U.S. CLS. 100 AND 101).

FIRST USE 0-0-1879; IN COMMERCE 9-0-1984.

SUSAN HAYASH, EXAMINING ATTORNEY

SN 76-505,341. DREAM MERCHANT COMPANY KFT., THE, VIGADO TER 1, HUNGARY, FILED 4-9-2003.

ANOTHER SIDE OF CIRQUE DU SOLEIL



### CLASS 3—COSMETICS AND CLEANING PREPARATIONS

FOR BODY AND HAIR CARE PRODUCTS, NAMELY—ESSENTIAL OILS, BATH SALTS, BEAUTY MASKS, MASSAGE OILS, SKIN AND BODY CREAMS, BODY CLEANSING MILK, COSMETIC KIT, COSMETICS; HAIR PRODUCTS, NAMELY SHAMPOO, CONDITIONER, GEL, MOUSSE, SPRAY; SKIN AND BODY LOTIONS, NAIL CARE PREPARATIONS, PERFUMES, SACHETS, POTPOURRIS, SKIN SOAPS, PERSONAL DEODORANTS, DENTIFRICES (U.S. CLS. 1, 4, 6, 50, 51 AND 52).

### CLASS 6—METAL GOODS

FOR METAL KEY CHAINS; METAL KEY RINGS (U.S. CLS. 2, 12, 13, 14, 23, 25 AND 50).

### CLASS 9—ELECTRICAL AND SCIENTIFIC APPARATUS

FOR PRE-RECORDED MEDIA FOR THE STORAGE AND REPRODUCTION OF SOUND AND VIDEO, FEATURING MUSIC AND THEATRICAL OR DRAMATIC PERFORMANCES, NAMELY—AUDIOCASSETTES, VIDEOCASSETTES, AUDIO DISCS, VIDEO DISCS, COMPACT DISCS, DIGITAL VIDEO DISCS, INTERACTIVE COMPACT DISCS, DISKETTES; MOTION PICTURE FILMS FEATURING MUSICAL, THEATRICAL AND DRAMATIC PERFORMANCES; CASES FOR HOLDING AUDIOTAPE AND VIDEOTAPE CASSETTES AND DISCS; SUNGLASSES AND SUNGLASSES CASES; DECORATIVE MAGNETS; ENTERTAINMENT SOFTWARE, NAMELY VIDEO AND COMPUTER GAMES; MAGNETICALLY-ENCODED DEBIT CARDS FOR USE IN PUBLIC TELEPHONES; PROTECTIVE BICYCLE HELMETS; BINOCULARS, OPERA GLASSES, MOUSE PADS, MOBILE PHONE STRAPS; VIEWERS FOR 3-D PLASTIC TRANSPARENCIES (U.S. CLS. 21, 23, 26, 36 AND 38).

**CLASS 14—JEWELRY**

FOR FINE AND COSTUME JEWELRY, NAMELY—JEWELRY PINS, BROOCHES, EARRINGS, BRACELETS, NECKLACES, RINGS, CHARMS, TIE CLIPS, ORNAMENTAL PINS; ITEMS MADE OF PRECIOUS METAL OR COATED THEREWITH, NAMELY CANDLESTICKS, CANDLE HOLDERS, DECORATIVE BOXES, BOOK ENDS, PICTURE FRAMES, KEY RINGS, KEY CHAINS, LIGHTERS, BOOKMARKS, LETTER OPENERS, SCULPTURES; CLOCKS AND WATCHES (U.S. CLS. 2, 27, 28 AND 50).

**CLASS 16—PAPER GOODS AND PRINTED MATTER**

FOR PAPER GOODS, NAMELY—MAGAZINES, BROCHURES, SOUVENIR PROGRAMS, PHOTOS, BOOKS AND COMMEMORATIVE BOOKS REGARDING CIRCUSES AND THE ARTS; POSTERS, LITHOGRAPHS, CALENDARS, DIARIES, MEMO PADS, DECALCOMANIAS, DECORATIVE TATTOOS, PAPER FLAGS, BANNERS AND PENNANTS, COLORING BOOKS, PAINTING AND COLORING SETS FOR CHILDREN, COMIC BOOKS, MUSIC BOOKS, SCRAP BOOKS, ADDRESS BOOKS, BOOKMARKS, PHOTO ALBUMS, APPOINTMENT BOOKS, LOOSE-LEAF BINDERS, GIFT WRAPPING PAPER, STATIONERY, GREETING CARDS, POST CARDS, NOTE CARDS, LAMINATED PICTURES, PICTURE FRAMES; PENS, PENCILS, DESK SETS, PEN AND PENCIL SETS; PLASTIC FOLDERS, RUBBER BANDS; NOT-MAGNETICALLY-ENCODED DEBIT CARDS FOR USE IN PUBLIC TELEPHONES, PENCIL CASES, GLASS PAPERWEIGHTS, BOOK ENDS (U.S. CLS. 2, 5, 22, 23, 29, 37, 38 AND 50).

**CLASS 18—LEATHER GOODS**

FOR BAGS AND CASES, NAMELY TOTE BAGS, SPORTS BAGS, TRAVEL BAGS, LUGGAGE, SUITCASES, GARMENT BAGS FOR TRAVEL, TRUNKS, ATTACHE CASES, CLUTCH BAGS, HAND BAGS, SHOPPING BAGS, WALLETTS, PURSES, KNAPSACKS, FANNY PACKS, GYM BAGS, KEY CASES, COIN PURSES, COMBINATION WALLETTS FOR CARRYING KEYS AND COINS, ID HOLDERS, PENCIL CASES, COSMETIC BAGS SOLD EMPTY, BEEPER BAGS; UMBRELLAS (U.S. CLS. 1, 2, 3, 22 AND 41).

**CLASS 19—NON-METALLIC BUILDING MATERIALS**

FOR STONE AND MARBLE FIGURINES (U.S. CLS. 1, 12, 33 AND 50).

**CLASS 20—FURNITURE AND ARTICLES NOT OTHERWISE CLASSIFIED**

FOR PLASTIC FLAGS, BANNERS AND PENNANTS, KEY CHAINS AND KEY FOBS NOT OF METAL, PICTURE FRAMES, DECORATIVE MOBILES, DECORATIVE BOXES MADE OF WOOD, FIGURINES OF WOOD, WAX, PLASTER AND PLASTIC, CUSHIONS AND PILLOWS; WIND CHIMES; SCULPTURES IN THE NATURE OF DECORATIVE MASKS MADE PRIMARILY OF WOOD, PLASTIC AND PLASTER (U.S. CLS. 2, 13, 22, 25, 32 AND 50).

**CLASS 21—HOUSEWARES AND GLASS**

FOR HOUSEHOLD AND NOVELTY ITEMS, NAMELY—MUGS, CUPS, DRINKING GLASSES, PITCHERS, DECORATIVE AND COMMEMORATIVE PLATES AND BOWLS, NON-ELECTRIC COFFEE POTS AND TEAPOTS; DECORATIVE BOXES, CANDLESTICKS AND CANDLE HOLDERS NOT OF PRECIOUS METAL; FIGURINES AND SCULPTURES MADE OF CHINA, CRYSTAL, EARTHENWARE, GLASS, PORCELAIN AND TERRA COTTA; VASES, BOTTLE STOPPERS MADE OF CORK, DECORATIVE GLASS BOTTLES (U.S. CLS. 2, 13, 23, 29, 30, 33, 40 AND 50).

**CLASS 24—FABRICS**

FOR TEXTILE AND PIECE GOODS, NAMELY—BED LINEN, NAMELY PILLOWCASES, SHEETS, COMFORTERS, QUILTS, COTTON THROWS, DUVET COVERS AND BLANKETS; BATH LINEN, NAMELY TOWELS, WASHCLOTHS; TABLE LINEN, NAMELY TABLECLOTHS, PLACE-MATS, NAPKINS, DISH TOWELS, OVEN MITTS (U.S. CLS. 42 AND 50).

**CLASS 25—CLOTHING**

FOR DECORATIVE FABRICS, CLOTHING, WEARING APPAREL AND ACCESSORIES, NAMELY—SHIRTS, SWEATSHIRTS, T-SHIRTS, JERSEYS, SWEATERS, TANK TOPS, PANTS, SWEAT PANTS, SHORTS, BOXER SHORTS, BATHROBES, NIGHT SHIRTS, PAJAMAS, COATS, JACKETS, WIND-RESISTANT JACKETS, VESTS, DRESSES, SKIRTS, BLOUSES, ROMPERS, SWIMWEAR; RAINWEAR, NAMELY RAINCOATS, RAIN BONNETS, RAIN BOOTS AND RAIN CAPES; TIES, ASCOTS, BELTS, SCARVES; FOOTWEAR NAMELY SHOES, BOOTS AND SOCKS; HEADGEAR NAMELY HATS, CAPS AND BEANIES; APRONS; MASQUERADE COSTUMES (U.S. CLS. 22 AND 39).

**CLASS 26—FANCY GOODS**

FOR HAIR BARRETTES (U.S. CLS. 37, 39, 40, 42 AND 50).

**CLASS 27—FLOOR COVERINGS**

FOR WALLPAPER, CARPETS (U.S. CLS. 19, 20, 37, 42 AND 50).

**CLASS 28—TOYS AND SPORTING GOODS**

FOR GAMES, TOYS AND PLAYTHINGS NAMELY—PLAYING CARDS, COLLECTIBLE DOLLS, JUGGLING BALLS, JUGGLING PLATES, JUGGLING PINS, DIABOLOS, FLOWER STICKS, JUGGLING STICKS, JUGGLING SCARVES, SKIPPING ROPES, JIGSAW PUZZLES, 3-D PUZZLES, SPIN TOYS, TOY MOBILES, YOYOS, DOLLS AND ACCESSORIES THEREFORE, PLUSH TOYS, MECHANICAL ACTION TOYS, GOLF BALLS, SOAP BUBBLES, KITES, CHRISTMAS TREE DECORATIONS; FACE MASKS; PUPPETS AND MARIONETTE PUPPETS; CLOWN NOSES; CARNIVAL MASKS AND COSTUME MASKS (U.S. CLS. 22, 23, 38 AND 50).

**CLASS 30—STAPLE FOODS**

FOR CANDIES, WAFFLES, CHOCOLATE, COOKIES (U.S. CL. 46).

**CLASS 41—EDUCATION AND ENTERTAINMENT**

FOR ENTERTAINMENT SERVICES, NAMELY—CONCEPTION, CREATION, PRODUCTION AND PRESENTATION OF THEATRICAL PERFORMANCES FEATURING ARTISTIC ACTS, COMICAL ACTS, CHOREOGRAPHY AND DANCE, SET TO MUSIC AND SONG; CONCEPTION, CREATION, AND PRODUCTION OF TELEVISION PROGRAMS, RADIO PROGRAMS, AND MOTION PICTURE FILMS; ENTERTAINMENT IN THE NATURE OF TELEVISION PROGRAMS AND RADIO PROGRAMS FEATURING ARTISTIC ACTS, COMICAL ACTS, CHOREOGRAPHY AND DANCE, SET TO MUSIC AND SONG (U.S. CLS. 100, 101 AND 107).

**CLASS 43—HOTEL AND RESTAURANT SERVICES**

FOR RESTAURANT, HOTEL AND BAR SERVICES (U.S. CLS. 100 AND 101).

WILLIAM BRECKENFELD, EXAMINING ATTORNEY

SN 76-506,359. TARGET BRANDS, INC., MINNEAPOLIS, MN. FILED 4-15-2003.

## ARCHER FARMS

OWNER OF U.S. REG. NOS. 2,290,302, 2,292,831 AND 2,455,323.

NO CLAIM IS MADE TO THE EXCLUSIVE RIGHT TO USE "FARMS", APART FROM THE MARK AS SHOWN.

### CLASS 29—MEATS AND PROCESSED FOODS

FOR PROCESSED LUNCHEON MEATS; POULTRY; MEAT; SEAFOOD; FISH IN GENERAL FOR FOOD PURPOSES; PEANUT BUTTER; PICKLES; PROCESSED OLIVES; CANNED CUT VEGETABLES; FROZEN VEGETABLES; SOUPS; SHORTENING; VEGETABLE OILS; OLIVE OIL; PROCESSED BEANS; DRIED FRUIT; CULTURED PRODUCTS, NAMELY, COTTAGE CHEESE; SOUR CREAM; SNACK FOOD DIPS; PROCESSED NUTS; BAGGED GARDEN SALADS; MARASCHINO CHERRIES; PROCESSED COCONUT; FRUIT PRESERVES; FRUIT-BASED READY-TO-EAT FOOD BARS; FRUIT-BASED SNACK FOOD; POTATO CHIPS; PROCESSED APRICOTS; AND STRAWBERRY TOPPINGS (U.S. CL. 46).

FIRST USE 10-31-2001; IN COMMERCE 10-31-2001.

### CLASS 30—STAPLE FOODS

FOR CANNED SPAGHETTI SAUCE WITH PASTA; SALAD DRESSINGS; CROUTONS; VINEGAR; PROCESSED HERBS; RICE; SAUCES; PANCAKE MIXES; PANCAKE AND TABLE SYRUP; MIXES FOR BAKERY GOODS; SUGAR; FLOUR; BAKERY DESSERTS; ICE CREAM CONES; CHOCOLATE TOPPINGS, AND TOPPING SYRUP; PIZZA; ICE CREAM; MARSHMALLOWS; BISCUITS; COOKIES; CRACKERS; GRAVY; PASTA; SPAGHETTI SAUCES; TEA; COCOA; COFFEE; COFFEE-BASED BEVERAGES CONTAINING MILK; CORN CHIPS; CHEESE FLAVORED PUFFED CORN SNACKS; PRETZELS; CANDY; AND SNACK MIX CONSISTING PRIMARILY OF CRACKERS, PRETZELS, AND/OR NUT (U.S. CL. 46).

FIRST USE 7-31-2001; IN COMMERCE 7-31-2001.

### CLASS 32—LIGHT BEVERAGES

FOR CHILLED FRUIT JUICES; NON-ALCOHOLIC FRUIT EXTRACTS USED IN THE PREPARATION OF BEVERAGES; VEGETABLE JUICE; SPRING WATER (U.S. CLS. 45, 46 AND 48).

FIRST USE 6-30-2000; IN COMMERCE 6-30-2000.

ODESSA BIBBINS, EXAMINING ATTORNEY

SN 76-507,279. BIOVERSE, INC., BLOOMINGTON, MN. FILED 4-3-2003.

## HEALTHY PONDS

NO CLAIM IS MADE TO THE EXCLUSIVE RIGHT TO USE PONDS, APART FROM THE MARK AS SHOWN.

### CLASS 1—CHEMICALS

FOR CHEMICAL ANALYSIS KIT FOR TESTING PONDS COMPRISED OF POND-TEST STRIPS USED TO TEST FOR AMMONIA, PHOSPHATES, AND OTHER CHEMICALS; CHEMICALS USED TO RAISE OR LOWER THE PH LEVEL OF WATER; TOXIN PRODUCING BACTERIA FOR USE IN BODIES OF WATER IN CONNECTION WITH MOSQUITO CONTROL (U.S. CLS. 1, 5, 6, 10, 26 AND 46).

FIRST USE 9-1-2002; IN COMMERCE 9-1-2002.

### CLASS 16—PAPER GOODS AND PRINTED MATTER

FOR WATER SOLUBLE PLASTIC BAGS USED TO PACKAGE TOXIN-PRODUCING BACTERIA FOR USE IN BODIES OF WATER IN CONNECTION WITH MOSQUITO CONTROL; WATER SOLUBLE PLASTIC BAGS USED TO PACKAGE BACTERIA USED TO REDUCE AND ELIMINATE AQUATIC NUTRIENTS AND TO REDUCE AND ELIMINATE ODORS CAUSED BY AQUATIC PLANT LIFE; BIODEGRADABLE PACKAGING CONSISTING OF PAPER BAGS USED TO PACKAGE TOXIN-PRODUCING BACTERIA FOR USE IN BODIES OF WATER IN CONNECTION WITH MOSQUITO CONTROL; BIODEGRADABLE PACKAGING CONSISTING OF PAPER BAGS USED TO PACKAGE BACTERIA USED TO REDUCE AND ELIMINATE AQUATIC NUTRIENTS AND TO REDUCE AND ELIMINATE ODORS CAUSED BY AQUATIC PLANT LIFE (U.S. CLS. 2, 5, 22, 23, 29, 37, 38 AND 50).

FIRST USE 6-15-2002; IN COMMERCE 6-15-2002.

### CLASS 40—MATERIAL TREATMENT

FOR ENVIRONMENTAL REMEDIATION SERVICES, NAMELY POND MANAGEMENT SERVICES, POND AND WATER TREATMENT SERVICES (U.S. CLS. 100, 103 AND 106).

FIRST USE 1-8-2003; IN COMMERCE 1-8-2003.

GINA FINK, EXAMINING ATTORNEY

SN 76-507,682. TRINITY FELLOWSHIP CHURCH, AMARILLO, TX. FILED 4-18-2003.

## TRINITY FELLOWSHIP

NO CLAIM IS MADE TO THE EXCLUSIVE RIGHT TO USE FELLOWSHIP, APART FROM THE MARK AS SHOWN.

### CLASS 35—ADVERTISING AND BUSINESS

FOR ASSOCIATION SERVICES, NAMELY, PROMOTING THE INTERESTS OF MEMBER CHURCHES AND MINISTRIES (U.S. CLS. 100, 101 AND 102).

### CLASS 45—PERSONAL SERVICES

FOR EVANGELISTIC AND MINISTERIAL SERVICES; PROVIDING INFORMATION AND ARTICLES IN THE FIELDS OF CHRISTIANITY, RELIGION, THEOLOGY, SPIRITUALITY, ETHICS, CULTURE, AND SOCIAL ISSUES VIA A GLOBAL COMMUNICATIONS NETWORK; RELIGIOUS COUNSELING SERVICES (U.S. CLS. 100 AND 101).

TANYA AMOS, EXAMINING ATTORNEY

SN 76-507,832. BEN E. KEITH COMPANY, FORT WORTH, TX. FILED 4-18-2003.

## GOLDEN HARVEST

### CLASS 29—MEATS AND PROCESSED FOODS

FOR (BASED ON INTENT TO USE) PREPARED SALADS, NAMELY, COLESLAW, POTATO SALAD, TUNA SALAD, CHICKEN SALAD, TROPICAL FRUIT SALAD, PIMENTO SALAD AND BEAN SALAD (U.S. CL. 46).

**CLASS 30—STAPLE FOODS**

FOR (BASED ON USE IN COMMERCE) SALAD DRESSING; MAYONNAISE; BBQ SAUCE; PREPARED SALADS, NAMELY, MACARONI SALAD AND PASTA SALAD (U.S. CL. 46).

FIRST USE 9-0-1995; IN COMMERCE 9-0-1995.  
GENE MACIOL, EXAMINING ATTORNEY

SN 76-510,836. IJANE, INC, BEVERLY HILLS, CA. FILED 4-30-2003.

**FACE THE ISSUE****CLASS 35—ADVERTISING AND BUSINESS**

FOR PROMOTING AWARENESS IN THE FIELD OF CHALLENGES FACING YOUNG ADULTS, NAMELY, DEPRESSION, SELF ESTEEM ISSUES, PHYSICAL AND EMOTIONAL ABUSE, ALCOHOL AND SUBSTANCE ABUSE AND EATING DISORDERS (U.S. CLS. 100, 101 AND 102).

**CLASS 41—EDUCATION AND ENTERTAINMENT**

FOR EDUCATIONAL AND ENTERTAINMENT SERVICES, NAMELY, PROVIDING PUBLIC SERVICE ANNOUNCEMENTS IN THE FIELD OF CHALLENGES FACING YOUNG ADULTS, NAMELY, DEPRESSION, SELF ESTEEM ISSUES, PHYSICAL AND EMOTIONAL ABUSE, ALCOHOL AND SUBSTANCE ABUSE AND EATING DISORDERS (U.S. CLS. 100, 101 AND 107).

**CLASS 44—MEDICAL, BEAUTY AND AGRICULTURAL SERVICES**

FOR PROVIDING INFORMATION IN THE FIELD OF CHALLENGES FACING YOUNG ADULTS, NAMELY, DEPRESSION, SELF ESTEEM ISSUES, PHYSICAL AND EMOTIONAL ABUSE, ALCOHOL AND SUBSTANCE ABUSE AND EATING DISORDERS (U.S. CLS. 100 AND 101).

ESTHER BELENKER, EXAMINING ATTORNEY

SN 76-509,745. TORAY KABUSHIKI KAISHA (TORAY INDUSTRIES, INC.), CHUO-KU, TOKYO, JAPAN, FILED 4-28-2003.

**CLASS 18—LEATHER GOODS**

FOR LEATHER AND IMITATION LEATHER, SYNTHETIC LEATHER PIECE GOODS, AND ARTICLES MADE FROM THESE MATERIALS, NAMELY, PURSES; TRUNKS, TRAVELING BAGS, HAND BAGS AND SHOULDER BAGS; UMBRELLAS, PARASOLS AND WALKING STICKS; WHIPS, HARNESES, SADDLERY (U.S. CLS. 1, 2, 3, 22 AND 41).

**CLASS 22—CORDAGE AND FIBERS**

FOR ROPES, TWINES, STRINGS, TENTS, AWNINGS OF FABRIC, CANVAS TARPULINS, SAILS, SACKS FOR THE TRANSPORTATION OR STORAGE OF MATERIALS IN BULK AND FISHING NETS; PADDING MATERIALS NOT OF PLASTIC AND STUFFING MATERIALS FOR CUSHION, PILLOW, QUILT OR MATTRESS; RAW FIBROUS TEXTILE MATERIALS, STAPLE FIBERS (U.S. CLS. 1, 2, 7, 19, 22, 42 AND 50).

**CLASS 23—YARNS AND THREADS**

FOR YARNS AND THREADS (U.S. CL. 43).

**CLASS 24—FABRICS**

FOR TEXTILE PIECE GOODS NAMELY, WOVEN, NON-WOVEN, KNITTED AND NETTED FABRICS MADE OF WHOLLY OR PARTIALLY OF SYNTHETIC FIBERS; BED SHEETS AND TABLE COVERS, NAMELY TABLE RUNNERS AND TABLE LINENS; COVERS FOR CUSHIONS, TEXTILE ARTICLES, NAMELY, TOWELS OF TEXTILE, CURTAINS, PILLOW CASES, QUILTS, MAKE-UP CLOTH, MOSQUITO NETS (U.S. CLS. 42 AND 50).

**CLASS 25—CLOTHING**

FOR CLOTHING, NAMELY, SHIRTS, PANTS, COATS, JACKETS, JERSEYS, JUMPERS, SKIRTS, BLOUSES, SWIMSUITS, BATHING SUITS, UNDERWEAR, SOCKS, STOCKINGS, HOSIERY, SHOES, HAT, CAP (U.S. CLS. 22 AND 39).

JOHN LINCOSKI, EXAMINING ATTORNEY

SN 76-512,345. FURNERVE, INC., HIGH POINT, NC. FILED 5-6-2003.

NO CLAIM IS MADE TO THE EXCLUSIVE RIGHT TO USE "SOFTWARE" FOR CLASS 9 AND "SERVICES" FOR CLASS 35, APART FROM THE MARK AS SHOWN.

**CLASS 9—ELECTRICAL AND SCIENTIFIC APPARATUS**

FOR COMPUTER SOFTWARE PROVIDING DATABASE MANAGEMENT AND OPERATIONAL AND PROCEDURAL TRACKING AND CONTROL FOR USE IN RETAIL FURNITURE STORES (U.S. CLS. 21, 23, 26, 36 AND 38).

FIRST USE 9-5-2002; IN COMMERCE 9-5-2002.

**CLASS 35—ADVERTISING AND BUSINESS**

FOR BUSINESS CONSULTING SERVICES FOR THE FURNITURE INDUSTRY (U.S. CLS. 100, 101 AND 102).

FIRST USE 9-5-2002; IN COMMERCE 9-5-2002.

KARANENDRA S. CHHINA, EXAMINING ATTORNEY

SN 76-512,346. FURNERVE, INC., HIGH POINT, NC. FILED 5-6-2003.

SN 76-514,065. PHILA APPAREL & ACCESSORY COMPANY, PHILADELPHIA, PA. FILED 5-9-2003.

## FURNERVE

### CLASS 9—ELECTRICAL AND SCIENTIFIC APPARATUS

FOR COMPUTER SOFTWARE PROVIDING DATABASE MANAGEMENT AND OPERATIONAL AND PROCEDURAL TRACKING AND CONTROL FOR USE IN RETAIL FURNITURE STORES (U.S. CLS. 21, 23, 26, 36 AND 38).

FIRST USE 4-8-1997; IN COMMERCE 4-8-1997.

### CLASS 35—ADVERTISING AND BUSINESS

FOR BUSINESS CONSULTING SERVICES FOR THE FURNITURE INDUSTRY (U.S. CLS. 100, 101 AND 102).

FIRST USE 4-8-1997; IN COMMERCE 4-8-1997.  
KARANENDRA S. CHHINA, EXAMINING ATTORNEY



NO CLAIM IS MADE TO THE EXCLUSIVE RIGHT TO USE "PHILA APPAREL", APART FROM THE MARK AS SHOWN.

THE LIKENESS (OR, "PORTRAIT") IN THE MARK DOES NOT IDENTIFY A LIVING INDIVIDUAL.

### CLASS 21—HOUSEWARES AND GLASS

FOR COFFEE MUGS (U.S. CLS. 2, 13, 23, 29, 30, 33, 40 AND 50).

### CLASS 25—CLOTHING

FOR T-SHIRTS, SWEATERS, JACKETS, HATS, SWEATSHIRTS, HOODED SWEATSHIRTS, SWEAT BANDS, SWEAT PANTS, ATHLETIC APPAREL (U.S. CLS. 22 AND 39).

SUSAN HAYASH, EXAMINING ATTORNEY

SN 76-512,740. SOLAR ACTIVE INTERNATIONAL, TARZANA, CA. FILED 5-8-2003.

## SOLAR ACTIVE

SEC. 2(F).

### CLASS 3—COSMETICS AND CLEANING PREPARATIONS

FOR COSMETICS NAMELY NAIL POLISH (U.S. CLS. 1, 4, 6, 50, 51 AND 52).

FIRST USE 1-0-1997; IN COMMERCE 1-0-1997.

### CLASS 14—JEWELRY

FOR JEWELRY NAMELY BRACELETS AND BEADS (U.S. CLS. 2, 27, 28 AND 50).

FIRST USE 1-0-1997; IN COMMERCE 1-0-1997.

### CLASS 23—YARNS AND THREADS

FOR YARNS AND THREADS (U.S. CL. 43).

FIRST USE 1-0-1997; IN COMMERCE 1-0-1997.

### CLASS 25—CLOTHING

FOR CLOTHING NAMELY T-SHIRTS (U.S. CLS. 22 AND 39).

FIRST USE 1-0-1997; IN COMMERCE 1-0-1997.

### CLASS 26—FANCY GOODS

FOR FANCY GOODS, NAMELY SHOE LACES, BUTTONS AND HAIR ACCESSORIES, NAMELY, BARRETTES, TWISTERS, AND HAIR BANDS (U.S. CLS. 37, 39, 40, 42 AND 50).

FIRST USE 1-0-1997; IN COMMERCE 1-0-1997.  
CYNTHIA SLOAN, EXAMINING ATTORNEY

SN 76-514,113. BSH PROFILO ELEKTRIKLI GERECLER SANAYI A.S., MECIDIYEKÖY, ISTANBUL, TURKEY, FILED 5-14-2003.



OWNER OF TURKEY REG. NO. 193798, DATED 12-11-1990, EXPIRES 12-11-2010.

### CLASS 7—MACHINERY

FOR ALL KINDS OF SINGLE AND THREE PHASE ELECTRIC MOTORS WITH OR WITHOUT COLLECTORS FOR WHITE GOODS NAMELY REFRIGERATORS, DEEP FREEZERS, WASHERS, DRYERS, WASHER/DRYERS, DISH WASHERS, OVENS, COOK TOPS, VACUUM CLEANERS AND FOR SMALL HOME APPLIANCES NAMELY FOOD PROCESSORS, KITCHEN MACHINES, MIXERS, JUICERS, BLENDERS, HAND VACUUM CLEANERS, ASPIRATORS, VENTILATORS, WATER HEATERS, UPLIFTING RELAYS USED IN COMPRESSORS AND MOTORS, ALL TYPES OF COMPRESSORS NOT FOR MEDICAL USE, CLOTHES WASHING MACHINES, VACUUM CLEANERS, DISH WASHING MACHINES, BUTTERING MACHINES/CHUM MACHINES FOR MAKING BUTTER BY BEATING THE MILK (U.S. CLS. 13, 19, 21, 23, 31, 34 AND 35).

**CLASS 11—ENVIRONMENTAL CONTROL APPARATUS**

FOR REFRIGERATORS, DEEP FREEZERS, CARAVAN TYPES COMMERCIAL REFRIGERATORS, VIENNA TYPE COMMERCIAL REFRIGERATORS, SHOW CASE TYPE COMMERCIAL REFRIGERATORS, COMMERCIAL REFRIGERATORS; WATER COOLING DEVICES NAMELY WATER COOLERS, WATER FREEZING MACHINES, AIR COOLING DEVICES NAMELY ELECTRIC FANS AIR CONDITIONERS FOR COMMERCIAL, DOMESTIC AND INDUSTRIAL PURPOSES, AIR COOLING UNITS FOR WHITE PRODUCTS AND SMALL HOME APPLIANCES, AIR COOLING UNIT ELEMENTS FOR COMMERCIAL, DOMESTIC OR COMMERCIAL AND INDUSTRIAL USE NAMELY AIR COOLING ELECTRIC EVAPORATORS, FINNED TYPE ELECTRIC EVAPORATORS, ELECTRIC REFRIGERATOR EVAPORATORS; COOK STOVES AND OVENS WITH COOK STOVES FOR USE WITH GAS OR ELECTRIC FUEL, AIR GAS OVENS, PLUMBING FITTINGS NAMELY GAS COCKS AND THERMO SIPHONS, ELECTRIC STOVES, BUTANE GAS OPERATED STOVES, ELECTRIC DRY BOTTLE COOLERS, CLOTHES DRYING MACHINES, ELECTRIC AND GAS OPERATED INSTANTANEOUS WATER HEATERS, CLIMATIZATION/AIR CONDITIONING DEVICES NAMELY ELECTRIC FANS, AIR CONDITIONERS, WINDOW TYPES AIR CONDITIONERS, CENTRAL TYPES AIR CONDITIONERS, CENTRAL TYPE AIR CONDITIONER COMPRESSORS, KITCHEN ASPIRATORS, NAMELY, VENTILATION HOODS FOR STOVES (U.S. CLS. 13, 21, 23, 31 AND 34).

CATHERINE FAINT, EXAMINING ATTORNEY

**CLASS 20—FURNITURE AND ARTICLES NOT OTHERWISE CLASSIFIED**

FOR FURNITURE, FURNITURE SECTIONS OF WOODWORK, WOOD FOR FURNITURE (U.S. CLS. 2, 13, 22, 25, 32 AND 50).

JEAN IM, EXAMINING ATTORNEY

SN 76-515,989. KOOPNAUTIC HOLLAND B.V., 6411 RP HEERLEN, NETHERLANDS, FILED 5-21-2003.

SCA

SN 76-514,632. CHEMBLOCK INDUSTRIES, INC., WILMINGTON, DE. FILED 5-14-2003.

**TENGES****CLASS 2—PAINTS**

FOR PAINTS, NAMELY, HOUSE PAINT AND FURNITURE PAINT; VARNISHES; LACQUERS IN THE NATURE OF A COATING; PRESERVATIVES AGAINST RUST IN THE NATURE OF A COATING; PRESERVATIVES AGAINST DETERIORATION OF WOOD IN THE NATURE OF IMPREGNATION WOOD PRESERVATIVES; COLORANTS FOR USE IN THE MANUFACTURE OF IMPREGNATION WOOD PRESERVATIVES; COLORANTS FOR USE IN THE MANUFACTURE OF PAINT; COLORANTS FOR USE IN THE MANUFACTURE OF PAINT FOR WOOD; MORDANTS FOR USE ON WOOD; PRESERVATIVES FOR WOOD; OILS FOR PRESERVING WOOD; AND WOOD IMPREGNATION PRESERVATIVES (U.S. CLS. 6, 11 AND 16).

**CLASS 19—NON-METALLIC BUILDING MATERIALS**

FOR NON-METALLIC BUILDING MATERIALS, NAMELY, BUILDING PANELS IN THE NATURE OF CEILING PANELS, FLOOR PANELS, AND FURNITURE PANELS; NON-METAL PLANKS FOR BUILDING; NON-METAL RIGID PIPES FOR BUILDING; FRAMEWORK, NAMELY, DOOR FRAMES AND WINDOW FRAMES FOR BUILDING; NON-METAL FACADE CLADDING FOR CONSTRUCTION AND BUILDING; NON-METAL WINDOW JOINERY FOR BUILDING; WOOD PANELING FOR BUILDING; NON-METALLIC FLOORS; PARQUET WOOD FLOORING; ROOFING UNDERLAYMENT AND NON-METAL ROOFING BOARDS; WOOD POLES; AND SEMI-WORKED WOOD, NAMELY, MILLWORK, MOLDING, AND FLOORING (U.S. CLS. 1, 12, 33 AND 50).

OWNER OF BENELUX REG. NO. 0714034, DATED 9-24-2002, EXPIRES 9-24-2012.

**CLASS 7—MACHINERY**

FOR MACHINES AND MACHINE TOOLS USED FOR THE MOVEMENT OF VEHICLES AND/OR VESSELS IN THE NAUTICAL INDUSTRY; MOTORS AND ENGINES USED IN THE NAUTICAL INDUSTRY, NAMELY, BOAT MOTORS, STARTERS FOR BOAT MOTORS AND ENGINES; MACHINE COUPLING AND TRANSMISSION COMPONENTS FOR MOVING PARTS OF VEHICLES AND/OR VESSELS IN THE NAUTICAL INDUSTRY (U.S. CLS. 13, 19, 21, 23, 31, 34 AND 35).

**CLASS 9—ELECTRICAL AND SCIENTIFIC APPARATUS**

FOR STABILIZATION CONTROLLERS AND ACCOMPANYING CONTROL PANELS FOR SCIENTIFIC, NAUTICAL, SURVEYING, OPTICAL, WEIGHING, MEASURING, SIGNALING, CHECKING, LIFE-SAVING AND TEACHING PURPOSES; STABILIZATION CONTROLLERS AND ACCOMPANYING CONTROL PANELS USED FOR CONDUCTING, SWITCHING, TRANSFORMING, ACCUMULATING, REGULATING OR CONTROLLING ELECTRICITY; STABILIZATION CONTROLLERS AND ACCOMPANYING CONTROL PANELS USED FOR RECORDING, TRANSMISSION OR REPRODUCTION OF SOUND OR IMAGES; PRERECORDED MAGNETIC OR ELECTRIC CARRIERS CONTAINING SOFTWARE FOR STABILIZATION CONTROLLERS AND CONTROL PANELS; DATA PROCESSORS, COMPUTERS, SIGNAL PROCESSORS, MICROPROCESSORS, EITHER ANALOG, DIGITAL OR ANALOG/DIGITAL COMBINED; FIRE EXTINGUISHERS (U.S. CLS. 21, 23, 26, 36 AND 38).

**CLASS 12—VEHICLES**

FOR HYDRAULIC SYSTEMS FOR THE NAUTICAL INDUSTRY APPARATUS FOR LOCOMOTION BY LAND, AIR OR WATER, SAID SYSTEMS COMPRISED OF FINS WHICH REDUCE OR STABILIZE THE MOTIONS OF VESSELS (U.S. CLS. 19, 21, 23, 31, 35 AND 44).

HEATHER THOMPSON, EXAMINING ATTORNEY



SN 76-516,233. PAPO D'ANJO - CONFECCOES TEXTEIS LIMITADA, 1200-243, LISBON, PORTUGAL, FILED 5-23-2003.

## PAPO D'ANJO

THE NAME PAPO D'ANJO DOES NOT IDENTIFY A LIVING INDIVIDUAL.  
THE ENGLISH TRANSLATION OF PAPO D'ANJO IS ANGELS' TUMMIES.

### CLASS 24—FABRICS

FOR BEDDING, NAMELY, SHEETS AND PILLOW-CASES; CURTAINS; TOWELS (U.S. CLS. 42 AND 50).

### CLASS 35—ADVERTISING AND BUSINESS

FOR RETAIL STORE SERVICES FEATURING BEDDING, LINENS, TABLE CLOTHS, NAPKINS, CURTAINS, TOWELS, CLOTHING, SHOES, HATS, PURSES AND BAGS (U.S. CLS. 100, 101 AND 102).  
CURTIS FRENCH, EXAMINING ATTORNEY

SN 76-517,766. HAMPTON PRODUCTS INTERNATIONAL CORPORATION, FOOTHILL RANCH, CA. FILED 5-5-2003.

# HAMPTON

### CLASS 6—METAL GOODS

FOR METAL LOCKS, NAMELY KEYED LOCKS, KEYED CABINET AND DESK LOCKS, KEYED GATE AND DOOR LOCKS, KEYED PADLOCKS, NON-KEYED DOOR AND GATE LOCKS, ELECTRONIC DOOR LOCKS, GATE LOCKS AND PADLOCKS, AND COMBINATION DOOR AND GATE LOCKS AND PADLOCKS; METAL PADLOCK ACCESSORIES, NAMELY PADLOCK CHAINS AND CABLES; METAL LOCK ACCESSORIES, NAMELY BOLTS, CHAIN LATCHES, HASPS, HINGES, KEY BLANKS AND CUT KEYS; METAL SECURITY HARDWARE FOR DOOR AND WINDOW SECURITY, NAMELY DEADBOLTS, DOOR, CABINET AND GATE LATCHES, KEYED ENTRY DOOR SETS, KEYED DEADBOLTS, DOOR HANDLES FOR LATCHES, LOCKS, DEADBOLTS, AND DOOR SETS, CHAIN DOOR GUARDS, SLIDING DEADBOLTS, WINDOW SASH LOCKS, DOOR CHAIN LOCKS, KEYED DOOR CHAIN LOCKS, DOOR SECURITY GUARDS, AND DOOR, CABINET AND GATE HINGES (U.S. CLS. 2, 12, 13, 14, 23, 25 AND 50).

### CLASS 9—ELECTRICAL AND SCIENTIFIC APPARATUS

FOR ELECTRONIC SECURITY SYSTEMS, NAMELY, A PROGRAMMABLE AND NON-PROGRAMMABLE SECURITY SYSTEM FOR COMMERCIAL OR RESIDENTIAL BUILDINGS COMPRISING ELECTRONIC SECURITY CONTROLS, SENSORS, ALARMS, ENTRY AND CONTROLS AND PADS, AND SECURITY SOFTWARE USED IN CONNECTION THEREWITH (U.S. CLS. 21, 23, 26, 36 AND 38).

### CLASS 11—ENVIRONMENTAL CONTROL APPARATUS

FOR SECURITY LIGHTING, NAMELY SECURITY LAMPS WITH MOTION AND/OR LIGHT SENSORS (U.S. CLS. 13, 21, 23, 31 AND 34).

### CLASS 20—FURNITURE AND ARTICLES NOT OTHERWISE CLASSIFIED

FOR NON-METAL PADLOCK ACCESSORIES, NAMELY PADLOCK JACKETS AND COVERS (U.S. CLS. 2, 13, 22, 25, 32 AND 50).  
LAURA KOVAISKY, EXAMINING ATTORNEY

SN 76-517,767. HAMPTON PRODUCTS INTERNATIONAL CORPORATION, FOOTHILL RANCH, CA. FILED 5-5-2003.



### CLASS 6—METAL GOODS

FOR METAL LOCKS, NAMELY KEYED LOCKS, KEYED CABINET AND DESK LOCKS, KEYED GATE AND DOOR LOCKS, KEYED PADLOCKS, NON-KEYED DOOR AND GATE LOCKS, ELECTRONIC DOOR LOCKS, GATE LOCKS AND PADLOCKS, AND COMBINATION DOOR AND GATE LOCKS AND PADLOCKS; METAL PADLOCK ACCESSORIES, NAMELY PADLOCK CHAINS AND CABLES; METAL LOCK ACCESSORIES, NAMELY BOLTS, CHAIN LATCHES, HASPS, HINGES, KEY BLANKS AND CUT KEYS; METAL SECURITY HARDWARE FOR DOOR AND WINDOW SECURITY, NAMELY DEADBOLTS, DOOR, CABINET AND GATE LATCHES, KEYED ENTRY DOOR SETS, KEYED DEADBOLTS, DOOR HANDLES FOR LATCHES, LOCKS, DEADBOLTS, AND DOOR SETS, CHAIN DOOR GUARDS, SLIDING DEADBOLTS, WINDOW SASH LOCKS, DOOR CHAIN LOCKS, KEYED DOOR CHAIN LOCKS, DOOR SECURITY GUARDS, AND DOOR, CABINET AND GATE HINGES (U.S. CLS. 2, 12, 13, 14, 23, 25 AND 50).

### CLASS 9—ELECTRICAL AND SCIENTIFIC APPARATUS

FOR ELECTRONIC SECURITY SYSTEMS, NAMELY, A PROGRAMMABLE AND NON-PROGRAMMABLE SECURITY SYSTEM FOR COMMERCIAL OR RESIDENTIAL BUILDINGS COMPRISING ELECTRONIC SECURITY CONTROLS, SENSORS, ALARMS, ENTRY AND CONTROLS AND PADS, AND SECURITY SOFTWARE USED IN CONNECTION THEREWITH (U.S. CLS. 21, 23, 26, 36 AND 38).

### CLASS 11—ENVIRONMENTAL CONTROL APPARATUS

FOR SECURITY LIGHTING, NAMELY SECURITY LAMPS WITH MOTION AND/OR LIGHT SENSORS (U.S. CLS. 13, 21, 23, 31 AND 34).

### CLASS 20—FURNITURE AND ARTICLES NOT OTHERWISE CLASSIFIED

FOR NON-METAL PADLOCK ACCESSORIES, NAMELY PADLOCK JACKETS AND COVERS (U.S. CLS. 2, 13, 22, 25, 32 AND 50).  
LAURA KOVAISKY, EXAMINING ATTORNEY

SN 76-521,045. PACON CORPORATION, APPLETON, WI.  
FILED 6-6-2003.

## LET YOUR IMAGINATION SHINE

### CLASS 16—PAPER GOODS AND PRINTED MATTER

FOR PAPER PRODUCTS, NAMELY, ART PADS, DECORATIVE BORDERS, CONSTRUCTION PAPER, CORRUGATED PAPER, CREPE PAPER, DRAWING PAPER, FADE-RESISTANT PAPER, FINGER PAINT PAPER, FLAME RETARDANT PAPER, MAT FRAMES, ORIGAMI PAPER, POSTER BOARD, TISSUE PAPER, KRAFT PAPER, TAG BOARD, AND TEXTURED PAPERS; AND ARTS AND CRAFT PRODUCTS, NAMELY, ART TAPE, CELLOPHANE, PAPER DOILIES, IRIDESCENT PLASTIC FILM NOT FOR COMMERCIAL OR INDUSTRIAL PURPOSES, PAINTING ACCESSORIES, NAMELY, PAINT POTS, EASELS AND DISPOSABLE APRONS, PLASTER IMPREGNATED MODELING MATERIAL FOR USE BY CHILDREN, PAPER PARTY BAGS, NOTCHED CARDBOARD PATTERNS FOR WEAVING CRAFTS (U.S. CLS. 2, 5, 22, 23, 29, 37, 38 AND 50).

### CLASS 20—FURNITURE AND ARTICLES NOT OTHERWISE CLASSIFIED

FOR GLITTER; FOAM SHAPES AND SHEETS (U.S. CLS. 2, 13, 22, 25, 32 AND 50).

### CLASS 23—YARNS AND THREADS

FOR YARN FOR ARTS AND CRAFTS (U.S. CL. 43).

### CLASS 26—FANCY GOODS

FOR ARTS AND CRAFTS FINDINGS, NAMELY, SEQUINS, SPANGLES, PLASTIC GEMSTONES, CHEVILLE STEMS, CRAFT FEATHERS, CRAFT FLUFFS, POM-POMS, AND PLASTIC WIGGLY EYES; BEADS FOR HANDICRAFT PURPOSES, PLASTIC NEEDLES, EMPTY YARN CONES (U.S. CLS. 37, 39, 40, 42 AND 50).  
JENNIFER CHICOSKI, EXAMINING ATTORNEY

SN 76-521,444. FLORIDA ATLANTIC UNIVERSITY, BOCA RATON, FL. FILED 6-11-2003.



### CLASS 16—PAPER GOODS AND PRINTED MATTER

FOR WRITING PAPER, PENS, PENCILS, AND SOUVENIR SPORTS PROGRAMS (U.S. CLS. 2, 5, 22, 23, 29, 37, 38 AND 50).  
FIRST USE 0-0-2001; IN COMMERCE 0-0-2001.

### CLASS 18—LEATHER GOODS

FOR LEATHER KEY CHAINS, AND ATHLETIC BAGS (U.S. CLS. 1, 2, 3, 22 AND 41).  
FIRST USE 0-0-2001; IN COMMERCE 0-0-2001.

### CLASS 25—CLOTHING

FOR CLOTHING, NAMELY, T-SHIRTS, SWEATSHIRTS, SHORTS, SWEATPANTS, WIND RESISTANT JACKETS, AND HATS (U.S. CLS. 22 AND 39).  
FIRST USE 0-0-2001; IN COMMERCE 0-0-2001.

### CLASS 28—TOYS AND SPORTING GOODS

FOR GAMES, NAMELY, PLAYING CARDS, PLUSH TOYS, CHRISTMAS TREE ORNAMENTS, EXCEPT CONFECTIONERY OR ILLUMINATION ARTICLES, AND FOOTBALLS (U.S. CLS. 22, 23, 38 AND 50).  
FIRST USE 0-0-2001; IN COMMERCE 0-0-2001.  
ASMAT KHAN, EXAMINING ATTORNEY

SN 76-522,417. LOWER MANHATTAN DEVELOPMENT CORPORATION, NEW YORK, NY. FILED 6-13-2003.



NO CLAIM IS MADE TO THE EXCLUSIVE RIGHT TO USE LOWER MANHATTAN DEVELOPMENT CORPORATION, APART FROM THE MARK AS SHOWN.

### CLASS 25—CLOTHING

FOR CLOTHING, NAMELY T-SHIRTS (U.S. CLS. 22 AND 39).  
FIRST USE 4-0-2003; IN COMMERCE 4-0-2003.

### CLASS 35—ADVERTISING AND BUSINESS

FOR BUSINESS DEVELOPMENT AND OTHER SERVICES, NAMELY REBUILDING, REVITALIZING, AND SUPPORTING NEW AND EXISTING BUSINESSES (U.S. CLS. 100, 101 AND 102).  
FIRST USE 7-0-2002; IN COMMERCE 7-0-2002.

### CLASS 37—CONSTRUCTION AND REPAIR

FOR REAL ESTATE DEVELOPMENT AND OTHER SERVICES, NAMELY REBUILDING AND REVITALIZING RESIDENTIAL COMMUNITIES (U.S. CLS. 100, 103 AND 106).  
FIRST USE 7-0-2002; IN COMMERCE 7-0-2002.  
ZACHARY BELLO, EXAMINING ATTORNEY

SN 76-523,806. PACIFICARE HEALTH SYSTEMS, INC., CYPRESS, CA. FILED 6-11-2003.

## PacifiCare Advanced Analytic

THE MARK CONSISTS OF STANDARD CHARACTERS WITHOUT CLAIM TO ANY PARTICULAR FONT, STYLE, SIZE, OR COLOR.

**CLASS 42—SCIENTIFIC, COMPUTER AND LEGAL SERVICES**

FOR PROVIDING MEDICAL ANALYSIS AND RESEARCH FOR MEDICAL PROFESSIONALS, INSURERS, EMPLOYERS AND CONSUMERS (U.S. CLS. 100 AND 101).

**CLASS 44—MEDICAL, BEAUTY AND AGRICULTURAL SERVICES**

FOR PROVIDING MEDICAL INFORMATION FOR MEDICAL PROFESSIONALS, INSURERS, EMPLOYERS AND CONSUMERS (U.S. CLS. 100 AND 101).  
HOWARD B. LEVINE, EXAMINING ATTORNEY

---

SN 76-524,407. COURTROOM TELEVISION NETWORK LLC, NEW YORK, NY. FILED 6-20-2003.

**FORENSIC FIELD TRIP**

NO CLAIM IS MADE TO THE EXCLUSIVE RIGHT TO USE FORENSIC, APART FROM THE MARK AS SHOWN.

**CLASS 9—ELECTRICAL AND SCIENTIFIC APPARATUS**

FOR PRERECORDED VIDEOTAPES, AUDIOTAPES AND CD-ROMS FEATURING JUDICIAL TRIALS, JUDICIAL NEWS AND ISSUES, CASE ANALYSES, INCLUDING CRIMINAL INVESTIGATIONS, CASE COMMENTARIES AND INTERVIEWS (U.S. CLS. 21, 23, 26, 36 AND 38).

**CLASS 42—SCIENTIFIC, COMPUTER AND LEGAL SERVICES**

FOR INTERACTIVE ONLINE SERVICES, NAMELY, PROVIDING INFORMATION AND GRAPHIC IMAGES RELATING TO JUDICIAL TRIALS, JUDICIAL NEWS AND ISSUES, CASE ANALYSES, INCLUDING CRIMINAL INVESTIGATIONS, AND CASE COMMENTARIES VIA A GLOBAL COMPUTER NETWORK (U.S. CLS. 100 AND 101).

KAREN K. BUSH, EXAMINING ATTORNEY

---

SN 76-525,057. ATLANTIC PASTE & GLUE CO., INC., BROOKLYN, NY. FILED 6-25-2003.

**LETHAL WEAPON****CLASS 5—PHARMACEUTICALS**

FOR RODENTICIDES (U.S. CLS. 6, 18, 44, 46, 51 AND 52).

**CLASS 21—HOUSEWARES AND GLASS**

FOR PEST MANAGEMENT DEVICES, NAMELY, MOUSE AND RAT TRAPS, GLUE TRAPS FOR MICE AND RATS, AND BAIT STATIONS FOR USE WITH MOUSE AND RAT TRAPS (U.S. CLS. 2, 13, 23, 29, 30, 33, 40 AND 50).

BRETT J. GOLDEN, EXAMINING ATTORNEY

SN 76-530,458. NISSAN JIDOSHA KABUSHIKI KAISHA, TA NISSAN MOTOR CO., LTD., YOKOHAMA-SHI, KANAGAWA-KEN, JAPAN, FILED 7-8-2003.

**FX35****CLASS 6—METAL GOODS**

FOR METAL KEY CHAIN HOLDERS, MONEY CLIPS (U.S. CLS. 2, 12, 13, 14, 23, 25 AND 50).

**CLASS 9—ELECTRICAL AND SCIENTIFIC APPARATUS**

FOR INTERACTIVE COMPUTER GAMES OF VIRTUAL REALITY COMPRISED OF COMPUTER HARDWARE AND SOFTWARE (U.S. CLS. 21, 23, 26, 36 AND 38).

**CLASS 14—JEWELRY**

FOR JEWELRY AND FASHION ACCESSORIES, NAMELY TIE CLIPS, PRECIOUS METAL MONEY CLIPS, CUFF LINKS AND LAPEL PINS (U.S. CLS. 2, 27, 28 AND 50).

**CLASS 16—PAPER GOODS AND PRINTED MATTER**

FOR PRINTED MATERIALS, NAMELY GRAPHIC ART REPRODUCTIONS, DECALS, PENS, PENCILS, CALENDARS, STATIONARY-TYPE WRITING PORTFOLIOS, POSTERS, PHOTO ALBUMS AND POCKET DIARIES (U.S. CLS. 2, 5, 22, 23, 29, 37, 38 AND 50).

**CLASS 21—HOUSEWARES AND GLASS**

FOR HOUSEWARES AND BEVERAGeware, NAMELY MUGS, CUPS (U.S. CLS. 2, 13, 23, 29, 30, 33, 40 AND 50).

**CLASS 27—FLOOR COVERINGS**

FOR CARPETED TRUNK MATS FOR CARGO STORAGE IN VEHICLES (U.S. CLS. 19, 20, 37, 42 AND 50).

**CLASS 28—TOYS AND SPORTING GOODS**

FOR TOYS AND PLAYTHINGS, NAMELY MINIATURE DIE CAST VEHICLES, BATTERY OPERATED REMOTE CONTROL VEHICLES, PLASTIC MODEL HOBBY CRAFT KITS, SIT-IN AND RIDE-ON TOY VEHICLES, AND PLAYING CARDS (U.S. CLS. 22, 23, 38 AND 50).

KARANENDRA S. CHHINA, EXAMINING ATTORNEY

---

SN 76-531,852. NATIONAL PORK BOARD, CLIVE, IA. FILED 7-24-2003.

**SWAP****CLASS 16—PAPER GOODS AND PRINTED MATTER**

FOR PRINTED MATERIALS, NAMELY MANUALS USED FOR TEACHING LIVESTOCK PRODUCERS ABOUT THE MANAGEMENT AND CARE OF LIVESTOCK (U.S. CLS. 2, 5, 22, 23, 29, 37, 38 AND 50).

FIRST USE 2-27-2003; IN COMMERCE 2-27-2003.

**CLASS 35—ADVERTISING AND BUSINESS**

FOR LIVESTOCK WELFARE ASSESSMENT PROGRAM IN THE NATURE OF BUSINESS CONSULTING, MANAGEMENT AND PLANNING RELATED TO RAISING AND THE CARE OF LIVESTOCK (U.S. CLS. 100, 101 AND 102).

FIRST USE 2-27-2003; IN COMMERCE 2-27-2003.

**CLASS 41—EDUCATION AND ENTERTAINMENT**

FOR EDUCATIONAL SERVICES, NAMELY, CONDUCTING CLASSES, SEMINARS, CONFERENCES AND WORKSHOPS IN THE FIELD OF ASSESSMENT OF LIVESTOCK OPERATIONS AND THE MANAGEMENT AND CARE OF LIVESTOCK; TRAINING SERVICES IN THE FIELD OF MANAGEMENT AND CARE OF LIVESTOCK (U.S. CLS. 100, 101 AND 107).

FIRST USE 2-27-2003; IN COMMERCE 2-27-2003.  
BRENDAN MCCAULEY, EXAMINING ATTORNEY

SN 76-535,825. VITRINEN UND GLASBAU REIER, LAUTA, SAXONY, FED REP GERMANY, FILED 7-30-2003.



SN 76-531,854. NATIONAL PORK BOARD, CLIVE, IA. FILED 7-24-2003.



NO CLAIM IS MADE TO THE EXCLUSIVE RIGHT TO USE SWINE WELFARE ASSURANCE PROGRAM, APART FROM THE MARK AS SHOWN.

**CLASS 16—PAPER GOODS AND PRINTED MATTER**

FOR PRINTED MATERIALS, NAMELY MANUALS USED FOR TEACHING LIVESTOCK PRODUCERS ABOUT THE MANAGEMENT AND CARE OF LIVESTOCK (U.S. CLS. 2, 5, 22, 23, 29, 37, 38 AND 50).

FIRST USE 2-27-2003; IN COMMERCE 2-27-2003.

**CLASS 35—ADVERTISING AND BUSINESS**

FOR LIVESTOCK WELFARE ASSESSMENT PROGRAM IN THE NATURE OF BUSINESS CONSULTING, MANAGEMENT AND PLANNING RELATED TO RAISING AND THE CARE OF LIVESTOCK (U.S. CLS. 100, 101 AND 102).

FIRST USE 2-27-2003; IN COMMERCE 2-27-2003.

**CLASS 41—EDUCATION AND ENTERTAINMENT**

FOR EDUCATIONAL SERVICES, NAMELY, CONDUCTING CLASSES, SEMINARS, CONFERENCES AND WORKSHOPS IN THE FIELD OF ASSESSMENT OF LIVESTOCK OPERATIONS AND THE MANAGEMENT AND CARE OF LIVESTOCK; TRAINING SERVICES IN THE FIELD OF MANAGEMENT AND CARE OF LIVESTOCK (U.S. CLS. 100, 101 AND 107).

FIRST USE 2-27-2003; IN COMMERCE 2-27-2003.  
BRENDAN MCCAULEY, EXAMINING ATTORNEY

THE STIPLING IS FOR SHADING PURPOSES.

**CLASS 6—METAL GOODS**

FOR MAGNETIC CABINET DOOR CATCHES AND LOCKS FOR USE IN DISPLAY CASES AND ROOMS AS WELL AS FOR THE PROTECTION OF PAINTINGS, EXHIBITS AND BUILDINGS; METAL HANGING SYSTEMS FOR PAINTINGS COMPRISED OF WALL-MOUNTED SUSPENSION RAILS, RAIL CONNECTORS, SLIDING HOOKS AND SYNTHETIC AND STEEL WIRES AND ADJUSTABLE PAINTING HOOKS (U.S. CLS. 2, 12, 13, 14, 23, 25 AND 50).

**CLASS 9—ELECTRICAL AND SCIENTIFIC APPARATUS**

FOR SENSORS AND ALARMS, NAMELY, MOTION DETECTORS, VIBRATION DETECTORS, STRUCTURE-BORNE SOUND DETECTORS, CULLET DETECTORS, AND CAPACITIVE FEEDBACK DETECTORS; ELECTRONIC LOCKS FOR USE IN DISPLAY CASES AND ROOMS AS WELL AS FOR THE PROTECTION OF PAINTINGS, EXHIBITS AND BUILDINGS; ELECTRICAL DIMMERS, REMOTE CONTROLS, AND LIGHT CONTROLS FOR FLUORESCENT-, HALOGEN-, FIBRE OPTIC, AND LED LIGHTING SYSTEMS (U.S. CLS. 21, 23, 26, 36 AND 38).

**CLASS 11—ENVIRONMENTAL CONTROL APPARATUS**

FOR AIR CONDITIONERS, ENVIRONMENTAL TEMPERATURE CONTROLLERS, AND DEVICES, NAMELY AIR FILTERS FOR THE ABSORPTION OF POLLUTANTS FOR USE IN DISPLAY CASES AND ROOMS; LIGHTING SYSTEMS FOR DISPLAY CASES, PAINTINGS, EXHIBITION WALLS, BULLETIN BOARDS AND ROOMS, NAMELY, FLUORESCENT-, HALOGEN-, FIBRE OPTIC-, AND LED-LAMPS (U.S. CLS. 13, 21, 23, 31 AND 34).

**CLASS 19—NON-METALLIC BUILDING MATERIALS**

FOR NON-LUMINOUS, NON-MECHANICAL, NON-METAL SIGNS MADE FROM WOOD OR SYNTHETIC MATERIALS; NON-METAL HANGING SYSTEMS FOR PAINTINGS COMPRISED OF WALL-MOUNTED SUSPENSION RAILS, RAIL CONNECTORS, SLIDING HOOKS AND SYNTHETIC AND STEEL WIRES AND ADJUSTABLE PAINTING HOOKS (U.S. CLS. 1, 12, 33 AND 50).

**CLASS 20—FURNITURE AND ARTICLES NOT OTHERWISE CLASSIFIED**

FOR DISPLAY CASES, NAMELY, ALL-GLASS DISPLAY CASES, TABLE DISPLAY CASES, WALL-MOUNTED DISPLAY CASES, WALL-STANDING DISPLAY CASES, LARGE CAPACITY DISPLAY CASES, DISPLAY CASES FOR DIORAMAS, DISPLAY CASES FOR PAINTINGS, WALLBOOK-LIKE DISPLAY CASES, DISPLAY CASES WITH DRAWERS, DISPLAY CASES FOR MUSEUM RESERVE DEPOTS, AND DISPLAY CASES BUILT INTO EXHIBITION WALLS; FURNITURE IN THE NATURE OF PREFABRICATED MODULAR EXHIBITION WALL SYSTEMS; FURNITURE FOR PRESENTATION, NAMELY, PARTITIONS, SHELVES; SITTING FURNITURE, NAMELY, COUCHES, CHAIRS, FURNITURE, NAMELY, DISPLAY COUNTERS FOR RECEPTION AND ENTRANCE AREAS MADE OF METAL, GLASS, SYNTHETIC AND OTHER MATERIALS FOR USE IN MUSEUMS AND EXHIBITIONS; FURNISHINGS FOR MUSEUM RESERVE DEPOTS AND ARCHIVES, NAMELY, DISPLAY CASES (U.S. CLS. 2, 13, 22, 25, 32 AND 50).

**CLASS 42—SCIENTIFIC, COMPUTER AND LEGAL SERVICES**

FOR DESIGN OF FURNISHINGS FOR MUSEUM EXHIBITION AND PRESENTATION AREAS, MUSEUM DISPLAY CASES, MUSEUM EXHIBITION WALL UNITS, MUSEUM ROUTE SIGNAGE SYSTEMS, MUSEUM LIGHTING SYSTEMS, AND MUSEUM FURNISHINGS (U.S. CLS. 100 AND 101).

CATHERINE CAIN, EXAMINING ATTORNEY

SN 76-536,393. JOHNSON & JOHNSON, NEW BRUNSWICK, NJ. FILED 8-13-2003.

**ON YOUR BODY. OFF YOUR MIND.****CLASS 5—PHARMACEUTICALS**

FOR PHARMACEUTICAL, NAMELY, TRANSDERMAL CONTRACEPTIVES (U.S. CLS. 6, 18, 44, 46, 51 AND 52).

FIRST USE 11-0-2002; IN COMMERCE 11-0-2002.

**CLASS 16—PAPER GOODS AND PRINTED MATTER**

FOR PRINTED PUBLICATIONS AND FLYERS ON USING TRANSDERMAL CONTRACEPTIVE PATCHES (U.S. CLS. 2, 5, 22, 23, 29, 37, 38 AND 50).

FIRST USE 11-0-2002; IN COMMERCE 11-0-2002.

JEFF DEFORD, EXAMINING ATTORNEY

SN 76-537,566. FMI CORPORATION, RALEIGH, NC. FILED 8-6-2003.

**FMI QUARTERLY**

NO CLAIM IS MADE TO THE EXCLUSIVE RIGHT TO USE QUARTERLY, APART FROM THE MARK AS SHOWN.

**CLASS 16—PAPER GOODS AND PRINTED MATTER**

FOR PERIODICAL PUBLICATIONS FEATURING INFORMATION OF INTEREST TO THE CONSTRUCTION INDUSTRY (U.S. CLS. 2, 5, 22, 23, 29, 37, 38 AND 50).

FIRST USE 4-28-2003; IN COMMERCE 4-28-2003.

**CLASS 37—CONSTRUCTION AND REPAIR**

FOR PROVIDING INFORMATION OF INTEREST TO THE CONSTRUCTION INDUSTRY VIA A WEBSITE ON THE INTERNET (U.S. CLS. 100, 103 AND 106).

ANN LINNEHAN, EXAMINING ATTORNEY

SN 76-542,020. CUSTOM FABRICATORS, INC., WATER-TOWN, SD. FILED 9-3-2003.



NO CLAIM IS MADE TO THE EXCLUSIVE RIGHT TO USE "ENGINEERING", APART FROM THE MARK AS SHOWN.

THE NAME JERRY GREER IDENTIFIES A LIVING INDIVIDUAL WHOSE CONSENT IS OF RECORD.

**CLASS 37—CONSTRUCTION AND REPAIR**

FOR RENOVATION OF MOTORCYCLES, MOTORCYCLES PARTS AND ACCESSORIES, REMANUFACTURE OF MOTORCYCLE PARTS AND ACCESSORIES TO THE ORDER AND SPECIFICATIONS OF OTHERS, RENOVATION IN THE FIELD OF MOTORCYCLES, AND MOTORCYCLE REPAIR AND MAINTENANCE SERVICES (U.S. CLS. 100, 103 AND 106).

FIRST USE 10-30-2002; IN COMMERCE 10-30-2002.

**CLASS 40—MATERIAL TREATMENT**

FOR CUSTOM CONSTRUCTION FOR OTHERS IN THE FIELD OF MOTORCYCLES, MOTORCYCLE PARTS AND ACCESSORIES (U.S. CLS. 100, 103 AND 106).

FIRST USE 10-30-2002; IN COMMERCE 10-30-2002.

RONALD MCMORROW, EXAMINING ATTORNEY

SN 76-542,159. PASSOFF, MICHELLE, NEW YORK, NY. FILED 9-2-2003.

**LIGHTEN UP! FREE YOURSELF FROM CLUTTER****CLASS 41—EDUCATION AND ENTERTAINMENT**

FOR EDUCATIONAL SERVICES, NAMELY, CONDUCTING SEMINARS, WORKSHOPS, CLASSES, AND CONFERENCES IN THE FIELDS OF PERSONAL ORGANIZATION, CLUTTER REDUCTION, AND PERSONAL AWARENESS, AND DISTRIBUTING COURSE MATERIALS IN CONNECTION THEREWITH (U.S. CLS. 100, 101 AND 107).

FIRST USE 11-0-1991; IN COMMERCE 11-0-1991.

**CLASS 45—PERSONAL SERVICES**

FOR CONSULTING SERVICES IN THE FIELDS OF PERSONAL ORGANIZATION, CLUTTER REDUCTION, AND PERSONAL AWARENESS (U.S. CLS. 100 AND 101).

FIRST USE 11-0-1991; IN COMMERCE 11-0-1991.

ROBERT COGGINS, EXAMINING ATTORNEY

SN 76-542,692. PEPSICO, INC., PURCHASE, NY. FILED 8-25-2003.

SN 76-546,042. COLONIAL REALTY LIMITED PARTNERSHIP, BIRMINGHAM, AL. FILED 9-18-2003.

## **QRAZY QREATIONS**

**CLASS 29—MEATS AND PROCESSED FOODS**  
FOR YOGURT (U.S. CL. 46).

**CLASS 30—STAPLE FOODS**

FOR PRETZELS (U.S. CL. 46).  
BARBARA GAYNOR, EXAMINING ATTORNEY

SN 76-542,804. HAW-DI-I FOODS CO., LTD., TAINAN, TAIWAN, FILED 9-5-2003.

## **BULL HEAD**

OWNER OF U.S. REG. NOS. 1,165,724 AND 1,885,131.

**CLASS 29—MEATS AND PROCESSED FOODS**

FOR POWDERED SOUP MIXES FOR USE AS A RELISH, NAMELY, CHICKEN SOUP POWDER, CHICKEN BOUILLON CUBES FOR RELISHING USE (U.S. CL. 46).  
FIRST USE 8-0-1969; IN COMMERCE 8-0-1970.

**CLASS 30—STAPLE FOODS**

FOR SEASONINGS, KETCHUP, BARBECUE POWDER, BARBECUE SAUCE, SAUCES, SEASONING POWDERS, POWDERED SPICE EXTRACTS FOR USE AS A CONDIMENT (U.S. CL. 46).  
FIRST USE 8-0-1969; IN COMMERCE 8-0-1970.  
REBECCA SMITH, EXAMINING ATTORNEY

SN 76-543,856. KVAERNER POWER OY, FINLAND, FILED 8-29-2003.

## **AGGLOSTOP**

PRIORITY CLAIMED UNDER SEC. 44(D) ON ERPNCMNTY TM OFC APPLICATION NO. 003106119, FILED 3-24-2003, REG. NO. 003106119, DATED 10-5-2004, EXPIRES 3-24-2013.

**CLASS 1—CHEMICALS**

FOR QUARTZ-FREE BED MATERIALS FOR FLUIDIZED BED BOILERS AND DIABASES TO ENABLE EFFICIENT COMBUSTION (U.S. CLS. 1, 5, 6, 10, 26 AND 46).

**CLASS 11—ENVIRONMENTAL CONTROL APPARATUS**

FOR INDUSTRIAL POWER BOILERS AND SPARE PARTS THEREOF (U.S. CLS. 13, 21, 23, 31 AND 34).

**CLASS 37—CONSTRUCTION AND REPAIR**

FOR INSTALLATION, MAINTENANCE, AND REPAIR OF INDUSTRIAL POWER BOILERS; MAINTENANCE AND REPAIR OF SPARE PARTS FOR INDUSTRIAL POWER BOILERS (U.S. CLS. 100, 103 AND 106).  
KEVON CHISOLM, EXAMINING ATTORNEY

## **E CONNECT**

THE MARK CONSISTS OF STANDARD CHARACTERS WITHOUT CLAIM TO ANY PARTICULAR FONT, STYLE, SIZE, OR COLOR.

OWNER OF U.S. REG. NOS. 2,113,049, 2,595,400 AND OTHERS.

NO CLAIM IS MADE TO THE EXCLUSIVE RIGHT TO USE "E", APART FROM THE MARK AS SHOWN.

**CLASS 35—ADVERTISING AND BUSINESS**

FOR ON-LINE AGENCY REPRESENTATION FOR RESIDENTIAL APARTMENT RESIDENTS OBTAINING NEEDED SERVICES, NAMELY, UTILITY HOOK-UPS; AND ON-LINE UTILITY BILL MANAGEMENT SERVICES FOR RESIDENTIAL APARTMENT RESIDENTS, NAMELY, TRACKING, REPORTING, ANALYZING AND DELIVERING ENERGY INFORMATION IN THE FORM OF UTILITY BILLS AND UTILITY METER DATA RATE SCHEDULES (U.S. CLS. 100, 101 AND 102).  
FIRST USE 8-25-2003; IN COMMERCE 8-25-2003.

**CLASS 36—INSURANCE AND FINANCIAL**

FOR ON-LINE UTILITY ENERGY BROKERAGE SERVICES FOR RESIDENTIAL APARTMENT RESIDENTS (U.S. CLS. 100, 101 AND 102).  
FIRST USE 8-25-2003; IN COMMERCE 8-25-2003.  
ALEXANDER L. POWERS, EXAMINING ATTORNEY

SN 76-547,191. TIBA SOLUTIONS, LLC, GREENVILLE, SC. FILED 9-26-2003.

## **TIBA SOLUTIONS**

**CLASS 35—ADVERTISING AND BUSINESS**

FOR BUSINESS CONSULTATION; BUSINESS PROJECT MANAGEMENT; BUSINESS PROCESS MANAGEMENT; PROCUREMENT OF COMPUTER HARDWARE AND SOFTWARE FOR OTHERS (U.S. CLS. 100, 101 AND 102).

FIRST USE 9-7-2003; IN COMMERCE 9-7-2003.

**CLASS 42—SCIENTIFIC, COMPUTER AND LEGAL SERVICES**

FOR COMPUTER PROJECT MANAGEMENT SERVICES; COMPUTER INFORMATION SYSTEMS DEVELOPMENT, SPECIFICATION, INSTALLATION, AND IMPLEMENTATION; CONSULTING SERVICES IN THE FIELD OF COMPUTER AND INFORMATION SOFTWARE AND SYSTEMS, NAMELY, COMPUTER SOFTWARE DESIGN, DEVELOPMENT AND IMPLEMENTATION, COMPUTER SOFTWARE LICENSING, INTERNET WEB CONSULTING SERVICES, DEVELOPMENT OF COMPUTER SOFTWARE AND INTERNET-SITES, ENTERPRISE ORGANIZATION CONSULTING, INFORMATION TECHNOLOGY INFRASTRUCTURE DESIGN AND DEVELOPMENT AND SOFTWARE APPLICATION HOSTING (U.S. CLS. 100 AND 101).

FIRST USE 9-7-2003; IN COMMERCE 9-7-2003.  
CIMMERIAN COLEMAN, EXAMINING ATTORNEY

SN 76-547,796. VERSAILLES FOUNDATION, INC., THE, NEW YORK, NY. FILED 9-29-2003.

## VERSAILLES PALACE

OWNER OF U.S. REG. NOS. 1,489,395, 2,253,826 AND 2,398,345.

### CLASS 20—FURNITURE AND ARTICLES NOT OTHERWISE CLASSIFIED

FOR CURTAIN RODS AND DRAPERY HARDWARE, NAMELY TRAVERSE RODS, POLES, NON-METAL CURTAIN HOOKS, RINGS, CLIPS, TIE-BACK HARDWARE AND FINIALS; NON-METAL WALL HOOKS; MIRRORS; BOXES TO STORE LINENS; STORAGE SHELVING AND CLOSET DRAWERS; UPHOLSTERED HEADBOARDS; INTERIOR WINDOW SHUTTERS (U.S. CLS. 2, 13, 22, 25, 32 AND 50).

### CLASS 21—HOUSEWARES AND GLASS

FOR BATH ACCESSORIES, NAMELY TOOTHBRUSH HOLDERS, BEAKERS, SOAP DISHES, VANITY DISHES, VANITY BOXES, VANITY BOTTLES, TISSUE BOXES AND WASTEPAPER BASKETS; DECORATIVE FIXTURES, NAMELY TOWEL HOLDERS AND HOOKS AND SHOWER CADDIES (U.S. CLS. 2, 13, 23, 29, 30, 33, 40 AND 50).

### CLASS 24—FABRICS

FOR COMFORTERS, QUILTS, BEDSPREADS, DUVETS AND DUVET COVERS, SHEETS, PILLOWCASES, SHAMS, PILLOWS, MATTRESS PADS, FEATHER BEDS, BED SKIRTS, BLANKETS, COORDINATED DECORATIVE PILLOWS, COORDINATED TOP-OF-BED THROWS; BATH LINEN, NAMELY TOWELS, WASH-CLOTHS, BATH SHEETS, BEACH TOWELS AND SHOWER CURTAINS; AND WINDOW TREATMENTS, NAMELY CURTAINS, DRAPERIES, SHEERS, FABRIC VALANCES, AND WINDOW SHADES (U.S. CLS. 42 AND 50).

### CLASS 27—FLOOR COVERINGS

FOR BATH RUGS AND BATH MATS; ACCENT RUGS, SCATTER RUGS AND AREA RUGS; RUGS AND CARPETS (U.S. CLS. 19, 20, 37, 42 AND 50).  
PAULA MAYS, EXAMINING ATTORNEY

SN 76-548,681. FIVE STAR, INC., BELMAR, NJ. FILED 9-16-2003.

## HOLIDAZE SKI TOURS

NO CLAIM IS MADE TO THE EXCLUSIVE RIGHT TO USE "SKI TOURS", APART FROM THE MARK AS SHOWN.

### CLASS 39—TRANSPORTATION AND STORAGE

FOR TRAVEL AGENCY SERVICES, NAMELY, MAKING RESERVATIONS AND BOOKINGS FOR TRANSPORTATION (U.S. CLS. 100 AND 105).  
FIRST USE 10-0-1980; IN COMMERCE 10-0-1980.

### CLASS 43—HOTEL AND RESTAURANT SERVICES

FOR TRAVEL AGENCY SERVICES, NAMELY, MAKING RESERVATIONS AND BOOKINGS FOR TEMPORARY LODGING; TRAVEL AGENCY SERVICES, NAMELY, MAKING RESERVATIONS AND BOOKINGS FOR RESTAURANTS AND MEALS (U.S. CLS. 100 AND 101).

FIRST USE 10-0-1980; IN COMMERCE 10-0-1980.  
JOHN HWANG, EXAMINING ATTORNEY

SN 76-549,902. CITYSAFE, INC., FARMINGDALE, NJ. FILED 10-8-2003.

## MODUL-X

### CLASS 6—METAL GOODS

FOR METAL SAFES AND BANK VAULTS IN INTERNATIONAL (U.S. CLS. 2, 12, 13, 14, 23, 25 AND 50).

### CLASS 19—NON-METALLIC BUILDING MATERIALS

FOR COMPOSITE BANK VAULTS, NOT OF METAL (U.S. CLS. 1, 12, 33 AND 50).

### CLASS 20—FURNITURE AND ARTICLES NOT OTHERWISE CLASSIFIED

FOR NON-METAL COMPOSITE SAFES IN INTERNATIONAL (U.S. CLS. 2, 13, 22, 25, 32 AND 50).  
TRICIA THOMPkins, EXAMINING ATTORNEY

SN 76-550,816. BRAXTON, JOHN H., CAPE ELIZABETH, ME. FILED 10-10-2003.



### CLASS 9—ELECTRICAL AND SCIENTIFIC APPARATUS

FOR COMPUTER SOFTWARE FOR GATHERING AND INTEGRATING HOSPITAL PATIENT HEALTH CARE INFORMATION INTO A HAND-HELD DEVICE (U.S. CLS. 21, 23, 26, 36 AND 38).

### CLASS 41—EDUCATION AND ENTERTAINMENT

FOR COMPUTER EDUCATION TRAINING SERVICES IN THE USE OF COMPUTER SOFTWARE DESIGNED TO INTEGRATE AND MANAGE HOSPITAL PATIENT HEALTH CARE INFORMATION (U.S. CLS. 100, 101 AND 107).  
LESLEY LAMOTHE, EXAMINING ATTORNEY

SN 76-551,743. CHRISTINA HAN, INC., MEGURO-KU TOKYO, JAPAN, FILED 10-10-2003.

  
**Christina Han**

OWNER OF JAPAN REG. NO. 4702520, DATED 8-22-2003, EXPIRES 8-22-2013.

#### CLASS 14—JEWELRY

FOR PRECIOUS METALS; PURSES AND WALLETS OF PRECIOUS METAL; ORNAMENTS MADE OF PRECIOUS METAL; CUFF-LINKS; JEWELRY AND IMITATION JEWELRY; CLOCKS AND WATCHES (U.S. CLS. 2, 27, 28 AND 50).

#### CLASS 18—LEATHER GOODS

FOR FUR PELTS, FURS SOLD IN BULK; CLUTCH BAGS, HANDBAGS, SHOULDERS BAGS, SUITCASES, CARRY-ON BAGS, BUSINESS CARD CASES, CREDIT CARD CASES, KEY CASES, SHOPPING BAGS MADE OF TEXTILE, TOTE BAGS, WALLETS NOT MADE OF PRECIOUS METAL, DRAWSTRING POUCHES (U.S. CLS. 1, 2, 3, 22 AND 41).

#### CLASS 24—FABRICS

FOR TOWELS MADE OF TEXTILE, HANDKERCHIEFS; TABLE LINEN, NAMELY COASTERS, NAPKINS, PLACEMATS, AND TABLE CLOTHS (U.S. CLS. 42 AND 50).

#### CLASS 25—CLOTHING

FOR CLOTHING, NAMELY COATS, JACKETS, PANTS, SHIRTS, DRESSES, SKIRTS, SWEATERS, AND BLOUSES; APRONS, SCARVES, NECKTIES, NECKERCHIEFS, AND MUFFLERS (U.S. CLS. 22 AND 39).  
VERNA BETH RIRIE, EXAMINING ATTORNEY

SN 76-551,913. FOUNDATION TO SUPPORT ANIMAL PROTECTION, NORFOLK, VA. FILED 10-10-2003.

## ANIMAL TIMES

OWNER OF U.S. REG. NOS. 1,705,510, 2,125,245 AND OTHERS.

NO CLAIM IS MADE TO THE EXCLUSIVE RIGHT TO USE "ANIMAL", APART FROM THE MARK AS SHOWN.  
SEC. 2(F).

#### CLASS 16—PAPER GOODS AND PRINTED MATTER

FOR MAGAZINES ABOUT ANIMALS, ANIMAL RIGHTS, ANIMAL WELFARE, AND PREVENTION OF CRUELTY AND MISTREATMENT OF ANIMALS, AS WELL AS, ABOUT MEANS TO PROMOTE THE PUBLIC AWARENESS OF EACH SUCH TOPICS (U.S. CLS. 2, 5, 22, 23, 29, 37, 38 AND 50).

FIRST USE 5-1-1994; IN COMMERCE 5-1-1994.

#### CLASS 35—ADVERTISING AND BUSINESS

FOR PROMOTING THE PUBLIC AWARENESS OF THE NEED TO PREVENT CRUELTY AND MISTREATMENT OF ANIMALS VIA A PRINT AND AN ON-LINE MAGAZINE (U.S. CLS. 100, 101 AND 102).

FIRST USE 9-1-1998; IN COMMERCE 9-1-1998.

#### CLASS 41—EDUCATION AND ENTERTAINMENT

FOR PROVIDING AN ON-LINE MAGAZINE ON THE SUBJECT OF ANIMALS, ANIMAL RIGHTS, ANIMAL WELFARE, AND PREVENTION OF CRUELTY AND MISTREATMENT OF ANIMALS, AS WELL AS, ABOUT MEANS TO PROMOTE THE PUBLIC AWARENESS OF EACH SUCH TOPICS (U.S. CLS. 100, 101 AND 107).

FIRST USE 9-1-1998; IN COMMERCE 9-1-1998.

JILL C. ALT, EXAMINING ATTORNEY

SN 76-551,990. ALDERSON, STEPHEN J., LAGUNA NIGUEL, CA. FILED 10-14-2003.

## KARR SECURITY SYSTEMS

NO CLAIM IS MADE TO THE EXCLUSIVE RIGHT TO USE "SECURITY SYSTEMS", APART FROM THE MARK AS SHOWN.

#### CLASS 12—VEHICLES

FOR AUTOMOTIVE STARTER INTERRUPT ANTI-THEFT ALARM (U.S. CLS. 19, 21, 23, 31, 35 AND 44).

FIRST USE 7-1-1993; IN COMMERCE 7-1-1993.

#### CLASS 36—INSURANCE AND FINANCIAL

FOR UNDERWRITING WARRANTY PROGRAM IN THE AUTOMOTIVE SECURITY FIELD (U.S. CLS. 100, 101 AND 102).

FIRST USE 7-1-1993; IN COMMERCE 7-1-1993.

CHERYL CLAYTON, EXAMINING ATTORNEY

SN 76-552,087. KNOTT'S BERRY FARM, BUENA PARK, CA. FILED 10-15-2003.

## XCELERATOR THE RIDE

NO CLAIM IS MADE TO THE EXCLUSIVE RIGHT TO USE "RIDE", APART FROM THE MARK AS SHOWN.

#### CLASS 6—METAL GOODS

FOR METAL KEY CHAINS (U.S. CLS. 2, 12, 13, 14, 23, 25 AND 50).

#### CLASS 9—ELECTRICAL AND SCIENTIFIC APPARATUS

FOR SOUVENIR MAGNETS (U.S. CLS. 21, 23, 26, 36 AND 38).

#### CLASS 16—PAPER GOODS AND PRINTED MATTER

FOR POSTERS, POSTCARDS, PENS AND PENCILS (U.S. CLS. 2, 5, 22, 23, 29, 37, 38 AND 50).



**CLASS 20—FURNITURE AND ARTICLES NOT OTHERWISE CLASSIFIED**

FOR NON-METAL KEY CHAINS (U.S. CLS. 2, 13, 22, 25, 32 AND 50).

**CLASS 21—HOUSEWARES AND GLASS**

FOR SOUVENIR SPORT BOTTLES SOLD EMPTY AND BEVERAGEWARE (U.S. CLS. 2, 13, 23, 29, 30, 33, 40 AND 50).

**CLASS 25—CLOTHING**

FOR CLOTHING, NAMELY, T-SHIRTS AND SWEAT-SHIRTS AND HEADGEAR, NAMELY, VISORS, BASEBALL CAPS, AND BEANIES (U.S. CLS. 22 AND 39).

**CLASS 28—TOYS AND SPORTING GOODS**

FOR TOYS, NAMELY, PLAYGROUND BALLS, TOY CARS, FLYING DISKS, AND PLASTIC TOY HOOPS; AMUSEMENT PARK RIDES (U.S. CLS. 22, 23, 38 AND 50).

**CLASS 41—EDUCATION AND ENTERTAINMENT**

FOR AMUSEMENT PARK SERVICES (U.S. CLS. 100, 101 AND 107).  
ANN LINNEHAN, EXAMINING ATTORNEY

SN 76-552,233. GRANT MEDIA, LLC, SAN FRANCISCO, CA.  
FILED 9-29-2003.

**SEX.XXX****CLASS 35—ADVERTISING AND BUSINESS**

FOR PROVIDING ON-LINE DIRECTORY INFORMATION SERVICES ALSO FEATURING HYPERLINKS TO OTHER WEB SITES (U.S. CLS. 100, 101 AND 102).  
FIRST USE 9-23-2003; IN COMMERCE 9-23-2003.

**CLASS 42—SCIENTIFIC, COMPUTER AND LEGAL SERVICES**

FOR COMPUTER SERVICES, NAMELY, PROVIDING SOFTWARE INTERFACES AVAILABLE OVER A NETWORK IN ORDER TO CREATE A PERSONALIZED ON-LINE INFORMATION SERVICES; EXTRACTION AND RETRIEVAL OF INFORMATION AND DATA MINING BY MEANS OF INTERNET, CREATING INDEXES OF INFORMATION, INDEXES OF WEB SITES AND INDEXES OF OTHER INFORMATION SOURCES IN CONNECTION WITH INTERNET, PROVIDING INFORMATION FROM SEARCHABLE INDEXES AND DATABASES OF INFORMATION, INCLUDING TEXT, ELECTRONIC DOCUMENTS, DATABASES, GRAPHICS AND AUDIO VISUAL INFORMATION VIA THE INTERNET; ELECTRONIC NAVIGATION SERVICES, NAMELY, PROVIDING SEARCH ENGINE SERVICES FOR OBTAINING DATA VIA A GLOBAL COMPUTER NETWORK (U.S. CLS. 100 AND 101).

FIRST USE 9-23-2003; IN COMMERCE 9-23-2003.  
BILL DAWE, EXAMINING ATTORNEY

SN 76-552,410. ALEF STANDARD PACKAGING COMPANY,  
PHILADELPHIA, PA. FILED 10-17-2003.

**ALEF STANDARD  
PACKAGING**

OWNER OF U.S. REG. NO. 2,122,717.  
NO CLAIM IS MADE TO THE EXCLUSIVE RIGHT TO USE "STANDARD PACKAGING", APART FROM THE MARK AS SHOWN.

**CLASS 6—METAL GOODS**

FOR METAL BOXES, METAL JEWELRY BOXES (U.S. CLS. 2, 12, 13, 14, 23, 25 AND 50).  
FIRST USE 0-0-1985; IN COMMERCE 0-0-1998.

**CLASS 9—ELECTRICAL AND SCIENTIFIC APPARATUS**

FOR EYEGLASS CASES; DISPOSABLE LABORATORY SUITS AND ROBES MADE OF PAPER (U.S. CLS. 21, 23, 26, 36 AND 38).  
FIRST USE 0-0-1985; IN COMMERCE 0-0-1998.

**CLASS 14—JEWELRY**

FOR CLOCKS (U.S. CLS. 2, 27, 28 AND 50).  
FIRST USE 0-0-1985; IN COMMERCE 0-0-1998.

**CLASS 16—PAPER GOODS AND PRINTED MATTER**

FOR GENERAL PURPOSE PLASTIC BAGS FOR RETAIL AND INDUSTRIAL USE, CARDBOARD GIFT BOXES FOR RETAIL USE, CARDBOARD BOXES FOR APPAREL AND JEWELRY FOR RETAIL USE, PAPER RIBBONS FOR GIFT WRAPPING; PLASTIC WRAP; GREETING CARDS; CARDBOARD FILE BOXES; CARDBOARD SHIPPING BOXES; CARDBOARD GIFT BOXES; PAPER BAGS; HOLIDAY AND GIFT BAGS MADE OF PAPER; PAPER TAPE (U.S. CLS. 2, 5, 22, 23, 29, 37, 38 AND 50).  
FIRST USE 0-0-1985; IN COMMERCE 0-0-1998.

**CLASS 20—FURNITURE AND ARTICLES NOT OTHERWISE CLASSIFIED**

FOR JEWELRY BOXES NOT OF METAL, PLASTIC AND WOOD HANDLES FOR PACKAGES, PICTURE FRAMES, PLAQUES, AND DISPLAY STANDS FOR WATCHES (U.S. CLS. 2, 13, 22, 25, 32 AND 50).  
FIRST USE 0-0-1985; IN COMMERCE 0-0-1998.

**CLASS 21—HOUSEWARES AND GLASS**

FOR KITCHENWARE, NAMELY FOOD STORAGE CONTAINERS, BOWLS, BASKETS, CUPS AND MUGS (U.S. CLS. 2, 13, 23, 29, 30, 33, 40 AND 50).  
FIRST USE 0-0-1985; IN COMMERCE 0-0-1998.

**CLASS 22—CORDAGE AND FIBERS**

FOR MULTI-PURPOSE CLOTH BAGS FOR RETAIL USE; CLOTH BAGS FOR JEWELRY (U.S. CLS. 1, 2, 7, 19, 22, 42 AND 50).  
FIRST USE 0-0-1985; IN COMMERCE 0-0-1998.  
BRETT J. GOLDEN, EXAMINING ATTORNEY

SN 76-553,286. SOUNDLINE, LLC, RANDOLPH, NJ. FILED 9-22-2003.

SN 76-553,931. ROUSE IP, LLC, COLUMBIA, MD. FILED 10-22-2003.

## SOUNDLINE

### CLASS 9—ELECTRICAL AND SCIENTIFIC APPARATUS

FOR PRE-RECORDED CDS, DVDS, LASER DISCS, AUDIO CASSETTES, AUDIO DISCS, VIDEO TAPES, OPTICAL DISCS, AND INTERACTIVE COMPUTER PROGRAMS IN THE FIELD OF MUSIC, EDUCATION AND ADVERTISING; BLANK OPTICAL DISCS; COMPUTER SCREEN SAVER SOFTWARE; BUSINESS CARDS CONSISTING OF AUDIO CDROMS (U.S. CLS. 21, 23, 26, 36 AND 38).

FIRST USE 1-15-1990; IN COMMERCE 1-15-1990.

### CLASS 16—PAPER GOODS AND PRINTED MATTER

FOR CALENDARS, GREETING CARDS, MUSICAL GREETING CARDS AND HOLIDAY CARDS (U.S. CLS. 2, 5, 22, 23, 29, 37, 38 AND 50).

FIRST USE 1-15-1990; IN COMMERCE 1-15-1990.

### CLASS 35—ADVERTISING AND BUSINESS

FOR CREATING AND UPDATING ADVERTISING MATERIAL (U.S. CLS. 100, 101 AND 102).

FIRST USE 1-15-1990; IN COMMERCE 1-15-1990.

### CLASS 41—EDUCATION AND ENTERTAINMENT

FOR PRODUCTION OF AUDIO TAPES, CDS AND DVDS (U.S. CLS. 100, 101 AND 107).

FIRST USE 1-15-1990; IN COMMERCE 1-15-1990.

JACQUELINE A. LAVINE, EXAMINING ATTORNEY

SN 76-553,606. HCL GYMNASTICS EXPRESS, NATICK, MA. FILED 10-23-2003.



NO CLAIM IS MADE TO THE EXCLUSIVE RIGHT TO USE GYMNASTICS, APART FROM THE MARK AS SHOWN.

### CLASS 25—CLOTHING

FOR GYMNASTICS CLOTHING NAMELY LEOTARDS, SHIRTS, SWEATSHIRTS, SHORTS, PANTS, JACKETS, HATS (U.S. CLS. 22 AND 39).

### CLASS 41—EDUCATION AND ENTERTAINMENT

FOR GYMNASTICS INSTRUCTION SERVICES (U.S. CLS. 100, 101 AND 107).

AMY HELLA, EXAMINING ATTORNEY



NO CLAIM IS MADE TO THE EXCLUSIVE RIGHT TO USE "USA", APART FROM THE MARK AS SHOWN.

### CLASS 36—INSURANCE AND FINANCIAL

FOR SHOPPING CENTER SERVICES; LEASING RETAIL SPACE TO OTHERS; REAL ESTATE MANAGEMENT SERVICES (U.S. CLS. 100, 101 AND 102).

FIRST USE 8-8-2003; IN COMMERCE 8-8-2003.

### CLASS 41—EDUCATION AND ENTERTAINMENT

FOR CHILDREN'S PLAY AREAS WITHIN SHOPPING CENTERS AND RETAIL COMPLEXES (U.S. CLS. 100, 101 AND 107).

FIRST USE 8-8-2003; IN COMMERCE 8-8-2003.

DANIEL CAPSHAW, EXAMINING ATTORNEY

SN 76-555,706. THE SCRIPPS RESEARCH INSTITUTE, LA JOLLA, CA. FILED 10-31-2003.

## TSRI FLORIDA

NO CLAIM IS MADE TO THE EXCLUSIVE RIGHT TO USE FLORIDA, APART FROM THE MARK AS SHOWN.

### CLASS 9—ELECTRICAL AND SCIENTIFIC APPARATUS

FOR PRERECORDED AUDIO AND VIDEO TAPES AND CD-ROMS FEATURING MEDICAL AND SCIENTIFIC INFORMATION FOR USE IN MEDICAL AND SCIENTIFIC RESEARCH AND MEDICAL SERVICES AND EDUCATION SERVICES AND INFORMATION (U.S. CLS. 21, 23, 26, 36 AND 38).

### CLASS 16—PAPER GOODS AND PRINTED MATTER

FOR PRINTED TEACHING AND EDUCATIONAL MATERIALS FOR USE IN MEDICAL AND SCIENTIFIC RESEARCH AND MEDICAL AND EDUCATION SERVICES AND INFORMATION (U.S. CLS. 2, 5, 22, 23, 29, 37, 38 AND 50).

### CLASS 41—EDUCATION AND ENTERTAINMENT

FOR EDUCATIONAL SERVICES, NAMELY, CONDUCTING PROGRAMS IN THE FIELD OF MEDICINE AND SCIENTIFIC RESEARCH (U.S. CLS. 100, 101 AND 107).

### CLASS 42—SCIENTIFIC, COMPUTER AND LEGAL SERVICES

FOR SCIENTIFIC AND MEDICAL RESEARCH (U.S. CLS. 100 AND 101).

**CLASS 44—MEDICAL, BEAUTY AND AGRICULTURAL SERVICES**

FOR MEDICAL SERVICES (U.S. CLS. 100 AND 101).  
TRICIA SONNEBORN, EXAMINING ATTORNEY

SN 76-556,161. TENNESSEE EDUCATION LOTTERY CORPORATION, NASHVILLE, TN. FILED 11-3-2003.

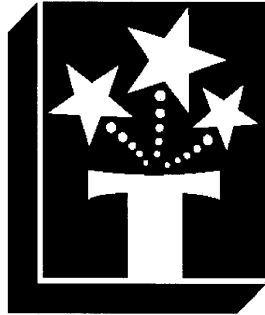

**CLASS 25—CLOTHING**

FOR CLOTHING; NAMELY GOLF SHIRTS, SUN VISORS, CAPS, HATS AND T-SHIRTS (U.S. CLS. 22 AND 39).  
FIRST USE 1-20-2004; IN COMMERCE 1-20-2004.

**CLASS 28—TOYS AND SPORTING GOODS**

FOR LOTTERY CARDS AND LOTTERY TICKETS (U.S. CLS. 22, 23, 38 AND 50).  
FIRST USE 1-20-2004; IN COMMERCE 1-20-2004.  
GIANCARLO CASTRO, EXAMINING ATTORNEY

SN 76-556,470. NATIONAL DIALOGUE ON CANCER, WASHINGTON, DC. FILED 11-4-2003.

**C-CHANGE**

THE MARK CONSISTS OF STANDARD CHARACTERS WITHOUT CLAIM TO ANY PARTICULAR FONT, STYLE, SIZE, OR COLOR.

**CLASS 35—ADVERTISING AND BUSINESS**

FOR ASSOCIATION SERVICES, NAMELY PROMOTING THE PUBLIC INTEREST AND AWARENESS IN CANCER RESEARCH, PREVENTION, DETECTION AND CLINICAL TRIALS, ACCESS TO QUALITY CANCER CARE AND STATE CANCER PLANS (U.S. CLS. 100, 101 AND 102).

**CLASS 36—INSURANCE AND FINANCIAL**

FOR CHARITABLE FUNDRAISING (U.S. CLS. 100, 101 AND 102).

**CLASS 41—EDUCATION AND ENTERTAINMENT**

FOR EDUCATIONAL SERVICES, NAMELY, DEVELOPMENT AND DISSEMINATION OF EDUCATIONAL MATERIALS OF OTHERS IN THE FIELD OF RESEARCH, PREVENTION, DETECTION, TREATMENT AND ELIMINATION OF CANCER (U.S. CLS. 100, 101 AND 107).  
RAUL CORDOVA, EXAMINING ATTORNEY

SN 76-558,187. BIOGEN IDEC MA INC., CAMBRIDGE, MA. FILED 10-23-2003.

**BIOGEN IDEC**

OWNER OF U.S. REG. NOS. 1,314,274, 2,815,504 AND OTHERS.

**CLASS 35—ADVERTISING AND BUSINESS**

FOR PROVIDING ASSISTANCE TO PATIENTS IN OBTAINING REIMBURSEMENTS FROM INSURERS OF HEALTH CARE COSTS (U.S. CLS. 100, 101 AND 102).

**CLASS 36—INSURANCE AND FINANCIAL**

FOR PROVIDING GRANTS FOR IMPROVING THE QUALITY OF LIFE OF PATIENTS AND THEIR FAMILIES, PROVIDING GRANTS IN SUPPORT OF SCIENTIFIC, MEDICAL AND BUSINESS MEETINGS AND WORKSHOPS, AND PROVIDING GRANTS IN SUPPORT OF EDUCATING THE PUBLIC ABOUT MEDICAL ISSUES (U.S. CLS. 100, 101 AND 102).

**CLASS 41—EDUCATION AND ENTERTAINMENT**

FOR EDUCATIONAL SERVICES, NAMELY, PROVIDING TRAINING AND INSTRUCTION IN THE USE OF SPECIALIZED DRUG ADMINISTRATION TECHNIQUES, AND CONDUCTING SEMINARS IN THE FIELD OF HEALTH CARE (U.S. CLS. 100, 101 AND 107).

**CLASS 42—SCIENTIFIC, COMPUTER AND LEGAL SERVICES**

FOR RESEARCH AND CONSULTATION SERVICES IN THE FIELD OF BIOTECHNOLOGY (U.S. CLS. 100 AND 101).

**CLASS 44—MEDICAL, BEAUTY AND AGRICULTURAL SERVICES**

FOR PROVIDING HEALTH CARE SERVICES, NAMELY, PROVIDING HEALTH CARE INFORMATION TO INDIVIDUALS BY MEANS OF A TOLL-FREE TELEPHONE NUMBER, AND MONITORING AND ADVISING PATIENTS' COMPLIANCE WITH DRUG TREATMENT PROCEDURES (U.S. CLS. 100 AND 101).  
JAMES GRIFFIN, EXAMINING ATTORNEY

SN 76-558,728. SOLVAY (SOCIÉTÉ ANONYME), B-1050 BRUSSELS, BELGIUM, FILED 11-13-2003.

SN 76-559,214. CORNERSTONE GROUP HOLDINGS, INC., CUMMING, GA. FILED 11-12-2003.

# SUPRADEL

THE MARK CONSISTS OF STANDARD CHARACTERS WITHOUT CLAIM TO ANY PARTICULAR FONT, STYLE, SIZE, OR COLOR.

PRIORITY CLAIMED UNDER SEC. 44(D) ON BENELUX APPLICATION NO. 1034089, FILED 6-4-2003, REG. NO. 0729900, DATED 6-4-2003, EXPIRES 6-4-2013.

## CLASS 1—CHEMICALS

FOR UNPROCESSED ARTIFICIAL RESINS, UNPROCESSED PLASTICS FOR GENERAL INDUSTRIAL USE (U.S. CLS. 1, 5, 6, 10, 26 AND 46).

## CLASS 17—RUBBER GOODS

FOR PLASTICS AND SYNTHETIC RESINS IN EXTRUDED FORM, PELLETS, FIBERS, FILMS, AND SHEETS FOR GENERAL INDUSTRIAL USE; SEMI-MANUFACTURED PARTS MADE FROM PLASTICS AND SYNTHETIC RESINS FOR FURTHER PROCESSING, FOR USE IN AUTOMOTIVE, AEROSPACE, ELECTRICAL, ELECTRONIC AND INDUSTRIAL PRODUCT APPLICATIONS (U.S. CLS. 1, 5, 12, 13, 35 AND 50).

JENNIFER MARTIN, EXAMINING ATTORNEY

SN 76-558,772. HOLTZ, GERALD N., ROSEMONT, PA. FILED 11-7-2003.

# VIKNOW

THE MARK CONSISTS OF STANDARD CHARACTERS WITHOUT CLAIM TO ANY PARTICULAR FONT, STYLE, SIZE, OR COLOR.

## CLASS 9—ELECTRICAL AND SCIENTIFIC APPARATUS

FOR KIOSKS AND PORTABLE AND HANDHELD DEVICES INCORPORATING COMPUTER HARDWARE AND COMPUTER SOFTWARE AND USED FOR THE PURPOSE OF PROVIDING INFORMATION ON WINE REVIEWS, WINE, AND WINE RELEASES (U.S. CLS. 21, 23, 26, 36 AND 38).

## CLASS 43—HOTEL AND RESTAURANT SERVICES

FOR PROVIDING ONLINE INFORMATION ABOUT WINE REVIEWS, WINE, AND WINE RELEASES BOTH GENERALLY AND BASED ON PERSONAL PREFERENCES BY MEANS OF ANALYSIS OF WINE PREFERENCES, INTERESTS OF WEB SITE USERS AND CONSUMERS, AND REQUESTS FOR INFORMATION FROM WEB SITE USERS AND CONSUMERS (U.S. CLS. 100 AND 101).

PRISCILLA MILTON, EXAMINING ATTORNEY

## WELLSTONE RETIREMENT COMMUNITIES

THE MARK CONSISTS OF STANDARD CHARACTERS WITHOUT CLAIM TO ANY PARTICULAR FONT, STYLE, SIZE, OR COLOR.

NO CLAIM IS MADE TO THE EXCLUSIVE RIGHT TO USE "RETIREMENT COMMUNITIES", APART FROM THE MARK AS SHOWN.

## CLASS 36—INSURANCE AND FINANCIAL

FOR RENTAL OF ASSISTED LIVING FACILITIES AND RETIREMENT HOMES (U.S. CLS. 100, 101 AND 102).

## CLASS 37—CONSTRUCTION AND REPAIR

FOR DEVELOPING, PLANNING, LAYING OUT, CONSTRUCTING AND RENOVATING ASSISTED LIVING FACILITIES, RETIREMENT HOMES AND RESIDENTIAL COMMUNITIES FOR SENIOR ADULTS AND THE ELDERLY; REMODELING OF ASSISTED LIVING FACILITIES, RETIREMENT HOMES AND RESIDENTIAL COMMUNITIES FOR SENIOR ADULTS AND THE ELDERLY (U.S. CLS. 100, 103 AND 106).

## CLASS 43—HOTEL AND RESTAURANT SERVICES

FOR PROVIDING ASSISTED LIVING FACILITIES; RETIREMENT HOMES (U.S. CLS. 100 AND 101).

MICHAEL HALL, EXAMINING ATTORNEY

SN 76-559,767. CORNERSTONE GROUP HOLDINGS, INC., CUMMING, GA. FILED 11-17-2003.

## WELLSTONE SENIOR LIVING COMMUNITIES

THE MARK CONSISTS OF STANDARD CHARACTERS WITHOUT CLAIM TO ANY PARTICULAR FONT, STYLE, SIZE, OR COLOR.

NO CLAIM IS MADE TO THE EXCLUSIVE RIGHT TO USE "SENIOR LIVING COMMUNITIES", APART FROM THE MARK AS SHOWN.

## CLASS 36—INSURANCE AND FINANCIAL

FOR RENTAL OF ASSISTED LIVING FACILITIES AND RETIREMENT HOMES (U.S. CLS. 100, 101 AND 102).

## CLASS 37—CONSTRUCTION AND REPAIR

FOR DEVELOPING, PLANNING, LAYING OUT, CONSTRUCTING AND RENOVATING ASSISTED LIVING FACILITIES, RETIREMENT HOMES AND RESIDENTIAL COMMUNITIES FOR SENIOR ADULTS AND THE ELDERLY; REMODELING OF ASSISTED LIVING FACILITIES, RETIREMENT HOMES AND RESIDENTIAL COMMUNITIES FOR SENIOR ADULTS AND THE ELDERLY (U.S. CLS. 100, 103 AND 106).

## CLASS 43—HOTEL AND RESTAURANT SERVICES

FOR PROVIDING ASSISTED LIVING FACILITIES; RETIREMENT HOMES (U.S. CLS. 100 AND 101).

MICHAEL HALL, EXAMINING ATTORNEY

SN 76-560,613. LEWIS, CHRISTOPHER M., DBA CUT RIVER DESIGN, MARSHFIELD, MA. FILED 11-17-2003.

# OH MY COD

## CLASS 16—PAPER GOODS AND PRINTED MATTER

FOR CHILDREN'S BOOKS; DECALS; NOTE PADS; PENS AND PENCILS; ADDRESS BOOKS AND APPOINTMENT BOOKS; AUTOGRAPH BOOKS; CALENDARS; PAPER COASTERS (U.S. CLS. 2, 5, 22, 23, 29, 37, 38 AND 50).

## CLASS 18—LEATHER GOODS

FOR TOTE BAGS, BACKPACKS, SPORT BAGS, UMBRELLAS, LUGGAGE TAGS (U.S. CLS. 1, 2, 3, 22 AND 41).

## CLASS 21—HOUSEWARES AND GLASS

FOR MUGS, CUPS, DRINKING GLASSES, DISHES, SERVICE TRAYS NOT OF PRECIOUS METAL, AND MEAL TRAYS, JUGS, SALT AND PEPPER SHAKERS, LUNCH BOXES (U.S. CLS. 2, 13, 23, 29, 30, 33, 40 AND 50).

## CLASS 25—CLOTHING

FOR T-SHIRTS, POLO SHIRTS, SWEAT SHIRTS, SWEATERS, SWEAT PANTS, SHORTS, CAPS AND HATS (U.S. CLS. 22 AND 39).

## CLASS 35—ADVERTISING AND BUSINESS

FOR MAIL ORDER CATALOG SERVICES FEATURING CLOTHING, HATS, MUGS AND BAGS; MAIL ORDER CATALOG SERVICES FEATURING MUGS, CLOTHING, HATS AND COSMETICS (U.S. CLS. 100, 101 AND 102).

AISHA CLARKE, EXAMINING ATTORNEY

## CLASS 12—VEHICLES

FOR TRUCK BODIES (U.S. CLS. 19, 21, 23, 31, 35 AND 44).

FIRST USE 9-0-1964; IN COMMERCE 0-0-1973.  
STACY WAHLBERG, EXAMINING ATTORNEY

SN 76-560,832. NATIONAL DIALOGUE ON CANCER, WASHINGTON, DC. FILED 11-19-2003.

## COLLABORATING TO CONQUER CANCER

THE MARK CONSISTS OF STANDARD CHARACTERS WITHOUT CLAIM TO ANY PARTICULAR FONT, STYLE, SIZE, OR COLOR.

NO CLAIM IS MADE TO THE EXCLUSIVE RIGHT TO USE CANCER, APART FROM THE MARK AS SHOWN.

## CLASS 35—ADVERTISING AND BUSINESS

FOR ASSOCIATION SERVICES, NAMELY PROMOTING THE PUBLIC INTEREST AND AWARENESS IN CANCER RESEARCH, PREVENTION, DETECTION AND CLINICAL TRIALS, ACCESS TO QUALITY CANCER CARE AND STATE CANCER PLANS (U.S. CLS. 100, 101 AND 102).

## CLASS 36—INSURANCE AND FINANCIAL

FOR CHARITABLE FUNDRAISING (U.S. CLS. 100, 101 AND 102).

## CLASS 41—EDUCATION AND ENTERTAINMENT

FOR EDUCATIONAL SERVICES, NAMELY DEVELOPMENT AND DISSEMINATION OF EDUCATIONAL MATERIALS OF OTHERS IN THE FIELD OF RESEARCH, PREVENTION, DETECTION, TREATMENT AND ELIMINATION OF CANCER (U.S. CLS. 100, 101 AND 102).

WON TEAK OH, EXAMINING ATTORNEY

SN 76-560,628. TAFCO EQUIPMENT CO., INC., BLUE EARTH, MN. FILED 11-18-2003.

# SCOTT

THE MARK CONSISTS OF STANDARD CHARACTERS WITHOUT CLAIM TO ANY PARTICULAR FONT, STYLE, SIZE, OR COLOR.

OWNER OF U.S. REG. NO. 1,295,987.

## CLASS 7—MACHINERY

FOR HOISTS (U.S. CLS. 13, 19, 21, 23, 31, 34 AND 35).  
FIRST USE 0-0-1979; IN COMMERCE 0-0-1980.

SN 76-561,050. FOWLER, JULIA S., GREENVILLE, SC. FILED 11-19-2003.

# SOLUTIENCE

THE MARK CONSISTS OF STANDARD CHARACTERS WITHOUT CLAIM TO ANY PARTICULAR FONT, STYLE, SIZE, OR COLOR.

## CLASS 35—ADVERTISING AND BUSINESS

FOR BUSINESS CONSULTATION (U.S. CLS. 100, 101 AND 102).  
FIRST USE 11-1-2003; IN COMMERCE 11-1-2003.

**CLASS 42—SCIENTIFIC, COMPUTER AND LEGAL SERVICES**

FOR CONSULTATION SERVICES IN THE FIELD OF INFORMATION TECHNOLOGY (U.S. CLS. 100 AND 101).

FIRST USE 11-1-2003; IN COMMERCE 11-1-2003.  
WON TEAK OH, EXAMINING ATTORNEY

SN 76-561,200. BROWNE & CO. LTD., MARKHAM, ONTARIO, CANADA, FILED 11-21-2003.

# DONVIER

THE MARK CONSISTS OF STANDARD CHARACTERS WITHOUT CLAIM TO ANY PARTICULAR FONT, STYLE, SIZE, OR COLOR.

PRIORITY CLAIMED UNDER SEC. 44(D) ON CANADA APPLICATION NO. 1,178,720, FILED 5-21-2003.

OWNER OF U.S. REG. NO. 1,415,581.

THE ENGLISH TRANSLATION OF THE WORD "DONVIER" IN THE MARK IS "GETTING VERY COLD".

**CLASS 11—ENVIRONMENTAL CONTROL APPARATUS**

FOR NON-ELECTRIC ICE CREAM MAKERS AND REPLACEMENT PARTS THEREFOR, ELECTRIC YOGURT MAKERS AND REPLACEMENT PARTS THEREFOR, AND NON-ELECTRIC YOGURT CHEESE MAKERS AND REPLACEMENT PARTS THEREFOR (U.S. CLS. 13, 21, 23, 31 AND 34).

FIRST USE 12-23-1983; IN COMMERCE 1-31-1984.

**CLASS 21—HOUSEWARES AND GLASS**

FOR FROZEN POP MOLDS (U.S. CLS. 2, 13, 23, 29, 30, 33, 40 AND 50).

FIRST USE 0-0-1996; IN COMMERCE 0-0-1996.

GINA FINK, EXAMINING ATTORNEY

SN 76-561,470. NATIONAL FOUNDATION FOR CREDIT COUNSELING, INC., SILVER SPRING, MD. FILED 11-24-2003.

KNOW THE NFCC MEMBER DIFFERENCE

THE MARK CONSISTS OF STANDARD CHARACTERS WITHOUT CLAIM TO ANY PARTICULAR FONT, STYLE, SIZE, OR COLOR.

OWNER OF U.S. REG. NO. 2,452,433.

**CLASS 35—ADVERTISING AND BUSINESS**

FOR ASSOCIATION SERVICES, NAMELY, PROMOTING THE INTERESTS OF CONSUMER CREDIT AND DEBT MANAGEMENT AGENCIES BY FOSTERING AND ENCOURAGING THEIR ESTABLISHMENT AND PROPER FUNCTIONING (U.S. CLS. 100, 101 AND 102).

**CLASS 36—INSURANCE AND FINANCIAL**

FOR CREDIT AND DEBT COUNSELING SERVICES, FINANCIAL COUNSELING SERVICES (U.S. CLS. 100, 101 AND 102).

**CLASS 41—EDUCATION AND ENTERTAINMENT**

FOR EDUCATIONAL SERVICES, NAMELY, SEMINARS, WORKSHOPS AND LECTURES IN THE FIELDS OF DEBT AND CREDIT MANAGEMENT, FINANCIAL PLANNING, AND FINANCES (U.S. CLS. 100, 101 AND 107).

WILLIAM VERHOSEK, EXAMINING ATTORNEY

SN 76-561,633. CITICORP, NEW YORK, NY. FILED 11-7-2003.

# CITITRAVEL

**CLASS 35—ADVERTISING AND BUSINESS**

FOR BENEFITS PROGRAMS OFFERED TO CREDIT CARD HOLDERS, NAMELY, PROMOTING THE GOODS AND SERVICES OF OTHERS THROUGH SPECIAL PROMOTIONS, SPONSORSHIPS AND DISCOUNTS FOR TRAVEL, HOTEL, RESTAURANT, PARKING AND AUTOMOBILE RENTALS (U.S. CLS. 100, 101 AND 102).

FIRST USE 0-0-1986; IN COMMERCE 0-0-1986.

**CLASS 39—TRANSPORTATION AND STORAGE**

FOR BENEFITS PROGRAMS OFFERED TO CREDIT CARD HOLDERS, NAMELY, TRAVEL PLANNING SERVICES IN THE NATURE OF MAKING RESERVATIONS AND BOOKINGS FOR TRANSPORTATION (U.S. CLS. 100 AND 105).

FIRST USE 0-0-1986; IN COMMERCE 0-0-1986.

**CLASS 43—HOTEL AND RESTAURANT SERVICES**

FOR BENEFITS PROGRAMS OFFERED TO CREDIT CARD HOLDERS, NAMELY, TRAVEL PLANNING SERVICES IN THE NATURE OF MAKING RESERVATIONS AND BOOKING FOR TEMPORARY LODGING (U.S. CLS. 100 AND 101).

FIRST USE 0-0-1986; IN COMMERCE 0-0-1986.

GRETTA YAO, EXAMINING ATTORNEY

SN 76-561,654. UNITED SITE SERVICES, INC., MANSFIELD, MA. FILED 11-12-2003.

# UNITED SITE SERVICES

THE MARK CONSISTS OF STANDARD CHARACTERS WITHOUT CLAIM TO ANY PARTICULAR FONT, STYLE, SIZE, OR COLOR.

OWNER OF U.S. REG. NO. 2,489,123.

NO CLAIM IS MADE TO THE EXCLUSIVE RIGHT TO USE "SITE SERVICES", APART FROM THE MARK AS SHOWN.

**CLASS 37—CONSTRUCTION AND REPAIR**

FOR RENTAL OF TEMPORARY CONSTRUCTION SITE FENCING (U.S. CLS. 100, 103 AND 106).

**CLASS 39—TRANSPORTATION AND STORAGE**

FOR RENTAL OF CONSTRUCTION, OFFICE AND STORAGE TRAILERS (U.S. CLS. 100 AND 105).  
DAVID H. STINE, EXAMINING ATTORNEY

**CLASS 29—MEATS AND PROCESSED FOODS**

FOR SNACK BARS, NAMELY, PROTEIN-BASED, NUTRIENT DENSE SNACK BARS (U.S. CL. 46).

**CLASS 30—STAPLE FOODS**

FOR SNACK BARS, NAMELY, READY-TO-EAT CEREAL DERIVED FOOD BARS; CEREAL BASED ENERGY BARS; AND GRANOLA BASED SNACK BARS (U.S. CL. 46).  
KIMBERLY PERRY, EXAMINING ATTORNEY

SN 76-561,656. UNITED SITE SERVICES, INC., MANSFIELD, MA. FILED 11-12-2003.



OWNER OF U.S. REG. NO. 2,489,123.  
NO CLAIM IS MADE TO THE EXCLUSIVE RIGHT TO USE "SITE SERVICES", APART FROM THE MARK AS SHOWN.

**CLASS 37—CONSTRUCTION AND REPAIR**

FOR RENTAL OF TEMPORARY CONSTRUCTION SITE FENCING (U.S. CLS. 100, 103 AND 106).

**CLASS 39—TRANSPORTATION AND STORAGE**

FOR RENTAL OF CONSTRUCTION, OFFICE AND STORAGE TRAILERS (U.S. CLS. 100 AND 105).  
DAVID H. STINE, EXAMINING ATTORNEY

SN 76-562,498. HAY HOUSE, INC., CARLSBAD, CA. FILED 11-17-2003.

[www.louiselhay.com](http://www.louiselhay.com)

THE NAME IN THE MARK IDENTIFIES A LIVING INDIVIDUAL WHOSE CONSENT IS OF RECORD.

**CLASS 35—ADVERTISING AND BUSINESS**

FOR ONLINE RETAIL STORE SERVICES FEATURING BOOKS, COMPACT DISKS AND AUDIO CASSETTES (U.S. CLS. 100, 101 AND 102).

**CLASS 41—EDUCATION AND ENTERTAINMENT**

FOR ARRANGING FOR TICKET RESERVATIONS ON LINE, FOR EDUCATIONAL WORKSHOPS (U.S. CLS. 100, 101 AND 107).  
DEZMONA MIZELLE, EXAMINING ATTORNEY

SN 76-561,760. MARS, INCORPORATED, MCLEAN, VA. FILED 11-25-2003.



THE COLOR(S) WHITE, YELLOW AND RED ARE CLAIMED AS A FEATURE OF THE MARK.  
"MARATHON" APPEARS IN WHITE WITH A BEAM OF YELLOW LIGHT PIERCING IT TO FORM A COLLABORATION OF RED AND YELLOW COLORED LINES.  
THE MARK CONSISTS OF THE WORD MARATHON IN STYLIZED WHITE LETTERS WITH A BEAM OF YELLOW "LIGHT" PIERCING THROUGH IT FORMING A COLLABORATION OF RED AND YELLOW COLORED LINES.

**CLASS 5—PHARMACEUTICALS**

FOR NUTRITIONAL ENERGY BARS, MEAL REPLACEMENT ENERGY BARS; MEAL REPLACEMENT ENERGY BARS; MEAL REPLACEMENT NUTRITION BARS; READY-TO-EAT NUTRITION BARS FOR MEAL REPLACEMENT; AND READY-TO-EAT ENERGY BARS FOR MEAL REPLACEMENT (U.S. CLS. 6, 18, 44, 46, 51 AND 52).

SN 76-564,227. CHRISTIAN BERNARD STORES CORP., SECAUCUS, NJ. FILED 11-25-2003.

POETIC

THE MARK CONSISTS OF STANDARD CHARACTERS WITHOUT CLAIM TO ANY PARTICULAR FONT, STYLE, SIZE, OR COLOR.

**CLASS 14—JEWELRY**

FOR JEWELRY (U.S. CLS. 2, 27, 28 AND 50).

**CLASS 35—ADVERTISING AND BUSINESS**

FOR RETAIL STORE SERVICES FEATURING JEWELRY (U.S. CLS. 100, 101 AND 102).  
FRED MANDIR, EXAMINING ATTORNEY

SN 76-564,677. HEALTHAMERICA NETWORK CORPORATION, EAST AMHERST, NY. FILED 12-11-2003.



NO CLAIM IS MADE TO THE EXCLUSIVE RIGHT TO USE "HEALTH TRANSACTION NETWORK", APART FROM THE MARK AS SHOWN.

THE MARK CONSISTS OF IN PART THE WORDING HEALTHTRANSACTION WITH THE DESIGN OF A CROSS IN THE LETTER H.

#### CLASS 9—ELECTRICAL AND SCIENTIFIC APPARATUS

FOR COMPUTER HARDWARE TO ALLOW USERS TO PERFORM HEALTH CARE RELATED ELECTRONIC BUSINESS TRANSACTIONS VIA THE GLOBAL COMPUTER NETWORK; COMPUTER HARDWARE FOR USE IN HEALTH INSURANCE BENEFIT MANAGEMENT, PATIENT CARE REFERRALS, MEDICAL INFORMATION, CONSUMER IDENTIFICATION, PATIENT HEALTH, PATIENT CHART NOTING AND RECORDS MANAGEMENT, HEALTH CARE RELATED AND OTHER FINANCIAL TRANSACTIONS AND HEALTH CARE RELATED CLAIMS BILLING VIA THE GLOBAL COMPUTER NETWORK AND TRAINING MANUALS SOLD THEREWITH (U.S. CLS. 21, 23, 26, 36 AND 38).

#### CLASS 16—PAPER GOODS AND PRINTED MATTER

FOR HEALTH INSURANCE BENEFITS AND MEDICAL IDENTIFICATION CARD AND NEWSLETTERS IN THE FIELD OF HEALTH, MEDICINE AND INSURANCE (U.S. CLS. 2, 5, 22, 23, 29, 37, 38 AND 50).

#### CLASS 35—ADVERTISING AND BUSINESS

FOR COMPUTER SERVICES, NAMELY PROVIDING DATABASES AND ONLINE INFORMATION SERVICES IN THE FIELD OF PATIENT CARE REFERRALS, HEALTH CARE RELATED CLAIMS BILLING SERVICES VIA A GLOBAL COMPUTER NETWORK. (U.S. CLS. 100, 101 AND 102).

#### CLASS 36—INSURANCE AND FINANCIAL

FOR FINANCIAL SERVICES, NAMELY DEBIT CARD SERVICES; COMPUTER SERVICES, NAMELY PROVIDING DATABASES AND ONLINE INFORMATION SERVICES IN THE FIELD OF HEALTH INSURANCE BENEFITS VIA A GLOBAL COMPUTER NETWORK. (U.S. CLS. 100, 101 AND 102).

#### CLASS 44—MEDICAL, BEAUTY AND AGRICULTURAL SERVICES

FOR COMPUTER SERVICES, NAMELY PROVIDING DATABASES AND ONLINE INFORMATION SERVICES IN THE FIELD OF MEDICAL INFORMATION AND PATIENT HEALTH INFORMATION, MAINTAINING FILES AND RECORDS CONCERNING THE MEDICAL CONDITION OF INDIVIDUALS VIA A GLOBAL COMPUTER NETWORK. (U.S. CLS. 100 AND 101).  
GINNY ISAACSON, EXAMINING ATTORNEY

SN 76-564,750. AVENTINE RENEWABLE ENERGY, INC., PEKIN, IL. FILED 12-11-2003.



NO CLAIM IS MADE TO THE EXCLUSIVE RIGHT TO USE RENEWABLE ENERGY, INC., APART FROM THE MARK AS SHOWN.

#### CLASS 1—CHEMICALS

FOR PURE GASES AND MIXTURES THEREOF, NAMELY CARBON DIOXIDE AND ETHANOL FOR USE IN THE GENERAL INDUSTRIAL AGRICULTURAL CHEMICAL, AND FUEL-RELATED INDUSTRIES (U.S. CLS. 1, 5, 6, 10, 26 AND 46).

FIRST USE 11-1-2003; IN COMMERCE 11-1-2003.

#### CLASS 31—NATURAL AGRICULTURAL PRODUCTS

FOR ANIMAL FEED, ANIMAL FEED ADDITIVES, NAMELY NON-NUTRITIONAL CORN-BASED AND YEAST-BASED ADDITIVES (U.S. CLS. 1 AND 46).

FIRST USE 11-1-2003; IN COMMERCE 11-1-2003.

STEVEN BERK, EXAMINING ATTORNEY

SN 76-564,877. GENERAL THORACIC SURGICAL CLUB, ROCHESTER, MN. FILED 12-12-2003.

# GTSC

THE MARK CONSISTS OF STANDARD CHARACTERS WITHOUT CLAIM TO ANY PARTICULAR FONT, STYLE, SIZE, OR COLOR.

#### CLASS 35—ADVERTISING AND BUSINESS

FOR CONDUCTING BUSINESS CONFERENCES AND MEETINGS FOR PHYSICIANS IN THE FIELD OF GENERAL THORACIC SURGERY (U.S. CLS. 100, 101 AND 102).

FIRST USE 9-1-2003; IN COMMERCE 9-1-2003.

#### CLASS 41—EDUCATION AND ENTERTAINMENT

FOR EDUCATIONAL SERVICES, NAMELY, CONDUCTING SEMINARS, EDUCATIONAL CONFERENCES, LECTURES, EDUCATIONAL MEETINGS, WORKSHOPS AND CLASSES FOR PHYSICIANS IN THE FIELD OF GENERAL THORACIC SURGERY AND DISTRIBUTING COURSE MATERIALS IN CONNECTION THEREWITH, NAMELY PAPERS AND JOURNALS FEATURING NEWS AND INFORMATION IN THE FIELD OF GENERAL THORACIC SURGERY (U.S. CLS. 100, 101 AND 107).

FIRST USE 9-1-2003; IN COMMERCE 9-1-2003.

MARY ROSSMAN, EXAMINING ATTORNEY



SN 76-564,883. GENERAL THORACIC SURGICAL CLUB, ROCHESTER, MN. FILED 12-12-2003.

SN 76-566,527. INTERSTATE BATTERY SYSTEM INTERNATIONAL, INC., DALLAS, TX. FILED 12-15-2003.

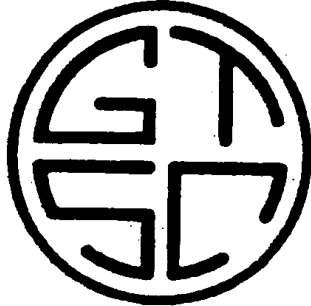

**CLASS 35—ADVERTISING AND BUSINESS**

FOR CONDUCTING BUSINESS CONFERENCES AND MEETINGS FOR PHYSICIANS IN THE FIELD OF GENERAL THORACIC SURGERY (U.S. CLS. 100, 101 AND 102).

FIRST USE 9-21-2003; IN COMMERCE 9-21-2003.

**CLASS 41—EDUCATION AND ENTERTAINMENT**

FOR EDUCATIONAL SERVICES, NAMELY, CONDUCTING SEMINARS, EDUCATIONAL CONFERENCES, LECTURES, EDUCATIONAL MEETINGS, WORKSHOPS AND CLASSES FOR PHYSICIANS IN THE FIELD OF GENERAL THORACIC SURGERY AND DISTRIBUTING COURSE MATERIALS IN CONNECTION THEREWITH, NAMELY PAPERS AND JOURNALS FEATURING NEWS AND INFORMATION IN THE FIELD OF GENERAL THORACIC SURGERY (U.S. CLS. 100, 101 AND 107).

FIRST USE 9-21-2003; IN COMMERCE 9-21-2003.  
MARY ROSSMAN, EXAMINING ATTORNEY

SN 76-566,036. OHIO RESTAURANT ASSOCIATION, COLUMBUS, OH. FILED 12-5-2003.

**North America Pizza Team**

THE MARK CONSISTS OF STANDARD CHARACTERS WITHOUT CLAIM TO ANY PARTICULAR FONT, STYLE, SIZE, OR COLOR.

NO CLAIM IS MADE TO THE EXCLUSIVE RIGHT TO USE "NORTH AMERICA PIZZA", APART FROM THE MARK AS SHOWN.

**CLASS 35—ADVERTISING AND BUSINESS**

FOR CONDUCTING TRADE SHOWS IN THE FIELD OF RESTAURANT SERVICES (U.S. CLS. 100, 101 AND 102).

**CLASS 41—EDUCATION AND ENTERTAINMENT**

FOR ENTERTAINMENT SERVICES, NAMELY CONDUCTING CONTESTS WITHIN THE RESTAURANT TRADE SHOW INDUSTRY (U.S. CLS. 100, 101 AND 107).  
MARK T. MULLEN, EXAMINING ATTORNEY

**THE OFFICIAL BATTERY OF THE GREAT OUTDOORS**

THE MARK CONSISTS OF STANDARD CHARACTERS WITHOUT CLAIM TO ANY PARTICULAR FONT, STYLE, SIZE, OR COLOR.

OWNER OF U.S. REG. NO. 2,406,894.

NO CLAIM IS MADE TO THE EXCLUSIVE RIGHT TO USE "BATTERY", APART FROM THE MARK AS SHOWN.

**CLASS 9—ELECTRICAL AND SCIENTIFIC APPARATUS**

FOR ELECTRICAL STORAGE BATTERIES; ELECTRICAL STORAGE BATTERIES, NAMELY ALKALINE BATTERIES; ELECTRICAL STORAGE BATTERIES FOR USE IN TRANSPORTATION EQUIPMENT, NAMELY AUTOMOBILES, AIRCRAFTS, TRUCKS, CAMPERS, MARINE/BOATS, ALL TERRAIN VEHICLES, JET SKIS; ELECTRICAL STORAGE BATTERIES FOR USE IN EQUIPMENT, NAMELY LAWN EQUIPMENT, GARDEN EQUIPMENT, CAMPING EQUIPMENT, HOUSEHOLD EQUIPMENT, SAFETY EQUIPMENT, COMMERCIAL EQUIPMENT (U.S. CLS. 21, 23, 26, 36 AND 38).

**CLASS 35—ADVERTISING AND BUSINESS**

FOR RETAIL STORE SERVICES IN THE FIELD OF BATTERIES; DISTRIBUTORSHIP SERVICES IN THE FIELD OF BATTERIES (U.S. CLS. 100, 101 AND 102).

RENEE MCCRAY, EXAMINING ATTORNEY

SN 76-570,224. EIKOS INC., FRANKLIN, MA. FILED 1-16-2004.

**INVISICON**

THE MARK CONSISTS OF STANDARD CHARACTERS WITHOUT CLAIM TO ANY PARTICULAR FONT, STYLE, SIZE, OR COLOR.

**CLASS 1—CHEMICALS**

FOR CHEMICAL SUBSTRATES USED IN THE MANUFACTURE OF TRANSPARENT CONDUCTIVE COATINGS, INKS, AND COATING FILMS (U.S. CLS. 1, 5, 6, 10, 26 AND 46).

FIRST USE 11-17-2003; IN COMMERCE 11-25-2003.

**CLASS 2—PAINTS**

FOR TRANSPARENT CONDUCTIVE COATINGS, INKS, COATING FILMS AND COATING SUBSTRATES USED IN THE MANUFACTURE OF TOUCH SCREENS, LCD DISPLAYS, SOLAR CELLS, AND ELECTRODES AND CIRCUITS (U.S. CLS. 6, 11 AND 16).

FIRST USE 11-17-2003; IN COMMERCE 11-25-2003.  
HOWARD B. LEVINE, EXAMINING ATTORNEY

SN 76-570,689. DANESI CAFFE S.P.A., ROME, ITALY, FILED 1-20-2004.



PRIORITY CLAIMED UNDER SEC. 44(D) ON ITALY APPLICATION NO. RM2003C00408, FILED 7-25-2003, REG. NO. 00906506, DATED 9-3-2003, EXPIRES 7-25-2013.

OWNER OF U.S. REG. NOS. 1,378,327 AND 1,518,186.

NO CLAIM IS MADE TO THE EXCLUSIVE RIGHT TO USE "CAFFE", APART FROM THE MARK AS SHOWN.

#### CLASS 35—ADVERTISING AND BUSINESS

FOR ADVERTISING AND BUSINESS SERVICES, NAMELY, ARRANGING AND SPONSORSHIP OF CULTURAL EVENTS, ART EXHIBITIONS, AND SPORTING EVENTS (U.S. CLS. 100, 101 AND 102).

#### CLASS 43—HOTEL AND RESTAURANT SERVICES

FOR SERVICES FOR PROVIDING FOOD AND DRINK, NAMELY, RESTAURANT AND CAFETERIA SERVICES; PROVIDING TEMPORARY ACCOMMODATIONS (U.S. CLS. 100 AND 101).

LINDA E. BLOHM, EXAMINING ATTORNEY

---

SN 76-573,381. THE OUTDOOR RECREATION GROUP, LOS ANGELES, CA. FILED 2-3-2004.



NO CLAIM IS MADE TO THE EXCLUSIVE RIGHT TO USE THE DESIGN OF THE FISH, APART FROM THE MARK AS SHOWN.

THE COLOR GRAY IS A FEATURE OF THE MARK. THE COLOR GRAY APPEARS IN THE GRAPHICAL REPRESENTATION OF THE FISH AND ABOUT THE WORDING.

#### CLASS 25—CLOTHING

FOR FISHING VEST (U.S. CLS. 22 AND 39).

#### CLASS 28—TOYS AND SPORTING GOODS

FOR FISHING TACKLE BAGS AND FISHING GEAR, NAMELY, FISHING TACKLE BOXES (U.S. CLS. 22, 23, 38 AND 50).

RICHARD A. STRASER, EXAMINING ATTORNEY

SN 76-573,584. CAL FARLEY'S BOYS RANCH, DBA CAL FARLEY'S, AMARILLO, TX. FILED 2-2-2004.

## CAL FARLEY'S

THE MARK CONSISTS OF STANDARD CHARACTERS WITHOUT CLAIM TO ANY PARTICULAR FONT, STYLE, SIZE, OR COLOR.

OWNER OF U.S. REG. NOS. 2,174,601, 2,653,839 AND OTHERS.

THE NAME "CAL FARLEY" DOES NOT IDENTIFY A LIVING INDIVIDUAL.

#### CLASS 41—EDUCATION AND ENTERTAINMENT

FOR EDUCATIONAL SERVICES, NAMELY, PROVIDING COURSES OF INSTRUCTION AT THE PRIMARY AND SECONDARY LEVEL; CAREER COUNSELING SERVICES FOR REHABILITATING CHILDREN AND MEETING THEIR CAREER DEVELOPMENTAL NEEDS (U.S. CLS. 100, 101 AND 107).

FIRST USE 0-0-1939; IN COMMERCE 0-0-1939.

#### CLASS 43—HOTEL AND RESTAURANT SERVICES

FOR RESIDENTIAL CHILDCARE SERVICES FOR CHILDREN PARTICIPATING IN SPECIFICALLY DESIGNED EDUCATIONAL PROGRAMS AND INDIVIDUALLY TAILORED COUNSELING PROGRAMS (U.S. CLS. 100 AND 101).

FIRST USE 0-0-1939; IN COMMERCE 0-0-1939.

#### CLASS 44—MEDICAL, BEAUTY AND AGRICULTURAL SERVICES

FOR PSYCHOLOGICAL COUNSELING SERVICES IN THE FIELD OF REHABILITATING CHILDREN AND MEETING THEIR CHILDHOOD DEVELOPMENTAL NEEDS; MEDICAL AND NUTRITION COUNSELING SERVICES FOR REHABILITATING CHILDREN AND MEETING THEIR PHYSICAL DEVELOPMENTAL NEEDS (U.S. CLS. 100 AND 101).

FIRST USE 0-0-1939; IN COMMERCE 0-0-1939.

NELSON SNYDER, EXAMINING ATTORNEY

---

SN 76-574,373. ALABANZA, INC., BALTIMORE, MD. FILED 2-6-2004.

## SITEXPRESS

THE MARK CONSISTS OF STANDARD CHARACTERS WITHOUT CLAIM TO ANY PARTICULAR FONT, STYLE, SIZE, OR COLOR.

#### CLASS 9—ELECTRICAL AND SCIENTIFIC APPARATUS

FOR COMPUTER SOFTWARE FOR THE CREATION AND DESIGN OF WEB SITES (U.S. CLS. 21, 23, 26, 36 AND 38).

**CLASS 42—SCIENTIFIC, COMPUTER AND LEGAL SERVICES**

FOR PROVIDING TEMPORARY USE OF DOWNLOADABLE SOFTWARE FOR THE CREATION AND DESIGN OF WEB SITES (U.S. CLS. 100 AND 101).  
VIVIAN MICZNIK FIRST, EXAMINING ATTORNEY

---

SN 76-575,004. CARNEGIE MELLON UNIVERSITY, PITTSBURGH, PA. FILED 2-9-2004.

**THE DA VINCI EFFECT**

THE MARK CONSISTS OF STANDARD CHARACTERS WITHOUT CLAIM TO ANY PARTICULAR FONT, STYLE, SIZE, OR COLOR.

**CLASS 35—ADVERTISING AND BUSINESS**

FOR PROMOTING THE INTERESTS OF THE UNIVERSITY, ITS PROGRAMS, AND ITS STUDENTS AND ALUMNI (U.S. CLS. 100, 101 AND 102).

**CLASS 36—INSURANCE AND FINANCIAL**

FOR FUNDRAISING SERVICES, NAMELY, SOLICITING AND MANAGING DONATIONS TO PROMOTE THE INTERESTS OF THE UNIVERSITY, ITS PROGRAMS, AND ITS STUDENTS AND ALUMNI (U.S. CLS. 100, 101 AND 102).

**CLASS 41—EDUCATION AND ENTERTAINMENT**

FOR EDUCATIONAL SERVICES, NAMELY PROVIDING INSTRUCTIONAL, MOTIVATIONAL, OUTREACH AND MENTORING PROGRAMS TO HIGH SCHOOL, UNDERGRADUATE, GRADUATE, POST-GRADUATE, AND PROFESSIONAL STUDENTS IN THE FIELDS OF LIBERAL ARTS, ENGINEERING, SCIENCE, COMPUTER SCIENCE, FINE ARTS, HUMANITIES AND SOCIAL SCIENCES, INDUSTRIAL ADMINISTRATION, AND PUBLIC POLICY AND MANAGEMENT (U.S. CLS. 100, 101 AND 107).

MATTHEW PAPPAS, EXAMINING ATTORNEY

---

SN 76-575,523. MESHNETWORKS, INC., MAITLAND, FL. FILED 2-13-2004.

**MESHCONNEX**

THE MARK CONSISTS OF STANDARD CHARACTERS WITHOUT CLAIM TO ANY PARTICULAR FONT, STYLE, SIZE, OR COLOR.

**CLASS 9—ELECTRICAL AND SCIENTIFIC APPARATUS**

FOR COMPUTER SOFTWARE FOR WIRELESS BROADBAND APPLICATIONS THAT PROVIDE VOICE, DATA, AND STREAMING MEDIA TO USERS OF PERSONAL COMPUTERS AND WIRELESS COMMUNICATION DEVICES SUCH AS PERSONAL DIGITAL ASSISTANTS, PERSONAL COMPUTERS, AND CELLULAR TELEPHONES (U.S. CLS. 21, 23, 26, 36 AND 38).

**CLASS 38—COMMUNICATION**

FOR WIRELESS BROADBAND SERVICES, NAMELY, PROVIDING VOICE, DATA, AND STREAMING MEDIA VIA WIRELESS MEANS SUCH AS PERSONAL DIGITAL ASSISTANTS, PERSONAL COMPUTERS, AND CELLULAR TELEPHONES (U.S. CLS. 100, 101 AND 104).  
ANN E. SAPPENFIELD, EXAMINING ATTORNEY

---

SN 76-577,076. GLOBAL INTERNET VENTURES, INC., PALM DESERT, CA. FILED 2-17-2004.

**MR. FUSSY****CLASS 37—CONSTRUCTION AND REPAIR**

FOR CLEANING AND JANITORIAL SERVICES FOR RESIDENTIAL, VACATION AND COMMERCIAL PROPERTIES (U.S. CLS. 100, 103 AND 106).

**CLASS 45—PERSONAL SERVICES**

FOR CONCIERGE SERVICES FOR OWNERS AND MANAGERS OF RESIDENTIAL, VACATION AND COMMERCIAL PROPERTIES, NAMELY, VACATION HOMES, HOTELS, MOTELS AND RESORT PROPERTIES, COMPRISING MAKING REQUESTED PERSONAL ARRANGEMENTS AND RESERVATIONS AND PROVIDING CUSTOMER-SPECIFIC INFORMATION TO MEET INDIVIDUAL NEEDS (U.S. CLS. 100 AND 101).  
MICHAEL HALL, EXAMINING ATTORNEY

---

SN 76-577,215. THE NEW YORK TIMES COMPANY, NEW YORK, NY. FILED 2-18-2004.

**LIVES THEY LIVED**

THE MARK CONSISTS OF STANDARD CHARACTERS WITHOUT CLAIM TO ANY PARTICULAR FONT, STYLE, SIZE, OR COLOR.

SEC. 2(F) SECTION 2(F) (FOR CLASS 16 GOODS ONLY).

**CLASS 16—PAPER GOODS AND PRINTED MATTER**

FOR PRINTED PUBLICATIONS, NAMELY AN ANNUAL MAGAZINE AND NEWSPAPER SECTION FEATURING BIOGRAPHIES OF RECENTLY DECEASED INDIVIDUALS (U.S. CLS. 2, 5, 22, 23, 29, 37, 38 AND 50).  
FIRST USE 12-31-1995; IN COMMERCE 12-31-1995.

**CLASS 41—EDUCATION AND ENTERTAINMENT**

FOR ENTERTAINMENT SERVICES, NAMELY, ONGOING TELEVISION PROGRAMS FEATURING BIOGRAPHIES OF RECENTLY DECEASED INDIVIDUALS; ONLINE PUBLICATIONS, NAMELY AN ANNUAL MAGAZINE AND NEWSPAPER SECTION FEATURING BIOGRAPHIES OF RECENTLY DECEASED INDIVIDUALS (U.S. CLS. 100, 101 AND 107).  
FIRST USE 12-29-2002; IN COMMERCE 12-29-2002.  
STEVEN BERK, EXAMINING ATTORNEY

SN 76-578,865. KABUSHIKI KAISHA KIBUN SHOKUHIN, TA KIBUN FOODS INC., CHUO-KU, TOKYO, JAPAN, FILED 3-3-2004.



OWNER OF JAPAN REG. NO. 2615975, DATED 1-31-1994, RENEWED AS REG. NO. 2615975, DATED 8-19-2003, EXPIRES 1-31-2014.

OWNER OF U.S. REG. NOS. 2,554,515 AND 2,562,873.  
APPLICANT ALSO CLAIMS THE COLOR RED INSIDE OF THE THREE HEARTS.

SN 76-578,491. GOTTBETTER & PARTNERS, LLP, NEW YORK, NY. FILED 3-1-2004.

**CLASS 29—MEATS AND PROCESSED FOODS**

FOR EDIBLE OILS AND FATS; DAIRY PRODUCTS EXCLUDING ICE CREAM, ICE MILK, AND FROZEN YOGURT; STEAMED FISH CAKE; BOILED FISH CAKE; BAKED FISH CAKE WITH BURDOCK (U.S. CL. 46).

**CLASS 30—STAPLE FOODS**

FOR SEASONINGS; SPICES (U.S. CL. 46).  
KATHERINE STOIDES, EXAMINING ATTORNEY

**GPO**

SN 76-580,047. DREAMWORKS ANIMATION L.L.C., GLENDALE, CA. FILED 3-9-2004.

THE MARK CONSISTS OF STANDARD CHARACTERS WITHOUT CLAIM TO ANY PARTICULAR FONT, STYLE, SIZE, OR COLOR.

**CLASS 35—ADVERTISING AND BUSINESS**

FOR BUSINESS CONSULTING SERVICES INTENDED TO ASSIST AND FACILITATE COMPANIES IN THE PROCESS OF SELF-UNDERWRITTEN INITIAL PUBLIC OFFERINGS (U.S. CLS. 100, 101 AND 102).  
FIRST USE 4-0-1999; IN COMMERCE 4-0-1999.

**CLASS 36—INSURANCE AND FINANCIAL**

FOR FINANCIAL CONSULTING SERVICES INTENDED TO ASSIST AND FACILITATE COMPANIES IN THE PROCESS OF SELF-UNDERWRITTEN INITIAL PUBLIC OFFERINGS (U.S. CLS. 100, 101 AND 102).  
FIRST USE 4-0-1999; IN COMMERCE 4-0-1999.

**CLASS 42—SCIENTIFIC, COMPUTER AND LEGAL SERVICES**

FOR LEGAL SERVICES, NAMELY, ASSISTING AND FACILITATING COMPANIES IN THE PROCESS OF SELF-UNDERWRITTEN INITIAL PUBLIC OFFERINGS (U.S. CLS. 100 AND 101).  
FIRST USE 4-0-1999; IN COMMERCE 4-0-1999.  
RONALD MCMORROW, EXAMINING ATTORNEY

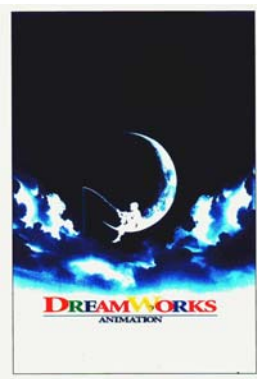

OWNER OF U.S. REG. NOS. 1,693,222, 2,665,088 AND OTHERS.

NO CLAIM IS MADE TO THE EXCLUSIVE RIGHT TO USE "ANIMATION", APART FROM THE MARK AS SHOWN.

THE COLORS ORANGE, RED, BLUE, PINK, GREEN AND YELLOW ARE CLAIMED AS FEATURES OF THE MARK.

THE MARK CONSISTS OF A BOY IN THE MOON AND THE FOLLOWING COLORS—ORANGE ON THE LETTERS "D" AND "O"; GREEN ON THE LETTER "R"; BLUE ON THE LETTERS "E" AND "R"; PINK ON THE LETTER "A"; AND RED ON THE LETTERS "M", "K" AND "S"; YELLOW APPEARS ON THE LETTER "W". BLUE APPEARS IN THE SKY PORTION OF THE MARK. THE WORD ANIMATION APPEARS IN BLUE.

**CLASS 9—ELECTRICAL AND SCIENTIFIC APPARATUS**

FOR PRERECORDED VIDEO TAPES AND DVD'S CONTAINING ANIMATED MOTION PICTURES, PRE-RECORDED COMPACT DISCS AND AUDIO TAPES CONTAINING SOUND TRACKS FROM ANIMATED MOTION PICTURES, PRERECORDED AUDIO TAPES CONTAINING MUSIC FROM ANIMATED MOTION PICTURES, AND INTERACTIVE VIDEO GAME PROGRAMS CONTAINING CHARACTERS AND SCENES FROM ANIMATED MOTION PICTURES (U.S. CLS. 21, 23, 26, 36 AND 38).

**CLASS 41—EDUCATION AND ENTERTAINMENT**

FOR ENTERTAINMENT SERVICES, NAMELY THE PRODUCTION AND DISTRIBUTION OF ANIMATED MOTION PICTURES AND ANIMATED TELEVISION PROGRAMS FOR OTHERS (U.S. CLS. 100, 101 AND 107).  
CHRISIE B. KING, EXAMINING ATTORNEY



SN 76-580,264. ABLEMARLE CORPORATION, BATON ROUGE, LA. FILED 3-9-2004.

**ABZOL**

THE MARK CONSISTS OF STANDARD CHARACTERS WITHOUT CLAIM TO ANY PARTICULAR FONT, STYLE, SIZE, OR COLOR.

**CLASS 1—CHEMICALS**

FOR CHEMICAL CARRIER SOLVENTS FOR INDUSTRIAL USE (U.S. CLS. 1, 5, 6, 10, 26 AND 46).  
FIRST USE 5-31-1996; IN COMMERCE 5-31-1996.

**CLASS 3—COSMETICS AND CLEANING PREPARATIONS**

FOR INDUSTRIAL CLEANER FOR USE PRIMARILY ON METAL AND PLASTIC SURFACES; CHEMICAL CLEANING SOLVENTS FOR INDUSTRIAL USE (U.S. CLS. 1, 4, 6, 50, 51 AND 52).  
FIRST USE 5-31-1996; IN COMMERCE 5-31-1996.  
JOHN DALIER, EXAMINING ATTORNEY



SN 76-580,355. RANE, JAMES W., ABBEVILLE, AL. FILED 3-10-2004.

**HUGGIN' MOLLY**

THE MARK CONSISTS OF STANDARD CHARACTERS WITHOUT CLAIM TO ANY PARTICULAR FONT, STYLE, SIZE, OR COLOR.

**CLASS 16—PAPER GOODS AND PRINTED MATTER**

FOR BOOKS, NAMELY, COLORING BOOKS, COOK BOOKS, ADDRESS BOOKS, APPOINTMENT BOOKS, COMIC BOOKS, CHILDREN'S BOOKS, RECIPE BOOKS, AND TELEPHONE BOOKS; PAPER PLACE MATS (U.S. CLS. 2, 5, 22, 23, 29, 37, 38 AND 50).

**CLASS 28—TOYS AND SPORTING GOODS**

FOR DOLLS, GOLF BALLS, GOLF TEES, AND GOLF BALL MARKERS (U.S. CLS. 22, 23, 38 AND 50).  
ZACHARY BELLO, EXAMINING ATTORNEY



SN 76-580,736. FIRST ACT, INC., NEWTON, MA. FILED 3-12-2004.

**FA**

THE MARK CONSISTS OF STANDARD CHARACTERS WITHOUT CLAIM TO ANY PARTICULAR FONT, STYLE, SIZE, OR COLOR.

**CLASS 9—ELECTRICAL AND SCIENTIFIC APPARATUS**

FOR COMPUTER SOFTWARE FOR LEARNING ABOUT MUSIC AND THE PLAYING OF MUSICAL INSTRUMENTS; PRERECORDED AUDIO CASSETTES, VIDEO CASSETTES AND DVD'S FEATURING INSTRUCTION IN MUSIC AND THE PLAYING OF MUSICAL INSTRUMENTS; SOUND AMPLIFIERS; MICROPHONES (U.S. CLS. 21, 23, 26, 36 AND 38).

**CLASS 15—MUSICAL INSTRUMENTS**

FOR FULL LINE OF MUSICAL INSTRUMENTS AND PARTS THEREFOR; ELECTRONIC TUNERS FOR MUSICAL INSTRUMENTS; CARRYING CASES FOR MUSICAL INSTRUMENTS; SHEET MUSIC STANDS (U.S. CLS. 2, 21 AND 36).

**CLASS 16—PAPER GOODS AND PRINTED MATTER**

FOR BOOKS AND PAMPHLETS FEATURING INSTRUCTION IN MUSIC AND THE PLAYING OF MUSICAL INSTRUMENTS (U.S. CLS. 2, 5, 22, 23, 29, 37, 38 AND 50).

**CLASS 28—TOYS AND SPORTING GOODS**

FOR TOY MUSICAL INSTRUMENTS; A FULL LINE OF TOYS (U.S. CLS. 22, 23, 38 AND 50).  
MARY ROSSMAN, EXAMINING ATTORNEY

SN 76-580,953. SHABBY CHIC, INC., LOS ANGELES, CA.  
FILED 3-15-2004.

**SSC**

OWNER OF U.S. REG. NOS. 1,753,006, 2,757,921 AND OTHERS.

**CLASS 11—ENVIRONMENTAL CONTROL APPARATUS**

FOR LAMP SHADES AND LAMPS (U.S. CLS. 13, 21, 23, 31 AND 34).

**CLASS 18—LEATHER GOODS**

FOR FABRIC TOTE BAGS, BACKPACKS, ALL PURPOSE SPORTS BAGS, UMBRELLAS, LEATHER KEY FOBs, LUGGAGE TAGS, DUFFLE BAGS, TRAVELING BAGS, GARMENT BAGS FOR TRAVEL, LUGGAGE, WALLETS, PURSES AND HANDBAGS (U.S. CLS. 1, 2, 3, 22 AND 41).

**CLASS 20—FURNITURE AND ARTICLES NOT OTHERWISE CLASSIFIED**

FOR FURNITURE; NAMELY, CHAIR PADS, WALL UNITS, END TABLES, NIGHT STANDS, VANITY TABLES, COFFEE TABLES, DINING TABLES, ARMOIRES, BOOKCASES, CHAIRS, SOFAS, OTTOMANS, COUCHES, PILLOWS, LOVE SEATS, TABLES, ROOM DIVIDER SCREENS, FIRE PLACE SCREENS, WALL CABINETS, DRESSERS AND FITTED FABRIC COVERS FOR FURNITURE, FABRIC CHAIR PADS, AND NON-METAL SHOWER HOOKS (U.S. CLS. 2, 13, 22, 25, 32 AND 50).

**CLASS 21—HOUSEWARES AND GLASS**

FOR TOOTHBRUSH HOLDERS; TOOTHBRUSHES; TUMBLERS; MEAL TRAYS LOTION DISPENSERS AND PUMPS; SOAP DISHES; FITTED VANITY CASES; WASTEBASKETS; SHOWER HOOKS; TOWEL BARS; SHOWER CADDIES; PERFUME SPRAYERS SOLD EMPTY; MUGS; MUG TREES; GLASS AND PORCELAIN FABRIC MITTS FOR CLEANING; NAPKIN HOLDERS; NAIL BRUSHES; HAIR COMBS; HAIR BRUSHES; BOTTLE OPENERS; CHINA, CRYSTAL, GLASS, PORCELAIN, AND TERRA COTTA CHRISTMAS, HOLIDAY AND THEME ORNAMENTS NOT BEING TREE ORNAMENTS; MOPS; BROOMS; DINNERWARE; CHINA DINNERWARE; DISHES; CUPS; DRINKING GLASSES; GLASS BOWLS; GLASS PANS; PAPER CUPS AND PLATES; PITCHERS; PLATES; SALT AND PEPPER SHAKERS; SERVING SPOONS; SPICE RACKS; LUNCH BOXES; JUGS; NON-METAL KEEPSAKE BOXES; NON-METAL DECORATIVE BOXES; DECORATIVE GLASS BOXES; NON-METAL TRINKET BOXES; CANDLE HOLDERS NOT OF PRECIOUS METAL; CANDLE STICKS NOT OF PRECIOUS METAL (U.S. CLS. 2, 13, 23, 29, 30, 33, 40 AND 50).

**CLASS 24—FABRICS**

FOR FABRIC NAPKINS, FABRICS, LINENS AND TEXTILES FOR THE FURTHER MANUFACTURE OF HOUSEWARES; FABRIC, LINEN AND TEXTILE PIECES FOR THE FURTHER MANUFACTURE OF HOUSEWARES; FABRICS, LINENS AND TEXTILES FOR THE FURTHER MANUFACTURE OF BEDDING, BATHWARE, FURNITURE, HOME FURNISHINGS, HOUSEHOLD GOODS, WINDOW TREATMENTS AND CLOTHING; BED SPREADS; BED SHEETS; FITTED BED SHEETS; FLAT BED SHEETS; POPLIN AND T-SHIRT BED SHEETS; BED BLANKETS; RECEIVING BLANKETS; BED CANOPIES; DUVETS; DUVET COVERS; BED PADS; BEDDING LINEN; DUST RUFFLES; PILLOW CASES; PILLOW SHAMS; POTATOSACK PILLOW CASES; PILLOW CASES WITH RUFFLES; PILLOW SHAMS WITH RUFFLES; RUFFLED BEDSKIRTS; BEDSKIRTS; COMFORTERS; TEXTILE BATH MATS; TOWELS; HOODED TOWELS; BATH LINENS; BATH MATS; CLOTH BANNERS; FABRIC CURTAINS; DRAPERIES; DRAPERY PANELS; DISH CLOTHS; CLOTH DOILIES; CLOTH AND TEXTILE NAPKINS; WASH CLOTHS; CLOTH AND TEXTILE PLACEMATS; PUFFS FOR WINDOW TREATMENTS; FABRIC TABLE RUNNERS; SHROUDS; TABLE CLOTHS NOT OF PAPER; TEXTILE TAPESTRIES; FABRIC VALANCES; FABRIC CHAIR PADS; QUILTS; QUILTED SHAMS; SHOWER CURTAINS; TOWELS; BATHROOM TOWELS; HAND TOWELS; WASH TOWELS; KITCHEN TOWELS; POT HOLDERS; AND MATTRESS PADS (U.S. CLS. 42 AND 50).

**CLASS 27—FLOOR COVERINGS**

FOR RUGS, CARPETS, DOORMATS, RUBBER PLASTIC BATH MATS, CARPET PADDING, BATHROOM RUGS AND TEXTILE FLOOR MATS FOR USE IN HOME, TEXTILE BATH MATS; AND BATH MATS (U.S. CLS. 19, 20, 37, 42 AND 50).

RON FAIRBANKS, EXAMINING ATTORNEY

SN 76-581,390. CCSG INVESTMENTS, INC., HOUSTON, TX.  
FILED 3-15-2004.

**CHRISTOPHER PHILIP**

THE MARK CONSISTS OF STANDARD CHARACTERS WITHOUT CLAIM TO ANY PARTICULAR FONT, STYLE, SIZE, OR COLOR.

THE NAME CHRISTOPHER PHILIP IDENTIFIES A LIVING INDIVIDUAL WHOSE CONSENT IS OF RECORD.

**CLASS 3—COSMETICS AND CLEANING PREPARATIONS**

FOR MAKEUP TOOLS, NAMELY, MAKEUP BRUSHES (U.S. CLS. 1, 4, 6, 50, 51 AND 52).

**CLASS 8—HAND TOOLS**

FOR EYEBROW TWEEZERS (U.S. CLS. 23, 28 AND 44).

**CLASS 18—LEATHER GOODS**

FOR MAKEUP CASES SOLD EMPTY (U.S. CLS. 1, 2, 3, 22 AND 41).

**CLASS 21—HOUSEWARES AND GLASS**

FOR MAKEUP SPONGES (U.S. CLS. 2, 13, 23, 29, 30, 33, 40 AND 50).

REGINA DRUMMOND, EXAMINING ATTORNEY

SN 76-581,427. KANEBO KABUSHIKI KAISHA (KANEBO, LTD.), SUMIDA-KU, TOKYO, JAPAN, FILED 3-17-2004.

SN 76-583,785. EXPORTING EXCELLENCE, LLC, RENO, NV. FILED 3-29-2004.

# FUITECLOTH

# EXPORTING EXCELLENCE

THE MARK CONSISTS OF STANDARD CHARACTERS WITHOUT CLAIM TO ANY PARTICULAR FONT, STYLE, SIZE, OR COLOR.

THE MARK CONSISTS OF STANDARD CHARACTERS WITHOUT CLAIM TO ANY PARTICULAR FONT, STYLE, SIZE, OR COLOR.

## CLASS 21—HOUSEWARES AND GLASS

FOR WIPING CLOTH, WIPING CLOTH FOR INDUSTRIAL USE (U.S. CLS. 2, 13, 23, 29, 30, 33, 40 AND 50).

## CLASS 35—ADVERTISING AND BUSINESS

FOR BUSINESS MARKETING CONSULTING SERVICES (U.S. CLS. 100, 101 AND 102).

## CLASS 24—FABRICS

FOR WOVEN AND KNITTED FABRICS FOR USE IN THE MANUFACTURE OF WIPING CLOTH, AND WIPING CLOTH FOR INDUSTRIAL USE (U.S. CLS. 42 AND 50).

## CLASS 41—EDUCATION AND ENTERTAINMENT

FOR SEMINARS AND WORKSHOPS IN THE FIELD OF FOREIGN BUSINESS DEVELOPMENT (U.S. CLS. 100, 101 AND 107).

DOUGLAS LEE, EXAMINING ATTORNEY

RICHARD A. STRASER, EXAMINING ATTORNEY

SN 76-581,770. ROLLER BEARING COMPANY OF AMERICA, INC., FAIRFIELD, CT. FILED 3-18-2004.

SN 76-584,829. INDUSTRIAS MACIER, S.A., MOCA, REP. DOM., DOMINICAN REP, FILED 4-1-2004.



# MACIER

OWNER OF U.S. REG. NOS. 2,394,785 AND 2,394,786. NO CLAIM IS MADE TO THE EXCLUSIVE RIGHT TO USE AEROSPACE AND BEARINGS, APART FROM THE MARK AS SHOWN.

THE MARK CONSISTS OF STANDARD CHARACTERS WITHOUT CLAIM TO ANY PARTICULAR FONT, STYLE, SIZE, OR COLOR.

## CLASS 7—MACHINERY

FOR ANTI-FRICTION BEARINGS INCLUDING STRAIGHT ROLLER, TAPERED ROLLER, SPHERICAL ROLLER, NEEDLE AND BALL BEARINGS; BALL SLIDE BEARINGS; BALL, ROLLER AND NEEDLE THRUST BEARINGS; NEEDLE AND BEARING RACES; SELF-ALIGNING BUSHINGS, CAGE AND ROLLER ASSEMBLIES (U.S. CLS. 13, 19, 21, 23, 31, 34 AND 35).

## CLASS 3—COSMETICS AND CLEANING PREPARATIONS

FOR HAIR SHAMPOO, SHAMPOO-CONDITIONERS, HAIR GEL, LAUNDRY BLEACH, DISINFECTANT SOAPS, AND DISHWASHING DETERGENTS (U.S. CLS. 1, 4, 6, 50, 51 AND 52).

## CLASS 12—VEHICLES

FOR BEARINGS FOR USE IN AIRCRAFT AND VEHICLES NAMELY, ANTI-FRICTION BEARINGS INCLUDING STRAIGHT ROLLER, TAPERED ROLLER, SPHERICAL ROLLER, NEEDLE AND BALL BEARINGS; BALL SLIDE BEARINGS; BALL, ROLLER AND NEEDLE THRUST BEARINGS; NEEDLE AND BEARING RACES; SELF-ALIGNING BUSHINGS, CAGE AND ROLLER ASSEMBLIES (U.S. CLS. 19, 21, 23, 31, 35 AND 44).  
PAULA MAYS, EXAMINING ATTORNEY

## CLASS 30—STAPLE FOODS

FOR VINEGAR (U.S. CL. 46).  
HEATHER THOMPSON, EXAMINING ATTORNEY

SN 76-585,018. GILI MUSIC LLC, MIAMI, FL. FILED 4-5-2004.

SN 76-585,654. DOLLAR TREE STORES, INC., CHESAPEAKE, VA. FILED 4-7-2004.

# GILI

THE MARK CONSISTS OF STANDARD CHARACTERS WITHOUT CLAIM TO ANY PARTICULAR FONT, STYLE, SIZE, OR COLOR.

## CLASS 9—ELECTRICAL AND SCIENTIFIC APPARATUS

FOR PRERECORDED COMPACT DISCS, CD-ROMS, CASSETTE TAPES, DVDS AND PHONOGRAPH RECORDS, ALL FEATURING MUSIC; PRERECORDED VIDEOTAPES, DVDS, COMPACT DISCS AND CD-ROMS, ALL FEATURING MUSIC VIDEOS (U.S. CLS. 21, 23, 26, 36 AND 38).

## CLASS 35—ADVERTISING AND BUSINESS

FOR BUSINESS MANAGEMENT SERVICES IN THE FIELD OF ENTERTAINMENT; MANAGEMENT OF PERFORMING ARTISTS (U.S. CLS. 100, 101 AND 102).

## CLASS 41—EDUCATION AND ENTERTAINMENT

FOR ENTERTAINMENT CONSULTING SERVICES IN THE FIELD OF MUSIC; ENTERTAINMENT SERVICES, NAMELY PRODUCTION AND DISTRIBUTION OF AUDIO AND VISUAL TAPES, PHONOGRAPH RECORDS, COMPACT DISCS, DVDS AND CD-ROMS, ALL FEATURING MUSIC, MUSIC VIDEOS AND MUSICAL PERFORMANCES; MUSIC PUBLISHING SERVICES (U.S. CLS. 100, 101 AND 107).

CURTIS FRENCH, EXAMINING ATTORNEY

SN 76-585,334. PHONAK HOLDING AG, CH-8712 STAEFA, SWITZERLAND, FILED 4-6-2004.

# OpenSound

OWNER OF SWITZERLAND REG. NO. 519543, DATED 3-18-2004, EXPIRES 3-5-2014.

## CLASS 9—ELECTRICAL AND SCIENTIFIC APPARATUS

FOR COMPUTER SOFTWARE FOR THE CONTROL OF BIOMEDICAL APPARATUS, NAMELY, HEARING AIDS (U.S. CLS. 21, 23, 26, 36 AND 38).

## CLASS 10—MEDICAL APPARATUS

FOR BIOMEDICAL APPARATUS, NAMELY HEARING AIDS (U.S. CLS. 26, 39 AND 44).

CHARLES L. JENKINS, EXAMINING ATTORNEY

# ROYAL NORFOLK

THE MARK CONSISTS OF STANDARD CHARACTERS WITHOUT CLAIM TO ANY PARTICULAR FONT, STYLE, SIZE, OR COLOR.

## CLASS 8—HAND TOOLS

FOR CUTLERY NAMELY, STEAK KNIVES, BREAD KNIVES, CARVING KNIVES, PARING KNIVES, CUTTING AND SLICING KNIVES (U.S. CLS. 23, 28 AND 44).

FIRST USE 8-15-2001; IN COMMERCE 8-15-2001.

## CLASS 21—HOUSEWARES AND GLASS

FOR HOUSEHOLD GOODS NAMELY, DINNERWARE MADE OF CERAMIC (U.S. CLS. 2, 13, 23, 29, 30, 33, 40 AND 50).

FIRST USE 8-15-2001; IN COMMERCE 8-15-2001.

## CLASS 24—FABRICS

FOR LINENS AND TEXTILES NAMELY KITCHEN TOWELS, FINGERTIP TOWELS, DISHCLOTHS, PLACE-MATS, POT HOLDERS, OVEN MITTS, AND WASH CLOTHS (U.S. CLS. 42 AND 50).

FIRST USE 8-15-2001; IN COMMERCE 8-15-2001.

SHARI SHEFFIELD, EXAMINING ATTORNEY

SN 76-585,705. TANKE, WILLIAM B., WALNUT, CA. FILED 4-7-2004.

# ALOE ESSENTIALS

THE MARK CONSISTS OF STANDARD CHARACTERS WITHOUT CLAIM TO ANY PARTICULAR FONT, STYLE, SIZE, OR COLOR.

NO CLAIM IS MADE TO THE EXCLUSIVE RIGHT TO USE "ALOE", APART FROM THE MARK AS SHOWN.

## CLASS 3—COSMETICS AND CLEANING PREPARATIONS

FOR SKIN CARE PRODUCTS CONTAINING ALOE VERA, NAMELY, BODY WASHES, CONDITIONERS, CLEANSERS, CREAMS, TONER AND SPRAY-ON FACE AND BODY COOLING AGENTS; HAIR SHAMPOO AND HAIR GEL (U.S. CLS. 1, 4, 6, 50, 51 AND 52).

FIRST USE 5-0-1996; IN COMMERCE 10-0-1997.

## CLASS 5—PHARMACEUTICALS

FOR SKIN CARE PRODUCTS CONTAINING ALOE VERA, NAMELY CLEAR SKIN SERUM AND BLEMISH TREATMENT PREPARATIONS IN THE NATURE OF BLEMISH REMOVERS (U.S. CLS. 6, 18, 44, 46, 51 AND 52).

FIRST USE 5-0-1996; IN COMMERCE 10-0-1997.

VIVIAN MICZNIK FIRST, EXAMINING ATTORNEY



SN 76-585,993. SONY COMPUTER ENTERTAINMENT AMERICA INC., FOSTER CITY, CA. FILED 4-9-2004.

SN 76-587,919. EPIX MEDICAL, INC., CAMBRIDGE, MA. FILED 4-21-2004.

# GOD OF WAR

## CLASS 9—ELECTRICAL AND SCIENTIFIC APPARATUS

FOR COMPUTER GAME SOFTWARE AND VIDEO GAME SOFTWARE (U.S. CLS. 21, 23, 26, 36 AND 38).

## CLASS 28—TOYS AND SPORTING GOODS

FOR TOYS, NAMELY ACTION FIGURES (U.S. CLS. 22, 23, 38 AND 50).  
PAULA MAYS, EXAMINING ATTORNEY

# EPIX-PHARMA

THE MARK CONSISTS OF STANDARD CHARACTERS WITHOUT CLAIM TO ANY PARTICULAR FONT, STYLE, SIZE, OR COLOR.

OWNER OF U.S. REG. NOS. 2,496,893, 2,884,997 AND OTHERS.

## CLASS 5—PHARMACEUTICALS

FOR PHARMACEUTICALS AND THERAPEUTICS FOR USE IN CONNECTION WITH ONCOLOGY AND FOR DETECTING, MONITORING AND TREATING CARDIOVASCULAR DISEASE (U.S. CLS. 6, 18, 44, 46, 51 AND 52).

## CLASS 42—SCIENTIFIC, COMPUTER AND LEGAL SERVICES

FOR MEDICAL RESEARCH; RESEARCH AND DEVELOPMENT OF PHARMACEUTICALS AND THERAPEUTICS (U.S. CLS. 100 AND 101).

KELLEY WELLS, EXAMINING ATTORNEY

SN 76-586,192. GEORGE ZIMMER 1988 LIVING TRUST, COMPRISING JAMES ZIMMER, LAURIE ECKSTEIN, DAVID EDWAB AND CHARLES BRESLER ALL U.S. CITIZEN., FREMONT, CA. FILED 4-12-2004.

SN 76-588,867. SECURITY ASSOCIATES, INC., HUNT VALLEY, MD. FILED 4-23-2004.



# Your Hometown Alarm Company

THE MARK CONSISTS OF STANDARD CHARACTERS WITHOUT CLAIM TO ANY PARTICULAR FONT, STYLE, SIZE, OR COLOR.

NO CLAIM IS MADE TO THE EXCLUSIVE RIGHT TO USE ALARM COMPANY, APART FROM THE MARK AS SHOWN.

OWNER OF U.S. REG. NO. 2,655,808.  
THE STIPPLING IS A FEATURE OF THE MARK AND DOES NOT INDICATE COLOR.

THE LIKENESS (OR, "PORTRAIT") IN THE MARK IDENTIFIES A LIVING INDIVIDUAL WHOSE CONSENT IS OF RECORD.

THE MARK CONSISTS OF A LIKENESS (OR, "PORTRAIT") OF GEORGE ZIMMER'S FACE.

## CLASS 37—CONSTRUCTION AND REPAIR

FOR INSTALLATION, MAINTENANCE AND REPAIR OF RESIDENTIAL AND COMMERCIAL SECURITY SYSTEMS, WIRELESS AND WIRELINE HOME AUTOMATION, LIGHTING AND PC/NETWORKING CONTROL AND MOTION DETECTOR SYSTEMS (U.S. CLS. 100, 103 AND 106).

FIRST USE 1-1-1990; IN COMMERCE 1-1-1990.

## CLASS 37—CONSTRUCTION AND REPAIR

FOR DRY CLEANING AND LAUNDRY SERVICES (U.S. CLS. 100, 103 AND 106).

## CLASS 45—PERSONAL SERVICES

FOR MONITORING OF RESIDENTIAL AND COMMERCIAL SECURITY ALARM SYSTEMS (U.S. CLS. 100 AND 101).

FIRST USE 1-1-1990; IN COMMERCE 1-1-1990.  
STEVEN BERK, EXAMINING ATTORNEY

## CLASS 40—MATERIAL TREATMENT

FOR TAILORING AND CLOTHING ALTERATION (U.S. CLS. 100, 103 AND 106).  
JOHN DALIER, EXAMINING ATTORNEY

SN 76-588,984. DAVISON OIL COMPANY, INC., MOBILE, AL. FILED 4-26-2004.

## ENGINEERED WITH PRIDE

THE MARK CONSISTS OF STANDARD CHARACTERS WITHOUT CLAIM TO ANY PARTICULAR FONT, STYLE, SIZE, OR COLOR.

### CLASS 1—CHEMICALS

FOR ANTIFREEZE (U.S. CLS. 1, 5, 6, 10, 26 AND 46). FIRST USE 0-0-1976; IN COMMERCE 0-0-1976.

### CLASS 4—LUBRICANTS AND FUELS

FOR MOTOR OIL, FUEL OIL, AND INDUSTRIAL OILS (U.S. CLS. 1, 6 AND 15). FIRST USE 0-0-1976; IN COMMERCE 0-0-1976. WON TEAK OH, EXAMINING ATTORNEY

SN 76-589,528. BG STAR PRODUCTIONS, INC., SHERMAN OAKS, CA. FILED 4-30-2004.

## THE FASTEST HOUR IN FITNESS

THE MARK CONSISTS OF STANDARD CHARACTERS WITHOUT CLAIM TO ANY PARTICULAR FONT, STYLE, SIZE, OR COLOR.

### CLASS 9—ELECTRICAL AND SCIENTIFIC APPARATUS

FOR RECORDED MEDIA, NAMELY, PRE-RECORDED VIDEO TAPES, COMPACT DISCS, DIGITAL AUDIO AND VIDEO DISCS, DVD'S, INTERACTIVE COMPACT DISCS AND SOFTWARE, AND AUDIO TAPES FEATURING AEROBICS, EXERCISE INSTRUCTION, MARTIAL ARTS INSTRUCTION, MUSIC, WEIGHT CONTROL, HEALTH DIETING, NUTRITION AND PERSONAL MOTIVATION (U.S. CLS. 21, 23, 26, 36 AND 38).

### CLASS 16—PAPER GOODS AND PRINTED MATTER

FOR PRINTED MATERIALS, NAMELY BOOKS, PAMPHLETS, COURSE MATERIALS, INSTRUCTIONAL AND TRAINING MATERIALS, MAGAZINES, PERIODICALS, NEWSLETTERS, AND CATALOGS IN THE FIELDS OF NUTRITION, HEALTH, AEROBICS, EXERCISE, MARTIAL ARTS AND PERSONAL MOTIVATION; PRINTED STICKERS, BOOKMARKS, CATALOGS, PHOTOGRAPHS, POSTERS, STATIONERY, CERTIFICATES AND COOKBOOKS (U.S. CLS. 2, 5, 22, 23, 29, 37, 38 AND 50).

### CLASS 25—CLOTHING

FOR CLOTHING FOR ADULTS AND CHILDREN, NAMELY FOOTWEAR, SHOES, SOCKS; SHIRTS, SWEATSHIRTS, SWEATSUITS, SWEATPANTS, T-SHIRTS, JACKETS, ATHLETIC PANTS, TANK TOPS; HEADWEAR, NAMELY HEADBANDS, HATS, VISORS AND BANDANNAS; WRISTBANDS, GLOVES; AND BRAS AND UNDERWEAR FOR USE DURING EXERCISE OR FITNESS TRAINING (U.S. CLS. 22 AND 39).

### CLASS 28—TOYS AND SPORTING GOODS

FOR EXERCISE AND MARTIAL ARTS EQUIPMENT AND ACCESSORIES, NAMELY EXERCISE WEIGHTS, MANUALLY OPERATED EXERCISE EQUIPMENT; WEIGHTLIFTING GLOVES, ATHLETIC HAND WRAPS, ATHLETIC WRIST AND JOINT SUPPORTS, WRIST WRAPS; SKIPPING AND JUMPING ROPES; MARTIAL ARTS AND TARGET PADS, KICK PADS, SHIN PADS, GLOVES AND HEAD GUARDS; AND PERSONAL EXERCISE MATS (U.S. CLS. 22, 23, 38 AND 50).

### CLASS 41—EDUCATION AND ENTERTAINMENT

FOR EDUCATIONAL SERVICES, NAMELY CLASSES, SEMINARS, CONFERENCES AND WORKSHOPS IN THE FIELDS OF MOTIVATIONAL TEACHING, AEROBICS, EXERCISE, MARTIAL ARTS, DIET, EXERCISE AND NUTRITION (U.S. CLS. 100, 101 AND 107). DARRYL SPRUILL, EXAMINING ATTORNEY

SN 76-589,847. DONNER, JENNIFER T., HERNDON, VA. FILED 4-30-2004.

## SOULT3EC

THE MARK CONSISTS OF STANDARD CHARACTERS WITHOUT CLAIM TO ANY PARTICULAR FONT, STYLE, SIZE, OR COLOR.

### CLASS 9—ELECTRICAL AND SCIENTIFIC APPARATUS

FOR MUSICAL VIDEO RECORDINGS; MUSICAL SOUND RECORDINGS (U.S. CLS. 21, 23, 26, 36 AND 38).

### CLASS 41—EDUCATION AND ENTERTAINMENT

FOR MUSIC RECORDING, PRODUCTION AND PUBLISHING SERVICES; MUSIC VIDEO RECORDING, PRODUCTION AND PUBLISHING SERVICES (U.S. CLS. 100, 101 AND 107).

RON FAIRBANKS, EXAMINING ATTORNEY

SN 76-590,440. THYMES LIMITED, THE, MINNEAPOLIS, MN. FILED 5-4-2004.

## STATES OF BEING

THE MARK CONSISTS OF STANDARD CHARACTERS WITHOUT CLAIM TO ANY PARTICULAR FONT, STYLE, SIZE, OR COLOR.

**CLASS 3—COSMETICS AND CLEANING PREPARATIONS**

FOR SKIN SOAP; HAIR AND BODY SHAMPOO; NON-MEDICATED BATH PREPARATIONS, NAMELY, LIQUID SOAP, BATH TABLETS, BATH CONDITIONER, GELS, SALTS AND BODY SCRUBS; BODY CREME; BODY POWDER; BODY OIL; BODY LOTION; SACHETS; PERFUME; EAU DE TOILETTE; AEROSOL ROOM SCENTING SPRAYS (U.S. CLS. 1, 4, 6, 50, 51 AND 52).

**CLASS 4—LUBRICANTS AND FUELS**

FOR CANDLES (U.S. CLS. 1, 6 AND 15).

**CLASS 5—PHARMACEUTICALS**

FOR AEROSOL ROOM DEODORIZING SPRAYS (U.S. CLS. 6, 18, 44, 46, 51 AND 52).  
ANDREW RHIM, EXAMINING ATTORNEY

**CLASS 11—ENVIRONMENTAL CONTROL APPARATUS**

FOR ELECTRIC HAND HELD HAIR DRYERS (U.S. CLS. 13, 21, 23, 31 AND 34).

**CLASS 21—HOUSEWARES AND GLASS**

FOR HAIR COMBS AND HAIR BRUSHES (U.S. CLS. 2, 13, 23, 29, 30, 33, 40 AND 50).  
MARY CRAWFORD, EXAMINING ATTORNEY

SN 76-590,762. HELEN OF TROY LIMITED, BRIDGETOWN, BARBADOS, FILED 5-6-2004.

**WIGO EUROPE**

THE MARK CONSISTS OF STANDARD CHARACTERS WITHOUT CLAIM TO ANY PARTICULAR FONT, STYLE, SIZE, OR COLOR.

OWNER OF U.S. REG. NOS. 804,565 AND 2,501,028.  
NO CLAIM IS MADE TO THE EXCLUSIVE RIGHT TO USE EUROPE, APART FROM THE MARK AS SHOWN.

**CLASS 8—HAND TOOLS**

FOR ELECTRIC HAND HELD HAIR CLIPPERS (U.S. CLS. 23, 28 AND 44).

**CLASS 21—HOUSEWARES AND GLASS**

FOR HAIR COMBS AND HAIR BRUSHES (U.S. CLS. 2, 13, 23, 29, 30, 33, 40 AND 50).  
MARY CRAWFORD, EXAMINING ATTORNEY

SN 76-590,763. HELEN OF TROY LIMITED, BRIDGETOWN, BARBADOS, FILED 5-6-2004.

**BRUT**

THE MARK CONSISTS OF STANDARD CHARACTERS WITHOUT CLAIM TO ANY PARTICULAR FONT, STYLE, SIZE, OR COLOR.

**CLASS 8—HAND TOOLS**

FOR ELECTRIC HAND HELD HAIR CLIPPERS (U.S. CLS. 23, 28 AND 44).

SN 76-591,139. DIFRANCESCO, JOSEPH, LONGWOOD, FL. AND DIFRANCESCO, BERNADETTE, LONGWOOD, FL. FILED 5-10-2004.

**THE TRANSISTOR SISTERS**

THE MARK CONSISTS OF STANDARD CHARACTERS WITHOUT CLAIM TO ANY PARTICULAR FONT, STYLE, SIZE, OR COLOR.

**CLASS 28—TOYS AND SPORTING GOODS**

FOR TOYS, NAMELY ACTION FIGURES AND PLUSH TOYS (U.S. CLS. 22, 23, 38 AND 50).  
FIRST USE 4-20-2004; IN COMMERCE 4-20-2004.

**CLASS 41—EDUCATION AND ENTERTAINMENT**

FOR ENTERTAINMENT IN THE NATURE OF ONGOING TELEVISION SHOWS AND LIVE STAGE SHOWS FEATURING A CARTOON CHARACTER (U.S. CLS. 100, 101 AND 107).  
FIRST USE 9-7-1999; IN COMMERCE 9-7-1999.  
DAWN FELDMAN, EXAMINING ATTORNEY

SN 76-591,590. AWABA GROUP PTY LTD., EAGLEMONT, VIC, 3084, AUSTRALIA, FILED 5-11-2004.

**BELLA DANCERELLA**

PRIORITY CLAIMED UNDER SEC. 44(D) ON AUSTRALIA APPLICATION NO. 9824433, FILED 12-16-2003.  
PRIORITY CLAIMED UNDER SEC. 44(D) ON AUSTRALIA APPLICATION NO. 983034, FILED 12-22-2003.

**CLASS 9—ELECTRICAL AND SCIENTIFIC APPARATUS**

FOR AUDIO AND VIDEO TAPES, DVDS, CDS, FILMS, COMPUTER PROGRAMS AND PRINTED MANUALS DISTRIBUTED THEREWITH, COMPUTER GAMES, ALL RELATING TO THE DANCE, BODY MOVEMENT, COORDINATION, TRAINING, DANCE INSTRUCTION AND TRAINING, DANCE ENTERTAINMENT, EDUCATION, COACHING AND TUTORING; VIDEO RECORDERS AND PLAYERS (U.S. CLS. 21, 23, 26, 36 AND 38).

**CLASS 28—TOYS AND SPORTING GOODS**

FOR EQUIPMENT FOR DANCE TRAINING AND PRACTICE, NAMELY, FREE STANDING PORTABLE BALANCING BARS, INSTRUCTIONAL MATS WITH GUIDES FOR PROPER POSITIONING OF FEET, AND INSTRUCTIONAL GUIDES SOLD THEREWITH; TOYS, GAMES AND PLAYTHINGS, NAMELY, DOLLS, DOLL CLOTHING, TOY BALANCING BARS AND DANCING INSTRUCTIONAL MATS, HAND-HELD COMPUTER GAMES (U.S. CLS. 22, 23, 38 AND 50).

JERI J. FICKES, EXAMINING ATTORNEY

**CLASS 41—EDUCATION AND ENTERTAINMENT**

FOR CONDUCTING SEMINARS, WORKSHOPS, CONFERENCES AND CONVENTIONS IN THE FIELD OF CHRISTIAN EDUCATION; AND IN THE FIELD OF PRESCHOOL, ELEMENTARY AND SECONDARY LEVEL EDUCATION; AND IN THE FIELD OF POST-SECONDARY EDUCATION IN:TEACHER AND ADMINISTRATOR TRAINING (U.S. CLS. 100, 101 AND 107).

JOHN DALIER, EXAMINING ATTORNEY

---

SN 76-592,026. PACKAGING CONCEPTS ASSOC. INC., BOYNTON BEACH, FL. FILED 5-13-2004.

SN 76-591,616. ASSOCIATION OF CHRISTIAN SCHOOLS INTERNATIONAL, COLORADO SPRINGS, CO. FILED 5-11-2004.

**EVERYTHING OUTDOORS****CLASS 3—COSMETICS AND CLEANING PREPARATIONS**

FOR SUN SCREEN SPRAY (U.S. CLS. 1, 4, 6, 50, 51 AND 52).

**CLASS 5—PHARMACEUTICALS**

FOR FIRST AID SPRAY AND INSECT REPELLENT (U.S. CLS. 6, 18, 44, 46, 51 AND 52).

STEVEN R. FINE, EXAMINING ATTORNEY

---

SN 76-592,066. DEROSIER, MELISSA, CARY, NC. FILED 5-13-2004.

OWNER OF U.S. REG. NO. 2,701,132.

**CLASS 9—ELECTRICAL AND SCIENTIFIC APPARATUS**

FOR PRE-RECORDED AUDIOCASSETTES, VIDEOTAPES, FILMSTRIPS, COMPUTER DISKS, CDROM DISCS AND OTHER ELECTRONIC MEDIA, NAMELY, DOWNLOADABLE SOFTWARE, ALL IN THE FIELD OF RELIGION; AND IN THE FIELD OF GENERAL PRESCHOOL, ELEMENTARY AND SECONDARY EDUCATION IN BIBLE CLASSES, LANGUAGE ARTS, FOREIGN LANGUAGES, MATH, SCIENCE, SOCIAL STUDIES AND ENGLISH AS A SECOND LANGUAGE; AND IN THE FIELD OF POST-SECONDARY EDUCATION IN TEACHER AND ADMINISTRATOR TRAINING (U.S. CLS. 21, 23, 26, 36 AND 38).

**CLASS 16—PAPER GOODS AND PRINTED MATTER**

FOR PRINTED MATERIALS, NAMELY, PROMOTIONAL BOOKS, PAMPHLETS, NEWSLETTERS AND CATALOGUES, AND NAMELY, EDUCATIONAL AND INSTRUCTIONAL BOOKS, TEXTBOOKS, MANUALS, WORKBOOKS AND STUDY GUIDES ALL IN THE FIELD OF RELIGION; AND IN THE FIELD OF GENERAL PRESCHOOL, ELEMENTARY AND SECONDARY EDUCATION IN BIBLE CLASSES, LANGUAGE ARTS, FOREIGN LANGUAGES, MATH, SCIENCE, SOCIAL STUDIES AND ENGLISH AS A SECOND LANGUAGE; AND IN THE FIELD OF POST-SECONDARY EDUCATION IN TEACHER AND ADMINISTRATOR TRAINING (U.S. CLS. 2, 5, 22, 23, 29, 37, 38 AND 50).

**CLASS 9—ELECTRICAL AND SCIENTIFIC APPARATUS**

FOR SOFTWARE, NAMELY, SOCIOMETRIC DATA COLLECTION AND ANALYSIS TOOLS (U.S. CLS. 21, 23, 26, 36 AND 38).

FIRST USE 1-5-2001; IN COMMERCE 1-5-2001.

**CLASS 16—PAPER GOODS AND PRINTED MATTER**

FOR BOOKS, MANUALS, SCRIPTS, GUIDES, AND OTHER PRINTED MATTER, NAMELY, SCIENTIFICALLY VALIDATED ASSESSMENT AND INTERVENTION TOOLS FOR PROFESSIONALS AND PARENTS WHO WISH TO HELP CHILDREN BUILD POSITIVE PEER RELATIONSHIPS AND SOCIAL COPING SKILLS (U.S. CLS. 2, 5, 22, 23, 29, 37, 38 AND 50).

FIRST USE 10-6-1996; IN COMMERCE 10-6-1996.

**CLASS 45—PERSONAL SERVICES**

FOR PSYCHOLOGICAL, AND SOCIAL SERVICES, NAMELY, THE EVALUATION AND TREATMENT OF SOCIAL, BEHAVIORAL, AND EMOTIONAL DIFFICULTIES FACING CHILDREN, ADOLESCENTS, AND FAMILIES (U.S. CLS. 100 AND 101).

FIRST USE 10-6-1996; IN COMMERCE 10-6-1996.  
DOMINIC J. FERRAIUOLO, EXAMINING ATTORNEY

SN 76-592,676. WALGREEN CO., DEERFIELD, IL. FILED 5-17-2004.

**GET FIT WITH WALGREENS**

SN 76-592,121. PACKAGING CONCEPTS ASSOC. INC., BOYNTON BEACH, FL. FILED 5-13-2004.

**EVERYTHING PERSONAL**

OWNER OF U.S. REG. NOS. 1,057,249, 2,810,183 AND OTHERS.

**CLASS 16—PAPER GOODS AND PRINTED MATTER**

FOR FITNESS WORKBOOKS (U.S. CLS. 2, 5, 22, 23, 29, 37, 38 AND 50).

**CLASS 3—COSMETICS AND CLEANING PREPARATIONS**

FOR ANTIPERSPIRANT, DEODORANT, BREATH FRESHENER (U.S. CLS. 1, 4, 6, 50, 51 AND 52).

**CLASS 25—CLOTHING**

FOR CLOTHING, NAMELY T-SHIRTS (U.S. CLS. 22 AND 39).

**CLASS 5—PHARMACEUTICALS**

FOR ANTIFUNGAL SPRAY, HAND SANITIZER (U.S. CLS. 6, 18, 44, 46, 51 AND 52).  
PAULA MAYS, EXAMINING ATTORNEY

**CLASS 41—EDUCATION AND ENTERTAINMENT**

FOR HEALTH EDUCATION AND FITNESS INITIATIVES PROGRAM FOR SCHOOL CHILDREN PROMOTING PHYSICAL FITNESS (U.S. CLS. 100, 101 AND 107).  
ANNE MADDEN, EXAMINING ATTORNEY

SN 76-592,663. SAMSUNG CORPORATION, CHUNG-KU, SEOUL, REPUBLIC OF KOREA, FILED 5-18-2004.



SN 76-593,915. PITTS, JIM, TUCSON, AZ. FILED 5-17-2004.

**BASIC MAINTENANCE FOR THE AMERICAN DREAM****CLASS 1—CHEMICALS**

FOR UNEXPOSED SENSITIZED PHOTOGRAPHIC FILM (U.S. CLS. 1, 5, 6, 10, 26 AND 46).

**CLASS 16—PAPER GOODS AND PRINTED MATTER**

FOR PUBLICATIONS, NAMELY BOOKS AND CATALOGS RELATING TO HOME IMPROVEMENT; BOOKS AND MAGAZINES FEATURING IDEAS, METHODS AND INSTRUCTIONS RELATING TO HOME IMPROVEMENT, CONSTRUCTION, DECORATING, GARDENING, LANDSCAPING AND RELATED ACTIVITIES (U.S. CLS. 2, 5, 22, 23, 29, 37, 38 AND 50).

FIRST USE 3-1-2004; IN COMMERCE 3-16-2004.

**CLASS 9—ELECTRICAL AND SCIENTIFIC APPARATUS**

FOR SINGLE-USE CAMERA; DRY BATTERIES; STORAGE BATTERIES; BLANK COMPACT DISCS FOR AUDIO AND VIDEO; BLANK DIGITAL VERSATILE DISCS; BLANK FLOPPY DISCS FOR COMPUTER; BLANK VIDEO TAPES; PORTABLE MEDIA, NAMELY, USB HARDWARE, BLANK SECURE DIGITAL CARDS, BLANK SMART MEDIA CARDS, COMPACT FLASH MEMORY CARDS AND PC CARD ADAPTER; PERSONAL COMPUTER ACCESSORIES, NAMELY, MOUSE AND CAMERA; PHOTOGRAPHIC CAMERAS; DIGITAL PHOTOGRAPHIC CAMERAS (U.S. CLS. 21, 23, 26, 36 AND 38).

GINNY ISAACSON, EXAMINING ATTORNEY

**CLASS 41—EDUCATION AND ENTERTAINMENT**

FOR EDUCATIONAL SERVICES, NAMELY CONDUCTING CLINICS AND WORKSHOPS AND PROVIDING WRITTEN MATERIALS REGARDING HOME IMPROVEMENT PRODUCTS; EDUCATIONAL SERVICES, NAMELY, CONDUCTING CLINICS AND WORKSHOPS RELATING TO HOME MAINTENANCE AND REPAIR, THE INSTALLATION AND REPAIR OF APPLIANCES, BUILDING MATERIALS, LIGHTING AND ELECTRICAL SUPPLIES, PLUMBING SUPPLIES, ROOFING MATERIALS; AND EDUCATIONAL SERVICES, NAMELY, CONDUCTING CLASSES AND WORKSHOPS THAT PROMOTE HOME SAFETY AND HOME PROTECTION PROCEDURES AND PRODUCTS AND DISTRIBUTING COURSE MATERIALS IN CONNECTION THEREWITH (U.S. CLS. 100, 101 AND 107).

FIRST USE 3-1-2004; IN COMMERCE 3-16-2004.  
MARK T. MULLEN, EXAMINING ATTORNEY

SN 76-594,615. SAFEWAY INC., PLEASANTON, CA. FILED 5-27-2004.

# PRIORITY

THE MARK CONSISTS OF STANDARD CHARACTERS WITHOUT CLAIM TO ANY PARTICULAR FONT, STYLE, SIZE, OR COLOR.

## CLASS 18—LEATHER GOODS

FOR RAWHIDE CHEWS FOR DOGS (U.S. CLS. 1, 2, 3, 22 AND 41).

## CLASS 31—NATURAL AGRICULTURAL PRODUCTS

FOR PET FOOD, ANIMAL LITTER, PET TREATS, AND BIRD SEED (U.S. CLS. 1 AND 46).  
REGINA DRUMMOND, EXAMINING ATTORNEY

SN 78-061,142. PHARMAGENE LABORATORIES LIMITED, ROYSTON, HERTFORDSHIRE, UNITED KINGDOM, FILED 4-30-2001.

# INDICATION SWITCH

## CLASS 9—ELECTRICAL AND SCIENTIFIC APPARATUS

FOR COMPUTER SOFTWARE FOR USE IN PRE-CLINICAL, CLINICAL AND PHARMACEUTICAL RESEARCH BY ANALYZING, INTERPRETING AND PROCESSING INFORMATION RELATING TO SUCH RESEARCH; ELECTRONIC COMPUTER DATABASES FOR USE IN DRUG DISCOVERY AND DRUG RESEARCH AND FOR RESEARCH INTO HUMAN GENE DISTRIBUTION AND FUNCTION RECORDED ON CD ROM, HARD DISK, AND SERVERS AND DOWNLOADABLE VIA A GLOBAL COMPUTER NETWORK; ELECTRONIC PUBLICATIONS IN THE NATURE OF TEST REPORTS, MAGAZINES AND MANUALS FEATURING PRE-CLINICAL, CLINICAL AND PHARMACEUTICAL RESEARCH RECORDED ON CD ROM, HARD DISK AND SERVERS AND DOWNLOADABLE VIA A GLOBAL COMPUTER NETWORK (U.S. CLS. 21, 23, 26, 36 AND 38).

## CLASS 16—PAPER GOODS AND PRINTED MATTER

FOR PRINTED MATTER, NAMELY, BOOKS, REPORTS AND MANUALS ALL ON THE SUBJECT OF DRUG DISCOVERY PROGRAMS, PRE-CLINICAL AND CLINICAL SCREENING PROGRAMS AND PHARMACEUTICAL RESEARCH PROGRAMS; PRINTED TEACHING MATERIALS FEATURING PRE-CLINICAL, CLINICAL AND PHARMACEUTICAL RESEARCH; COMPUTER PROGRAM MANUALS FOR USE WITH COMPUTER DATABASES IN THE FIELD OF PHARMACEUTICAL AND GENETIC RESEARCH (U.S. CLS. 2, 5, 22, 23, 29, 37, 38 AND 50).

## CLASS 42—SCIENTIFIC, COMPUTER AND LEGAL SERVICES

FOR RESEARCH AND DEVELOPMENT OF DRUG PRODUCTS, NAMELY DRUG DISCOVERY SERVICES FOR OTHERS; PHARMACEUTICAL RESEARCH SERVICES; PRE-CLINICAL SCREENING AND CLINICAL RESEARCH AND EVALUATION SERVICES; BIOINFORMATICS, GENOMICS, PROTEOMICS AND PHARMACOLOGY RESEARCH SERVICES; DEVELOPMENT OF HUMAN DISEASE MODELS FOR USE IN EVALUATION OF DRUGS AND DISCOVERY OF NEW DRUGS; DRUG DISCOVERY, DRUG SCREENING, PRE-CLINICAL SCREENING, CLINICAL RESEARCH AND PHARMACEUTICAL EVALUATION SERVICES; PROVIDING AN ONLINE COMPUTER DATABASE FOR USE IN PHARMACEUTICAL RESEARCH; PROVIDING AN ONLINE COMPUTER DATABASE FOR USE IN RESEARCH INTO HUMAN GENE AND HUMAN PROTEIN FUNCTIONS; DESIGN OF COMPUTER MODELS FOR USE IN PRE-CLINICAL, CLINICAL AND PHARMACEUTICAL RESEARCH; COLLECTION AND MAINTENANCE OF DATA FOR STUDY OF GENOMES; COLLECTION AND MAINTENANCE OF GENETIC INFORMATION INCLUDING GENE FORM AND GENE FUNCTION; CONSULTANCY, INFORMATION AND ADVISORY SERVICES FOR ALL THE AFORESAID SERVICES (U.S. CLS. 100 AND 101).

STEVEN BERK, EXAMINING ATTORNEY

SN 78-101,624. CONCHITA FOODS, INC., MIAMI, FL. FILED 1-9-2002.

# CONCHITA

## CLASS 29—MEATS AND PROCESSED FOODS

FOR PROCESSED FRUITS, NAMELY, FRUIT PASTES, FRUIT SHELLS, MARMALADES, FRUIT CHUNKS, FRUIT HALVES, FRUIT PRESERVES, FRUIT SLICES, GRATED COCONUT, COCONUT MILK, AND COCONUT WATER, AND FOR TOMATO PRESERVES; AND FOR PROCESSED WHOLE BABY CORN, PROCESSED BEANS, DRIED BEANS, SOUPS, PROCESSED PIGEON PEAS, PROCESSED OLIVES, PROCESSED PIMIENTOS, VEGETABLE OIL, CORN OIL, OLIVE OIL, PROCESSED WHOLE GREEN PEAS, PROCESSED SPLIT GREEN PEAS, CANNED VIENNA SAUSAGES, CANNED SARDINES, CANNED ENTREES CONSISTING PRIMARILY OF SEAFOOD AND RICE, CANNED ENTREES CONSISTING PRIMARILY OF CHICKEN AND RICE, CANNED ENTREES CONSISTING PRIMARILY OF SQUID AND RICE, CANNED ENTREES CONSISTING PRIMARILY OF FISH AND RICE, AND CANNED ENTREES CONSISTING PRIMARILY OF FISH (U.S. CL. 46).

FIRST USE 0-0-1944; IN COMMERCE 0-0-1944.

## CLASS 30—STAPLE FOODS

FOR SEASONING PASTE, TOMATO SAUCE, MARIANES, SPICES, MINCED GARLIC IN OIL, MEAT SAUCE, VINEGAR, RICE, PASTA, CHOCOLATE POWDER, HONEY, AND PROCESSED CAPERS (U.S. CL. 46).  
FIRST USE 0-0-1944; IN COMMERCE 0-0-1944.

## CLASS 32—LIGHT BEVERAGES

FOR FRUIT NECTARS, AND LEMON JUICE (U.S. CLS. 45, 46 AND 48).  
FIRST USE 0-0-1944; IN COMMERCE 0-0-1944.

## CLASS 33—WINES AND SPIRITS

FOR COOKING WINES (U.S. CLS. 47 AND 49).  
FIRST USE 0-0-1944; IN COMMERCE 0-0-1944.  
REBECCA SMITH, EXAMINING ATTORNEY

SN 78-106,215. ADVANCED COMPOSITES GROUP LIMITED, HEANOR, DERBYSHIRE, UNITED KINGDOM, FILED 2-1-2002.

## VTA

### CLASS 1—CHEMICALS

FOR CHEMICALS AND CHEMICAL PRODUCTS FOR USE IN THE PRODUCTION OF ADHESIVES AND COMPOSITE MATERIALS IN THE AERONAUTICS, SPACE, MARINE, TRANSPORT, RECREATION, LEISURE, MOTORSPORT, ENERGY AND INFRASTRUCTURE INDUSTRIES, ADHESIVES USED FOR BONDING OF METALLIC AND NON-METALLIC MATERIALS IN THE AERONAUTICS, SPACE, MARINE, TRANSPORT, RECREATION, LEISURE, MOTORSPORT, ENERGY AND INFRASTRUCTURE INDUSTRIES; PROCESSED SYNTHETIC RESINOUS MATERIALS IN LIQUID AND SEMI-LIQUID FORM USED FOR THE PRODUCTION OF MOLDED ARTICLES; PROCESSED SYNTHETIC RESINOUS MATERIALS IN THE FORM OF ADHESIVES FOR USE IN MANUFACTURING OF LOAD-BEARING COMPOSITES AND METALLIC STRUCTURES (U.S. CLS. 1, 5, 6, 10, 26 AND 46).

FIRST USE 4-0-2001; IN COMMERCE 2-0-2003.

### CLASS 17—RUBBER GOODS

FOR PLASTIC MATERIALS IN THE FORM OF BARS, BLOCKS, PELLETS, RODS, SHEETS AND TUBES FOR USE IN MANUFACTURING; COMPOSITE PLASTIC MATERIALS IN THE FORM OF PROFILES, BOARDS, SHEETS, BLOCKS, RODS, POWDERS AND PELLETS FOR USE IN MANUFACTURING; PROCESSED SYNTHETIC RESINOUS MATERIALS IN THE FORM OF ADHESIVES AND BONDED ADHESIVE JOINTS FOR USE IN MANUFACTURING OF LOAD-BEARING COMPOSITES AND METALLIC STRUCTURES; FIBER-REINFORCED PROCESSED SYNTHETIC RESINOUS MATERIALS IN THE FORM OF PRE-PRE-FORMED ARTICLES OR PARTS OF ARTICLES USED FOR THE MANUFACTURE OF MOLDED ARTICLES; FIBER-REINFORCED PROCESSED SYNTHETIC RESINOUS MATERIALS IN THE FORM OF LOAD-BEARING NON-METALLIC STRUCTURES; SEMI-PROCESSED PLASTIC MATERIALS IN THE FORM OF BARS, BLOCKS, RODS AND SHEETS FOR GENERAL INDUSTRIAL USE; RESINS IN EXTRUDED FORM FOR GENERAL MANUFACTURING; PLASTIC COMPOSITE MATERIALS IN THE FORM OF PROFILES, BOARDS, SHEETS, RODS AND POWDERS FOR USE IN MANUFACTURING; FIBER-REINFORCED PLASTIC MATERIALS FOR USE IN THE PRODUCTION OF PRE-FORMED ARTICLES AND PARTS OF ARTICLES FOR USE IN MANUFACTURING; FIBER-REINFORCED PLASTIC MATERIALS FOR USE IN THE MANUFACTURE OF COMPONENTS FOR THE AERONAUTICS, SPACE, MARINE, TRANSPORT, RECREATION, LEISURE, MOTORSPORT, ENERGY AND INFRASTRUCTURE INDUSTRIES; FILLERS FOR EXPANSION JOINTS FOR PAVEMENTS; ADHESIVE SEALANTS FOR GENERAL USE; PRE-IMPREGNATED PLASTIC FIBER FOR USE IN MOLDING; ADHESIVE TAPE FOR INDUSTRIAL AND COMMERCIAL USE (U.S. CLS. 1, 5, 12, 13, 35 AND 50).

FIRST USE 4-0-2001; IN COMMERCE 2-0-2003.

JOHN DWYER, EXAMINING ATTORNEY

SN 78-138,080. FOSS A/S, 3400 HILLERØD, DENMARK, FILED 6-24-2002.

## FOSS4ME

PRIORITY CLAIMED UNDER SEC. 44(D) ON ERP NCNTY TM OFC APPLICATION NO. 002630119, FILED 3-25-2002, REG. NO. 2630119, DATED 8-21-2003, EXPIRES 3-25-2012.

### CLASS 1—CHEMICALS

FOR CHEMICALS USED IN FOOD, BEVERAGES, DAIRY, FEED, FORAGE, GRAIN, WATER, SOIL, MICROBIOLOGY, WET CHEMICALS, DRY CHEMICALS, POLYMERS, FIBRE OPTICS, PETROCHEMICALS, PHARMACEUTICAL AND DIAGNOSTICS INDUSTRIES, SCIENCE, AGRICULTURE, HORTICULTURE AND FORESTRY INDUSTRIES, NAMELY CHEMICAL PREPARATIONS FOR TESTING, ANALYZING, MEASURING AND CALIBRATING FOOD, BEVERAGES, DAIRY PRODUCTS, SOILS, WATER, FEED, MICROBIOLOGICAL PRODUCTS, WET CHEMICALS, POLYMERS, FIBRE OPTICS, PETROCHEMICALS, PHARMACEUTICALS; AND DIAGNOSTIC PRODUCTS IN THE NATURE OF ALIPHATIC ALCOHOL C12-C18 MAINLY LINEAR EITHER ETHOXYLATED OR PROPOXYLATED; BACTERIAL CULTURE NOT FOR MEDICAL PURPOSES; BENZALKONIUM CHLORIDE; CALCIUM PROPIONATE; ETHANOL; LACTOSE MONOHYDRATE, DISODIUM METASILICATE, DISODIUM TETRABORATE DECAHYDRATE; ETHIDIUM BROMIDE GLYCERIN, HOMIDIUM BROMIDE, LACRODAN-80; LACTOSE MONOHYDRATE; POLYETHYLENEGLYCOL OCTYPHENYLETHER; SODIUM AZIDE; SODIUM CARBONATE, EDTA DISODIUM SALT DIHYDRATE; PROPAN-1-OL; SUBTILISIN; TRIETHANOLAMINE DODECYLBENZENESULFONATE; CHEMICAL REAGENTS FOR USE IN VITRO PROCEDURES FOR INDUSTRY USE AND INDUSTRY RESEARCH; BIOLOGICAL, BACTERIAL AND BACTERIOLOGICAL PREPARATIONS NOT FOR MEDICAL AND VETERINARY USE, NAMELY PREPARATIONS FOR TESTING, ANALYZING, MEASURING AND CALIBRATING FOOD, BEVERAGES, DAIRY PRODUCTS, SOILS, WATER, FEED, MICROBIOLOGICAL PRODUCTS, WET CHEMICALS, POLYMERS, FIBRE OPTICS, AND PETROCHEMICALS IN THE NATURE OF PREPARATIONS AND VIALS FOR MICROBIOLOGICAL SCREENING, INCLUDING SCREENING FOR SALMONELLA, E; COLI, YEAST, TVC, LISTERIA; CAMPYLOBACTER, AND ENTEROBACTERIACEAE; UNPROCESSED ARTIFICIAL RESINS, UNPROCESSED PLASTICS IN THE NATURE OF FILTERING MATERIALS FOR USE IN THE FOOD, BEVERAGES, DAIRY, MICROBIOLOGY, WET CHEMICALS, DRY CHEMICALS, POLYMERS, FIBRE OPTICS, PETROCHEMICALS, PHARMACEUTICAL AND DIAGNOSTIC INDUSTRIES; MANURES; AND FIRE EXTINGUISHING COMPOSITIONS (U.S. CLS. 1, 5, 6, 10, 26 AND 46).

### CLASS 5—PHARMACEUTICALS

FOR ALL PURPOSE DISINFECTANTS; PREPARATIONS FOR DESTROYING VERMIN, FUNGICIDES AND HERBICIDES FOR AGRICULTURE, HORTICULTURAL, FORESTRY AND INDUSTRIAL USE; CHEMICAL, BIOLOGICAL, BACTERIAL AND BACTERIOLOGICAL PREPARATIONS FOR MEDICAL AND VETERINARY USE, NAMELY PREPARATIONS FOR TESTING, ANALYZING, MEASURING AND CALIBRATING FOOD, BEVERAGES, DAIRY PRODUCTS, SOILS, WATER, FEED, MICROBIOLOGICAL PRODUCTS, WET CHEMICALS, POLYMERS, FIBRE OPTICS, AND PETROCHEMICALS FOR USE IN THE FOOD, BEVERAGES, DAIRY, FEED, FORAGE, GRAIN, WATER, SOIL, MICROBIOLOGY, WET CHEMICALS, DRY CHEMICALS, POLYMERS, FIBRE OPTICS, PETROCHEMICALS, PHARMACEUTICAL AND DIAGNOSTICS INDUSTRIES, NAMELY PREPARATIONS AND VIALS FOR MICROBIOLOGICAL SCREENING, INCLUDING SALMONELLA, E; COLI, YEAST, TVC, LISTERIA; CAMPYLOBACTER, ENTEROBACTERIACEAE; MEDICAL DIAGNOSTIC REAGENTS FOR MEDICAL AND VETERINARY USE (U.S. CLS. 6, 18, 44, 46, 51 AND 52).

**CLASS 9—ELECTRICAL AND SCIENTIFIC APPARATUS**

FOR SCIENTIFIC, ELECTRIC, PHOTOGRAPHIC, CINEMATOGRAPHIC APPARATUS AND INSTRUMENTS AND APPARATUS AND INSTRUMENTS FOR WEIGHING, MEASURING, CHECKING, ANALYZING, NAMELY ANALYZING, TESTING, MEASURING AND CELL COUNTING APPARATUS INSTRUMENTS FOR USE IN THE DAIRY, FOOD, BEVERAGE, MICROBIOLOGICAL, GRAIN, FEED, CHEMICAL AND PHARMACEUTICAL INDUSTRY AND FOR USE IN LABORATORIES; APPARATUS FOR RECORDING, TRANSMISSION AND REPRODUCTION OF SOUND OR IMAGES, NAMELY APPARATUS FOR RECORDING, TRANSMITTING AND REPRODUCING DATA AND RESULTS OF ANALYSES, MEASUREMENTS AND CELL COUNTING FOR USE IN THE FOOD, BEVERAGE, DAIRY, MICROBIOLOGICAL, GRAIN, FEED, CHEMICAL AND PHARMACEUTICAL INDUSTRY AND IN LABORATORIES; PRERECORDED MAGNETIC DATA CARRIERS FEATURING COMPUTER SOFTWARE FOR STEERING AND CONTROLLING THE TESTING, MEASURING, ANALYZING AND CELL COUNTING APPARATUS AND INSTRUMENTS; CALCULATORS AND DATA PROCESSORS AND COMPUTERS; RECORDED COMPUTER SOFTWARE FOR STEERING AND CONTROL OF ANALYZING, MEASURING, TEST PROCESSORS AND CELL COUNTING APPARATUS INSTRUMENTS FOR USE IN THE FOOD, BEVERAGE, DAIRY, MICROBIOLOGICAL, GRAIN, FEED, CHEMICAL AND PHARMACEUTICAL INDUSTRY AND IN LABORATORIES FOR USE IN CONNECTION WITH THE MENTIONED APPARATUS AND INSTRUMENTS; PARTS FOR ALL THE AFOREMENTIONED APPARATUS AND INSTRUMENTS; LABORATORY AND SCIENTIFIC EQUIPMENT, NAMELY, PHOTOMETRIC ANALYZERS, INSTRUMENTATION AND ANCILLARY EQUIPMENT ALL RELATED TO WET CHEMICAL ANALYSIS AND BIOLOGICAL PARTICLE COUNTERS AND MONITORS ALL FOR USE IN THE PHARMACEUTICAL AND DIAGNOSTICS INDUSTRIES FOR IDENTIFICATION AND QUALIFICATION OF RAW MATERIALS (U.S. CLS. 21, 23, 26, 36 AND 38).

**CLASS 10—MEDICAL APPARATUS**

FOR SURGICAL, MEDICAL, DENTAL AND VETERINARY APPARATUS AND INSTRUMENT AND ANALYZING AND DIAGNOSTIC APPARATUS FOR MEDICAL USE, NAMELY PHOTOMETRIC ANALYZERS, INSTRUMENTATIONS AND ANCILLARY EQUIPMENT ALL RELATED TO WET CHEMICAL ANALYSIS AND BIOLOGICAL PARTICLE COUNTERS AND MONITORS ALL FOR USE IN THE PHARMACEUTICAL AND DIAGNOSTICS INDUSTRIES FOR IDENTIFICATION AND QUALIFICATION OF RAW MATERIALS AND FOR QUANTITATIVE ANALYSIS OF COMPOUNDS IN THE NATURE (U.S. CLS. 26, 39 AND 44).

**CLASS 42—SCIENTIFIC, COMPUTER AND LEGAL SERVICES**

FOR SCIENTIFIC AND BACTERIOLOGICAL RESEARCH; INDUSTRIAL RESEARCH FOR USE IN THE FOOD, BEVERAGES, DAIRY, SOIL, WATER, FEED, MICROBIOLOGICAL, WET CHEMICALS, DRY CHEMICALS, POLYMERS, FIBER OPTICS, PETROCHEMICALS, PHARMACEUTICALS, AND DIAGNOSTICS INDUSTRIES; LABORATORY RESEARCH IN THE FIELD OF CHEMISTRY, BACTERIOLOGY, MICROBIOLOGY, PHARMACEUTICALS, FIBER OPTICS, AND POLYMERS; TECHNICAL CONSULTATION IN THE FIELDS OF AGRICULTURE, CHEMISTRY, BACTERIOLOGY, MICROBIOLOGY, AND PHARMACEUTICALS; CHEMICAL ANALYSIS AND RESEARCH; QUALITY CONTROL FOR OTHERS (U.S. CLS. 100 AND 101).

SUSAN HAYASH, EXAMINING ATTORNEY

SN 78-138,289. WANOLGY, LLC, LODI, NJ. FILED 6-24-2002.

**WANOLGY****CLASS 35—ADVERTISING AND BUSINESS**

FOR ACCOUNTING SERVICES; BUSINESS INFORMATION TECHNOLOGY MANAGEMENT SERVICES (U.S. CLS. 100, 101 AND 102).

**CLASS 37—CONSTRUCTION AND REPAIR**

FOR INSTALLATION OF COMPUTER NETWORKS AND INSTALLATION OF COMPUTER SYSTEMS (U.S. CLS. 100, 103 AND 106).

**CLASS 38—COMMUNICATION**

FOR PROVIDING A HIGH SPEED AND MULTIPLE USER ACCESS TO AREA NETWORKS AND A GLOBAL COMPUTER INFORMATION NETWORK; ELECTRONIC MAIL SERVICES; TELECOMMUNICATIONS ROUTING, JUNCTION SERVICES AND GATEWAY SERVICES; AND PROVIDING DATA COMMUNICATION SERVICES, VOICE-OVER INTERNET PROTOCOL SERVICES (U.S. CLS. 100, 101 AND 104).

**CLASS 42—SCIENTIFIC, COMPUTER AND LEGAL SERVICES**

FOR INSTALLATION OF COMPUTER SOFTWARE; AND CONSULTATION IN THE FIELD OF INFORMATION TECHNOLOGY, COMPUTER NETWORKING AND COMPUTER SYSTEMS MANAGEMENT; CONFIGURATION OF COMPUTER SOFTWARE AND HARDWARE IN THE FIELDS OF NETWORKING, INFORMATION TECHNOLOGY AND SYSTEMS MANAGEMENT; INTERNET SERVICES, NAMELY, DESIGNING, AND MAINTAINING COMPUTER NETWORKS, WIDE-AREA NETWORKS, PRIVATE NETWORKS, VIRTUAL PRIVATE NETWORKS, REMOTE PRIVATE NETWORKS, REMOTE VIRTUAL PRIVATE NETWORKS, MANAGED REMOTE VIRTUAL PRIVATE NETWORKS; AND PROVIDING TECHNICAL SUPPORT SERVICES, NAMELY, TROUBLESHOOTING OF COMPUTER HARDWARE AND SOFTWARE PROBLEMS AND MONITORING COMPUTER NETWORKS; DESIGNING, INTEGRATING, AND MAINTAINING COMPUTER NETWORKS AND THE ASSOCIATED HARDWARE AND SOFTWARE; AND PROVIDING TECHNICAL AND CUSTOMER SUPPORT SERVICES THEREFOR; INSTALLING AND MAINTAINING THE HARDWARE AND SOFTWARE FOR FIREWALLS; AND HOSTING THE WEB SITES OF OTHERS ON A COMPUTER SERVER FOR A GLOBAL COMPUTER NETWORK (U.S. CLS. 100 AND 101).

KIMBERLY PERRY, EXAMINING ATTORNEY

SN 78-158,968. SYGMAN, STEVEN, AMAGANSETT, NY. FILED 8-28-2002.

**UNITED WE STAND****CLASS 16—PAPER GOODS AND PRINTED MATTER**

FOR BUMPER STICKERS AND STICKERS (U.S. CLS. 2, 5, 22, 23, 29, 37, 38 AND 50).

**CLASS 25—CLOTHING**

FOR HATS, SHIRTS, PANTS (U.S. CLS. 22 AND 39).  
DAVID ELTON, EXAMINING ATTORNEY



SN 78-160,589. IMS SOFTWARE SERVICES, LTD., WILMINGTON, DE. FILED 9-4-2002.

## LIFECYCLE

### CLASS 9—ELECTRICAL AND SCIENTIFIC APPARATUS

FOR COMPUTER SOFTWARE CD-ROM AND ACCOMPANYING USER MANUALS USED TO PROVIDE, MANIPULATE AND EXTRAPOLATE DATA AND INFORMATION PERTAINING TO THE PHARMACEUTICAL, MEDICAL AND HEALTHCARE INDUSTRIES; COMPUTER SOFTWARE AND ACCOMPANYING USER MANUALS USED TO PROVIDE, MANIPULATE AND EXTRAPOLATE DATA AND INFORMATION PERTAINING TO THE PHARMACEUTICAL, MEDICAL AND HEALTHCARE INDUSTRIES THAT MAY BE DOWNLOADED FROM A GLOBAL COMPUTER NETWORK; DOWNLOADABLE ELECTRONIC PUBLICATIONS IN THE NATURE OF MARKET RESEARCH REPORTS IN COMPUTER READABLE FORMAT RELATING TO THE PHARMACEUTICAL, MEDICAL AND HEALTHCARE INDUSTRIES; ELECTRONIC PUBLICATIONS, NAMELY, MARKET RESEARCH REPORTS IN COMPUTER READABLE FORMAT RELATING TO THE PHARMACEUTICAL, MEDICAL AND HEALTHCARE INDUSTRIES RECORDED ON COMPUTER MEDIA (U.S. CLS. 21, 23, 26, 36 AND 38).

FIRST USE 12-0-1996; IN COMMERCE 0-0-1997.

### CLASS 35—ADVERTISING AND BUSINESS

FOR CONDUCTING BUSINESS AND MARKET RESEARCH SURVEYS OVER A GLOBAL COMMUNICATIONS NETWORK, ALL PERTAINING TO THE PHARMACEUTICAL, MEDICAL OR HEALTHCARE INDUSTRIES; PROVIDING CONSUMER INFORMATION IN FIELDS OF THE PHARMACEUTICAL, MEDICAL AND HEALTHCARE INDUSTRIES (U.S. CLS. 100, 101 AND 102).

FIRST USE 12-0-1996; IN COMMERCE 0-0-1997.

### CLASS 42—SCIENTIFIC, COMPUTER AND LEGAL SERVICES

FOR PROVIDING TEMPORARY USE OF ON-LINE NON-DOWNLOADABLE SOFTWARE AND ACCOMPANYING USER MANUALS USED TO PROVIDE, MANIPULATE AND EXTRAPOLATE DATA AND INFORMATION PERTAINING TO THE PHARMACEUTICAL, MEDICAL AND HEALTHCARE INDUSTRIES (U.S. CLS. 100 AND 101).

FIRST USE 12-0-1996; IN COMMERCE 0-0-1997.

MARIA-VICTORIA SUAREZ, EXAMINING ATTORNEY

---

SN 78-162,349. ASSA ABLOY AB, STOCKHOLM, SWEDEN, FILED 9-10-2002.

## ASSA ABLOY

PRIORITY CLAIMED UNDER SEC. 44(D) ON SWEDEN APPLICATION NO. 2002/04759, FILED 7-19-2002, REG. NO. 368445, DATED 9-17-2004, EXPIRES 9-17-2014.

OWNER OF U.S. REG. NOS. 927,239, 1,302,393 AND 1,782,388.

### CLASS 6—METAL GOODS

FOR [BASED ON SECTION 1(A) AND SECTION 44] GOODS OF METAL AND PREDOMINANTLY OF METAL AND PARTS THEREFORE, NAMELY METAL LOCKS AND KEYS THEREFOR AND METAL LOCK PARTS AND ACCESSORIES, NAMELY LOCK CASES, LOCK CYLINDERS, AND LOCK STRIKING PLATES; METAL DOORS AND METAL WINDOWS; METAL DOOR FRAMES AND METAL WINDOW FRAMES, METAL HINGES AND METAL DOOR HANDLES; NON-ELECTRONIC EMERGENCY AND PANIC DEVICES FOR DOORS AND WINDOWS, NAMELY, METAL LATCH BARS, METAL LATCHES, METAL PUSH LEVERS FOR OPENING DOORS AND WINDOWS, METAL DOOR LATCHING ASSEMBLIES THAT RELEASE UPON THE APPLICATION OF FORCE CAUSING THE DOOR TO MOVE IN THE DIRECTION OF EXIT TRAVEL; FITTINGS AND MOUNTINGS FOR DOORS AND WINDOWS AS WELL AS OTHER DOOR AND WINDOW HARDWARE, NAMELY, METAL LOCK ESCUTCHEONS, METAL PADLOCKS, MANUALLY-OPERATED METAL DOOR HOLDERS FOR HOLDING DOORS OPEN, METAL DEAD BOLTS, METAL HOOK BOLTS, METAL LATCH BOLTS, METAL KNOBS, METAL PUSH BARS, METAL LEVERS, METAL PUSH PLATES, METAL DOOR TRIMS, METAL DOOR PANELS, METAL WINDOW PULLEYS, METAL WINDOW SCREENS, METAL WINDOW STAYS, METAL WINDOW FASTENERS, METAL WINDOW HANDLE OPERATORS, METAL DOOR HOLDERS, ROLLER CARRIAGES FOR DOORS (U.S. CLS. 2, 12, 13, 14, 23, 25 AND 50).

FIRST USE 3-5-2000; IN COMMERCE 3-5-2000.

### CLASS 9—ELECTRICAL AND SCIENTIFIC APPARATUS

FOR [BASED ON SECTION 1(A) AND SECTION 44] ELECTRIC, ELECTRONIC AND ELECTROMECHANICAL LOCKS AND LOCK PARTS AND ACCESSORIES THEREFOR, NAMELY ELECTRONIC LOCK CYLINDERS, ELECTRIC STRIKING PLATES, DOOR MAGNETS, ELECTRONIC KEYS, ELECTRONIC AND MAGNETIC KEY CARDS, ACCESS CONTROL CARDS AND SMART CARDS, KEY CARD READERS, ACCESS CONTROL CARD READERS AND SMART CARD READERS ALL FOR THE PURPOSE OF PROVIDING LOCK AND SECURE ENTRY FUNCTIONS; COMPUTERS FOR PROGRAMMING LOCKS, LOCK CYLINDERS, KEYS, KEY CARDS AND KEY CARD READERS; ELECTROMECHANICAL AND ELECTROHYDRAULICAL DOOR OPENERS, DOOR CLOSERS AND DOOR OPERATORS; ELECTRIC AND ELECTROMECHANICAL DOOR AND WINDOW HARDWARE, NAMELY, ELECTROMAGNETIC DOOR HOLDERS AND RELEASERS WITH OR WITHOUT DETECTORS TO ACTIVATE SUCH HOLDERS AND RELEASERS UPON CHANGE IN AMBIENT CONDITIONS AND UPON DETECTION OF FIRE AND SMOKE, MONITORING CONSOLES, SWITCHES, KEYPADS, PUSH BUTTONS, PROXIMITY READERS AND SMART CONTROLLERS FOR ELECTRICAL DOOR OPERATORS AND LOCKS, ANTI INTRUSION ALARMS, ELECTRONIC CONTROLS FOR ACCESSING INGRESS AND EGRESS TO DOORS AND WINDOWS, TRANSPONDERS FOR USE WITH ACCESS CONTROL CARDS; ELECTRONIC AND ELECTROMAGNETIC SENSORS FOR THE PURPOSE OF PROTECTING HOMES AND BUSINESSES FROM INTRUDERS; APPARATUS AND INSTRUMENTS FOR SIGNALING AND CHECKING, CHECKING AND CONTROLLING PEOPLE'S MOVEMENT WITHIN, ENTRANCE TO AND EXIT FROM BUILDINGS AND THROUGH DOORS AND GATES AND FOR USE WITH LOCKS COMPRISED OF COMPUTERS, COMPUTER HARDWARE, ELECTRONIC SENSORS, VIDEO CAMERAS, COMPUTER MONITORS; ENCODED ELECTRONIC CHIP AND MAGNETIC IDENTITY CARDS FOR USE IN GRANTING ENTRANCE AND EXIT TO DWELLINGS AND BUSINESSES; PRE-RECORDED MAGNETIC DATA CARRIERS AND COMPUTER SOFTWARE FOR USE IN SECURING ACCESS AND EGRESS TO BUILDINGS AND DWELLINGS (U.S. CLS. 21, 23, 26, 36 AND 38).

FIRST USE 3-5-2000; IN COMMERCE 3-5-2000.

**CLASS 45—PERSONAL SERVICES**

SN 78-168,360. DIAGEO NORTH AMERICA, INC., STAMFORD, CT. FILED 9-26-2002.

FOR [BASED ON SECTION 44 ONLY] SECURITY SERVICES FOR THE PROTECTION OF PROPERTY AND INDIVIDUALS, NAMELY, SECURITY GUARD SERVICES AND MONITORING SECURITY SYSTEMS AND SECURITY CONSULTATION SERVICES IN THE FIELD OF LOCK SECURITY (U.S. CLS. 100 AND 101).  
STEVEN BERK, EXAMINING ATTORNEY



SN 78-165,513. SHAMBHU, MANVENDRA B, LEXINGTON, KY. FILED 9-18-2002.

**GLADSTONE TOOLS**

NO CLAIM IS MADE TO THE EXCLUSIVE RIGHT TO USE "TOOLS", APART FROM THE MARK AS SHOWN.

**CLASS 8—HAND TOOLS**

FOR HAND TOOLS, NAMELY, MARKING KNIVES, PRECISION SQUARES, AND MITER SQUARES (U.S. CLS. 23, 28 AND 44).  
FIRST USE 9-1-2002; IN COMMERCE 9-1-2002.

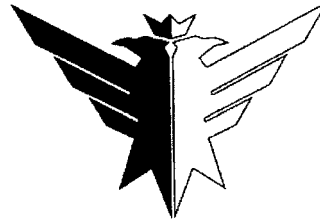

**CLASS 9—ELECTRICAL AND SCIENTIFIC APPARATUS**

FOR CALIPERS FOR MEASURING; DOVETAIL MARKERS, GRADUATED RULERS, HOOK RULES, CENTER FINDER RULES, THICKNESS PLATES, NAMELY, A STANDARD AGAINST WHICH MEASUREMENTS ARE MADE IN WOODWORKING OPERATIONS, BEVELS, AND TRAMMEL POINTS (U.S. CLS. 21, 23, 26, 36 AND 38).  
PAULA MAYS, EXAMINING ATTORNEY



SN 78-166,419. ADAMS, LAUREN, PARK CITY, UT. FILED 9-20-2002.

**ATHLETES WITH ALTITUDE**

**CLASS 25—CLOTHING**

FOR CLOTHING, NAMELY SHIRTS, SHORTS, PANTS, CAPS, JACKETS, SOCKS, RUNNING SHORTS, RUNNING SINGLETS, RUNNING SOCKS AND RUNNING SUITS (U.S. CLS. 22 AND 39).

**CLASS 41—EDUCATION AND ENTERTAINMENT**

FOR PHYSICAL FITNESS INSTRUCTION AND PERSONAL TRAINER SERVICES (U.S. CLS. 100, 101 AND 107).  
JOHN GARTNER, EXAMINING ATTORNEY

**CLASS 32—LIGHT BEVERAGES**

FOR ALCOHOLIC BEVERAGES, NAMELY, FLAVORED MALT BEVERAGES (U.S. CLS. 45, 46 AND 48).

**CLASS 33—WINES AND SPIRITS**

FOR ALCOHOLIC BEVERAGES, NAMELY, DISTILLED SPIRITS (U.S. CLS. 47 AND 49).  
PAULA MAYS, EXAMINING ATTORNEY

SN 78-176,416. LAND ROVER, WARWICKSHIRE, UNITED KINGDOM, FILED 10-21-2002.



**CONNECT**

#### CLASS 35—ADVERTISING AND BUSINESS

FOR PROMOTING THE SALE OF GOODS AND SERVICES OF OTHERS BY DISSEMINATION OF PROMOTIONAL MATERIAL THROUGH AN ON-LINE GLOBAL COMPUTER NETWORK, THROUGH THE DISTRIBUTION OF PRINTED MATERIAL, AUDIO AND VIDEO TAPES, TELEVISION AND RADIO BROADCASTS, NAMELY, PROVIDING TELEVISION AND RADIO ADVERTISEMENTS FOR OTHERS, AND PROMOTIONAL CONTESTS, AND THROUGH THE ADMINISTRATION OF CUSTOMER LOYALTY PROGRAMS; PROVIDING DEALERSHIP INCENTIVE AWARD PROGRAMS TO RECOGNIZE DEALERSHIP EXCELLENCE; MOTOR VEHICLE DEALERSHIP SERVICES; BUSINESS AND ADVERTISING SERVICES, NAMELY, PLACING ADVERTISEMENTS FOR OTHERS IN THE FIELD OF AUTOMOBILE SALES; PROVIDING ON-LINE INFORMATION REGARDING ELECTRONIC COUPONS FOR ORDERING AND PURCHASING VEHICLES AND MOTOR VEHICLE PARTS, TO THE PURCHASER'S SPECIFICATIONS; RETAIL STORE SERVICES IN THE FIELDS OF AUTOMOTIVE PARTS, ACCESSORIES, AND CLOTHING; BUSINESS SERVICES, NAMELY, CUSTOMER SERVICE AND CUSTOMER RELATIONSHIP MANAGEMENT FOR OTHERS IN THE FIELD OF AUTOMOBILES; PROVIDING ON-LINE INFORMATION FOR AUTOMOTIVE CONSUMER AND DEALERS REGARDING VEHICLES REGARDING PRICING, VEHICLE DEALER LOCATIONS, PROMOTIONAL VEHICLE ELECTRONIC COUPONS; PROVIDING ON-LINE INFORMATION FOR INVENTORY MANAGEMENT IN THE FIELD OF VEHICLE AVAILABILITY AND VEHICLE PARTS AVAILABILITY; COMPUTERIZED ON-LINE RETAIL SERVICES IN THE FIELD OF VEHICLES, VEHICLE PARTS; ON-LINE ORDERING OF VEHICLES TO THE PURCHASER'S SPECIFICATIONS; PROVIDING ON-LINE INFORMATION REGARDING CUSTOMER RELATIONSHIP MANAGEMENT (U.S. CLS. 100, 101 AND 102).

#### CLASS 36—INSURANCE AND FINANCIAL

FOR ON-LINE FINANCING OF VEHICLES (U.S. CLS. 100, 101 AND 102).

#### CLASS 37—CONSTRUCTION AND REPAIR

FOR PROVIDING ON-LINE INFORMATION FOR AUTOMOTIVE CONSUMER AND DEALERS REGARDING VEHICLE PARTS AND ACCESSORY OPTIONS, VEHICLE SPECIFICATIONS, VEHICLE RECALL NOTICES, VEHICLE MAINTENANCE REMINDERS, VEHICLE MANUFACTURING, ENGINEERING AND REPAIR; MOTOR CLUB SERVICES, NAMELY, EMERGENCY ROAD SIDE SERVICES (U.S. CLS. 100, 103 AND 106).

#### CLASS 39—TRANSPORTATION AND STORAGE

FOR LEASING OF NEW AND USED MOTOR VEHICLES; MOTOR VEHICLE FLEET LEASING (U.S. CLS. 100 AND 105).

#### CLASS 42—SCIENTIFIC, COMPUTER AND LEGAL SERVICES

FOR TESTING AND DESIGNING FOR OTHERS IN THE FIELD OF MOTOR VEHICLES, AUTOMOTIVE ELECTRONICS, SOFTWARE, MULTIMEDIA SYSTEMS AND CLIMATE CONTROL SYSTEMS; MOTOR VEHICLE INSPECTION SERVICES; DESIGNING WEB SITES FOR OTHERS IN THE FIELD OF MOTOR VEHICLES (U.S. CLS. 100 AND 101).

LINDA E. BLOHM, EXAMINING ATTORNEY

SN 78-176,419. FLATIRON INFORMATION SERVICES INC., TORONTO, CANADA, FILED 10-21-2002.

### THE FLATIRON REPORT

PRIORITY CLAIMED UNDER SEC. 44(D) ON CANADA APPLICATION NO. 1155075, FILED 10-15-2002, REG. NO. TMA595217, DATED 11-20-2003, EXPIRES 11-20-2018.

NO CLAIM IS MADE TO THE EXCLUSIVE RIGHT TO USE "REPORT", APART FROM THE MARK AS SHOWN.

#### CLASS 16—PAPER GOODS AND PRINTED MATTER

FOR RESEARCH REPORTS FEATURING BUSINESS ANALYSIS (U.S. CLS. 2, 5, 22, 23, 29, 37, 38 AND 50).

#### CLASS 35—ADVERTISING AND BUSINESS

FOR PREPARING BUSINESS REPORTS; BUSINESS RESEARCH (U.S. CLS. 100, 101 AND 102).

LINDA E. BLOHM, EXAMINING ATTORNEY

SN 78-176,420. FLATIRON INFORMATION SERVICES INC., TORONTO, CANADA, FILED 10-21-2002.

### FLATIRON INFORMATION SERVICES

PRIORITY CLAIMED UNDER SEC. 44(D) ON CANADA APPLICATION NO. 1155076, FILED 10-15-2002, REG. NO. TMA595399, DATED 11-21-2003, EXPIRES 11-21-2018.

NO CLAIM IS MADE TO THE EXCLUSIVE RIGHT TO USE "INFORMATION SERVICES", APART FROM THE MARK AS SHOWN.

#### CLASS 16—PAPER GOODS AND PRINTED MATTER

FOR RESEARCH REPORTS FEATURING BUSINESS ANALYSIS (U.S. CLS. 2, 5, 22, 23, 29, 37, 38 AND 50).

#### CLASS 35—ADVERTISING AND BUSINESS

FOR PREPARING BUSINESS REPORTS; BUSINESS RESEARCH (U.S. CLS. 100, 101 AND 102).

LINDA E. BLOHM, EXAMINING ATTORNEY

SN 78-182,765. R.O.C. DEI FRATELLI UBALDI & C. S.N.C.,  
47821 SANTA GIUSTINA DI RIMINI (RN), ITALY, FILED  
11-7-2002.

SN 78-189,806. MEDIAMOST INTERNATIONAL, INC., NEW  
YORK, NY. FILED 11-29-2002.



## UFO

OWNER OF ERPN CMNTY TM OFC REG. NO. 002.666.188,  
DATED 7-30-2003, EXPIRES 4-24-2012.

### CLASS 7—MACHINERY

FOR AGRICULTURAL MACHINES, NAMELY, CULTIVATORS, DISK HARROWS, INCORPORATORS, EARTH AUGERS, HOEING MACHINES; INDUSTRIAL AGRICULTURAL MACHINES, NAMELY, EXCAVATORS, SCRAPERS, GRADERS, LOADERS, SCARIFIERS, BULLDOZERS, FRONT-END LOADERS, BACKHOES; AGRICULTURAL SEEDING MACHINES, NAMELY, SEEDERS; AGRICULTURAL FERTILIZER SPREADERS AND APPLICATORS; AGRICULTURAL DEHYDRATORS AND DESSICATORS FOR VEGETABLE MATERIAL; AGRICULTURAL MACHINES FOR THE MAINTENANCE OF PLANTS AND LAWNS/MEADOWS, NAMELY, BUSH CUTTERS, POWER-MOWERS, SWEEPERS, SHREDDERS, PRUNING MACHINES, TREE TRIMMING MACHINES, GRASS MOWERS, DECORTICATORS, GRUBBERS, TRANSPLANTING MACHINES, MACHINES FOR CUTTING BRANCHES OFF, WOOD-CUTTERS, WOOD CHIPPERS, MULCHING MACHINES, STUMP GRINDERS, DEFOLIATORS; MOTORIZED TOOLS FOR AGRICULTURAL MACHINES FOR THE TREATMENT OF PLANTS AND LAWNS/MEADOWS, NAMELY, MOTORIZED DISKS AND BLADES FOR CUTTING AND SAWING; DISKS AND MOTORIZED ROTATING TOOLS FOR MACHINES FOR CUTTING BUSHES OFF; AGRICULTURAL MACHINES FOR HARVESTING/PICKING AND TREATING FRUITS, LEGUMES, GREENS AND VEGETABLES, SUGAR BEETS, TEA, COFFEE, TOBACCO, HEAT AND FORAGE, NAMELY, MOWERS, MOWERS WITH HAYMAKERS, PATHWAY-MAKING MACHINES, CARRIERS, BALE-LOADERS, LOADERS, ELEVATORS, BALING PRESSES, THRESHING-MACHINES, HAY-TEDDERS AND HAY-SPREADERS, SHREDDERS; STONE PICKING-UP MACHINES; FODDER MILLING/GRINDING MACHINES; FODDER MIXING MACHINES; AGRICULTURAL IRRIGATORS; IRRIGATION PUMPS; SNOW PLOWS; AGRICULTURAL EQUIPMENT, NAMELY, PLOWS, HARROWS, LOADERS, POWER LOADERS; HARVESTERS, COMBINES, THRESHERS, CORN-PICKERS (U.S. CLS. 13, 19, 21, 23, 31, 34 AND 35).

### CLASS 12—VEHICLES

FOR LIFT TRUCKS, FORK LIFTS, TRACTORS, SMALL TRACTORS FOR GARDENING, MOTORIZED GOLF CARTS, WAGONS; CARGO TRAILERS; AGRICULTURAL TOW VEHICLES (U.S. CLS. 19, 21, 23, 31, 35 AND 44).

KELLY BOULTON, EXAMINING ATTORNEY

### CLASS 9—ELECTRICAL AND SCIENTIFIC APPARATUS

FOR ELECTRICAL AND ELECTRONIC APPARATUS AND INSTRUMENTS FOR USE IN THE PRODUCTION, PRESENTATION, BROADCASTING, TRANSMISSION, RECEIVING, PROCESSING, REPRODUCING, ENCODING AND DECODING OF RADIO AND TELEVISION PROGRAMS AND INFORMATION AND DATA OF TELEVISION AND RADIO PROGRAMS, NAMELY, BROADCAST, CABLE, AND SATELLITE RECEIVERS, BROADCAST, CABLE AND SATELLITE TRANSMITTERS, USER/COMMUNICATIONS TERMINALS, BROADCAST, CABLE AND SATELLITE ANTENNAS, SATELLITES, SATELLITE DISHES, SATELLITE PROCESSORS, MOBILE DATA RECEIVERS, RADIO TRANSMITTERS, ELECTRONIC PROGRAM GUIDES FOR BROADCAST, CABLE AND SATELLITE TELEVISION PROGRAMMING RECORDED ON COMPUTER MEDIA; VIDEOTEXT AND CLOSED CAPTIONING PROCESSORS AND CONTROLLERS USED FOR PROVIDING TEXT TRANSLATIONS OF AUDIO TRANSMISSION FOR THE HEARING IMPAIRED, DECODER BOXES AND REMOTE CONTROLLERS FOR USE IN PROVIDING AND UTILIZING ON-SCREEN ELECTRONIC LISTINGS, SCHEDULES AND GUIDES FOR BROADCAST, CABLE, TELEVISION AND NETWORK PROGRAMS AND PROGRAM LISTINGS, TELEVISION AND RADIO SIGNAL TRANSMITTERS AND RECEIVERS FOR USE IN RECORDING, PRODUCING, PRESENTING, BROADCASTING, TRANSMITTING, RECEIVING, PROCESSING, REPRODUCING, ENCODING AND DECODING OF RADIO AND TELEVISION PROGRAMS, INFORMATION AND DATA, AMPLIFIERS, COMPUTER AND TELEPHONE MODEMS, CABLE MODEMS, CONDITIONAL ACCESS SMART CARDS, SMART CARD READERS, SMART CARD WRITERS, AND SMART CARD IDENTIFIERS, MIXERS, EQUALIZERS, SIGNAL GENERATORS, OSCILLATORS AND FILTERS, TELEVISION STANDARDS CONVERTERS, SIGNAL CONVERTERS, MODULATORS AND DEMODULATORS, SOUND AND PICTURE MONITORS; SOUND, VIDEO AND DATA RECORDING AND REPRODUCING APPARATUS, NAMELY, DIGITAL AUDIO TAPE PLAYERS AND RECORDERS, DIGITAL VIDEO PLAYERS AND RECORDERS, VIDEO TAPE PLAYERS AND RECORDERS, AUDIO TAPE PLAYERS AND RECORDERS, DVD PLAYERS AND RECORDERS, COMPACT DISC PLAYERS AND RECORDERS, AUDIO CASSETTE PLAYERS AND RECORDERS, VIDEO CASSETTE PLAYERS AND RECORDERS, VIDEO CAMERAS, VIDEO PROCESSORS; MOTION PICTURE FILMS, SOUND FILMS, CINEMATOGRAPHIC FILMS AND PHOTOGRAPHIC FILMS FEATURING COMEDY, DRAMA, ADVENTURE, ACTION, DOCUMENTARIES, CARTOONS, ANIMATION, ROMANCE, SPORTS, LEISURE, SCIENCE AND TECHNOLOGY, TRAVEL, RELIGION, MUSIC, NATURE, LIVE CONCERTS AND EVENTS, HISTORY, SCIENCE FICTION, FICTION, NON-FICTION, HEALTH, NATURAL HISTORY, GEOGRAPHY, GEOLOGY, BIOLOGY, CULTURE, ENTERTAINMENT, INSTRUCTION, EDUCATION AND OTHER TOPICS OF GENERAL INTEREST; PRERECORDED VIDEO TAPES AND VIDEO DISCS FEATURING NEWS, COMEDY, DRAMA, ACTION, ADVENTURE, DOCUMENTARIES, LAW, CRIME, CARTOONS, ANIMATION, GAMES, QUIZZES, ROMANCE, SPORTS, LEISURE, SCIENCE AND TECHNOLOGY, TRAVEL, RECREATIONAL ACTIVITIES, RELIGION, MUSIC, DO-IT-YOURSELF PROJECTS, HOME IMPROVEMENT, FOOD AND COOKING, INTERIOR DECORATING, NATURE, GARDENING, LANDSCAPING, EXERCISE AND FITNESS, LIVE CONCERTS AND EVENTS, HISTORY, SCIENCE FICTION, FICTION, NON-FICTION, INTERVIEWS, CURRENT AFFAIRS, HEALTH, NATURAL HISTORY, SOCIAL ISSUES, MATHEMATICS, GEOGRAPHY, HISTORY,

GEOLOGY, BIOLOGY, ENGLISH AND FOREIGN LANGUAGES, POLITICS, ARTS, ANTIQUES, WEATHER, CULTURE, ENTERTAINMENT, INSTRUCTION, EDUCATION AND OTHER TOPICS OF GENERAL INTEREST; COMPUTER GAME SOFTWARE; VIDEO GAME SOFTWARE; INTERACTIVE DOWNLOADABLE COMPUTER GAMES AND DOWNLOADABLE VIDEO GAMES WHICH CAN BE ACCESSED, PLAYED AND DOWNLOADED OVER CABLE AND SATELLITE NETWORKS, WIRELESS NETWORKS, COMPUTER NETWORKS OR THE INTERNET; INTERACTIVE ENTERTAINMENT SOFTWARE, NAMELY, SOFTWARE FOR PLAYING INTERACTIVE GAMES; COMPUTER SOFTWARE FOR RECEIVING, PROCESSING AND DISPLAYING AUDIO, VIDEO, TEXT AND GRAPHICS TRANSMITTED VIA A COMPUTER, TELEVISION OR THE INTERNET; ELECTRONIC GAMES, NAMELY, VIDEO GAME MACHINES FOR USE WITH TELEVISIONS; PRERECORDED SOUND, VIDEO AND DATA RECORDINGS, NAMELY, MAGNETIC CARDS, MAGNETIC TAPES, CDS, CD-IS, DVDS, OPTICAL DISCS, DIGITAL VIDEO TAPES, DIGITAL AUDIO TAPES, VIDEO TAPES, AUDIO TAPES, AUDIO CASSETTES, VIDEO CASSETTES, CD-ROMS, RECORDS, CARTRIDGES, DIGITAL, AND AUDIO AND VIDEO COMPRESSION SOFTWARE FILES, NAMELY, MP3S, MP4S AND JPEGs, FEATURING NEWS, COMEDY, DRAMA, FILM, ACTION, ADVENTURE, DOCUMENTARIES, LAW, CRIME, CARTOONS, ANIMATION, GAMES, QUIZZES, ROMANCE, SPORTS, LEISURE, SCIENCE AND TECHNOLOGY, TRAVEL, RECREATIONAL ACTIVITIES, RELIGION, MUSIC, DO-IT-YOURSELF PROJECTS, FOOD AND COOKING, INTERIOR DECORATING, NATURE, GARDENING, LANDSCAPING, EXERCISE AND FITNESS, LIVE CONCERTS AND EVENTS, HISTORY, SCIENCE FICTION, FICTION, NON-FICTION, INTERVIEWS, CURRENT AFFAIRS, HEALTH, NATURAL HISTORY, SOCIAL ISSUES, MATHEMATICS, GEOGRAPHY, HISTORY, GEOLOGY, BIOLOGY, POLITICS, ARTS, ANTIQUES, ON-LINE CONTENT, ENGLISH AND FOREIGN LANGUAGES, WEATHER, CULTURE, ENTERTAINMENT, INSTRUCTION, EDUCATION AND OTHER TOPICS OF GENERAL INTEREST; COMPUTER GAME AND VIDEO GAME EQUIPMENT, NAMELY, COMPUTER GAME PROGRAMS, SOFTWARE, DISCS, CASSETTES AND TAPES FOR USE WITH A TELEVISION SCREEN OR VIDEO MONITOR; INTERACTIVE VIDEO GAME PROGRAMS; VIDEO GAME CARTRIDGES FOR USE WITH ELECTRONIC GAMES APPARATUS; VIDEO GAME INTERACTIVE REMOTE, CONTROL UNITS, CONTROL FLOOR MATS OR PADS, AND JOYSTICKS; ELECTRONIC PUBLICATIONS, NAMELY, DOWNLOADABLE MAGAZINES, NEWSLETTERS, NEWSPAPERS, AND PROGRAMMING GUIDES, FEATURING INFORMATION ON RADIO AND TELEVISION PROGRAMS, NEWS, COMEDY, DRAMA, FILM, ACTION, ADVENTURE, DOCUMENTARIES, LAW, CRIME, CARTOONS, ANIMATION, GAMES, QUIZZES, ROMANCE, SPORTS, LEISURE, SCIENCE AND TECHNOLOGY, TRAVEL, RECREATIONAL ACTIVITIES, RELIGION, MUSIC, DO-IT-YOURSELF PROJECTS, FOOD AND COOKING, INTERIOR DECORATING, NATURE, GARDENING, LANDSCAPING, EXERCISE AND FITNESS, LIVE CONCERTS AND EVENTS, HISTORY, SCIENCE FICTION, FICTION, NON-FICTION, INTERVIEWS, CURRENT AFFAIRS, HEALTH, NATURAL HISTORY, SOCIAL ISSUES, MATHEMATICS, GEOGRAPHY, HISTORY, GEOLOGY, BIOLOGY, POLITICS, ARTS, ANTIQUES, ON-LINE CONTENT, ENGLISH AND FOREIGN LANGUAGES, WEATHER, CULTURE, ENTERTAINMENT, INSTRUCTION, EDUCATION AND OTHER TOPICS OF GENERAL INTEREST AND MAGAZINES, NEWSLETTERS, NEWSPAPERS, AND PROGRAMMING GUIDES, FEATURING INFORMATION ON RADIO AND TELEVISION PROGRAMS, NEWS, COMEDY, DRAMA, FILM, ACTION, ADVENTURE, DOCUMENTARIES, LAW, CRIME, CARTOONS, ANIMATION, GAMES, QUIZZES, ROMANCE, SPORTS, LEISURE, SCIENCE AND TECHNOLOGY, TRAVEL, RECREATIONAL ACTIVITIES, RELIGION, MUSIC, DO-IT-YOURSELF PROJECTS, FOOD AND COOKING, INTERIOR DECORATING, NATURE, GARDENING, LANDSCAPING, EXERCISE AND FITNESS, LIVE CONCERTS AND EVENTS, HISTORY, SCIENCE FICTION, FICTION, NON-FICTION, INTERVIEWS, CURRENT AFFAIRS, HEALTH, NATURAL HISTORY, SOCIAL ISSUES, MATHEMATICS, GEOGRAPHY, HISTORY, GEOLOGY, BIOLOGY, POLITICS, ARTS, ANTIQUES, ON-LINE CONTENT, ENGLISH AND FOREIGN LANGUAGES, WEATHER, CULTURE, ENTERTAINMENT, INSTRUCTION, EDUCATION AND OTHER TOPICS OF GENERAL INTEREST

TAINMENT, INSTRUCTION, EDUCATION AND OTHER TOPICS OF GENERAL INTEREST RECORDED ON COMPUTER MEDIA; DOWNLOADABLE SOUND RECORDINGS FEATURING MUSIC; DOWNLOADABLE DIGITAL MUSIC SOUND RECORDINGS PROVIDED FROM MP3 INTERNET WEBSITES (U.S. CLS. 21, 23, 26, 36 AND 38).

#### **CLASS 16—PAPER GOODS AND PRINTED MATTER**

FOR PRINTED MATTER, NAMELY, PERIODICALS, BOOKS, BOOKLETS, MAGAZINES, NEWSLETTERS, CATALOGUES, GUIDES, MANUALS, PAMPHLETS, BROCHURES, PROGRAMS, NEWS SHEETS, AND INFORMATIONAL FLYERS FEATURING OR RELATING TO RADIO AND TELEVISION PROGRAMS AND SCHEDULES, NEWS, COMEDY, DRAMA, FILM, ACTION, ADVENTURE, DOCUMENTARIES, LAW, CRIME, CARTOONS, ANIMATION, GAMES, QUIZZES, ROMANCE, SPORTS, LEISURE, SCIENCE AND TECHNOLOGY, TRAVEL, RECREATIONAL ACTIVITIES, RELIGION, MUSIC, DO-IT-YOURSELF PROJECTS, FOOD AND COOKING, INTERIOR DECORATING, NATURE, GARDENING, LANDSCAPING, EXERCISE AND FITNESS, LIVE CONCERTS AND EVENTS, HISTORY, SCIENCE FICTION, FICTION, NON-FICTION, INTERVIEWS, CURRENT AFFAIRS, HEALTH, NATURAL HISTORY, SOCIAL ISSUES, MATHEMATICS, GEOGRAPHY, HISTORY, GEOLOGY, BIOLOGY, POLITICS, ARTS, ANTIQUES, ON-LINE CONTENT, ENGLISH AND FOREIGN LANGUAGES, WEATHER, CULTURE, ENTERTAINMENT, INSTRUCTION, EDUCATION AND OTHER TOPICS OF GENERAL INTEREST; TELEVISION GUIDES; PLASTIC BAGS; PAPER BAGS; STATIONARY; ENVELOPES; WRITING PADS; DRAWING PADS; NOTE PADS; GREETING CARDS; NOTE CARDS; TRADING CARDS; WRAPPING AND PACKAGING PAPERS; BOOKMARKERS; PENS, PENCILS AND CRAYONS; ERASERS; ADHESIVE TAPES; PAPER CLIPS; PAPER WEIGHTS; PEN AND PENCIL CASES, BOXES AND HOLDERS; PENCIL SHARPENERS; DRAFTING, DRAWING AND UNGRADUATED RULERS; STENCILS; STENCIL CASES AND STENCIL PLATES; WRITING CHALK; POSTERS; MOUNTED AND UNMOUNTED PHOTOGRAPHS; PICTURES; PHOTOGRAPH ALBUMS; DIARIES; CALENDARS; DRAWINGS; STICKERS; TRANSFERS; PREPRINTED INSTRUCTIONAL, EDUCATIONAL AND TEACHING MATERIALS FEATURING OR RELATING TO RADIO AND TELEVISION PROGRAMS AND SCHEDULES, NEWS, COMEDY, DRAMA, FILM, ACTION, ADVENTURE, DOCUMENTARIES, LAW, CRIME, CARTOONS, ANIMATION, GAMES, QUIZZES, ROMANCE, SPORTS, LEISURE, SCIENCE AND TECHNOLOGY, TRAVEL, RECREATIONAL ACTIVITIES, RELIGION, MUSIC, DO-IT-YOURSELF PROJECTS, FOOD AND COOKING, INTERIOR DECORATING, NATURE, GARDENING, LANDSCAPING, EXERCISE AND FITNESS, LIVE CONCERTS AND EVENTS, HISTORY, SCIENCE FICTION, FICTION, NON-FICTION, INTERVIEWS, CURRENT AFFAIRS, HEALTH, NATURAL HISTORY, SOCIAL ISSUES, MATHEMATICS, GEOGRAPHY, HISTORY, GEOLOGY, BIOLOGY, POLITICS, ARTS, ANTIQUES, ON-LINE CONTENT, ENGLISH AND FOREIGN LANGUAGES, WEATHER, CULTURE, ENTERTAINMENT, INSTRUCTION, EDUCATION AND OTHER TOPICS OF GENERAL INTEREST (U.S. CLS. 2, 5, 22, 23, 29, 37, 38 AND 50).

#### **CLASS 35—ADVERTISING AND BUSINESS**

FOR DISSEMINATION OF ADVERTISING FOR OTHERS VIA TELEVISION, RADIO, THE INTERNET, PRINTED PUBLICATIONS, AND ELECTRONIC PUBLICATIONS; PROMOTIONAL SERVICES, NAMELY, PREPARING PROMOTIONAL AND MERCHANDISING MATERIALS FOR OTHERS; BUSINESS SERVICES, NAMELY, BUSINESS MANAGEMENT AND CONSULTATION; BUSINESS SERVICES, NAMELY, PROVIDING COMPUTER DATABASES REGARDING THE PURCHASE AND SALE OF A WIDE VARIETY OF PRODUCTS AND SERVICES OF OTHERS; BUSINESS MARKETING AND DIRECT MAIL SERVICES; BUSINESS ADMINISTRATION SERVICES, NAMELY, ADMINISTRATION OF BUSINESS PAYROLL FOR OTHERS; MARKET RESEARCH SERVICES; PUBLICITY SERVICES, NAMELY, PUBLICITY AGENT; BUSINESS

INFORMATION PROVIDED ON-LINE FROM A COMPUTER DATABASE OR FROM THE INTERNET; PREPARATION, DISSEMINATION AND UPDATING OF ONLINE ADVERTISING FOR OTHERS; PROVIDING TELEVISION ADVERTISING FOR OTHERS; RENTAL OF ADVERTISING SPACE; MARKET RESEARCH FOR COMPILING INFORMATION ON LISTENERS AND VIEWERS OF TELEVISION; PRODUCTION OF TELEVISION COMMERCIALS; TELEVISION ADVERTISING; INTERACTIVE RETAIL SERVICES PROVIDED VIA COMPUTER, TELEVISION AND THE INTERNET FEATURING GENERAL MERCHANDISE; BUSINESS INFORMATION, BUSINESS CONSULTATION AND BUSINESS ADVISORY SERVICES; NEWS CLIPPING SERVICES (U.S. CLS. 100, 101 AND 102).

#### **CLASS 36—INSURANCE AND FINANCIAL**

FOR FINANCIAL SPONSORSHIP OF TELEVISION COMMERCIALS AND TELEVISION PROGRAMS; FINANCIAL INFORMATION PROVIDED ON-LINE FROM A COMPUTER DATABASE OR FROM THE INTERNET (U.S. CLS. 100, 101 AND 102).

#### **CLASS 38—COMMUNICATION**

FOR INTERNET, SATELLITE, CABLE TELEVISION AND RADIO BROADCASTING; TELEVISION AND RADIO BROADCASTING VIA ANALOGUE OR DIGITAL NETWORKS, INCLUDING THE INTERNET; AUDIO BROADCASTING; VIDEO BROADCASTING; TELEVISION BROADCASTING; INTERACTIVE TELEVISION BROADCASTING; CABLE TELEVISION BROADCASTING; SATELLITE BROADCASTING; RADIO BROADCASTING; INTERACTIVE RADIO BROADCASTING; CABLE RADIO BROADCASTING; TELEVISION TRANSMISSION; SATELLITE TRANSMISSION; CABLE TELEVISION TRANSMISSION; INTERACTIVE TELEVISION TRANSMISSION; VIDEO-ON-DEMAND TRANSMISSION SERVICES; RADIO TRANSMISSION; CABLE RADIO TRANSMISSION; INTERACTIVE RADIO TRANSMISSION; ELECTRONIC BROADCASTING AND TRANSMISSION OF DATA, DOCUMENTS, MESSAGES, TEXT, SOUND, IMAGES, GRAPHICS, ENTERTAINMENT AND EDUCATION VIA COMPUTER TERMINALS AND THE INTERNET; TRANSMISSION OF TEXT, MESSAGES, INFORMATION, SOUND, IMAGES AND DATA BY METAL OR OPTICAL TELEPHONE LINES; BROADCASTING AND TRANSMISSION OF DIGITAL INFORMATION AND DATA; ELECTRONIC TRANSMISSION OF MESSAGES AND DATA INCLUDING STREAMING ACROSS BROAD BAND; TRANSMISSION, BROADCAST AND RECEPTION OF AUDIO, VIDEO, STILL AND MOVING IMAGES AND DATA IN COMPRESSED AND UNCOMPRESSED FORM AND IN REAL AND DELAYED TIME; PROVIDING MULTIPLE-USER ACCESS TO THE INTERNET; ELECTRONIC MAIL SERVICES; TELETXT SERVICES; MESSAGE DELIVERY; RENTAL OF RADIO AND TELEVISION BROADCASTING EQUIPMENT FOR OUTSIDE LOCATIONS; RENTAL OF APPARATUS FOR THE BROADCAST OF AUDIO SIGNALS; RENTAL OF APPARATUS FOR THE BROADCAST OF VIDEO SIGNALS; RENTAL OF BROADCASTING EQUIPMENT; RENTAL OF BROADCASTING TIME; TELECOMMUNICATIONS CONSULTATION AND ADVISORY SERVICES, NAMELY, PROVIDING INFORMATION ABOUT INTERNET, SATELLITE, CABLE TELEVISION AND RADIO BROADCASTING AND TRANSMISSION SERVICES; RENTAL OF RADIO AND TELEVISION BROADCASTING FACILITIES; PROVIDING ONLINE CHAT ROOMS FOR TRANSMISSION OF MESSAGES AMONG COMPUTER USERS OF TOPICS OF GENERAL INTEREST; PROVIDING AN ONLINE ELECTRONIC BULLETIN BOARD FOR TRANSMISSION OF MESSAGES AMONG COMPUTER USERS CONCERNING TOPICS OF GENERAL INTEREST; AUDIO/VIDEO STREAMING VIA THE INTERNET (U.S. CLS. 100, 101 AND 104).

#### **CLASS 41—EDUCATION AND ENTERTAINMENT**

FOR ENTERTAINMENT IN THE NATURE OF ONGOING RADIO AND TELEVISION PROGRAMS FEATURING NEWS, COMEDY, DRAMA, FILM, ACTION, ADVENTURE, DOCUMENTARIES, LAW, CRIME, CARTOONS, ANIMATION, GAMES, QUIZZES, ROMANCE, SPORTS, LEISURE, SCIENCE AND TECHNOLOGY, TRAVEL, RECREATIONAL ACTIVITIES, RELIGION, MUSIC, DO-IT-YOURSELF PROJECTS, FOOD AND COOKING, INTERIOR DECORATING, NATURE, GARDENING, LANDSCAPING, EXERCISE AND FITNESS, LIVE CONCERTS AND EVENTS, HISTORY, SCIENCE FICTION, FICTION, NON-FICTION, INTERVIEWS, CURRENT AFFAIRS, HEALTH, NATURAL HISTORY, SOCIAL ISSUES, MATHEMATICS, GEOGRAPHY, HISTORY, GEOLOGY, BIOLOGY, POLITICS, ARTS, ANTIQUES, ON-LINE CONTENT, ENGLISH AND FOREIGN LANGUAGES, WEATHER, CULTURE, ENTERTAINMENT, INSTRUCTION, EDUCATION AND OTHER TOPICS OF GENERAL INTEREST; PRODUCTION OF TELEVISION AND RADIO PROGRAMS; ENTERTAINMENT SERVICES, NAMELY, PROVIDING ONLINE ENTERTAINMENT AND ON-LINE INTERACTIVE ENTERTAINMENT SERVICES IN THE FORM OF A WEBSITE FEATURING NEWS, COMEDY, DRAMA, FILM, ACTION, ADVENTURE, DOCUMENTARIES, LAW, CRIME, CARTOONS, ANIMATION, GAMES, QUIZZES, ROMANCE, SPORTS, LEISURE, SCIENCE AND TECHNOLOGY, TRAVEL, RECREATIONAL ACTIVITIES, RELIGION, MUSIC, DO-IT-YOURSELF PROJECTS, FOOD AND COOKING, INTERIOR DECORATING, NATURE, GARDENING, LANDSCAPING, EXERCISE AND FITNESS, LIVE CONCERTS AND EVENTS, HISTORY, SCIENCE FICTION, FICTION, NON-FICTION, INTERVIEWS, CURRENT AFFAIRS, HEALTH, NATURAL HISTORY, SOCIAL ISSUES, MATHEMATICS, GEOGRAPHY, HISTORY, GEOLOGY, BIOLOGY, POLITICS, ARTS, ANTIQUES, ON-LINE CONTENT, ENGLISH AND FOREIGN LANGUAGES, WEATHER, AND CULTURE; ENTERTAINMENT SERVICES, NAMELY, PROVIDING ONLINE COMPUTER GAMES; PRODUCTION OF SOUND AND VIDEO RECORDINGS, MOTION PICTURE FILMS, TELEVISION AND RADIO SHOWS; PUBLICATION OF PRINTED EDUCATIONAL AND INSTRUCTIONAL MATERIALS; RENTAL OF PRERECORDED DIGITAL, AUDIO AND VIDEO RECORDINGS, VIDEOTAPES, COMPUTER GAMES, CD-IS, AND CD-ROMS; ENTERTAINMENT SERVICES, NAMELY, LIVE PERFORMANCES BY A MUSICAL GROUP, LIVE MUSIC CONCERTS, THEATRE PRODUCTIONS, STAGE PLAYS, AND STAGE AND ROAD SHOWS; ENTERTAINMENT SERVICES, NAMELY, PROVIDING PRERECORDED MUSIC INFORMATION IN THE FIELD OF MUSIC AND COMMENTARY AND ARTICLES ABOUT MUSIC VIA THE INTERNET; ORGANIZATION OF ATHLETIC AND SPORTING COMPETITIONS, FUN DAYS, SPORTING EVENTS AND CULTURAL ACTIVITIES; ENTERTAINMENT SERVICES IN THE NATURE OF ORCHESTRA PERFORMANCES; ORGANIZING EXHIBITIONS FOR ENTERTAINMENT, EDUCATIONAL, CULTURAL AND SPORTING PURPOSES ALL OF THE AFORESAID SERVICES RELATING TO OR FEATURING RADIO AND TELEVISION PROGRAMS PERTAINING TO OR FEATURING NEWS, COMEDY, DRAMA, FILM, ACTION, ADVENTURE, DOCUMENTARIES, LAW, CRIME, CARTOONS, ANIMATION, GAMES, QUIZZES, ROMANCE, SPORTS, LEISURE, SCIENCE AND TECHNOLOGY, TRAVEL, RECREATIONAL ACTIVITIES, RELIGION, MUSIC, DO-IT-YOURSELF PROJECTS, FOOD AND COOKING, INTERIOR DECORATING, NATURE, GARDENING, LANDSCAPING, EXERCISE AND FITNESS, LIVE CONCERTS AND EVENTS, HISTORY, SCIENCE FICTION, FICTION, NON-FICTION, INTERVIEWS, CURRENT AFFAIRS, HEALTH, NATURAL HISTORY, SOCIAL ISSUES, MATHEMATICS, GEOGRAPHY, HISTORY, GEOLOGY, BIOLOGY, POLITICS, ARTS, ANTIQUES, ON-LINE CONTENT, ENGLISH AND FOREIGN LANGUAGES, WEATHER, CULTURE, ENTERTAINMENT, INSTRUCTION, EDUCATION AND OTHER TOPICS OF GENERAL INTEREST; PUBLISHING SERVICES, NAMELY, PUBLICATION OF TEXT AND GRAPHIC WORKS OF OTHERS ON CDS, CD-IS, DVDS AND ONLINE FEATURING OR RELATING TO RADIO AND TELEVISION PROGRAMS AND SCHEDULES, NEWS, COMEDY, DRAMA, FILM, ACTION, ADVENTURE, DOCUMENTARIES, LAW, CRIME, CARTOONS,

ANIMATION, GAMES, QUIZZES, ROMANCE, SPORTS, LEISURE, SCIENCE AND TECHNOLOGY, TRAVEL, RECREATIONAL ACTIVITIES, RELIGION, MUSIC, DO-IT-YOURSELF PROJECTS, FOOD AND COOKING, INTERIOR DECORATING, NATURE, GARDENING, LANDSCAPING, EXERCISE AND FITNESS, LIVE CONCERTS AND EVENTS, HISTORY, SCIENCE FICTION, FICTION, NON-FICTION, INTERVIEWS, CURRENT AFFAIRS, HEALTH, NATURAL HISTORY, SOCIAL ISSUES, MATHEMATICS, GEOGRAPHY, HISTORY, GEOLOGY, BIOLOGY, POLITICS, ARTS, ANTIQUES, ON-LINE CONTENT, ENGLISH AND FOREIGN LANGUAGES, WEATHER, CULTURE, ENTERTAINMENT, INSTRUCTION, EDUCATION AND OTHER TOPICS OF GENERAL INTEREST; PROVIDING INFORMATION ON FEATURING OR RELATING TO RADIO AND TELEVISION PROGRAMS AND SCHEDULES, NEWS, COMEDY, DRAMA, FILM, ACTION, ADVENTURE, DOCUMENTARIES, LAW, CRIME, CARTOONS, ANIMATION, GAMES, QUIZZES, ROMANCE, SPORTS, LEISURE, SCIENCE AND TECHNOLOGY, TRAVEL, RECREATIONAL ACTIVITIES, RELIGION, MUSIC, DO-IT-YOURSELF PROJECTS, FOOD AND COOKING, INTERIOR DECORATING, NATURE, GARDENING, LANDSCAPING, EXERCISE AND FITNESS, LIVE CONCERTS AND EVENTS, HISTORY, SCIENCE FICTION, FICTION, NON-FICTION, INTERVIEWS, CURRENT AFFAIRS, HEALTH, NATURAL HISTORY, SOCIAL ISSUES, MATHEMATICS, GEOGRAPHY, HISTORY, GEOLOGY, BIOLOGY, POLITICS, ARTS, ANTIQUES, ON-LINE CONTENT, ENGLISH AND FOREIGN LANGUAGES, WEATHER, CULTURE, ENTERTAINMENT, INSTRUCTION, EDUCATION AND OTHER TOPICS OF GENERAL INTEREST VIA A COMPUTER DATABASE AND THE INTERNET; PROVIDING ON-LINE ENTERTAINMENT IN THE NATURE OF A WEB SITE FEATURING OR RELATING TO RADIO AND TELEVISION PROGRAMS AND SCHEDULES, NEWS, COMEDY, DRAMA, FILM, ACTION, ADVENTURE, DOCUMENTARIES, LAW, CRIME, CARTOONS, ANIMATION, GAMES, QUIZZES, ROMANCE, SPORTS, LEISURE, SCIENCE AND TECHNOLOGY, TRAVEL, RECREATIONAL ACTIVITIES, RELIGION, MUSIC, DO-IT-YOURSELF PROJECTS, FOOD AND COOKING, INTERIOR DECORATING, NATURE, GARDENING, LANDSCAPING, EXERCISE AND FITNESS, LIVE CONCERTS AND EVENTS, HISTORY, SCIENCE FICTION, FICTION, NON-FICTION, INTERVIEWS, CURRENT AFFAIRS, HEALTH, NATURAL HISTORY, SOCIAL ISSUES, MATHEMATICS, GEOGRAPHY, HISTORY, GEOLOGY, BIOLOGY, POLITICS, ARTS, ANTIQUES, ON-LINE CONTENT, ENGLISH AND FOREIGN LANGUAGES, WEATHER, CULTURE, ENTERTAINMENT, INSTRUCTION, EDUCATION AND OTHER TOPICS OF GENERAL INTEREST; ENTERTAINMENT SERVICES, NAMELY, PROVIDING ON-LINE RADIO AND TELEVISION PROGRAMS FEATURING OR RELATING TO RADIO AND TELEVISION PROGRAMS AND SCHEDULES, NEWS, COMEDY, DRAMA, FILM, ACTION, ADVENTURE, DOCUMENTARIES, LAW, CRIME, CARTOONS, ANIMATION, GAMES, QUIZZES, ROMANCE, SPORTS, LEISURE, SCIENCE AND TECHNOLOGY, TRAVEL, RECREATIONAL ACTIVITIES, RELIGION, MUSIC, DO-IT-YOURSELF PROJECTS, FOOD AND COOKING, INTERIOR DECORATING, NATURE, GARDENING, LANDSCAPING, EXERCISE AND FITNESS, LIVE CONCERTS AND EVENTS, HISTORY, SCIENCE FICTION, FICTION, NON-FICTION, INTERVIEWS, CURRENT AFFAIRS, HEALTH, NATURAL HISTORY, SOCIAL ISSUES, MATHEMATICS, GEOGRAPHY, HISTORY, GEOLOGY, BIOLOGY, POLITICS, ARTS, ANTIQUES, ON-LINE CONTENT, ENGLISH AND FOREIGN LANGUAGES, WEATHER, CULTURE, ENTERTAINMENT, INSTRUCTION, EDUCATION AND OTHER TOPICS OF GENERAL INTEREST; LANGUAGE TEACHING; PROVISION OF LANGUAGE SCHOOLS AND COURSES; DEVELOPMENT AND DISSEMINATION OF EDUCATIONAL MATERIALS IN THE FIELDS OF NEWS, SPORT, SCHEDULE, WEATHER, RECEPTION, MUSIC, ENTERTAINMENT, INSTRUCTION, AND EDUCATION; EDUCATIONAL SERVICES, NAMELY, CONDUCTING CLASSES FEATURING FOREIGN LANGUAGES; NEWS AGENCY SERVICES, NAMELY, GATHERING AND DISSEMINATION OF NEWS; NEWS REPORTING SERVICES; PROVISION OF RADIO AND TELEVISION CREWS FOR PRODUCTION SERVICES FOR OUTSIDE LOCATIONS; ONLINE PUBLICATIONS, NAMELY, ELECTRONIC PROGRAM GUIDES FOR BROADCAST, CABLE AND SATELLITE TELEVISION PROGRAM-

MING; TELEVISION AND RADIO PROGRAM DISTRIBUTORSHIP SERVICES; DISTRIBUTION OF TELEVISION PROGRAMMING TO CABLE, TERRESTRIAL OR SATELLITE TELEVISION SYSTEMS; TELEVISION AND RADIO PROGRAMMING AND PRODUCTION CONSULTATION AND ADVISORY SERVICES (U.S. CLS. 100, 101 AND 107).

#### CLASS 42—SCIENTIFIC, COMPUTER AND LEGAL SERVICES

FOR COMPUTER SERVICES, NAMELY, PROVIDING SEARCH ENGINES FOR OBTAINING DATA ON THE INTERNET; WEATHER FORECASTING; COPYRIGHT MANAGEMENT RELATING TO FILMS, TELEVISION, THEATRE AND MUSIC; DESIGN, DRAWING AND COMMISSIONED WRITING, ALL FOR THE COMPILATION OF WEB PAGES ON THE INTERNET; CREATING AND MAINTAINING WEBSITES FOR OTHERS; COMPUTER SERVICES, NAMELY, DESIGNING, IMPLEMENTING AND HOSTING WEBSITES FOR OTHERS ON THE INTERNET; LICENSING OF INTELLECTUAL PROPERTY, NAMELY, COPYRIGHTS, IN FILMS, TELEVISION PROGRAMS, FILMS AND MUSIC (U.S. CLS. 100 AND 101).

PATRICIA EVANKO, EXAMINING ATTORNEY

SN 78-192,864. FAUSTUS FORSCHUNGS CIE. TRANSLATIONAL CANCER RESEARCH GMBH, LEIPZIG, FED REP GERMANY, FILED 12-10-2002.



PRIORITY CLAIMED UNDER SEC. 44(D) ON AUSTRIA APPLICATION NO. 38472002, FILED 6-13-2002, REG. NO. 207571, DATED 12-13-2002, EXPIRES 12-31-2012.

NO CLAIM IS MADE TO THE EXCLUSIVE RIGHT TO USE "FORSCHUNG AUSTRIA" AND "TRANSLATIONAL DRUG DEVELOPMENT AG", APART FROM THE MARK AS SHOWN.

THE NON-LIVING CHARACTERS DEPICTED IN THE MARK ARE DR. JOHANN FAUST AND MEPHISTO.

THE ENGLISH TRANSLATION OF THE WORDING FAUSTUS FORSCHUNG IN THE MARK IS FAUSTUS RESEARCH.

#### CLASS 35—ADVERTISING AND BUSINESS

FOR BUSINESS MANAGEMENT AND ADMINISTRATION, NAMELY, MANAGEMENT AND ADMINISTRATION OF INTELLECTUAL PROPERTY (U.S. CLS. 100, 101 AND 102).

#### CLASS 42—SCIENTIFIC, COMPUTER AND LEGAL SERVICES

FOR LICENSING OF INTELLECTUAL PROPERTY; INTELLECTUAL PROPERTY CONSULTATION (U.S. CLS. 100 AND 101).

REBECCA SMITH, EXAMINING ATTORNEY

SN 78-194,342. GUINNESS WORLD RECORDS LIMITED, EASTLEIGH, HAMPSHIRE, UNITED KINGDOM, FILED 12-13-2002.



PRIORITY CLAIMED UNDER SEC. 44(D) ON ERPN CMNTY TM OFC APPLICATION NO. 2736023, FILED 6-14-2002, REG. NO. 2736023, DATED 7-27-2004, EXPIRES 6-14-2012.

OWNER OF U.S. REG. NOS. 1,230,450 AND 2,437,975. SEC. 2(F) AS TO "WORLD RECORDS".

#### CLASS 38—COMMUNICATION

FOR PROVIDING ON-LINE CHAT ROOMS FOR TRANSMISSION OF MESSAGES AMONG COMPUTER USERS CONCERNING RECORD BREAKING ACHIEVEMENTS; TELEVISION BROADCASTING, RADIO BROADCASTING, VIDEO BROADCASTING; ALL OF THE AFOREMENTIONED SERVICES ARE LIMITED TO THOSE RELATING TO RECORD ACHIEVEMENTS, RECORD BREAKING EVENTS OR OCCURRENCES THAT ARE RELATING TO HUMAN BEINGS, NATURAL PHENOMENA OR OTHERWISE OCCURRING, RECORD BREAKING ATTEMPTS AND OUTSTANDING AND UNUSUAL ACHIEVEMENTS, FAILURES AND OCCURRENCES (U.S. CLS. 100, 101 AND 104).

#### CLASS 41—EDUCATION AND ENTERTAINMENT

FOR AMUSEMENT PARK SERVICES; ARRANGING AND CONDUCTING WORKSHOPS IN THE FIELD OF RECORD ACHIEVEMENTS, RECORD BREAKING EVENTS OR OCCURRENCES; TRAINING SERVICES IN THE FIELD OF RECORD ACHIEVEMENTS, RECORD BREAKING EVENTS OR OCCURRENCES; EDUCATIONAL SERVICES, NAMELY, CONDUCTING CLASSES, SEMINARS, CONFERENCES, AND WORKSHOPS IN THE FIELD OF RECORD ACHIEVEMENTS, RECORD BREAKING EVENTS OR OCCURRENCES AND DISTRIBUTING COURSE MATERIALS IN CONNECTION THEREWITH; INSTRUCTION IN THE FIELD OF RECORD ACHIEVEMENTS, RECORD BREAKING EVENTS OR OCCURRENCES; ELECTRONIC PUBLISHING SERVICES, NAMELY, PUBLICATION OF TEXT AND GRAPHIC WORKS OF OTHERS ON CD, DVD, AND ON-LINE FEATURING RECORD ACHIEVEMENTS, RECORD BREAKING EVENTS OR OCCURRENCES; PRODUCTION OF RADIO AND TELEVISION ENTERTAINMENT PROGRAMS; PROVIDING INFORMATION RELATING TO ENTERTAINMENT AND EDUCATION PROVIDED ON-LINE VIA THE INTERNET; PROVIDING AN ON-LINE COMPUTER DATABASE IN THE FIELD OF ENTERTAINMENT AND EDUCATION; ON-LINE LIBRARY SERVICES, NAMELY, PROVIDING ELECTRONIC LIBRARY SERVICES WHICH FEATURE NEWSPAPERS, MAGAZINES, PHOTOGRAPHS AND PICTURES VIA AN ON-LINE COMPUTER NETWORK; MUSEUMS; GUIDED TOURS OF MUSEUMS; ENTERTAINMENT IN THE NATURE OF COMPETITIONS IN THE FIELD OF RECORD ACHIEVEMENTS, RECORD BREAKING EVENTS OR OCCURRENCES; ENTERTAINMENT IN THE NATURE OF ONLINE COMPUTER GAMES; ENTERTAINMENT IN THE NATURE OF QUIZZES IN THE FIELD OF RECORD ACHIEVEMENTS, RECORD BREAKING EVENTS OR OCCURRENCES; ENTERTAINMENT IN THE NATURE OF LIVE AND RECORDED STAGE AND SYNDICATED TELEVISION SHOWS; ORGANIZATION OF EXHIBI-

TIONS FOR RECORD ACHIEVEMENTS, RECORD BREAKING EVENTS OR OCCURRENCES; ORGANIZATION, PRODUCTION AND PRESENTATION OF LIVE PERFORMANCES FEATURING RECORD ACHIEVEMENTS, RECORD BREAKING EVENTS OR OCCURRENCES AND AUDIENCE PARTICIPATION EVENTS FEATURING RECORD ACHIEVEMENTS, RECORD BREAKING EVENTS OR OCCURRENCES; PRODUCTION, EDITING, RENTAL AND EXHIBITION OF FILMS, SOUND AND VIDEO RECORDINGS, TELEVISION AND RADIO PROGRAMS; PRODUCTION AND DISTRIBUTION OF MOTION PICTURES AND TELEVISION PROGRAMS; PROVIDING ON-LINE NON-DOWNLOADABLE ELECTRONIC PUBLICATIONS, NAMELY, MAGAZINES AND NEWSLETTERS IN THE FIELD OF RECORD ACHIEVEMENTS, RECORD BREAKING EVENTS OR OCCURRENCES; CHILDREN'S ENTERTAINMENT AND AMUSEMENT CENTERS, NAMELY, INTERACTIVE PLAY AREAS; PROVISION OF WORKSHOPS IN THE FIELD OF RECORD ACHIEVEMENTS, RECORD BREAKING EVENTS OR OCCURRENCES; PUBLICATION OF BOOKS, MAGAZINES, ALMANACS AND JOURNALS; PUBLICATION OF ELECTRONIC BOOKS AND JOURNALS ON-LINE; SCRIPTWRITING SERVICES; FAN CLUBS; ADVISORY INFORMATION AND CONSULTATION SERVICES RELATING TO ALL THE AFORESAID SERVICES; ALL OF THE AFOREMENTIONED SERVICES ARE LIMITED TO THOSE RELATING TO RECORD ACHIEVEMENTS, RECORD BREAKING EVENTS OR OCCURRENCES THAT ARE RELATING TO HUMAN BEINGS, NATURAL PHENOMENA OR OTHERWISE OCCURRING, RECORD BREAKING ATTEMPTS AND OUTSTANDING AND UNUSUAL ACHIEVEMENTS, FAILURES AND OCCURRENCES (U.S. CLS. 100, 101 AND 107).

GINA FINK, EXAMINING ATTORNEY

SN 78-199,047. NATIONAL PREARRANGED SERVICES, INC., ST. LOUIS, MO. FILED 12-31-2002.



#### CLASS 35—ADVERTISING AND BUSINESS

FOR PERSONNEL MANAGEMENT FOR FUNERAL SERVICE ESTABLISHMENTS, NAMELY HIRING SALES PERSONNEL FOR MARKETING PRE-PAID FUNERAL EXPENSE SERVICES; BUSINESS MARKETING CONSULTATION SERVICES FOR THE FUNERAL INDUSTRY (U.S. CLS. 100, 101 AND 102).

FIRST USE 7-30-1982; IN COMMERCE 3-9-1987.

#### CLASS 36—INSURANCE AND FINANCIAL

FOR PRE-PAID FUNERAL EXPENSE SERVICES FOR FUNERAL HOMES AND INDIVIDUALS; BROKERAGE AND UNDERWRITING OF CEMETERY AND FUNERAL INSURANCE, WHICH INCLUDES BURIAL, PRE-NEED CONTRACTS, CASKETS, VAULTS AND LICENSED MORTUARY CARE (U.S. CLS. 100, 101 AND 102).

FIRST USE 7-30-1982; IN COMMERCE 3-9-1987.



**CLASS 41—EDUCATION AND ENTERTAINMENT**

FOR EDUCATIONAL SERVICES, NAMELY, CONDUCTING TRAINING WORKSHOPS IN THE FIELD OF MARKETING PRE-PAID FUNERAL EXPENSE SERVICES (U.S. CLS. 100, 101 AND 107).

FIRST USE 7-30-1982; IN COMMERCE 3-9-1987.

**CLASS 45—PERSONAL SERVICES**

FOR FUNERAL PRE-ARRANGEMENT SERVICES (U.S. CLS. 100 AND 101).

FIRST USE 7-30-1982; IN COMMERCE 3-9-1987.

IRA J. GOODSAD, EXAMINING ATTORNEY

SN 78-204,783. ASIAN AGRO TRADING PTE LTD, SINGAPORE, SINGAPORE, FILED 1-17-2003.

**SHANGHAI NOODLE HOUSE**

NO CLAIM IS MADE TO THE EXCLUSIVE RIGHT TO USE SHANGHAI NOODLE, APART FROM THE MARK AS SHOWN.

**CLASS 29—MEATS AND PROCESSED FOODS**

FOR PRESERVED AND PROCESSED FRUITS AND VEGETABLES, NAMELY CURRY VEGETABLES; COCONUT PRODUCTS, NAMELY COCONUT MILK; EDIBLE OILS, AND SOUPS (U.S. CL. 46).

**CLASS 30—STAPLE FOODS**

FOR FOOD PRODUCTS, NAMELY SAUCES, SPICES, NOODLES, AND RICE (U.S. CL. 46).

HOWARD SMIGA, EXAMINING ATTORNEY

SN 78-207,993. MIKI PULLEY KABUSHIKI KAISHA, TA MIKI PULLEY CO., LTD., KANAGAWA, JAPAN, FILED 1-28-2003.

**miki pulley**

NO CLAIM IS MADE TO THE EXCLUSIVE RIGHT TO USE "PULLEY", APART FROM THE MARK AS SHOWN.

**CLASS 7—MACHINERY**

FOR MACHINE AND MACHINE TOOL PARTS, NAMELY, ELECTROMAGNETIC CLUTCHES AND BRAKES, NON-EXCITED BRAKES, ELECTROMAGNETIC TOOTHED CLUTCHES, BRAKE MOTORS, ELECTROMAGNETIC CLUTCH AND BRAKE MOTOR SPINDLES WITH HIGH FREQUENCY ELECTRIC CONVERTERS AND POWER SUPPLY UNITS, RUBBER AND PLASTIC COUPLINGS, FRICTION JOINTS, SUSPENSION TENSIONERS, HOLLOW SHAFTS AND SOLID SHAFT SPEED CHANGERS AND REDUCERS, BELT SPEED CHANGE DRIVES AND DRIVE UNITS, VARIABLE SPEED TRANSMISSIONS FOR USE WITH MACHINE AND CONTROLS THEREWITH SOLD AS A UNIT, SERVO MOTORS FOR MACHINES, DC MOTORS; LINEAR ACTUATORS, METAL COUPLINGS FOR MACHINES (U.S. CLS. 13, 19, 21, 23, 31, 34 AND 35).

**CLASS 9—ELECTRICAL AND SCIENTIFIC APPARATUS**

FOR INVERTERS; OVERLOAD PROTECTION EQUIPMENT, NAMELY, ELECTRICAL CURRENT SURGE PROTECTORS; VOLTAGE SURGE PROTECTORS; ELECTRONIC THERMAL CONTROLLERS; ROTATION SPEED INDICATORS (U.S. CLS. 21, 23, 26, 36 AND 38).

BRETT J. GOLDEN, EXAMINING ATTORNEY

SN 78-208,209. NINACLIP, PLC, LEEDS, WEST YORKSHIRE, UNITED KINGDOM, FILED 1-29-2003.

**NINASUN**

OWNER OF ERPN CMNTY TM OFC REG. NO. 003026838, DATED 5-11-2004, EXPIRES 1-28-2013.

**CLASS 20—FURNITURE AND ARTICLES NOT OTHERWISE CLASSIFIED**

FOR FURNITURE AND COMPONENT PARTS THEREFORE SOLD AS A UNIT; CHAIRS; LOUNGE CHAIRS; SUN LOUNGE CHAIRS; TABLES; TABLES FOR RELEASABLY FASTENING TO FURNITURE; DECK CHAIRS, EASY CHAIRS; FURNITURE SCREENS; FITTED FABRIC FURNITURE COVERS, NAMELY, FABRIC IN THE FORM OF SUN CANOPY COVERS (U.S. CLS. 2, 13, 22, 25, 32 AND 50).

**CLASS 22—CORDAGE AND FIBERS**

FOR AWNINGS NOT OF METAL; AWNINGS NOT OF METAL, FOR ATTACHMENT TO FURNITURE; FABRIC SUN CANOPIES FOR FURNITURE; FABRIC SUN CANOPIES FOR ATTACHMENT TO FURNITURE FEATURING A RELEASABLE FASTENER; FABRIC SUN CANOPIES; SUN CANOPIES FEATURING DETACHABLE FABRIC COVERS (U.S. CLS. 1, 2, 7, 19, 22, 42 AND 50).

JOHN KELLY, EXAMINING ATTORNEY

SN 78-213,988. PURITY LIFE HEALTH PRODUCTS LIMITED, ACTON, ONTARIO, CANADA, FILED 2-12-2003.

**VIVITAS**

PRIORITY CLAIMED UNDER SEC. 44(D) ON CANADA APPLICATION NO. 1161823, FILED 12-10-2002, REG. NO. TMA619676, DATED 9-15-2004, EXPIRES 9-15-2019.

**CLASS 3—COSMETICS AND CLEANING PREPARATIONS**

FOR BEAUTY PRODUCTS, NAMELY, HAIR CARE PREPARATIONS AND NON-MEDICATED SKIN CARE PREPARATIONS (U.S. CLS. 1, 4, 6, 50, 51 AND 52).

**CLASS 5—PHARMACEUTICALS**

FOR NATURAL HEALTH PRODUCTS, NAMELY, VITAMINS, MINERALS, AND NUTRITIONAL SUPPLEMENTS (U.S. CLS. 6, 18, 44, 46, 51 AND 52).

CURTIS FRENCH, EXAMINING ATTORNEY

SN 78-218,523. PRINCE LIONHEART, INC., SANTA MARIA, CA. FILED 2-25-2003.

## EVER-FRESH SYSTEM

NO CLAIM IS MADE TO THE EXCLUSIVE RIGHT TO USE SYSTEMS, APART FROM THE MARK AS SHOWN.

### CLASS 3—COSMETICS AND CLEANING PREPARATIONS

FOR NON-MEDICATED PREMOISTENED DISPOSABLE INFANT CARE WIPES, TISSUES AND TOWELETTES (U.S. CLS. 1, 4, 6, 50, 51 AND 52).

FIRST USE 10-3-2003; IN COMMERCE 10-3-2003.

### CLASS 11—ENVIRONMENTAL CONTROL APPARATUS

FOR HEATED DISPENSING UNIT FOR PREMOISTENED WIPES, TISSUES AND TOWELETTES (U.S. CLS. 13, 21, 23, 31 AND 34).

FIRST USE 4-11-2003; IN COMMERCE 7-10-2003.  
TONI HICKEY, EXAMINING ATTORNEY

---

SN 78-218,557. FOXMIND GAMES BV, AMSTERDAM, NETHERLANDS, FILED 2-25-2003.

## SQUAD 7

THE MARK CONSISTS OF SQUAD 7.

### CLASS 9—ELECTRICAL AND SCIENTIFIC APPARATUS

FOR ELECTRONIC GAME PROGRAMS; VIDEO GAME DISCS; VIDEO GAME MACHINES FOR USE WITH TELEVISIONS (U.S. CLS. 21, 23, 26, 36 AND 38).

### CLASS 28—TOYS AND SPORTING GOODS

FOR CARD GAMES, NAMELY, BOARD GAMES; TOY MODEL VEHICLES; DOLLS; MODELED PLASTIC TOY FIGURINES; PLAYING CARDS (U.S. CLS. 22, 23, 38 AND 50).

WON TEAK OH, EXAMINING ATTORNEY

---

SN 78-219,930. MEGATRAX PRODUCTION MUSIC, INC., NORTH HOLLYWOOD, CA. FILED 2-27-2003.

## MEGASONICS

### CLASS 9—ELECTRICAL AND SCIENTIFIC APPARATUS

FOR SOUND RECORDINGS FEATURING MUSICAL AND NON-MUSICAL SOUND EFFECTS FOR OTHERS (U.S. CLS. 21, 23, 26, 36 AND 38).

### CLASS 41—EDUCATION AND ENTERTAINMENT

FOR SOUND DESIGN, NAMELY CREATION OF MUSICAL AND NON-MUSICAL SOUND EFFECTS FOR OTHERS (U.S. CLS. 100, 101 AND 107).  
JOHN KELLY, EXAMINING ATTORNEY

SN 78-222,467. NIKE, INC., BEAVERTON, OR. FILED 3-6-2003.



### CLASS 19—NON-METALLIC BUILDING MATERIALS

FOR FLOORING UNDERLAYMENTS FOR INDOOR AND OUTDOOR SPORTS AND RECREATIONAL SURFACES WITH CUSHIONING AND PADDING (U.S. CLS. 1, 12, 33 AND 50).

FIRST USE 9-30-2002; IN COMMERCE 9-30-2002.

### CLASS 27—FLOOR COVERINGS

FOR ARTIFICIAL SURFACES AND UNDERLAYMENTS, NAMELY, ARTIFICIAL GRASS, TURF, AND MATS MADE OF FOAM, RUBBER, NYLON, LEATHER, COTTON, PLASTIC, OR POLYETHYLENE FOR INDOOR AND OUTDOOR SPORTS AND RECREATIONAL SURFACES (U.S. CLS. 19, 20, 37, 42 AND 50).

FIRST USE 9-30-2002; IN COMMERCE 9-30-2002.  
ANN LINNEHAN, EXAMINING ATTORNEY

---

SN 78-227,775. APPLE CARE FOUNDATION, NEW YORK, NY. FILED 3-19-2003.

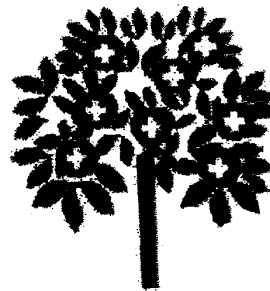

### CLASS 16—PAPER GOODS AND PRINTED MATTER

FOR BOOKS, MAGAZINES, MANUALS, JOURNALS AND MAGAZINE AND JOURNAL ARTICLES FEATURING HEALTHCARE, EMERGENCY MANAGEMENT, OR PUBLIC HEALTH AND SAFETY (U.S. CLS. 2, 5, 22, 23, 29, 37, 38 AND 50).

### CLASS 36—INSURANCE AND FINANCIAL

FOR CHARITABLE FUND RAISING; PROVIDING GRANTS AND FINANCIAL DONATIONS TO ENTITIES IN THE FIELD OF HEALTHCARE AND PUBLIC HEALTH AND PUBLIC AWARENESS PROGRAMS (U.S. CLS. 100, 101 AND 102).

**CLASS 41—EDUCATION AND ENTERTAINMENT**

FOR ARRANGING AND CONDUCTING EDUCATIONAL CONFERENCES; CHARITABLE SERVICES, NAMELY, PROVIDING TRAINING PROGRAMS IN THE FIELD OF HEALTHCARE AND PUBLIC HEALTH; EDUCATIONAL SERVICES, NAMELY, CONDUCTING CLASSES, SEMINARS, CONFERENCES AND WORKSHOPS IN THE FIELD OF HEALTHCARE OR PUBLIC HEALTH; PRODUCTION OF VIDEO DISCS FOR OTHERS; PRODUCTION OF VIDEO CASSETTES; DEVELOPING, MAINTAINING AND PROVIDING ON-LINE BOOKS, MAGAZINES, MANUALS, JOURNALS, DATABASES AND ARTICLES IN THE FIELD OF HEALTHCARE AND PUBLIC HEALTH; EDUCATIONAL SERVICES, NAMELY, PROVIDING ONLINE REFERENCE MATERIALS AND EDUCATIONAL INFORMATION IN THE FIELDS OF HEALTHCARE AND PUBLIC HEALTH (U.S. CLS. 100, 101 AND 107).

ROBIN CHOSID, EXAMINING ATTORNEY

SN 78-234,019. PROJECT RENEWAL, INC., NEW YORK, NY. FILED 4-4-2003.

**PROJECT RENEWAL****CLASS 36—INSURANCE AND FINANCIAL**

FOR HOUSING AGENCY SERVICES, NAMELY ARRANGING AND PROVIDING PERMANENT HOUSING ACCOMMODATIONS TO HOMELESS AND DISABLED PERSONS (U.S. CLS. 100, 101 AND 102).

FIRST USE 0-0-1991; IN COMMERCE 0-0-1991.

**CLASS 41—EDUCATION AND ENTERTAINMENT**

FOR PROVIDING TRAINING TO THE HOMELESS, PERSONS LIVING IN SHELTERS AND OTHERS IN THE FIELDS OF LIFE SKILLS, LITERACY AND MATH SKILLS, JOB-SKILLS TRAINING, TRAINING THE HOMELESS, PERSONS LIVING IN SHELTERS AND OTHERS IN NEED TO LEARN BASIC COOKING THEORY AND FOOD PREPARATION; SPONSORING AND DEVELOPING EDUCATIONAL INTERNSHIPS FOR THE HOMELESS, PERSONS LIVING IN SHELTERS AND OTHERS IN NEED AT RESTAURANTS AND CORPORATE DINING SERVICES; PROVIDING A VOLUNTARY EDUCATIONAL FARM PROGRAM FOR THE HOMELESS, PERSONS LIVING IN SHELTERS AND OTHERS IN NEED TO LEARN GOOD WORK HABITS AND NEW SKILLS IN THE NATURE OF PRODUCING ORGANICALLY GROWN PRODUCE FOR SALE TO A VARIETY OF MARKETS AND TO HELP FEED OTHER HOMELESS PERSONS; PROVIDING ARTS PROGRAMS THAT OFFER AN OPPORTUNITY TO PARTICIPATE AS STUDENT-ARTISTS IN AN INTENSIVE STUDIO COURSE, NAMELY INSTRUCTION AND PRACTICE IN PAINTING, DRAWING, SCULPTURE, PHOTOGRAPHY AND VIDEO (U.S. CLS. 100, 101 AND 107).

FIRST USE 0-0-1991; IN COMMERCE 0-0-1991.

**CLASS 43—HOTEL AND RESTAURANT SERVICES**

FOR ARRANGING AND PROVIDING TEMPORARY HOUSING ACCOMMODATIONS TO HOMELESS AND DISABLED PERSONS; CHARITABLE SERVICES, NAMELY PROVIDING FOOD AND TEMPORARY HOUSING TO NEEDY MENTALLY ILL AND SUBSTANCE ABUSING HOMELESS PERSONS (U.S. CLS. 100 AND 101).

FIRST USE 0-0-1991; IN COMMERCE 0-0-1991.

**CLASS 44—MEDICAL, BEAUTY AND AGRICULTURAL SERVICES**

FOR PROVIDING MEDICAL AND MENTAL HEALTH CARE TO MENTALLY ILL HOMELESS PERSONS; PROVIDING MOBILE PSYCHIATRIC TEAMS THAT FUNCTION AS TRAVELING PSYCHIATRIC CENTERS, SERVING THE HOMELESS, PERSONS LIVING IN SHELTERS AND OTHERS IN NEED; PROVIDING MEDICAL SERVICES THAT FUNCTION AS TRAVELING MEDICAL CENTERS, SERVING THE HOMELESS, PERSONS LIVING IN SHELTERS AND OTHERS IN NEED; PROVIDING MEDICALLY-SUPPORTED DETOXIFICATION TO HOMELESS ALCOHOLICS AND DRUG ADDICTS (U.S. CLS. 100 AND 101).

FIRST USE 0-0-1991; IN COMMERCE 0-0-1991.

JENNIFER CHICOSKI, EXAMINING ATTORNEY

SN 78-235,005. V.E.W., LTD., NEW YORK, NY. FILED 4-8-2003.

**VERA WANG COLLECTION**

OWNER OF U.S. REG. NOS. 1,797,058, 2,635,884 AND OTHERS.

NO CLAIM IS MADE TO THE EXCLUSIVE RIGHT TO USE "COLLECTION", APART FROM THE MARK AS SHOWN.

THE NAME "VERA WANG" IDENTIFIES A LIVING INDIVIDUAL WHOSE CONSENT IS OF RECORD.

**CLASS 21—HOUSEWARES AND GLASS**

FOR WASTEPAPER BASKETS, SOAP DISHES, TUMBLERS, TOILET TISSUE HOLDERS, TRAYS FOR USE IN FINGERNAIL POLISHING, TOOTHBRUSH HOLDERS, AND DISPENSERS FOR LIQUID HAND LOTION (U.S. CLS. 2, 13, 23, 29, 30, 33, 40 AND 50).

**CLASS 24—FABRICS**

FOR TOWELS, BED SHEETS, PILLOW CASES, PILLOW SHAMS, BED SKIRTS, COMFORTERS, BED BLANKETS, COMFORTER AND BLANKET COVERS, FABRIC CURTAINS, SHOWER CURTAINS, TABLECLOTHS NOT OF PAPER, CLOTH COASTERS, TEXTILE NAPKINS, TEXTILE PLACEMATS, FABRIC TABLE RUNNERS, POT HOLDERS, OVEN MITTS, UNFITTED FABRIC FURNITURE COVERS, BLANKET THROWS, DUST RUFFLES AND DUVET COVERS (U.S. CLS. 42 AND 50).

NELSON SNYDER, EXAMINING ATTORNEY

SN 78-235,908. CEMEX, S.A. DE C.V., MONTERREY, NUEVO LEON, MEXICO, FILED 4-9-2003.

**PRACTICAL VISIONARIES**

PRIORITY CLAIMED UNDER SEC. 44(D) ON MEXICO APPLICATION NO. 0585228, FILED 1-27-2003, REG. NO. 832470, DATED 5-25-2004, EXPIRES 1-27-2013.

PRIORITY CLAIMED UNDER SEC. 44(D) ON MEXICO APPLICATION NO. 0585227, FILED 1-27-2003, REG. NO. 782073, DATED 1-28-2003, EXPIRES 1-27-2013.

PRIORITY CLAIMED UNDER SEC. 44(D) ON MEXICO APPLICATION NO. 0585226, FILED 1-27-2003, REG. NO. 782072, DATED 1-28-2003, EXPIRES 1-27-2013.

PRIORITY CLAIMED UNDER SEC. 44(D) ON MEXICO APPLICATION NO. 0585225, FILED 1-27-2003, REG. NO. 782071, DATED 1-28-2003, EXPIRES 1-27-2013.

PRIORITY CLAIMED UNDER SEC. 44(D) ON MEXICO APPLICATION NO. 0585224, FILED 1-27-2003, REG. NO. 782070, DATED 1-28-2003, EXPIRES 1-27-2013.

PRIORITY CLAIMED UNDER SEC. 44(D) ON MEXICO APPLICATION NO. 0585223, FILED 1-27-2003, REG. NO. 781347, DATED 1-27-2003, EXPIRES 1-27-2013.

**CLASS 35—ADVERTISING AND BUSINESS**

FOR BUSINESS CONSULTATION AND PLANNING REGARDING COMPUTER SERVICES AND THE RECORDING, TRANSCRIPTION, BROADCAST OR SYSTEMATIZATION OF WRITTEN OR TAPED COMMUNICATIONS; OUTSOURCING IN THE FIELD OF INFORMATION TECHNOLOGY; BUSINESS MANAGEMENT SERVICES, NAMELY, THE DEVELOPMENT OR COMPILATION OF MATHEMATICAL DATA OR STATISTICS RELATED TO BUSINESS OPERATIONS; CONSULTING AND IMPLEMENTATION ASSISTANCE IN THE DISSEMINATION OF ADVERTISING MATTER; INDUSTRIAL AND COMMERCIAL MANAGEMENT ASSISTANCE; BUSINESS MANAGEMENT; CONSULTING IN THE FIELDS OF ACCOUNTING SERVICES AND PERSONNEL MANAGEMENT; BUSINESS INVESTIGATIONS; BUSINESS RESEARCH AND SURVEYS; PROVIDING BUSINESS MARKETING SERVICES FOR OTHERS IN THE FIELDS OF COMPUTING AND ELECTRONICS EQUIPMENT AND TECHNOLOGY; PROMOTING THE GOODS AND SERVICES OF OTHERS BY MEANS OF A BUSINESS TO BUSINESS E-COMMERCE PLATFORM VIA THE INTERNET ENABLING BUYERS OF GOODS OR SERVICES TO LOCATE AND RECEIVE QUOTATIONS FROM MULTIPLE COMPETITIVE SOURCES AND ENABLING SELLERS OF GOODS OR SERVICES TO IDENTIFY AND BID ON MULTIPLE NEW SALES OPPORTUNITIES AND IN WHICH SELLERS POST PRODUCTS TO BE SOLD OR AUCTIONED AND BUYERS PURCHASE, BID, OR POST REQUESTS FOR PRODUCTS; AND PROFESSIONAL CONSULTATION CONCERNING DATA PROCESSING (U.S. CLS. 100, 101 AND 102).

**CLASS 36—INSURANCE AND FINANCIAL**

FOR FINANCIAL CONSULTATION TO THE FINANCIAL INDUSTRY, NAMELY CONSULTATION REGARDING FINANCIAL TRANSACTIONS, OPERATIONS, AND DEALINGS IN THE NATURE OF INSURANCE, CREDIT, E-PAYMENT, FOREIGN EXCHANGE, INVOICING, PAYMENT PROCESSING, CASH MANAGEMENT INCLUDING PROTOCOLS FOR CAPTURING EARLY PAYMENT DISCOUNTS; AND ADMINISTRATION OF EMPLOYEE BENEFIT PLANS FOR INDUSTRIAL AND COMMERCIAL COMPANIES (U.S. CLS. 100, 101 AND 102).

**CLASS 37—CONSTRUCTION AND REPAIR**

FOR INSTALLATION, MAINTENANCE AND REPAIR OF COMPUTER NETWORKS; SETTING UP, MAINTAINING, AND REPAIRING TELECOMMUNICATIONS CONNECTIONS TO ACCESS PROVIDERS FOR ENABLING COMPUTER- ASSISTED TRANSMISSION OF MESSAGES AND IMAGES BY MEANS OF LOCAL AND LONG DISTANCE TRANSMISSION OF VOICE, DATA, AND GRAPHICS, VIA TELEPHONE, CABLE, AND SATELLITE TRANSMISSIONS (U.S. CLS. 100, 103 AND 106).

**CLASS 38—COMMUNICATION**

FOR PROVIDING INFORMATION IN THE FIELD OF TELECOMMUNICATIONS; AND PROFESSIONAL CONSULTING CONCERNING TELECOMMUNICATIONS SERVICES (U.S. CLS. 100, 101 AND 104).

**CLASS 41—EDUCATION AND ENTERTAINMENT**

FOR EDUCATIONAL SERVICES, NAMELY, CONDUCTING CLASSES, SEMINARS, CONFERENCES, WORKSHOPS, PROGRAMS IN THE FIELDS OF E-COMMERCE, TELECOMMUNICATIONS, COMPUTING, DATA PROCESSING, BUSINESS STRUCTURING AND MANAGEMENT; ARRANGING AND CONDUCTING EDUCATIONAL CONFERENCES, CONVENTIONS, SEMINARS, SYMPOSIA, LECTURES, AND EXAMINATION PREPARATORY COURSES IN THE FIELDS OF E-COMMERCE, TELECOMMUNICATIONS, COMPUTING, DATA PROCESSING, BUSINESS STRUCTURING AND MANAGEMENT; TEACHING IN THE FIELDS OF E-COMMERCE, TELECOMMUNICATIONS, COMPUTING, DATA PROCESSING, BUSINESS STRUCTURING AND MANAGEMENT; EDUCATION IN THE FIELDS OF E-COMMERCE, TELECOMMUNICATIONS, COMPUTING, DATA PROCESSING, BUSINESS STRUCTURING AND MANAGEMENT RENDERED THROUGH CORRESPONDENCE COURSES; AND EDUCATIONAL TESTING (U.S. CLS. 100, 101 AND 107).

**CLASS 42—SCIENTIFIC, COMPUTER AND LEGAL SERVICES**

FOR COMPUTER CONSULTATION AND PROFESSIONAL CONSULTING RELATED TO COMPUTING; INDUSTRIAL PROPERTY CONSULTATION SERVICES REGARDING THE DEVELOPMENT OF PATENTS; PRODUCT RESEARCH AND DEVELOPMENT IN THE FIELDS OF COMPUTERS, TELECOMMUNICATIONS AND DATA PROCESSING; GRANTING OF INTELLECTUAL PROPERTY LICENSES; COMPUTER PROGRAMMING FOR OTHERS; APPLICATION MANAGEMENT SUPPORT, NAMELY, DEVELOPING, UPDATING, MAINTENANCE, REPAIR, AND LEASING OF COMPUTER SOFTWARE; COMPUTER NETWORK DESIGN FOR OTHERS; CONSULTING SERVICES IN THE FIELD OF DESIGN, SELECTION, IMPLEMENTATION AND USE OF COMPUTER HARDWARE AND SOFTWARE SYSTEMS FOR OTHERS; TECHNICAL SUPPORT SERVICES, NAMELY, TROUBLESHOOTING OF COMPUTER HARDWARE AND SOFTWARE PROBLEMS (U.S. CLS. 100 AND 101).

VERNA BETH RIRIE, EXAMINING ATTORNEY

---

SN 78-237,838. W WING YIP AND BROTHERS (HOLDINGS) LIMITED, BIRMINGHAM, UNITED KINGDOM, FILED 4-15-2003.

**WING YIP**

OWNER OF ERPN CMNTY TM OFC REG. NO. 001874775, DATED 10-9-2001, EXPIRES 9-27-2010.

OWNER OF ERPN CMNTY TM OFC REG. NO. 002610202, DATED 6-20-2003, EXPIRES 2-22-2012.

THE NAME "WING YIP" DOES NOT IDENTIFY A LIVING INDIVIDUAL.

**CLASS 16—PAPER GOODS AND PRINTED MATTER**

FOR (CTM REGISTRATION NO: 001874775) CARDBOARD PACKAGING, NAMELY CARDBOARD BOXES, CARDBOARD CARTONS (U.S. CLS. 2, 5, 22, 23, 29, 37, 38 AND 50).

**CLASS 21—HOUSEWARES AND GLASS**

FOR (CTM REGISTRATION NO: 001874775) DOMESTIC UTENSILS, NAMELY NON ELECTRIC WOKS, GRATERS, SPATULAS, STRAINERS AND CONTAINERS FOR HOUSEHOLD OR KITCHEN USE; INSTRUMENTS AND MATERIALS ALL FOR USE IN CLEANING, SWEEPING, DUSTING, WIPING, POLISHING, NAMELY BROOMS, POLISHING CLOTHS, MOPS, FEATHER DUSTERS, FURNITURE DUSTERS AND WINDOW DUSTERS; BEVERAGE GLASSWARE; PORCELAIN AND EARTHENWARE, NAMELY PLATES, CUPS, BOWLS, CASSEROLE DISHES, TEAPOTS NOT OF PRECIOUS METAL, BASTING SPOONS, MIXING SPOONS, SERVING SPOONS, SLOTTED SPOONS AND SERVING PLATTERS; CONTAINERS FOR FOODS, NAMELY CONTAINERS FOR STORING AND COOKING FOODS AND PLASTIC AND FOIL CONTAINERS WITH LIDS FOR STORING AND COOKING FOODS (U.S. CLS. 2, 13, 23, 29, 30, 33, 40 AND 50).

**CLASS 29—MEATS AND PROCESSED FOODS**

FOR (CTM REGISTRATION NO: 001874775) MEAT, FISH, POULTRY AND GAME; MEAT EXTRACTS; PRESERVED, DRIED AND COOKED FRUITS AND VEGETABLES; JELLIES, JAMS; EGGS, MILK AND MILK PRODUCTS; EDIBLE OILS AND FATS; FRUIT PRESERVES; FROZEN FOODS, NAMELY FROZEN MEAT, FROZEN VEGETABLES, FROZEN FISH, FROZEN POULTRY AND FROZEN SEAFOOD; FROZEN MEALS CONSISTING PRIMARILY OF MEAT, FISH, POULTRY AND VEGETABLES; CUTTLEFISH (U.S. CL. 46).

**CLASS 30—STAPLE FOODS**

FOR (CTM REGISTRATION NO: 001874775) COFFEE, TEA, COCOA, SUGAR, RICE, TAPIOCA, SAGO, ARTIFICIAL COFFEE, NAMELY GRAIN OR CHICORY BASED COFFEE SUBSTITUTES; FLOUR; BREAD, PASTRIES AND CONFECTIONERY, NAMELY BISCUITS; FLAVOURED ICES; HONEY, TREACLE, YEAST, BAKING POWDER; SALT, MUSTARD; VINEGAR, SAUCES NAMELY BLACK BEAN SAUCE, YELLOW BEAN SAUCE, CANTONESE STIR FRY SAUCE, CHOW MIEN NOODLE SAUCE, SOY SAUCE, LIGHT SOY SAUCE, DARK SOY SAUCE, GARLIC CHILI SAUCE, GINGER AND SPRING ONION SAUCE, GINGER CHILI SAUCE, HOY SIN SAUCE, CHILI SAUCE, HOT CHILI SAUCE, HOT AND SPICY SZECHUAN SAUCE, HONG PO SAUCE, OYSTER AND MUSHROOM VEGETABLE SAUCE, OYSTER FLAVOUR SAUCE, SPICY SZECHUAN SAUCE, SUPERIOR DARK SOY SAUCE, SUPERIOR LIGHT SOY SAUCE, SWEET AND SOUR SAUCE, SWEET CHILI SAUCE, THAI CHILI SAUCE, CHINESE CURRY SAUCE CONCENTRATE, MALAYSIAN CURRY SAUCE CONCENTRATE, THAI CURRY SAUCE CONCENTRATE, CURRY SAUCE CONCENTRATE, TERIYAKI SAUCE, TOMATO SAUCE, BARBECUE SAUCE, SPARE RIB SAUCE, SATAY SAUCE, PEKING DUCK SAUCE, HOT SAUCE AND PLUM SAUCE; MIXES FOR ALL THE AFORESAID SAUCES; SPICES; SALAD DRESSINGS; NOODLES AND EDIBLE CRACKERS; FROZEN GOODS, NAMELY FROZEN MEALS CONSISTING PRIMARILY OF PASTA, NOODLES OR RICE; DRIED CHILI PEPPERS (U.S. CL. 46).

**CLASS 31—NATURAL AGRICULTURAL PRODUCTS**

FOR (CTM REGISTRATION NO: 001874775) AGRICULTURAL, HORTICULTURAL AND FORESTRY PRODUCTS, NAMELY AGRICULTURAL GRAINS FOR EATING; FRESH FRUITS AND VEGETABLES; FRESH, RAW AND UNPROCESSED NUTS; FRESH, RAW AND UNPROCESSED BEANS; FRESH, RAW AND UNPROCESSED HERBS AND FLOWER SEEDS; FRESH CHILI PEPPERS (U.S. CLS. 1 AND 46).

**CLASS 32—LIGHT BEVERAGES**

FOR (CTM REGISTRATION NO: 001874775) BEERS, MINERAL AND AERATED WATERS AND OTHER NON-ALCOHOLIC DRINKS, NAMELY NON-ALCOHOLIC BEER; FRUIT DRINKS AND FRUIT JUICES; SYRUPS FOR MAKING FRUIT DRINK BEVERAGES (U.S. CLS. 45, 46 AND 48).

**CLASS 33—WINES AND SPIRITS**

FOR (CTM REGISTRATION NO: 001874775) ALCOHOLIC BEVERAGES, NAMELY WINE (U.S. CLS. 47 AND 49).

**CLASS 35—ADVERTISING AND BUSINESS**

FOR (CTM REGISTRATION NO: 002610202) WHOLESALE STORES FEATURING GROCERIES AND CATERING PRODUCTS; RETAIL STORES FEATURING GROCERIES AND CATERING PRODUCTS; SUPERMARKETS; MAIL ORDER CATALOGUES FEATURING GROCERIES AND CATERING PRODUCTS; COMPUTERIZED ONLINE RETAIL SERVICES IN THE FIELD OF GROCERIES AND CATERING PRODUCTS; ADVERTISING AGENCY SERVICES; BUSINESS MARKETING CONSULTANCY SERVICES; PROMOTING THE GOODS OF OTHERS THROUGH ONLINE ORDERING AND CATALOGUING OF THOSE GOODS AND SERVICES; WHOLESALE DISTRIBUTORSHIPS FEATURING GROCERIES AND CATERING PRODUCTS; BUSINESS MANAGEMENT; PRODUCT MERCHANDISING; EXPORT AGENCY; COMMERCIAL INFORMATION AND DIRECTORY AGENCY; BUSINESS SERVICES, NAMELY FACILITIES MANAGEMENT OF TECHNICAL OPERATIONS; INDUSTRIAL ASSET MANAGEMENT SERVICES, NAMELY AUCTIONEERING, LIQUIDATING AND REMARKETING INDUSTRIAL ASSETS FOR OTHERS (U.S. CLS. 100, 101 AND 102).

**CLASS 36—INSURANCE AND FINANCIAL**

FOR (CTM REGISTRATION NO: 002610202) REAL ESTATE INVESTMENT AND REAL ESTATE MANAGEMENT SERVICES; REAL ESTATE PROCUREMENT FOR OTHERS; LAND ACQUISITION SERVICES, NAMELY REAL ESTATE BROKERAGE; LEASING OF REAL ESTATE; RENTAL OF REAL ESTATE, NAMELY RETAIL AND OFFICE SPACE; LEASING OF REAL ESTATE, NAMELY LEASING OF COMMERCIAL, INDUSTRIAL, RETAIL AND RESIDENTIAL PROPERTIES; ASSET VALUATION SERVICES, NAMELY FINANCIAL VALUATION OF PERSONAL PROPERTY AND REAL ESTATE; FINANCING SERVICES, NAMELY FINANCING OF PROPERTY DEVELOPMENT PROJECTS AND FINANCIAL CONSULTANCY SERVICES; COMMODITY TRADING FOR OTHERS; RENTAL OF OFFICE AND RETAIL SPACE; INVESTMENT ADVICE (U.S. CLS. 100, 101 AND 102).

**CLASS 37—CONSTRUCTION AND REPAIR**

FOR (CTM REGISTRATION NO: 002610202) REAL ESTATE DEVELOPMENT; LAND DEVELOPMENT SERVICES, NAMELY PLANNING AND LAYING OUT OF RESIDENTIAL AND/OR COMMERCIAL COMMUNITIES; CONSTRUCTION MANAGEMENT, NAMELY MANAGEMENT OF PROPERTY DEVELOPMENT AND REFURBISHMENT PROJECTS; MAINTENANCE OF BUILDINGS; BUILDING CONSTRUCTION AND REPAIR SERVICES; PERSONAL PROPERTY CONSERVATION SERVICES, NAMELY CONSERVATION AND PRESERVATION FOR WORKS OF ART; CONSTRUCTION PLANNING AND SUPERVISION (U.S. CLS. 100, 103 AND 106).

**CLASS 39—TRANSPORTATION AND STORAGE**

FOR (CTM REGISTRATION NO: 002610202) TRANSPORTATION OF PASSENGERS AND/OR GOODS BY AIR, BOAT, RAIL AND TRUCK; TRANSPORTATION AND DELIVERY SERVICES, NAMELY SAME-DAY SHIPMENT SERVICES; TRANSPORTATION LOGISTICS CONSULTATION SERVICES, NAMELY CONSULTATION CONCERNING ARRANGING THE TRANSPORTATION OF GOODS FOR OTHERS (U.S. CLS. 100 AND 105).

**CLASS 43—HOTEL AND RESTAURANT SERVICES**

FOR (CTM REGISTRATION NO: 001874775) RESTAURANTS, SELF SERVICE RESTAURANTS AND SNACK BAR SERVICES; CAFÉ AND CATERING SERVICES; CANTEEN AND CATERING SERVICES; FOOD PREPARATION, NAMELY PREPARATION OF FOOD AND DRINKS FOR CONSUMPTION OFF THE PREMISES (U.S. CLS. 100 AND 101).

SONYA STEPHENS, EXAMINING ATTORNEY

SN 78-244,281. RIKEN VITAMIN CO., LTD., TOKYO, JAPAN, FILED 5-1-2003.

**CLASS 1—CHEMICALS**

FOR AMYL ALCOHOL; PENTANOL; ARABITOL; ALYL ALCOHOL; ETHYL ALCOHOL; OLEYL ALCOHOL; GLYCOL; GLYCERINE; CINNAMYL ALCOHOL; CETYL ALCOHOL; FUSEL OIL; BUTANOL; BENZYL ALCOHOL; METHYL ALCOHOL; MERCAPTAN; LAURYL ALCOHOL; ETHYL PHTHALATE; AMYL ACETATE; ACETIC ACID ESTER; OCTYL ACETATE; VINYL ACETATE; BUTYL ACETATE; METHYL ACETATE; DIETHYL PHTHALATE; DIMETHYL PHTHALATE; DIMETHYL SULPHATE; ETHYL MALONATE; FOAMING AGENTS FOR USE IN THE MANUFACTURE OF FOODS; FINISHING ASSISTANTS; MOISTENING OR WETTING AGENTS FOR USE IN THE MANUFACTURE OF FOODS; DEFOAMING AGENTS FOR USE IN THE MANUFACTURE OF FOODS; WEAVING ASSISTANTS; DYEING ASSISTANTS; ANTI-STATIC PREPARATIONS NOT FOR HOUSEHOLD USE; ANTI-STATIC PREPARATIONS FOR PLASTICS; LUBRICANT AGENTS FOR PLASTICS; ANTI-FOGGING AGENTS FOR PLASTIC; DEGREASING AGENTS NOT FOR HOUSEHOLD USE; DECOLORING AGENTS DECOLORANTS; EMULSIFIERS FOR USE IN THE MANUFACTURE OF FOODS; WATER REPELLENTS; DISPERSING AGENTS; DISPERSANTS; SPINNING ASSISTANTS; MOULD-RELEASE PREPARATIONS; ION-EXCHANGE RESINS; ION-EXCHANGE RESIN MEMBRANES; PLASTICIZERS; CARBURIZING AGENTS; VULCANIZATION ACCELERATORS; REDUCING AGENTS; METAL WELDING FLUX; AIR ENTRAINING AGENTS; RUBBER PROCESSING PREPARATIONS; OXIDIZING AGENTS; FIRE EXTINGUISHING COMPOSITIONS; CATALYTIC AGENTS; FOOD PRESERVATIVES; ANTI-INCRUSTANTS; CEMENT SET ACCELERATORS; CEMENT BLENDING AGENTS; FIREPROOFING PREPARATIONS; DELUSTERING AGENTS; BATTERY ANTI-SULPHURIZING AGENTS; SOIL STABILIZING AGENTS; FUEL SAVING AGENTS; EXOTHERMIC AGENTS; SOLDERING FLUXES; CLOTHES PLEATING AGENTS; BLEACHING PREPARATIONS NOT FOR LAUNDRY USE; ANTI-FREEZING PREPARATIONS; MILDEW PROOFING AGENTS; DAMP PROOFING AGENTS; ANTI-SHRINK AGENTS; ANTI-CREASING AGENTS; WATERPROOFING CHEMICAL COMPOSITIONS; METAL TEMPERING PREPARATIONS; TEMPERING CHEMICALS; SOLVENTS; REFRIGERANTS; ANTI-AGING AGENTS; OLEIC ACID; STEARIC ACID; PALMITIC ACID; ARTIFICIAL SWEETENERS (U.S. CLS. 1, 5, 6, 10, 26 AND 46).

SN 78-243,216. THE BOC GROUP, INC., NEW PROVIDENCE, NJ. FILED 4-29-2003.

**BOC EDWARDS****CLASS 7—MACHINERY**

FOR CHEMICAL BLENDING APPARATUS AND DELIVERY SYSTEM AND POINT OF USE CHEMICAL BLENDING APPARATUS AND DELIVERY SYSTEM, NAMELY, MACHINES USED TO BLEND CHEMICAL MIXTURES AND DELIVER THEM TO TOOLS USED TO MANUFACTURE SEMICONDUCTORS; APPARATUS AND SYSTEM FOR BLENDING AND DISTRIBUTION OF CHEMICAL MECHANICAL POLISHING SLURRIES, NAMELY, MACHINES TO BLEND CHEMICAL MIXTURES USED FOR POLISHING SEMICONDUCTOR WAFERS AND INTEGRATED CIRCUITS; ON LINE PARTICLE SIZE ANALYTICAL DEVICE FOR USE IN CHEMICAL MECHANICAL POLISHING SYSTEM, NAMELY, MACHINES FOR MONITORING AND MEASURING CHEMICAL MECHANICAL POLISHING SLURRY CONDITIONS FOR SEMICONDUCTOR MANUFACTURING PROCESSES (U.S. CLS. 13, 19, 21, 23, 31, 34 AND 35).

**CLASS 9—ELECTRICAL AND SCIENTIFIC APPARATUS**

FOR SPECTROGRAPHS; MASS SPECTROMETERS; LEAK DETECTORS FOR USE IN SEMICONDUCTOR PRODUCTION PROCESSES; COMPUTER SOFTWARE FOR MONITORING SYSTEM STATUS AND PROVIDING DATA RELATING TO VACUUM, EXHAUST ABATEMENT, CHEMICAL USE AND GAS USE, RELATING TO THE MANUFACTURE OF SEMICONDUCTORS AND INTEGRATED CIRCUITS; TEMPERATURE CONTROL UNITS FOR SEMICONDUCTOR MANUFACTURING PROCESSES, NAMELY CHILLERS FOR PRODUCING CONSTANT TEMPERATURES UNDER CONDITIONS OF VARYING HEAT LOADS IN SEMICONDUCTOR MANUFACTURING PROCESSES (U.S. CLS. 21, 23, 26, 36 AND 38).

MICHAEL KEATING, EXAMINING ATTORNEY

**CLASS 29—MEATS AND PROCESSED FOODS**

FOR VEGETABLE OILS AND FATS FOR FOODS, NAMELY, OLIVE OIL, CORN OIL, SESAME OIL, SOY-BEAN OIL, BLENDED OIL, RAPE OIL, PALM OIL, COCONUT OIL AND FAT, SUNFLOWER OIL, AND PEANUT OIL; ANIMAL OILS, AND FATS FOR FOOD, NAMELY, BEEF TALLOW, BONE OIL, LARD, AND POULTRY FAT; PROCESSED OILS AND FATS FOR FOODS, NAMELY, HYDROGENATED OIL, SHORTENING, POWDERED OILS AND FATS, AND SEASONING OILS; MILK PRODUCTS, NAMELY, DRY WHOLE MILK POWDER, DRY LOW-FAT MILK POWDER, DRY NON-FAT MILK POWDER, DRY BUTTERMILK POWDER, WHEY POWDER, LACTIC ACID DRINKS, AND CREAM;

MEAT FOR HUMAN CONSUMPTION; EGGS; EDIBLE AQUATIC ANIMALS NOT LIVE; FROZEN VEGETABLES; FROZEN FRUITS; PROCESSED MEAT PRODUCTS, NAMELY, BOVINE MEAT AND BONE EXTRACTS, SWINE MEAT AND BONE EXTRACTS, POULTRY MEAT AND BONE EXTRACTS; FISH OR SHELLFISH PRESERVED IN SAKE LEES; STEAMED OR TOASTED CAKES OF FISH PASTE; FERMENTED FISH GUTS, SQUID GUTS, SEA CUCUMBER GUTS, SHRIMPS, CALLING CRABS, AND OYSTERS; SEA-FOODS BOILED DOWN IN SOY SAUCE; FISH AND SHELLFISH DRIED IN THE SHADE OF THE SUN; TUBE-SHAPED TOASTED CAKES OFFISH PASTE; BOILED AND DRIED FISH AND SHELLFISH; STEAMED CAKES OF SMASHED FISH AND YAM; FISH SAUSAGES; BLOCKS OF BOILED, SMOKED AND THEN DRIED BONITOS; DRIED PIECES OF AGAR JELLY; FLAKES OF DRIED FISH MEAT; FISHMEAL FOR HUMAN CONSUMPTION; EDIBLE SHAVINGS OF DRIED KELP; SHEETS OF DRIED LAVER; DRIED BROWN ALGAE; DRIED EDIBLE SEAWEED; PROCESSED EDIBLE SEAWEED; TOASTED SHEETS OF LAVER; PROCESSED VEGETABLES; PROCESSED FRUITS; FRIED TOFU PIECES; FREEZE-DRIED TOFU PIECES; JELLY MADE FROM DEVILS' TONGUE ROOT; SOYBEAN MILK; SOY MILK; TOFU; FERMENTED SOYBEANS; PROCESSED EGGS; STEW AND SOUP MIXES; DRIED FLAKES OF LAVER FOR SPRINKLING ON RICE IN HOT WATER; FERMENTED SOYBEAN FOODS AS ACCOMPANIMENT; PROTEIN FOR HUMAN CONSUMPTION, NAMELY, VEGETABLE PROTEIN ADDED TO RAW MATERIALS FOR BUCKWHEAT AND NOODLE FOR GETTING THEIR CHEWINESS (U.S. CL. 46).

#### CLASS 30—STAPLE FOODS

FOR BINDING AGENTS FOR ICE CREAM; MEAT TENDERIZERS FOR HOUSEHOLD PURPOSES; PREPARATIONS FOR STIFFENING WHIPPED CREAM; AROMATIC PREPARATIONS FOR FOOD NOT FROM ESSENTIAL OILS; TEA; COFFEE AND COCOA; ICE; CONFECTIONERY, NAMELY, BEAN JAM, CHESTNUTS ROASTED WITH SYRUP, SWEETENED BOILED ADZUKI-BEANS, CANDIES, FRUIT JELLIES, VEGETABLE JELLIES, CAKES, CHEWING GUMS, CHOCOLATE, ICE CREAM, SPONGE CAKES, PANCAKES, DOUGHNUTS, PIES, BISCUITS, COOKIES, CRACKERS, WAFERS, AND SYRUP; BREAD AND BUNS; SEASONINGS; SPICES; ICE CREAM MIXES; SHERBET MIXES; CHINESE STUFFED DUMPLINGS COOKED; SANDWICHES; CHINESE STEAMED DUMPLINGS COOKED; SUSHI; FRIED BALLS OF BATTER MIX WITH SMALL PIECES OF OCTOPUS; STEAMED BUNS STUFFED WITH MINCED MEAT; PREPARED HAMBURGER SANDWICHES; PREPARED PIZZAS; PREPARED HOT DOG SANDWICHES; PREPARED MEAT PIES; PREPARED RAVIOLI; YEAST POWDER; FERMENTING MALTED RICE; YEAST; BAKING POWDER; INSTANT CONFECTIONERY MIXES, NAMELY, JELLY MIXES, DOUGHNUT MIXES, PUDDING MIXES, AND CAKE MIXES; CURRY; AND JAPANESE ARROW ROOT POWDER FOR USE IN THE MANUFACTURE OF FOODS; JAPANESE ARROW ROOT POWDER FOR INDUSTRIAL PURPOSES; WHEAT FLOUR FOR INDUSTRIAL PURPOSES; RICE FLOUR FOR INDUSTRIAL PURPOSES; CORN STARCH FOR INDUSTRIAL PURPOSES; SWEET POTATO FLOUR FOR INDUSTRIAL PURPOSES; POTATO FLOUR FOR INDUSTRIAL PURPOSES; BUCKWHEAT FLOUR FOR INDUSTRIAL PURPOSES; PULSE FLOUR FOR INDUSTRIAL PURPOSES; BARLEY FLOUR FOR INDUSTRIAL PURPOSES; CURRY MIXES; CURRY POWDER; AND CURRY PASTES. (U.S. CL. 46).

#### CLASS 31—NATURAL AGRICULTURAL PRODUCTS

FOR UNPROCESSED EDIBLE SEAWEEDS; FRESH AND CHILLED VEGETABLES; FRESH AND CHILLED FRUITS; AND RAW PULSES, NAMELY, RAW RED BEANS, RAW KIDNEY BEANS, RAW PEAS, RAW BROAD BEANS, RAW SOYBEANS AND RAW PEANUTS. (U.S. CLS. 1 AND 46).

SHAUNIA WALLACE, EXAMINING ATTORNEY

SN 78-247,221. LIFE CYCLE PHARMA A/S, DK-2970 HORSHOLM, DENMARK, FILED 5-8-2003.

## L C PHARMA

#### CLASS 5—PHARMACEUTICALS

FOR PHARMACEUTICAL PREPARATIONS; MEDICAL PREPARATIONS; AND DRUG DELIVERY SYSTEMS, PHARMACEUTICAL MODIFIED RELEASE SYSTEMS, AND CONTROLLED RELEASE SYSTEMS, COMPRISED OF TABLETS, GRANULES, PILLS, SACHETS, POWDERS, AND CAPSULES; ALL OF THE ABOVE FOR USE IN THE TREATMENT OF MENTAL AND PHYSICAL DISORDERS, TRAUMAS AND EMERGENCIES, ADDICTIONS, AGING, ALLERGY/IMMUNOLOGY, BURNS, DISEASES OF THE HEART AND BLOOD VESSELS, DENTAL AND GUM DISEASES, SKIN DISEASES, NUTRITIONAL AND DIETARY DISEASES, DISEASES OF THE ENDOCRINOLOGICAL SYSTEM AND PANCREATIC DISEASES, DIABETES, EPIDEMICAL DISEASES, DISEASES AND AFFLICTIONS OF THE GASTROENTEROLOGICAL SYSTEM, DISEASES OF THE BLOOD, INFECTIOUS DISEASES, NEUROLOGICAL DISEASES, NEPHROLOGICAL DISEASES, DISEASES IN THE OBSTETRICAL AND GYNECOLOGICAL FIELD, CANCER, OPHTHALMOLOGICAL DISEASES, DISEASES AND AFFLICTIONS AFFECTING THE BONES, JOINTS, CARTILAGE MATERIAL AND MUSCLES, DISEASES AND AFFLICTIONS OF THE EAR, NOSE AND THROAT, DISEASES AND AFFLICTIONS IN THE PSYCHIATRIC FIELD, PULMONOLOGICAL DISEASES AND AFFLICTIONS, RHEUMATISM, UROLOGICAL DISEASES AND AFFLICTIONS AND GENERALISED PAIN (U.S. CLS. 6, 18, 44, 46, 51 AND 52).

#### CLASS 40—MATERIAL TREATMENT

FOR TREATMENT OF MATERIALS, NAMELY, MILLING, GRINDING, MIXING, COMPRESSING, AND MELTING OF PHARMACEUTICAL, MEDICINAL, BIOTECHNICAL AND BACTERIOLOGICAL SUBSTANCES, PREPARATIONS, FORMULATIONS, SOLUTIONS, FOR USE IN THE PHARMACEUTICAL AND MEDICAL INDUSTRIES (U.S. CLS. 100, 103 AND 106).

#### CLASS 41—EDUCATION AND ENTERTAINMENT

FOR EDUCATIONAL TRAINING SERVICES, NAMELY, ARRANGING AND CONDUCTING OF SEMINARS, WORKSHOPS, CONFERENCES, LECTURES AND CONGRESSES, ALL IN THE MEDICAL, CHEMICAL AND PHARMACEUTICAL FIELDS (U.S. CLS. 100, 101 AND 107).

#### CLASS 42—SCIENTIFIC, COMPUTER AND LEGAL SERVICES

FOR SCIENTIFIC RESEARCH WITHIN THE MEDICAL, PHARMACEUTICAL, BIOTECHNICAL AND BACTERIOLOGICAL AREAS AND PROVIDING CONSULTATION AND INFORMATION RELATING THERETO; CONDUCTING OF TESTS REGARDING MEDICAL APPLICATIONS; PACKAGING DESIGN FOR OTHERS; DESIGNING AND DEVELOPMENT OF MEDICAL EQUIPMENT; DESIGNING PHARMACEUTICAL MEDICAL PREPARATIONS; PREPARATION OF PHARMACEUTICAL FORMULATIONS; DESIGN AND DEVELOPMENT OF GRANULATION TECHNOLOGY AND TABLET TECHNOLOGY AND PROVIDING CONSULTATION AND INFORMATION THERETO; AND MATERIALS TESTING FOR THE PHARMACEUTICAL AND MEDICAL INDUSTRIES. (U.S. CLS. 100 AND 101).

ALICIA COLLINS, EXAMINING ATTORNEY

SN 78-247,222. LIFECYCLE PHARMA A/S, DK-2970 HORSHOLM, DENMARK, FILED 5-8-2003.

SN 78-247,225. LIFECYCLE PHARMA A/S, DK-2970 HORSHOLM, DENMARK, FILED 5-8-2003.

## LIFE CYCLE PHARMA

### CLASS 5—PHARMACEUTICALS

FOR PHARMACEUTICAL PREPARATIONS; MEDICAL PREPARATIONS; AND DRUG DELIVERY SYSTEMS, PHARMACEUTICAL MODIFIED RELEASE SYSTEMS, AND CONTROLLED RELEASE SYSTEMS, COMPRISED OF TABLETS, GRANULES, PILLS, SACHETS, POWDERS, AND CAPSULES; ALL OF THE ABOVE FOR USE IN THE TREATMENT OF MENTAL AND PHYSICAL DISORDERS, TRAUMAS AND EMERGENCIES, ADDICTIONS, AGING, ALLERGY/IMMUNOLOGY, BURNS, DISEASES OF THE HEART AND BLOOD VESSELS, DENTAL AND GUM DISEASES, SKIN DISEASES, NUTRITIONAL AND DIETARY DISEASES, DISEASES OF THE ENDOCRINOLOGICAL SYSTEM AND PANCREATIC DISEASES, DIABETES, EPIDEMICAL DISEASES, DISEASES AND AFFLICTIONS OF THE GASTROENTEROLOGICAL SYSTEM, DISEASES OF THE BLOOD, INFECTIOUS DISEASES, NEUROLOGICAL DISEASES, NEPHROLOGICAL DISEASES, DISEASES, DISEASES IN THE OBSTETRICAL- AND GYNECOLOGICAL FIELD, CANCER, OPHTHALMOLOGICAL DISEASES, DISEASES AND AFFLICTIONS AFFECTING THE BONES, JOINTS, CARTILAGE MATERIAL AND MUSCLES, DISEASES AND AFFLICTIONS OF THE EAR, NOSE AND THROAT, DISEASES AND AFFLICTIONS IN THE PSYCHIATRIC FIELD, PULMONOLOGICAL DISEASES AND AFFLICTIONS, RHEUMATISM, UROLOGICAL DISEASES AND AFFLICTIONS AND GENERALISED PAIN (U.S. CLS. 6, 18, 44, 46, 51 AND 52).

### CLASS 40—MATERIAL TREATMENT

FOR TREATMENT OF MATERIALS, NAMELY, MILLING, GRINDING, MIXING, COMPRESSING, AND MELTING OF PHARMACEUTICAL, MEDICINAL, BIOTECHNICAL AND BACTERIOLOGICAL SUBSTANCES, PREPARATIONS, FORMULATIONS, SOLUTIONS, FOR USE IN THE PHARMACEUTICAL AND MEDICAL INDUSTRIES (U.S. CLS. 100, 103 AND 106).

### CLASS 41—EDUCATION AND ENTERTAINMENT

FOR EDUCATIONAL TRAINING SERVICES, NAMELY, ARRANGING AND CONDUCTING OF SEMINARS, WORKSHOPS, CONFERENCES, LECTURES AND CONGRESSES, ALL IN THE MEDICAL, CHEMICAL AND PHARMACEUTICAL FIELDS (U.S. CLS. 100, 101 AND 107).

### CLASS 42—SCIENTIFIC, COMPUTER AND LEGAL SERVICES

FOR SCIENTIFIC RESEARCH WITHIN THE MEDICAL, PHARMACEUTICAL, BIOTECHNICAL AND BACTERIOLOGICAL AREAS AND PROVIDING CONSULTATION AND INFORMATION RELATING THERETO; CONDUCTING OF TESTS REGARDING MEDICAL APPLICATIONS; PACKAGING DESIGN FOR OTHERS; DESIGNING AND DEVELOPMENT OF MEDICAL EQUIPMENT; DESIGNING PHARMACEUTICAL MEDICAL PREPARATIONS; PREPARATION OF PHARMACEUTICAL FORMULATIONS; DESIGN AND DEVELOPMENT OF GRANULATION TECHNOLOGY AND TABLET TECHNOLOGY AND PROVIDING CONSULTATION AND INFORMATION THERETO; AND MATERIALS TESTING FOR THE PHARMACEUTICAL AND MEDICAL INDUSTRIES (U.S. CLS. 100 AND 101).  
ALICIA COLLINS, EXAMINING ATTORNEY



THE STIPPLING IS FOR SHADING PURPOSES ONLY, AND IT IS NOT INTENDED TO INDICATE COLOR.

### CLASS 5—PHARMACEUTICALS

FOR PHARMACEUTICAL PREPARATIONS; MEDICAL PREPARATIONS; AND DRUG DELIVERY SYSTEMS, PHARMACEUTICAL MODIFIED RELEASE SYSTEMS, AND CONTROLLED RELEASE SYSTEMS, COMPRISED OF TABLETS, GRANULES, PILLS, SACHETS, POWDERS, AND CAPSULES; ALL OF THE ABOVE FOR USE IN THE TREATMENT OF MENTAL AND PHYSICAL DISORDERS, TRAUMAS AND EMERGENCIES, ADDICTIONS, AGING, ALLERGY/IMMUNOLOGY, BURNS, DISEASES OF THE HEART AND BLOOD VESSELS, DENTAL AND GUM DISEASES, SKIN DISEASES, NUTRITIONAL AND DIETARY DISEASES, DISEASES OF THE ENDOCRINOLOGICAL SYSTEM AND PANCREATIC DISEASES, DIABETES, EPIDEMICAL DISEASES, DISEASES AND AFFLICTIONS OF THE GASTROENTEROLOGICAL SYSTEM, DISEASES OF THE BLOOD, INFECTIOUS DISEASES, NEUROLOGICAL DISEASES, NEPHROLOGICAL DISEASES, DISEASES IN THE OBSTETRICAL- AND GYNECOLOGICAL FIELD, CANCER, OPHTHALMOLOGICAL DISEASES, DISEASES AND AFFLICTIONS AFFECTING THE BONES, JOINTS, CARTILAGE MATERIAL AND MUSCLES, DISEASES AND AFFLICTIONS OF THE EAR, NOSE AND THROAT, DISEASES AND AFFLICTIONS IN THE PSYCHIATRIC FIELD, PULMONOLOGICAL DISEASES AND AFFLICTIONS, RHEUMATISM, UROLOGICAL DISEASES AND AFFLICTIONS AND GENERALISED PAIN (U.S. CLS. 6, 18, 44, 46, 51 AND 52).

### CLASS 40—MATERIAL TREATMENT

FOR TREATMENT OF MATERIALS, NAMELY, MILLING, GRINDING, MIXING, COMPRESSING, AND MELTING OF PHARMACEUTICAL, MEDICINAL, BIOTECHNICAL AND BACTERIOLOGICAL SUBSTANCES, PREPARATIONS, FORMULATIONS, SOLUTIONS, FOR USE IN THE PHARMACEUTICAL AND MEDICAL INDUSTRIES (U.S. CLS. 100, 103 AND 106).

### CLASS 41—EDUCATION AND ENTERTAINMENT

FOR EDUCATIONAL TRAINING SERVICES, NAMELY, ARRANGING AND CONDUCTING OF SEMINARS, WORKSHOPS, CONFERENCES, LECTURES AND CONGRESSES, ALL IN THE MEDICAL, CHEMICAL AND PHARMACEUTICAL FIELDS (U.S. CLS. 100, 101 AND 107).



**CLASS 42—SCIENTIFIC, COMPUTER AND LEGAL SERVICES**

FOR SCIENTIFIC RESEARCH WITHIN THE MEDICAL, PHARMACEUTICAL, BIOTECHNICAL AND BACTERIOLOGICAL AREAS AND PROVIDING CONSULTATION AND INFORMATION RELATING THERETO; CONDUCTING OF TESTS REGARDING MEDICAL APPLICATIONS; PACKAGING DESIGN FOR OTHERS; DESIGNING AND DEVELOPMENT OF MEDICAL EQUIPMENT; DESIGNING PHARMACEUTICAL MEDICAL PREPARATIONS; PREPARATION OF PHARMACEUTICAL FORMULATIONS; DESIGN AND DEVELOPMENT OF GRANULATION TECHNOLOGY AND TABLET TECHNOLOGY AND PROVIDING CONSULTATION AND INFORMATION THERETO; AND MATERIALS TESTING FOR THE PHARMACEUTICAL AND MEDICAL INDUSTRIES (U.S. CLS. 100 AND 101).

ALICIA COLLINS, EXAMINING ATTORNEY

**CLASS 35—ADVERTISING AND BUSINESS**

FOR BUSINESS MARKETING AND CONSULTING SERVICES RELATED THERETO; OPERATING AN ON-LINE MARKETPLACE THAT BRINGS BUSINESSES AND CONSUMERS TO ENTITIES THAT SELL GOODS AND SERVICES, BUT SPECIFICALLY EXCLUDING SUCH SERVICES AS THEY PERTAIN TO THE FOOD INDUSTRY, INCLUDING BUT NOT LIMITED TO WHOLESALE GROCERY DISTRIBUTORSHIP SERVICES; PROVIDING A WEB SITE WHICH FEATURES ADVERTISEMENTS FOR THE GOODS AND SERVICES OF OTHERS ON A GLOBAL COMPUTER NETWORK; PROVIDING ON-LINE DIRECTORY INFORMATION SERVICES ALSO FEATURING HYPERLINKS TO OTHER WEB SITES; PROMOTING THE GOODS AND SERVICES OF OTHERS BY PROVIDING HYPERTEXT LINKS TO THE WEB SITES OF OTHERS (U.S. CLS. 100, 101 AND 102).

FIRST USE 2-5-2003; IN COMMERCE 2-5-2003.

**CLASS 38—COMMUNICATION**

FOR ELECTRONIC TRANSMISSION OF DATA VIA A GLOBAL COMPUTER NETWORK; PROVIDING MULTIPLE USER ACCESS TO A GLOBAL COMPUTER NETWORK (U.S. CLS. 100, 101 AND 104).

FIRST USE 2-5-2003; IN COMMERCE 2-5-2003.

WILLIAM VERHOSEK, EXAMINING ATTORNEY

SN 78-248,831. HARVESTGOLD, L.P., HARRISON CITY, PA.  
FILED 5-13-2003.

**HARVESTGOLD****CLASS 9—ELECTRICAL AND SCIENTIFIC APPARATUS**

FOR COMPUTER SOFTWARE, NAMELY, SOFTWARE THAT FACILITATES THE SALES PLANNING PROCESS AND THE DEVELOPMENT AND PUBLICATION OF SALES PLANS (U.S. CLS. 21, 23, 26, 36 AND 38).

SN 78-250,680. LIFECYCLE PHARMA A/S, DK-2970 HORSHOOLM, DENMARK, FILED 5-16-2003.

**LIFECYCLE PHARMA****CLASS 16—PAPER GOODS AND PRINTED MATTER**

FOR PUBLICATIONS, NAMELY, PAMPHLETS, TRAINING MANUALS AND PRESENTATION AND MARKETING MATERIALS, NAMELY, TEXTBOOKS, BROCHURES AND PAMPHLETS ALL IN THE FIELD OF TERRITORY SALES PLANNING (U.S. CLS. 2, 5, 22, 23, 29, 37, 38 AND 50).

**CLASS 5—PHARMACEUTICALS**

FOR PHARMACEUTICAL PREPARATIONS; MEDICAL PREPARATIONS; AND DRUG DELIVERY SYSTEMS, PHARMACEUTICAL MODIFIED RELEASE SYSTEMS, AND CONTROLLED RELEASE SYSTEMS, COMPRISED OF TABLETS, GRANULES, PILLS, SACHETS, POWDERS, AND CAPSULES; ALL OF THE ABOVE FOR USE IN THE TREATMENT OF MENTAL AND PHYSICAL DISORDERS, TRAUMAS AND EMERGENCIES, ADDICTIONS, AGING, ALLERGY/IMMUNOLOGY, BURNS, DISEASES OF THE HEART AND BLOOD VESSELS, DENTAL AND GUM DISEASES, SKIN DISEASES, NUTRITIONAL AND DIETARY DISEASES, DISEASES OF THE ENDOCRINOLOGICAL SYSTEM AND PANCREATIC DISEASES, DIABETES, EPIDEMICAL DISEASES, DISEASES AND AFFLICTIONS OF THE GASTROENTEROLOGICAL SYSTEM, DISEASES OF THE BLOOD, INFECTIOUS DISEASES, NEUROLOGICAL DISEASES, NEPHROLOGICAL DISEASES, DISEASES IN THE OBSTETRICAL- AND GYNECOLOGICAL FIELD, CANCER, OPHTHALMOLOGICAL DISEASES, DISEASES AND AFFLICTIONS AFFECTING THE BONES, JOINTS, CARTILAGE MATERIAL AND MUSCLES, DISEASES AND AFFLICTIONS OF THE EAR, NOSE AND THROAT, DISEASES AND AFFLICTIONS IN THE PSYCHIATRIC FIELD, PULMONOLOGICAL DISEASES AND AFFLICTIONS, RHEUMATISM, UROLOGICAL DISEASES AND AFFLICTIONS AND GENERALISED PAIN (U.S. CLS. 6, 18, 44, 46, 51 AND 52).

**CLASS 41—EDUCATION AND ENTERTAINMENT**

FOR EDUCATIONAL SERVICES, NAMELY, CONDUCTING SEMINARS IN THE FIELD OF TERRITORY SALES PLANNING WHEREBY SALES PERSONNEL, MANAGERS, EXECUTIVES AND SALES REPRESENTATIVES LEARN HOW TO DEVELOP AND MANAGE EFFECTIVE SALES PLANS TO BE MORE PRODUCTIVE IN SELLING TO A SPECIFIC MARKET, AREA OR TERRITORY (U.S. CLS. 100, 101 AND 107).

GIANCARLO CASTRO, EXAMINING ATTORNEY

SN 78-249,655. FINDWHAT.COM, INC., FT. MYERS, FL.  
FILED 5-14-2003.

**PERFORMANCE-DRIVEN MARKETING****CLASS 40—MATERIAL TREATMENT**

FOR TREATMENT OF MATERIALS, NAMELY, MILLING, GRINDING, MIXING, COMPRESSING, AND MELTING OF PHARMACEUTICAL, MEDICINAL, BIOTECHNICAL AND BACTERIOLOGICAL SUBSTANCES, PREPARATIONS, FORMULATIONS, SOLUTIONS, FOR USE IN THE PHARMACEUTICAL AND MEDICAL INDUSTRIES (U.S. CLS. 100, 103 AND 106).

NO CLAIM IS MADE TO THE EXCLUSIVE RIGHT TO USE "MARKETING" WITH RESPECT TO INTERNATIONAL CLASS 38, APART FROM THE MARK AS SHOWN.

**CLASS 41—EDUCATION AND ENTERTAINMENT**

FOR EDUCATIONAL TRAINING SERVICES, NAMELY, ARRANGING AND CONDUCTING OF SEMINARS, WORKSHOPS, CONFERENCES, LECTURES AND CONGRESSES, ALL IN THE MEDICAL, CHEMICAL AND PHARMACEUTICAL FIELDS (U.S. CLS. 100, 101 AND 107).

**CLASS 42—SCIENTIFIC, COMPUTER AND LEGAL SERVICES**

FOR SCIENTIFIC RESEARCH WITHIN THE MEDICAL, PHARMACEUTICAL, BIOTECHNICAL AND BACTERIOLOGICAL AREAS AND PROVIDING CONSULTATION AND INFORMATION RELATING THERETO; CONDUCTING OF TESTS REGARDING MEDICAL APPLICATIONS; PACKAGING DESIGN FOR OTHERS; DESIGNING AND DEVELOPMENT OF MEDICAL EQUIPMENT; DESIGNING PHARMACEUTICAL MEDICAL PREPARATIONS; PREPARATION OF PHARMACEUTICAL FORMULATIONS; DESIGN AND DEVELOPMENT OF GRANULATION TECHNOLOGY AND TABLET TECHNOLOGY AND PROVIDING CONSULTATION AND INFORMATION THERETO; AND MATERIALS TESTING FOR THE PHARMACEUTICAL AND MEDICAL INDUSTRIES. (U.S. CLS. 100 AND 101).  
ALICIA COLLINS, EXAMINING ATTORNEY

**CLASS 36—INSURANCE AND FINANCIAL**

FOR FINANCIAL AND INVESTMENT ADVISORY, CONSULTANCY, EVALUATION, INFORMATION AND MANAGEMENT SERVICES, NAMELY, RETIREMENT PLANNING, WEALTH CREATION SERVICES, AND PROVIDING FINANCIAL PLANNING ADVICE; LEASING OF REAL ESTATE; REAL ESTATE ACQUISITION SERVICES; REAL ESTATE AGENCIES; REAL ESTATE APPRAISAL; REAL ESTATE BROKERAGE; REAL ESTATE ESCROW SERVICES; REAL ESTATE INVESTMENT; REAL ESTATE LISTING; REAL ESTATE MANAGEMENT; LEASING OF REAL PROPERTY; ANNUITY UNDERWRITING AND CONSULTATION RELATED THERETO (U.S. CLS. 100, 101 AND 102).  
NELSON SNYDER, EXAMINING ATTORNEY

SN 78-254,498. HOBBYENGINE MODEL INDUSTRIAL LTD., TSIMSHATSUI EAST, HONG KONG, FILED 5-27-2003.



NO CLAIM IS MADE TO THE EXCLUSIVE RIGHT TO USE "HOBBY" AND "HOBBY ENGINE", APART FROM THE MARK AS SHOWN.

**CLASS 16—PAPER GOODS AND PRINTED MATTER**

FOR PAINTING SETS, ARTS AND CRAFT PAINT KITS (U.S. CLS. 2, 5, 22, 23, 29, 37, 38 AND 50).

**CLASS 28—TOYS AND SPORTING GOODS**

FOR TOYS, GAMES AND PLAYTHINGS, NAMELY TOY PLASTIC CONSTRUCTION KITS, TOY MODEL HOBBYCRAFT KITS, TOY VEHICLES, INCLUDING SPORTS CARS, RACING CARS, FIRE ENGINES, AMBULANCES, MILITARY VEHICLES, TANKS, CONSTRUCTION/WORK VEHICLES, EXCAVATORS, CRANE EXCAVATORS, GIANT TRUCKS, LOADERS, FORKLIFT TRUCKS, AIRPLANES, HELICOPTERS, ROCKETS, SPACE SHUTTLES, SPACE SHIPS, HELIUM AIR SHIPS, UFOS, BOATS, SUBMARINES, TRAIN SETS, ANIMALS AND FIGURES; TOY MODELS, NAMELY TOY MODEL KIT CARS; TOY MODEL VEHICLES, NAMELY SPORTS CARS, RACING CARS, FIRE ENGINES, AMBULANCES, MILITARY VEHICLES, TANKS, CONSTRUCTION/WORK VEHICLES, EXCAVATORS, CRANE EXCAVATORS, GIANT TRUCKS, LOADERS, FORKLIFT TRUCKS, AIRPLANES, HELICOPTERS, ROCKETS, SPACE SHUTTLES, SPACE SHIPS, HELIUM AIR SHIPS, UFOS, BOATS, SUBMARINES, TRAIN SETS, ANIMALS AND FIGURES; TOY REMOTE CONTROL MODELS, NAMELY RADIO CONTROLLED MODEL VEHICLES, NAMELY SPORTS CARS, RACING CARS, FIRE ENGINES, AMBULANCES, MILITARY VEHICLES, TANKS, CONSTRUCTION/WORK VEHICLES, EXCAVATORS, CRANE EXCAVATORS, GIANT TRUCKS, LOADERS, FORKLIFT TRUCKS, AIRPLANES, HELICOPTERS, ROCKETS, SPACE SHUTTLES, SPACE SHIPS, HELIUM AIR SHIPS, UFOS, BOATS, SUBMARINES, TRAIN SETS, ANIMALS AND FIGURES; BATTERY OPERATED TOY MODEL VEHICLES, NAMELY SPORTS CARS, RACING CARS, FIRE ENGINES, AMBULANCES, MILITARY VEHICLES, TANKS, CONSTRUCTION/WORK VEHICLES, EXCAVATORS, CRANE EXCAVATORS, GIANT TRUCKS, LOADERS, FORKLIFT TRUCKS, AIRPLANES, HELICOPTERS, ROCKETS, SPACE SHUTTLES, SPACE SHIPS, HELIUM AIR SHIPS, UFOS, BOATS, SUBMARINES, TRAIN SETS, ANIMALS AND FIGURES; INFRARED CONTROLLED TOY MODEL VEHICLES, NAMELY SPORTS CARS, RACING CARS, FIRE ENGINES, AMBULANCES, MILITARY VEHICLES, TANKS, CONSTRUCTION/WORK VEHICLES, EXCAVATORS, CRANE EXCAVATORS, GIANT TRUCKS, LOADERS, FORKLIFT

SN 78-252,627. TRASS, KIERAN JOHN, AUKLAND, NEW ZEALAND, FILED 5-21-2003.

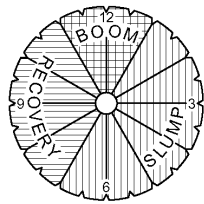

PRIORITY CLAIMED UNDER SEC. 44(D) ON NEW ZEALAND APPLICATION NO. 671839, FILED 1-14-2003, REG. NO. 671839, DATED 7-17-2003, EXPIRES 1-14-2010.

PRIORITY CLAIMED UNDER SEC. 44(D) ON NEW ZEALAND APPLICATION NO. 671838, FILED 1-14-2003, REG. NO. 671838, DATED 7-17-2003, EXPIRES 1-14-2010.

NO CLAIM IS MADE TO THE EXCLUSIVE RIGHT TO USE "BOOM" "SLUMP" "RECOVERY", APART FROM THE MARK AS SHOWN.

THE DRAWING IS LINED FOR THE COLORS RED, BLUE AND YELLOW.

**CLASS 28—TOYS AND SPORTING GOODS**

FOR GAMES, NAMELY, BOARD GAMES AND CARD GAMES (U.S. CLS. 22, 23, 38 AND 50).

TRUCKS, AIRPLANES, HELICOPTERS, ROCKERS, SPACE SHUTTLES, SPACE SHIPS, HELIUM AIR SHIPS, UFOS, BOATS, SUBMARINES, TRAIN SETS, ANIMALS AND FIGURES (U.S. CLS. 22, 23, 38 AND 50).  
AMY HELLA, EXAMINING ATTORNEY

SN 78-254,675. TELIASONERA AB, FARSTA, SWEDEN,  
FILED 5-27-2003.

# TeliaSonera

PRIORITY CLAIMED UNDER SEC. 44(D) ON SWEDEN APPLICATION NO. 200208024, FILED 12-6-2002, REG. NO. 362156, DATED 7-18-2003, EXPIRES 7-18-2013.

OWNER OF U.S. REG. NOS. 259,997, 2,763,088 AND OTHERS.

## CLASS 9—ELECTRICAL AND SCIENTIFIC APPARATUS

FOR VENDING-MACHINES AND MECHANISMS FOR COIN-OPERATED DEVICES, CASH REGISTERS, CALCULATING MACHINES; CALCULATORS; DATA PROCESSORS; COMPUTERS; COMPUTER HARDWARE, COMPUTER TERMINALS, COMPUTER PERIPHERALS, COMPUTER OPERATING SYSTEM SOFTWARE TO FACILITATE COMPUTER USE AND OPERATION, COMPUTER SOFTWARE FOR CONNECTING TO THE GLOBAL COMPUTER NETWORK OR INTRANET; MODEMS; TRANSMITTERS OF ELECTRONIC SIGNALS, FACSIMILE MACHINES; ELECTRONIC APPARATUS AND INSTRUMENTS, NAMELY COMPUTERS WITH DISPLAY UNITS, ALL FOR PROCESSING, REGISTRATION, STORING, TRANSMISSION, RECEPTION, SHOWING AND/OR PRINTOUT OF DATA; COMPUTER EQUIPMENT FOR RECOGNITION AND SYNTHESIZING OF SPEECH; ELECTRONIC INTERFACES; ELECTRONIC CIRCUIT BOARDS; TELEPHONES; AUTOMATIC TELEPHONE DIALERS; TELEPHONE RECEIVERS; TELEPHONE ANSWERING MACHINES; TELECOMMUNICATION AND DATA COMMUNICATION NETWORKS AND BROADBAND COMMUNICATION NETWORKS BEING COMPUTERS, PERIPHERALS FOR COMPUTERS, ELECTRIC CABLES; COMPUTER MEMORIES AND MODEMS; EQUIPMENT FOR ENCRYPTION/DECRYPTION OF DATA, VOICES AND SPOKEN INFORMATION AS WELL AS FOR VIDEO AND FAX ENCRYPTION/DECRYPTION; MAGNETIC ENCODED CARDS AND CARD READERS, NAMELY, ENCODED CARDS FOR USE IN COMMUNICATIONS, SUCH AS MODEM CARDS, TELEFAX CARDS, TELEPHONE CALLING CARDS, AND SMART CARDS; TELECOMMUNICATIONS HARDWARE, NAMELY TRANSMITTERS, RECEIVERS, SWITCHES, BASES STATIONS, TERMINALS, AND CABLES, ALL FOR ELECTRICAL AND OPTICAL SIGNAL TRANSMISSIONS; STATIONARY AND MOBILE COMMUNICATION APPARATUS AND INSTRUMENTS, NAMELY, ANTENNAS, TRANSMITTERS, AND RECEIVERS; RADIO PAGERS; RADIO TELEPHONES; RADIOS; TELEVISION SETS; FAX MACHINES; BLANK MAGNETIC COMPUTER TAPES; COMPUTER DISC DRIVES; BLANK FLOPPY AND HARD DISCS FOR COMPUTERS; ELECTRICAL, INTEGRATED AND PRINTED CIRCUITS; TELECOMMUNICATION OFFICES BEING COMPUTERS AND PERIPHERALS FOR COMPUTERS; ELECTRICAL SIDE CIRCUITS, TRANSMITTERS, TELECOMMUNICATION RECEIVERS, SWITCHES, TELEPHONE AND DATABASE STATIONS, COMPUTER TERMINALS, CABLES FOR ELECTRICAL AND OPTICAL SIGNAL TRANSMISSIONS FOR USE IN COMMUNICATION NETWORKS AND OPERATING DEVICES THEREFORE (U.S. CLS. 21, 23, 26, 36 AND 38).

## CLASS 16—PAPER GOODS AND PRINTED MATTER

FOR PAPER, CARDBOARD AND PRODUCTS THEREOF, NAMELY, BAGS, CARDBOARD BOXES, PAPER BOXES; STREAMERS; BROCHURES ABOUT TELE AND DATA COMMUNICATIONS, TELEPHONE DIRECTORIES, DATA BOOKS, MANUALS FOR COMPUTER PROGRAMS IN THE DATA AND TELECOMMUNICATIONS FIELD, NEWSLETTERS AND MAGAZINES IN THE FIELD OF TELE AND DATA COMMUNICATIONS; TAPE, CLOTH, AND WIRE FOR BOOK BINDING; PASTE AND GLUE FOR PAPER ARTICLES AND HOUSEHOLD USE; PHOTOS; PAINT-BRUSHES; TYPEWRITERS; FILM-WRAP FOR PACKING; PLASTIC MATERIAL FOR WRAPPING PAPER BOXES, BOXES AND PAPER BAGS; PLASTIC BUBBLE WRAP FOR PACKING; PRINTING TYPES; AND PRINTING BLOCKS (U.S. CLS. 2, 5, 22, 23, 29, 37, 38 AND 50).

## CLASS 35—ADVERTISING AND BUSINESS

FOR ADVERTISING SERVICES, NAMELY, CREATING CORPORATE AND BRAND IDENTITY FOR OTHERS; INDUSTRIAL MANAGEMENT; INDUSTRIAL MANAGEMENT ASSISTANCE FOR OTHERS; INDUSTRIAL ADMINISTRATION; ASSISTANCE AT MANAGEMENT OF BUSINESS ACTIVITY; COMMERCIAL BUSINESS MANAGEMENT ASSISTANCE FOR OTHERS; COMPUTER SERVICES, NAMELY, COMPUTERIZED DATA MANAGEMENT; COMPUTERIZED DATABASE MANAGEMENT; COMPUTERIZED FILE MANAGEMENT; COMPUTERIZED REGISTER MANAGEMENT; COMPUTERIZED STORING AND RETRIEVAL OF BUSINESS INFORMATION; COMPUTERIZED ACCOUNTING SERVICES; COMPUTERIZED WORD PROCESSING; TELEPHONE ANSWERING SERVICES; AND TECHNICAL DATA PROCESSING (U.S. CLS. 100, 101 AND 102).

## CLASS 36—INSURANCE AND FINANCIAL

FOR ESTATE TRUSTEE SERVICES; FINANCING SERVICES; MONEY ORDER SERVICES; MONETARY EXCHANGE; BILL PAYMENT SERVICES; ELECTRONIC PAYMENT, NAMELY ELECTRONIC PROCESSING AND TRANSMISSION OF BILL PAYMENT DATA; TELEPHONE CALLING CARD SERVICES; TELECOMMUNICATIONS AIR TIME BROKERAGE SERVICES; DEBIT CARD SERVICES; CREDIT CARD VERIFICATION AND SERVICES; ELECTRONIC MONEY TRANSACTIONS; ELECTRONIC DEBIT TRANSACTIONS; CHARGE CARD, ACCOUNT CARD AND CREDIT CARD SERVICES; FINANCIAL INFORMATION PROVIDED VIA ELECTRONIC MEANS; REAL ESTATE MANAGEMENT; ON-LINE INFORMATION SERVICES RELATED TO FINANCES; FINANCIAL MANAGEMENT RELATING TO TELECOMMUNICATION AND DATA COMMUNICATION EQUIPMENT; REAL ESTATE ADMINISTRATION; LEASING OF OFFICES AND PREMISES; AND INSURANCE CONSULTATION (U.S. CLS. 100, 101 AND 102).

## CLASS 37—CONSTRUCTION AND REPAIR

FOR BUILDING CONSTRUCTION AND ERECTION OF BUILDINGS; MOUNTING, INSTALLATION, MAINTENANCE AND REPAIRING OF INSTALLATIONS AND EQUIPMENT IN THE FIELD OF DATA COMMUNICATION HARDWARE, AND TELECOMMUNICATIONS AND COMMUNICATION NETWORKS; AND INSTALLATION OF SECURITY SYSTEMS (U.S. CLS. 100, 103 AND 106).

**CLASS 38—COMMUNICATION**

FOR MOBILE RADIO COMMUNICATION; TELEPHONE COMMUNICATION SERVICES; TELECOMMUNICATION SERVICES, NAMELY PROVIDING FIBER OPTIC NETWORK SERVICES, TELEGRAM TRANSMISSION AND COMMUNICATION, ELECTRONIC TRANSMISSION OF MESSAGES AND DATA; ELECTRONIC TRANSMISSION OF DATA AND DOCUMENTS VIA COMPUTER TERMINALS; RADIO COMMUNICATION AND TELECOMMUNICATIONS SERVICES; DELIVERY OF MULTIMEDIA MESSAGES BY ELECTRONIC TRANSMISSION; COMPUTER AIDED TRANSMISSION AND RECEPTION OF SPEECH, TEXT, SOUND, IMAGE AND DATA; ELECTRONIC TRANSMISSION OF DATA AND DOCUMENTS VIA COMPUTER TERMINALS; ELECTRONIC MAIL SERVICES; ELECTRONIC TRANSMISSION AND RECEPTION OF DATABASE INFORMATION VIA TELECOMMUNICATIONS NETWORKS; LEASING OF TELECOMMUNICATION, DATA AND RADIO COMMUNICATION SYSTEMS AND EQUIPMENT; PROVIDING MULTIPLE-USER ACCESS TO A GLOBAL COMPUTER INFORMATION NETWORK; COLLECTION AND STORING OF CALLS IN OFFICE TELEPHONE EXCHANGES AND TELECOMMUNICATION AND DATA COMMUNICATION NETWORKS; DATA PACKET TRANSMISSION SERVICES; AND SATELLITE TRANSMISSIONS; DATA COMMUNICATIONS, NAMELY LINKING SERVICES ON COMPUTER NETWORKS; INFORMATION SERVICES RELATED TO TELECOMMUNICATIONS, DATA AND RADIO COMMUNICATIONS; CONSULTANCY, INFORMATION AND ADVICE RELATED TO TELECOMMUNICATIONS AND DATA COMMUNICATIONS (U.S. CLS. 100, 101 AND 104).

**CLASS 41—EDUCATION AND ENTERTAINMENT**

FOR EDUCATION AND TRAINING IN THE FIELD OF DATA AND TELECOMMUNICATION; COMPUTER EDUCATION TRAINING SERVICES; PRODUCTION OF RADIO, TELEVISION AND VIDEO PROGRAMS; LEASING OF SOUND RECORDINGS, IMAGE RECORDINGS, FILMS, VIDEOTAPES AND CASSETTES; LEASING OF RADIO AND TELEVISION PROGRAMS; PROVIDING AN ONLINE WEBSITE FEATURING INFORMATION RELATED TO ELECTRONIC GAMES AND ONLINE CONTESTS VIA THE INTERNET; ENTERTAINMENT INFORMATION SERVICES, NAMELY, PROVIDING ON-LINE INFORMATION WITH REGARD TO ENTERTAINMENT TIME FOR MOVIES, GAMES, SHOWS, LIVE PERFORMANCES, EXHIBITIONS, SPORTS AND MUSICAL EVENTS THROUGH WORLD-WIDE-WEB AND CELL PHONES (U.S. CLS. 100, 101 AND 107).

**CLASS 42—SCIENTIFIC, COMPUTER AND LEGAL SERVICES**

FOR LEGAL SERVICES; SCIENTIFIC AND INDUSTRIAL RESEARCH; COMPUTER PROGRAMMING; CONSULTANCY AND ADVISING RELATED TO TECHNICAL COMPUTER PROCESSING, TECHNICAL CALCULATIONS AND COMPUTER PROGRAMMING; CONSULTING ACTIVITY WITHIN INFORMATION TECHNOLOGY (IT); COMPUTER AIDED CONSTRUCTION AND ENGINEERING SERVICES; DATA SYSTEMS ANALYSES FOR CONSTRUCTION, MAINTENANCE AND TESTING OF SOFTWARE AND PROGRAMS; RESEARCH RELATED TO DEVELOPMENT OF TELECOMMUNICATION APPARATUS, COMPUTER HARDWARE, RECORDED COMPUTER SOFTWARE AND COMPUTER PROGRAMS FOR OTHERS; LEASING OF DATA SOFTWARE; TECHNICAL RESEARCH; RESEARCH AND DEVELOPMENT SERVICES RELATED TO NEW PRODUCTS FOR OTHERS (U.S. CLS. 100 AND 101).

**CLASS 45—PERSONAL SERVICES**

FOR PERSONAL AND SOCIAL SERVICES TO MEET THE NEEDS OF INDIVIDUALS; NAMELY, DATING SERVICES AND HOROSCOPE FORECASTING; SECURITY SERVICES FOR THE PROTECTION OF INDIVIDUALS, PROPERTY AND COMPUTERS, NAMELY, MONITORING OF BURGLAR AND SECURITY ALARMS; MONITORING OF COMPUTER SYSTEMS FOR SECURITY PURPOSES; SECURITY PRINTING, NAMELY, ENCODING IDENTIFICATION INFORMATION ON VALUABLE DOCUMENTS AND PRODUCTS (U.S. CLS. 100 AND 101).

MELVIN AXILBUND, EXAMINING ATTORNEY

SN 78-258,166. HAKIMIAN, BEHROOZ, DBA WOVEN CONCEPTS, GREAT NECK, NY. FILED 6-4-2003.

**WOVEN CONCEPTS**

NO CLAIM IS MADE TO THE EXCLUSIVE RIGHT TO USE "WOVEN", APART FROM THE MARK AS SHOWN.

**CLASS 24—FABRICS**

FOR FABRICS FOR USE IN THE FURTHER MANUFACTURE OF ORIENTAL RUGS, SHAWLS, SCARVES, KILIMS, BED COVERS, THROWS, AND PILLOWS; BED COVERS, NAMELY, BLANKETS AND QUILTS; BLANKET THROWS, BLANKETS, COTTON FABRICS, WOOL FABRICS, SILK FABRICS, TAPESTRIES OF TEXTILES (U.S. CLS. 42 AND 50).

**CLASS 27—FLOOR COVERINGS**

FOR HAND-KNOTTED AND HAND-CRAFTED ORIENTAL RUGS, INCLUDING FLAT-WEAVES (U.S. CLS. 19, 20, 37, 42 AND 50).

JERI J. FICKES, EXAMINING ATTORNEY

SN 78-259,280. HYPERCAR, INC., BASALT, CO. FILED 6-6-2003.

**FIBERFORGE****CLASS 40—MATERIAL TREATMENT**

FOR CUSTOM MANUFACTURE AND MANUFACTURING CONSULTATION OF AND RELATING TO ADVANCED COMPOSITES (U.S. CLS. 100, 103 AND 106).

**CLASS 42—SCIENTIFIC, COMPUTER AND LEGAL SERVICES**

FOR ENGINEERING SERVICES AND ENGINEERING CONSULTATION RELATED TO ADVANCED COMPOSITES AND PRODUCTS COMPRISED OF ADVANCED COMPOSITES; PROVIDING ENGINEERING SERVICES RELATED TO AUTOMATED MANUFACTURING OF ADVANCED COMPOSITES AND PRODUCTS COMPRISED OF ADVANCED COMPOSITES (U.S. CLS. 100 AND 101).

TARAH HARDY, EXAMINING ATTORNEY

SN 78-263,387. BIEDERMANN MOTECH GMBH, SCHWENNINGEN, FED REP GERMANY, FILED 6-17-2003.

## CALC-I-CAGE

PRIORITY CLAIMED UNDER SEC. 44(D) ON ERPN CMNTY TM OFC APPLICATION NO. 3118411, FILED 4-2-2003, REG. NO. 3118411, DATED 3-23-2004, EXPIRES 4-2-2013.

### CLASS 5—PHARMACEUTICALS

FOR ORTHOPEDIC IMPLANTS, NAMELY BIOLOGICAL BONE AND SKIN TISSUE INTENDED FOR SUBSEQUENT IMPLANTATION, SURGICAL IMPLANTS COMPRISING LIVING TISSUE, BONE CEMENT FOR MEDICAL PURPOSES AND COATING MATERIALS FOR SURGICAL IMPLANTS; MATERIAL FOR STOPPING TEETH; DENTAL WAX (U.S. CLS. 6, 18, 44, 46, 51 AND 52).

### CLASS 10—MEDICAL APPARATUS

FOR SURGICAL, MEDICAL, DENTAL AND VETERINARY APPARATUS AND INSTRUMENTS, NAMELY BONE IMPLANTS COMPOSED OF ARTIFICIAL MATERIALS, DENTAL IMPLANTS, OCULAR IMPLANTS, SURGICAL IMPLANTS COMPRISING ARTIFICIAL MATERIAL, ARTIFICIAL LIMBS, EYES AND TEETH; ORTHOPEDIC JOINT IMPLANTS; SUTURES (U.S. CLS. 26, 39 AND 44).

GINA FINK, EXAMINING ATTORNEY

SN 78-265,880. SPILLER, GLENN, GLENDALE, NY, FILED 6-23-2003.

## YOOJ

### CLASS 9—ELECTRICAL AND SCIENTIFIC APPARATUS

FOR SUNGLASSES (U.S. CLS. 21, 23, 26, 36 AND 38).

### CLASS 25—CLOTHING

FOR PANTS, SHIRTS, SWEATSHIRTS, SWEATPANTS, SKIRTS, DRESSES, SOCKS, HATS, CAPS, TIES, T-SHIRTS, SCARVES, UNDERWEAR, PAJAMAS, COATS, JACKETS, GLOVES AND SHOES (U.S. CLS. 22 AND 39).

JULIA HARDY COFIELD, EXAMINING ATTORNEY

SN 78-266,481. INFINEON TECHNOLOGIES AG, MUNICH, FED REP GERMANY, FILED 6-24-2003.

## ConverGate

PRIORITY CLAIMED UNDER SEC. 44(D) ON FED REP GERMANY APPLICATION NO. 30301295109, FILED 1-10-2003, REG. NO. 30301295, DATED 3-14-2003, EXPIRES 1-31-2013.

### CLASS 9—ELECTRICAL AND SCIENTIFIC APPARATUS

FOR ELECTRONIC COMPONENTS, NAMELY, INTEGRATED CIRCUITS AND PRINTED CIRCUITS, WIRES, RESISTORS, CAPACITORS, MICROCONTROLLERS, DIGITAL SIGNAL PROCESSORS, CODERS, TRANSCIEVERS FOR COMMUNICATION, ANALOG AND DIGITAL SWITCHES AND NET CONNECTORS; SEMICONDUCTOR COMPONENTS, NAMELY, DISCRETE AND INTEGRATED SEMICONDUCTOR COMPONENTS; TRANSISTORS, NAMELY, POWER TRANSISTORS AND HIGH-FREQUENCY TRANSISTORS; LIGHT EMITTING DIODES; INTEGRATED SEMICONDUCTOR COMPONENTS (ICS); OPTOELECTRONIC SEMICONDUCTOR COMPONENTS, NAMELY, LIGHT EMITTING DIODES, COMPONENTS FOR CYBER OPTICS; COMPUTER HARDWARE AND SOFTWARE FOR RECEIVING, DISPLAYING AND OPERATING VIDEO, AUDIO AND DIGITAL DATA SIGNALS; COMPUTER SOFTWARE FOR THE DEVELOPMENT, MAINTENANCE AND OPERATION OF LOCAL AREA NETWORKS AND WIDE AREA NETWORKS; COMPUTER HARDWARE AND SOFTWARE FOR THE DEVELOPMENT, MAINTENANCE AND OPERATION OF WIRE-CONNECTED AND/OR WIRELESS TELECOMMUNICATION NETWORKS (U.S. CLS. 21, 23, 26, 36 AND 38).

### CLASS 38—COMMUNICATION

FOR TELECOMMUNICATIONS SERVICES, NAMELY, TRANSMISSION OF SOUND AND IMAGES VIA SATELLITES AND FIBER OPTIC NETWORKS, TRANSMISSION AND PROCUREMENT OF IMAGE, SOUND AND DATA SIGNALS (U.S. CLS. 100, 101 AND 104).

INGA ERVIN, EXAMINING ATTORNEY

SN 78-268,005. SHIELD MEDICARE LIMITED, YSTRADGYNLAIS, UNITED KINGDOM, FILED 6-27-2003.

## SHIELD MEDICARE

PRIORITY CLAIMED UNDER SEC. 44(D) ON UNITED KINGDOM APPLICATION NO. 2329498, FILED 4-15-2003.

### CLASS 3—COSMETICS AND CLEANING PREPARATIONS

FOR ALCOHOL FOR CLEANING PURPOSES; NEUTRAL DETERGENTS FOR USE IN PHARMACEUTICAL, BIOTECHNOLOGY AND LABORATORY CLEANROOMS; NEUTRAL GERMICIDAL DETERGENTS FOR USE IN THE MEDICAL FIELD; AND DISPOSABLE CLEANING WIPES IMPREGNATED WITH CHEMICALS OR COMPOUNDS FOR USE IN PHARMACEUTICAL, BIOTECHNOLOGY AND LABORATORY CLEANROOMS (PRIORITY CLAIMED) (U.S. CLS. 1, 4, 6, 50, 51 AND 52).

### CLASS 5—PHARMACEUTICALS

FOR ISOPROPYL ALCOHOL AND ETHANOL ALCOHOL FOR MEDICAL OR PHARMACEUTICAL PURPOSES; ANTISEPTIC WIPES FOR MEDICAL PURPOSES; AND BIOCIDES (PRIORITY CLAIMED) (U.S. CLS. 6, 18, 44, 46, 51 AND 52).

### CLASS 16—PAPER GOODS AND PRINTED MATTER

FOR STERILE MARKER PENS (U.S. CLS. 2, 5, 22, 23, 29, 37, 38 AND 50).

**CLASS 21—HOUSEWARES AND GLASS**

FOR CLEANING TOOLS FOR CLEANING ISOLATION CABINETS, COMPRISING A HANDLE AND A HEAD TO WHICH IS FITTED A CLEANING PAD; CLEANING PADS FOR THE AFORESAID (PRIORITY CLAIMED) (U.S. CLS. 2, 13, 23, 29, 30, 33, 40 AND 50).

TINA L. SNAPP, EXAMINING ATTORNEY

SN 78-270,484. GOJO INDUSTRIES, INC., AKRON, OH. FILED 7-3-2003.

**FOMA**

OWNER OF U.S. REG. NO. 2,336,041.

**CLASS 3—COSMETICS AND CLEANING PREPARATIONS**

FOR HAND AND SKIN SOAPS (U.S. CLS. 1, 4, 6, 50, 51 AND 52).

**CLASS 5—PHARMACEUTICALS**

FOR HAND AND SKIN SANITIZING AND DISINFECTING PREPARATIONS WITH ANTIBACTERIAL AND ANTI-MICROBIAL PROPERTIES AND HAND AND SKIN LOTIONS WITH ANTIBACTERIAL AND ANTIMICROBIAL PROPERTIES (U.S. CLS. 6, 18, 44, 46, 51 AND 52).

**CLASS 21—HOUSEWARES AND GLASS**

FOR DISPENSERS AND DISPENSER REFILL CONTAINERS FOR SKIN CARE PRODUCTS AND SHAMPOOS (U.S. CLS. 2, 13, 23, 29, 30, 33, 40 AND 50).

SAMUEL E. SHARPER JR., EXAMINING ATTORNEY

SN 78-268,867. NATIONAL E COMMERCE, DBA E CHEX, IRVING, TX. FILED 6-30-2003.



NO CLAIM IS MADE TO THE EXCLUSIVE RIGHT TO USE "E CHEX", APART FROM THE MARK AS SHOWN.

**CLASS 36—INSURANCE AND FINANCIAL**

FOR CHECK VERIFICATION SERVICES; CHECK PAYMENT GUARANTEE SERVICES; ELECTRONIC FUNDS TRANSFER SERVICES; CHECK PROCESSING, NAMELY, PROVIDING CHECK SERVICES FOR CHECKS INITIATED BY TELEPHONE AND OVER A GLOBAL COMPUTER NETWORK (U.S. CLS. 100, 101 AND 102).

FIRST USE 3-8-1999; IN COMMERCE 3-8-1999.

SN 78-279,590. UNIQUE INTERIOR DESIGN, INC., LAWRENCEVILLE, GA. FILED 7-28-2003.

**READY TO SELL****CLASS 40—MATERIAL TREATMENT**

FOR ELECTRONIC CHECK CONVERSION PROCESSING THROUGH DOCUMENT DATA TRANSFER AND PHYSICAL CONVERSION SERVICES FROM ONE MEDIA TO ANOTHER; DIGITAL CHECK IMAGING SERVICES (U.S. CLS. 100, 103 AND 106).

FIRST USE 3-8-1999; IN COMMERCE 3-8-1999.

VIVIAN MICZNIK FIRST, EXAMINING ATTORNEY

**CLASS 37—CONSTRUCTION AND REPAIR**

FOR RENOVATION SERVICES IN THE FIELD OF RESIDENTIAL PROPERTIES (U.S. CLS. 100, 103 AND 106).

**CLASS 42—SCIENTIFIC, COMPUTER AND LEGAL SERVICES**

FOR INTERIOR DESIGN SERVICES IN THE FIELD OF RESIDENTIAL PROPERTIES (U.S. CLS. 100 AND 101).

KARANENDRA S. CHHINA, EXAMINING ATTORNEY

SN 78-269,150. CARLSON TRAVEL GROUP, INC., MINNEAPOLIS, MN. FILED 7-1-2003.

**SEAMASTERS****CLASS 39—TRANSPORTATION AND STORAGE**

FOR TRAVEL AGENCY SERVICES, NAMELY, MAKING RESERVATIONS AND BOOKINGS FOR TRANSPORTATION, AND MAKING CRUISE RESERVATIONS FOR INDIVIDUALS AND GROUPS (U.S. CLS. 100 AND 105).

**CLASS 42—SCIENTIFIC, COMPUTER AND LEGAL SERVICES**

FOR TRAVEL AGENCY SERVICES, NAMELY, MAKING RESERVATIONS AND BOOKINGS FOR TEMPORARY LODGING (U.S. CLS. 100 AND 101).

PATRICIA EVANKO, EXAMINING ATTORNEY

SN 78-280,109. ADVANCED AMR TECHNOLOGIES LLC, PEABODY, MA. FILED 7-29-2003.

**AdvancedAMR**  
TECHNOLOGIES LLC

NO CLAIM IS MADE TO THE EXCLUSIVE RIGHT TO USE TECHNOLOGIES LLC, APART FROM THE MARK AS SHOWN.

**CLASS 9—ELECTRICAL AND SCIENTIFIC APPARATUS**

FOR NETWORK COMMUNICATIONS SERVERS; NETWORK ACCESS SERVER HARDWARE; COMPUTER NETWORKING PRODUCTS, NAMELY, WIRELESS ROUTERS; DATA PROCESSORS; COMPUTERS; ELECTRONIC AND OPTICAL COMMUNICATIONS INSTRUMENTS AND COMPONENTS, NAMELY, OPTICAL DATA LINKS AND TRANSCEIVERS; TRANSCEIVERS; ETHERNET REPEATERS (U.S. CLS. 21, 23, 26, 36 AND 38).

**CLASS 35—ADVERTISING AND BUSINESS**

FOR WEB BASED ENERGY USAGE MANAGEMENT; ENERGY AUDITING; UTILITY DEMAND-SIDE MANAGEMENT SERVICES FOR ENERGY CONSERVATION; ELECTRICAL LOAD MANAGEMENT AND ELECTRICAL ENERGY MANAGEMENT SERVICES, PROVIDED TO RESIDENTIAL AND SMALL BUSINESS USERS (U.S. CLS. 100, 101 AND 102).

**CLASS 42—SCIENTIFIC, COMPUTER AND LEGAL SERVICES**

FOR METERING AND MONITORING ELECTRIC POWER CONSUMPTION BY THIRD PARTIES FOR ELECTRIC POWER PROVIDERS; AUTOMATIC METER READING (U.S. CLS. 100 AND 101).

STANLEY I. OSBORNE, EXAMINING ATTORNEY

---

SN 78-283,129. BEST FOODS INC., MASPETH, NY. FILED 8-5-2003.

**DEER****CLASS 29—MEATS AND PROCESSED FOODS**

FOR LENTILS (U.S. CL. 46).  
FIRST USE 6-0-1999; IN COMMERCE 6-0-1999.

**CLASS 30—STAPLE FOODS**

FOR RICE AND RICE PRODUCTS, NAMELY BASMATI RICE, NOODLES, FLOUR, CHUTNEY, SAUCES, HONEY, SPICES, CRACKERS, BISCUITS AND TEAS, ALL SOLD IN SPECIALTY ETHNIC FOOD GROCERIES (U.S. CL. 46).

FIRST USE 12-1-1998; IN COMMERCE 12-1-1998.  
TRACY CROSS, EXAMINING ATTORNEY

---

SN 78-283,137. BEST FOODS INC., MASPETH, NY. FILED 8-5-2003.

**O DEER****CLASS 29—MEATS AND PROCESSED FOODS**

FOR LENTILS AND PASTE, NAMELY GARLIC AND GINGER PASTE (U.S. CL. 46).  
FIRST USE 6-0-1999; IN COMMERCE 6-0-1999.

**CLASS 30—STAPLE FOODS**

FOR RICE AND RICE PRODUCTS, NAMELY BASMATI RICE, NOODLES, FLOUR, CHUTNEY, SAUCES, HONEY, SPICES, CRACKERS, BISCUITS AND TEAS, ALL SOLD IN SPECIALTY ETHNIC FOOD GROCERIES (U.S. CL. 46).

FIRST USE 12-1-1998; IN COMMERCE 12-1-1998.  
TRACY CROSS, EXAMINING ATTORNEY

SN 78-284,229. ALEX C. FERGUSSON, INC., FRAZER, PA. FILED 8-7-2003.

**MICRO-CLEAR****CLASS 1—CHEMICALS**

FOR POULTRY PROCESSING CHEMICALS, NAMELY, CHEMICAL ADDITIVES FOR USE IN MANUFACTURING POULTRY (U.S. CLS. 1, 5, 6, 10, 26 AND 46).

**CLASS 3—COSMETICS AND CLEANING PREPARATIONS**

FOR POULTRY PROCESSING CHEMICALS, NAMELY, CHEMICALS FOR CLEANING TO MAINTAIN SANITARY CONDITIONS IN POULTRY PROCESSING (U.S. CLS. 1, 4, 6, 50, 51 AND 52).

**CLASS 7—MACHINERY**

FOR EQUIPMENT FOR POULTRY PROCESSING, NAMELY, CUTTING MACHINES, SHAPING MACHINES, PACKAGING MACHINES (U.S. CLS. 13, 19, 21, 23, 31, 34 AND 35).

**CLASS 11—ENVIRONMENTAL CONTROL APPARATUS**

FOR EQUIPMENT FOR POULTRY PROCESSING, NAMELY, FOOD CHILLERS AND COOLERS, STERILIZERS FOR NON-MEDICAL PURPOSES, FOOD PASTEURIZERS (U.S. CLS. 13, 21, 23, 31 AND 34).

**CLASS 40—MATERIAL TREATMENT**

FOR POULTRY PROCESSING TO THE ORDER AND SPECIFICATION OF OTHERS (U.S. CLS. 100, 103 AND 106).

GWEN STOKOLS, EXAMINING ATTORNEY

---

SN 78-284,350. BC NATURAL FOODS, LLC, GOLDEN, CO. FILED 8-7-2003.

**PURELY NATURAL COLLECTION**

NO CLAIM IS MADE TO THE EXCLUSIVE RIGHT TO USE NATURAL COLLECTION, APART FROM THE MARK AS SHOWN.

**CLASS 29—MEATS AND PROCESSED FOODS**

FOR FRESH, PROCESSED, COOKED AND FROZEN POULTRY, BEEF, PORK, LAMB AND SEAFOOD; POULTRY, BEEF, PORK, LAMB AND SEAFOOD PRODUCTS, NAMELY PREPACKAGED COOKED AND UNCOOKED MEALS (U.S. CL. 46).

**CLASS 30—STAPLE FOODS**

FOR SAUCES, MARINADES, MEAT TENDERIZERS; SEASONINGS FOR USE IN THE PREPARATION OF MEAT; CONDIMENTS, NAMELY KETCHUP, MUSTARD, RELISH, PICKLES, FLAVORED MAYONNAISE, SPICE BLENDS, RUBS AND SALSAS (U.S. CL. 46).

**CLASS 35—ADVERTISING AND BUSINESS**

FOR RETAIL KIOSK SERVICES, NAMELY A SECTION WITHIN A RETAIL SUPERMARKET OR STORE WHICH FEATURES FRESH, PROCESSED, COOKED AND FROZEN POULTRY, BEEF, PORK, LAMB AND SEAFOOD AND POULTRY, BEEF, PORK, LAMB AND SEAFOOD PRODUCTS, NAMELY PREPACKAGED COOKED AND UNCOOKED MEALS, SAUCES, MARINADES, MEAT TENDERIZERS, SEASONINGS FOR USE IN THE PREPARATION OF MEAT, AND CONDIMENTS, NAMELY KETCHUP, MUSTARD, RELISH, PICKLES, FLAVORED MAYONNAISE, SPICE BLENDS, RUBS AND SALSAS (U.S. CLS. 100, 101 AND 102).

CHERYL STEPLIGHT, EXAMINING ATTORNEY

**CLASS 35—ADVERTISING AND BUSINESS**

FOR PROVISION OF MEMBERSHIP IDENTITY THEFT PREVENTION, PROTECTION AND RECOVERY SERVICES, NAMELY, MONITORING CONSUMER CREDIT REPORTS AND PROVIDING PARTICIPANTS WITH WEEKLY CREDIT ALERTS AND YEARLY CREDIT REPORTS, AS WELL AS, IN THE EVENT PARTICIPANTS BECOME VICTIMS OF IDENTITY THEFT, REFERRAL TO RECOVERY ADVOCATES, FRAUD INVESTIGATORS, LEGAL COUNSEL AND OTHER EXPERTS NECESSARY TO DEVELOP AND EXECUTE RECOVERY PLANS (U.S. CLS. 100, 101 AND 102).

**CLASS 36—INSURANCE AND FINANCIAL**

FOR PROVISION OF MEMBERSHIP IDENTITY THEFT PREVENTION AND PROTECTION SERVICES, NAMELY, PROVIDING PARTICIPANTS WITH CUSTOMIZED FINANCIAL PROTECTION PLANS AND IDENTITY THEFT PREVENTION COUNSELING (U.S. CLS. 100, 101 AND 102).

**CLASS 45—PERSONAL SERVICES**

FOR PROVISION OF MEMBERSHIP IDENTITY THEFT PREVENTION AND PROTECTION SERVICES, NAMELY, FINANCIAL IDENTITY MONITORING (U.S. CLS. 100 AND 101).

H. M. FISHER, EXAMINING ATTORNEY

SN 78-284,887. MR. GOODLIVING OY, HELSINKI, FINLAND, FILED 8-8-2003.

**DAMAGE-SAN**

PRIORITY CLAIMED UNDER SEC. 44(D) ON ERPN CMNTY TM OFC APPLICATION NO. 003192671, FILED 6-4-2003.

THE ENGLISH TRANSLATION OF SAN IS MR.

**CLASS 9—ELECTRICAL AND SCIENTIFIC APPARATUS**

FOR COMPUTER GAME SOFTWARE FOR COMMUNICATION DEVICES; COMPUTER GAME SOFTWARE, COMPUTER GAME PROGRAMS, AND COMPUTER OPERATING PROGRAMS THAT ENABLE USERS TO PLAY GAMES WITH MOBILE PHONES AND PERSONAL DIGITAL ASSISTANTS; COMPUTER COMMUNICATIONS SOFTWARE AND COMMUNICATIONS PROGRAMS THAT ENABLE USERS OF COMMUNICATION DEVICES TO SIMULTANEOUSLY ACCESS DATABASES AND GLOBAL COMPUTER NETWORKS; COMPUTER COMMUNICATIONS SOFTWARE THAT ENABLES THE TRANSMISSION OF DATA BETWEEN MOBILE COMMUNICATION APPARATUS (U.S. CLS. 21, 23, 26, 36 AND 38).

**CLASS 41—EDUCATION AND ENTERTAINMENT**

FOR ENTERTAINMENT SERVICES, NAMELY, PROVIDING COMPUTER GAMES VIA A GLOBAL COMPUTER NETWORK THAT MAY BE ACCESSED NETWORK-WIDE BY COMMUNICATIONS NETWORK USERS; PROVIDING ON-LINE COMPUTER GAMES; PROVIDING ONLINE COMPUTER INTERACTIVE GAMES AND ONLINE COMPUTER VIDEO GAMES THAT ARE ACCESSED FROM DATABASES ON WEB SITES, GLOBAL COMPUTER INFORMATION NETWORKS, AND FROM MOBILE AND CELLULAR PHONES AND PERSONAL DIGITAL ASSISTANTS (U.S. CLS. 100, 101 AND 107).

TONJA GASKINS, EXAMINING ATTORNEY

SN 78-286,812. PIVOTAL CORPORATION, VANCOUVER BRITISH COLUMBIA, CANADA, FILED 8-13-2003.

**SYNCSTREAM****CLASS 9—ELECTRICAL AND SCIENTIFIC APPARATUS**

FOR SOFTWARE FOR USE IN SYNCHRONIZING, ORGANIZING, MANAGING, AND TRANSMITTING INFORMATION AND DATA BETWEEN A MASTER AND SUBSET DATABASES, NAMELY, SOFTWARE FOR SUPPORTING SATELLITES AND DISCONNECTED MOBILE USERS TO ALLOW SCALABLE, REAL-TIME READ AND WRITE ACCESS TO DATA, AND RELATED HELP FILES AND TECHNICAL DOCUMENTATION SOLD TOGETHER AS A UNIT (U.S. CLS. 21, 23, 26, 36 AND 38).

**CLASS 41—EDUCATION AND ENTERTAINMENT**

FOR EDUCATION AND TRAINING IN THE USE OF COMPUTER SOFTWARE (U.S. CLS. 100, 101 AND 107).

**CLASS 42—SCIENTIFIC, COMPUTER AND LEGAL SERVICES**

FOR COMPUTER SOFTWARE CONSULTING SERVICES; COMPUTER SOFTWARE SUPPORT, NAMELY, TECHNICAL CONSULTATION REGARDING SOFTWARE PROBLEMS AND UPDATING OF COMPUTER SOFTWARE, AND MAINTENANCE OF COMPUTER SOFTWARE (U.S. CLS. 100 AND 101).

JENNIFER CHICOSKI, EXAMINING ATTORNEY

SN 78-286,737. IDENTITY THEFT GUARD SOLUTIONS, LLC, TUALATIN, OR. FILED 8-13-2003.

**IDENTITY SAFEGUARDS**

NO CLAIM IS MADE TO THE EXCLUSIVE RIGHT TO USE "IDENTITY", APART FROM THE MARK AS SHOWN.



SN 78-291,330. TAYLOR, MARY, DBA BUCK OFF, LAS VEGAS, NV. FILED 8-22-2003.

SN 78-294,401. VOGL, ROLAND MICHAEL, PALO ALTO, CA. FILED 8-29-2003.

## BUCK OFF COWBOY GEAR

NO CLAIM IS MADE TO THE EXCLUSIVE RIGHT TO USE "COWBOY GEAR", APART FROM THE MARK AS SHOWN.

### CLASS 18—LEATHER GOODS

FOR BAGS, NAMELY RODEO TOTE OR SHOULDER BAGS (U.S. CLS. 1, 2, 3, 22 AND 41).

### CLASS 25—CLOTHING

FOR CLOTHING, NAMELY T-SHIRTS, BUTTON SHIRTS, SWEATS, JACKETS, SHORTS AND BANDANAS (U.S. CLS. 22 AND 39).

ARETHA SOMERVILLE, EXAMINING ATTORNEY

---

SN 78-293,075. THE ST. LOUIS TRUST COMPANY, ST. LOUIS, MO. FILED 8-27-2003.



NO CLAIM IS MADE TO THE EXCLUSIVE RIGHT TO USE "ST. LOUIS TRUST COMPANY", APART FROM THE MARK AS SHOWN.

THE LINING SHOWN IN THE DRAWING IS A FEATURE OF THE MARK AND IS NOT INTENDED TO INDICATE COLOR.

### CLASS 35—ADVERTISING AND BUSINESS

FOR TAX SERVICES, NAMELY, TAX ASSESSMENT, TAX CONSULTATION, AND TAX PREPARATION (U.S. CLS. 100, 101 AND 102).

FIRST USE 11-1-2002; IN COMMERCE 11-1-2002.

### CLASS 36—INSURANCE AND FINANCIAL

FOR FINANCIAL SERVICES, NAMELY, TRUST ADMINISTRATION, INVESTMENT MANAGEMENT, CASH MANAGEMENT, TAX SERVICES IN THE NATURE OF TAX PAYMENT PROCESSING SERVICES, AND INDIVIDUALIZED FINANCIAL CONSULTATION SERVICES (U.S. CLS. 100, 101 AND 102).

FIRST USE 11-1-2002; IN COMMERCE 11-1-2002.  
CATHERINE CAIN, EXAMINING ATTORNEY

## ADDICTED

### CLASS 35—ADVERTISING AND BUSINESS

FOR PROMOTIONAL SERVICES, NAMELY, PROVIDING AN ONLINE WEBSITE THAT OFFERS THE PUBLIC THE OPPORTUNITY TO SUBMIT SELF-MADE COMMERCIALS AND OTHER PROMOTIONAL AND ADVERTISING DIGITAL CONTENT FOR DISPLAY AND PARTICIPATION IN CONTESTS, SWEEPSTAKES, ONLINE VOTING, COMPETITIONS, PRIZES AND THAT PROVIDES ADVERTISING INDUSTRY NEWS, INFORMATION AND CAREER OPPORTUNITIES (U.S. CLS. 100, 101 AND 102).

### CLASS 41—EDUCATION AND ENTERTAINMENT

FOR ENTERTAINMENT IN THE NATURE OF A NON-FICTION TELEVISION SERIES ABOUT ADVERTISING AND ENTERTAINMENT TALENT COMPETING TO CREATE ADVERTISING CAMPAIGNS AND TELEVISION COMMERCIALS FOR FEATURED SPONSORS; ENTERTAINMENT SERVICES, NAMELY, PROVIDING AN ONLINE WEBSITE THAT OFFERS THE PUBLIC THE OPPORTUNITY TO SUBMIT SELF-MADE ENTERTAINMENT FILMS AND OTHER ENTERTAINMENT DIGITAL CONTENT FOR DISPLAY AND PARTICIPATION IN CONTESTS, SWEEPSTAKES, ONLINE VOTING, COMPETITIONS, PRIZES AND THAT PROVIDES ENTERTAINMENT NEWS AND INFORMATION ABOUT AN ONGOING NON-FICTION TELEVISION SERIES (U.S. CLS. 100, 101 AND 107).

STACY WAHLBERG, EXAMINING ATTORNEY

---

SN 78-299,142. OCCIDENTAL HOTELES MANAGEMENT, S.A., MADRID 28003, SPAIN, FILED 9-11-2003.



OCCIDENTAL

### CLASS 35—ADVERTISING AND BUSINESS

FOR HOTEL MANAGEMENT (U.S. CLS. 100, 101 AND 102).

### CLASS 43—HOTEL AND RESTAURANT SERVICES

FOR PROVIDING RENTAL AND RESERVATION OF TEMPORARY ACCOMMODATIONS FOR OTHERS; MAKING HOTEL RESERVATIONS FOR OTHERS; BAR AND PUB SERVICES, CAFETERIAS, SNACK BARS; PROVIDING CAMP GROUND FACILITIES; PROVIDING HOLIDAY CAMP SERVICES, NAMELY, LODGING AND CANTEN SERVICES FOR OTHERS; HOTEL SERVICES; RESTAURANT SERVICES; SELF-SERVICE RESTAURANT SERVICES (U.S. CLS. 100 AND 101).

MARGERY A. TIERNEY, EXAMINING ATTORNEY

SN 78-299,751. GENEON ENTERTAINMENT K. K., SHI-BUYA-KU, TOKYO, JAPAN, FILED 9-12-2003.



PRIORITY CLAIMED UNDER SEC. 44(D) ON JAPAN APPLICATION NO. 2003-79245, FILED 9-12-2003, REG. NO. 4788202, DATED 7-23-2004, EXPIRES 7-23-2014.

THE COLOR(S) RED AND GREY IS/ARE CLAIMED AS A FEATURE OF THE MARK.

THE MARK CONSISTS OF THE LETTER "G" STYLIZED. IT IS COLORED RED AND GREY.

#### CLASS 9—ELECTRICAL AND SCIENTIFIC APPARATUS

FOR CHILDREN'S VIDEO RECORDINGS AND DOWNLOADABLE CHILDREN'S VIDEO RECORDINGS; VIDEO RECORDINGS AND DOWNLOADABLE VIDEO RECORDINGS FEATURING CARTOONS, ANIME, MUSIC, DOCUMENTARY FILMS, SPORTING EVENTS, TRAVELOGUES, CONCERTS, OPERAS, PERFORMING ARTS EVENTS, GENERAL ENTERTAINMENT FILMS, COMEDY FILMS, AND ACTION/ADVENTURE FILMS; MUSICAL SOUND RECORDINGS AND DOWNLOADABLE MUSICAL SOUND RECORDINGS; VIDEO GAME SOFTWARE; COMPUTER GAME SOFTWARE; DOWNLOADABLE ELECTRONIC PUBLICATIONS IN THE NATURE OF COMIC BOOKS, GRAPHIC NOVELS, NOVELS, CHILDREN'S BOOKS AND SCIENCE FICTION BOOKS (U.S. CLS. 21, 23, 26, 36 AND 38).

#### CLASS 16—PAPER GOODS AND PRINTED MATTER

FOR PHOTOGRAPHS; BOOKS OF PHOTOGRAPHS; COMIC BOOKS; GRAPHIC NOVELS; NOVELS; CHILDREN'S BOOKS; SCIENCE FICTION BOOKS (U.S. CLS. 2, 5, 22, 23, 29, 37, 38 AND 50).

#### CLASS 41—EDUCATION AND ENTERTAINMENT

FOR ENTERTAINMENT IN THE NATURE OF SCIENCE FICTION, ACTION/ADVENTURE, DOCUMENTARY, SPORTS, CHILDREN'S, CARTOON OR COMEDY TELEVISION SERIES; PRODUCTION OF RADIO AND TELEVISION PROGRAMS; MULTIMEDIA ENTERTAINMENT SOFTWARE PRODUCTION SERVICES; PRODUCTION AND DISTRIBUTION OF MOTION PICTURES; DISTRIBUTION OF TELEVISION PROGRAMS FOR OTHERS; PUBLICATION OF BOOKS; ONLINE PUBLICATION OF BOOKS; RENTAL OF VIDEO GAMES, COMPUTER GAME PROGRAMS, FILMS AND SOUND RECORDINGS; ENTERTAINMENT SERVICES, NAMELY, PROVIDING A WEB SITE FEATURING MUSICAL PERFORMANCES, MUSICAL VIDEOS, RELATED FILM CLIPS, PHOTOGRAPHY AND OTHER MULTIMEDIA MATERIALS; ON-LINE LIBRARY SERVICES, NAMELY ELECTRONIC LIBRARY SERVICES WHICH FEATURE PHOTOGRAPHS VIA AN ON-LINE COMPUTER NETWORK; ENTERTAINMENT, NAMELY, PROVIDING ON-LINE COMPUTER GAMES; PROVIDING ON-LINE INFORMATION ABOUT COMPUTER GAMES, MOVIES, ANIME, COMIC BOOKS AND ENTERTAINMENT; CINEMATOGRAPHIC ADAPTATION AND EDITING (U.S. CLS. 100, 101 AND 107).

ANNE MADDEN, EXAMINING ATTORNEY

SN 78-299,901. CONSTRUCTION RESEARCH & TECHNOLOGY GMBH, TROSTBERG, FED REP GERMANY, FILED 9-12-2003.

## MEYCO

OWNER OF U.S. REG. NO. 1,619,439.

#### CLASS 1—CHEMICALS

FOR CHEMICAL ADDITIVES AND ADMIXTURES FOR USE IN CEMENTITIOUS TOPPING, LIQUID FOAMING POLYMER, GROUT AND CONCRETE (U.S. CLS. 1, 5, 6, 10, 26 AND 46).

FIRST USE 0-0-1975; IN COMMERCE 0-0-1975.

#### CLASS 19—NON-METALLIC BUILDING MATERIALS

FOR NON-METALLIC BUILDING MATERIALS, NAMELY, CEMENTITIOUS TOPPING, GROUT AND CONCRETE (U.S. CLS. 1, 12, 33 AND 50).

FIRST USE 0-0-1975; IN COMMERCE 0-0-1975.

DANIELLE MATTESSICH, EXAMINING ATTORNEY

SN 78-299,930. WORLD VISION, INC., FEDERAL WAY, WA, FILED 9-12-2003.

## VISION YOUTH

NO CLAIM IS MADE TO THE EXCLUSIVE RIGHT TO USE "YOUTH", APART FROM THE MARK AS SHOWN.

#### CLASS 35—ADVERTISING AND BUSINESS

FOR CHARITABLE SERVICES, NAMELY, RECRUITING VOLUNTEERS TO MENTOR HIGH RISK TEENS (U.S. CLS. 100, 101 AND 102).

FIRST USE 7-31-1998; IN COMMERCE 7-31-1998.

#### CLASS 36—INSURANCE AND FINANCIAL

FOR CHARITABLE FUNDRAISING; CHARITABLE SERVICES, NAMELY, ADMINISTERING AND PROVIDING MONETARY RELIEF TO PAY FOR ALL OR A PORTION OF OUTREACH WORKERS' SALARIES FOR THE PURPOSE OF WORKING WITH HIGH RISK TEENS (U.S. CLS. 100, 101 AND 102).

FIRST USE 7-31-1998; IN COMMERCE 7-31-1998.

#### CLASS 41—EDUCATION AND ENTERTAINMENT

FOR EDUCATION SERVICES, NAMELY, PROVIDING ONE-ON-ONE MENTORING TO HIGH RISK TEENS IN THE FIELD OF ACADEMICS AND LIFE SKILLS; CHARITABLE SERVICES, NAMELY, TRAINING VOLUNTEERS TO MENTOR HIGH RISK TEENS (U.S. CLS. 100, 101 AND 107).

FIRST USE 7-31-1998; IN COMMERCE 7-31-1998.

DOUGLAS LEE, EXAMINING ATTORNEY

SN 78-299,934. TEQUILA CUERVO LA ROJENA, S.A. DE C.V., CODIGO 45070, MEXICO, FILED 9-12-2003.

## POTRILLO

THE ENGLISH TRANSLATION OF POTRILLO IS "LITTLE COLT."

**CLASS 32—LIGHT BEVERAGES**

FOR NON-ALCOHOLIC COCKTAIL MIXES (U.S. CLS. 45, 46 AND 48).

**CLASS 33—WINES AND SPIRITS**

FOR ALCOHOLIC BEVERAGES, NAMELY, ALCOHOLIC COCKTAIL MIXES, TEQUILA, LIQUEURS (U.S. CLS. 47 AND 49).  
RICHARD WHITE, EXAMINING ATTORNEY

SN 78-304,123. PUTTING THE OM IN SHALOM, PHILADELPHIA, PA. FILED 9-23-2003.

**PUTTING THE OM IN SHALOM**

**CLASS 16—PAPER GOODS AND PRINTED MATTER**

FOR BOOKS FEATURING YOGA (U.S. CLS. 2, 5, 22, 23, 29, 37, 38 AND 50).

**CLASS 25—CLOTHING**

FOR T-SHIRTS, SWEATSHIRTS, AND ARTICLES OF CLOTHING RELATED TO FITNESS, NAMELY, SHORTS AND SWEAT SUITS (U.S. CLS. 22 AND 39).

**CLASS 27—FLOOR COVERINGS**

FOR GYMNASIUM EXERCISE MATS FOR YOGA (U.S. CLS. 19, 20, 37, 42 AND 50).  
GLENN CLARK, EXAMINING ATTORNEY

SN 78-302,263. YUWONO, TJIOE BUDI, JAKARTA BARAT, INDONESIA, FILED 9-18-2003.

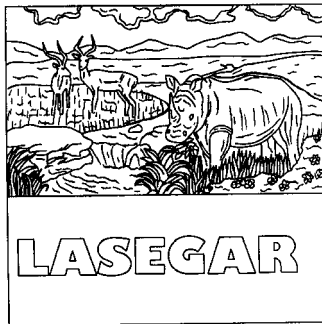

THE MARK CONSISTS OF THE WORD LASEGAR AND REPRESENTATIONS OF RHINOCEROS AND DEER.

**CLASS 5—PHARMACEUTICALS**

FOR LIQUID MEDICATION USED TO REDUCE FEVER, AND FOR THE TREATMENT OF COLDS, COUGHS, SORE THROATS, AND STOMACH, GASTROINTESTINAL AND DIGESTIVE DISORDERS; MEDICATED ISOTONIC DRINKS; MEDICATED ENERGY DRINKS; VITAMINS; MEDICINAL HERB EXTRACTS AND MEDICINAL HERBS IN DRIED OR PRESERVED FORM; HERBAL TEAS FOR MEDICINAL PURPOSES; BALMS, OINTMENTS AND RUBBING COMPOUNDS FOR MEDICAL AND/OR THERAPEUTIC USE; DIETARY FOOD SUPPLEMENTS; BABY FOOD (U.S. CLS. 6, 18, 44, 46, 51 AND 52).

**CLASS 32—LIGHT BEVERAGES**

FOR NON-ALCOHOLIC BEVERAGES, NAMELY, FRUIT DRINKS, FRUIT JUICES, ENERGY DRINKS, ISOTONIC DRINKS, MINERAL WATERS, AND AERATED WATERS; PREPARATIONS FOR MAKING BEVERAGES, NAMELY, CONCENTRATES, SYRUPS AND POWDERS USED IN THE PREPARATION OF NON-ALCOHOLIC BEVERAGES, NAMELY, FRUIT DRINKS, FRUIT JUICES, ENERGY DRINKS, AND ISOTONIC DRINKS (U.S. CLS. 45, 46 AND 48).  
JAMES GRIFFIN, EXAMINING ATTORNEY

SN 78-304,267. NEW LIFE RESOURCES, LLC, CARTHAGE, MO. FILED 9-23-2003.

**NEM**

**CLASS 1—CHEMICALS**

FOR INGREDIENTS FOR USE IN THE MANUFACTURE OF COSMETICS AND SKIN CARE PRODUCTS, NAMELY, EGGSHHELL MEMBRANE, EGGSHHELL MEMBRANE POWDER; INGREDIENTS, NAMELY, EGGSHHELL MEMBRANE POWDER, EGGSHHELL MEMBRANE ISOLATES AND EGGSHHELL MEMBRANE HYDROLYSATES FOR USE IN THE MANUFACTURE OF NUTRITIONAL AND DIETARY SUPPLEMENTS, NUTRITIONAL SUPPLEMENTS AND MEDICINAL PRODUCTS (U.S. CLS. 1, 5, 6, 10, 26 AND 46).

**CLASS 3—COSMETICS AND CLEANING PREPARATIONS**

FOR COSMETICS; SUNSCREEN; AND NON-MEDICATED SKIN CARE PREPARATIONS (U.S. CLS. 1, 4, 6, 50, 51 AND 52).

**CLASS 5—PHARMACEUTICALS**

FOR MEDICATED SKIN CARE PREPARATIONS; NEUTRACEUTICALS FOR USE IN NETRACEUTICALS FOR USE IN IMPROVING JOINT FLEXIBILITY, IMPROVING COMFORT, IMPROVING JOINT RANGE OF MOTION, RELIEF OF JOINT AND SOFT TISSUE PAIN, WEIGHT CONTROL; NUTRITIONAL SUPPLEMENTS; NEUTRACEUTICAL PREPARATIONS FOR WOUND TREATMENT FOR HUMANS AND ANIMALS, INCLUDING POWDERS, CREAMS AND OINTMENTS; NEUTRACEUTICAL CAPSULES FOR USE IN IMPROVING JOINT FLEXIBILITY, IMPROVING COMFORT, IMPROVING JOINT RANGE OF MOTION, RELIEF OF JOINT AND SOFT TISSUE PAIN, WEIGHT CONTROL; NEUTRACEUTICAL CREAM FOR ANTI-ANGING; NEUTRACEUTICALS FOR USE AS DIETARY SUPPLEMENTS IN FOODS AND ANIMAL FEED; THERAPEUTIC PREPARATIONS FOR SKIN, HAIR AND NAILS; LOCALLY APPLIED MEDICINAL PRODUCT FOR JOINT PAIN, NAMELY, CREAMS AND LOTIONS; AND MEDICINAL PRODUCTS, NAMELY, WOUND DRESSINGS (U.S. CLS. 6, 18, 44, 46, 51 AND 52).  
BRIAN NEVILLE, EXAMINING ATTORNEY

SN 78-305,608. AMINA RUBINACCI S.R.L., 80121 NAPOLI, ITALY, FILED 9-25-2003.

**AMINA RUBINACCI**

**CLASS 18—LEATHER GOODS**

FOR HANDBAGS, SUITCASES, WALLETS, BRIEF-CASES, SCHOOL BAGS, HANDBAGS FOR MEN, TRUNKS FOR TRAVEL, LEATHER AND IMITATION LEATHER SOLD IN BULK, HIDE AND IMITATION HIDE SOLD IN BULK, PARASOLS, PATIO, UMBRELLAS, WALKING STICKS, HARNESSES AND OTHER SADDLERY ARTICLES (U.S. CLS. 1, 2, 3, 22 AND 41).  
FIRST USE 0-0-1967; IN COMMERCE 0-0-1971.

**CLASS 24—FABRICS**

FOR GOODS OF TEXTILE MATERIALS, NAMELY, BROCADES, BUCKRAM, COTTON FABRICS, DAMASK, DIAPERED LINEN, LINEN CLOTH, FLANNEL, JERSEY MATERIAL, JUTE FABRICS, RAYON FABRICS, SILK CLOTH, FUSTIAN, CREPE FABRICS, TAFFETA, TULLE, VELVET, WOOLEN CLOTH, ZEPHYR FABRIC, GUMMED CLOTH FABRIC, CHIFFON FABRIC, CHENILLE FABRICS, HEMP FABRICS, GOODS OF TEXTILE ELASTIC MATERIALS, NAMELY, FABRICS OF ANIMAL SKIN IMITATION, GLASS YARN TISSUES FOR TEXTILE USE, ARTICLES OF TEXTILE MATERIALS, NAMELY, TEXTILE CURTAINS FOR WINDOWS, TISSUE TAPESTRY AND UPHOLSTERY FABRIC, CLOTH FLAGS, BED BLANKETS, BED CLOTHES IN THE NATURE OF BED LINEN, BED SHEETS, BED COVERS IN THE NATURE OF BED SPREADS, PILLOWCASES, TABLE COVERS IN THE NATURE OF TABLECLOTHS, TABLE BLANKETS, HOUSEHOLD LINEN, TOWELS MADE OF TEXTILE MATERIALS, TOILET GLOVES IN THE NATURE OF FITTED TOILET LID COVERS, BATH LINEN EXCEPT CLOTHING, HANDKERCHIEFS MADE OF TEXTILE MATERIALS, TISSUES OF TEXTILE FOR REMOVING MAKEUP, NAMELY, CLOTH NAPKINS FOR REMOVING MAKEUP, FABRICS FOR THE MANUFACTURE OF SHOES (U.S. CLS. 42 AND 50).  
FIRST USE 0-0-1967; IN COMMERCE 0-0-1971.

**CLASS 25—CLOTHING**

FOR CLOTHING ARTICLES FOR MEN, WOMEN AND CHILDREN; NAMELY, SHIRTS, BLOUSES, SKIRTS, COATS, TROUSERS, PANTS, VESTS, JERSEYS, PAJAMAS, SOCKS AND STOCKINGS, SINGLETTS, CORSETS, GARTERS, UNDERPANTS, PETTICOATS, HATS, HEADSCARVES, NECKTIES, RAINCOATS, OVERCOATS, GREATCOAT, BATHING SUITS, SPORTS OVERALLS, WIND-RESISTANT JACKETS, SKI PANTS, BELTS FOR COATS, SCARVES, GLOVES, DRESSING GOWNS, FOOTWEAR; NAMELY, SHOES, SPORTS SHOES, SLIPPERS AND BOOTS (U.S. CLS. 22 AND 39).  
FIRST USE 0-0-1967; IN COMMERCE 0-0-1971.  
CHERYL CLAYTON, EXAMINING ATTORNEY

SN 78-307,825. OFF-CAMPUS DINING NETWORK, KING OF PRUSSIA, PA. FILED 10-1-2003.

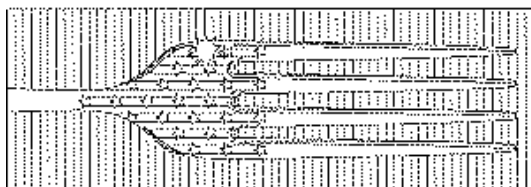

THE DRAWING IS LINED FOR THE COLOR(S) RED AND BLUE AND THE COLOR IS CLAIMED AS A FEATURE OF THE MARK.

**CLASS 9—ELECTRICAL AND SCIENTIFIC APPARATUS**

FOR PRINTED MATTER AND PUBLICATIONS, NAMELY, PRINTED PLASTIC AND PAPER DEBIT CARDS WITH MAGNETIC CODING (U.S. CLS. 21, 23, 26, 36 AND 38).  
FIRST USE 5-0-2003; IN COMMERCE 5-0-2003.

**CLASS 16—PAPER GOODS AND PRINTED MATTER**

FOR PRINTED MATTER AND PUBLICATIONS, NAMELY, PRINTED PLASTIC AND PAPER DEBIT CARDS WITHOUT MAGNETIC CODING (U.S. CLS. 2, 5, 22, 23, 29, 37, 38 AND 50).  
FIRST USE 5-0-2003; IN COMMERCE 5-0-2003.

**CLASS 36—INSURANCE AND FINANCIAL**

FOR DEBIT CARD SERVICES FOR STUDENT MEAL PLANS (U.S. CLS. 100, 101 AND 102).  
FIRST USE 5-0-2003; IN COMMERCE 5-0-2003.  
MITCHELL FRONT, EXAMINING ATTORNEY

SN 78-308,706. AMCOR FLEXIBLES UK LIMITED, LONDON, UNITED KINGDOM, FILED 10-2-2003.

**AGRIFRESH**

**CLASS 16—PAPER GOODS AND PRINTED MATTER**

FOR PLASTIC PACKAGING MATERIAL, NAMELY PLASTIC BAGS FOR PACKING, PLASTIC FILM FOR WRAPPING NOT FOR COMMERCIAL OR INDUSTRIAL PACKAGING USE; WRAPPING MATERIAL, NAMELY PLASTIC WRAP (U.S. CLS. 2, 5, 22, 23, 29, 37, 38 AND 50).

**CLASS 17—RUBBER GOODS**

FOR PLASTIC FILM FOR INDUSTRIAL AND COMMERCIAL PACKING USE, NAMELY PLASTIC FILM FOR WRAPPING; PLASTIC FILMS USED AS PACKAGING FOR FOOD, NAMELY PRINTED AND UNPRINTED FLEXIBLE PLASTIC PACKAGING FILMS FOR WRAPPING ITEMS OF FRESH PRODUCE (U.S. CLS. 1, 5, 12, 13, 35 AND 50).  
STEVEN BERK, EXAMINING ATTORNEY

SN 78-309,692. WALTER'S PUBLISHING, WASECA, MN. FILED 10-6-2003.

**WALTER'S**

**CLASS 36—INSURANCE AND FINANCIAL**

FOR CHARITABLE FUND RAISING SERVICES (U.S. CLS. 100, 101 AND 102).  
FIRST USE 6-4-1974; IN COMMERCE 6-4-1974.

**CLASS 41—EDUCATION AND ENTERTAINMENT**

FOR PUBLICATION SERVICES FOR YEARBOOKS AND COOKBOOKS (U.S. CLS. 100, 101 AND 107).  
FIRST USE 6-4-1974; IN COMMERCE 6-4-1974.  
MIDGE BUTLER, EXAMINING ATTORNEY

SN 78-311,078. BALANCE BAR COMPANY, NORTHFIELD, IL. FILED 10-8-2003.

SN 78-312,279. REGAL CINEMEDIA CORPORATION, ENGLEWOOD, CO. FILED 10-10-2003.

**BALANCE BAR. GRAB LIFE.**

OWNER OF U.S. REG. NO. 2,659,753.

**CLASS 29—MEATS AND PROCESSED FOODS**

FOR PROTEIN-BASED, NUTRIENT-DENSE SNACK BARS, AND SOY BASED CHIPS (U.S. CL. 46).

**CLASS 30—STAPLE FOODS**

FOR COOKIES, CRACKERS, GRAIN-BASED CHIPS AND TORTILLA CHIPS (U.S. CL. 46).  
GINA FINK, EXAMINING ATTORNEY

SN 78-312,072. RCA TRADEMARK MANAGEMENT SA, BOULOGNE-BILLANCOURT, FRANCE, FILED 10-10-2003.



OWNER OF U.S. REG. NOS. 853,565, 1,188,515 AND OTHERS.

**CLASS 9—ELECTRICAL AND SCIENTIFIC APPARATUS**

FOR TELEVISIONS WITH VIDEO RECORDERS INTEGRATED; PROJECTION TV'S; TELEVISION SCREENS; VIDEO PROJECTORS; DIGITAL AUDIO DISC PLAYERS AND RECORDERS; AMPLIFIERS; HIGH FIDELITY MICRO/MINI SYSTEMS COMPRISED OF STEREO TUNERS, STEREO RECEIVERS, STEREO SPEAKERS, CD PLAYERS AND RECORDERS, CASSETTE PLAYERS AND RECORDERS; PROGRAMMABLE DIGITAL VIDEO DISC PLAYERS AND RECORDERS; PROGRAMMABLE DIGITAL AUDIO DISC PLAYERS AND RECORDERS; AUDIO-VIDEO RECEIVERS; SET TOP BOXES; PERSONAL VIDEO RECORDERS; REMOTE CONTROLS FOR ALL THE AFORESAID GOODS; CAMCORDERS; VIDEO TRANSMITTERS; VIDEO SENDERS; CONVERTERS; ENCODERS; DECODERS; CABLE MODEMS; ROUTERS; VIDEO SERVERS; VIDEO MIXERS; GATEWAYS; HOME SERVERS; MEDIA SERVERS; VIDEO SERVERS; REMOTE CONTROLS; HEADPHONES; ANTENNAS; DONGLES; PCMCIA CARDS (U.S. CLS. 21, 23, 26, 36 AND 38).

**CLASS 38—COMMUNICATION**

FOR CABLE RADIO TRANSMISSION; CABLE TELEVISION TRANSMISSION; DIGITAL TRANSMISSION OF VOICES, DATA, IMAGES, SIGNALS; DELIVERY OF MESSAGES VIA SATELLITE, CABLE, AND ANTENNA (U.S. CLS. 100, 101 AND 104).  
GIANCARLO CASTRO, EXAMINING ATTORNEY

**ENTERTAINMENT IGNITED**

NO CLAIM IS MADE TO THE EXCLUSIVE RIGHT TO USE "ENTERTAINMENT", APART FROM THE MARK AS SHOWN.

**CLASS 35—ADVERTISING AND BUSINESS**

FOR BUSINESS MARKETING AND CONSULTING SERVICES, NAMELY DEVELOPMENT, MARKETING AND IMPLEMENTATION OF ADVERTISING AND THE PROMOTION OF ADVERTISING SERVICES; DEVELOPING ADVERTISING FOR OTHERS; COOPERATIVE MARKETING OF MERCHANDISE AND GENERAL CONSUMER GOODS. (U.S. CLS. 100, 101 AND 102).

**CLASS 41—EDUCATION AND ENTERTAINMENT**

FOR ENTERTAINMENT SERVICES, NAMELY THE PRODUCTION, DISTRIBUTION AND EXHIBITION OF PROGRAMS CONSISTING OF ACTION, COMEDY, DRAMA, ANIMATION, ADVERTISING AND MARKETING CONTENT (U.S. CLS. 100, 101 AND 107).  
KATHERINE STOIDES, EXAMINING ATTORNEY

SN 78-314,376. CECCHI E CECCHI TESSITURE S.R.L., 50041 CALENZANO - FIRENZE, ITALY, FILED 10-16-2003.



**CLASS 24—FABRICS**

FOR BEDSPREADS, BED BLANKET, THROWS (U.S. CLS. 42 AND 50).  
FIRST USE 1-0-2002; IN COMMERCE 1-0-2002.

**CLASS 25—CLOTHING**

FOR SCARVES AND SHAWLS (U.S. CLS. 22 AND 39).  
FIRST USE 1-0-2002; IN COMMERCE 1-0-2002.  
MIDGE BUTLER, EXAMINING ATTORNEY

SN 78-314,746. ROCKHURST UNIVERSITY, KANSAS CITY, MO. FILED 10-16-2003.

SN 78-316,188. SCIENTEUR CORPORATION, GREENFIELD, IN. FILED 10-21-2003.



## SCIENTEUR

### CLASS 42—SCIENTIFIC, COMPUTER AND LEGAL SERVICES

FOR PROVIDING AN ONLINE ELECTRONIC COMPUTER DATABASE ON GLOBAL COMPUTER NETWORKS IN THE FIELD OF SCIENTIFIC INFORMATION (U.S. CLS. 100 AND 101).

FIRST USE 6-27-2003; IN COMMERCE 6-27-2003.

### CLASS 44—MEDICAL, BEAUTY AND AGRICULTURAL SERVICES

FOR PROVIDING AN ONLINE ELECTRONIC COMPUTER DATABASE ON GLOBAL COMPUTER NETWORKS IN THE FIELD OF MEDICAL AND PHARMACEUTICAL INFORMATION (U.S. CLS. 100 AND 101).

FIRST USE 6-27-2003; IN COMMERCE 6-27-2003.  
ALICE BENMAMAN, EXAMINING ATTORNEY

### CLASS 16—PAPER GOODS AND PRINTED MATTER

FOR PRINTED MATTER, NAMELY, PRINTED AWARDS, DIPLOMAS, DIPLOMA COVERS, PRINTED INVITATIONS, GREETING CARDS, NOTE CARDS, BUSINESS CARDS, STATIONARY, ENVELOPES, CLIPBOARDS, DECALS, PAPER FLAGS, PENCILS, PENS, PHOTOGRAPH ALBUMS, NOTEBOOKS, PRINTED PAPER SIGNS, PAPER BANNERS, PAPER IDENTIFICATION CARDS, PAPER NAME BADGES, TRADING CARDS, POSTCARDS, PHOTOGRAPHIC PRINTS, ART PRINTS, STICKERS AND PLASTIC TRANSFERS, BANK CHECKS, CHECKBOOKS, CHECKBOOK COVERS, CHECKBOOK HOLDERS, CHECKBOOK WALLET, PASSPORT WALLET, PUBLICATIONS, NAMELY NEWSLETTERS, BROCHURES AND NEWSPAPERS FEATURING INFORMATION REGARDING EDUCATION, SPORTS, ENTERTAINMENT AND ALUMNI NEWS; PAPER TABLE LINENS, PAPER NAPKINS, PLACE MATS OF PAPER, AND COASTERS MADE OF PAPER (U.S. CLS. 2, 5, 22, 23, 29, 37, 38 AND 50).

FIRST USE 7-1-1999; IN COMMERCE 7-1-1999.

### CLASS 25—CLOTHING

FOR APPAREL, NAMELY SHIRTS, T-SHIRTS, SWEATERS, JACKETS, COATS, SWEAT SHIRTS, SWEAT PANTS, PAJAMAS, NIGHT SHIRTS, PANTS, BASEBALL CAPS, HATS, VISORS, TIES, GLOVES, MITTENS, MUFFLERS, BOXER SHORTS, AND ATHLETIC UNIFORMS (U.S. CLS. 22 AND 39).

FIRST USE 7-1-1999; IN COMMERCE 7-1-1999.

### CLASS 41—EDUCATION AND ENTERTAINMENT

FOR EDUCATIONAL SERVICES, NAMELY, PROVIDING COURSES OF INSTRUCTION AT THE UNDERGRADUATE AND GRADUATE LEVEL AT MULTIPLE SITES AND VIA A GLOBAL COMPUTER NETWORK; CONDUCTING INTERCOLLEGIATE ATHLETIC EXHIBITIONS; AND PROVIDING ENTERTAINMENT EXHIBITIONS IN THE NATURE OF THEATER AND LIVE MUSIC CONCERT PRODUCTIONS; EDUCATIONAL SERVICES, NAMELY, PROVIDING INFORMATION IN THE NATURE OF UNDERGRADUATE AND GRADUATE LEVEL EDUCATION AND COURSES OF INSTRUCTION, BOTH LIVE AND VIA A GLOBAL COMPUTER NETWORK (U.S. CLS. 100, 101 AND 107).

FIRST USE 7-1-1999; IN COMMERCE 7-1-1999.  
DANIEL CAPSHAW, EXAMINING ATTORNEY

SN 78-316,276. NEW YORK SUB, INC., DALLAS, TX. FILED 10-21-2003.



NO CLAIM IS MADE TO THE EXCLUSIVE RIGHT TO USE "SUB" AND "SUB SINCE 1974", APART FROM THE MARK AS SHOWN.

### CLASS 35—ADVERTISING AND BUSINESS

FOR RESTAURANT FRANCHISING SERVICES FEATURING SUBMARINE AND DELI SANDWICHES (U.S. CLS. 100, 101 AND 102).

FIRST USE 2-11-1994; IN COMMERCE 2-11-1994.

### CLASS 43—HOTEL AND RESTAURANT SERVICES

FOR RESTAURANT SERVICES, CATERING SERVICES, AND TAKE OUT RESTAURANT SERVICES (U.S. CLS. 100 AND 101).

FIRST USE 2-11-1994; IN COMMERCE 2-11-1994.  
ASMAT KHAN, EXAMINING ATTORNEY

SN 78-317,524. OPORTO PORTUGUESE STYLE CHICKEN PTY LIMITED, SYDNEY, NEW SOUTH WALES, AUSTRALIA, FILED 10-23-2003.

SN 78-318,962. WILTON COMPANY, THE, MOUNT JOY, PA. FILED 10-27-2003.

## CABIN HOME

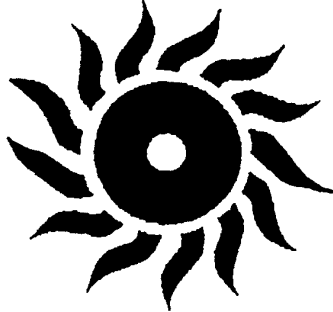

OWNER OF AUSTRALIA REG. NO. 676670, DATED 10-30-1995, EXPIRES 10-30-2005.

OWNER OF AUSTRALIA REG. NO. 676669, DATED 10-30-1995, EXPIRES 10-30-2005.

THE STIPPLING IS FOR SHADING PURPOSES ONLY.

### CLASS 29—MEATS AND PROCESSED FOODS

FOR MEAT; FISH; MEAT EXTRACTS; BEEF BURGERS, NAMELY HAMBURGERS; POULTRY, NAMELY UNCOOKED, MARINATED, PREPARED FOR COOKING, COOKED AND OTHER POULTRY; POULTRY, NAMELY PREPARED CHICKEN, CHICKEN BURGERS, CHICKEN SCHNITZEL AND CHICKEN SCHNITZEL BURGERS, CHILI CHICKEN; POULTRY AND VEGETABLES, NAMELY, PRE-PACKAGED DINNERS CONSISTING OF CHICKEN WITH POTATOES, NAMELY, FRENCH-FRIED POTATOES AND CHICKEN, VEGETABLES AND SALADS; SAUSAGES; FRUIT SALADS; VEGETABLE SALADS; MEAT JELLIES; COOKED, DRIED AND PRESERVED VEGETABLES; COOKED, DRIED AND PRESERVED VEGETABLES PREPARED WITH SAUCES AND DRESSINGS; CONDIMENTS, NAMELY, PEPPER OIL AND MARINATED AND PROCESSED ONIONS (U.S. CL. 46).

### CLASS 30—STAPLE FOODS

FOR GRAVIES; JELLIES, NAMELY, FRUIT JELLIES AND FLAVORED JELLIES; CONDIMENTS, NAMELY, KETCHUP, RELISH, MUSTARD; SAUCES, NAMELY, CHILI SAUCE, HOT SAUCE, PIQUANTE SAUCE, TOMATO SAUCE, BARBEQUE SAUCE, LEMON AND HERB SAUCE AND MAYONNAISE (U.S. CL. 46).

### CLASS 43—HOTEL AND RESTAURANT SERVICES

FOR RESTAURANT SERVICES, NAMELY RESTAURANTS, CAFES AND SNACK BARS FEATURING DINE-IN AND TAKE-OUT SERVICES, HOME DELIVERY AND SELF-SERVICE (U.S. CLS. 100 AND 101).  
RENEE MCCRAY, EXAMINING ATTORNEY

### CLASS 8—HAND TOOLS

FOR FLATWARE MADE OF NON-PRECIOUS METAL, NAMELY KNIVES, FORKS AND SPOONS, TONGS, AND SEAFOOD MALLETS; MORTAR AND PESTLE SETS FOR KITCHEN AND DECORATIVE USE; CHEF KNIVES FOR CARVING FOODS (U.S. CLS. 23, 28 AND 44).

### CLASS 11—ENVIRONMENTAL CONTROL APPARATUS

FOR CHAFING DISHES (U.S. CLS. 13, 21, 23, 31 AND 34).

### CLASS 21—HOUSEWARES AND GLASS

FOR BOTTLES SOLD EMPTY, BOWLS, SERVING BREAD TRAYS NOT OF PRECIOUS METAL, BUTTER DISHES, CAKE STANDS, CASSEROLES, COASTERS NOT OF PAPER AND NOT BEING TABLE LINEN, CUPS NOT OF PRECIOUS METAL, DUTCH OVENS, GOBLETS, GRAVY AND SAUCE BOATS, MUGS, METAL COOKING PANS, PITCHERS, SERVING PLATTERS, POTS, SALT AND PEPPER HOLDERS, SAUCE CUPS, SAUCERS, SERVING DISHES, SUGAR HOLDERS, TRIVETS, VASES, TANKARDS NOT OF PRECIOUS METAL, SERVING TRAYS NOT OF PRECIOUS METAL, SOUP TUREENS, CANISTERS FOR HOUSEHOLD USE, COFFEE AND TEA POTS NOT OF PRECIOUS METAL, NON-ELECTRIC KETTLES, POT LIDS, NAPKIN HOLDERS AND NAPKIN RINGS NOT OF PRECIOUS METAL, PLATES, CANDLE HOLDERS NOT OF PRECIOUS METAL, CANDLE SNUFFERS NOT OF PRECIOUS METAL, CREAM PITCHERS NOT OF PRECIOUS METAL, AND BUCKETS FOR HOLDING ICE OR BOTTLES OF CHAMPAGNE OR BOTTLES OF WINE, COOKING UTENSILS, NAMELY GRILLS; SERVINGWARE FOR SERVING FOOD, NAMELY, SERVING SPOONS, SERVING FORKS, KITCHEN LADLES AND TONGS; TURNERS, SPATULAS, SKEWERS, BRUSHES AND WHISKS; GRILL SCRAPPERS, AND POT AND PAN SCRAPPERS (U.S. CLS. 2, 13, 23, 29, 30, 33, 40 AND 50).

RUSS HERMAN, EXAMINING ATTORNEY

SN 78-319,025. SHEPLEY WOOD PRODUCTS, INC., HYANNIS, MA. FILED 10-27-2003.

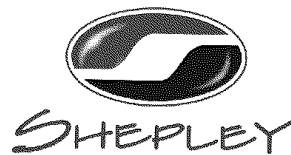

### CLASS 35—ADVERTISING AND BUSINESS

FOR WHOLESALE AND RETAIL STORE SERVICES FEATURING BUILDING MATERIALS, CONSTRUCTION MATERIALS AND LUMBER (U.S. CLS. 100, 101 AND 102).

FIRST USE 4-3-1997; IN COMMERCE 4-3-1997.

**CLASS 37—CONSTRUCTION AND REPAIR**

FOR INSTALLATION, MAINTENANCE AND REPAIR OF WINDOWS AND DOORS (U.S. CLS. 100, 103 AND 106).

FIRST USE 4-3-1997; IN COMMERCE 4-3-1997.  
ALICE BENMAMAN, EXAMINING ATTORNEY

SN 78-319,997. KURARAY CO., LTD., KURASHIKI CITY, OKAYAMA PREFECTURE, JAPAN, FILED 10-29-2003.



The logo for 'astrino' is written in a lowercase, bold, sans-serif font. The letter 'a' is stylized with a long, sweeping tail that curves under the 's' and extends to the left. The 'i' has a simple dot above it. The 'n' and 'o' are also in the same bold, sans-serif style.

**CLASS 24—FABRICS**

FOR WOVEN FABRICS COMPOSED OF VISCOSE RAYON, CUPRAMMONIUM RAYON, ACETATE, POLY-MIX, NYLON, POLYAMINO-ACID, POLYESTER, POLY-ETHYLENE, POLYURETHANE, POLYPROPYLENE, POLYOLEFIN, POLYVINYL, VINYLON, POLYCHLAL, AND ACRYLIC FOR THE MANUFACTURE OF CLOTHING, GLOVES, HEADWEAR, WAISTBANDS AND FOOTWEAR; KNITTED FABRICS COMPOSED OF VISCOSE RAYON, CUPRAMMONIUM RAYON, ACETATE, POLY-MIX, NYLON, POLYAMINO ACID, POLYESTER, POLY-ETHYLENE, POLYURETHANE, POLYPROPYLENE, POLYOLEFIN, POLYVINYL, VINYLON, POLYCHLAL, AND ACRYLIC FOR THE MANUFACTURE OF CLOTHING, GLOVES, HEADWEAR, WAISTBANDS AND FOOTWEAR; FELT CLOTH; NON-WOVEN TEXTILE FABRICS COMPOSED OF VISCOSE RAYON, CUPRAMMONIUM RAYON, ACETATE, POLY-MIX, NYLON, POLYAMINO-ACID, POLYESTER, POLYURETHANE, POLYPROPYLENE, POLYOLEFIN, POLYVINYL, VINYLON, POLYCHLAL, AND ACRYLIC FOR THE MANUFACTURE OF CLOTHING, GLOVES, HEADWEAR, WAISTBANDS AND FOOTWEAR; OIL CLOTHS; GUMMED WATERPROOF CLOTH FOR THE MANUFACTURE OF CLOTHING, GLOVES, HEADWEAR, WAISTBANDS AND FOOTWEAR, NAMELY, CLOTH PROCESSED WITH GUM FOR WATERPROOFING; VINYL COATED CLOTH FOR THE MANUFACTURE OF CLOTHING, GLOVES, HEADWEAR, WAISTBANDS AND FOOTWEAR, NAMELY, CLOTH COATED WITH VINYL; RUBBERIZED CLOTH FOR THE MANUFACTURE OF CLOTHING, GLOVES, HEADWEAR, WAISTBANDS AND FOOTWEAR, NAMELY, CLOTH PROCESSED WITH RUBBER; LEATHER CLOTH, NAMELY, CLOTH PROCESSED WITH LEATHER AND SYNTHETIC LEATHER FOR THE MANUFACTURE OF CLOTHING, GLOVES, HEADWEAR, WAISTBANDS AND FOOTWEAR; TEXTILE FILTER CLOTH, NAMELY, CLOTH PROCESSED WITH LEATHER AND SYNTHETIC LEATHER FOR THE MANUFACTURE OF CLOTHING, GLOVES, HEADWEAR, WAISTBANDS AND FOOTWEAR; TEXTILE FILTER CLOTH, NAMELY, CLOTH OF FILTERING LIQUID AND POWDER; PERSONAL ARTICLES OF WOVEN, KNITTED AND NON-WOVEN TEXTILES, NOT FOR WEAR, NAMELY, TOWELS, HANDKERCHIEFS, JAPANESE CEREMONIAL WRAPPING CLOTH AND JAPANESE GENERAL WRAPPING CLOTH; MOSQUITO NETS; BED SHEETS; QUILTS; FUTON AND QUILTS COVERS; PILLOWCASES; BED BLANKETS; TABLE NAPKINS OF TEXTILE; DISH CLOTHS; SHOWER CURTAINS; CLOTH BANNERS AND CLOTH FLAGS; FITTED TOILET SEAT COVERS MADE OF TEXTILE; WALL HANGINGS OF TEXTILE; CURTAINS; TABLE CLOTHS NOT OF PAPER; DRAPERIES; SHROUDS; JAPANESE CLOTH SCREENS WITH BLACK AND WHITE STRIPES FOR UNHAPPY EVENT PURPOSES; JAPANESE CLOTH SCREENS WITH RED AND WHITE STRIPES FOR HAPPY EVENT PURPOSES; BILLIARD CLOTH; LABELS OF CLOTH (U.S. CLS. 42 AND 50).

**CLASS 25—CLOTHING**

FOR CLOTHING, NAMELY, OUTERWEAR, NAMELY, DRESSES, CHILDREN'S WEARS, NAMELY, JUMPSUITS AND PANTS, LIVERIES, NAMELY, UNIFORMS, JACKETS, JOGGING PANTS, SWEAT PANTS, SUITS, SKIRTS, SKI JACKETS, SKI PANTS, TROUSERS, SMOCKS, FORMALWEAR, NAMELY, TUXEDOS, BOW TIES, VESTS, GOWNS, TIES FOR CLOTHING, COATS, MANTLES, RAINWEAR, SNOW PANTS, SWEATERS, CARDIGANS, VESTS, WAISTCOATS, SHIRTS, BLOUSES, NIGHT-GOWNS, NEGLIGEEES, NIGHTWEAR, NAMELY, PAJAMAS AND BATH ROBES, UNDERWEAR, SWIMWEAR, SWIMMING CAPS, JAPANESE TRADITIONAL CLOTHING, NAMELY, JAPANESE KIMONOS, APRONS FOR WEAR, COLLAR PROTECTORS FOR WEAR, SOCKS, STOCKINGS, SHAWLS, SCARVES, GLOVES AND MITTENS, NECKTIES, NECKERCHIEFS, WARMTH-KEEPING SUPPORTERS, MUFFLERS, EAR MUFFS, HEADWEAR; GARTERS; SUSPENDERS; WAISTBANDS; FOOTWEAR; MASQUERADE COSTUMES; CLOTHES FOR SPORTS, NAMELY, SHORTS, SHIRTS, ANORAKS, WIND RESISTANT JACKET, SKI SUITS, VESTS, SPORTS TEAM UNIFORMS, HOSIERY AND STOCKINGS AND WRISTBANDS AND GYMNAS TIC WEAR, NAMELY, TIGHTS AND PULLOVERS, ALL FOR SPORTS; FOOTWEAR FOR SPORTS, NAMELY, GOLF SHOES, SOCCER SHOES, SKI BOOTS, GYMNAS TIC SHOES, TENNIS SHOES, CLIMBING BOOTS, BASKETBALL SNEAKERS, VOLLEYBALL SHOES, HANDBALL SHOES, BOWLING SHOES, BOXING SHOES, HOCKEY SHOES, BASEBALL SHOES, RUGBY SHOES, FOOTWEAR FOR TRACK AND FIELD ATHLETICS, AND HORSE-RIDING BOOTS (U.S. CLS. 22 AND 39).

ANNE MADDEN, EXAMINING ATTORNEY

SN 78-320,431. VISION BIOSYSTEMS LIMITED, MOUNT WAVERLEY, AUSTRALIA, FILED 10-29-2003.

**PELORIS****CLASS 1—CHEMICALS**

FOR CHEMICAL DIAGNOSTIC PREPARATIONS FOR SCIENTIFIC OR RESEARCH USE; CHEMICALS FOR USE IN HISTOLOGICAL AND CYTOLOGICAL TISSUE PROCESSING, NAMELY, FIXATIVE, DEHYDRANT, CLEARANT AND INFILTRATING HYDROCARBONS (U.S. CLS. 1, 5, 6, 10, 26 AND 46).

**CLASS 10—MEDICAL APPARATUS**

FOR APPARATUS FOR PERFORMING HISTOLOGICAL AND CYTOLOGICAL TISSUE PROCESSING INCLUDING ANY ONE OR MORE OF THE FOLLOWING, NAMELY FIXING, DEHYDRATING, CLEARING AND EMBEDDING TISSUE; TISSUE PROCESSORS (U.S. CLS. 26, 39 AND 44).

CAROLINE WOOD, EXAMINING ATTORNEY



SN 78-321,009. GIBSON, LENISE, L., DANVILLE, CA. FILED 10-30-2003.

SN 78-323,220. BARA ISHIDU INTERNATIONAL CORPORATION, NEW PROVIDENCE, BAHAMAS, FILED 11-5-2003.



# TAVISTOCK

### CLASS 24—FABRICS

FOR SWADDLING BLANKETS FOR INFANTS (U.S. CLS. 42 AND 50).

### CLASS 25—CLOTHING

FOR CAPS AND MITTENS FOR INFANTS (U.S. CLS. 22 AND 39).  
MICHAEL ENGEL, EXAMINING ATTORNEY

THE MARK CONSISTS OF STANDARD CHARACTERS WITHOUT CLAIM TO ANY PARTICULAR FONT, STYLE, SIZE, OR COLOR.

### CLASS 6—METAL GOODS

FOR METAL MONEY CLIPS (U.S. CLS. 2, 12, 13, 14, 23, 25 AND 50).

### CLASS 9—ELECTRICAL AND SCIENTIFIC APPARATUS

FOR PRERECORDED AUDIO VIDEO TAPES, AUDIO VIDEO CASSETTES, COMPACT DISCS, DVD'S AND EQUIVALENT OPTICAL AND ELECTROMAGNETIC MEDIA CONTAINING INFORMATION PERTAINING TO THE GAME OF GOLF; COMPUTER SOFTWARE AND COMPUTER DISCS PERTAINING TO THE GAME OF GOLF; COMPUTER MOUSE PADS; COMPUTER SOFTWARE SCREENSAVERS; DECORATIVE MAGNETS; SUNGLASSES (U.S. CLS. 21, 23, 26, 36 AND 38).

SN 78-323,052. HOMEGROWN KIDS, INC., MAHATTAN BEACH, CA. FILED 11-4-2003.

### CLASS 14—JEWELRY

FOR PRECIOUS METAL MONEY CLIPS (U.S. CLS. 2, 27, 28 AND 50).

# SUDCITY

### CLASS 16—PAPER GOODS AND PRINTED MATTER

FOR BOOKS, SOUVENIR PROGRAMS, JOURNALS, AND MANUALS PERTAINING TO THE GAME OF GOLF AND TO GOLF TOURNAMENTS; PAIRING SHEETS, POSTERS, AND LITHOGRAPHIC PRINTS; CALENDARS, STATIONERY, DESK SETS AND PAPERWEIGHTS; PENS AND PENCILS (U.S. CLS. 2, 5, 22, 23, 29, 37, 38 AND 50).

THE MARK CONSISTS OF STANDARD CHARACTERS WITHOUT CLAIM TO ANY PARTICULAR FONT, STYLE, SIZE, OR COLOR.

### CLASS 3—COSMETICS AND CLEANING PREPARATIONS

FOR SHAMPOOS (U.S. CLS. 1, 4, 6, 50, 51 AND 52).

### CLASS 18—LEATHER GOODS

FOR UMBRELLAS AND GOLF UMBRELLAS; ATHLETIC BAGS, GARMENT BAGS, TOTE BAGS, SHOE BAGS FOR TRAVEL, BACK PACKS, WAIST PACKS, AND FANNY PACKS; LEATHER BILLFOLDS; LEATHER KEY CHAINS; ATTACHE CASES AND BRIEFCASES; HANDBAGS, PURSES, AND WALLETS (U.S. CLS. 1, 2, 3, 22 AND 41).

### CLASS 28—TOYS AND SPORTING GOODS

FOR CHILDREN'S TOYS, NAMELY, TOY VEHICLES; RIDE-ON TOY VEHICLES; TOY VEHICLES AND ACCESSORIES THEREFOR; PLAYSETS FOR TOY VEHICLES (U.S. CLS. 22, 23, 38 AND 50).  
CAROLINE WOOD, EXAMINING ATTORNEY

### CLASS 20—FURNITURE AND ARTICLES NOT OTHERWISE CLASSIFIED

FOR GOLF STOOLS AND CHAIRS; CHAIR PADS; PILLOWS; NON-METAL MONEY CLIPS (U.S. CLS. 2, 13, 22, 25, 32 AND 50).

**CLASS 21—HOUSEWARES AND GLASS**

FOR BEVERAGE GLASSWARE; PLASTIC CUPS AND MUGS; PEWTER MUGS; ORNAMENTAL DECORATIVE TABLE ACCESSORIES, NAMELY, BOWLS WITH AND WITHOUT LIDS, DISHES, FIGURINES AND SCULPTURES, MADE OF GLASS, CRYSTAL AND CHINA (U.S. CLS. 2, 13, 23, 29, 30, 33, 40 AND 50).

**CLASS 24—FABRICS**

FOR GOLF TOWELS; BATH AND BEACH TOWELS; SOUVENIR PENNANTS AND FLAGS MADE OF CLOTH (U.S. CLS. 42 AND 50).

**CLASS 25—CLOTHING**

FOR FOOTWEAR, HEADWEAR, CLOTHING AND ACCESSORIES, NAMELY, MEN'S AND WOMEN'S GOLF SHOES, T-SHIRTS, COLLARED SHIRTS, SWEATERS, JACKETS, COATS, PANTS, SHORTS, RAINSUITS, NECKTIES, HATS, SUN VISORS, SCARVES, BELTS AND SOCKS (U.S. CLS. 22 AND 39).

**CLASS 28—TOYS AND SPORTING GOODS**

FOR SPORTING GOODS RELATING TO GOLF; GOLF EQUIPMENT AND ACCESSORIES, NAMELY, GOLF BAGS, GOLF BAG COVERS, GOLF BAG IDENTIFICATION TAGS, GOLF BALLS, GOLF CLUBS, GOLF CLUB COVERS, GOLF GLOVES, GOLF FLAGS, GOLF BALL MARKERS, DIVOT REPAIR TOOLS AND PLAYING CARDS (U.S. CLS. 22, 23, 38 AND 50).

**CLASS 41—EDUCATION AND ENTERTAINMENT**

FOR ENTERTAINMENT SERVICES IN THE NATURE OF ORGANIZING AND CONDUCTING GOLF TOURNAMENTS WHICH ARE TELEVIEWED FOR THE ENJOYMENT OF A WORLDWIDE AUDIENCE (U.S. CLS. 100, 101 AND 107).

SEAN DWYER, EXAMINING ATTORNEY

SN 78-324,129. ASBURY SERVICES, INC., GAITHERSBURG, MD. FILED 11-6-2003.



The logo for ASBURY SERVICES features the word "ASBURY" in a large, bold, serif font. Below it, the word "SERVICES" is written in a smaller, all-caps, sans-serif font. A horizontal line separates the two words, and a stylized, curved graphic element is positioned to the left of the "S" in "SERVICES".

OWNER OF U.S. REG. NOS. 2,223,829, 2,238,255 AND 2,240,322.

NO CLAIM IS MADE TO THE EXCLUSIVE RIGHT TO USE SERVICES, APART FROM THE MARK AS SHOWN.

THE MARK CONSISTS OF THE WORDS ASBURY SERVICES WITH A LINE BETWEEN THE TWO WORDS AND TWO OPPOSING CRESCENTS UNDER THE "A" OF ASBURY AND BESIDE THE "S" OF SERVICES.

**CLASS 35—ADVERTISING AND BUSINESS**

FOR MANAGEMENT OF CONTINUING CARE RETIREMENT COMMUNITIES FOR OTHERS (U.S. CLS. 100, 101 AND 102).

**CLASS 43—HOTEL AND RESTAURANT SERVICES**

FOR PROVIDING CONTINUING CARE RETIREMENT COMMUNITIES (U.S. CLS. 100 AND 101).

KIM SAITO, EXAMINING ATTORNEY

SN 78-324,507. BRIGHT STATION LIMITED, LONDON, UNITED KINGDOM, FILED 11-7-2003.

**BRIGHTSTATION**

THE MARK CONSISTS OF STANDARD CHARACTERS WITHOUT CLAIM TO ANY PARTICULAR FONT, STYLE, SIZE, OR COLOR.

PRIORITY CLAIMED UNDER SEC. 44(D) ON UNITED KINGDOM APPLICATION NO. 2333141, FILED 5-24-2003, REG. NO. 2333141, DATED 5-24-2003, EXPIRES 5-24-2013.

**CLASS 9—ELECTRICAL AND SCIENTIFIC APPARATUS**

FOR COMPUTER SOFTWARE AND COMPUTER SYSTEMS PROGRAMS FOR ENABLING COLLABORATION WITH INTERNAL AND EXTERNAL SERVICE PROVIDERS THROUGH HOSTED SOFTWARE APPLICATION PROVIDER FOR A-COMMERCE TRANSACTIONS TO ALLOW BUSINESSES AND THEIR SUPPLY CHAINS TO CONDUCT TRANSACTIONS OVER REMOTE COMPUTER DATABASES; COMPUTER SOFTWARE APPLICATIONS PROGRAMS ALLOWING ORDER MANAGEMENT AND TRACKING, REMOTE SITE MANAGEMENT AND CUSTOMER RELATIONSHIP MANAGEMENT, ANALYSIS OF CUSTOMER PREFERENCES AND BUYING PATTERNS; COMPUTER SOFTWARE APPLICATION PROGRAMS TO ALLOW SECURE REAL TIME FINANCIAL TRANSACTIONS AND AUTHENTICATION; COMPUTER SOFTWARE APPLICATIONS PROGRAMS FOR USE IN DATABASE MANAGEMENT, SPREADSHEETS, WORD PROCESSING AND FOR GRAPHICAL APPLICATIONS; COMPUTER SOFTWARE APPLICATION PROGRAMS FOR PROCESSING, MANIPULATING AND ANALYZING DATA AND FOR TRANSMITTING THE DATA BY MEANS OF COMPUTER TERMINALS, BY MEANS OF FIBER-OPTIC NETWORKS, BY MEANS OF FIBER-OPTIC CABLES, PROVIDED THROUGH AND/OR DOWNLOADED FROM THE INTERNET BY MEANS OF HOSTED COMPUTER SOFTWARE, TELEPHONES, MOBILE PHONES AND WAP PHONES AND INTERACTIVE TELEVISION APPARATUS; PRE-RECORDED DATA MEDIA, NAMELY, MAGNETIC DISCS, OPTICAL DISCS, MAGNETO-OPTICAL DISCS, ALL CONTAINING THE AFORESAID COMPUTER PROGRAMS (U.S. CLS. 21, 23, 26, 36 AND 38).

**CLASS 35—ADVERTISING AND BUSINESS**

FOR PROVIDING BUSINESS INFORMATION, CONDUCTING BUSINESS INQUIRIES FOR OTHERS, CONDUCTING BUSINESS INVESTIGATIONS AND BUSINESS RESEARCH; PROVISION OF BUSINESS AND COMMERCIAL INFORMATION; COMMERCIAL INVENTORY MANAGEMENT SERVICES IN THE FIELD OF FREIGHT FORWARDING; COMPILATION AND SYSTEMATIZING INFORMATION INTO DATABASES, MARKETING RESEARCH, PROVIDING STATISTICAL INFORMATION, NEWS CLIPPING SERVICES, COMPANY STATISTICS, ADVISORY SERVICES AND CONSULTANCY SERVICES RELATING TO THE AFORESAID SERVICES; ADVISORY AND CONSULTANCY SERVICES RELATING TO THE AFORESAID SERVICES (U.S. CLS. 100, 101 AND 102).

**CLASS 36—INSURANCE AND FINANCIAL**

FOR PROVIDING FINANCIAL INFORMATION; PROVIDING FINANCIAL SERVICES, NAMELY, BILL PAYMENT SERVICES, ELECTRONIC COMMERCE PAYMENT SERVICES, NAMELY, ESTABLISHING FUNDED ACCOUNTS USED TO PURCHASE GOODS AND SERVICES ON THE INTERNET, ELECTRONIC PAYMENT, NAMELY, ELECTRONIC PROCESSING AND TRANSMISSION OF BILL PAYMENT DATA; ADVISORY AND CONSULTANCY SERVICES RELATING TO ALL THE AFORESAID (U.S. CLS. 100, 101 AND 102).

**CLASS 38—COMMUNICATION**

FOR ELECTRONIC TRANSMISSION OF FINANCIAL DATA AND DOCUMENTS VIA COMPUTER TERMINALS; COMMUNICATION AND TRANSMISSION OF BUSINESS AND COMMERCIAL INFORMATION, TRANSMISSION OF INFORMATION PERTAINING TO INTELLECTUAL PROPERTY, PATENTS, TRADEMARKS AND GENERAL SCIENTIFIC INFORMATION BY ELECTRONIC MEANS, BY MEANS OF COMPUTER TERMINALS, BY MEANS OF FIBER-OPTIC NETWORKS, FIBER-OPTIC CABLES AND VIA THE INTERNET BY MEANS OF HOSTED COMPUTER SOFTWARE, TELEPHONES, MOBILE PHONES AND WAP PHONES AND INTERACTIVE TELEVISION; ADVISORY AND CONSULTANCY SERVICES RELATING TO ALL THE AFORESAID (U.S. CLS. 100, 101 AND 104).

**CLASS 42—SCIENTIFIC, COMPUTER AND LEGAL SERVICES**

FOR APPLICATION SERVICE PROVIDER (ASP) SERVICES, NAMELY, HOSTING COMPUTER SOFTWARE APPLICATIONS OF OTHERS FOR ENABLING E-COMMERCE TRANSACTIONS; HANDLING, TREATING, CODIFYING AND PROVISION OF INFORMATION PERTAINING TO INTELLECTUAL PROPERTY, PATENTS, TRADEMARKS, BIOLOGICAL, MEDICAL AND GENERAL SCIENTIFIC INFORMATION BY ELECTRONIC MEANS, BY MEANS OF COMPUTER TERMINALS, BY MEANS OF FIBER-OPTIC NETWORKS, FIBER-OPTIC CABLES AND VIA THE INTERNET BY MEANS OF HOSTED COMPUTER SOFTWARE, TELEPHONES, MOBILE PHONES AND WAP PHONES AND INTERACTIVE TELEVISION; ADVISORY AND CONSULTANCY SERVICES RELATING TO ALL THE AFORESAID (U.S. CLS. 100 AND 101).

CAROLYN CATALDO, EXAMINING ATTORNEY

---

SN 78-326,291. REBACK BOOTS USA, ESCONDIDO, CA. FILED 11-11-2003.

# REDBACK

THE MARK CONSISTS OF STANDARD CHARACTERS WITHOUT CLAIM TO ANY PARTICULAR FONT, STYLE, SIZE, OR COLOR.

**CLASS 18—LEATHER GOODS**

FOR BAGS, NAMELY TOTE BAGS AND TOOL BAGS SOLD EMPTY (U.S. CLS. 1, 2, 3, 22 AND 41). FIRST USE 1-4-2003; IN COMMERCE 10-4-2003.

**CLASS 25—CLOTHING**

FOR FOOTWEAR AND CLOTHING, NAMELY, BOOTS, SHOES, INNER SOLES FOR FOOTWEAR, BELTS, TEE SHIRTS, SUSPENDERS AND SOCKS (U.S. CLS. 22 AND 39). FIRST USE 10-14-1996; IN COMMERCE 10-14-1996. DEZMONA MIZELLE, EXAMINING ATTORNEY

---

SN 78-328,124. PIVOT DESIGN, INC., CHICAGO, IL. FILED 11-14-2003.

**CLASS 35—ADVERTISING AND BUSINESS**

FOR ADVERTISING AND MARKETING SERVICES (U.S. CLS. 100, 101 AND 102). FIRST USE 6-0-1992; IN COMMERCE 6-0-1992.

**CLASS 42—SCIENTIFIC, COMPUTER AND LEGAL SERVICES**

FOR GRAPHIC ART DESIGN SERVICES (U.S. CLS. 100 AND 101). FIRST USE 6-0-1992; IN COMMERCE 6-0-1992. TRACY FLETCHER, EXAMINING ATTORNEY

---

SN 78-328,304. NVENT LLC, NEW YORK, NY. FILED 11-14-2003.

# PERMALYNX

THE MARK CONSISTS OF STANDARD CHARACTERS WITHOUT CLAIM TO ANY PARTICULAR FONT, STYLE, SIZE, OR COLOR.

**CLASS 6—METAL GOODS**

FOR METAL PIPE COUPLINGS, METAL PIPE FITTINGS, MANUALLY-OPERATED METAL VALVES (U.S. CLS. 2, 12, 13, 14, 23, 25 AND 50).

**CLASS 17—RUBBER GOODS**

FOR GASKETS FOR PIPE COUPLINGS, PIPE FITTINGS AND VALVES; RINGS OF RUBBER FOR USE AS PIPE CONNECTION SEALS (U.S. CLS. 1, 5, 12, 13, 35 AND 50).

VIVIAN MICZNIK FIRST, EXAMINING ATTORNEY

SN 78-329,427. IRON ROSE RANCH LLC, CARBONDALE, CO. FILED 11-18-2003.

**IRON ROSE CUTTING HORSES**

THE MARK CONSISTS OF STANDARD CHARACTERS WITHOUT CLAIM TO ANY PARTICULAR FONT, STYLE, SIZE, OR COLOR.

NO CLAIM IS MADE TO THE EXCLUSIVE RIGHT TO USE "CUTTING HORSES", APART FROM THE MARK AS SHOWN.

SN 78-329,314. ONCOVANCE TECHNOLOGIES, INC., HOUSTON, TX. FILED 11-18-2003.

**ONCOVANCE****CLASS 31—NATURAL AGRICULTURAL PRODUCTS**

FOR LIVE ANIMALS, NAMELY, THOROUGHBRED AND CUTTING HORSES (U.S. CLS. 1 AND 46).

**CLASS 41—EDUCATION AND ENTERTAINMENT**

FOR HORSE SHOWING AND TRAINING (U.S. CLS. 100, 101 AND 107).

**CLASS 44—MEDICAL, BEAUTY AND AGRICULTURAL SERVICES**

FOR HORSE BREEDING (U.S. CLS. 100 AND 101).  
RENEE MCCRAY, EXAMINING ATTORNEY

THE MARK CONSISTS OF STANDARD CHARACTERS WITHOUT CLAIM TO ANY PARTICULAR FONT, STYLE, SIZE, OR COLOR.

**CLASS 5—PHARMACEUTICALS**

FOR PHARMACEUTICALS, NAMELY, PHARMACEUTICAL PREPARATIONS AND REAGENTS USED FOR CANCER DIAGNOSIS AND TREATMENT (U.S. CLS. 6, 18, 44, 46, 51 AND 52).

**CLASS 9—ELECTRICAL AND SCIENTIFIC APPARATUS**

FOR COMPUTER SOFTWARE FOR USE IN THE FIELD OF CANCER RESEARCH, DIAGNOSIS AND TREATMENT, NAMELY, COMPUTER MEDICAL SOFTWARE FOR DIAGNOSIS, PROGNOSIS AND MAINTENANCE OF TREATMENT TO CANCER PATIENTS (U.S. CLS. 21, 23, 26, 36 AND 38).

**CLASS 42—SCIENTIFIC, COMPUTER AND LEGAL SERVICES**

FOR MEDICAL AND SCIENTIFIC RESEARCH SERVICES IN THE FIELD OF CANCER TREATMENT AND DIAGNOSIS; DESIGN, CONSULTING AND DEVELOPMENT OF COMPUTER SOFTWARE IN THE FIELD OF CANCER TREATMENT, SCIENTIFIC AND MEDICAL RESEARCH AND DIAGNOSIS (U.S. CLS. 100 AND 101).

**CLASS 44—MEDICAL, BEAUTY AND AGRICULTURAL SERVICES**

FOR PROVIDING HEALTH CARE SERVICES, NAMELY, TREATING CANCER PATIENTS (U.S. CLS. 100 AND 101).  
ESTHER BELENKER, EXAMINING ATTORNEY

SN 78-329,435. IRON ROSE RANCH LLC, CARBONDALE, CO. FILED 11-18-2003.

**IRON ROSE QUARTER HORSES**

THE MARK CONSISTS OF STANDARD CHARACTERS WITHOUT CLAIM TO ANY PARTICULAR FONT, STYLE, SIZE, OR COLOR.

NO CLAIM IS MADE TO THE EXCLUSIVE RIGHT TO USE "QUARTER HORSES", APART FROM THE MARK AS SHOWN.

**CLASS 31—NATURAL AGRICULTURAL PRODUCTS**

FOR LIVE ANIMALS, NAMELY, THOROUGHBRED AND QUARTERHORSES (U.S. CLS. 1 AND 46).

**CLASS 41—EDUCATION AND ENTERTAINMENT**

FOR HORSE SHOWING AND TRAINING (U.S. CLS. 100, 101 AND 107).

**CLASS 44—MEDICAL, BEAUTY AND AGRICULTURAL SERVICES**

FOR HORSE BREEDING (U.S. CLS. 100 AND 101).  
RENEE MCCRAY, EXAMINING ATTORNEY

SN 78-330,874. INFORMATION ET DEVELOPPEMENT SOCIAL, PARIS, FRANCE, FILED 11-20-2003.

SN 78-332,124. PDNS, LLC, HAROLD, KY. FILED 11-24-2003.

**MASTER OF  
COMPETENCE**

**TIUSA**

THE MARK CONSISTS OF STANDARD CHARACTERS WITHOUT CLAIM TO ANY PARTICULAR FONT, STYLE, SIZE, OR COLOR.

PRIORITY CLAIMED UNDER SEC. 44(D) ON FRANCE APPLICATION NO. 033226408, FILED 5-21-2003, REG. NO. 033226408, DATED 5-21-2003, EXPIRES 5-21-2013.

**CLASS 16—PAPER GOODS AND PRINTED MATTER**

FOR PRINTED INSTRUCTIONAL, EDUCATIONAL AND TEACHING MATERIALS IN THE FIELD OF BUSINESS MANAGEMENT AND HUMAN RESOURCES; BOOKS IN THE FIELD OF BUSINESS MANAGEMENT AND HUMAN RESOURCES; GUIDES IN THE FIELD OF EDUCATION ABOUT BUSINESS MANAGEMENT AND HUMAN RESOURCES (U.S. CLS. 2, 5, 22, 23, 29, 37, 38 AND 50).

**CLASS 35—ADVERTISING AND BUSINESS**

FOR BUSINESS ORGANIZATION CONSULTANCY, BUSINESS MANAGEMENT ASSISTANCE, DOCUMENT REPRODUCTION, DOCUMENT INDEXING FOR OTHERS; ORGANIZATION OF EXHIBITIONS FOR COMMERCIAL OR ADVERTISING PURPOSES, DIRECT MAIL ADVERTISING, DISSEMINATION OF ADVERTISING FOR OTHERS VIA THE INTERNET (U.S. CLS. 100, 101 AND 102).

**CLASS 41—EDUCATION AND ENTERTAINMENT**

FOR PROVIDING TRAINING COURSES IN THE FIELD OF BUSINESS MANAGEMENT AND HUMAN RESOURCES; ONLINE PUBLICATION OF BOOKS AND LEAFLETS IN THE FIELD OF BUSINESS MANAGEMENT AND HUMAN RESOURCES; ARRANGING AND CONDUCTING COLLOQUIUMS AND EDUCATIONAL CONFERENCES; ORGANIZATION OF EXHIBITIONS FOR EDUCATIONAL PURPOSES (U.S. CLS. 100, 101 AND 107).

JIM RINGLE, EXAMINING ATTORNEY

THE MARK CONSISTS OF STANDARD CHARACTERS WITHOUT CLAIM TO ANY PARTICULAR FONT, STYLE, SIZE, OR COLOR.

**CLASS 37—CONSTRUCTION AND REPAIR**

FOR INSTALLATION, MAINTENANCE AND REPAIR OF NETWORK COMPUTERS (U.S. CLS. 100, 103 AND 106).

**CLASS 38—COMMUNICATION**

FOR TELECOMMUNICATIONS SERVICES, NAMELY, ELECTRONIC TRANSMISSION OF DATA, IMAGES, AND DOCUMENTS VIA COMPUTER TERMINALS AND AUDIOVISUAL EQUIPMENT; PROVIDING MULTIPLE USER ACCESS TO INTERACTIVE COMPUTER NETWORKS; ELECTRONIC MAIL SERVICES (U.S. CLS. 100, 101 AND 104).

**CLASS 41—EDUCATION AND ENTERTAINMENT**

FOR ENTERTAINMENT SERVICES, NAMELY, PROVIDING ON-LINE COMPUTER GAMES (U.S. CLS. 100, 101 AND 107).

**CLASS 42—SCIENTIFIC, COMPUTER AND LEGAL SERVICES**

FOR ELECTRONIC COMMERCE PAYMENT SERVICES, NAMELY PROVIDING SECURITY AND ANONYMITY FOR ELECTRONICALLY TRANSMITTED CREDIT CARD TRANSACTIONS FOR USERS TO PURCHASE GOODS AND SERVICES ON THE INTERNET; COMPUTER SERVICES, NAMELY DESIGNING AND IMPLEMENTING WEB SITES FOR OTHERS; HOSTING THE WEB SITES OF OTHERS ON A COMPUTER SERVER FOR A GLOBAL COMPUTER NETWORK; AND TECHNICAL SUPPORT SERVICES, NAMELY, TROUBLESHOOTING OF COMPUTER HARDWARE AND SOFTWARE PROBLEMS (U.S. CLS. 100 AND 101).

JENNIFER CHICOSKI, EXAMINING ATTORNEY

SN 78-337,073. PRODUCTIVITY, INC., PLYMOUTH, MN.  
FILED 12-5-2003.

# REDLINE

THE MARK CONSISTS OF STANDARD CHARACTERS WITHOUT CLAIM TO ANY PARTICULAR FONT, STYLE, SIZE, OR COLOR.

## CLASS 7—MACHINERY

FOR MACHINE CUTTING POWER TOOLS AND ACCESSORIES, NAMELY, HIGH SPEED STEEL AND COBALT DRILLS, CARBIDE AND CARBIDE TIPPED DRILLS; COMBINATION DRILL AND CHAMFER CUTTERS, TAPS, HIGH SPEED STEEL AND COBALT END MILLS; INDEXABLE MILLING CUTTERS; COMBINATION COUNTERSINK AND SPOT DRILLS, INDEXABLE AND INSERTABLE DRILLS; BURS; THREAD MILLS; CARBIDE END MILLS AND REAMERS (U.S. CLS. 13, 19, 21, 23, 31, 34 AND 35).

## CLASS 8—HAND TOOLS

FOR HAND CUTTING TOOLS AND ACCESSORIES, NAMELY, HIGH SPEED STEEL AND COBALT DRILLS, CARBIDE AND CARBIDE TIPPED DRILLS; COMBINATION DRILL AND CHAMFER CUTTERS, TAPS, HIGH SPEED STEEL AND COBALT END MILLS; INDEXABLE MILLING CUTTERS; COMBINATION COUNTERSINK AND SPOT DRILLS; INDEXABLE AND INSERTABLE DRILLS, BURS, THREAD MILLS; CARBIDE END MILLS AND REAMERS (U.S. CLS. 23, 28 AND 44).  
ALICIA COLLINS, EXAMINING ATTORNEY

SN 78-337,338. AMY'S KITCHEN, INC., SANTA ROSA, CA.  
FILED 12-5-2003.

# AMY'S KITCHEN

THE MARK CONSISTS OF STANDARD CHARACTERS WITHOUT CLAIM TO ANY PARTICULAR FONT, STYLE, SIZE, OR COLOR.

OWNER OF U.S. REG. NOS. 1,885,120, 1,893,229 AND OTHERS.

## CLASS 29—MEATS AND PROCESSED FOODS

FOR VEGETARIAN REFRIED BEANS, VEGETARIAN PROCESSED BEANS, NAMELY, CANNED BEANS, AND MEATLESS CHILI (U.S. CL. 46).  
FIRST USE 6-14-2000; IN COMMERCE 6-14-2000.

## CLASS 30—STAPLE FOODS

FOR FROZEN VEGETARIAN MEALS IN A BOWL CONSISTING PRIMARILY OF PASTA, RICE OR CORN MEAL, NAMELY, STUFFED PASTA SHELLS IN A BOWL, RICE AND VEGETABLE COMBINATIONS IN A BOWL, ENCHILADAS IN A BOWL, PASTA AND VEGETABLE COMBINATIONS IN A BOWL, TORTELLINI IN A BOWL; FROZEN POCKET SANDWICHES CONSISTING OF A GRAIN BASED SHELLS WITH VARIOUS FILLINGS; FROZEN TOASTER PASTRIES WITH VARIOUS FILLINGS; FROZEN SNACK GRAIN-BASED FOODS CONSISTING OF MINIATURE GRAIN BASED SHELLS WITH VARIOUS FILLINGS; AND SALSA (U.S. CL. 46).

FIRST USE 4-11-1996; IN COMMERCE 4-11-1996.  
NANCY CLARKE, EXAMINING ATTORNEY

SN 78-338,995. INVIDEX INC., MONTREAL, QUEBEC, CANADA, FILED 12-10-2003.

# INVIDEX

THE MARK CONSISTS OF STANDARD CHARACTERS WITHOUT CLAIM TO ANY PARTICULAR FONT, STYLE, SIZE, OR COLOR.

## CLASS 9—ELECTRICAL AND SCIENTIFIC APPARATUS

FOR (BASED ON INTENT TO USE) COMPUTER SOFTWARE USED TO HOST AND MAINTAIN VIDEO TRANSMISSION FOR COMMUNICATIONS NETWORKS (U.S. CLS. 21, 23, 26, 36 AND 38).

## CLASS 38—COMMUNICATION

FOR (BASED ON USE IN COMMERCE) VIDEO TELECOMMUNICATIONS GATEWAY INTERCONNECTIVITY SERVICES, NAMELY, PROVIDING ACCESS TO HIGH-QUALITY VIDEO TRANSMISSION ROUTES OVER MULTIPLE INTERCONNECTION FACILITIES USING COMPUTERIZED COMMUNICATION SERVICES; PROVIDING VIDEO ON DEMAND TRANSMISSION LOGISTICAL AND RESERVATION SERVICES USED TO BOOK AND PROVIDE HIGH-QUALITY VIDEO ON DEMAND TRANSMISSION SERVICES OVER MULTIPLE INTERCONNECTION FACILITIES USING COMMUNICATIONS NETWORKS VIA A GLOBAL COMPUTER NETWORK; CONSULTATION SERVICES IN THE FIELD OF VIDEO AND TELECOMMUNICATIONS (U.S. CLS. 100, 101 AND 104).

FIRST USE 5-31-2002; IN COMMERCE 5-31-2002.  
INGA ERVIN, EXAMINING ATTORNEY

SN 78-339,760. STARR PRODUCTIONS, LLC., HOLLYWOOD, CA. FILED 12-11-2003.

### STARR PRODUCTIONS

THE MARK CONSISTS OF STANDARD CHARACTERS WITHOUT CLAIM TO ANY PARTICULAR FONT, STYLE, SIZE, OR COLOR.

NO CLAIM IS MADE TO THE EXCLUSIVE RIGHT TO USE "PRODUCTIONS", APART FROM THE MARK AS SHOWN.

#### CLASS 9—ELECTRICAL AND SCIENTIFIC APPARATUS

FOR DIGITAL VIDEO DISCS (DVDS) AND VIDEOTAPES IN THE FIELD OF ADULT ENTERTAINMENT (U.S. CLS. 21, 23, 26, 36 AND 38).

FIRST USE 11-1-2003; IN COMMERCE 11-1-2003.

#### CLASS 35—ADVERTISING AND BUSINESS

FOR ON LINE RETAIL STORE SERVICES FEATURING ADULT ORIENTED ENTERTAINMENT PRODUCTS (U.S. CLS. 100, 101 AND 102).

FIRST USE 11-1-2003; IN COMMERCE 11-1-2003.

#### CLASS 41—EDUCATION AND ENTERTAINMENT

FOR ENTERTAINMENT SERVICES, NAMELY, PROVIDING ADULT ORIENTED INFORMATION AND ADULT ENTERTAINMENT SERVICES OVER A GLOBAL COMPUTER NETWORK (U.S. CLS. 100, 101 AND 107).

FIRST USE 11-1-2003; IN COMMERCE 11-1-2003.

TINA L. SNAPP, EXAMINING ATTORNEY

SN 78-344,214. KIND HEART INSTITUTE, SANTA BARBARA, CA. FILED 12-22-2003.

# Kind Heart Institute

THE MARK CONSISTS OF STANDARD CHARACTERS WITHOUT CLAIM TO ANY PARTICULAR FONT, STYLE, SIZE, OR COLOR.

NO CLAIM IS MADE TO THE EXCLUSIVE RIGHT TO USE "INSTITUTE", APART FROM THE MARK AS SHOWN.

#### CLASS 9—ELECTRICAL AND SCIENTIFIC APPARATUS

FOR DECORATIVE MAGNETS; PRE-RECORDED AUDIO TAPES, AUDIO CASSETTES, DIGITAL AUDIO TAPES, VIDEO TAPES, VIDEO CASSETTES, VIDEO DISCS, LASER DISCS, CD'S, AND DVD'S, ALL FEATURING INFORMATION ON THE PREVENTION, REDUCTION, AND REVERSAL OF CARDIOVASCULAR HEART DISEASE THROUGH DIET, EXERCISE, AND RELAXATION (U.S. CLS. 21, 23, 26, 36 AND 38).

#### CLASS 16—PAPER GOODS AND PRINTED MATTER

FOR COOK BOOKS, RECIPE BOOKS, BOOKMARKS, POSTERS, CALENDARS, PENS, PENCILS, STICKERS, BUMPER STICKERS, NOTE PADS, MEMO PADS, FILE FOLDERS, COMIC BOOKS, PAPER GIFT BAGS, PAPER PENNANTS, PAPER BANNERS, NON-ELECTRIC ERASERS, NOTEBOOKS, BINDERS, FLASH CARDS, MOTIVATIONAL CARDS, LOG BOOKS, AND DIARIES; JOURNALS TO RECORD GOALS, ACTIVITIES, AND PROGRESS IN PREVENTING, REDUCING, AND REVERSING CARDIOVASCULAR HEART DISEASE; SERIES OF NON-FICTION BOOKS ON THE TOPIC OF PREVENTION, REDUCTION, AND REVERSAL OF CARDIOVASCULAR HEART DISEASE (U.S. CLS. 2, 5, 22, 23, 29, 37, 38 AND 50).

#### CLASS 44—MEDICAL, BEAUTY AND AGRICULTURAL SERVICES

FOR PROVIDING HEALTH INFORMATION; PROVIDING MEDICAL INFORMATION; PROVIDING INFORMATION IN THE FIELD OF CARDIOVASCULAR HEART DISEASE VIA THE INTERNET; MEDICAL EVALUATION SERVICES, NAMELY, FUNCTIONAL ASSESSMENT PROGRAM FOR CLIENTS RECEIVING HEALTH REHABILITATION SERVICES FOR PURPOSES OF GUIDING TREATMENT AND ASSESSING PROGRAM EFFECTIVENESS; MEDICAL SERVICES (U.S. CLS. 100 AND 101).

BARBARA GAYNOR, EXAMINING ATTORNEY

SN 78-345,511. ZYDAS TECHNOLOGY CORPORATION, HSINCHU, TAIWAN, FILED 12-24-2003.

# ZyDAS

THE MARK CONSISTS OF "ZYDAS" IN STYLIZED CHARACTER FORM.

**CLASS 9—ELECTRICAL AND SCIENTIFIC APPARATUS**

FOR COMPUTER CHIPS, MASK ALIGNERS FOR USE IN MANUFACTURING SEMICONDUCTORS, ELECTRICAL CIRCUITS BOARDS, SEMICONDUCTORS, INTERFACE CARDS, MICRO PROCESSING INTEGRATED CIRCUITS, INTEGRATED CIRCUITS, ELECTRICAL CIRCUITS, PRINTED CIRCUIT BOARDS, SEMICONDUCTOR ELEMENTS, MICRO-PROCESSING CHIPS, VERY LARGE SCALE INTEGRATED CIRCUITS, LARGE SCALE INTEGRATED CIRCUITS, SILICON CHIPS (U.S. CLS. 21, 23, 26, 36 AND 38).

FIRST USE 4-13-2003; IN COMMERCE 4-13-2003.

**CLASS 42—SCIENTIFIC, COMPUTER AND LEGAL SERVICES**

FOR COMPUTER SYSTEM DESIGN FOR OTHERS IN THE FIELDS OF COMPUTER PROGRAM, INTEGRATED CIRCUIT, SEMICONDUCTOR AND COMPUTER CHIP (U.S. CLS. 100 AND 101).

FIRST USE 4-13-2003; IN COMMERCE 4-13-2003.  
CIMMERIAN COLEMAN, EXAMINING ATTORNEY

---

SN 78-346,453. NEHA TRAINING LLC, DENVER, CO. FILED 12-30-2003.

## The Regulator's Choice

THE MARK CONSISTS OF STANDARD CHARACTERS WITHOUT CLAIM TO ANY PARTICULAR FONT, STYLE, SIZE, OR COLOR.

**CLASS 16—PAPER GOODS AND PRINTED MATTER**

FOR EDUCATIONAL PUBLICATIONS, NAMELY, TRAINING MANUALS IN THE FIELD OF FOOD SAFETY (U.S. CLS. 2, 5, 22, 23, 29, 37, 38 AND 50).

FIRST USE 1-11-2004; IN COMMERCE 1-11-2004.

**CLASS 41—EDUCATION AND ENTERTAINMENT**

FOR EDUCATIONAL SERVICES, NAMELY, DISTRIBUTING COURSE MATERIALS IN CONNECTION WITH CONDUCTING FOOD SAFETY MANAGER CERTIFICATION TRAINING CLASSES THROUGH A NETWORK OF REGISTERED FOOD SAFETY TRAINERS (U.S. CLS. 100, 101 AND 107).

FIRST USE 1-11-2004; IN COMMERCE 1-11-2004.  
BRIAN NEVILLE, EXAMINING ATTORNEY

SN 78-347,883. LOTARDO, JOHN T., PHOENIX, AZ. FILED 1-5-2004.

## Ask the TITLEMAN

THE MARK CONSISTS OF STANDARD CHARACTERS WITHOUT CLAIM TO ANY PARTICULAR FONT, STYLE, SIZE, OR COLOR.

**CLASS 16—PAPER GOODS AND PRINTED MATTER**

FOR SYNDICATED NEWSPAPER ARTICLES IN THE FIELD OF REAL ESTATE (U.S. CLS. 2, 5, 22, 23, 29, 37, 38 AND 50).

**CLASS 41—EDUCATION AND ENTERTAINMENT**

FOR CONDUCTING SEMINARS IN THE FIELD OF REAL ESTATE (U.S. CLS. 100, 101 AND 107).

KHANH LE, EXAMINING ATTORNEY

---

SN 78-354,355. LIFE INDUSTRIES CORPORATION, CHARLESTON, SC. FILED 1-20-2004.

**CLASS 1—CHEMICALS**

FOR MARINE MAINTENANCE PRODUCTS, NAMELY, EPOXIES FOR GENERAL BONDING AND REPAIR PURPOSES AND SOLVENTS, FOR USE ON BOATS (U.S. CLS. 1, 5, 6, 10, 26 AND 46).

FIRST USE 11-21-1949; IN COMMERCE 1-4-1950.

**CLASS 2—PAINTS**

FOR MARINE MAINTENANCE PRODUCTS, NAMELY, COATINGS IN THE NATURE OF FINISHES, PAINTS, PRESERVATIVES, STAINS, SEALANTS, AND PRIMERS, FOR USE ON BOATS (U.S. CLS. 6, 11 AND 16).

FIRST USE 11-21-1949; IN COMMERCE 1-4-1950.

**CLASS 3—COSMETICS AND CLEANING PREPARATIONS**

FOR MARINE MAINTENANCE PRODUCTS, NAMELY, CLEANERS, WAXES, POLISHES, AND CLEANSING EMULSIONS, FOR USE ON BOATS (U.S. CLS. 1, 4, 6, 50, 51 AND 52).

FIRST USE 11-21-1949; IN COMMERCE 1-4-1950.

**CLASS 17—RUBBER GOODS**

FOR MARINE MAINTENANCE CAULKS FOR USE ON BOATS (U.S. CLS. 1, 5, 12, 13, 35 AND 50).

FIRST USE 12-22-1966; IN COMMERCE 12-22-1966.  
RICHARD WHITE, EXAMINING ATTORNEY



SN 78-361,715. PERFORMANCE ART, LLC, WESTMINSTER, CA. FILED 2-3-2004.



NO CLAIM IS MADE TO THE EXCLUSIVE RIGHT TO USE "TV", APART FROM THE MARK AS SHOWN.

THE MARK CONSISTS OF A LARGE CIRCLE THAT IS A GEAR. ON TOP OF THE CIRCLE AND OVERLAPPING IT IS A LARGE 5 POINT STAR. INSIDE OF THE STAR AND ALSO OVERLAPPING IT ARE THE WORDS GEARHEAD TV.

#### CLASS 16—PAPER GOODS AND PRINTED MATTER

FOR BOOKS AND PERIODICALS FEATURING CUSTOM CULTURE, NAMELY, CARS, TRUCKS AND MOTORCYCLES; CALENDARS, GENERAL FEATURE MAGAZINES, STICKERS, DECALS, PAPER BANNERS, APPLIQUES IN THE FORM OF DECALS, AND ENGRAVING PLATES (U.S. CLS. 2, 5, 22, 23, 29, 37, 38 AND 50).

#### CLASS 25—CLOTHING

FOR CLOTHING, NAMELY, BASEBALL HATS AND CAPS, COWBOY HATS, TRUCKER HATS AND CAPS, BONNETS, BANDANAS, SCARVES; SHIRTS, T-SHIRTS, SWEATSHIRTS, CAMP SHIRTS, HAWAIIAN SHIRTS, POLO SHIRTS, KNIT SHIRTS, SPORT SHIRTS, WIND SHIRTS, COWBOY SHIRTS; JACKETS, SWEAT JACKETS, DENIM JACKETS, LEATHER JACKETS, WIND JACKETS; PANTS, JEANS, LEATHER PANTS, SWEAT PANTS, OVERALLS, SHORTS, SWEAT SHORTS, JEAN SHORTS, RUNNING SHORTS, WALKING SHORTS; FOUNDATION GARMENTS, NAMELY, PANTIES, THONG UNDERWEAR, THERMAL UNDERWEAR; SHOES, SANDALS, BEACH SHOES, THONGS, ATHLETIC SHOES, BOOTS, COWBOY BOOTS AND SOCKS (U.S. CLS. 22 AND 39).

#### CLASS 41—EDUCATION AND ENTERTAINMENT

FOR ENTERTAINMENT, NAMELY, PRODUCTION OF TELEVISION SHOWS, TELEVISION SERIES, TELEVISION SPECIALS, CABLE SHOWS, MOVIES, MOTION PICTURES, RADIO PROGRAMS; ENTERTAINMENT IN THE NATURE OF ON-GOING TELEVISION PROGRAMS IN THE FIELDS OF EDUCATION, NEWS, COMEDY AND VARIETY; ENTERTAINMENT SERVICES, NAMELY, PROVIDING A TELEVISION PROGRAM IN THE FIELDS OF EDUCATION, NEWS, COMEDY AND VARIETY VIA A GLOBAL COMPUTER NETWORK; ENTERTAINMENT SERVICES, NAMELY, PROVIDING A WEB SITE FEATURING MUSICAL PERFORMANCES, MUSICAL VIDEOS, RELATED FILM CLIPS, PHOTOGRAPHS, AND OTHER MULTIMEDIA MATERIALS; ENTERTAINMENT, NAMELY, A CONTINUING VARIETY, NEWS AND COMEDY SHOWS BROADCAST OVER TELEVISION, SATELLITE, AUDIO, AND VIDEO MEDIA; ON-LINE LIBRARY SERVICES, NAMELY, PROVIDING ELECTRONIC LIBRARY SERVICES WHICH FEATURE NEWSPAPERS, MAGAZINES, PHOTOGRAPHS AND PICTURES VIA AN ON-LINE COMPUTER NETWORK (U.S. CLS. 100, 101 AND 107).  
MITCHELL FRONT, EXAMINING ATTORNEY

SN 78-363,991. MOUNTAIN STATES EMPLOYERS COUNCIL, INC., DENVER, CO. FILED 2-6-2004.



THE MARK CONSISTS OF, IN PART, A STYLIZED LETTER M.

#### CLASS 35—ADVERTISING AND BUSINESS

FOR BUSINESS CONSULTING AND ADVISORY SERVICES, HUMAN RESOURCE CONSULTING SERVICES (U.S. CLS. 100, 101 AND 102).  
FIRST USE 0-0-1995; IN COMMERCE 0-0-1995.

#### CLASS 41—EDUCATION AND ENTERTAINMENT

FOR EDUCATIONAL SERVICES, NAMELY, PROVIDING SEMINARS, CLASSES, COURSES AND WORKSHOPS IN THE FIELDS OF BUSINESS MANAGEMENT, MANAGEMENT OF HUMAN RESOURCES AND EMPLOYMENT LAW (U.S. CLS. 100, 101 AND 107).  
FIRST USE 0-0-1995; IN COMMERCE 0-0-1995.

#### CLASS 42—SCIENTIFIC, COMPUTER AND LEGAL SERVICES

FOR LEGAL SERVICES IN THE FIELD OF EMPLOYMENT LAW (U.S. CLS. 100 AND 101).  
FIRST USE 0-0-1995; IN COMMERCE 0-0-1995.  
AMY GEARIN, EXAMINING ATTORNEY

SN 78-365,674. DREAM HEALTH L.L.C., OLYMPIA, WA.  
FILED 2-10-2004.

**DREAM DIET REST  
EXERCISE  
ALTERNATIVE CARE  
MOTIVATION**

THE MARK CONSISTS OF STANDARD CHARACTERS  
WITHOUT CLAIM TO ANY PARTICULAR FONT, STYLE,  
SIZE, OR COLOR.

**CLASS 5—PHARMACEUTICALS**

FOR HEALTH PRODUCTS, NAMELY, NUTRITIONAL  
SUPPLEMENTS (U.S. CLS. 6, 18, 44, 46, 51 AND 52).  
FIRST USE 11-7-1999; IN COMMERCE 3-1-2002.

**CLASS 35—ADVERTISING AND BUSINESS**

FOR RETAIL AND ONLINE DISTRIBUTORSHIPS IN  
THE FIELD OF HEALTH PRODUCTS, NUTRITIONAL  
SUPPLEMENTS AND BOOKS (U.S. CLS. 100, 101 AND  
102).  
FIRST USE 11-7-1999; IN COMMERCE 3-1-2002.  
CHARLES L. JENKINS, EXAMINING ATTORNEY

SN 78-365,713. VITAPATH FOODS INC., LOS ANGELES, CA.  
FILED 2-10-2004.

**VITAPRO**

THE MARK CONSISTS OF STANDARD CHARACTERS  
WITHOUT CLAIM TO ANY PARTICULAR FONT, STYLE,  
SIZE, OR COLOR.

**CLASS 5—PHARMACEUTICALS**

FOR MEAL REPLACEMENT BARS (U.S. CLS. 6, 18, 44,  
46, 51 AND 52).

**CLASS 30—STAPLE FOODS**

FOR CEREAL-BASED SNACK FOOD, READY TO EAT  
CEREAL DERIVED FOOD BARS, GRAIN-BASED FOOD  
BARS, BAKERY GOODS, COOKIES, PUDDINGS (U.S.  
CL. 46).  
KIM SAITO, EXAMINING ATTORNEY

SN 78-368,568. HELEN OF TROY LIMITED, BRIDGETOWN,  
BARBADOS, FILED 2-16-2004.

**ION SELECT**

THE MARK CONSISTS OF STANDARD CHARACTERS  
WITHOUT CLAIM TO ANY PARTICULAR FONT, STYLE,  
SIZE, OR COLOR.  
OWNER OF U.S. REG. NOS. 2,677,799, 2,849,873 AND  
OTHERS.  
NO CLAIM IS MADE TO THE EXCLUSIVE RIGHT TO  
USE "ION", APART FROM THE MARK AS SHOWN.

**CLASS 9—ELECTRICAL AND SCIENTIFIC  
APPARATUS**

FOR ELECTRIC HAND HELD HAIR STYLING IRONS,  
ELECTRIC HAND HELD CURLING IRONS, ELECTRIC  
HAND HELD FLAT IRONS (U.S. CLS. 21, 23, 26, 36 AND  
38).

**CLASS 11—ENVIRONMENTAL CONTROL AP-  
PARATUS**

FOR ELECTRIC HAND HELD HAIR DRYERS (U.S.  
CLS. 13, 21, 23, 31 AND 34).  
GWEN STOKOLS, EXAMINING ATTORNEY

SN 78-371,047. MINDSET PHARMACEUTICALS (USA) INC.,  
NEW YORK, NY. FILED 2-20-2004.

**BRAINSELECT**

THE MARK CONSISTS OF STANDARD CHARACTERS  
WITHOUT CLAIM TO ANY PARTICULAR FONT, STYLE,  
SIZE, OR COLOR.  
OWNER OF U.S. REG. NO. 2,747,137.

**CLASS 9—ELECTRICAL AND SCIENTIFIC APPARATUS**

FOR COMPUTER SOFTWARE, NAMELY, SOFTWARE USED FOR THE ANALYSIS OF CHEMICALS AND BIOCHEMICALS FOR USE IN THE PHARMACEUTICAL, BIOTECHNOLOGICAL, CHEMICAL, VETERINARY AND MEDICAL FIELDS; COMPUTER SOFTWARE, NAMELY, SOFTWARE USED FOR COMPUTER AIDED MOLECULAR DESIGN AND MODELING FOR USE IN THE PHARMACEUTICAL, BIOTECHNOLOGICAL, CHEMICAL, VETERINARY AND MEDICAL FIELDS (U.S. CLS. 21, 23, 26, 36 AND 38).

**CLASS 42—SCIENTIFIC, COMPUTER AND LEGAL SERVICES**

FOR SCIENTIFIC AND MEDICAL RESEARCH; CHEMICAL AND BIOCHEMICAL ANALYSIS FOR OTHERS; PHARMACEUTICAL DRUG DEVELOPMENT SERVICES (U.S. CLS. 100 AND 101).

**CLASS 44—MEDICAL, BEAUTY AND AGRICULTURAL SERVICES**

FOR HEALTH CARE SERVICES; DIAGNOSIS OF PREDISPOSITION TO ALZHEIMER'S DISEASE; PROPHYLAXIS AND TREATMENT OF MEDICAL DISORDERS; PROPHYLAXIS AND TREATMENT OF ALZHEIMER'S DISEASE PATIENTS AND VACCINATION OF ALZHEIMER'S DISEASE PATIENTS (U.S. CLS. 100 AND 101).

JEFFREY S. MOLINOFF, EXAMINING ATTORNEY

SN 78-376,943. OWENS STATE COMMUNITY COLLEGE, TOLEDO, OH. FILED 3-2-2004.



OWNER OF U.S. REG. NO. 2,734,336.

**CLASS 16—PAPER GOODS AND PRINTED MATTER**

FOR WRITING PAPER AND ENVELOPES, NOTEBOOKS, PAPER PADS, BLOTTING PAPER, PAPER FOLDERS, CLIPBOARDS, RING BINDERS, PENS, PENCILS, MARKERS, PEN AND PENCIL HOLDERS, CALENDARS, DECALS, POSTERS, POSTCARDS, STICKERS, BULLETIN BOARDS, BOOKENDS, PAPERWEIGHTS, AND LETTER OPENERS (U.S. CLS. 2, 5, 22, 23, 29, 37, 38 AND 50).

FIRST USE 11-1-1994; IN COMMERCE 11-1-1994.

**CLASS 24—FABRICS**

FOR BED BLANKETS, BLANKET THROWS, STADIUM BLANKETS AND QUILTS; PENNANTS AND PLACEMATS MADE FROM CLOTH (U.S. CLS. 42 AND 50).

FIRST USE 11-1-1994; IN COMMERCE 11-1-1994.

**CLASS 25—CLOTHING**

FOR SWEATSHIRTS; T-SHIRTS; SHIRTS; SHORTS; BOXER SHORTS; SWEATSUITS; JACKETS; SCARVES; SOCKS; HATS; APRONS; PLASTIC OR CLOTH BIBS; AND TIES (U.S. CLS. 22 AND 39).

FIRST USE 11-1-1994; IN COMMERCE 11-1-1994.

**CLASS 41—EDUCATION AND ENTERTAINMENT**

FOR EDUCATIONAL SERVICES AND EDUCATION-RELATED ENTERTAINMENT SERVICES, SPECIFICALLY, SPORTING EVENTS; LECTURES AND EXHIBITIONS IN THE FIELD OF ART, GRAPHIC AND COMMERCIAL ART, PAINTING, CERAMICS, SCULPTURE, MUSIC, BEHAVIORAL, ENVIRONMENTAL AND POLITICAL ISSUES AND CURRENT EVENTS; RECREATION PROGRAMS, NAMELY, INTRAMURAL SPORTS COMPETITIONS, FITNESS CLASSES, DRAMA, SKIING, CHESS, BASEBALL, BASKETBALL, VOLLEYBALL, SOFTBALL, CONCERTS AND THEATRICAL EVENTS, NAMELY, PLAYS, READINGS, MUSICALS AND MUSICAL EVENTS (U.S. CLS. 100, 101 AND 107).

FIRST USE 11-1-1994; IN COMMERCE 11-1-1994.  
BRIAN BROWN, EXAMINING ATTORNEY

SN 78-373,862. COACH-NET SERVICES GROUP, INC., LAKE HAVASU CITY, AZ. FILED 2-25-2004.

**RV TECH ADVANTAGE**

THE MARK CONSISTS OF STANDARD CHARACTERS WITHOUT CLAIM TO ANY PARTICULAR FONT, STYLE, SIZE, OR COLOR.

NO CLAIM IS MADE TO THE EXCLUSIVE RIGHT TO USE "RV TECH", APART FROM THE MARK AS SHOWN.

**CLASS 37—CONSTRUCTION AND REPAIR**

FOR AUTOMOTIVE SERVICES, NAMELY, AUTOMOTIVE ROADSIDE ASSISTANCE AND TECHNICAL SUPPORT SERVICES (U.S. CLS. 100, 103 AND 106).

FIRST USE 2-19-2004; IN COMMERCE 2-19-2004.

**CLASS 39—TRANSPORTATION AND STORAGE**

FOR TRAVEL INFORMATION SERVICES (U.S. CLS. 100 AND 105).

FIRST USE 2-19-2004; IN COMMERCE 2-19-2004.  
CHERYL STEPLIGHT, EXAMINING ATTORNEY

SN 78-377,137. ALBERT S. HAGOOD, PORTLAND, OR.  
FILED 3-2-2004.

**CLASS 35—ADVERTISING AND BUSINESS**

FOR COMPUTERIZED ON-LINE RETAIL STORE FEATURING WOMEN'S CLOTHING, NAMELY, JACKETS, PANTS, SHORTS, SHIRTS, VESTS, PAJAMAS, ROBES, BATHROBES, NIGHTWEAR, NIGHT CLOTHES, RAINWEAR, TOPS, PULLOVER TOPS, ZIP-NECK TOPS, T-NECK TOPS, T-SHIRTS, LINGERIE, SOCKS, TIGHTS, HATS, GLOVES AND TOTE BAGS (U.S. CLS. 100, 101 AND 102).

TARAH HARDY, EXAMINING ATTORNEY

**MADE**

THE MARK CONSISTS OF STANDARD CHARACTERS WITHOUT CLAIM TO ANY PARTICULAR FONT, STYLE, SIZE, OR COLOR.

**CLASS 20—FURNITURE AND ARTICLES NOT OTHERWISE CLASSIFIED**

FOR FURNITURE (U.S. CLS. 2, 13, 22, 25, 32 AND 50).

**CLASS 42—SCIENTIFIC, COMPUTER AND LEGAL SERVICES**

FOR DESIGN OF FURNITURE, DESIGN SERVICES IN THE FIELD OF INTERIOR DESIGN AND INTERIOR SPACE LAYOUT (U.S. CLS. 100 AND 101).

MARLENE BELL, EXAMINING ATTORNEY

SN 78-380,383. MACDERMID PRINTING SOLUTIONS, LLC,  
WATERBURY, CT. FILED 3-8-2004.

**LAVA**

SN 78-379,426. RENHARD, DJI, SEATTLE, WA. FILED 3-5-2004.

**ROSERED REGALIA**

THE MARK CONSISTS OF STANDARD CHARACTERS WITHOUT CLAIM TO ANY PARTICULAR FONT, STYLE, SIZE, OR COLOR.

**CLASS 1—CHEMICALS**

FOR PHOTOPOLYMERS IN THE NATURE OF UR-ETHANE BASED PHOTOPOLYMERS FOR USE IN FABRICATING PRINTING PLATES (U.S. CLS. 1, 5, 6, 10, 26 AND 46).

THE MARK CONSISTS OF STANDARD CHARACTERS WITHOUT CLAIM TO ANY PARTICULAR FONT, STYLE, SIZE, OR COLOR.

**CLASS 18—LEATHER GOODS**

FOR TOTE BAGS (U.S. CLS. 1, 2, 3, 22 AND 41).

**CLASS 9—ELECTRICAL AND SCIENTIFIC APPARATUS**

FOR EQUIPMENT FOR USE IN FABRICATING PRINTING PHOTOPOLYMER PLATES, NAMELY ULTRAVIOLET EXPOSURE AND IMAGING EQUIPMENT, INFRARED IMAGING EQUIPMENT, SOLVENT AND THERMAL DEVELOPING EQUIPMENT, DETACKIFICATION EQUIPMENT, AND POST EXPOSURE PROCESSING EQUIPMENT (U.S. CLS. 21, 23, 26, 36 AND 38).

PAULA MAYS, EXAMINING ATTORNEY

**CLASS 25—CLOTHING**

FOR WOMEN'S CLOTHING-NAMELY JACKETS, PANTS, SHORTS, SHIRTS, VESTS, PAJAMAS, ROBES, BATHROBES, NIGHTWEAR, NIGHT CLOTHES, RAINWEAR, TOPS, PULLOVER TOPS, ZIP-NECK TOPS, T-NECK TOPS, T-SHIRTS, UNDERWEAR TANKS, LINGERIE, SOCKS, TIGHTS, HATS, GLOVES (U.S. CLS. 22 AND 39).

SN 78-381,393. BELGIUM IRON WORKS, LLC, AKRON, OH. FILED 3-10-2004.

# GELAFFLE

THE MARK CONSISTS OF STANDARD CHARACTERS WITHOUT CLAIM TO ANY PARTICULAR FONT, STYLE, SIZE, OR COLOR.

## CLASS 30—STAPLE FOODS

FOR WAFFLES (U.S. CL. 46).

## CLASS 43—HOTEL AND RESTAURANT SERVICES

FOR RESTAURANT SERVICES (U.S. CLS. 100 AND 101).  
BARNEY CHARLON, EXAMINING ATTORNEY

SN 78-383,087. PLAYSOUP, LLC, PARKER, CO. FILED 3-12-2004.

# PLAYSOUP

THE MARK CONSISTS OF STANDARD CHARACTERS WITHOUT CLAIM TO ANY PARTICULAR FONT, STYLE, SIZE, OR COLOR.

## CLASS 9—ELECTRICAL AND SCIENTIFIC APPARATUS

FOR VIDEO RECORDINGS, AUDIO RECORDINGS, VIDEODISCS, CD-ROMS AND EDUCATIONAL SOFTWARE, ALL FEATURING INFORMATION AND ENTERTAINMENT OF GENERAL INTEREST TO CHILDREN, PARENTS AND FAMILIES (U.S. CLS. 21, 23, 26, 36 AND 38).

## CLASS 28—TOYS AND SPORTING GOODS

FOR GAMES AND TOYS, NAMELY, ACTION SKILL GAMES, BOARD GAMES, CARD GAMES, MANIPULATIVE GAMES, HAND HELD UNITS FOR PLAYING ELECTRONIC GAMES, PLUSH TOYS, SQUEEZE TOYS, TOY FIGURES, BATH TOYS, BEACH TOYS, MULTIPLE ACTIVITY BABY TOYS, PUPPETS, TOY FILM CARTRIDGES AND VIEWERS, DOLLS, BEAN BAGS, PULL TOYS, BABY RATTLES RIDE-ON TOYS, ELECTRONIC LEARNING TOYS, TOY SCOOTERS, WIND UP TOYS, BALLOONS, TOY BUILDING BLOCKS, CONSTRUCTION TOYS (U.S. CLS. 22, 23, 38 AND 50).

## CLASS 41—EDUCATION AND ENTERTAINMENT

FOR PRODUCTION AND DISTRIBUTION OF ENTERTAINMENT AND EDUCATIONAL MOTION PICTURE FILMS, TELEVISION AND CABLE PROGRAMS FOR OTHERS, PRODUCTION OF DVDS, VIDEO AND AUDIO TAPE FEATURING A VARIETY OF ENTERTAINMENT AND EDUCATIONAL THEMES; LIVE PERFORMANCES IN THE NATURE OF LITERARY, MUSICAL, COMEDY, DRAMA AND THEATRICAL PERFORMANCES; PUBLICATION OF BOOKS FEATURING A VARIETY OF ENTERTAINMENT AND EDUCATIONAL THEMES; ENTERTAINMENT SERVICES, NAMELY, PROVIDING ONLINE AND OFFLINE COMPUTER GAMES FEATURING A VARIETY OF ENTERTAINMENT AND EDUCATIONAL THEMES (U.S. CLS. 100, 101 AND 107).  
HOWARD B. LEVINE, EXAMINING ATTORNEY

SN 78-387,551. TRANSITIONS OPTICAL, INC., PINELLAS PARK, FL. FILED 3-19-2004.

# TRANSITIONS

THE MARK CONSISTS OF STANDARD CHARACTERS WITHOUT CLAIM TO ANY PARTICULAR FONT, STYLE, SIZE, OR COLOR.  
OWNER OF U.S. REG. NOS. 1,576,217 AND 2,396,411.

## CLASS 35—ADVERTISING AND BUSINESS

FOR PROMOTING THE SALE OF LENSES AND LENS BLANKS THROUGH THE ADMINISTRATION OF INCENTIVE AND REWARD PROGRAMS FOR EYE CARE AND MEDICAL PROFESSIONALS (U.S. CLS. 100, 101 AND 102).

## CLASS 41—EDUCATION AND ENTERTAINMENT

FOR EDUCATIONAL SERVICES, NAMELY, CONDUCTING CLASSES, WORKSHOPS AND SEMINARS AND PROVIDING TRAINING IN THE FIELD OF LENSES AND LENS BLANKS AND THE MARKETING OF OPTICAL PRODUCTS, FOR EYE CARE AND MEDICAL PROFESSIONALS (U.S. CLS. 100, 101 AND 107).  
JOHN HWANG, EXAMINING ATTORNEY

SN 78-390,688. ATHENA ISG/GTXXTREME, INC., RANCHO CUCAMONGA, CA. FILED 3-25-2004.

## MIDDAS

THE MARK CONSISTS OF STANDARD CHARACTERS WITHOUT CLAIM TO ANY PARTICULAR FONT, STYLE, SIZE, OR COLOR.

### CLASS 9—ELECTRICAL AND SCIENTIFIC APPARATUS

FOR [ INTENT TO USE ] CUSTOM GRAPHICAL USER INTERFACE SOFTWARE (U.S. CLS. 21, 23, 26, 36 AND 38).

### CLASS 10—MEDICAL APPARATUS

FOR MOBILE HUMAN MEDICAL DIAGNOSTIC AND DATA ANALYSIS SYSTEMS, NAMELY, HUMAN DIAGNOSTIC DATA ACQUISITION GLOVES, PATIENT SENSORY UNITS; HUMAN DIAGNOSTIC MONITORS FOR DIAGNOSTIC MEDICAL APPARATUS, MINIATURIZED VITAL SIGNS SENSORS (U.S. CLS. 26, 39 AND 44).

FIRST USE 5-12-1997; IN COMMERCE 3-15-1998.

### CLASS 38—COMMUNICATION

FOR [ INTENT TO USE ] LOCAL AREA NETWORK SERVICES, LOCAL WIRELESS NETWORK SERVICES, LONG DISTANCE WIRELESS COMMUNICATION SERVICES, TELEMEDICINE, NAMELY HUMAN DIAGNOSTIC AND DATA ANALYSIS TRANSMISSION VIA WIRELESS SERVICES (U.S. CLS. 100, 101 AND 104).

LINDA E. BLOHM, EXAMINING ATTORNEY

SN 78-391,463. KIDVID, INC., ALPHARETTA, GA. FILED 3-26-2004.

## AMEN BABY

THE MARK CONSISTS OF STANDARD CHARACTERS WITHOUT CLAIM TO ANY PARTICULAR FONT, STYLE, SIZE, OR COLOR.

NO CLAIM IS MADE TO THE EXCLUSIVE RIGHT TO USE "BABY", APART FROM THE MARK AS SHOWN.

### CLASS 9—ELECTRICAL AND SCIENTIFIC APPARATUS

FOR SERIES OF PRERECORDED VIDEOTAPES, AUDIO CASSETTES, DIGITAL VIDEO DISCS AND COMPACT DISCS FEATURING LIVE AND ANIMATED EDUCATIONAL MATERIALS WITH AN INSPIRATIONAL THEME INTENDED TO DEVELOP AND IMPROVE THE CREATIVE AND INTELLECTUAL FACULTIES OF INFANTS AND CHILDREN (U.S. CLS. 21, 23, 26, 36 AND 38).

### CLASS 16—PAPER GOODS AND PRINTED MATTER

FOR CALENDARS, BABY AND CHILDREN'S BOOKS OF ALL TYPES, SHEET MUSIC, PHOTO AND SCRAPBOOK ALBUMS, GIFT WRAPPING PAPER, GREETING CARDS, ARTS AND CRAFT PAINT KITS, MARKERS, CRAYONS, PENS, PENCILS, STICKERS, RUBBER STAMPS, STAMP PADS, STATIONERY, CRAFT PAPER, PENCIL BOXES, AND PRINTED TEACHING MATERIALS FEATURING EDUCATIONAL MATERIALS ALL WITH AN INSPIRATIONAL THEME FOR USE IN DEVELOPING AND IMPROVING THE CREATIVE AND INTELLECTUAL FACULTIES OF INFANTS AND CHILDREN (U.S. CLS. 2, 5, 22, 23, 29, 37, 38 AND 50).

BILL DAWE, EXAMINING ATTORNEY

SN 78-392,266. HOT POPS, L.L.C., COLUMBUS, OH. FILED 3-29-2004.

## HOT POPS

THE MARK CONSISTS OF STANDARD CHARACTERS WITHOUT CLAIM TO ANY PARTICULAR FONT, STYLE, SIZE, OR COLOR.

### CLASS 29—MEATS AND PROCESSED FOODS

FOR BREAKFAST FOODS, NAMELY EGGS AND OMELETTES, AND FROZEN, PREPARED OR PACKAGED ENTREES CONSISTING PRIMARILY OF BEEF, CHICKEN AND FISH (U.S. CL. 46).

### CLASS 30—STAPLE FOODS

FOR BREAKFAST FOODS, NAMELY PANCAKES, FRENCH TOAST, CREPES, BLINTZES AND WAFFLES; PASTA PRODUCTS, NAMELY SPAGHETTI, RIGATONI AND MACARONI; TORTILLAS, WONTONS, AND BAKERY DESSERTS (U.S. CL. 46).

STANLEY I. OSBORNE, EXAMINING ATTORNEY

SN 78-392,274. HOT POPS, L.L.C., COLUMBUS, OH. FILED 3-29-2004.

SN 78-394,322. LUMA, CYNTHIA GRACE, YORK, ME. FILED 3-31-2004.

## TRAVELIN' JACKS

THE MARK CONSISTS OF STANDARD CHARACTERS WITHOUT CLAIM TO ANY PARTICULAR FONT, STYLE, SIZE, OR COLOR.

### CLASS 29—MEATS AND PROCESSED FOODS

FOR BREAKFAST FOODS, NAMELY EGGS AND OMELETTES, AND FROZEN, PREPARED OR PACKAGED ENTREES CONSISTING PRIMARILY OF BEEF, CHICKEN AND FISH (U.S. CL. 46).

### CLASS 30—STAPLE FOODS

FOR BREAKFAST FOODS, NAMELY PANCAKES, FRENCH TOAST, CREPES, BLINTZES AND WAFFLES; PASTA PRODUCTS, NAMELY SPAGHETTI, RIGATONI AND MACARONI; TORTILLAS, WONTONS, AND BAKERY DESSERTS (U.S. CL. 46).

STANLEY I. OSBORNE, EXAMINING ATTORNEY

SN 78-392,846. CALIFORNIA ACRYLIC INDUSTRIES, POMONA, CA. FILED 3-29-2004.

## HIDE-A-WAY

THE MARK CONSISTS OF STANDARD CHARACTERS WITHOUT CLAIM TO ANY PARTICULAR FONT, STYLE, SIZE, OR COLOR.

### CLASS 11—ENVIRONMENTAL CONTROL APPARATUS

FOR SPAS IN THE NATURE OF HEATED POOLS, BARBECUE GRILLS, SAUNAS, FIREPLACES, PORTABLE METAL FIRE PITS FOR USE AS BARBECUE GRILLS, AND WET BARS, NAMELY, SINKS (U.S. CLS. 13, 21, 23, 31 AND 34).

### CLASS 19—NON-METALLIC BUILDING MATERIALS

FOR GAZEBOS (U.S. CLS. 1, 12, 33 AND 50).

### CLASS 28—TOYS AND SPORTING GOODS

FOR BILLIARD TABLES (U.S. CLS. 22, 23, 38 AND 50). NANCY CLARKE, EXAMINING ATTORNEY

## AGING WITH ATTITUDE

THE MARK CONSISTS OF STANDARD CHARACTERS WITHOUT CLAIM TO ANY PARTICULAR FONT, STYLE, SIZE, OR COLOR.

### CLASS 9—ELECTRICAL AND SCIENTIFIC APPARATUS

FOR PRE-RECORDED AUDIOTAPES, CD'S, AND VIDEOTAPES, PRESENTING MATERIAL THAT ASSISTS THE LISTENERS TO EXPLORE THEIR FEELINGS, BELIEFS AND VALUES AND THE CULTURAL MESSAGES AND INFLUENCES RELATED TO AGING, YOUTH, ATTRACTIVENESS, HEALTH AND WELL-BEING (U.S. CLS. 21, 23, 26, 36 AND 38).

### CLASS 16—PAPER GOODS AND PRINTED MATTER

FOR BOOKS, BOOKLETS, AND WORKBOOKS CONTAINING WRITTEN MATERIAL THAT ASSISTS THE READERS TO EXPLORE THEIR FEELINGS, BELIEFS AND VALUES AND THE CULTURAL MESSAGES AND INFLUENCES RELATED TO AGING, YOUTH, ATTRACTIVENESS, HEALTH AND WELL-BEING (U.S. CLS. 2, 5, 22, 23, 29, 37, 38 AND 50).

DOUGLAS LEE, EXAMINING ATTORNEY

SN 78-395,663. ROYAL PHARMACEUTICAL SOCIETY OF GREAT BRITAIN, LONDON, UNITED KINGDOM, FILED 4-2-2004.



THE MARK CONSISTS OF THE LETTERS "M" AND "C" IN A TEARDROP-SHAPED DESIGN WITH THE WORDS MEDICINES COMPLETE.

**CLASS 9—ELECTRICAL AND SCIENTIFIC APPARATUS**

FOR COMPUTER SOFTWARE NAMELY PROGRAMS FOR SEARCHING AND RETRIEVING STORED DATA AND INFORMATION IN THE FIELD OF MEDICINE AND PHARMACOLOGY; DATA AND INFORMATION STORED IN ELECTRONIC, DIGITAL AND MAGNETIC FORM, NAMELY, PRE-RECORDED CD-ROMS, DIGITAL VIDEO DISCS ALL FEATURING PUBLICATIONS, DATABASES AND INFORMATION ON MEDICINE AND PHARMACOLOGY; PUBLICATIONS IN ELECTRONIC FORM, SUPPLIED ON-LINE FROM DATABASES OR FROM FACILITIES PROVIDED ON THE INTERNET, NAMELY, DOWNLOADABLE ELECTRONIC PUBLICATIONS IN THE NATURE OF BOOKS IN THE FIELD OF MEDICINE AND PHARMACOLOGY; ELECTRONIC DATABASE IN THE FIELD OF MEDICINE AND PHARMACOLOGY RECORDED ON COMPUTER MEDIA; ELECTRONIC DATABASE IN THE FIELD OF MEDICINE AND PHARMACOLOGY RECORDED ON COMPUTER MEDIA; MULTIMEDIA SOFTWARE RECORDED ON CD-ROMS IN THE FIELD OF MEDICINE AND PHARMACOLOGY (U.S. CLS. 21, 23, 26, 36 AND 38).

**CLASS 16—PAPER GOODS AND PRINTED MATTER**

FOR PRINTED MATTER AND PUBLISHED MATTER, NAMELY BOOKS, JOURNALS, INSTRUCTIONAL, TEACHING AND REFERENCE MATERIALS, ALL RELATING TO MEDICINE AND PHARMACOLOGY (U.S. CLS. 2, 5, 22, 23, 29, 37, 38 AND 50).

**CLASS 41—EDUCATION AND ENTERTAINMENT**

FOR PUBLISHING SERVICES, NAMELY BOOK PUBLISHING AND PROVIDING NON-DOWNLOADABLE PUBLISHED MATTER, NAMELY, BOOKS, JOURNALS, MAGAZINES, INSTRUCTIONAL, TEACHING AND REFERENCE PUBLISHED MATERIAL FEATURING MEDICINE AND PHARMACOLOGY AND PROVIDED VIA THE INTERNET (U.S. CLS. 100, 101 AND 107).

**CLASS 44—MEDICAL, BEAUTY AND AGRICULTURAL SERVICES**

FOR PROVIDING INFORMATION REGARDING MEDICINE AND PHARMACOLOGY BY MEANS OF THE INTERNET; MEDICAL SERVICES; HYGIENIC AND BEAUTY CARE FOR HUMAN BEINGS (U.S. CLS. 100 AND 101).

SEAN DWYER, EXAMINING ATTORNEY

SN 78-397,096. STAR STRUCK, INC., BETHEL, CT. FILED 4-6-2004.

**AT THE YARD**

THE MARK CONSISTS OF STANDARD CHARACTERS WITHOUT CLAIM TO ANY PARTICULAR FONT, STYLE, SIZE, OR COLOR.

**CLASS 16—PAPER GOODS AND PRINTED MATTER**

FOR SPORTS MAGAZINES AND CATALOGS FEATURING TEAM CLOTHING (U.S. CLS. 2, 5, 22, 23, 29, 37, 38 AND 50).

FIRST USE 4-0-2004; IN COMMERCE 4-0-2004.

**CLASS 35—ADVERTISING AND BUSINESS**

FOR ONLINE RETAIL STORE SERVICES AND MAIL ORDER CATALOG SERVICES FEATURING TEAM CLOTHING (U.S. CLS. 100, 101 AND 102).

FIRST USE 4-0-1998; IN COMMERCE 4-0-1998.

CHARLES JOYNER, EXAMINING ATTORNEY

SN 78-397,818. FLOORPLANS EXPRESS, INC., SAN JOSE, CA. FILED 4-7-2004.

**FLOORPLANS EXPRESS**

THE MARK CONSISTS OF STANDARD CHARACTERS WITHOUT CLAIM TO ANY PARTICULAR FONT, STYLE, SIZE, OR COLOR.

NO CLAIM IS MADE TO THE EXCLUSIVE RIGHT TO USE "FLOORPLANS", APART FROM THE MARK AS SHOWN.

**CLASS 35—ADVERTISING AND BUSINESS**

FOR REAL ESTATE MARKETING SERVICES, NAMELY, ON-LINE SERVICES FEATURING TOURS OF RESIDENTIAL AND COMMERCIAL REAL ESTATE (U.S. CLS. 100, 101 AND 102).

**CLASS 42—SCIENTIFIC, COMPUTER AND LEGAL SERVICES**

FOR DRAFTING; HOSTING OF DIGITAL CONTENT ON THE INTERNET (U.S. CLS. 100 AND 101).

CHARLES JOYNER, EXAMINING ATTORNEY

SN 78-397,979. HENDON PUBLISHING CO., DEERFIELD, IL. FILED 4-7-2004.

**Tactical  
TR Response**

OWNER OF U.S. REG. NO. 2,679,233.

NO CLAIM IS MADE TO THE EXCLUSIVE RIGHT TO USE TACTICAL RESPONSE, APART FROM THE MARK AS SHOWN.

THE MARK CONSISTS OF A CIRCLE DIVIDED INTO FOUR EQUAL SECTIONS WITH THE LETTERS "TR", ATTACHED, WITHIN THE CIRCLE. ALONG THE TOP AND SIDE OF THE CIRCLE IN MUCH LARGER FONT ARE THE WORDS "TACTICAL RESPONSE". THE LETTERS ARE SHADOWED.



**CLASS 16—PAPER GOODS AND PRINTED MATTER**

FOR MAGAZINES RELATING TO LAW ENFORCEMENT (U.S. CLS. 2, 5, 22, 23, 29, 37, 38 AND 50).  
FIRST USE 11-1-2002; IN COMMERCE 11-1-2002.

**CLASS 41—EDUCATION AND ENTERTAINMENT**

FOR PUBLICATION OF MAGAZINES RELATING TO LAW ENFORCEMENT (U.S. CLS. 100, 101 AND 107).  
FIRST USE 2-8-2002; IN COMMERCE 2-8-2002.  
JAMES A. RAUEN, EXAMINING ATTORNEY

**CLASS 35—ADVERTISING AND BUSINESS**

FOR PROVIDING INFORMATION IN THE NATURE OF EMPLOYMENT RECORD VERIFICATION, VIA GLOBAL COMPUTER NETWORKS (U.S. CLS. 100, 101 AND 102).  
FIRST USE 6-17-1998; IN COMMERCE 6-17-1998.

**CLASS 36—INSURANCE AND FINANCIAL**

FOR PROVIDING INFORMATION REGARDING INSURANCE, VIA GLOBAL COMPUTER NETWORKS (U.S. CLS. 100, 101 AND 102).  
FIRST USE 6-17-1998; IN COMMERCE 6-17-1998.

**CLASS 37—CONSTRUCTION AND REPAIR**

FOR PROVIDING INFORMATION REGARDING CONSTRUCTION, VIA GLOBAL COMPUTER NETWORKS (U.S. CLS. 100, 103 AND 106).  
FIRST USE 6-17-1998; IN COMMERCE 6-17-1998.

**CLASS 42—SCIENTIFIC, COMPUTER AND LEGAL SERVICES**

FOR PROVIDING INFORMATION REGARDING RECORDS OF DEATH AND REGARDING SOCIAL SECURITY, VIA GLOBAL COMPUTER NETWORKS (U.S. CLS. 100 AND 101).  
FIRST USE 6-17-1998; IN COMMERCE 6-17-1998.  
IRENE D. WILLIAMS, EXAMINING ATTORNEY

SN 78-398,772. THE DANNON COMPANY, INC., TARRYTOWN, NY. FILED 4-8-2004.

**XLLLENT**

SN 78-399,029. DAYMEN PHOTO MARKETING, LTD., MARKHAM, ONTARIO, CANADA, FILED 4-8-2004.

THE MARK CONSISTS OF STANDARD CHARACTERS WITHOUT CLAIM TO ANY PARTICULAR FONT, STYLE, SIZE, OR COLOR.

**CLASS 29—MEATS AND PROCESSED FOODS**

FOR YOGURT, YOGURT-BASED BEVERAGES (U.S. CL. 46).

**CLASS 32—LIGHT BEVERAGES**

FOR SMOOTHIES (U.S. CLS. 45, 46 AND 48).  
MICHAEL HALL, EXAMINING ATTORNEY

**PROFICIONADO**

THE MARK CONSISTS OF STANDARD CHARACTERS WITHOUT CLAIM TO ANY PARTICULAR FONT, STYLE, SIZE, OR COLOR.

**CLASS 9—ELECTRICAL AND SCIENTIFIC APPARATUS**

FOR BAGS, HARD AND SOFT COVERED CASES, RUCKSACKS, HOLDALLS, BACKPACKS WITH AND WITHOUT ROLLING WHEELS, BELT PACKS IN THE NATURE OF WAIST PACKS, AND TOTE BAGS, ALL FOR CARRYING PHOTOGRAPHIC, CINEMATOGRAPHIC, VIDEOGRAPHIC, OPTICAL, AUDIO, CONSUMER ELECTRONIC AND COMPUTER EQUIPMENT, PERSONAL DIGITAL ASSISTANTS, COMPACT DISC PLAYERS AND BINOCULARS; FILM ORGANIZERS, NAMELY CASES FOR CARRYING EXPOSED AND UNEXPOSED CAMERA FILM, CELL PHONE CARRYING CASES IN THE NATURE OF HOOK AND LOOP CLOSURE AND DRAWSTRING FELT LINED POUCHES SOLD EMPTY, WAIST AND SHOULDER HARNESS STRAPS SOLD AS A COMPONENT PART OF THE AFORESAID GOODS (U.S. CLS. 21, 23, 26, 36 AND 38).

SN 78-399,009. DATA CONTROL CORPORATION, GRANITE BAY, CA. FILED 4-8-2004.

**@CONTENT.COM**

THE MARK CONSISTS OF STANDARD CHARACTERS WITHOUT CLAIM TO ANY PARTICULAR FONT, STYLE, SIZE, OR COLOR.  
OWNER OF U.S. REG. NOS. 2,226,819 AND 2,233,044.  
SEC. 2(F).

**CLASS 18—LEATHER GOODS**

FOR CARRYING BAGS AND LUGGAGE, NAMELY, BACKPACKS WITH AND WITHOUT ROLLING WHEELS, KNAPSACKS, SHOULDER BAGS, TOTE BAGS, FANNY PACKS, BELT PACKS IN THE NATURE OF WAIST PACKS, HOOK AND LOOP CLOSURE AND DRAWSTRING FELT LINED POUCHES SOLD EMPTY AND SOFT-COVERED BRIEFCASES (U.S. CLS. 1, 2, 3, 22 AND 41).

ALEXANDER L. POWERS, EXAMINING ATTORNEY

SN 78-400,766. FISKARS BRANDS, INC., MADISON, WI. FILED 4-13-2004.

# GERBER

SN 78-400,396. ASHCO GROUP LIMITED LIABILITY COMPANY, FORT WORTH, TX. FILED 4-12-2004.

# ASHCO

THE MARK CONSISTS OF STANDARD CHARACTERS WITHOUT CLAIM TO ANY PARTICULAR FONT, STYLE, SIZE, OR COLOR.

OWNER OF U.S. REG. NOS. 512,677, 2,279,229 AND OTHERS.  
SEC. 2(F).

**CLASS 8—HAND TOOLS**

FOR HAND TOOLS, NAMELY SPADES, AXES, HAND SAWS, AND HATCHETS (U.S. CLS. 23, 28 AND 44).  
FIRST USE 1-1-1999; IN COMMERCE 1-1-1999.

**CLASS 11—ENVIRONMENTAL CONTROL APPARATUS**

FOR FLASHLIGHTS, ELECTRIC LANTERNS, KEY-CHAIN FLASHLIGHTS, AND PERSONAL HEADLAMPS (U.S. CLS. 13, 21, 23, 31 AND 34).

FIRST USE 4-2-2004; IN COMMERCE 4-2-2004.  
ANDREW RHIM, EXAMINING ATTORNEY

THE MARK CONSISTS OF STANDARD CHARACTERS WITHOUT CLAIM TO ANY PARTICULAR FONT, STYLE, SIZE, OR COLOR.

**CLASS 35—ADVERTISING AND BUSINESS**

FOR BUSINESS ACQUISITION CONSULTATIONS (U.S. CLS. 100, 101 AND 102).

**CLASS 36—INSURANCE AND FINANCIAL**

FOR PRIVATE INVESTMENT AND ACQUISITION RELATED ACTIVITIES, NAMELY INVESTMENT OF FUNDS OF OTHERS AND INVESTMENT MANAGEMENT; RESIDENTIAL AND COMMERCIAL REAL ESTATE SERVICES, NAMELY LAND ACQUISITION BROKERAGE, REAL ESTATE INVESTMENT, REAL ESTATE SYNDICATION, LISTING AND REAL ESTATE MANAGEMENT; AND PROPERTY MANAGEMENT SERVICES FOR CORPORATE AND BUSINESS FACILITIES (U.S. CLS. 100, 101 AND 102).

**CLASS 37—CONSTRUCTION AND REPAIR**

FOR COMMERCIAL AND RESIDENTIAL CONSTRUCTION AND DEVELOPMENT SERVICES, NAMELY PLANNING, REAL ESTATE SITE SELECTION, LAYING OUT, MANAGEMENT AND CUSTOM CONSTRUCTION OF LAND, RESIDENTIAL AND COMMERCIAL BUILDINGS AND COMMUNITIES (U.S. CLS. 100, 103 AND 106).

JOANNA DUKOVIC, EXAMINING ATTORNEY

SN 78-400,820. POWELL-CHRISTENSEN, INC., GRANDVIEW, WA. FILED 4-13-2004.

# AMERIWASH

THE MARK CONSISTS OF STANDARD CHARACTERS WITHOUT CLAIM TO ANY PARTICULAR FONT, STYLE, SIZE, OR COLOR.

**CLASS 3—COSMETICS AND CLEANING PREPARATIONS**

FOR CAR WASH SOAPS, WHEEL CLEANING SOLUTIONS, WHITE WALL CLEANERS, ENGINE CLEANERS, TAR REMOVING PREPARATIONS, FINISH SEALANTS FOR USE ON THE INTERIOR AND EXTERIOR OF VEHICLES, POLISHES, WAX, SPRAY-ON DETERGENTS, FOAMING DETERGENT FOR USE ON THE EXTERIOR OF VEHICLES, DRYING AGENT, ALL FOR USE IN COMMERCIAL CAR WASHES AND BY INDIVIDUALS (U.S. CLS. 1, 4, 6, 50, 51 AND 52).

**CLASS 37—CONSTRUCTION AND REPAIR**

FOR LAUNDRY FACILITIES FOR SELF-CLEANING OF LAUNDRY; 24-HOUR SELF SERVICE AUTOMATED LAUNDROMAT AND SPECIALTY LAUNDRY CLEANING; LAUNDROMAT SERVICES, NAMELY, PROVIDING COIN-OPERATED LAUNDRY CLEANING APPARATUS AND FACILITIES; AUTOMOBILE CLEANING AND WASHING SERVICES; PROVIDING AUTOMATED CAR WASHING SERVICES; CARWASH AND TRUCK WASH SERVICES (U.S. CLS. 100, 103 AND 106).  
ARETHA SOMERVILLE, EXAMINING ATTORNEY

SN 78-401,658. GATEWAY LEARNING CORPORATION, SANTA ANA, CA. FILED 4-14-2004.

**HOOKED ON READING**

THE MARK CONSISTS OF STANDARD CHARACTERS WITHOUT CLAIM TO ANY PARTICULAR FONT, STYLE, SIZE, OR COLOR.

NO CLAIM IS MADE TO THE EXCLUSIVE RIGHT TO USE "READING", APART FROM THE MARK AS SHOWN.

**CLASS 16—PAPER GOODS AND PRINTED MATTER**

FOR EDUCATIONAL INSTRUCTIONAL MATERIALS, NAMELY, BOOKS IN THE FIELD OF READING, PRE-RECORDED TAPES AND COMPACT DISCS IN THE FIELD OF READING AND FLASH CARDS (U.S. CLS. 2, 5, 22, 23, 29, 37, 38 AND 50).

**CLASS 41—EDUCATION AND ENTERTAINMENT**

FOR PROVIDING INFORMATION IN THE FIELD OF READING THROUGH ARTICLES, GAMES, CONTESTS, TESTING, EVALUATIONS AND RECOMMENDATIONS VIA THE INTERNET (U.S. CLS. 100, 101 AND 107).

TIMOTHY FINNEGAN, EXAMINING ATTORNEY

SN 78-402,434. CUNARD LINE LIMITED, MIAMI, FL. FILED 4-15-2004.

**QE2**

THE MARK CONSISTS OF STANDARD CHARACTERS WITHOUT CLAIM TO ANY PARTICULAR FONT, STYLE, SIZE, OR COLOR.

OWNER OF U.S. REG. NOS. 1,435,958 AND 1,502,965.

**CLASS 9—ELECTRICAL AND SCIENTIFIC APPARATUS**

FOR MULTIMEDIA SOFTWARE RECORDED ON CD-ROM IN THE FIELD OF THE TRAVEL AND CRUISE INDUSTRY INCLUDING ETIQUETTE, ATTIRE, CUISINE, DINING, SHOPPING, SAFETY, PORTS OF CALL, DAY EXCURSIONS, SIGHTSEEING, CULTURAL INTERESTS, CURRENT NEWS, HISTORICAL AND EDUCATIONAL INFORMATION, ENTERTAINMENT AND SHIP INNOVATIONS; PRE-RECORDED CD'S, VIDEO TAPES, VIDEO DISCS, VIDEO RECORDINGS, LASER DISKS AND DVD'S, CD-ROMS IN THE FIELD OF THE TRAVEL AND CRUISE INDUSTRY INCLUDING ETIQUETTE, ATTIRE, CUISINE, DINING, SHOPPING, SAFETY, PORTS OF CALL, DAY EXCURSIONS, SIGHTSEEING, CULTURAL INTERESTS, CURRENT NEWS, HISTORICAL AND EDUCATIONAL INFORMATION, ENTERTAINMENT AND SHIP INNOVATIONS. (U.S. CLS. 21, 23, 26, 36 AND 38).

**CLASS 41—EDUCATION AND ENTERTAINMENT**

FOR ENTERTAINMENT IN THE NATURE OF A TELEVISION SERIES IN THE FIELD OF THE TRAVEL AND CRUISE INDUSTRY INCLUDING ETIQUETTE, ATTIRE, CUISINE, DINING, SHOPPING, SAFETY, PORTS OF CALL, DAY EXCURSIONS, SIGHTSEEING, CULTURAL INTERESTS, CURRENT NEWS, HISTORICAL AND EDUCATIONAL INFORMATION, ENTERTAINMENT AND SHIP INNOVATIONS; ENTERTAINMENT SERVICES, NAMELY, PROVIDING A WEB SITE FEATURING VIDEOS, FILM CLIPS, PHOTOGRAPHS, AND OTHER MULTIMEDIA MATERIALS; ENTERTAINMENT, NAMELY A CONTINUING SHOW IN THE FIELD OF THE TRAVEL AND CRUISE INDUSTRY INCLUDING ETIQUETTE, ATTIRE, CUISINE, DINING, SHOPPING, SAFETY, PORTS OF CALL, DAY EXCURSIONS, SIGHTSEEING, CULTURAL INTERESTS, CURRENT NEWS, HISTORICAL AND EDUCATIONAL INFORMATION, ENTERTAINMENT AND SHIP INNOVATIONS; BROADCAST OVER SATELLITE, AUDIO, AND VIDEO MEDIA (U.S. CLS. 100, 101 AND 107).

GRETTA YAO, EXAMINING ATTORNEY

SN 78-402,961. KERMEL, COLMAR, FRANCE, FILED 4-16-2004.

**SOFSHIELD**

THE MARK CONSISTS OF STANDARD CHARACTERS WITHOUT CLAIM TO ANY PARTICULAR FONT, STYLE, SIZE, OR COLOR.

**CLASS 9—ELECTRICAL AND SCIENTIFIC APPARATUS**

FOR PROTECTIVE AND SAFETY CLOTHING MANUFACTURED FROM PROTECTIVE FABRICS TO PREVENT AGAINST HEAT AND FLAMES, RADIATION AND CHEMICAL RISKS, NAMELY, UNIFORMS, OVERALLS, JACKETS, TROUSERS, PULL OVERS, POLOS, GLOVES, HOODS, SOCKS, UNDERWEAR, SHIRTS AND OVERTROUSERS (U.S. CLS. 21, 23, 26, 36 AND 38).

**CLASS 22—CORDAGE AND FIBERS**

FOR RAW FIBROUS TEXTILE MATERIALS (U.S. CLS. 1, 2, 7, 19, 22, 42 AND 50).

SN 78-414,940. ANSUL, INCORPORATED, MARINETTE, WI. FILED 5-7-2004.

**CLASS 23—YARNS AND THREADS**

FOR YARNS FOR TEXTILE USE (U.S. CL. 43).

**CLASS 24—FABRICS**

FOR FABRICS FOR THE MANUFACTURE OF CLOTHING; FABRICS MANUFACTURED FROM THERMOSTABLE FIBERS; PROTECTIVE FABRICS AGAINST HEAT AND FLAMES; PROTECTIVE FABRICS USED TO MAKE PROTECTIVE CLOTHING (U.S. CLS. 42 AND 50).

**SAPPHIRE**

**CLASS 25—CLOTHING**

FOR CLOTHES, NAMELY, UNIFORMS, OVERALLS, JACKETS, TROUSERS, PULLOVERS, POLOS, GLOVES, HOODS, SOCKS, UNDERWEAR, SHIRTS AND OVERTROUSERS (U.S. CLS. 22 AND 39).  
WON TEAK OH, EXAMINING ATTORNEY

THE MARK CONSISTS OF STANDARD CHARACTERS WITHOUT CLAIM TO ANY PARTICULAR FONT, STYLE, SIZE, OR COLOR.

**CLASS 1—CHEMICALS**

FOR CHEMICAL COMPOSITION FOR SUPPRESSION OF FIRES (U.S. CLS. 1, 5, 6, 10, 26 AND 46).  
FIRST USE 10-18-2003; IN COMMERCE 10-18-2003.

SN 78-413,318. OMP, INC., LONG BEACH, CA. FILED 5-5-2004.

**CLASS 9—ELECTRICAL AND SCIENTIFIC APPARATUS**

FOR FIRE SUPPRESSION SYSTEMS COMPRISING SENSORS, ELECTRONIC CONTROLS, ACTUATORS, STORAGE CONTAINERS AND DISTRIBUTION PIPES (U.S. CLS. 21, 23, 26, 36 AND 38).  
FIRST USE 10-18-2003; IN COMMERCE 10-18-2003.  
ALICE BENMAMAN, EXAMINING ATTORNEY

**OBAGI-C**

SN 78-414,989. MYTHIC ENTERTAINMENT, INC., FAIRFAX, VA. FILED 5-7-2004.

THE MARK CONSISTS OF STANDARD CHARACTERS WITHOUT CLAIM TO ANY PARTICULAR FONT, STYLE, SIZE, OR COLOR.

OWNER OF U.S. REG. NOS. 2,203,028, 2,454,186 AND OTHERS.

**MYTHICA**

**CLASS 3—COSMETICS AND CLEANING PREPARATIONS**

FOR NON-MEDICATED SKIN CARE PREPARATIONS (U.S. CLS. 1, 4, 6, 50, 51 AND 52).  
FIRST USE 4-26-2004; IN COMMERCE 4-26-2004.

**CLASS 5—PHARMACEUTICALS**

FOR MEDICATED SKIN CARE PREPARATIONS (U.S. CLS. 6, 18, 44, 46, 51 AND 52).  
FIRST USE 4-26-2004; IN COMMERCE 4-26-2004.  
ZHALEH DELANEY, EXAMINING ATTORNEY

THE MARK CONSISTS OF STANDARD CHARACTERS WITHOUT CLAIM TO ANY PARTICULAR FONT, STYLE, SIZE, OR COLOR.

**CLASS 9—ELECTRICAL AND SCIENTIFIC APPARATUS**

FOR COMPUTER PROGRAMS, NAMELY, GAME SOFTWARE FOR USE ON COMPUTERS AND VIDEO GAME PLAYERS; COMPUTER GAME CARTRIDGES; COMPUTER GAME DISKS; VIDEO GAME CARTRIDGES; VIDEO GAME CASSETTES; PRERECORDED VIDEOTAPES, AUDIO TAPES, CDS AND DVDS FEATURING SOUND AND VIDEO IN THE FIELDS OF MUSIC, LIVE ACTION PROGRAMS, MOTION PICTURES AND ANIMATED CARTOONS; AND MOTION PICTURE FILMS FEATURING COMEDY, DRAMA, ACTION, ADVENTURE AND ANIMATION; AND MOTION PICTURE FILMS FOR BROADCAST ON TELEVISION FEATURING COMEDY, DRAMA, ACTION, ADVENTURE AND ANIMATION (U.S. CLS. 21, 23, 26, 36 AND 38).

**CLASS 41—EDUCATION AND ENTERTAINMENT**

FOR ENTERTAINMENT SERVICES, NAMELY, PROVIDING AN ON-LINE COMPUTER GAME FOR OTHERS; PROVIDING AN ON-LINE MAGAZINE AND WEB SITE FEATURING INFORMATION IN THE FIELD OF COMPUTER GAMES, SCIENCE FICTION, FANTASY GAMES AND ENTERTAINMENT; PROVIDING INFORMATION ON-LINE RELATING TO COMPUTER GAMES AND COMPUTER ENHANCEMENTS FOR GAMES; PRODUCTION AND DISTRIBUTION OF MOTION PICTURES AND TELEVISION PROGRAMS; ENTERTAINMENT IN THE NATURE OF ON-GOING TELEVISION PROGRAMS IN THE FIELD OF COMPUTER GAMES, SCIENCE FICTION, GAMES AND ENTERTAINMENT (U.S. CLS. 100, 101 AND 107).

TINA L. SNAPP, EXAMINING ATTORNEY

SN 78-415,202. GIRLS & SPORTS, LLC, LOS ANGELES, CA. FILED 5-7-2004.

**BAD DRUNK GIRL**

THE MARK CONSISTS OF STANDARD CHARACTERS WITHOUT CLAIM TO ANY PARTICULAR FONT, STYLE, SIZE, OR COLOR.

**CLASS 16—PAPER GOODS AND PRINTED MATTER**

FOR CARTOONS, CARTOON PRINTS, CARTOON STRIPS, NEWSPAPER CARTOONS, NEWSPAPER COMIC STRIPS, COMIC BOOKS, ADDRESS BOOKS, ANIMATION CELLS, ANNOUNCEMENT CARDS, AUTOGRAPH BOOKS, APPOINTMENT BOOKS, GUEST BOOKS, PICTURE BOOKS, TELEPHONE NUMBER BOOKS, CALENDARS, TRADING CARDS, GREETING CARDS, DAILY PLANNERS, DECALS, DESK CALENDARS, ENVELOPES, GIFT CARDS, ADDRESS LABELS, NOTEBOOKS, PAPER NAPKINS, PRINTED PAPER SIGNS, PICTURE POSTCARDS, POSTCARDS, POSTERS, ART PRINTS, COLOR PRINTS, LITHOGRAPH PRINTS, PHOTOGRAPHIC PRINTS, RUBBER STAMPS (U.S. CLS. 2, 5, 22, 23, 29, 37, 38 AND 50).

FIRST USE 5-0-2004; IN COMMERCE 5-0-2004.

**CLASS 25—CLOTHING**

FOR CLOTHING, NAMELY, ATHLETIC UNIFORMS, BASEBALL CAPS, BATHING TRUNKS, BEACHWEAR, BOXER SHORTS, GYM SHORTS, HATS, JACKETS, SHIRTS, SHORTS, SWEAT PANTS, SWEAT SHIRTS, SWEAT SHORTS, SWEAT SUITS, SWEATERS, SWIM TRUNKS, TEE SHIRTS, TANK TOPS, AND UNIFORMS (U.S. CLS. 22 AND 39).

FIRST USE 5-0-2004; IN COMMERCE 5-0-2004.  
SALLY SHIN, EXAMINING ATTORNEY

SN 78-416,007. JOHN BOOS & CO., EFFINGHAM, IL. FILED 5-10-2004.

**4COOKS BY JOHN BOOS**

THE MARK CONSISTS OF STANDARD CHARACTERS WITHOUT CLAIM TO ANY PARTICULAR FONT, STYLE, SIZE, OR COLOR.

**CLASS 20—FURNITURE AND ARTICLES NOT OTHERWISE CLASSIFIED**

FOR FURNITURE, NAMELY, TABLES, ISLANDS, CARTS, BENCHES, STOOLS, RACKS AND SHELVES, AND PARTS THEREOF (U.S. CLS. 2, 13, 22, 25, 32 AND 50).

**CLASS 21—HOUSEWARES AND GLASS**

FOR CUTTING BOARDS; BUTCHER BLOCKS; POT RACKS; KNIFE BLOCKS (U.S. CLS. 2, 13, 23, 29, 30, 33, 40 AND 50).

RICHARD WHITE, EXAMINING ATTORNEY

SN 78-416,059. CRUISIN' FRIED CHICKEN, LLC, MONTGOMERY, AL. FILED 5-10-2004.



NO CLAIM IS MADE TO THE EXCLUSIVE RIGHT TO USE "FRIED CHICKEN", APART FROM THE MARK AS SHOWN.

**CLASS 16—PAPER GOODS AND PRINTED MATTER**

FOR PAPER PRODUCTS, NAMELY, NAPKINS, CARRY-OUT BOXES, BAGS, AND POSTERS (U.S. CLS. 2, 5, 22, 23, 29, 37, 38 AND 50).

**CLASS 30—STAPLE FOODS**

FOR BATTER, MARINADE, BREADING, AND MIXES THEREFOR (U.S. CL. 46).

**CLASS 35—ADVERTISING AND BUSINESS**

FOR COMPUTERIZED ON-LINE ORDERING AND RETAIL STORE SERVICES IN THE FIELD OF RESTAURANT AND FOOD PREPARATION EQUIPMENT, PAPER PRODUCTS AND PACKAGING; PROVIDING ADVICE IN THE FIELD OF ESTABLISHMENT AND OPERATION OF RESTAURANTS AND FREE STANDING FOOD STANDS; FOOD KIOSK SERVICES; VENDING IN THE FIELD OF FOOD (U.S. CLS. 100, 101 AND 102).

**CLASS 43—HOTEL AND RESTAURANT SERVICES**

FOR RESTAURANT SERVICES; FOOD PREPARATION SERVICES; TAKE-OUT FOOD SERVICES (U.S. CLS. 100 AND 101).  
TRICIA SONNEBORN, EXAMINING ATTORNEY

**CLASS 41—EDUCATION AND ENTERTAINMENT**

FOR EDUCATIONAL SERVICES; NAMELY, CONDUCTING CLASSES, SEMINARS AND TRAINING IN THE FIELD OF PROPER HAND HYGIENE (U.S. CLS. 100, 101 AND 107).  
ELIZABETH PIGNATELLO, EXAMINING ATTORNEY

---

SN 78-416,799, DC WEB WOMEN, WASHINGTON, DC. FILED 5-11-2004.

---

SN 78-416,150, ECOLAB INC., ST. PAUL, MN. FILED 5-10-2004.

DCWW

The logo for KIDigits features the word "KIDigits" in a bold, stylized font. The "K" is significantly larger and more prominent than the other letters. The "i" and "t" in "digits" have small, decorative elements above them that resemble stylized figures or characters. The entire logo is rendered in black.

OWNER OF U.S. REG. NO. 2,635,381.

**CLASS 3—COSMETICS AND CLEANING PREPARATIONS**

FOR HAND SOAPS AND HAND LOTIONS (U.S. CLS. 1, 4, 6, 50, 51 AND 52).

**CLASS 5—PHARMACEUTICALS**

FOR ANTIBACTERIAL ALCOHOL HAND SANITIZER GEL (U.S. CLS. 6, 18, 44, 46, 51 AND 52).

**CLASS 9—ELECTRICAL AND SCIENTIFIC APPARATUS**

FOR ELECTRONIC INDICATOR USED FOR MEASURING THE EFFECTIVENESS OF ANTIMICROBIAL SOAPS (U.S. CLS. 21, 23, 26, 36 AND 38).

**CLASS 21—HOUSEWARES AND GLASS**

FOR SOAP DISPENSERS (U.S. CLS. 2, 13, 23, 29, 30, 33, 40 AND 50).

THE MARK CONSISTS OF STANDARD CHARACTERS WITHOUT CLAIM TO ANY PARTICULAR FONT, STYLE, SIZE, OR COLOR.

**CLASS 35—ADVERTISING AND BUSINESS**

FOR PROMOTING PUBLIC AWARENESS OF AND THE INTEREST OF WOMEN ENGAGED IN INTERNET AND RELATED COMPUTER INFORMATION TECHNOLOGY AND PROFESSIONAL DEVELOPMENT (U.S. CLS. 100, 101 AND 102).  
FIRST USE 6-1-1999; IN COMMERCE 6-1-1999.

**CLASS 41—EDUCATION AND ENTERTAINMENT**

FOR EDUCATIONAL SERVICES, NAMELY CONDUCTING PROGRAMS AND WORKSHOPS IN THE FIELD OF THE INTERNET, COMPUTER INFORMATION TECHNOLOGY AND PROFESSIONAL DEVELOPMENT (U.S. CLS. 100, 101 AND 107).  
FIRST USE 6-1-1999; IN COMMERCE 6-1-1999.  
ANGELA M. MICHELI, EXAMINING ATTORNEY

SN 78-416,839. FULL HOUSE, INC., DEADWOOD, SD. FILED 5-11-2004.

SN 78-418,862. INTERACTIVE MARKET SYSTEMS, INC., NEW YORK, NY. FILED 5-14-2004.



THE ENGLISH TRANSLATION OF THE WORD BELLA IN THE MARK IS BEAUTIFUL.

**CLASS 41—EDUCATION AND ENTERTAINMENT**

FOR GAMBLING CASINO SERVICES (U.S. CLS. 100, 101 AND 107).

**CLASS 43—HOTEL AND RESTAURANT SERVICES**

FOR HOTEL AND BAR SERVICES (U.S. CLS. 100 AND 101).  
MICHAEL TANNER, EXAMINING ATTORNEY



SN 78-417,123. SMITH LAKE LIVING LLC, BREMEN, AL. FILED 5-12-2004.

Smith Lake Living

THE MARK CONSISTS OF STANDARD CHARACTERS WITHOUT CLAIM TO ANY PARTICULAR FONT, STYLE, SIZE, OR COLOR.

NO CLAIM IS MADE TO THE EXCLUSIVE RIGHT TO USE "LAKE", APART FROM THE MARK AS SHOWN.

**CLASS 21—HOUSEWARES AND GLASS**

FOR FOAM DRINK HOLDERS (U.S. CLS. 2, 13, 23, 29, 30, 33, 40 AND 50).

**CLASS 25—CLOTHING**

FOR IMPRINTED T-SHIRTS, CAPS AND VISORS (U.S. CLS. 22 AND 39).  
MARGERY A. TIERNEY, EXAMINING ATTORNEY

OPTACCUME

THE MARK CONSISTS OF STANDARD CHARACTERS WITHOUT CLAIM TO ANY PARTICULAR FONT, STYLE, SIZE, OR COLOR.

**CLASS 9—ELECTRICAL AND SCIENTIFIC APPARATUS**

FOR COMPUTER SOFTWARE PROGRAM AND DOWNLOADABLE COMPUTER SOFTWARE PROGRAM FOR USE IN ACCESSING, MANIPULATING, AND PREPARING REPORTS AND ANALYSES FROM DATABASE REGARDING MAGAZINE REACH, FREQUENCY, AND RELATED INFORMATION, AND FOR USE IN PLANNING, PERFORMING, AND EVALUATING MAGAZINE PLACEMENT (U.S. CLS. 21, 23, 26, 36 AND 38).

**CLASS 35—ADVERTISING AND BUSINESS**

FOR MARKET RESEARCH SERVICES, NAMELY PROVIDING REACH AND FREQUENCY INFORMATION FOR MAGAZINES AND MAGAZINE SCHEDULES THROUGH ONLINE ACCESSIBLE DATABASES (U.S. CLS. 100, 101 AND 102).  
GRETTA YAO, EXAMINING ATTORNEY



SN 78-418,950. WARRIOR LACROSSE, INC., WARREN, MI. FILED 5-14-2004.



THE MARK CONSISTS OF SPIKE DESIGN.

**CLASS 9—ELECTRICAL AND SCIENTIFIC APPARATUS**

FOR PROTECTIVE SPORTS EQUIPMENT, NAMELY, HELMETS (U.S. CLS. 21, 23, 26, 36 AND 38).

**CLASS 25—CLOTHING**

FOR CLOTHING, NAMELY TEE SHIRTS, SWEATSHIRTS, SHORTS, MOISTURE MANAGEMENT GARMENTS, NAMELY SHIRTS AND SHORTS; HATS (U.S. CLS. 22 AND 39).

**CLASS 28—TOYS AND SPORTING GOODS**

FOR LACROSSE HEADS, LACROSSE STICKS, LACROSSE HANDLES, LACROSSE BALLS, PROTECTIVE SPORTS EQUIPMENT, NAMELY, GLOVES FOR LACROSSE AND HOCKEY, SHOULDER PADS AND ELBOW PADS (U.S. CLS. 22, 23, 38 AND 50).

RUDY R. SINGLETON, EXAMINING ATTORNEY

**CLASS 41—EDUCATION AND ENTERTAINMENT**

FOR ENTERTAINMENT SERVICES, NAMELY, ARRANGING AND CONDUCTING ATHLETIC EVENTS AND COMPETITIONS (U.S. CLS. 100, 101 AND 107).

AMY HELLA, EXAMINING ATTORNEY

SN 78-418,992. PLAYBOY ENTERPRISES INTERNATIONAL, INC., CHICAGO, IL. FILED 5-14-2004.

SN 78-420,572. SFCC, INC., OVERLAND PARK, KS. FILED 5-18-2004.

**NIGHT CALLS**

THE MARK CONSISTS OF STANDARD CHARACTERS WITHOUT CLAIM TO ANY PARTICULAR FONT, STYLE, SIZE, OR COLOR.

**CLASS 38—COMMUNICATION**

FOR CABLE TELEVISION AND TELEVISION BROADCASTING, SATELLITE TRANSMISSION SERVICES, ALL FEATURING ADULT ENTERTAINMENT (U.S. CLS. 100, 101 AND 104).

FIRST USE 8-30-1995; IN COMMERCE 8-30-1995.

**CLASS 41—EDUCATION AND ENTERTAINMENT**

FOR ENTERTAINMENT SERVICES, NAMELY, TELEVISION PROGRAMMING SERVICES FEATURING ADULT PROGRAMS AND MOVIES (U.S. CLS. 100, 101 AND 107).

FIRST USE 8-30-1995; IN COMMERCE 8-30-1995.

DOUGLAS LEE, EXAMINING ATTORNEY

SN 78-419,465. THE UNIVERSITY OF SOUTH DAKOTA, VERMILLION, SD. FILED 5-15-2004.

**SOUTH DAKOTA'S  
TEAM**

THE MARK CONSISTS OF STANDARD CHARACTERS WITHOUT CLAIM TO ANY PARTICULAR FONT, STYLE, SIZE, OR COLOR.

NO CLAIM IS MADE TO THE EXCLUSIVE RIGHT TO USE SOUTH DAKOTA'S, APART FROM THE MARK AS SHOWN.

**CLASS 25—CLOTHING**

FOR CLOTHING, NAMELY, CAPS, HATS, VISORS, JERSEYS, SHIRTS, SWEATSHIRTS, SWEATPANTS, PANTS, SHORTS, SWEATERS, JACKETS, SOCKS, AND INFANTWEAR (U.S. CLS. 22 AND 39).

**BRING THE KIDS,  
BRING THE  
NEIGHBORS, BRING  
THE DOG!**

THE MARK CONSISTS OF STANDARD CHARACTERS WITHOUT CLAIM TO ANY PARTICULAR FONT, STYLE, SIZE, OR COLOR.

**CLASS 35—ADVERTISING AND BUSINESS**

FOR RETAIL FROZEN CUSTARD STORE SERVICES; RETAIL ICE CREAM CONFECTIONARY STORE SERVICES (U.S. CLS. 100, 101 AND 102).

**CLASS 43—HOTEL AND RESTAURANT SERVICES**

FOR RESTAURANT SERVICES (U.S. CLS. 100 AND 101).

GEORGE LORENZO, EXAMINING ATTORNEY

SN 78-420,815. MOTT'S INC., STAMFORD, CT. FILED 5-18-2004.



OWNER OF U.S. REG. NOS. 160,454, 2,183,972 AND OTHERS.

**CLASS 29—MEATS AND PROCESSED FOODS**

FOR APPLE SAUCE (U.S. CL. 46).

FIRST USE 11-30-2003; IN COMMERCE 11-30-2003.



**CLASS 32—LIGHT BEVERAGES**

FOR FRUIT JUICES AND FRUIT-FLAVORED DRINKS (U.S. CLS. 45, 46 AND 48).  
FIRST USE 3-31-2004; IN COMMERCE 3-31-2004.  
JOANNA DUKOVIC, EXAMINING ATTORNEY

SN 78-421,925, ANGLOGOLD ASHANTI LIMITED, JOHANNESBURG 2001, SOUTH AFRICA, FILED 5-19-2004.



THE MARK CONSISTS OF AN ARBITRARY LOGO.

SN 78-421,012, PROTECTICOM CORPORATION, HIGHLANDS RANCH, CO. FILED 5-18-2004.

**PROTECTIPOD**

THE MARK CONSISTS OF STANDARD CHARACTERS WITHOUT CLAIM TO ANY PARTICULAR FONT, STYLE, SIZE, OR COLOR.

**CLASS 9—ELECTRICAL AND SCIENTIFIC APPARATUS**

FOR ELECTRONIC MESSAGING DEVICE FOR WIRELESS/WIRELINE RECEPTION AND TRANSMISSION OF DATA WHICH ENABLES THE USER TO REQUEST TELEMARKETING CONTACT REGARDING A SPECIFIC SOLICITATION OF A PRODUCT AND/OR SERVICE; SOFTWARE FOR WIRELESS/WIRELINE RECEPTION AND TRANSMISSION OF DATA TO ONE OR MORE ELECTRONIC MESSAGING DEVICES WHICH ENABLES THE USER TO REQUEST TELEMARKETING CONTACT REGARDING A SPECIFIC SOLICITATION OF A PRODUCT AND/OR SERVICE (U.S. CLS. 21, 23, 26, 36 AND 38).

**CLASS 38—COMMUNICATION**

FOR WIRELESS/WIRELINE DATA MESSAGING SERVICES, NAMELY, SERVICES THAT ENABLE A USER TO SEND AND RECEIVE MESSAGES AND GRAPHICAL IMAGES THROUGH A WIRELESS/WIRELINE DATA NETWORK USING A HANDHELD PORTABLE ELECTRONIC DEVICE FOR THE PURPOSE OF ORDERING PRODUCTS AND SERVICES AND/OR PURCHASING GOODS AND/OR SERVICES IN COMBINATION WITH TELEMARKETING; PROVIDING INFORMATION TO THIRD PARTIES TO ASSIST THEM IN DEVELOPING AND INTEGRATING ONE WAY OR TWO WAY WIRELESS/WIRELINE CONNECTIVITY TO DATA FOR THE PURPOSE OF SELLING PRODUCTS AND/OR SERVICES IN CONJUNCTION WITH TELEMARKETING (U.S. CLS. 100, 101 AND 104).  
SHAUNIA WALLACE, EXAMINING ATTORNEY

**CLASS 14—JEWELRY**

FOR PRECIOUS METALS AND THEIR ALLOYS; GOODS IN PRECIOUS METALS OR COATED THEREWITH, NAMELY, PRECIOUS METAL JEWELRY; PRECIOUS METALS, NAMELY GOLD, SILVER AND PLATINIUM; JEWELRY, INCLUDING GOLD, SILVER AND PLATINIUM JEWELRY; PRECIOUS AND SEMI-PRECIOUS STONES; HOROLOGICAL INSTRUMENTS IN THE NATURE OF CLOCKS AND WATCHES (U.S. CLS. 2, 27, 28 AND 50).

**CLASS 35—ADVERTISING AND BUSINESS**

FOR RETAIL OUTLETS AND WHOLESALE DISTRIBUTORSHIPS FEATURING JEWELRY, PRECIOUS METALS, PRECIOUS AND SEMI-PRECIOUS STONES; MAIL ORDER SERVICES FEATURING JEWELRY, PRECIOUS METALS, PRECIOUS STONES AND SEMI-PRECIOUS STONES; COMPUTERIZED ON-LINE RETAIL STORE SERVICES IN THE FIELD OF JEWELRY, PRECIOUS METALS, PRECIOUS AND SEMI-PRECIOUS STONES (U.S. CLS. 100, 101 AND 102).  
ROBIN CHOSID, EXAMINING ATTORNEY

SN 78-422,310, GROSSMAN, JOANNE, MERCHANTVILLE, NJ. FILED 5-20-2004.

**3SUM**

THE MARK CONSISTS OF STANDARD CHARACTERS WITHOUT CLAIM TO ANY PARTICULAR FONT, STYLE, SIZE, OR COLOR.

**CLASS 3—COSMETICS AND CLEANING PREPARATIONS**

FOR HAIR CARE PRODUCTS, NAMELY, SHAMPOOS, CONDITIONERS, LEAVE-IN CONDITIONERS, GLOSSES, GELS, STYLING LOTIONS, SPRAY GLOSS, THICKENING SPRAYS, MOUSSES, CREME WAX, HAIR CREAMS, HAIR PASTES, SMOOTHING GELS, STRAIGHTENING BALMS, STRAIGHTENING GELS, SETTING LOTIONS, STYLING CREAMS, HAIR SPRAYS, BRILLIANTINE, POMADES AND DE-FRIZZERS (U.S. CLS. 1, 4, 6, 50, 51 AND 52).

**CLASS 9—ELECTRICAL AND SCIENTIFIC APPARATUS**

FOR ELECTRIC HAND-HELD HAIR STRAIGHTENING IRONS (U.S. CLS. 21, 23, 26, 36 AND 38).

**CLASS 11—ENVIRONMENTAL CONTROL APPARATUS**

FOR ELECTRIC HAND-HELD HAIR DRYERS (U.S. CLS. 13, 21, 23, 31 AND 34).  
KEVON CHISOLM, EXAMINING ATTORNEY

SN 78-430,926. LF, LLC, WILMINGTON, DE. FILED 6-7-2004.

**PROMISE TO PREPARE**

THE MARK CONSISTS OF STANDARD CHARACTERS WITHOUT CLAIM TO ANY PARTICULAR FONT, STYLE, SIZE, OR COLOR.

**CLASS 6—METAL GOODS**

FOR METAL SAFETY GATES FOR CHILDREN; METAL BATHTUB GRAB BARS AND RAILS (U.S. CLS. 2, 12, 13, 14, 23, 25 AND 50).

**CLASS 7—MACHINERY**

FOR ELECTRIC GENERATORS (U.S. CLS. 13, 19, 21, 23, 31, 34 AND 35).

**CLASS 9—ELECTRICAL AND SCIENTIFIC APPARATUS**

FOR HOME SAFETY PRODUCTS, NAMELY, FIRE AND SMOKE ALARMS, FIRE EXTINGUISHERS AND CARBON MONOXIDE DETECTORS; PROTECTIVE SAFETY EQUIPMENT, NAMELY, HARD HATS, SAFETY HELMETS, FACE SHIELDS, SAFETY GLASSES, SAFETY GOGGLES, VISORS, EARPLUGS, EARMUFFS AND SAFETY GLOVES; PERSONAL SAFETY MASK AND AIR FILTERS; KNEE PADS; LIFE JACKETS; PROTECTIVE SHOES AND BOOTS; SAFETY OUTLET COVERS AND PLUGS; BATTERIES; BATTERY CHARGERS; FLASHING SAFETY LIGHTS; HELMET SAFETY LIGHTS; ELECTRICAL EXTENSION CORDS; SURGE PROTECTORS; THEFT ALARMS; BATTERY-OPERATED RADIOS (U.S. CLS. 21, 23, 26, 36 AND 38).

**CLASS 11—ENVIRONMENTAL CONTROL APPARATUS**

FOR WATER HEATERS, WATER FILTERS, WATER FILTRATION UNITS, AIR FILTERS FOR DOMESTIC USE, FLASHLIGHTS AND NIGHT LIGHTS (U.S. CLS. 13, 21, 23, 31 AND 34).

**CLASS 16—PAPER GOODS AND PRINTED MATTER**

FOR PRINTED MATTER, NAMELY, EDUCATIONAL MATERIALS ON HOME SAFETY (U.S. CLS. 2, 5, 22, 23, 29, 37, 38 AND 50).

**CLASS 17—RUBBER GOODS**

FOR ADHESIVE-BACKED BATHTUB APPLIQUES (U.S. CLS. 1, 5, 12, 13, 35 AND 50).

**CLASS 19—NON-METALLIC BUILDING MATERIALS**

FOR NON-METAL SAFETY GATES FOR CHILDREN (U.S. CLS. 1, 12, 33 AND 50).

**CLASS 20—FURNITURE AND ARTICLES NOT OTHERWISE CLASSIFIED**

FOR CHILD SAFETY DEVICES, NAMELY, NON-METALLIC LOCKS AND LATCHES FOR CABINET DOORS AND DRAWERS, DOORS, AND TOILET LIDS, DOOR KNOB SAFETY COVERS, WINDOW GUARDS, FURNITURE BUMPER GUARDS, ELECTRIC WIRE GUARDS, DOOR GUARDS, STOVE LOCKS AND GUARDS, APPLIANCE LOCKS AND GUARDS, POOL GUARDS AND DRIVEWAY GUARDS; NON-METALLIC GUARDS FOR DRAPERY AND BLIND CORDS; BATHTUB GRAB BARS AND RAILS, NOT MADE OF METAL (U.S. CLS. 2, 13, 22, 25, 32 AND 50).

**CLASS 27—FLOOR COVERINGS**

FOR PLASTIC AND RUBBER SAFETY BATH MATS (U.S. CLS. 19, 20, 37, 42 AND 50).

**CLASS 41—EDUCATION AND ENTERTAINMENT**

FOR EDUCATIONAL SERVICES, NAMELY, CONDUCTING CLINICS AND WORKSHOPS AND PROVIDING WRITTEN MATERIALS TO PROMOTE HOME SAFETY AND REGARDING HOME PROTECTION PROCEDURES AND PRODUCTS (U.S. CLS. 100, 101 AND 107).

ZACHARY BELLO, EXAMINING ATTORNEY

SN 78-457,787. LIMCO, INC., WILMINGTON, DE. FILED 7-28-2004.

**LIMITED LUXE**

THE MARK CONSISTS OF STANDARD CHARACTERS WITHOUT CLAIM TO ANY PARTICULAR FONT, STYLE, SIZE, OR COLOR.

OWNER OF U.S. REG. NOS. 1,020,794, 2,234,267 AND OTHERS.

**CLASS 25—CLOTHING**

FOR CLOTHING, NAMELY, BATHROBES, BEACH COVER-UPS, BELTS, BLAZERS, BLOUSES, BODY SUITS, BOOTS, BOXER SHORTS, BRAS, BUSTIERS, CAMISOLES, CAPS, COATS, DRESSES, GARTER BELTS, GIRDLES, GLOVES, GOWNS, HALTER TOPS, HATS, HEADBANDS, JACKETS, JEANS, JOGGING SUITS, KNIT SHIRTS, KNIT TOPS, LEOTARDS, LINGERIE, MITTENS, NEGLIGEEES, NIGHT GOWNS, NIGHT SHIRTS, PAJAMAS, PANTIES, PANTS, PANTYHOSE, SANDALS, SARONGS, SCARVES, SHIRTS, SHOES, SHORTS, SKIRTS, SLACKS, SLIPPERS, SLIPS, SNEAKERS, SOCKS, STOCKINGS, SUITS, SWEAT PANTS, SWEAT SHIRTS, SWEAT SHORTS, SWEAT SUITS, SWEATERS, SWIMSUITS, T-SHIRTS, TANK TOPS, TEDDIES, TIES, TIGHTS, UNDERPANTS, UNDERSHIRTS, UNDERWEAR AND VESTS (U.S. CLS. 22 AND 39).

**CLASS 35—ADVERTISING AND BUSINESS**

FOR RETAIL STORE SERVICES, MAIL ORDER CATALOG SERVICES AND ON-LINE RETAIL STORE SERVICES FEATURING CLOTHING (U.S. CLS. 100, 101 AND 102).

DARRYL SPRULL, EXAMINING ATTORNEY

SN 78-485,486. DREAMWORKS ANIMATION L.L.C., GLENDALE, CA. FILED 9-17-2004.



The logo for DreamWorks Animation SKG features the word "DREAMWORKS" in a large, blue, serif font with a horizontal line underneath. Below the line, the words "ANIMATION SKG" are written in a smaller, blue, sans-serif font.

OWNER OF U.S. REG. NOS. 2,596,916, 2,644,242 AND 2,665,088.

NO CLAIM IS MADE TO THE EXCLUSIVE RIGHT TO USE "ANIMATION", APART FROM THE MARK AS SHOWN.

THE COLOR(S) BLUE IS/ARE CLAIMED AS A FEATURE OF THE MARK.

THE MARK CONSISTS OF THE WORDS DREAMWORKS ANIMATION SKG AND A LINE IN BLUE.

**CLASS 9—ELECTRICAL AND SCIENTIFIC APPARATUS**

FOR COMPUTER PERIPHERAL, NAMELY MOUSE PADS, HOLDERS FOR COMPACT DISCS, COMPUTER GAME CARTRIDGES, COMPUTER GAME CASSETTES, AND COMPUTER GAME TAPES; VIDEO GAME CARTRIDGES, VIDEO GAME TAPE CASSETTES; PRERECORDED AUDIO CASSETTES, PRERECORDED VIDEO CASSETTES, PRERECORDED AUDIO TAPES, PRERECORDED VIDEO TAPES, PRERECORDED COMPACT DISCS FEATURING MUSIC AND MOTION PICTURE SOUND TRACKS; DVDS FEATURING MUSIC AND MOTION PICTURE SOUND TRACKS; COMPUTER OPERATING SYSTEM SOFTWARE; COMPUTER GAME DISCS AND VIDEO GAME DISCS; INTERACTIVE MULTIMEDIA SOFTWARE PROGRAMS FOR MOTION PICTURES FOR ENTERTAINMENT; COMPUTER GAME PROGRAMS; MAGNETS AND SUNGLASSES (U.S. CLS. 21, 23, 26, 36 AND 38).

**CLASS 16—PAPER GOODS AND PRINTED MATTER**

FOR PAPER PARTY DECORATIONS; PAPER PARTY SUPPLIES, NAMELY, PAPER PARTY HATS, PAPER NAPKINS, PAPER PLACE MATS, GIFT WRAPPING PAPER AND GIFT WRAPPING RIBBONS, PAPER GIFT WRAP BOWS, PAPER TABLE CLOTHS AND PAPER PARTY BAGS; CHILDREN'S ACTIVITY BOOKS, CHILDREN'S STORYBOOKS, COMIC BOOKS, COLORING BOOKS, BOOK MARKS, LOOSE LEAF BINDERS, STATIONERY-TYPE PORTFOLIOS, SPIRAL BOUND NOTEBOOKS, NOTE PADS OR WRITING PADS, DIARIES, DAILY PLANNERS, CALENDARS, SCRAPBOOK ALBUMS, SKETCHBOOK ALBUMS, PHOTOGRAPH ALBUMS, STICKER ALBUMS, STICKERS, DECALS, STAMP PADS OR INKING PADS, RUBBER STAMPS, HEAT APPLIED APPLIQUES IN THE FORM OF DECALS MADE OF PAPER, TEMPORARY TATTOOS, SLATE BOARDS FOR WRITING, PENCILS, PENS, PENCIL ERASERS, DECORATIVE PENCIL-TOP ORNAMENTS, PEN CASES AND PENCIL CASES, PEN BOXES AND PENCIL BOXES, PENCIL SHARPENERS, CHALK, MARKERS, POSTERS, POSTCARDS, TRADING CARDS, GREETING CARDS, PENNANTS MADE OF PAPER, PAINTING SETS FOR CHILDREN; ARTS AND CRAFTS PAINT KITS; STUDY KITS, CONSISTING OF PENCIL ERASERS, DRAWING RULERS, PENCIL SHARPENERS AND PENCIL CASE; STATIONERY PACKS CONSISTING OF WRITING PAPER, ENVELOPES, MARKERS, AND STENCILS; AND ACTIVITY KITS CONSISTING OF STICKERS AND RUBBER STAMPS (U.S. CLS. 2, 5, 22, 23, 29, 37, 38 AND 50).

**CLASS 25—CLOTHING**

FOR SHIRTS AND TOPS, DRESSES, SKIRTS, PANTS, TROUSERS, JEANS, SHORTS, ROMPERS, OVERALLS, SWEATSHIRTS AND SWEAT PANTS, SWEATSUITS, CAPS AND HATS, GLOVES, SUSPENDERS, TIES, COATS AND JACKETS, HOSIERY, SHOES, BOOTS, SLIPPERS, PAJAMAS, ROBES, SLEEPSHIRTS, SLEEPWEAR, UNDERWEAR, HALLOWEEN COSTUMES, AND CLOTH BABY BIBS (U.S. CLS. 22 AND 39).

**CLASS 28—TOYS AND SPORTING GOODS**

FOR ACTION FIGURES AND ACCESSORIES THEREFOR, BATHTUB TOYS, KITES, TOY BUILDING BLOCKS, BOARD GAMES, COSTUME MASKS, HANDHELD UNIT FOR PLAYING ELECTRONIC GAMES, DIE CAST MINIATURE TOY VEHICLES, DOLLS, DOLL ACCESSORIES, DOLL CLOTHING, BEAN BAG DOLLS, BENDABLE PLAY FIGURES, FLYING DISCS, INFLATABLE VINYL PLAY FIGURES, JIGSAW PUZZLES, MARBLES, PLUSH TOYS, PUPPETS, RIDE-ON TOYS, SKATEBOARDS, BALLOONS, ROLLERSKATES, TOY BANKS, WATER SQUIRTING TOYS, STUFFED TOYS, TOY VEHICLES, CHRISTMAS TREE ORNAMENTS; PINBALL MACHINES AND MODEL CRAFT KITS OF TOY FIGURES; AND PLAYING CARDS (U.S. CLS. 22, 23, 38 AND 50).

**CLASS 41—EDUCATION AND ENTERTAINMENT**

FOR ENTERTAINMENT SERVICES, NAMELY THE PRODUCTION AND DISTRIBUTION OF ANIMATED MOTION PICTURES AND ANIMATED TELEVISION PROGRAMS (U.S. CLS. 100, 101 AND 107).

CHRISIE B. KING, EXAMINING ATTORNEY

SN 78-501,820. BRIDGESTONE SPORTS CO., LTD., TOKYO, JAPAN, FILED 10-19-2004.

SN 79-000,006. C J WILDBIRD FOODS LIMITED, UNITED KINGDOM, FILED 11-2-2003.

# VIVARA

OWNER OF INTERNATIONAL REGISTRATION 0797462 DATED 12-11-2002, EXPIRES 12-11-2012.

## J33

THE MARK CONSISTS OF STANDARD CHARACTERS WITHOUT CLAIM TO ANY PARTICULAR FONT, STYLE, SIZE, OR COLOR.

### CLASS 25—CLOTHING

FOR CAPS, HATS, VISORS (U.S. CLS. 22 AND 39).

### CLASS 28—TOYS AND SPORTING GOODS

FOR GOLF CLUBS, GOLF CLUB HEAD COVERS, GOLF BAGS (U.S. CLS. 22, 23, 38 AND 50).  
KIMBERLY PERRY, EXAMINING ATTORNEY

---

SN 78-501,822. BRIDGESTONE SPORTS CO., LTD., TOKYO, JAPAN, FILED 10-19-2004.

## TOUR B330

THE MARK CONSISTS OF STANDARD CHARACTERS WITHOUT CLAIM TO ANY PARTICULAR FONT, STYLE, SIZE, OR COLOR.

### CLASS 25—CLOTHING

FOR CAPS, HATS, VISORS (U.S. CLS. 22 AND 39).

### CLASS 28—TOYS AND SPORTING GOODS

FOR GOLF BALLS, GOLF BAGS (U.S. CLS. 22, 23, 38 AND 50).  
KIMBERLY PERRY, EXAMINING ATTORNEY

### CLASS 6—METAL GOODS

FOR BIRD BATHS OF METAL; METAL STANDS FOR FEEDERS AND PARTS AND FITTINGS THEREFOR, NAMELY, POLE HOOKS, HANGING CHAINS, TREE HOOKS, BRACKETS, METAL FEEDER LINKS, METAL CAGES TO PROTECT FEEDERS, GROUND GUARDS, COLLETS FOR USE WITH GARDEN POLES, HOOKS FOR COLLETS, WATER BATHS, FOOD TRAYS, AND FOOD BOWLS; CANDELABRA ARMS, GARDEN POLES, POLE EXTENDERS AND PATIO BASES; ALL FOR USE BY BIRDS, HEDGEHOGS, BADGERS AND SIMILAR SMALL WILDLIFE (U.S. CLS. 2, 12, 13, 14, 23, 25 AND 50).

### CLASS 9—ELECTRICAL AND SCIENTIFIC APPARATUS

FOR CDS, DVDS, DISCS, NAMELY, AUDIO DISCS, LASER DISCS, CD ROMS, DVD ROMS, CD VIDEOS, DVD VIDEOS, AND INTERACTIVE CDS AND DVDS BEARING RECORDED MATERIAL; VIDEOS AND FILM BEARING RECORDED MATERIAL, ALL FEATURING BIRDS, HEDGEHOGS, BADGERS AND SIMILAR SMALL WILDLIFE, CARRIERS FOR RECORDED MATERIAL, NAMELY, ELECTRONIC DATABASES FEATURING BIRDS, HEDGEHOGS, BADGERS AND SIMILAR SMALL WILDLIFE RECORDED ON COMPUTER MEDIA; OR MULTI-MEDIA SOFTWARE RECORDED ON CD-ROMS FEATURING BIRDS, HEDGEHOGS, BADGERS, AND SIMILAR WILDLIFE; PUBLICATIONS, NAMELY, ELECTRONIC PUBLICATIONS, NAMELY, BOOKS AND MAGAZINES FEATURING BIRDS, HEDGEHOGS, BADGERS, AND SIMILAR SMALL WILDLIFE RECORDED ON COMPUTER MEDIA (U.S. CLS. 21, 23, 26, 36 AND 38).

### CLASS 16—PAPER GOODS AND PRINTED MATTER

FOR BOOKS, NEWSLETTERS, PUBLICATIONS, NAMELY, MAGAZINES AND PHOTOGRAPHS ALL IN RELATION TO BIRDS, HEDGEHOGS, BADGERS AND SIMILAR SMALL WILDLIFE (U.S. CLS. 2, 5, 22, 23, 29, 37, 38 AND 50).

### CLASS 19—NON-METALLIC BUILDING MATERIALS

FOR STONE AND CERAMIC BIRD BATHS ALL FOR USE BY BIRDS, HEDGEHOGS, BADGERS AND SIMILAR SMALL WILDLIFE (U.S. CLS. 1, 12, 33 AND 50).

### CLASS 20—FURNITURE AND ARTICLES NOT OTHERWISE CLASSIFIED

FOR NESTING BOXES OF WOOD, PLASTIC AND WOODCRETE; HEDGEHOG NEST BOXES OF WOOD, PLASTIC AND WOODCRETE; CONTAINERS FOR FOOD FOR WILD ANIMALS; ALL FOR USE BY BIRDS, HEDGEHOGS, BADGERS AND SIMILAR SMALL WILDLIFE (U.S. CLS. 2, 13, 22, 25, 32 AND 50).

### CLASS 21—HOUSEWARES AND GLASS

FOR BIRD BATHS; BIRD FEEDERS ALL FOR USE BY BIRDS, HEDGEHOGS, BADGERS AND SIMILAR SMALL WILDLIFE (U.S. CLS. 2, 13, 23, 29, 30, 33, 40 AND 50).

**CLASS 31—NATURAL AGRICULTURAL PRODUCTS**

FOR FOOD FOR BIRDS; BADGER FOOD; FOOD FOR ANIMALS; ANIMAL FORAGE ALL FOR USE BY BIRDS, HEDGEHOGS, BADGERS AND SIMILAR SMALL WILDLIFE (U.S. CLS. 1 AND 46).  
MARLENE BELL, EXAMINING ATTORNEY

SN 79-000,370. RVS-TEC OY, FINLAND, FILED 12-11-2003.



OWNER OF INTERNATIONAL REGISTRATION 0787382 DATED 8-13-2002, EXPIRES 8-13-2012.

NO CLAIM IS MADE TO THE EXCLUSIVE RIGHT TO USE TECHNOLOGY, APART FROM THE MARK AS SHOWN.

THE COLORS YELLOW AND BLACK ARE CLAIMED AS A FEATURE OF THE MARK.

THE COLOR YELLOW APPEARS IN THE CIRCLE PORTION OF THE MARK AND THE COLOR BLACK APPEARS IN THE LETTERING.

SN 79-000,081. SIEMENS AKTIENGESELLSCHAFT, FED REP GERMANY, FILED 11-5-2003.

**SERVOPT**

THE MARK CONSISTS OF STANDARD CHARACTERS WITHOUT CLAIM TO ANY PARTICULAR FONT, STYLE, SIZE, OR COLOR.

PRIORITY DATE OF 7-21-2003 IS CLAIMED.

OWNER OF INTERNATIONAL REGISTRATION 0814687 DATED 11-5-2003, EXPIRES 11-5-2013.

**CLASS 9—ELECTRICAL AND SCIENTIFIC APPARATUS**

FOR DATA PROCESSING PROGRAMS IN PARTICULAR PROCESS SIMULATION SOFTWARE FOR THE INDUSTRIAL SERVICE BUSINESS (U.S. CLS. 21, 23, 26, 36 AND 38).

**CLASS 35—ADVERTISING AND BUSINESS**

FOR MANAGERIAL AND ORGANIZATIONAL CONSULTANCY SERVICES FOR COMPANIES (U.S. CLS. 100, 101 AND 102).

**CLASS 42—SCIENTIFIC, COMPUTER AND LEGAL SERVICES**

FOR TECHNICAL CONSULTING SERVICES FOR COMPANIES, NAMELY, COMPUTER CONSULTATION, COMPUTER SOFTWARE CONSULTATION (U.S. CLS. 100 AND 101).  
JACQUELINE A. LAVINE, EXAMINING ATTORNEY

**CLASS 4—LUBRICANTS AND FUELS**

FOR ALL PURPOSE LUBRICANTS, AUTOMOBILE LUBRICANTS, AUTOMOTIVE LUBRICANTS, INDUSTRIAL LUBRICANTS, LUBRICANTS FOR INDUSTRIAL MACHINERY (U.S. CLS. 1, 6 AND 15).

**CLASS 40—MATERIAL TREATMENT**

FOR TREATMENT OF MATERIALS, NAMELY PROTECTION AND SURFACE RESTORATION OF METALS AND METAL COMPOUNDS CONTAINING IRON; PROVIDING INFORMATION AND CONSULTANCY RELATING TO COMPOUND FOR METAL MODIFICATION AND METAL SURFACE RESTORATION (U.S. CLS. 100, 103 AND 106).

**CLASS 42—SCIENTIFIC, COMPUTER AND LEGAL SERVICES**

FOR SCIENTIFIC RESEARCH RELATING TO COMPOUND FOR METAL MODIFICATION AND METAL SURFACE RESTORATION; DESIGN FOR OTHERS IN THE FIELD OF COMPOUND FOR METAL MODIFICATION AND METAL SURFACE RESTORATION (U.S. CLS. 100 AND 101).

LINDA E. BLOHM, EXAMINING ATTORNEY

SN 79-000,607. SANKYO LIFETECH COMPANY, LIMITED, JAPAN, FILED 11-27-2003.



THE MARK CONSISTS OF STANDARD CHARACTERS WITHOUT CLAIM TO ANY PARTICULAR FONT, STYLE, SIZE, OR COLOR.

PRIORITY DATE OF 5-29-2003 IS CLAIMED.

OWNER OF INTERNATIONAL REGISTRATION 0817442 DATED 11-27-2003, EXPIRES 11-27-2013.

**CLASS 1—CHEMICALS**

FOR RESEARCH REAGENTS FOR INDUSTRIAL USE, NAMELY, FOR FOOD TESTING, AND REAGENTS FOR SCIENTIFIC RESEARCH USE (U.S. CLS. 1, 5, 6, 10, 26 AND 46).

**CLASS 5—PHARMACEUTICALS**

FOR PHARMACEUTICAL PREPARATIONS FOR THE TREATMENT OF CANCER, CARDIOVASCULAR DISEASE, DIABETES, CROHN'S DISEASE, CYTOMEGALOVIRUS RETINITIS, HEPATITIS C, PSORIASIS, RHEUMATOID ARTHRITIS, ULCERATIVE COLITIS, AND AGE-RELATED MACULAR DEGENERATION (U.S. CLS. 6, 18, 44, 46, 51 AND 52).

LINDA M. KING, EXAMINING ATTORNEY

**CLASS 35—ADVERTISING AND BUSINESS**

FOR BUSINESS INFORMATION SERVICES, NAMELY, INPUT, RECORDING, TRANSCRIPTION, TRANSFORMATION, COMPOSITION, COMPILATION, AND SYSTEMATIZATION OF COMMERCIAL AND BUSINESS INFORMATION; TRANSCRIPTION, COMPILATION AND SYSTEMATIZATION OF STATISTICS AND INDEXES CONCERNING STOCK EXCHANGE DEALINGS, VALUABLES, INTEREST RATES, PRICES, EXCHANGE RATES AND OTHER ECONOMIC DATA; PROVIDING COMMERCIAL INFORMATION AND DATA MESSAGES VIA THE GLOBAL COMPUTER NETWORK INCLUDING THE INTERNET; CONDUCTING BUSINESS RESEARCH AND SURVEYS; BUSINESS APPRAISALS; MARKETING STATISTICAL STUDIES; BUSINESS CONSULTATION; PROVIDING INFORMATION CONCERNING COMPUTER-ASSISTED DATA PROCESSING VIA GLOBAL COMPUTER NETWORKS, INCLUDING THE INTERNET (U.S. CLS. 100, 101 AND 102).

SN 79-000,621. SWX SWISS EXCHANGE, SWITZERLAND, FILED 11-2-2003.

# GROUP SWX

THE MARK CONSISTS OF STANDARD CHARACTERS WITHOUT CLAIM TO ANY PARTICULAR FONT, STYLE, SIZE, OR COLOR.

PRIORITY DATE OF 6-3-2003 IS CLAIMED.

OWNER OF INTERNATIONAL REGISTRATION 0817505 DATED 11-2-2003, EXPIRES 11-2-2013.

OWNER OF U.S. REG. NOS. 2,427,951, 2,648,260 AND OTHERS.

NO CLAIM IS MADE TO THE EXCLUSIVE RIGHT TO USE GROUP, APART FROM THE MARK AS SHOWN.

**CLASS 9—ELECTRICAL AND SCIENTIFIC APPARATUS**

FOR COMPUTER SOFTWARE FOR THE MANAGEMENT OF DATABASES AND THE DISTRIBUTION OF INFORMATION; COMPUTER SOFTWARE FOR STOCK EXCHANGE TRADING; FOR STOCK RELATED TRADING SYSTEMS FOR THE COMPILATION, ANALYSIS, REPRESENTATION AND COMMUNICATION OF DATA AND INFORMATION; VIDEO TAPES, PRE-RECORDED MAGNETIC DISKS AND OPTICAL DISKS ON THE SUBJECTS OF FINANCE, STOCK EXCHANGE, STOCKS, STOCK INDEXES AND STOCK MARKETS (U.S. CLS. 21, 23, 26, 36 AND 38).

**CLASS 16—PAPER GOODS AND PRINTED MATTER**

FOR BOOKS, PAMPHLETS AND MANUALS IN THE FIELDS OF FINANCE, STOCK EXCHANGE, STOCKS, STOCK INDEXES AND STOCK MARKETS; LISTS OF PRICES AND TABLES OF STOCK EXCHANGE SECURITIES AND CONTRACTS; PRINTED INSTRUCTIONAL AND TEACHING MATERIAL IN THE FIELD OF FINANCIAL INVESTMENTS AND STOCKS (U.S. CLS. 2, 5, 22, 23, 29, 37, 38 AND 50).

**CLASS 36—INSURANCE AND FINANCIAL**

FOR GUARANTEE ASSURANCE UNDERWRITING; SECURITIES EXCHANGE SERVICES, NAMELY, PROVIDING A MARKET FOR SECURITIES, AND PROVIDING INFORMATION ABOUT SECURITIES AND CORPORATIONS ISSUING SECURITIES; COMPILING AND PROVIDING FINANCIAL DATA REGARDING SECURITIES AND INDEXES THEREFORE; ISSUING OF FINANCIAL INSTRUMENTS IN THE NATURE OF SECURITIES, OPTIONS, INDEX FUNDS, AND REPURCHASE AGREEMENTS; SERVICES IN RELATION TO MONETARY AND FINANCIAL TRANSACTIONS, NAMELY, MARKET MONITORING, ANALYSIS, INDEXING PRICING, TRADING AND ARBITRAGE OF STOCKS, BONDS, SECURITIES, COMMODITIES, FUTURES, DERIVATIVES OR OPTIONS; EXCHANGE SERVICES FOR EXECUTING TRANSACTIONS IN CONNECTION WITH STOCKS, BONDS, SHARES, WARRANTS AND DERIVATIVE FINANCIAL PRODUCTS; PORTFOLIO MANAGEMENT; PROFESSIONAL CONSULTING SERVICES FOR THE ORGANIZATION AND ADMINISTRATION OF BANKING AND FINANCIAL BUSINESS; UNDERWRITING IN THE FIELD OF LIFE INSURANCE; PROVIDING ONLINE COMPUTER DATABASES CONTAINING FINANCIAL INFORMATION AND INDEX FIGURES; INPUT, RECORDING, TRANSCRIPTION, TRANSFORMATION, COMPOSITION, COMPILATION, AND SYSTEMATIZATION OF FINANCIAL AND STOCK MARKET INFORMATION; PROVIDING FINANCIAL AND STOCK MARKET INFORMATION AND DATA, MESSAGES, SOUNDS AND IMAGES VIA THE GLOBAL COMPUTER NETWORK INCLUDING THE INTERNET; BANKING SERVICES; FINANCIAL ANALYSIS AND CONSULTATION; FINANCIAL APPRAISALS, NAMELY, DETERMINING THE NET VALUE OF BUSINESSES (U.S. CLS. 100, 101 AND 102).

**CLASS 41—EDUCATION AND ENTERTAINMENT**

FOR PUBLICATION OF BOOKS, PAMPHLETS, BROCHURES, MAGAZINES AND INSTRUCTION MANUALS CONTAINING STATISTICS, STOCK EXCHANGE QUOTATIONS, STOCK INFORMATION, CURRENCIES, INTEREST RATES AND OTHER ECONOMIC FACTORS AND PUBLISHING THE FOREGOING VIA AN ONLINE DATABASE (U.S. CLS. 100, 101 AND 107).

**CLASS 42—SCIENTIFIC, COMPUTER AND LEGAL SERVICES**

FOR COMPUTER PROGRAMMING FOR OTHERS; COMPUTER SOFTWARE DEVELOPMENT, NAMELY WRITING AND UPDATING OF DATA PROCESSING PROGRAMS; CONSULTANT SERVICES WITH RESPECT TO DATABASES AND THE USE OF STOCK MARKET INFORMATION AND INDEXES; COMPUTER CONSULTATION WITH RESPECT TO ESTABLISHING ELECTRONIC SYSTEMS FOR ADMINISTERING BANKING AND FINANCIAL AFFAIRS; TECHNICAL SUPPORT SERVICES, NAMELY, TROUBLESHOOTING OF COMPUTER HARDWARE AND SOFTWARE PROBLEMS; COMPUTER SOFTWARE RESEARCH AND DEVELOPMENTS; COMPUTER SYSTEMS ANALYSIS; COMPUTER RENTAL; COMPUTER DATA RECOVERY SERVICES; CONSULTATION IN THE FIELD OF COMPUTER SOFTWARE FOR USE IN FINANCIAL AND STOCK EXCHANGE SECTORS (U.S. CLS. 100 AND 101).

WILLIAM BRECKENFELD, EXAMINING ATTORNEY

SN 79-002,701. AMI AGROLINZ MELAMINE INTERNATIONAL; GMBH, AUSTRIA, FILED 3-23-2004.

# ADGREEN

THE MARK CONSISTS OF STANDARD CHARACTERS WITHOUT CLAIM TO ANY PARTICULAR FONT, STYLE, SIZE, OR COLOR.

PRIORITY DATE OF 9-24-2003 IS CLAIMED.

OWNER OF INTERNATIONAL REGISTRATION 0825332 DATED 3-23-2004, EXPIRES 3-23-2014.

**CLASS 1—CHEMICALS**

FOR CHEMICALS USED IN INDUSTRY AND SCIENCE (U.S. CLS. 1, 5, 6, 10, 26 AND 46).

**CLASS 4—LUBRICANTS AND FUELS**

FOR FUELS (U.S. CLS. 1, 6 AND 15).

CHRISTOPHER ADKINS, EXAMINING ATTORNEY

SN 79-002,613. SULZER ORTHOPEDICS LTD., SWITZERLAND, FILED 3-24-2004.

# VARIALL

THE MARK CONSISTS OF STANDARD CHARACTERS WITHOUT CLAIM TO ANY PARTICULAR FONT, STYLE, SIZE, OR COLOR.

OWNER OF INTERNATIONAL REGISTRATION 0726539 DATED 1-24-2000, EXPIRES 1-24-2010.

**CLASS 5—PHARMACEUTICALS**

FOR BONE CEMENT FOR USE IN ORTHOPEDIC SURGERY (U.S. CLS. 6, 18, 44, 46, 51 AND 52).

**CLASS 10—MEDICAL APPARATUS**

FOR SURGICAL, MEDICAL AND VETERINARY INSTRUMENTS AND APPARATUS, NAMELY, ARTIFICIAL LIMBS, ARTIFICIAL JOINTS AND IMPLANTS, ARTIFICIAL HIP JOINTS, ARTIFICIAL FEMORAL RODS AND ACETABULAR CUPS AND ARTIFICIAL HIP IMPLANT HEADS; INSTRUMENTS AND TOOLS FOR IMPLANTATION THEREOF, NAMELY RASPS, MILLING CUTTERS, DRILLING JIGS, HAMMERING INSTRUMENTS; MARKING JIGS AS WELL AS MEDULLARY SPACE BLOCKERS; RAILS, SAWS AND PROBES FOR MEDICAL PURPOSES; MODELS FOR ORTHOPEDIC USE (U.S. CLS. 26, 39 AND 44).

SEAN DWYER, EXAMINING ATTORNEY

SN 79-004,247. WERNER KAUFMANN, SWITZERLAND, FILED 2-16-2004.

# papersmile

THE MARK CONSISTS OF STANDARD CHARACTERS WITHOUT CLAIM TO ANY PARTICULAR FONT, STYLE, SIZE, OR COLOR.

PRIORITY DATE OF 12-2-2003 IS CLAIMED.

OWNER OF INTERNATIONAL REGISTRATION 0830145 DATED 2-16-2004, EXPIRES 2-16-2014.

**CLASS 3—COSMETICS AND CLEANING PREPARATIONS**

FOR COSMETICS, PERFUMERY, ESSENTIAL OILS FOR PERSONAL USE AND PRODUCTS FOR MOISTENING TOILET PAPER, NAMELY, LIQUID SOAPS FOR CLEANSING THE BODY (U.S. CLS. 1, 4, 6, 50, 51 AND 52).

**CLASS 16—PAPER GOODS AND PRINTED MATTER**

FOR PAPER TOWELS AND TOILET PAPER FOR USE IN COMBINED DISPENSERS OF DRY AND MOIST PAPERS (U.S. CLS. 2, 5, 22, 23, 29, 37, 38 AND 50).

**CLASS 21—HOUSEWARES AND GLASS**

FOR HOUSEHOLD UTENSILS AND CONTAINERS NOT OF PRECIOUS METAL, NAMELY COMBINED DISPENSERS FOR DRY TOILET PAPER AND MOIST TOILET PAPER AND PARTS THEREFOR AND NON-METAL PAPER DISPENSERS, NAMELY COMBINED DISPENSERS FOR DRY TOILET PAPER AND MOIST TOILET PAPER AND PARTS THEREFOR (U.S. CLS. 2, 13, 23, 29, 30, 33, 40 AND 50).

PATRICIA EVANKO, EXAMINING ATTORNEY

## SECTION 2.— INTERNATIONAL CLASSIFICATION

The short titles associated below with the international class numbers are terms designed merely for quick identification and are not an official part of the international classification. The full names of international classes are given in section 6.1 of the trademark rules of practice.

The designation "U.S. Cl." appearing in this section refers to the U.S. class in effect prior to Sep. 1, 1973 rather than the international class which applies to applications filed on or after that date. For adoption of international classification see notice in the OFFICIAL GAZETTE of Jun. 26, 1973 (911 O.G. TM 210).

### Application in one class

#### CLASS 1—CHEMICALS

SN 76-383,361. STERIS INC, TEMECULA, CA. FILED 3-15-2002.

### SURGICOT

FOR CHEMICALLY TREATED MATERIAL WHICH IS POSITIONED IN A STERILIZER AND UNDERGOES A PHYSICAL CHANGE WHEN IT HAS BEEN SUBJECT TO THE CONDITIONS OF A DESIGNATED STERILIZATION PROCESS; CHEMICALLY TREATED PAPER WHICH CHANGES COLOR WHEN SUBJECT TO A STERILIZATION PROCESS (U.S. CLS. 1, 5, 6, 10, 26 AND 46).

ALEXANDER L. POWERS, EXAMINING ATTORNEY

---

SN 76-393,554. BROMINE COMPOUNDS LTD., BEER SHEVA, 84101, ISRAEL, FILED 4-10-2002.

### SAFRON

PRIORITY CLAIMED UNDER SEC. 44(D) ON ISRAEL APPLICATION NO. 153126, FILED 11-1-2001, REG. NO. 153126, DATED 2-3-2003, EXPIRES 2-3-2013.

FOR CHEMICAL ADDITIVES FOR USE IN IMPROVING FLAME RETARDANCY AND OTHER PROPERTIES OF PLASTICS DURING THE MANUFACTURE OF PLASTICS (U.S. CLS. 1, 5, 6, 10, 26 AND 46).

JEFF DEFORD, EXAMINING ATTORNEY

---

SN 76-468,595. NORSK HYDRO ASA, NORWAY, FILED 11-8-2002.

### ECOFORM

OWNER OF NORWAY REG. NO. 220730, DATED 9-25-2003, EXPIRES 9-25-2013.

FOR OILFIELD CHEMICALS, NAMELY DRILLING AND COMPLETION FLUIDS BASED ON POTASSIUM FORMATE AND SODIUM FORMATE (U.S. CLS. 1, 5, 6, 10, 26 AND 46).

JOHN DALIER, EXAMINING ATTORNEY

#### CLASS 1—(Continued).

SN 76-478,660. FLAME STOP INC., FT. WORTH, TX. FILED 12-27-2002.

### FLAME STOP

NO CLAIM IS MADE TO THE EXCLUSIVE RIGHT TO USE "FLAME", APART FROM THE MARK AS SHOWN. SEC. 2(F).

FOR FIRE AND FLAME RETARDANTS AND STOPS, CHEMICAL COMPOSITIONS IN LIQUID FORM TO PREVENT AND RETARD COMBUSTION; FIRE EXTINGUISHING COMPOSITIONS (U.S. CLS. 1, 5, 6, 10, 26 AND 46).

FIRST USE 1-31-1981; IN COMMERCE 1-31-1981.  
BARNEY CHARLON, EXAMINING ATTORNEY

---

SN 76-543,674. CHEMISCHES LABORATORIUM DR. KURT RICHTER GMBH, 12159 BERLIN, FED REP GERMANY, FILED 8-28-2003.

### PHYTOSAN

FOR CHEMICAL PRODUCTS FOR USE IN INDUSTRY, NAMELY, RAW MATERIALS AND ADDITIVES FOR THE PRODUCTION OF COSMETICS (U.S. CLS. 1, 5, 6, 10, 26 AND 46).

FIRST USE 3-0-2002; IN COMMERCE 5-0-2002.  
AISHA CLARKE, EXAMINING ATTORNEY

---

SN 76-544,689. HAIFA CHEMICALS LTD., HAIFA BAY 26120, ISRAEL, FILED 9-15-2003.

### 2 Green

THE MARK CONSISTS OF STANDARD CHARACTERS WITHOUT CLAIM TO ANY PARTICULAR FONT, STYLE, SIZE, OR COLOR.

FOR FERTILIZERS FOR AGRICULTURAL USE (U.S. CLS. 1, 5, 6, 10, 26 AND 46).

REBECCA SMITH, EXAMINING ATTORNEY



**CLASS 1—(Continued).**

SN 76-544,690. HAIFA CHEMICALS LTD., HAIFA BAY 26120, ISRAEL, FILED 9-15-2003.

## **4 Green**

THE MARK CONSISTS OF STANDARD CHARACTERS WITHOUT CLAIM TO ANY PARTICULAR FONT, STYLE, SIZE, OR COLOR.

FOR FERTILIZERS FOR AGRICULTURAL USE (U.S. CLS. 1, 5, 6, 10, 26 AND 46).

REBECCA SMITH, EXAMINING ATTORNEY

SN 76-547,720. HYPERLAST LIMITED, HIGH PEAK, ENGLAND, FILED 9-26-2003.

## **DIPRANE**

OWNER OF UNITED KINGDOM REG. NO. 1100706, DATED 8-25-1978, EXPIRES 8-25-2009.

FOR CHEMICAL PRODUCTS AND PREPARATIONS, NAMELY, FOR USE IN INDUSTRY AND MANUFACTURING PROCESSES; PLASTICS IN THE FORM OF POWDERS, LIQUIDS, PASTES AND GRANULES (U.S. CLS. 1, 5, 6, 10, 26 AND 46).

CAROLINE WOOD, EXAMINING ATTORNEY

SN 76-565,447. MICRO ESSENTIAL LABORATORY, INC., BROOKLYN, NY. FILED 12-3-2003.

## **PHYDRION**

THE MARK CONSISTS OF STANDARD CHARACTERS WITHOUT CLAIM TO ANY PARTICULAR FONT, STYLE, SIZE, OR COLOR.

FOR CHEMICAL TEST PRODUCTS COMPRISING CHEMICAL TEST PAPERS, CHEMICAL INDICATORS, CHEMICAL TEST KITS, CHEMICAL INDICATOR KITS, PH INDICATOR PENCILS, CHEMICAL BUFFERS, BUFFER SALTS, BUFFER PRESERVATIVES, DISPENSERS, COLOR CHARTS, AND TESTING PRODUCTS, FOR USE IN TESTING, DETECTING, IDENTIFYING, MEASURING, AND INDICATING LEVELS OF PH, OF SANITIZERS, AND OF OTHER SUBSTANCES (U.S. CLS. 1, 5, 6, 10, 26 AND 46).

FIRST USE 4-0-1937; IN COMMERCE 4-0-1937.  
KIMBERLY PERRY, EXAMINING ATTORNEY

**CLASS 1—(Continued).**

SN 76-568,771. BASF AKTIENGESELLSCHAFT, LUDWIGSHAFEN, FED REP GERMANY, FILED 1-7-2004.

## **ADEG**

THE MARK CONSISTS OF STANDARD CHARACTERS WITHOUT CLAIM TO ANY PARTICULAR FONT, STYLE, SIZE, OR COLOR.

FOR CHEMICALS FOR PURIFYING AND SCRUBBING GASES AND FLUE GASES FOR THE APPLICATION IN THE CHEMICAL INDUSTRY, POWER PLANTS AND PETROLEUM PROCESSING INDUSTRY (U.S. CLS. 1, 5, 6, 10, 26 AND 46).

FIRST USE 8-26-2003; IN COMMERCE 8-26-2003.  
DAVID C. REIHNER, EXAMINING ATTORNEY

SN 76-569,570. VOLTAIX, INC., NORTH BRANCH, NJ. FILED 1-8-2004.

## **Voltaix, Inc.**

THE MARK CONSISTS OF STANDARD CHARACTERS WITHOUT CLAIM TO ANY PARTICULAR FONT, STYLE, SIZE, OR COLOR.

NO CLAIM IS MADE TO THE EXCLUSIVE RIGHT TO USE "INC", APART FROM THE MARK AS SHOWN.

FOR CHEMICALS USED IN THE MANUFACTURE OF SEMICONDUCTORS AND PHOTOVOLTAIC DEVICES (U.S. CLS. 1, 5, 6, 10, 26 AND 46).

FIRST USE 1-0-1990; IN COMMERCE 1-0-1990.  
TANYA AMOS, EXAMINING ATTORNEY

SN 76-570,291. BIAGRO WESTERN SALES, INC., VISALIA, CA. FILED 1-15-2004.

## **CALCI PHITE**

THE MARK CONSISTS OF STANDARD CHARACTERS WITHOUT CLAIM TO ANY PARTICULAR FONT, STYLE, SIZE, OR COLOR.

FOR AGRICULTURAL AND HORTICULTURAL FERTILIZERS; CHEMICAL FERTILIZERS AND CHEMICALS FOR USE IN THE MANUFACTURE OF FERTILIZERS; PLANT NUTRIENTS (U.S. CLS. 1, 5, 6, 10, 26 AND 46).

FIRST USE 10-25-2004; IN COMMERCE 10-25-2004.  
LANA PHAM, EXAMINING ATTORNEY

**CLASS 1—(Continued).**

SN 76-571,123. GREAT LAKES PULP COMPANY, MENOMINEE, MI. FILED 1-21-2004.



NO CLAIM IS MADE TO THE EXCLUSIVE RIGHT TO USE "PULP & FIBRE", APART FROM THE MARK AS SHOWN.

THE MARK IS COMPRISED OF THE PHRASE "GREAT LAKES PULP & FIBRE" IN A STYLIZED FORM AND A DESIGN OF A LIGHTHOUSE SCENE.

SEC. 2(F) AS TO "GREAT LAKES PULP & FIBRE".  
FOR RECYCLED PULP, NAMELY, RECYCLED PAPER PULP FOR MANUFACTURING PURPOSES (U.S. CLS. 1, 5, 6, 10, 26 AND 46).

FIRST USE 6-0-1996; IN COMMERCE 6-0-1996.  
MICHAEL HALL, EXAMINING ATTORNEY

**CLASS 1—(Continued).**

SN 76-585,935. THE TRUSTEE OF THE WILLIAM A. ROSTINE REVOCABLE TRUST UNDER AGREEMENT DATED NOVEMBER 9, 2001, SPRINGFIELD, MO. FILED 4-9-2004.

**CAST-O-MAGIC**

THE MARK CONSISTS OF STANDARD CHARACTERS WITHOUT CLAIM TO ANY PARTICULAR FONT, STYLE, SIZE, OR COLOR.

FOR RELEASE COMPOUNDS FOR USE IN CONCRETE FABRICATION, NAMELY COMPOUNDS FOR RELEASING CONCRETE FROM FORMS, STAMPS, AND MACHINERY AND EQUIPMENT (U.S. CLS. 1, 5, 6, 10, 26 AND 46).

FIRST USE 4-0-1984; IN COMMERCE 4-0-1984.  
VERNA BETH RIRIE, EXAMINING ATTORNEY

SN 76-583,433. STANHOPE PRODUCTS COMPANY, BROOKVILLE, OH. FILED 3-29-2004.

**SIRAY**

THE MARK CONSISTS OF STANDARD CHARACTERS WITHOUT CLAIM TO ANY PARTICULAR FONT, STYLE, SIZE, OR COLOR.

FOR CARTRIDGES AND POUCHES CONTAINING DESICCANT MATERIAL FOR THE AUTOMOBILE INDUSTRY (U.S. CLS. 1, 5, 6, 10, 26 AND 46).

MATTHEW KLINE, EXAMINING ATTORNEY

SN 76-586,140. INSTRUMENT SPECIALISTS, INC., BOERNE, TX. FILED 4-12-2004.

**ENDOTERG**

THE MARK CONSISTS OF STANDARD CHARACTERS WITHOUT CLAIM TO ANY PARTICULAR FONT, STYLE, SIZE, OR COLOR.

FOR ENZYMATIC DETERGENT FOR CLEANING ENDOSCOPES AND SURGICAL INSTRUMENTS (U.S. CLS. 1, 5, 6, 10, 26 AND 46).

MICHAEL WEBSTER, EXAMINING ATTORNEY

SN 76-584,191. DUCK CREEK RESOURCES, INC., CLEVELAND, OH. FILED 3-31-2004.

**AQUASALINA**

THE MARK CONSISTS OF STANDARD CHARACTERS WITHOUT CLAIM TO ANY PARTICULAR FONT, STYLE, SIZE, OR COLOR.

FOR PURIFIED OIL FIELD BRINE COMPOSITION FOR USE IN ICE MELTING AND DUST CONTROL (U.S. CLS. 1, 5, 6, 10, 26 AND 46).

FIRST USE 11-0-2003; IN COMMERCE 11-0-2003.  
RONALD MCMORROW, EXAMINING ATTORNEY

SN 76-588,489. J & M APPLIED TECHNOLOGY, INC., DBA APTEK LABORATORIES, INC., VALENCIA, CA. FILED 4-23-2004.

**B/C/B**

THE MARK CONSISTS OF STANDARD CHARACTERS WITHOUT CLAIM TO ANY PARTICULAR FONT, STYLE, SIZE, OR COLOR.

FOR ADHESIVES FOR USE IN THE ELECTRONICS INDUSTRY (U.S. CLS. 1, 5, 6, 10, 26 AND 46).

FIRST USE 4-0-1996; IN COMMERCE 4-0-1996.  
GIANCARLO CASTRO, EXAMINING ATTORNEY

**CLASS 1—(Continued).**

SN 76-590,631. CELL SIGNALING TECHNOLOGY, INC., BEVERLY, MA. FILED 5-3-2004.

# HTSCAN

FOR REAGENTS FOR SCIENTIFIC AND CLINICAL RESEARCH USE, NAMELY, KITS CONTAINING MODIFICATION-SPECIFIC ANTIBODIES AND ENZYMES (U.S. CLS. 1, 5, 6, 10, 26 AND 46).  
RON FAIRBANKS, EXAMINING ATTORNEY

**CLASS 1—(Continued).**

SN 78-291,018. K & W PRODUCTS INC., GAFIELD, NJ. FILED 8-22-2003.



NO CLAIM IS MADE TO THE EXCLUSIVE RIGHT TO USE "FORMULA", APART FROM THE MARK AS SHOWN. FOR CHEMICALS USED IN CONNECTION WITH STAIN REPELLANTS FOR FABRICS (U.S. CLS. 1, 5, 6, 10, 26 AND 46).  
KEVON CHISOLM, EXAMINING ATTORNEY

SN 76-591,859. STRATAGENE CALIFORNIA, LA JOLLA, CA. FILED 5-12-2004.

# ACCUSCRIPT

THE MARK CONSISTS OF STANDARD CHARACTERS WITHOUT CLAIM TO ANY PARTICULAR FONT, STYLE, SIZE, OR COLOR.  
FOR REAGENTS FOR SCIENTIFIC RESEARCH USE (U.S. CLS. 1, 5, 6, 10, 26 AND 46).  
NANCY CLARKE, EXAMINING ATTORNEY

SN 78-381,471. HUNTSMAN ADVANCED MATERIALS AMERICAS INC., AUBURN HILLS, MI. FILED 3-10-2004.

# RenLam

SN 78-217,422. MERCK KGAA, D-64293 DARMSTADT, FED REP GERMANY, FILED 2-21-2003.

# P-PLUS

OWNER OF FED REP GERMANY REG. NO. 30302096, DATED 2-6-2003, EXPIRES 1-31-2013.  
FOR CHEMICALS AND KITS FOR ANALYTIC PURPOSES FOR USE IN CHROMATOGRAPHY AND BIOSCIENCE (U.S. CLS. 1, 5, 6, 10, 26 AND 46).  
INGA ERVIN, EXAMINING ATTORNEY

THE MARK CONSISTS OF STANDARD CHARACTERS WITHOUT CLAIM TO ANY PARTICULAR FONT, STYLE, SIZE, OR COLOR.  
OWNER OF U.S. REG. NOS. 678,703, 781,908 AND OTHERS.  
FOR UNPROCESSED ARTIFICIAL RESINS AND PLASTICS FOR THE PRODUCTION OF MODELS, MOLDS, TOOLS AND OTHER SHAPES (U.S. CLS. 1, 5, 6, 10, 26 AND 46).  
FIRST USE 3-0-2003; IN COMMERCE 3-0-2003.  
LA TONIA FISHER, EXAMINING ATTORNEY

**CLASS 1—(Continued).**

SN 78-381,500. HUNTSMAN ADVANCED MATERIALS AMERICAS INC., AUBURN HILLS, MI. FILED 3-10-2004.

**CLASS 1—(Continued).**

SN 78-409,302. INDOPCO, INC., DBA NATIONAL STARCH AND CHEMICAL COMPANY, BRIDGEWATER, NJ. FILED 4-28-2004.

# RenInfiltrant

# RIDI-CAL

THE MARK CONSISTS OF STANDARD CHARACTERS WITHOUT CLAIM TO ANY PARTICULAR FONT, STYLE, SIZE, OR COLOR.

OWNER OF U.S. REG. NOS. 678,703, 781,908 AND OTHERS.

FOR UNPROCESSED ARTIFICIAL RESINS AND PLASTICS FOR THE PRODUCTION OF MODELS, MOLDS, TOOLS AND OTHER SHAPES (U.S. CLS. 1, 5, 6, 10, 26 AND 46).

LA TONIA FISHER, EXAMINING ATTORNEY

THE MARK CONSISTS OF STANDARD CHARACTERS WITHOUT CLAIM TO ANY PARTICULAR FONT, STYLE, SIZE, OR COLOR.

FOR CALCIUM ANTI-DEPOSITION ADDITIVE FOR STARCH BASED CORRUGATING ADHESIVES (U.S. CLS. 1, 5, 6, 10, 26 AND 46).

FIRST USE 6-25-2003; IN COMMERCE 6-25-2003.

JAMES GRIFFIN, EXAMINING ATTORNEY

---

SN 78-398,920. PROFESSIONAL SECURITY CORPORATION, CEDAR RAPIDS, IA. FILED 4-8-2004.

---

SN 78-413,790. ALPHA INNOTECH CORPORATION, SAN LEANDRO, CA. FILED 5-5-2004.

# 4-IN-1

# CHEMIGLOW

THE MARK CONSISTS OF STANDARD CHARACTERS WITHOUT CLAIM TO ANY PARTICULAR FONT, STYLE, SIZE, OR COLOR.

OWNER OF U.S. REG. NO. 2,292,371.

FOR PERSONAL DEFENSE CHEMICAL SPRAY (U.S. CLS. 1, 5, 6, 10, 26 AND 46).

FIRST USE 6-0-1996; IN COMMERCE 6-0-1996.

FLORENTINA BLANDU, EXAMINING ATTORNEY

THE MARK CONSISTS OF STANDARD CHARACTERS WITHOUT CLAIM TO ANY PARTICULAR FONT, STYLE, SIZE, OR COLOR.

FOR KITS FOR BIOMOLECULE SAMPLE PREPARATION, DETECTION, QUANTITATION, PURIFICATION, AND PREPARATION, NAMELY, REAGENTS FOR SCIENTIFIC OR MEDICAL RESEARCH USE (U.S. CLS. 1, 5, 6, 10, 26 AND 46).

FIRST USE 6-1-2000; IN COMMERCE 6-1-2000.

WON TEAK OH, EXAMINING ATTORNEY

**CLASS 1—(Continued).**

SN 78-419,002. POLYONE CORPORATION, AVON LAKE, OH. FILED 5-14-2004.

**CLASS 1—(Continued).**

SN 78-422,568. TURF SCIENCE LABORATORIES, INC., NATIONAL CITY, CA. FILED 5-20-2004.

**POLYONE**

**RESURGE**

THE MARK CONSISTS OF STANDARD CHARACTERS WITHOUT CLAIM TO ANY PARTICULAR FONT, STYLE, SIZE, OR COLOR.

OWNER OF U.S. REG. NOS. 2,463,935, 2,463,947 AND 2,717,863.

FOR POLYMER RESINS USED TO MAKE PLASTIC MOLDED OR EXTRUDED ARTICLES (U.S. CLS. 1, 5, 6, 10, 26 AND 46).

BARBARA BROWN, EXAMINING ATTORNEY

THE MARK CONSISTS OF STANDARD CHARACTERS WITHOUT CLAIM TO ANY PARTICULAR FONT, STYLE, SIZE, OR COLOR.

FOR TREATMENT SOIL SURFACTANT THAT WILL CORRECT EXISTING SOIL WATER REPELLENCY (U.S. CLS. 1, 5, 6, 10, 26 AND 46).

MICHAEL WEBSTER, EXAMINING ATTORNEY

SN 78-420,132. BIOLAB SERVICES, INC., WILMINGTON, DE. FILED 5-17-2004.

SN 79-002,774. BAKELITE AG, FED REP GERMANY, FILED 3-11-2004.

**HYDROTECH**

**mgs**

THE MARK CONSISTS OF STANDARD CHARACTERS WITHOUT CLAIM TO ANY PARTICULAR FONT, STYLE, SIZE, OR COLOR.

FOR WATER TREATMENT CHEMICALS FOR SWIMMING POOLS AND SPAS (U.S. CLS. 1, 5, 6, 10, 26 AND 46).

FIRST USE 9-15-1981; IN COMMERCE 9-15-1981.

JULIA HARDY COFIELD, EXAMINING ATTORNEY

THE MARK CONSISTS OF STANDARD CHARACTERS WITHOUT CLAIM TO ANY PARTICULAR FONT, STYLE, SIZE, OR COLOR.

OWNER OF INTERNATIONAL REGISTRATION 0825584 DATED 3-11-2004, EXPIRES 3-11-2014.

FOR CHEMICAL PRODUCTS FOR COMMERCIAL USE, NAMELY, UNPROCESSED PLASTICS, UNPROCESSED ARTIFICIAL RESINS; CHEMICAL PRODUCTS FOR COMMERCIAL USE, NAMELY, ADDITIVES FOR USE IN THE MANUFACTURE OF A WIDE VARIETY OF GOODS IN OTHER INDUSTRIES INCLUDING RELEASING AGENTS (U.S. CLS. 1, 5, 6, 10, 26 AND 46).

MAUREEN DALL, EXAMINING ATTORNEY

**CLASS 2—PAINTS**

SN 76-501,826. TEIJIN KABUSHIKI KAISHA (TEIJIN LIMITED), CHUO-KU, OSAKA 541-8574, JAPAN, AND NISSAN JIDOSHA KABUSHIKI KAISHA, TA NISSAN MOTOR CO., LTD., KANAGAWA-KEN, JAPAN, AND TANAKA KINKINZOKU KOGYO K.K., TOKYO, 103-8206, JAPAN, FILED 3-27-2003.

**MORPHOTONE**

OWNER OF JAPAN REG. NO. 4282372, DATED 6-11-1999, EXPIRES 6-11-2009.

FOR GLAZES, NAMELY, PAINTS; LACQUERS, NAMELY, SHELLAC; VARNISHES, NAMELY, PINE OIL; RUST PRESERVATIVES IN THE NATURE OF A COATING; WOOD PRESERVATIVES; COLORANTS FOR USE IN THE MANUFACTURE OF COSMETICS, PAINTS, PAPER AND TEXTILES; MORDANTS FOR USE IN THE FOOD INDUSTRY AND IN THE TEXTILE INDUSTRY; RAW NATURAL RESINS FOR USE IN THE MANUFACTURE OF ADHESIVE, PAINT AND COSMETICS, NAMELY, CANADA BALSAM, COPAL, SANDARAC, DAMMAR, MASTIC, AND PINE GUM; METAL IN FOIL AND POWDER FORM FOR PAINTERS, DECORATORS AND ARTISTS (U.S. CLS. 6, 11 AND 16).

CATHERINE CAIN, EXAMINING ATTORNEY

SN 76-547,157. LIFE PAINT COMPANY, SANTA FE SPRINGS, CA. FILED 9-26-2003.



NO CLAIM IS MADE TO THE EXCLUSIVE RIGHT TO USE "RAIN SHIELD", APART FROM THE MARK AS SHOWN.

THE STIPPLING IN THE DRAWING IS A FEATURE OF THE MARK FOR SHADING PURPOSES.

THE BROKEN LINES DEPICTED IN THE DRAWING ARE NOT A FEATURE OF THE MARK BUT ARE INTENDED TO DEPICT THE PLACEMENT OF MATTER THAT IS NOT CLAIMED AS A FEATURE OF THE MARK.

FOR LIQUID COATINGS AND CHEMICAL-BASED COATINGS AND SURFACE TREATMENTS FOR EXTERIOR PROTECTION OF WALLS AND SURFACES (U.S. CLS. 6, 11 AND 16).

ELIZABETH HUGHITT, EXAMINING ATTORNEY

**CLASS 2—(Continued).**

SN 76-569,119. BENJAMIN MOORE & CO., MONTVALE, NJ. FILED 12-3-2003.

**THE COLOR AUTHORITY**

THE MARK CONSISTS OF STANDARD CHARACTERS WITHOUT CLAIM TO ANY PARTICULAR FONT, STYLE, SIZE, OR COLOR.

NO CLAIM IS MADE TO THE EXCLUSIVE RIGHT TO USE "COLOR", APART FROM THE MARK AS SHOWN.

FOR INTERIOR AND EXTERIOR PAINTS AND COATINGS IN THE NATURE OF A PAINT (U.S. CLS. 6, 11 AND 16).

FIRST USE 1-1-1957; IN COMMERCE 1-1-1957.

SEAN DWYER, EXAMINING ATTORNEY

SN 76-570,748. ADVANTAGE SIGN SUPPLY, GRAND RAPIDS, MI. FILED 1-20-2004.

**APEX**

FOR CARTRIDGES CONTAINING PIGMENTED RESIN THAT BONDS TO VINYL PRODUCTS USED IN MACHINERY THAT PRODUCES VINYL GRAPHICS (U.S. CLS. 6, 11 AND 16).

SUSAN HAYASH, EXAMINING ATTORNEY

SN 76-592,527. BONAKEMI USA, INC., AURORA, CO. FILED 5-17-2004.

**COURTLINES**

FOR WOOD FLOOR FINISH (U.S. CLS. 6, 11 AND 16). FIRST USE 3-15-1999; IN COMMERCE 3-15-1999.

ANNE MADDEN, EXAMINING ATTORNEY

SN 78-151,611. REVOTECH INDUSTRIES INT'L, LOS ANGELES, CA. FILED 8-6-2002.

**REVOTECH**

FOR FILLED INK CARTRIDGES (U.S. CLS. 6, 11 AND 16).

SCOTT BALDWIN, EXAMINING ATTORNEY

**CLASS 2—(Continued).**

SN 78-345,525. DURA-LOC ROOFING SYSTEMS LIMITED, COURTLAND, NOJ 1E0, 01 ONTARIO, CANADA, FILED 12-24-2003.

**CLASS 2—(Continued).**

SN 78-368,564. GAMBLIN ARTISTS COLORS CO., PORTLAND, OR. FILED 2-16-2004.

**COOL COVERINGS**

**GAMSOL**

THE MARK CONSISTS OF STANDARD CHARACTERS WITHOUT CLAIM TO ANY PARTICULAR FONT, STYLE, SIZE, OR COLOR.

PRIORITY CLAIMED UNDER SEC. 44(D) ON CANADA APPLICATION NO. 1194,985, FILED 10-28-2003, REG. NO. TMA612,769, DATED 6-15-2004, EXPIRES 6-15-2019.

FOR ENERGY EFFICIENT COATING FOR METAL ROOFING AND/OR SIDING COMPONENTS COMPRISED OF CERAMIC COLOURED CRYSTALS, BONDED AND SEALED WITH ACRYLICS (U.S. CLS. 6, 11 AND 16).

FIRST USE 10-0-2003; IN COMMERCE 10-0-2003.  
DOMINIC J. FERRAIUOLO, EXAMINING ATTORNEY

THE MARK CONSISTS OF STANDARD CHARACTERS WITHOUT CLAIM TO ANY PARTICULAR FONT, STYLE, SIZE, OR COLOR.

FOR SOLVENTS, NAMELY MINERAL SPIRITS FOR USE AS A PAINT THINNER (U.S. CLS. 6, 11 AND 16).  
FIRST USE 1-31-1994; IN COMMERCE 1-31-1994.  
HOWARD B. LEVINE, EXAMINING ATTORNEY

---

SN 78-367,432. STRICKLAND, ELLEN, SANTA BARBARA, CA. FILED 2-12-2004.

---

SN 78-397,133. MICRO INKS LIMITED, GUJARAT, INDIA, FILED 4-6-2004.

**Livinggreen Marine**

**WINGS OF IMAGINATION**

THE MARK CONSISTS OF STANDARD CHARACTERS WITHOUT CLAIM TO ANY PARTICULAR FONT, STYLE, SIZE, OR COLOR.

OWNER OF U.S. REG. NO. 2,540,007.  
NO CLAIM IS MADE TO THE EXCLUSIVE RIGHT TO USE "MARINE", APART FROM THE MARK AS SHOWN.

FOR NON-TOXIC WOOD STAINS, VARNISHES AND CLEAR FINISHES FOR USE IN THE BOATING AND MARINA INDUSTRY AND ON OFFICE EQUIPMENT, NAMELY, CHAIRS, DESKS AND TABLES (U.S. CLS. 6, 11 AND 16).  
GWEN STOKOLS, EXAMINING ATTORNEY

THE MARK CONSISTS OF STANDARD CHARACTERS WITHOUT CLAIM TO ANY PARTICULAR FONT, STYLE, SIZE, OR COLOR.

FOR PRINTING INKS (U.S. CLS. 6, 11 AND 16).  
TONJA GASKINS, EXAMINING ATTORNEY

**CLASS 2—(Continued).**

SN 78-403,857. STANDARD DYES, INC., HIGH POINT, NC.  
FILED 4-19-2004.

**Permalon**

THE MARK CONSISTS OF STANDARD CHARACTERS WITHOUT CLAIM TO ANY PARTICULAR FONT, STYLE, SIZE, OR COLOR.

FOR POWDER AND OR LIQUID DYESTUFF USED IN BOTH TEXTILE AND NON-TEXTILE APPLICATIONS (U.S. CLS. 6, 11 AND 16).

GEORGIA CARTY, EXAMINING ATTORNEY

**CLASS 2—(Continued).**

SN 78-412,428. FERRO CORPORATION, CLEVELAND, OH.  
FILED 5-3-2004.

**PURACOLOR**

THE MARK CONSISTS OF STANDARD CHARACTERS WITHOUT CLAIM TO ANY PARTICULAR FONT, STYLE, SIZE, OR COLOR.

FOR COLOR CONCENTRATES FOR USE IN THE MANUFACTURE OF MOLDED AND EXTRUDED PLASTIC PARTS AND SHEETS (U.S. CLS. 6, 11 AND 16).

ROBERT LORENZO, EXAMINING ATTORNEY

SN 78-403,873. STANDARD DYES, INC., HIGH POINT, NC.  
FILED 4-19-2004.

**Permacryl**

THE MARK CONSISTS OF STANDARD CHARACTERS WITHOUT CLAIM TO ANY PARTICULAR FONT, STYLE, SIZE, OR COLOR.

FOR POWDER AND OR LIQUID DYESTUFFS USED IN BOTH TEXTILE AND NON-TEXTILE APPLICATIONS (U.S. CLS. 6, 11 AND 16).

GEORGIA CARTY, EXAMINING ATTORNEY

**CLASS 3—COSMETICS AND CLEANING PREPARATIONS**

SN 76-285,146. GOODMARK USA INC., BOCA RATON, FL.  
FILED 7-13-2001.



FOR GLITTER SPRAY, GLITTER GEL, HAIR COLOR SPRAY, AND GLOW IN THE DARK SPRAY FOR THE HAIR AND BODY (U.S. CLS. 1, 4, 6, 50, 51 AND 52).

BARBARA GAYNOR, EXAMINING ATTORNEY



**CLASS 3—(Continued).**

SN 76-435,481. PROV. 31:30, INC., NEW HYDE PARK, NY. FILED 7-26-2002.



NO CLAIM IS MADE TO THE EXCLUSIVE RIGHT TO USE "PROV. 31:30" AND "BEAUTY", APART FROM THE MARK AS SHOWN.

FOR COSMETICS, NAMELY, FOUNDATIONS, BLUSHES, POWDERS, CONCEALERS, EYE MAKE-UP, LIP GLOSSES AND LINERS, NAIL COLORS, AND COSMETIC ACCESSORIES, NAMELY, BRUSH CLEANER, AND EYE MAKE-UP REMOVER (U.S. CLS. 1, 4, 6, 50, 51 AND 52).

AMY HELLA, EXAMINING ATTORNEY

**CLASS 3—(Continued).**

SN 76-539,329. SMITH, JOSEPH, WELLINGTON, FL. FILED 7-28-2003.

**SportsFusion**

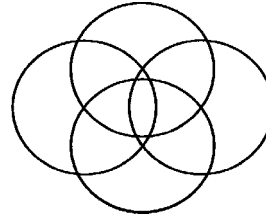

THE MARK CONSISTS OF OVERLAPPING CIRCLES. FOR SKIN CARE PREPARATION, NAMELY SUN PROTECTION LOTION, LIP BALM (U.S. CLS. 1, 4, 6, 50, 51 AND 52).

FIRST USE 3-1-2002; IN COMMERCE 3-1-2002. CYNTHIA SLOAN, EXAMINING ATTORNEY

SN 76-524,449. AIR TECHNIQUES, INC., HICKSVILLE, NY. FILED 6-23-2003.



FOR DETERGENTS USED BY DENTAL PROFESSIONALS IN DENTAL EVACUATION SYSTEMS (U.S. CLS. 1, 4, 6, 50, 51 AND 52).

STANLEY I. OSBORNE, EXAMINING ATTORNEY

SN 76-545,003. LABORATOIRE GARNIER & CIE, PARIS, FRANCE, FILED 9-3-2003.



PRIORITY CLAIMED UNDER SEC. 44(D) ON FRANCE APPLICATION NO. 03/3,225,105, FILED 5-14-2003, REG. NO. 03/3,225,105, DATED 5-14-2003, EXPIRES 5-14-2013.

NO CLAIM IS MADE TO THE EXCLUSIVE RIGHT TO USE "VOLUME", APART FROM THE MARK AS SHOWN.

FOR PERFUME, TOILET WATER; GELS, SALTS FOR THE BATH AND THE SHOWER NOT FOR MEDICAL PURPOSE; TOILET SOAPS; BODY DEODORANTS; COSMETICS NAMELY CREAMS, MILKS, LOTIONS, GELS AND POWDERS FOR THE FACE, THE BODY AND HANDS; TOTAL SUNSCREEN, HIGH PROTECTION CREAMS AND MOISTURIZING TANNING MILK, AFTER SUN MOISTURIZER; MAKE-UP PREPARATIONS; SHAMPOOS; GELS, SPRAYS, MOUSSES AND BALMS FOR HAIR STYLING AND HAIR CARE; HAIR LACQUERS; HAIR COLOURING AND HAIR DECOLORANT PREPARATIONS; PERMANENT WAVING AND CURLING PREPARATIONS; ESSENTIAL OILS FOR PERSONAL USE (U.S. CLS. 1, 4, 6, 50, 51 AND 52).

H. M. FISHER, EXAMINING ATTORNEY

SN 76-535,430. JOHNSON & JOHNSON, NEW BRUNSWICK, NJ. FILED 7-25-2003.

**EZ GRIP SOAP**

OWNER OF U.S. REG. NO. 2,759,855. NO CLAIM IS MADE TO THE EXCLUSIVE RIGHT TO USE "SOAP", APART FROM THE MARK AS SHOWN. FOR BAR SOAP FOR SKIN (U.S. CLS. 1, 4, 6, 50, 51 AND 52).

FIRST USE 2-10-2002; IN COMMERCE 2-10-2002. JENNIFER CHICOSKI, EXAMINING ATTORNEY

**CLASS 3—(Continued).**

SN 76-546,367. LANCOME PARFUMS ET BEAUTE & CIE, PARIS, FRANCE, FILED 9-8-2003.

**NEONLIGHT**

PRIORITY CLAIMED UNDER SEC. 44(D) ON FRANCE APPLICATION NO. 03/3.213.967, FILED 3-7-2003, REG. NO. 033213967, DATED 3-7-2003, EXPIRES 3-7-2013.

FOR SHAMPOOS, CONDITIONERS, TREATMENTS, SERUMS, MASQUES AND MOUSSE FOR THE HAIR (U.S. CLS. 1, 4, 6, 50, 51 AND 52).

DAVID C. REIHNER, EXAMINING ATTORNEY

SN 76-546,689. BALENCIAGA, 75006 PARIS, FRANCE, FILED 9-23-2003.

**LE DIX BALENCIAGA**

OWNER OF FRANCE REG. NO. 1,595,160, DATED 2-10-1950, RENEWED AS REG. NO. 2159132, DATED 12-8-1999, EXPIRES 12-8-2009.

OWNER OF U.S. REG. NOS. 547,687, 2,822,083 AND OTHERS.

THE ENGLISH TRANSLATION OF "LE DIX" IS "THE TEN".

FOR PERFUMERY PRODUCTS, NAMELY, PERFUMES AND TOILET WATER; BODY MILK; TOILET SOAPS; DEODORANT WATER; BEAUTY PRODUCTS, NAMELY, ROUGE, EYE SHADOW, BASE MAKE-UP, FACE AND BEAUTY MASKS, LIPSTICKS, NAIL POLISHES AND REMOVERS, BODY LOTIONS, CREAMS AND OTHER MAKE-UP REMOVERS; TOILET PRODUCTS, NAMELY, SHAMPOOS, BATH SALTS, BATH AND SHOWER GELS, BUBBLE BATH, ESSENTIAL OILS FOR PERSONAL USE, COSMETICS, HAIR LOTIONS, SHAVING SOAPS, CREAMS AND FOAMS, AFTER-SHAVE LOTIONS AND BALMS, DENTIFRICES; SKIN TANNING PRODUCTS, NAMELY, OILS, MILKS, LOTIONS AND CREAMS, SELF-TANNING CREAMS, SKIN TANNING PRODUCTS; NON-MEDICATED PREPARATIONS FOR SKIN, BODY, FACE, EYES, LIPS, NECK, LEGS AND FOOT CARE, NAMELY, NON-MEDICATED SKIN CARE PREPARATIONS, NON-MEDICATED LIP CARE PREPARATIONS, NON-MEDICATED EYE CARE PREPARATIONS, NON-MEDICATED NECK CARE PREPARATIONS, NON-MEDICATED LEG CARE PREPARATIONS, NON-MEDICATED FOOT CARE PREPARATIONS, BODY AND BEAUTY CARE PREPARATIONS; ANTI-WRINKLE CREAMS; NON-MEDICATED VITALIZING AND TONING LOTIONS AND CREAMS, MOISTURIZING SKIN LOTIONS AND CREAMS, GRANULATED SKIN CREAMS; DEODORANTS FOR PERSONAL USE; CLEANING PRODUCTS, NAMELY, ALL PURPOSE CLEANING PREPARATIONS (U.S. CLS. 1, 4, 6, 50, 51 AND 52).

JEFFREY S. MOLINOFF, EXAMINING ATTORNEY

SN 76-552,705. RYSELL INTERNATIONAL, INC., MIAMI, FL. FILED 10-20-2003.

**RYSELL**

FOR PERSONAL CARE AND BEAUTY PRODUCTS, NAMELY, HAIR SHAMPOO, HAIR CONDITIONER, BODY LOTION; DEODORANT, ANTI-PERSPIRANT, HAIR DYE, NAIL ENAMELS, NAIL POLISH REMOVER (U.S. CLS. 1, 4, 6, 50, 51 AND 52).

GIANCARLO CASTRO, EXAMINING ATTORNEY

**CLASS 3—(Continued).**

SN 76-557,746. HOOKS, LEROY, DBA BROTHER KAHNIYAH PEDICURE AND REFLEXOLOGY, CHICAGO, IL. FILED 10-16-2003.

**BROTHER KAHNIYAH**

FOR SKIN CARE PRODUCTS, NAMELY, SKIN CLEANSERS, SKIN CONDITIONERS, SKIN MOISTURIZERS, SKIN LOTIONS, SKIN TEXTURIZING CREAMS, HAIR EMOLLIENT, HAIR LOTION, HAIR CLEANING PREPARATIONS, HAIR SHAMPOO, HAIR CARE PREPARATIONS, DEODORANTS AND ANTI-PERSPIRANTS (U.S. CLS. 1, 4, 6, 50, 51 AND 52).

FIRST USE 7-3-2003; IN COMMERCE 7-3-2003.

REBECCA SMITH, EXAMINING ATTORNEY

SN 76-560,542. LANCOME PARFUMS ET BEAUTE & CIE, PARIS, FRANCE, FILED 10-29-2003.

**FORCE DENSITE**

THE MARK CONSISTS OF STANDARD CHARACTERS WITHOUT CLAIM TO ANY PARTICULAR FONT, STYLE, SIZE, OR COLOR.

THE FOREIGN WORDING IN THE MARK TRANSLATES INTO ENGLISH AS DENSITY.

FOR HAIR CARE PREPARATIONS NAMELY, SHAMPOO, CONDITIONER, HAIR TREATMENT PREPARATION AND HAIR SERUM (U.S. CLS. 1, 4, 6, 50, 51 AND 52).

RENEE MCCRAY, EXAMINING ATTORNEY

SN 76-562,997. LAURICE EL BADRY RAHME LTD., DBA LAURICE & CO., NEW YORK, NY. FILED 12-3-2003.

**SEDUCTIVE BOND**

THE MARK CONSISTS OF STANDARD CHARACTERS WITHOUT CLAIM TO ANY PARTICULAR FONT, STYLE, SIZE, OR COLOR.

FOR COSMETICS, INCLUDING SKIN CARE PRODUCTS, NAMELY NON-MEDICATED SKIN PREPARATIONS, SKIN LOTIONS, SKIN CLEANSERS, SKIN CREAMS, SKIN EXFOLIANTS, SKIN MOISTURIZERS AND SKIN TONERS, MAKEUP, LIPSTICK, FOUNDATION POWDERS, EYESHADOW, NAIL POLISH, MASCARA AND EYE PENCILS (U.S. CLS. 1, 4, 6, 50, 51 AND 52).

ELIZABETH HUGHITT, EXAMINING ATTORNEY

**CLASS 3—(Continued).**

SN 76-568,753. LANCOME PARFUMS ET BEAUTE & CIE, PARIS, FRANCE, FILED 12-29-2003.

**EDITION DIAMANT**

THE MARK CONSISTS OF STANDARD CHARACTERS WITHOUT CLAIM TO ANY PARTICULAR FONT, STYLE, SIZE, OR COLOR.

THE ENGLISH TRANSLATION OF THE FRENCH WORD DIAMANT IS DIAMOND.

FOR PERFUMES, TOILET WATER, GELS, COSMETIC SALTS FOR THE BATH AND THE SHOWER, TOILET SOAPS, BODY DEODORANTS, CREAMS, MILKS, GELS, LOTIONS AND POWDERS FOR THE FACE, THE BODY AND THE HANDS, EYE SHADOWS, EYEBROW PENCILS, EYE LINER PENCILS, MASCARA, LIPSTICKS, NAIL POLISH, FOUNDATION CREAMS, BLUSHERS, ROUGE FOR CHEEKS (U.S. CLS. 1, 4, 6, 50, 51 AND 52).  
HELEN BRYAN, EXAMINING ATTORNEY

**CLASS 3—(Continued).**

SN 76-585,760. NEERUAM, INCORPORATED, GRANITE BAY, CA. FILED 4-6-2004.

**SOUND & SCENT**

THE MARK CONSISTS OF STANDARD CHARACTERS WITHOUT CLAIM TO ANY PARTICULAR FONT, STYLE, SIZE, OR COLOR.

FOR POURABLE COMPOSITION HAVING SEEDS AND GRAIN AS PRIMARY ELEMENTS, WHICH WHEN HEATED, SIMULATES THE SOUND AND SCENT OF A WOOD FIRE (U.S. CLS. 1, 4, 6, 50, 51 AND 52).

FIRST USE 4-15-2002; IN COMMERCE 9-15-2002.  
CHARLES JOYNER, EXAMINING ATTORNEY

SN 76-584,455. JUST ACRYLICS, HUNTINGTON BEACH, CA. FILED 4-1-2004.

**CLEAN & PREP**

THE MARK CONSISTS OF STANDARD CHARACTERS WITHOUT CLAIM TO ANY PARTICULAR FONT, STYLE, SIZE, OR COLOR.

FOR ARTIFICIAL NAIL PREPARATION, NAMELY, NAIL DEHYDRATING LIQUID AND NAIL BED CLEANSER (U.S. CLS. 1, 4, 6, 50, 51 AND 52).  
ANDREW RHIM, EXAMINING ATTORNEY

SN 76-585,652. TODD CHRISTOPHER INTERNATIONAL, INC., DBA VOGUE INTERNATIONAL, INC., OLDSMAR, FL. FILED 4-7-2004.

**EGO TRIP**

THE MARK CONSISTS OF STANDARD CHARACTERS WITHOUT CLAIM TO ANY PARTICULAR FONT, STYLE, SIZE, OR COLOR.

FOR MEN'S FRAGRANCES FOR PERSONAL USE; BODY SPRAYS (U.S. CLS. 1, 4, 6, 50, 51 AND 52).  
FIRST USE 9-0-2002; IN COMMERCE 9-0-2002.  
SHARI SHEFFIELD, EXAMINING ATTORNEY

SN 76-589,476. NATURE'S THERAPY, INC., LUTZ, FL. FILED 4-30-2004.

**SMOOTH WORKS**

THE MARK CONSISTS OF STANDARD CHARACTERS WITHOUT CLAIM TO ANY PARTICULAR FONT, STYLE, SIZE, OR COLOR.

FOR HAIR CARE PRODUCTS, NAMELY, SHAMPOO, CONDITIONER, HAIR SPRAY, POMADE, STYLING GEL AND STYLING CREAM (U.S. CLS. 1, 4, 6, 50, 51 AND 52).

SHARON MEIER, EXAMINING ATTORNEY

SN 76-589,477. DEMERT BRANDS, INC., LUTZ, FL. FILED 4-30-2004.

**NOT YOUR MOTHER'S**

THE MARK CONSISTS OF STANDARD CHARACTERS WITHOUT CLAIM TO ANY PARTICULAR FONT, STYLE, SIZE, OR COLOR.

FOR HAIR CARE PRODUCTS, NAMELY, SHAMPOO, CONDITIONER, HAIR SPRAY, POMADE, STYLING GEL AND STYLING CREAM (U.S. CLS. 1, 4, 6, 50, 51 AND 52).

SHARON MEIER, EXAMINING ATTORNEY

**CLASS 3—(Continued).**

SN 76-591,303. DR. JESSICA WU COSMECEUTICALS, INC.,  
LOS ANGELES, CA. FILED 5-7-2004.



FOR COSMETICS; HAIR CARE PREPARATIONS,  
NAMELY SHAMPOO, CONDITIONER, MOISTURIZER,  
HAIR MIST, AND HAIR SPRAY; AND NON-MEDI-  
CATED SKIN CARE PREPARATIONS, NAMELY BODY  
LOTION, LIP BALM, SKIN POWDER, PRE-MOISTENED  
SKIN WIPES, SKIN MASKS, SUNSCREEN, MOISTUR-  
IZER, EYE CREAM, HEEL CREAM, SKIN CLEANSERS,  
FACE CREAM, HAND CREAM, AND SKIN CREAM  
(U.S. CLS. 1, 4, 6, 50, 51 AND 52).

MARTHA FROMM, EXAMINING ATTORNEY

SN 76-592,530. GARLAND COMMERCIAL RANGES LIM-  
ITED, MISSISSAUGA, ONTARIO, CANADA, FILED 5-17-  
2004.

**G-WIZ**

THE MARK CONSISTS OF STANDARD CHARACTERS  
WITHOUT CLAIM TO ANY PARTICULAR FONT, STYLE,  
SIZE, OR COLOR.

FOR CLEANERS, NAMELY CLEANERS FOR COM-  
MERCIAL KITCHEN VENTILATION HOODS (U.S. CLS.  
1, 4, 6, 50, 51 AND 52).

H. M. FISHER, EXAMINING ATTORNEY

**CLASS 3—(Continued).**

SN 76-592,548. JULIA KAROLY ENTERPRISES, LLC, BU-  
FORD, GA. FILED 5-17-2004.

**PHASE 14**

THE MARK CONSISTS OF STANDARD CHARACTERS  
WITHOUT CLAIM TO ANY PARTICULAR FONT, STYLE,  
SIZE, OR COLOR.

FOR COSMETIC SKIN RENEWAL PRODUCTS,  
NAMELY, WRINKLE REMOVING AND MINIMIZING  
SKIN CARE PREPARATIONS; LIP, FACE, AND EYE  
SERUMS, CREAMS AND LOTIONS; MOISTURIZING  
CREAMS AND LOTIONS (U.S. CLS. 1, 4, 6, 50, 51 AND  
52).

H. M. FISHER, EXAMINING ATTORNEY

SN 76-592,556. ASANA ENTERPRISES, LLC, DALLAS, TX.  
FILED 5-17-2004.

**ASANA**

THE MARK CONSISTS OF STANDARD CHARACTERS  
WITHOUT CLAIM TO ANY PARTICULAR FONT, STYLE,  
SIZE, OR COLOR.

FOR CLEANING PREPARATIONS AND SOLUTIONS  
FOR MATS (U.S. CLS. 1, 4, 6, 50, 51 AND 52).

FIRST USE 3-1-2004; IN COMMERCE 3-1-2004.  
GIANCARLO CASTRO, EXAMINING ATTORNEY

SN 76-593,128. TANKE, WILLIAM B., WALNUT, CA. FILED  
5-18-2004.



FOR SKIN CARE PRODUCTS CONTAINING ALOE  
VERA, NAMELY BODY WASHES, BLEMISH REMOV-  
ERS, CONDITIONERS, CLEANSERS, CREAMS, TONER,  
CLEAR SKIN SERUM AND SPRAY-ON FACE AND  
BODY COOLING AGENTS; HAIR SHAMPOO AND HAIR  
GEL (U.S. CLS. 1, 4, 6, 50, 51 AND 52).

FIRST USE 5-0-1996; IN COMMERCE 10-0-1997.

CAROLYN GRAY, EXAMINING ATTORNEY

**CLASS 3—(Continued).**

SN 78-091,393. MEDICAL EXPRESS (UK) LIMITED, HORSHAM, WEST SUSSEX, UNITED KINGDOM, FILED 11-2-2001.

**VOLUME MIRACLE**

PRIORITY CLAIMED UNDER SEC. 44(D) ON ERPN CMNTY TM OFC APPLICATION NO. 2333342, FILED 8-8-2001.

NO CLAIM IS MADE TO THE EXCLUSIVE RIGHT TO USE "VOLUME", APART FROM THE MARK AS SHOWN. SEC. 2(F).

FOR HAIR CARE PRODUCTS, NAMELY, SHAMPOO, CONDITIONERS, PERMS, HAIR CARE PREPARATIONS, NAMELY, SOLUTIONS FOR FIXING, SETTING AND STYLING HAIR, RINSES, HAIR TINTING, DYING AND COLORING SOLUTIONS AND PREPARATIONS, HAIR LAMINATE, HAIR SETTING AND STYLING SPRAYS, GELS AND LOTIONS (U.S. CLS. 1, 4, 6, 50, 51 AND 52).

FIRST USE 5-0-2002; IN COMMERCE 5-0-2002.  
PATRICIA EVANKO, EXAMINING ATTORNEY

SN 78-163,425. CALIFORNIA TAN, INC., LOS ANGELES, CA. FILED 9-12-2002.

**BATH 360**

NO CLAIM IS MADE TO THE EXCLUSIVE RIGHT TO USE "BATH", APART FROM THE MARK AS SHOWN.

FOR DETERGENT SOAP; WINDOW AND HARD SURFACE CLEANERS; AND FLOOR CLEANING PREPARATIONS (U.S. CLS. 1, 4, 6, 50, 51 AND 52).

WON TEAK OH, EXAMINING ATTORNEY

SN 78-216,836. BIOLITEC, INC., EAST LONGMEADOW, MA. FILED 2-20-2003.

**WHITEPRO**

FOR KITS FOR LIGHT ACTIVATED DENTAL WHITENING CONTAINING POWDERS, FLUIDS AND A MIXING BOWL (U.S. CLS. 1, 4, 6, 50, 51 AND 52).

FIRST USE 1-0-2003; IN COMMERCE 1-0-2003.

JANICE L. MCMORROW, EXAMINING ATTORNEY

SN 78-279,629. PRL USA HOLDINGS, INC., WILMINGTON, DE. FILED 7-28-2003.

**RALPH RALPH LAUREN  
SWEETHEART**

OWNER OF U.S. REG. NOS. 1,222,278, 2,798,966 AND OTHERS.

THE NAME "RALPH LAUREN" IDENTIFIES A LIVING INDIVIDUAL WHOSE CONSENT IS OF RECORD.

FOR PERFUME, EAU DE TOILETTE, BODY LOTIONS AND SHOWER GELS (U.S. CLS. 1, 4, 6, 50, 51 AND 52).

ROBERT COGGINS, EXAMINING ATTORNEY

**CLASS 3—(Continued).**

SN 78-298,524. MANDALAY CORP., LAS VEGAS, NV. FILED 9-10-2003.

**INFUSE**

FOR BODY LOTION; BODY SCRUB; SKIN CLARIFIERS; SKIN CLEANSERS; SKIN CONDITIONERS; SKIN CREAM; SKIN LOTION; SKIN MOISTURIZER; SKIN SOAP; FACIAL LOTION; BATH AND SHOWER GELS; BATH OILS; BATH SALTS; BATH SOAPS; SCENTED OILS USED TO PRODUCE AROMAS; SCENTED ROOM SPRAYS; SUN SCREENS; SUNTAN LOTIONS; HAIR SHAMPOO AND CONDITIONER; HAIR GEL; HAIR SCULPTING GEL; HAIR POMADES; HAIR STYLING PREPARATIONS; BODY POWDER. (U.S. CLS. 1, 4, 6, 50, 51 AND 52).

DAVID TAYLOR, EXAMINING ATTORNEY

SN 78-301,718. RECKITT & COLMAN SUBSIDIARY CORPORATION, WILMINGTON, DE. FILED 9-17-2003.



NO CLAIM IS MADE TO THE EXCLUSIVE RIGHT TO USE "PROTECTANT", APART FROM THE MARK AS SHOWN.

FOR PREPARATIONS FOR CLEANING, POLISHING, MOISTURIZING, WAXING AND PROTECTING FLOORS, FURNITURE, PANELLING, WOOD AND OTHER HARD SURFACES; SCRATCH COVERING PREPARATIONS FOR FLOORS, FURNITURE, PANELLING AND OTHER WOOD SURFACES; FLOOR CARE PRODUCTS NAMELY STRIPPER, SEALER AND FLOOR FINISHING PREPARATIONS (U.S. CLS. 1, 4, 6, 50, 51 AND 52).

FIRST USE 6-16-2003; IN COMMERCE 6-16-2003.  
PRISCILLA MILTON, EXAMINING ATTORNEY

SN 78-306,977. PRIMARY INVESTMENTS GROUP LIMITED, ROAD TOWN, TORTOLA, BR.VIRGIN ISLANDS, FILED 9-29-2003.

**NUTRACEUTICAL WRINKLE  
CURE**

NO CLAIM IS MADE TO THE EXCLUSIVE RIGHT TO USE NUTRACEUTICAL WRINKLE, APART FROM THE MARK AS SHOWN.

FOR SOAPS; NON-MEDICATED SKIN LOTIONS AND CREAM; PERFUMERY; ESSENTIAL OILS FOR PERSONAL USE; COSMETICS; AND NON-MEDICATED HAIR LOTIONS (U.S. CLS. 1, 4, 6, 50, 51 AND 52).

GLENN CLARK, EXAMINING ATTORNEY

**CLASS 3—(Continued).**

SN 78-307,869. INDUSTRIAS ALEN, S.A. DE C.V., SANTA CATARINA, N.L. C.P. 66350, MEXICO, FILED 10-1-2003.

**TECH-NATURAL CLEANER**

NO CLAIM IS MADE TO THE EXCLUSIVE RIGHT TO USE "CLEANER", APART FROM THE MARK AS SHOWN. FOR ALL PURPOSE CLEANERS (U.S. CLS. 1, 4, 6, 50, 51 AND 52).  
MITCHELL FRONT, EXAMINING ATTORNEY

**CLASS 3—(Continued).**

SN 78-330,056. KISS MY FACE CORPORATION, GARDNER, NY. FILED 11-19-2003.

**FACE FACTOR**

SN 78-311,548. JACKSON, JANNA S., OJAI, CA. FILED 10-9-2003.

**TRANCE**

FOR ESSENTIAL OILS FOR PERSONAL USE; COSMETICS; SKIN CARE PRODUCTS, NAMELY, SKIN LOTIONS, CREAMS, BALMS AND CLEANSERS; HAIR CARE PRODUCTS, NAMELY, SHAMPOOS AND CONDITIONERS (U.S. CLS. 1, 4, 6, 50, 51 AND 52).  
LANA PHAM, EXAMINING ATTORNEY

THE MARK CONSISTS OF STANDARD CHARACTERS WITHOUT CLAIM TO ANY PARTICULAR FONT, STYLE, SIZE, OR COLOR.

NO CLAIM IS MADE TO THE EXCLUSIVE RIGHT TO USE "FACE", APART FROM THE MARK AS SHOWN. FOR FACIAL CREAM (U.S. CLS. 1, 4, 6, 50, 51 AND 52).  
ANNE MADDEN, EXAMINING ATTORNEY

SN 78-316,297. BURGESS ENT, LLC, CONCORD, NC. FILED 10-21-2003.

**QUIKLEEN**

FOR ABSORBENT FLOOR SWEEPING COMPOUND (U.S. CLS. 1, 4, 6, 50, 51 AND 52).  
LESLEY LAMOTHE, EXAMINING ATTORNEY

SN 78-336,920. MADAV, INC., INDIANAPOLIS, IN. FILED 12-5-2003.

**SPA:HE [THE MANDATORY ESSENTIALS FOR HIM]**

SN 78-320,740. RIVENBURG, ADAM F., STAMFORD, CT. FILED 10-30-2003.

**ENCHANTED SOAP**

NO CLAIM IS MADE TO THE EXCLUSIVE RIGHT TO USE SOAP, APART FROM THE MARK AS SHOWN. FOR BATH SOAP (U.S. CLS. 1, 4, 6, 50, 51 AND 52).  
DOMINIC J. FERRAIUOLO, EXAMINING ATTORNEY

THE MARK CONSISTS OF STANDARD CHARACTERS WITHOUT CLAIM TO ANY PARTICULAR FONT, STYLE, SIZE, OR COLOR.

NO CLAIM IS MADE TO THE EXCLUSIVE RIGHT TO USE "FOR HIM", APART FROM THE MARK AS SHOWN.

FOR SKIN CARE AND COSMETIC PRODUCTS FOR MEN, NAMELY, FACIAL WASH, BODY WASH, SPLASH, TONER, MOISTURIZER, EXFOLIATOR, EYE CREAM, SERUM, FACIAL FINISHING PRODUCTS, NAMELY MAKEUP, CONCEALER; SUN SCREEN; BATH/SHOWER GEL (U.S. CLS. 1, 4, 6, 50, 51 AND 52).  
ANN E. SAPPENFIELD, EXAMINING ATTORNEY

**CLASS 3—(Continued).**

SN 78-360,092. RENATURE SKIN CARE INC., NEW YORK, NY. FILED 1-30-2004.

**HYPER-VITALIZER**

THE MARK CONSISTS OF STANDARD CHARACTERS WITHOUT CLAIM TO ANY PARTICULAR FONT, STYLE, SIZE, OR COLOR.

FOR SKIN CARE PRODUCTS, NAMELY, CLEANSING LOTIONS, MASKS AND PEELS; FACE SHAMPOO, SKIN SCRUBS, SKIN TONERS, MASKS AND PEELS; ANTI WRINKLE CREAMS, ANTI-AGING CREAMS, MOISTURE CREAMS, LOTIONS FOR DAY AND NIGHT, SKIN WHITENING CREAM, EYE CREAM, EYE GEL, TONING LOTIONS, MASKS AND PEELS; NON-MEDICATED SKIN SERUM, SKIN EMULSIONS; COSMETICS; HAIR CARE PRODUCTS NAMELY; SHAMPOO, CONDITIONER; STYLING GEL, MOUSSE, AND CREAM; HAIR MOISTURIZER; HOT OIL TREATMENT; POMADE (U.S. CLS. 1, 4, 6, 50, 51 AND 52).

FIRST USE 6-1-2001; IN COMMERCE 6-1-2001.  
HELEN BRYAN, EXAMINING ATTORNEY

SN 78-364,727. INFINITY INTERNATIONAL HEALTH & BEAUTY, INC., ANAHEIM, CA. FILED 2-9-2004.

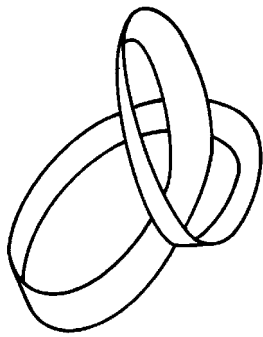

FOR SKIN CARE PRODUCTS, NAMELY CLARIFYING CLEANSER, PURIFYING TONER, HYDRATING SKIN LIGHTENER, SKIN LIGHTENER LOTION, ACTIVATING ENHANCER, SKIN MOISTURIZER, SUNSCREEN, REFINING RETINOL FACIAL TREATMENT CREAM, SOOTHING HYDROCORTISONE, REJUVENATING COLLAGEN FACIAL CREAM, LIP AND EYE CONCENTRATE WITH RETINOL AND SKIN LIGHTENER GEL (U.S. CLS. 1, 4, 6, 50, 51 AND 52).

FIRST USE 5-14-2002; IN COMMERCE 5-14-2002.  
MARIA-VICTORIA SUAREZ, EXAMINING ATTORNEY

**CLASS 3—(Continued).**

SN 78-367,502. AVON PRODUCTS, INC., NEW YORK, NY. FILED 2-13-2004.

**FRUITY LIP JUICE**

THE MARK CONSISTS OF STANDARD CHARACTERS WITHOUT CLAIM TO ANY PARTICULAR FONT, STYLE, SIZE, OR COLOR.

NO CLAIM IS MADE TO THE EXCLUSIVE RIGHT TO USE "FRUITY LIP", APART FROM THE MARK AS SHOWN, FOR COSMETICS, NAMELY, LIP GLOSS (U.S. CLS. 1, 4, 6, 50, 51 AND 52).

FIRST USE 2-14-2002; IN COMMERCE 2-14-2002.  
MICHAEL HALL, EXAMINING ATTORNEY

SN 78-373,584. AMERIPLUS, INC., OLDSMAR, FL. FILED 2-25-2004.

**TILE PLUS OXI-PRO**

THE MARK CONSISTS OF STANDARD CHARACTERS WITHOUT CLAIM TO ANY PARTICULAR FONT, STYLE, SIZE, OR COLOR.

NO CLAIM IS MADE TO THE EXCLUSIVE RIGHT TO USE TILE, APART FROM THE MARK AS SHOWN.

FOR MULTI-SURFACE ALL-PURPOSE CLEANER (U.S. CLS. 1, 4, 6, 50, 51 AND 52).

NANCY CLARKE, EXAMINING ATTORNEY

SN 78-377,397. BODY LANGUAGE, DALLAS, TX. FILED 3-2-2004.

**BODY LANGUAGE**

THE MARK CONSISTS OF STANDARD CHARACTERS WITHOUT CLAIM TO ANY PARTICULAR FONT, STYLE, SIZE, OR COLOR.

FOR COSMETICS, BODY CLEANSERS, BODY MOISTURIZERS (U.S. CLS. 1, 4, 6, 50, 51 AND 52).

TRACY FLETCHER, EXAMINING ATTORNEY

**CLASS 3—(Continued).**

SN 78-379,597. ESSIE COSMETICS, LTD., ASTORIA, NY.  
FILED 3-5-2004.

**ESSIE SMOOTHIES**

THE MARK CONSISTS OF STANDARD CHARACTERS  
WITHOUT CLAIM TO ANY PARTICULAR FONT, STYLE,  
SIZE, OR COLOR.

OWNER OF U.S. REG. NOS. 1,712,921, 2,710,584 AND  
OTHERS.

FOR MOISTURIZING PERSONAL SKIN CARE PRO-  
DUCTS, NAMELY, HYDRATING CREMES AND LO-  
TIONS FOR THE HANDS AND BODY (U.S. CLS. 1, 4, 6,  
50, 51 AND 52).

STEVEN BERK, EXAMINING ATTORNEY

---

SN 78-386,908. CELLEX-C INTERNATIONAL INC., TORON-  
TO, ONTARIO, CANADA, FILED 3-18-2004.



OWNER OF U.S. REG. NO. 2,092,395.  
FOR NON-MEDICATED SKIN CARE PREPARATIONS  
FOR TOPICAL APPLICATION TO THE SKIN (U.S. CLS.  
1, 4, 6, 50, 51 AND 52).

FIRST USE 0-0-1996; IN COMMERCE 0-0-1996.  
VERNA BETH RIRIE, EXAMINING ATTORNEY

---

SN 78-392,765. AMERICAN INTERNATIONAL INDUS-  
TRIES, LOS ANGELES, CA. FILED 3-29-2004.

**FIRMOXYL-BC**

THE MARK CONSISTS OF STANDARD CHARACTERS  
WITHOUT CLAIM TO ANY PARTICULAR FONT, STYLE,  
SIZE, OR COLOR.

FOR SKIN CARE PREPARATIONS, NAMELY, NON-  
MEDICATED SKIN SERUM (U.S. CLS. 1, 4, 6, 50, 51 AND  
52).

SCOTT OSLICK, EXAMINING ATTORNEY

**CLASS 3—(Continued).**

SN 78-393,980. ZOTOS INTERNATIONAL, INC., DARIEN,  
CT. FILED 3-31-2004.

**AMPLIFUSION**

THE MARK CONSISTS OF STANDARD CHARACTERS  
WITHOUT CLAIM TO ANY PARTICULAR FONT, STYLE,  
SIZE, OR COLOR.

FOR HAIR CARE PRODUCTS NAMELY, SHAMPOOS,  
CONDITIONERS, AND STYLING PREPARATIONS (U.S.  
CLS. 1, 4, 6, 50, 51 AND 52).

AMOS T. MATTHEWS, JR., EXAMINING ATTORNEY

---

SN 78-394,071. BLUE Q CORPORATION, PITTSFIELD, MA.  
FILED 3-31-2004.

**HOT & FLASHY  
BECAUSE YOU'RE NOT  
CRAZY YOU'RE JUST  
HOT**

THE MARK CONSISTS OF STANDARD CHARACTERS  
WITHOUT CLAIM TO ANY PARTICULAR FONT, STYLE,  
SIZE, OR COLOR.

FOR BATH AND BODY PRODUCTS, NAMELY, SOAP,  
BATH SALTS, BODY LOTION, BODY POWDER, BODY  
WASH, PRE MOISTENED COSMETIC TOWELETTES  
AND NON-MEDICATED LIP BALM (U.S. CLS. 1, 4, 6,  
50, 51 AND 52).

LA TONIA FISHER, EXAMINING ATTORNEY



**CLASS 3—(Continued).**

SN 78-394,748. T. TAPP, INC., SAFETY HARBOR, FL. FILED 4-1-2004.

**CLASS 3—(Continued).**

SN 78-398,335. PALEY, KENNETH S., CINCINNATI, OH. FILED 4-7-2004.

**BLOW YOUR BUNS**

THE MARK CONSISTS OF STANDARD CHARACTERS WITHOUT CLAIM TO ANY PARTICULAR FONT, STYLE, SIZE, OR COLOR.  
FOR HEAT ACTIVATED ESSENTIAL OIL FOR CELLULITE (U.S. CLS. 1, 4, 6, 50, 51 AND 52).  
MICHAEL KEATING, EXAMINING ATTORNEY

**IVY STOP**

THE MARK CONSISTS OF STANDARD CHARACTERS WITHOUT CLAIM TO ANY PARTICULAR FONT, STYLE, SIZE, OR COLOR.  
FOR NON-MEDICATED SKIN AND HAND LOTION AND CREAM FOR GARDENERS AND PEOPLE OUTDOORS; NON-MEDICATED SKIN AND HAND BARRIER LOTION AND CREAM (U.S. CLS. 1, 4, 6, 50, 51 AND 52).  
CHARLES L. JENKINS, EXAMINING ATTORNEY

SN 78-395,811. BNG ENTERPRISES, INC., TEMPE, AZ. FILED 4-2-2004.

SN 78-399,449. ADVANCED TECHNOLOGY SYSTEMS, INC., INDIANAPOLIS, IN. FILED 4-9-2004.

**FACEPHORIA**

THE MARK CONSISTS OF STANDARD CHARACTERS WITHOUT CLAIM TO ANY PARTICULAR FONT, STYLE, SIZE, OR COLOR.  
FOR COSMETICS (U.S. CLS. 1, 4, 6, 50, 51 AND 52).  
MELVIN AXILBUND, EXAMINING ATTORNEY

**SWEDISH BEAUTY  
ELEGANCE**

THE MARK CONSISTS OF STANDARD CHARACTERS WITHOUT CLAIM TO ANY PARTICULAR FONT, STYLE, SIZE, OR COLOR.  
OWNER OF U.S. REG. NO. 1,928,801.  
FOR INDOOR AND OUTDOOR TANNING PREPARATIONS (U.S. CLS. 1, 4, 6, 50, 51 AND 52).  
BARNEY CHARLON, EXAMINING ATTORNEY

**CLASS 3—(Continued).**

SN 78-400,167. PERFORMANCE BRANDS, INC., SUNRISE, FL. FILED 4-12-2004.

## GLOW GIRL

THE MARK CONSISTS OF STANDARD CHARACTERS WITHOUT CLAIM TO ANY PARTICULAR FONT, STYLE, SIZE, OR COLOR.

NO CLAIM IS MADE TO THE EXCLUSIVE RIGHT TO USE "GIRL", APART FROM THE MARK AS SHOWN.

FOR INDOOR AND OUTDOOR TANNING PREPARATIONS (U.S. CLS. 1, 4, 6, 50, 51 AND 52).  
INGA ERVIN, EXAMINING ATTORNEY

**CLASS 3—(Continued).**

SN 78-410,536. PROCYTE CORPORATION, REDMOND, WA. FILED 4-29-2004.

## TRICOMIN

THE MARK CONSISTS OF STANDARD CHARACTERS WITHOUT CLAIM TO ANY PARTICULAR FONT, STYLE, SIZE, OR COLOR.

OWNER OF U.S. REG. NO. 1,959,138.

FOR HAIR AND SCALP CARE PRODUCTS FOR PERSONAL AND PROFESSIONAL USE, NAMELY, HAIR SHAMPOO, HAIR CONDITIONER, HAIR CONDITIONING SPRAY, AND STYLING PRODUCTS (U.S. CLS. 1, 4, 6, 50, 51 AND 52).

FIRST USE 4-3-1995; IN COMMERCE 4-3-1995.

WON TEAK OH, EXAMINING ATTORNEY

SN 78-411,219. GRIMES, DAVID E., SAINT AUGUSTINE, FL. FILED 4-30-2004.

SN 78-403,053. DIAL BRANDS, INC., SCOTTSDALE, AZ. FILED 4-16-2004.

## BORAX BASICS

THE MARK CONSISTS OF STANDARD CHARACTERS WITHOUT CLAIM TO ANY PARTICULAR FONT, STYLE, SIZE, OR COLOR.

NO CLAIM IS MADE TO THE EXCLUSIVE RIGHT TO USE "BORAX", APART FROM THE MARK AS SHOWN.

FOR ALL PURPOSE HOUSEHOLD CLEANERS; LAUNDRY DETERGENTS, FABRIC SOFTENERS, LAUNDRY DETERGENT BOOSTER (U.S. CLS. 1, 4, 6, 50, 51 AND 52).  
CURTIS FRENCH, EXAMINING ATTORNEY

## Non Culotte

THE MARK CONSISTS OF STANDARD CHARACTERS WITHOUT CLAIM TO ANY PARTICULAR FONT, STYLE, SIZE, OR COLOR.

THE ENGLISH TRANSLATION OF "NON CULOTTE" IS "NO BREECHES" OR "NO PANTIES".

FOR PERFUMES, COLOGNES, TOILET WATER, HAND AND BODY LOTION; BABY, TALCUM, FACE AND BODY POWDER; LIPSTICK, EYESHADOW, LIP BALM, SHAMPOO AND CONDITIONER (U.S. CLS. 1, 4, 6, 50, 51 AND 52).

BARBARA BROWN, EXAMINING ATTORNEY

**CLASS 3—(Continued).**

SN 78-415,165. SPARTACUS, LLC, DALLAS, TX. FILED 5-7-2004.

**CLASS 3—(Continued).**

SN 78-415,344. DISNEY ENTERPRISES, INC., BURBANK, CA. FILED 5-7-2004.

**CLORLAVA**

**KYLION**

THE MARK CONSISTS OF STANDARD CHARACTERS WITHOUT CLAIM TO ANY PARTICULAR FONT, STYLE, SIZE, OR COLOR.  
FOR LAUNDRY PRODUCTS, NAMELY, BLEACH AND DETERGENT (U.S. CLS. 1, 4, 6, 50, 51 AND 52).  
KHANH LE, EXAMINING ATTORNEY

THE MARK CONSISTS OF STANDARD CHARACTERS WITHOUT CLAIM TO ANY PARTICULAR FONT, STYLE, SIZE, OR COLOR.  
FOR TOILETRIES, COSMETICS, DENTIFRICES (U.S. CLS. 1, 4, 6, 50, 51 AND 52).  
MELVIN AXILBUND, EXAMINING ATTORNEY

SN 78-415,679. VIACOM INTERNATIONAL INC., NEW YORK, NY. FILED 5-10-2004.

SN 78-415,228. CABOODLES, LLC, MEMPHIS, TN. FILED 5-7-2004.

**REAL DEAL**

**NATURALLY NAPA**

THE MARK CONSISTS OF STANDARD CHARACTERS WITHOUT CLAIM TO ANY PARTICULAR FONT, STYLE, SIZE, OR COLOR.  
FOR COSMETICS (U.S. CLS. 1, 4, 6, 50, 51 AND 52).  
KARLA PERKINS, EXAMINING ATTORNEY

THE MARK CONSISTS OF STANDARD CHARACTERS WITHOUT CLAIM TO ANY PARTICULAR FONT, STYLE, SIZE, OR COLOR.  
FOR HEALTH AND BEAUTY AIDS, NAMELY, HAIR SHAMPOOS, HAIR GEL, HAIR CONDITIONERS, BUBBLE BATH, SKIN SOAPS, LIQUID SKIN SOAP, COSMETICS, NAMELY, PERFUME AND COLOGNE; TOOTHPASTE, BODY WASH, FRAGRANCES FOR PERSONAL USE; BATH OIL, BODY OIL, MASSAGE OIL, BATH SALTS, BODY LOTION, SKIN LOTION, INCENSE, BODY CREAM, BODY POWDER, SKIN CLEANING CREAM, FACIAL SCRUBS, BATH GEL; MAKEUP, PERSONAL DEODORANTS (U.S. CLS. 1, 4, 6, 50, 51 AND 52).  
PAUL F. GAST, EXAMINING ATTORNEY

**CLASS 3—(Continued).**

SN 78-416,190. DAVEWORLD INC., FAIRFAX, CA. FILED 5-10-2004.

**ORGANIC BRIDE**

THE MARK CONSISTS OF STANDARD CHARACTERS WITHOUT CLAIM TO ANY PARTICULAR FONT, STYLE, SIZE, OR COLOR.

NO CLAIM IS MADE TO THE EXCLUSIVE RIGHT TO USE "ORGANIC", APART FROM THE MARK AS SHOWN. FOR SCENTED BODY SPRAY; MASSAGE OIL; NON-MEDICATED BATH SALTS (U.S. CLS. 1, 4, 6, 50, 51 AND 52).

FIRST USE 5-1-2004; IN COMMERCE 5-1-2004.  
KELLY CHOE, EXAMINING ATTORNEY

**CLASS 3—(Continued).**

SN 78-416,905. ELIZABETH ARDEN, INC., MIAMI LAKES, FL. FILED 5-11-2004.



ONYX

FOR COLOGNE (U.S. CLS. 1, 4, 6, 50, 51 AND 52).  
DEZMONA MIZELLE, EXAMINING ATTORNEY

SN 78-417,034. GEMSMETICS, INC., OLD TAPPAN, NJ.  
FILED 5-11-2004.

**GEMSMETICS**

THE MARK CONSISTS OF STANDARD CHARACTERS WITHOUT CLAIM TO ANY PARTICULAR FONT, STYLE, SIZE, OR COLOR.

FOR COSMETICS (U.S. CLS. 1, 4, 6, 50, 51 AND 52).  
FIRST USE 6-1-2004; IN COMMERCE 6-1-2004.  
HOWARD SMIGA, EXAMINING ATTORNEY

SN 78-416,832. NU SKIN INTERNATIONAL, INC., PROVO, UT. FILED 5-11-2004.

**TRI-PHASIC WHITE**

THE MARK CONSISTS OF STANDARD CHARACTERS WITHOUT CLAIM TO ANY PARTICULAR FONT, STYLE, SIZE, OR COLOR.

NO CLAIM IS MADE TO THE EXCLUSIVE RIGHT TO USE WHITE, APART FROM THE MARK AS SHOWN.

FOR SKIN CLEANSER, SKIN TONER, SKIN LOTION, SKIN CREAM, NON-MEDICATED SKIN SERUM, FACIAL WIPES, FACIAL MOISTURIZER (U.S. CLS. 1, 4, 6, 50, 51 AND 52).

TARAH HARDY, EXAMINING ATTORNEY

SN 78-417,364. AVON PRODUCTS, INC., NEW YORK, NY.  
FILED 5-12-2004.

**BEACH BEAUTY**

THE MARK CONSISTS OF STANDARD CHARACTERS WITHOUT CLAIM TO ANY PARTICULAR FONT, STYLE, SIZE, OR COLOR.

FOR HAIR CARE PREPARATIONS (U.S. CLS. 1, 4, 6, 50, 51 AND 52).

GIANCARLO CASTRO, EXAMINING ATTORNEY

**CLASS 3—(Continued).**

SN 78-418,384. ELIZABETH ARDEN, INC., MIAMI LAKES, FL. FILED 5-13-2004.

**CLASS 3—(Continued).**

SN 78-419,087. MELALEUCA, INC., IDAHO FALLS, ID. FILED 5-14-2004.

# CURIOUS

# HARVEST PURE

THE MARK CONSISTS OF STANDARD CHARACTERS WITHOUT CLAIM TO ANY PARTICULAR FONT, STYLE, SIZE, OR COLOR.

FOR FRAGRANCE PRODUCTS FOR PERSONAL USE, NAMELY, PERFUME, EAU DE PARFUM, EAU DE TOILETTE, SCENTED BODY LOTIONS; BATH GELS, FACE POWDER, FACE GLITTER, SKIN MOISTURIZERS, LIPSTICK, LIP GLOSS, EYE SHADOW, SKIN HIGHLIGHTER, SKIN CLEANSER, TONER, AND EXFOLIATOR FOR THE SKIN (U.S. CLS. 1, 4, 6, 50, 51 AND 52).

CAROL SPILS, EXAMINING ATTORNEY

THE MARK CONSISTS OF STANDARD CHARACTERS WITHOUT CLAIM TO ANY PARTICULAR FONT, STYLE, SIZE, OR COLOR.

FOR CLEANING AND WASHING PREPARATIONS FOR FRESH PRODUCE (U.S. CLS. 1, 4, 6, 50, 51 AND 52).  
STANLEY I. OSBORNE, EXAMINING ATTORNEY

SN 78-419,718. THE PROCTER & GAMBLE COMPANY, CINCINNATI, OH. FILED 5-17-2004.

SN 78-419,012. INTERJEN LLC, MEMPHIS, TN. FILED 5-14-2004.

# PRO SOLUTIONS

# BABY FRESH

THE MARK CONSISTS OF STANDARD CHARACTERS WITHOUT CLAIM TO ANY PARTICULAR FONT, STYLE, SIZE, OR COLOR.

FOR HAIR SHAMPOOS; HAIR CONDITIONERS; HAIR SPRAYS; HAIR SETTING LOTIONS AND GELS; HAIR COLORING PREPARATIONS (U.S. CLS. 1, 4, 6, 50, 51 AND 52).

BARBARA BROWN, EXAMINING ATTORNEY

THE MARK CONSISTS OF STANDARD CHARACTERS WITHOUT CLAIM TO ANY PARTICULAR FONT, STYLE, SIZE, OR COLOR.

OWNER OF U.S. REG. NO. 985,162.  
NO CLAIM IS MADE TO THE EXCLUSIVE RIGHT TO USE "BABY", APART FROM THE MARK AS SHOWN.

FOR BABY LOTION IMPREGNATED CLEANSING CLOTHS FOR USE ON INFANTS (U.S. CLS. 1, 4, 6, 50, 51 AND 52).

LAURA KOVAISKY, EXAMINING ATTORNEY

**CLASS 3—(Continued).**

SN 78-420,141. BIOLAB SERVICES, INC., WILMINGTON, DE.  
FILED 5-17-2004.

**HYDROTECH**

THE MARK CONSISTS OF STANDARD CHARACTERS WITHOUT CLAIM TO ANY PARTICULAR FONT, STYLE, SIZE, OR COLOR.

OWNER OF U.S. REG. NO. 1,277,608.  
FOR METAL STAIN REMOVING PREPARATION FOR POOLS AND SPAS; FILTER CLEANER PREPARATION FOR POOLS AND SPAS AND SCALE REMOVER PREPARATION FOR POOLS AND SPAS; TILE AND VINYL CLEANER PREPARATION FOR POOLS AND SPAS (U.S. CLS. 1, 4, 6, 50, 51 AND 52).

FIRST USE 9-15-1981; IN COMMERCE 9-15-1981.  
ELLEN B. AWRICH, EXAMINING ATTORNEY

**CLASS 3—(Continued).**

SN 78-420,641. BIOLAB SERVICES, INC., WILMINGTON, DE.  
FILED 5-18-2004.

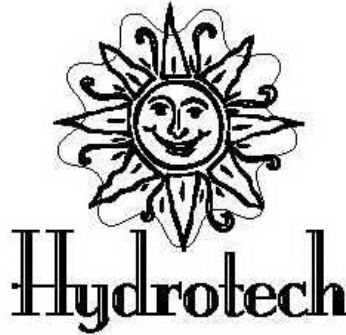

OWNER OF U.S. REG. NO. 1,277,608.  
FOR METAL STAIN REMOVING PREPARATION FOR POOLS AND SPAS; FILTER CLEANER PREPARATION FOR POOLS AND SPAS AND SCALE REMOVER PREPARATION FOR POOLS AND SPAS; TILE AND VINYL CLEANER PREPARATION FOR POOLS AND SPAS (U.S. CLS. 1, 4, 6, 50, 51 AND 52).

FIRST USE 3-0-2000; IN COMMERCE 3-0-2000.  
ELLEN B. AWRICH, EXAMINING ATTORNEY

SN 78-421,358. BULLIE PRODUCTS LLC, HOUSTON, TX.  
FILED 5-19-2004.

**praetorian**

SN 78-420,187. INTERJEN LLC, MEMPHIS, TN. FILED 5-17-2004.

**THE BEAUTY OF  
SCIENCE**

THE MARK CONSISTS OF STANDARD CHARACTERS WITHOUT CLAIM TO ANY PARTICULAR FONT, STYLE, SIZE, OR COLOR.

FOR HAIR SHAMPOOS; HAIR CONDITIONERS; HAIR SPRAYS; HAIR SETTING LOTIONS AND GELS; HAIR COLORING PREPARATIONS (U.S. CLS. 1, 4, 6, 50, 51 AND 52).

LESLEY LAMOTHE, EXAMINING ATTORNEY

THE MARK CONSISTS OF STANDARD CHARACTERS WITHOUT CLAIM TO ANY PARTICULAR FONT, STYLE, SIZE, OR COLOR.

FOR COSMETICS, LIP BALM, LIP GLOSS, NON-MEDICATED LIP CARE PREPARATIONS, NON-MEDICATED LIP PROTECTOR, EYE CREAM, EYE GELS (U.S. CLS. 1, 4, 6, 50, 51 AND 52).

CAROLYN GRAY, EXAMINING ATTORNEY

**CLASS 3—(Continued).**

SN 78-421,721. BEAUTYBANK INC., NEW YORK, NY. FILED 5-19-2004.

**BERRY, BERRY GOOD**

THE MARK CONSISTS OF STANDARD CHARACTERS WITHOUT CLAIM TO ANY PARTICULAR FONT, STYLE, SIZE, OR COLOR.

FOR COSMETICS; FRAGRANCES FOR PERSONAL USE; NON-MEDICATED SKINCARE PREPARATIONS; HAIRCARE PREPARATIONS; TOILETRIES, NAMELY BATH AND BODY SOAPS, CLEANSERS, GELS, LOTIONS, CREAMS AND SPRAYS; SUN CARE PREPARATIONS (U.S. CLS. 1, 4, 6, 50, 51 AND 52).

CHERYL CLAYTON, EXAMINING ATTORNEY

SN 79-000,651. LIDL STIFTUNG & CO. KG, FED REP GERMANY, FILED 12-18-2003.

**éruption**

OWNER OF INTERNATIONAL REGISTRATION 0654024 DATED 3-2-1996, EXPIRES 3-2-2006.

FOR PERFUMES, COSMETICS (U.S. CLS. 1, 4, 6, 50, 51 AND 52).

JIM RINGLE, EXAMINING ATTORNEY

**CLASS 4—LUBRICANTS AND FUELS**

SN 76-503,285. HANGSTERFER'S LABORATORIES, INC., MANTUA, NJ. FILED 3-31-2003.

**VEGGIE CUT**

NO CLAIM IS MADE TO THE EXCLUSIVE RIGHT TO USE "VEGGIE", APART FROM THE MARK AS SHOWN.

FOR METALWORKING COMPOUNDS AND FLUIDS, NAMELY, CUTTING OIL, LUBRICANTS, HONING OILS, COOLANTS, DRAWING COMPOUNDS, AND GRINDING COMPOUNDS (U.S. CLS. 1, 6 AND 15).

LINDA E. BLOHM, EXAMINING ATTORNEY

**CLASS 4—(Continued).**

SN 76-503,286. HANGSTERFER'S LABORATORIES, INC., MANTUA, NJ. FILED 3-31-2003.

**VEGGIE COOL**

NO CLAIM IS MADE TO THE EXCLUSIVE RIGHT TO USE "VEGGIE", APART FROM THE MARK AS SHOWN.

FOR METALWORKING COMPOUNDS AND FLUIDS, NAMELY, CUTTING OIL, LUBRICANTS, HONING OILS, COOLANTS, DRAWING COMPOUNDS, AND GRINDING COMPOUNDS (U.S. CLS. 1, 6 AND 15).

LINDA E. BLOHM, EXAMINING ATTORNEY

SN 76-503,287. HANGSTERFER'S LABORATORIES, INC., MANTUA, NJ. FILED 3-31-2003.

**VEGGIE LUBE**

NO CLAIM IS MADE TO THE EXCLUSIVE RIGHT TO USE "VEGGIE", APART FROM THE MARK AS SHOWN.

FOR METALWORKING COMPOUNDS AND FLUIDS, NAMELY, CUTTING OIL, LUBRICANTS, HONING OILS, COOLANTS, DRAWING COMPOUNDS, AND GRINDING COMPOUNDS (U.S. CLS. 1, 6 AND 15).

LINDA E. BLOHM, EXAMINING ATTORNEY

SN 76-588,983. ULTRACHEM, INC., NEW CASTLE, DE. FILED 4-26-2004.

**OMNILUBE**

OWNER OF U.S. REG. NO. 1,193,489.

FOR LUBRICATING OILS AND GREASES WHICH ARE PLASTIC COMPATIBLE - NAMELY, OILS AND GREASES (U.S. CLS. 1, 6 AND 15).

FIRST USE 4-8-1980; IN COMMERCE 4-8-1980.

WON TEAK OH, EXAMINING ATTORNEY

SN 78-255,074. DIAL BRANDS, INC., SCOTTSDALE, AZ. FILED 5-28-2003.

**CREAMY VANILLA**

NO CLAIM IS MADE TO THE EXCLUSIVE RIGHT TO USE "VANILLA", APART FROM THE MARK AS SHOWN.

FOR CANDLES (U.S. CLS. 1, 6 AND 15).

LINDA MICKLEBURGH, EXAMINING ATTORNEY

**CLASS 4—(Continued).**

SN 78-313,068. PANIKOWSKI, LINDA M., SOUTHTON, CT. FILED 10-14-2003.

*Soy to the World Candle Company*

NO CLAIM IS MADE TO THE EXCLUSIVE RIGHT TO USE CANDLE COMPANY, APART FROM THE MARK AS SHOWN.

FOR CANDLES MADE OF NATURAL SOY WAX AND NATURAL WICKING MATERIALS MADE OF COTTON AND PAPER, IN VARIOUS FRAGRANCES AND COLORS, AND IN VARIOUS SIZES, INCLUDING 16 OZ., 12 OZ., 3.5 OZ., VOTIVES, AND TARTS (U.S. CLS. 1, 6 AND 15).

FIRST USE 9-1-2003; IN COMMERCE 10-10-2003.  
GLENN CLARK, EXAMINING ATTORNEY

SN 78-331,696. SUN DRILLING PRODUCTS CORPORATION, BELLE CHASSE, LA. FILED 11-21-2003.

**EZE-SLIDE OS**

THE MARK CONSISTS OF STANDARD CHARACTERS WITHOUT CLAIM TO ANY PARTICULAR FONT, STYLE, SIZE, OR COLOR.

FOR OILFIELD DRILLING DOWNHOLE LUBRICANT (U.S. CLS. 1, 6 AND 15).

FIRST USE 7-17-2000; IN COMMERCE 7-17-2000.  
JENNIFER MARTIN, EXAMINING ATTORNEY

**CLASS 4—(Continued).**

SN 78-331,698. SUN DRILLING PRODUCTS CORPORATION, BELLE CHASSE, LA. FILED 11-21-2003.

**EZE-SLIDE XLT**

THE MARK CONSISTS OF STANDARD CHARACTERS WITHOUT CLAIM TO ANY PARTICULAR FONT, STYLE, SIZE, OR COLOR.

FOR OILFIELD DRILLING DOWNHOLE LUBRICANT (U.S. CLS. 1, 6 AND 15).

FIRST USE 7-19-2000; IN COMMERCE 7-19-2000.  
JENNIFER MARTIN, EXAMINING ATTORNEY

SN 78-331,704. SUN DRILLING PRODUCTS CORPORATION, BELLE CHASSE, LA. FILED 11-21-2003.

**EZE-SLIDE D**

THE MARK CONSISTS OF STANDARD CHARACTERS WITHOUT CLAIM TO ANY PARTICULAR FONT, STYLE, SIZE, OR COLOR.

FOR OILFIELD DRILLING DOWNHOLE LUBRICANT (U.S. CLS. 1, 6 AND 15).

FIRST USE 1-31-2001; IN COMMERCE 1-31-2001.  
JENNIFER MARTIN, EXAMINING ATTORNEY



**CLASS 4—(Continued).**

SN 78-413,638. DOALL COMPANY, DES PLAINES, IL. FILED 5-5-2004.

**CLASS 4—(Continued).**

SN 78-419,489. MCLELLAN PRODUCTS & SERVICES, INC., DBA THE CANDLEMEISTER, JUPITER, FL. FILED 5-15-2004.

# KLEEN-KOOL

# THE CANDLEMEISTER

THE MARK CONSISTS OF STANDARD CHARACTERS WITHOUT CLAIM TO ANY PARTICULAR FONT, STYLE, SIZE, OR COLOR.

FOR MULTI-PURPOSE LIQUID FOR USE AS A LUBRICANT AND COOLANT USED IN GRINDING (U.S. CLS. 1, 6 AND 15).

FIRST USE 11-1-1954; IN COMMERCE 1-14-1955.  
ANDREW BENZMILLER, EXAMINING ATTORNEY

THE MARK CONSISTS OF STANDARD CHARACTERS WITHOUT CLAIM TO ANY PARTICULAR FONT, STYLE, SIZE, OR COLOR.

THE FOREIGN WORDING IN THE MARK TRANSLATES INTO ENGLISH AS "MASTER".

FOR CANDLES (U.S. CLS. 1, 6 AND 15).  
FIRST USE 1-27-1997; IN COMMERCE 1-27-1997.  
DORITT L. CARROLL, EXAMINING ATTORNEY

---

SN 78-418,858. AMREP, INC., MARIETTA, GA. FILED 5-14-2004.

**CLASS 5—PHARMACEUTICALS**

SN 76-029,450. MUSCLETECH RESEARCH AND DEVELOPMENT INC., MISSISSAUGA, ONTARIO, CANADA, FILED 4-19-2000.

# SUPERFILM

# INSULOGEN

THE MARK CONSISTS OF STANDARD CHARACTERS WITHOUT CLAIM TO ANY PARTICULAR FONT, STYLE, SIZE, OR COLOR.

FOR AUTOMOTIVE AND MACHINE GREASES AND LUBRICANTS, NAMELY, GEAR AND WHEEL GREASES, CHAIN AND CABLE LUBRICANTS, COMPRESSOR OILS, GEAR LUBRICANTS, HYDRAULIC OILS, TRANSMISSION OILS, MOTOR OILS, OIL SUPPLEMENTS, SILICON LUBRICANTS (U.S. CLS. 1, 6 AND 15).

FIRST USE 1-1-1987; IN COMMERCE 1-1-1987.  
MICHAEL ENGEL, EXAMINING ATTORNEY

PRIORITY CLAIMED UNDER SEC. 44(D) ON CANADA APPLICATION NO. 1032914, FILED 10-19-1999.

FOR NUTRITIONAL SUPPLEMENT INGREDIENT SOLD AS COMPONENT OF FOOD AND SPORT SUPPLEMENTS FOR STRENGTH AND PERFORMANCE ENHANCEMENT (U.S. CLS. 6, 18, 44, 46, 51 AND 52).

FIRST USE 10-1-1999; IN COMMERCE 3-1-2000.  
JOHN E. MICHOS, EXAMINING ATTORNEY

**CLASS 5—(Continued).**

SN 76-348,699. SUN TEN LABORATORIES, INC., IRVINE, CA. FILED 12-17-2001.



APPLICANT SEEKS REGISTRATION OF THE MARK THROUGHOUT THE UNITED STATES FOR THE GOODS IDENTIFIED IN THE APPLICATION.

THE ENGLISH TRANSLATION FOR THE WORD SUN-TEN IN THE MARK IS "FOLLOW THE DEVINE." THE ENGLISH TRANSLATION FOR THE WORD CH'I IS "LIFE FORCE."

THE CHINESE CHARACTER IN THE IN THE MARK TRANSLITERATES TO "LIFE FORCE," WHICH MEANS "LIFE FORCE" IN ENGLISH.

FOR DIETARY SUPPLEMENTS (U.S. CLS. 6, 18, 44, 46, 51 AND 52).

FIRST USE 8-1-2001; IN COMMERCE 8-1-2001.

JULIA HARDY COFIELD, EXAMINING ATTORNEY

SN 76-494,135. LASAL LABORATORIES, LLC, PROVO, UT. FILED 3-3-2003.

**SILVER SOFT**

NO CLAIM IS MADE TO THE EXCLUSIVE RIGHT TO USE "SILVER", APART FROM THE MARK AS SHOWN.

FOR ANTISEPTICS; GENERAL-PURPOSE GERMICIDE FOR EXTERNAL BODY PARTS (U.S. CLS. 6, 18, 44, 46, 51 AND 52).

FIRST USE 6-15-1999; IN COMMERCE 2-15-2002.

INGA ERVIN, EXAMINING ATTORNEY

SN 76-494,303. VITA ZAHNFABRIK H. RAUTER GMBH & CO. KG, D-79713 BAD SACKINGEN, FED REP GERMANY, FILED 3-3-2003.

**OM1**

SEC. 2(F).

FOR RESTORATIVE MATERIALS OF A SPECIFIC TOOTH COLOR (U.S. CLS. 6, 18, 44, 46, 51 AND 52).

FIRST USE 12-0-1999; IN COMMERCE 12-0-1999.

BARBARA A. LOUGHRAN, EXAMINING ATTORNEY

**CLASS 5—(Continued).**

SN 76-533,467. UPTIN, INC., DBA BENSON-PENDANT, LAS VEGAS, NV. FILED 7-30-2003.



THE LINING SHOWN IN THE DRAWING IS A FEATURE OF THE MARK.

THE MARK CONSISTS, IN PART, OF A STYLIZED LETTER "I" WHICH IS REPRESENTED BY A DOME LINED THROUGH TO REFLECT A LOWER CASE LETTER "I" FOLLOWED BY THE REMAINDER OF THE MARK IN BASIC BLOCKED LETTERING.

FOR NUTRACEUTICAL, IN PILL FORM, USED IN CONNECTION WITH THE ON-DEMAND ENHANCEMENT OF MALE ERECTILE FUNCTION (U.S. CLS. 6, 18, 44, 46, 51 AND 52).

FIRST USE 7-18-2002; IN COMMERCE 7-18-2002.

WON TEAK OH, EXAMINING ATTORNEY

SN 76-538,206. AVENTIS (IRELAND) LIMITED, DUBLIN, IRELAND, FILED 8-18-2003.

**VISCONTOUR**

OWNER OF SWITZERLAND REG. NO. 482016, DATED 2-26-2001, EXPIRES 2-2-2011.

FOR PHARMACEUTICAL PREPARATIONS FOR SKIN CARE AND AND THE TREATMENT OF TISSUE REPAIR (U.S. CLS. 6, 18, 44, 46, 51 AND 52).

DAWN FELDMAN, EXAMINING ATTORNEY

SN 76-552,671. RYSELL INTERNATIONAL, INC., MIAMI, FL. FILED 10-20-2003.

**RYSELL ICE BLUE**

NO CLAIM IS MADE TO THE EXCLUSIVE RIGHT TO USE "BLUE", APART FROM THE MARK AS SHOWN.

FOR NON-GREASY PAIN RELIEVING GEL APPLIED TO SKIN FOR TREATMENT OF MUSCLE SORENESS (U.S. CLS. 6, 18, 44, 46, 51 AND 52).

GIANCARLO CASTRO, EXAMINING ATTORNEY

**CLASS 5—(Continued).**

SN 76-555,100. WINTER DAWN INC., HOUSTON, TX. FILED 10-29-2003.

**SCIBALM**

FOR PHARMACEUTICAL PREPARATIONS, NAMELY, PREPARATIONS FOR THE TREATMENT OF SKIN DISORDERS, DRY SKIN AND FOR SKIN CARE; ANTIBIOTICS, ANTI-INFLAMMATORIES, ANTI-ALLERGY PREPARATIONS; PHARMACEUTICAL PREPARATIONS FOR DERMATOLOGY AND VITAMIN AND MINERAL PHARMACEUTICAL PREPARATIONS AND FOR THE TREATMENT OF INFECTIONS; VETERINARY PREPARATIONS, NAMELY, ANTIBIOTICS, ANTI-INFLAMMATORIES, ANTI-ALLERGY PREPARATIONS AND PREPARATIONS FOR THE TREATMENT OF ANIMAL SKIN DISORDERS, DRY SKIN AND FOR ANIMAL SKIN CARE; SANITARY PREPARATIONS FOR MEDICAL PURPOSES, NAMELY, MEDICAL SOAPS AND CLEANSERS AND DISINFECTANTS; DIETETIC SUBSTANCES FOR MEDICAL USE, FOOD FOR BABIES; MEDICAL PLASTERS, WOUND AND SURGICAL DRESSINGS; MATERIAL FOR STOPPING TEETH, DENTAL WAX; DISINFECTANTS FOR MEDICAL INSTRUMENTS; PREPARATIONS FOR DESTROYING VERMIN; FUNGICIDES AND HERBICIDES FOR AGRICULTURAL AND DOMESTIC USES; SURGICAL BANDAGES AND DRESSINGS; NUTRITIONAL SUPPLEMENTS; MEDICATED LOTIONS USED FOR THE HAIR, SKIN AND FACE; MEDICATED PRE-MOISTENED WIPES; MEDICATED SHAMPOO; MEDICATED LIP AND SKIN BALM AND MEDICATED OINTMENTS; ANALGESIC BALM; ANTISEPTICS AND MEDICAL CLEANSERS FOR SKIN AND WOUNDS (U.S. CLS. 6, 18, 44, 46, 51 AND 52).  
JULIA HARDY COFIELD, EXAMINING ATTORNEY

SN 76-566,529. HVS LABORATORIES, INC., NAPLES, FL. FILED 12-15-2003.

**HOMEOVITICS**

THE MARK CONSISTS OF STANDARD CHARACTERS WITHOUT CLAIM TO ANY PARTICULAR FONT, STYLE, SIZE, OR COLOR.

OWNER OF U.S. REG. NO. 2,129,300.  
FOR NUTRITIONAL SUPPLEMENTS FOR HUMAN CONSUMPTION (U.S. CLS. 6, 18, 44, 46, 51 AND 52).  
GEORGE LORENZO, EXAMINING ATTORNEY

SN 76-568,479. KENPAL FARM PRODUCTS INC., CENTRALIA, ONTARIO, N0M 1K0, CANADA, FILED 1-6-2004.



FOR MEDICATED ANIMAL FEED (U.S. CLS. 6, 18, 44, 46, 51 AND 52).  
FIRST USE 11-1-2003; IN COMMERCE 11-1-2003.  
JENNIFER CHICOSKI, EXAMINING ATTORNEY

**CLASS 5—(Continued).**

SN 76-569,590. SUMITOMO CHEMICAL CO., LTD., CHUOKU, OSAKA, JAPAN, FILED 1-8-2004.

**SUMIMET**

THE MARK CONSISTS OF STANDARD CHARACTERS WITHOUT CLAIM TO ANY PARTICULAR FONT, STYLE, SIZE, OR COLOR.

PRIORITY CLAIMED UNDER SEC. 44(D) ON JAPAN APPLICATION NO. 42180/2003, FILED 5-23-2003, REG. NO. 4740594, DATED 1-16-2004, EXPIRES 1-16-2014.

FOR NUTRITIONAL FEED ADDITIVES FOR VETERINARY PURPOSES, ADDITIVES FOR FODDER FOR MEDICAL PURPOSES, FEE ADDITIVES AND SUPPLEMENTS FOR ANIMAL NUTRITION. (U.S. CLS. 6, 18, 44, 46, 51 AND 52).

KAREN BRACEY, EXAMINING ATTORNEY

SN 76-569,591. SUMITOMO CHEMICAL CO., LTD., CHUOKU, OSAKA, JAPAN, FILED 1-8-2004.

**SUMIVITA**

THE MARK CONSISTS OF STANDARD CHARACTERS WITHOUT CLAIM TO ANY PARTICULAR FONT, STYLE, SIZE, OR COLOR.

PRIORITY CLAIMED UNDER SEC. 44(D) ON JAPAN APPLICATION NO. 42179/2003, FILED 5-23-2003, REG. NO. 4740593, DATED 1-16-2004, EXPIRES 1-16-2014.

FOR NUTRITIONAL FEED ADDITIVES FOR VETERINARY PURPOSES, ADDITIVES FOR FODDER FOR MEDICAL PURPOSES, VITAMIN PREPARATION, FEED ADDITIVES AND SUPPLEMENTS FOR ANIMAL NUTRITION. (U.S. CLS. 6, 18, 44, 46, 51 AND 52).

KAREN BRACEY, EXAMINING ATTORNEY

SN 76-578,760. BRECKENRIDGE PHARMACEUTICAL, INC., BOCA RATON, FL. FILED 3-1-2004.

**HISTACOL DM PEDIATRIC**

THE MARK CONSISTS OF STANDARD CHARACTERS WITHOUT CLAIM TO ANY PARTICULAR FONT, STYLE, SIZE, OR COLOR.

NO CLAIM IS MADE TO THE EXCLUSIVE RIGHT TO USE DM PEDIATRIC, APART FROM THE MARK AS SHOWN.

FOR PHARMACEUTICAL PREPARATIONS FOR THE TREATMENT OF COUGH AND COLD CONDITIONS (U.S. CLS. 6, 18, 44, 46, 51 AND 52).

SEAN DWYER, EXAMINING ATTORNEY

**CLASS 5—(Continued).**

SN 76-578,761. BRECKENRIDGE PHARMACEUTICAL, INC.,  
BOCA RATON, FL. FILED 3-1-2004.

**HISTACOL DM**

THE MARK CONSISTS OF STANDARD CHARACTERS WITHOUT CLAIM TO ANY PARTICULAR FONT, STYLE, SIZE, OR COLOR.

NO CLAIM IS MADE TO THE EXCLUSIVE RIGHT TO USE DM, APART FROM THE MARK AS SHOWN.

FOR PHARMACEUTICAL PREPARATIONS FOR THE TREATMENT OF COUGH AND COLD CONDITIONS (U.S. CLS. 6, 18, 44, 46, 51 AND 52).

SEAN DWYER, EXAMINING ATTORNEY

**CLASS 5—(Continued).**

SN 76-578,767. BRECKENRIDGE PHARMACEUTICAL, INC.,  
BOCA RATON, FL. FILED 3-1-2004.

**E BODY CARE**

THE MARK CONSISTS OF STANDARD CHARACTERS WITHOUT CLAIM TO ANY PARTICULAR FONT, STYLE, SIZE, OR COLOR.

NO CLAIM IS MADE TO THE EXCLUSIVE RIGHT TO USE "E BODY", APART FROM THE MARK AS SHOWN.

FOR PHARMACEUTICAL PREPARATIONS FOR THE TREATMENT OF VITAMIN, MINERAL, AND NUTRITIONAL DEFICIENCIES (U.S. CLS. 6, 18, 44, 46, 51 AND 52).

SEAN DWYER, EXAMINING ATTORNEY

SN 76-578,762. BRECKENRIDGE PHARMACEUTICAL, INC.,  
BOCA RATON, FL. FILED 3-1-2004.

**FOLBEE PLUS**

THE MARK CONSISTS OF STANDARD CHARACTERS WITHOUT CLAIM TO ANY PARTICULAR FONT, STYLE, SIZE, OR COLOR.

NO CLAIM IS MADE TO THE EXCLUSIVE RIGHT TO USE PLUS, APART FROM THE MARK AS SHOWN.

FOR PHARMACEUTICAL PREPARATIONS FOR THE TREATMENT OF VITAMIN, MINERAL, AND NUTRITIONAL DEFICIENCIES (U.S. CLS. 6, 18, 44, 46, 51 AND 52).

SEAN DWYER, EXAMINING ATTORNEY

SN 76-578,769. BRECKENRIDGE PHARMACEUTICAL, INC.,  
BOCA RATON, FL. FILED 3-1-2004.

**CARBETAPLEX LIQUID**

THE MARK CONSISTS OF STANDARD CHARACTERS WITHOUT CLAIM TO ANY PARTICULAR FONT, STYLE, SIZE, OR COLOR.

NO CLAIM IS MADE TO THE EXCLUSIVE RIGHT TO USE LIQUID, APART FROM THE MARK AS SHOWN.

FOR PHARMACEUTICAL PREPARATIONS FOR THE TREATMENT OF COUGH AND COLD CONDITIONS (U.S. CLS. 6, 18, 44, 46, 51 AND 52).

SEAN DWYER, EXAMINING ATTORNEY

SN 76-578,766. BRECKENRIDGE PHARMACEUTICAL, INC.,  
BOCA RATON, FL. FILED 3-1-2004.

**E BODY SCIENCE**

THE MARK CONSISTS OF STANDARD CHARACTERS WITHOUT CLAIM TO ANY PARTICULAR FONT, STYLE, SIZE, OR COLOR.

NO CLAIM IS MADE TO THE EXCLUSIVE RIGHT TO USE "E BODY", APART FROM THE MARK AS SHOWN.

FOR PHARMACEUTICAL PREPARATIONS FOR THE TREATMENT OF VITAMIN, MINERAL, AND NUTRITIONAL DEFICIENCIES (U.S. CLS. 6, 18, 44, 46, 51 AND 52).

SEAN DWYER, EXAMINING ATTORNEY

SN 76-578,773. BRECKENRIDGE PHARMACEUTICAL, INC.,  
BOCA RATON, FL. FILED 3-1-2004.

**BROMPHENEX DM LIQUID**

THE MARK CONSISTS OF STANDARD CHARACTERS WITHOUT CLAIM TO ANY PARTICULAR FONT, STYLE, SIZE, OR COLOR.

NO CLAIM IS MADE TO THE EXCLUSIVE RIGHT TO USE DM LIQUID, APART FROM THE MARK AS SHOWN.

FOR PHARMACEUTICAL PREPARATIONS FOR THE TREATMENT OF COUGH AND COLD CONDITIONS (U.S. CLS. 6, 18, 44, 46, 51 AND 52).

SEAN DWYER, EXAMINING ATTORNEY

**CLASS 5—(Continued).**

SN 76-578,790. BRECKENRIDGE PHARMACEUTICAL, INC., BOCA RATON, FL. FILED 3-1-2004.

**VINATE WILDBERRY**

THE MARK CONSISTS OF STANDARD CHARACTERS WITHOUT CLAIM TO ANY PARTICULAR FONT, STYLE, SIZE, OR COLOR.

OWNER OF U.S. REG. NOS. 2,520,191 AND 2,520,192. NO CLAIM IS MADE TO THE EXCLUSIVE RIGHT TO USE WILD BERRY, APART FROM THE MARK AS SHOWN. FOR PHARMACEUTICAL PREPARATIONS FOR THE TREATMENT OF PRENATAL CONDITIONS (U.S. CLS. 6, 18, 44, 46, 51 AND 52).

AMY HELLA, EXAMINING ATTORNEY

**CLASS 5—(Continued).**

SN 76-584,394. NO STINK, INC., PHOENIX, AZ. FILED 4-1-2004.

**DR. STINK**

THE MARK CONSISTS OF STANDARD CHARACTERS WITHOUT CLAIM TO ANY PARTICULAR FONT, STYLE, SIZE, OR COLOR.

NO CLAIM IS MADE TO THE EXCLUSIVE RIGHT TO USE "STINK", APART FROM THE MARK AS SHOWN. FOR ALL NATURAL ODOR ELIMINATORS (U.S. CLS. 6, 18, 44, 46, 51 AND 52).

FIRST USE 6-14-2001; IN COMMERCE 6-14-2001. BRIAN BROWN, EXAMINING ATTORNEY

SN 76-578,798. BRECKENRIDGE PHARMACEUTICAL, INC., BOCA RATON, FL. FILED 3-1-2004.

**SULFATOL CLEANSER**

THE MARK CONSISTS OF STANDARD CHARACTERS WITHOUT CLAIM TO ANY PARTICULAR FONT, STYLE, SIZE, OR COLOR.

NO CLAIM IS MADE TO THE EXCLUSIVE RIGHT TO USE CLEANSER, APART FROM THE MARK AS SHOWN. FOR PHARMACEUTICAL PREPARATIONS FOR THE TREATMENT OF DERMATOLOGICAL CONDITIONS (U.S. CLS. 6, 18, 44, 46, 51 AND 52).

AMY HELLA, EXAMINING ATTORNEY

SN 76-584,470. L. PERRIGO COMPANY, ALLEGAN, MI. FILED 4-1-2004.

**GEL-GLOSS**

FOR DIETARY SUPPLEMENTS (U.S. CLS. 6, 18, 44, 46, 51 AND 52).

HENRY S. ZAK, EXAMINING ATTORNEY

SN 76-580,590. FUJI CHEMICAL INDUSTRY CO., LTD., NAKANIKAWA-GUN, TOYAMA-KEN, JAPAN, FILED 3-11-2004.

**ASTAVITA**

THE MARK CONSISTS OF STANDARD CHARACTERS WITHOUT CLAIM TO ANY PARTICULAR FONT, STYLE, SIZE, OR COLOR.

FOR FOOD SUPPLEMENTS CONTAINING CAROTENOIDS (U.S. CLS. 6, 18, 44, 46, 51 AND 52).

DAVID MURRAY, EXAMINING ATTORNEY

SN 76-585,202. HERBAL TECHNOLOGIES INC., MARINA DEL REY, CA. FILED 4-5-2004.

**METASYSTEM THERMO CARB CONTROL**

THE MARK CONSISTS OF STANDARD CHARACTERS WITHOUT CLAIM TO ANY PARTICULAR FONT, STYLE, SIZE, OR COLOR.

OWNER OF U.S. REG. NO. 2,125,520. NO CLAIM IS MADE TO THE EXCLUSIVE RIGHT TO USE "CARB CONTROL", APART FROM THE MARK AS SHOWN.

FOR NUTRITIONAL SUPPLEMENTS FOR HUMANS, NAMELY, DIETARY FOOD SUPPLEMENTS, HERBAL SUPPLEMENTS, NUTRITIONAL SUPPLEMENTS, VITAMIN AND MINERAL SUPPLEMENTS, NATURAL FOOD SUPPLEMENTS (U.S. CLS. 6, 18, 44, 46, 51 AND 52).

JOHN GARTNER, EXAMINING ATTORNEY

**CLASS 5—(Continued).**

SN 76-585,205. HERBAL TECHNOLOGIES INC., MARINA DEL REY, CA. FILED 4-5-2004.

**METASYSTEM THERMO LIPO CONTROL**

THE MARK CONSISTS OF STANDARD CHARACTERS WITHOUT CLAIM TO ANY PARTICULAR FONT, STYLE, SIZE, OR COLOR.

OWNER OF U.S. REG. NO. 2,125,520.

NO CLAIM IS MADE TO THE EXCLUSIVE RIGHT TO USE "LIPO CONTROL", APART FROM THE MARK AS SHOWN.

FOR NUTRITIONAL SUPPLEMENTS FOR HUMANS, NAMELY, DIETARY FOOD SUPPLEMENTS, HERBAL SUPPLEMENTS, NUTRITIONAL SUPPLEMENTS, VITAMIN AND MINERAL SUPPLEMENTS, NATURAL FOOD SUPPLEMENTS (U.S. CLS. 6, 18, 44, 46, 51 AND 52).

JOHN GARTNER, EXAMINING ATTORNEY

SN 76-586,825. THE TRUSTEES OF FOREMOST LABS, COMPRISING LAWRENCE M. LOGSDON AND NORMA JO LOGSDON BOTH U.S. CITIZEN, LAGUNA NIGUEL, CA. FILED 4-15-2004.

**STING ZAPPER**

THE MARK CONSISTS OF STANDARD CHARACTERS WITHOUT CLAIM TO ANY PARTICULAR FONT, STYLE, SIZE, OR COLOR.

NO CLAIM IS MADE TO THE EXCLUSIVE RIGHT TO USE STING, APART FROM THE MARK AS SHOWN.

FOR TOPICAL FIRST AID GEL (U.S. CLS. 6, 18, 44, 46, 51 AND 52).

FIRST USE 9-1-2003; IN COMMERCE 9-1-2003.

MICHELE SWAIN, EXAMINING ATTORNEY

SN 76-589,008. BIOENERGIMED, L.L.C., SCHUYLKILL HAVEN, PA. FILED 4-26-2004.



THE LINING SHOWN IN THE DRAWING IS A FEATURE OF THE MARK, BUT THE LINING PATTERN IS NOT INTENDED TO INDICATE COLOR.

FOR DIETARY SUPPLEMENTS FOR HUMAN CONSUMPTION, NAMELY HORMONAL PRECURSORS (U.S. CLS. 6, 18, 44, 46, 51 AND 52).

FIRST USE 4-1-2002; IN COMMERCE 4-19-2004.

SKYE YOUNG, EXAMINING ATTORNEY

**CLASS 5—(Continued).**

SN 76-590,844. ALFA WASSERMANN S.P.A., 65020 ALANNO (PESCARA), ITALY, FILED 5-6-2004.

**ZIR-FOS**

FOR NUTRITIONAL AND DIETARY SUPPLEMENT FOR THE TREATMENT OF INTESTINAL PATHOLOGIES (U.S. CLS. 6, 18, 44, 46, 51 AND 52).

ZHALEH DELANEY, EXAMINING ATTORNEY

SN 76-591,228. SISSON, MARK, MALIBU, CA. FILED 5-10-2004.

**PROLOFTIN**

THE MARK CONSISTS OF STANDARD CHARACTERS WITHOUT CLAIM TO ANY PARTICULAR FONT, STYLE, SIZE, OR COLOR.

FOR VITAMINS, MINERALS, AND FOOD SUPPLEMENTS FOR HUMAN CONSUMPTION (U.S. CLS. 6, 18, 44, 46, 51 AND 52).

ANNE E. GUSTASON, EXAMINING ATTORNEY

SN 76-591,492. THE ISLER ANSWER, INC., DENVER, NJ. FILED 5-10-2004.

**DREAMWHITE**

THE MARK CONSISTS OF STANDARD CHARACTERS WITHOUT CLAIM TO ANY PARTICULAR FONT, STYLE, SIZE, OR COLOR.

FOR ORAL HYGIENE SOLUTION FOR USE AT NIGHT DURING SLEEP TO REMOVE DENTAL PLAQUE, WHITEN TEETH, MOISTURIZE TEETH, FIGHT TOOTH DECAY AND SUPPORT THE HEALTH OF THE ORAL CAVITY AND FIGHT THE EFFECTS OF CHANGES IN HEALTH OF THE ORAL CAVITY, AND APPLICATORS USED THEREWITH TO APPLY THE SOLUTION (U.S. CLS. 6, 18, 44, 46, 51 AND 52).

H. M. FISHER, EXAMINING ATTORNEY

**CLASS 5—(Continued).**

SN 76-591,762. IVY ANIMAL HEALTH, INC., OVERLAND PARK, KS. FILED 5-10-2004.

**IMPLUS-S**

THE MARK CONSISTS OF STANDARD CHARACTERS WITHOUT CLAIM TO ANY PARTICULAR FONT, STYLE, SIZE, OR COLOR.

OWNER OF U.S. REG. NOS. 1,751,786, 1,805,076 AND 2,012,137.

FOR VETERINARY PREPARATIONS, NAMELY, HORMONES FOR USE IN PROMOTING GROWTH IN FOOD ANIMALS (U.S. CLS. 6, 18, 44, 46, 51 AND 52).

CYNTHIA SLOAN, EXAMINING ATTORNEY



SN 76-592,342. SWANSON HEALTH PRODUCTS, INCORPORATED, FARGO, ND. FILED 5-17-2004.

**RIGHT AGE**

THE MARK CONSISTS OF STANDARD CHARACTERS WITHOUT CLAIM TO ANY PARTICULAR FONT, STYLE, SIZE, OR COLOR.

FOR NUTRITIONAL AND DIETARY SUPPLEMENTS (U.S. CLS. 6, 18, 44, 46, 51 AND 52).

FIRST USE 5-0-2001; IN COMMERCE 5-0-2001.

STEVEN R. FOSTER, EXAMINING ATTORNEY



SN 76-592,557. PERFORMANCE LABS, INC., CALABASAS, CA. FILED 5-17-2004.

**STRESS RELIEF YOU CAN SLEEP ON**

THE MARK CONSISTS OF STANDARD CHARACTERS WITHOUT CLAIM TO ANY PARTICULAR FONT, STYLE, SIZE, OR COLOR.

THE MARK CONSISTS OF THE WORDS "STRESS RELIEF YOU CAN SLEEP ON" AS SHOWN IN THE DRAWING.

FOR VITAMINS, MINERAL SUPPLEMENTS, HERBAL SUPPLEMENTS, NUTRITIONAL SUPPLEMENTS AND DIETARY SUPPLEMENTS (U.S. CLS. 6, 18, 44, 46, 51 AND 52).

GIANCARLO CASTRO, EXAMINING ATTORNEY

**CLASS 5—(Continued).**

SN 76-592,678. WALGREEN CO., DEERFIELD, IL. FILED 5-17-2004.

**CARBOLESS**

OWNER OF U.S. REG. NOS. 2,479,423, 2,673,177 AND 2,742,570.

FOR DIETARY SUPPLEMENTS (U.S. CLS. 6, 18, 44, 46, 51 AND 52).

ANNE MADDEN, EXAMINING ATTORNEY



SN 76-592,679. WALGREEN CO., DEERFIELD, IL. FILED 5-17-2004.

**HYDROYLESS**

OWNER OF U.S. REG. NOS. 2,479,423, 2,673,177 AND 2,742,570.

FOR DIETARY SUPPLEMENTS (U.S. CLS. 6, 18, 44, 46, 51 AND 52).

ANNE MADDEN, EXAMINING ATTORNEY



SN 76-605,448. C.B. FLEET COMPANY, INCORPORATED, LYNCHBURG, VA. FILED 8-2-2004.

**SUMMER'S EVE**

THE MARK CONSISTS OF STANDARD CHARACTERS WITHOUT CLAIM TO ANY PARTICULAR FONT, STYLE, SIZE, OR COLOR.

OWNER OF U.S. REG. NOS. 973,790, 2,408,646 AND OTHERS.

FOR MEDICATED ANTI-ITCH GEL (U.S. CLS. 6, 18, 44, 46, 51 AND 52).

FIRST USE 2-23-2004; IN COMMERCE 2-23-2004.

JIM RINGLE, EXAMINING ATTORNEY



SN 78-047,776. N.V.E., INC., NEWTON, NJ. FILED 2-12-2001.

**EL TIGRE**

THE FOREIGN WORDING IN THE MARK TRANSLATES INTO ENGLISH AS "THE TIGER."

FOR NUTRITIONAL AND DIETARY SUPPLEMENTS. (U.S. CLS. 6, 18, 44, 46, 51 AND 52).

MARIA-VICTORIA SUAREZ, EXAMINING ATTORNEY

**CLASS 5—(Continued).**

SN 78-154,179. CELLTECH MANUFACTURING, INC., ROCHESTER, NY. FILED 8-14-2002.

**IEDS**

FOR ION EXCHANGE RESIN COATING FOR USE AS A DRUG DELIVERY SYSTEM, SOLD AS A COMPONENT OF A PHARMACEUTICAL FORMULATION COMPRISING A DRUG-RESIN COMPLEX, WHICH ALLOWS FOR CONTROLLED-RELEASE AND DELIVERY OF PHARMACEUTICAL SUBSTANCES (U.S. CLS. 6, 18, 44, 46, 51 AND 52).

ANDREA SAUNDERS, EXAMINING ATTORNEY

SN 78-206,871. TEVA PHARMACEUTICAL INDUSTRIES LTD., JERUSALEM 91010, ISRAEL, FILED 1-24-2003.

**TEVA-TECH**

PRIORITY CLAIMED UNDER SEC. 44(D) ON ISRAEL APPLICATION NO. 159847, FILED 10-16-2002, REG. NO. 159847, DATED 7-4-2004, EXPIRES 10-16-2009.

THE ENGLISH TRANSLATION OF "TEVA" IS "NATURE".

FOR CHEMICAL INTERMEDIATES AND ACTIVE CHEMICAL INGREDIENTS FOR USE IN PHARMACEUTICALS (U.S. CLS. 6, 18, 44, 46, 51 AND 52).

NAAKWAMA ANKRAH, EXAMINING ATTORNEY

SN 78-213,405. MONARCH PHARMACEUTICALS, INC., BRISTOL, TN. FILED 2-11-2003.

**ACCUDOSE**

OWNER OF U.S. REG. NOS. 2,029,430 AND 2,505,802. FOR TABLETS WHICH ARE DESIGNATED TO BE DIVIDED INTO VARIOUS DOSAGE AMOUNTS, NAMELY, TABLETS CONTAINING PHARMACEUTICAL PREPARATIONS FOR USE IN THE TREATMENT OF THYROID CONDITIONS, BRONCHIAL CONDITIONS, CARDIAC CONDITIONS AND INFECTIOUS CONDITIONS (U.S. CLS. 6, 18, 44, 46, 51 AND 52).

JOHN KELLY, EXAMINING ATTORNEY

SN 78-216,388. DOCTORS' BRAND, LP, DALLAS, TX. FILED 2-19-2003.

**LIQUISENTIALS**

FOR NUTRITIONAL SUPPLEMENTS (U.S. CLS. 6, 18, 44, 46, 51 AND 52).

NAAKWAMA ANKRAH, EXAMINING ATTORNEY

**CLASS 5—(Continued).**

SN 78-224,221. GLAXO GROUP LIMITED, GREENFORD, MIDDLESEX, UNITED KINGDOM, FILED 3-11-2003.

**ZEFFIX**

OWNER OF UNITED KINGDOM REG. NO. 1538976, DATED 7-8-1994, EXPIRES 6-18-2010.

OWNER OF U.S. REG. NO. 2,042,640.

FOR PHARMACEUTICAL PREPARATIONS AND SUBSTANCES FOR THE TREATMENT OF METABOLIC AND INFECTIOUS DISEASES, PAIN, INFLAMMATION, SEPSIS, ALOPECIA AND OBESITY, AND FOR THE TREATMENT OF VIRAL, MUSCULOSKELETAL, CARDIOPULMONARY, GENITOURINARY, ONCOLOGICAL, RESPIRATORY, NEUROLOGICAL, GASTROINTESTINAL, HORMONAL, DERMATOLOGICAL AND PSYCHIATRIC RELATED DISEASES AND DISORDERS AND SKIN AND TISSUE REPAIR PREPARATIONS (U.S. CLS. 6, 18, 44, 46, 51 AND 52).

HENRY S. ZAK, EXAMINING ATTORNEY

SN 78-229,040. BIOSYNTRX, INC., LEXINGTON, SC. FILED 3-24-2003.

**SYNTRX COMPLETE**

NO CLAIM IS MADE TO THE EXCLUSIVE RIGHT TO USE "CALCIUM COMPLETE", APART FROM THE MARK AS SHOWN.

FOR VITAMIN AND NUTRACEUTICALS FOR USE AS A DIETARY SUPPLEMENT TO ENHANCE EYE AND OVERALL HEALTH (U.S. CLS. 6, 18, 44, 46, 51 AND 52).

THEODORE MCBRIDE, EXAMINING ATTORNEY

SN 78-233,950. KOICHEM, HANS-GUENTER, D-45134 ESSEN, FED REP GERMANY, FILED 4-4-2003.

**Phallofit**

OWNER OF FED REP GERMANY REG. NO. 30227774, DATED 1-29-2003, EXPIRES 6-30-2012.

FOR PHARMACEUTICAL PREPARATIONS, ESPECIALLY RESTORATIVES FOR THE SEXUAL POWER WITH APHRODISIACAL EFFECT. (U.S. CLS. 6, 18, 44, 46, 51 AND 52).

JAMES A. RAUEN, EXAMINING ATTORNEY



**CLASS 5—(Continued).**

SN 78-293,892. KING PHARMACEUTICALS, INC., BRISTOL, TN. FILED 8-29-2003.

**DROP DOSE**

SEC. 2(F).  
FOR OPHTHALMIC SOLUTION (U.S. CLS. 6, 18, 44, 46, 51 AND 52).  
FIRST USE 3-22-1973; IN COMMERCE 3-22-1973.  
THEODORE MCBRIDE, EXAMINING ATTORNEY

SN 78-304,743. NUTRI/SYSTEM IPHC, INC., WILMINGTON, DE. FILED 9-24-2003.

**nutrisystem nourish**

OWNER OF U.S. REG. NOS. 1,213,599, 2,492,546 AND OTHERS.  
FOR VITAMINS, MINERAL SUPPLEMENTS, NUTRITIONAL SUPPLEMENTS, PROTEIN SUPPLEMENTS, HERBAL SUPPLEMENTS, MEAL REPLACEMENT POWDERS AND DRINKS, USED IN CONNECTION WITH A WEIGHT MANAGEMENT PROGRAM (U.S. CLS. 6, 18, 44, 46, 51 AND 52).  
FIRST USE 12-15-2003; IN COMMERCE 12-15-2003.  
RAUL CORDOVA, EXAMINING ATTORNEY

SN 78-313,684. AVENTIS PHARMA S.A., ANTONY, FRANCE, FILED 10-15-2003.

**GARDIVES**

PRIORITY CLAIMED UNDER SEC. 44(D) ON FRANCE APPLICATION NO. 033221255, FILED 4-17-2003, REG. NO. 033221255, DATED 4-17-2003, EXPIRES 4-17-2013.  
FOR CARDIOVASCULAR PRODUCTS, NAMELY CARDIOVASCULAR PHARMACEUTICALS AND CARDIOVASCULAR TREATMENT PREPARATIONS (U.S. CLS. 6, 18, 44, 46, 51 AND 52).  
STEVEN BERK, EXAMINING ATTORNEY

SN 78-317,097. BRISTOL-MYERS SQUIBB COMPANY, NEW YORK, NY. FILED 10-22-2003.

**GOVOMNI**

FOR PHARMACEUTICAL PREPARATIONS FOR HUMAN USE FOR THE TREATMENT AND PREVENTION OF OBESITY, DIABETES, INCONTINENCE, CARDIOVASCULAR DISEASES, CENTRAL NERVOUS SYSTEM DISEASES AND DISORDERS, STROKE, CANCER, INFLAMMATION AND INFLAMMATORY DISEASES, RESPIRATORY AND INFECTIOUS DISEASES, AUTO-IMMUNE DISEASES, SOLID ORGAN TRANSPLANT REJECTION; PHARMACEUTICAL PREPARATIONS FOR HUMAN USE, NAMELY, ANTIBIOTICS, ANTI-FUNGALS, ANTI-VIRALS AND IMMUNOSUPPRESSANTS (U.S. CLS. 6, 18, 44, 46, 51 AND 52).  
GINA FINK, EXAMINING ATTORNEY

**CLASS 5—(Continued).**

SN 78-327,687. SCHELLING, CHRISTIANNE, THREE RIVERS, CA. FILED 11-13-2003.

**HEALTHCO**

THE MARK CONSISTS OF STANDARD CHARACTERS WITHOUT CLAIM TO ANY PARTICULAR FONT, STYLE, SIZE, OR COLOR.  
FOR NUTRITIONAL SUPPLEMENTS FOR PETS (U.S. CLS. 6, 18, 44, 46, 51 AND 52).  
FIRST USE 11-10-2003; IN COMMERCE 11-10-2003.  
LINDA M. KING, EXAMINING ATTORNEY

SN 78-338,178. HIRSH, MARK, HINGHAM, MA. FILED 12-9-2003.

**HURRI-SPRAY**

THE MARK CONSISTS OF STANDARD CHARACTERS WITHOUT CLAIM TO ANY PARTICULAR FONT, STYLE, SIZE, OR COLOR.  
FOR ANESTHETIC COMPOSITIONS FOR SURGICAL AND NONSURGICAL USE, TOPICAL ANESTHETIC COMPOSITION FOR SURGICAL AND NONSURGICAL USE, AND TOPICALLY APPLIED ANESTHETIC SPRAYS FOR SURGICAL AND NONSURGICAL USE (U.S. CLS. 6, 18, 44, 46, 51 AND 52).  
TRICIA SONNEBORN, EXAMINING ATTORNEY

**CLASS 5—(Continued).**

SN 78-341,101. BIO-OREGON, INC., WARRENTON, OR. FILED 12-15-2003.

**CLASS 5—(Continued).**

SN 78-347,598. HEALTH RESEARCH PTY LTD, ADELAIDE, SOUTH AUSTRALIA, AUSTRALIA, FILED 1-5-2004.

**PERCY'S POWDER**

**SeaPro**

THE MARK CONSISTS OF STANDARD CHARACTERS WITHOUT CLAIM TO ANY PARTICULAR FONT, STYLE, SIZE, OR COLOR.

OWNER OF AUSTRALIA REG. NO. 927855, DATED 9-20-2002, EXPIRES 9-20-2012.

NO CLAIM IS MADE TO THE EXCLUSIVE RIGHT TO USE "POWDER", APART FROM THE MARK AS SHOWN.

FOR PHARMACEUTICAL PREPARATIONS USED IN THE TREATMENT OF CANCER; VITAMIN AND MINERAL BLOOD TONIC (U.S. CLS. 6, 18, 44, 46, 51 AND 52).

SUSAN HAYASH, EXAMINING ATTORNEY

THE MARK CONSISTS OF STANDARD CHARACTERS WITHOUT CLAIM TO ANY PARTICULAR FONT, STYLE, SIZE, OR COLOR.

FOR ANIMAL FEED ADDITIVE, NAMELY, FISH PROTEIN CONCENTRATE, FOR USE AS A NUTRITIONAL SUPPLEMENT (U.S. CLS. 6, 18, 44, 46, 51 AND 52).

FIRST USE 10-22-2002; IN COMMERCE 10-22-2002.  
TONI HICKEY, EXAMINING ATTORNEY

SN 78-370,689. JOHNSON & JOHNSON, NEW BRUNSWICK, NJ. FILED 2-19-2004.

SN 78-342,124. HANFANG INT. BIOCHEMISTRY TECHNOLOGY CO., LTD., TAIPEI CITY, TAIWAN, FILED 12-17-2003.

**IONSIS**



THE MARK CONSISTS OF STANDARD CHARACTERS WITHOUT CLAIM TO ANY PARTICULAR FONT, STYLE, SIZE, OR COLOR.

FOR HUMAN PHARMACEUTICALS, NAMELY, AN-ALGESICS; ANALGESIC PREPARATIONS ADMINIS-TERED TRANSDERMALLY IN THE FORM OF A PATCH (U.S. CLS. 6, 18, 44, 46, 51 AND 52).

GRETTA YAO, EXAMINING ATTORNEY

FOR SANITARY NAPKINS (U.S. CLS. 6, 18, 44, 46, 51 AND 52).  
REBECCA SMITH, EXAMINING ATTORNEY

**CLASS 5—(Continued).**

SN 78-376,152. NEWAYS, INC., SPRINGVILLE, UT. FILED 3-1-2004.

**CLASS 5—(Continued).**

SN 78-376,158. NEWAYS, INC., SPRINGVILLE, UT. FILED 3-1-2004.

MAXIMOL SOLUTIONS

VMM

THE MARK CONSISTS OF STANDARD CHARACTERS WITHOUT CLAIM TO ANY PARTICULAR FONT, STYLE, SIZE, OR COLOR.

OWNER OF U.S. REG. NO. 2,225,943.  
FOR DIETARY SUPPLEMENT (U.S. CLS. 6, 18, 44, 46, 51 AND 52).  
FIRST USE 4-0-1996; IN COMMERCE 4-0-1996.  
MARLENE BELL, EXAMINING ATTORNEY

THE MARK CONSISTS OF STANDARD CHARACTERS WITHOUT CLAIM TO ANY PARTICULAR FONT, STYLE, SIZE, OR COLOR.

OWNER OF U.S. REG. NO. 2,245,998.  
FOR HERBAL AND NUTRITIONAL SUPPLEMENT (U.S. CLS. 6, 18, 44, 46, 51 AND 52).  
FIRST USE 1-1-1989; IN COMMERCE 1-1-1989.  
MARLENE BELL, EXAMINING ATTORNEY

SN 78-376,154. NEWAYS, INC., SPRINGVILLE, UT. FILED 3-1-2004.

SN 78-376,171. NEWAYS, INC., SPRINGVILLE, UT. FILED 3-1-2004.

ORACHEL

REVENOL

THE MARK CONSISTS OF STANDARD CHARACTERS WITHOUT CLAIM TO ANY PARTICULAR FONT, STYLE, SIZE, OR COLOR.

OWNER OF U.S. REG. NO. 2,249,476.  
FOR HEALTH CARE AND NUTRITIONAL SUPPLEMENT; NAMELY, MINERALS, VITAMINS, AND ANTI-OXIDANTS (U.S. CLS. 6, 18, 44, 46, 51 AND 52).  
FIRST USE 2-14-1996; IN COMMERCE 2-14-1996.  
MARLENE BELL, EXAMINING ATTORNEY

THE MARK CONSISTS OF STANDARD CHARACTERS WITHOUT CLAIM TO ANY PARTICULAR FONT, STYLE, SIZE, OR COLOR.

OWNER OF U.S. REG. NO. 2,787,769.  
FOR DIETARY SUPPLEMENT (U.S. CLS. 6, 18, 44, 46, 51 AND 52).  
FIRST USE 1-1-1995; IN COMMERCE 1-1-1995.  
MARLENE BELL, EXAMINING ATTORNEY

**CLASS 5—(Continued).**

SN 78-376,191. NEWAYS, INC., SPRINGVILLE, UT. FILED 3-1-2004.

**CLASS 5—(Continued).**

SN 78-390,480. PFIZER INC., NEW YORK, NY. FILED 3-25-2004.

## BIOGEVITY

THE MARK CONSISTS OF STANDARD CHARACTERS WITHOUT CLAIM TO ANY PARTICULAR FONT, STYLE, SIZE, OR COLOR.

OWNER OF U.S. REG. NO. 2,311,795.  
FOR DIETARY SUPPLEMENT (U.S. CLS. 6, 18, 44, 46, 51 AND 52).

FIRST USE 1-25-1999; IN COMMERCE 1-25-1999.  
MARLENE BELL, EXAMINING ATTORNEY

## ADRISTES

---

SN 78-386,195. AGRIGENIC FOOD CORPORATION, HUNTINGTON BEACH, CA. FILED 3-17-2004.

## Ageless Beauty

THE MARK CONSISTS OF STANDARD CHARACTERS WITHOUT CLAIM TO ANY PARTICULAR FONT, STYLE, SIZE, OR COLOR.

OWNER OF U.S. REG. NO. 1,560,419.  
FOR DIETARY SUPPLEMENT CONSISTING OF ANTI-OXIDANT ENZYMES, NAMELY GLUTATHIONE PEROXIDASE (U.S. CLS. 6, 18, 44, 46, 51 AND 52).  
FIRST USE 3-11-1983; IN COMMERCE 3-11-1983.  
GINA HAYES, EXAMINING ATTORNEY

THE MARK CONSISTS OF STANDARD CHARACTERS WITHOUT CLAIM TO ANY PARTICULAR FONT, STYLE, SIZE, OR COLOR.

FOR PHARMACEUTICAL PREPARATIONS FOR THE TREATMENT OF CARDIOVASCULAR DISEASE, CENTRAL NERVOUS SYSTEM DISEASES AND DISORDERS, NEUROLOGICAL DISORDERS, SLEEP DISORDERS, UROLOGICAL DISORDERS, UROGENITAL DISORDERS, GASTROINTESTINAL DISORDERS, MUSCULOSKELETAL DISORDERS, ALLERGIES, DIABETES, HYPERTENSION, ERECTILE DYSFUNCTION, SEXUAL DYSFUNCTION, STROKE, CANCER, MIGRAINES, PAIN, OBESITY, INFLAMMATION, INFLAMMATORY DISEASES, RESPIRATORY DISEASES, INFECTIOUS DISEASES, IMMUNOLOGICAL DISORDERS, VIRAL DISORDERS, FUNGAL DISORDERS; PHARMACEUTICAL PREPARATIONS, NAMELY, CHOLESTEROL PREPARATIONS, SMOKING CESSATION PREPARATIONS, DERMATOLOGICAL PREPARATIONS, GYNECOLOGICAL PREPARATIONS, OSTEOPOROSIS PREPARATIONS, OPHTHALMOLOGICAL PREPARATIONS, PREPARATIONS FOR THE TREATMENT OF HIV AND AIDS (U.S. CLS. 6, 18, 44, 46, 51 AND 52).  
ZACHARY BELLO, EXAMINING ATTORNEY

**CLASS 5—(Continued).**

SN 78-390,486. PFIZER INC., NEW YORK, NY. FILED 3-25-2004.

**FONAMI**

THE MARK CONSISTS OF STANDARD CHARACTERS WITHOUT CLAIM TO ANY PARTICULAR FONT, STYLE, SIZE, OR COLOR.

FOR PHARMACEUTICAL PREPARATIONS FOR THE TREATMENT OF CARDIOVASCULAR DISEASE, CENTRAL NERVOUS SYSTEM DISEASES AND DISORDERS, NEUROLOGICAL DISORDERS, SLEEP DISORDERS, UROLOGICAL DISORDERS, UROGENITAL DISORDERS, GASTROINTESTINAL DISORDERS, MUSCULOSKELETAL DISORDERS, ALLERGIES, DIABETES, HYPERTENSION, ERECTILE DYSFUNCTION, SEXUAL DYSFUNCTION, STROKE, CANCER, MIGRAINES, PAIN, OBESITY, INFLAMMATION, INFLAMMATORY DISEASES, RESPIRATORY DISEASES, INFECTIOUS DISEASES, IMMUNOLOGICAL DISORDERS, VIRAL DISORDERS, FUNGAL DISORDERS; PHARMACEUTICAL PREPARATIONS, NAMELY, CHOLESTEROL PREPARATIONS, SMOKING CESSATION PREPARATIONS, DERMATOLOGICAL PREPARATIONS, GYNECOLOGICAL PREPARATIONS, OSTEOPOROSIS PREPARATIONS, OPHTHALMOLOGICAL PREPARATIONS, PREPARATIONS FOR THE TREATMENT OF HIV AND AIDS (U.S. CLS. 6, 18, 44, 46, 51 AND 52).

ZACHARY BELLO, EXAMINING ATTORNEY

SN 78-391,320. SOLOFLEX, INC., HILLSBORO, OR. FILED 3-26-2004.

**VEGIO**

THE MARK CONSISTS OF STANDARD CHARACTERS WITHOUT CLAIM TO ANY PARTICULAR FONT, STYLE, SIZE, OR COLOR.

FOR DIETARY SUPPLEMENTS (U.S. CLS. 6, 18, 44, 46, 51 AND 52).

RAMONA ORTIGA, EXAMINING ATTORNEY

**CLASS 5—(Continued).**

SN 78-394,671. RATH, MATTHIAS, ALMELO, KL, NETHERLANDS, FILED 4-1-2004.

**VitaminCforte**

THE MARK CONSISTS OF STANDARD CHARACTERS WITHOUT CLAIM TO ANY PARTICULAR FONT, STYLE, SIZE, OR COLOR.

OWNER OF U.S. REG. NOS. 2,731,007 AND 2,749,121.

FOR PHARMACEUTICAL PREPARATIONS FOR USE IN THE TREATMENT OF HEART DISEASE AND HEART CONDITIONS, DIABETES, MENSTRUAL DISORDERS, BLOOD PRESSURE PROBLEMS, CARDIOVASCULAR PROBLEMS, LIPID METABOLISM DISORDERS, ASTHMA, ARTHRITIS, ARTHROSIS, TINNITUS, PERIODONTOSIS, ANEMIA, CELL DEFICIENCIES, AND CANCER; VITAMINS AND MINERALS FOR MEDICAL PURPOSES; FOOD SUPPLEMENTS FOR NON-MEDICAL PURPOSES, CONSISTING PRIMARILY OF VITAMINS, AMINO ACIDS AND TRACE ELEMENTS; DIETETIC SUPPLEMENTS FOR NON-MEDICAL USE, NAMELY AMINO ACIDS AND TRACE ELEMENTS IN THE NATURE OF DIETARY SUPPLEMENTS; NUTRITIONALLY FORTIFIED BEVERAGES (U.S. CLS. 6, 18, 44, 46, 51 AND 52).

AMY ALFIERI, EXAMINING ATTORNEY

SN 78-394,707. INNOVATION VENTURES LLC, DBA LIVING ESSENTIALS, WALLED LAKE, MI. FILED 4-1-2004.

**HEMEDICA**

THE MARK CONSISTS OF STANDARD CHARACTERS WITHOUT CLAIM TO ANY PARTICULAR FONT, STYLE, SIZE, OR COLOR.

FOR HOMEOPATHIC SUPPLEMENTS, PHARMACEUTICAL PREPARATIONS, NUTRITIONAL SUPPLEMENTS AND DIETARY SUPPLEMENTS THAT RELIEVE OR PREVENT HEMORRHOIDS (U.S. CLS. 6, 18, 44, 46, 51 AND 52).

MICHAEL KEATING, EXAMINING ATTORNEY

**CLASS 5—(Continued).**

SN 78-395,137. PAMLAB, LLC, COVINGTON, LA. FILED 4-1-2004.

**CLASS 5—(Continued).**

SN 78-397,946. VITAQUEST INTERNATIONAL INC., WEST CALDWELL, NJ. FILED 4-7-2004.

**SMOKER'S SOLUTION**

**TUSSX**

THE MARK CONSISTS OF STANDARD CHARACTERS WITHOUT CLAIM TO ANY PARTICULAR FONT, STYLE, SIZE, OR COLOR.

NO CLAIM IS MADE TO THE EXCLUSIVE RIGHT TO USE "SMOKER'S", APART FROM THE MARK AS SHOWN FOR DIETARY SUPPLEMENT (U.S. CLS. 6, 18, 44, 46, 51 AND 52).

RAMONA ORTIGA, EXAMINING ATTORNEY

THE MARK CONSISTS OF STANDARD CHARACTERS WITHOUT CLAIM TO ANY PARTICULAR FONT, STYLE, SIZE, OR COLOR.

FOR ANTITUSSIVE COUGH TREATMENT PREPARATION (U.S. CLS. 6, 18, 44, 46, 51 AND 52).

MELISSA SHELLA, EXAMINING ATTORNEY

SN 78-398,454. DERM CARE-VET PTY LTD, SPRINGWOOD, AUSTRALIA, FILED 4-8-2004.

SN 78-395,367. LEGACY FOR LIFE, LLC, MELBOURNE, FL. FILED 4-2-2004.

**OTINIDE**



OWNER OF U.S. REG. NOS. 2,261,688 AND 2,600,731. THE MARK CONSISTS OF A MAN BALANCING ON TOP OF THE LETTER A.

FOR DIETARY AND NUTRITIONAL SUPPLEMENTS (U.S. CLS. 6, 18, 44, 46, 51 AND 52).

FIRST USE 12-1-2003; IN COMMERCE 12-1-2003.

CHARLES JOYNER, EXAMINING ATTORNEY

THE MARK CONSISTS OF STANDARD CHARACTERS WITHOUT CLAIM TO ANY PARTICULAR FONT, STYLE, SIZE, OR COLOR.

FOR VETERINARY PHARMACEUTICAL PREPARATIONS, NAMELY ANIMAL WASHES AND COMPOSITIONS FOR TREATING SKIN INFECTIONS AND SKIN DISORDERS IN ANIMALS (U.S. CLS. 6, 18, 44, 46, 51 AND 52).

SONYA STEPHENS, EXAMINING ATTORNEY

**CLASS 5—(Continued).**

SN 78-400,023. YAMANOUCHI EUROPE B.V., LEIDERDORP, NETHERLANDS, FILED 4-12-2004.

**CLASS 5—(Continued).**

SN 78-403,351. DIAL BRANDS, INC., SCOTTSDALE, AZ. FILED 4-16-2004.

**LOCOID LIPOFOAM**

**BORAX BASICS**

THE MARK CONSISTS OF STANDARD CHARACTERS WITHOUT CLAIM TO ANY PARTICULAR FONT, STYLE, SIZE, OR COLOR.

OWNER OF U.S. REG. NOS. 1,058,915 AND 2,136,591. FOR MEDICATED TOPICAL SKIN PREPARATION FOR THE TREATMENT OF SKIN DISEASES (U.S. CLS. 6, 18, 44, 46, 51 AND 52).  
DORITT L. CARROLL, EXAMINING ATTORNEY

THE MARK CONSISTS OF STANDARD CHARACTERS WITHOUT CLAIM TO ANY PARTICULAR FONT, STYLE, SIZE, OR COLOR.

NO CLAIM IS MADE TO THE EXCLUSIVE RIGHT TO USE "BORAX", APART FROM THE MARK AS SHOWN. FOR AIR FRESHENERS, ROOM DEODORIZERS, CARPET AND FABRIC FRESHENERS, ODOR NEUTRALIZERS (U.S. CLS. 6, 18, 44, 46, 51 AND 52).  
CURTIS FRENCH, EXAMINING ATTORNEY

SN 78-400,572. VALEANT PHARMACEUTICALS INTERNATIONAL, COSTA MESA, CA. FILED 4-12-2004.

SN 78-404,216. THE BOARD OF SUPERVISORS OF LSU REPRESENTED BY THE LSU HEALTH SCIENCES CENTER IN NEW ORLEANS, NEW ORLEANS, LA. FILED 4-19-2004.

**EFUDEX-40**

**Neuroprotectin D1**

THE MARK CONSISTS OF STANDARD CHARACTERS WITHOUT CLAIM TO ANY PARTICULAR FONT, STYLE, SIZE, OR COLOR.

OWNER OF U.S. REG. NO. 2,621,546. FOR DERMATOTHERAPEUTIC PREPARATION (U.S. CLS. 6, 18, 44, 46, 51 AND 52).  
HOWARD SMIGA, EXAMINING ATTORNEY

THE MARK CONSISTS OF STANDARD CHARACTERS WITHOUT CLAIM TO ANY PARTICULAR FONT, STYLE, SIZE, OR COLOR.

FOR PHARMACEUTICALS FOR THE TREATMENT OF ISCHEMIC STROKES AND NEUROLOGICAL INJURY (U.S. CLS. 6, 18, 44, 46, 51 AND 52).  
PRISCILLA MILTON, EXAMINING ATTORNEY

**CLASS 5—(Continued).**

SN 78-408,643. DEBACHE, SIMON, MIAMI BEACH, FL.  
FILED 4-27-2004.

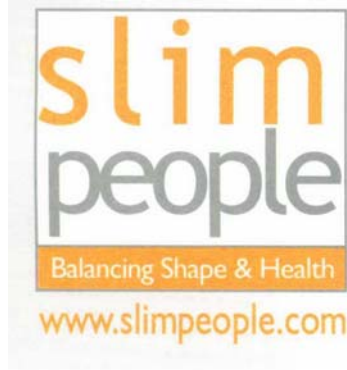

THE COLOR(S) GREY AND ORANGE IS/ARE CLAIMED AS A FEATURE OF THE MARK.

THE MARK CONSISTS OF "SLIM" IN ORANGE, "PEOPLE" IN GREY, "BALANCING SHAPE & HEALTH" WHITE ON ORANGESLIM.

FOR HERBAL SUPPLEMENTS FOR DIET AND EN-  
DERMOLOGIE (U.S. CLS. 6, 18, 44, 46, 51 AND 52).

FIRST USE 9-4-2003; IN COMMERCE 9-4-2003.  
RICHARD WHITE, EXAMINING ATTORNEY

SN 78-413,255. BODY SUISSE, INC., BEAVER FALLS, PA.  
FILED 5-5-2004.

**Body Swiss**

THE MARK CONSISTS OF STANDARD CHARACTERS WITHOUT CLAIM TO ANY PARTICULAR FONT, STYLE, SIZE, OR COLOR.

FOR NUTRITIONAL SUPPLEMENTS (U.S. CLS. 6, 18, 44, 46, 51 AND 52).

STEVEN R. FINE, EXAMINING ATTORNEY

**CLASS 5—(Continued).**

SN 78-414,169. BLOCK DRUG COMPANY, INC., WEST TRENTON, NJ. FILED 5-6-2004.

**GOODY'S STICK PACK**

THE MARK CONSISTS OF STANDARD CHARACTERS WITHOUT CLAIM TO ANY PARTICULAR FONT, STYLE, SIZE, OR COLOR.

OWNER OF U.S. REG. NOS. 527,865, 1,601,822 AND OTHERS.

NO CLAIM IS MADE TO THE EXCLUSIVE RIGHT TO USE "STICK PACK", APART FROM THE MARK AS SHOWN.

SEC. 2(F) AS TO "GOODY'S".

FOR ANALGESICS (U.S. CLS. 6, 18, 44, 46, 51 AND 52).  
ELLEN B. AWRICH, EXAMINING ATTORNEY

SN 78-414,529. CELGENE CORPORATION, WARREN, NJ.  
FILED 5-6-2004.

**BIOVANCE**

THE MARK CONSISTS OF STANDARD CHARACTERS WITHOUT CLAIM TO ANY PARTICULAR FONT, STYLE, SIZE, OR COLOR.

FOR BIOLOGICAL TISSUE INTENDED FOR USE AS A WOUND COVERING; WOUND DRESSINGS; BURN DRESSINGS; SURGICAL DRESSINGS; PHARMACEUTICAL PREPARATIONS FOR WOUNDS (U.S. CLS. 6, 18, 44, 46, 51 AND 52).

RUSS HERMAN, EXAMINING ATTORNEY



**CLASS 5—(Continued).**

SN 78-414,765. HEALTHMINDED, L.C., PROVO, UT. FILED 5-7-2004.

**MAGTIME**

THE MARK CONSISTS OF STANDARD CHARACTERS WITHOUT CLAIM TO ANY PARTICULAR FONT, STYLE, SIZE, OR COLOR.  
FOR NUTRITIONAL AND DIETARY SUPPLEMENTS (U.S. CLS. 6, 18, 44, 46, 51 AND 52).  
JOHN LINCOSKI, EXAMINING ATTORNEY

SN 78-414,769. HEALTHMINDED, L.C., PROVO, UT. FILED 5-7-2004.

**PAINPREP**

THE MARK CONSISTS OF STANDARD CHARACTERS WITHOUT CLAIM TO ANY PARTICULAR FONT, STYLE, SIZE, OR COLOR.  
FOR NUTRITIONAL AND DIETARY SUPPLEMENTS (U.S. CLS. 6, 18, 44, 46, 51 AND 52).  
JOHN LINCOSKI, EXAMINING ATTORNEY

**CLASS 5—(Continued).**

SN 78-414,945. GLAXO GROUP LIMITED, MIDDLESEX, UNITED KINGDOM, FILED 5-7-2004.

**REVERTEOS**

THE MARK CONSISTS OF STANDARD CHARACTERS WITHOUT CLAIM TO ANY PARTICULAR FONT, STYLE, SIZE, OR COLOR.  
FOR PHARMACEUTICAL PREPARATIONS FOR THE TREATMENT OF INFECTIOUS DISEASES, PAIN, INFLAMMATION, SEPSIS, ALOPECIA AND OBESITY, AND FOR THE TREATMENT OF METABOLIC, MUSCULOSKELETAL, CARDIOVASCULAR, CARDIOPULMONARY, GENITOURINARY, SEXUAL DYSFUNCTION, ONCOLOGICAL, RESPIRATORY, NEUROLOGICAL, GASTROINTESTINAL, HORMONAL, DERMATOLOGICAL AND PSYCHIATRIC RELATED DISEASES AND DISORDERS AND SKIN AND TISSUE REPAIR PREPARATIONS (U.S. CLS. 6, 18, 44, 46, 51 AND 52).  
ALICE BENMAMAN, EXAMINING ATTORNEY

SN 78-415,593. LAWN & GARDEN PRODUCTS, INC., FRESNO, CA. FILED 5-10-2004.

**NO DEER ZONE**

THE MARK CONSISTS OF STANDARD CHARACTERS WITHOUT CLAIM TO ANY PARTICULAR FONT, STYLE, SIZE, OR COLOR.  
NO CLAIM IS MADE TO THE EXCLUSIVE RIGHT TO USE DEER, APART FROM THE MARK AS SHOWN.  
FOR DEER REPELLENT (U.S. CLS. 6, 18, 44, 46, 51 AND 52).  
AMY HELLA, EXAMINING ATTORNEY

**CLASS 5—(Continued).**

SN 78-415,594. LAWN & GARDEN PRODUCTS, INC., FRESNO, CA. FILED 5-10-2004.

**CLASS 5—(Continued).**

SN 78-415,921. PHOENIX SCIENTIFIC, INC., ST. JOSEPH, MO. FILED 5-10-2004.

## NO GOOSE ZONE

THE MARK CONSISTS OF STANDARD CHARACTERS WITHOUT CLAIM TO ANY PARTICULAR FONT, STYLE, SIZE, OR COLOR.

NO CLAIM IS MADE TO THE EXCLUSIVE RIGHT TO USE GOOSE, APART FROM THE MARK AS SHOWN.

FOR GOOSE REPELLENT (U.S. CLS. 6, 18, 44, 46, 51 AND 52).

AMY HELLA, EXAMINING ATTORNEY

## REBALANCE

THE MARK CONSISTS OF STANDARD CHARACTERS WITHOUT CLAIM TO ANY PARTICULAR FONT, STYLE, SIZE, OR COLOR.

FOR VETERINARY PREPARATION FOR EQUINE FOR USE IN THE TREATMENT OF NEUROLOGICAL DISEASE (U.S. CLS. 6, 18, 44, 46, 51 AND 52).

VIVIAN MICZNIK FIRST, EXAMINING ATTORNEY

---

SN 78-415,677. VITAQUEST INTERNATIONAL, INC., WEST CALDWELL, NJ. FILED 5-10-2004.

---

SN 78-416,290. B2E BIOTECH LLC, HARRISON, NY. FILED 5-10-2004.

## VegefleX

THE MARK CONSISTS OF STANDARD CHARACTERS WITHOUT CLAIM TO ANY PARTICULAR FONT, STYLE, SIZE, OR COLOR.

FOR DIETARY SUPPLEMENT (U.S. CLS. 6, 18, 44, 46, 51 AND 52).

RAMONA ORTIGA, EXAMINING ATTORNEY

## SCIARAPRENE

THE MARK CONSISTS OF STANDARD CHARACTERS WITHOUT CLAIM TO ANY PARTICULAR FONT, STYLE, SIZE, OR COLOR.

FOR INSECTICIDES (U.S. CLS. 6, 18, 44, 46, 51 AND 52).

SUE LAWRENCE, EXAMINING ATTORNEY

**CLASS 5—(Continued).**

SN 78-416,687. SAVIENT PHARMACEUTICALS, INC., EAST BRUNSWICK, NJ. FILED 5-11-2004.

**CLASS 5—(Continued).**

SN 78-418,813. ALCON, INC., CH-6331 HÜNENBERG, SWITZERLAND, FILED 5-14-2004.

**NUFLEXA**

**RETAAVE**

THE MARK CONSISTS OF STANDARD CHARACTERS WITHOUT CLAIM TO ANY PARTICULAR FONT, STYLE, SIZE, OR COLOR.

FOR PRE-FILLED SYRINGE CONTAINING A VISCOELASTIC COMPOSITION FOR INJECTION INTO THE KNEE FOR AMELIORATION OF PAIN DUE TO OSTEOARTHRITIS (U.S. CLS. 6, 18, 44, 46, 51 AND 52).  
DANIEL CAPSHAW, EXAMINING ATTORNEY

THE MARK CONSISTS OF STANDARD CHARACTERS WITHOUT CLAIM TO ANY PARTICULAR FONT, STYLE, SIZE, OR COLOR.

FOR OPHTHALMIC PHARMACEUTICAL PREPARATIONS FOR THE TREATMENT OF ADVANCED MACULAR DEGENERATION (U.S. CLS. 6, 18, 44, 46, 51 AND 52).  
JOANNA DUKOVIC, EXAMINING ATTORNEY

SN 78-418,031. ZICAM, LLC, PHOENIX, AZ. FILED 5-13-2004.

SN 78-418,820. NUTRACEA, EL DORADO HILLS, CA. FILED 5-14-2004.

**COUGH MIST**

**Blondez**

THE MARK CONSISTS OF STANDARD CHARACTERS WITHOUT CLAIM TO ANY PARTICULAR FONT, STYLE, SIZE, OR COLOR.

FOR PHARMACEUTICAL AND HOMEOPATHIC PREPARATIONS FOR THE RELIEF OF COLDS AND ALLERGY SYMPTOMS, NAMELY ORAL COUGH SUPPRESSANT SPRAYS (U.S. CLS. 6, 18, 44, 46, 51 AND 52).  
KENNETH D. BATTLE, EXAMINING ATTORNEY

THE MARK CONSISTS OF STANDARD CHARACTERS WITHOUT CLAIM TO ANY PARTICULAR FONT, STYLE, SIZE, OR COLOR.

FOR NUTRITIONAL SUPPLEMENTS AND DIETARY SUPPLEMENTS (U.S. CLS. 6, 18, 44, 46, 51 AND 52).  
JOANNA DUKOVIC, EXAMINING ATTORNEY

**CLASS 5—(Continued).**

SN 78-419,230. NORTHWEST NATURAL PRODUCTS, INC., VANCOUVER, WA. FILED 5-14-2004.

**ESSENTIAL START**

THE MARK CONSISTS OF STANDARD CHARACTERS WITHOUT CLAIM TO ANY PARTICULAR FONT, STYLE, SIZE, OR COLOR.

FOR VITAMINS AND DIETARY SUPPLEMENTS (U.S. CLS. 6, 18, 44, 46, 51 AND 52).

KELLEY WELLS, EXAMINING ATTORNEY

---

SN 78-420,072. BIOSANTE PHARMACEUTICALS, INC., LINCOLNSHIRE, IL. FILED 5-17-2004.

**LIBIGEL**

THE MARK CONSISTS OF STANDARD CHARACTERS WITHOUT CLAIM TO ANY PARTICULAR FONT, STYLE, SIZE, OR COLOR.

FOR PHARMACEUTICAL PRODUCTS, NAMELY, PREPARATIONS FOR THE ADMINISTRATION OF HORMONES (U.S. CLS. 6, 18, 44, 46, 51 AND 52).

SHAUNIA WALLACE, EXAMINING ATTORNEY

---

SN 78-420,173. MYTHICAL RESEARCH, INC., MONTPELIER, VT. FILED 5-17-2004.

**EDISON FACTOR**

THE MARK CONSISTS OF STANDARD CHARACTERS WITHOUT CLAIM TO ANY PARTICULAR FONT, STYLE, SIZE, OR COLOR.

FOR FOOD SUPPLEMENT (U.S. CLS. 6, 18, 44, 46, 51 AND 52).

MIDGE BUTLER, EXAMINING ATTORNEY

**CLASS 5—(Continued).**

SN 78-420,419. G. D. SEARLE LLC, PEAPACK, NJ. FILED 5-18-2004.

**XENDIOR**

THE MARK CONSISTS OF STANDARD CHARACTERS WITHOUT CLAIM TO ANY PARTICULAR FONT, STYLE, SIZE, OR COLOR.

FOR PHARMACEUTICAL PREPARATIONS, NAMELY PREPARATIONS FOR THE TREATMENT OF INFECTIOUS DISEASES, CANCER, TREATMENT AND SYMPTOMS OF DIABETES, OPHTHALMOLOGICAL CONDITIONS AND DISEASES; CENTRAL NERVOUS SYSTEMS DISEASES AND DISORDERS; PARKINSON'S DISEASE, CARDIOVASCULAR DISEASES; GYNECOLOGICAL PREPARATIONS, ANTI-INFLAMMATORY PHARMACEUTICAL PREPARATIONS, ANALGESICS; HORMONAL PREPARATIONS AND PREPARATIONS FOR THE TREATMENT OF MIGRAINES (U.S. CLS. 6, 18, 44, 46, 51 AND 52).

THEODORE MCBRIDE, EXAMINING ATTORNEY

---

SN 78-422,713. BLOCK DRUG COMPANY, INC., WEST TRENTON, NJ. FILED 5-21-2004.

**GOODY'S FLO & GO  
STIX**

THE MARK CONSISTS OF STANDARD CHARACTERS WITHOUT CLAIM TO ANY PARTICULAR FONT, STYLE, SIZE, OR COLOR.

OWNER OF U.S. REG. NOS. 527,865, 1,601,822 AND OTHERS.

NO CLAIM IS MADE TO THE EXCLUSIVE RIGHT TO USE "STICKS", APART FROM THE MARK AS SHOWN.

FOR ANALGESICS (U.S. CLS. 6, 18, 44, 46, 51 AND 52). ELLEN B. AWRICH, EXAMINING ATTORNEY

**CLASS 5—(Continued).**

SN 78-422,714. BLOCK DRUG COMPANY, INC., WEST TRENTON, NJ. FILED 5-21-2004.

**CLASS 5—(Continued).**

SN 78-479,573. HELENA HOLDING COMPANY, WILMINGTON, DE. FILED 9-7-2004.

**GOODY'S CITRUS  
MINT RUSH**

**IMPINGE**

THE MARK CONSISTS OF STANDARD CHARACTERS WITHOUT CLAIM TO ANY PARTICULAR FONT, STYLE, SIZE, OR COLOR.  
OWNER OF U.S. REG. NOS. 527,865, 1,601,822 AND OTHERS.  
NO CLAIM IS MADE TO THE EXCLUSIVE RIGHT TO USE "CITRUS MINT", APART FROM THE MARK AS SHOWN.  
FOR ANALGESICS (U.S. CLS. 6, 18, 44, 46, 51 AND 52).  
ELLEN B. AWRICH, EXAMINING ATTORNEY

THE MARK CONSISTS OF STANDARD CHARACTERS WITHOUT CLAIM TO ANY PARTICULAR FONT, STYLE, SIZE, OR COLOR.  
FOR HERBICIDES, FUNGICIDES, AND INSECTICIDES FOR USE IN AGRICULTURAL, ORNAMENTAL AND TURF USE (U.S. CLS. 6, 18, 44, 46, 51 AND 52).  
MARLENE BELL, EXAMINING ATTORNEY

SN 78-483,747. ISI BRANDS INC., GRAND RAPIDS, MI. FILED 9-15-2004.

SN 78-463,150. SUNNY ISLAND LLC, BUFFALO GROVE, IL. FILED 8-6-2004.

**NITRATE FUEL CHEWS**

THE MARK CONSISTS OF STANDARD CHARACTERS WITHOUT CLAIM TO ANY PARTICULAR FONT, STYLE, SIZE, OR COLOR.  
NO CLAIM IS MADE TO THE EXCLUSIVE RIGHT TO USE NITRATE AND CHEWS, APART FROM THE MARK AS SHOWN.  
FOR NUTRITIONAL SUPPLEMENTS (U.S. CLS. 6, 18, 44, 46, 51 AND 52).  
TRICIA SONNEBORN, EXAMINING ATTORNEY

**TRIM LESS**

SN 78-483,817. ISI BRANDS INC., GRAND RAPIDS, MI. FILED 9-15-2004.

**NITRATE3 FUEL SHOT**

THE MARK CONSISTS OF STANDARD CHARACTERS WITHOUT CLAIM TO ANY PARTICULAR FONT, STYLE, SIZE, OR COLOR.  
FOR DIETARY SUPPLEMENTS (U.S. CLS. 6, 18, 44, 46, 51 AND 52).  
ESTHER BELENKER, EXAMINING ATTORNEY

THE MARK CONSISTS OF STANDARD CHARACTERS WITHOUT CLAIM TO ANY PARTICULAR FONT, STYLE, SIZE, OR COLOR.  
NO CLAIM IS MADE TO THE EXCLUSIVE RIGHT TO USE NITRATE AND SHOT, APART FROM THE MARK AS SHOWN.  
FOR NUTRITIONAL SUPPLEMENTS (U.S. CLS. 6, 18, 44, 46, 51 AND 52).  
TRICIA SONNEBORN, EXAMINING ATTORNEY

**CLASS 5—(Continued).**

SN 78-483,823. ISI BRANDS INC., GRAND RAPIDS, MI.  
FILED 9-15-2004.

**NITRATE FUEL**

THE MARK CONSISTS OF STANDARD CHARACTERS  
WITHOUT CLAIM TO ANY PARTICULAR FONT, STYLE,  
SIZE, OR COLOR.

NO CLAIM IS MADE TO THE EXCLUSIVE RIGHT TO  
USE NITRATE, APART FROM THE MARK AS SHOWN.

FOR NUTRITIONAL SUPPLEMENTS (U.S. CLS. 6, 18,  
44, 46, 51 AND 52).

TRICIA SONNEBORN, EXAMINING ATTORNEY

SN 79-000,823. NOVARTIS AG, SWITZERLAND, FILED 1-8-  
2004.

**NETURYA**

THE MARK CONSISTS OF STANDARD CHARACTERS  
WITHOUT CLAIM TO ANY PARTICULAR FONT, STYLE,  
SIZE, OR COLOR.

PRIORITY DATE OF 12-15-2003 IS CLAIMED.

OWNER OF INTERNATIONAL REGISTRATION 0818331  
DATED 1-8-2004, EXPIRES 1-8-2014.

FOR PHARMACEUTICAL PREPARATIONS FOR THE  
TREATMENT OF DISEASES AND DISORDERS OF THE  
CENTRAL NERVOUS SYSTEM, THE IMMUNE SYSTEM,  
THE CARDIO-VASCULAR SYSTEM, THE RESPIRA-  
TORY SYSTEM, FOR MUSCULO-SKELETAL AND IN-  
FLAMMATORY DISORDERS, FOR USE IN  
DERMATOLOGY AND ONCOLOGY (U.S. CLS. 6, 18,  
44, 46, 51 AND 52).

YSA DEJESUS, EXAMINING ATTORNEY

SN 79-001,628. SANKOM SARL, SWITZERLAND, FILED 2-3-  
2004.

**SANKOM SWITZERLAND**

THE MARK CONSISTS OF STANDARD CHARACTERS  
WITHOUT CLAIM TO ANY PARTICULAR FONT, STYLE,  
SIZE, OR COLOR.

OWNER OF INTERNATIONAL REGISTRATION 0821575  
DATED 2-3-2004, EXPIRES 2-3-2014.

NO CLAIM IS MADE TO THE EXCLUSIVE RIGHT TO  
USE "SWITZERLAND", APART FROM THE MARK AS  
SHOWN.

FOR CANDY FOR PHARMACEUTICAL USE,  
NAMELY FOR THE MAINTAINING OF NORMAL  
GASTRO-INTESTINAL FUNCTION; THE MOVING OF  
FOOD AND DIGESTIVE BY-PRODUCTS THROUGH  
THE LARGE INTESTINE (COLON) AND OUT OF THE  
BODY; THE REMOVING OF POTENTIAL CARCINO-  
GENS; THE REDUCTION OF LEVEL OF BILE ACIDS  
(U.S. CLS. 6, 18, 44, 46, 51 AND 52).

STEPHANIE DAVIS, EXAMINING ATTORNEY

**CLASS 5—(Continued).**

SN 79-001,721. ORION CORPORATION, FINLAND, FILED 3-  
5-2004.

**CLEVOR**

THE MARK CONSISTS OF STANDARD CHARACTERS  
WITHOUT CLAIM TO ANY PARTICULAR FONT, STYLE,  
SIZE, OR COLOR.

OWNER OF INTERNATIONAL REGISTRATION 0821818  
DATED 3-5-2004, EXPIRES 3-5-2014.

FOR PHARMACEUTICAL AND VETERINARY PRE-  
PARATIONS TO TREAT HEART FAILURE (U.S. CLS. 6,  
18, 44, 46, 51 AND 52).

SUE LAWRENCE, EXAMINING ATTORNEY

**CLASS 6—METAL GOODS**

SN 76-272,491. MINUTE MAN PRODUCTS, INC., EAST  
FLAT ROCK, NC. FILED 6-15-2001.

**MINUTE MAN PRODUCTS**

NO CLAIM IS MADE TO THE EXCLUSIVE RIGHT TO  
USE "PRODUCTS", APART FROM THE MARK AS SHOWN.  
FOR ANCHORING SYSTEMS COMPRISED OF METAL  
FOUNDATION PLATES, GROUND ANCHORS, AND  
STABILIZATION AND BRACING STRUTS (U.S. CLS. 2,  
12, 13, 14, 23, 25 AND 50).

FIRST USE 7-0-1997; IN COMMERCE 7-0-1997.

WON TEAK OH, EXAMINING ATTORNEY

**CLASS 6—(Continued).**

SN 76-494,629. SIMONSWERK, GESELLSCHAFT MIT BESCHRANKTER HAFTUNG, D-33378 RHEDA-WIEDENBRÜCK, FED REP GERMANY, FILED 2-28-2003.



PRIORITY CLAIMED UNDER SEC. 44(D) ON ERPNTY TM OFC APPLICATION NO. 003039732, FILED 2-6-2003, REG. NO. 003039732, DATED 6-7-2004, EXPIRES 2-6-2013.

THE MARK CONSISTS OF A STYLIZED VERSION OF THE LETTER "S" SUPERIMPOSED UPON A SHADED SQUARE BACKGROUND.

FOR BUILDING HARDWARE MADE OF METAL, NAMELY, METAL HINGES FOR DOOR FRAMES, WINDOWS AND GATES; DOOR SECURITIES MADE OF METAL, NAMELY, METAL CLASPS FOR USE AS DOOR SECURITY HARDWARE; FURNITURE HARDWARE MADE OF METAL, NAMELY, METAL HINGES FOR DOORS OF CUPBOARDS AND CLOSETS; SMALL IRONWARE FASTENERS, NAMELY, BRACKETS MADE OF SHEET METAL OR METAL WIRE, AND METAL DOWEL PINS (U.S. CLS. 2, 12, 13, 14, 23, 25 AND 50).

ZHALEH DELANEY, EXAMINING ATTORNEY

**CLASS 6—(Continued).**

SN 76-550,828. XM INTERNATIONAL INC., EAST RUTHERFORD, NJ. FILED 10-10-2003.

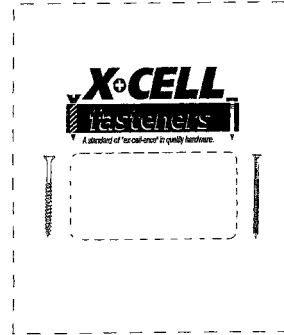

OWNER OF U.S. REG. NOS. 2,577,806 AND 2,584,775. NO CLAIM IS MADE TO THE EXCLUSIVE RIGHT TO USE "FASTENERS" AND THE PICTORIAL REPRESENTATIONS OF THE SCREWS AND NAILS, APART FROM THE MARK AS SHOWN.

THE MARK CONSISTS, IN PART, OF THE COLOR LIGHT BLUE AS APPLIED TO THE PACKAGING FOR THE GOODS AND IS SHOWN AS APPLIED TO THE FRONT FACET OF THE PACKAGING. THE DOTTED OUTLINE IS INTENDED TO SHOW THE POSITION OF THE MARK AND IS NOT PART OF THE MARK. THE SMALLER RECTANGULAR WINDOW IN DOTTED OUTLINE DOES NOT FORM PART OF THE MARK BUT IS ALSO USED TO SHOW PLACEMENT.

FOR METAL FASTENERS, NAMELY, NAILS AND SCREWS (U.S. CLS. 2, 12, 13, 14, 23, 25 AND 50).

FIRST USE 11-10-2000; IN COMMERCE 11-10-2000. ALEX KEAM, EXAMINING ATTORNEY

SN 76-564,678. HARKK PTY LTD, 5013, SOUTH AUSTRALIA, AUSTRALIA, FILED 12-11-2003.

**HARKKEDGE**

**GIGGLE-LINGS**

FOR ORNAMENTAL BELLS, MADE PREDOMINANTLY OF METAL, NAMELY, BELLS DECORATED TO REPRESENT FANCIFUL CHARACTERS, PEOPLE, AND ANIMALS (U.S. CLS. 2, 12, 13, 14, 23, 25 AND 50).

FIRST USE 3-26-2003; IN COMMERCE 3-26-2003. JEFFREY S. MOLINOFF, EXAMINING ATTORNEY

THE MARK CONSISTS OF STANDARD CHARACTERS WITHOUT CLAIM TO ANY PARTICULAR FONT, STYLE, SIZE, OR COLOR.

FOR METAL HANDRAIL ASSEMBLIES, NAMELY, METAL RAILS AND POSTS; METAL OUTDOOR FENCING SCREENS; METAL PARTITION SCREENS; METAL BALUSTRADES (U.S. CLS. 2, 12, 13, 14, 23, 25 AND 50).

GINNY ISAACSON, EXAMINING ATTORNEY

**CLASS 6—(Continued).**

SN 76-567,305. BREEZWAY AUSTRALIA PTY LTD, QUEENSLAND, AUSTRALIA, FILED 12-29-2003.

**PALMAIR**

THE MARK CONSISTS OF STANDARD CHARACTERS WITHOUT CLAIM TO ANY PARTICULAR FONT, STYLE, SIZE, OR COLOR.

FOR LOUVRE WINDOWS MADE WHOLLY OR PRINCIPALLY OF METAL AND PARTS AND FITTINGS THEREOF (U.S. CLS. 2, 12, 13, 14, 23, 25 AND 50).

FIRST USE 11-0-1993; IN COMMERCE 1-0-1994.  
SONYA STEPHENS, EXAMINING ATTORNEY

SN 76-573,107. ARCH ALUMINUM & GLASS CO., INC., TAMARAC, FL. FILED 1-30-2004.

**IFG 5000**

THE MARK CONSISTS OF STANDARD CHARACTERS WITHOUT CLAIM TO ANY PARTICULAR FONT, STYLE, SIZE, OR COLOR.

FOR BUILDING MATERIALS, NAMELY FRAMES MADE OF METAL FOR NON-BEARING EXTERIOR CURTAIN WALLS (U.S. CLS. 2, 12, 13, 14, 23, 25 AND 50).  
CHERYL STEPLIGHT, EXAMINING ATTORNEY

SN 76-576,255. JUPITER ALUMINUM CORP., HAMMOND, IN. FILED 2-19-2004.



OWNER OF U.S. REG. NO. 1,792,929.  
FOR ALUMINUM SHEETS AND COILS (U.S. CLS. 2, 12, 13, 14, 23, 25 AND 50).  
FIRST USE 9-0-1993; IN COMMERCE 9-0-1993.  
ALICE BENMAMAN, EXAMINING ATTORNEY

**CLASS 6—(Continued).**

SN 76-579,013. EXCLUSIVE DOOR HANDLES, INC., DALLAS, TX. FILED 3-2-2004.

**EDH PUSHBOARD**

OWNER OF U.S. REG. NOS. 2,598,481, 2,724,599 AND OTHERS.

FOR METAL HANDLES FOR DOORS (U.S. CLS. 2, 12, 13, 14, 23, 25 AND 50).

FIRST USE 1-30-2004; IN COMMERCE 1-30-2004.  
PAULA MAYS, EXAMINING ATTORNEY

SN 76-590,100. GAME TRACKER, INC., FLUSHING, MI. FILED 5-3-2004.

**EASY START**

FOR METAL SCREW-IN TREE STEPS FOR USE BY HUNTERS (U.S. CLS. 2, 12, 13, 14, 23, 25 AND 50).

FIRST USE 1-0-1983; IN COMMERCE 1-0-1983.  
RUDY R. SINGLETON, EXAMINING ATTORNEY

SN 76-591,898. U.S. PLY, INC., PORT ARTHUR, TX. FILED 5-12-2004.

**PLYFAST**

THE MARK CONSISTS OF STANDARD CHARACTERS WITHOUT CLAIM TO ANY PARTICULAR FONT, STYLE, SIZE, OR COLOR.

FOR METAL DECK FASTENERS, NAMELY, NAILS AND SCREWS; METAL CONCRETE FASTENERS, NAMELY, NAILS AND SCREWS; METAL INSULATION FASTENERS FOR USE IN THE INSTALLATION OF ROOFING, NAMELY, NAILS AND SCREWS (U.S. CLS. 2, 12, 13, 14, 23, 25 AND 50).

RUDY R. SINGLETON, EXAMINING ATTORNEY



**CLASS 6—(Continued).**

SN 78-309,633. BLACK & DECKER CORPORATION, THE, TOWSON, MD. FILED 10-6-2003.

**CLASS 6—(Continued).**

SN 78-381,705. HUTCHINSON & GEBHARDT, INC., LILBURN, GA. FILED 3-10-2004.

**SPIRIT OF PLACE**

FOR METAL DOOR HARDWARE, NAMELY, KNOBS, LEVERS, LEVER SETS, HANDLES, HANDLE SETS, DEAD BOLTS, KEYS AND KEY BLANKS; NON-ELECTRIC METAL DOOR BELLS, METAL DOOR KNOCKERS, METAL DOOR STOPS, NON-MAGNIFIED METAL DOOR VIEWERS, METAL DOOR HINGES, METAL DOOR KICK PLATES, METAL HOUSE ADDRESS NUMBERS (U.S. CLS. 2, 12, 13, 14, 23, 25 AND 50).

BRIAN PINO, EXAMINING ATTORNEY

**CANTSINK**

THE MARK CONSISTS OF STANDARD CHARACTERS WITHOUT CLAIM TO ANY PARTICULAR FONT, STYLE, SIZE, OR COLOR.

FOR SOIL ANCHORS, HELICAL PILES, AND HELICAL PIERS, ALL METALLIC, USED IN BUILDING FOUNDATIONS (U.S. CLS. 2, 12, 13, 14, 23, 25 AND 50).

FIRST USE 10-1-2003; IN COMMERCE 11-15-2003.  
SOPHIA S. KIM, EXAMINING ATTORNEY

SN 78-344,475. NORAM, INC., TUSCALOOSA, AL. FILED 12-22-2003.

SN 78-406,501. FORTRESS BUILDING PRODUCTS, DEPERE, WI. FILED 4-22-2004.



THE LINING SHOWN IN THE DRAWING IS A FEATURE OF THE MARK.

THE COLOR(S) RED, BLUE, BLACK, GREEN AND WHITE IS/ARE CLAIMED AS A FEATURE OF THE MARK.

THE MARK CONSISTS OF THE STYLIZED LETTERING NORAM AND A GLOBE THAT CONTAINS BOTH CONTINENTS DISPLAYED IN GREEN, MERIDIANS AND PARALLELS IN BLACK, TWO ARCS ON EACH SIDE OF THE GLOBE, THE LEFT OF WHICH IS DISPLAYED IN BLUE WITH THE INSIDE OF THE ARC EDGE IN RED AND THE RIGHT ARC IN RED WITH THE INSIDE OF THE ARC EDGE IN BLUE; THE REMAINDER OF THE MARK IS COLORED WHITE.

FOR PAINT SPRAY BOOTHS OF METAL (U.S. CLS. 2, 12, 13, 14, 23, 25 AND 50).

FIRST USE 1-1-1995; IN COMMERCE 1-1-1995.

BRIAN PINO, EXAMINING ATTORNEY

**TRU-ARX RESISTING  
THE FORCES OF  
NATURE**

THE MARK CONSISTS OF STANDARD CHARACTERS WITHOUT CLAIM TO ANY PARTICULAR FONT, STYLE, SIZE, OR COLOR.

FOR BUILDING MATERIALS, NAMELY, ALUMINUM CLADDING FOR CONSTRUCTION AND BUILDING (U.S. CLS. 2, 12, 13, 14, 23, 25 AND 50).

GEORGE LORENZO, EXAMINING ATTORNEY

**CLASS 6—(Continued).**

SN 78-414,555. EDRO ENGINEERING, INC., WALNUT, CA. FILED 5-6-2004.

# THERMALLOY

THE MARK CONSISTS OF STANDARD CHARACTERS WITHOUT CLAIM TO ANY PARTICULAR FONT, STYLE, SIZE, OR COLOR.  
FOR STEEL ALLOY FOR USE IN MOLD FABRICATION (U.S. CLS. 2, 12, 13, 14, 23, 25 AND 50).  
GENE MACIOL, EXAMINING ATTORNEY

SN 78-420,188. HUCK INTERNATIONAL, INC., TUCSON, AZ. FILED 5-17-2004.

# AERO-FLUSH

THE MARK CONSISTS OF STANDARD CHARACTERS WITHOUT CLAIM TO ANY PARTICULAR FONT, STYLE, SIZE, OR COLOR.  
FOR METAL FASTENERS, NAMELY BLIND BOLTS (U.S. CLS. 2, 12, 13, 14, 23, 25 AND 50).  
LESLEY LAMOTHE, EXAMINING ATTORNEY

**CLASS 6—(Continued).**

SN 78-421,788. NEWELL OPERATING COMPANY, FREEPORT, IL. FILED 5-19-2004.

# LEVOLOR

THE MARK CONSISTS OF STANDARD CHARACTERS WITHOUT CLAIM TO ANY PARTICULAR FONT, STYLE, SIZE, OR COLOR.

OWNER OF U.S. REG. NOS. 196,370, 1,450,334 AND 2,015,382.

FOR METAL CABINET HARDWARE, NAMELY, DOOR AND DRAWER PULLS AND KNOBS; METAL DOOR CATCHES AND HINGES; METAL DRAWER SLIDES; METAL DESK HARDWARE, NAMELY, DRAWER PULLS AND KNOBS; METAL ESCUTCHEONS FOR USE BEHIND DOOR HANDLES AND KNOBS; METAL WINDOW SASH LOCKS AND FINGER GRIPS; METAL SHELF HARDWARE, NAMELY, MOUNTING BRACKETS; METAL COAT HOOKS; METAL DOOR STOPS; METAL HANDRAIL BRACKETS; METAL PULLS, ROLLERS AND PULLS FOR SLIDING PATIO DOORS; METAL HARDWARE FOR WINDOWS, NAMELY, FINGER LIFTS, AND METAL COUNTERBALANCING UNITS TO COUNTERBALANCE THE WEIGHT OF WINDOWS (U.S. CLS. 2, 12, 13, 14, 23, 25 AND 50).

BRIDGETT SMITH, EXAMINING ATTORNEY

SN 78-422,329. DANA CORPORATION, TOLEDO, OH. FILED 5-20-2004.

# BOLT-ME

THE MARK CONSISTS OF STANDARD CHARACTERS WITHOUT CLAIM TO ANY PARTICULAR FONT, STYLE, SIZE, OR COLOR.

FOR METAL BOLTS (U.S. CLS. 2, 12, 13, 14, 23, 25 AND 50).

KEVON CHISOLM, EXAMINING ATTORNEY

**CLASS 7—MACHINERY**

SN 76-250,342. HUSKY INJECTION MOLDING SYSTEMS LTD., BOLTON, ONTARIO, CANADA, FILED 5-2-2001.



PRIORITY CLAIMED UNDER SEC. 44(D) ON CANADA APPLICATION NO. 1094561, FILED 3-1-2001, REG. NO. TMA602502, DATED 2-17-2004, EXPIRES 2-17-2019.

THE STYLIZED WORK HYLECTRIC WITH A LIGHTNING BOLT FORMING THE LETTER "Y".

FOR INJECTION MOLDING MACHINES AND RELATED PARTS THEREOF, NAMELY, TAKE-OFF UNITS, ROBOT TRANSFER MECHANISMS, INJECTION-BLOW UNITS, UNSCREWING ATTACHMENTS, SCRAP GRINDERS, CONVEYORS, STACKERS, SORTERS, COOLING UNITS AND INJECTION MOLDS, FOR MOLDING PLASTICS AND OTHER SYNTHETIC RESINS (U.S. CLS. 13, 19, 21, 23, 31, 34 AND 35).

KHANH LE, EXAMINING ATTORNEY

SN 76-320,512. FKI PLC, LONDON, EC4A 1LY, UNITED KINGDOM, FILED 10-2-2001.



OWNER OF ERPN CMNTY TM OFC REG. NO. 002330421, DATED 12-9-2002, EXPIRES 8-6-2011.

SEC. 2(F).

FOR DYNAMOS; ELECTRIC GENERATORS; TRANSMISSION GEARS FOR MACHINES; GEARED ELECTRIC MOTORS FOR MACHINES (U.S. CLS. 13, 19, 21, 23, 31, 34 AND 35).

FIRST USE 12-31-1970; IN COMMERCE 12-31-1970.

VIVIAN MICZNIK FIRST, EXAMINING ATTORNEY

SN 76-537,886. COLLICUTT ENERGY SERVICES, LTD., ALBERTA T4P 3R2, CANADA, FILED 8-15-2003.



FOR STATIONERY AND MOVABLE STANDBY AND PRIME POWER ELECTRIC GENERATOR SYSTEMS CONSISTING OF FOUR STROKE ENGINES, DIESEL AND GAS POWERED GENERATORS, ELECTRIC ALTERNATORS, ELECTRIC CONTROL PANEL, ELECTRIC TRANSFER SWITCH, AND CIRCUIT BREAKERS AND MOUNTED ON A SKID WITH OR WITHOUT ENCLOSURE AND WITH OR WITHOUT A FUEL TANK FOR BOTH MARINE AND LAND BASED APPLICATIONS; ELECTRIC GENERATORS AND PARTS THEREFOR FOR INDUSTRIAL MACHINERY (U.S. CLS. 13, 19, 21, 23, 31, 34 AND 35).

FIRST USE 6-1-1974; IN COMMERCE 6-1-1974.

BARBARA RUTLAND, EXAMINING ATTORNEY

**CLASS 7—(Continued).**

SN 76-540,223. WASTE PROCESSING EQUIPMENT, INC., RAINSVILLE, AL. FILED 8-26-2003.



FOR BALERS AND COMPACTORS FOR WASTE PAPER AND SOLID WASTE (U.S. CLS. 13, 19, 21, 23, 31, 34 AND 35).

FIRST USE 6-0-1976; IN COMMERCE 6-0-1976.

MONIQUE MILLER, EXAMINING ATTORNEY

SN 76-558,556. BIO-MICROBICS INCORPORATED, SHAWNEE, KS. FILED 10-27-2003.



FOR WASTEWATER SEPTIC TANK EFFLUENT PUMP THAT INCLUDES A FILTRATION DEVICE TO PRECLUDE CLOGGING OF THE PUMP (U.S. CLS. 13, 19, 21, 23, 31, 34 AND 35).

FIRST USE 7-28-2003; IN COMMERCE 7-28-2003.

JEFFREY S. MOLINOFF, EXAMINING ATTORNEY

SN 76-564,733. MURRAY, INC., BRENTWOOD, TN. FILED 12-11-2003.



THE MARK CONSISTS OF STANDARD CHARACTERS WITHOUT CLAIM TO ANY PARTICULAR FONT, STYLE, SIZE, OR COLOR.

FOR ELECTRONIC DASHBOARDS FOR LAWN AND GARDEN TRACTORS AND RIDING LAWN MOWERS (U.S. CLS. 13, 19, 21, 23, 31, 34 AND 35).

ARETHA SOMERVILLE, EXAMINING ATTORNEY

**CLASS 7—(Continued).**

SN 76-576,374. MAGNUM INTEGRATED TECHNOLOGIES INC., BRAMPTON, ONTARIO L4W 4T5, CANADA, FILED 2-19-2004.

# AS-U-ROLL

THE MARK CONSISTS OF STANDARD CHARACTERS WITHOUT CLAIM TO ANY PARTICULAR FONT, STYLE, SIZE, OR COLOR.

PRIORITY CLAIMED UNDER SEC. 44(D) ON CANADA APPLICATION NO. 1196978, FILED 11-14-2003, REG. NO. TMA624655, DATED 11-4-2004, EXPIRES 11-4-2019.

FOR MILLING MACHINES, NAMELY ROLLING MILLS FOR ROLLING, REDUCING AND FINISHING METAL AND ALLOYS; MILLING MACHINES, NAMELY, ROLLING MILLS FOR ROLLING METAL; MILLING MACHINES, NAMELY, ROLLING MILLS FOR REDUCING METAL; MILLING MACHINES, NAMELY ROLLING MILLS FOR FINISHING METAL; MILLING MACHINES, NAMELY, ROLLING MILLS FOR ROLLING ALLOYS; MILLING MACHINES, NAMELY, ROLLING MILLS FOR REDUCING ALLOYS; MILLING MACHINES, NAMELY ROLLING MILLS FOR FINISHING ALLOYS (U.S. CLS. 13, 19, 21, 23, 31, 34 AND 35).

FIRST USE 3-1-1968; IN COMMERCE 3-1-1968.  
HOWARD SMIGA, EXAMINING ATTORNEY

**CLASS 7—(Continued).**

SN 76-579,771. KUAN CHANG CO., LTD., TAIPEI COUNTRY, TAIWAN, FILED 3-8-2004.



FOR POWER OPERATED PAINT AND GLUE SPRAYERS; POWER OPERATED ELECTROSTATIC COATING MACHINES; SPRAY GUNS FOR PAINT AND ELECTRIC GLUE GUNS (U.S. CLS. 13, 19, 21, 23, 31, 34 AND 35).

KAREN BRACEY, EXAMINING ATTORNEY

SN 76-590,863. VARCO I/P, INC., HOUSTON, TX. FILED 5-6-2004.

# ROTO-DRIVER

THE MARK CONSISTS OF STANDARD CHARACTERS WITHOUT CLAIM TO ANY PARTICULAR FONT, STYLE, SIZE, OR COLOR.

OWNER OF U.S. REG. NO. 2,766,597.

FOR OIL AND GAS WELL TOOLS, NAMELY, HYDRAULICALLY POWERED IMPACT DRILLS AND PARTS AND ATTACHMENTS THEREOF (U.S. CLS. 13, 19, 21, 23, 31, 34 AND 35).

JENNIFER KRISP, EXAMINING ATTORNEY

SN 76-576,916. RPM OUTLET, INC, STAFFORD, TX. FILED 12-8-2003.

# MOTOBLUE

THE MARK CONSISTS OF STANDARD CHARACTERS WITHOUT CLAIM TO ANY PARTICULAR FONT, STYLE, SIZE, OR COLOR.

FOR AFTER MARKET AUTOMOTIVE PARTS NAMELY UPPER BLOWER PULLEY, LOWER CRANK PULLEY, HEADERS, U-BOLT CLAMPS AND FRONT HANGER, SUPER-CHARGED HEAT EXCHANGER, DIESEL TURBO-DOWN PIPE, OVERDRIVE WATER PUMPS, ALUMINIZED STEEL EXHAUST, WATER PUMP PULL-EY, 3-STAGE POWER MODULE, EXHAUST TIP, WATER PUMP AND ALTERNATOR (U.S. CLS. 13, 19, 21, 23, 31, 34 AND 35).

TARAH HARDY, EXAMINING ATTORNEY

SN 76-592,801. ECKEL MANUFACTURING CO., INC., ODESSA, TX. FILED 5-12-2004.

# CHROMEBOSS

OWNER OF U.S. REG. NOS. 1,165,238 AND 1,365,227.  
FOR POWER TONGS (U.S. CLS. 13, 19, 21, 23, 31, 34 AND 35).

FIRST USE 5-3-2004; IN COMMERCE 5-3-2004.  
CHERYL CLAYTON, EXAMINING ATTORNEY

**CLASS 7—(Continued).**

SN 78-122,973. KG INTERNATIONAL FZCO, DUBAI, ARAB EMIRATES, FILED 4-19-2002.



OWNER OF ARAB EMIRATES REG. NO. 38736, DATED 4-28-2003, EXPIRES 4-28-2013.  
FOR BALL AND ROLLER BEARINGS (U.S. CLS. 13, 19, 21, 23, 31, 34 AND 35).  
DARRYL SPRUILL, EXAMINING ATTORNEY

**BALE BUSTER**

NO CLAIM IS MADE TO THE EXCLUSIVE RIGHT TO USE "BALE", APART FROM THE MARK AS SHOWN.  
FOR AGRICULTURAL MACHINES, NAMELY, SELF LOADING BALE MOVERS (U.S. CLS. 13, 19, 21, 23, 31, 34 AND 35).  
PRISCILLA MILTON, EXAMINING ATTORNEY

**CLASS 7—(Continued).**

SN 78-218,463. KOBZAR, VICTOR, BERLIN, FED REP GERMANY, FILED 2-24-2003.



OWNER OF FED REP GERMANY REG. NO. 30073850, DATED 2-21-2001, EXPIRES 10-31-2010.

FOR MACHINES AND MACHINE TOOLS, NAMELY ELECTRICALLY-POWERED DRILLING MACHINES AND ELECTRIC HAND-HELD DRILLS; MILLING MACHINES; CONVEYING SYSTEM EQUIPMENT, NAMELY, BLOWERS; MULTI-PURPOSE HIGH PRESSURE WASHERS; POWER TOOLS, NAMELY, THREAD MILLS; AIR COMPRESSORS; COMPRESSORS FOR MACHINES; ELECTRIC FOOD BLENDERS; KITCHEN MACHINES, NAMELY, MIXERS; POLISHING MACHINES FOR USE IN GRINDING AND POLISHING METAL, WOOD, CERAMICS AND PLASTICS; POWER-OPERATED FLOOR BURNISHERS; LAWN MOWERS; POWER-OPERATED GRASS/WEED TRIMMERS; ELECTRIC POWER-OPERATED SAWS; CIRCULAR SAWS; BLADES FOR POWER SAWS; ELECTRIC SCISSORS; POWER-OPERATED TOOLS, NAMELY, GRINDERS, ANGLE GRINDERS, AND STRAIGHT GRINDERS; ABRASIVE DISKS FOR POWER-OPERATED GRINDERS; MACHINES FOR THE CUTTING AND FORMING OF MATERIALS; ELECTRIC WELDING MACHINES; AUTOMATIC DISHWASHING MACHINES; ALL-PURPOSE VACUUM CLEANERS; ELECTRIC GENERATORS; POWER-OPERATED ABRASIVE WHEELS; FANS FOR MACHINE ENGINES; ELECTRIC FANS; VENTILATING FANS FOR COMMERCIAL AND INDUSTRIAL USE; CLOTHES WASHING MACHINES; DISH WASHING MACHINES; FLOOR WASHING MACHINES; PRESSURE WASHING MACHINES; WINCHES; ENGINES NOT FOR LAND VEHICLES; CLUTCHES FOR MACHINES; POWER TRANSMISSION BELTS FOR MACHINES; TRANSMISSION GEARS FOR MACHINES (U.S. CLS. 13, 19, 21, 23, 31, 34 AND 35).

NELSON SNYDER, EXAMINING ATTORNEY

SN 78-269,551. XALOY INCORPORATED, PULASKI, VA. FILED 7-2-2003.

**EASYMELT**

FOR FEED SCREWS FOR USE IN EXTRUSION AND INJECTION MOLDING MACHINES (U.S. CLS. 13, 19, 21, 23, 31, 34 AND 35).

JOHN KELLY, EXAMINING ATTORNEY

SN 78-278,664. ENERGY CRANES LLC, HOUSTON, TX. FILED 7-24-2003.

**HSMC**

OWNER OF U.S. REG. NO. 2,000,364.

FOR CRANE SYSTEMS COMPRISING CRANES, RIG SKIDDING, LEVELING JACKS, MOTION COMPENSATORS, LINE-UP STATIONS, CONVEYORS, POWER UNITS AND CONTROLS THEREFOR ALL SOLD AS A UNIT (U.S. CLS. 13, 19, 21, 23, 31, 34 AND 35).

FIRST USE 0-0-1995; IN COMMERCE 0-0-1995.

LINDA MICKLEBURGH, EXAMINING ATTORNEY

**CLASS 7—(Continued).**

SN 78-278,672. ENERGY CRANES LLC, HOUSTON, TX.  
FILED 7-24-2003.

## HOUSTON SYSTEMS MARINE PRODUCTS

OWNER OF U.S. REG. NO. 2,151,098.  
NO CLAIM IS MADE TO THE EXCLUSIVE RIGHT TO USE "HOUSTON" AND "MARINE PRODUCTS", APART FROM THE MARK AS SHOWN.  
FOR CRANE SYSTEMS COMPRISING CRANES, RIG SKIDDING, LEVELING JACKS, MOTION COMPENSATORS, LINE-UP STATIONS, CONVEYORS, POWER UNITS AND CONTROLS THEREFOR ALL SOLD AS A UNIT (U.S. CLS. 13, 19, 21, 23, 31, 34 AND 35).  
FIRST USE 11-0-1997; IN COMMERCE 11-0-1997.  
LINDA MICKLEBURGH, EXAMINING ATTORNEY

SN 78-278,679. ENERGY CRANES LLC, HOUSTON, TX.  
FILED 7-24-2003.

## HERCULES MARINE PRODUCTS

OWNER OF U.S. REG. NO. 2,084,360.  
NO CLAIM IS MADE TO THE EXCLUSIVE RIGHT TO USE "MARINE PRODUCTS", APART FROM THE MARK AS SHOWN.  
FOR LOAD BLOCKS AND STRUCTURAL PARTS THEREFOR, FOR OFFSHORE USAGE (U.S. CLS. 13, 19, 21, 23, 31, 34 AND 35).  
FIRST USE 11-0-1996; IN COMMERCE 11-0-1996.  
LINDA MICKLEBURGH, EXAMINING ATTORNEY

SN 78-296,382. CHAN, SIU FAI, WEIFANG, CHINA, FILED 9-4-2003.

## CAMDEX

THE MARK CONSISTS OF SIX (6) STYLIZED ENGLISH LETTERS IN THE ORDER OF C A M D E X.  
FOR CAMS AND INDEXING DRIVE UNITS, TORQUE REDUCERS UNIT, PRECISION MOTION CONTROL UNITS COMPRISED OF CAMS, GEARS AND MOTORS (U.S. CLS. 13, 19, 21, 23, 31, 34 AND 35).  
AISHA CLARKE, EXAMINING ATTORNEY

**CLASS 7—(Continued).**

SN 78-297,842. COTTING, STEVEN R., ATLANTA, GA.  
FILED 9-9-2003.

## DOUBLE-TUBE

SEC. 2(F).  
FOR CHEMICAL PROCESSING EQUIPMENT, NAMELY, A REACTOR, IN WHICH A PORTION OF A REACTION TUBE CONTAINING A CENTER RETURN TUBE EXTENDS WITHIN A FURNACE ENCLOSURE FOR THE PRODUCTION OF HYDROGEN (U.S. CLS. 13, 19, 21, 23, 31, 34 AND 35).  
FIRST USE 11-19-1999; IN COMMERCE 11-19-1999.  
LEIGH CAROLINE CASE, EXAMINING ATTORNEY

SN 78-303,597. THE HOOVER COMPANY, NORTH CANTON, OH. FILED 9-22-2003.

## MASTER YOUR TIME AND SPACE

FOR FLOOR CARE APPLIANCES, NAMELY, VACUUM CLEANERS, BARE FLOOR CLEANING MACHINES, DEEP CARPET CLEANING MACHINES, CARPET SHAMPOOING MACHINES, FLOOR POLISHING MACHINES; AND PARTS THEREFOR. (U.S. CLS. 13, 19, 21, 23, 31, 34 AND 35).  
DOMINIC J. FERRAIUOLO, EXAMINING ATTORNEY

SN 78-303,630. THE HOOVER COMPANY, NORTH CANTON, OH. FILED 9-22-2003.

## LET VIVO DO IT

THE FOREIGN WORDING IN THE MARK TRANSLATES INTO ENGLISH AS I LIVE.  
FOR FLOOR CARE APPLIANCES, NAMELY, VACUUM CLEANERS, BARE FLOOR CLEANING MACHINES, DEEP CARPET CLEANING MACHINES, CARPET SHAMPOOING MACHINES, FLOOR POLISHING MACHINES; AND PARTS THEREFOR. (U.S. CLS. 13, 19, 21, 23, 31, 34 AND 35).  
DOMINIC J. FERRAIUOLO, EXAMINING ATTORNEY

**CLASS 7—(Continued).**

SN 78-316,750. HAYDEN INDUSTRIES INC., ONTARIO, CANADA, FILED 10-21-2003.



OWNER OF U.S. REG. NO. 2,106,134.  
NO CLAIM IS MADE TO THE EXCLUSIVE RIGHT TO USE "CENTRAL VACUUM SYSTEMS", APART FROM THE MARK AS SHOWN.

FOR CENTRAL VACUUM CLEANERS AND PARTS AND FITTINGS THEREFOR; VACUUM CLEANER ATTACHMENTS, NAMELY, SECTION NOZZLES, BAGS, HOSES, WANDS AND BRUSHES (U.S. CLS. 13, 19, 21, 23, 31, 34 AND 35).

FIRST USE 10-0-2001; IN COMMERCE 10-0-2001.  
CAROLINE WOOD, EXAMINING ATTORNEY

**CLASS 7—(Continued).**

SN 78-330,414. ZACH & DANI'S, LLC, GREENWOOD VILLAGE, CO. FILED 11-19-2003.



OWNER OF U.S. REG. NOS. 2,682,850 AND 2,701,006.  
FOR ELECTRIC COFFEE GRINDERS (U.S. CLS. 13, 19, 21, 23, 31, 34 AND 35).  
FIRST USE 7-1-2002; IN COMMERCE 7-1-2002.  
MARIA-VICTORIA SUAREZ, EXAMINING ATTORNEY

SN 78-318,093. STOUT TOOL CORP., WIXOM, MI. FILED 10-24-2003.

**STOUT TOOL CORP.**

NO CLAIM IS MADE TO THE EXCLUSIVE RIGHT TO USE "TOOL CORP.", APART FROM THE MARK AS SHOWN.

FOR POWER OPERATED HAND TOOLS, NAMELY, BAND SAWS (U.S. CLS. 13, 19, 21, 23, 31, 34 AND 35).

FIRST USE 8-10-2003; IN COMMERCE 8-10-2003.  
TINA L. SNAPP, EXAMINING ATTORNEY

SN 78-368,687. BEKO CONDENSATE SYSTEMS CORPORATION, DBA BEKO TECHNOLOGIES CORPORATION, MOORESVILLE, NORTH CAROLINA, OH. FILED 2-16-2004.

**QWIK-PURE**

SN 78-320,473. REEDHYCLOG, L.P., HOUSTON, TX. FILED 10-29-2003.

**TREX**

FOR TOOL, SPECIFICALLY A POLYCRYSTALLINE DIAMOND COMPACT CUTTER USED AS A CUTTING ELEMENT FOR SHEARING ROCK IN THE OIL AND GAS INDUSTRY (U.S. CLS. 13, 19, 21, 23, 31, 34 AND 35).  
FIRST USE 10-31-2001; IN COMMERCE 10-31-2001.  
TRICIA SONNEBORN, EXAMINING ATTORNEY

THE MARK CONSISTS OF STANDARD CHARACTERS WITHOUT CLAIM TO ANY PARTICULAR FONT, STYLE, SIZE, OR COLOR.

FOR OIL/WATER SEPARATOR FOR COMPRESSOR CONDENSATE (U.S. CLS. 13, 19, 21, 23, 31, 34 AND 35).  
FIRST USE 5-1-2003; IN COMMERCE 5-1-2003.  
CHARLES L. JENKINS, EXAMINING ATTORNEY

**CLASS 7—(Continued).**

SN 78-388,128. WASKO, ERIK, C., BOYNTON BEACH, FL. FILED 3-21-2004.

**CLASS 7—(Continued).**

SN 78-403,654. WINKLER, MIKE V., ALBUQUERQUE, NM. FILED 4-17-2004.

Multi Trac

vorturi

THE MARK CONSISTS OF STANDARD CHARACTERS WITHOUT CLAIM TO ANY PARTICULAR FONT, STYLE, SIZE, OR COLOR.

FOR HAND-HELD PNEUMATIC NAILING GUNS; POWER-OPERATED NAILING GUNS (U.S. CLS. 13, 19, 21, 23, 31, 34 AND 35).

STANLEY I. OSBORNE, EXAMINING ATTORNEY

THE MARK CONSISTS OF STANDARD CHARACTERS WITHOUT CLAIM TO ANY PARTICULAR FONT, STYLE, SIZE, OR COLOR.

FOR VEHICLE ENGINE PARTS, NAMELY, VORTEX-INDUCING UNITS FOR VENTURI TUBES WHICH INCREASE INTERNAL COMBUSTION ENGINE EFFICIENCY (U.S. CLS. 13, 19, 21, 23, 31, 34 AND 35).

IRA J. GOODSaid, EXAMINING ATTORNEY

SN 78-406,296. SPRAYING SYSTEMS COMPANY, WHEATON, IL. FILED 4-22-2004.

SN 78-394,100. COLLINS INDUSTRIES, INC., HUTCHINSON, KS. FILED 3-31-2004.

DIGMASTER

QCIMEG

THE MARK CONSISTS OF STANDARD CHARACTERS WITHOUT CLAIM TO ANY PARTICULAR FONT, STYLE, SIZE, OR COLOR.

FOR EARTH MOVING MACHINES, NAMELY BACK-HOE LOADERS (U.S. CLS. 13, 19, 21, 23, 31, 34 AND 35).

MICHAEL KEATING, EXAMINING ATTORNEY

THE MARK CONSISTS OF STANDARD CHARACTERS WITHOUT CLAIM TO ANY PARTICULAR FONT, STYLE, SIZE, OR COLOR.

FOR MACHINE PARTS, NAMELY SPRAY NOZZLES WHICH ARE PARTS OF HIGH PRESSURE CLEANING EQUIPMENT FOR INDUSTRIAL USES (U.S. CLS. 13, 19, 21, 23, 31, 34 AND 35).

FIRST USE 7-1-1998; IN COMMERCE 7-1-1998.

JOANNA DUKOVIC, EXAMINING ATTORNEY



**CLASS 7—(Continued).**

SN 78-408,760. SPRAYING SYSTEMS COMPANY, WHEATON, IL. FILED 4-27-2004.

**CLASS 7—(Continued).**

SN 78-418,656. BSH HOME APPLIANCES CORPORATION, HUNTINGTON BEACH, CA. FILED 5-14-2004.

Paradigm

QCZMEG

THE MARK CONSISTS OF STANDARD CHARACTERS WITHOUT CLAIM TO ANY PARTICULAR FONT, STYLE, SIZE, OR COLOR.

FOR ELECTRIC KITCHEN MACHINES AND EQUIPMENT FOR DOMESTIC FOOD AND BEVERAGE PREPARATION AND PROCESSING, NAMELY MINCING MACHINES, MIXING AND KNEADING MACHINES, PRESSING MACHINES, JUICE EXTRACTORS, JUICE CENTRIFUGES, GRINDERS, SLICING MACHINES, AND PARTS THEREFOR; ELECTRIC MOTOR-DRIVEN TOOLS, NAMELY, ELECTRIC CAN OPENERS, KNIFE SHARPENERS AND PARTS THEREFOR; ELECTRIC WASTE DISPOSAL UNITS, NAMELY, WASTE MASTICATORS AND COMPRESSORS AND PARTS THEREFOR; DISHWASHERS AND PARTS THEREFOR; ELECTRIC MACHINES AND APPLIANCES FOR TREATING LAUNDRY AND CLOTHING, NAMELY, WASHING MACHINES, LAUNDRY PRESSES, CLOTHES IRONING MACHINES AND PARTS THEREFOR; ELECTRIC CLEANING EQUIPMENT FOR HOUSEHOLD USE, NAMELY, WINDOW CLEANING MACHINES, SHOE CLEANING MACHINES AND PARTS THEREFOR; VACUUM CLEANERS AND PARTS THEREFOR, NAMELY, VACUUM CLEANER HOSES, PIPES, DUST FILTERS AND DUST FILTER BAGS (U.S. CLS. 13, 19, 21, 23, 31, 34 AND 35).

MICHAEL HALL, EXAMINING ATTORNEY

THE MARK CONSISTS OF STANDARD CHARACTERS WITHOUT CLAIM TO ANY PARTICULAR FONT, STYLE, SIZE, OR COLOR.

FOR MACHINE PARTS, NAMELY, SPRAY NOZZLES AS PART OF POWER OPERATED SPRAYERS FOR INDUSTRIAL APPLICATIONS (U.S. CLS. 13, 19, 21, 23, 31, 34 AND 35).

FIRST USE 1-31-2004; IN COMMERCE 1-31-2004.  
JOANNA DUKOVIC, EXAMINING ATTORNEY

**CLASS 7—(Continued).**

SN 78-421,652. MIZUNAMI SEIKI CO., LTD., GIFU-KEN, JAPAN, FILED 5-19-2004.

# CELADE

THE MARK CONSISTS OF STANDARD CHARACTERS WITHOUT CLAIM TO ANY PARTICULAR FONT, STYLE, SIZE, OR COLOR.

FOR PRINTING MACHINES AND PARTS THEREFOR AND DUPLICATORS; DIGITAL PRINTING MACHINES, INCLUDING DIGITAL MIMEOGRAPHING PRINTING MACHINES AND PARTS THEREFOR; DIGITAL DUPLICATORS (U.S. CLS. 13, 19, 21, 23, 31, 34 AND 35).

CHERYL CLAYTON, EXAMINING ATTORNEY

SN 79-000,251. SEB, FRANCE, FILED 11-26-2003.

# FRESH X PRESS

THE MARK CONSISTS OF STANDARD CHARACTERS WITHOUT CLAIM TO ANY PARTICULAR FONT, STYLE, SIZE, OR COLOR.

PRIORITY DATE OF 6-2-2003 IS CLAIMED.

OWNER OF INTERNATIONAL REGISTRATION 0815845 DATED 11-26-2003, EXPIRES 11-26-2013.

OWNER OF U.S. REG. NO. 2,416,093.

NO CLAIM IS MADE TO THE EXCLUSIVE RIGHT TO USE FRESH, APART FROM THE MARK AS SHOWN.

FOR FOOD MIXERS, ELECTRIC FOOD PROCESSORS, ELECTRIC MACHINES TO SQUEEZE CITRUS FRUIT, ELECTRIC JUICE EXTRACTORS (U.S. CLS. 13, 19, 21, 23, 31, 34 AND 35).

WILLIAM BRECKENFELD, EXAMINING ATTORNEY

**CLASS 8—HAND TOOLS**

SN 76-547,388. TIMBERWOLF CORPORATION, WHITEFISH, MT. FILED 9-12-2003.

# TIMBERLINE TOOL

NO CLAIM IS MADE TO THE EXCLUSIVE RIGHT TO USE TOOL, APART FROM THE MARK AS SHOWN.

FOR HAND TOOLS FOR USE ON PIPES AND HOSES, NAMELY, SQUEEZE-OFF TOOLS FOR RESTRICTING FLOW IN PLASTIC PIPES AND HOSES (U.S. CLS. 23, 28 AND 44).

CHRISTOPHER BUONGIORNO, EXAMINING ATTORNEY

**CLASS 8—(Continued).**

SN 76-559,706. C.A.S. IBERIA, INC., SALE CREEK, TN. FILED 10-30-2003.

# ZATOICHI

FOR JAPANESE STYLE SWORDS (U.S. CLS. 23, 28 AND 44).

FIRST USE 7-2-1999; IN COMMERCE 7-2-1999.

GRETTA YAO, EXAMINING ATTORNEY

SN 76-566,152. BLUE WIZARD INDUSTRIES LLC, ROCKVILLE CENTRE, NY. FILED 12-19-2003.

# STEEL WIZARD

THE MARK CONSISTS OF STANDARD CHARACTERS WITHOUT CLAIM TO ANY PARTICULAR FONT, STYLE, SIZE, OR COLOR.

NO CLAIM IS MADE TO THE EXCLUSIVE RIGHT TO USE "STEEL", APART FROM THE MARK AS SHOWN.

FOR MANUALLY OPERATED HAND TOOLS, NAMELY, MAGNETIC HAND TOOLS USED FOR ALL PURPOSE CLEANING (U.S. CLS. 23, 28 AND 44).

YSA DEJESUS, EXAMINING ATTORNEY

SN 76-566,447. BLITZ U.S.A., INC., MIAMI, OK. FILED 12-22-2003.

# ICE BUSTER

THE MARK CONSISTS OF STANDARD CHARACTERS WITHOUT CLAIM TO ANY PARTICULAR FONT, STYLE, SIZE, OR COLOR.

OWNER OF U.S. REG. NO. 1,224,291.

NO CLAIM IS MADE TO THE EXCLUSIVE RIGHT TO USE ICE, APART FROM THE MARK AS SHOWN.

FOR ICE SCRAPER (U.S. CLS. 23, 28 AND 44).

JAMES GRIFFIN, EXAMINING ATTORNEY

**CLASS 8—(Continued).**

SN 76-588,326. SOUTHEASTERN DEVELOPMENT, INC.,  
LOUISVILLE, KY. FILED 4-20-2004.

**STOPSA-DROP**

THE MARK CONSISTS OF STANDARD CHARACTERS  
WITHOUT CLAIM TO ANY PARTICULAR FONT, STYLE,  
SIZE, OR COLOR.

FOR TOOL BELTS IN THE NATURE OF BELTS  
INCORPORATING RETRACTABLE CORDS TETHERED  
TO TOOLS (U.S. CLS. 23, 28 AND 44).

FIRST USE 4-1-2004; IN COMMERCE 4-1-2004.  
ALLISON HOLTZ, EXAMINING ATTORNEY

SN 78-255,004. "JAGUAR" STAHLWARENFABRIK GMBH &  
CO. KG, SOLINGEN, FED REP GERMANY, FILED 5-28-  
2003.



OWNER OF FED REP GERMANY REG. NO. 30242975,  
DATED 11-11-2002, EXPIRES 8-31-2012.

NO CLAIM IS MADE TO THE EXCLUSIVE RIGHT TO  
USE STEEL, APART FROM THE MARK AS SHOWN.

FOR CUTLERY, NAMELY KNIVES, PRUNING SCIS-  
SORS, RAZORS, RAZOR BLADES, SAFETY RAZORS,  
THINNING RAZOR TOOLS, NAMELY THINNERS,  
NAIL SCISSORS, NAIL CLIPPERS, BARBER SCISSORS,  
THINNING SCISSORS, TWEEZERS, NAIL FILES, POK-  
ET KNIVES, TABLE KNIVES, STEAK KNIVES, KITCH-  
EN KNIVES, NON-ELECTRIC HAIR CLIPPERS,  
COSMETIC EQUIPMENT, NAMELY NASAL SCISSORS,  
CUTICLE SCISSORS, CUTICLE NIPPERS, NAIL NIP-  
PERS, CUTICLE KNIVES; HAND TOOLS, NAMELY  
HORNSKIN SCRAPER, HORNSKIN SCRAPER  
BLADES, MANICURE SETS, BAGS AND BOXES COM-  
PRISED OF THE AFOREMENTIONED GOODS (U.S.  
CLS. 23, 28 AND 44).

BRIDGETT SMITH, EXAMINING ATTORNEY

**CLASS 8—(Continued).**

SN 78-334,315. LOIK, JAMES B, KINGSTON, NH. FILED 12-1-  
2003.

**THE STRAW WIZARD**

THE MARK CONSISTS OF STANDARD CHARACTERS  
WITHOUT CLAIM TO ANY PARTICULAR FONT, STYLE,  
SIZE, OR COLOR.

NO CLAIM IS MADE TO THE EXCLUSIVE RIGHT TO  
USE "STRAW", APART FROM THE MARK AS SHOWN.

FOR HAND OPERATED CRAFT TOOL USED TO CUT  
DRINKING STRAWS INTO ENTERTAINING AND/OR  
DECORATIVE SHAPES (U.S. CLS. 23, 28 AND 44).

FIRST USE 5-14-2003; IN COMMERCE 11-19-2003.  
INGA ERVIN, EXAMINING ATTORNEY

SN 78-378,619. OCAMICA HERMANOS S.A., GUIPUZCOA,  
SPAIN, FILED 3-4-2004.



FOR TOOLS AND HAND OPERATED IMPLEMENTS  
USED AS TOOLS, IN PARTICULAR HAND JACKS AND  
SQUARES (U.S. CLS. 23, 28 AND 44).

JENNIFER KRISP, EXAMINING ATTORNEY

SN 78-421,806. NEWELL OPERATING COMPANY, FREE-  
PORT, IL. FILED 5-19-2004.

**LEVOLOR**

THE MARK CONSISTS OF STANDARD CHARACTERS  
WITHOUT CLAIM TO ANY PARTICULAR FONT, STYLE,  
SIZE, OR COLOR.

OWNER OF U.S. REG. NOS. 196,370, 1,450,334 AND  
2,015,382.

FOR HAND HELD WRENCHES FOR USE IN INSTAL-  
LING CABINET PULLS, KNOBS, HINGES, CATCHES,  
MOLDINGS AND DRAWER SLIDES; HAND HELD  
WRENCHES AND PLIERS FOR ADJUSTING HINGES  
(U.S. CLS. 23, 28 AND 44).

BRIDGETT SMITH, EXAMINING ATTORNEY

**CLASS 9—ELECTRICAL AND SCIENTIFIC APPARATUS**

SN 75-921,947. ACME LAUNDRY PRODUCTS, INC., CHATSWORTH, CA. FILED 2-17-2000.

**HI-TEC**

FOR REUSABLE PROTECTIVE CLOTHING AND FOOTWEAR FOR INDUSTRIAL USE (U.S. CLS. 21, 23, 26, 36 AND 38).

FIRST USE 9-0-1983; IN COMMERCE 9-0-1983.  
MIDGE BUTLER, EXAMINING ATTORNEY

SN 76-150,765. CSI TECHNOLOGY, INC., WILMINGTON, DE. FILED 10-20-2000.



OWNER OF U.S. REG. NOS. 1,943,477 AND 2,413,722.  
FOR PREDICTIVE INSTRUMENTS AND COMPUTER PROGRAMS FOR USE IN DETERMINING THE MAINTENANCE STATUS OF MACHINERY AND EQUIPMENT, NAMELY, MICROPROCESSOR BASED MONITORS, DATA COLLECTORS AND ANALYZERS FOR COLLECTING, STORING AND ANALYZING DATA RELATING TO THE VIBRATION, ALIGNMENT AND BALANCE STATUS OF INDUSTRIAL MACHINES; SHAFT ALIGNMENT DETECTORS AND ANALYZERS FOR MONITORING THE ALIGNMENT STATUS OF MATED SHAFTS; MONITORS AND ANALYZERS FOR DETECTING AND ANALYZING THE BALANCE OF ROTATING MACHINERY AND EQUIPMENT PARTS; INSTRUMENT FOR ANALYZING AND QUANTIFYING THE LUBRICATING CHARACTERISTICS OF USED LUBRICANTS, ACCELEROMETERS, VELOCITY AND DISPLACEMENT PROBES, AND THERMAL SENSORS; AND SOFTWARE FOR USE IN STORING, ANALYZING AND REPORTING MAINTENANCE DATA AND GENERATING MAINTENANCE STATUS REPORTS FOR INDUSTRIAL MACHINERY AND EQUIPMENT (U.S. CLS. 21, 23, 26, 36 AND 38).

FIRST USE 0-0-1992; IN COMMERCE 0-0-1992.  
BRIAN BROWN, EXAMINING ATTORNEY

SN 76-183,486. TIRE PRESSURE CONTROL INTERNATIONAL LTD., EDMONTON, ALBERTA, CANADA, FILED 12-20-2000.

**TIREBOSS**

PRIORITY CLAIMED UNDER SEC. 44(D) ON CANADA APPLICATION NO. 1065835, FILED 7-5-2000, REG. NO. TMA569,342, DATED 10-22-2002, EXPIRES 10-22-2017.

FOR TIRE PRESSURE CONTROL SYSTEMS COMPRISED OF A COMPUTERIZED OPERATOR CONTROL/DISPLAY UNIT, A COMPUTERIZED VALVE CONTROL MODULE, AND AIR CONTROL VALVES THAT ENABLE A VEHICLE'S TIRE PRESSURE TO BE INCREASED OR DECREASED WHILE THE VEHICLE IS MOVING (U.S. CLS. 21, 23, 26, 36 AND 38).

KATHY DE JONGE, EXAMINING ATTORNEY

**CLASS 9—(Continued).**

SN 76-210,011. NORDEA BANK FINLAND ABP, HELSINKI, FINLAND, FILED 2-12-2001.

**SOLO**

OWNER OF U.S. REG. NO. 2,252,393.

FOR AUTOMATED TELLER MACHINES; AUTOMATIC BANK NOTE DISPENSERS, NAMELY, AUTOMATIC PAPER MONEY SORTING MACHINES; BANK CARDS INCORPORATING DATA CARRIERS; MAGNETICALLY ENCODED DEBIT CARDS; MAGNETIC ENCODED CARD READERS FOR CREDIT CARDS; COMPUTER TERMINALS FOR USE WITH CREDIT CARDS AND DEBIT CARDS; MAGNETICALLY ENCODED CREDIT CARDS FOR ELECTRONIC FUNDS TRANSFER AND FINANCIAL TRANSACTIONS; APPARATUS FOR PAYMENT WITH MAGNETIC MEMORY CARDS, NAMELY, COMPUTER TERMINALS; APPARATUS FOR RECEIVING, CASH PAYMENTS, NAMELY, AUTOMATIC TELLER MACHINES; AUTOMATIC PAYMENT MACHINES, NAMELY, AUTOMATED BANKING MACHINES; ELECTRONIC IDENTIFICATION CARDS FOR USE IN PAYING FOR SERVICES; MACHINE READABLE DEVICES, CONSISTING OF DISKETTES, MAGNETIC TAPES AND BAR CODE CARRIERS FOR CASHLESS PAYMENT SYSTEMS; MAGNETIC AND ENCODED PAYMENT CARDS; PAYMENT CARDS INCORPORATING DATA CARRIERS; EQUIPMENT FOR TELECOMMUNICATION AND INTERACTIVE COMMUNICATION, NAMELY, COMPUTERS, TELEPHONES, RADIOS AND TELEVISIONS; COMPUTER COMMUNICATIONS SOFTWARE TO ALLOW CUSTOMERS TO ACCESS BANK ACCOUNT INFORMATION AND TRANSACT BANKING BUSINESS; COMPUTER E-COMMERCE SOFTWARE FOR VERIFYING AND FACILITATING ON-LINE RETAIL SALES AND BUSINESS TO BUSINESS TRANSACTIONS; COMPUTER E-COMMERCE SOFTWARE TO ALLOW USERS TO PERFORM ELECTRONIC BUSINESS TRANSACTIONS VIA A GLOBAL COMPUTER NETWORK EXCLUDING PERSONAL COMPUTERS AND PERSONAL COMPUTER TERMINALS (U.S. CLS. 21, 23, 26, 36 AND 38).

ALEXANDER L. POWERS, EXAMINING ATTORNEY

SN 76-286,751. MITSUBISHI ELECTRIC CORPORATION, CHIYODA-KU, TOKYO, JAPAN, FILED 7-17-2001.

**SOLARBIRD**

OWNER OF JAPAN REG. NO. 4496264, DATED 8-3-2001, EXPIRES 8-3-2011.

FOR SOLAR POWER SATELLITES; SPACE SOLAR POWER GENERATION SYSTEMS CONSISTING OF REFLECTION MIRRORS, SOLAR CELLS, CONVERTERS OF SOLAR POWER TO MICROWAVE, ANTENNAS FOR TRANSMITTING MICROWAVE TO AN EARTH STATION, PILOT SIGNAL RECEIVERS, PILOT SIGNAL TRANSMITTERS, ANTENNAS FOR RECEIVING MICROWAVE FROM A SPACE STATION, CONVERTERS OF MICROWAVE TO DIRECT CURRENT, CONVERTERS OF DIRECT CURRENT TO ALTERNATING CURRENT, TRANSFORMERS AND COMPUTERS AND COMPUTER SOFTWARE FOR CONTROLLING AND MONITORING OPERATION OF SPACE SOLAR POWER GENERATION SYSTEMS (U.S. CLS. 21, 23, 26, 36 AND 38).

JAMES A. RAUEN, EXAMINING ATTORNEY

**CLASS 9—(Continued).**

SN 76-394,280. BOHLIN INSTRUMENTS LIMITED, CIRENCESTER, GLOUCESTER, GREAT BRITAIN, FILED 4-12-2002.

**GEMINI**

OWNER OF ERPN CMNTY TM OFC REG. NO. 2653129, DATED 6-16-2003, EXPIRES 4-12-2012.

FOR MEASURING APPARATUS AND INSTRUMENTS, NAMELY, RHEOMETERS, VISCOMETERS, TORQUE TRANSDUCERS; PARTS AND FITTINGS FOR THE AFORESAID GOODS; COMPUTER SOFTWARE AND HARDWARE FOR CONTROLLING SUCH GOODS AND FOR ANALYZING MEASUREMENTS MADE BY SUCH GOODS; BUT NOT INCLUDING SUCH GOODS WHICH ARE SUITABLE FOR USE ON BICYCLES, AND NOT INCLUDING WATERBATH APPARATUS (U.S. CLS. 21, 23, 26, 36 AND 38).

MARY ROSSMAN, EXAMINING ATTORNEY

SN 76-431,480. NWL BUYING, INC., WEST HEMPSTEAD, NY. FILED 7-17-2002.



NO CLAIM IS MADE TO THE EXCLUSIVE RIGHT TO USE "CELL", APART FROM THE MARK AS SHOWN.

THE MARK COMPRISES A STYLIZED DESIGNATION WHICH INTEGRALLY INCLUDES A LIGHTNING BOLT INTERCONNECTING THE WORDS "TIGER AND CELL."

FOR DRY CELL BATTERIES FOR FLASHLIGHTS (U.S. CLS. 21, 23, 26, 36 AND 38).

CATHERINE FAINT, EXAMINING ATTORNEY

SN 76-456,704. 4LIFE RESEARCH, L.C., SANDY, UT. FILED 10-3-2002.

**4LIFE**

OWNER OF U.S. REG. NOS. 2,475,300 AND 2,486,970.

FOR PRE-RECORDED MEDIA, NAMELY, AUDIO-TAPES, VIDEO TAPES, CDS, AND DVDS, ALL IN THE FIELDS OF HEALTHY DIETS AND LIFESTYLES, DIETARY AND NUTRITIONAL SUPPLEMENTS, VITAMINS, MINERALS, HERBAL SUPPLEMENTS, AND PERSONAL AND EMPLOYEE ASSESSMENT; SOFTWARE FOR USE IN DATABASE MANAGEMENT AND PROVIDING INFORMATION IN THE FIELD OF HEALTHY DIETS AND LIFESTYLES, DIETARY AND NUTRITIONAL SUPPLEMENTS, VITAMINS, MINERALS, HERBAL SUPPLEMENTS, AND PERSONAL AND EMPLOYEE ASSESSMENT (U.S. CLS. 21, 23, 26, 36 AND 38).

FIRST USE 6-0-1998; IN COMMERCE 6-0-1998.

JAMES GRIFFIN, EXAMINING ATTORNEY

**CLASS 9—(Continued).**

SN 76-457,241. PAYKEY USA, INC., GREENVILLE, SC. FILED 10-9-2002.

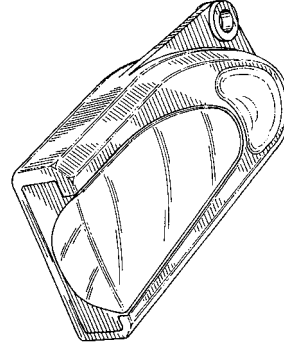

THE LINING SHOWN IN THE MARK IS TO INDICATE SHADING.

THE MARK CONSISTS OF AN ELECTRONIC KEY HAVING A GENERALLY RECTANGULAR FORWARD PORTION, A GENERALLY CURVED REARWARD PORTION, AND A TRANSPARENT SIDE PORTION.

FOR ELECTRONIC APPARATUS FOR CASHLESS PAYMENTS FOR GOODS AND SERVICES, NAMELY, ELECTRONIC KEYS (U.S. CLS. 21, 23, 26, 36 AND 38).

FIRST USE 10-16-2002; IN COMMERCE 10-16-2002.

SUSAN STIGLITZ, EXAMINING ATTORNEY

SN 76-465,109. HARDEN, DANIEL, LOS ANGELES, CA. FILED 10-31-2002.

**MOGUL LIFE, INC.**

NO CLAIM IS MADE TO THE EXCLUSIVE RIGHT TO USE "INC.", APART FROM THE MARK AS SHOWN.

FOR PHONOGRAPH RECORDS, AUDIO CASSETTE TAPES AND COMPACT DISCS FEATURING MUSIC (U.S. CLS. 21, 23, 26, 36 AND 38).

PAM WILLIS, EXAMINING ATTORNEY

SN 76-478,369. PRUFTECHNIK DIETER BUSCH AG, D-85737 ISMANING, FED REP GERMANY, FILED 12-26-2002.

**VIBXPERT**

FOR ELECTRONIC APPARATUS, NAMELY, CONDITION MONITORING INSTRUMENTS, NAMELY, DATA LOGGERS, VIBRATION MONITORING INSTRUMENTS, NAMELY, FFT DATA COLLECTORS AND SPECTROGRAPHIC DISPLAYS, MACHINERY ANALYZERS AND MACHINE PROTECTION SYSTEMS COMPRISING SIGNAL ANALYZERS AND DATA ACQUISITION MODULES FOR MEASURING OSCILLATORY AND VIBRATORY BEHAVIOR OF ROTARY MACHINES; SOFTWARE FOR ANALYZING OSCILLATORY AND VIBRATORY BEHAVIOR OF ROTARY MACHINES, NAMELY, MOTORS, PUMPS, FANS, ELECTRICAL GENERATORS, AND TURBINES, AND FOR VISUALIZING RESULTS OF SUCH ANALYSIS BY MEANS OF DISPLAYS OR PRINTERS (U.S. CLS. 21, 23, 26, 36 AND 38).

FIRST USE 12-0-2003; IN COMMERCE 12-0-2003.

MICHELE SWAIN, EXAMINING ATTORNEY

**CLASS 9—(Continued).**

SN 76-493,060. KING OF KINGS LUTHERAN CHURCH,  
U.A.C., OMAHA, NE. FILED 2-25-2003.



FOR DOWNLOADABLE INSTRUCTIONAL, EDUCATIONAL AND TEACHING MATERIALS IN THE FIELD OF RELIGION, AND ELECTRONIC INSTRUCTIONAL, EDUCATION AND TEACHING MATERIALS IN THE FIELD OF RELIGION RECORDED ON COMPUTER MEDIA, ALL FOR USE BY TEACHERS AND STUDENTS (U.S. CLS. 21, 23, 26, 36 AND 38).

FIRST USE 8-11-2004; IN COMMERCE 8-11-2004.  
ALICIA COLLINS, EXAMINING ATTORNEY

SN 76-494,614. RYSHCO MEDIA INC., LONGUEUIL, QUEBEC, H2X 2T2, CANADA, FILED 2-28-2003.

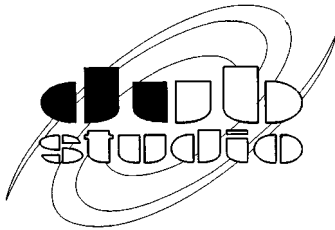

PRIORITY CLAIMED UNDER SEC. 44(D) ON CANADA APPLICATION NO. 1151364, FILED 9-3-2002, REG. NO. TMA623463, DATED 10-25-2004, EXPIRES 10-25-2019.

NO CLAIM IS MADE TO THE EXCLUSIVE RIGHT TO USE DUB STUDIO, APART FROM THE MARK AS SHOWN. FOR COMPUTER HARDWARE AND SOFTWARE WHICH AUTOMATICALLY SYNCHRONIZES SPEECH TO MOUTH MOVEMENTS IN FILM AND VIDEO POST-PRODUCTION (U.S. CLS. 21, 23, 26, 36 AND 38).

TRICIA SONNEBORN, EXAMINING ATTORNEY

SN 76-498,110. WESTERN INVENTORY SERVICE LTD., TORONTO, ONTARIO, CANADA, FILED 2-19-2003.

**WISARD**

PRIORITY CLAIMED UNDER SEC. 44(D) ON CANADA APPLICATION NO. 1167411, FILED 2-7-2003, REG. NO. TMA606306, DATED 3-26-2004, EXPIRES 3-26-2019.

FOR COMPUTER HARDWARE, NAMELY, A HANDHELD PORTABLE DATA COLLECTION TERMINAL THAT SCANS BARCODES AND COLLECTS DATA FOR USE IN INVENTORY DATA MANAGEMENT (U.S. CLS. 21, 23, 26, 36 AND 38).

FIRST USE 12-0-1997; IN COMMERCE 1-0-1999.  
LINDA E. BLOHM, EXAMINING ATTORNEY

**CLASS 9—(Continued).**

SN 76-505,679. RAG DOLL MERCHANDISING, INC., LOS ANGELES, CA. FILED 4-11-2003.

**AEROSMITH**

FOR VIDEO DISCS, LASER DISCS, CD-ROM DISCS, DIGITAL VIDEO DISCS, DIGITAL VERSATILE DISCS, COMPACT DISCS, AUDIO CASSETTES AND VIDEO CASSETTES FEATURING MUSIC (U.S. CLS. 21, 23, 26, 36 AND 38).

FIRST USE 9-0-1972; IN COMMERCE 9-0-1972.  
DEZMONA MIZELLE, EXAMINING ATTORNEY

SN 76-505,869. BROADATA COMMUNICATIONS, INC., TORRANCE, CA. FILED 4-11-2003.

**Concierge**

FOR FIBER OPTIC LINK ELECTRONIC PLATFORM, NAMELY, ELECTRONIC COMMUNICATION DEVICES, NAMELY, AUDIO PROCESSORS, VIDEO PROCESSORS, AND DATA PROCESSORS, INTERCONNECTED BY FIBER OPTIC CABLES (U.S. CLS. 21, 23, 26, 36 AND 38).

THEODORE MCBRIDE, EXAMINING ATTORNEY

SN 76-505,870. BROADATA COMMUNICATIONS, INC., TORRANCE, CA. FILED 4-11-2003.

**Fiberstation**

FOR FIBER OPTIC LINK ELECTRONIC PLATFORM, NAMELY, ELECTRONIC COMMUNICATION DEVICES, NAMELY, AUDIO PROCESSORS, VIDEO PROCESSORS, AND DATA PROCESSORS, INTERCONNECTED BY FIBER OPTIC CABLES (U.S. CLS. 21, 23, 26, 36 AND 38).

THEODORE MCBRIDE, EXAMINING ATTORNEY

**CLASS 9—(Continued).**

SN 76-507,997. SCINTERA NETWORKS, INC., SAN JOSE, CA. FILED 4-21-2003.



FOR INTEGRATED CIRCUITS WHICH PROVIDE SIGNAL CONDITIONING FOR A DIGITAL SIGNAL TRANSMISSION SYSTEM (U.S. CLS. 21, 23, 26, 36 AND 38).

TINA L. SNAPP, EXAMINING ATTORNEY

SN 76-519,821. WESTERBEKE CORPORATION, TAUNTON, MA. FILED 6-5-2003.

**YACHT COMMAND**

NO CLAIM IS MADE TO THE EXCLUSIVE RIGHT TO USE "YACHT", APART FROM THE MARK AS SHOWN.

FOR ELECTRONIC DIGITAL CONTROLS FOR GENERATORS AND ENGINES SOLD SEPARATELY AND AS A COMPONENT OF GENERATORS AND ENGINES (U.S. CLS. 21, 23, 26, 36 AND 38).

JULIA HARDY COFIELD, EXAMINING ATTORNEY

SN 76-523,754. RAFAEL ARMAMENT DEVELOPMENT AUTHORITY LTD., HAIFA 31021, ISRAEL, FILED 6-16-2003.

**BRITENING**

PRIORITY CLAIMED UNDER SEC. 44(D) ON ISRAEL APPLICATION NO. 164468, FILED 5-20-2003, REG. NO. 164468, DATED 5-20-2003, EXPIRES 5-20-2010.

FOR ELECTRO-OPTIC SELF-DEFENSE SYSTEM TO PROTECT CIVILIAN AIRCRAFT AGAINST MISSILE THREATS (U.S. CLS. 21, 23, 26, 36 AND 38).

PAULA MAYS, EXAMINING ATTORNEY

SN 76-529,704. CARL-ZEISS-STIFTUNG, DBA CARL ZEISS, FED REP GERMANY, FILED 7-17-2003.

**FACS**

PRIORITY CLAIMED UNDER SEC. 44(D) ON FED REP GERMANY APPLICATION NO. 30328978.3/0, FILED 6-12-2003, REG. NO. 30328978, DATED 7-7-2003, EXPIRES 6-30-2013.

FOR SOFTWARE USED TO OPERATE COORDINATE MEASURING MACHINES (U.S. CLS. 21, 23, 26, 36 AND 38).

RONALD MCMORROW, EXAMINING ATTORNEY

**CLASS 9—(Continued).**

SN 76-534,677. FREY, ERIC, ROCHESTER, NY. FILED 8-4-2003.

**PEERPLACE**

FOR COMPUTER SOFTWARE— NAMELY-CASE MANAGEMENT SOFTWARE FOR THE SOCIAL SERVICES INDUSTRY (U.S. CLS. 21, 23, 26, 36 AND 38).

FIRST USE 6-1-2003; IN COMMERCE 6-1-2003.  
MATTHEW KLINE, EXAMINING ATTORNEY

SN 76-536,463. BKS NETWORKS, INC., STAMFORD, CT. FILED 7-28-2003.

**BKS**

FOR SERVER-SIDE DRIVEN BRAND MARKETING COMMUNICATION INSTRUMENTS, NAMELY, SERVER-SIDE MULTI-MODE VIRTUAL KIOSKS HAVING MULTIPLE MODES OF DISPLAY OPERATION FOR DISPLAYING RICH-MEDIA ADVERTISING SPOTS, PROMOTIONAL SPOTS, AND BRAND INFORMATION NETWORKS COMPOSED OF VIRTUALLY ANY MEDIA FORMAT, WHICH ARE INDEXED USING BRAND-RELATED INFORMATION KEYS; AND AN INDUSTRIAL STRENGTH INTERNET-BASED BRAND MARKETING COMMUNICATION INSTRUMENTATION NETWORK FOR REMOTELY PROGRAMMING THE MODES OF DISPLAY OPERATION OF SAID MULTI-MODE VIRTUAL KIOSKS SO THAT MARKETERS OF PRODUCT AND SERVICE BRANDS CAN COMMUNICATE DIRECTLY AND FREELY WITH CONSUMERS ANYWHERE ALONG THE INTERNET, WITHOUT ADVERSELY AFFECTING THEIR TRADING PARTNERS, AND ENABLE THE RELIABLE DELIVERY OF VALUABLE BRAND BUILDING INFORMATION RESOURCES TO SUCH CONSUMERS, REGARDLESS OF WHERE SUCH BRAND BUILDING INFORMATION RESOURCES MAY ACTUALLY BE HOSTED ON INFORMATION SERVERS CONNECTED TO THE INTERNET (U.S. CLS. 21, 23, 26, 36 AND 38).

TRACY CROSS, EXAMINING ATTORNEY

SN 76-537,969. SEIKO EPSON KABUSHIKI KAISHA, DBA SEIKO EPSON CORPORATION, SHINJUKU-KU, TOKYO, JAPAN, FILED 8-18-2003.

**EpsonNet ServicePlatform**

THE MARK CONSISTS OF STANDARD CHARACTERS WITHOUT CLAIM TO ANY PARTICULAR FONT, STYLE, SIZE, OR COLOR.

PRIORITY CLAIMED UNDER SEC. 44(D) ON JAPAN APPLICATION NO. 2003-064138, FILED 7-30-2003, REG. NO. 4749586, DATED 2-20-2004, EXPIRES 2-20-2014.

OWNER OF U.S. REG. NOS. 2,614,930, 2,731,287 AND 2,816,098.

NO CLAIM IS MADE TO THE EXCLUSIVE RIGHT TO USE "SERVICEPLATFORM", APART FROM THE MARK AS SHOWN.

FOR COMPUTER SOFTWARE FOR ENABLING NETWORK APPARATUS AND PERIPHERALS NAMELY, PRINTERS, IMAGE SCANNERS AND LIQUID CRYSTAL PROJECTORS, TO EXTEND THEIR FUNCTIONS (U.S. CLS. 21, 23, 26, 36 AND 38).

ELLEN B. AWRICH, EXAMINING ATTORNEY

**CLASS 9—(Continued).**

SN 76-540,245. ARISTOCRAT TECHNOLOGIES AUSTRALIA PTY LTD, LANE COVE, NEW SOUTH WALES 2066, AUSTRALIA, FILED 8-26-2003.

**TOMBSTONE POKER**

NO CLAIM IS MADE TO THE EXCLUSIVE RIGHT TO USE POKER, APART FROM THE MARK AS SHOWN.

FOR GAMING DEVICES, NAMELY, GAMING MACHINES AND COMPUTER SOFTWARE ASSOCIATED THEREWITH, TO ENABLE THE GAMING MACHINE TO RUN (U.S. CLS. 21, 23, 26, 36 AND 38).

GWEN STOKOLS, EXAMINING ATTORNEY

**CLASS 9—(Continued).**

SN 76-546,029. YOUNGSTAR LEARNING TECHNOLOGIES, INC., DENVER, CO. FILED 9-22-2003.

**YOUNGSTAR MATH SKILLS**

NO CLAIM IS MADE TO THE EXCLUSIVE RIGHT TO USE "MATH SKILLS", APART FROM THE MARK AS SHOWN.

FOR EDUCATIONAL SOFTWARE FEATURING INSTRUCTION IN THE FIELD OF MATHEMATICS (U.S. CLS. 21, 23, 26, 36 AND 38).

DAVID TAYLOR, EXAMINING ATTORNEY

SN 76-541,151. ARISTOCRAT TECHNOLOGIES AUSTRALIA PTY LTD, LANE COVE, NEW SOUTH WALES 2066, AUSTRALIA, FILED 8-29-2003.

**BLACKBART PRIME**

FOR GAMING MACHINE ACCOUNTING SYSTEMS, COMPRISED OF COMPUTER HARDWARE AND SOFTWARE FOR MONITORING GAMING MACHINE ACTIVITY AND FOR CALCULATING, ANALYZING, TRACKING AND MANAGING PLAYER FINANCIAL ACCOUNTS (U.S. CLS. 21, 23, 26, 36 AND 38).

STANLEY I. OSBORNE, EXAMINING ATTORNEY

SN 76-541,198. ARISTOCRAT TECHNOLOGIES AUSTRALIA PTY LTD, LANE COVE, NEW SOUTH WALES 2066, AUSTRALIA, FILED 8-29-2003.

**QUICKETS PRIME**

FOR GAMING MACHINE ACCOUNTING SYSTEMS, COMPRISED OF COMPUTER HARDWARE AND SOFTWARE FOR MONITORING GAMING MACHINE ACTIVITY AND FOR CALCULATING, ANALYZING, TRACKING AND MANAGING PLAYER FINANCIAL ACCOUNTS (U.S. CLS. 21, 23, 26, 36 AND 38).

STANLEY I. OSBORNE, EXAMINING ATTORNEY

SN 76-541,314. PARK, SCOTT, DBA SEARCH SYSTEMS, BAKERSFIELD, CA. FILED 8-18-2003.

**TAC TIC**

FOR TACTICAL THERMAL IMAGING CAMERA DESIGNED FOR SEARCHES IN HARD TO REACH LOCATIONS (U.S. CLS. 21, 23, 26, 36 AND 38).

KATHRYN COWARD, EXAMINING ATTORNEY

SN 76-546,993. JOYMASTER, INC., NEIHU CHIU, TAIPEI, TAIWAN, FILED 9-25-2003.



THE COLORS PINK AND GRAY ARE CLAIMED AS A FEATURE OF THE MARK.

THE MARK CONSISTS OF THE WORD "JOYMASTER" WHEREIN THE LETTERS "J" AND "Y" ARE A BOLD PINK COLOR AND THE LETTERS "MASTER" ARE GRAY AND THE LETTER "O" IS A SWIRL OF BOLD PINK AND GRAY.

FOR COMPUTER GAME SOFTWARE COMPRISED OF OPERATING SYSTEM PROGRAMS; COMPUTER PROGRAMS FOR USE IN RELATION TO TELECOMMUNICATION DEVICES FOR ELECTRONIC GAMES, FOR THE TRANSMISSION, REPRODUCTION, RECEIVING, ACCESSING, SEARCHING, INDEXING AND RETRIEVING OF GAMES, IMAGES, MUSIC, SOUNDS, TEXT, MOVIES, VIDEOS AND ANIMATIONS IN THE FIELD OF GENERAL ENTERTAINMENT; COMMUNICATION SOFTWARE FOR CONNECTING COMPUTER NETWORK USERS AND GLOBAL COMPUTER NETWORKS; COMPUTERS; COMPUTER GAME CARTRIDGES, CASSETTE, TAPES, AND DISCS BEARING COMPUTER GAMES SOFTWARE; COMMUNICATION SERVER; VIDEO COMMUNICATION DEVICES FOR GAMING; COMMUNICATION APPARATUS, NAMELY, TELEPHONE HANDSETS, EARPIECES, HANDS-FREE SETS AND TELEPHONE HOLDERS; SATELLITE SIGNAL COMMUNICATION PROCESSOR; CELLULAR PHONES; PERSONAL DIGITAL ASSISTANT (PDA); WIRELESS COMMUNICATIONS DEVICES, NAMELY, CELLULAR PHONES, MOBILE TELEPHONES, TELEPHONE EQUIPMENT CABINETS; WIRELESS DATA TRANSMISSION APPARATUS FOR TRANSFERRING DATA FROM COMPUTER NETWORK TO HAND-HELD UNITS OR PORTABLE COMPUTER DEVICES; WIRELESS AUDIO AND VIDEO DATA TRANSMISSION DEVICES FOR TRANSFERRING SOUND, IMAGES OR SIGNALS FROM COMPUTER NETWORK TO HAND-HELD UNITS OR PORTABLE COMPUTER DEVICES; COMMUNICATION CONNECTING MODULES FOR VOICE AND DATA TRANSMISSION; DIGITAL SATELLITE RECEIVERS; SATELLITE RECEIVER AND DECODER; WIRELESS LAN (LOCAL AREA NETWORK) COMPUTER CARDS FOR CONNECTING PORTABLE COMPUTER DEVICES TO COMPUTER NETWORKS; ETHERNET ADAPTOR CARDS, NAMELY (MODEM CARDS); SATELLITE ANTENNA (U.S. CLS. 21, 23, 26, 36 AND 38).

FIRST USE 3-0-2003; IN COMMERCE 4-0-2003.

KATHRYN COWARD, EXAMINING ATTORNEY



**CLASS 9—(Continued).**

SN 76-549,411. KONINKLIJKE PHILIPS ELECTRONICS N.V., EINDHOVEN, NETHERLANDS, FILED 9-15-2003.

**DON'T DREAM IT, STREAM IT**

PRIORITY CLAIMED UNDER SEC. 44(D) ON BENELUX APPLICATION NO. 1030190, FILED 3-31-2003, REG. NO. 0731508, DATED 3-31-2003, EXPIRES 3-31-2013.

FOR ELECTRIC APPARATUS FOR RECORDING, REPRODUCING, TRANSMITTING, AMPLIFYING AND PROCESSING SOUND, NAMELY, CD AND MP3 FILES PLAYBACK UNIT AND RECORDER, INTERNET RADIO FOR PLAYING ONLINE MUSIC FROM THE INTERNET, ALL SOLD AS A UNIT, AND, RADIO RECEIVERS (U.S. CLS. 21, 23, 26, 36 AND 38).

TRACY CROSS, EXAMINING ATTORNEY



SN 76-551,410. RICOH COMPANY, LTD., OHTA-KU, TOKYO, JAPAN, FILED 9-25-2003.

**RC GATE**

FOR INTERFACE DEVICE FOR CONNECTING MULTI-FUNCTION MACHINES, NAMELY COPIERS, FACSIMILES, SCANNERS AND PRINTERS WITH THE NETWORK (U.S. CLS. 21, 23, 26, 36 AND 38).

SUSAN HAYASH, EXAMINING ATTORNEY



SN 76-552,502. NORTHROP GRUMMAN CORPORATION, LOS ANGELES, CA. FILED 10-1-2003.

**SURECAL**

FOR COMPUTER SOFTWARE FOR TESTING AND CALIBRATING ELECTRONIC EQUIPMENT (U.S. CLS. 21, 23, 26, 36 AND 38).

FIRST USE 11-14-1995; IN COMMERCE 11-14-1995.  
BRIAN PINO, EXAMINING ATTORNEY



SN 76-556,012. RESILENT, LLC, OMAHA, NE. FILED 11-3-2003.

**RESILENT**

FOR ENCODED ELECTRONIC CHIP CARDS CONTAINING PROGRAMMING USED TO DIGITALLY STORE AND READ PERSONAL DATA (U.S. CLS. 21, 23, 26, 36 AND 38).

GIANCARLO CASTRO, EXAMINING ATTORNEY

**CLASS 9—(Continued).**

SN 76-556,454. ANDIGILOG, INC., TEMPE, AZ. FILED 11-4-2003.

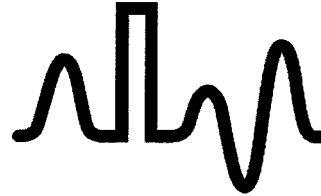

THE MARK IS COMPRISED OF AN ANALOG AND DIGITAL WAVEFORM.

FOR INTEGRATED CIRCUITS USING ANALOG AND/OR DIGITAL DESIGN TECHNIQUES (U.S. CLS. 21, 23, 26, 36 AND 38).

FIRST USE 2-13-2001; IN COMMERCE 2-13-2001.  
KELLY BOULTON, EXAMINING ATTORNEY



SN 76-557,337. TYSON, JAMES, PENNSAUKEN, NJ. FILED 11-6-2003.

**CIP-CHECK**

FOR ACOUSTIC MONITOR FOR SENSING THE PROPER OPERATION OF A TANK CLEANER (U.S. CLS. 21, 23, 26, 36 AND 38).

FIRST USE 10-6-2003; IN COMMERCE 10-6-2003.  
SUSAN HAYASH, EXAMINING ATTORNEY



SN 76-560,254. SONY KABUSHIKI KAISHA, TA SONY CORPORATION, TOKYO, JAPAN, FILED 11-3-2003.

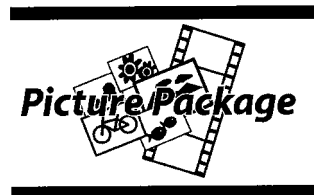

THE MARK CONSISTS, IN PART, OF A STYLIZED VERSION OF A GROUP OF PHOTOGRAPHS PARTIALLY SUPERIMPOSED ON A FILM STRIP. THE PHOTOGRAPHS DEPICTING FLOWERS, MOUNTS AND CLOUDS, FISH, A BICYCLE AND CHICKS.

FOR COMPUTER APPLICATION SOFTWARE FOR VIDEO DATA PROCESSING; DIGITAL STILL CAMERAS; VIDEO CAMERAS (U.S. CLS. 21, 23, 26, 36 AND 38).

ZHALEH DELANEY, EXAMINING ATTORNEY

**CLASS 9—(Continued).**

SN 76-560,466. IPFLEX INC., TOKYO 141-0021, JAPAN,  
FILED 11-17-2003.



FOR COMPUTER HARDWARE, NAMELY, INTEGRATED CIRCUITS WITH AND WITHOUT SOFTWARE, INCLUDING LARGE SCALE INTEGRATED (LSI'S), VERY LARGE SCALE INTEGRATED (VLSI'S) SYSTEM LSI'S, CENTRAL PROCESSING UNITS, RECONFIGURABLE PROGRAMMABLE LOGIC DEVICES, MICROPROCESSORS, PERIPHERAL CHIPS, MICROPROCESSOR CORES, MACRO CELLS, MICROCONTROLLERS AND BUS INTERFACES, FOR COMPUTERS, COMPUTER PERIPHERALS, COMPUTER COMMUNICATIONS, NETWORKING AND PROGRAMMABLE LOGICS APPARATUS, CIRCUIT BOARDS, MEMORY AND MEMORY BOARDS; COMMUNICATIONS DEVICES NAMELY, INTEGRATED CIRCUITS AND CIRCUIT BOARDS FOR TELEPHONES, WIRELESS COMMUNICATION, MOBILE PHONES, TELEPHONES VIA COMPUTER NETWORKS SUCH AS INTERNET PHONES, AND FOR COMMUNICATION VIA RADIO AND/OR TELEVISION TRANSMISSION; NETWORKING DEVICES, NAMELY, INTEGRATED CIRCUITS AND CIRCUIT BOARDS FOR ROUTING AND/OR MANAGING COMPUTER NETWORKS, AND FOR USE WITH COMPUTER NETWORKS; PERSONAL DATA PROCESSING DEVICES, NAMELY, INTEGRATED CIRCUITS AND CIRCUIT BOARDS FOR MOBILE AND PERSONAL COMPUTING AND COMMUNICATION; MULTIMEDIA DEVICES, NAMELY, INTEGRATED CIRCUITS AND CIRCUIT BOARDS FOR CODING AND ENCODING VISUAL AND SOUND DATA, VOICE CONTROL AND TRANSLATION; INTEGRATED CIRCUITS AND CIRCUIT BOARDS FOR APPARATUS FOR GAMES; INTEGRATED CIRCUITS AND CIRCUIT BOARDS FOR APPARATUS FOR NAVIGATION SYSTEMS; COMPUTER SOFTWARE USED IN OPERATING INTEGRATED CIRCUITS INCLUDING LARGE SCALE INTEGRATED (LSI'S), VERY LARGE SCALE INTEGRATED (VLSI'S), SYSTEM LSI'S, CENTRAL PROCESSING UNITS, RECONFIGURABLE PROGRAMMABLE LOGIC DEVICES, MICROPROCESSORS, PERIPHERAL CHIPS, MICROPROCESSOR CORES, MACRO CELLS, MICROCONTROLLERS AND BUS INTERFACES, AND CIRCUIT BOARDS; COMPILERS, SIMULATORS AND COMPUTER SOFTWARE FOR USE IN THE DESIGN AND DEVELOPMENT OF INTEGRATED CIRCUITS INCLUDING LARGE SCALE INTEGRATED (LSI'S), VERY LARGE SCALE INTEGRATED (VLSI'S), SYSTEM LSI'S, CENTRAL PROCESSING UNITS, RECONFIGURABLE PROGRAMMABLE LOGIC DEVICES, MICROPROCESSORS, PERIPHERAL CHIPS, MICROPROCESSOR CORES, MACRO CELLS, MICROCONTROLLERS AND BUS INTERFACES, AND CIRCUIT BOARDS; COMPUTER SOFTWARE FOR USE IN THE DESIGN AND DEVELOPMENT OF APPLICATION SOFTWARE AND OPERATING SYSTEM SOFTWARE; APPARATUS FOR TESTING AND PROGRAMMING INTEGRATED CIRCUITS; AND USER MANUALS FOR USE WITH THE ABOVE GOODS, MANUALS SOLD AS A UNIT WITH THE REFERENCED GOODS AND DOWNLOADABLE FROM A COMPUTER NETWORK (U.S. CLS. 21, 23, 26, 36 AND 38).

FIRST USE 6-7-2004; IN COMMERCE 6-7-2004.  
ESTHER BELENKER, EXAMINING ATTORNEY

**CLASS 9—(Continued).**

SN 76-561,041. NAPOLEX CO., LTD., TOKYO 116-0002,  
JAPAN, FILED 11-21-2003.

# Skysonic

FOR AMPLIFIERS; ANTENNAS; CAR NAVIGATION SYSTEM COMPRISED OF CAR NAVIGATION COMPUTER; DIVERSITY ANTENNA UNIT; DVD PLAYERS; ELECTRIC CABLE; COMPUTER AND VIDEO MONITORS; REAR VIEW CAMERAS; REMOTE CONTROL FOR RADIOS, TELEVISIONS, VIDEOS, STEREOS, NAVIGATION COMPUTERS AND DVD PLAYERS; SWITCHING BOX FOR TELEVISION, NAVIGATION COMPUTER, VIDEO PLAYERS/RECORDERS, REAR VIEW CAMERA, LIQUID CRYSTAL DISPLAY GAME MACHINES AND VIDEO GAME MACHINES FOR USE WITH TELEVISIONS; TELEVISION ANTENNAS; TELEVISION RECEIVERS FOR TV SETS; TRANSMITTERS; TELEVISION TUNER; VIDEO AMPLIFIER; VIDEO PLAYERS AND RECORDERS; TELEVISION AND REMOTE CONTROL STANDS AND HOLDERS, USED FOR INSTALLING TO AN AUTOMOBILE; PARTS AND FITTINGS FOR ABOVE MENTIONED GOODS (U.S. CLS. 21, 23, 26, 36 AND 38).

BRIAN NEVILLE, EXAMINING ATTORNEY

SN 76-563,217. HUTCHINS, CORRINE C., VICTORVILLE,  
CA. FILED 11-20-2003.

# MyFamilyCD

THE MARK CONSISTS OF STANDARD CHARACTERS WITHOUT CLAIM TO ANY PARTICULAR FONT, STYLE, SIZE, OR COLOR.

FOR MULTIMEDIA SOFTWARE RECORDED ON CD-ROMS FOR CHILD, TEENAGER, YOUNG ADULT, ADULT AND PET IDENTIFICATION AND PRERECORDED MULTIMEDIA SOFTWARE ON BUSINESS CARD SIZED CD-ROMS ALL FEATURING DIGITAL PICTURES OF CHILDREN, TEENAGERS, YOUNG ADULTS, ADULTS AND/OR PETS, TOGETHER WITH IDENTIFICATION INFORMATION, NAMELY, EYE AND HAIR COLOR, SEX, HOME ADDRESSES AND PHONE NUMBERS, FINGERPRINTS, HEIGHT, WEIGHT, DATE OF BIRTH AND OTHER SPECIFIC IDENTIFYING INFORMATION AND PRINTED INSTRUCTIONS FOR USE THEREFORE (U.S. CLS. 21, 23, 26, 36 AND 38).

FIRST USE 9-15-2003; IN COMMERCE 9-15-2003.  
REBECCA SMITH, EXAMINING ATTORNEY

**CLASS 9—(Continued).**

SN 76-563,314. AIR RIDE TECHNOLOGIES, INC., JASPER, IN. FILED 12-4-2003.

**RIDEPRO**

THE MARK CONSISTS OF STANDARD CHARACTERS WITHOUT CLAIM TO ANY PARTICULAR FONT, STYLE, SIZE, OR COLOR.

FOR ELECTRONIC CONTROL SYSTEMS COMPRISED OF A COMPUTER PROCESSOR AND ELECTRONIC SENSORS FOR AIR COMPRESSORS, AIR VALVES, AIR SHOCKS AND STRUTS FOR USE IN VEHICLES AND PRESSURE GAUGES (U.S. CLS. 21, 23, 26, 36 AND 38).

FIRST USE 11-4-2003; IN COMMERCE 11-4-2003.  
CIMMERIAN COLEMAN, EXAMINING ATTORNEY

SN 76-564,442. QUEST FOUNDATION, INC., TALLAHASSEE, FL. FILED 12-10-2003.

**WISDOM OF THE ANCIENT FORESTS**

THE MARK CONSISTS OF STANDARD CHARACTERS WITHOUT CLAIM TO ANY PARTICULAR FONT, STYLE, SIZE, OR COLOR.

NO CLAIM IS MADE TO THE EXCLUSIVE RIGHT TO USE "FORESTS", APART FROM THE MARK AS SHOWN.

FOR AUDIO-VISUAL RECORDINGS IN THE FIELD OF SCIENCE AND NATURE, FOR HOME, SCIENTIFIC AND EDUCATIONAL USES (U.S. CLS. 21, 23, 26, 36 AND 38).

FIRST USE 8-9-2003; IN COMMERCE 8-9-2003.  
MONIQUE MILLER, EXAMINING ATTORNEY

SN 76-565,677. NATIONAL INSTITUTE FOR TRUTH VERIFICATION LLC, WEST PALM BEACH, FL. FILED 12-8-2003.

**F.I.S.T.**

THE MARK CONSISTS OF STANDARD CHARACTERS WITHOUT CLAIM TO ANY PARTICULAR FONT, STYLE, SIZE, OR COLOR.

FOR HAND-HELD COMPUTERS FOR FIELD INTERROGATION SUPPORT (U.S. CLS. 21, 23, 26, 36 AND 38).

FIRST USE 8-0-2003; IN COMMERCE 8-0-2003.  
JOHN HWANG, EXAMINING ATTORNEY

**CLASS 9—(Continued).**

SN 76-566,465. SHAFER, JAMES, STUART, FL. FILED 12-22-2003.

**MARINA GUARD**

THE MARK CONSISTS OF STANDARD CHARACTERS WITHOUT CLAIM TO ANY PARTICULAR FONT, STYLE, SIZE, OR COLOR.

NO CLAIM IS MADE TO THE EXCLUSIVE RIGHT TO USE MARINA, APART FROM THE MARK AS SHOWN.

FOR ELECTRICAL EQUIPMENT, NAMELY GROUND FAULT MONITOR (U.S. CLS. 21, 23, 26, 36 AND 38).

FIRST USE 10-16-2002; IN COMMERCE 8-11-2003.  
SUE LAWRENCE, EXAMINING ATTORNEY

SN 76-567,842. MAMAC SYSTEMS, INC., EDEN PRAIRIE, MN. FILED 12-31-2003.



OWNER OF U.S. REG. NOS. 1,529,452, 2,779,703 AND 2,784,412.

NO CLAIM IS MADE TO THE EXCLUSIVE RIGHT TO USE "SYSTEMS", APART FROM THE MARK AS SHOWN.

FOR ELECTRICAL, ELECTROPNEUMATIC, AND MECHANICAL DEVICES, NAMELY, TEMPERATURE SENSORS, PRESSURE SENSORS, HUMIDITY SENSORS, TRANSDUCER INDICATORS, TEMPERATURE TRANSDUCERS, HUMIDITY TRANSDUCERS, TEMPERATURE AND HUMIDITY TRANSDUCERS, PRESSURE TRANSDUCERS, LIGHT TRANSDUCERS, ELECTROPNEUMATIC TRANSDUCERS, TRISTATE SWITCHES, ROTARY ACTUATORS, PILOT RELAYS, POWER SUPPLIES, PRESSURE PROBES, AND THERMOWELLS, FOR USE IN INDUSTRIAL CONTROL SYSTEMS AND IN RESIDENTIAL AND COMMERCIAL HVAC SYSTEMS (U.S. CLS. 21, 23, 26, 36 AND 38).

FIRST USE 1-0-2003; IN COMMERCE 1-0-2003.  
TONJA GASKINS, EXAMINING ATTORNEY

SN 76-568,555. MINE SAFETY APPLIANCES COMPANY, PITTSBURGH, PA. FILED 1-7-2004.

**ULTRAVUE**

THE MARK CONSISTS OF STANDARD CHARACTERS WITHOUT CLAIM TO ANY PARTICULAR FONT, STYLE, SIZE, OR COLOR.

OWNER OF U.S. REG. NO. 952,168.  
FOR GAS MASKS (U.S. CLS. 21, 23, 26, 36 AND 38).  
FIRST USE 8-0-1970; IN COMMERCE 8-0-1970.  
BERYL GARDNER, EXAMINING ATTORNEY

**CLASS 9—(Continued).**

SN 76-568,961. ELLSWORTH SYSTEMS, LLC, FRANKLIN, TN. FILED 1-8-2004.

**COIN MAGIC**

THE MARK CONSISTS OF STANDARD CHARACTERS WITHOUT CLAIM TO ANY PARTICULAR FONT, STYLE, SIZE, OR COLOR.

NO CLAIM IS MADE TO THE EXCLUSIVE RIGHT TO USE "COIN", APART FROM THE MARK AS SHOWN.

FOR MACHINES FOR COUNTING AND SORTING COINS (U.S. CLS. 21, 23, 26, 36 AND 38).

FIRST USE 10-15-2003; IN COMMERCE 10-15-2003.

MIDGE BUTLER, EXAMINING ATTORNEY

---

SN 76-573,298. BLACK CAT DECISIONS, LLC, FAIRFIELD, CT. FILED 2-2-2004.

**BROKER VILLAGE**

THE MARK CONSISTS OF STANDARD CHARACTERS WITHOUT CLAIM TO ANY PARTICULAR FONT, STYLE, SIZE, OR COLOR.

OWNER OF U.S. REG. NO. 2,851,174.

NO CLAIM IS MADE TO THE EXCLUSIVE RIGHT TO USE "BROKER", APART FROM THE MARK AS SHOWN.

FOR COMPUTER SOFTWARE FOR USE IN FINANCIAL FORECASTING AND ANALYSIS IN THE NATURE OF PORTFOLIO MODELING, CALCULATING FEES AND COMMISSIONS (U.S. CLS. 21, 23, 26, 36 AND 38).

FIRST USE 6-0-2002; IN COMMERCE 6-0-2002.

JOHN DWYER, EXAMINING ATTORNEY

---

SN 76-574,983. HENSON, CHRISTOPHER, LAKEWOOD, CO. FILED 2-10-2004.

**LayoffShield**

THE MARK CONSISTS OF STANDARD CHARACTERS WITHOUT CLAIM TO ANY PARTICULAR FONT, STYLE, SIZE, OR COLOR.

FOR PRE-RECORDED AUDIOTAPES AND CDS FEATURING INFORMATION IN THE FIELD SELF-HELP (U.S. CLS. 21, 23, 26, 36 AND 38).

FIRST USE 11-19-2003; IN COMMERCE 11-19-2003.

JANICE L. MCMORROW, EXAMINING ATTORNEY

**CLASS 9—(Continued).**

SN 76-580,442. DDB PRODUCTIONS, MARINA DEL REY, CA. FILED 3-11-2004.

**DDB RECORDS**

THE MARK CONSISTS OF STANDARD CHARACTERS WITHOUT CLAIM TO ANY PARTICULAR FONT, STYLE, SIZE, OR COLOR.

NO CLAIM IS MADE TO THE EXCLUSIVE RIGHT TO USE RECORDS, APART FROM THE MARK AS SHOWN.

FOR PRE-RECORDED PHONOGRAPH RECORDS, MAGNETIC TAPES, AUDIO CASSETTE TAPES, VIDEO CASSETTE TAPES, COMPACT DISCS AND DVD'S FOR ENTERTAINMENT ON THE SUBJECT OF MUSIC AND EDUCATION ON THE SUBJECT OF MUSIC (U.S. CLS. 21, 23, 26, 36 AND 38).

FRED MANDIR, EXAMINING ATTORNEY

---

SN 76-582,100. KALLMAN, ISABEL, NEW YORK, NY. FILED 3-15-2004.

**ALPHA MOM PRESENTS**

THE MARK CONSISTS OF STANDARD CHARACTERS WITHOUT CLAIM TO ANY PARTICULAR FONT, STYLE, SIZE, OR COLOR.

NO CLAIM IS MADE TO THE EXCLUSIVE RIGHT TO USE PRESENTS, APART FROM THE MARK AS SHOWN.

FOR MUSICAL SOUND RECORDINGS; AUDIO-VISUAL RECORDINGS, NAMELY, COMPACT DISCS, TAPE CASSETTES, AUDIO CASSETTES, AUDIO TAPES, AUDIO DISCS, RECORDS, CD-ROMS, VIDEO TAPES, VIDEO CASSETTES, VIDEO DISCS, DVDS, DATS, MP3S, AND LASER DISCS, ALL FEATURING MUSIC, MOVIES, TELEVISION SHOWS, CABLE TELEVISION SHOWS AND INFORMATION REGARDING CONCEPTION, ADOPTION, FOSTER CARE, FERTILITY, PREGNANCY AND FETAL DEVELOPMENT, BIRTHING, PARENTING, CHILD CARE, PHYSICAL AND EMOTIONAL CHILD DEVELOPMENT, CHILDREN'S EDUCATION, CHILDREN'S FITNESS, CHILD SAFETY, CHILDREN'S HEALTH AND NUTRITION AND CHILDREN'S ENTERTAINMENT; DOWNLOADABLE MUSICAL SOUND RECORDINGS; DOWNLOADABLE VIDEO RECORDINGS FEATURING MUSIC, MOVIES, TELEVISION SHOWS, CABLE TELEVISION SHOWS AND INFORMATION REGARDING CONCEPTION, ADOPTION, FOSTER CARE, FERTILITY, PREGNANCY AND FETAL DEVELOPMENT, BIRTHING, PARENTING, CHILD CARE, PHYSICAL AND EMOTIONAL CHILD DEVELOPMENT, CHILDREN'S EDUCATION, CHILDREN'S FITNESS, CHILD SAFETY, CHILDREN'S HEALTH AND NUTRITION AND CHILDREN'S ENTERTAINMENT; COMPUTER GAME SOFTWARE; INTERACTIVE VIDEO GAMES OF VIRTUAL REALITY COMPRISED OF COMPUTER HARDWARE AND SOFTWARE; COIN OPERATED GAMING MACHINES; VIDEO GAME DISCS; VIDEO GAME MACHINES FOR USE WITH TELEVISIONS; COMPUTER GAME CASSETTES AND TAPES (U.S. CLS. 21, 23, 26, 36 AND 38).

TRACY CROSS, EXAMINING ATTORNEY

**CLASS 9—(Continued).**

SN 76-584,405. CHARMANT INC., FUKUI-KEN, JAPAN, FILED 4-1-2004.

# CLUB BLUE

THE MARK CONSISTS OF STANDARD CHARACTERS WITHOUT CLAIM TO ANY PARTICULAR FONT, STYLE, SIZE, OR COLOR.

FOR EYEGLASS FRAMES (U.S. CLS. 21, 23, 26, 36 AND 38).  
KIMBERLY FRYE, EXAMINING ATTORNEY



SN 76-584,529. EZON, INC., GERMANTOWN, TN. FILED 3-30-2004.

# REDI

THE MARK CONSISTS OF STANDARD CHARACTERS WITHOUT CLAIM TO ANY PARTICULAR FONT, STYLE, SIZE, OR COLOR.

OWNER OF U.S. REG. NO. 1,109,225.  
FOR ELECTRIC CUT-OUT FUSES AND RELATED CURRENT BREAKERS (U.S. CLS. 21, 23, 26, 36 AND 38).  
FIRST USE 12-1-1976; IN COMMERCE 12-1-1976.  
LESLEY LAMOTHE, EXAMINING ATTORNEY



SN 76-584,602. CASTEL, INC., BEVERLY, MA. FILED 4-2-2004.

# CASTEL CONNECTS

THE MARK CONSISTS OF STANDARD CHARACTERS WITHOUT CLAIM TO ANY PARTICULAR FONT, STYLE, SIZE, OR COLOR.

NO CLAIM IS MADE TO THE EXCLUSIVE RIGHT TO USE CONNECTS, APART FROM THE MARK AS SHOWN.  
THE ENGLISH TRANSLATION OF THE WORD CASTEL IN THE MARK IS MANOR HOUSE.

FOR COMPUTER SOFTWARE FOR ORGANIZING AND MANAGING COMPUTER-BASED CUSTOMER CONTACT INFORMATION AND FOR PLACING AND DIRECTING TELEPHONE CALLS FROM A HOST COMPUTER FOR USE IN TELEMARKETING, CALL CENTER MANAGEMENT, CONTACT MANAGEMENT AND CUSTOMER SUPPORT (U.S. CLS. 21, 23, 26, 36 AND 38).  
TARAH HARDY, EXAMINING ATTORNEY

**CLASS 9—(Continued).**

SN 76-585,304. NEC ELECTRONICS CORPORATION, KANAGAWA, JAPAN, FILED 4-6-2004.

# MINICUBE

THE MARK CONSISTS OF STANDARD CHARACTERS WITHOUT CLAIM TO ANY PARTICULAR FONT, STYLE, SIZE, OR COLOR.

FOR COMPUTER SOFTWARE AND ELECTRICAL AND ELECTRONIC APPARATUS AND INSTRUMENTS FOR TESTING AND ANALYZING SOFTWARE AND HARDWARE, NAMELY, DEBUGGERS, IN-CIRCUIT EMULATORS, ANALYZERS, SIMULATORS AND MONITORS (U.S. CLS. 21, 23, 26, 36 AND 38).  
MICHAEL KEATING, EXAMINING ATTORNEY



SN 76-585,327. KAPRO INDUSTRIES LTD., HAKERAM, 12390, ISRAEL, FILED 4-6-2004.

# SET & MATCH

THE MARK CONSISTS OF STANDARD CHARACTERS WITHOUT CLAIM TO ANY PARTICULAR FONT, STYLE, SIZE, OR COLOR.

FOR LAYOUT AND MARKING TOOL COMPRISED OF A STRAIGHT EDGE AND A LEVEL; RULERS; SPIRIT LEVELS (U.S. CLS. 21, 23, 26, 36 AND 38).  
FIRST USE 3-0-2000; IN COMMERCE 5-0-2000.  
LEIGH CAROLINE CASE, EXAMINING ATTORNEY



SN 76-585,754. METRONICS, INC., BEDFORD, NH. FILED 4-8-2004.

# GAGE-CHEK

THE MARK CONSISTS OF STANDARD CHARACTERS WITHOUT CLAIM TO ANY PARTICULAR FONT, STYLE, SIZE, OR COLOR.

FOR HIGH RESOLUTION DIGITAL READOUT UNIT FOR USE WITH ANALOG AND DIGITAL PROBES (U.S. CLS. 21, 23, 26, 36 AND 38).  
FIRST USE 2-15-2002; IN COMMERCE 9-9-2002.  
STANLEY I. OSBORNE, EXAMINING ATTORNEY

**CLASS 9—(Continued).**

SN 76-586,018. CESSNA AIRCRAFT COMPANY, WICHITA, KS. FILED 4-9-2004.

# CESS NAV

FOR DOWNLOADABLE ELECTRONIC PUBLICATIONS IN THE NATURE OF AIRCRAFT NAVIGATIONAL CHARTS AND PERFORMANCE MANUALS (U.S. CLS. 21, 23, 26, 36 AND 38).  
CHERYL CLAYTON, EXAMINING ATTORNEY

SN 76-586,749. BERNSTEIN, JONATHAN A., NEW YORK, NY. FILED 4-14-2004.

# SCOUT

THE MARK CONSISTS OF STANDARD CHARACTERS WITHOUT CLAIM TO ANY PARTICULAR FONT, STYLE, SIZE, OR COLOR.  
FOR HAND HELD ELECTRICAL DEVICE FOR REMOTELY LOCATING GOLF BALLS (U.S. CLS. 21, 23, 26, 36 AND 38).  
FRED MANDIR, EXAMINING ATTORNEY

SN 76-587,037. CITADEL SECURITY SOFTWARE INC., DALLAS, TX. FILED 4-13-2004.

# CONNECTGUARD

FOR SOFTWARE FOR ANALYZING, FILTERING, AND/OR RESTRICTING NETWORK TRAFFIC BETWEEN A COMPUTER AND OTHER COMPUTERS OR A COMPUTER NETWORK (U.S. CLS. 21, 23, 26, 36 AND 38).  
DANIEL CAPSHAW, EXAMINING ATTORNEY

**CLASS 9—(Continued).**

SN 76-587,898. BLUE RIDGE NETWORKS, INC., CHANTILLY, VA. FILED 4-21-2004.

# BORDERGUARD

THE MARK CONSISTS OF STANDARD CHARACTERS WITHOUT CLAIM TO ANY PARTICULAR FONT, STYLE, SIZE, OR COLOR.  
FOR VIRTUAL PRIVATE NETWORK (VPN) HARDWARE AND OPERATING SOFTWARE (U.S. CLS. 21, 23, 26, 36 AND 38).  
FIRST USE 8-0-1997; IN COMMERCE 8-0-1997.  
KATHERINE STOIDES, EXAMINING ATTORNEY

SN 76-588,028. PERFECT FIT GLOVE CO., LLC, BUFFALO, NY. FILED 4-22-2004.

# POWERCOAT

THE MARK CONSISTS OF STANDARD CHARACTERS WITHOUT CLAIM TO ANY PARTICULAR FONT, STYLE, SIZE, OR COLOR.  
FOR PROTECTIVE GLOVES FOR INDUSTRIAL AND COMMERCIAL USE (U.S. CLS. 21, 23, 26, 36 AND 38).  
FIRST USE 0-0-1996; IN COMMERCE 0-0-1996.  
REGINA DRUMMOND, EXAMINING ATTORNEY

SN 76-588,405. THE LIFESTYLE GP COMPANY, LAKEWOOD, CO. FILED 4-22-2004.

# MARQUIS

THE MARK CONSISTS OF STANDARD CHARACTERS WITHOUT CLAIM TO ANY PARTICULAR FONT, STYLE, SIZE, OR COLOR.  
FOR OCULAR LENSES, NAMELY CONTACT LENSES, PLASTIC BLANKS FOR CONTACT LENSES, AND CONTAINERS FOR CONTACT LENSES (U.S. CLS. 21, 23, 26, 36 AND 38).  
KELLY CHOE, EXAMINING ATTORNEY

**CLASS 9—(Continued).**

SN 76-588,449. KISS NAIL PRODUCTS, INC., PORT WASHINGTON, NY. FILED 4-22-2004.

## MOBILE FESTIVAL

NO CLAIM IS MADE TO THE EXCLUSIVE RIGHT TO USE "MOBILE", APART FROM THE MARK AS SHOWN. FOR COMPUTER PROGRAMS, NAMELY, INTERACTIVE VIDEO GAME PROGRAMS AND COMPUTER GAME SOFTWARE FOR USE ON WIRELESS DEVICES AND CELL PHONES (U.S. CLS. 21, 23, 26, 36 AND 38).  
CAROLYN CATALDO, EXAMINING ATTORNEY

SN 76-589,914. LOW AND INSIDE, LLC, MINNEAPOLIS, MN. FILED 4-12-2004.

## LOW AnD inSiDE

THE MARK CONSISTS OF STANDARD CHARACTERS WITHOUT CLAIM TO ANY PARTICULAR FONT, STYLE, SIZE, OR COLOR.  
FOR ELECTRONIC PUBLICATIONS NAMELY BOOKS, MAGAZINES AND ARTICLES FEATURING BASEBALL RELATED INFORMATION RECORDED ON COMPUTER MEDIA (U.S. CLS. 21, 23, 26, 36 AND 38).  
GEORGE LORENZO, EXAMINING ATTORNEY

SN 76-590,135. UBISOFT, INC., SAN FRANCISCO, CA. FILED 5-3-2004.

## NOTORIOUS: DIE TO DRIVE

THE MARK CONSISTS OF STANDARD CHARACTERS WITHOUT CLAIM TO ANY PARTICULAR FONT, STYLE, SIZE, OR COLOR.  
FOR SOFTWARE AND ELECTRONIC GAMES, NAMELY SOFTWARE GAMES RECORDED ON CD-ROM AND DIGITAL VIDEO DISCS FOR COMPUTERS; SOFTWARE GAMES RECORDED ON CD-ROMS, DIGITAL VIDEO DISCS, AND CARTRIDGES FOR CONSOLE AND INDIVIDUAL, PORTABLE GAMING SYSTEMS; SOFTWARE GAMES THAT ARE DOWNLOADABLE FROM A REMOTE COMPUTER SITE; AND SOFTWARE GAMES FOR MOBILE PHONES, PERSONAL DIGITAL ASSISTANTS, AND HANDHELD COMPUTERS (U.S. CLS. 21, 23, 26, 36 AND 38).  
IRENE D. WILLIAMS, EXAMINING ATTORNEY

**CLASS 9—(Continued).**

SN 76-590,294. COMMAND ALKON INCORPORATED, BIRMINGHAM, AL. FILED 5-3-2004.

## COMMANDSERIES XP

THE MARK CONSISTS OF STANDARD CHARACTERS WITHOUT CLAIM TO ANY PARTICULAR FONT, STYLE, SIZE, OR COLOR.  
OWNER OF U.S. REG. NOS. 2,782,441, 2,823,983 AND OTHERS.  
FOR COMPUTER SOFTWARE, NAMELY, SOFTWARE USED BY CONCRETE MANUFACTURERS TO TRACK AND MONITOR ORDER, ACCOUNT, DISPATCHING, LOCATION, AND DELIVERY INFORMATION WITH RESPECT TO CONCRETE PRODUCTS (U.S. CLS. 21, 23, 26, 36 AND 38).  
SUE LAWRENCE, EXAMINING ATTORNEY

SN 76-590,608. CHAMPION RANCH, LTD., CENTERVILLE, TX. FILED 5-5-2004.

## RANCH HAND

THE MARK CONSISTS OF STANDARD CHARACTERS WITHOUT CLAIM TO ANY PARTICULAR FONT, STYLE, SIZE, OR COLOR.  
FOR COMPUTER PROGRAM FOR RECEIVING INFORMATION THAT HAS BEEN RECORDED ON A TAG ATTACHED TO AN ANIMAL, WHERE THE INFORMATION INCLUDES AN IDENTIFIER AND CHARACTERISTICS OF THE ANIMAL, AND RECORDING THE INFORMATION IN A DATABASE IN A COMPUTER (U.S. CLS. 21, 23, 26, 36 AND 38).  
KELLY CHOE, EXAMINING ATTORNEY

SN 76-590,852. LAB-VOLT SYSTEMS, INC., FARMINGDALE, NJ. FILED 5-6-2004.

## TECH-DESIGN

OWNER OF U.S. REG. NO. 1,827,806.  
FOR MULTIMEDIA EDUCATIONAL MATERIALS; NAMELY, PRERECORDED COMPUTER PROGRAMS PROVIDING INSTRUCTIONS IN A BROAD RANGE OF TECHNOLOGIES (U.S. CLS. 21, 23, 26, 36 AND 38).  
FIRST USE 5-15-1997; IN COMMERCE 5-15-1997.  
ALEXANDER L. POWERS, EXAMINING ATTORNEY

**CLASS 9—(Continued).**

SN 76-591,138. LORD'S COMPANY OF ORLANDO, THE, DBA KELLYCO, WINTER SPRINGS, FL. FILED 5-10-2004.

**AUTOMAX PRECISION V<sub>2</sub> PINPOINTER**

FOR METAL DETECTORS (U.S. CLS. 21, 23, 26, 36 AND 38).

FIRST USE 12-1-2001; IN COMMERCE 12-1-2001.  
DAWN FELDMAN, EXAMINING ATTORNEY

SN 76-591,154. BACOU-DALLOZ EYE & FACE PROTECTION, INC., SMITHFIELD, RI. FILED 5-10-2004.

**CLARION**

THE MARK CONSISTS OF STANDARD CHARACTERS WITHOUT CLAIM TO ANY PARTICULAR FONT, STYLE, SIZE, OR COLOR.

FOR SAFETY EYEWEAR (U.S. CLS. 21, 23, 26, 36 AND 38).

BRIAN NEVILLE, EXAMINING ATTORNEY

SN 76-591,291. CYBERLINK CORP., SHINDIAN CITY, TAIPEI, TAIWAN, FILED 5-10-2004.

**MAGICDIRECTOR**

THE MARK CONSISTS OF STANDARD CHARACTERS WITHOUT CLAIM TO ANY PARTICULAR FONT, STYLE, SIZE, OR COLOR.

FOR COMPUTER SOFTWARE FOR AUDIO AND VIDEO EDITING FOR PRODUCING EDITED VIDEO AND AUDIO EFFECTS ON A COMPUTER; PRERECORDED COMPUTER COMPACT AND FLOPPY DISCS HAVING RECORDED COMPUTER PROGRAMS FOR AUDIO AND VIDEO EDITING OF DATA (U.S. CLS. 21, 23, 26, 36 AND 38).

MARY CRAWFORD, EXAMINING ATTORNEY

**CLASS 9—(Continued).**

SN 76-591,413. GROUP PUBLISHING, INC., LOVELAND, CO. FILED 5-11-2004.

**THE 1 THING**

THE MARK CONSISTS OF STANDARD CHARACTERS WITHOUT CLAIM TO ANY PARTICULAR FONT, STYLE, SIZE, OR COLOR.

FOR PRERECORDED VIDEO CASSETTES, PRERECORDED VIDEO DISCS, PRERECORDED AUDIO CASSETTES AND PRERECORDED AUDIO DISCS SOLD SEPARATELY OR WITHIN A MULTIMEDIA KIT ALL FEATURING CHRISTIAN EDUCATIONAL INFORMATION TO BE USED IN CHURCHES AND OTHER CHRISTIAN EDUCATIONAL SETTINGS (U.S. CLS. 21, 23, 26, 36 AND 38).

LINDA M. KING, EXAMINING ATTORNEY

SN 76-591,498. BSG SOFTWARE SOLUTIONS, L.L.C., BATON ROUGE, LA. FILED 5-10-2004.

**PROEXECUTE**

THE MARK CONSISTS OF STANDARD CHARACTERS WITHOUT CLAIM TO ANY PARTICULAR FONT, STYLE, SIZE, OR COLOR.

FOR SOFTWARE FOR MANAGING CONSTRUCTION PROJECT INFORMATION (U.S. CLS. 21, 23, 26, 36 AND 38).

KATHRYN COWARD, EXAMINING ATTORNEY

SN 76-591,589. HUSKY INJECTION MOLDING SYSTEMS LTD., BOLTON, ONTARIO, CANADA, FILED 5-11-2004.

**SIMPET**

THE MARK CONSISTS OF STANDARD CHARACTERS WITHOUT CLAIM TO ANY PARTICULAR FONT, STYLE, SIZE, OR COLOR.

FOR MULTIMEDIA SOFTWARE RECORDED ON CD-ROM COVERING TRAINING SEMINARS, MANUALS AND PROGRAMS FOR USE WITH INJECTION MOLDING MACHINES (U.S. CLS. 21, 23, 26, 36 AND 38).

JERI J. FICKES, EXAMINING ATTORNEY



**CLASS 9—(Continued).**

SN 76-591,615. BRAND DESIGN COMPANY, INC., DBA HOUSE INDUSTRIES, YORKLYN, DE. FILED 5-11-2004.

**UNITED**

THE MARK CONSISTS OF STANDARD CHARACTERS WITHOUT CLAIM TO ANY PARTICULAR FONT, STYLE, SIZE, OR COLOR.

FOR TYPE FACE FONTS RECORDED ON MAGNETIC AND OPTICAL MEDIA (U.S. CLS. 21, 23, 26, 36 AND 38). FIRST USE 5-20-2002; IN COMMERCE 5-20-2002. CIMMERIAN COLEMAN, EXAMINING ATTORNEY

**CLASS 9—(Continued).**

SN 76-591,779. YORK TELECOM CORPORATION, EATON-TOWN, NJ. FILED 5-12-2004.

**C-CURE WARE**

THE MARK CONSISTS OF STANDARD CHARACTERS WITHOUT CLAIM TO ANY PARTICULAR FONT, STYLE, SIZE, OR COLOR.

FOR NETWORK ACCESS SYSTEMS COMPRISING COMPUTER HARDWARE AND SOFTWARE FOR THE AGGREGATION AND MANAGEMENT OF VOICE, VIDEO, AND DATA TRAFFIC OVER COMPUTER NETWORKS IN FIELD OF TELECOMMUNICATION (U.S. CLS. 21, 23, 26, 36 AND 38). FIRST USE 6-1-2003; IN COMMERCE 6-1-2003.

NAKWAMA ANKRAH, EXAMINING ATTORNEY

SN 76-591,682. AMERICAN OPTICAL IP CORPORATION, GREENWICH, CT. FILED 5-12-2004.

**AOSAFETY**

OWNER OF U.S. REG. NO. 1,725,248. FOR PROTECTIVE SAFETY APPARATUS; NAMELY, SAFETY PRESCRIPTION AND NON-PRESCRIPTION EYEWEAR; NAMELY, SAFETY EYEGASSES, SUNGLASSES AND GOGGLES; FACESHIELDS; HEAD PROTECTORS; NAMELY, SAFETY HELMETS AND CONSTRUCTION HARD HATS; AND INDUSTRIAL RESPIRATORS (U.S. CLS. 21, 23, 26, 36 AND 38). FIRST USE 10-31-1990; IN COMMERCE 10-31-1990. DANIEL CAPSHAW, EXAMINING ATTORNEY

SN 76-591,869. INFORMATICA CORPORATION, REDWOOD CITY, CA. FILED 5-12-2004.

**POWEREXCHANGE**

THE MARK CONSISTS OF STANDARD CHARACTERS WITHOUT CLAIM TO ANY PARTICULAR FONT, STYLE, SIZE, OR COLOR.

FOR COMPUTER SOFTWARE IN THE FIELD OF DATA AND METADATA CONNECTIVITY THAT FACILITATES DATA INTEGRATION FOR APPLICATION DEVELOPMENT, DATABASE MANAGEMENT, ACCESS TO AN INTERNAL COMPUTER NETWORK, ACCESS TO A GLOBAL COMPUTER INFORMATION NETWORK AND FOR DESIGN OF NETWORK BASES AUTOMATED DECISION SUPPORT AND ASSOCIATED MANUALS PROVIDED AS A UNIT (U.S. CLS. 21, 23, 26, 36 AND 38). FIRST USE 1-0-2004; IN COMMERCE 5-3-2004.

LEIGH CAROLINE CASE, EXAMINING ATTORNEY

SN 76-591,760. WYLE LABORATORIES, EL SEGUNDO, CA. FILED 5-10-2004.

**TRAIN LIKE YOU FLY**

THE MARK CONSISTS OF STANDARD CHARACTERS WITHOUT CLAIM TO ANY PARTICULAR FONT, STYLE, SIZE, OR COLOR.

FOR COMPUTER BASED FLIGHT SIMULATOR (U.S. CLS. 21, 23, 26, 36 AND 38). CYNTHIA SLOAN, EXAMINING ATTORNEY

SN 76-591,871. RADIAN, INC., ALEXANDRIA, VA. FILED 5-12-2004.

**RASP**

FOR POWER SUPPLIES (U.S. CLS. 21, 23, 26, 36 AND 38).

NAKWAMA ANKRAH, EXAMINING ATTORNEY

**CLASS 9—(Continued).**

SN 76-592,168. IBEX HEALTHDATA SYSTEMS, INC., ROSEMONT, IL. FILED 5-14-2004.

**IBEXPEN**

THE MARK CONSISTS OF STANDARD CHARACTERS WITHOUT CLAIM TO ANY PARTICULAR FONT, STYLE, SIZE, OR COLOR.

OWNER OF U.S. REG. NOS. 2,594,952, 2,864,585 AND OTHERS.

FOR HANDHELD DEVICE THAT WRITES ON PAPER, ALSO FORMS AN ELECTRONIC RECORD OF WHAT IS WRITTEN, AND TRANSFERS THE ELECTRONIC RECORD TO A COMPUTER MEMORY; COMPUTER PERIPHERALS USED TO TRANSFER THE ELECTRONIC RECORD TO THE COMPUTER, NAMELY, AN ELECTRONIC CRADLE, MODEM, PORTABLE MEMORY DEVICE, OR DATA TRANSFER CABLE (U.S. CLS. 21, 23, 26, 36 AND 38).

MICHAEL WEBSTER, EXAMINING ATTORNEY

**CLASS 9—(Continued).**

SN 76-615,411. MOBILITY ELECTRONICS, INC., SCOTTSDALE, AZ. FILED 10-5-2004.

**IGO EVERYWHEREPOWER**

THE MARK CONSISTS OF STANDARD CHARACTERS WITHOUT CLAIM TO ANY PARTICULAR FONT, STYLE, SIZE, OR COLOR.

OWNER OF U.S. REG. NOS. 2,405,382, 2,407,905 AND 2,415,357.

FOR ADAPTERS FOR POWERING AND CHARGING LAPTOP COMPUTERS, NOTEBOOK COMPUTERS, CELL PHONES, PORTABLE DIGITAL ASSISTANTS, PORTABLE ELECTRONIC UNITS FOR THE TRANSMISSION AND RECEIPT OF ELECTRONIC MAIL, DIGITAL CAMERAS, PORTABLE GAME CONSOLES, CAMCORDERS, DIGITAL VIDEO DISC PLAYERS, AND PORTABLE ELECTRONIC UNITS FOR THE STORAGE AND TRANSMISSION OF DIGITAL AND ELECTRONIC DATA; AND POWER CONVERTERS AND INTERCHANGEABLE TIPS FOR USE WITH ADAPTERS FOR POWERING AND CHARGING LAPTOP COMPUTERS, NOTEBOOK COMPUTERS, CELL PHONES, PORTABLE DIGITAL ASSISTANTS, PORTABLE ELECTRONIC UNITS FOR THE TRANSMISSION AND RECEIPT OF ELECTRONIC MAIL, DIGITAL CAMERAS, PORTABLE GAME CONSOLES, CAMCORDERS, DIGITAL VIDEO DISC PLAYERS, AND PORTABLE ELECTRONIC UNITS FOR THE STORAGE AND TRANSMISSION OF DIGITAL AND ELECTRONIC DATA (U.S. CLS. 21, 23, 26, 36 AND 38).

FIRST USE 7-1-2004; IN COMMERCE 7-1-2004.

ANN E. SAPPENFIELD, EXAMINING ATTORNEY

SN 76-615,412. MOBILITY ELECTRONICS, INC., SCOTTSDALE, AZ. FILED 10-5-2004.

**IGO DUALPOWER**

THE MARK CONSISTS OF STANDARD CHARACTERS WITHOUT CLAIM TO ANY PARTICULAR FONT, STYLE, SIZE, OR COLOR.

OWNER OF U.S. REG. NOS. 2,405,382, 2,407,905 AND 2,415,357.

FOR POWER CONVERTERS FOR USE WITH ADAPTERS FOR POWERING AND CHARGING LAPTOP COMPUTERS, NOTEBOOK COMPUTERS, CELL PHONES, PORTABLE DIGITAL ASSISTANTS, PORTABLE ELECTRONIC UNITS FOR THE TRANSMISSION AND RECEIPT OF ELECTRONIC MAIL, DIGITAL CAMERAS, PORTABLE GAME CONSOLES, CAMCORDERS, DIGITAL VIDEO DISC PLAYERS, AND PORTABLE ELECTRONIC UNITS FOR THE STORAGE AND TRANSMISSION OF DIGITAL AND ELECTRONIC DATA (U.S. CLS. 21, 23, 26, 36 AND 38).

FIRST USE 7-1-2004; IN COMMERCE 7-1-2004.

ANN E. SAPPENFIELD, EXAMINING ATTORNEY

SN 76-592,523. GLOBAL SPAN PRODUCTS, INC., CAMPBELL, CA. FILED 5-17-2004.



FOR ELECTRICAL CLIPS; ELECTRICAL CONNECTORS (U.S. CLS. 21, 23, 26, 36 AND 38).

FIRST USE 2-27-2004; IN COMMERCE 2-27-2004.

JOHN GARTNER, EXAMINING ATTORNEY

**CLASS 9—(Continued).**

SN 76-615,413. MOBILITY ELECTRONICS, INC., SCOTTS-DALE, AZ. FILED 10-5-2004.

**IGO AUTOPOWER**

THE MARK CONSISTS OF STANDARD CHARACTERS WITHOUT CLAIM TO ANY PARTICULAR FONT, STYLE, SIZE, OR COLOR.

OWNER OF U.S. REG. NOS. 2,405,382, 2,407,905 AND 2,415,357.

FOR ADAPTERS FOR POWERING AND CHARGING LAPTOP COMPUTERS, NOTEBOOK COMPUTERS, CELL PHONES, PORTABLE DIGITAL ASSISTANTS, PORTABLE ELECTRONIC UNITS FOR THE TRANSMISSION AND RECEIPT OF ELECTRONIC MAIL, DIGITAL CAMERAS, PORTABLE GAME CONSOLES, CAMCORDERS, DIGITAL VIDEO DISC PLAYERS, AND PORTABLE ELECTRONIC UNITS FOR THE STORAGE AND TRANSMISSION OF DIGITAL AND ELECTRONIC DATA; AND INTERCHANGEABLE TIPS FOR USE WITH ADAPTERS FOR POWERING AND CHARGING LAPTOP COMPUTERS, NOTEBOOK COMPUTERS, CELL PHONES, PORTABLE DIGITAL ASSISTANTS, PORTABLE ELECTRONIC UNITS FOR THE TRANSMISSION AND RECEIPT OF ELECTRONIC MAIL, DIGITAL CAMERAS, PORTABLE GAME CONSOLES, CAMCORDERS, DIGITAL VIDEO DISC PLAYERS, AND PORTABLE ELECTRONIC UNITS FOR THE STORAGE AND TRANSMISSION OF DIGITAL AND ELECTRONIC DATA (U.S. CLS. 21, 23, 26, 36 AND 38).

FIRST USE 7-1-2004; IN COMMERCE 7-1-2004.

ANN E. SAPPENFIELD, EXAMINING ATTORNEY

SN 76-615,414. MOBILITY ELECTRONICS, INC., SCOTTS-DALE, AZ. FILED 10-5-2004.

**IGO WALLPOWER**

THE MARK CONSISTS OF STANDARD CHARACTERS WITHOUT CLAIM TO ANY PARTICULAR FONT, STYLE, SIZE, OR COLOR.

OWNER OF U.S. REG. NOS. 2,405,382, 2,407,905 AND 2,415,357.

FOR ADAPTERS FOR POWERING AND CHARGING LAPTOP COMPUTERS, NOTEBOOK COMPUTERS, CELL PHONES, PORTABLE DIGITAL ASSISTANTS, PORTABLE ELECTRONIC UNITS FOR THE TRANSMISSION AND RECEIPT OF ELECTRONIC MAIL, DIGITAL CAMERAS, PORTABLE GAME CONSOLES, CAMCORDERS, DIGITAL VIDEO DISC PLAYERS, AND PORTABLE ELECTRONIC UNITS FOR THE STORAGE AND TRANSMISSION OF DIGITAL AND ELECTRONIC DATA; AND INTERCHANGEABLE TIPS FOR USE WITH ADAPTERS FOR POWERING AND CHARGING LAPTOP COMPUTERS, NOTEBOOK COMPUTERS, CELL PHONES, PORTABLE DIGITAL ASSISTANTS, PORTABLE ELECTRONIC UNITS FOR THE TRANSMISSION AND RECEIPT OF ELECTRONIC MAIL, DIGITAL CAMERAS, PORTABLE GAME CONSOLES, CAMCORDERS, DIGITAL VIDEO DISC PLAYERS, AND PORTABLE ELECTRONIC UNITS FOR THE STORAGE AND TRANSMISSION OF DIGITAL AND ELECTRONIC DATA (U.S. CLS. 21, 23, 26, 36 AND 38).

FIRST USE 7-1-2004; IN COMMERCE 7-1-2004.

ANN E. SAPPENFIELD, EXAMINING ATTORNEY

**CLASS 9—(Continued).**

SN 78-030,737. EASTMAN KODAK COMPANY, ROCHESTER, NY. FILED 10-16-2000.

**I.LAB**

FOR PHOTOGRAPHIC INSTRUMENTS AND APPARATUS FOR RECORDING, MANIPULATING, TRANSMITTING OR REPRODUCING IMAGES, NAMELY, COMPUTERS, COMPUTER KEYBOARDS AND MICE, MONITORS, SCANNERS, AND COMPACT DISCS FEATURING DIGITAL IMAGES; COMPUTER HARDWARE AND RELATED COMPUTER SOFTWARE FOR USE IN SCANNING, STORING, RETRIEVING, DISPLAYING, AND MANIPULATING IMAGES, ALL FOR USE BY COMMERCIAL PHOTOGRAPHIC FILM PROCESSING LABORATORIES. (U.S. CLS. 21, 23, 26, 36 AND 38).

JOHN GARTNER, EXAMINING ATTORNEY

SN 78-107,940. WAREONEARTH COMMUNICATIONS, INC., MCLEAN, VA. FILED 2-11-2002.

**ZONE LOCK**

NO CLAIM IS MADE TO THE EXCLUSIVE RIGHT TO USE "ZONE", APART FROM THE MARK AS SHOWN.

FOR COMPUTER SOFTWARE AND HARDWARE SOLUTIONS FOR INTRUSION DETECTION, ISOLATION, AND REMEDIATION REQUIRED TO PROTECT AGAINST ACCESS BY UNAUTHORIZED USERS OR FOR UNAUTHORIZED PURPOSES; AND FOR PROTECTION OF IDENTITIES, ACCESS RIGHTS, PRIVILEGES, AND RELATIONSHIPS BETWEEN ENTITIES FROM UNAUTHORIZED OBSERVATION, INTRUSION, AND INTERRUPTION WITH THE ADDED CHARACTERISTIC THAT ALL ACCESS, EXIT, AND OTHER TRANSACTIONS, INCLUDING COLLABORATIVE COMMUNICATION, CAN BE CERTIFIED VIA NON-REPUDIATION AND PROTECTION TRANSPORT SCHEMA (U.S. CLS. 21, 23, 26, 36 AND 38).

KIMBERLY PERRY, EXAMINING ATTORNEY

**CLASS 9—(Continued).**

SN 78-149,728. NEW ORLEANS HORNETS NBA LIMITED PARTNERSHIP, NEW ORLEANS, LA. FILED 8-1-2002.



FOR AUDIO, VIDEO, COMPUTER AND LASER DISCS, PRE-RECORDED AUDIO AND VIDEO CASSETTES, PRE-RECORDED AUDIO AND VIDEO TAPES, PRE-RECORDED COMPACT DISCS, PRE-RECORDED COMPUTER DISCS, ALL RELATED TO BASKETBALL; COMPUTER ACCESSORIES, NAMELY MOUSE PADS, MICE, DISC CASES, COMPUTER CARRY-ON CASES, KEYBOARD WRIST PADS, COMPUTER MONITOR CARDBOARD FRAMES, ALL RELATED TO BASKETBALL; COMPUTER PROGRAMS FOR VIEWING INFORMATION, STATISTICS OR TRIVIA ABOUT BASKETBALL; COMPUTER SOFTWARE FEATURING BASKETBALL, NAMELY SCREEN SAVERS, COMPUTER SOFTWARE TO ASSESS AND VIEW COMPUTER WALLPAPER, COMPUTER BROWSERS, COMPUTER SKINS AND COMPUTER CURSORS; COMPUTER GAME SOFTWARE; VIDEO GAME SOFTWARE, VIDEO GAME CARTRIDGES AND VIDEO GAME MACHINES FOR USE WITH TELEVISIONS; RADIO AND TELEPHONES; BINOCULARS; SUNGLASSES; EYEGLOSS FRAMES; EYEWEAR STRAPS AND CHAINS; EYEGLOSS AND SUNGLASS CASES; MAGNETS; DISPOSABLE CAMERAS; CREDIT CARDS AND PRE-PAID TELEPHONE CALLING CARDS MAGNETICALLY ENCODED, DOWNLOADABLE VIDEO RECORDINGS, DOWNLOADABLE VIDEO STREAM RECORDINGS, AND DOWNLOADABLE AUDIO RECORDINGS IN THE FIELD OF BASKETBALL; DOWNLOADABLE COMPUTER SOFTWARE FOR VIEWING DATABASES OF INFORMATION, STATISTICAL INFORMATION, TRIVIA, POLLING INFORMATION, AND INTERACTIVE POLLING IN THE FIELD OF BASKETBALL; DOWNLOADABLE COMPUTER GAME SOFTWARE, VIDEO GAME PROGRAMS, INTERACTIVE VIDEO GAMES AND TRIVIA GAME SOFTWARE; DOWNLOADABLE COMPUTER SOFTWARE FOR USE AS SCREENSAVERS, WALLPAPER, BROWSERS, SKINS, AVATARS AND CURSORS OVER THE INTERNET, DOWNLOADABLE ELECTRONIC PUBLICATIONS IN THE NATURE OF MAGAZINES AND NEWSLETTERS IN THE FIELD OF BASKETBALL, DOWNLOADABLE COLORING BOOKS IN THE NATURE OF PICTURES AND DRAWINGS, AND DOWNLOADABLE CATALOGS FEATURING AN ARRAY OF BASKETBALL-THEMED PRODUCTS (U.S. CLS. 21, 23, 26, 36 AND 38).

REBECCA SMITH, EXAMINING ATTORNEY

**CLASS 9—(Continued).**

SN 78-181,025. RAMPAGE VENTURES INC., GEORGE TOWN, GRAND CAYMAN, CAYMAN ISLANDS, FILED 11-1-2002.

**MAGNA-WEDGE**

PRIORITY CLAIMED UNDER SEC. 44(D) ON CANADA APPLICATION NO. 1139536, FILED 5-1-2002, REG. NO. TMA590820, DATED 9-25-2003, EXPIRES 9-25-2018.

FOR MAGNETS, NAMELY, FLEXIBLE ELASTOMETRIC COMPOUNDS WITH MAGNETIC ELEMENTS FOR INDUSTRIAL USE IN SEPARATING MAGNETIC MATERIAL FROM NON-MAGNETIC MATERIAL (U.S. CLS. 21, 23, 26, 36 AND 38).

FIRST USE 4-15-2002; IN COMMERCE 4-15-2002.  
MICHELE SWAIN, EXAMINING ATTORNEY

SN 78-199,272. MAGNITUDE INFORMATION SYSTEMS, INC., CHESTER, NJ. FILED 1-1-2003.

**ERGO SCOUT**

FOR COMPUTER SOFTWARE FOR HELPING PEOPLE LEARN GOOD ERGONOMICS AT THE COMPUTER (U.S. CLS. 21, 23, 26, 36 AND 38).

JOHN E. MICHOS, EXAMINING ATTORNEY

SN 78-204,978. INET ACCESS, ATLANTA, GA. FILED 1-20-2003.



NO CLAIM IS MADE TO THE EXCLUSIVE RIGHT TO USE "INET ACCESS", APART FROM THE MARK AS SHOWN.

FOR TELECOMMUNICATION EQUIPMENT HARDWARE, NAMELY, MODEMS, ROUTERS, SWITCHES, AND ASSOCIATED HARDWARE FOR FACILITATING AND MANAGING VOICE TRANSMISSION OVER LOCAL AREA NETWORKS, VIRTUAL PRIVATE NETWORKS, WIDE AREA NETWORKS AND GLOBAL COMPUTER NETWORKS; INTERNET EQUIPMENT HARDWARE, NAMELY, PLUG AND PLAY SERVERS, ROUTERS, SWITCHES, HUBS, CONVERTERS, HARDWARE FOR WIRELESS DATA AND VOICE COMMUNICATIONS, HARDWARE FOR CREATING, FACILITATING, AND MANAGING REMOTE ACCESS TO AND COMMUNICATION WITH LOCAL AREA NETWORKS, VIRTUAL PRIVATE NETWORKS, WIDE AREA NETWORKS AND GLOBAL COMPUTER NETWORKS (U.S. CLS. 21, 23, 26, 36 AND 38).

FIRST USE 7-20-2002; IN COMMERCE 9-1-2002.  
HOWARD SMIGA, EXAMINING ATTORNEY

**CLASS 9—(Continued).**

SN 78-210,176. PRISTINE SOFTWARE, L.L.C., DAVIS, CA. FILED 2-3-2003.

**CLASS 9—(Continued).**

SN 78-214,590. YUEQING PUQI ELECTRICAL PLASTIC FACTORY, ZHEJIANG, CHINA, FILED 2-13-2003.

**SYSCCHANGE**

FOR COMPUTER SOFTWARE FOR MANAGING SYSTEM SOFTWARE CHANGES IN MAINFRAME ENVIRONMENTS (U.S. CLS. 21, 23, 26, 36 AND 38).  
PAULA MAYS, EXAMINING ATTORNEY



SN 78-211,502. KLAVIS TECHNOLOGIES, WATERLOO, BELGIUM, FILED 2-6-2003.

FOR ELECTRONIC CONVERTERS, ELECTRIC PLUGS, ELECTRIC SOCKETS, ELECTRIC SWITCHES, ELECTRICAL CONNECTORS, ELECTRIC COILS, ELECTRIC LIGHT REGULATORS, ELECTRIC SWITCH PLATES, ELECTRIC RELAYS, INVERTERS, VOLTAGE REGULATORS FOR ELECTRIC POWER, INTEGRATED CIRCUITS, JUNCTION SLEEVES FOR ELECTRICAL CABLES, COMMUTATORS, ELECTRICAL WIRES, ELECTRICAL CABLES, ELECTRIC DOOR BELLS, BATTERIES (U.S. CLS. 21, 23, 26, 36 AND 38).  
FIRST USE 12-1-2002; IN COMMERCE 12-1-2002.  
ESTHER A. BORSUK, EXAMINING ATTORNEY

**CopperLan**

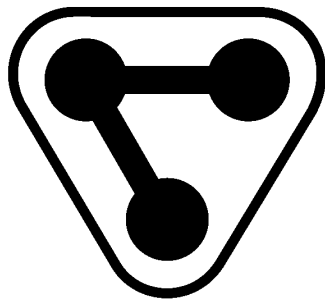

SN 78-217,954. ACULA TECHNOLOGY CORP., LUCHU HSIANG, TAIWAN, FILED 2-24-2003.

**AQSONIC**

FOR MUSICAL INSTRUMENT CONNECTORS; NETWORK INTERFACES, NAMELY ROUTERS, BRIDGES, GATEWAYS, AND HUBS; PROFESSIONAL AND CONSUMER AUDIO AND MUSICAL AMPLIFIERS; COMPUTER UTILITY SOFTWARE; COMPUTERS; COMPUTER PERIPHERALS; ELECTRIC AUDIO PLAYBACK UNITS WITH LIGHTS AND SPEAKERS (U.S. CLS. 21, 23, 26, 36 AND 38).  
RON FAIRBANKS, EXAMINING ATTORNEY

PRIORITY CLAIMED UNDER SEC. 44(D) ON TAIWAN APPLICATION NO. 92002865, FILED 12-31-2002, REG. NO. 1068724, DATED 12-1-2003, EXPIRES 11-30-2013.  
FOR LCD TELEVISION, LCD MONITOR, TELEVISION SETS AND COMPUTER MONITORS AND VIDEO MONITORS (U.S. CLS. 21, 23, 26, 36 AND 38).  
CHERYL CLAYTON, EXAMINING ATTORNEY

**CLASS 9—(Continued).**

SN 78-219,186. PIEZOMOTOR UPPSALA AB, UPPSALA, SWEDEN, FILED 2-26-2003.

**PIEZO LEGS**

PRIORITY CLAIMED UNDER SEC. 44(D) ON ERPN CMNTY TM OFC APPLICATION NO. 002840460, FILED 9-6-2002, REG. NO. 002840460, DATED 6-28-2004, EXPIRES 9-6-2012.

NO CLAIM IS MADE TO THE EXCLUSIVE RIGHT TO USE PIEZO, APART FROM THE MARK AS SHOWN.

FOR PIEZO ELECTRIC MOTORS; PIEZO ELECTRIC APPARATUS AND INSTRUMENTS AND SCIENTIFIC, NAUTICAL, PHOTOGRAPHIC, CINEMATOGRAPHIC AND OPTICAL APPARATUS AND INSTRUMENTS CONTAINING PIEZO ELECTRIC TECHNOLOGY, NAMELY, TRANSLATION STAGES, ZOOM LENSES, DIGITAL CAMERAS, FILM CAMERAS, VIDEO RECORDERS, LASERS NOT FOR MEDICAL USE, MINIATURE GEAR CONTROLLERS, BAR CODE SCANNERS AND MICROSCOPES; APPARATUS FOR RECORDING, TRANSMITTING OR REPRODUCING SOUND OR IMAGES, NAMELY, DVD RECORDERS AND PLAYERS, HARD DISK DRIVES, PICK-UP SYSTEMS FOR DVD AND HARD DISK DRIVES; BLANK MAGNETIC DATA CARRIERS; DATA PROCESSORS; AND COMPUTERS (U.S. CLS. 21, 23, 26, 36 AND 38).

JANICE L. MCMORROW, EXAMINING ATTORNEY

SN 78-240,926. KING SHOW GAMES LLC, MINNETONKA, MN. FILED 4-23-2003.

**BARN BUCKS**

FOR GAMBLING AND GAMING MACHINES; SLOT MACHINES; INTERACTIVE VIDEO GAMES OF VIRTUAL REALITY COMPRISED OF COMPUTER HARDWARE AND SOFTWARE; COMPUTER SOFTWARE FOR OPERATING GAMBLING AND GAMING MACHINES, VIDEO DISPLAY SERVERS (U.S. CLS. 21, 23, 26, 36 AND 38).

KATHLEEN M. VANSTON, EXAMINING ATTORNEY

SN 78-245,322. BUTTE, FAWN CHANETTE, MESA, AZ. FILED 5-2-2003.

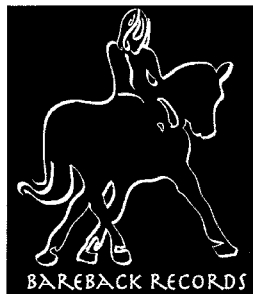

NO CLAIM IS MADE TO THE EXCLUSIVE RIGHT TO USE "RECORDS", APART FROM THE MARK AS SHOWN. FOR SOUND RECORDINGS FEATURING MUSIC (U.S. CLS. 21, 23, 26, 36 AND 38).

FIRST USE 3-11-2002; IN COMMERCE 3-22-2002.

THEODORE MCBRIDE, EXAMINING ATTORNEY

**CLASS 9—(Continued).**

SN 78-258,818. HERRING, DEXTER R., DBA BUCK HERRING PRODUCTIONS, DURANGO, CO. FILED 6-5-2003.

**2ND CHAPTER OF ACTS**

FOR SERIES OF PRE-RECORDED CD'S FEATURING RECORDED MUSICAL PERFORMANCES BY A VOCAL GROUP (U.S. CLS. 21, 23, 26, 36 AND 38).

FIRST USE 10-31-1971; IN COMMERCE 10-31-1971.

SOPHIA S. KIM, EXAMINING ATTORNEY

SN 78-265,269. BELL MOTORSPORTS, OAKLAND, CA. FILED 6-20-2003.

**PYROTECT**

FOR PROTECTIVE HELMETS, GLOVES, SHOES, AND HARNESSES FOR SAFETY PURPOSES (U.S. CLS. 21, 23, 26, 36 AND 38).

FIRST USE 12-31-1972; IN COMMERCE 12-31-1972.

CATHERINE FAINT, EXAMINING ATTORNEY

SN 78-278,090. OUTBACK SOFTWARE PTY LIMITED, A.C.N., THIRROUL, NEW SOUTH WALES, 2515, AUSTRALIA, FILED 7-24-2003.

**METRIX**

PRIORITY CLAIMED UNDER SEC. 44(D) ON AUSTRALIA APPLICATION NO. 958900, FILED 6-23-2003, REG. NO. 958900, DATED 6-23-2003, EXPIRES 6-23-2013.

FOR COMPUTER SOFTWARE FOR THE PRINTING INDUSTRY, FOR THE CALCULATION AND MANAGEMENT OF PRINT PRODUCTION DATA (U.S. CLS. 21, 23, 26, 36 AND 38).

FIRST USE 6-1-2003; IN COMMERCE 7-1-2004.

CAROLYN GRAY, EXAMINING ATTORNEY

SN 78-278,640. ENERGY CRANES LLC, HOUSTON, TX. FILED 7-24-2003.

**HERCULOG**

OWNER OF U.S. REG. NO. 2,109,672.

FOR TIME MONITORS FOR RECORDING OPERATIONAL TIME OF CRANES AND CRANE COMPONENTS (U.S. CLS. 21, 23, 26, 36 AND 38).

FIRST USE 10-0-1996; IN COMMERCE 10-0-1996.

LINDA MICKLEBURGH, EXAMINING ATTORNEY

**CLASS 9—(Continued).**

SN 78-279,450. TUCANO S.R.L., MILANO, ITALY, FILED 7-28-2003.



PRIORITY CLAIMED UNDER SEC. 44(D) ON ITALY APPLICATION NO. MI2003C00648, FILED 6-25-2003, REG. NO. 00902074, DATED 7-16-2003, EXPIRES 6-25-2013.

THE ENGLISH TRANSLATION OF TUCANO IS TOUCAN.

FOR CASES FOR COMPUTER DISCS, CASES FOR COMPACT DISCS, MOUSE PADS, COMPUTER BAGS, BAGS FOR COMPUTER ACCESSORIES (U.S. CLS. 21, 23, 26, 36 AND 38).

MELVIN AXILBUND, EXAMINING ATTORNEY

**CLASS 9—(Continued).**

SN 78-286,394. JENOPTIK LASER, OPTIK, SYSTEME GMBH, D-07745 JENA, FED REP GERMANY, FILED 8-12-2003.



**ProgRes**

FOR ELECTRONIC VIDEO CAMERAS, DIGITAL LCD CAMERAS AND SCANNERS (U.S. CLS. 21, 23, 26, 36 AND 38).

FIRST USE 11-30-2001; IN COMMERCE 11-30-2001.  
TONI HICKEY, EXAMINING ATTORNEY

SN 78-281,808. IDETIX, INC., AUBURN HILLS, MI. FILED 8-1-2003.

**REVIZE WEBSITE**

NO CLAIM IS MADE TO THE EXCLUSIVE RIGHT TO USE "WEBSITE", APART FROM THE MARK AS SHOWN.

FOR COMPUTER SOFTWARE, NAMELY SOFTWARE USED FOR WEB SITE SECURITY ADMINISTRATION AND TO ADMINISTRATIVELY CONTROL ASSETS RELATING TO WEB SITE DESIGN, WEB SITE DATA ENTRY AND WEB SITE DATA RETRIEVAL (U.S. CLS. 21, 23, 26, 36 AND 38).

FIRST USE 1-31-2003; IN COMMERCE 1-31-2003.  
INGA ERVIN, EXAMINING ATTORNEY

SN 78-286,666. PEAVEY ELECTRONICS CORPORATION, MERIDIAN, MS. FILED 8-13-2003.

**GRABBER**

FOR ELECTRICAL APPARATUS, NAMELY, AUDIO SAMPLER COMPRISED OF CIRCUIT BOARDS, OPERATING SYSTEM SOFTWARE AND ELECTRONIC CONTROLS FOR MIXING AND SEQUENCING SOUNDS AND MUSIC (U.S. CLS. 21, 23, 26, 36 AND 38).

AMY GEARIN, EXAMINING ATTORNEY

SN 78-282,173. ZIRCON CORPORATION, CAMPBELL, CA. FILED 8-1-2003.

**ILINE**

FOR ELECTRONIC AND BATTERY-OPERATED MEASURING, SENSING AND DETECTING APPARATUS, NAMELY, ELECTRONIC HARDWARE LASER LEVELS, LASER PLUMBS AND LASERS FOR MEASURING PURPOSES. (U.S. CLS. 21, 23, 26, 36 AND 38).

STEVEN BERK, EXAMINING ATTORNEY

SN 78-291,514. OWEN, MARY CLAIRE, ARLINGTON, VA. FILED 8-24-2003.

**BUBBA UNLIMITED**

FOR INTERACTIVE COMPACT DISCS FEATURING INSTRUCTIONAL AND EDUCATIONAL MATERIALS IN THE AREAS OF SOCIAL STUDIES, LANGUAGE ARTS, MATHEMATICS, SCIENCE, ART, MUSIC, AND PHYSICAL EDUCATION USED BY TEACHERS AND STUDENTS TO ENHANCE LEARNING ACROSS THE ELEMENTARY CURRICULA (U.S. CLS. 21, 23, 26, 36 AND 38).

CAROLYN GRAY, EXAMINING ATTORNEY

**CLASS 9—(Continued).**

SN 78-291,520. OWEN, MARY CLAIRE, ARLINGTON, VA.  
FILED 8-24-2003.



FOR INTERACTIVE COMPACT DISCS FEATURING INSTRUCTIONAL AND EDUCATIONAL TEACHING MATERIALS IN THE AREAS OF SOCIAL STUDIES, LANGUAGE ARTS, MATHEMATICS, SCIENCE, ART, MUSIC, AND PHYSICAL EDUCATION USED BY TEACHERS AND STUDENTS TO ENHANCE LEARNING ACROSS THE ELEMENTARY CURRICULA (U.S. CLS. 21, 23, 26, 36 AND 38).

CAROLYN GRAY, EXAMINING ATTORNEY

SN 78-291,522. OWEN, MARY CLAIRE, ARLINGTON, VA.  
FILED 8-24-2003.



FOR INTERACTIVE COMPUTER SOFTWARE USED FOR EDUCATIONAL PURPOSES IN THE AREAS OF SOCIAL STUDIES, LANGUAGE ARTS, MATHEMATICS, SCIENCE, ART, MUSIC AND PHYSICAL EDUCATION FOR USE BY TEACHERS OR STUDENTS TO ENHANCE LEARNING ACROSS THE ELEMENTARY CURRICULA (U.S. CLS. 21, 23, 26, 36 AND 38).

ARETHA SOMERVILLE, EXAMINING ATTORNEY

SN 78-292,989. QOVIA, INC., FERDERICK, MD. FILED 8-27-2003.

**QOVIA**

FOR COMPUTER SOFTWARE FOR MONITORING AND MANAGING TELECOMMUNICATIONS NETWORKS; COMPUTER HARDWARE FOR USE IN VOICE OVER INTERNET PROTOCOL IP/PBX SYSTEMS ENVIRONMENT MANAGEMENT (U.S. CLS. 21, 23, 26, 36 AND 38).

FIRST USE 1-9-2003; IN COMMERCE 1-9-2003.  
BILL DAWE, EXAMINING ATTORNEY

**CLASS 9—(Continued).**

SN 78-297,539. TOSE CO., LTD., OTOKUNI-GUN, KYOTO, JAPAN, FILED 9-8-2003.

**TOSE**

FOR COMPUTER GAME SOFTWARE, COMPUTER GAME PROGRAMS, INTERACTIVE MULTIMEDIA COMPUTER GAME PROGRAM, COMPUTER GAME SOFTWARE THAT MAY BE DOWNLOADED FROM A GLOBAL COMPUTER NETWORK OR A WIRELESS COMMUNICATIONS NETWORK (U.S. CLS. 21, 23, 26, 36 AND 38).

PAULA MAHONEY, EXAMINING ATTORNEY

SN 78-298,835. NIKE, INC., BEAVERTON, OR. FILED 9-10-2003.



THE MARK CONSISTS OF THE STYLIZED LETTER AND NUMBER COMBINATION L23.

FOR EYEWEAR, NAMELY, PROTECTIVE EYEWEAR, EYEGLASSES, SUNGLASSES; ELECTRONIC DEVICES, NAMELY MP3 PLAYERS. (U.S. CLS. 21, 23, 26, 36 AND 38).

BRIAN PINO, EXAMINING ATTORNEY

SN 78-300,245. BIRD TECHNOLOGIES GROUP INC., MAYFIELD HEIGHTS, OH. FILED 9-15-2003.



FOR RADIO APPARATUS, NAMELY, ELECTRICAL METERS, ELECTRICAL CO-AXIAL LINE POWER ATTENUATORS, ELECTRICAL FILTERS, AND ELECTRICAL SWITCHES (U.S. CLS. 21, 23, 26, 36 AND 38).

FIRST USE 12-31-1995; IN COMMERCE 12-31-1995.  
JEFFREY S. MOLINOFF, EXAMINING ATTORNEY



**CLASS 9—(Continued).**

SN 78-301,405. TORCH CONCEPTS, INC., HUNTSVILLE, AL.  
FILED 9-17-2003.

**ACUMEN PREDICT**

FOR COMPUTER SOFTWARE IN THE FIELD OF ANALYZING AND FORECASTING THE TRADING VALUES FOR EQUITIES IN PUBLICLY-TRADED COMPANIES FOR USE BY PROFESSIONAL STOCK FORECASTERS (U.S. CLS. 21, 23, 26, 36 AND 38).  
GWEN STOKOLS, EXAMINING ATTORNEY

SN 78-305,416. INTER-IMAGES PARTNERS, LP, FORT WORTH, TX. FILED 9-25-2003.

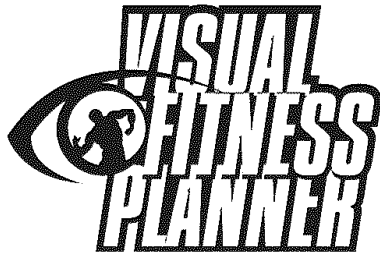

NO CLAIM IS MADE TO THE EXCLUSIVE RIGHT TO USE "FITNESS PLANNER", APART FROM THE MARK AS SHOWN.

FOR COMPUTER SOFTWARE FOR CREATING AND DISPLAYING PREDICTIVE IMAGES OF HUMAN APPEARANCE; COMPUTER SOFTWARE FOR PREDICTING HEALTH RISKS (U.S. CLS. 21, 23, 26, 36 AND 38).

FIRST USE 12-3-2001; IN COMMERCE 12-3-2001.  
GEOFFREY FOSDICK, EXAMINING ATTORNEY

SN 78-305,639. AVARUA SYSTEMS AND SERVICES, INC., BOISE, ID. FILED 9-25-2003.

**HIPAA INTERPRETR**

NO CLAIM IS MADE TO THE EXCLUSIVE RIGHT TO USE "HIPAA", APART FROM THE MARK AS SHOWN.

FOR COMPUTER SOFTWARE FOR USE IN VIEWING AND INTERPRETING THE CONTENTS OF THE ELECTRONIC TRANSACTION STANDARDS MANDATED BY HIPAA (I; E; HEALTH INSURANCE PORTABILITY AND ACCOUNTABILITY ACT OF 1996) (U.S. CLS. 21, 23, 26, 36 AND 38).

FIRST USE 3-1-2003; IN COMMERCE 3-1-2003.  
NANCY CLARKE, EXAMINING ATTORNEY

**CLASS 9—(Continued).**

SN 78-305,976. VISIONARTS, INC., TOKYO, JAPAN, FILED 9-26-2003.

**GLASS**

FOR COMPUTER PROGRAMS, NAMELY, COMPUTER SOFTWARE FOR WEB CONTENT MANAGEMENT, AND GRAPHICAL USER INTERFACE SOFTWARE. (U.S. CLS. 21, 23, 26, 36 AND 38).

JOHN GARTNER, EXAMINING ATTORNEY

SN 78-306,019. VISIONARTS, INC., TOKYO, JAPAN, FILED 9-26-2003.

**GLASS TECHNOLOGY**

OWNER OF JAPAN REG. NO. 4651972, DATED 3-7-2003, EXPIRES 3-7-2013.

NO CLAIM IS MADE TO THE EXCLUSIVE RIGHT TO USE TECHNOLOGY, APART FROM THE MARK AS SHOWN.

FOR COMPUTER PROGRAMS, NAMELY, COMPUTER SOFTWARE FOR WEB CONTENT MANAGEMENT, AND GRAPHICAL USER INTERFACE SOFTWARE (U.S. CLS. 21, 23, 26, 36 AND 38).

JOHN GARTNER, EXAMINING ATTORNEY

SN 78-313,280. NUCLETRON B.V., 3905 TH VEENENDAAL, NETHERLANDS, FILED 10-14-2003.

**SOFTGUARD**

PRIORITY CLAIMED UNDER SEC. 44(D) ON BENELUX APPLICATION NO. 1031160, FILED 4-15-2003, REG. NO. 0736905, DATED 4-15-2003, EXPIRES 4-15-2013.

FOR COMPUTER SOFTWARE AND COMPUTER HARDWARE FOR APPLICATIONS IN THE FIELD OF RADIOTHERAPY; THE AFOREMENTIONED GOODS TO BE USED WITHIN THE FRAMEWORK OF THE SIMULATION PROCESS NAMELY A SIMULATOR FOR DEFINITION AND VERIFICATION OF A TREATMENT PLAN (U.S. CLS. 21, 23, 26, 36 AND 38).

KARANENDRA S. CHHINA, EXAMINING ATTORNEY

SN 78-314,657. ATMEL CORPORATION, SAN JOSE, CA. FILED 10-16-2003.

**Z-LINK**

FOR SEMICONDUCTOR INTEGRATED CIRCUITS, NAMELY WIRELESS INTEGRATED CIRCUITS FOR LOW DATA RATE APPLICATIONS; RELATED SOFTWARE FOR USE WITH SAID INTEGRATED CIRCUITS; RELATED DESIGN KITS FOR EVALUATION, TESTING AND DEVELOPMENT OF INTEGRATED CIRCUITS AND RELATED SOFTWARE HAVING COMPACT DISCS, WIRELESS TOOLS, SOFTWARE, BATTERIES, CIRCUIT BOARDS, BOARDS FOR TESTING SAID INTEGRATED CIRCUITS, CONNECTOR BOARDS, ADAPTERS, CABLES, AND PRINTED USER GUIDES (U.S. CLS. 21, 23, 26, 36 AND 38).

DOMINIC J. FERRAIUOLO, EXAMINING ATTORNEY

**CLASS 9—(Continued).**

SN 78-316,070. TECUMSEH PRODUCTS COMPANY, TECUMSEH, MI. FILED 10-20-2003.



OWNER OF U.S. REG. NOS. 660,341, 2,633,074 AND OTHERS.

THE NAME "TECUMSEH" DOES NOT IDENTIFY A PARTICULAR LIVING INDIVIDUAL.

FOR ELECTRONIC CONTROLLERS FOR PACKAGED TERMINAL AIR CONDITIONERS (U.S. CLS. 21, 23, 26, 36 AND 38).

ELIZABETH J. WINTER, EXAMINING ATTORNEY



SN 78-316,074. TECUMSEH PRODUCTS COMPANY, TECUMSEH, MI. FILED 10-20-2003.



OWNER OF U.S. REG. NOS. 660,341, 2,633,074 AND OTHERS.

THE NAME "TECUMSEH" DOES NOT IDENTIFY A PARTICULAR LIVING INDIVIDUAL.

FOR ELECTRONIC CONTROLLERS FOR REFRIGERATED DISPLAY CASES (U.S. CLS. 21, 23, 26, 36 AND 38).

ELIZABETH J. WINTER, EXAMINING ATTORNEY



SN 78-319,094. IMLOGIC INC., WALTHAM, MA. FILED 10-27-2003.

**IMLOGIC**

FOR COMPUTER PROGRAMS FOR USE IN MANAGING AND ARCHIVING INSTANT MESSAGES AND BUILDING SOFTWARE APPLICATIONS USING INSTANT MESSAGES (U.S. CLS. 21, 23, 26, 36 AND 38).

FIRST USE 7-30-2001; IN COMMERCE 7-30-2001.

JIM RINGLE, EXAMINING ATTORNEY

**CLASS 9—(Continued).**

SN 78-323,871. SITECORE, COPENHAGEN K, DENMARK, FILED 11-6-2003.



**sitecore**

THE MARK CONSISTS OF THE WORDING SITECORE AND A CIRCLE, WITHIN WHICH ARE THREE SWATCHES OF GRADUATED SIZE.

FOR COMPUTER SOFTWARE FOR MANAGING ON-LINE CONTENT, COMPUTER SOFTWARE FOR EDITING AND MANAGING THE INFORMATION CONTAINED ON THE INTERNET, INTRANET AND EXTRANET SITES, AND COMPUTER SOFTWARE FOR DEVELOPMENT OF INTERNET APPLICATIONS (U.S. CLS. 21, 23, 26, 36 AND 38).

FIRST USE 10-30-2003; IN COMMERCE 10-30-2003.

JENNIFER KRISP, EXAMINING ATTORNEY



SN 78-324,817. BREMERS, ROBERT C, LOUISVILLE, CO. FILED 11-7-2003.

**BrokerForce**

THE MARK CONSISTS OF STANDARD CHARACTERS WITHOUT CLAIM TO ANY PARTICULAR FONT, STYLE, SIZE, OR COLOR.

FOR MANUFACTURERS' REPRESENTATIVE SOFTWARE FOR ACCEPTING AND RELAYING ORDERS, INVENTORY CONTROL, SALES FORCE AUTOMATION, AND CUSTOMER RELATIONSHIP MANAGEMENT (U.S. CLS. 21, 23, 26, 36 AND 38).

FIRST USE 3-0-1996; IN COMMERCE 3-0-1996.

CAROLINE WOOD, EXAMINING ATTORNEY

**CLASS 9—(Continued).**

SN 78-328,261. INSYSTEK, INC., SOLDIER, KS. FILED 11-14-2003.

**CLASS 9—(Continued).**

SN 78-330,507. FORUM SYSTEMS, INC., SANDY, UT. FILED 11-20-2003.

**THE AGENTLESS  
SOLUTION**

**ANATOMY OF A WEB  
SERVICES ATTACK**

THE MARK CONSISTS OF STANDARD CHARACTERS WITHOUT CLAIM TO ANY PARTICULAR FONT, STYLE, SIZE, OR COLOR.

NO CLAIM IS MADE TO THE EXCLUSIVE RIGHT TO USE AGENTLESS, APART FROM THE MARK AS SHOWN.

FOR SOFTWARE FOR MANAGING SOFTWARE DISTRIBUTION ACROSS A SYSTEM OR NETWORK, FOR SOFTWARE AND COMPUTER SYSTEM PERFORMANCE MONITORING, AND FOR SYSTEM INVENTORY FOR ELECTRONIC DEVICES, INCLUDING COMPUTERS, NETWORK HARDWARE AND PERSONAL DATA ASSISTANTS (U.S. CLS. 21, 23, 26, 36 AND 38).

ESTHER BELENKER, EXAMINING ATTORNEY

THE MARK CONSISTS OF STANDARD CHARACTERS WITHOUT CLAIM TO ANY PARTICULAR FONT, STYLE, SIZE, OR COLOR.

FOR COMPUTER HARDWARE AND SOFTWARE FOR PROCESSING SECURED DATA (U.S. CLS. 21, 23, 26, 36 AND 38).

MATTHEW KLINE, EXAMINING ATTORNEY

---

SN 78-328,963. AVECTEC.COM, INC., TAIPEI COUNTY, TAIWAN, FILED 11-17-2003.

---

SN 78-333,222. VIACOM INTERNATIONAL INC., NEW YORK, NY. FILED 11-25-2003.



**NICK JR. BABY**

FOR COMPUTER SOFTWARE, NAMELY, CUSTOMER RELATIONSHIP MANAGEMENT SOFTWARE FOR USE IN DATABASE MANAGEMENT IN THE FORM OF A CUSTOMER SERVICE DATABASE THAT ENABLES A COMPANY OR ORGANIZATION TO EVALUATE A CONTACT CENTER AGENT'S EFFICIENCY AND FORM MARKETING STRATEGIES (U.S. CLS. 21, 23, 26, 36 AND 38).

CIMMERIAN COLEMAN, EXAMINING ATTORNEY

THE MARK CONSISTS OF STANDARD CHARACTERS WITHOUT CLAIM TO ANY PARTICULAR FONT, STYLE, SIZE, OR COLOR.

OWNER OF U.S. REG. NOS. 1,578,189, 2,750,325 AND OTHERS.

FOR THEATRICAL OR MUSICAL SOUND RECORDINGS; THEATRICAL OR MUSICAL VIDEO RECORDINGS; THEATRICAL OR MUSICAL DVD RECORDINGS. (U.S. CLS. 21, 23, 26, 36 AND 38).

MELVIN AXILBUND, EXAMINING ATTORNEY

**CLASS 9—(Continued).**

SN 78-335,682. CENTENNIAL OPTICAL LIMITED, DOWNSVIEW, ONTARIO, CANADA, FILED 12-3-2003.

# INTEGRITY

THE MARK CONSISTS OF STANDARD CHARACTERS WITHOUT CLAIM TO ANY PARTICULAR FONT, STYLE, SIZE, OR COLOR.

FOR EYEGLASS FRAMES, SUNGLASSES, CLIPON SUNGLASSES, READING GLASSES, SAFETY GLASSES, EYEGLASS CASES, EYEGLASS CORDS, EYEGLASS CHAINS, AND EYEGLASS RETENTION STRAPS (U.S. CLS. 21, 23, 26, 36 AND 38).

JOHN E. MICHOS, EXAMINING ATTORNEY

SN 78-340,452. MESA ANALYTICS & COMPUTING, LLC, SANTA FE, NM. FILED 12-12-2003.

# ChemTattoo

THE MARK CONSISTS OF STANDARD CHARACTERS WITHOUT CLAIM TO ANY PARTICULAR FONT, STYLE, SIZE, OR COLOR.

FOR COMPUTER SOFTWARE FOR ANALYZING CHEMICAL COMPOUNDS, AND COMPUTER SOFTWARE FOR FINDING COMMONALITIES AMONG COMPOUNDS IN A GROUP OF COMPOUNDS (U.S. CLS. 21, 23, 26, 36 AND 38).

FIRST USE 11-15-2002; IN COMMERCE 1-18-2003.  
JENNIFER KRISP, EXAMINING ATTORNEY

**CLASS 9—(Continued).**

SN 78-343,633. INTEGRATED MANAGEMENT SOLUTIONS, INC., HUNTSVILLE, AL. FILED 12-19-2003.

# WinTOX

FOR COMPUTER SOFTWARE FOR USE IN DATABASE MANAGEMENT IN THE FIELD OF TOXICOLOGY LABORATORY WORKFLOW AND CONTROL (U.S. CLS. 21, 23, 26, 36 AND 38).

FIRST USE 11-30-1999; IN COMMERCE 11-30-1999.  
RENEE MCCRAY, EXAMINING ATTORNEY

SN 78-357,496. DNA TODAY, LLC, WEST DES MOINES, IA. FILED 1-26-2004.

# RELATEDNESS TODAY

THE MARK CONSISTS OF STANDARD CHARACTERS WITHOUT CLAIM TO ANY PARTICULAR FONT, STYLE, SIZE, OR COLOR.

FOR SOFTWARE, NAMELY, DNA IDENTIFICATION SOFTWARE (U.S. CLS. 21, 23, 26, 36 AND 38).

BRIAN NEVILLE, EXAMINING ATTORNEY

SN 78-361,278. DONGAH ALUMINUM CORPORATION, INCHON, REPUBLIC OF KOREA, FILED 2-2-2004.

# HELINOX

OWNER OF U.S. REG. NO. 2,840,743.

THE COLOR RED IS CLAIMED AS A FEATURE OF THE MARK.

THE COLOR RED APPEARS IN THE LETTER "O" WITHIN THE WORD HELINOX.

FOR ASTRONOMY TELESCOPES, TELESCOPES, MOUNTS FOR ASTRONOMY TELESCOPES, MOUNTS FOR TELESCOPES, TRIPODS FOR ASTRONOMY TELESCOPES, TRIPODS FOR TELESCOPES, APERTOMETERS FOR OPTICS, ZOOM MICROSCOPES, MICROSCOPES FOR METALS AND BINOCULARS (U.S. CLS. 21, 23, 26, 36 AND 38).

FIRST USE 10-0-2003; IN COMMERCE 10-0-2003.  
INGRID C. EULIN, EXAMINING ATTORNEY

**CLASS 9—(Continued).**

SN 78-362,265. FOXFALES, INC., NOKOMIS, FL. FILED 2-4-2004.



THE COLOR(S) BROWN AND YELLOW ARE CLAIMED AS A FEATURE OF THE MARK.

THE MARK CONSISTS OF THE WORDS FOXFALES IN THE COLOR BROWN AND A LOGO WHICH LOOKS LIKE BOTH A FOX FOOT AND A FOX TALE IN THE COLOR YELLOW.

FOR COMPUTER SOFTWARE FOR INVENTORY AND SCHEDULING IN DOCTOR'S OFFICES (U.S. CLS. 21, 23, 26, 36 AND 38).

FIRST USE 6-1-2003; IN COMMERCE 6-1-2003.  
CURTIS FRENCH, EXAMINING ATTORNEY

**CLASS 9—(Continued).**

SN 78-364,177. LIGHTMASTER SYSTEMS, INC., SANTA CLARA, CA. FILED 2-6-2004.

**LMS XT**

THE MARK CONSISTS OF STANDARD CHARACTERS WITHOUT CLAIM TO ANY PARTICULAR FONT, STYLE, SIZE, OR COLOR.

FOR LIGHT PRISMS FOR SCIENTIFIC USE, NAMELY, FOR USE IN TELEVISIONS, HIGH DEFINITION TELEVISIONS, COMPUTER MONITORS, PROJECTORS AND COMPONENTS THEREOF, NAMELY, MICRODISPLAY PACKAGES, PACKAGING OF OPTICAL ELEMENTS, PATHLENGTH MATCHED OPTICAL ELEMENTS, LIQUID COUPLED OPTICAL ELEMENTS, OPTICAL FILTERS, WAVEPLATES, LIGHT SOURCES, BEAMSPLITTERS AND MIRRORS (U.S. CLS. 21, 23, 26, 36 AND 38).

LAURA KOVAISKY, EXAMINING ATTORNEY

SN 78-364,168. LIGHTMASTER SYSTEMS, INC., SANTA CLARA, CA. FILED 2-6-2004.

SN 78-365,501. A B BROWN, INC., CARLSBAD, CA. FILED 2-10-2004.

**LMS**

THE MARK CONSISTS OF STANDARD CHARACTERS WITHOUT CLAIM TO ANY PARTICULAR FONT, STYLE, SIZE, OR COLOR.

FOR LIGHT PRISMS FOR SCIENTIFIC USE, NAMELY, FOR USE IN TELEVISIONS, HIGH DEFINITION TELEVISIONS, COMPUTER MONITORS, PROJECTORS AND COMPONENTS THEREOF, NAMELY, MICRODISPLAY PACKAGES, PACKAGING OF OPTICAL ELEMENTS, PATHLENGTH MATCHED OPTICAL ELEMENTS, LIQUID COUPLED OPTICAL ELEMENTS, OPTICAL FILTERS, WAVEPLATES, LIGHT SOURCES, BEAMSPLITTERS AND MIRRORS (U.S. CLS. 21, 23, 26, 36 AND 38).

AMY HELLA, EXAMINING ATTORNEY

**Cash Infusion  
ATM's**

THE MARK CONSISTS OF STANDARD CHARACTERS WITHOUT CLAIM TO ANY PARTICULAR FONT, STYLE, SIZE, OR COLOR.

NO CLAIM IS MADE TO THE EXCLUSIVE RIGHT TO USE "CASH" OR "ATM'S", APART FROM THE MARK AS SHOWN.

FOR AUTOMATED TELLER MACHINES [ATM] (U.S. CLS. 21, 23, 26, 36 AND 38).

THEODORE MCBRIDE, EXAMINING ATTORNEY

**CLASS 9—(Continued).**

SN 78-366,523. MASTER HOUSEHOLD, INC., ALHAMBRA, CA. FILED 2-11-2004.

# Bar Boy

THE MARK CONSISTS OF STANDARD CHARACTERS WITHOUT CLAIM TO ANY PARTICULAR FONT, STYLE, SIZE, OR COLOR.

NO CLAIM IS MADE TO THE EXCLUSIVE RIGHT TO USE "BAR", APART FROM THE MARK AS SHOWN.

FOR LIQUID MEASURING APPARATUS (U.S. CLS. 21, 23, 26, 36 AND 38).

FIRST USE 1-1-2003; IN COMMERCE 1-1-2003.  
AMY ALFIERI, EXAMINING ATTORNEY

**CLASS 9—(Continued).**

SN 78-367,821. CABOT SAFETY INTERMEDIATE CORPORATION, NEWARK, DE. FILED 2-13-2004.

# HearCom

THE MARK CONSISTS OF STANDARD CHARACTERS WITHOUT CLAIM TO ANY PARTICULAR FONT, STYLE, SIZE, OR COLOR.

FOR EARPIECE COMMUNICATION SYSTEMS CONSISTING ESSENTIALLY OF TRANSMITTERS, RECEIVERS, AND PARTS AND ACCESSORIES THEREFOR. (U.S. CLS. 21, 23, 26, 36 AND 38).

JOHN E. MICHOS, EXAMINING ATTORNEY

---

SN 78-366,862. VADIUM TECHNOLOGY, INC., TACOMA, WA. FILED 2-12-2004.

# ALPHACIPHER MOBILE

THE MARK CONSISTS OF STANDARD CHARACTERS WITHOUT CLAIM TO ANY PARTICULAR FONT, STYLE, SIZE, OR COLOR.

NO CLAIM IS MADE TO THE EXCLUSIVE RIGHT TO USE "MOBILE", APART FROM THE MARK AS SHOWN.

FOR COMPUTER SECURITY PRODUCTS FOR USE IN THE FIELD OF DATA SECURITY, NAMELY, COMPUTER HARDWARE AND COMPUTER SOFTWARE THAT INTEGRATE CRYPTOGRAPHIC SECURITY FEATURES INTO PRIMARY SOFTWARE AND HARDWARE APPLICATIONS AND OTHER SOFTWARE AND HARDWARE APPLICATIONS, AND COMPUTER HARDWARE AND COMPUTER SOFTWARE THAT PERMIT ACCESS TO DATA, FACILITIES OR CONTROLLED LOCATIONS WHETHER ELECTRONIC OR PHYSICAL LOCATIONS BY GENERATING ACCESS CODES AND BY VERIFYING ACCESS CODES, COMPUTER HARDWARE AND COMPUTER SOFTWARE THAT AUTHENTICATE USERS, COMPUTER HARDWARE AND COMPUTER SOFTWARE THAT ISSUE AND MANAGE DIGITAL USER IDENTITIES AND ACCESS PRIVILEGES FOR ELECTRONIC AND PHYSICAL SECURITY (U.S. CLS. 21, 23, 26, 36 AND 38).

KIMBERLY PERRY, EXAMINING ATTORNEY

---

SN 78-373,481. CLEVER MACHINE, INC., SAN FRANCISCO, CA. FILED 2-24-2004.



THE MARK CONSISTS OF DESIGN OF "CM" FORMING A HUMAN TORSO & HEAD, WITH AN IDEA BUBBLE.

FOR COMPUTER SOFTWARE FOR USE IN DATABASE MANAGEMENT; COMPUTER SOFTWARE FOR USE IN SOFTWARE DEVELOPMENT (U.S. CLS. 21, 23, 26, 36 AND 38).

STANLEY I. OSBORNE, EXAMINING ATTORNEY

**CLASS 9—(Continued).**

SN 78-373,963. SOLIDWORKS CORPORATION, CONCORD, MA. FILED 2-25-2004.

**CLASS 9—(Continued).**

SN 78-377,254. OLYMPUS AMERICA INC., MELVILLE, NY. FILED 3-2-2004.

# COSMIC BLOBS



THE MARK CONSISTS OF STANDARD CHARACTERS WITHOUT CLAIM TO ANY PARTICULAR FONT, STYLE, SIZE, OR COLOR.

FOR COMPUTER SOFTWARE FOR THE INTERACTIVE MODELING OR DESIGN OF THREE-DIMENSIONAL OBJECTS; COMPUTER ENTERTAINMENT OR GAME SOFTWARE (U.S. CLS. 21, 23, 26, 36 AND 38).

FIRST USE 8-11-2004; IN COMMERCE 8-11-2004.

YONG KIM, EXAMINING ATTORNEY

OWNER OF U.S. REG. NO. 2,564,169. FOR DIGITAL CAMERAS (U.S. CLS. 21, 23, 26, 36 AND 38).

FLORENTINA BLANDU, EXAMINING ATTORNEY

---

SN 78-375,012. ED DIGITAL INC., MONTEREY PARK, CA. FILED 2-26-2004.

# ED DIGITAL

---

SN 78-377,995. EVERLIGHT ELECTRONICS CO., LTD., TAIPEI SHIEN, TAIWAN, FILED 3-3-2004.



THE MARK CONSISTS OF STANDARD CHARACTERS WITHOUT CLAIM TO ANY PARTICULAR FONT, STYLE, SIZE, OR COLOR.

NO CLAIM IS MADE TO THE EXCLUSIVE RIGHT TO USE "DIGITAL", APART FROM THE MARK AS SHOWN.

FOR AUDIO SPEAKERS, AUDIO AMPLIFIERS, AUDIOCASSETTE RECORDERS, COMPACT DISC PLAYERS, DIGITAL VERSATILE DISC PLAYER, MP3 PLAYERS, DIGITAL AUDIO TAPE PLAYERS, DIGITAL AUDIO TAPE RECORDERS, DIGITAL VIDEO RECORDERS, TELEVISION SETS (U.S. CLS. 21, 23, 26, 36 AND 38).

TARAH HARDY, EXAMINING ATTORNEY

THE MARK CONSISTS OF THE STYLIZED WORD EVERLIGHT SURROUNDED BY A BOX.

FOR APPARATUS FOR SEMICONDUCTORS, NAMELY COMPUTER PERIPHERALS, ELECTRONIC SIGNAL EMITTERS, PHOTOTUBES, VACUUM TUBES, LIGHT-EMITTING DIODES (LED), LED LAMPS, LED DISPLAYS, INFRARED LED, ELECTRONIC SIGNBOARD DISPLAYS, LIQUID CRYSTAL DISPLAYS, NAMELY ELECTRIC LUMINESCENT DISPLAY PANELS, LIQUID CRYSTAL DISPLAYS (LCD), AUDIO, VIDEO AND SATELLITE SIGNAL RECEIVERS, OPTICAL SIGNAL TRANSMITTERS, BAR CODE READERS, AUDIO AND VIDEO DECODERS, AND PHOTO COUPLERS. (U.S. CLS. 21, 23, 26, 36 AND 38).

ELLEN PERKINS, EXAMINING ATTORNEY

**CLASS 9—(Continued).**

SN 78-378,101. PLANTRONICS, INC., SANTA CRUZ, CA. FILED 3-3-2004.

**CLASS 9—(Continued).**

SN 78-381,307. CRAIG T. MILLER, BLANCHESTER, OH. FILED 3-9-2004.

# CLARITY

THE MARK CONSISTS OF STANDARD CHARACTERS WITHOUT CLAIM TO ANY PARTICULAR FONT, STYLE, SIZE, OR COLOR.

OWNER OF U.S. REG. NO. 1,581,278.

FOR TELEPHONES; TELEPHONE EQUIPMENT, NAMELY TELEPHONE AMPLIFIERS, RINGERS, CORDS, ANSWERING MACHINES, SPEAKERS, HANDSETS; TELEPHONE HEADSETS; TELEPHONE LINE TEST EQUIPMENT; ASSISTIVE DEVICES FOR DEAF AND HEARING IMPAIRED PERSONS, PERSONS WITH VISION IMPAIRMENTS, PERSONS WITH LIMITED MOBILITY, AND PERSONS WITH LIMITED SPEAKING ABILITY, NAMELY, AMPLIFIERS, ALARM APPARATUS, NAMELY, TIME ALARM, SMOKE ALARM AND DOOR ALARM, WAKE-UP APPARATUS IN THE NATURE OF INDICATOR LIGHTS AND ELECTRONIC BED SHAKERS, TEXT TELEPHONES (TTYs), TELECOMMUNICATIONS DEVICES FOR THE DEAF (TDDs), AND NOTIFICATION SYSTEMS COMPRISED OF A CENTRAL PROCESSOR THAT INTERPRETS INCOMING STIMULI AND ACTIVATES A CORRESPONDING ALARM THAT NOTIFIES USERS THROUGH SIGHT, SOUND OR VIBRATIONS; EXCLUDING HEARING AIDS (U.S. CLS. 21, 23, 26, 36 AND 38).

FIRST USE 12-11-2003; IN COMMERCE 12-11-2003.

KARANENDRA S. CHHINA, EXAMINING ATTORNEY

*For Pretty Hands!*

THE COLOR(S) WHITE, BLACK, AND PINK IS/ARE CLAIMED AS A FEATURE OF THE MARK.

THE MARK CONSISTS OF WHITE FORGROUND OF FONT WITH BLACK OUTLINE AND PINK SHADOW.

FOR PRE-RECORDED CD'S, VIDEO TAPES, LASER DISKS AND DVDS FEATURING EDUCATIONAL SUBJECT MATTER IN THE FIELD OF AUTOMOBILE SAFETY, MAINTENANCE, AND REPAIR, FOR FEMALE DRIVERS. (U.S. CLS. 21, 23, 26, 36 AND 38).

JOSETTE BEVERLY, EXAMINING ATTORNEY

SN 78-382,592. RESOLUTE FILMS, INC., BOSTON, MA. FILED 3-11-2004.

# EditShare

SN 78-379,892. RUBY, PAUL, FOLSOM, CA. FILED 3-7-2004.

# ruby amplification

THE MARK CONSISTS OF STANDARD CHARACTERS WITHOUT CLAIM TO ANY PARTICULAR FONT, STYLE, SIZE, OR COLOR.

NO CLAIM IS MADE TO THE EXCLUSIVE RIGHT TO USE "AMPLIFICATION", APART FROM THE MARK AS SHOWN.

FOR HAND-BUILT, CUSTOM-BUILT GUITAR AMPLIFIERS (U.S. CLS. 21, 23, 26, 36 AND 38).

EVELYN BRADLEY, EXAMINING ATTORNEY

THE MARK CONSISTS OF STANDARD CHARACTERS WITHOUT CLAIM TO ANY PARTICULAR FONT, STYLE, SIZE, OR COLOR.

FOR COMPUTER SOFTWARE AND COMPUTER SERVER HARDWARE THAT ALLOW COMPUTERIZED NON-LINEAR VIDEO EDITING SYSTEMS TO SIMULTANEOUSLY ACCESS A COMMON GROUP OF AUDIO AND VIDEO FILES OVER A NETWORK (U.S. CLS. 21, 23, 26, 36 AND 38).

BRIDGETT SMITH, EXAMINING ATTORNEY



**CLASS 9—(Continued).**

SN 78-383,486. EDUFUSION LLC, WINCHESTER, MA. FILED 3-12-2004.

**CLASS 9—(Continued).**

SN 78-384,705. FOVEON, INC., SANTA CLARA, CA. FILED 3-15-2004.

edufusion

THE POWER OF  
DIGITAL. THE  
ESSENCE OF FILM.

THE MARK CONSISTS OF STANDARD CHARACTERS WITHOUT CLAIM TO ANY PARTICULAR FONT, STYLE, SIZE, OR COLOR.

FOR EDUCATIONAL SOFTWARE THAT DISSEMINATES PEDAGOGICAL MATERIAL THROUGH COGNITIVELY ADVANCED, INTERACTIVE INTERFACES IN THE LIBERAL ARTS FOR USE AT THE PRIMARY, POSTSECONDARY OR COLLEGE LEVEL, OR A COMBINATION OF ALL THREE (U.S. CLS. 21, 23, 26, 36 AND 38).

BARNEY CHARLON, EXAMINING ATTORNEY

THE MARK CONSISTS OF STANDARD CHARACTERS WITHOUT CLAIM TO ANY PARTICULAR FONT, STYLE, SIZE, OR COLOR.

FOR DIGITAL CAMERAS, PHOTOGRAPHIC IMAGE SENSORS, DIGITAL IMAGE PROCESSORS, AND SOFTWARE FOR DIGITAL IMAGE PROCESSING (U.S. CLS. 21, 23, 26, 36 AND 38).

TONI HICKEY, EXAMINING ATTORNEY

SN 78-384,271. RIPALDI, SUSAN, TOLUCA LAKE, CA. FILED 3-15-2004.

SN 78-385,261. ARTEMIS CONSULTING SERVICES, INC., RANDOLPH, NJ. FILED 3-16-2004.

POWERMANAGE



THE MARK CONSISTS OF STANDARD CHARACTERS WITHOUT CLAIM TO ANY PARTICULAR FONT, STYLE, SIZE, OR COLOR.

FOR COMPUTER SOFTWARE FOR USE IN DATABASE VERIFICATION AND MANAGEMENT OF ELECTIONS, CANDIDATURE AND PETITIONS FOR USE AT CITY, COUNTY, STATE, NATIONAL AND GLOBAL LEVELS AND FOR ANY SINGLE/ MULTIPLE TYPE BALLOT CONFIGURATIONS (U.S. CLS. 21, 23, 26, 36 AND 38).

TRICIA SONNEBORN, EXAMINING ATTORNEY

NO CLAIM IS MADE TO THE EXCLUSIVE RIGHT TO USE "HR", APART FROM THE MARK AS SHOWN.

THE COLOR(S) GRAY AND BLUE IS/ARE CLAIMED AS A FEATURE OF THE MARK.

THE COLOR GRAY APPEARS IN THE LETTERING HR AND IN THE STEM AND THE FOUR CIRCULAR OUTLINES OF THE DESIGN; THE COLOR BLUE APPEARS IN THE INTERIOR OF THE FOUR CIRCLES OF THE DESIGN FOR COMPUTER SOFTWARE FOR USE IN DATA STORAGE, PROCESS MANAGEMENT, REPORTING AND ANALYTICS FOR USE IN THE FIELD OF SALARY PLANNING, MARKET PRICING, SUCCESSION MANAGEMENT IN THE NATURE OF HUMAN RESOURCES, AND PERFORMANCE MANAGEMENT IN THE NATURE OF HUMAN RESOURCES (U.S. CLS. 21, 23, 26, 36 AND 38).

FIRST USE 12-1-2003; IN COMMERCE 12-1-2003.  
BARNEY CHARLON, EXAMINING ATTORNEY

**CLASS 9—(Continued).**

SN 78-385,746. ELECTRONIC EVIDENCE DISCOVERY, INC., SEATTLE, WA. FILED 3-17-2004.

**CLASS 9—(Continued).**

SN 78-388,630. MYELIN MEDIA LLC, NEW YORK, NY. FILED 3-22-2004.

**Marginal Discovery  
Utility**

**IMMORTAL CITIES -  
CHILDREN OF THE  
NILE**

THE MARK CONSISTS OF STANDARD CHARACTERS WITHOUT CLAIM TO ANY PARTICULAR FONT, STYLE, SIZE, OR COLOR.

NO CLAIM IS MADE TO THE EXCLUSIVE RIGHT TO USE "DISCOVERY UTILITY", APART FROM THE MARK AS SHOWN.

FOR COMPUTER PROGRAMS FOR RECOVERING AND/OR ANALYZING DATA ON COMPUTER DATA STORAGE DEVICES FOR PURPOSES OF DETECTION, RECOVERY, SECURING, RETRIEVAL, CONVERSION, AGGREGATION, INTERPRETATION, VERIFICATION, SEARCHING, ANALYSIS, IDENTIFICATION, ANNOTATION, ORGANIZATION AND PRODUCTION OF COMPUTER DATA RECORDS FOR USE IN LITIGATION, CORPORATE RECORDS MANAGEMENT AND INFORMATION MANAGEMENT (U.S. CLS. 21, 23, 26, 36 AND 38).

GEOFFREY FOSDICK, EXAMINING ATTORNEY

THE MARK CONSISTS OF STANDARD CHARACTERS WITHOUT CLAIM TO ANY PARTICULAR FONT, STYLE, SIZE, OR COLOR.

FOR COMPUTER GAME SOFTWARE AND INSTRUCTION SHEETS, USER MANUALS AND HINT PAMPHLETS SOLD THEREWITH AS A UNIT; AND VIDEO GAME SOFTWARE AND INSTRUCTION SHEETS, USER MANUALS AND HINT PAMPHLETS SOLD THEREWITH AS A UNIT; DOWNLOADABLE COMPUTER GAME SOFTWARE. (U.S. CLS. 21, 23, 26, 36 AND 38).

CHRISTOPHER BUONGIORNO, EXAMINING ATTORNEY

SN 78-388,202. INTERNATIONAL POLICE TECHNOLOGIES, INC., TULSA, OK. FILED 3-22-2004.

SN 78-391,211. WMS GAMING INC., WAUKEGAN, IL. FILED 3-26-2004.



**LUCKY LIZARD**

THE MARK CONSISTS OF HAWK EYES. FOR CAMERAS AND RECORDING SYSTEMS PRIMARILY COMPOSED OF VIDEO CAMERAS AND AUDIO AND VIDEO RECORDERS FOR USE IN POLICE AND EMERGENCY VEHICLES ONLY (U.S. CLS. 21, 23, 26, 36 AND 38).

BERYL GARDNER, EXAMINING ATTORNEY

THE MARK CONSISTS OF STANDARD CHARACTERS WITHOUT CLAIM TO ANY PARTICULAR FONT, STYLE, SIZE, OR COLOR.

FOR GAMING MACHINES (U.S. CLS. 21, 23, 26, 36 AND 38).

MARK SPARACINO, EXAMINING ATTORNEY

**CLASS 9—(Continued).**

SN 78-392,218. LUCASFILM ENTERTAINMENT COMPANY LTD., NICASIO, CA. FILED 3-29-2004.

**THE SITH LORDS**

THE MARK CONSISTS OF STANDARD CHARACTERS WITHOUT CLAIM TO ANY PARTICULAR FONT, STYLE, SIZE, OR COLOR.

OWNER OF U.S. REG. NO. 2,625,341.

FOR PRE-RECORDED AUDIO TAPES, VIDEO TAPES, AUDIO CASSETTES, VIDEO CASSETTES, CD-ROMS, DVDS, COMPACT DISCS, AND VIDEO DISCS, FEATURING ENTERTAINMENT RELATED TO FILMS, GAMES AND MUSIC; COMPUTER GAME SOFTWARE; COMPUTER GAME SOFTWARE AND MANUALS SOLD AS A UNIT; COMPUTER VIDEO GAME SOFTWARE; COMPUTER VIDEO GAME SOFTWARE AND MANUALS SOLD AS A UNIT; INTERACTIVE VIDEO GAMES; INTERACTIVE COMPUTER GAMES, DOWNLOADABLE COMPUTER GAME SOFTWARE, DOWNLOADABLE INTERACTIVE ENTERTAINMENT SOFTWARE FOR PLAYING COMPUTER GAMES, DOWNLOADABLE INTERACTIVE ENTERTAINMENT SOFTWARE FOR PLAYING VIDEO GAMES (U.S. CLS. 21, 23, 26, 36 AND 38).

GINA HAYES, EXAMINING ATTORNEY

**CLASS 9—(Continued).**

SN 78-394,124. LOTS TO LEARN, MASSAPEQUA, NY. FILED 3-31-2004.



FOR EDUCATIONAL VIDEOTAPES FOR PRE-SCHOOL CHILDREN IN THE FIELD OF THE ALPHABET, NUMBERS, PHYSICAL EXERCISE, SHAPES, COLORS AND SOUNDS (U.S. CLS. 21, 23, 26, 36 AND 38).

ESTHER A. BORSUK, EXAMINING ATTORNEY

SN 78-392,267. POST HOLES LLC, WINSTON-SALEM, NC. FILED 3-29-2004.

**POST HOLES**

THE MARK CONSISTS OF STANDARD CHARACTERS WITHOUT CLAIM TO ANY PARTICULAR FONT, STYLE, SIZE, OR COLOR.

FOR PRE-RECORDED CD'S, VIDEO TAPES, LASER DISKS AND DVD'S FEATURING MOTION AND STILL STOCK FOOTAGE AND IMAGES; DOWNLOADABLE VIDEO AND MULTI-MEDIA RECORDINGS FEATURING MOTION AND STILL STOCK FOOTAGE AND IMAGES (U.S. CLS. 21, 23, 26, 36 AND 38).

STANLEY I. OSBORNE, EXAMINING ATTORNEY

SN 78-394,316. CLARK, JOHN P, POWAY, CA. FILED 3-31-2004.

**JAVAKNIFE-6000**

THE MARK CONSISTS OF STANDARD CHARACTERS WITHOUT CLAIM TO ANY PARTICULAR FONT, STYLE, SIZE, OR COLOR.

FOR MEDICAL SOFTWARE PROGRAM FOR LOCATION AND TREATMENT PLANNING OF BRAIN TUMORS (U.S. CLS. 21, 23, 26, 36 AND 38).

DOUGLAS LEE, EXAMINING ATTORNEY

**CLASS 9—(Continued).**

SN 78-394,475. MX-TECHNOLOGIES INC., PASADENA, CA.  
FILED 4-1-2004.

**CLASS 9—(Continued).**

SN 78-394,800. SPECIFIX, SAN JOSE, CA. FILED 4-1-2004.

# SPECIFIX

# GECKO

THE MARK CONSISTS OF STANDARD CHARACTERS WITHOUT CLAIM TO ANY PARTICULAR FONT, STYLE, SIZE, OR COLOR.

FOR COMPUTER SOFTWARE, NAMELY, COMPUTER PROGRAMS FOR OPERATING SYSTEMS, COMPUTER PROGRAMS FOR SYSTEM ADMINISTRATION, COMPUTER PROGRAMS FOR NETWORK ADMINISTRATION SERVICES DELIVERED OVER A GLOBAL COMPUTER NETWORK, NAMELY, SOFTWARE USED TO PROVIDE SOFTWARE MAINTENANCE, UPDATES AND ENHANCEMENTS AND SOFTWARE USED TO PROVIDE NETWORK SECURITY MAINTENANCE, UPDATES AND ENHANCEMENTS AND SOFTWARE USED FOR MANAGING NETWORK ASSETS; COMPUTER SOFTWARE USED FOR PERFORMANCE MEASUREMENT, BENCHMARKING AND CAPACITY PLANNING OF COMPUTER NETWORKS; COMPUTER SOFTWARE FOR USE IN DEVELOPMENT, MODIFICATION, DEBUGGING, TROUBLESHOOTING, ENHANCEMENT OF SPEED AND STABILITY OF COMPUTER SYSTEMS, PROFILING AND SIMULATION OF SOFTWARE; COMPUTER SOFTWARE AND COMPUTER HARDWARE FOR HOST AND EMBEDDED MICROPROCESSOR SYSTEMS FOR USE IN DEVELOPMENT, MODIFICATION, DEBUGGING, TROUBLESHOOTING, PERFORMANCE ENHANCEMENT, PROFILING AND SIMULATION OF SOFTWARE; EMBEDDED SYSTEM COMPUTER SOFTWARE, REAL-TIME SYSTEM COMPUTER SOFTWARE FOR USE AS AN OPERATING SYSTEM AND FOR USE IN CONTROLLING EMBEDDED COMPUTING DEVICES, NAMELY, CELL PHONES, INTERNET ACCESS DEVICES, PERSONAL DATA ASSISTANTS AND MICROPROCESSORS, IN REAL TIME; EMBEDDED APPLICATION PROGRAMMING INTERFACE SOFTWARE; COMPUTER SOFTWARE DEVELOPMENT TOOLS; INSTRUCTIONAL MANUALS FOR ALL OF THE FOREGOING SOLD AS A UNIT THEREWITH (U.S. CLS. 21, 23, 26, 36 AND 38).

MATTHEW PAPPAS, EXAMINING ATTORNEY

THE MARK CONSISTS OF STANDARD CHARACTERS WITHOUT CLAIM TO ANY PARTICULAR FONT, STYLE, SIZE, OR COLOR.

FOR STOCK MARKET ANALYSIS AND PORTFOLIO MANAGEMENT SOFTWARE (U.S. CLS. 21, 23, 26, 36 AND 38).

FIRST USE 1-1-2004; IN COMMERCE 1-1-2004.  
JENNIFER KRISP, EXAMINING ATTORNEY

**CLASS 9—(Continued).**

SN 78-395,427. THE PUTMAN GROUP, INCORPORATED, SHERIDAN, WY. FILED S.R. 4-2-2004; AM. P.R. 10-25-2004.

**CLASS 9—(Continued).**

SN 78-395,809. SILICON BANDWIDTH, INC., SAN JOSE, CA. FILED 4-2-2004.



**CAPCORE**

FOR ELECTRONIC ADAPTERS FOR INTERFACING MOBILE ELECTRONICS (U.S. CLS. 21, 23, 26, 36 AND 38).  
FIRST USE 1-30-1996; IN COMMERCE 5-15-1996.  
CHARLES JOYNER, EXAMINING ATTORNEY

THE MARK CONSISTS OF STANDARD CHARACTERS WITHOUT CLAIM TO ANY PARTICULAR FONT, STYLE, SIZE, OR COLOR.  
FOR COMPUTER HARDWARE: ELECTRONIC CONNECTORS AND SEMICONDUCTOR PACKAGES (U.S. CLS. 21, 23, 26, 36 AND 38).  
MELVIN AXILBUND, EXAMINING ATTORNEY

SN 78-395,458. ORAK, ZEKI, SAN FRANCISCO, CA. FILED 4-2-2004.

SN 78-396,856. HARRAH'S OPERATING COMPANY, INC., LAS VEGAS, NV. FILED 4-6-2004.

**SLOOP puzzle**

**Royal Rewards**

THE MARK CONSISTS OF STANDARD CHARACTERS WITHOUT CLAIM TO ANY PARTICULAR FONT, STYLE, SIZE, OR COLOR.  
NO CLAIM IS MADE TO THE EXCLUSIVE RIGHT TO USE "PUZZLE", APART FROM THE MARK AS SHOWN.  
FOR COMPUTER GAME SOFTWARE FEATURING SLIDING AND LOOPING COLOR TILES WHERE PLAYER MUST MATCH COLORS TO MAKE POINTS FOR CONTINUOUS SCORING OPPORTUNITIES (U.S. CLS. 21, 23, 26, 36 AND 38).  
CHARLES JOYNER, EXAMINING ATTORNEY

THE MARK CONSISTS OF STANDARD CHARACTERS WITHOUT CLAIM TO ANY PARTICULAR FONT, STYLE, SIZE, OR COLOR.  
FOR GAMING EQUIPMENT; NAMELY, SLOT MACHINES, VIDEO POKER MACHINES AND VIDEO SLOT MACHINES AND VIDEO LOTTERY TERMINALS (U.S. CLS. 21, 23, 26, 36 AND 38).  
CHARLES JOYNER, EXAMINING ATTORNEY

**CLASS 9—(Continued).**

SN 78-398,137. SANDISK CORPORATION, SUNNYVALE, CA. FILED 4-7-2004.

**CLASS 9—(Continued).**

SN 78-399,094. ROTANI, INC., SCOTTSDALE, AZ. FILED 4-8-2004.

## SANDISK SHOOT 'N STORE

THE MARK CONSISTS OF STANDARD CHARACTERS WITHOUT CLAIM TO ANY PARTICULAR FONT, STYLE, SIZE, OR COLOR.

FOR SEMICONDUCTOR MEMORY DEVICES, NAMELY, INTEGRATED CIRCUITS, ELECTRONIC CIRCUIT CARDS AND CARTRIDGES, AND OTHER SEMICONDUCTOR DEVICES, NAMELY, FLASH MEMORY CARDS, CARTRIDGES, DRIVES, ADAPTERS, CONVERTERS, CONTROLLERS, PLAYERS, READERS, STORAGE MODULES, AND COMPUTER PERIPHERALS; PORTABLE AUDIO AND VIDEO PLAYERS/RECORDERS WHICH USE SEMICONDUCTOR DEVICES AS RECORDING MEDIA; DIGITAL PHOTO VIEWERS; MP3 PLAYERS; AND COMPUTER OPERATING PROGRAMS FOR SEMICONDUCTOR MEMORY DEVICES (U.S. CLS. 21, 23, 26, 36 AND 38).

JOHN DALIER, EXAMINING ATTORNEY

## AirReferee

SN 78-398,980. PTT L.L.C., DBA HIGH 5 GAMES, NANUET, NY. FILED 4-8-2004.

## WHITE ORCHID

THE MARK CONSISTS OF STANDARD CHARACTERS WITHOUT CLAIM TO ANY PARTICULAR FONT, STYLE, SIZE, OR COLOR.

FOR REEL SLOT MACHINES; GAMING MACHINES FEATURING SLOT MACHINE TYPE GAMES VIA VIDEO DISPLAY; COIN-OPERATED VIDEO OUTPUT GAMING MACHINES; ELECTRO-MECHANICAL AND VIDEO DISPLAY GAMING MACHINES (U.S. CLS. 21, 23, 26, 36 AND 38).

KELLEY WELLS, EXAMINING ATTORNEY

THE MARK CONSISTS OF STANDARD CHARACTERS WITHOUT CLAIM TO ANY PARTICULAR FONT, STYLE, SIZE, OR COLOR.

FOR COMPUTER HARDWARE AND SOFTWARE FOR INTERCONNECTING, MANAGING, SECURING AND OPERATING LOCAL AND WIDE AREA NETWORKS; ELECTRONIC COMMUNICATION DEVICES, NAMELY, PERSONAL DIGITAL ASSISTANTS, PAGERS; WIRELESS COMMUNICATIONS DEVICES, NAMELY, WIRELESS LAN HARDWARE AND SOFTWARE FOR THE TRANSMISSION OF VOICE, DATA, AND VIDEO; STORAGE NETWORKING PRODUCTS, NAMELY ROUTERS, SWITCHES, PORT ADAPTERS, ANTENNAS, HUBS AND SOFTWARE USED IN THE OPERATION AND MANAGEMENT THEREOF; VIRTUAL PRIVATE NETWORK (VPN) HARDWARE; VPN OPERATING SOFTWARE; COMPUTER SOFTWARE FOR MANAGING AND OPERATING COMPUTER AND COMMUNICATIONS HARDWARE OVER ELECTRONIC, OPTICAL, OR WIRELESS COMMUNICATIONS NETWORKS; DOWNLOADABLE INSTRUCTIONAL MATERIALS, NAMELY BOOKS, MANUALS, PRINTED GUIDES FOR TEACHERS, TEST BOOKLETS, MAGAZINES, NEWSLETTERS AND BULLETINS IN THE FIELDS OF NETWORK COMMUNICATIONS, AND MANAGING, OPERATING AND USING LOCAL, WIDE AND GLOBAL NETWORKS (U.S. CLS. 21, 23, 26, 36 AND 38).

RONALD MCMORROW, EXAMINING ATTORNEY

**CLASS 9—(Continued).**

SN 78-399,736. MICROSOFT CORPORATION, REDMOND, WA. FILED 4-9-2004.

**FORZA MOTORSPORT**

THE MARK CONSISTS OF STANDARD CHARACTERS WITHOUT CLAIM TO ANY PARTICULAR FONT, STYLE, SIZE, OR COLOR.

NO CLAIM IS MADE TO THE EXCLUSIVE RIGHT TO USE "MOTORSPORT", APART FROM THE MARK AS SHOWN.

THE FOREIGN WORDING IN THE MARK TRANSLATES INTO ENGLISH AS FORCE.

FOR COMPUTER PROGRAMS, NAMELY, GAME SOFTWARE FOR USE ON COMPUTERS AND VIDEO GAME PLAYERS; PRERECORDED VIDEOTAPES, AUDIO TAPES, CDS AND DVDS FEATURING SOUND AND VIDEO IN THE FIELDS OF MUSIC, LIVE ACTION PROGRAMS, MOTION PICTURES AND ANIMATED CARTOONS (U.S. CLS. 21, 23, 26, 36 AND 38).

MARY CRAWFORD, EXAMINING ATTORNEY

**CLASS 9—(Continued).**

SN 78-400,273. ANDERSON UNIVERSITY, INC., ANDERSON, IN. FILED 4-12-2004.



FOR PRE-RECORDED CD'S FEATURING MUSICAL PERFORMANCES (U.S. CLS. 21, 23, 26, 36 AND 38).  
FIRST USE 10-21-2003; IN COMMERCE 10-21-2003.  
RONALD MCMORROW, EXAMINING ATTORNEY

SN 78-401,124. TELEX COMMUNICATIONS, INC., BURNSVILLE, MN. FILED 4-13-2004.

**RTS**

SN 78-399,875. CRITICAL NETWORKS, INC., SAN DIEGO, CA. FILED 4-10-2004.

**CRITICAL NETWORKS**

THE MARK CONSISTS OF STANDARD CHARACTERS WITHOUT CLAIM TO ANY PARTICULAR FONT, STYLE, SIZE, OR COLOR.

NO CLAIM IS MADE TO THE EXCLUSIVE RIGHT TO USE "NETWORKS", APART FROM THE MARK AS SHOWN.

FOR COMPUTER HARDWARE FOR USE IN DATA NETWORKING, NAMELY, SWITCHES, ROUTERS, AND CIRCUIT PROTECTION DEVICES (U.S. CLS. 21, 23, 26, 36 AND 38).

SUSAN LESLIE DUBOIS, EXAMINING ATTORNEY

THE MARK CONSISTS OF STANDARD CHARACTERS WITHOUT CLAIM TO ANY PARTICULAR FONT, STYLE, SIZE, OR COLOR.

OWNER OF U.S. REG. NO. 1,268,986.

FOR INTERCOM SYSTEMS AND DIGITAL MATRIX INTERCOM SYSTEMS, COMPRISED OF SYSTEM POWER SUPPLIES, INTERCOM MATRICES, MASTER STATIONS, USER STATIONS, HEADSET STATIONS, SPEAKER STATIONS, PASSIVE SPEAKERS, BELTPACK STATIONS, ELECTRONIC STATIONS, MICROPHONE PREAMPLIFIERS, CARD FRAME ASSEMBLIES, POWER SUPPLY ASSEMBLIES, COMMUNICATIONS AMPLIFIERS, DISTRIBUTION AMPLIFIERS, MICROPHONE TO LINE LEVEL AMPLIFIERS, BUFFER AMPLIFIERS, INTERFACES, SYSTEM TO SYSTEM ADAPTERS, DUAL DIGITAL HYBRID INTERFACES, RACK MOUNT PANELS, CALL LIGHT INDICATORS, ASSIGN PANELS, JUNCTION BOXES, RACK MOUNT KITS, PANEL MOUNT MICROPHONES, SPLITTERS, INPUT AND OUTPUT PINS, CHANNEL WALL PLATES, INTERFACE CARDS, NETWORK CARDS, MATRIX TRUNKING, KEYPANELS, AND PARTS THEREFOR (U.S. CLS. 21, 23, 26, 36 AND 38).

DAVID MURRAY, EXAMINING ATTORNEY

**CLASS 9—(Continued).**

SN 78-401,129. EVOGY, INC., SAN JOSE, CA. FILED 4-13-2004.

**CLASS 9—(Continued).**

SN 78-401,338. GUNDAVELLI, LATHA, SUNNYVALE, CA. FILED 4-13-2004.

**EVOGY**

**SILICONROCK**

THE MARK CONSISTS OF STANDARD CHARACTERS WITHOUT CLAIM TO ANY PARTICULAR FONT, STYLE, SIZE, OR COLOR.

FOR FUEL CELLS, NAMELY AN ELECTROCHEMICAL DEVICE THAT COMBINES HYDROGEN FUEL AND OXYGEN FROM THE AIR TO PRODUCE ELECTRICITY (U.S. CLS. 21, 23, 26, 36 AND 38).

STEVEN JACKSON, EXAMINING ATTORNEY

THE MARK CONSISTS OF STANDARD CHARACTERS WITHOUT CLAIM TO ANY PARTICULAR FONT, STYLE, SIZE, OR COLOR.

FOR TELECOMMUNICATIONS EQUIPMENT, NAMELY, COMPUTER TELEPHONY HARDWARE AND SOFTWARE, TELEPHONY HARDWARE ATTACHED TO DATA NETWORK FOR DIGITIZING VOICE AND TRANSMITTING ACROSS DATA NETWORKS, GATEWAY DEVICES FOR INTERCONNECTING DATA NETWORKS AND TRADITIONAL TELEPHONE NETWORKS, TELECONFERENCING SERVERS AND VOICE MAIL SERVERS (U.S. CLS. 21, 23, 26, 36 AND 38).

STEVEN JACKSON, EXAMINING ATTORNEY

SN 78-401,207. LUSTER LEAF PRODUCTS, INC., WOODSTOCK, IL. FILED 4-13-2004.

SN 78-403,506. PRISM - HUMAN RESOURCE CONSULTING SERVICES, LLC, LAS VEGAS, NV. FILED 4-16-2004.

**RAPITEST**

**Market Your Job  
Search**

THE MARK CONSISTS OF STANDARD CHARACTERS WITHOUT CLAIM TO ANY PARTICULAR FONT, STYLE, SIZE, OR COLOR.

FOR SOIL TEST KITS, COMPRISED OF FILTERS, DROPPER TOP BOTTLES, PLUNGERS, TEST TUBES, AND REACTANTS, ELECTRICAL TEST METERS, BATTERY, BULB AND FUSE TESTERS, ELECTRONIC THERMOMETERS (U.S. CLS. 21, 23, 26, 36 AND 38).

FIRST USE 3-9-1989; IN COMMERCE 3-9-1989.  
CHERYL STEPLIGHT, EXAMINING ATTORNEY

THE MARK CONSISTS OF STANDARD CHARACTERS WITHOUT CLAIM TO ANY PARTICULAR FONT, STYLE, SIZE, OR COLOR.

FOR ELECTRONIC PUBLICATIONS, NAMELY A SERIES OF ONLINE BOOKS ASSISTING WITH JOB SEARCH INFORMATION AND INCLUDING LEGAL RIGHTS OF JOB APPLICANTS, RECORDED ON COMPUTER MEDIA (U.S. CLS. 21, 23, 26, 36 AND 38).

DANIEL BRODY, EXAMINING ATTORNEY



**CLASS 9—(Continued).**

SN 78-406,762. SILICON LABORATORIES, INC., AUSTIN, TX. FILED 4-22-2004.

**CLASS 9—(Continued).**

SN 78-411,328. HARRAH'S OPERATING COMPANY, INC., LAS VEGAS, NV. FILED 4-30-2004.

# USBXPRESS

# Royal Order

THE MARK CONSISTS OF STANDARD CHARACTERS WITHOUT CLAIM TO ANY PARTICULAR FONT, STYLE, SIZE, OR COLOR.

FOR SOFTWARE FOR USE IN THE DESIGN OF COMPUTER AND TELEPHONY SYSTEMS AND USER MANUALS SOLD AS A UNIT (U.S. CLS. 21, 23, 26, 36 AND 38).

FIRST USE 4-0-2003; IN COMMERCE 4-0-2003.  
BILL DAWE, EXAMINING ATTORNEY

THE MARK CONSISTS OF STANDARD CHARACTERS WITHOUT CLAIM TO ANY PARTICULAR FONT, STYLE, SIZE, OR COLOR.

FOR GAMING EQUIPMENT, NAMELY, SLOT MACHINES, VIDEO POKER MACHINES AND VIDEO SLOT MACHINES AND VIDEO LOTTERY TERMINALS (U.S. CLS. 21, 23, 26, 36 AND 38).

CHARLES JOYNER, EXAMINING ATTORNEY

SN 78-410,273. BPS INFO SOLUTIONS, INC., TUCKER, GA. FILED 4-29-2004.

SN 78-411,465. ALPHA VIDEO DISTRIBUTORS, INC., CONSHOCKEN, PA. FILED 4-30-2004.

# UltraCart



THE MARK CONSISTS OF STANDARD CHARACTERS WITHOUT CLAIM TO ANY PARTICULAR FONT, STYLE, SIZE, OR COLOR.

FOR COMPUTER E-COMMERCE SOFTWARE TO ALLOW USERS TO PERFORM ELECTRONIC BUSINESS TRANSACTIONS VIA A GLOBAL COMPUTER NETWORK (U.S. CLS. 21, 23, 26, 36 AND 38).

FIRST USE 11-26-1998; IN COMMERCE 11-26-1998.  
BARBARA BROWN, EXAMINING ATTORNEY

NO CLAIM IS MADE TO THE EXCLUSIVE RIGHT TO USE "CLASSICS", APART FROM THE MARK AS SHOWN.

FOR PRE-RECORDED VIDEO CASSETTES, VIDEO DISCS, DVD DISCS, CONTAINING MOTION PICTURES THAT FEATURE ACTION, COMEDY, DRAMA, HORROR, ANIMATION, THRILLERS, SERIALS, SCI-FI AND WESTERNS (U.S. CLS. 21, 23, 26, 36 AND 38).

SAMUEL E. SHARPER JR., EXAMINING ATTORNEY

**CLASS 9—(Continued).**

SN 78-411,472. SYNERGISTIC SOFTWARE SYSTEMS, INC., NEPTUNE BEACH, FL. FILED 4-30-2004.

# ScrapBoss

THE MARK CONSISTS OF STANDARD CHARACTERS WITHOUT CLAIM TO ANY PARTICULAR FONT, STYLE, SIZE, OR COLOR.

FOR COMPUTER SOFTWARE FOR USE IN— DATA MANAGEMENT FOR ROUTE AND CONTAINER DATA IN SCRAP RECYCLING INDUSTRY; TRACKING DRIVER ACTIVITIES; COMMUNICATION WITH DRIVERS; DRIVER DATA INPUT; INTERFACING DRIVER DATA INPUT TO ACCOUNTING SYSTEMS; AND BAR CODING OF SCRAP CONTAINERS (U.S. CLS. 21, 23, 26, 36 AND 38).

FIRST USE 10-31-2003; IN COMMERCE 4-25-2004.  
HEATHER THOMPSON, EXAMINING ATTORNEY

SN 78-413,161. BALLY GAMING INTERNATIONAL, INC., LAS VEGAS, NV. FILED 5-4-2004.

# ENGINE ENGINE NO. 9

THE MARK CONSISTS OF STANDARD CHARACTERS WITHOUT CLAIM TO ANY PARTICULAR FONT, STYLE, SIZE, OR COLOR.

FOR GAMING EQUIPMENT, NAMELY GAMING MACHINES, WITH OR WITHOUT VIDEO OUTPUT, ELECTRONIC GAMING MACHINES, ELECTRO-MECHANICAL GAMING MACHINES AND MECHANICAL GAMING MACHINES; LOTTERY MACHINES, NAMELY AN ELECTRONIC GAMING MACHINE THAT GENERATES LOTTERY TICKETS; COMPUTER SOFTWARE FOR GAMING AND LOTTERY GAMES (U.S. CLS. 21, 23, 26, 36 AND 38).

MITCHELL FRONT, EXAMINING ATTORNEY

**CLASS 9—(Continued).**

SN 78-413,163. BALLY GAMING INTERNATIONAL, INC., LAS VEGAS, NV. FILED 5-4-2004.

# HUNKS OF CASH

THE MARK CONSISTS OF STANDARD CHARACTERS WITHOUT CLAIM TO ANY PARTICULAR FONT, STYLE, SIZE, OR COLOR.

FOR GAMING EQUIPMENT, NAMELY GAMING MACHINES, WITH OR WITHOUT VIDEO OUTPUT, ELECTRONIC GAMING MACHINES, ELECTRO-MECHANICAL GAMING MACHINES AND MECHANICAL GAMING MACHINES; LOTTERY MACHINES, NAMELY AN ELECTRONIC GAMING MACHINE THAT GENERATES LOTTERY TICKETS; COMPUTER SOFTWARE FOR GAMING AND LOTTERY GAMES (U.S. CLS. 21, 23, 26, 36 AND 38).

MITCHELL FRONT, EXAMINING ATTORNEY

SN 78-413,558. ASCENT TECHNOLOGY, INC., CAMBRIDGE, MA. FILED 5-5-2004.

# ARIS/SMARTBUS

THE MARK CONSISTS OF STANDARD CHARACTERS WITHOUT CLAIM TO ANY PARTICULAR FONT, STYLE, SIZE, OR COLOR.

FOR COMPUTER SOFTWARE FOR INTEGRATING AIRPORT AND AIRLINE RESOURCE AND FINANCIAL MANAGEMENT SYSTEMS, AND USER MANUALS SOLD AS A UNIT THEREWITH (U.S. CLS. 21, 23, 26, 36 AND 38).

FIRST USE 6-0-2002; IN COMMERCE 6-0-2002.  
INGA ERVIN, EXAMINING ATTORNEY

**CLASS 9—(Continued).**

SN 78-413,980. MAYSTEEL LLC, MENOMONEE FALLS, WI. FILED 5-6-2004.

# FLEXIGEAR

THE MARK CONSISTS OF STANDARD CHARACTERS WITHOUT CLAIM TO ANY PARTICULAR FONT, STYLE, SIZE, OR COLOR.

FOR SWITCHGEARS USED IN THE TRANSMISSION AND DISTRIBUTION OF ELECTRICAL POWER, NAMELY, CAPACITOR SWITCHES, VACUUM SWITCHES, OIL SWITCHES, MULTIPLE RELAY LIGHTING CONTROLS, GROUND FAULT DETECTORS AND MEDIUM VOLTAGE PADMOUNT FUSED SWITCHGEARS (U.S. CLS. 21, 23, 26, 36 AND 38).

ELLEN PERKINS, EXAMINING ATTORNEY

SN 78-413,982. INNERPHASE DESIGN, LLC, INDIANAPOLIS, IN. FILED 5-6-2004.

# SWITCH-N-SWITCH

THE MARK CONSISTS OF STANDARD CHARACTERS WITHOUT CLAIM TO ANY PARTICULAR FONT, STYLE, SIZE, OR COLOR.

FOR ELECTRIC SWITCH COVERS (U.S. CLS. 21, 23, 26, 36 AND 38).

ANDREW RHIM, EXAMINING ATTORNEY

**CLASS 9—(Continued).**

SN 78-414,469. CONTROL CORPORATION, MAPLE GROVE, MN. FILED 5-6-2004.

# NITRON

THE MARK CONSISTS OF STANDARD CHARACTERS WITHOUT CLAIM TO ANY PARTICULAR FONT, STYLE, SIZE, OR COLOR.

FOR MICROCOMPUTERS FOR USE WITH A COMPUTER NETWORK TO PROVIDE REMOTE COMMUNICATIONS AND MANAGEMENT AND TO RUN SOFTWARE PROGRAMS (U.S. CLS. 21, 23, 26, 36 AND 38).

SKYE YOUNG, EXAMINING ATTORNEY

SN 78-415,361. BOTTLEROCKET ENTERTAINMENT, INC., DEL MAR, CA. FILED 5-7-2004.



OWNER OF U.S. REG. NOS. 2,298,684, 2,312,311 AND 2,350,547.

NO CLAIM IS MADE TO THE EXCLUSIVE RIGHT TO USE "ENTERTAINMENT", APART FROM THE MARK AS SHOWN.

THE MARK CONSISTS OF STYLIZED LETTERS FORMING THE WORD "BOTTLEROCKET" WITH THE LETTER B IN LARGE LOWERCASE, THE LETTERS O, T, AND C IN SMALL LOWERCASE, THE LETTERS L, E AND K IN SMALL UPPERCASE, AND THE LETTER R IN LARGE UPPERCASE, AND THE WORD "ENTERTAINMENT" WITH ALL OF THE LETTERS IN LOWERCASE AND APPEARING DIRECTLY BELOW THE WORD "BOTTLEROCKET".

FOR SOFTWARE, NAMELY COMPUTER GAME SOFTWARE, VIDEO GAME SOFTWARE, GAME SOFTWARE FOR GAME OR VIDEO CONSOLES, SOFTWARE FOR DEVELOPING COMPUTER GAMES, VIDEO GAMES AND GAMES FOR GAME OR VIDEO CONSOLES, SOFTWARE FOR PROVIDING COMPUTER GAMES, VIDEO GAMES AND GAMES FOR GAME OR VIDEO CONSOLES ONLINE, BY MEANS OF A GLOBAL COMPUTER NETWORK OR BY MEANS OF WIRELESS DEVICES, SOFTWARE FOR GAME OR VIDEO CONSOLES, AND SOFTWARE TOOLS FOR IMAGE PROCESSING, FOR CONTROLLING OF AND INTERFACING WITH VIDEO CARDS AND FOR THE SIMULATION AND DISPLAYING OF PHYSICAL EFFECTS; COMPUTER GAME DISCS, TAPES AND CASSETTES; VIDEO GAME DISCS, ALSO AS AUXILIARY DEVICES FOR TV RECEIVERS; GAME DISCS, TAPES AND CASSETTES FOR GAME OR VIDEO CONSOLES; DOWNLOADABLE PUBLICATIONS IN THE NATURE OF BOOKS, MAGAZINES OR MANUALS IN ELECTRONIC FORM OR OTHER DATA PROVIDED BY MEANS OF MULTIMEDIA ELECTRONIC BROADCAST OR ONLINE NET-

**CLASS 9—(Continued).**

WORK TRANSMISSION DEVOTED TO COMPUTER GAMES, VIDEO GAMES, GAMES FOR VIDEO OR GAME CONSOLES, IMAGE PROCESSING AND SOFTWARE TOOLS FOR IMAGE PROCESSING AND DESIGNING COMPUTER GAMES OR GAMES FOR VIDEO OR GAME CONSOLES; MAGNETIC OR OPTICAL DATA CARRIERS PRE-RECORDED WITH SOFTWARE FOR COMPUTER GAMES, SOFTWARE FOR GAME OR VIDEO CONSOLES, GAMES SOFTWARE, VIDEO GAMES SOFTWARE, SOFTWARE FOR ONLINE GAMING, SOFTWARE TOOLS FOR IMAGE PROCESSING AND FOR DESIGNING COMPUTER GAMES OR GAMES FOR VIDEO OR GAME CONSOLES; VIDEO CASSETTES AND VIDEO TAPES PRERECORDED WITH VIDEO GAMES OR GAMES FOR GAME OR VIDEO CONSOLES; DATA PROCESSING EQUIPMENT, NAMELY COMPUTERS, GAME OR VIDEO CONSOLES AND HARDWARE COMPONENTS FOR THE AFORESAID GOODS INCLUDING INTEGRATED CIRCUITS, APPLICATION SPECIFIC INTEGRATED CIRCUITS AND SPECIAL PURPOSE PROCESSORS; AND PRINTED MATTER IN THE NATURE OF BOOKS, BROCHURES, FLY SHEETS, LEAFLETS, INSTRUCTIONAL AND TEACHING MATERIAL, EXCEPT APPARATUS, ALL SOLD TOGETHER WITH THE AFORESAID GOODS (U.S. CLS. 21, 23, 26, 36 AND 38).

JOHN DWYER, EXAMINING ATTORNEY

**CLASS 9—(Continued).**

OR GAME CONSOLES; MAGNETIC OR OPTICAL DATA CARRIERS PRE-RECORDED WITH SOFTWARE FOR COMPUTER GAMES, SOFTWARE FOR GAME OR VIDEO CONSOLES, GAMES SOFTWARE, VIDEO GAMES SOFTWARE, SOFTWARE FOR ONLINE GAMING, SOFTWARE TOOLS FOR IMAGE PROCESSING AND FOR DESIGNING COMPUTER GAMES OR GAMES FOR VIDEO OR GAME CONSOLES; VIDEO CASSETTES AND VIDEO TAPES PRERECORDED WITH VIDEO GAMES OR GAMES FOR GAME OR VIDEO CONSOLES; DATA PROCESSING EQUIPMENT, NAMELY COMPUTERS, GAME OR VIDEO CONSOLES AND HARDWARE COMPONENTS FOR THE AFORESAID GOODS INCLUDING INTEGRATED CIRCUITS, APPLICATION SPECIFIC INTEGRATED CIRCUITS AND SPECIAL PURPOSE PROCESSORS; AND PRINTED MATTER IN THE NATURE OF BOOKS, BROCHURES, FLY SHEETS, LEAFLETS, INSTRUCTIONAL AND TEACHING MATERIAL, EXCEPT APPARATUS, ALL SOLD TOGETHER WITH THE AFORESAID GOODS (U.S. CLS. 21, 23, 26, 36 AND 38).

ANDREW BENZMILLER, EXAMINING ATTORNEY

SN 78-415,379. BOTTLEROCKET ENTERTAINMENT, INC., DEL MAR, CA. FILED 5-7-2004.



THE MARK CONSISTS OF A SKULL DIRECTLY ABOVE A VIDEO GAME CONTROLLER.

FOR SOFTWARE, NAMELY COMPUTER GAME SOFTWARE, VIDEO GAME SOFTWARE, GAME SOFTWARE FOR GAME OR VIDEO CONSOLES, SOFTWARE FOR DEVELOPING COMPUTER GAMES, VIDEO GAMES AND GAMES FOR GAME OR VIDEO CONSOLES, SOFTWARE FOR PROVIDING COMPUTER GAMES, VIDEO GAMES AND GAMES FOR GAME OR VIDEO CONSOLES ONLINE, BY MEANS OF A GLOBAL COMPUTER NETWORK OR BY MEANS OF WIRELESS DEVICES, SOFTWARE FOR GAME OR VIDEO CONSOLES, AND SOFTWARE TOOLS FOR IMAGE PROCESSING, FOR CONTROLLING OF AND INTERFACING WITH VIDEO CARDS AND FOR THE SIMULATION AND DISPLAYING OF PHYSICAL EFFECTS; COMPUTER GAME DISCS, TAPES AND CASSETTES; VIDEO GAME DISCS, ALSO AS AUXILIARY DEVICES FOR TV RECEIVERS; GAME DISCS, TAPES AND CASSETTES FOR GAME OR VIDEO CONSOLES; DOWNLOADABLE PUBLICATIONS IN THE NATURE OF BOOKS, MAGAZINES OR MANUALS IN ELECTRONIC FORM OR OTHER DATA PROVIDED BY MEANS OF MULTIMEDIA ELECTRONIC BROADCAST OR ONLINE NETWORK TRANSMISSION DEVOTED TO COMPUTER GAMES, VIDEO GAMES, GAMES FOR VIDEO OR GAME CONSOLES, IMAGE PROCESSING AND SOFTWARE TOOLS FOR IMAGE PROCESSING AND DESIGNING COMPUTER GAMES OR GAMES FOR VIDEO

SN 78-415,492. VIRSENSE TECHNOLOGIES LLC, ORLANDO, FL. FILED 5-8-2004.

# VIRSENSE

THE MARK CONSISTS OF STANDARD CHARACTERS WITHOUT CLAIM TO ANY PARTICULAR FONT, STYLE, SIZE, OR COLOR.

FOR COMPUTER FIRMWARE, COMPUTER HARDWARE, COMPUTER SOFTWARE, AND COMPUTER SOFTWARE DEVELOPMENT TOOLS, ALL FOR USE IN THE FIELDS OF THREE DIMENSIONAL VISUALIZATION, VIRTUAL REALITY AND AUGMENTED REALITY; COMPUTER SOFTWARE APPLICATIONS FOR USE IN NETWORK-DISTRIBUTED LEARNING, REMOTE LEARNING, DISTANCE LEARNING, AND COLLABORATIVE LEARNING (U.S. CLS. 21, 23, 26, 36 AND 38).

MICHAEL KAZAZIAN, EXAMINING ATTORNEY

**CLASS 9—(Continued).**

SN 78-416,134. LEUPOLD & STEVENS, INC., BEAVERTON, OR. FILED 5-10-2004.

**CLASS 9—(Continued).**

SN 78-416,241. AUSTIN, DALLAS, ATLANTA, GA. FILED 5-10-2004.

# ALUMINA

THE MARK CONSISTS OF STANDARD CHARACTERS WITHOUT CLAIM TO ANY PARTICULAR FONT, STYLE, SIZE, OR COLOR.

FOR ACCESSORIES FOR RIFLE SCOPES, HAND GUN SCOPES, SPOTTING SCOPES, BINOCULARS, AND OPTICAL LENS SCOPES, NAMELY, LENS CAPS, LENS FILTERS, LENS COVERS (U.S. CLS. 21, 23, 26, 36 AND 38).

MELVIN AXILBUND, EXAMINING ATTORNEY

# ROWDY FILMS

THE MARK CONSISTS OF STANDARD CHARACTERS WITHOUT CLAIM TO ANY PARTICULAR FONT, STYLE, SIZE, OR COLOR.

OWNER OF U.S. REG. NOS. 2,307,641 AND 2,315,414. NO CLAIM IS MADE TO THE EXCLUSIVE RIGHT TO USE "FILMS", APART FROM THE MARK AS SHOWN.

FOR MUSICAL SOUND RECORDINGS AND AUDIO-VISUAL RECORDINGS (U.S. CLS. 21, 23, 26, 36 AND 38). ALICE SUE CARRUTHERS, EXAMINING ATTORNEY

SN 78-416,253. INTELICAM SYSTEMS, WEST CHESTER, OH. FILED 5-10-2004.

SN 78-416,181. FUSION DISTRIBUTORS LLC, STAMFORD, CT. FILED 5-10-2004.

# STAIN ZAPPER

THE MARK CONSISTS OF STANDARD CHARACTERS WITHOUT CLAIM TO ANY PARTICULAR FONT, STYLE, SIZE, OR COLOR.

NO CLAIM IS MADE TO THE EXCLUSIVE RIGHT TO USE "STAIN", APART FROM THE MARK AS SHOWN.

FOR ELECTRONIC STAIN REMOVING MACHINE FOR CLOTHING (U.S. CLS. 21, 23, 26, 36 AND 38).

LAURA KOVAISKY, EXAMINING ATTORNEY

# VIDGIO

THE MARK CONSISTS OF STANDARD CHARACTERS WITHOUT CLAIM TO ANY PARTICULAR FONT, STYLE, SIZE, OR COLOR.

FOR VIDEORECORDERS (U.S. CLS. 21, 23, 26, 36 AND 38).

MICHAEL KAZAZIAN, EXAMINING ATTORNEY

**CLASS 9—(Continued).**

SN 78-416,435. ATARI, INC., NEW YORK, NY. FILED 5-11-2004.

**BACKYARD SKATER**

THE MARK CONSISTS OF STANDARD CHARACTERS WITHOUT CLAIM TO ANY PARTICULAR FONT, STYLE, SIZE, OR COLOR.

OWNER OF U.S. REG. NOS. 2,722,271, 2,747,587 AND 2,757,107.

NO CLAIM IS MADE TO THE EXCLUSIVE RIGHT TO USE "SKATER", APART FROM THE MARK AS SHOWN.

FOR INTERACTIVE MULTIMEDIA GAME SOFTWARE FOR USE ON PERSONAL COMPUTERS AND ELECTRONIC GAME-PLAYING UNITS (U.S. CLS. 21, 23, 26, 36 AND 38).

LINDA ESTRADA, EXAMINING ATTORNEY

---

SN 78-416,846. COST PLUS MARKETING SERVICES, INC., OAKLAND, CA. FILED 5-11-2004.

**WORLD MARKET**

THE MARK CONSISTS OF STANDARD CHARACTERS WITHOUT CLAIM TO ANY PARTICULAR FONT, STYLE, SIZE, OR COLOR.

OWNER OF U.S. REG. NOS. 1,772,080, 2,080,865 AND OTHERS.

FOR MAGNETICALLY ENCODED CARDS, NAMELY, CREDIT CARDS, CHARGE CARDS, STORE VALUE CARDS, AND PREPAID PURCHASING CARDS (U.S. CLS. 21, 23, 26, 36 AND 38).

FIRST USE 10-1-1999; IN COMMERCE 10-1-1999.

STEVEN R. FINE, EXAMINING ATTORNEY

---

SN 78-417,001. AMERICAN FUTURE TECHNOLOGY CORP., DBA IBUYPOWER, MONTEREY PARK, CA. FILED 5-11-2004.



THE COLOR(S) SILVER, RED AND BLACK IS/ARE CLAIMED AS A FEATURE OF THE MARK.

THE MARK CONSISTS OF THE MARK CONSISTS OF FOUR SILVER PROGNS PROJECTING FROM A ROUND RED CIRCLE FOLLOWED BY THE STYLIZED CHARACTERS IN RED "IBUY" AND IN BLACK "POWER".

FOR COMPUTERS (U.S. CLS. 21, 23, 26, 36 AND 38).

FIRST USE 1-1-2003; IN COMMERCE 1-1-2003.

TIMOTHY FINNEGAN, EXAMINING ATTORNEY

**CLASS 9—(Continued).**

SN 78-417,657. ENERGYWINDOW, INC., BOULDER, CO. FILED 5-12-2004.

**POWERMONITOR**

THE MARK CONSISTS OF STANDARD CHARACTERS WITHOUT CLAIM TO ANY PARTICULAR FONT, STYLE, SIZE, OR COLOR.

FOR COMPUTER SOFTWARE FOR BUYING AND SELLING ENERGY ON THE GLOBAL COMPUTER NETWORK IN THE ELECTIC, COAL, GAS, NUCLEAR, AND SOLAR ENERGY INDUSTRIES (U.S. CLS. 21, 23, 26, 36 AND 38).

CAROLINE WOOD, EXAMINING ATTORNEY

---

SN 78-417,731. KEY-TRAK, INC., HOUSTON, TX. FILED 5-12-2004.

**KEYPOLLER**

THE MARK CONSISTS OF STANDARD CHARACTERS WITHOUT CLAIM TO ANY PARTICULAR FONT, STYLE, SIZE, OR COLOR.

FOR COMPUTER SOFTWARE FOR COMMUNICATING INFORMATION RELATING TO MANAGEMENT, RETRIEVAL AND RETURN, OF KEYS (U.S. CLS. 21, 23, 26, 36 AND 38).

FIRST USE 12-31-1997; IN COMMERCE 12-31-1997.

DANIEL CAPSHAW, EXAMINING ATTORNEY

**CLASS 9—(Continued).**

SN 78-418,045. PLANAR SYSTEMS, INC., BEAVERTON, OR.  
FILED 5-13-2004.

**CLASS 9—(Continued).**

SN 78-418,872. SOUTHWIRE COMPANY, CARROLLTON,  
GA. FILED 5-14-2004.

**DS15 INTEGRATED  
MARKETING  
SOLUTION**

**STRIKESHIELD**

THE MARK CONSISTS OF STANDARD CHARACTERS  
WITHOUT CLAIM TO ANY PARTICULAR FONT, STYLE,  
SIZE, OR COLOR.  
FOR KIOSKS FOR INTERACTIVE COMMUNICATION  
WITH USERS (U.S. CLS. 21, 23, 26, 36 AND 38).  
FIRST USE 3-31-2004; IN COMMERCE 3-31-2004.  
KENNETH D. BATTLE, EXAMINING ATTORNEY

THE MARK CONSISTS OF STANDARD CHARACTERS  
WITHOUT CLAIM TO ANY PARTICULAR FONT, STYLE,  
SIZE, OR COLOR.  
FOR ELECTRICAL WIRE AND CABLE (U.S. CLS. 21,  
23, 26, 36 AND 38).  
FIRST USE 7-8-2003; IN COMMERCE 7-8-2003.  
MICHAEL HALL, EXAMINING ATTORNEY

SN 78-418,204. CBS BROADCASTING INC., NEW YORK, NY.  
FILED 5-13-2004.

SN 78-418,881. TERADYNE, INC., BOSTON, MA. FILED 5-14-  
2004.

**CSItem:**

**VENTURA**

OWNER OF U.S. REG. NO. 2,775,596.  
FOR VIDEOCASSETTES, LASER DISCS AND DIGITAL  
VIDEO DISCS/DIGITAL VERSATILE DISCS ("DVD")  
FEATURING PRERECORDED ENTERTAINMENT IN  
THE NATURE OF MOTION PICTURES, TELEVISION  
SERIES EPISODES AND MADE FOR TELEVISION  
MOTION PICTURES; DECORATIVE REFRIGERATOR  
MAGNETS; COMPUTER GAME SOFTWARE RE-  
CORDED ON CD ROM; COMPUTER GAME PRO-  
GRAMS; COMPUTER GAME DVD; COMPUTER GAME  
TAPES; VIDEO GAME CARTRIDGES; VIDEO GAME  
SOFTWARE; CURRENCY AND CREDIT OPERATED  
SLOT MACHINES AND GAMING DEVICES, NAMELY,  
GAMING MACHINES FOR USE IN GAMING ESTAB-  
LISHMENTS (U.S. CLS. 21, 23, 26, 36 AND 38).  
ESTHER BELENKER, EXAMINING ATTORNEY

THE MARK CONSISTS OF STANDARD CHARACTERS  
WITHOUT CLAIM TO ANY PARTICULAR FONT, STYLE,  
SIZE, OR COLOR.  
FOR ELECTRICAL CONNECTORS (U.S. CLS. 21, 23,  
26, 36 AND 38).  
KATHLEEN M. VANSTON, EXAMINING ATTORNEY

**CLASS 9—(Continued).**

SN 78-419,245. PACIFIC WIRELESS MANUFACTURING INC, DRAPER, UT. FILED 5-14-2004.

**CLASS 9—(Continued).**

SN 78-419,592. POINTCROSS, INC., FOSTER CITY, CA. FILED 5-17-2004.

# RooTenna

# SOXVault

THE MARK CONSISTS OF STANDARD CHARACTERS WITHOUT CLAIM TO ANY PARTICULAR FONT, STYLE, SIZE, OR COLOR.

FOR COMMUNICATIONS ANTENNAS (U.S. CLS. 21, 23, 26, 36 AND 38).

FIRST USE 9-25-2003; IN COMMERCE 10-1-2003.  
BARBARA RUTLAND, EXAMINING ATTORNEY

THE MARK CONSISTS OF STANDARD CHARACTERS WITHOUT CLAIM TO ANY PARTICULAR FONT, STYLE, SIZE, OR COLOR.

FOR COMPUTER SOFTWARE FOR RECORDS MANAGEMENT RELATED TO SARBANES-OXLEY COMPLIANCE (U.S. CLS. 21, 23, 26, 36 AND 38).

KARLA PERKINS, EXAMINING ATTORNEY

---

SN 78-419,468. PUSHPLAY INTERACTIVE, LLC, SARATOGA SPRINGS, NY. FILED 5-15-2004.

---

SN 78-419,600. L.C. LICENSING, INC., NEW YORK, NY. FILED 5-17-2004.



# LIZWEAR

THE MARK CONSISTS OF A CIRCLE, HAND, AND TRIANGLE.

FOR REMOTE CONTROLS FOR USE BY CHILDREN IN CONTROLLING ELECTRONIC MEDIA DEVICES, NAMELY, DVD-PLAYERS; DVDS HAVING PRERECORDED MEDIA CONTENT SPECIFICALLY FOR CHILDREN; REMOVABLE USER INTERFACES FOR COUPLING WITH REMOTE CONTROLS FOR USE BY CHILDREN IN CONTROLLING ELECTRONIC MEDIA DEVICES, NAMELY, DVD-PLAYERS; MEDIA PACKAGES SOLD AS UNITS EACH INCLUDING A DVD HAVING PRERECORDED MEDIA CONTENT SPECIFICALLY FOR CHILDREN AND A REMOVABLE USER INTERFACE CORRESPONDING TO THE MEDIA CONTENT OF THE DVD FOR COUPLING WITH REMOTE CONTROLS FOR USE BY CHILDREN IN CONTROLLING ELECTRONIC MEDIA DEVICES, NAMELY, DVD-PLAYERS (U.S. CLS. 21, 23, 26, 36 AND 38).

AMY HELLA, EXAMINING ATTORNEY

THE MARK CONSISTS OF STANDARD CHARACTERS WITHOUT CLAIM TO ANY PARTICULAR FONT, STYLE, SIZE, OR COLOR.

OWNER OF U.S. REG. NOS. 1,346,383, 1,463,605 AND 1,531,982.

FOR SUNGLASSES, EYEGLASSES, EYEGLASS FRAMES, EYEGLASS CASES AND EYEGLASS RETAINER CORDS (U.S. CLS. 21, 23, 26, 36 AND 38).

ZACHARY BELLO, EXAMINING ATTORNEY



**CLASS 9—(Continued).**

SN 78-420,364. HUSICK, LAWRENCE A., SOUTHEASTERN, PA. FILED 5-17-2004.

**CLASS 9—(Continued).**

SN 78-421,713. MULTIMEDIA GAMES, INC., AUSTIN, TX. FILED 5-19-2004.

**THEMEBOT**

**SuperCharger**

THE MARK CONSISTS OF STANDARD CHARACTERS WITHOUT CLAIM TO ANY PARTICULAR FONT, STYLE, SIZE, OR COLOR.

FOR COMPUTER AND INTERNET SEARCH ENGINE SOFTWARE, QUERY PARSING SOFTWARE, SEARCH RESULTS PROCESSING AND PRESENTATION SOFTWARE (U.S. CLS. 21, 23, 26, 36 AND 38).  
DORITT L. CARROLL, EXAMINING ATTORNEY

THE MARK CONSISTS OF STANDARD CHARACTERS WITHOUT CLAIM TO ANY PARTICULAR FONT, STYLE, SIZE, OR COLOR.

FOR COMPUTER OPERATING SYSTEMS FOR CONTROL AND PLAY OF ELECTRONIC GAMING MACHINES (U.S. CLS. 21, 23, 26, 36 AND 38).  
CHERYL CLAYTON, EXAMINING ATTORNEY

SN 78-421,504. 3PN, LLC, BALA CYNWYD, PA. FILED 5-19-2004.

SN 78-424,249. VETRO INC., VANCOUVER, WA. FILED 5-24-2004.

**3PN Lets Doctors  
be Doctors Again**

**GOT AIR?**

THE MARK CONSISTS OF STANDARD CHARACTERS WITHOUT CLAIM TO ANY PARTICULAR FONT, STYLE, SIZE, OR COLOR.

FOR MEDICAL SOFTWARE FOR PATIENT CHARTS (U.S. CLS. 21, 23, 26, 36 AND 38).  
SEAN DWYER, EXAMINING ATTORNEY

THE MARK CONSISTS OF STANDARD CHARACTERS WITHOUT CLAIM TO ANY PARTICULAR FONT, STYLE, SIZE, OR COLOR.

FOR TIRE PRESSURE GAUGES (U.S. CLS. 21, 23, 26, 36 AND 38).  
GRETTA YAO, EXAMINING ATTORNEY

**CLASS 9—(Continued).**

SN 78-462,185. FAROUK SYSTEMS, INC., HOUSTON, TX.  
FILED 8-4-2004.

**CLASS 9—(Continued).**

SN 78-485,529. MGA ENTERTAINMENT, INC., VAN NUYS,  
CA. FILED 9-17-2004.

**KHI**

THE MARK CONSISTS OF STANDARD CHARACTERS  
WITHOUT CLAIM TO ANY PARTICULAR FONT, STYLE,  
SIZE, OR COLOR.

FOR ELECTRIC HAIR CURLING AND STYLING  
IRONS (U.S. CLS. 21, 23, 26, 36 AND 38).

BRENDAN REGAN, EXAMINING ATTORNEY

**GNARL**

---

SN 78-478,819. BALLY GAMING INTERNATIONAL, INC.,  
LAS VEGAS, NV. FILED 9-3-2004.

**BONUS WHEEL**

THE MARK CONSISTS OF STANDARD CHARACTERS  
WITHOUT CLAIM TO ANY PARTICULAR FONT, STYLE,  
SIZE, OR COLOR.

FOR GAMING DEVICES, NAMELY SLOT MACHINES,  
WITH OR WITHOUT VIDEO OUTPUT (U.S. CLS. 21, 23,  
26, 36 AND 38).

SUSAN LESLIE DUBOIS, EXAMINING ATTORNEY

THE MARK CONSISTS OF STANDARD CHARACTERS  
WITHOUT CLAIM TO ANY PARTICULAR FONT, STYLE,  
SIZE, OR COLOR.

FOR CALCULATORS; CASES FOR EYEGLASSES;  
CELLULAR TELEPHONES; COMPACT DISC PLAYERS;  
DIGITAL CAMERAS; DVD MACHINES; FIBER OPTIC  
LIGHT AND IMAGE CONDUITS; JOYSTICKS FOR  
COMPUTER AND VIDEO GAMES; KARAOKE MA-  
CHINES; MOBILE RADIO SETS SOLD AS A UNIT;  
MOTION PICTURE FILMS FEATURING ANIMATED  
AND NON-ANIMATED CHARACTERS; MP3 PLAYERS;  
PHOTOGRAPHIC CAMERAS; PROTECTIVE HELMETS;  
PRE-RECORDED COMPACT DISCS, DVDS AND VIDEO-  
CASSETTES FEATURING ANIMATED AND/OR NON-  
ANIMATED CHARACTERS AND MUSIC; RADIOS;  
SUNGLASSES; SWIM GOGGLES; TELEVISIONS; VIDEO-  
CASSETTE PLAYERS/RECORDERS; VIDEO DISC  
PLAYERS; VIDEO GAME INTERACTIVE HAND HELD  
REMOTE CONTROLS FOR PLAYING ELECTRONIC  
GAMES; AND VIDEO GAME SOFTWARE (U.S. CLS. 21,  
23, 26, 36 AND 38).

MICHAEL WEBSTER, EXAMINING ATTORNEY

**CLASS 9—(Continued).**

SN 78-485,550. MGA ENTERTAINMENT, INC., VAN NUYS, CA. FILED 9-17-2004.

**CLASS 9—(Continued).**

SN 78-488,475. ENERGYWINDOW, INC., BOULDER, CO. FILED 9-23-2004.

# SKRASH

# POWERPURCHASE

THE MARK CONSISTS OF STANDARD CHARACTERS WITHOUT CLAIM TO ANY PARTICULAR FONT, STYLE, SIZE, OR COLOR.

FOR CALCULATORS; CASES FOR EYEGLASSES; CELLULAR TELEPHONES; COMPACT DISC PLAYERS; DIGITAL CAMERAS; DVD MACHINES; FIBER OPTIC LIGHT AND IMAGE CONDUITS; JOYSTICKS FOR COMPUTER AND VIDEO GAMES; KARAOKE MACHINES; MOBILE RADIO SETS SOLD AS A UNIT; MOTION PICTURE FILMS FEATURING ANIMATED AND NON-ANIMATED CHARACTERS; MP3 PLAYERS; PHOTOGRAPHIC CAMERAS; PROTECTIVE HELMETS; PRE-RECORDED COMPACT DISCS, DVDS AND VIDEO-CASSETTES FEATURING ANIMATED AND/OR NON-ANIMATED CHARACTERS AND MUSIC; RADIOS; SUNGLASSES; SWIM GOGGLES; TELEVISIONS; VIDEO-CASSETE PLAYERS/RECORDERS; VIDEO DISC PLAYERS; VIDEO GAME INTERACTIVE HAND HELD REMOTE CONTROLS FOR PLAYING ELECTRONIC GAMES; AND VIDEO GAME SOFTWARE (U.S. CLS. 21, 23, 26, 36 AND 38).

MICHAEL WEBSTER, EXAMINING ATTORNEY

THE MARK CONSISTS OF STANDARD CHARACTERS WITHOUT CLAIM TO ANY PARTICULAR FONT, STYLE, SIZE, OR COLOR.

FOR COMPUTER SOFTWARE FOR BUYING AND SELLING ENERGY ON THE GLOBAL COMPUTER NETWORK IN THE ELECTRIC, COAL, GAS, NUCLEAR, AND SOLAR ENERGY INDUSTRIES (U.S. CLS. 21, 23, 26, 36 AND 38).

CAROLINE WOOD, EXAMINING ATTORNEY

SN 78-506,957. BALLY GAMING INTERNATIONAL, INC., LAS VEGAS, NV. FILED 10-27-2004.

SN 78-485,698. BALLY GAMING INTERNATIONAL, INC., LAS VEGAS, NV. FILED 9-17-2004.

# REEL MONEY

# CRAZY MONEY

THE MARK CONSISTS OF STANDARD CHARACTERS WITHOUT CLAIM TO ANY PARTICULAR FONT, STYLE, SIZE, OR COLOR.

FOR GAMING DEVICES, NAMELY SLOT MACHINES, WITH OR WITHOUT VIDEO OUTPUT (U.S. CLS. 21, 23, 26, 36 AND 38).

SUSAN LESLIE DUBOIS, EXAMINING ATTORNEY

THE MARK CONSISTS OF STANDARD CHARACTERS WITHOUT CLAIM TO ANY PARTICULAR FONT, STYLE, SIZE, OR COLOR.

FOR GAMING DEVICES, NAMELY SLOT MACHINES, WITH OR WITHOUT VIDEO OUTPUT (U.S. CLS. 21, 23, 26, 36 AND 38).

SUSAN LESLIE DUBOIS, EXAMINING ATTORNEY

**CLASS 9—(Continued).**

SN 78-520,175. MULTIMEDIA GAMES, INC., AUSTIN, TX.  
FILED 11-19-2004.

Cashino

THE MARK CONSISTS OF STANDARD CHARACTERS WITHOUT CLAIM TO ANY PARTICULAR FONT, STYLE, SIZE, OR COLOR.

FOR GAMING MACHINES, NAMELY ELECTRONIC BINGO MACHINES; SLOT MACHINES; VIDEO LOTTERY TERMINALS (U.S. CLS. 21, 23, 26, 36 AND 38).

CHERYL CLAYTON, EXAMINING ATTORNEY

SN 79-001,512. MEMORY SOLUTION GMBH, FED REP GERMANY, FILED 2-18-2004.

takeMS

OWNER OF INTERNATIONAL REGISTRATION 0788743 DATED 8-29-2002, EXPIRES 8-29-2012.

NO CLAIM IS MADE TO THE EXCLUSIVE RIGHT TO USE "MEMORY SOLUTION", APART FROM THE MARK AS SHOWN.

THE COLOR(S) RED, BLUE IS/ARE CLAIMED AS A FEATURE OF THE MARK.

THE MARK CONSISTS OF THE COLORS RED FOR THE TAKEMS-WORDING AND THE UNDERLINE BLUE ONLY FOR THE SPOT RIGHT FROM THE S.

FOR MEMORY AND MEMORY EXPANSIONS FOR COMPUTERS AND ELECTRONIC DEVICES (U.S. CLS. 21, 23, 26, 36 AND 38).

JOHN DALIER, EXAMINING ATTORNEY

**CLASS 9—(Continued).**

SN 79-002,049. ESSILOR INTERNATIONAL; (COMPAGNIE GENERALE D'OPTIQUE), FRANCE, FILED 2-9-2004.

ELLIPSE

THE MARK CONSISTS OF STANDARD CHARACTERS WITHOUT CLAIM TO ANY PARTICULAR FONT, STYLE, SIZE, OR COLOR.

PRIORITY DATE OF 8-13-2003 IS CLAIMED.

OWNER OF INTERNATIONAL REGISTRATION 0823012 DATED 2-9-2004, EXPIRES 2-9-2014.

FOR OPHTHALMIC LENSES; SPECTACLE LENSES, INCLUDING PLASTICS LENSES, MINERAL LENSES, CORRECTIVE LENSES, PROGRESSIVE LENSES, SUN-GLASS LENSES, POLARIZING LENSES, TINTED LENSES, LIGHT-SENSITIVE LENSES, PHOTOCHROMIC LENSES, TREATED LENSES, COATED LENSES, ANTI-REFLECTIVE LENSES, SEMI-FINISHED LENSES; SPECTACLE LENS BLANKS; SEMI-FINISHED SPECTACLE LENS BLANKS; CASES FOR ALL THE AFORESAID GOODS (U.S. CLS. 21, 23, 26, 36 AND 38).

ELIZABETH PIGNATELLO, EXAMINING ATTORNEY

**CLASS 10—MEDICAL APPARATUS**

SN 76-468,329. BEECH MEDICAL PRODUCTS, INC., NEW PORT RICHEY, FL. FILED 11-20-2002.

SELFSHIELD HN

FOR MEDICAL DEVICES, NAMELY HYPODERMIC SYRINGES (U.S. CLS. 26, 39 AND 44).

CHARLES L. JENKINS, EXAMINING ATTORNEY

SN 76-557,733. COOLTOUCH INCORPORATED, ROSEVILLE, CA. FILED 10-16-2003.

COOLTOUCH<sup>3</sup>  
CT<sup>3</sup>

NO CLAIM IS MADE TO THE EXCLUSIVE RIGHT TO USE COOL TOUCH, APART FROM THE MARK AS SHOWN.

FOR MEDICAL AND DERMATOLOGICAL LASER (U.S. CLS. 26, 39 AND 44).

FIRST USE 3-21-2003; IN COMMERCE 3-21-2003.

GRETTA YAO, EXAMINING ATTORNEY

**CLASS 10—(Continued).**

SN 76-557,734. COOLTOUCH INCORPORATED, ROSEVILLE, CA. FILED 10-16-2003.

# CoolTouch CTIII

NO CLAIM IS MADE TO THE EXCLUSIVE RIGHT TO USE COOL TOUCH, APART FROM THE MARK AS SHOWN.

FOR MEDICAL AND DERMATOLOGICAL LASER (U.S. CLS. 26, 39 AND 44).  
FIRST USE 3-21-2003; IN COMMERCE 3-21-2003.  
GRETTA YAO, EXAMINING ATTORNEY

**CLASS 10—(Continued).**

SN 76-564,706. RUSSELL, MIDGE, NORTH BEACH, MD. FILED 12-11-2003.

# BOOB TUBE

THE MARK CONSISTS OF STANDARD CHARACTERS WITHOUT CLAIM TO ANY PARTICULAR FONT, STYLE, SIZE, OR COLOR.

FOR MEDICAL DEVICES, NAMELY HARD PLASTIC TUBES TO LIFT AND SEPARATE WOMEN'S BREASTS WHILE SLEEPING OR LYING HORIZONTALLY (U.S. CLS. 26, 39 AND 44).

CAROLINE WOOD, EXAMINING ATTORNEY

SN 76-558,866. HU-FRIEDY MFG. CO., INC., CHICAGO, IL. FILED 10-29-2003.

# ENDOEDGE

FOR DENTAL INSTRUMENTS, NAMELY, FILES, PLUGGERS, SPREADERS (U.S. CLS. 26, 39 AND 44).  
GEORGE LORENZO, EXAMINING ATTORNEY

SN 76-565,794. THERMABOOT, STATEN ISLAND, NY. FILED 12-4-2003.



NO CLAIM IS MADE TO THE EXCLUSIVE RIGHT TO USE "HEAT & COLD THERAPY PRODUCTS FOR HOME USE & HEALTHCARE PROFESSIONALS", APART FROM THE MARK AS SHOWN.

FOR HOT AND COLD THERAPY PRODUCTS FOR HOME USE AND HEALTHCARE PROFESSIONALS, NAMELY MEDICAL COLD OR HEATING PADS WITH "BUMPS" FOR USE IN ORTHOPEDIC ARTICLES (U.S. CLS. 26, 39 AND 44).

FIRST USE 11-1-2003; IN COMMERCE 11-1-2003.  
STACY WAHLBERG, EXAMINING ATTORNEY

SN 76-560,889. MATTIOLI ENGINEERING LTD., W2 1HY, GREAT BRITAIN, FILED 11-19-2003.

# ENDERMOPORATION

THE MARK CONSISTS OF STANDARD CHARACTERS WITHOUT CLAIM TO ANY PARTICULAR FONT, STYLE, SIZE, OR COLOR.

FOR APPARATUS FOR CELLULITE REDUCTION USING ELECTROPORATION (U.S. CLS. 26, 39 AND 44).  
ESTHER A. BORSUK, EXAMINING ATTORNEY

SN 76-566,184. WILSON-COOK MEDICAL INC., WINSTON-SALEM, NC. FILED 12-19-2003.

# PETFLEX

THE MARK CONSISTS OF STANDARD CHARACTERS WITHOUT CLAIM TO ANY PARTICULAR FONT, STYLE, SIZE, OR COLOR.

FOR MEDICAL DEVICES, NAMELY, ESOPHAGEAL, PYLORIC, COLONIC, AND BILIARY DILATION BALLOONS (U.S. CLS. 26, 39 AND 44).

MARY ROSSMAN, EXAMINING ATTORNEY

**CLASS 10—(Continued).**

SN 76-570,354. STANDARD TEXTILE CO., INC., CINCINNATI, OH. FILED 1-12-2004.

**WRAPPEL**

THE MARK CONSISTS OF STANDARD CHARACTERS WITHOUT CLAIM TO ANY PARTICULAR FONT, STYLE, SIZE, OR COLOR.

FOR REUSABLE BARRIER FABRIC FOR HOSPITALS FOR USE AS A COMPONENT OF SURGICAL DRAPES AND WRAPPERS (U.S. CLS. 26, 39 AND 44).

FIRST USE 10-24-1988; IN COMMERCE 6-16-1989.

JENNIFER MARTIN, EXAMINING ATTORNEY

---

SN 76-571,103. TP ORTHODONTICS, INC., LAPORTE, IN. FILED 1-21-2004.

**PLUS IQ**

FOR ORTHODONTIC BRACES, NAMELY BRACKETS, TUBES, WIRES AND ELASTOMERICS (U.S. CLS. 26, 39 AND 44).

FIRST USE 1-9-2004; IN COMMERCE 1-9-2004.

JILL C. ALT, EXAMINING ATTORNEY

---

SN 76-574,256. ACRI.TEC GMBH, 16548 GLIENICKE, FED REP GERMANY, FILED 2-6-2004.

**\*AT.Smart**

PRIORITY CLAIMED UNDER SEC. 44(D) ON FED REP GERMANY APPLICATION NO. 30340350.0/1, FILED 8-8-2003, REG. NO. 30340350, DATED 10-28-2003, EXPIRES 8-8-2013.

FOR INTRAOCULAR LENSES (U.S. CLS. 26, 39 AND 44).

VIVIAN MICZNIK FIRST, EXAMINING ATTORNEY

**CLASS 10—(Continued).**

SN 76-575,817. GYRUS GROUP PLC, BERKS RG41 5RA, UNITED KINGDOM, FILED 2-17-2004.

**PK SYSTEM SEAL**

THE MARK CONSISTS OF STANDARD CHARACTERS WITHOUT CLAIM TO ANY PARTICULAR FONT, STYLE, SIZE, OR COLOR.

NO CLAIM IS MADE TO THE EXCLUSIVE RIGHT TO USE "SYSTEM SEAL", APART FROM THE MARK AS SHOWN.

FOR FORCEPS INSTRUMENTS FOR ELECTROSURGICAL SEALING AND DESICCATION OF TISSUE WITH THE ABILITY TO RETRACT AND DISSECT (U.S. CLS. 26, 39 AND 44).

FIRST USE 2-18-2004; IN COMMERCE 2-18-2004.

MARC LEIPZIG, EXAMINING ATTORNEY

---

SN 76-578,866. TOSHIBA MEDICAL SYSTEMS CORPORATION, OTAWARA-SHI, TOCHIGI 324-8550, JAPAN, FILED 3-3-2004.

**FAMIO**

THE MARK CONSISTS OF STANDARD CHARACTERS WITHOUT CLAIM TO ANY PARTICULAR FONT, STYLE, SIZE, OR COLOR.

PRIORITY CLAIMED UNDER SEC. 44(D) ON JAPAN APPLICATION NO. 2003-106030, FILED 11-28-2003, REG. NO. 4770966, DATED 5-14-2004, EXPIRES 5-14-2014.

FOR ULTRA-SONIC DIAGNOSTIC APPARATUS FOR MEDICAL USE (U.S. CLS. 26, 39 AND 44).

KATHERINE STOIDES, EXAMINING ATTORNEY

---

SN 76-586,184. ADVANCED NEUROMODULATION SYSTEMS, INC., PLANO, TX. FILED 4-12-2004.

**STEERX**

FOR MEDICAL DEVICE, NAMELY, A STEERABLE STYLET (U.S. CLS. 26, 39 AND 44).

PRISCILLA MILTON, EXAMINING ATTORNEY

**CLASS 10—(Continued).**

SN 76-587,417. DENTAL DISPOSABLES INTERNATIONAL, INC., MARLBORO, NJ. FILED 4-19-2004.

# ALLRAP

THE MARK CONSISTS OF STANDARD CHARACTERS WITHOUT CLAIM TO ANY PARTICULAR FONT, STYLE, SIZE, OR COLOR.

FOR PLASTIC FILM MATERIALS, NAMELY, ADHESIVE BARRIER FILMS FOR APPLICATION TO TOOLS AND EQUIPMENT, FOR PURPOSES OF INFECTION CONTROL, FOR USE IN DENTAL AND MEDICAL OFFICES, HOSPITALS AND LABORATORIES (U.S. CLS. 26, 39 AND 44).

FIRST USE 11-19-1990; IN COMMERCE 11-19-1990.  
JENNIFER CHICOSKI, EXAMINING ATTORNEY



SN 76-587,495. INCISIVE SURGICAL, INC., PLYMOUTH, MN. FILED 4-19-2004.

## INSORB SUBCUTICULAR SKIN STAPLER

THE MARK CONSISTS OF STANDARD CHARACTERS WITHOUT CLAIM TO ANY PARTICULAR FONT, STYLE, SIZE, OR COLOR.

FOR SURGICAL INSTRUMENTS AND MEDICAL EQUIPMENT, NAMELY, WOUND CLOSURE DEVICES, SURGICAL STAPLES, SURGICAL STAPLER, CLIP APPLIERS AND LIGATING CLIPS FOR MEDICAL USE (U.S. CLS. 26, 39 AND 44).

FIRST USE 3-1-2004; IN COMMERCE 3-1-2004.  
KATHRYN COWARD, EXAMINING ATTORNEY



SN 76-591,855. C. R. BARD, INC., MURRAY HILL, NJ. FILED 5-12-2004.

# ECLIPSE

THE MARK CONSISTS OF STANDARD CHARACTERS WITHOUT CLAIM TO ANY PARTICULAR FONT, STYLE, SIZE, OR COLOR.

FOR MEDICAL PRODUCTS, NAMELY, ANASTOMOTIC DEVICES AND TOOLS FOR USE IN PERIPHERAL VASCULAR BYPASS AND ACCESS PROCEDURES (U.S. CLS. 26, 39 AND 44).

CHERYL CLAYTON, EXAMINING ATTORNEY

**CLASS 10—(Continued).**

SN 76-592,250. MILTEX TECHNOLOGY CORPORATION, WILMINGTON, DE. FILED 5-17-2004.

# GRIPLITE

THE MARK CONSISTS OF STANDARD CHARACTERS WITHOUT CLAIM TO ANY PARTICULAR FONT, STYLE, SIZE, OR COLOR.

FOR DENTAL INSTRUMENTS, NAMELY, CURETTES AND SCALERS (U.S. CLS. 26, 39 AND 44).

DANIEL CAPSHAW, EXAMINING ATTORNEY



SN 76-592,558. CARDIAC PACEMAKERS, INC., ST. PAUL, MN. FILED 5-17-2004.

# SITELINE

THE MARK CONSISTS OF STANDARD CHARACTERS WITHOUT CLAIM TO ANY PARTICULAR FONT, STYLE, SIZE, OR COLOR.

FOR LEADS FOR HEART PACEMAKERS AND DEFIBRILLATORS (U.S. CLS. 26, 39 AND 44).

GIANCARLO CASTRO, EXAMINING ATTORNEY



SN 76-593,136. MICROTEK MEDICAL, INC., COLUMBUS, MS. FILED 5-18-2004.

# ISO-KIT

THE MARK CONSISTS OF STANDARD CHARACTERS WITHOUT CLAIM TO ANY PARTICULAR FONT, STYLE, SIZE, OR COLOR.

FOR PATHOGEN SPILL KITS FEATURING POWDER, GLOVES, SCRAPERS, DISPOSABLE TOWELETTES AND CLOTHS, TOWELS AND BAGS FOR MEDICAL WASTE (U.S. CLS. 26, 39 AND 44).

PAM WILLIS, EXAMINING ATTORNEY

**CLASS 10—(Continued).**

SN 78-229,178. CANNON RUBBER LIMITED, TOTTENHAM, LONDON, UNITED KINGDOM, FILED 3-24-2003.

**MAGIC CUP**

OWNER OF U.S. REG. NO. 2,587,241.  
NO CLAIM IS MADE TO THE EXCLUSIVE RIGHT TO USE CUP, APART FROM THE MARK AS SHOWN.

FOR FEEDING BOTTLES AND TRAINING BOTTLES FOR BABIES, INFANTS AND CHILDREN; FEEDING CUPS AND FEEDING BOTTLES FOR BABIES, INFANTS AND CHILDREN; PARTS AND FITTINGS FOR THE AFORESAID GOODS (U.S. CLS. 26, 39 AND 44).

FIRST USE 3-0-2000; IN COMMERCE 3-0-2000.  
AISHA CLARKE, EXAMINING ATTORNEY

**CLASS 10—(Continued).**

SN 78-332,362. ACTIVATOR METHODS INTERNATIONAL, LTD., PHOENIX, AZ. FILED 11-24-2003.

**ELECTRONIC-  
ACTIVATOR**

SN 78-236,529. SPRINGBOARD ORTHOPAEDICS LLC, MT. STERLING, KY. FILED 4-11-2003.

**SPRINGBOARD  
ORTHOPAEDICS**

NO CLAIM IS MADE TO THE EXCLUSIVE RIGHT TO USE "ORTHOPAEDICS", APART FROM THE MARK AS SHOWN.

FOR ORTHOPAEDIC REHABILITATION EQUIPMENT, NAMELY, TRAINING DEVICES MADE OF POLYETHYLENE FOAM GENERALLY OF A HEMI-ELLIPSOIDAL SHAPE USED FOR EXERCISE AND TO IMPROVE NEUROMUSCULAR STABILIZATION, PROPRIOCEPTION, BALANCE, RANGE OF MOTION AND STRENGTH (U.S. CLS. 26, 39 AND 44).

FIRST USE 10-25-2002; IN COMMERCE 10-25-2002.  
MICHELE SWAIN, EXAMINING ATTORNEY

SN 78-303,283. LACEY, DWAYNE D, PERTH, W.A., AUSTRALIA, FILED 9-22-2003.

**TREMBLER**

FOR MASSAGING EQUIPMENT, NAMELY, MANUAL AND POWER OPERATED MASSAGING APPARATUS PROVIDED WITH A PLURALITY OF MASSAGING FINGERS AND MASSAGE HEADS, AND HEAD AND BODY MASSAGING APPARATUS (U.S. CLS. 26, 39 AND 44).

INGRID C. EULIN, EXAMINING ATTORNEY

SN 78-307,564. NOVALUNG GMBH, HECHINGEN, FED REP GERMANY, FILED 9-30-2003.

**ILUNG**

FOR MEDICAL APPARATUS AND INSTRUMENTS FOR SUPPORTING LUNG FUNCTION OF A HUMAN BEING, NAMELY ARTIFICIAL LUNGS; DEVICES FOR MEASURING BLOOD FLOW, NAMELY BLOOD FLOW METERS; DILATORS, NAMELY BRONCHIAL DILATORS; TUBES, FILTERS, MEMBRANES, CLAMPS, NEEDLES, CANULAS AND CLOSURES FOR THE AFOREMENTIONED GOODS; SCALPELS (U.S. CLS. 26, 39 AND 44).

TRICIA THOMPSON, EXAMINING ATTORNEY

THE MARK CONSISTS OF STANDARD CHARACTERS WITHOUT CLAIM TO ANY PARTICULAR FONT, STYLE, SIZE, OR COLOR.

OWNER OF U.S. REG. NOS. 1,124,263, 2,559,540 AND OTHERS.

FOR CHIROPRACTIC ADJUSTING INSTRUMENT, NAMELY, AN ELECTRONICALLY OPERATED APPARATUS FOR CHIROPRACTIC ADJUSTMENT OF THE SPINE. (U.S. CLS. 26, 39 AND 44).

APRIL L. RADEMACHER, EXAMINING ATTORNEY



**CLASS 10—(Continued).**

SN 78-333,549. LUCITE INTERNATIONAL, INC., CORDOVA, TN. FILED 11-26-2003.

**CLASS 10—(Continued).**

SN 78-346,538. URO CONCEPTS INC., MALIBU, CA. FILED 12-30-2003.

# Better Pant

# LUCITE

THE MARK CONSISTS OF STANDARD CHARACTERS WITHOUT CLAIM TO ANY PARTICULAR FONT, STYLE, SIZE, OR COLOR.

FOR REUSABLE UNDERWEAR TO BE USED WITH URINARY COLLECTION SYSTEMS (U.S. CLS. 26, 39 AND 44).

BRIAN NEVILLE, EXAMINING ATTORNEY

SN 78-353,113. ANSELL HEALTHCARE PRODUCTS, LLC, DBA ANSELL HEALTHCARE, RED BANK, NJ. FILED 1-16-2004.

THE MARK CONSISTS OF STANDARD CHARACTERS WITHOUT CLAIM TO ANY PARTICULAR FONT, STYLE, SIZE, OR COLOR.

OWNER OF U.S. REG. NOS. 350,093, 1,936,713 AND OTHERS.

FOR CERVICAL, MEDICAL, DENTAL AND VETERINARY INSTRUMENTS AND APPARATUS; NAMELY, ORTHODONTIC AND DENTAL APPARATUS, NAMELY, ORTHODONTIC APPLIANCES, BRACES FOR TEETH, DENTAL ARTICULATORS, DENTAL BITE TRAYS, DENTAL BRIDGES, DENTAL BURRS, DENTAL CAPS, DENTAL CROWNS, DENTAL DAMS, DENTAL CLIPS FOR SECURING PRE-EXISTING DENTURES, DENTAL IMPLANTS, DENTAL IMPRESSION TRAYS, DENTAL INLAYS AND DENTAL ONLAYS; DENTAL PROSTHETIC IMPLANTS AND ARTIFICIAL JAWS; ARTIFICIAL AND ORTHOPADIC MEDICAL COMPONENTS AND APPLIANCES, NAMELY, ORTHOPEDIC BELTS, ORTHOPEDIC BRACES, ORTHOPEDIC FOOTWEAR, ORTHOPEDIC JOINT IMPLANTS, ORTHOPEDIC SOLES, ORTHOPEDIC SUPPORT BANDAGES, ORTHOPEDIC SUPPORTS, ORTHOPEDIC SPLINTS; DENTURES, ARTIFICIAL TEETH, ARTIFICIAL EYES AND ARTIFICIAL LIMBS; SUTURE MATERIALS; BONE IMPLANTS COMPOSED OF ARTIFICIAL MATERIALS AND CRANIAL REPAIR PREPARATIONS MADE WHOLLY OR PRINCIPALLY OF POLYMERS; MODELING AND MOLDING MATERIALS FOR SURGICAL, MEDICAL, DENTAL AND VETERINARY PURPOSES, NAMELY, FILLER MATERIAL MADE WHOLLY OR PRINCIPALLY OF POLYMERS FOR FILLING VOIDS IN IMPRESSION MOLDS AND AMALGAMS (U.S. CLS. 26, 39 AND 44).

JIM RINGLE, EXAMINING ATTORNEY



NO CLAIM IS MADE TO THE EXCLUSIVE RIGHT TO USE "RELIABILITY COMFORT SENSITIVITY", APART FROM THE MARK AS SHOWN.

FOR CONDOMS (U.S. CLS. 26, 39 AND 44).

FIRST USE 8-25-2003; IN COMMERCE 8-25-2003.

ANN E. SAPPENFIELD, EXAMINING ATTORNEY

**CLASS 10—(Continued).**

SN 78-374,570. JOHNSON & JOHNSON, NEW BRUNSWICK, NJ. FILED 2-26-2004.

**CLASS 10—(Continued).**

SN 78-388,119. TANG, BRIAN, MOUNTAIN VIEW, CA. FILED 3-21-2004.

# BIOINTRAFIX

# EZ Stent

THE MARK CONSISTS OF STANDARD CHARACTERS WITHOUT CLAIM TO ANY PARTICULAR FONT, STYLE, SIZE, OR COLOR.

FOR BONE SCREWS AND SURGICAL INSTRUMENTS USED IN KNEE IMPLANT AND KNEE RECONSTRUCTION SURGERY (U.S. CLS. 26, 39 AND 44).

GRETTA YAO, EXAMINING ATTORNEY

THE MARK CONSISTS OF STANDARD CHARACTERS WITHOUT CLAIM TO ANY PARTICULAR FONT, STYLE, SIZE, OR COLOR.

FOR SURGICAL TEMPLATE FOR DENTAL IMPLANTS (U.S. CLS. 26, 39 AND 44).

FIRST USE 3-18-2004; IN COMMERCE 3-18-2004.

STANLEY I. OSBORNE, EXAMINING ATTORNEY

SN 78-381,876. AMS RESEARCH CORPORATION, MINNETONKA, MN. FILED 3-10-2004.

SN 78-389,050. ALLEGIANCE CORPORATION, MCGAW PARK, IL. FILED 3-23-2004.

# APOGEE

# MISTY FINITY

THE MARK CONSISTS OF STANDARD CHARACTERS WITHOUT CLAIM TO ANY PARTICULAR FONT, STYLE, SIZE, OR COLOR.

FOR MEDICAL DEVICES, NAMELY, A SLING SYSTEM FOR UROLOGICAL AND GYNECOLOGICAL USE CONSISTING OF AN IMPLANTABLE SLING, SLING CONNECTORS, AND INSERTION DEVICES (U.S. CLS. 26, 39 AND 44).

GRETTA YAO, EXAMINING ATTORNEY

THE MARK CONSISTS OF STANDARD CHARACTERS WITHOUT CLAIM TO ANY PARTICULAR FONT, STYLE, SIZE, OR COLOR.

FOR CONTINUOUS STREAM NEBULIZER (U.S. CLS. 26, 39 AND 44).

JENNIFER KRISP, EXAMINING ATTORNEY

**CLASS 10—(Continued).**

**CLASS 10—(Continued).**

SN 78-391,186. WALLACH SURGICAL DEVICES, INC.,  
ORANGE, CT. FILED 3-26-2004.

SN 78-395,180. BREG, INC., VISTA, CA. FILED 4-1-2004.

**PAPETTE**

**T SCOPE**

THE MARK CONSISTS OF STANDARD CHARACTERS  
WITHOUT CLAIM TO ANY PARTICULAR FONT, STYLE,  
SIZE, OR COLOR.

FOR CERVICAL CELL COLLECTORS FOR MEDICAL  
USE (U.S. CLS. 26, 39 AND 44).

FIRST USE 4-0-1991; IN COMMERCE 4-0-1991.  
STACY WAHLBERG, EXAMINING ATTORNEY

THE MARK CONSISTS OF STANDARD CHARACTERS  
WITHOUT CLAIM TO ANY PARTICULAR FONT, STYLE,  
SIZE, OR COLOR.

FOR ORTHOPEDIC KNEE BRACE (U.S. CLS. 26, 39  
AND 44).  
ESTHER A. BORSUK, EXAMINING ATTORNEY

---

SN 78-394,686. ARTHREX, INC., NAPLES, FL. FILED 4-1-  
2004.

---

SN 78-397,107. ASHTON INDUSTRIES, INC., BOXFORD,  
MA. FILED 4-6-2004.

**BIRDBEAK**

**ARCHANGELS**

THE MARK CONSISTS OF STANDARD CHARACTERS  
WITHOUT CLAIM TO ANY PARTICULAR FONT, STYLE,  
SIZE, OR COLOR.

FOR MEDICAL APPARATUS AND SURGICAL INSTRUMENTS,  
NAMESLY ARTHROSCOPIC SUTURE PASSES (U.S. CLS. 26, 39  
AND 44).

FIRST USE 4-0-1999; IN COMMERCE 4-0-1999.  
ANDREA SAUNDERS, EXAMINING ATTORNEY

THE MARK CONSISTS OF STANDARD CHARACTERS  
WITHOUT CLAIM TO ANY PARTICULAR FONT, STYLE,  
SIZE, OR COLOR.

FOR ORTHOTIC INSERTS FOR FOOTWEAR (U.S.  
CLS. 26, 39 AND 44).

TONJA GASKINS, EXAMINING ATTORNEY

**CLASS 10—(Continued).**

SN 78-400,357. EBI, L.P., PARSIPPANY, NJ. FILED 4-12-2004.

**ARRAY**

THE MARK CONSISTS OF STANDARD CHARACTERS WITHOUT CLAIM TO ANY PARTICULAR FONT, STYLE, SIZE, OR COLOR.

FOR PEDICLE SCREWS AND INTERNAL FIXATION DEVICES, NAMELY, SPINAL INSTRUMENTATION CONSISTING OF RODS, SCREWS, SET SCREWS AND HOOKS (U.S. CLS. 26, 39 AND 44).

FIRST USE 2-5-2004; IN COMMERCE 2-5-2004.

GEOFFREY FOSDICK, EXAMINING ATTORNEY

---

SN 78-400,444. EMPI CORP., ST. PAUL, MN. FILED 4-12-2004.

**INFINITY**

THE MARK CONSISTS OF STANDARD CHARACTERS WITHOUT CLAIM TO ANY PARTICULAR FONT, STYLE, SIZE, OR COLOR.

FOR TRANSCUTANEOUS ELECTRONIC NERVE STIMULATORS AND MUSCLE STIMULATORS FOR USE IN PHYSICAL REHABILITATION THERAPY AND PAIN MANAGEMENT (U.S. CLS. 26, 39 AND 44).

KARLA PERKINS, EXAMINING ATTORNEY

**CLASS 10—(Continued).**

SN 78-404,976. J. MORITA MFG. CORP., KYOTO, JAPAN, FILED 4-20-2004.

**PENCURE**

THE MARK CONSISTS OF STANDARD CHARACTERS WITHOUT CLAIM TO ANY PARTICULAR FONT, STYLE, SIZE, OR COLOR.

FOR DENTAL CURING LIGHTS FOR HARDENING PHOTO-INDUCED RESIN; CORDLESS DENTAL CURING LIGHTS FOR HARDENING PHOTO-INDUCED RESIN; RECHARGERS FOR DENTAL CURING LIGHTS; DISPOSABLE COVERS FOR LIGHT GUIDES OF DENTAL CURING LIGHTS FOR AVOIDING INFECTION (U.S. CLS. 26, 39 AND 44).

ROBERT COGGINS, EXAMINING ATTORNEY

---

SN 78-419,013. ORTHEON MEDICAL, WINTER PARK, FL. FILED 5-14-2004.

**ACP**

THE MARK CONSISTS OF STANDARD CHARACTERS WITHOUT CLAIM TO ANY PARTICULAR FONT, STYLE, SIZE, OR COLOR.

FOR SURGICAL INSTRUMENT FOR USE IN ARTHROSCOPIC PROCEDURES (U.S. CLS. 26, 39 AND 44).

BARBARA BROWN, EXAMINING ATTORNEY

**CLASS 10—(Continued).**

SN 78-419,091. HENKE-SASS, WOLF GMBH, TUTTLINGEN, FED REP GERMANY, FILED 5-14-2004.

**CLASS 10—(Continued).**

SN 78-421,176. PROFESSIONAL ABSORBENT DEVICE SYSTEMS INC., WAYNE, NJ. FILED 5-18-2004.

# Tongue'N Cheek

# FINE-JECT

THE MARK CONSISTS OF STANDARD CHARACTERS WITHOUT CLAIM TO ANY PARTICULAR FONT, STYLE, SIZE, OR COLOR.

FOR SALIVA ABSORBER FOR DENTISTS (U.S. CLS. 26, 39 AND 44).

CAROLYN GRAY, EXAMINING ATTORNEY

THE MARK CONSISTS OF STANDARD CHARACTERS WITHOUT CLAIM TO ANY PARTICULAR FONT, STYLE, SIZE, OR COLOR.

FOR NEEDLES FOR VETERINARY SYRINGES (U.S. CLS. 26, 39 AND 44).

FIRST USE 10-27-2003; IN COMMERCE 10-27-2003.  
STANLEY I. OSBORNE, EXAMINING ATTORNEY

SN 79-000,911. MAQUET CRITICAL CARE AB, SWEDEN, FILED 11-24-2003.

# Servos

SN 78-420,493. SUNHEALTH SOLUTIONS, LLC, NAPLES, FL. FILED 5-18-2004.

PRIORITY DATE OF 6-4-2003 IS CLAIMED.  
OWNER OF INTERNATIONAL REGISTRATION 0818655 DATED 11-24-2003, EXPIRES 11-24-2013.

FOR ELECTROMEDICAL, MEDICAL AND SURGICAL DEVICES, NAMELY, RESPIRATORS (U.S. CLS. 26, 39 AND 44).

KAREN BRACEY, EXAMINING ATTORNEY

# SunSignals

## CLASS 11—ENVIRONMENTAL CONTROL APPARATUS

SN 76-388,580. L2B ENVIRONMENTAL SYSTEMS INC., BARRIE, ONTARIO, CANADA, FILED 3-29-2002.

# ALL AIR

THE MARK CONSISTS OF STANDARD CHARACTERS WITHOUT CLAIM TO ANY PARTICULAR FONT, STYLE, SIZE, OR COLOR.

FOR PHOTOCROMIC PATCHES WHICH ARE APPLIED TO AN INDIVIDUAL'S SKIN FOR SENSING AND PROVIDING AN EARLY WARNING THAT SUNSCREEN LOTION HAS WORN OFF OR LOST ITS EFFECTIVENESS AND SHOULD BE REAPPLIED (U.S. CLS. 26, 39 AND 44).

FIRST USE 7-9-2004; IN COMMERCE 7-9-2004.  
JAMES A. RAUEN, EXAMINING ATTORNEY

PRIORITY CLAIMED UNDER SEC. 44(D) ON CANADA APPLICATION NO. 1118142, FILED 10-11-2001, REG. NO. TMA621,936, DATED 10-6-2004, EXPIRES 10-6-2019.

FOR AIR PURIFYING UNITS FOR DOMESTIC, COMMERCIAL, INSTITUTIONAL AND INDUSTRIAL USE (U.S. CLS. 13, 21, 23, 31 AND 34).

TRICIA THOMPSON, EXAMINING ATTORNEY

**CLASS 11—(Continued).**

SN 76-467,053. ENVIRONMENTAL LIGHTING CONCEPTS, INC., TAMPA, FL. FILED 11-14-2002.

**CLASS 11—(Continued).**

SN 76-547,892. PLANTEC INC., NISHI-KU, OSAKA-SHI, OSAKA, 550-0003, JAPAN, FILED 9-29-2003.

**SOFTWARE FOR YOUR EYES**

FOR FLUORESCENT LIGHTING FIXTURES AND LIGHT BULBS (U.S. CLS. 13, 21, 23, 31 AND 34).  
FIRST USE 7-17-2002; IN COMMERCE 7-17-2002.  
WILLIAM VERHOSEK, EXAMINING ATTORNEY



---

SN 76-504,066. RG DELAWARE, INC., WILMINGTON, DE. FILED 4-3-2003.

**PWI**

OWNER OF JAPAN REG. NO. 2680892, DATED 6-29-1994, EXPIRES 6-29-2014.

FOR INDUSTRIAL FURNACES, FURNACE BOILERS, WASTE HEAT BOILERS, REFUSE INCINERATORS FOR INDUSTRIAL PURPOSES, PRE-COATED BAG FILTERS USED FOR INCINERATORS, HEAT EXCHANGERS, SEWAGE TREATMENT UNIT, ASH TREATMENT UNIT USED FOR INCINERATORS (U.S. CLS. 13, 21, 23, 31 AND 34).

ALICIA COLLINS, EXAMINING ATTORNEY

---

FOR FILTER UNDERDRAINS AND REPLACEMENT PARTS (U.S. CLS. 13, 21, 23, 31 AND 34).  
FIRST USE 12-1-2002; IN COMMERCE 12-1-2002.  
TARAH HARDY, EXAMINING ATTORNEY

---

SN 76-556,486. TOTO U.S.A., INC., MORROW, GA. FILED 11-4-2003.

**TOTO'S ECOPOWER FLUSH VALVES**

---

SN 76-530,054. PENTAIR PUMP GROUP, INC., DBA FAIRBANKS MORSE PUMP, GOLDEN VALLEY, MN. FILED 6-24-2003.

**TURBO-FREE**

NO CLAIM IS MADE TO THE EXCLUSIVE RIGHT TO USE "FLUSH VALVES", APART FROM THE MARK AS SHOWN.

FOR PLUMBING FITTINGS, NAMELY, FLUSH VALVES FOR TOILETS (U.S. CLS. 13, 21, 23, 31 AND 34).  
KATHERINE STOIDES, EXAMINING ATTORNEY

FOR EQUIPMENT, NAMELY, CONDUITS, PIPING, INLETS AND ELBOW INLETS FOR USE IN INDUSTRIAL, MUNICIPAL AND COMMERCIAL WASTE WATER AND WATER TREATMENT SYSTEMS (U.S. CLS. 13, 21, 23, 31 AND 34).  
VIVIAN MICZNIK FIRST, EXAMINING ATTORNEY

---

SN 76-556,487. TOTO U.S.A., INC., MORROW, GA. FILED 11-4-2003.

**ECOPOWER FLUSH VALVES BY TOTO**

---

SN 76-532,939. GREAT IDEAS, INC., HIGHLAND PARK, IL. FILED 7-28-2003.

**COMFORTSEAT**

NO CLAIM IS MADE TO THE EXCLUSIVE RIGHT TO USE "FLUSH VALVES", APART FROM THE MARK AS SHOWN.

FOR PLUMBING FIXTURES, NAMELY, FLUSH VALVES FOR TOILETS (U.S. CLS. 13, 21, 23, 31 AND 34).  
SHARI SHEFFIELD, EXAMINING ATTORNEY

FOR BIDETS (U.S. CLS. 13, 21, 23, 31 AND 34).  
FIRST USE 1-1-2002; IN COMMERCE 1-1-2002.  
RUSS HERMAN, EXAMINING ATTORNEY

**CLASS 11—(Continued).**

SN 76-559,109. ADVANCED MODERN TECHNOLOGIES CORPORATION, LOS ANGELES, CA. FILED 11-10-2003.

# DUALFLUSH

THE MARK CONSISTS OF STANDARD CHARACTERS WITHOUT CLAIM TO ANY PARTICULAR FONT, STYLE, SIZE, OR COLOR.

FOR APPARATUS FOR WATER SUPPLY AND SANITARY PURPOSES; NAMELY, AUTOMATIC FAUCETS, AUTOMATIC FLUSH VALVES, AUTOMATIC FLUSH VALVES WITH DIGITAL DISPLAY, AUTOMATIC HAND DRYERS (U.S. CLS. 13, 21, 23, 31 AND 34).

FIRST USE 11-5-2003; IN COMMERCE 11-5-2003.  
DOMINIC J. FERRAIUOLO, EXAMINING ATTORNEY

**CLASS 11—(Continued).**

SN 76-570,473. BURNHAM SERVICES, INC., WILMINGTON, DE. FILED 1-16-2004.

# SERIES 2

THE MARK CONSISTS OF STANDARD CHARACTERS WITHOUT CLAIM TO ANY PARTICULAR FONT, STYLE, SIZE, OR COLOR.

FOR GAS-FIRED CAST IRON HOT WATER BOILERS FOR RESIDENTIAL AND COMMERCIAL USE (U.S. CLS. 13, 21, 23, 31 AND 34).

FIRST USE 6-30-1981; IN COMMERCE 6-30-1981.  
CHERYL CLAYTON, EXAMINING ATTORNEY

SN 76-579,856. DESA IP, LLC, MIAMI, FL. FILED 3-8-2004.

SN 76-564,344. NEW ERA LIFESTYLE SYSTEMS, LLC, LEESBURG, VA. FILED 12-9-2003.

**so hot it's cool** 

FOR HEAT PUMPS FOR RESIDENTIAL AND COMMERCIAL MOBILE AND STATIONARY MARKETS (U.S. CLS. 13, 21, 23, 31 AND 34).

FIRST USE 11-10-2003; IN COMMERCE 11-10-2003.  
VIVIAN MICZNIK FIRST, EXAMINING ATTORNEY



OWNER OF U.S. REG. NO. 2,098,785.  
FOR ELECTRIC LIGHTING FIXTURES (U.S. CLS. 13, 21, 23, 31 AND 34).

FIRST USE 0-0-1996; IN COMMERCE 0-0-1996.  
TRACY FLETCHER, EXAMINING ATTORNEY

SN 76-586,297. LIGHTSTREAM TECHNOLOGIES, INC., RESTON, VA. FILED 4-12-2004.

SN 76-568,958. WDI INTERNATIONAL, INC., IRVINE, CA. FILED 1-8-2004.

**WHERE QUALITY AND COMFORT MEET**

# AOT

THE MARK CONSISTS OF STANDARD CHARACTERS WITHOUT CLAIM TO ANY PARTICULAR FONT, STYLE, SIZE, OR COLOR.

FOR TOILETS AND PLUMBING FIXTURES, NAMELY, CONTROL VALVES, HANDLES, FAUCETS, STOP COCKS, FLOATS, TRAPS, SPRAYERS, STRAINERS, SPOUTS, STRAINERS, FILTERS, COUPLERS AND BIBBS (U.S. CLS. 13, 21, 23, 31 AND 34).

MIDGE BUTLER, EXAMINING ATTORNEY

THE MARK CONSISTS OF STANDARD CHARACTERS WITHOUT CLAIM TO ANY PARTICULAR FONT, STYLE, SIZE, OR COLOR.

FOR MACHINE FOR PHOTO-DISSOCIATION, INCLUDING DISINFECTION OR STERILIZATION, OF WATER, AIR AND OTHER LIQUID AND GASEOUS FLUIDS (U.S. CLS. 13, 21, 23, 31 AND 34).

GEORGE LORENZO, EXAMINING ATTORNEY

**CLASS 11—(Continued).**

SN 76-589,046. AMERICAN SUPERLITE INC., BURBANK, CA. FILED 4-26-2004.

**WHITE DRAGON**

THE MARK CONSISTS OF STANDARD CHARACTERS WITHOUT CLAIM TO ANY PARTICULAR FONT, STYLE, SIZE, OR COLOR.

FOR LAMPS, LIGHT EMITTING DIODES, VEHICLE HEAD LIGHTS, VEHICLE TAIL LIGHTS, AND RUNNING LIGHTS FOR AUTOMOBILES, TRUCKS AND TRAILERS, ELECTRIC LIGHTING FIXTURES (U.S. CLS. 13, 21, 23, 31 AND 34).

SKYE YOUNG, EXAMINING ATTORNEY

SN 76-590,162. CLEVELAND PROCESS CORPORATION, HOMESTEAD, FL. FILED 5-3-2004.

**BUOY BOY**

THE MARK CONSISTS OF STANDARD CHARACTERS WITHOUT CLAIM TO ANY PARTICULAR FONT, STYLE, SIZE, OR COLOR.

FOR ELECTRICAL HEATERS; NAMELY, IMMERSION AND SUBMERSIBLE HEATERS AND CONTROLS THEREFOR (U.S. CLS. 13, 21, 23, 31 AND 34).

FIRST USE 3-1-2004; IN COMMERCE 3-1-2004.  
RICHARD WHITE, EXAMINING ATTORNEY

SN 76-592,526. MINKA LIGHTING, INC., CORONA, CA. FILED 5-17-2004.

**BELIZE**

THE MARK CONSISTS OF STANDARD CHARACTERS WITHOUT CLAIM TO ANY PARTICULAR FONT, STYLE, SIZE, OR COLOR.

FOR CEILING FANS AND LIGHTING FIXTURES (U.S. CLS. 13, 21, 23, 31 AND 34).

H. M. FISHER, EXAMINING ATTORNEY

**CLASS 11—(Continued).**

SN 76-593,145. AFC-HOLCROFT, L.L.C., WIXOM, MI. FILED 5-18-2004.

**PYRO-KLEEN**

THE MARK CONSISTS OF STANDARD CHARACTERS WITHOUT CLAIM TO ANY PARTICULAR FONT, STYLE, SIZE, OR COLOR.

OWNER OF U.S. REG. NO. 1,852,334.  
FOR INDUSTRIAL FURNACES (U.S. CLS. 13, 21, 23, 31 AND 34).

CAROLYN GRAY, EXAMINING ATTORNEY

SN 78-239,952. HP INTELLECTUAL CORP., WILMINGTON, DE. FILED 4-21-2003.

**INFRAWAVE**

FOR ELECTRIC TOASTERS AND TOASTER OVENS FOR DOMESTIC USE (U.S. CLS. 13, 21, 23, 31 AND 34).

LAURA KOVAISKY, EXAMINING ATTORNEY

SN 78-251,456. VILLEROY & BOCH AG, METTLACH, FED REP GERMANY, FILED 5-19-2003.

**SUBWAY**

PRIORITY CLAIMED UNDER SEC. 44(D) ON FED REP GERMANY APPLICATION NO. 30256743721, FILED 11-19-2002, REG. NO. 30256743, DATED 5-23-2003, EXPIRES 11-30-2012.

FOR LAMPS, ELECTRIC WALL LIGHT FIXTURES AND ELECTRIC LIGHT APPLIANCES, NAMELY, TRACK LIGHTING UNITS, FLUORESCENT LIGHTING TUBES, SCONCES AND SOCKETS; SANITARY EQUIPMENT ITEMS, NAMELY, WHIRLPOOL TUBS AND STEAM POOLS, LAVATORIES, TOILET TANKS, TOILET SEATS, COVERS FOR URINALS, BIDETS AND URINALS; BATHROOM FITTINGS FOR CONNECTION, MIXING AND DISTRIBUTION OF WATER, NAMELY, BIBBS, COCKS, TRAPS AND VALVES; PLUMBING SUPPLIES, NAMELY, COUPLINGS, TAPS, VALVES, TRAPS, BIBBS, COCKS AND CONTROL FITTINGS, NAMELY, AERATORS, REDUCERS, DIVERTERS, VALVES, TRAPS, COCKS AND BIBBS; SHOWERS AND SHOWER TUBS FOR BATHROOM AND PUBLIC BATHS AND FEET FOR BATHTUBS IN METAL AND ACRYLIC; FITTINGS FOR WASHBASINS AND SINKS AS WELL AS BATHTUBS AND SHOWERS, NAMELY, COUPLINGS, FAUCETS, TAPS, SHOWER VALVES AND HEADS AND TUB FILLERS; MANUALLY AND AUTOMATICALLY CONTROLLABLE VALVES AND MIXING VALVES FOR SANITARY WATER SUPPLY; STRUCTURAL AND REPLACEMENT PARTS AND COMPONENTS FOR THE AFOREMENTIONED GOODS (U.S. CLS. 13, 21, 23, 31 AND 34).

WILLIAM BRECKENFELD, EXAMINING ATTORNEY



**CLASS 11—(Continued).**

SN 78-256,505. INTERBATH, INC., CITY OF INDUSTRY, CA. FILED 5-30-2003.

**CLASS 11—(Continued).**

SN 78-343,513. EVEREADY BATTERY COMPANY, INC., ST. LOUIS, MO. FILED 12-19-2003.

**DISCOVER**

FOR PLUMBING FIXTURES AND FITTINGS, NAMELY, SHOWERHEADS, HAND SHOWERS, SHOWER HEAD HOLDERS, FAUCETS, AND PRE-PACKAGED SHOWER SYSTEMS, SOLD AS A UNIT (U.S. CLS. 13, 21, 23, 31 AND 34).  
FIRST USE 5-22-2003; IN COMMERCE 6-1-2003.  
INGA ERVIN, EXAMINING ATTORNEY

**ENERGIZER HARD  
CASE LED**

SN 78-292,320. RGF O3 SYSTEMS, INC., WEST PALM BEACH, FL. FILED 8-26-2003.

***Photohydroionization***

FOR WATER, FOOD AND AIR TREATMENT EQUIPMENT, NAMELY STERILIZATION UNITS AND COMPONENTS THEREFORE (U.S. CLS. 13, 21, 23, 31 AND 34).  
STEVEN R. FINE, EXAMINING ATTORNEY

THE MARK CONSISTS OF STANDARD CHARACTERS WITHOUT CLAIM TO ANY PARTICULAR FONT, STYLE, SIZE, OR COLOR.  
OWNER OF U.S. REG. NOS. 1,177,083, 2,670,053 AND OTHERS.  
NO CLAIM IS MADE TO THE EXCLUSIVE RIGHT TO USE "HARD CASE LED", APART FROM THE MARK AS SHOWN.  
FOR FLASHLIGHTS (U.S. CLS. 13, 21, 23, 31 AND 34).  
LINDA MICKLEBURGH, EXAMINING ATTORNEY

SN 78-313,824. IMI CORNELIUS INC., ANOKA, MN. FILED 10-15-2003.

**FLAVORFUSION**

FOR REFRIGERATED BEVERAGE DISPENSING UNITS (U.S. CLS. 13, 21, 23, 31 AND 34).  
FLORENTINA BLANDU, EXAMINING ATTORNEY

SN 78-383,031. KEN-CO INDUSTRIES, INC., ORLANDO, FL. FILED 3-12-2004.

SN 78-338,279. DYNAMIC COOKING SYSTEMS, INC., HUNTINGTON BEACH, CA. FILED 12-9-2003.

**SWINGBURNER.COM**



OWNER OF U.S. REG. NO. 2,470,241.  
FOR RESIDENTIAL GAS AND/OR ELECTRIC RANGES, BARBECUE GRILLE, COMMERCIAL COOKING EQUIPMENT, NAMELY, GAS AND/OR ELECTRIC RANGES, OVENS, COOKTOPS, BROILERS, FRYERS AND FOOD WARMING STATIONS, GAS PATIO HEATERS (U.S. CLS. 13, 21, 23, 31 AND 34).  
FIRST USE 1-15-1989; IN COMMERCE 1-15-1989.  
RENEE MCCRAY, EXAMINING ATTORNEY

THE MARK CONSISTS OF STANDARD CHARACTERS WITHOUT CLAIM TO ANY PARTICULAR FONT, STYLE, SIZE, OR COLOR.  
FOR OUTDOOR EXTENDABLE ARM FOR SUPPORTING A COOKING BURNER FOR SKILLETS, POTS AND COFFEEPOTS TO GUNWALES AND HANDRAILS ON BOATS AND BALCONIES, AND TO BUMPERS AND TAILGATES FOR AUTOMOBILES AND TRUCKS, AND TO TOOL CHESTS (U.S. CLS. 13, 21, 23, 31 AND 34).  
FIRST USE 3-10-2004; IN COMMERCE 3-12-2004.  
ANNE MADDEN, EXAMINING ATTORNEY

**CLASS 11—(Continued).**

SN 78-389,267. ON SITE SANITATION, INC., ST. PAUL, MN. FILED 3-23-2004.

SANISINK

THE MARK CONSISTS OF STANDARD CHARACTERS WITHOUT CLAIM TO ANY PARTICULAR FONT, STYLE, SIZE, OR COLOR.

FOR PORTABLE DRINKING WATER SUPPLY NAMELY, CABINET, WATER HEATER, PUMP, POTABLE WATER SOURCE, FAUCET AND SINK, ELECTRICAL POWER CONTROL UNIT AND PARTS THEREFORE (U.S. CLS. 13, 21, 23, 31 AND 34).

FIRST USE 4-30-2003; IN COMMERCE 4-30-2003.  
CAROLYN GRAY, EXAMINING ATTORNEY

SN 78-392,682. MEGTEC SYSTEMS, INC., DEPERE, WI. FILED 3-29-2004.

MODULAIR

THE MARK CONSISTS OF STANDARD CHARACTERS WITHOUT CLAIM TO ANY PARTICULAR FONT, STYLE, SIZE, OR COLOR.

FOR WEB DRYING, CONDITIONING, AND CURING MACHINES ALL FOR USE IN THE WEB PROCESSING INDUSTRY (U.S. CLS. 13, 21, 23, 31 AND 34).

ERNEST SHOSHO, EXAMINING ATTORNEY

**CLASS 11—(Continued).**

SN 78-416,017. MESTEK, INC., WESTFIELD, MA. FILED 5-10-2004.



NO CLAIM IS MADE TO THE EXCLUSIVE RIGHT TO USE "STANDARD FIN", APART FROM THE MARK AS SHOWN.

FOR BASEBOARD HYDRONIC HEATING UNITS (U.S. CLS. 13, 21, 23, 31 AND 34).

ERNEST SHOSHO, EXAMINING ATTORNEY

SN 78-421,530. ACUIITY BRANDS, INC., ATLANTA, GA. FILED 5-19-2004.

PARALLELS

THE MARK CONSISTS OF STANDARD CHARACTERS WITHOUT CLAIM TO ANY PARTICULAR FONT, STYLE, SIZE, OR COLOR.

FOR ELECTRIC LIGHTING FIXTURES (U.S. CLS. 13, 21, 23, 31 AND 34).

CAROLYN GRAY, EXAMINING ATTORNEY

SN 78-421,551. ILIGHT TECHNOLOGIES, INC., EVANSTON, IL. FILED 5-19-2004.

PLEXINEON

THE MARK CONSISTS OF STANDARD CHARACTERS WITHOUT CLAIM TO ANY PARTICULAR FONT, STYLE, SIZE, OR COLOR.

OWNER OF U.S. REG. NO. 2,648,918.

FOR ELECTRIC LIGHTING FIXTURES AND LIGHTING STRIPS UTILIZING WAVEGUIDES AND HIGH INTENSITY LIGHT EMITTING DIODES (U.S. CLS. 13, 21, 23, 31 AND 34).

FIRST USE 7-31-2001; IN COMMERCE 7-31-2001.

GIANCARLO CASTRO, EXAMINING ATTORNEY

**CLASS 11—(Continued).**

SN 78-462,176. FAROUK SYSTEMS, INC., HOUSTON, TX.  
FILED 8-4-2004.

**CLASS 12—(Continued).**

SN 76-557,526. SPEEDPLAY, INC., SAN DIEGO, CA. FILED  
11-6-2003.

**X CLEAT****KHI**

NO CLAIM IS MADE TO THE EXCLUSIVE RIGHT TO  
USE CLEAT, APART FROM THE MARK AS SHOWN.  
FOR BICYCLE PARTS AND ACCESSORIES, NAMELY,  
CLEATS FOR ATTACHMENT TO BICYCLE PEDALS  
(U.S. CLS. 19, 21, 23, 31, 35 AND 44).  
FIRST USE 9-0-1991; IN COMMERCE 1-0-2002.  
DORITT L. CARROLL, EXAMINING ATTORNEY

THE MARK CONSISTS OF STANDARD CHARACTERS  
WITHOUT CLAIM TO ANY PARTICULAR FONT, STYLE,  
SIZE, OR COLOR.

FOR HAIR DRYERS (U.S. CLS. 13, 21, 23, 31 AND 34).  
BRENDAN REGAN, EXAMINING ATTORNEY

SN 76-558,045. BAYERISCHE MOTOREN WERKE AKTIEN-  
GESELLSCHAFT, 80809 MUNICH, FED REP GERMANY,  
FILED 11-7-2003.

**EL PLACER DE CONDUCIR**

THE MARK CONSISTS OF STANDARD CHARACTERS  
WITHOUT CLAIM TO ANY PARTICULAR FONT, STYLE,  
SIZE, OR COLOR.

THE ENGLISH TRANSLATION OF THE MARK IS "THE  
PLEASURE OF DRIVING".  
FOR AUTOMOBILES (U.S. CLS. 19, 21, 23, 31, 35 AND  
44).

FIRST USE 10-0-2002; IN COMMERCE 10-0-2002.  
SEAN DWYER, EXAMINING ATTORNEY

**CLASS 12—VEHICLES**

SN 76-070,500. WIRTH MASCHINENBAU GMBH, D-88074  
MECKENBEUREN-REUTE, FED REP GERMANY, FILED  
6-15-2000.

SN 76-583,281. TRUCK ACCESSORIES GROUP, INC., EL-  
KHART, IN. FILED 3-25-2004.

**OKTOPUS**

OWNER OF FED REP GERMANY REG. NO. 2070212/12,  
DATED 7-6-1994, RENEWED AS REG. NO. 2070212/12,  
DATED 7-15-2003, EXPIRES 7-15-2013.

FOR FLOOR CONVEYOR VEHICLES, NAMELY, CON-  
VEYORS AND LIFTERS FOR USE IN THE CONSTRU-  
TION INDUSTRY; FORKLIFT TRUCKS, FORK  
STACKER VEHICLES AND CRANES AND STRUCTUR-  
AL PARTS THEREFOR, NAMELY, ATTACHMENTS  
FOR LIFTING, MANIPULATING, ADJUSTMENT, AND  
ARRESTING LARGE PLANE AERIALS AND LOADS  
SUCH AS BOARDS, WALLS AND CEILING PANELS,  
GLASS PANELS, PROFILE PANELS, ALL BY VACUUM  
SUCTION MEANS (U.S. CLS. 19, 21, 23, 31, 35 AND 44).  
FIRST USE 0-0-1994; IN COMMERCE 0-0-1998.

JOHN SCHUYLER YARD, EXAMINING ATTORNEY

**BOXTOP**

THE MARK CONSISTS OF STANDARD CHARACTERS  
WITHOUT CLAIM TO ANY PARTICULAR FONT, STYLE,  
SIZE, OR COLOR.

FOR TRUCK COVERS, NAMELY, TONNEAU COVERS  
AND TRUCK CAPS (U.S. CLS. 19, 21, 23, 31, 35 AND 44).  
FIRST USE 11-1-2003; IN COMMERCE 11-1-2003.

CURTIS FRENCH, EXAMINING ATTORNEY

**CLASS 12—(Continued).**

SN 76-584,553. THE YOKOHAMA RUBBER COMPANY LIMITED, TOKYO, JAPAN, FILED 4-2-2004.

**Connoisseur**

THE MARK CONSISTS OF STANDARD CHARACTERS WITHOUT CLAIM TO ANY PARTICULAR FONT, STYLE, SIZE, OR COLOR.

FOR WHEEL RIMS AND WHEELS FOR AUTOMOBILES; WHEEL RIMS AND WHEELS FOR MOTORCYCLES (U.S. CLS. 19, 21, 23, 31, 35 AND 44).  
DAVID MURRAY, EXAMINING ATTORNEY



SN 76-588,775. ASSEMBLED PRODUCTS CORPORATION, ROGERS, AR. FILED 4-26-2004.

**ROCKOVER**

THE MARK CONSISTS OF STANDARD CHARACTERS WITHOUT CLAIM TO ANY PARTICULAR FONT, STYLE, SIZE, OR COLOR.

FOR VEHICLE CONSOLE MOUNT (U.S. CLS. 19, 21, 23, 31, 35 AND 44).  
WON TEAK OH, EXAMINING ATTORNEY



SN 76-590,532. BIG O TIRES, INC., CENTENNIAL, CO. FILED 5-5-2004.

**VENGEANCE**

THE MARK CONSISTS OF STANDARD CHARACTERS WITHOUT CLAIM TO ANY PARTICULAR FONT, STYLE, SIZE, OR COLOR.

OWNER OF U.S. REG. NO. 2,902,045.  
FOR WHEELS FOR AUTOMOBILES (U.S. CLS. 19, 21, 23, 31, 35 AND 44).  
KELLY CHOE, EXAMINING ATTORNEY

**CLASS 12—(Continued).**

SN 76-591,910. BOSTROM SEATING, INC., PIEDMONT, AL. FILED 5-12-2004.

**C-Series**

FOR SEATS AND PARTS THEREOF FOR COMMERCIAL, HEAVY AND MEDIUM TRUCKS AND BUSES (U.S. CLS. 19, 21, 23, 31, 35 AND 44).

SUSAN STIGLITZ, EXAMINING ATTORNEY



SN 78-203,351. WOOD MANUFACTURING COMPANY, INC., FLIPPIN, AR. FILED 1-15-2003.



OWNER OF U.S. REG. NOS. 902,091, 2,409,429 AND OTHERS.

NO CLAIM IS MADE TO THE EXCLUSIVE RIGHT TO USE BOATS BEST BUILT BEST BACKED WARRANTY, APART FROM THE MARK AS SHOWN.

FOR BOATS AND STRUCTURAL PARTS THEREFOR (U.S. CLS. 19, 21, 23, 31, 35 AND 44).  
TRACY FLETCHER, EXAMINING ATTORNEY



SN 78-221,996. TECUMSEH PRODUCTS COMPANY, TECUMSEH, MI. FILED 3-5-2003.

**STERLING**

FOR INTERNAL COMBUSTION ENGINES FOR LAND VEHICLES, NAMELY, GO-CARTS AND MULTIPURPOSE LAWN, GARDEN, AND LANDSCAPING VEHICLES (U.S. CLS. 19, 21, 23, 31, 35 AND 44).

ODESSA BIBBINS, EXAMINING ATTORNEY

**CLASS 12—(Continued).**

SN 78-270,218. BAJAJ AUTO LIMITED, PUNE MAHARASHTRA, INDIA, FILED 7-3-2003.

**BAJAJ**

OWNER OF U.S. REG. NO. 1,230,997.  
FOR TWO WHEELED AND THREE WHEELED LAND VEHICLES NAMELY, MOTORIZED AND NON-MOTORIZED SCOOTERS, SCOOTERETTES (MOPEDS), MOTORCYCLES AND PARTS THEREOF SOLD AS A UNIT (U.S. CLS. 19, 21, 23, 31, 35 AND 44).  
STEPHANIE DAVIS, EXAMINING ATTORNEY

**CLASS 12—(Continued).**

SN 78-323,440. LEHMAN TRIKES, INC., WESTLOCK, ALBERTA, CANADA, FILED 11-5-2003.

**ROMANI**

THE MARK CONSISTS OF STANDARD CHARACTERS WITHOUT CLAIM TO ANY PARTICULAR FONT, STYLE, SIZE, OR COLOR.

PRIORITY CLAIMED UNDER SEC. 44(D) ON CANADA APPLICATION NO. 1175602, FILED 5-5-2003, REG. NO. TMA612,782, DATED 6-15-2004, EXPIRES 6-15-2019.

FOR MOTORIZED TRICYCLES, KITS FOR CONVERTING MOTORCYCLES INTO TRICYCLES CONSISTING PRIMARILY OF A FIBERGLASS BODY, REAR AXLE DIFFERENTIAL GEAR, SEAT AND FASTENING BOLTS, SOLD AS A UNIT (U.S. CLS. 19, 21, 23, 31, 35 AND 44).

MITCHELL FRONT, EXAMINING ATTORNEY

SN 78-273,379. GROUPE HENRI HEULIEZ, 79140 CERIZAY, FRANCE, FILED 7-11-2003.

**DEFLECTOP**

OWNER OF FRANCE REG. NO. 033205268, DATED 1-14-2003, EXPIRES 1-14-2013.

FOR VEHICLES FOR LOCOMOTION BY LAND, NAMELY AUTOMOBILES (U.S. CLS. 19, 21, 23, 31, 35 AND 44).

SONYA STEPHENS, EXAMINING ATTORNEY

SN 78-291,743. MAYER, WILLIAM J. III, OJAI, CA. FILED 8-25-2003.

**BILL MAYER SADDLES**

NO CLAIM IS MADE TO THE EXCLUSIVE RIGHT TO USE "SADDLES", APART FROM THE MARK AS SHOWN.

FOR MOTORCYCLE SADDLES (U.S. CLS. 19, 21, 23, 31, 35 AND 44).

PATRICIA EVANKO, EXAMINING ATTORNEY

SN 78-333,718. LUCITE INTERNATIONAL, INC., CORDOVA, TN. FILED 11-26-2003.

**LUCITE**

THE MARK CONSISTS OF STANDARD CHARACTERS WITHOUT CLAIM TO ANY PARTICULAR FONT, STYLE, SIZE, OR COLOR.

FOR TRANSPORT GLASS AND TRANSPORT WINDOWS, NAMELY, GLASS WINDOWS FOR VEHICLES; PROTECTIVE COVERS FOR VEHICLES; VEHICLE DOOR PANELS; VEHICLE ROOF PANELS; VEHICLE FRONT DASH PANELS; VEHICLE SEATS; AND PARTS AND FITTINGS FOR ALL THE AFORESAID GOODS (U.S. CLS. 19, 21, 23, 31, 35 AND 44).

JIM RINGLE, EXAMINING ATTORNEY

SN 78-301,368. PIRELLI DEUTSCHLAND AG, D-64747 BREUBERG, FED REP GERMANY, FILED 9-17-2003.

**ROADTEC**

PRIORITY CLAIMED UNDER SEC. 44(D) ON FED REP GERMANY APPLICATION NO. 30314967.1, FILED 3-20-2003, REG. NO. 30314967, DATED 5-23-2003, EXPIRES 3-31-2013.

FOR TIRES; PNEUMATIC AND SOLID TIRES, NAMELY FOR VEHICLE WHEELS; WHEELS FOR VEHICLES; INNER TUBES FOR WHEELS; WHEEL RIMS; PARTS AND FITTINGS FOR ALL OF THE AFORESAID PRODUCTS, NAMELY, VALVES, RIM BANDS, AND SPONGE RUBBER RINGS; AND MOTORCYCLE STRUCTURAL PARTS, NAMELY, FORKS, SEATS, AND SHOCK ABSORBERS (U.S. CLS. 19, 21, 23, 31, 35 AND 44).

TONI HICKEY, EXAMINING ATTORNEY

**CLASS 12—(Continued).**

SN 78-361,005. UNICAM INCORPORATED, EMERSON, NJ.  
FILED 2-2-2004.



THE MARK CONSISTS OF THE MARK CONSISTS OF STYLIZED LOWER CASE "UNI" LETTERS CONNECTED TO ONE ANOTHER AND THEN SEPARATED BY A HYPHEN CONNECTED TO A STYLIZED "C" WITH AN OUTLINE OF A DOT AT THE TOP OF THE FIGURE FOLLOWED BY THE LETTERS "AM" CONNECTED TO ONE ANOTHER AND POSITIONED WITHIN THE SCOPE OF THE MOUTH OF THE PRECEDING "C" .

FOR BICYCLE PARTS FOR ADAPTING A BICYCLE FOR PERSONS WITH DISABILITIES, NAMELY, PEDALS, CRANKS, GEARS, WHEELS, CHAINS, TUBES AND CONNECTORS FOR FRAMES, HANDLE BARS, KICKSTANDS, GRIPS, FRAMES, BRAKES, BRAKE SHOES, RACKS, SEATS, STANDS, MOTORS, RACKS, RIMS, SPOKES, SUSPENSION SYSTEMS, SPROCKETS, TIRES, WHEEL HUBS, WHEEL RIMS, SADDLES AND SADDLE COVERS, RACKS, SAFETY PADS AND PUMPS, DRIVE TRAINS, FORKS, FORK CROWN COVERS, FRONT FORK JOINTS AND HANDLE BAR ENDS (U.S. CLS. 19, 21, 23, 31, 35 AND 44).

FIRST USE 1-1-1999; IN COMMERCE 5-1-2002.  
JOHN E. MICHOS, EXAMINING ATTORNEY

**CLASS 12—(Continued).**

SN 78-383,296. CHOPPER HELL LLC, FORT WAYNE, IN.  
FILED 3-12-2004.

**CHOPPER HELL**

THE MARK CONSISTS OF STANDARD CHARACTERS WITHOUT CLAIM TO ANY PARTICULAR FONT, STYLE, SIZE, OR COLOR.

NO CLAIM IS MADE TO THE EXCLUSIVE RIGHT TO USE "CHOPPER", APART FROM THE MARK AS SHOWN, FOR MOTORCYCLES AND STRUCTURAL PARTS THEREFOR (U.S. CLS. 19, 21, 23, 31, 35 AND 44).

WANDA KAY PRICE, EXAMINING ATTORNEY

---

SN 78-372,968. GENERAL MOTORS CORPORATION, DETROIT, MI. FILED 2-24-2004.

**HX**

THE MARK CONSISTS OF STANDARD CHARACTERS WITHOUT CLAIM TO ANY PARTICULAR FONT, STYLE, SIZE, OR COLOR.

FOR MOTOR LAND VEHICLES FOR USE BY THE GENERAL PUBLIC ON PUBLIC ROADWAYS, NAMELY AUTOMOBILES, TRUCKS, SPORT UTILITY VEHICLES, VANS, ENGINES THEREFOR AND STRUCTURAL PARTS THEREOF (U.S. CLS. 19, 21, 23, 31, 35 AND 44).

MELVIN AXILBUND, EXAMINING ATTORNEY

---

SN 78-392,582. GOODYEAR TIRE & RUBBER COMPANY, THE, AKRON, OH. FILED 3-29-2004.

**ULTRA SPRAYER**

THE MARK CONSISTS OF STANDARD CHARACTERS WITHOUT CLAIM TO ANY PARTICULAR FONT, STYLE, SIZE, OR COLOR.

FOR TIRES (U.S. CLS. 19, 21, 23, 31, 35 AND 44).

MATTHEW KLINE, EXAMINING ATTORNEY

**CLASS 12—(Continued).**

SN 78-394,789. FENDERLIMITATORS, INC., MERRITT ISLAND, FL. FILED 4-1-2004.

**FENDERLIMITATOR**

THE MARK CONSISTS OF STANDARD CHARACTERS WITHOUT CLAIM TO ANY PARTICULAR FONT, STYLE, SIZE, OR COLOR.

FOR MOTORCYCLE REPLACEMENT PARTS AND ACCESSORIES, NAMELY, LICENSE PLATE FRAMES AND HOLDERS, LIGHT BARS AND SPOILERS, TURN SIGNAL VISORS, TURN SIGNALS FOR VEHICLES, EMBLEMS, FRONT FENDER ACCENTS, LIGHT BRACKETS, TURN SIGNAL GRILLE SETS; AND LIGHTING, NAMELY, TAIL LIGHTS, TURN SIGNAL LIGHTS, FENDER LIGHTS, CORNERING LIGHTS, DECORATIVE LIGHTS, REFLECTORS, MARKER LIGHTS, VANITY LIGHTS, FORK LIGHTS, REPLACEMENT INCANDESCENT AND HALOGEN BULBS; AND KITS TO REPLACE FENDERS WITH BRACKETS AND FRAMES FOR HOLDING LICENSE PLATES AND TURN SIGNAL LIGHTS (U.S. CLS. 19, 21, 23, 31, 35 AND 44).

FIRST USE 3-26-2004; IN COMMERCE 3-26-2004.  
MIDGE BUTLER, EXAMINING ATTORNEY

**CLASS 12—(Continued).**

SN 78-395,489. PORTMAN SECURITY SYSTEM (USA) LTD., WOBURN, MA. FILED 4-2-2004.



FOR AUTO SECURITY SYSTEMS COMPRISING MODULES AND CENTRAL CONTROLLER FOR ELECTRICAL AND ELECTRONIC ALARMS, ANTI-THEFT ALARM DEVICES, ELECTRONIC SIRENS, REMOTE CONTROL TRANSMITTERS AND RECEIVERS, ELECTRIC MAGNETIC CONTACTS, RELAYS, STROBE LIGHTS, AND PROCESSORS OF ELECTRONIC SIGNALS (U.S. CLS. 19, 21, 23, 31, 35 AND 44).

FIRST USE 5-1-2004; IN COMMERCE 5-1-2004.  
ROBERT COGGINS, EXAMINING ATTORNEY

SN 78-395,127. WALSH, GREGORY, LONG BEACH, CA. FILED 4-1-2004.

**COALITION**

THE MARK CONSISTS OF STANDARD CHARACTERS WITHOUT CLAIM TO ANY PARTICULAR FONT, STYLE, SIZE, OR COLOR.

FOR BICYCLE COMPONENTS AND ACCESSORIES; NAMELY, FORKS, HUBS, RIMS, TIRES, HANDLEBARS, HANDLEBAR GRIPS, STEMS, BAR ENDS, BRAKES, PEDALS, SPROCKETS, CRANKS, SEATS, SEAT POSTS, AND PEGS (U.S. CLS. 19, 21, 23, 31, 35 AND 44).

APRIL L. RADEMACHER, EXAMINING ATTORNEY

SN 78-397,471. SPECIALIZED BICYCLE COMPONENTS, INC., CONCORD, CA. FILED 4-6-2004.

**HARDROCK**

THE MARK CONSISTS OF STANDARD CHARACTERS WITHOUT CLAIM TO ANY PARTICULAR FONT, STYLE, SIZE, OR COLOR.

OWNER OF U.S. REG. NO. 1,496,690.  
FOR BICYCLES AND BICYCLE FRAMES (U.S. CLS. 19, 21, 23, 31, 35 AND 44).

FIRST USE 7-0-2001; IN COMMERCE 7-0-2001.  
TIMOTHY FINNEGAN, EXAMINING ATTORNEY

**CLASS 12—(Continued).**

SN 78-397,824. AIRO-SERIES, INC., SANTEE, CA. FILED 4-7-2004.

**TRANSITION**

THE MARK CONSISTS OF STANDARD CHARACTERS WITHOUT CLAIM TO ANY PARTICULAR FONT, STYLE, SIZE, OR COLOR.

FOR BICYCLE FRAME (U.S. CLS. 19, 21, 23, 31, 35 AND 44).

FIRST USE 3-22-2004; IN COMMERCE 3-26-2004.  
FRED MANDIR, EXAMINING ATTORNEY

**CLASS 12—(Continued).**

SN 78-412,455. WICK WERKS, LLC, OGDEN, UT. FILED 5-3-2004.



THE MARK CONSISTS OF TWO CAPITAL WS ALIGNED VERTICALLY AND ENCIRCLED BY THE OUTLINE OF A BICYCLE CHAINRING.

FOR BICYCLE DRIVETRAIN COMPONENTS, NAMELY DERAILLEURS, SHIFTERS, CRANKSETS, CHAINRINGS, BOTTOM BRACKETS, CHAIN GUARDS AND BICYCLE CHAINS (U.S. CLS. 19, 21, 23, 31, 35 AND 44).

TARAH HARDY, EXAMINING ATTORNEY

SN 78-414,172. TRUE TEMPER SPORTS, INC., MEMPHIS, TN. FILED 5-6-2004.

SN 78-400,138. INTERNATIONAL ENGINE INTELLECTUAL PROPERTY COMPANY, LLC, WARRENVILLE, IL. FILED 4-12-2004.

**THUNDER STROKE**

**T3**

THE MARK CONSISTS OF STANDARD CHARACTERS WITHOUT CLAIM TO ANY PARTICULAR FONT, STYLE, SIZE, OR COLOR.

FOR ENGINES FOR LAND VEHICLES (U.S. CLS. 19, 21, 23, 31, 35 AND 44).

TRACY WHITAKER-BOWN, EXAMINING ATTORNEY

THE MARK CONSISTS OF STANDARD CHARACTERS WITHOUT CLAIM TO ANY PARTICULAR FONT, STYLE, SIZE, OR COLOR.

FOR BICYCLE PARTS, NAMELY HANDLE BARS AND FRAME COMPONENTS (U.S. CLS. 19, 21, 23, 31, 35 AND 44).

RICHARD A. STRASER, EXAMINING ATTORNEY



**CLASS 12—(Continued).**

SN 78-415,402. CONFEDERATE MOTOR COMPANY, NEW ORLEANS, LA. FILED 5-7-2004.

**CLASS 12—(Continued).**

SN 78-415,678. PENNZOIL-QUAKER STATE COMPANY, HOUSTON, TX. FILED 5-10-2004.

# FIGHTER

THE MARK CONSISTS OF STANDARD CHARACTERS WITHOUT CLAIM TO ANY PARTICULAR FONT, STYLE, SIZE, OR COLOR.  
FOR MOTORCYCLES (U.S. CLS. 19, 21, 23, 31, 35 AND 44).  
APRIL L. RADEMACHER, EXAMINING ATTORNEY

# SUNCUTTERS

THE MARK CONSISTS OF STANDARD CHARACTERS WITHOUT CLAIM TO ANY PARTICULAR FONT, STYLE, SIZE, OR COLOR.  
FOR AUTOMOTIVE ACCESSORIES, NAMELY SUN PROTECTION SHADES (U.S. CLS. 19, 21, 23, 31, 35 AND 44).  
FIRST USE 3-31-2004; IN COMMERCE 3-31-2004.  
RAMONA ORTIGA, EXAMINING ATTORNEY

SN 78-418,946. WORLDWIDE TRANSMISSION CORE SUPPLY, INCORPORATED, LAKE ZURICH, IL. FILED 5-14-2004.

SN 78-415,620. AMES TRUE TEMPER PROPERTIES, INC., WILMINGTON, DE. FILED 5-10-2004.



# GARDEN CHARIOT

THE MARK CONSISTS OF STANDARD CHARACTERS WITHOUT CLAIM TO ANY PARTICULAR FONT, STYLE, SIZE, OR COLOR.  
NO CLAIM IS MADE TO THE EXCLUSIVE RIGHT TO USE "GARDEN", APART FROM THE MARK AS SHOWN.  
FOR LAWN AND GARDEN CARTS (U.S. CLS. 19, 21, 23, 31, 35 AND 44).  
JOHN GARTNER, EXAMINING ATTORNEY

NO CLAIM IS MADE TO THE EXCLUSIVE RIGHT TO USE " TRANSMISSION GROUP", APART FROM THE MARK AS SHOWN.  
THE COLORS RED AND BLUE ARE CLAIMED AS A FEATURE OF THE MARK.  
THE COLOR BLUE APPEARS ON THE "GLOBE" DESIGN WHILE THE COLOR RED APPEARS ON THE "OBLONG" DESIGN  
THE MARK CONSISTS OF THE LITERAL WORLDWIDE WITH A BLUE GLOBE DEPICTING THE LETTER 'O'. AND UNDERNEATH, THE LITERALS TRANSMISSION GROUP IN RED BACKGROUND.  
SEC. 2(F).  
FOR LAND VEHICLE TRANSMISSIONS AND REPLACEMENT PARTS THEREOF, INCLUDING TRANSFER CASES, TORQUE CONVERTERS, STATORS, PLANETARY GEARS, CLUTCH PACKS AND DRUM HOUSINGS, DIFFERENTIAL GEARS, RING GEARS, DRIVE GEARS, TURBINE SHAFTS AND PUMP SHAFTS (U.S. CLS. 19, 21, 23, 31, 35 AND 44).  
FIRST USE 6-5-1995; IN COMMERCE 6-5-1995.  
RUDY R. SINGLETON, EXAMINING ATTORNEY

**CLASS 12—(Continued).**

SN 78-421,040. BENDIX COMMERCIAL VEHICLE SYSTEMS LLC, ELYRIA, OH. FILED 5-18-2004.

# AD-IS

THE MARK CONSISTS OF STANDARD CHARACTERS WITHOUT CLAIM TO ANY PARTICULAR FONT, STYLE, SIZE, OR COLOR.

FOR AIR DRYER MODULE FOR VEHICLE BRAKING SYSTEMS AND PARTS THEREFOR (U.S. CLS. 19, 21, 23, 31, 35 AND 44).

FIRST USE 5-5-2001; IN COMMERCE 5-5-2001.  
ANNE MADDEN, EXAMINING ATTORNEY

SN 78-421,804. TOPDOWN INC., ISSAQUAH, WA. FILED 5-19-2004.

# TOPDOWN

THE MARK CONSISTS OF STANDARD CHARACTERS WITHOUT CLAIM TO ANY PARTICULAR FONT, STYLE, SIZE, OR COLOR.

FOR STRUCTURAL PART OF CONVERTIBLE VEHICLES AIMED AT DEMINISHING TURBULENCE IN THE COCKPIT (U.S. CLS. 19, 21, 23, 31, 35 AND 44).

HEATHER THOMPSON, EXAMINING ATTORNEY

**CLASS 12—(Continued).**

SN 78-424,251. VETRO INC., VANCOUVER, WA. FILED 5-24-2004.

# GOT AIR?

THE MARK CONSISTS OF STANDARD CHARACTERS WITHOUT CLAIM TO ANY PARTICULAR FONT, STYLE, SIZE, OR COLOR.

FOR TIRES (U.S. CLS. 19, 21, 23, 31, 35 AND 44).  
GRETTA YAO, EXAMINING ATTORNEY

**CLASS 14—JEWELRY**

SN 75-552,651. RICHEMONT INTERNATIONAL SA, VILARS-SUR GLANE, SWITZERLAND, FILED 9-14-1998.

# SALTARELLO

OWNER OF SWITZERLAND REG. NO. 450695, DATED 5-12-1998, EXPIRES 10-28-2007.

THE ENGLISH TRANSLATION OF THE WORD "SALTARELLO" IN THE MARK IS "SHORT JUMP, SKIP, HOP".

FOR ITEMS MADE OF PRECIOUS METAL OR COATED THEREWITH, NAMELY, PILLBOXES, BOXES AND CASES FOR WATCHES, JEWELRY AND CIGARETTES, CUFFLINKS, ASHTRAYS, CANDLESTICKS, BADGES, SERVING TRAYS, POWDER COMPACTS SOLD EMPTY, SALT SHAKERS AND SUGAR BOWLS, AND COFFEE AND TEA SERVICES, JEWELRY; PRECIOUS GEM STONES; WATCHES; CLOCKS; CHROMETERS (U.S. CLS. 2, 27, 28 AND 50).

KIM SAITO, EXAMINING ATTORNEY

SN 76-446,217. SEIKO INSTRUMENTS KABUSHIKI KAISHA, TA SEIKO INSTRUMENTS INC., CHIBA 261-8507, JAPAN, FILED 8-30-2002.

# COMPLEX

PRIORITY CLAIMED UNDER SEC. 44(D) ON JAPAN APPLICATION NO. 2002-055036, FILED 7-2-2002, REG. NO. 4747895, DATED 7-2-2002, EXPIRES 7-2-2012.

FOR WATCHES AND CLOCKS (U.S. CLS. 2, 27, 28 AND 50).

CHRISTOPHER BUONGIORNO, EXAMINING ATTORNEY

**CLASS 14—(Continued).**

SN 76-528,398. WOLF, OLLECH, B-2018 ANTWERPEN, BELGIUM, FILED 7-10-2003.

**LUMINIS STAR**

PRIORITY CLAIMED UNDER SEC. 44(D) ON BENELUX APPLICATION NO. 1024865, FILED 1-10-2003, REG. NO. 0728405, DATED 1-10-2003, EXPIRES 1-10-2013.

FOR PRECIOUS STONES AND DIAMONDS (U.S. CLS. 2, 27, 28 AND 50).  
JERI J. FICKES, EXAMINING ATTORNEY

SN 76-567,951. HENRY DUNAY DESIGNS, INC., NEW YORK, NY. FILED 1-2-2004.

**DUNAY**

OWNER OF U.S. REG. NOS. 1,616,667, 2,350,787 AND OTHERS.  
SEC. 2(F).  
FOR PRECIOUS METAL JEWELRY (U.S. CLS. 2, 27, 28 AND 50).  
FIRST USE 8-31-1973; IN COMMERCE 8-31-1973.  
SHARI SHEFFIELD, EXAMINING ATTORNEY

SN 76-568,678. INVICTA WATCH COMPANY OF AMERICA, INC., HOLLYWOOD, FL. FILED 12-24-2003.

**TESSIO**

THE MARK CONSISTS OF STANDARD CHARACTERS WITHOUT CLAIM TO ANY PARTICULAR FONT, STYLE, SIZE, OR COLOR.

FOR WATCHES (U.S. CLS. 2, 27, 28 AND 50).  
FIRST USE 4-0-2003; IN COMMERCE 4-0-2003.  
DOUGLAS LEE, EXAMINING ATTORNEY

**CLASS 14—(Continued).**

SN 76-570,116. JOSEPH, TERESA, BROOKLYN, NY. FILED 1-14-2004.

**LONG MEADOW**

THE MARK CONSISTS OF STANDARD CHARACTERS WITHOUT CLAIM TO ANY PARTICULAR FONT, STYLE, SIZE, OR COLOR.

FOR JEWELRY, NAMELY NECKLACES, PENDANTS, CHAINS, BRACELETS, ANKLE BRACELETS, CHARMS, EARRINGS, PINS, ORNAMENTAL PINS, BROOCHES, RINGS AND CUFFLINKS (U.S. CLS. 2, 27, 28 AND 50).  
KELLY BOULTON, EXAMINING ATTORNEY

SN 76-584,124. JRD LICENSING, INC., SAINT PAUL, MN. FILED 3-29-2004.

**LIFESCAPES**

THE MARK CONSISTS OF STANDARD CHARACTERS WITHOUT CLAIM TO ANY PARTICULAR FONT, STYLE, SIZE, OR COLOR.

FOR JEWELRY (U.S. CLS. 2, 27, 28 AND 50).  
MICHAEL ENGEL, EXAMINING ATTORNEY

SN 76-585,196. DESIGNWORKS JEWELRY GROUP LTD., LONG ISLAND CITY, NY. FILED 4-5-2004.

*CaressaCut*

OWNER OF U.S. REG. NO. 2,730,482.  
FOR FINE GOLD, PLATINUM AND DIAMOND JEWELRY, NAMELY EARRINGS, RINGS, BRACELETS, NECKLACES AND PENDANTS; LOOSE DIAMONDS (U.S. CLS. 2, 27, 28 AND 50).  
JOHN GARTNER, EXAMINING ATTORNEY

SN 76-588,975. K.L.H. DIAMONDS INC., NEW YORK, NY. FILED 4-26-2004.

**IDEAL WOMAN**

NO CLAIM IS MADE TO THE EXCLUSIVE RIGHT TO USE "IDEAL", APART FROM THE MARK AS SHOWN.  
FOR DIAMONDS AND FOR JEWELRY SET WITH PRECIOUS GEMSTONES OR DIAMONDS (U.S. CLS. 2, 27, 28 AND 50).

FIRST USE 4-5-2004; IN COMMERCE 4-5-2004.  
WON TEAK OH, EXAMINING ATTORNEY

**CLASS 14—(Continued).**

SN 76-589,792. LE TRESOR, LLC, BOCA RATON, FL. FILED 4-30-2004.



THE WORD "TRESOR" MEANS "TREASURE" IN ENGLISH.  
FOR JEWELRY, WATCHES, WATCH CASES, BRACELETS AND CLOCKS (U.S. CLS. 2, 27, 28 AND 50).  
PAM WILLIS, EXAMINING ATTORNEY

SN 76-590,713. CHROME HEARTS, INC., HOLLYWOOD, CA. FILED 5-6-2004.



FOR JEWELRY, NAMELY, BRACELETS, NECKLACES, RINGS, EARRINGS, PENDANTS, CUFF LINKS AND WATCH BRACELETS (U.S. CLS. 2, 27, 28 AND 50).  
FIRST USE 1-0-1992; IN COMMERCE 1-0-1992.  
TANYA AMOS, EXAMINING ATTORNEY

SN 76-591,451. E.F.D. DIAMONDS COMPANY LIMITED, RAMAT-GAN, ISRAEL, FILED 5-10-2004.

**NO MATTER WHERE YOU COME  
FROM, A PRINCESS IS THE  
UNIVERSAL CHOICE**

THE MARK CONSISTS OF STANDARD CHARACTERS WITHOUT CLAIM TO ANY PARTICULAR FONT, STYLE, SIZE, OR COLOR.  
FOR DIAMONDS AND JEWELRY (U.S. CLS. 2, 27, 28 AND 50).  
RAMONA ORTIGA, EXAMINING ATTORNEY

**CLASS 14—(Continued).**

SN 76-591,453. E.F.D. DIAMONDS COMPANY LIMITED, RAMAT-GAN, ISRAEL, FILED 5-10-2004.

**DON'T SETTLE FOR SECOND BEST -  
SEEK PRINCESS PERFECTION**

THE MARK CONSISTS OF STANDARD CHARACTERS WITHOUT CLAIM TO ANY PARTICULAR FONT, STYLE, SIZE, OR COLOR.  
FOR DIAMONDS AND JEWELRY (U.S. CLS. 2, 27, 28 AND 50).  
RAMONA ORTIGA, EXAMINING ATTORNEY

SN 76-591,454. E.F.D. DIAMONDS COMPANY LIMITED, RAMAT-GAN, ISRAEL, FILED 5-10-2004.

**DON'T SETTLE FOR SECOND BEST -  
SEEK DIAMOND PERFECTION**

THE MARK CONSISTS OF STANDARD CHARACTERS WITHOUT CLAIM TO ANY PARTICULAR FONT, STYLE, SIZE, OR COLOR.  
FOR DIAMONDS AND JEWELRY (U.S. CLS. 2, 27, 28 AND 50).  
RAMONA ORTIGA, EXAMINING ATTORNEY

SN 76-592,078. ASI IMPORTS, INC., ROSEVILLE, CA. FILED 5-13-2004.

**CHARMED EXPRESSIONS**

THE MARK CONSISTS OF STANDARD CHARACTERS WITHOUT CLAIM TO ANY PARTICULAR FONT, STYLE, SIZE, OR COLOR.  
FOR JEWELRY, NAMELY, BRACELETS, NECKLACES, ANKLETS, WAIST CHAINS, BELLY CHAINS, MODULAR ITALIAN STYLE CHARM BRACELETS, CHARMS, PENDANTS AND WATCHES (U.S. CLS. 2, 27, 28 AND 50).  
FIRST USE 6-0-2001; IN COMMERCE 6-0-2001.  
DOMINIC J. FERRAIUOLO, EXAMINING ATTORNEY

SN 78-206,378. HANNAH ROSE CORPORATION, DALLAS, TX. FILED 1-23-2003.

**RSE**

FOR SILVER, GOLD AND BASE METAL JEWELRY WITH AND WITHOUT STONES (U.S. CLS. 2, 27, 28 AND 50).  
FIRST USE 1-0-2003; IN COMMERCE 2-0-2003.  
GINA FINK, EXAMINING ATTORNEY

**CLASS 14—(Continued).**

SN 78-255,867. O'MEARA, STEPHEN VAN, SCOTTSDALE, AZ. FILED 5-29-2003.

**MASTER OF OBLIVION**

FOR PRECIOUS METALS AND THEIR ALLOYS, NAMELY, FINE SILVER, STERLING SILVER, FINE GOLD, 22KT, 195KT, 18KT GOLD, 14KT GOLD, 10KT GOLD, PLATINUM; JEWELRY, PRECIOUS STONES; HOROLOGICAL AND CHRONOMETRIC INSTRUMENTS, NAMELY—ALARM CLOCKS; ANKLE BRACELETS; ARTIFICIAL FINGERNAILS OF PRECIOUS METALS; ASHTRAYS OF PRECIOUS METAL; BADGES OF PRECIOUS METAL; BEADS FOR USE IN THE MANUFACTURE OF JEWELRY; BELT BUCKLES OF PRECIOUS METAL FOR CLOTHING; BODY-PIERCING RINGS; BODY-PIERCING STUDS; BOLO TIES WITH PRECIOUS METAL TIPS; BOOK MARKERS OF PRECIOUS METAL; BOWLS MADE OF PRECIOUS METALS; BRACELETS BEING JEWELRY; BRACELETS OF PRECIOUS METAL; BROOCHES; BUSTS OF PRECIOUS METAL; CANDLE HOLDERS OF PRECIOUS METAL; CANDLE RINGS OF PRECIOUS METAL; CANDLE SNUFFER AND TRAY COMBINATION MADE IN WHOLE OR IN PART OF PRECIOUS METAL; CANDLE SNUFFERS OF PRECIOUS METAL; CANDLESTICKS OF PRECIOUS METAL; CHARMS; CHOKERS; CHRONOGRAPHS FOR USE AS WATCHES; CHRONOMETERS; CHRONOSCOPES; CIGARETTE CASES MADE OF PRECIOUS METAL; CIGARETTE HOLDERS OF PRECIOUS METAL; CIGARETTE LIGHTERS OF PRECIOUS METAL; CLIP EARRINGS; CLOCK DIALS; CLOCKS; CLOISONNE PINS; COFFEE POTS OF PRECIOUS METAL; COFFEE SERVICES OF PRECIOUS METALS; COMMEMORATIVE COINS; COMMEMORATIVE STATUARY CUPS MADE OF PRECIOUS METAL; CRUET STANDS FOR OIL OR VINEGAR OF PRECIOUS METAL; CRUETS OF PRECIOUS METAL; CUFF-LINKS, DECORATIVE BOXES MADE OF PRECIOUS METAL, DESKTOP STATUARY MADE OF PRECIOUS METAL, DIAMONDS, EAR CLIPS, EARRINGS, EGG CUPS OF PRECIOUS METAL, EMERALDS, FIGURES OF PRECIOUS METAL, FIGURINES OF PRECIOUS METAL, FLOWER BOWLS OF PRECIOUS METAL, GRAVE MARKERS OF PRECIOUS METAL, FUNERY URNS OF PRECIOUS METALS, HAT ORNAMENTS OF PRECIOUS METAL, HAT PINS OF PRECIOUS METAL, HOLIDAY ORNAMENTS OF PRECIOUS METAL, IDENTIFICATION BRACELETS BEING JEWELRY, INGOTS OF PRECIOUS METAL, JEWELRY BOXES OF PRECIOUS METAL, JEWELRY CASES OF PRECIOUS METAL; JEWELRY CHAINS; JEWELRY FINDINGS, JEWELRY PINS FOR USE ON HATS; JEWELRY, NAMELY, AMULETS AND BRACELETS; JEWELRY, NAMELY, CROSSES AND OTHER RELIGIOUS MEDALLIONS AND SYMBOLS WORN AS JEWELRY; JEWELRY, NAMELY, LAPEL PINS, TIE TACKS; LETTER OPENERS, OF PRECIOUS METAL; CANDLE SNUFFERS; MATCH BOXES, LIGHTERS, CIGAR TUBES, ASHTRAYS AND HUMIDORS OF PRECIOUS METAL; MATCH HOLDERS OF PRECIOUS METAL; MEDALLIONS; MEDALS; NAPKIN HOLDERS OF PRECIOUS METAL; NAPKIN RINGS OF PRECIOUS METAL; NECK CHAINS, NECKLACES AND OTHER JEWELRY WORN ON OR ABOUT THE NECK; NECKTIE FASTENERS; NON-ELECTRIC CANDELABRAS MADE OF PRECIOUS METAL; NON-ELECTRIC COFFEE SERVERS OF PRECIOUS METAL; NON-MONETARY COINS; NUT CRACKERS OF PRECIOUS METAL; ORNAMENTAL LAPEL PINS; BAR WARE, NAMELY, COASTERS, WINE GOBLETS, JIGGERS, WINE COOLERS, ICE BUCKETS WITH TONGS, MADE OF PRECIOUS METALS; ORNAMENTAL PINS OF PRECIOUS METALS INCLUDING THOSE INCORPORATING STONES AND PEARLS; ORNAMENTS OF PRECIOUS METAL; PARTS FOR CLOCKS; PARTS FOR WATCHES; PEARLS; PENDANTS; PENDULUM CLOCKS; BABY CUPS, PIGGY BANKS, MADE OF PRECIOUS METAL; PILLAR CANDLE PLATE MADE IN WHOLE OR IN PART OF PRECIOUS METAL; PILLBOXES OF PRECIOUS METAL; PINS BEING JEWELRY; POCKET WATCHES; POTPOURRI DISHES, TRINKET BOXES, VANITY SETS MADE IN WHOLE OR IN PART OF PRECIOUS METAL; PRECIOUS GEMSTONES; PRECIOUS METAL TROPHIES; PRECIOUS METAL TROPHY COLUMNS; RINGS BEING

**CLASS 14—(Continued).**

JEWELRY; SALT AND PEPPER SHAKERS, PINCH BOWLS AND CASTERS OF PRECIOUS METAL; SCULPTURES MADE OF PRECIOUS METAL; SEMI-PRECIOUS GEMSTONES; SERVIETTE RINGS OF PRECIOUS METAL; SERVING PLATTERS OF PRECIOUS METAL; SERVING TRAYS OF PRECIOUS METAL; SHOE ORNAMENTS OF PRECIOUS METAL; SLIDES FOR BOLO TIES; PRECIOUS METAL BUCKLES FOR BAGGAGE, HANDBAGS, BRIEFCASES; SNUFF BOXES OF PRECIOUS METAL; STATUES OF PRECIOUS METAL; STATUETTES OF PRECIOUS METAL; STIRRING RODS OF PRECIOUS METAL; HAIR CLIPS AND COMBS OF PRECIOUS METAL; STOP WATCHES; SUGAR BOWLS AND CREAM PITCHERS OF PRECIOUS METAL; SUN DIALS; TANKARDS OF PRECIOUS METAL; TEA BALLS AND STRAINERS OF PRECIOUS METAL; TEA INFUSERS OF PRECIOUS METAL; TEA POTS OF PRECIOUS METAL; TEA SERVICES OF PRECIOUS METAL; TIARAS OF PRECIOUS METALS WITH OR WITH OUT PRECIOUS STONE INCORPORATED INTO THEM; TIE CLIPS; TIE FASTENERS; TIE PINS; TOMBSTONES OF PRECIOUS METAL; TOOTHPICKS AND OR HOLDERS OF PRECIOUS METAL; VASES OF PRECIOUS METAL; NON-ELECTRIC WALL CLOCKS; WALL SCONCES OF PRECIOUS METALS; WATCH BANDS; WATCH CASES; WATCH CHAINS; WATCH FOBS; WATCH MOVEMENTS; WATCH STRAPS; WATCHES; WEDDING BANDS; WRIST WATCHES (U.S. CLS. 2, 27, 28 AND 50).

MARK T. MULLEN, EXAMINING ATTORNEY

---

SN 78-309,597. AZOTIC COATING TECHNOLOGY, INC., ROCHESTER, MN. FILED 10-6-2003.

**MYSTIC PLATINUM TOPAZ**

NO CLAIM IS MADE TO THE EXCLUSIVE RIGHT TO USE PLATINUM TOPAZ, APART FROM THE MARK AS SHOWN.

FOR GEMSTONES AND JEWELRY (U.S. CLS. 2, 27, 28 AND 50).

DOMINIC J. FERRAIUOLO, EXAMINING ATTORNEY

---

SN 78-310,241. JÜRGENS FINE JEWELRY, INC., NORTH BEND, OR. FILED 10-7-2003.

**JÜRGENS**

SEC. 2(F).

FOR JEWELRY, NAMELY, MALE AND FEMALE RINGS, EARRINGS, BRACELETS, AND NECKLACES (U.S. CLS. 2, 27, 28 AND 50).

FIRST USE 1-0-1990; IN COMMERCE 1-0-1990.

AMY GEARIN, EXAMINING ATTORNEY

**CLASS 14—(Continued).**

SN 78-336,797. HISTORIC ORIGINALS LIMITED, READING, UNITED KINGDOM, FILED 12-5-2003.

**CLASS 14—(Continued).**

SN 78-358,279. YURMAN STUDIOS INC., NEW YORK, NY, FILED 1-27-2004.

**HOT DIAMONDS**

THE MARK CONSISTS OF STANDARD CHARACTERS WITHOUT CLAIM TO ANY PARTICULAR FONT, STYLE, SIZE, OR COLOR.

NO CLAIM IS MADE TO THE EXCLUSIVE RIGHT TO USE DIAMONDS, APART FROM THE MARK AS SHOWN.

FOR WATCHES AND HOROLOGICAL INSTRUMENTS, NAMELY, WRIST WATCHES, POCKET WATCHES, STOP WATCHES, CLOCKS AND CHRONOMETERS (U.S. CLS. 2, 27, 28 AND 50).  
ELLEN PERKINS, EXAMINING ATTORNEY

**Copella**

THE MARK CONSISTS OF STANDARD CHARACTERS WITHOUT CLAIM TO ANY PARTICULAR FONT, STYLE, SIZE, OR COLOR.

FOR FINE JEWELRY, PRECIOUS STONES AND WATCHES (U.S. CLS. 2, 27, 28 AND 50).  
JEFF DEFORD, EXAMINING ATTORNEY

---

SN 78-345,494. AMERICAN LUXURY PRODUCTS, INC., DALLAS, TX. FILED 12-24-2003.

---

SN 78-359,884. COUSIN CORPORATION OF AMERICA, LARGO, FL. FILED 1-30-2004.

**JULIEN COUDRAY  
1518**

THE MARK CONSISTS OF STANDARD CHARACTERS WITHOUT CLAIM TO ANY PARTICULAR FONT, STYLE, SIZE, OR COLOR.

NO CLAIM IS MADE TO THE EXCLUSIVE RIGHT TO USE 1518, APART FROM THE MARK AS SHOWN.

THE NAME(S), PORTRAIT(S), AND/OR SIGNATURE(S) SHOWN IN THE MARK DOES NOT IDENTIFY A PARTICULAR LIVING INDIVIDUAL.

FOR WATCHES, CLOCKS, WATCHBANDS; JEWELRY, NAMELY, PINS, TIE-PINS, CUFF-LINKS, TIE-CLASPS, BRACELETS, EARRINGS, CHARMS, PENDANTS, RINGS AND NECKLACES (U.S. CLS. 2, 27, 28 AND 50).  
CIMMERIAN COLEMAN, EXAMINING ATTORNEY

**STERLING ELEGANCE**

THE MARK CONSISTS OF STANDARD CHARACTERS WITHOUT CLAIM TO ANY PARTICULAR FONT, STYLE, SIZE, OR COLOR.

NO CLAIM IS MADE TO THE EXCLUSIVE RIGHT TO USE "STERLING", APART FROM THE MARK AS SHOWN. FOR JEWELRY FINDINGS MADE IN WHOLE OR SUBSTANTIAL PART OF STERLING SILVER (U.S. CLS. 2, 27, 28 AND 50).

FIRST USE 1-1-2004; IN COMMERCE 1-1-2004.  
JASON TURNER, EXAMINING ATTORNEY

**CLASS 14—(Continued).**

SN 78-372,190. ROSY BLUE, N.V., 2018 ANTWERP, BELGIUM, FILED 2-23-2004.

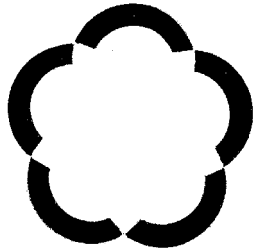

FOR DIAMONDS AND PRECIOUS AND SEMI-PRECIOUS STONES; JEWELRY, NAMELY, EARRINGS, RINGS, BRACELETS, CHARMS, NECKLACES, PENDANTS, PINS AND BROOCHES (U.S. CLS. 2, 27, 28 AND 50).

CIMMERIAN COLEMAN, EXAMINING ATTORNEY

**CLASS 14—(Continued).**

SN 78-381,372. STEINWAY, INC., LONG ISLAND CITY, NY. FILED 3-10-2004.



OWNER OF U.S. REG. NOS. 1,741,209, 1,743,058 AND 1,898,854.  
NO CLAIM IS MADE TO THE EXCLUSIVE RIGHT TO USE "BOSTON DESIGNED BY", APART FROM THE MARK AS SHOWN.

THE MARK CONSISTS OF BOSTON APPEARING IN STYLIZED LETTERS AND DESIGNED BY STEINWAY & SONS IN BLOCK LETTERS WITHIN A DESIGN ELEMENT. FOR CLOCKS, CLOCKS WITH RADIOS, CLOCKS WITH CDS, AND ALARM CLOCKS (U.S. CLS. 2, 27, 28 AND 50).

TARAH HARDY, EXAMINING ATTORNEY

SN 78-379,290. DIAMINTANGIBLES INTERNATIONAL, LTD., NASSAU, BAHAMAS, FILED 3-5-2004.

**THE DIAMOND  
FOUNDRY**

THE MARK CONSISTS OF STANDARD CHARACTERS WITHOUT CLAIM TO ANY PARTICULAR FONT, STYLE, SIZE, OR COLOR.

NO CLAIM IS MADE TO THE EXCLUSIVE RIGHT TO USE "DIAMOND", APART FROM THE MARK AS SHOWN. FOR DIAMONDS AND FINE JEWELRY MADE IN WHOLE OR SIGNIFICANT PART OF DIAMONDS (U.S. CLS. 2, 27, 28 AND 50).

JERI J. FICKES, EXAMINING ATTORNEY

SN 78-381,412. HEARTS ON FIRE COMPANY, BOSTON, MA. FILED 3-10-2004.

**BABY DREAM**

THE MARK CONSISTS OF STANDARD CHARACTERS WITHOUT CLAIM TO ANY PARTICULAR FONT, STYLE, SIZE, OR COLOR.

FOR JEWELRY AND PRECIOUS GEMSTONES (U.S. CLS. 2, 27, 28 AND 50).

CHARLES L. JENKINS, EXAMINING ATTORNEY

**CLASS 14—(Continued).**

SN 78-390,645. K.P. SANGHVI, INC., NEW YORK, NY. FILED 3-25-2004.

AMANTE

THE MARK CONSISTS OF STANDARD CHARACTERS WITHOUT CLAIM TO ANY PARTICULAR FONT, STYLE, SIZE, OR COLOR.

THE FOREIGN WORDING IN THE MARK TRANSLATES INTO ENGLISH AS "LOVER".  
FOR JEWELRY AND DIAMONDS (U.S. CLS. 2, 27, 28 AND 50).

RENEE MCCRAY, EXAMINING ATTORNEY

SN 78-391,003. MILLER, LINDA GAIL, PETALUMA, CA. FILED 3-25-2004.

Cleverback

THE MARK CONSISTS OF STANDARD CHARACTERS WITHOUT CLAIM TO ANY PARTICULAR FONT, STYLE, SIZE, OR COLOR.

FOR CLASP FOR EARRING (U.S. CLS. 2, 27, 28 AND 50).

BARBARA GAYNOR, EXAMINING ATTORNEY

**CLASS 14—(Continued).**

SN 78-391,401. SIS DESIGNS, LLC, VIRGINIA BEACH, VA. FILED 3-26-2004.



THE MARK CONSISTS OF THE STYLIZED LETTERS "SIS" SURROUNDED BY AN OVAL.

FOR JEWELRY; COSTUME JEWELRY; PRECIOUS METAL AND NON-PRECIOUS METAL JEWELRY; JEWELRY, NAMELY CHARMS, CHARM BRACELETS, CHAINS, BRACELETS, BANGLES, NECKLACES, EARRINGS, PENDANTS, PINS, HAT PINS, BROOCHES, SLIDES FOR BOLO TIES; JEWELRY WITH AND WITHOUT PRECIOUS AND SEMI-PRECIOUS GEMSTONES; JEWELRY, NAMELY STERLING SILVER JEWELRY; WATCH FOBS; WATCHES; WRISTWATCHES (U.S. CLS. 2, 27, 28 AND 50).

FIRST USE 3-16-2004; IN COMMERCE 3-16-2004.  
BARBARA RUTLAND, EXAMINING ATTORNEY

SN 78-398,136. ERIN H. WEIK, LANCASTER, VA. FILED 4-7-2004.

Lytha Studios

THE MARK CONSISTS OF STANDARD CHARACTERS WITHOUT CLAIM TO ANY PARTICULAR FONT, STYLE, SIZE, OR COLOR.

NO CLAIM IS MADE TO THE EXCLUSIVE RIGHT TO USE "STUDIOS", APART FROM THE MARK AS SHOWN.

FOR JEWELRY (U.S. CLS. 2, 27, 28 AND 50).

FIRST USE 12-1-1996; IN COMMERCE 12-1-1996.

CHARLES JOYNER, EXAMINING ATTORNEY



**CLASS 14—(Continued).**

SN 78-399,840. SEEQ WATCH CORPORATION, STOWE, VT. FILED 4-10-2004.



FOR WRISTWATCHES (U.S. CLS. 2, 27, 28 AND 50).  
ROBERT LORENZO, EXAMINING ATTORNEY

SN 78-400,125. JEN USA INC., NEW BRUNSWICK, NJ. FILED 4-12-2004.

**EASTSPORT**

THE MARK CONSISTS OF STANDARD CHARACTERS WITHOUT CLAIM TO ANY PARTICULAR FONT, STYLE, SIZE, OR COLOR.  
FOR JEWELRY, CLOCKS AND WATCHES (U.S. CLS. 2, 27, 28 AND 50).  
SAMUEL E. SHARPER JR., EXAMINING ATTORNEY

SN 78-416,092. HYPERION CONCEPTS LLC, THE WOODLANDS, TX. FILED 5-10-2004.

**ACCUTRAC**

THE MARK CONSISTS OF STANDARD CHARACTERS WITHOUT CLAIM TO ANY PARTICULAR FONT, STYLE, SIZE, OR COLOR.  
FOR CLOCKS (U.S. CLS. 2, 27, 28 AND 50).  
JULIA HARDY COFIELD, EXAMINING ATTORNEY

**CLASS 14—(Continued).**

SN 78-416,493. STARWOOD WHOLESALE, INC., RANDOLPH, NJ. FILED 5-11-2004.

**STARWOOD**

THE MARK CONSISTS OF STANDARD CHARACTERS WITHOUT CLAIM TO ANY PARTICULAR FONT, STYLE, SIZE, OR COLOR.  
FOR JEWELRY MADE OF PRECIOUS METALS, PRECIOUS STONES AND PEARLS (U.S. CLS. 2, 27, 28 AND 50).  
CAROL SPILS, EXAMINING ATTORNEY

SN 78-418,192. HEARTS ON FIRE COMPANY LLC, BOSTON, MA. FILED 5-13-2004.

**ENCOURAGEMENT**

THE MARK CONSISTS OF STANDARD CHARACTERS WITHOUT CLAIM TO ANY PARTICULAR FONT, STYLE, SIZE, OR COLOR.  
FOR JEWELRY (U.S. CLS. 2, 27, 28 AND 50).  
CAROLYN CATALDO, EXAMINING ATTORNEY

SN 78-418,210. HEARTS ON FIRE COMPANY LLC, BOSTON, MA. FILED 5-13-2004.

**EXULTATION**

THE MARK CONSISTS OF STANDARD CHARACTERS WITHOUT CLAIM TO ANY PARTICULAR FONT, STYLE, SIZE, OR COLOR.  
FOR JEWELRY (U.S. CLS. 2, 27, 28 AND 50).  
CAROLINE WOOD, EXAMINING ATTORNEY

**CLASS 14—(Continued).**

SN 78-418,263. HEARTS ON FIRE COMPANY LLC, BOSTON, MA. FILED 5-13-2004.

# INTENSITY

THE MARK CONSISTS OF STANDARD CHARACTERS WITHOUT CLAIM TO ANY PARTICULAR FONT, STYLE, SIZE, OR COLOR.

FOR JEWELRY (U.S. CLS. 2, 27, 28 AND 50).  
MAUREEN DALL, EXAMINING ATTORNEY

---

SN 79-005,191. ALFRED DUNHILL LIMITED, UNITED KINGDOM, FILED 5-14-2004.

# BOBBY FINDER

THE MARK CONSISTS OF STANDARD CHARACTERS WITHOUT CLAIM TO ANY PARTICULAR FONT, STYLE, SIZE, OR COLOR.

PRIORITY DATE OF 11-21-2003 IS CLAIMED.  
OWNER OF INTERNATIONAL REGISTRATION 0832927 DATED 5-14-2004, EXPIRES 5-14-2014.

FOR JEWELRY; CUFF-LINKS; TIE BARS, TIE CLIPS, TIE PINS; WATCHES, CLOCKS; PRECIOUS METAL KEY RINGS, KEY FOBS AND KEY CHAINS; WATCH STRAPS, WATCH BRACELETS (U.S. CLS. 2, 27, 28 AND 50).

H. M. FISHER, EXAMINING ATTORNEY

**CLASS 15—MUSICAL INSTRUMENTS**

SN 76-554,804. J.D. CALATO MANUFACTURING CO., INC., NIAGARA FALLS, NY. FILED 10-14-2003.

# CALATO

SEC. 2(F).  
FOR DRUMSTICKS AND PERCUSSION MUSICAL INSTRUMENTS (U.S. CLS. 2, 21 AND 36).  
FIRST USE 0-0-1975; IN COMMERCE 0-0-1975.  
KATHRYN COWARD, EXAMINING ATTORNEY

**CLASS 15—(Continued).**

SN 76-591,518. ANTIGUA WINDS, INC., SAN ANTONIO, TX. FILED 5-10-2004.

# ANTIGUA

THE MARK CONSISTS OF STANDARD CHARACTERS WITHOUT CLAIM TO ANY PARTICULAR FONT, STYLE, SIZE, OR COLOR.

THE ENGLISH TRANSLATION OF THE WORD ANTIGUA IN THE MARK IS OLD OR ANTIQUE.

FOR SHEET MUSIC STANDS AND MUSICAL INSTRUMENTS, NAMELY FLUTES, CLARINETS, SAXOPHONES, TRUMPETS, AND TROMBONES (U.S. CLS. 2, 21 AND 36).

FIRST USE 1-0-2003; IN COMMERCE 1-0-2003.  
MELISSA SHELLA, EXAMINING ATTORNEY

---

SN 78-412,535. SUNMECK, DAYTON, MD. FILED 5-3-2004.

# SoniKing

THE MARK CONSISTS OF STANDARD CHARACTERS WITHOUT CLAIM TO ANY PARTICULAR FONT, STYLE, SIZE, OR COLOR.

FOR SAXOPHONES, CLARINETS, OBOES, FLUTES, PICCOLOS, BASSOONS/CONTRABASSOONS, ENGLISH HORNS, TRUMPETS, TROMBONES, CORNETS, BUGLES, FRENCH HORNS, ALTO HORNS, BARITONE HORNS, FLÜGELHORNS, TUBAS, EUPHONIUMS, SOUSAPHONES, MELLOPHONES, PIANOS, REED AND PIPE ORGANS, ACCORDIONS, VIOLINS, VIOLAS, CELLOS, STRING BASSES, HARPS, GUITARS, DRUMS, CYMBALS, TRIANGLES, HARMONICAS, XYLOPHONES (U.S. CLS. 2, 21 AND 36).

ANDREA SAUNDERS, EXAMINING ATTORNEY

**CLASS 15—(Continued).**

SN 78-419,485. KAISER, PETE M., LINDEN, CA. FILED 5-15-2004.

**CLASS 16—PAPER GOODS AND PRINTED MATTER**

SN 76-508,525. TRADES PUBLISHING, INC., LAMBERTVILLE, NJ. FILED 4-21-2003.

**JOBSITE**

**Squarebeat  
Drumsticks**

FOR PRINTED MAGAZINES DEALING WITH COMMERCIALLY AVAILABLE TOOLS, EQUIPMENT AND BUILDING MATERIALS FOR USE BY PROFESSIONAL PAINTERS AND WALL COVERING TRADESMEN (U.S. CLS. 2, 5, 22, 23, 29, 37, 38 AND 50).  
FIRST USE 2-1-2001; IN COMMERCE 2-1-2001.  
JOHN LINCOSKI, EXAMINING ATTORNEY

THE MARK CONSISTS OF STANDARD CHARACTERS WITHOUT CLAIM TO ANY PARTICULAR FONT, STYLE, SIZE, OR COLOR.

NO CLAIM IS MADE TO THE EXCLUSIVE RIGHT TO USE "DRUMSTICKS", APART FROM THE MARK AS SHOWN.

FOR DRUMSTICKS (U.S. CLS. 2, 21 AND 36).  
MIDGE BUTLER, EXAMINING ATTORNEY

SN 76-509,095. AMERICAN SOCIETY FOR CLINICAL PATHOLOGY, INC., CHICAGO, IL. FILED 4-23-2003.



SN 78-421,784. SABIAN LTD., MEDUCTIC, NEW BRUNSWICK, CANADA, FILED 5-19-2004.

OWNER OF U.S. REG. NO. 747,081.  
FOR SERIES OF BOOKS, BROCHURES, PAMPHLETS AND TECHNICAL BOOKLETS FOR USE BY MEDICAL LABORATORY PERSONNEL FOR SELF-ASSESSMENT IN THE FIELD OF PATHOLOGY AND LABORATORY MEDICINE (U.S. CLS. 2, 5, 22, 23, 29, 37, 38 AND 50).  
FIRST USE 1-1-2002; IN COMMERCE 1-1-2002.  
KELLY BOULTON, EXAMINING ATTORNEY

**VAULT**

SN 76-532,659. SMORGANBORD, LTD., CHICAGO, IL. FILED 7-28-2003.

**PUMPS PATCH UP MY  
PRETTY SOUL**

THE MARK CONSISTS OF STANDARD CHARACTERS WITHOUT CLAIM TO ANY PARTICULAR FONT, STYLE, SIZE, OR COLOR.

FOR MUSICAL CYMBALS AND GONGS (U.S. CLS. 2, 21 AND 36).  
CHERYL CLAYTON, EXAMINING ATTORNEY

FOR (BASED ON INTENT TO USE) STATIONERY; (BASED ON USE IN COMMERCE) GREETING CARDS (U.S. CLS. 2, 5, 22, 23, 29, 37, 38 AND 50).  
FIRST USE 6-1-2002; IN COMMERCE 6-1-2002.  
SUE LAWRENCE, EXAMINING ATTORNEY

**CLASS 16—(Continued).**

SN 76-543,014. CAREER COMMUNICATIONS, OVERLAND PARK, KS. FILED 8-25-2003.

## **ACK! AMERICAN CAREERS FOR KIDS**

OWNER OF U.S. REG. NO. 1,836,754.  
SEC. 2(F).

FOR MAGAZINES, PRIMARILY FOR ELEMENTARY SCHOOL AGE STUDENTS DEALING WITH JOB OPPORTUNITIES AND THE VARIOUS EDUCATIONAL AND OTHER REQUIREMENTS FOR SUCH OPPORTUNITIES (U.S. CLS. 2, 5, 22, 23, 29, 37, 38 AND 50).

FIRST USE 5-31-1996; IN COMMERCE 5-31-1996.  
RONALD MCMORROW, EXAMINING ATTORNEY

SN 76-554,519. TUB PRODUCTIONS, LLC, ROSEMONT, PA.  
FILED 10-27-2003.

## **HELLO MUSIC**

NO CLAIM IS MADE TO THE EXCLUSIVE RIGHT TO USE MUSIC, APART FROM THE MARK AS SHOWN.

FOR EARLY CHILDHOOD EDUCATION KIT CONSISTING OF PRINTED CURRICULUM MATERIALS, MUSIC RECORDINGS, AND SUPPORTING MANIPULATIVES FEATURING MUSIC FOR ASSISTING CHILDREN TO LEARN A VARIETY OF SUBJECTS (U.S. CLS. 2, 5, 22, 23, 29, 37, 38 AND 50).

PRISCILLA MILTON, EXAMINING ATTORNEY

SN 76-554,520. TUB PRODUCTIONS, LLC, ROSEMONT, PA.  
FILED 10-27-2003.

## **HIPPO ABUELO**

THE SPANISH TRANSLATION OF "ABUELO" IS "GRANDFATHER".

FOR EARLY CHILDHOOD EDUCATION KIT CONSISTING OF PRINTED CURRICULUM MATERIALS, MUSIC RECORDINGS, AND SUPPORTING MANIPULATIVES FEATURING MUSIC FOR ASSISTING CHILDREN TO LEARN A VARIETY OF SUBJECTS (U.S. CLS. 2, 5, 22, 23, 29, 37, 38 AND 50).

PRISCILLA MILTON, EXAMINING ATTORNEY

SN 76-554,521. TUB PRODUCTIONS, LLC, ROSEMONT, PA.  
FILED 10-27-2003.

## **TINY TURTLES**

FOR EARLY CHILDHOOD EDUCATION KIT CONSISTING OF PRINTED CURRICULUM MATERIALS, MUSIC RECORDINGS, AND SUPPORTING MANIPULATIVES FEATURING MUSIC FOR ASSISTING CHILDREN TO LEARN A VARIETY OF SUBJECTS (U.S. CLS. 2, 5, 22, 23, 29, 37, 38 AND 50).

FIRST USE 9-0-2001; IN COMMERCE 12-0-2001.  
PRISCILLA MILTON, EXAMINING ATTORNEY

**CLASS 16—(Continued).**

SN 76-556,885. BANKABLE INCORPORATED, LOS ANGELES, CA. FILED 9-17-2003.

## **LUVTY**

FOR PAPER PARTY PRODUCTS, NAMELY, PARTY FAVORS, PARTY BAGS, PARTY DECORATIONS AND PARTY HATS; GIFT WRAPPING PAPER, PAPER BOWS AND RIBBONS FOR GIFT WRAP; PAPER RIBBONS; METALLIC GIFT WRAP AND GIFT WRAPPING PAPER; SCENTED PAPER DRAWER LINERS, SHELF PAPER, PLASTIC GIFT WRAP, PAPER BOXES AND PAPER DISPLAY BOXES, PAPER GIFT TAGS, PAPER FOR PACKAGING AND TISSUE PAPER; CORRUGATED PAPER, BOXES AND CONTAINERS; CORRUGATED RECORD STORAGE BOXES; PAPER CUTTERS; PRINTING PAPER, RECYCLED PAPER, ART PAPER, CRAFT PAPER, CREPE PAPER, TRACING PAPER, PAPER MACHE, PAPER MACHE FIGURINES, DRAWING PAPER, CONSTRUCTION PAPER, CORRUGATED PAPER, FLUORESCENT PAPER, ILLUSTRATION PAPER, LAMINATED PAPER, LINING PAPER, PAPER BABY BIBS, PAPER MAIL POUCHES, PAPER MATS, PAPER PILLOWCASES, PAPER NAPKINS, PAPER PLACE MATS, PAPER BAKING CUPS, PAPER BOARDS, PAPER CAKE DECORATIONS, PAPER DOILIES, PAPER DROP CLOTHS, PAPER TABLE CLOTHS AND LINENS, PAPER TRAYS AND PAPER TRAY COVERS, PAPER WASH-CLOTHS, PAPER TOWELS, PAPER BAKING CUPS, PARCHMENT PAPER AND WAX PAPER; PRINTED AND RELATED MATTER, NAMELY, POSTERS, CALENDARS, TEMPORARY TATTOOS, STICKERS, DECALS, IRON-ON OR PLASTIC TRANSFERS, BUMPER STICKERS, PAPER BAGS AND PAPER GIFT BAGS, FABRIC GIFT BAGS, NOTE CARDS, POSTCARDS, PICTURE POSTCARDS, GREETING CARDS, MUSICAL GREETING CARDS, PRINTED GREETING CARDS WITH ELECTRONIC INFORMATION STORED THEREIN, GIFT CARDS, OCCASION CARDS, SOCIAL NOTE CARDS, MOTIVATIONAL CARDS, CARDS BEARING UNIVERSAL GREETINGS, BLANK CARDS, BLANK NOTE CARDS, PLACE CARDS, BLANK AND PARTIALLY PRINTED CARDS, RECORD CARDS, SCORE CARDS, TRADING CARDS, SCRAPBOOKS, STATIONERY, NOTE PADS, NOTE PAPER, PAPER NOTE TABLETS, WRITING TABLETS, LOOSE LEAF PAPER, NOTEBOOKS, FOLDERS, FILE FOLDERS, STATIONERY FOLDERS, BOOKMARKS, PAPER PENNANTS, BINDERS, WRITING PAPER, ENVELOPES, APPOINTMENT BOOKS, ADDRESS BOOKS, DESK PADS AND PAPER TAGS; PAPER LABELS; PASSPORT HOLDERS, PAPER HOLE PUNCHES, PERSONAL ORGANIZERS, DESK TOP ORGANIZERS, ORGANIZERS FOR STATIONERY USE AND STATIONERY-TYPE PORTFOLIOS, STATIONERY BOXES, PAPER FLAGS, MOUNTS FOR STAMPS, RUBBER STAMPS, RUBBER DOCUMENT STAMPS, STAMP ALBUMS, STAMP PAD INKS, STAMP PADS, SLEEVES FOR HOLDING AND PROTECTING STAMPS, PAPER BANNERS, HOLDERS FOR DESK ACCESSORIES, COASTERS MADE OF PAPER, LETTER OPENERS, LETTER TRAYS, LETTER RACKS, PEN AND PENCIL CUPS, PENS, PENCILS, MARKERS, PEN AND PENCIL SETS, STICK MARKERS, ERASERS, DRAWING AND DRAFTING RULERS, PENCIL SHARPENERS, BOOK ENDS, BOOK COVERS, CHECKBOOK COVERS, BOOK HOLDERS, PHOTOGRAPH AND COIN ALBUMS; BULLETIN BOARDS; PHOTOGRAPH MOUNTS; PHOTOGRAPHIC OR ART MOUNTS; PHOTOGRAPHIC PRINTS; PHOTOGRAPHS; LITHOGRAPHS; DECORATIVE PAPER CENTERPIECES; DECORATIVE PENCIL-TOP ORNAMENTS; PICTURE BOOKS; PAPER AND CARDBOARD PICTURE MOUNTS; PAPER PHOTO FRAMES AND PAPER PICTURE FRAMES; STORAGE CONTAINERS MADE OF PAPER; GLOBES; PAPERWEIGHTS; PAPER CLIP HOLDERS; PAPER SIGN HOLDERS; PRINTED PAPER SIGNS; PAPER EMBLEMS; PAPER IDENTIFICATION TAGS; PAPER NAME

**CLASS 16—(Continued).**

BADGES; PAPER ILLUSTRATION BOARDS; PAPER FLOWER POT COVERS; CLIP BOARDS; PAPER CLOTHS FOR POLISHING AND CLEANING; PAPER HANDKERCHIEFS; TOUR BOOKS AND FOLIOS; EVENT PROGRAMS AND SOUVENIR PROGRAMS CONCERNING MODELING AND FASHION SHOWS; MAGAZINES, LEAFLETS, JOURNALS, NEWSLETTERS, BOOKLETS, PAMPHLETS AND BROCHURES, ALL OF THE AFORESAID FEATURING LIFESTYLES, BEAUTY AND FASHION, MODELING, ENTERTAINING AND ENTERTAINMENT, MUSIC, THE ARTS, CULTURE AND POLITICS (U.S. CLS. 2, 5, 22, 23, 29, 37, 38 AND 50).  
TRACY CROSS, EXAMINING ATTORNEY

**CLASS 16—(Continued).**

SN 76-564,481. TUESDAY REIGN, INC., ALABASTER, AL. FILED 12-10-2003.

**ROOT**

SN 76-557,457. VANDERSHACK ENTERPRISES, LLC, PULASKI, TN. FILED 10-23-2003.

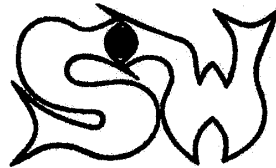

FOR PRINTED MATTER, NAMELY, STICKERS, POSTERS, AND ART PRINTS (U.S. CLS. 2, 5, 22, 23, 29, 37, 38 AND 50).

FIRST USE 9-1-2002; IN COMMERCE 9-1-2002.  
WILLIAM BRECKENFELD, EXAMINING ATTORNEY

THE MARK CONSISTS OF STANDARD CHARACTERS WITHOUT CLAIM TO ANY PARTICULAR FONT, STYLE, SIZE, OR COLOR.

FOR MAGAZINES IN THE FIELD OF MUSIC; PRINTED MATERIALS, NAMELY POSTERS, BOOKLETS AND BROCHURES IN THE FIELD OF MUSIC (U.S. CLS. 2, 5, 22, 23, 29, 37, 38 AND 50).  
JOHN LINCOSKI, EXAMINING ATTORNEY

SN 76-567,099. GRUNER + JAHR PRINTING & PUBLISHING CO., NEW YORK, NY. FILED 12-24-2003.

**CEO SEE-YA**

SN 76-559,429. REAL TRENDS, INC., LITTLETON, CO. FILED 11-13-2003.

lore  
LIVES OF REAL ESTATE

THE MARK CONSISTS OF STANDARD CHARACTERS WITHOUT CLAIM TO ANY PARTICULAR FONT, STYLE, SIZE, OR COLOR.

NO CLAIM IS MADE TO THE EXCLUSIVE RIGHT TO USE REAL ESTATE, APART FROM THE MARK AS SHOWN.

FOR MAGAZINE IN THE FIELD OF REAL ESTATE (U.S. CLS. 2, 5, 22, 23, 29, 37, 38 AND 50).  
PRISCILLA MILTON, EXAMINING ATTORNEY

THE MARK CONSISTS OF STANDARD CHARACTERS WITHOUT CLAIM TO ANY PARTICULAR FONT, STYLE, SIZE, OR COLOR.

NO CLAIM IS MADE TO THE EXCLUSIVE RIGHT TO USE "CEO", APART FROM THE MARK AS SHOWN.

FOR MAGAZINE COLUMN FEATURING SELECTED CORPORATE OFFICERS (U.S. CLS. 2, 5, 22, 23, 29, 37, 38 AND 50).

FIRST USE 11-18-2003; IN COMMERCE 11-18-2003.  
JASON TURNER, EXAMINING ATTORNEY

SN 76-574,374. MURRAY, MARY CAREY, GARDEN CITY, NY. FILED 2-6-2004.

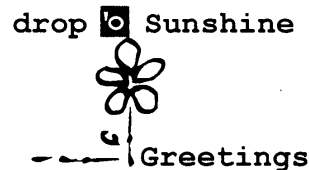

NO CLAIM IS MADE TO THE EXCLUSIVE RIGHT TO USE "GREETINGS", APART FROM THE MARK AS SHOWN.

FOR GREETING CARDS (U.S. CLS. 2, 5, 22, 23, 29, 37, 38 AND 50).  
VIVIAN MICZNIK FIRST, EXAMINING ATTORNEY

**CLASS 16—(Continued).**

SN 76-579,146. HONDA MOTOR CO., LTD., MINATO-KU, TOKYO 107-8556, JAPAN, FILED 3-4-2004.

# HONDA

OWNER OF U.S. REG. NOS. 826,779, 2,390,539 AND OTHERS.  
FOR WRITING INSTRUMENTS (U.S. CLS. 2, 5, 22, 23, 29, 37, 38 AND 50).  
FIRST USE 1-1-1970; IN COMMERCE 1-1-1970.  
EVELYN BRADLEY, EXAMINING ATTORNEY

SN 76-579,438. KMD MEDIA, L.L.C., MCLEAN, VA. FILED 2-26-2004.

**HOMELAND SECURITY TODAY**

THE MARK CONSISTS OF STANDARD CHARACTERS WITHOUT CLAIM TO ANY PARTICULAR FONT, STYLE, SIZE, OR COLOR.

NO CLAIM IS MADE TO THE EXCLUSIVE RIGHT TO USE "HOMELAND SECURITY", APART FROM THE MARK AS SHOWN.

FOR PRINTED MATERIALS, NAMELY, NATIONAL DEFENSE AND HOMELAND SECURITY MAGAZINES, NEWSLETTERS, AND JOURNALS (U.S. CLS. 2, 5, 22, 23, 29, 37, 38 AND 50).

FIRST USE 1-0-2004; IN COMMERCE 1-0-2004.  
ELLEN B. AWRICH, EXAMINING ATTORNEY

SN 76-581,448. FLORIDA SENIOR PRESS, L.L.C., MIAMI BEACH, FL. FILED 3-17-2004.

# FOY

FOR GENERAL FEATURE MAGAZINES (U.S. CLS. 2, 5, 22, 23, 29, 37, 38 AND 50).  
INGA ERVIN, EXAMINING ATTORNEY

**CLASS 16—(Continued).**

SN 76-584,091. SENTEN, INC., DESTIN, FL. FILED 3-29-2004.

**THRIFTY NICKEL**

THE MARK CONSISTS OF STANDARD CHARACTERS WITHOUT CLAIM TO ANY PARTICULAR FONT, STYLE, SIZE, OR COLOR.

OWNER OF U.S. REG. NOS. 1,645,224, 1,645,992 AND 2,878,187.

FOR WANT-ADS NEWSPAPER (U.S. CLS. 2, 5, 22, 23, 29, 37, 38 AND 50).

FIRST USE 5-24-1974; IN COMMERCE 6-8-1974.  
IRA J. GOODSaid, EXAMINING ATTORNEY

SN 76-586,431. GOLDSTEIN, IRA, RALEIGH, NC. AND GOLDSTEIN, DAVID, RALEIGH, NC. FILED 4-1-2004.

**HARMONY QUILL**

FOR ARTIST'S MATERIALS, NAMELY, PAINT BRUSHES (U.S. CLS. 2, 5, 22, 23, 29, 37, 38 AND 50).

FIRST USE 1-1-2002; IN COMMERCE 1-1-2002.  
GEORGIA CARTY, EXAMINING ATTORNEY

SN 76-589,551. PICKETT, STACEY, ENID, OK. AND PICKETT, KIMBERLY, ENID, OK. FILED 4-19-2004.

**Letters from Christ**

**...brings gifts from the heart**

FOR INFORMATIONAL LETTERS CONCERNING RELIGION (U.S. CLS. 2, 5, 22, 23, 29, 37, 38 AND 50).  
ARETHA SOMERVILLE, EXAMINING ATTORNEY

SN 76-590,550. HOFFER, PETER, MONTREAL, QUEBEC, CANADA, FILED 5-5-2004.

**THE TULIP BOX**

THE MARK CONSISTS OF STANDARD CHARACTERS WITHOUT CLAIM TO ANY PARTICULAR FONT, STYLE, SIZE, OR COLOR.

FOR DECORATIVE ART WORK, NAMELY, PRINTS AND REPRODUCTIONS (U.S. CLS. 2, 5, 22, 23, 29, 37, 38 AND 50).

FIRST USE 5-10-2000; IN COMMERCE 5-10-2000.  
LOURDES AYALA, EXAMINING ATTORNEY

**CLASS 16—(Continued).**

SN 76-591,172. CLAMPIT, SHELLEY A., DBA THE GIFT SHAKER, MONTICELLO, AR. FILED 5-10-2004.

**GIFT SHAKER**

THE MARK CONSISTS OF STANDARD CHARACTERS WITHOUT CLAIM TO ANY PARTICULAR FONT, STYLE, SIZE, OR COLOR.

NO CLAIM IS MADE TO THE EXCLUSIVE RIGHT TO USE "GIFT", APART FROM THE MARK AS SHOWN.

FOR DECORATIVELY WRAPPED PAPER AND CARDBOARD CONTAINERS FOR MISCELLANEOUS GOODS (U.S. CLS. 2, 5, 22, 23, 29, 37, 38 AND 50).

FIRST USE 1-4-2003; IN COMMERCE 2-15-2003.  
CYNTHIA SLOAN, EXAMINING ATTORNEY

**CLASS 16—(Continued).**

SN 76-592,564. SCHOLASTIC INC., NEW YORK, NY. FILED 5-17-2004.



FOR SERIES OF CHILDREN'S BOOKS (U.S. CLS. 2, 5, 22, 23, 29, 37, 38 AND 50).

LAURA KOVAISKY, EXAMINING ATTORNEY

SN 76-591,877. SOUTHSTAR ENERGY SERVICES LLC, DBA GEORGIA NATURAL GAS AND GEORGIA NATURAL GAS SERVICES, ATLANTA, GA. FILED 5-12-2004.

**TRUE BLUE NOTES**

THE MARK CONSISTS OF STANDARD CHARACTERS WITHOUT CLAIM TO ANY PARTICULAR FONT, STYLE, SIZE, OR COLOR.

FOR CUSTOMER INFORMATIONAL PUBLICATIONS THAT ARE INSERTED INTO CUSTOMER BILLINGS, NAMELY, PRINTED INFORMATIONAL NEWSLETTERS FOR CONSUMERS OF NATURAL GAS ENERGY SERVICES (U.S. CLS. 2, 5, 22, 23, 29, 37, 38 AND 50).

FIRST USE 8-1-1999; IN COMMERCE 8-1-1999.  
LEIGH CAROLINE CASE, EXAMINING ATTORNEY

SN 76-592,565. SCHOLASTIC INC., NEW YORK, NY. FILED 5-17-2004.

**THINK FACTORY**

THE MARK CONSISTS OF STANDARD CHARACTERS WITHOUT CLAIM TO ANY PARTICULAR FONT, STYLE, SIZE, OR COLOR.

FOR SERIES OF CHILDREN'S BOOKS (U.S. CLS. 2, 5, 22, 23, 29, 37, 38 AND 50).

LAURA KOVAISKY, EXAMINING ATTORNEY

SN 76-592,563. SCHOLASTIC INC., NEW YORK, NY. FILED 5-17-2004.



FOR SERIES OF CHILDREN'S BOOKS (U.S. CLS. 2, 5, 22, 23, 29, 37, 38 AND 50).

LAURA KOVAISKY, EXAMINING ATTORNEY

SN 76-618,708. ROCKLINE INDUSTRIES, INC., SHEBOYGAN, WI. FILED 10-28-2004.

**ON MY OWN**

THE MARK CONSISTS OF STANDARD CHARACTERS WITHOUT CLAIM TO ANY PARTICULAR FONT, STYLE, SIZE, OR COLOR.

FOR DISPOSABLE TRAINING PANTS (U.S. CLS. 2, 5, 22, 23, 29, 37, 38 AND 50).

GRETTA YAO, EXAMINING ATTORNEY

**CLASS 16—(Continued).**

SN 78-155,366. IT PAYS, INC., GRAND HAVEN, MI. FILED 8-19-2002.



NO CLAIM IS MADE TO THE EXCLUSIVE RIGHT TO USE "HOCKEY", APART FROM THE MARK AS SHOWN.

THE MARK CONSISTS OF A CIRCLE ON WHICH IS SUPERIMPOSED A STYLIZED ARM WHICH IS DISPOSED IN A COUNTERCLOCKWISE DIRECTION, TERMINATING IN AN OTHERWISE CLOSED HAND HAVING A RAISED INDEX FINGER. A CURVED CHEVRON IS LOCATED WITHIN THE ARM BELOW THE HAND. A STAR IS LOCATED IMMEDIATELY ABOVE THE RAISED INDEX FINGER. THE PHRASE "IT PAYS" IS LOCATED ON A SLIGHT INCLINE WITHIN THE STYLIZED WITH THE INITIAL LETTER OVERLAPPING THE ARM. THE WORD "HOCKEY" IS LOCATED IMMEDIATELY ABOVE THE PHRASE "IT PAYS" AND IS ALSO SLIGHTLY INCLINED.

FOR PRINTED MATERIALS, NAMELY, BROCHURES IN THE FIELD OF HOCKEY (U.S. CLS. 2, 5, 22, 23, 29, 37, 38 AND 50).

FIRST USE 3-6-2002; IN COMMERCE 3-6-2002.  
SHARON MEIER, EXAMINING ATTORNEY

SN 78-202,628. NETWORK ENTERPRISES, INC. NEW YORK, NY. FILED 1-13-2003.

**JIM TV**

NO CLAIM IS MADE TO THE EXCLUSIVE RIGHT TO USE "TV", APART FROM THE MARK AS SHOWN.

FOR PRINTED MATTER, NAMELY, NOTE PAPER AND LOOSE LEAF PAPER, ENVELOPES, SERIES OF FICTION BOOKS AND NON-FICTION BOOKS IN THE FIELD OF ENTERTAINMENT, DECALS, BUMPER STICKERS, TRADING CARDS, NOTE CARDS, POSTERS, FOLDERS, PENCILS, PENS, CALENDARS, PAPER BANNERS, PAPER NAPKINS; TRAVEL MAGAZINES; GENERAL FEATURE MAGAZINES; TRAVEL GUIDE BOOKS; HOTEL DIRECTORIES (U.S. CLS. 2, 5, 22, 23, 29, 37, 38 AND 50).

ANN E. SAPPENFIELD, EXAMINING ATTORNEY

**CLASS 16—(Continued).**

SN 78-220,323. ANGEL TOES, INC., EDINA, MN. FILED 2-28-2003.

**GOOD NEWZ TATTOOZ**

NO CLAIM IS MADE TO THE EXCLUSIVE RIGHT TO USE "TATTOOS", APART FROM THE MARK AS SHOWN. FOR TEMPORARY TATTOOS (U.S. CLS. 2, 5, 22, 23, 29, 37, 38 AND 50).

FIRST USE 5-1-2002; IN COMMERCE 6-1-2002.  
BARBARA GAYNOR, EXAMINING ATTORNEY

SN 78-225,652. BROOKS, GLENN M., MOE, AUSTRALIA, FILED 3-14-2003.

**ROCKY MOUNTAIN RAILROAD**

FOR SERIES OF FICTIONAL BOOKS (U.S. CLS. 2, 5, 22, 23, 29, 37, 38 AND 50).

WENDY GOODMAN, EXAMINING ATTORNEY

SN 78-228,112. PAPER CONVERTING OF AMERICA, INC., BROOKLYN, NY. FILED 3-20-2003.

*Happy Faces*

FOR DISPOSABLE DIAPERS (U.S. CLS. 2, 5, 22, 23, 29, 37, 38 AND 50).

FIRST USE 6-1-1998; IN COMMERCE 6-1-1998.  
TRACY FLETCHER, EXAMINING ATTORNEY

SN 78-294,629. JOSS PRODUCTIONS, INC., ALBANY, NY. FILED 9-1-2003.

**ANONYMOUSLY YOURS**

FOR PAPER GOODS, NAMELY GREETING CARDS AND STATIONERY (U.S. CLS. 2, 5, 22, 23, 29, 37, 38 AND 50).

FIRST USE 1-1-2003; IN COMMERCE 9-1-2003.  
IRA J. GOODSAD, EXAMINING ATTORNEY



**CLASS 16—(Continued).**

SN 78-298,135. VOLVO CAR CORPORATION, AKA VOLVO PERSONVAGNAR AB, GOTEBOURG, SWEDEN, FILED 9-9-2003.



THE MARK CONSISTS OF A FANCIFUL REPRESENTATION OF A SAFETY PIN IN THE SHAPE OF AN AUTOMOBILE.

FOR PUBLICATIONS, NAMELY, BROCHURES, POSTERS, PAMPHLETS AND NEWSLETTERS RELATING TO VEHICLES AND VEHICLE SAFETY (U.S. CLS. 2, 5, 22, 23, 29, 37, 38 AND 50).

FIRST USE 6-30-2001; IN COMMERCE 6-30-2001.  
REBECCA GILBERT, EXAMINING ATTORNEY

SN 78-309,904. SIERPINA, ANGELA B., CAVE CREEK, AZ. FILED 10-6-2003.

**WHOLE MOTHER**

FOR PRINTED INSTRUCTIONAL AND EDUCATIONAL TEACHING MATERIALS, SYNDICATED NEWSPAPER COLUMNS, MAGAZINES, NEWSLETTERS, CALENDARS, JOURNALS, SERIES OF FICTION AND NON-FICTION BOOKS IN THE FIELDS OF INSPIRATIONAL, SPIRITUALITY, PERSONAL DEVELOPMENT, SELF-FULFILLMENT, SELF-HELP, SELF-ANALYSIS, HERITAGE, ETHNICITY, CULTURAL TRADITIONS AND CUSTOMS, WOMEN'S STUDIES AND MOTIVATIONAL TOPICS (U.S. CLS. 2, 5, 22, 23, 29, 37, 38 AND 50).

DOMINIC J. FERRAIUOLO, EXAMINING ATTORNEY

SN 78-317,140. JAIN, SHRI RAMANLAL RUGHNATHMALJI, MAHARAHSTRA, INDIA, FILED 10-22-2003.

**MONTEX**

FOR FOUNTAIN PENS, PEN NIBS, PENCILS, BALL POINT PENS, ROLLER PENS, GEL INK PENS AND ALL OTHER TYPES OF WRITING INSTRUMENTS AND COVERS THEREFOR, ALL TYPES OF PEN REFILLS, WRITING INKS, ELECTRIC AND NON-ELECTRIC PENCIL SHARPENERS, PEN STANDS, OFFICE AND SCHOOL STATIONERIES, ALL TYPES OF SKETCH PENS, COLOR PENS, FELT AND PLASTIC NIB PENS, MARKER PENS AND PENCILS, HIGHLIGHTING MARKERS, PENCIL LEADS, ERASERS, ADHESIVES AND GLUES FOR STATIONERY AND HOUSEHOLD PURPOSES, COLOR CRAYONS, COLOR PASTELS, PAINT BRUSHES, STATIONERY, WRITING SLATES AND BOARDS, WHITE BOARDS, PHOTOGRAPHS, ADHESIVES FOR STATIONERY PURPOSES, PRINTING TYPE AND PRINTING CLICHES, PRINTING PAPER, BOOK BINDINGS, DRAWING INSTRUMENT BOXES, NAMELY, BOXES FOR GEOMETRICAL INSTRUMENTS SUCH AS DRAWING COMPASSES, CURVES, TRIANGLES, SHIELDS AND THE LIKE (U.S. CLS. 2, 5, 22, 23, 29, 37, 38 AND 50).

SUE LAWRENCE, EXAMINING ATTORNEY

**CLASS 16—(Continued).**

SN 78-331,489. RODALE INC., EMMAUS, PA. FILED 11-21-2003.

**WALK OFF WEIGHT**

THE MARK CONSISTS OF STANDARD CHARACTERS WITHOUT CLAIM TO ANY PARTICULAR FONT, STYLE, SIZE, OR COLOR.

FOR MAGAZINE IN THE FIELD OF HEALTH, FITNESS, DIET, EXERCISE AND LEISURE (U.S. CLS. 2, 5, 22, 23, 29, 37, 38 AND 50).

FIRST USE 9-30-1999; IN COMMERCE 9-30-1999.  
CAROLINE WOOD, EXAMINING ATTORNEY

SN 78-333,725. LUCITE INTERNATIONAL, INC., CORDOVA, TN. FILED 11-26-2003.

**LUCITE**

THE MARK CONSISTS OF STANDARD CHARACTERS WITHOUT CLAIM TO ANY PARTICULAR FONT, STYLE, SIZE, OR COLOR.

FOR BOOK BINDING MATERIAL; ARTISTS' MATERIALS, NAMELY, ARTISTS' BRUSHES, ARTISTS' PASTELS, ARTISTS' PENCILS, ARTISTS' PENS, CANVAS PANELS FOR ARTISTS, PAINT FOR ARTISTS AND PAINTING SETS FOR ARTISTS; PLASTIC BAGS FOR PACKAGING; PLASTIC BUBBLE PACKS FOR PACKAGING; MODELING COMPOUNDS INCLUDING MODELING POLYMER; ADHESIVE FOR STATIONERY AND HOUSEHOLD PURPOSES; INDOOR AQUARIUM; AND PARTS AND FITTINGS FOR ALL THE AFORESAID GOODS (U.S. CLS. 2, 5, 22, 23, 29, 37, 38 AND 50).

JIM RINGLE, EXAMINING ATTORNEY

**CLASS 16—(Continued).**

SN 78-348,620. INTERNATIONAL IMAGING MATERIALS, INC., AMHERST, NY. FILED 1-7-2004.

**CLEAN START**

THE MARK CONSISTS OF STANDARD CHARACTERS WITHOUT CLAIM TO ANY PARTICULAR FONT, STYLE, SIZE, OR COLOR.

FOR THERMAL TRANSFER RIBBON WITH A PRINT-HEAD CLEANING LEADER (U.S. CLS. 2, 5, 22, 23, 29, 37, 38 AND 50).

SEAN DWYER, EXAMINING ATTORNEY

**CLASS 16—(Continued).**

SN 78-376,080. MARCOS, JENNY, SHERMAN OAKS, CA. FILED 3-1-2004.

**CLEOPATRA OF THE NILE**

THE MARK CONSISTS OF STANDARD CHARACTERS WITHOUT CLAIM TO ANY PARTICULAR FONT, STYLE, SIZE, OR COLOR.

FOR PRINTED MATERIAL, NAMELY, COMIC BOOKS, PICTURE BOOKS, CALENDARS, AND MAGAZINES IN THE FIELDS OF SPORTS, MUSCLE AND FITNESS, ART, PHOTOGRAPHY, MODELING, ADULT ENTERTAINMENT, CARS, TRUCKS, BICYCLES, COMICS, AND CARTOONS (U.S. CLS. 2, 5, 22, 23, 29, 37, 38 AND 50).

EVELYN BRADLEY, EXAMINING ATTORNEY

SN 78-366,132. CURVES INTERNATIONAL, WACO, TX. FILED 2-11-2004.

**DIANE**

THE MARK CONSISTS OF STANDARD CHARACTERS WITHOUT CLAIM TO ANY PARTICULAR FONT, STYLE, SIZE, OR COLOR.

FOR MAGAZINE PERTAINING TO HEALTH, NUTRITION AND FITNESS (U.S. CLS. 2, 5, 22, 23, 29, 37, 38 AND 50).

FIRST USE 3-10-2004; IN COMMERCE 3-10-2004.  
CHARLES L. JENKINS, EXAMINING ATTORNEY

SN 78-378,035. TEWARI DE-OX SYSTEMS, INC., SAN ANTONIO, TX. AND TEWARI, GAURAV, SAN ANTONIO, TX. FILED 3-3-2004.



THE COLOR(S) BLUE IS/ARE CLAIMED AS A FEATURE OF THE MARK.

THE MARK CONSISTS OF AN IMAGE OF RISING SUN WITH BLUE COLORED FLAMES AND THE WORD "TEWARI" IN BLUE LETTERING INSIDE THE IMAGE OF THE RISING SUN

FOR PLASTIC BAGS FOR PACKAGING THAT EXTENDS THE SHELF LIFE OF FRESH MEATS (U.S. CLS. 2, 5, 22, 23, 29, 37, 38 AND 50).

FIRST USE 0-0-2002; IN COMMERCE 0-0-2002.  
CHARLES L. JENKINS, EXAMINING ATTORNEY

**CLASS 16—(Continued).**

SN 78-380,256. NODINE, SAMANTHA L, RANDOLPH, NJ. FILED 3-8-2004.

**CLASS 16—(Continued).**

SN 78-385,264. GEOMASK, INC., LESUEUR, MN. FILED 3-16-2004.



# Paint Block

NO CLAIM IS MADE TO THE EXCLUSIVE RIGHT TO USE "PUBLICATIONS", APART FROM THE MARK AS SHOWN.

THE COLOR(S) RED IS/ARE CLAIMED AS A FEATURE OF THE MARK.

THE COLOR RED APPEARS AS THE COLOR OF THE MOTHER'S AND SON'S SHIRTS, THE TRIM ON THE OTHER CHILDREN'S CLOTHING AND THE COLOR OF THE ROUND BALL DESIGN.

FOR PRINTED LOG BOOKS TO RECORD AND STORE INFORMATION (U.S. CLS. 2, 5, 22, 23, 29, 37, 38 AND 50).

FIRST USE 0-0-2003; IN COMMERCE 0-0-2003.  
VERNA BETH RIRIE, EXAMINING ATTORNEY

THE MARK CONSISTS OF STANDARD CHARACTERS WITHOUT CLAIM TO ANY PARTICULAR FONT, STYLE, SIZE, OR COLOR.

FOR ADHESIVE TAPES FOR STATIONERY OR HOUSEHOLD PURPOSES (U.S. CLS. 2, 5, 22, 23, 29, 37, 38 AND 50).

INGRID C. EULIN, EXAMINING ATTORNEY

SN 78-380,555. GLASBERG, BOB, SAN DIEGO, CA. FILED 3-8-2004.

SN 78-385,332. MARTHA STEWART LIVING OMNIMEDIA, INC., NEW YORK, NY. FILED 3-16-2004.

# CMAV

# LIVING

THE MARK CONSISTS OF STANDARD CHARACTERS WITHOUT CLAIM TO ANY PARTICULAR FONT, STYLE, SIZE, OR COLOR.

FOR CARTOON STRIPS, CARTOON PRINTS NEWSPAPER CARTOONS (U.S. CLS. 2, 5, 22, 23, 29, 37, 38 AND 50).

CAROLINE WOOD, EXAMINING ATTORNEY

THE MARK CONSISTS OF STANDARD CHARACTERS WITHOUT CLAIM TO ANY PARTICULAR FONT, STYLE, SIZE, OR COLOR.

FOR GENERAL INTEREST MAGAZINES AND SECTION OR COLUMN OF A NEWSPAPER (U.S. CLS. 2, 5, 22, 23, 29, 37, 38 AND 50).

DOMINIC J. FERRAIUOLO, EXAMINING ATTORNEY

**CLASS 16—(Continued).**

SN 78-387,819. GENENTECH, INC., SOUTH SAN FRANCISCO, CA. FILED 3-19-2004.

**CLASS 16—(Continued).**

SN 78-393,348. HARTMAN, WADE, WAYNE, NJ. FILED 3-30-2004.

## TRANSLATING SCIENCE INTO LIFE

THE MARK CONSISTS OF STANDARD CHARACTERS WITHOUT CLAIM TO ANY PARTICULAR FONT, STYLE, SIZE, OR COLOR.

FOR PRINTED EDUCATIONAL AND INFORMATIONAL PUBLICATIONS RELATED TO CANCER, NAMELY, PAMPHLETS, MAGAZINES, REPORTS, BOOKS, MANUALS, LEAFLETS, CONVENTION DISPLAYS, JOURNALS, NEWSLETTERS, SLIDES, BULLETINS, FLASHCARDS, POSTERS, BROCHURES, TRAINING MATERIALS, CALENDARS, PANELS AND GUIDES (U.S. CLS. 2, 5, 22, 23, 29, 37, 38 AND 50).  
CAROLYN CATALDO, EXAMINING ATTORNEY

## KEY-PAK

THE MARK CONSISTS OF STANDARD CHARACTERS WITHOUT CLAIM TO ANY PARTICULAR FONT, STYLE, SIZE, OR COLOR.

FOR PAPERBOARD CONTAINERS FOR PHARMACEUTICAL PRODUCTS AND DRUGS (U.S. CLS. 2, 5, 22, 23, 29, 37, 38 AND 50).

FIRST USE 3-0-2003; IN COMMERCE 3-0-2003.  
DAVID MURRAY, EXAMINING ATTORNEY

---

SN 78-391,798. ELECTRONIC SENSOR TECHNOLOGY LP, NEWBURY PARK, CA. FILED 3-26-2004.

---

SN 78-395,753. WYNDCLYFFE LLC, NEW YORK, NY. FILED 4-2-2004.

## VAPORPRINT

## WYNDCLYFFE

THE MARK CONSISTS OF STANDARD CHARACTERS WITHOUT CLAIM TO ANY PARTICULAR FONT, STYLE, SIZE, OR COLOR.

OWNER OF U.S. REG. NO. 2,396,322.  
FOR CLOSED-FIGURE PRINTED POLAR DIAGRAMS WHICH ARE INDICATIVE OF THE CHEMICAL CONSTITUENTS OF PARTICULAR VAPORS (U.S. CLS. 2, 5, 22, 23, 29, 37, 38 AND 50).

FIRST USE 7-1-2001; IN COMMERCE 7-1-2001.  
ELLEN PERKINS, EXAMINING ATTORNEY

THE MARK CONSISTS OF STANDARD CHARACTERS WITHOUT CLAIM TO ANY PARTICULAR FONT, STYLE, SIZE, OR COLOR.

FOR ADDRESS BOOKS; PHOTOGRAPH ALBUMS; APPOINTMENT BOOKS; BLANK CARDS; BOOK HOLDERS; BOOKMARKS; BOOKS FEATURING INFORMATION ON RENOVATION AND HOME IMPROVEMENT; CALENDARS; COOKBOOKS; DAILY PLANNERS; DESK SETS; GREETING CARDS; LEATHER BOOK COVERS; RENOVATION AND HOME IMPROVEMENT MAGAZINES; PAPER NAPKINS; PAPER PARTY DECORATIONS; PAPER PLACE MATS; PAPER TABLE LINENS; PAPERWEIGHTS; SCRAPBOOK ALBUMS; SCRAPBOOKS; STATIONERY (U.S. CLS. 2, 5, 22, 23, 29, 37, 38 AND 50).

JENNIFER KRISP, EXAMINING ATTORNEY

**CLASS 16—(Continued).**

SN 78-397,990. GRAVNING, PATRICIA M., ENCINO, CA. FILED 4-7-2004.



FOR STICKERS (U.S. CLS. 2, 5, 22, 23, 29, 37, 38 AND 50).  
 FIRST USE 10-1-2002; IN COMMERCE 10-1-2002.  
 CHRISTOPHER BUONGIORNO, EXAMINING ATTORNEY

---

SN 78-397,994. GRAVNING, PATRICIA M., ENCINO, CA. FILED 4-7-2004.



FOR STICKERS (U.S. CLS. 2, 5, 22, 23, 29, 37, 38 AND 50).  
 FIRST USE 10-1-2002; IN COMMERCE 10-1-2002.  
 CHRISTOPHER BUONGIORNO, EXAMINING ATTORNEY

**CLASS 16—(Continued).**

SN 78-399,737. MICROSOFT CORPORATION, REDMOND, WA. FILED 4-9-2004.

**FORZA MOTORSPORT**

THE MARK CONSISTS OF STANDARD CHARACTERS WITHOUT CLAIM TO ANY PARTICULAR FONT, STYLE, SIZE, OR COLOR.

NO CLAIM IS MADE TO THE EXCLUSIVE RIGHT TO USE "MOTORSPORT", APART FROM THE MARK AS SHOWN.

THE FOREIGN WORDING IN THE MARK TRANSLATES INTO ENGLISH AS FORCE.

FOR PRINTED PUBLICATIONS, NAMELY, STRATEGY GUIDES, USER MANUALS, COMIC BOOKS, SERIES OF FICTION BOOKS, MAGAZINES AND NEWSLETTERS ALL IN THE FIELD OF COMPUTER GAMES, SCIENCE FICTION, GAMES AND HOME ENTERTAINMENT; PENS, PENCILS, MARKERS, STATIONERY, STATIONERY-TYPE PORTFOLIOS, CLIPBOARDS, DESK SETS, PEN AND PENCIL HOLDERS, MOUNTED AND UNMOUNTED PHOTOGRAPHS, POSTERS, MAGNETIC BOARDS, MEMO PADS, BINDERS, STAPLERS, PAPERWEIGHTS, PAPER COASTERS, CALENDARS, NOTEBOOKS, BOOK COVERS, STICKER BOOKS, GREETING CARDS AND NOTE CARDS (U.S. CLS. 2, 5, 22, 23, 29, 37, 38 AND 50).  
 BARNEY CHARLON, EXAMINING ATTORNEY

---

SN 78-399,900. REZAI, LAILA, SAN ANSELMO, CA. FILED 4-11-2004.

*Looky-Loo*

FOR STATIONERY (U.S. CLS. 2, 5, 22, 23, 29, 37, 38 AND 50).  
 FIRST USE 1-1-2004; IN COMMERCE 3-1-2004.  
 GRETTA YAO, EXAMINING ATTORNEY

**CLASS 16—(Continued).**

SN 78-400,574. ABELL, MARTHA S., BLAINE, WA. FILED 4-12-2004.

## Got the picture?

THE MARK CONSISTS OF STANDARD CHARACTERS WITHOUT CLAIM TO ANY PARTICULAR FONT, STYLE, SIZE, OR COLOR.

FOR GREETING CARDS, POSTERS, ART PICTURES, ART PRINTS, POSTCARDS, CALENDARS, ADDRESS BOOKS, SCRAPBOOK ALBUMS, APPOINTMENT BOOKS (U.S. CLS. 2, 5, 22, 23, 29, 37, 38 AND 50).

FIRST USE 4-7-2004; IN COMMERCE 4-7-2004.  
HOWARD SMIGA, EXAMINING ATTORNEY

---

SN 78-400,846. WIGGINS, LINDA A., NUTLEY, NJ. FILED 4-13-2004.

## The Brainy Bunch

THE MARK CONSISTS OF STANDARD CHARACTERS WITHOUT CLAIM TO ANY PARTICULAR FONT, STYLE, SIZE, OR COLOR.

FOR CHILDREN'S BOOKS, NAMELY, PICTURE BOOKS, ACTIVITY BOOKS, STORY BOOKS AND EDUCATIONAL BOOKS (U.S. CLS. 2, 5, 22, 23, 29, 37, 38 AND 50).

IRA J. GOODSID, EXAMINING ATTORNEY

---

SN 78-401,344. RUBEL, CHARLES B., CORONA DEL MAR, CA. FILED 4-13-2004.

## Quotoons

THE MARK CONSISTS OF (5) WORDS, LETTERS, AND/OR NUMBERS IN STYLIZED FORM.

FOR CARTOON PRINTS, ART PRINTS, NEWSPAPER CARTOONS, GREETING CARDS, PRINTS, DESK CALENDARS, CALENDARS (U.S. CLS. 2, 5, 22, 23, 29, 37, 38 AND 50).

MARK T. MULLEN, EXAMINING ATTORNEY

**CLASS 16—(Continued).**

SN 78-402,943. MARVEL CHARACTERS, INC., LOS ANGELES, CA. FILED 4-16-2004.

## LUKE CAGE

THE MARK CONSISTS OF STANDARD CHARACTERS WITHOUT CLAIM TO ANY PARTICULAR FONT, STYLE, SIZE, OR COLOR.

THE NAME(S), PORTRAIT(S), AND/OR SIGNATURE(S) SHOWN IN THE MARK DOES NOT IDENTIFY A PARTICULAR LIVING INDIVIDUAL.

FOR PUBLICATIONS, NAMELY COMIC BOOKS AND COMIC MAGAZINES AND PRINTED STORIES IN ILLUSTRATED FORM FEATURED IN BOOKS AND MAGAZINES (U.S. CLS. 2, 5, 22, 23, 29, 37, 38 AND 50).

ROBERT COGGINS, EXAMINING ATTORNEY

---

SN 78-408,979. LIBERTY MEMORIAL ASSOCIATION, KANSAS CITY, MO. FILED 4-27-2004.

## Lessons of Liberty

THE MARK CONSISTS OF STANDARD CHARACTERS WITHOUT CLAIM TO ANY PARTICULAR FONT, STYLE, SIZE, OR COLOR.

NO CLAIM IS MADE TO THE EXCLUSIVE RIGHT TO USE "LESSONS", APART FROM THE MARK AS SHOWN.

FOR PRINTED MATTER, NAMELY, PHOTOGRAPHS, STATIONERY, AND INSTRUCTIONAL, EDUCATIONAL AND TEACHING MATERIALS RELATED TO THE LIBERTY MEMORIAL MUSEUM OF WORLD WAR ONE (U.S. CLS. 2, 5, 22, 23, 29, 37, 38 AND 50).

LAURA KOVAISKY, EXAMINING ATTORNEY

**CLASS 16—(Continued).**

SN 78-410,112. INTERNATIONAL MASTERS PUBLISHERS AB, MALMO, SWEDEN, FILED 4-29-2004.

**CLASS 16—(Continued).**

SN 78-414,709. SUSSMAN, JANICE, BOCA RATON, FL. FILED 5-7-2004.

**FUN WITH PHOTOS  
MEMORIES & MORE**

THE MARK CONSISTS OF STANDARD CHARACTERS WITHOUT CLAIM TO ANY PARTICULAR FONT, STYLE, SIZE, OR COLOR.

FOR PRINTED MATERIAL, NAMELY, A SERIES OF CONTINUITY CARDS ON THE SUBJECT OF DESIGNING AND CREATING SCRAPBOOKS, FOR INSERTION INTO A BINDER, AND A BINDER FOR USE IN CONNECTION THEREWITH (U.S. CLS. 2, 5, 22, 23, 29, 37, 38 AND 50).

FIRST USE 3-10-2003; IN COMMERCE 3-10-2003.  
JAMES GRIFFIN, EXAMINING ATTORNEY

**SUPERITIS**

THE MARK CONSISTS OF STANDARD CHARACTERS WITHOUT CLAIM TO ANY PARTICULAR FONT, STYLE, SIZE, OR COLOR.

FOR PUBLICATIONS, NAMELY, BOOKS, NEWSLETTERS, BROCHURES, PAMPHLETS, AND MAGAZINES RELATING TO LIVING, WELL-BEING, HEALTH, BEAUTY, DIET, FITNESS AND EXERCISE (U.S. CLS. 2, 5, 22, 23, 29, 37, 38 AND 50).

KATHY DE JONGE, EXAMINING ATTORNEY

SN 78-413,447. RIVERWOOD CHURCH, CORPUS CHRISTI, TX. FILED 5-5-2004.

*Girlfriends In Grace*

FOR STATIONERY, WRITING PAPER AND ENVELOPES, PENS, BALLPOINT PENS, PENCILS, HIGHLIGHTING PENS, CHILDREN'S BOOKS, CHILDREN'S ACTIVITY BOOKS, COLORING BOOKS, NOTEBOOKS, PICTURE BOOKS, PRAYER BOOKS, PRINTED MUSIC BOOKS, RELIGIOUS BOOKS, SONG BOOKS, WIRE BOUND BOOKS, PAPER POUCHES FOR PACKAGING, PAPER POUCHES FOR MAILING, PAPER TEACHING MATERIALS FOR RELIGIOUS SEMINARS AND CONFERENCES, PRINTED PAPER LABELS, PRINTED PAPER SIGNS, PROTECTIVE COVERS FOR SHEETS OF PAPER AND PAGES OF BOOKS AND THE LIKE, PAPER IDENTIFICATION BADGES, PAPER LABELS, PAPER NAME BADGES, PAPER NAPKINS (U.S. CLS. 2, 5, 22, 23, 29, 37, 38 AND 50).

FIRST USE 5-1-2003; IN COMMERCE 9-27-2003.  
DOMINICK J. SALEMI, EXAMINING ATTORNEY

SN 78-416,076. NITSCHKE, ALETA A., GARFIELD, MN. FILED 5-10-2004.

**THE ROOMS  
CHRONICLE**

THE MARK CONSISTS OF STANDARD CHARACTERS WITHOUT CLAIM TO ANY PARTICULAR FONT, STYLE, SIZE, OR COLOR.

NO CLAIM IS MADE TO THE EXCLUSIVE RIGHT TO USE CHRONICLE, APART FROM THE MARK AS SHOWN. FOR MAGAZINES IN THE FIELD OF HOSPITALITY AND HOTEL SERVICES (U.S. CLS. 2, 5, 22, 23, 29, 37, 38 AND 50).

FIRST USE 7-1-1993; IN COMMERCE 7-1-1993.  
HENRY S. ZAK, EXAMINING ATTORNEY

**CLASS 16—(Continued).**

SN 78-418,674. VIACOM INTERNATIONAL INC., NEW YORK, NY. FILED 5-14-2004.

## FREDERICA

THE MARK CONSISTS OF STANDARD CHARACTERS WITHOUT CLAIM TO ANY PARTICULAR FONT, STYLE, SIZE, OR COLOR.

FOR PRINTED MATTER, NAMELY, NOTE PAPER AND LOOSE LEAF PAPER, SERIES OF FICTION BOOKS, DECALS, BUMPER STICKERS, TRADING CARDS, NOTE CARDS, POSTERS, FOLDERS, CALENDARS, STATIONERY WRITING PAPER AND ENVELOPES, ARTS AND CRAFT PAINT KITS; NOTEBOOKS; BLANK JOURNALS; ADDRESS BOOKS; DIARIES; DAILY PLANNERS; DESKTOP PLANNERS; PERSONAL PLANNERS; BOOKMARKS; AND CARDBOARD; CRAFT BOOKS; SCHOOL SUPPLIES, NAMELY, SCHOOL BOXES MADE OF CARDBOARD PENCIL, PENS, PEN AND PENCIL CASES AND HOLDERS, ERASERS, PENCIL SHARPENERS, HIGHLIGHTS MARKERS, MARKERS, AND DRAWING RULERS; GIFT WRAPPING PAPER; PAPER PARTY DECORATIONS; PARTY PAPER BAGS (U.S. CLS. 2, 5, 22, 23, 29, 37, 38 AND 50).

CHRISTOPHER BUONGIORNO, EXAMINING ATTORNEY

---

SN 78-418,692. VIACOM INTERNATIONAL INC., NEW YORK, NY. FILED 5-14-2004.

## BOOGIE WOOGIE

THE MARK CONSISTS OF STANDARD CHARACTERS WITHOUT CLAIM TO ANY PARTICULAR FONT, STYLE, SIZE, OR COLOR.

FOR PRINTED MATTER, NAMELY, NOTE PAPER AND LOOSE LEAF PAPER, SERIES OF FICTION BOOKS, DECALS, BUMPER STICKERS, TRADING CARDS, NOTE CARDS, POSTERS, FOLDERS, CALENDARS, STATIONERY WRITING PAPER AND ENVELOPES, ARTS AND CRAFT PAINT KITS; NOTEBOOKS; BLANK JOURNALS; ADDRESS BOOKS; DIARIES; DAILY PLANNERS; DESKTOP PLANNERS; PERSONAL PLANNERS; BOOKMARKS; AND CARDBOARD; CRAFT BOOKS; SCHOOL SUPPLIES, NAMELY, SCHOOL BOXES MADE OF CARDBOARD PENCIL, PENS, PEN AND PENCIL CASES AND HOLDERS, ERASERS, PENCIL SHARPENERS, HIGHLIGHTS MARKERS, MARKERS, AND DRAWING RULERS; GIFT WRAPPING PAPER; PAPER PARTY DECORATIONS; PARTY PAPER BAGS (U.S. CLS. 2, 5, 22, 23, 29, 37, 38 AND 50).

KATHLEEN M. VANSTON, EXAMINING ATTORNEY

**CLASS 16—(Continued).**

SN 78-419,132. INSPIRED LIFE MINISTRIES, INC., LEWISVILLE, TX. FILED 5-14-2004.

## Inspired Parents

THE MARK CONSISTS OF STANDARD CHARACTERS WITHOUT CLAIM TO ANY PARTICULAR FONT, STYLE, SIZE, OR COLOR.

FOR STATIONERY WRITING PAPER AND ENVELOPES, PENS, BALLPOINT PENS, PENCILS, HIGHLIGHTING PENS, CHILDREN'S BOOKS, CHILDREN'S ACTIVITY BOOKS, COLORING BOOKS, NOTEBOOKS, PICTURE BOOKS, PRAYER BOOKS, PRINTED MUSIC BOOKS, RELIGIOUS BOOKS, SONG BOOKS, WIRE BOUND BOOKS, PAPER POUCHES FOR PACKAGING, PAPER POUCHES FOR MAILING, PAPER TEACHING MATERIALS FOR RELIGIOUS SEMINARS AND CONFERENCES, PRINTED PAPER LABELS, PRINTED PAPER SIGNS, PROTECTIVE COVERS FOR SHEETS OR PAPER AND PAGES OF BOOKS AND THE LIKE, PAPER IDENTIFICATION BADGES, PAPER LABELS, PAPER NAME BADGES, PAPER NAPKINS (U.S. CLS. 2, 5, 22, 23, 29, 37, 38 AND 50).

FIRST USE 2-1-2004; IN COMMERCE 2-15-2004.

C. DIONNE CLYBURN, EXAMINING ATTORNEY

---

SN 78-419,747. KIMBERLY-CLARK WORLDWIDE, INC., NEENAH, WI. FILED 5-17-2004.



OWNER OF U.S. REG. NOS. 1,599,556 AND 1,758,319. THE MARK CONSISTS OF DESIGN OF A MAN, FOR PAPER TOWELS (U.S. CLS. 2, 5, 22, 23, 29, 37, 38 AND 50).

KAREN BRACEY, EXAMINING ATTORNEY



MARCH 1, 2005

U.S. PATENT AND TRADEMARK OFFICE

TM 285

**CLASS 16—(Continued).**

SN 78-420,781. THE NEW YORK TIMES COMPANY, NEW YORK, NY. FILED 5-18-2004.

**CLASS 17—RUBBER GOODS**

SN 76-584,851. TECHNOFORM CAPRANO UND BRUNNHOFER GMBH & CO., 34277 FULDABRÜCK, FED REP GERMANY, FILED 4-5-2004.

# TGI



THE MARK CONSISTS OF STANDARD CHARACTERS WITHOUT CLAIM TO ANY PARTICULAR FONT, STYLE, SIZE, OR COLOR.

FOR EXTRUDED PLASTIC MATERIAL, NAMELY, SPACERS IN THE FORM OF PROFILES, STRIPS, BARS AND RODS, AND INSULATING CONNECTING MEMBERS IN THE FORM OF PROFILES, STRIPS, RODS AND BARS, ALL FOR USE IN THE MANUFACTURE OF INSULATED WINDOW UNITS (U.S. CLS. 1, 5, 12, 13, 35 AND 50).

LAURA KOVAISKY, EXAMINING ATTORNEY

FOR GENERAL INTEREST MAGAZINE (U.S. CLS. 2, 5, 22, 23, 29, 37, 38 AND 50).  
FIRST USE 8-29-2004; IN COMMERCE 8-29-2004.  
JAMES GRIFFIN, EXAMINING ATTORNEY

SN 76-585,379. WEINGARDEN, MARSHALL L., HAWORTH, NJ. FILED 4-2-2004.

## CLEARGRIPZ

THE MARK CONSISTS OF STANDARD CHARACTERS WITHOUT CLAIM TO ANY PARTICULAR FONT, STYLE, SIZE, OR COLOR.

FOR ADHESIVE HUB POSTS FOR MOUNTING DATA-BEARING DISKS TO SUBSTRATES FOR PACKAGING (U.S. CLS. 1, 5, 12, 13, 35 AND 50).

FIRST USE 4-22-2003; IN COMMERCE 4-22-2003.  
LAURA KOVAISKY, EXAMINING ATTORNEY

SN 79-001,337. CROCCO S.P.A., ITALY, FILED 12-17-2003.

SN 78-260,495. PLACEMENTS CONTEMPORAINS, INC., CHATEAUGUAY, QUEBEC, CANADA, FILED 6-10-2003.

# ALIPROT



NO CLAIM IS MADE TO THE EXCLUSIVE RIGHT TO USE "SECURITY LAMINATES", APART FROM THE MARK AS SHOWN.

FOR BULLET RESISTANT, BURGLAR RESISTANT, FLAME RESISTANT, AND BOMB BLAST RESISTANT POLYESTER PROTECTIVE SHEETING FOR GLASS AND WINDOWS (U.S. CLS. 1, 5, 12, 13, 35 AND 50).

FIRST USE 12-1-1999; IN COMMERCE 12-1-1999.  
BARBARA GAYNOR, EXAMINING ATTORNEY

OWNER OF INTERNATIONAL REGISTRATION 0588311 DATED 7-7-1992, EXPIRES 7-7-2012.  
FOR POLYETHYLENE PACKAGING FILMS (U.S. CLS. 2, 5, 22, 23, 29, 37, 38 AND 50).  
CHARLES L. JENKINS, EXAMINING ATTORNEY

**CLASS 17—(Continued).**

SN 78-289,636. TASCAN, INC., HOUSTON, TX. FILED 8-20-2003.

**COMFORTEMP**

FOR CELLULOSE-BASED BUILDING INSULATION, NAMELY LOOSE FILL ATTIC INSULATION, STABILIZED INSULATION FOR INSULATING ATTICS, WALLS AND FLOORS, SOUNDWALL INSULATION FOR INSULATING WALLS, AND SPRAY-ON INSULATION FOR INSULATING CEILINGS, WALLS AND OTHER SURFACES WHERE THE INSULATION REMAINS EXPOSED TO VIEW (U.S. CLS. 1, 5, 12, 13, 35 AND 50).

CHRISTOPHER BUONGIORNO, EXAMINING ATTORNEY

SN 78-323,343. WESTLAKE PLASTICS COMPANY, LENNI, PA. FILED 11-5-2003.

**PROPYLUX HS**

THE MARK CONSISTS OF STANDARD CHARACTERS WITHOUT CLAIM TO ANY PARTICULAR FONT, STYLE, SIZE, OR COLOR.

OWNER OF U.S. REG. NO. 823,537.

FOR POLYPROPYLENE RODS, RIGID SHEETS AND TUBES FOR GENERAL USE BY INDUSTRIAL FABRICATORS (U.S. CLS. 1, 5, 12, 13, 35 AND 50).

FIRST USE 2-14-2003; IN COMMERCE 2-14-2003.  
DOUGLAS LEE, EXAMINING ATTORNEY

SN 78-420,098. E-WATCH, INC., SAN ANTONIO, TX. FILED 5-17-2004.

**VIEWWATCH**

THE MARK CONSISTS OF STANDARD CHARACTERS WITHOUT CLAIM TO ANY PARTICULAR FONT, STYLE, SIZE, OR COLOR.

FOR PAPER MACHINE CLOTH, NAMELY, PLASTIC WIRE CLOTH FOR USE IN MACHINERY FOR MAKING PAPER PRODUCTS (U.S. CLS. 1, 5, 12, 13, 35 AND 50).

BILL DAWE, EXAMINING ATTORNEY

**CLASS 17—(Continued).**

SN 78-424,252. VETRO INC., VANCOUVER, WA. FILED 5-24-2004.

**GOT AIR?**

THE MARK CONSISTS OF STANDARD CHARACTERS WITHOUT CLAIM TO ANY PARTICULAR FONT, STYLE, SIZE, OR COLOR.

FOR RUBBER HOSES FOR USE IN THE AUTOMOTIVE AND TRUCKING INDUSTRY (U.S. CLS. 1, 5, 12, 13, 35 AND 50).

GRETTA YAO, EXAMINING ATTORNEY

**CLASS 18—LEATHER GOODS**

SN 76-518,284. SWANY AMERICA CORPORATION, JOHNS-TOWN, NY. FILED 5-29-2003.

**WALKING BAG**

NO CLAIM IS MADE TO THE EXCLUSIVE RIGHT TO USE "BAG", APART FROM THE MARK AS SHOWN.

FOR ROLLING SUITCASES AND LUGGAGE (U.S. CLS. 1, 2, 3, 22 AND 41).

NORA BUCHANAN WILL, EXAMINING ATTORNEY

SN 76-580,764. ABBYSON CORPORATION, CALABASAS, CA. FILED 3-12-2004.

**ABBYSON U.S.A.**

THE MARK CONSISTS OF STANDARD CHARACTERS WITHOUT CLAIM TO ANY PARTICULAR FONT, STYLE, SIZE, OR COLOR.

OWNER OF U.S. REG. NO. 2,712,929.

NO CLAIM IS MADE TO THE EXCLUSIVE RIGHT TO USE U.S.A., APART FROM THE MARK AS SHOWN.

FOR LEATHER GOODS, NAMELY, SUITCASES, TOILETRY CASES SOLD EMPTY, HANDBAGS, BRIEFCASES, LUGGAGE, POCKETBOOKS, BACKPACKS, WALLET (U.S. CLS. 1, 2, 3, 22 AND 41).

FIRST USE 11-0-2002; IN COMMERCE 11-0-2002.

INGRID C. EULIN, EXAMINING ATTORNEY

**CLASS 18—(Continued).**

SN 76-587,664. STEVENS, KAREN, DBA BARK BACK!  
STYLE WITH DOGGIE ATTITUDE, NEW YORK, NY.  
FILED 4-16-2004.



FOR PET CLOTHING; DOG CLOTHING (U.S. CLS. 1,  
2, 3, 22 AND 41).  
TONI HICKEY, EXAMINING ATTORNEY

**CLASS 18—(Continued).**

SN 78-298,837. NIKE, INC., BEAVERTON, OR. FILED 9-10-  
2003.



THE MARK CONSISTS OF THE STYLIZED LETTER AND  
NUMBER COMBINATION L23.  
FOR ALL-PURPOSE SPORTS BAGS, BACKPACKS,  
WAISTPACKS AND SHOE BAGS FOR TRAVEL (U.S.  
CLS. 1, 2, 3, 22 AND 41).  
BRIAN PINO, EXAMINING ATTORNEY

SN 76-590,768. THREE C'S DESIGN, LLC, NEW YORK, NY.  
FILED 5-6-2004.

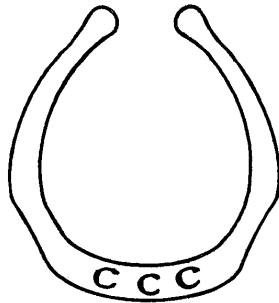

SN 78-304,997. JT INTERNATIONAL DISTRIBUTORS, INC.,  
INDIANAPOLIS, IN. FILED 9-24-2003.

FOR HAND BAGS, LUGGAGE FOR CARRYING PETS,  
DUFFEL BAGS FOR CARRYING PETS; PET LEASHES,  
COLLARS AND HARNESSSES (U.S. CLS. 1, 2, 3, 22 AND  
41).  
FIRST USE 8-16-2002; IN COMMERCE 8-16-2002.  
ZHALEH DELANEY, EXAMINING ATTORNEY



SN 78-298,555. EXO INC., QUEBEC, CANADA, FILED 9-10-  
2003.

**EXO**

FOR BACKPACKS AND WALLETS (U.S. CLS. 1, 2, 3, 22  
AND 41).  
FIRST USE 2-27-1998; IN COMMERCE 2-27-1998.  
PAM WILLIS, EXAMINING ATTORNEY

THE STIPLING IS A FEATURE OF THE MARK.  
FOR EQUINE CLOTHING, NAMELY, HORSE SHEETS,  
HORSE BLANKETS AND HORSE COOLERS (U.S. CLS. 1,  
2, 3, 22 AND 41).  
FIRST USE 6-30-2002; IN COMMERCE 6-30-2002.  
GLENN CLARK, EXAMINING ATTORNEY

**CLASS 18—(Continued).**

SN 78-405,873. OGIO INTERNATIONAL, INC., BLUFFDALE, UT. FILED 4-21-2004.

# SLED

THE MARK CONSISTS OF STANDARD CHARACTERS WITHOUT CLAIM TO ANY PARTICULAR FONT, STYLE, SIZE, OR COLOR.

FOR LUGGAGE, NAMELY, ALL PURPOSE ATHLETIC BAGS, DAYPACKS, BACKPACKS, TOTE BAGS, ALL PURPOSE SPORTS BAGS, DUFFEL BAGS, BOOK BAGS, SCHOOL BAGS, SHOULDER BAGS, HARD-SIDED AND SOFT-SIDED CARRY-ON BAGS (U.S. CLS. 1, 2, 3, 22 AND 41).

DANIEL BRODY, EXAMINING ATTORNEY

**CLASS 18—(Continued).**

SN 78-415,686. VIACOM INTERNATIONAL INC., NEW YORK, NY. FILED 5-10-2004.

# REAL DEAL

THE MARK CONSISTS OF STANDARD CHARACTERS WITHOUT CLAIM TO ANY PARTICULAR FONT, STYLE, SIZE, OR COLOR.

FOR UMBRELLAS, LUGGAGE, LUGGAGE TAGS, TOTE BAGS, BACKPACKS, FANNY PACKS, MESSENGER BAGS, HANDBAGS, WALLETS AND PURSES, ATHLETIC BAGS, GARMENT BAGS FOR TRAVEL, KNAPSACKS, CHANGE PURSES, DUFFLE BAGS, BEACH BAGS (U.S. CLS. 1, 2, 3, 22 AND 41).

PAUL F. GAST, EXAMINING ATTORNEY

---

SN 78-406,246. YASMENA INC., NEW YORK, NY. FILED 4-22-2004.

# Yasmena

THE MARK CONSISTS OF STANDARD CHARACTERS WITHOUT CLAIM TO ANY PARTICULAR FONT, STYLE, SIZE, OR COLOR.

OWNER OF U.S. REG. NO. 2,545,123.  
FOR BAGS NAMELY PURSES, ALL PURPOSE EVENING BAGS, ALL PURPOSE DAY BAGS, SACKS IN THE NATURE OF A PURSE, HANDBAGS, TRAVEL BAGS (U.S. CLS. 1, 2, 3, 22 AND 41).

FIRST USE 5-15-2001; IN COMMERCE 5-15-2001.  
SUSAN HAYASH, EXAMINING ATTORNEY

---

SN 78-418,670. VIACOM INTERNATIONAL INC., NEW YORK, NY. FILED 5-14-2004.

# FREDERICA

THE MARK CONSISTS OF STANDARD CHARACTERS WITHOUT CLAIM TO ANY PARTICULAR FONT, STYLE, SIZE, OR COLOR.

FOR UMBRELLAS, LUGGAGE, LUGGAGE TAGS, TOTE BAGS, BACKPACKS, FANNY PACKS, MESSENGER BAGS, HANDBAGS, WALLETS AND PURSES, ATHLETIC BAGS, GARMENT BAGS FOR TRAVEL, KNAPSACKS, CHANGE PURSES, DUFFLE BAGS, BEACH BAGS (U.S. CLS. 1, 2, 3, 22 AND 41).

CHRISTOPHER BUONGIORNO, EXAMINING ATTORNEY

**CLASS 18—(Continued).**

SN 78-420,023. HARDMAN, KIM A., SAN FRANCISCO, CA. FILED 5-17-2004.

**CLASS 19—NON-METALLIC BUILDING MATERIALS**

SN 75-778,087. FRASER MACHINERY LTD., SURREY, BRITISH COLUMBIA, CANADA, FILED 8-18-1999.

**THIRTYTHREE**

**FRASERVILLE**

THE MARK CONSISTS OF STANDARD CHARACTERS WITHOUT CLAIM TO ANY PARTICULAR FONT, STYLE, SIZE, OR COLOR.

FOR NYLON AND LEATHER GOODS, NAMELY ATTACHE CASES, BACKPACKS, BRIEFCASES, BRIEF-CASE-TYPE PORTFOLIOS, BUSINESS CARD CASES, CLUTCHES, COIN CASES, COSMETIC CASES SOLD EMPTY, CREDIT CARD CASES, DUFFEL BAGS, GARMENT BAGS, HANDBAGS, AND IDENTIFICATION TAGS FOR LUGGAGE, KEY CASES AND LEATHER KEY FOBS, LUGGAGE, PASSPORT COVERS AND PASSPORT HOLDERS, PORTFOLIOS, PURSES, SATCHELS, SHOULDER BAGS, TOILETRY CASES SOLD EMPTY, TOTE BAGS, VERTICAL MESSENGER/LAPTOP BAGS, WAIST POUCHES, WALLETS, AND WATER BOTTLE CARRIERS (U.S. CLS. 1, 2, 3, 22 AND 41).

FIRST USE 4-27-2004; IN COMMERCE 5-17-2004. JULIA HARDY COFIELD, EXAMINING ATTORNEY

PRIORITY CLAIMED UNDER SEC. 44(D) ON CANADA APPLICATION NO. 1024724, FILED 8-4-1999, REG. NO. TMA566706, DATED 8-29-2002, EXPIRES 8-29-2017.

FOR NON-METALLIC PORTABLE HOUSES AND SHEDS FOR HUMAN HABITATION AND STORAGE (U.S. CLS. 1, 12, 33 AND 50).

PAULA MAYS, EXAMINING ATTORNEY

SN 76-331,516. KROY BUILDING PRODUCTS, INC., YORK, NE. FILED 10-29-2001.

**IT'S A SNAP**

SN 78-446,259. CROTON WATCH CO. INC., MOONACHIE, NJ. FILED 7-6-2004.

FOR NON-METAL PORCH RAILS, GUARD RAILS, AND DECK RAILS (U.S. CLS. 1, 12, 33 AND 50).

JENNIFER CHICOSKI, EXAMINING ATTORNEY

SN 76-370,918. CCP HOLDINGS INC., TORONTO, ONTARIO, CANADA, FILED 2-15-2002.

**CROTON**



THE MARK CONSISTS OF STANDARD CHARACTERS WITHOUT CLAIM TO ANY PARTICULAR FONT, STYLE, SIZE, OR COLOR.

OWNER OF U.S. REG. NOS. 648,249 AND 1,713,482. FOR WALLETS, PURSES, BRIEF CASES, BILLFOLDS, TRAVEL BAGS, HANDBAGS, KEY CASES, LUGGAGE, COIN PURSES, UMBRELLAS (U.S. CLS. 1, 2, 3, 22 AND 41).

GRETTA YAO, EXAMINING ATTORNEY

PRIORITY CLAIMED UNDER SEC. 44(D) ON CANADA APPLICATION NO. 1124050, FILED 12-3-2001, REG. NO. TMA618205, DATED 8-31-2004, EXPIRES 8-31-2019.

NO CLAIM IS MADE TO THE EXCLUSIVE RIGHT TO USE "PREMIER RAILING", APART FROM THE MARK AS SHOWN.

FOR NON-METAL RAILING, RAILING COMPONENTS AND RAILING KITS, RAILING HARDWARE AND ACCESSORIES (U.S. CLS. 1, 12, 33 AND 50).

BRIAN NEVILLE, EXAMINING ATTORNEY

**CLASS 19—(Continued).**

SN 76-492,698. CARPETSTONES OF NORTH AMERICA, INC., ORLANDO, FL. FILED 2-26-2003.

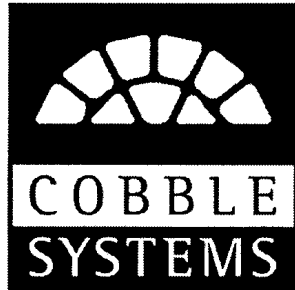

NO CLAIM IS MADE TO THE EXCLUSIVE RIGHT TO USE "COBBLE SYSTEMS", APART FROM THE MARK AS SHOWN.

AS SHOWN IN THE ACCOMPANYING DRAWING, THE MARK SOUGHT TO BE REGISTERED IS COMPRISED OF THE WORDING "COBBLE SYSTEMS" WITHIN A TRIANGULAR DESIGN FEATURING A STYLIZED DEPICTION OF PAVEMENT STONES.

FOR INTERCONNECTED PAVING STONES (U.S. CLS. 1, 12, 33 AND 50).

BARNEY CHARLON, EXAMINING ATTORNEY

SN 76-528,282. OUTDOOR TECHNOLOGIES INC., MACON, MS. FILED 7-7-2003.

**REDIPAK**

OWNER OF U.S. REG. NO. 1,706,780.  
FOR PRE-PACKAGED FENCING AND RAILING SECTIONS MADE PRIMARILY OF PLASTIC (U.S. CLS. 1, 12, 33 AND 50).

FIRST USE 8-0-1999; IN COMMERCE 8-0-1999.

ROBERT C. CLARK JR., EXAMINING ATTORNEY

SN 76-540,804. MARTIN MARIETTA MATERIALS SOUTH-WEST, LTD., SAN ANTONIO, TX. FILED 8-27-2003.



FOR AGGREGATES COMPOSED OF MORTAR, SAND, GRAVEL, CRUSHED STONE, AND STONE MIXES USED FOR LANDSCAPING PURPOSES (U.S. CLS. 1, 12, 33 AND 50).

RON FAIRBANKS, EXAMINING ATTORNEY

**CLASS 19—(Continued).**

SN 76-543,956. BLUE RIBBON STAIRS, INC., SACRAMENTO, CA. FILED 8-28-2003.

**Tred Pak**

NO CLAIM IS MADE TO THE EXCLUSIVE RIGHT TO USE TREAD, APART FROM THE MARK AS SHOWN.  
FOR SIMULATED STAIR TREAD EXTENSION WITH DECORATIVE MOLDING (U.S. CLS. 1, 12, 33 AND 50).  
GENE MACIOL, EXAMINING ATTORNEY

SN 76-554,644. CHURCHILL COATINGS CORPORATION, GRAFTON, MA. FILED 10-10-2003.

**NO BRAINER SIDING**

NO CLAIM IS MADE TO THE EXCLUSIVE RIGHT TO USE SIDING, APART FROM THE MARK AS SHOWN.

FOR WOOD BEVEL SIDING WITH FACTORY APPLIED COATING SYSTEM (U.S. CLS. 1, 12, 33 AND 50).  
FIRST USE 7-15-2003; IN COMMERCE 7-15-2003.

BARNEY CHARLON, EXAMINING ATTORNEY

SN 76-568,941. STONEY CREEK LOG STRUCTURES, LLC, PLYMOUTH, WI. FILED 1-9-2004.

**STONEY CREEK LOG STRUCTURES**

THE MARK CONSISTS OF STANDARD CHARACTERS WITHOUT CLAIM TO ANY PARTICULAR FONT, STYLE, SIZE, OR COLOR.

NO CLAIM IS MADE TO THE EXCLUSIVE RIGHT TO USE LOG STRUCTURES, APART FROM THE MARK AS SHOWN.

FOR PRE-FABRICATED LOG HOME PACKAGES CONSISTING OF PRE-CUT LOGS AND LUMBER; AND PRE-FABRICATED LOG HOMES (U.S. CLS. 1, 12, 33 AND 50).

ALICE BENMAMAN, EXAMINING ATTORNEY

SN 76-578,735. KLEER LUMBER, LLC, WILBRAHAM, MA. FILED 3-1-2004.



FOR LUMBER MADE OF MANMADE MATERIALS FOR GENERAL INDUSTRIAL (U.S. CLS. 1, 12, 33 AND 50).

KARANENDRA S. CHHINA, EXAMINING ATTORNEY

**CLASS 19—(Continued).**

SN 76-581,855. KEMLITE COMPANY, INC., CHANNAHON, IL. FILED 3-18-2004.

**SILHOUETTE TRIMS**

THE MARK CONSISTS OF STANDARD CHARACTERS WITHOUT CLAIM TO ANY PARTICULAR FONT, STYLE, SIZE, OR COLOR.

NO CLAIM IS MADE TO THE EXCLUSIVE RIGHT TO USE "TRIMS", APART FROM THE MARK AS SHOWN.

FOR PLASTIC PANEL TRIM EXTRUSIONS FOR USE WITH FIBERGLASS REINFORCED PLASTIC PANELS (U.S. CLS. 1, 12, 33 AND 50).

FIRST USE 1-23-2004; IN COMMERCE 1-23-2004.

WILLIAM BRECKENFELD, EXAMINING ATTORNEY

---

SN 78-177,540. KINECTRICS INC., TORONTO, ONTARIO, CANADA, FILED 10-23-2002.

**SorbWeb**

THE MARK CONSISTS OF STANDARD CHARACTERS WITHOUT CLAIM TO ANY PARTICULAR FONT, STYLE, SIZE, OR COLOR.

PRIORITY CLAIMED UNDER SEC. 44(D) ON CANADA APPLICATION NO. 1138750, FILED 4-25-2002, REG. NO. TMA616,376, DATED 8-6-2004, EXPIRES 8-6-2019.

FOR SUBTERRANEAN SYSTEM THAT USES GEOSYNTHETIC MATERIALS UNDERNEATH AND AROUND OIL FILLED EQUIPMENT COMPOSED OF SYNTHETIC IMPERMEABLE LINER, A SUBTERRANEAN BARRIER LAYER COMPRISED OF TREATED NATURAL PEAT MOSS OR OTHER NATURAL SORBENT MATERIAL, SEPARATED AND STABILIZED WITH GEOTEXTILE FABRIC AND A CELLULAR CONFINEMENT MESH FOR USE IN A SUBTERRANEAN SYSTEM TO PREVENT OIL FROM LEAKING INTO THE SURROUNDING SOIL (U.S. CLS. 1, 12, 33 AND 50).

MICHAEL SOUDERS, EXAMINING ATTORNEY

---

SN 78-307,311. TRAFFIX DEVICES, INC., SAN CLEMENTE, CA. FILED 9-30-2003.

**COMPRESSOR**

FOR PLASTIC REUSABLE ENERGY ABSORBING CRASH BARRIERS FOR HIGHWAYS, STREETS, AND ROADS (U.S. CLS. 1, 12, 33 AND 50).

KIM SAITO, EXAMINING ATTORNEY

**CLASS 19—(Continued).**

SN 78-361,057. MANLEY, BRENT, BRAINERD, MN. AND ERICKSON, MARK, BRAINERD, MN. FILED 2-2-2004.

**GREAT RIVER DOOR  
COMPANY**

THE MARK CONSISTS OF STANDARD CHARACTERS WITHOUT CLAIM TO ANY PARTICULAR FONT, STYLE, SIZE, OR COLOR.

NO CLAIM IS MADE TO THE EXCLUSIVE RIGHT TO USE "DOOR COMPANY", APART FROM THE MARK AS SHOWN.

FOR NON-METAL DOORS (U.S. CLS. 1, 12, 33 AND 50).

GRETTA YAO, EXAMINING ATTORNEY

---

SN 78-368,113. MOTZ ENTERPRISES, INC., CINCINNATI, OH. FILED 2-13-2004.

**FORTRESS ROCK**

THE MARK CONSISTS OF STANDARD CHARACTERS WITHOUT CLAIM TO ANY PARTICULAR FONT, STYLE, SIZE, OR COLOR.

NO CLAIM IS MADE TO THE EXCLUSIVE RIGHT TO USE "ROCK", APART FROM THE MARK AS SHOWN.

FOR CONCRETE BLOCKS AND WALLS FORMED FROM CONCRETE BLOCKS (U.S. CLS. 1, 12, 33 AND 50).

ALICIA COLLINS, EXAMINING ATTORNEY

---

SN 78-368,118. MOTZ ENTERPRISES, INC., CINCINNATI, OH. FILED 2-13-2004.

**FORTRESS MAT**

THE MARK CONSISTS OF STANDARD CHARACTERS WITHOUT CLAIM TO ANY PARTICULAR FONT, STYLE, SIZE, OR COLOR.

NO CLAIM IS MADE TO THE EXCLUSIVE RIGHT TO USE "MAT", APART FROM THE MARK AS SHOWN.

FOR FLEXIBLE MATS FORMED BY CONCRETE BLOCKS INTERCONNECTED WITH TIES FOR EROSION CONTROL (U.S. CLS. 1, 12, 33 AND 50).

PAULA MAYS, EXAMINING ATTORNEY

**CLASS 19—(Continued).**

SN 78-395,481. SPECCERAMICS, INC., ANAHEIM, CA.  
FILED 4-2-2004.

**CLASS 19—(Continued).**

SN 78-402,230. SOUTHERN MILLWORK COMPANY, HOUSTON, TX. FILED 4-15-2004.

## CREATIVE ENTRIES

# SpecColori

THE MARK CONSISTS OF STANDARD CHARACTERS WITHOUT CLAIM TO ANY PARTICULAR FONT, STYLE, SIZE, OR COLOR.

FOR CERAMIC MOSAIC TILE (U.S. CLS. 1, 12, 33 AND 50).

FIRST USE 2-24-2004; IN COMMERCE 2-24-2004.  
JENNIFER KRISP, EXAMINING ATTORNEY

THE MARK CONSISTS OF STANDARD CHARACTERS WITHOUT CLAIM TO ANY PARTICULAR FONT, STYLE, SIZE, OR COLOR.

NO CLAIM IS MADE TO THE EXCLUSIVE RIGHT TO USE ENTRIES, APART FROM THE MARK AS SHOWN.

FOR NON-METAL DOORS (U.S. CLS. 1, 12, 33 AND 50).

MONIQUE MILLER, EXAMINING ATTORNEY

SN 78-413,300. ORTON, MARK B., MIMBRES, NM. FILED 5-5-2004.

SN 78-395,751. SPECCERAMICS, INC., ANAHEIM, CA.  
FILED 4-2-2004.

# Brace E-Z

# SpecCeramics

THE MARK CONSISTS OF STANDARD CHARACTERS WITHOUT CLAIM TO ANY PARTICULAR FONT, STYLE, SIZE, OR COLOR.

FOR CERAMIC TILE (U.S. CLS. 1, 12, 33 AND 50).

FIRST USE 12-1-1986; IN COMMERCE 12-1-1986.  
JENNIFER KRISP, EXAMINING ATTORNEY

THE MARK CONSISTS OF STANDARD CHARACTERS WITHOUT CLAIM TO ANY PARTICULAR FONT, STYLE, SIZE, OR COLOR.

NO CLAIM IS MADE TO THE EXCLUSIVE RIGHT TO USE BRACE, APART FROM THE MARK AS SHOWN.

FOR CONSTRUCTION ELEMENTS NOT MADE OF METAL, NAMELY, BRACES (U.S. CLS. 1, 12, 33 AND 50).

FIRST USE 1-14-2002; IN COMMERCE 3-14-2002.  
GWEN STOKOLS, EXAMINING ATTORNEY



**CLASS 19—(Continued).**

SN 78-415,499. OCEANS, REEFS, AQUARIUMS, INC., FORT PIERCE, FL. FILED 5-8-2004.

**ROCK O' RAMA**

THE MARK CONSISTS OF STANDARD CHARACTERS WITHOUT CLAIM TO ANY PARTICULAR FONT, STYLE, SIZE, OR COLOR.

FOR ARTIFICIAL MODULAR AND CULTURED CORAL FOR USE IN AQUARIUMS (U.S. CLS. 1, 12, 33 AND 50).

SALLY SHIN, EXAMINING ATTORNEY

SN 78-420,086. WEYERHAEUSER COMPANY, FEDERAL WAY, WA. FILED 5-17-2004.

**ARROWOOD**

THE MARK CONSISTS OF STANDARD CHARACTERS WITHOUT CLAIM TO ANY PARTICULAR FONT, STYLE, SIZE, OR COLOR.

FOR NON METALLIC BUILDING MATERIALS, NAMELY, DECKING ENGINEERED FROM WOOD FIBER AND RECYCLED PLASTIC (U.S. CLS. 1, 12, 33 AND 50).

BARBARA BROWN, EXAMINING ATTORNEY

**CLASS 20—FURNITURE AND ARTICLES NOT OTHERWISE CLASSIFIED**

SN 76-548,129. KING PLASTIC CORPORATION, NORTH PORT, FL. FILED 9-15-2003.

**KING E-BOARD**

OWNER OF U.S. REG. NOS. 1,840,537, 1,986,494 AND OTHERS.

FOR PLASTIC BOARD FOR THE ORGANIZATION AND STORAGE OF WIRING, HARNESSSES AND HOSES ON BOATS AND IN BOAT DOCK AREAS, MARINAS AND OTHER MARINE ENVIRONMENTS (U.S. CLS. 2, 13, 22, 25, 32 AND 50).

FIRST USE 2-21-2003; IN COMMERCE 6-0-2003.

TRACY CROSS, EXAMINING ATTORNEY

**CLASS 20—(Continued).**

SN 76-556,887. BANKABLE INCORPORATED, LOS ANGELES, CA. FILED 9-17-2003.

**LUVTY**

FOR FURNITURE; BEDROOM AND LIVING ROOM FURNITURE, COMPUTER FURNITURE, OFFICE FURNITURE, LAWN AND OUTDOOR FURNITURE, BUMPER GUARDS FOR FURNITURE, CARPET COASTERS FOR PROTECTING FURNITURE LEGS, FIREPLACE SCREENS, FITTED FABRIC FURNITURE COVERS, FURNITURE FRAMES, BEDS, BED FRAMES, BOX SPRINGS, BASSINETS, FURNITURE PARTS AND PARTITIONS, FURNITURE MOLDINGS, FITTED FABRIC FURNITURE COVERS, ENTERTAINMENT CENTERS, WARDROBES, BUFFETS, DRAFTING TABLES, CABINETS, BOOK RESTS, BOOK STANDS, BOOK CASES, BOOSTER SEATS, HIGH CHAIRS, CRIBS, CRADLES, STOOLS, FOOT STOOLS, STEP STOOLS, PORTABLE BACK SUPPORT FOR USE WITH CHAIRS, MIRRORS, LEATHER JEWELRY AND ACCESSORY BOXES, JEWELRY BOXES AND CASES NOT OF PRECIOUS METAL OR COMMON METAL, NON-METAL MONEY BOXES, NON-METAL BOXES, NON-METAL MAIL BOXES, GIFT PACKAGE DECORATIONS MADE OF PLASTIC, NON-METAL MONEY CLIPS, NON-METAL KEY CHAINS AND RINGS, NON-METAL DOG TAGS, PLASTIC KEY TAGS, KEY CHAIN TAGS AND KEY RINGS, PLASTIC NOVELTY LICENSE PLATES, PLASTIC CARD KEYS, PLASTIC BANNERS AND PENNANTS, FANS FOR PERSONAL USE, HAND FANS, SCREENS, TOOL BOXES AND CHESTS, TOY BOXES, FIXED TOWEL DISPENSERS NOT OF METAL, BATHTUB GRAB BARS AND RAILS NOT OF PRECIOUS METAL, AND BATHROOM VANITIES; CURTAIN RAILS AND RODS; DECORATIVE BEAD CURTAINS; NON-METAL WINDOW TRIMS; FREE-STANDING NON-METAL TOOL RACKS, MAGAZINE RACKS, METAL STORAGE RACKS FOR SKI AND SPORTS EQUIPMENT, NON-METAL HAT RACKS, COATSTANDS, PLATE RACKS, STORAGE RACKS, FREE-STANDING TOOL RACKS, WALL-MOUNTED GUN RACKS AND NON-METAL TOOL RACKS, PICTURE FRAMES, EMBROIDERY FRAMES, LEATHER PICTURE FRAMES, PAPER PHOTO FRAMES AND PICTURE FRAME MOLDINGS; PLASTIC INSERTS FOR USE AS CONTAINER LINERS; SHELVES AND SHELVING, VENETIAN AND BAMBOO BLINDS; BLINDS OF REED, RATTAN OR BAMBOO; WINDOW BLINDS AND SHADES; INTERIOR WINDOW SHUTTERS; DECORATIVE WINDOW FINIALS; SLEEPING BAGS, MATTRESSES AND MATTRESS CUSHIONS, AIR MATTRESSES AND INFLATABLE MATTRESSES FOR USE WHEN CAMPING, NAP MATS, CHAIR PADS, CHAIR CUSHIONS, CHAIR MATS IN THE NATURE OF A PILLOW OR SEAT LINER, PILLOWS AND PILLOWFORMS; CLOSET ACCESSORIES, NAMELY, SHOE RACKS, BELT RACKS, CLOTHES BARS, SLIDING CLOTHES RAILS AND RODS, AND CLOTHES HANGERS; BATH PILLOWS, BATHROOM AND SHAVING MIRRORS, FIGURINES AND STATUES MADE OF BONE, IVORY, PLASTER, PLASTIC, FABRIC, WAX OR WOOD; GAZING GLOBES; WIND CHIMES; BAG RESEALER IN THE NATURE OF A PLASTIC CLIP (U.S. CLS. 2, 13, 22, 25, 32 AND 50).

TRACY CROSS, EXAMINING ATTORNEY

SN 76-558,597. KING KOIL LICENSING COMPANY, INC., HINSDALE, IL. FILED 10-28-2003.

**PERFECT RESPONSE**

FOR BEDS, MATTRESSES, BOX SPRINGS AND PILLOWS (U.S. CLS. 2, 13, 22, 25, 32 AND 50).

SEAN DWYER, EXAMINING ATTORNEY

**CLASS 20—(Continued).**

SN 76-584,927. MODULAR DISPLAY SYSTEMS, INC.,  
BROOKLYN, NY. FILED 4-1-2004.

# M-D-S

FOR CLOTHING DISPLAY RACKS (U.S. CLS. 2, 13, 22,  
25, 32 AND 50).  
FIRST USE 8-14-2003; IN COMMERCE 8-14-2003.  
KATHY DE JONGE, EXAMINING ATTORNEY

SN 76-584,928. ACCUPOSTURE, INC., NORWALK, CT.  
FILED 4-1-2004.

# ADJUS

THE MARK CONSISTS OF STANDARD CHARACTERS  
WITHOUT CLAIM TO ANY PARTICULAR FONT, STYLE,  
SIZE, OR COLOR.

FOR FURNITURE, NAMELY ERGONOMIC OFFICE  
AND INDUSTRIAL WORK STATIONS HAVING ADJUST-  
TABLE HEIGHT TABLE AND WORK SURFACES AND  
PARTS THEREFOR NAMELY, TABLE SURFACE LIFT-  
ING, TILTING AND ADJUSTING MECHANISMS (U.S.  
CLS. 2, 13, 22, 25, 32 AND 50).

DAVID MURRAY, EXAMINING ATTORNEY

SN 76-586,141. WOLF DESIGNS, INC., MALIBU, CA. FILED  
4-12-2004.

# WOOF

THE MARK CONSISTS OF STANDARD CHARACTERS  
WITHOUT CLAIM TO ANY PARTICULAR FONT, STYLE,  
SIZE, OR COLOR.

FOR FABRIC, LEATHER AND WOOD JEWELRY  
BOXES AND UTILITY BOXES (U.S. CLS. 2, 13, 22, 25,  
32 AND 50).

MICHAEL WEBSTER, EXAMINING ATTORNEY

**CLASS 20—(Continued).**

SN 76-587,022. P.S. PIBBS, INC., FLUSHING, NY. FILED 4-16-  
2004.

# SALON EVOLUTION

NO CLAIM IS MADE TO THE EXCLUSIVE RIGHT TO  
USE "SALON", APART FROM THE MARK AS SHOWN.

FOR FURNITURE FOR BEAUTY SALONS, NAMELY,  
CHAIRS, MIRRORS, VANITIES, LOUNGE CHAIRS,  
CABINETS AND STOOLS (U.S. CLS. 2, 13, 22, 25, 32  
AND 50).

ANN LINNEHAN, EXAMINING ATTORNEY

SN 78-227,246. WESTPORT BAY LLC, GREENSBORO, NC.  
FILED 3-19-2003.

# CHATEAU DESIGN

NO CLAIM IS MADE TO THE EXCLUSIVE RIGHT TO  
USE "DESIGN", APART FROM THE MARK AS SHOWN.

FOR KITCHEN AND BATH FURNITURE, CABINET-  
RY AND ACCESSORIES, NAMELY, MIRRORS,  
SHELVES, MEDICINE CABINETS AND LINEN CABI-  
NETS (U.S. CLS. 2, 13, 22, 25, 32 AND 50).

FIRST USE 9-30-2002; IN COMMERCE 9-30-2002.  
MONIQUE MILLER, EXAMINING ATTORNEY

SN 78-227,258. WESTPORT BAY LLC, GREENSBORO, NC.  
FILED 3-19-2003.

# TRADITIONELLE

FOR KITCHEN AND BATH FURNITURE, CABINET-  
RY AND ACCESSORIES, NAMELY, MIRRORS,  
SHELVES, MEDICINE CABINETS AND LINEN CABI-  
NETS (U.S. CLS. 2, 13, 22, 25, 32 AND 50).

FIRST USE 9-30-2002; IN COMMERCE 9-30-2002.  
MONIQUE MILLER, EXAMINING ATTORNEY

SN 78-237,553. LA CORNUE SA, SAINT-OUEN L'AUMONE,  
FRANCE, FILED 4-14-2003.

# CUISINES DE CHATEAU

PRIORITY CLAIMED UNDER SEC. 44(D) ON FRANCE  
APPLICATION NO. 02-3188933, FILED 10-15-2002, REG. NO.  
023188933, DATED 10-15-2002, EXPIRES 10-15-2012.

OWNER OF U.S. REG. NO. 2,099,742.

NO CLAIM IS MADE TO THE EXCLUSIVE RIGHT TO  
USE CUISINES, APART FROM THE MARK AS SHOWN.

THE ENGLISH TRANSLATION OF CUISINES DE CHA-  
TEAU IS CHATEAU KITCHENS.

FOR KITCHEN FURNITURE INCLUDING CABINETS  
(U.S. CLS. 2, 13, 22, 25, 32 AND 50).

FIRST USE 12-31-1990; IN COMMERCE 12-31-1990.  
ALLISON HOLTZ, EXAMINING ATTORNEY

**CLASS 20—(Continued).**

SN 78-282,988. GLOVE GUARD, L.P., HIGHLANDS, TX. FILED 8-4-2003.

**CLASS 20—(Continued).**

SN 78-308,610. NATIONAL GEOGRAPHIC SOCIETY, WASHINGTON, DC. FILED 10-2-2003.

**UTILITY GUARD**



NO CLAIM IS MADE TO THE EXCLUSIVE RIGHT TO USE "UTILITY", APART FROM THE MARK AS SHOWN.  
FOR BREAKAWAY NON-METAL CLIPS FOR ATTACHING ARTICLES TO BELTS OR CLOTHING (U.S. CLS. 2, 13, 22, 25, 32 AND 50).  
SONYA STEPHENS, EXAMINING ATTORNEY

OWNER OF U.S. REG. NOS. 242,080, 2,761,341 AND OTHERS.

THE COLOR(S) YELLOW IS/ARE CLAIMED AS A FEATURE OF THE MARK.

THE RECTANGLE APPEARS IN THE COLOR YELLOW AND THE COLOR YELLOW IS CLAIMED AS A FEATURE OF THE MARK.

THE MARK CONSISTS OF THE WORDS NATIONAL GEOGRAPHIC ACCOMPANIED BY THE DESIGN ELEMENT OF A RECTANGLE.

FOR FURNITURE; SMALL TELEPHONE TABLES; HAND-PAINTED ACCENT TABLES; TRAY TABLES; CUBES/HASSOCKS; COAT RACKS; FITTED FABRIC FURNITURE COVERS; PICTURE FRAMES; RESIN FIGURINES; MUSICAL RESIN FIGURINES; HAND HELD MIRRORS; WOOD BOXES; UMBRELLA STANDS; FURNITURE SCREENS; NATURAL FIBER SCREENS; WALL SCREENS; FLOOR SCREENS; SOFT SCULPTURE WALL DECORATIONS; PILLOWS; CUSHIONS; LOCKERS; SHELVES; NON-METAL HOOKS; MAGAZINE RACKS; PLATE RACKS; MAGAZINE HOLDERS; WINDOW BLINDS; WINDOW SHADES; NON-METAL HARDWARE NAMELY KNOBS, HANDLES, DRAWER PULLS AND CABINET PULLS OF WOOD, CORK, REED, CANE, WICKER, AND SUBSTITUTES FOR ALL OF THESE MATERIALS; DECORATIVE WALL MIRRORS; PLAQUES; FIREPLACE SCREENS; PET BEDS; SCENTED CLOTHES HANGERS; BOXES FOR STORING AND DISPENSING PILLS SOLD EMPTY; NON-METAL KEY RACKS; NON-METAL KEY CHAINS AND KEY RINGS; AIR MATTRESSES FOR USE WHEN CAMPING; SLEEPING BAGS; SLEEPING MATS; JEWELRY BOXES NOT OF METAL; JEWELRY CASES NOT OF METAL; WOOD CARVINGS; NON-METAL FIGURINES MADE OF BONE, IVORY OR PLASTIC; NON-METAL HOLIDAY ORNAMENTS, EXCLUDING CHRISTMAS TREE ORNAMENTS, MADE OF BONE, IVORY OR PLASTIC; NON-METAL MINIATURE REPLICAS OF BUILDINGS MADE OF BONE, IVORY OR PLASTIC; NON-METAL MINIATURE REPLICAS OF VILLAGES MADE OF BONE, IVORY OR PLASTIC; NON-METAL TIME CAPSULES; DECORATIVE WINDOW FINIALS; STATUARY BEING MADE OF BONE, PLASTER, PLASTIC, WAX OR WOOD; HAMPERS; WINDCHIMES (U.S. CLS. 2, 13, 22, 25, 32 AND 50).

TRICIA THOMPSON, EXAMINING ATTORNEY

SN 78-305,187. THE MARVEL GROUP, INC., CHICAGO, IL. FILED 9-25-2003.

**MARVELZAPF**

OWNER OF U.S. REG. NOS. 1,544,481 AND 1,619,748.  
FOR OFFICE FURNITURE (U.S. CLS. 2, 13, 22, 25, 32 AND 50).  
HOWARD SMIGA, EXAMINING ATTORNEY

**CLASS 20—(Continued).**

SN 78-326,590. OLD CHARLESTON JOGGLING BOARD CO., INC., CHARLESTON, SC. FILED 11-12-2003.

**MINT JULEP ROCKER**

THE MARK CONSISTS OF STANDARD CHARACTERS WITHOUT CLAIM TO ANY PARTICULAR FONT, STYLE, SIZE, OR COLOR.

NO CLAIM IS MADE TO THE EXCLUSIVE RIGHT TO USE "ROCKER", APART FROM THE MARK AS SHOWN. FOR WOODEN FURNITURE, NAMELY, ROCKING CHAIRS (U.S. CLS. 2, 13, 22, 25, 32 AND 50). FIRST USE 11-1-2002; IN COMMERCE 11-1-2002. INGA ERVIN, EXAMINING ATTORNEY

---

SN 78-327,461. OMEGA IP CO., WATERLOO, IA. FILED 11-13-2003.

**A LIFETIME OF CHOICES**

THE MARK CONSISTS OF STANDARD CHARACTERS WITHOUT CLAIM TO ANY PARTICULAR FONT, STYLE, SIZE, OR COLOR.

OWNER OF U.S. REG. NO. 2,657,178. FOR FURNITURE, NAMELY, CABINETS (U.S. CLS. 2, 13, 22, 25, 32 AND 50). FIRST USE 6-17-2002; IN COMMERCE 6-17-2002. JIM RINGLE, EXAMINING ATTORNEY

---

SN 78-327,717. REPUBLIC NATIONAL CABINET CORPORATION, MARSHALL, TX. FILED 11-13-2003.



NO CLAIM IS MADE TO THE EXCLUSIVE RIGHT TO USE NATIONAL CABINET CORPORATION, APART FROM THE MARK AS SHOWN.

THE COLOR(S) RED AND BLUE IS/ARE CLAIMED AS A FEATURE OF THE MARK.

THE COLOR RED APPEARS IN THE WORD REPUBLIC AND THE VERTICAL BAR ON THE LEFT, AND THE COLOR BLUE APPEARS IN THE WORD NATIONAL AND THE VERTICAL BAR ON THE RIGHT.

FOR KITCHEN AND BATH CABINETS AND CUSTOMIZED KITCHEN AND BATH CABINETS (U.S. CLS. 2, 13, 22, 25, 32 AND 50).

LAURA KOVAISKY, EXAMINING ATTORNEY

**CLASS 20—(Continued).**

SN 78-330,260. THE PLASTICS GROUP INC., WILLOW-BROOK, IL. FILED 11-19-2003.

**The Racing Can**

THE MARK CONSISTS OF STANDARD CHARACTERS WITHOUT CLAIM TO ANY PARTICULAR FONT, STYLE, SIZE, OR COLOR.

NO CLAIM IS MADE TO THE EXCLUSIVE RIGHT TO USE "CAN", APART FROM THE MARK AS SHOWN. FOR NON-METAL PORTABLE LIQUID FUEL CONTAINERS (U.S. CLS. 2, 13, 22, 25, 32 AND 50). ELIZABETH J. WINTER, EXAMINING ATTORNEY

---

SN 78-333,756. LUCITE INTERNATIONAL, INC., CORDOVA, TN. FILED 11-26-2003.

**LUCITE**

THE MARK CONSISTS OF STANDARD CHARACTERS WITHOUT CLAIM TO ANY PARTICULAR FONT, STYLE, SIZE, OR COLOR.

OWNER OF U.S. REG. NOS. 350,093, 1,936,713 AND OTHERS.

FOR SHOWCASES, SHELVES, DISPLAY SHELVES AND SLIDING SHELVES; SIGN BOARDS OF WOOD OR PLASTIC; PLASTIC LICENSE PLATES AND PLASTIC NOVELTY LICENSE PLATES; NON-METALLIC FURNITURE FITTINGS; FURNITURE PARTS MADE OF GLASS, ARTIFICIAL GLASS AND PLASTIC, NAMELY, TABLE LEAVES, COUNTERTOPS, FEET FOR FURNITURE AND FURNITURE FRAMES; KITCHEN AND BATHROOM FURNITURE; KITCHEN WORKTOPS; BATHROOM VANITIES; AND PARTS AND FITTINGS FOR ALL THE AFORESAID GOODS (U.S. CLS. 2, 13, 22, 25, 32 AND 50).

JIM RINGLE, EXAMINING ATTORNEY

**CLASS 20—(Continued).**

SN 78-359,040. WASHINGTON-TONEY, GLENDA FAYE, LOUISVILLE, KY. FILED 1-28-2004.

**CLASS 20—(Continued).**

SN 78-398,163. PDU LAD CORPORATION, DBA THE LAD COMPANY, ROCKFORD, IL. FILED 4-7-2004.

# My Pila'

# AMERI-SHELF

THE MARK CONSISTS OF STANDARD CHARACTERS WITHOUT CLAIM TO ANY PARTICULAR FONT, STYLE, SIZE, OR COLOR.  
FOR BODY SHAPED PILLOW WITH A BLANKET ATTACHED (U.S. CLS. 2, 13, 22, 25, 32 AND 50).  
FIRST USE 1-0-2004; IN COMMERCE 1-0-2004.  
GEOFFREY FOSDICK, EXAMINING ATTORNEY

THE MARK CONSISTS OF STANDARD CHARACTERS WITHOUT CLAIM TO ANY PARTICULAR FONT, STYLE, SIZE, OR COLOR.  
FOR DECORATIVE SHELVING (U.S. CLS. 2, 13, 22, 25, 32 AND 50).  
RONALD MCMORROW, EXAMINING ATTORNEY

SN 78-397,106. BACA, JAMES JR., CONCORD, CA. AND BACA, LORI JENEEN, CONCORD, CA. FILED 4-6-2004.

SN 78-416,266. AC PACIFIC CORPORATION, RANCHO CUCAMONGA, CA. FILED 5-10-2004.

# IF I'M LOST PLEASE CALL

# AmeriSofa

THE MARK CONSISTS OF STANDARD CHARACTERS WITHOUT CLAIM TO ANY PARTICULAR FONT, STYLE, SIZE, OR COLOR.  
FOR PLASTIC IDENTIFICATION BADGES FOR USE BY CHILDREN (U.S. CLS. 2, 13, 22, 25, 32 AND 50).  
TONJA GASKINS, EXAMINING ATTORNEY

THE MARK CONSISTS OF STANDARD CHARACTERS WITHOUT CLAIM TO ANY PARTICULAR FONT, STYLE, SIZE, OR COLOR.

SN 78-397,926. ARCHITECTURAL WOODWORKERS, PORTLAND, ME. FILED 4-7-2004.

FOR SOFA, LOVESEAT, CHAIR, SOFA WITH RECLINERS, LOVESEAT WITH RECLINERS, CHAIR WITH RECLINER, HOME THEATER SOFA SET, OTTOMAN, SECTIONAL SOFA SET, LEATHER SOFA SET, FABRIC SOFA SET, WOOD/FABRIC SOFA SET, LEATHER/FABRIC SOFA SET, LEATHER PILLOW FOR SOFA SET, FABRIC PILLOW FOR SOFA SET, FUTON, CHAISE, ARM CHAIR, RECLINER (U.S. CLS. 2, 13, 22, 25, 32 AND 50).  
RICHARD WHITE, EXAMINING ATTORNEY



NO CLAIM IS MADE TO THE EXCLUSIVE RIGHT TO USE "CONTEMPORARY AMERICAN FURNITURE", APART FROM THE MARK AS SHOWN.

THE MARK CONSISTS OF THE WORD FURNITUREA, WITH THE LETTER A CONTAINED IN THREE-DIMENSIONAL OVERLAPPING RECTANGLES, ABOVE THE WORDING CONTEMPORARY AMERICAN FURNITURE.  
FOR FURNITURE (U.S. CLS. 2, 13, 22, 25, 32 AND 50).  
JOANNA DUKOVIC, EXAMINING ATTORNEY

**CLASS 20—(Continued).**

SN 78-420,125. FOAMEX L.P., LINWOOD, PA. FILED 5-17-2004.

**DREAM CONCEPTS**

THE MARK CONSISTS OF STANDARD CHARACTERS WITHOUT CLAIM TO ANY PARTICULAR FONT, STYLE, SIZE, OR COLOR.

OWNER OF U.S. REG. NO. 1,516,407.  
FOR MATTRESSES (U.S. CLS. 2, 13, 22, 25, 32 AND 50).  
MICHAEL ENGEL, EXAMINING ATTORNEY

SN 78-421,420. MARDEL, INC., OKLAHOMA CITY, OK. FILED 5-19-2004.

**LIKE A CHILD**

THE MARK CONSISTS OF STANDARD CHARACTERS WITHOUT CLAIM TO ANY PARTICULAR FONT, STYLE, SIZE, OR COLOR.

FOR NATIVITY FIGURINES AND SETS MADE OF RESIN AND PLASTIC (U.S. CLS. 2, 13, 22, 25, 32 AND 50).  
NELSON SNYDER, EXAMINING ATTORNEY

SN 78-421,421. HNI TECHNOLOGIES INC., MUSCATINE, IA. FILED 5-19-2004.

**SOJOURN**

THE MARK CONSISTS OF STANDARD CHARACTERS WITHOUT CLAIM TO ANY PARTICULAR FONT, STYLE, SIZE, OR COLOR.

FOR OFFICE FURNITURE (U.S. CLS. 2, 13, 22, 25, 32 AND 50).  
NELSON SNYDER, EXAMINING ATTORNEY

**CLASS 20—(Continued).**

SN 78-421,567. HNI TECHNOLOGIES INC., MUSCATINE, IA. FILED 5-19-2004.

**PRESENCE**

THE MARK CONSISTS OF STANDARD CHARACTERS WITHOUT CLAIM TO ANY PARTICULAR FONT, STYLE, SIZE, OR COLOR.

FOR FURNITURE (U.S. CLS. 2, 13, 22, 25, 32 AND 50).  
RONALD AIKENS, EXAMINING ATTORNEY

**CLASS 21—HOUSEWARES AND GLASS**

SN 76-506,379. RUBIN, JEROME M., SAN GERONIMO, CA. FILED 4-14-2003.

**EARTHWARE  
BIODEGRADABLES**

NO CLAIM IS MADE TO THE EXCLUSIVE RIGHT TO USE BIODEGRADABLES, APART FROM THE MARK AS SHOWN.

FOR DISPOSABLE PLATES, CUPS, ALL-PURPOSE HOUSEHOLD CONTAINERS, AND BOTTLES SOLD EMPTY, ALL MADE OF RECYCLED, COMPOSTING OR BIODEGRADABLE MATERIALS (U.S. CLS. 2, 13, 23, 29, 30, 33, 40 AND 50).

FIRST USE 2-2-2003; IN COMMERCE 3-14-2003.  
LAURA KOVAISKY, EXAMINING ATTORNEY

SN 76-531,211. QUICKIE MANUFACTURING CORPORATION, CINNAMINSON, NJ. FILED 7-10-2003.

**CLEAN DESIGNS**

FOR BRUSHES, NAMELY, DISH WASHING BRUSHES FOR USE ON POTS AND PANS, BOTTLES, THERMAL INSULATED CONTAINERS FOR FOOD OR BEVERAGE AND PERCOLATORS; SCRUBBING BRUSHES FOR USE ON VEGETABLES; COSMETIC BRUSHES, INCLUDING HAND AND NAIL BRUSHES FOR PERSONAL USE; TOILET BRUSHES; CLEANING BRUSHES FOR HOUSEHOLD AND PERSONAL USE; MOPS, NAMELY, WET SPONGE AND DUST MOPS; AND BROOMS (U.S. CLS. 2, 13, 23, 29, 30, 33, 40 AND 50).

BILL DAWE, EXAMINING ATTORNEY

**CLASS 21—(Continued).**

SN 76-550,406, TVI CORPORATION, GLEN DALE, MD.  
FILED 10-8-2003.

**INTELLIJET**

FOR PLASTIC NOZZLES FOR SPRAYING LIQUIDS  
(U.S. CLS. 2, 13, 23, 29, 30, 33, 40 AND 50).  
FIRST USE 2-0-2004; IN COMMERCE 2-0-2004.  
CHRISTOPHER BUONGIORNO, EXAMINING ATTORNEY

SN 76-556,888, BANKABLE INCORPORATED, LOS ANGELES, CA. FILED 9-17-2003.

**LUVTY**

FOR MUGS, CUPS, GOBLETS, BOTTLES AND JARS SOLD EMPTY, BOTTLE SQUEEGEES, VACUUM BOTTLES AND SELTZER BOTTLES; DEWAR BOTTLES AND VESSELS; DRINKING VESSELS AND HEAT-INSULATED VESSELS; BOTTLE STANDS; WINE BOTTLE CRADLES AND WINE RACKS; GLASS STORAGE JARS, INSULATING JARS AND COOKIE JARS; NON-METAL JARS FOR JAMS AND JELLIES MADE OF EARTHENWARE, GLASS, PORCELAIN AND PLASTIC; BEER JUGS; DRINKING STEINS; FLASKS; COASTERS NOT OF PAPER AND NOT BEING TABLE LINEN; BARWARE, NAMELY, HIGH BALL GLASSES, SHOT GLASSES, COCKTAIL SHAKERS, CORK SCREWS, CORK HOLDERS, BOTTLE OPENERS, TUMBLERS, WINE GOBLETS, CARAFES, DECANTERS, COOLERS FOR WINE, WINE COOLER STANDS, PITCHERS, BUCKETS AND BEVERAGE STIRRERS; DINNERWARE, BEVERAGEWARE, BEVERAGE GLASSWARE AND DRINKING GLASSES; INSULATING SLEEVE HOLDERS FOR BEVERAGE CANS; FOAM DRINK HOLDERS; BREAD BOXES; CONTAINERS FOR FOODS; CONTAINERS FOR HOUSEHOLD OR KITCHEN USE; ALL PURPOSE PORTABLE HOUSEHOLD CONTAINERS; NON-ELECTRIC KITCHEN CONTAINERS NOT MADE OF PRECIOUS METAL; PORTABLE PLASTIC CONTAINERS FOR STORING HOUSEHOLD AND KITCHEN GOODS; CANTEENS; PORTABLE COOLERS, PORTABLE BEVERAGE COOLERS AND BEVERAGE DISPENSERS; PORTABLE ICE CHESTS FOR FOOD AND BEVERAGES; THERMAL INSULATED CONTAINERS FOR FOOD AND BEVERAGES; THERMAL INSULATED TOTE BAGS FOR FOOD AND BEVERAGES; THERMAL INSULATED WRAP FOR CANS TO KEEP THE CONTENTS COLD OR HOT; SERVIETTE HOLDERS; SERVIETTE RINGS NOT OF PRECIOUS METAL; LUNCH BOXES AND PAILS; INSULATED LUNCH BAGS; TEA KETTLES; COOKING AND KITCHEN UTENSILS AND EQUIPMENT, NAMELY, CUTTING BOARDS, WIRE BASKETS, STRAINERS, STEAMER BASKETS, KITCHEN AND SERVING LADLES, SPATULAS, SERVING TONGS, WHISKS, SKIMMERS, FUNNELS, GARLIC PRESSES, CORN COB HOLDERS, GLASS STOPPERS, COOKIE AND PASTRY CUTTERS, CHEESE GRATERS, REAMERS FOR FRUIT JUICE, EGG SEPARATORS, VEGETABLE MASHERS, MELON BALLERS, ROLLING PINS, MEAT TENDERIZERS, ICE CREAM SCOOPS AND ICE SCOOPS, POTS, METAL AND GLASS PANS, PIE PANS, BAKING DISHES, MUFFIN TINS, COOKIE SHEETS, CRUMB BRUSHES, BRUSHES FOR BASTING MEAT AND DISHWASHING BRUSHES, DISH DRYING RACKS, OVEN TO TABLE RACKS, STOVE BURNER COVERS, SPICE RACKS, POULTRY RINGS, RECIPE BOXES, CRUETS NOT OF PRECIOUS METAL, AND CRUET STANDS FOR OIL OR VINEGAR NOT OF PRECIOUS METAL; NON-ELECTRIC COFFEE SERVERS, TEA SERVICES, TEA INFUSERS, TEA BALLS, TEA POTS, AND NON-ELECTRIC KITCHEN CONTAINERS, ALL OF THE FOREGOING NOT OF PRECIOUS METAL; COFFEE MEASURES; BOWLS, PLATES, DISHES AND DISH COVERS; CAKE, CARVER, SPOON, FORK AND KNIFE RESTS; SAUCERS; SERVING PLATTERS; PIE SERVERS;

**CLASS 21—(Continued).**

SERVING TRAYS NOT OF PRECIOUS METAL; TRIVETS; SALT AND PEPPER SHAKERS; NON-ELECTRIC JUICERS; COLANDERS FOR HOUSEHOLD USE; WOKS AND HOT POTS; TOOTHPICKS AND TOOTHPICK HOLDERS; ELECTRIC TOOTHBRUSHES; CANISTER SETS; NAPKIN HOLDERS; NAPKIN RINGS NOT OF PRECIOUS METALS; TABLE PLACARD HOLDERS; BOXES FOR DISPENSING PAPER TOWELS; HAIR BRUSHES AND COMBS; DISPENSERS FOR HAIR BRUSHES AND COMBS; BATHROOM AND BEAUTY PRODUCTS AND ACCESSORIES, NAMELY, DENTAL FLOSS, TOOTH BRUSHES AND TOOTHBRUSH HOLDERS, CUP HOLDERS, BATH BRUSHES, SPONGES, NATURAL SEA SPONGES, LOOFAH SPONGES, EYEBROW, NAIL AND SHAVING BRUSHES, SHAVING BRUSH HOLDERS AND STANDS, SQUEEGEES FOR SHAVING BRUSHES, PLASTIC BATH RACKS, TOILET BRUSHES AND BRUSH HOLDERS, AND TOWEL RACKS; SOAP BOXES, BRACKETS, CONTAINERS, DISHES, DISPENSERS AND HOLDERS; COTTON BALLS AND COTTON BALL DISPENSERS; COSMETIC AND CLOTHES BRUSHES; CLOTHES DRYING RACKS AND CLOTHES PINS; BABY BATHTUBS; BATHROOM GLASS HOLDER NOT OF PRECIOUS METAL; EARRING ORGANIZER BOARD; CANDLE HOLDERS, CANDLE RINGS AND CANDLESTICKS NOT OF PRECIOUS METAL; CANDLE SNUFFERS; NON-ELECTRIC CANDLELABRAS, NOT OF PRECIOUS METAL; GLASS BOXES; BASKETS MADE OF STRAW, CLOTH, WICKER AND WOOD; FITTED PICNIC BASKETS; PLANT AND FLOWER POTS, BOWLS, BASKETS AND SYRINGES; PLASTIC LIDS FOR PLANT POTS; GARDEN SYRINGES AND GARDENING GLOVES; POT CLEANING BRUSHES; SCRAPING AND SCRUBBING BRUSHES; ELECTRIC LINT REMOVERS; VASES; FIGURINES MADE OF CHINA, CRYSTAL, EARTHENWARE, GLASS, PORCELAIN AND TERRA COTTA; WASTEPAPER BASKETS; TRASH CONTAINERS FOR HOUSEHOLD USE; NON-METAL PIGGY BANKS; SOUVENIR AND DECORATIVE PLATES; INCENSE BURNERS; PERFUME BURNERS; PERFUME VAPORIZERS AND SPRAYERS SOLD EMPTY; SHOE HORNS, SHOE, DUSTING, FLOOR AND FIREPLACE BRUSHES; GOLF BRUSH AND BRUSHES FOR BILLIARD TABLES; CLEANING CLOTHS, POLISHING CLOTHS, FURNITURE DUSTERS, DUST PANS AND BROOMS; IRONING BOARDS, SHAPED COVERS FOR IRONING BOARDS, AND HOLDERS FOR HOUSEHOLD IRONS; WIND CHIMES; ORNAMENTAL GLASS SPHERES (U.S. CLS. 2, 13, 23, 29, 30, 33, 40 AND 50).

TRACY CROSS, EXAMINING ATTORNEY

**CLASS 21—(Continued).**

SN 76-559,047. GANZ, WOODBRIDGE, ONTARIO L4L 3T2, CANADA, FILED 11-13-2003.

**QUEEN OF THE ROAD**

THE MARK CONSISTS OF STANDARD CHARACTERS WITHOUT CLAIM TO ANY PARTICULAR FONT, STYLE, SIZE, OR COLOR.

FOR MUGS, TRAVEL MUGS, DRINKING GLASSES, NAMELY, TUMBLERS; DECORATIVE FIGURINES MADE OF CHINA, CRYSTAL, EARTHENWARE, GLASS, PORCELAIN, AND TERRA COTTA, PLATES, DRINKING GLASSES, GOBLET, HAND BLOWN GLASS FIGURINES, PITCHERS, PLATES, GLASS ORNAMENTS NOT INCLUDING CHRISTMAS TREE ORNAMENTS; PORCELAIN ORNAMENTS NOT INCLUDING CHRISTMAS TREE ORNAMENTS; VASES, NON-METAL PIGGY BANKS, NON-METAL BASKETS, EMPTY GLASS BOTTLES, CERAMIC ORNAMENTAL BOXES, SERVING TRAYS NOT OF PRECIOUS METAL, GLASS CANDY JARS, NON-ELECTRIC NON-METAL COFFEE POTS; COOKIE JARS, COOKIE CUTTERS, GLASS STORAGE JARS; CANDLE HOLDERS NOT OF PRECIOUS METAL, LOTION DISPENSERS, CAPPUCCINO MUGS; PIE PLATES, SALSA BOWLS, SALT AND PEPPER SHAKERS, SERVING PLATTERS, PORCELAIN DECORATIVE FIGURINES, PORCELAIN FIGURINES, NAMELY, PORCELAIN BELLS, PORCELAIN TRINKET BOXES, PORCELAIN HEARTS; PITCHERS, TEA POTS NOT OF PRECIOUS METAL; SPOON RESTS, PORCELAIN CREAMER PITCHERS; SOAP DISH, SOUP TUREEN, TISSUE CADDIES, CORK HOLDERS, RESIN VICTORIAN TEA SETS, TERRA COTTA HOLDERS FOR FLOWERS AND PLANTS, CLOISONNE BALL ORNAMENTS NOT INCLUDING CHRISTMAS ORNAMENTS, CERAMIC TOOTHBRUSH HOLDERS, WATERING CANS; COASTERS NOT OF PAPER AND NOT BEING TABLE LINEN; CANDLE COASTERS NOT OF PAPER AND NOT BEING TABLE LINEN; HOUSEWARE ITEMS NOT MADE OF PRECIOUS METAL, NAMELY, PUNCH BOWLS, BOWLS, PLATTERS (U.S. CLS. 2, 13, 23, 29, 30, 33, 40 AND 50).

DOUGLAS LEE, EXAMINING ATTORNEY

SN 76-559,330. CONTEC, INC., SPARTANBURG, SC. FILED 11-14-2003.

**EDGELESS MOP**

THE MARK CONSISTS OF STANDARD CHARACTERS WITHOUT CLAIM TO ANY PARTICULAR FONT, STYLE, SIZE, OR COLOR.

NO CLAIM IS MADE TO THE EXCLUSIVE RIGHT TO USE "MOP", APART FROM THE MARK AS SHOWN. SEC. 2(F).

FOR CIRCULAR KNIT MOPS FOR CLEANROOM USE (U.S. CLS. 2, 13, 23, 29, 30, 33, 40 AND 50). FIRST USE 2-0-1993; IN COMMERCE 2-0-1993. GRETTA YAO, EXAMINING ATTORNEY

**CLASS 21—(Continued).**

SN 76-585,164. JONES, TIMOTHY, PRINCESS ANNE, MD. FILED 4-6-2004.

**DRINK DOCKER**

NO CLAIM IS MADE TO THE EXCLUSIVE RIGHT TO USE DRINK, APART FROM THE MARK AS SHOWN.

FOR INSULATING BEVERAGE HOLDER FOR INDIVIDUAL BEVERAGE CONTAINERS (U.S. CLS. 2, 13, 23, 29, 30, 33, 40 AND 50).

CAROL SPILS, EXAMINING ATTORNEY

SN 76-585,174. SHARP, MICHELLE E., MCKINNEY, TX. FILED 4-6-2004.

**TIDY POTTY**

NO CLAIM IS MADE TO THE EXCLUSIVE RIGHT TO USE POTTY, APART FROM THE MARK AS SHOWN.

FOR PLASTIC LINER FOR TODDLER POTTY TRAINER SEATS (U.S. CLS. 2, 13, 23, 29, 30, 33, 40 AND 50).

CAROL SPILS, EXAMINING ATTORNEY

SN 76-592,054. MINGES, JOHN T., JR., DBA MILLION IN ONE MITT, ROCKY MOUNT, NC. FILED 5-13-2004.

**MILLION IN ONE MITT**

THE MARK CONSISTS OF STANDARD CHARACTERS WITHOUT CLAIM TO ANY PARTICULAR FONT, STYLE, SIZE, OR COLOR.

FOR CLEANING PADS (U.S. CLS. 2, 13, 23, 29, 30, 33, 40 AND 50).

DOMINIC J. FERRAIUOLO, EXAMINING ATTORNEY

SN 78-052,292. ALCHEMY GLASS & LIGHT, INC., LOS ANGELES, CA. FILED 3-9-2001.

**ART FOR THE BATH**

NO CLAIM IS MADE TO THE EXCLUSIVE RIGHT TO USE "ART" OR "BATH", APART FROM THE MARK AS SHOWN.

FOR WASH BASINS (U.S. CLS. 2, 13, 23, 29, 30, 33, 40 AND 50).

FIRST USE 3-1-2000; IN COMMERCE 3-1-2000.

MARIA-VICTORIA SUAREZ, EXAMINING ATTORNEY



**CLASS 21—(Continued).**

SN 78-227,189. DISCUS DENTAL IMPRESSIONS, INC.,  
CULVER CITY, CA. FILED 3-18-2003.

**PROACTIVE CARE**

FOR DENTAL FLOSS AND TOOTHBRUSHES (U.S.  
CLS. 2, 13, 23, 29, 30, 33, 40 AND 50).  
LINDA MICKLEBURGH, EXAMINING ATTORNEY

**CLASS 21—(Continued).**

SN 78-332,904. SMART & FINAL STORES CORPORATION,  
COMMERCE, CA. FILED 11-25-2003.



OWNER OF U.S. REG. NOS. 2,180,065, 2,199,487 AND  
OTHERS.

FOR HOUSEHOLD AND KITCHEN UTENSILS AND  
CONTAINERS, NAMELY, CUPS, SALT SHAKERS, SU-  
GAR CANISTERS, OIL AND VINEGAR SHAKERS,  
CHEESE SHAKERS, CHEESE GRATERS, SUGAR  
POURERS, SYRUP DISPENSERS, CREAMERS, BOWLS,  
PLATES, CUPS, THERMAL INSULATED CONTAINERS  
FOR FOOD OR BEVERAGES, PAPER PLATES, SERVING  
PLATTERS, NAPKIN DISPENSERS, SQUEEZE DISPEN-  
SERS, DISPOSABLE LATEX GLOVES FOR GENERAL  
USE, BROOMS, MOPS, DUST BINS OR PANS, SCOUR-  
ING PADS AND SPONGES FOR HOUSEHOLD PUR-  
POSES, COOKWARE, NAMELY POTS AND PANS (U.S.  
CLS. 2, 13, 23, 29, 30, 33, 40 AND 50).

FIRST USE 9-1-2003; IN COMMERCE 9-1-2003.  
ELLEN B. AWRICH, EXAMINING ATTORNEY

SN 78-240,876. SPONGE-KING CORPORATION LIMITED,  
HONG KONG, HONG KONG, FILED 4-22-2003.

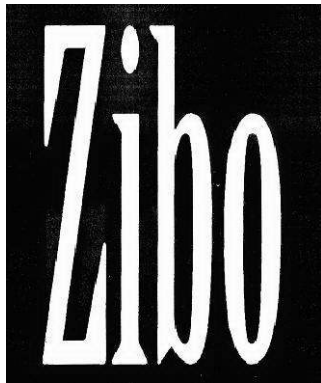

FOR CLOTH FOR WIPING OR DUSTING; CLEANING  
CLOTHS; CLEANING SPONGES; SPONGES FOR  
HOUSEHOLD PURPOSES SPONGES; BRUSHES,  
NAMELY, DUSTING BRUSHES, FLOOR BRUSHES,  
POT CLEANING BRUSHES, TOILET BRUSHES;  
BRUSHES FOR PARQUET FLOOR; HOUSEHOLD UTEN-  
SILS, NAMELY, POT AND PAN SCRAPERS, ROLLING  
PINS, SPATULAS, TURNERS, WHISKS, STRAINERS,  
GRATERS, SIEVES, SKIMMERS; COOKING UTENSILS,  
NAMELY, GRILLS, GRILL COVERS, WIRE BASKETS,  
COOKING POTS, COOKING SKEWERS, METAL COOK-  
ING PANS, NON-ELECTRIC PRESSURE COOKING  
SAUCEPANS (U.S. CLS. 2, 13, 23, 29, 30, 33, 40 AND 50).  
KAREN BRACEY, EXAMINING ATTORNEY

SN 78-347,912. ORBIT IRRIGATION PRODUCTS, INC.,  
BOUNTIFUL, UT. FILED 1-5-2004.

**SOFT TOP**

SN 78-247,107. GORDON, KELLY, E., CHICAGO, IL. FILED  
5-8-2003.

**MAGIC BRUSHOFF**

FOR REUSABLE TWO SIDED CLEANING SPONGE-  
LIKE FOAM PADS FOR REMOVING SPOTS AND  
STAINS FROM CLOTHING AND FABRICS (U.S. CLS.  
2, 13, 23, 29, 30, 33, 40 AND 50).  
BILL DAWE, EXAMINING ATTORNEY

THE MARK CONSISTS OF STANDARD CHARACTERS  
WITHOUT CLAIM TO ANY PARTICULAR FONT, STYLE,  
SIZE, OR COLOR.

OWNER OF U.S. REG. NO. 2,575,043.  
NO CLAIM IS MADE TO THE EXCLUSIVE RIGHT TO  
USE "TOP", APART FROM THE MARK AS SHOWN.  
FOR POP-UP SPRINKLER HEAD WITH RUBBERIZED  
OR ERGO-COVERED CAP (U.S. CLS. 2, 13, 23, 29, 30, 33,  
40 AND 50).

FIRST USE 11-22-2000; IN COMMERCE 11-22-2000.  
SEAN DWYER, EXAMINING ATTORNEY

**CLASS 21—(Continued).**

SN 78-361,327. FLAVA MUGS MARKETING, LLC, PHOENIX, AZ. FILED 2-2-2004.



FOR DRINKING GLASSES; DRINKING CUPS; GLASS COFFEE MUGS; CERAMIC COFFEE MUGS (U.S. CLS. 2, 13, 23, 29, 30, 33, 40 AND 50).

MICHAEL SOUDERS, EXAMINING ATTORNEY

---

SN 78-374,540. JOHNSON & JOHNSON, NEW BRUNSWICK, NJ. FILED 2-26-2004.

**CRYSTAL CLEAN**

THE MARK CONSISTS OF STANDARD CHARACTERS WITHOUT CLAIM TO ANY PARTICULAR FONT, STYLE, SIZE, OR COLOR.

FOR TOOTHBRUSHES (U.S. CLS. 2, 13, 23, 29, 30, 33, 40 AND 50).

GRETTA YAO, EXAMINING ATTORNEY

---

SN 78-380,029. HOLIDAY HOUSEWARES, INC., LEOMINSTER, MA. FILED 3-8-2004.

**PUM CAN**

THE MARK CONSISTS OF STANDARD CHARACTERS WITHOUT CLAIM TO ANY PARTICULAR FONT, STYLE, SIZE, OR COLOR.

NO CLAIM IS MADE TO THE EXCLUSIVE RIGHT TO USE "CAN", APART FROM THE MARK AS SHOWN.

FOR PLASTIC TRASH CANS (U.S. CLS. 2, 13, 23, 29, 30, 33, 40 AND 50).

JENNIFER KRISP, EXAMINING ATTORNEY

**CLASS 21—(Continued).**

SN 78-399,121. PEIFFER, WILLIAM R., ORLAND PARK, IL. FILED 4-9-2004.

**WAX BY MAX**

THE MARK CONSISTS OF STANDARD CHARACTERS WITHOUT CLAIM TO ANY PARTICULAR FONT, STYLE, SIZE, OR COLOR.

FOR CANDLE HOLDERS NOT OF PRECIOUS METAL (U.S. CLS. 2, 13, 23, 29, 30, 33, 40 AND 50).

BERYL GARDNER, EXAMINING ATTORNEY

---

SN 78-401,782. NESTLER, CARLOS W., JR., FARGO, ND. AND KLEIN, TERRILL, FARGO, ND. FILED 4-14-2004.

**PORTA-FILLET**

THE MARK CONSISTS OF STANDARD CHARACTERS WITHOUT CLAIM TO ANY PARTICULAR FONT, STYLE, SIZE, OR COLOR.

FOR FISH CLEANING AND FILLETING BOARD (U.S. CLS. 2, 13, 23, 29, 30, 33, 40 AND 50).

FIRST USE 2-1-2004; IN COMMERCE 2-1-2004.

JOANNA DUKOVIC, EXAMINING ATTORNEY

---

SN 78-418,905. WESTERHOLD, JOHN F., MARINA DEL REY, CA. FILED 5-14-2004.

**GLASSOVINO**

THE MARK CONSISTS OF STANDARD CHARACTERS WITHOUT CLAIM TO ANY PARTICULAR FONT, STYLE, SIZE, OR COLOR.

FOR BEVERAGEWARE (U.S. CLS. 2, 13, 23, 29, 30, 33, 40 AND 50).

GEOFFREY FOSDICK, EXAMINING ATTORNEY

**CLASS 21—(Continued).**

SN 78-420,803. BRANNON, ROBERT K., SEVIERVILLE, TN. AND BRANNON, EVAN D., SEVIERVILLE, TN. FILED 5-18-2004.

**JUST LIKE DADS**

THE MARK CONSISTS OF STANDARD CHARACTERS WITHOUT CLAIM TO ANY PARTICULAR FONT, STYLE, SIZE, OR COLOR.

OWNER OF U.S. REG. NO. 1,382,402. FOR TOOTHBRUSHES (U.S. CLS. 2, 13, 23, 29, 30, 33, 40 AND 50).

JOANNA DUKOVIC, EXAMINING ATTORNEY

SN 78-421,571. BP PRODUCTS NORTH AMERICA INC., WARRENVILLE, IL. FILED 5-19-2004.

**DIGI-DRINK**

THE MARK CONSISTS OF STANDARD CHARACTERS WITHOUT CLAIM TO ANY PARTICULAR FONT, STYLE, SIZE, OR COLOR.

FOR CUPS MADE OF PAPER AND PLASTIC (U.S. CLS. 2, 13, 23, 29, 30, 33, 40 AND 50).

RONALD AIKENS, EXAMINING ATTORNEY

SN 78-489,197. OFFICIAL PILLOWTEX LLC, COLUMBUS, OH. FILED 9-24-2004.



OWNER OF U.S. REG. NO. 1,126,849. FOR BATH ACCESSORIES, NAMELY, CUP HOLDERS, BATH BRUSHES, NATURAL SEA SPONGES, LOOFAH SPONGES, BODY SPONGES, BATH SPONGES, COTTON BALL DISPENSERS, CUPS, DISPENSERS FOR LIQUID SOAP, SOAP DISHES, SOAP DISPENSERS, TOOTHBRUSH HOLDERS, WASTEPAPER BASKETS (U.S. CLS. 2, 13, 23, 29, 30, 33, 40 AND 50).

CAROLINE WOOD, EXAMINING ATTORNEY

**CLASS 21—(Continued).**

SN 79-000,186. SCHOTT ZWIESEL AG, FED REP GERMANY, FILED 11-11-2003.

**DIVA**

THE MARK CONSISTS OF STANDARD CHARACTERS WITHOUT CLAIM TO ANY PARTICULAR FONT, STYLE, SIZE, OR COLOR.

PRIORITY DATE OF 7-25-2003 IS CLAIMED. OWNER OF INTERNATIONAL REGISTRATION 0815296 DATED 11-11-2003, EXPIRES 11-11-2013.

THE ENGLISH TRANSLATION OF PRIMA DONNA IS DIVA.

FOR HOUSEHOLD, HOTEL, RESTAURANT, BAR AND TABLE BEVERAGE GLASSWARE; BEVERAGE GLASSWARE; STEMWARE AND TUMBLERS ALL MADE FROM GLASS, CRYSTAL GLASS OR LEAD CRYSTAL (U.S. CLS. 2, 13, 23, 29, 30, 33, 40 AND 50).

ELLEN B. AWRICH, EXAMINING ATTORNEY

**CLASS 22—CORDAGE AND FIBERS**

SN 76-554,031. BK1 HOLDING CORPORATION, WILMINGTON, DE. FILED 10-24-2003.

**WALKISOFT**

FOR NONWOVEN MATERIAL CONSISTING OF POLYMERIC FIBERS FOR USE IN THE MANUFACTURE OF A VARIETY OF INDUSTRIAL AND CONSUMER PRODUCTS CONTAINING NONWOVEN MATERIAL SUCH AS HOUSEHOLD AND OTHER PRODUCTS INCLUDING WIPES AND MOPS, MOISTURE ABSORBING PRODUCTS, TABLE PRODUCTS SUCH AS NON-WOVEN TABLECLOTHS AND NAPKINS, AND PERSONAL HYGIENE PRODUCTS (U.S. CLS. 1, 2, 7, 19, 22, 42 AND 50).

FIRST USE 1-31-2001; IN COMMERCE 1-31-2001. GINA FINK, EXAMINING ATTORNEY

**CLASS 22—(Continued).**

SN 76-580,003. UNSA AMBALAJ SANAYI VE TICARET ANONIM SIRKETI, ISTANBUL, TURKEY, FILED 3-9-2004.



FOR ROPES; STRING; TENTS; AWNINGS; CANVAS TARPAULINS; SAILS; SACKS AND BAGS FOR THE TRANSPORTATION OF MATERIALS IN BULK; PADDING AND STUFFING MATERIALS NOT OF RUBBER OR PLASTIC; RAW FIBROUS TEXTILE MATERIALS; ANIMAL HAIR; AWNINGS OF SYNTHETIC MATERIALS; AWNINGS OF TEXTILE; BAGS, ENVELOPES AND POUCHES OF TEXTILE, FOR PACKAGING; BAGS FOR WASHING HOSIERY; MAIL BAGS; BAGS OR SACKS FOR THE TRANSPORT AND STORAGE OF MATERIALS IN BULK; HEMP BANDS AND BANDS, NOT OF METAL, FOR WRAPPING OR BINDING; FEATHERS FOR BEDDING, FEATHERS FOR STUFFING UPHOLSTERY; BELTS, NOT OF METAL, FOR HANDLING LOADS, BRACES, NOT OF METAL, FOR HANDLING LOADS; LADDER TAPES OR WEBBING FOR VENETIAN BLINDS; BOTTLE ENVELOPES OF STRAW; STRAW WRAPPERS FOR BOTTLES; TARRED BRATICE CLOTH; CABLE TIES FOR FASHIONING AND SECURING OBJECTS; CAMEL HAIR; COMMERCIAL NETS; BUTTERFLY NETS; CAR TOWING ROPES; CARBON FIBERS FOR TEXTILE USE; CARDED WOOL; COCONUT FIBER; COCOONS; COMBED WOOL; CORDS FOR HANGING PICTURES; SASH CORDS; RAW COTTON; COTTON TOW; COTTON WASTE FOR PADDING AND STUFFING; DOWN FEATHERS; EIDERDOWN FEATHERS; ESPARTO GRASS; TEXTILE FIBERS; WADDING FOR FILTERING; FISHING NETS; FLEECE WOOL; SILK FLOCK; FLOCK STUFFING NOT OF RUBBER OR PLASTIC; WOOL FLOCK; GLASS FIBERS FOR TEXTILE USE; GRASSES FOR UPHOLSTERING; HAIR FOR STUFFING, PADDING, AND PACKING PURPOSES; HAMMOCKS; HARNESS, NOT OF METAL, FOR HANDLING LOADS; HORSEHAIR; JUTE; KAPOK; ROPE LADDERS; LIBER; RAW LINEN AND RAW FLAX FIBER; LINTERS; SLINGS, NOT OF METAL, FOR HANDLING LOADS; STRAPS, NOT OF METAL, FOR HANDLING LOADS; TWINE FOR NETS, PACKING, CUSHIONING AND STUFFING MATERIALS NOT OF RUBBER OR PLASTICS; PACKING, OF STRAW, FOR BOTTLES; PACKING ROPE AND PACKING STRING NOT OF RUBBER PLASTIC OR METAL; PADDING MATERIALS, NOT OF RUBBER OR PLASTICS; TWINE MADE OF PAPER; PLASTIC FIBERS FOR TEXTILE USE; RAFFIA FIBERS; RAMIE FIBER; RAW FIBROUS TEXTILE MATERIALS; RAW OR TREATED WOOL; RAW SILK; ROPE LADDERS; ROPES; CAR TOWING ROPES; ROPES, NOT OF METAL; SACKS OR BAGS OF TEXTILE, FOR PACKAGING; SAILS; SAILS FOR SKI SAILING; SAWDUST; SCHAPPE SILK OR RAW SILK WASTE; SEA WRACK FOR STUFFING; SEAWEED FOR STUFFING; WOOD SHAVINGS; SHEAF-BINDING YAMS; SHORN WOOL; SILK FLOCK; SILK WASTE; SISAL FIBERS; SLINGS, NOT OF METAL, FOR HANDLING LOADS; SNARES, NOT OF PLASTIC, RUBBER OR METAL; STRAPS, NOT OF METAL, FOR HANDLING LOADS; STRAW FOR STUFFING UPHOLSTERY; STRING; STRIPS FOR TYPING-UP VINES; STUFFING, NOT OF RUBBER OR PLASTIC; TEXTILE FIBERS; FEATHERS FOR STUFFING UPHOLSTERY; WOOL STUFFING FOR UPHOLSTERY; VEHICLE COVERS UNFITTED; VITREOUS SILICA FIBERS FOR TEXTILE USE; WADDING FOR FILTERING, WADDING NOT OF RUBBER OR PLASTIC FOR PADDING AND STUFFING UPHOLSTERY; WAX ENDS; WHIPCORD; WOOD WOOL; WRAPPING OR BINDING BANDS, NOT OF METAL (U.S. CLS. 1, 2, 7, 19, 22, 42 AND 50).

FIRST USE 1-23-1987; IN COMMERCE 1-0-1987.  
RON FAIRBANKS, EXAMINING ATTORNEY

**CLASS 22—(Continued).**

SN 76-592,738. A-AZTEC RENTS & SELLS, INC., TORRANCE, CA. FILED 5-17-2004.

## ACADASPAN

THE MARK CONSISTS OF STANDARD CHARACTERS WITHOUT CLAIM TO ANY PARTICULAR FONT, STYLE, SIZE, OR COLOR.

FOR TENTS (U.S. CLS. 1, 2, 7, 19, 22, 42 AND 50).  
ANDREW RHIM, EXAMINING ATTORNEY

SN 78-288,052. AAA TENT & AWNING COMPANY, SALT LAKE CITY, UT. FILED 8-15-2003.

## BEST TENT MADE IN AMERICA

SEC. 2(F).  
FOR CAMPING EQUIPMENT, NAMELY, TENTS (U.S. CLS. 1, 2, 7, 19, 22, 42 AND 50).  
FIRST USE 4-0-1991; IN COMMERCE 4-0-1991.  
DOMINIC J. FERRAIUOLO, EXAMINING ATTORNEY

SN 78-383,928. STERLING FIBERS, INC., PACE, FL. FILED 3-13-2004.

## MICROSUPREME

THE MARK CONSISTS OF STANDARD CHARACTERS WITHOUT CLAIM TO ANY PARTICULAR FONT, STYLE, SIZE, OR COLOR.

OWNER OF U.S. REG. NOS. 2,391,877 AND 2,547,532.  
FOR ACRYLIC MICROFIBERS (U.S. CLS. 1, 2, 7, 19, 22, 42 AND 50).  
KELLY BOULTON, EXAMINING ATTORNEY

**CLASS 22—(Continued).**

SN 78-386,899. DAK AMERICAS, LLC, CHARLOTTE, NC. FILED 3-18-2004.

**CLASS 23—(Continued).**

SN 78-418,955. UNIFI, INC., GREENSBORO, NC. FILED 5-14-2004.

**SECURE PERFORMANCE**

THE MARK CONSISTS OF STANDARD CHARACTERS WITHOUT CLAIM TO ANY PARTICULAR FONT, STYLE, SIZE, OR COLOR.

FOR POLYESTER FIBERS, SYNTHETIC FIBERS AND TEXTILE FIBERS (U.S. CLS. 1, 2, 7, 19, 22, 42 AND 50).  
PAULA MAYS, EXAMINING ATTORNEY

**TENEX**

THE MARK CONSISTS OF STANDARD CHARACTERS WITHOUT CLAIM TO ANY PARTICULAR FONT, STYLE, SIZE, OR COLOR.

FOR YARN (U.S. CL. 43).  
RUDY R. SINGLETON, EXAMINING ATTORNEY

SN 78-417,978. UNIVERSAL COOPERATIVES, INC., EAGAN, MN. FILED 5-13-2004.

**DURABALE**

THE MARK CONSISTS OF STANDARD CHARACTERS WITHOUT CLAIM TO ANY PARTICULAR FONT, STYLE, SIZE, OR COLOR.

FOR ROPES, CORDAGE, TWINE, BALING TWINE, TEXTILE FIBERS AND STRING (U.S. CLS. 1, 2, 7, 19, 22, 42 AND 50).

JERI J. FICKES, EXAMINING ATTORNEY

**CLASS 24—FABRICS**

SN 75-764,260. AL-BAD MASSUOT YITZCHAK LTD., ISRAEL, FILED 7-30-1999.

**AIR LACE**

PRIORITY CLAIMED UNDER SEC. 44(D) ON ISRAEL APPLICATION NO. 128323, FILED 6-7-1999.

NO CLAIM IS MADE TO THE EXCLUSIVE RIGHT TO USE "LACE", APART FROM THE MARK AS SHOWN.

FOR IMPREGNATED AND NON-IMPREGNATED CLEANING NON-WOVEN FABRIC CLOTHS PRODUCED FROM SYNTHETIC FIBERS AND PULP (U.S. CLS. 42 AND 50).

FIRST USE 10-0-2003; IN COMMERCE 10-0-2003.  
KATHERINE STOIDES, EXAMINING ATTORNEY

**CLASS 23—YARNS AND THREADS**

SN 76-384,982. DALE OF NORWAY AS, NORWAY, FILED 3-20-2002.

**DALE BABY ULL**

FOR YARNS AND THREADS, FOR TEXTILE USE (U.S. CL. 43).

FIRST USE 0-0-1989; IN COMMERCE 0-0-1989.  
MICHAEL ENGEL, EXAMINING ATTORNEY

SN 76-560,604. SAEHAN INDUSTRIES INC. (PRESIDENT: PARK, KWANG-UP), KYUNGSAN-SI, KYUNGSANG-BUK-DO, REPUBLIC OF KOREA, FILED 11-17-2003.

**EZBON**

FOR NAPKINS OF CLOTH FOR REMOVING MAKE-UP, DISH CLOTHS, GLASS-CLOTH TOWELS, FIBER-GLASS FABRIC FOR TEXTILE USE, SILK, NON-WOVEN TEXTILE FABRICS, FELT CLOTH (U.S. CLS. 42 AND 50).

DORITT L. CARROLL, EXAMINING ATTORNEY

**CLASS 24—(Continued).**

SN 78-283,485. BRITANNE CORPORATION, SAN FRANCISCO, CA. FILED 8-5-2003.

**WRAP IT DRY**

FOR HAIR DRYING TOWELS IN THE NATURE OF TURBANS (U.S. CLS. 42 AND 50).  
NELSON SNYDER, EXAMINING ATTORNEY

SN 78-287,539. DISNEY ENTERPRISES, INC., BURBANK, CA. FILED 8-14-2003.

**KIM POSSIBLE**

OWNER OF U.S. REG. NO. 2,652,590.  
THE NAME IN THE MARK DOES NOT IDENTIFY A PARTICULAR LIVING INDIVIDUAL.  
FOR AFGHANS; BATH LINEN; BED BLANKETS; BED SHEETS; CRIB BUMPERS; PILLOW CASES; COMFORTERS; CURTAINS; BED SKIRTS; KITCHEN TOWELS; TABLE LINEN; BED LINEN; QUILTS; TOWELS; WASH-CLOTHS; HANDKERCHIEFS; BED SPREADS; FLAGS AND PENNANTS OF TEXTILE (U.S. CLS. 42 AND 50).  
DOMINICK J. SALEMI, EXAMINING ATTORNEY

**CLASS 24—(Continued).**

SN 78-297,825. KOMATSU SEIREN KABUSHIKI KAISHA (KOMATSU SEIREN CO., LTD.), ISHIKAWA, JAPAN, FILED 9-9-2003.

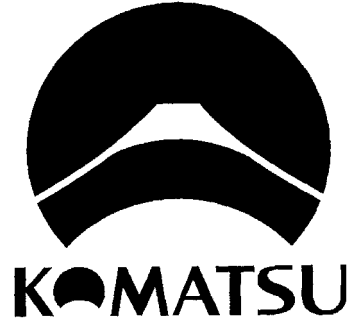

PRIORITY CLAIMED UNDER SEC. 44(D) ON JAPAN APPLICATION NO. 74976/75011, FILED 9-1-2003, REG. NO. 4771069, DATED 5-14-2004, EXPIRES 5-14-2014.  
THE WORD KOMATSU SHOWN IN THE MARK TRANSLATES IN ENGLISH TO "SMALL OR TINY PINE TREE".  
FOR WOVEN FABRICS COMPOSED OF NYLON, POLYESTER, POLYETHYLENE OR POLYURETHANE; KNITTED FABRICS COMPOSED OF NYLON, POLYESTER, POLYETHYLENE OR POLYURETHANE; FELT CLOTH; NON-WOVEN TEXTILE FABRICS COMPOSED OF NYLON, POLYESTER, POLYETHYLENE OR POLYURETHANE; OILCLOTH; GUMMED WATERPROOF CLOTH; VINYL COATED CLOTH; RUBBERIZED CLOTH; CLOTHS FOR CLEANING LEATHER; FILTER CLOTH; PERSONAL ARTICLES OF WOVEN TEXTILE NOT FOR WEAR, NAMELY, TOWELS, HANDKERCHIEFS, JAPANESE CEREMONIAL WRAPPING CLOTH AND JAPANESE GENERAL WRAPPING CLOTH; TABLE NAPKINS OF TEXTILE; DISH CLOTHS; MOSQUITO NETS; BED SHEETS; QUILTS; PILLOWCASES; BED BLANKETS; WALL HANGINGS OF TEXTILE; CURTAINS; SHOWER CURTAINS; TABLE CLOTHS NOT OF PAPER; DRAPERIES; TOILET SEAT COVERS OF TEXTILE; SHROUDS; LABELS OF CLOTH; BILLIARD CLOTH; BANNERS AND FLAGS MADE OF CLOTH (U.S. CLS. 42 AND 50).  
THEODORE MCBRIDE, EXAMINING ATTORNEY

SN 78-316,595. DISNEY ENTERPRISES, INC., BURBANK, CA. FILED 10-21-2003.

**WALT DISNEY WORLD**

OWNER OF U.S. REG. NOS. 980,995, 1,189,727 AND 2,189,177.  
THE NAME IN THE MARK DOES NOT IDENTIFY A PARTICULAR LIVING INDIVIDUAL.  
FOR AFGHANS; BATH LINEN; BED BLANKETS; BED SHEETS; CRIB BUMPERS; PILLOW CASES; COMFORTERS; CURTAINS; BED SKIRTS; KITCHEN TOWELS; TABLE LINEN; BED LINEN; QUILTS; TOWELS; WASH-CLOTHS; HANDKERCHIEFS; BED SPREADS; FLAGS AND PENNANTS OF TEXTILE (U.S. CLS. 42 AND 50).  
PAUL F. GAST, EXAMINING ATTORNEY

**CLASS 24—(Continued).**

SN 78-338,253. JOHNSON, BARBARANN, EVERETT, MA.  
FILED 12-9-2003.

**CLASS 24—(Continued).**

SN 78-396,825. DIAMOND, BETTY M., YORK, SC. FILED 4-6-  
2004.

**STUFFY WUFFY PUT  
AWAYS**

**PASSPORT  
COLLECTION**

THE MARK CONSISTS OF STANDARD CHARACTERS  
WITHOUT CLAIM TO ANY PARTICULAR FONT, STYLE,  
SIZE, OR COLOR.

FOR CURTAINS, PILLOWS, AND BEDSPREADS CON-  
TAINING POCKETS OR POUCHES, FOR THE STORAGE  
OF TOYS AND OTHER MATERIALS IN CHILDREN'S  
ROOMS. (U.S. CLS. 42 AND 50).

HOWARD B. LEVINE, EXAMINING ATTORNEY

THE MARK CONSISTS OF STANDARD CHARACTERS  
WITHOUT CLAIM TO ANY PARTICULAR FONT, STYLE,  
SIZE, OR COLOR.

NO CLAIM IS MADE TO THE EXCLUSIVE RIGHT TO  
USE COLLECTION, APART FROM THE MARK AS SHOWN.  
FOR BEDDING MATERIALS, NAMELY, SHEETS (U.S.  
CLS. 42 AND 50).

TARAH HARDY, EXAMINING ATTORNEY

---

SN 78-349,469. WARMIE PRODUCTS, L.L.C., PHOENIX, AZ.  
FILED 1-8-2004.

---

SN 78-421,660. INTERNATIONAL WOMEN'S APPAREL,  
INC., NEW YORK, NY. FILED 5-19-2004.

**Warmie**

**STARSETTA**

THE MARK CONSISTS OF STANDARD CHARACTERS  
WITHOUT CLAIM TO ANY PARTICULAR FONT, STYLE,  
SIZE, OR COLOR.

FOR CUSTOM MADE LAYERED THROW BLANKETS  
(U.S. CLS. 42 AND 50).

CHARLES JOYNER, EXAMINING ATTORNEY

THE MARK CONSISTS OF STANDARD CHARACTERS  
WITHOUT CLAIM TO ANY PARTICULAR FONT, STYLE,  
SIZE, OR COLOR.

FOR TEXTILE FABRIC, NAMELY, FOR THE MANU-  
FACTURE OF WOMEN'S APPAREL (U.S. CLS. 42 AND  
50).

FIRST USE 1-1-1985; IN COMMERCE 1-1-1985.  
SEAN DWYER, EXAMINING ATTORNEY

**CLASS 24—(Continued).**

SN 78-421,675. INTERNATIONAL WOMEN'S APPAREL, INC., NEW YORK, NY. FILED 5-19-2004.

**COTONICRO**

THE MARK CONSISTS OF STANDARD CHARACTERS WITHOUT CLAIM TO ANY PARTICULAR FONT, STYLE, SIZE, OR COLOR.

FOR FABRIC, NAMELY, FOR THE MANUFACTURE OF WOMEN'S APPAREL (U.S. CLS. 42 AND 50).  
CHERYL CLAYTON, EXAMINING ATTORNEY

**CLASS 25—CLOTHING**

SN 76-257,639. K.C.P.L., INC., NEW YORK, NY. FILED 5-16-2001.

**TRIBECA**

OWNER OF U.S. REG. NOS. 1,693,132 AND 2,255,844.  
FOR COATS, JACKETS, OVERCOATS, RAINWEAR AND TOPCOATS, SUITS, BLAZERS, SHIRTS, SLACKS, DRESSES, SWEATERS, JEANS, T-SHIRTS, SWEAT-SHIRTS, SWIM WEAR, SHORTS, UNDERWEAR, LOUNGEWEAR, LINGERIE, ROBES AND PAJAMAS, NECKWEAR, SCARVES, GLOVES, MITTENS, HEADWEAR, BELTS, FOOTWEAR, SOCKS AND HOSIERY (U.S. CLS. 22 AND 39).

DOUGLAS LEE, EXAMINING ATTORNEY

SN 76-283,430. RED HEAD, INC., DBA CABO WABO ENTERPRISES, NOVATO, CA. FILED 7-11-2001.

**RED ROCKER**

THE NAME "RED ROCKER" IDENTIFIES A LIVING INDIVIDUAL WHOSE CONSENT IS OF RECORD.  
FOR FOOTWEAR (U.S. CLS. 22 AND 39).

DANIELLE MATTESSICH, EXAMINING ATTORNEY

**CLASS 25—(Continued).**

SN 76-284,033. RED HEAD, INC., DBA CABO WABO ENTERPRISES, NOVATO, CA. FILED 7-13-2001.

**RED ROCKER**

THE NAME RED ROCKER IDENTIFIES A LIVING INDIVIDUAL WHOSE CONSENT IS OF RECORD.

FOR CLOTHING, NAMELY SHORTS, SHIRTS, T-SHIRTS, TANK TOPS, BATHING SUIT, JACKETS, HATS AND CAPS (U.S. CLS. 22 AND 39).

FIRST USE 3-0-1981; IN COMMERCE 3-0-1981.

DANIELLE MATTESSICH, EXAMINING ATTORNEY

SN 76-416,801. SEYCHELLES IMPORTS, LLC, EL SEGUNDO, CA. FILED 6-4-2002.

**BC**

OWNER OF U.S. REG. NOS. 2,173,318 AND 2,680,718.  
FOR CLOTHING, NAMELY, T-SHIRTS, SHIRTS, SHORTS, PANTS, SHORTS; AND FOOTWEAR (U.S. CLS. 22 AND 39).

FIRST USE 9-0-1996; IN COMMERCE 9-0-1996.

MIDGE BUTLER, EXAMINING ATTORNEY

SN 76-434,495. 3681441 CANADA INC., MONTREAL, QUEBEC H3L 1Z8, CANADA, FILED 7-24-2002.

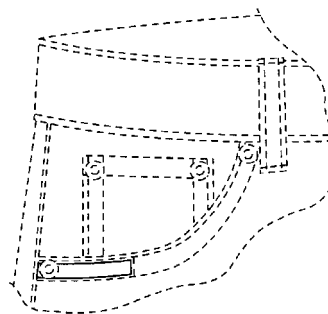

PRIORITY CLAIMED UNDER SEC. 44(D) ON CANADA APPLICATION NO. 1142511, FILED 6-3-2002, REG. NO. TMA625362, DATED 11-15-2004, EXPIRES 11-15-2019.

THE DOTTED LINES IN THE DRAWING ARE NOT PART OF THE MARK AND ONLY SERVE TO INDICATE THE POSITION OF THE MARK AS CLAIMED ON THE GOODS.  
FOR MEN'S, WOMEN'S AND CHILDREN'S JEANS AND APPAREL NAMELY, PANTS, SHORTS, SKIRTS (U.S. CLS. 22 AND 39).

SONYA STEPHENS, EXAMINING ATTORNEY



**CLASS 25—(Continued).**

SN 76-448,754. PLEASANT COMPANY, MIDDLETON, WI. FILED 9-12-2002.

**AMERICAN GIRL**

OWNER OF U.S. REG. NOS. 1,506,148, 2,614,557 AND OTHERS.  
FOR HALLOWEEN COSTUMES AND MASKS (U.S. CLS. 22 AND 39).  
FIRST USE 7-16-2001; IN COMMERCE 7-16-2001.  
MICHAEL ENGEL, EXAMINING ATTORNEY

SN 76-448,758. PLEASANT COMPANY, MIDDLETON, WI. FILED 9-12-2002.

**AMERICAN GIRL**

OWNER OF U.S. REG. NOS. 1,506,148, 2,614,557 AND OTHERS.  
FOR CLOTHING, NAMELY KERCHIEFS (U.S. CLS. 22 AND 39).  
FIRST USE 2-14-2000; IN COMMERCE 2-14-2000.  
MICHAEL ENGEL, EXAMINING ATTORNEY

SN 76-448,760. PLEASANT COMPANY, MIDDLETON, WI. FILED 9-12-2002.

**AMERICAN GIRL**

OWNER OF U.S. REG. NOS. 1,506,148, 2,614,557 AND OTHERS.  
FOR OUTERWEAR CLOTHING, NAMELY PARKAS (U.S. CLS. 22 AND 39).  
FIRST USE 7-27-1998; IN COMMERCE 7-27-1998.  
MICHAEL ENGEL, EXAMINING ATTORNEY

SN 76-448,768. PLEASANT COMPANY, MIDDLETON, WI. FILED 9-12-2002.

**AMERICAN GIRL**

OWNER OF U.S. REG. NOS. 1,269,348, 2,614,557 AND OTHERS.  
FOR SUN VISORS (U.S. CLS. 22 AND 39).  
FIRST USE 2-25-2002; IN COMMERCE 2-25-2002.  
MICHAEL ENGEL, EXAMINING ATTORNEY

SN 76-448,769. PLEASANT COMPANY, MIDDLETON, WI. FILED 9-12-2002.

**AMERICAN GIRL**

OWNER OF U.S. REG. NOS. 1,506,148, 2,614,557 AND OTHERS.  
FOR HOSIERY, NAMELY SOCKS (U.S. CLS. 22 AND 39).  
FIRST USE 7-27-1998; IN COMMERCE 7-27-1998.  
MICHAEL ENGEL, EXAMINING ATTORNEY

**CLASS 25—(Continued).**

SN 76-478,531. JCORP INC., ST. LAURENT, QUEBEC, CANADA, FILED 12-20-2002.

**VECTION**

PRIORITY CLAIMED UNDER SEC. 44(D) ON CANADA APPLICATION NO. 1159669, FILED 11-21-2002, REG. NO. TMA601968, DATED 2-11-2004, EXPIRES 2-11-2019.  
FOR SWIMWEAR (U.S. CLS. 22 AND 39).  
NICHOLAS ALTREE, EXAMINING ATTORNEY

SN 76-512,863. LEWIS, OLIVER WENDELL JR., WARREN, MI. FILED 5-8-2003.

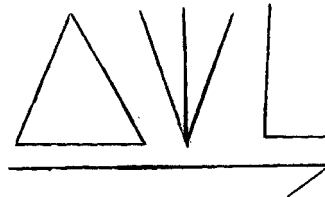

FOR CLOTHING AND ACCESSORIES, NAMELY—SHIRTS, VESTS, SWEATERS, SHOES, CAPS, PANTS, SOCKS, JACKETS, DRESSES, BLOUSES, FOOTWEAR, HATS, HEAD BANDS, UNDERWEAR, PAJAMAS, RAIN WEAR, SWIM WEAR AND SLEEP WEAR (U.S. CLS. 22 AND 39).  
INGA ERVIN, EXAMINING ATTORNEY

SN 76-532,877. CHARLOTTE RUSSE MERCHANDISING, INC., SAN DIEGO, CA. FILED 7-15-2003.

**REFERENCE**

FOR CLOTHING, NAMELY DRESSES, PANTS, SKIRTS, SHORTS, BLOUSES, JUMPERS, OVERALLS, KNIT AND WOVEN TOPS, SWEATERS, T-SHIRTS, PAJAMAS, NIGHTGOWNS, ROBES, LOUNGEWEAR, LINGERIE, SLIPS, UNDERGARMENTS, PANTIES, CASUAL AND DRESSY SHOES, SANDALS, BOOTS, SWEATPANTS, SWEATSHIRTS, SWEATSUITS, TIGHTS, LEGGINGS, AND SOCKS; PERFORMANCE WEAR, NAMELY JERSEYS, BICYCLE PANTS AND GYMNAS-TIC SUITS; SPORTSWEAR, NAMELY PANTS AND SHIRTS; SWIMWEAR, SWIMSUIT COVER-UPS AND LEOTARDS, TIGHTS, SOCKS, SHORTS; OUTERWEAR, NAMELY JACKETS, VESTS, COATS, SHELLS; AND HEADGEAR, NAMELY HATS, CAPS, HEADBANDS, VISORS, AND BELTS (U.S. CLS. 22 AND 39).  
RONALD MCMORROW, EXAMINING ATTORNEY

**CLASS 25—(Continued).**

SN 76-539,417. NBA PROPERTIES, INC., NEW YORK, NY.  
FILED 8-11-2003.



FOR CLOTHING, NAMELY HOSIERY, FOOTWEAR, BASKETBALL SHOES, BASKETBALL SNEAKERS, T-SHIRTS, SHIRTS, SWEATSHIRTS, SWEATPANTS, PANTS, TANK TOPS, JERSEYS, SHORTS, PAJAMAS, SPORT SHIRTS, RUGBY SHIRTS, SWEATERS, BELTS, TIES, NIGHTSHIRTS, HATS, CAPS, VISORS, WARM-UP SUITS, WARM-UP PANTS, WARM-UP TOPS/SHOOTING SHIRTS, JACKETS, WIND RESISTANT JACKETS, PARKAS, COATS, CLOTH BABY BIBS, HEAD BANDS, WRIST BANDS, APRONS, BOXER SHORTS, SLACKS, CAPS, EAR MUFFS, GLOVES, MITTENS, SCARVES, WOVEN AND KNIT SHIRTS, JERSEY DRESSES, DRESSES, CHEERLEADING DRESSES AND UNIFORMS (U.S. CLS. 22 AND 39).

FIRST USE 4-0-2001; IN COMMERCE 4-0-2001.  
YSA DEJESUS, EXAMINING ATTORNEY

SN 76-542,830. HAGGAR CLOTHING CO., DALLAS, TX.  
FILED 9-8-2003.

**FOREVER WHITE**

FOR MEN'S PANTS, SHORTS, SHIRTS, SUITS, JACKETS, NECKWEAR, WIND RESISTANT JACKETS, PARKAS, RAINCOATS, COATS, UNDERWEAR, LOUNGE WEAR, NAMELY, LOUNGE PANTS, SHOES, SOCKS, HOSIERY, BELTS, SWEATERS, VESTS, HEADWEAR, FOOTWEAR, GLOVES, OUTERWEAR, AND OTHER ACCESSORIES, NAMELY, TIES, CAPS AND HATS (U.S. CLS. 22 AND 39).

REBECCA SMITH, EXAMINING ATTORNEY

SN 76-544,549. AMERICAN APPAREL, INC., LOS ANGELES, CA. FILED 9-15-2003.

**AMERICAN APPAREL**

OWNER OF U.S. REG. NOS. 2,063,013 AND 2,359,401.  
NO CLAIM IS MADE TO THE EXCLUSIVE RIGHT TO USE APPAREL, APART FROM THE MARK AS SHOWN. SEC. 2(F).

FOR CLOTHING, NAMELY MENS, WOMENS AND CHILDRENS, TOPS AND UNDERWEAR (U.S. CLS. 22 AND 39).

FIRST USE 0-0-1988; IN COMMERCE 0-0-1988.  
CIMMERIAN COLEMAN, EXAMINING ATTORNEY

**CLASS 25—(Continued).**

SN 76-546,255. UNITED STATES ROWING ASSOCIATION, INDIANAPOLIS, IN. FILED 9-22-2003.



NO CLAIM IS MADE TO THE EXCLUSIVE RIGHT TO USE "USA", APART FROM THE MARK AS SHOWN.  
FOR CLOTHING, NAMELY, UNIFORMS, UNI-SUITS, T-SHIRTS, JACKETS, HATS, VISORS, SWEATSHIRTS, SWEATPANTS AND POLO SHIRTS (U.S. CLS. 22 AND 39).

FIRST USE 9-0-1987; IN COMMERCE 10-0-2002.  
KARANENDRA S. CHHINA, EXAMINING ATTORNEY

SN 76-549,287. RABBI'S DAUGHTERS, CULVER CITY, CA.  
FILED 10-6-2003.

***Rabbi's Daughters***

THE MARK CONSISTS OF STANDARD CHARACTERS WITHOUT CLAIM TO ANY PARTICULAR FONT, STYLE, SIZE, OR COLOR.

FOR T-SHIRTS, TANK TOPS, WOMEN'S PANTIES (U.S. CLS. 22 AND 39).

FIRST USE 7-15-2003; IN COMMERCE 7-25-2003.  
JAMES GRIFFIN, EXAMINING ATTORNEY

SN 76-554,269. ADLER LEATHER SPORTSWEAR MANUFACTURING CO., INC., SYLMAR, CA. FILED 10-27-2003.

**ADLER COLLECTION**

OWNER OF U.S. REG. NOS. 443,210 AND 758,891.  
NO CLAIM IS MADE TO THE EXCLUSIVE RIGHT TO USE "COLLECTION", APART FROM THE MARK AS SHOWN.

FOR LEATHER APPAREL FOR MEN, WOMEN AND CHILDREN, NAMELY, COATS, JACKETS, TOPS, BOTTOMS, GLOVES, BELTS, HEADWEAR AND FOOTWEAR (U.S. CLS. 22 AND 39).

FIRST USE 0-0-1996; IN COMMERCE 0-0-1996.  
MICHAEL WEBSTER, EXAMINING ATTORNEY

**CLASS 25—(Continued).**

SN 76-555,739. CANAL GROUP, INC., CHICAGO, IL. FILED 10-31-2003.

# SPACEBAR

THE MARK CONSISTS OF STANDARD CHARACTERS WITHOUT CLAIM TO ANY PARTICULAR FONT, STYLE, SIZE, OR COLOR.

FOR SOUVENIR CLOTHING COMMEMORATING A RESTAURANT AND COCKTAIL LOUNGE OF THE SAME NAME, NAMELY, SHIRTS, T-SHIRTS, SWEAT-SHIRTS, WARM-UP JACKETS, WARM-UP PANTS, BOXER SHORTS, SHORTS, HATS, SUN VISORS, BASEBALL CAPS, POLO SHIRTS, SPORT SHIRTS, BLOUSES, COATS, DRESSES, TANK TOPS, BATHING SUITS, HOSIERY, NECKTIES, UNDERWEAR, LINGERIE, AND GLOVES (U.S. CLS. 22 AND 39).

MIDGE BUTLER, EXAMINING ATTORNEY

SN 76-555,741. CANAL GROUP, INC., CHICAGO, IL. FILED 10-31-2003.

# SPACEBAR MORONGO

THE MARK CONSISTS OF STANDARD CHARACTERS WITHOUT CLAIM TO ANY PARTICULAR FONT, STYLE, SIZE, OR COLOR.

FOR SOUVENIR CLOTHING COMMEMORATING A RESTAURANT AND COCKTAIL LOUNGE OF THE SAME NAME, NAMELY, SHIRTS, T-SHIRTS, SWEAT-SHIRTS, WARM-UP JACKETS, WARM-UP PANTS, BOXER SHORTS, SHORTS, HATS, SUN VISORS, BASEBALL CAPS, POLO SHIRTS, SPORT SHIRTS, BLOUSES, COATS, DRESSES, TANK TOPS, BATHING SUITS, HOSIERY, NECKTIES, UNDERWEAR, LINGERIE, AND GLOVES (U.S. CLS. 22 AND 39).

MIDGE BUTLER, EXAMINING ATTORNEY

SN 76-557,559. THE TENNIS CHANNEL INC., SANTA MONICA, CA. FILED 11-6-2003.



NO CLAIM IS MADE TO THE EXCLUSIVE RIGHT TO USE TENNIS, APART FROM THE MARK AS SHOWN.

THE MARK IS A STYLIZED LETTER T AGAINST A BACKGROUND IN THE APPEARANCE OF A TENNIS COURT WITH THE WORDS TENNIS CHANNEL NEXT TO IT.

FOR SHIRTS, T-SHIRTS, SWEATSHIRTS, JACKETS, TOPS AND BOTTOMS, HATS, CAPS AND VISORS (U.S. CLS. 22 AND 39).

FIRST USE 7-0-2002; IN COMMERCE 7-0-2002.  
GINNY ISAACSON, EXAMINING ATTORNEY

**CLASS 25—(Continued).**

SN 76-558,946. C.R. DANIELS, INC., ELLICOTT CITY, MD. FILED 11-10-2003.

# EST EARLY SEASON TECHNOLOGY

THE MARK CONSISTS OF STANDARD CHARACTERS WITHOUT CLAIM TO ANY PARTICULAR FONT, STYLE, SIZE, OR COLOR.

NO CLAIM IS MADE TO THE EXCLUSIVE RIGHT TO USE "EARLY SEASON", APART FROM THE MARK AS SHOWN.

FOR CLOTHING FOR WATERFOWL HUNTING, NAMELY, JACKETS, PANTS, SHIRTS, VESTS, HATS, AND SWEATERS (U.S. CLS. 22 AND 39).

MICHAEL HALL, EXAMINING ATTORNEY

SN 76-559,174. SUB-URBAN INDUSTRIES, INC., LOS ANGELES, CA. FILED 11-10-2003.



THE MARK CONSISTS OF STANDARD CHARACTERS WITHOUT CLAIM TO ANY PARTICULAR FONT, STYLE, SIZE, OR COLOR.

FOR CLOTHING, NAMELY, SHIRTS, PANTS, T-SHIRTS, FOOTWEAR, HEADWEAR, BASEBALL CAPS, SHORTS, SWIMWEAR, LINGERIE, SWEAT SHIRTS, UNDERWEAR, JACKETS, DRESSES, AND SKIRTS, BELTS, SHOES, GLOVES (U.S. CLS. 22 AND 39).

CAROLINE WOOD, EXAMINING ATTORNEY

SN 76-559,564. RILEY, HOLLY, CHARLOTTE, NC. FILED 10-29-2003.

# BIMBOLINA HO

FOR T-SHIRTS (U.S. CLS. 22 AND 39).  
TRICIA SONNEBORN, EXAMINING ATTORNEY

**CLASS 25—(Continued).**

SN 76-559,858. CANAL GROUP, INC., CHICAGO, IL. FILED 11-14-2003.

**SPACEBAR PALMS**

THE MARK CONSISTS OF STANDARD CHARACTERS WITHOUT CLAIM TO ANY PARTICULAR FONT, STYLE, SIZE, OR COLOR.

FOR SOUVENIR CLOTHING COMMEMORATING A RESTAURANT AND COCKTAIL LOUNGE OF THE SAME NAME, NAMELY, SHIRTS, T-SHIRTS, SWEAT-SHIRTS, WARM-UP JACKETS, WARM-UP PANTS, BOXER SHORTS, SHORTS, HATS, SUN VISORS, BASEBALL CAPS, POLO SHIRTS, SPORT SHIRTS, BLOUSES, COATS, DRESSES, TANK TOPS, BATHING SUITS, HOSIERY, NECKTIES, UNDERWEAR, LINGERIE, AND GLOVES (U.S. CLS. 22 AND 39).

MIDGE BUTLER, EXAMINING ATTORNEY

SN 76-559,859. CANAL GROUP, INC., CHICAGO, IL. FILED 11-14-2003.

**BELLY MORONGO**

THE MARK CONSISTS OF STANDARD CHARACTERS WITHOUT CLAIM TO ANY PARTICULAR FONT, STYLE, SIZE, OR COLOR.

FOR SOUVENIR CLOTHING COMMEMORATING A RESTAURANT AND COCKTAIL LOUNGE OF THE SAME NAME, NAMELY, SHIRTS, T-SHIRTS, SWEAT-SHIRTS, WARM-UP JACKETS, WARM-UP PANTS, BOXER SHORTS, SHORTS, HATS, SUN VISORS, BASEBALL CAPS, POLO SHIRTS, SPORT SHIRTS, BLOUSES, COATS, DRESSES, TANK TOPS, BATHING SUITS, HOSIERY, NECKTIES, UNDERWEAR, LINGERIE, AND GLOVES (U.S. CLS. 22 AND 39).

GRETNA YAO, EXAMINING ATTORNEY

SN 76-561,305. ASICS CORPORATION, KOBE 650-8555, JAPAN, FILED 11-12-2003.

**GEL-GUTS**

THE MARK CONSISTS OF STANDARD CHARACTERS WITHOUT CLAIM TO ANY PARTICULAR FONT, STYLE, SIZE, OR COLOR.

OWNER OF U.S. REG. NOS. 1,813,790, 2,766,535 AND OTHERS.

FOR FOOTWEAR (U.S. CLS. 22 AND 39).  
FIRST USE 12-1-2002; IN COMMERCE 12-1-2002.  
JOHN GARTNER, EXAMINING ATTORNEY

**CLASS 25—(Continued).**

SN 76-561,721. PHOENIX FOOTWEAR GROUP, INC., OLD TOWN, ME. FILED 11-25-2003.



FOR CASUAL AND DRESS FOOTWEAR, NAMELY, SHOES, SANDALS, CLOGS AND SNEAKERS, SPECIFICALLY EXCLUDING SKI BOOTS AND SNOWBOARD BOOTS (U.S. CLS. 22 AND 39).

BRIDGETT SMITH, EXAMINING ATTORNEY

SN 76-561,993. KP SPORTS, INC., BALTIMORE, MD. FILED 11-26-2003.



**UNDER ARMOUR**

THE MARK CONSISTS OF THE STYLIZED LETTERS "U" AND "A" AND THE WORDS "UNDER ARMOUR".

FOR WRISTBANDS, HEADBANDS, RAIN SUITS, JACKETS, SOCKS, SKIRTS, ATHLETIC SLEEVES, HOODS, SKULL WRAPS, SKULL CAPS, VESTS, HATS, SHORTS, SHIRTS, LEGGINGS, PANTS, HEADWEAR FOR WINTER AND SUMMER, UNDERWEAR, TANK TOPS, BRAS, GIRDLES (U.S. CLS. 22 AND 39).

FIRST USE 12-1-1999; IN COMMERCE 12-1-1999.  
SEAN DWYER, EXAMINING ATTORNEY

**CLASS 25—(Continued).**

SN 76-562,679. WILSON, THOMAS M., LOVELAND, OH. FILED 12-2-2003.

**HIP HOP RAPPITS**

THE MARK CONSISTS OF STANDARD CHARACTERS WITHOUT CLAIM TO ANY PARTICULAR FONT, STYLE, SIZE, OR COLOR.

NO CLAIM IS MADE TO THE EXCLUSIVE RIGHT TO USE HIP HOP, APART FROM THE MARK AS SHOWN.

FOR ARTICLES OF CLOTHING, FOR MEN, WOMEN AND CHILDREN, NAMELY, PAJAMAS, NIGHTSHIRTS, ROBES, JOGGING SUITS, SWEATSUITS, T-SHIRTS, SWEATSHIRTS, JERSEYS, TANK TOPS, COLLAR SHIRTS, BLOUSES, SHORTS, PANTS, JUMPERS, OVERALLS, ROMPERS, LEOTARDS, DRESSES, SKIRTS, SHORT SETS COMPRISED OF SHORTS AND TOPS, SWEATERS, JACKETS, COATS, RAINCOATS, SCARVES, BANDANNAS, UNDERWEAR, VESTS, CLOTH BIBS FOR INFANTS AND CHILDREN, TIES, BELTS AND SUSPENDERS, SOCKS, TIGHTS, LEGGINGS, HOSIERY, GLOVES, MITTENS, APRONS, SWIMSUITS, KNITTED HEADWEAR, HATS, CAPS AND VISORS; FOOTWEAR AND MASQUERADE COSTUMES (U.S. CLS. 22 AND 39).  
ANDREA SAUNDERS, EXAMINING ATTORNEY

**CLASS 25—(Continued).**

SN 76-569,412. PARISH JAMES, INC., PROVIDENCE, RI. FILED 1-2-2004.

**PARISH JAMES**

THE MARK CONSISTS OF STANDARD CHARACTERS WITHOUT CLAIM TO ANY PARTICULAR FONT, STYLE, SIZE, OR COLOR.

THE NAME PARISH JAMES IS MERELY FANCIFUL AND DOES NOT IDENTIFY, A PARTICULAR LIVING INDIVIDUAL.

FOR CLOTHING, NAMELY, SWEATERS, JACKETS, PANTS, SNEAKERS, HATS, DRESS SHIRTS, JEAN JACKETS, JEAN PANTS, T-SHIRTS AND BUTTON-DOWN SHIRTS (U.S. CLS. 22 AND 39).

CURTIS FRENCH, EXAMINING ATTORNEY

SN 76-572,704. NATIONAL FOOTBALL LEAGUE, NEW YORK, NY. FILED 1-29-2004.

**SUPER BOWL**

SN 76-569,078. NATIONAL COLLEGIATE ATHLETIC ASSOCIATION, THE, INDIANAPOLIS, IN. FILED 1-9-2004.

**FINAL 4**

THE MARK CONSISTS OF STANDARD CHARACTERS WITHOUT CLAIM TO ANY PARTICULAR FONT, STYLE, SIZE, OR COLOR.

OWNER OF U.S. REG. NOS. 1,164,713, 2,377,720 AND OTHERS.

FOR CLOTHING, NAMELY, SHIRTS, SHORTS, SWEATSHIRTS, SWEATPANTS, PANTS, JACKETS, COATS, CAPS AND HATS (U.S. CLS. 22 AND 39).

FIRST USE 2-0-2003; IN COMMERCE 2-0-2003.  
ZACHARY BELLO, EXAMINING ATTORNEY

THE MARK CONSISTS OF STANDARD CHARACTERS WITHOUT CLAIM TO ANY PARTICULAR FONT, STYLE, SIZE, OR COLOR.

OWNER OF U.S. REG. NOS. 846,056, 1,226,261 AND OTHERS.

FOR MEN'S, WOMEN'S AND CHILDREN'S CLOTHING, NAMELY, FLEECE TOPS AND BOTTOMS, CAPS, HEADWEAR, T-SHIRTS, SWEATSHIRTS, SHORTS, TANK TOPS, JEANS, SWEATERS, PANTS, JACKETS, TURTLENECKS, JUMPSUITS, GOLF SHIRTS, WOVEN SHIRTS, KNIT SHIRTS, JERSEYS, WRISTBANDS, WARM UP SUITS, WIND RESISTANT JACKETS, RAINCOATS, PARKAS, PONCHOS, GLOVES, TIES, SUSPENDERS, CLOTH BIBS, SLEEPWEAR, NAMELY, ROBES, NIGHT SHIRTS AND PAJAMAS, MITTENS, KNIT HATS AND CAPS, SCARVES, APRONS, HEADBANDS, EAR MUFFS, UNDERWEAR, SNEAKERS AND SLIPPERS (U.S. CLS. 22 AND 39).

FIRST USE 1-30-1971; IN COMMERCE 1-30-1971.  
KELLEY WELLS, EXAMINING ATTORNEY

**CLASS 25—(Continued).**

SN 76-573,464. CODET INC., QUEBEC, CANADA, FILED 1-30-2004.

AMERICAN HOT ROD

THE MARK CONSISTS OF STANDARD CHARACTERS WITHOUT CLAIM TO ANY PARTICULAR FONT, STYLE, SIZE, OR COLOR.

OWNER OF U.S. REG. NO. 1,461,066.

NO CLAIM IS MADE TO THE EXCLUSIVE RIGHT TO USE AMERICAN, APART FROM THE MARK AS SHOWN.

FOR CLOTHING, NAMELY, SHIRTS, T-SHIRTS, PANTS, JEANS, SHORTS, VESTS, JACKETS, COVERALLS, OVERALLS, SWEATERS, SUSPENDERS, BELTS, HEADWEAR, CAPS, SOCKS, UNDERWEAR, GLOVES, FOOTWEAR, BOOTS, SHOES, SANDALS, APRONS, COATS, BANDANAS, PAJAMAS, SKIRTS, HOSIERY, NECK TIES, AND TANK TOPS (U.S. CLS. 22 AND 39).  
TRACY CROSS, EXAMINING ATTORNEY

**CLASS 25—(Continued).**

SN 76-576,197. JOYRIGGS CORPORATION, LAS VEGAS, NV. FILED 2-13-2004.



Robin Joy Riggsbee

THE NAME(S), PORTRAIT(S), AND/OR SIGNATURE(S) SHOWN IN THE MARK IDENTIFIES ROBIN JOY RIGGSBEE, WHOSE CONSENT(S) TO REGISTER IS SUBMITTED, FOR CLOTHING, NAMELY, SKIRTS, BLOUSES, PANTS, JACKETS, SCARVES AND BELTS (U.S. CLS. 22 AND 39).

FIRST USE 12-20-2003; IN COMMERCE 12-20-2003.  
FLORENTINA BLANDU, EXAMINING ATTORNEY

SN 76-577,271. GIBSON, GREGORY R., COUNCIL BLUFF, IA. FILED 2-17-2004.

WOLFBALL

THE MARK CONSISTS OF STANDARD CHARACTERS WITHOUT CLAIM TO ANY PARTICULAR FONT, STYLE, SIZE, OR COLOR.

OWNER OF U.S. REG. NO. 2,851,663.  
FOR CLOTHING; NAMELY, SHIRTS, CAPS, PANTS AND SHORTS (U.S. CLS. 22 AND 39).

FIRST USE 1-1-2002; IN COMMERCE 4-1-2002.  
BERYL GARDNER, EXAMINING ATTORNEY

SN 76-575,689. LEWIN, JAMIE P., NEW YORK, NY. FILED 2-3-2004.

PHYL CASUAL COUTURE

THE MARK CONSISTS OF STANDARD CHARACTERS WITHOUT CLAIM TO ANY PARTICULAR FONT, STYLE, SIZE, OR COLOR.

NO CLAIM IS MADE TO THE EXCLUSIVE RIGHT TO USE CASUAL COUTURE, APART FROM THE MARK AS SHOWN.

FOR MEN'S AND WOMEN'S CLOTHING, NAMELY WOMEN'S DRESSES, LONG SLEEVE T-SHIRTS, SHORT SLEEVE T-SHIRTS, TANK TOPS, SKIRTS, KNIT SHIRTS, WOVEN SHIRTS, JACKETS, PANTS, SWEATERS AND MEN'S T-SHIRTS, NECKTIES, JACKETS, SWEATERS (U.S. CLS. 22 AND 39).

FIRST USE 1-1-2004; IN COMMERCE 1-1-2004.  
ANNE MADDEN, EXAMINING ATTORNEY

SN 76-578,961. INTRICATE CONCEPTS INC., NEW YORK, NY. FILED 3-3-2004.



THE MARK CONSISTS OF THE WORDING FOURFRONT DEFINES LEADERSHIP AND DESIGN. THE DESIGN ELEMENT ABOVE THE MARK IS A DEPICTION OF A HUMAN BEING COMPRISED PRIMARILY OF THE NUMBER "4". A SMALLER VERSION OF THIS SAME DESIGN APPEARS BETWEEN THE TERMS DEFINES AND LEADERSHIP.

FOR CLOTHING, NAMELY, JEANS, COATS, JACKETS, SWEAT SHIRTS, T-SHIRTS, HATS AND FOOTWEAR (U.S. CLS. 22 AND 39).

ALICIA COLLINS, EXAMINING ATTORNEY

**CLASS 25—(Continued).**

SN 76-579,201. A & H SPORTSWEAR CO., INC., STOCKERTOWN, PA. FILED 3-5-2004.

**LOOK TRIM FEEL SLIM IN SECONDS**

THE MARK CONSISTS OF STANDARD CHARACTERS WITHOUT CLAIM TO ANY PARTICULAR FONT, STYLE, SIZE, OR COLOR.  
OWNER OF U.S. REG. NOS. 1,981,162, 2,340,925 AND OTHERS.  
FOR SWIMWEAR (U.S. CLS. 22 AND 39).  
LEIGH CAROLINE CASE, EXAMINING ATTORNEY

---

SN 76-579,456. KLEINMAN, KELLY, WESTLAKE VILLAGE, CA. FILED 3-5-2004.

**BALANCE STREETWEAR**

THE MARK CONSISTS OF STANDARD CHARACTERS WITHOUT CLAIM TO ANY PARTICULAR FONT, STYLE, SIZE, OR COLOR.  
NO CLAIM IS MADE TO THE EXCLUSIVE RIGHT TO USE "STREETWEAR", APART FROM THE MARK AS SHOWN.  
FOR SHIRTS, SWEATERS AND OTHER CLOTHING GARMENTS, NAMELY, SHIRTS, SWEATERS, PANTS, AND HATS (U.S. CLS. 22 AND 39).  
FIRST USE 2-6-2004; IN COMMERCE 2-6-2004.  
SEAN DWYER, EXAMINING ATTORNEY

---

SN 76-579,903. SALSEDA, LOUIS, NORTHRIDGE, CA. FILED 3-8-2004.



NO CLAIM IS MADE TO THE EXCLUSIVE RIGHT TO USE "BRAZILIAN JIU-JITSU", APART FROM THE MARK AS SHOWN.  
FOR CLOTHING, NAMELY, BANDANNAS, HEADBANDS, SWEATBANDS, WRISTBANDS, GYM SHORTS, SHIRTS, SWEATPANTS, SWEATSHIRTS, SWEATSHORTS, T-SHIRTS, TANK TOPS, TOPS, JOGGING SUITS, WARM UP SUITS, SWEAT SUITS; HEADWEAR, NAMELY, HATS (U.S. CLS. 22 AND 39).  
MARTHA FROMM, EXAMINING ATTORNEY

**CLASS 25—(Continued).**

SN 76-583,076. BULGARI S.P.A., ROME, ITALY, FILED 3-23-2004.

**BVLGARI**

THE MARK CONSISTS OF STANDARD CHARACTERS WITHOUT CLAIM TO ANY PARTICULAR FONT, STYLE, SIZE, OR COLOR.  
OWNER OF U.S. REG. NOS. 1,848,470, 2,783,545 AND OTHERS.  
FOR BELTS, TIES, SCARVES, SHAWLS, AND STOLES (U.S. CLS. 22 AND 39).  
FIRST USE 3-0-1995; IN COMMERCE 3-0-1995.  
ELLEN PERKINS, EXAMINING ATTORNEY

---

SN 76-583,252. KUMON INSTITUTE OF EDUCATION CO., LTD., KITA-KU, OSAKA, JAPAN, FILED 3-26-2004.



OWNER OF U.S. REG. NOS. 1,279,249, 2,433,293 AND OTHERS.  
FOR CLOTHING, NAMELY, COATS, SWEATERS, T-SHIRTS, SHIRTS, JUMPERS, JACKETS, SWEATSHIRTS, VESTS AND WAIST COATS, NIGHTWEAR, SWIMWEAR, SWIMMING CAPS, BATHING CAPS; APRONS, COLLAR PROTECTORS, SOCKS AND STOCKINGS, PUTTEES AND GATORS, FUR STOLES, SHAWLS, SCARVES, GLOVES AND MITTENS; BABIES DIAPERS OF TEXTILE, NECKTIES, NECKERCHIEFS, BANDANAS, SUPPORTIVE LEG WARMERS, MUFFLERS, HOODS AND EAR MUFFS, NIGHT CAPS; HEADGEAR, NAMELY HATS AND CAPS; GARTERS, SOCK SUSPENDERS, SUSPENDERS, BRACES, WAISTBANDS, BELTS FOR CLOTHING; MASQUERADE COSTUMES; CLOTHES FOR SPORTS, NAMELY, POLO SHIRTS, T-SHIRTS AND SWEATSHIRTS; BOOTS FOR SPORTS, EXCLUDING HORSE RIDING BOOTS (U.S. CLS. 22 AND 39).  
TRICIA SONNEBORN, EXAMINING ATTORNEY

---

SN 76-585,790. AMERICAN SPORTS LICENSING, INC., WILMINGTON, DE. FILED 4-8-2004.

**SILENT TRACKER**

THE MARK CONSISTS OF STANDARD CHARACTERS WITHOUT CLAIM TO ANY PARTICULAR FONT, STYLE, SIZE, OR COLOR.  
FOR FOOTWEAR, NAMELY, SHOES AND BOOTS (U.S. CLS. 22 AND 39).  
FRED MANDIR, EXAMINING ATTORNEY

**CLASS 25—(Continued).**

SN 76-585,883. DERMAHOSE INC., MIRAMAR, FL. FILED 4-9-2004.

# DERMA HOSE

THE MARK CONSISTS OF STANDARD CHARACTERS WITHOUT CLAIM TO ANY PARTICULAR FONT, STYLE, SIZE, OR COLOR.

NO CLAIM IS MADE TO THE EXCLUSIVE RIGHT TO USE "HOSE", APART FROM THE MARK AS SHOWN. FOR PANTYHOSE (U.S. CLS. 22 AND 39). VERA BETH RIRIE, EXAMINING ATTORNEY

**CLASS 25—(Continued).**

SN 76-586,095. SHEEHAN, WILLIAM J., MIDDLE ISLAND, NY. AND SCHWARZ, DARYL J., SMITHTOWN, NY. FILED 4-12-2004.



FOR HATS, SHIRTS, JACKETS AND GLOVES (U.S. CLS. 22 AND 39). STEVEN BERK, EXAMINING ATTORNEY

SN 76-586,042. PROFESSIONAL LACROSSE PLAYERS' ASSOCIATION, NEWPORT, RI. FILED 4-8-2004.



NO CLAIM IS MADE TO THE EXCLUSIVE RIGHT TO USE "PROFESSIONAL LACROSSE PLAYERS' ASSOCIATION", APART FROM THE MARK AS SHOWN.

THE COLOR(S) BLUE, BLACK, AND ORANGE IS/ARE CLAIMED AS A FEATURE OF THE MARK.

THE MARK CONSISTS OF THE COLOR WHITE IS USED FOR THE LETTERING NAMELY, "PROFESSIONAL LACROSSE PLAYERS' ASSOCIATION". THE COLOR ORANGE IS USED AS A BACKGROUND FOR THE INNER CIRCLE, AND FOR TWO STARS WITHIN THE OUTER RING. THE COLOR BLACK IS USED BY THE OUTER RING SUCH THAT THE STARS AND LETTERING ARE MORE EASILY VISIBLE. THE COLORS BLACK & WHITE ARE USED TO DEPICT A LACROSSE PLAYER WITHIN THE INNER (ORANGE) CIRCLE, AND THAT EXTENDS THROUGH THE OUTER (BLACK) RING.

FOR MEN'S, WOMEN'S AND CHILDREN'S CLOTHING, NAMELY SWEATSHIRTS, JACKETS, SWEATPANTS, HATS, HEADBANDS, VISORS, CAPS, WRISTBANDS, SOCKS, T-SHIRTS, COLLARED SHIRTS, SHORTS, FLEECE TOPS, SLEEPWEAR, AND AUTHENTIC AND REPLICA PLAYER IDENTIFIED TEAM JERSEYS (U.S. CLS. 22 AND 39).

FIRST USE 11-17-1998; IN COMMERCE 11-17-1998. REGINA DRUMMOND, EXAMINING ATTORNEY

SN 76-586,147. FOXWORTHY, JEFF, LOS ANGELES, CA. FILED 4-12-2004.



NO CLAIM IS MADE TO THE EXCLUSIVE RIGHT TO USE "ORIGINAL" AND "WEAR", APART FROM THE MARK AS SHOWN.

THE MARK IS A DIAMOND SHAPE WITH A BORDER AND THE WORDS ORIGINAL FOXWORTHY REDNECK WEAR IN THE CENTER.

FOR T-SHIRTS (U.S. CLS. 22 AND 39). FIRST USE 6-0-1998; IN COMMERCE 6-0-1998. DAVID MURRAY, EXAMINING ATTORNEY

SN 76-586,149. WHITNEY, DANIEL D., SANFORD, FL. FILED 4-12-2004.

# GIT-R-DONE

THE MARK CONSISTS OF STANDARD CHARACTERS WITHOUT CLAIM TO ANY PARTICULAR FONT, STYLE, SIZE, OR COLOR.

FOR HATS, SWEATSHIRTS AND T-SHIRTS (U.S. CLS. 22 AND 39).

FIRST USE 6-0-1991; IN COMMERCE 6-0-1991. MICHAEL WEBSTER, EXAMINING ATTORNEY



**CLASS 25—(Continued).**

SN 76-588,336. FAT KAT LLC, KEYPORT, NJ. FILED 4-22-2004.



NO CLAIM IS MADE TO THE EXCLUSIVE RIGHT TO USE "CLOTHING", APART FROM THE MARK AS SHOWN. FOR CLOTHING - NAMELY T-SHIRTS, POLO SHIRTS, SPORTS SHIRTS, SWEAT SHIRTS, SWEATERS, JACKETS, PANTS, SOCKS, UNDERWEAR, HATS AND CAPS (U.S. CLS. 22 AND 39).  
FIRST USE 3-15-2004; IN COMMERCE 3-15-2004.  
DANIEL BRODY, EXAMINING ATTORNEY

SN 76-588,369. TEMENOS, L.P., SAUSALITO, CA. FILED 4-22-2004.

**WMD WEAPONS OF MASS DISTRACTION**

FOR SWEATPANTS, SWEATSHIRTS, SWEAT SHORTS, SWEAT SUITS, T-SHIRTS AND SHIRTS (U.S. CLS. 22 AND 39).  
KARLA PERKINS, EXAMINING ATTORNEY

SN 76-590,606. ROGERS, ARZY, PORT ORANGE, FL. FILED 5-5-2004.

**I'm Gonna  
+ Procrastination =  
Nothing Accomplished**

THE MARK CONSISTS OF STANDARD CHARACTERS WITHOUT CLAIM TO ANY PARTICULAR FONT, STYLE, SIZE, OR COLOR.  
FOR CLOTHING, NAMELY T-SHIRTS, CAPS, AND BUTTONS (U.S. CLS. 22 AND 39).  
NAAKWAMA ANKRAH, EXAMINING ATTORNEY

**CLASS 25—(Continued).**

SN 76-591,198. BEARD, TODD, HUNTINGTON BEACH, CA. FILED 5-10-2004.

**CULTURED PEARL**

THE MARK CONSISTS OF STANDARD CHARACTERS WITHOUT CLAIM TO ANY PARTICULAR FONT, STYLE, SIZE, OR COLOR.  
FOR CLOTHING, NAMELY, SHORTS, SWIM WEAR, SHIRTS, PANTS, ATHLETIC SHOES, HATS, CLOTHING BELTS, JACKETS, TANK TOPS, T-SHIRTS, BLOUSES, UNDERWEAR, DRESSES, GLOVES, THONGS, SOCKS, DRESSES, HEADBANDS, WRISTBANDS, SKIRTS, TUBE TOPS, HALTER TOPS AND SCARFS (U.S. CLS. 22 AND 39).  
FIRST USE 5-7-2004; IN COMMERCE 5-7-2004.  
GEORGE LORENZO, EXAMINING ATTORNEY

SN 76-592,304. DHARMA LEATHER CORP., MIAMI, FL. FILED 5-13-2004.



OWNER OF U.S. REG. NO. 2,657,912.  
FOR SHOES (U.S. CLS. 22 AND 39).  
FIRST USE 4-0-2002; IN COMMERCE 4-0-2002.  
DAVID TAYLOR, EXAMINING ATTORNEY

SN 76-592,742. SILVER, LISA P., OSSINING, NY. FILED 5-17-2004.

**EL SHADDAI**

THE MARK CONSISTS OF STANDARD CHARACTERS WITHOUT CLAIM TO ANY PARTICULAR FONT, STYLE, SIZE, OR COLOR.  
THE ENGLISH TRANSLATION OF THE WORD EL SHADDAI IN THE MARK IS GOD ALMIGHTY.  
FOR WEDDING GOWNS, EVENING GOWNS, DRESSES, MEN'S SUITS, PANTS, TROUSERS, TUXEDOS, BLOUSES, SKIRTS, JUMPERS, LINGERIE, CAMISOLES, BRAS, BRIEFS AND BOXERS, UNDERWEAR, SWEATERS, SHIRTS, TIES, VESTS, SCARVES, CUMMERBUNDS, COATS, JACKETS, BLAZERS, CAPES, SOCKS, HATS, BELTS AND SUSPENDERS (U.S. CLS. 22 AND 39).  
LINDA E. BLOHM, EXAMINING ATTORNEY

**CLASS 25—(Continued).**

SN 76-592,802. POLLARD, FRED W., ATLANTA, GA. FILED 5-12-2004.

**GO-SEE**

THE MARK CONSISTS OF STANDARD CHARACTERS WITHOUT CLAIM TO ANY PARTICULAR FONT, STYLE, SIZE, OR COLOR.

FOR MEN'S, WOMEN'S AND CHILDREN'S CLOTHING, NAMELY SWEATSHIRTS, SHIRTS, JEANS, JACKETS, COATS, SWEATPANTS, SLACKS, SUITS, HATS, HEADBANDS, VISORS, CAPS, DRESSES, SHOES, SNEAKERS, BOOTS, WRISTBANDS, SOCKS, T-SHIRTS (U.S. CLS. 22 AND 39).

CHERYL CLAYTON, EXAMINING ATTORNEY

SN 78-099,097. DANCING FEET YOGA CENTER, INC., LONG BEACH, IN. FILED 12-19-2001.

**YOGAKIDS**

OWNER OF U.S. REG. NOS. 2,087,029 AND 2,483,936. FOR HATS, HAT BANDS, BASEBALL CAPS, SHIRTS, SPORT SHIRTS, SPORT COATS, SHORTS, PANTS, JACKETS, DENIM JACKETS, RAIN JACKETS, UNITARDS, LEOTARDS, SWEAT BANDS, PAJAMAS, SLEEPWEAR, SLEEP SHIRTS, SHOES, FOOTWEAR, SANDALS, SOCKS, AND HEAD BANDS (U.S. CLS. 22 AND 39).

CYNTHIA SLOAN, EXAMINING ATTORNEY

SN 78-111,189. JLB CORPORATION, HONOLULU, HI. FILED 2-26-2002.

**ALOHA.CALM**

FOR CLOTHING, NAMELY, T-SHIRTS, SWEATSHIRTS, SWEATPANTS, JACKETS, SHORTS, GOLF SHIRTS, CAPS AND VISORS (U.S. CLS. 22 AND 39).

FIRST USE 8-10-2000; IN COMMERCE 8-10-2000.  
LAURA KOVAISKY, EXAMINING ATTORNEY

SN 78-199,114. MEME, MASIFA, MIRAMAR, FL. FILED 12-31-2002.

**Masimé** 

THE MARK CONSISTS OF THE WORDING MASIME

**CLASS 25—(Continued).**

AND A STYLISH REPRESENTATION OF THE LETTER V. TWO "V'S" ARE POSITIONED ON TOP OF EACH OTHER WITH ONE "V" UPRIGHT AND THE OTHER UPTURNED. A LINE RUNS THROUGH THE CENTER OF BOTH LETTERS FOLLOWED BY TWO POINTS (DARK CIRCLED DOTS). ONE POINT IS LOCATED AT THE UPPER LEFT CORNER OF THE DESIGN AND THE OTHER IS LOCATED AT THE LOWER RIGHT CORNER. THE DESIGN CONVEYS TWO "M'S" ONE UPRIGHT THE OTHER OVERTURNED FOLLOWED BY TWO POINTS TO CONVEY INITIALS.

FOR CLOTHING, NAMELY, SHIRTS, SKIRTS AND PANTS (U.S. CLS. 22 AND 39).

FIRST USE 1-15-1995; IN COMMERCE 6-25-1998.

TRACY FLETCHER, EXAMINING ATTORNEY

SN 78-222,309. WARRIOR LACROSSE, INC., WARREN, MI. FILED 3-6-2003.

**22 LACROSSE**

NO CLAIM IS MADE TO THE EXCLUSIVE RIGHT TO USE "LACROSSE", APART FROM THE MARK AS SHOWN.

FOR CLOTHING, NAMELY T-SHIRTS, COLLARED SHIRTS, SWEATSHIRTS, JERSEYS, HATS, AND FOOTWEAR (U.S. CLS. 22 AND 39).

JERI J. FICKES, EXAMINING ATTORNEY

SN 78-234,174. MIRANDA, ARIADNA SODI, NEW YORK, NY. FILED 4-4-2003.



OWNER OF U.S. REG. NO. 2,163,352.

THE NAME THALIA SODI IDENTIFIES A LIVING INDIVIDUAL WHOSE CONSENT IS OF RECORD.

FOR SLEEPWEAR; GIRLS CLOTHING, NAMELY, TOPS, BOTTOMS, SLEEPWEAR; LADIES AND GIRLS LINGERIE, BRA AND PANTY COORDINATES, HOSIERY, LEG WARMERS; LADIES AND GIRLS FOOTWEAR; LADIES AND GIRLS HEADWEAR; LADIES WEAR NAMELY, SPORTSWEAR IN THE NATURE OF BLOUSES, TOPS, BOTTOMS, DRESSES, CARDIGANS, GOWNS, JUMPERS, KNIT SHIRTS, PANTS, SHIRTS, SLACKS, SUITS, SWEATER; ACTIVEWEAR AND OUTERWEAR, NAMELY, COATS, GLOVES, GYM SHORTS, GYM SUITS, HATS, JACKETS, JERSEYS, JOGGING SUITS, LEOTARDS, MITTENS, SCARVES, SHORTS, SWIM WEAR, VESTS; LADIES AND GIRLS ACCESSORIES, NAMELY, BELTS, BRAS, GARTERS, COLLARS, KERCHIEFS, NECKWEAR, ROBES, WRIST BANDS (U.S. CLS. 22 AND 39).

PAULA MAYS, EXAMINING ATTORNEY

**CLASS 25—(Continued).**

SN 78-248,351. L. L. BEAN, INC., FREEPORT, ME. FILED 5-12-2003.

**STORM CHASER**

NO CLAIM IS MADE TO THE EXCLUSIVE RIGHT TO USE "STORM", APART FROM THE MARK AS SHOWN. FOR FOOTWEAR AND RAINWEAR, NAMELY, JACKETS AND PANTS (U.S. CLS. 22 AND 39). FIRST USE 1-28-2003; IN COMMERCE 1-28-2003. INGA ERVIN, EXAMINING ATTORNEY

**CLASS 25—(Continued).**

SN 78-278,745. SHARP, GLORIA A., CLEVELAND, MO. FILED 7-24-2003.

**Bangdana**

THE MARK CONSISTS OF STANDARD CHARACTERS WITHOUT CLAIM TO ANY PARTICULAR FONT, STYLE, SIZE, OR COLOR.

FOR HEADWEAR; NAMELY SCARFS AND BANDANAS (U.S. CLS. 22 AND 39).

FIRST USE 6-3-2003; IN COMMERCE 8-4-2003.

JERI J. FICKES, EXAMINING ATTORNEY

SN 78-266,367. BROOKS SPORTS, INC., BOTHELL, WA. FILED 6-24-2003.

—  
—  
—



NO CLAIM IS MADE TO THE EXCLUSIVE RIGHT TO USE "PLATFORM", APART FROM THE MARK AS SHOWN. FOR SHOES. (U.S. CLS. 22 AND 39). ANNE MADDEN, EXAMINING ATTORNEY

SN 78-301,597. ZOOMP S/A, SAN PAULO, BRAZIL, FILED 9-17-2003.

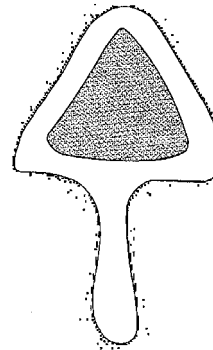

THE STIPPLING IN THE CENTER OF THE DRAWING IS FOR SHADING PURPOSES. THE REMAINING STIPPLING ALONG THE OUTSIDE BORDER IS A FEATURE OF THE MARK.

THE MARK CONSISTS OF A TRIANGULAR DESIGN WITHIN A TRIANGULAR DESIGN WITH A CENTRAL STEM.

FOR CLOTHING, NAMELY, BANDANAS, NECKERCHIEFS, BATHING DRAWERS, BATHING SUITS, BELTS, BERETS, BOAS, LINGERIE BODICES, BOOTS, BREECHES, CAMISOLES, CAPS, COATS, TOP-COATS, GABARDINES, HEADWEAR, HOODS, HOSIERY, JACKETS, JUMPERS, KNITWEAR, LEATHER CLOTHING, NAMELY, LEATHER COATS, JACKETS, PANTS AND SHOES; NECKTIES, OVERALLS, OVERCOATS, PANTS, PARKAS, POCKET SQUARES, PULLOVERS, SHAWLS, SHIRTS, SHOES, SKIRTS, SLIPPERS, SOCKS, SUITS, SWEATERS, T-SHIRTS, TROUSERS, UNDERWEAR AND VESTS (U.S. CLS. 22 AND 39).

CHERYL CLAYTON, EXAMINING ATTORNEY

SN 78-268,969. DIAMANTE, ALEX, BRONX, NY. FILED 7-1-2003.

**NO LABEL DENIM COMPANY**

NO CLAIM IS MADE TO THE EXCLUSIVE RIGHT TO USE DENIM COMPANY, APART FROM THE MARK AS SHOWN.

FOR SHIRTS, PANTS, COATS, HATS (U.S. CLS. 22 AND 39).

FIRST USE 10-10-2002; IN COMMERCE 9-1-2003. CHERYL CLAYTON, EXAMINING ATTORNEY

**CLASS 25—(Continued).**

SN 78-306,359. BRAZIER, JOSEPH GRANT III, AGOURA HILLS, CA. FILED 9-27-2003.

**KAIIZEN**

FOR T-SHIRTS, JEANS, PANTS, SHIRTS, SHOES, SANDALS, SHORTS, SOCKS, BELTS, HATS, SWEATERS, UNDERWEAR, JACKETS, TIES, WETSUITS, SUITS, BATHING SUITS, GLOVES, BOOTIES, AND BEANIES. (U.S. CLS. 22 AND 39).

JEFFREY S. MOLINOFF, EXAMINING ATTORNEY

---

SN 78-308,733. ALL PURPOSE, INC., SALT LAKE CITY, UT. FILED 10-2-2003.

**ALL-PURPOSE WINDOWS AND DOORS**

FOR CLOTHING AND SPORTSWEAR, NAMELY T-SHIRTS, JACKETS, SHIRTS AND HEAD WEAR NAMELY CAPS (U.S. CLS. 22 AND 39).  
FIRST USE 0-0-1986; IN COMMERCE 0-0-1986.  
GWEN STOKOLS, EXAMINING ATTORNEY

---

SN 78-310,278. ROTSTEIN, GALI, ENCINO, CA. FILED 10-7-2003.

**DIAMOND LULU**

THE NAME LULU DOES NOT IDENTIFY A LIVING INDIVIDUAL.

FOR LEATHER JACKETS, SKIRTS, SLEEPWEAR, SWEATERS, SHOES, COATS, PANTS, BATH ROBES, BELTS, BOOTS, DRESSES, SHORTS, SHIRTS, HATS, SCARVES, NONE OF THE ABOVE INCLUDE DIAMONDS, FAUX DIAMONDS OR RHINESTONES (U.S. CLS. 22 AND 39).

TRICIA SONNEBORN, EXAMINING ATTORNEY

**CLASS 25—(Continued).**

SN 78-313,072. JACKSON, PAMELA K., RANCHO CUCAMONGA, CA. FILED 10-14-2003.

**O 2 B Me**

THE MARK CONSISTS OF STANDARD CHARACTERS WITHOUT CLAIM TO ANY PARTICULAR FONT, STYLE, SIZE, OR COLOR.

FOR CLOTHING, NAMELY, KID'S TEE SHIRTS, SHORTS, PANTS, TANK TOPS, HATS, BUTTON DOWN SHIRTS, BASEBALL SHIRTS, V-NECK TEE SHIRTS, SWEAT PANTS, SWEAT SHIRTS, RINGER SHIRTS AND CREEPERS (U.S. CLS. 22 AND 39).

GLENN CLARK, EXAMINING ATTORNEY

---

SN 78-314,682. CHARLES GRAY LONDON LIMITED, LONDON, UNITED KINGDOM, FILED 10-16-2003.

**SARA BERMAN**

OWNER OF UNITED KINGDOM REG. NO. 2289988, DATED 6-21-2002, EXPIRES 1-12-2012.

THE NAME SARA BERMAN IDENTIFIES A LIVING INDIVIDUAL WHOSE CONSENT IS OF RECORD.

FOR ARTICLES OF CLOTHING, NAMELY SOCKS AND FOOTWEAR; FASHION CLOTHES FOR MEN, FOR WOMEN AND FOR CHILDREN, NAMELY KNITTED SWEATERS, JACKETS, GLOVES, SCARVES, HATS, DRESSES, SKIRTS, TEE-SHIRTS, CARDIGANS, VESTS, TOPS, COATS, TROUSERS, SHORTS, SHIRTS, PULLOVERS, MITTENS, SOCKS, CAPES AND SHAWLS; TAILORED SUITS, JACKETS, COATS, TROUSERS, SHORTS, SKIRTS, DRESSES, TOPS, SHIRTS, TEE-SHIRTS, BLOUSES, JUMPERS, SWEATERS, PULL-OVERS, CARDIGANS, FLEECE PULL OVERS, SCARVES, GLOVES AND HATS (U.S. CLS. 22 AND 39).

SONYA STEPHENS, EXAMINING ATTORNEY

---

SN 78-315,851. GIORDANO, ANTHONY, LAS VEGAS, NV. FILED 10-20-2003.

**LAS VEGAS CHOPPERS**

NO CLAIM IS MADE TO THE EXCLUSIVE RIGHT TO USE LAS VEGAS, APART FROM THE MARK AS SHOWN.

FOR T-SHIRTS, SWEATSHIRTS, JACKETS, TANK TOPS, HALTER TOPS, PANTIES (U.S. CLS. 22 AND 39).

MICHAEL ENGEL, EXAMINING ATTORNEY

**CLASS 25—(Continued).**

SN 78-337,611. CAYRE, KEN, NEW YORK, NY. FILED 12-8-2003.

**JACK RUSSELL**

THE MARK CONSISTS OF STANDARD CHARACTERS WITHOUT CLAIM TO ANY PARTICULAR FONT, STYLE, SIZE, OR COLOR.

THE NAME(S), PORTRAIT(S), AND/OR SIGNATURE(S) SHOWN IN THE MARK IDENTIFIES, WHOSE CONSENT(S) TO REGISTER IS SUBMITTED.

FOR CLOTHING, HEADWEAR, AND FOOTWEAR FOR MEN, WOMEN, BOYS AND GIRLS, NAMELY, DRESSES, SHIRTS, BLOUSES, JACKETS, COATS, VESTS, SUITS, SWEATERS, PANTS, RAINCOATS, SKIRTS, SHORTS, JEANS, PAJAMAS, NIGHTGOWNS, ROBES, SOCKS, SHOES, BOOTS, SLIPPERS, SCARVES, PONCHOS, SHAWLS, HATS, BELTS, GLOVES, MITTENS AND HEADBANDS AGAINST SWEATING AND FOR HOLDING BACK HAIR (U.S. CLS. 22 AND 39).

DOMINIC J. FERRAIUOLO, EXAMINING ATTORNEY

**CLASS 25—(Continued).**

SN 78-363,309. MAIDENFORM, INC., NEW YORK, NY. FILED 2-5-2004.

**BODYMATES**

THE MARK CONSISTS OF STANDARD CHARACTERS WITHOUT CLAIM TO ANY PARTICULAR FONT, STYLE, SIZE, OR COLOR.

FOR CLOTHING, WOMEN'S APPAREL, SHAPE WEAR AND INTIMATE APPAREL, NAMELY, FOUNDATION GARMENTS, SLEEPWEAR, LINGERIE, BRAS, BANDEAUX, PANTIES, UNDERWEAR, CORSETS, CORSELETS, PANTY-GIRDLES, GIRDLES, GARTER BELTS, FOOTWEAR, SLIPPERS, LOUNGEWEAR, BEACHWEAR, AND SWIMWEAR (U.S. CLS. 22 AND 39).

GIANCARLO CASTRO, EXAMINING ATTORNEY

SN 78-344,535. H. COMIN CORP., CITY OF INDUSTRY, CA. FILED 12-22-2003.



SN 78-371,033. DWAYNE A PRINCE, WASHINGTON, DC. FILED 2-20-2004.

**Obstacles**

NO CLAIM IS MADE TO THE EXCLUSIVE RIGHT TO USE "USA", APART FROM THE MARK AS SHOWN.

THE COLOR(S) RED, WHITE, BLUE AND BLACK IS/ARE CLAIMED AS A FEATURE OF THE MARK.

THE COLOR BLUE APPEARS IN THE BORDER PORTION OF THE MARK, THE LETTERING OF THE MARK IS BLACK AND THE BACKGROUND IS WHITE AND RED.

FOR WEARING APPAREL, NAMELY PANTS, JEANS, SHORTS, JACKETS, COATS, T-SHIRTS, SPORTSHIRTS, KNIT SHIRTS, SWEATSHIRTS, DRESSES, SKIRTS, BLOUSES, GLOVES, HATS, CAPS, SOCKS, UNDERWEAR AND FOOTWEAR (U.S. CLS. 22 AND 39).

SUSAN HAYASH, EXAMINING ATTORNEY

THE MARK CONSISTS OF STANDARD CHARACTERS WITHOUT CLAIM TO ANY PARTICULAR FONT, STYLE, SIZE, OR COLOR.

FOR CLOTHING FOR MEN'S, WOMAN'S AND CHILDREN'S, NAMELY, SHIRTS, PANTS, SHOES, COATS, AND HATS (U.S. CLS. 22 AND 39).

ALICE BENMAMAN, EXAMINING ATTORNEY

**CLASS 25—(Continued).**

SN 78-373,158. SCHMEER, CHARLYNE, LOS ALAMITOS, CA. FILED 2-24-2004.

**ANKLES UNLEASHED**

THE MARK CONSISTS OF STANDARD CHARACTERS WITHOUT CLAIM TO ANY PARTICULAR FONT, STYLE, SIZE, OR COLOR.

FOR HATS, JACKETS, PANTS, SHORTS, SHIRTS, COATS, HEAD BANDS, AND SOCKS. (U.S. CLS. 22 AND 39).

BARBARA BROWN, EXAMINING ATTORNEY

**CLASS 25—(Continued).**

SN 78-382,562. SANDOVAL, MICHAEL, SUNRISE, FL. FILED 3-11-2004.

**WHAT OF IT**

THE MARK CONSISTS OF STANDARD CHARACTERS WITHOUT CLAIM TO ANY PARTICULAR FONT, STYLE, SIZE, OR COLOR.

FOR CLOTHING NAMELY, SHIRTS AND HATS (U.S. CLS. 22 AND 39).

PAULA MAYS, EXAMINING ATTORNEY

SN 78-377,826. HOLMES, IAN E., DBA FAST KITTY, LONG BEACH, CA. AND HOLMES, ELIZABETH A., DBA FAST KITTY, LONG BEACH, CA. FILED 3-3-2004.



THE MARK CONSISTS OF A DRAWN CAT HEAD WEARING A HELMET AND GOGGLES ATOP THE HELMET. BEHIND THE CAT IS A BLACK AND WHITE CHECKERED FLAG PATTERN. BELOW THE DRAWING OF THE CAT AND CHECKERED FLAG ARE THE WORDS, FAST KITTY.

FOR CLOTHING, NAMELY T-SHIRTS, JACKETS, SHORTS, SKIRTS, SWEAT SHIRTS, CAPS AND HATS (U.S. CLS. 22 AND 39).

AMY HELLA, EXAMINING ATTORNEY

SN 78-383,993. WOLPA, STEVE, OMAHA, NE. FILED 3-14-2004.



THE COLOR(S) YELLOW, BLUE, WHITE, LIGHT BROWN/TAN, BROWN, DARK BROWN, GRAY AND BLACK IS/ARE CLAIMED AS A FEATURE OF THE MARK.

THE MARK CONSISTS OF- LIGHTBULB- YELLOW; "BEARD/MOUSTACHE" - BLUE; TEETH- WHITE; EYES- WHITE; SKIN - LIGHT BROWN/TAN; CLOTHING - BROWN; CLUB- DARK BROWN; FOOTWEAR- BLUE; HAIR- GRAY WITH BLACK OUTLINE.

FOR STRAPLESS FOOTWEAR (U.S. CLS. 22 AND 39). FIRST USE 11-29-2003; IN COMMERCE 11-29-2003.

MARIA-VICTORIA SUAREZ, EXAMINING ATTORNEY

**CLASS 25—(Continued).**

SN 78-384,530. MANUFACTURERA DE IMPLEMENTOS, S.A. DE C.V., CORDOBA, VERACRUZ, MEXICO, FILED 3-15-2004.



FOR T-SHIRTS, CAPS, JACKETS, AND WIND RESISTANT JACKETS (U.S. CLS. 22 AND 39).  
BILL DAWE, EXAMINING ATTORNEY

SN 78-385,312. LUWIA, ANASTASIA VERONA, JAKARTA PUSAT, INDONESIA, FILED 3-16-2004.

**CHAMELEON STASH**

THE MARK CONSISTS OF STANDARD CHARACTERS WITHOUT CLAIM TO ANY PARTICULAR FONT, STYLE, SIZE, OR COLOR.

FOR MEN'S, WOMEN'S AND CHILDREN'S CLOTHING, NAMELY, T-SHIRTS, BUTTON DOWN SHIRTS, BLOUSES, DRESSES, SWEATERS, SWEATSHIRTS, TANK TOPS, JACKETS, PANTS, SHORTS, SKIRTS, HATS, VISORS, SHOES, SOCKS, BELTS, SCARVES, SLEEPWEAR, UNDERWEAR AND LINGERIE (U.S. CLS. 22 AND 39).

MITCHELL FRONT, EXAMINING ATTORNEY

SN 78-385,349. LUWIA, ANASTASIA VERONA, JAKARTA PUSAT, INDONESIA, FILED 3-16-2004.

**CONTOUR EPIC**

THE MARK CONSISTS OF STANDARD CHARACTERS WITHOUT CLAIM TO ANY PARTICULAR FONT, STYLE, SIZE, OR COLOR.

FOR MEN'S, WOMEN'S AND CHILDREN'S CLOTHING, NAMELY, T-SHIRTS, BUTTON DOWN SHIRTS, BLOUSES, DRESSES, SWEATERS, SWEATSHIRTS, TANK TOPS, JACKETS, PANTS, SHORTS, SKIRTS, HATS, VISORS, SHOES, SOCKS, BELTS, SCARVES, SLEEPWEAR, UNDERWEAR AND LINGERIE (U.S. CLS. 22 AND 39).

DOMINIC J. FERRAIUOLO, EXAMINING ATTORNEY

**CLASS 25—(Continued).**

SN 78-389,048. ALVARADO DYE & KNITTING MILLS, UNION CITY, CA. FILED 3-23-2004.

**OURS**

THE MARK CONSISTS OF STANDARD CHARACTERS WITHOUT CLAIM TO ANY PARTICULAR FONT, STYLE, SIZE, OR COLOR.

FOR APPAREL, NAMELY, SHIRTS, PANTS, SKIRTS, SWEATERS, AND JACKETS (U.S. CLS. 22 AND 39).

FIRST USE 9-1-1988; IN COMMERCE 9-1-1988.

JENNIFER KRISP, EXAMINING ATTORNEY

SN 78-392,151. SANTANA, ALEXANDER P., DBA SURF805, THOUSAND OAKS, CA. FILED 3-28-2004.



THE MARK CONSISTS OF THE MARK REPRESENTS A MERGED LETTER "S" AND THE NUMBER "8" REPRESENTING THE COMPANY SURF805.

FOR SHIRTS, HATS, BEANIES, JACKETS, TANK TOPS, TUBE TOPS, POLO SHIRTS (U.S. CLS. 22 AND 39).  
JOANNA DUKOVIC, EXAMINING ATTORNEY

**CLASS 25—(Continued).**

SN 78-392,974. PARK AVENUE DRESS SHOPPE INC., VERONA, NJ. FILED 3-30-2004.

**CLASS 25—(Continued).**

SN 78-394,450. SHOGAKUKAN PRODUCTIONS CO., LTD., CHIYODA-KU, TOKYO, JAPAN, FILED 3-31-2004.

# CASE CLOSED

## SAMMI COUTURE

THE MARK CONSISTS OF STANDARD CHARACTERS WITHOUT CLAIM TO ANY PARTICULAR FONT, STYLE, SIZE, OR COLOR.

NO CLAIM IS MADE TO THE EXCLUSIVE RIGHT TO USE COUTURE, APART FROM THE MARK AS SHOWN.

FOR BRIDAL GOWNS, BRIDAL HEAD PIECES, MOTHER OF THE BRIDE DRESSES, AND ATTENDANTS' DRESSES (U.S. CLS. 22 AND 39).

ANNE E. GUSTASON, EXAMINING ATTORNEY

THE MARK CONSISTS OF STANDARD CHARACTERS WITHOUT CLAIM TO ANY PARTICULAR FONT, STYLE, SIZE, OR COLOR.

FOR CLOTHING; NAMELY, SHIRTS, T-SHIRTS, SWEATSHIRTS, SWEATERS, VESTS, JACKETS, WARM-UP SUITS, ROBES, PANTS, SHORTS, CLOTHING BELTS, DRESSES, OVERALLS, INFANTWEAR, PLAYSUITS, CLOTH BIBS, HEADWEAR, FOOTWEAR, BOOTS, SOCKS, TIGHTS, BEACHWEAR, SWIMSUITS, SWIMWEAR, BATHING CAPS, TENNIS WEAR, RAINWEAR, JACKETS, COATS, GLOVES, MUFFLERS, HATS, SUN VISORS, NECKWEAR, CUMMERBUNDS, BANDANAS, SCARVES, PAJAMAS, NIGHTSHIRTS, NIGHTGOWNS, UNDERGARMENTS, APRONS, MASQUERADE COSTUMES, MASQUERADE COSTUMES WITH MASKS SOLD IN CONNECTION THEREWITH, TANK TOPS, UNDERWEAR, AND WRISTBANDS (U.S. CLS. 22 AND 39).

DAVID MURRAY, EXAMINING ATTORNEY

---

SN 78-393,017. SJR 97 ENTERPRISES, INC., PHOENIX, AZ. FILED 3-30-2004.

---

SN 78-394,869. FULL METAL INC, MIAMI, FL. FILED 4-1-2004.

## WORN BY THE PROS

## Amadoll

THE MARK CONSISTS OF STANDARD CHARACTERS WITHOUT CLAIM TO ANY PARTICULAR FONT, STYLE, SIZE, OR COLOR.

FOR APPAREL, NAMELY, MEN'S, WOMEN'S, AND CHILDREN'S SHIRTS, TOPS, T-SHIRTS, PANTS, SHORTS, BODYSUITS, JACKETS, HATS, HEADWEAR, SKULLWRAPS, UNDERSHIRTS, UNDERPANTS, UNDERWEAR BRIEFS, SPORTS BRAS, HOCKEY PANTS, AND HOCKEY SHORTS (U.S. CLS. 22 AND 39).

NORA BUCHANAN WILL, EXAMINING ATTORNEY

THE MARK CONSISTS OF STANDARD CHARACTERS WITHOUT CLAIM TO ANY PARTICULAR FONT, STYLE, SIZE, OR COLOR.

FOR URBAN WOMEN'S APPAREL, NAMELY, T-SHIRTS, JEANS, JEAN SHORTS, SHORTS, SWEATERS, SWEAT SUITS, DRESSES, SHIRTS, CAPS, BASEBALL CAPS, SUITS, SOCKS, UNDERWEAR, JACKETS, LEATHER JACKETS, AND BELTS (U.S. CLS. 22 AND 39).

RICHARD WHITE, EXAMINING ATTORNEY



**CLASS 25—(Continued).**

SN 78-397,282. DLI INC., ALPHARETTA, GA. FILED 4-6-2004.



FOR YOUNG MEN'S SPORTSWEAR, NAMELY, SCREENPRINT T-SHIRTS, PANTS, KNIT SHIRTS, WOVEN SHIRTS, FLEECE TOPS AND BOTTOMS, CAPS, AND JEANS (U.S. CLS. 22 AND 39).  
RONALD MCMORROW, EXAMINING ATTORNEY

**CLASS 25—(Continued).**

SN 78-397,798. ROUND ROCK BASEBALL, INC, ROUND ROCK, TX. FILED 4-7-2004.



THE MARK CONSISTS OF "C" STYLIZED TO LOOK LIKE AN ANIMATED HOOK HOLDING A BAT.  
FOR CLOTHING, NAMELY, APRONS, ATHLETIC UNIFORMS, BANDANAS, BOXER SHORTS, CAPS, CLOTH BABY BIBS, COATS, GOLF SHIRTS, GYM SHORTS, GYM SUITS, HATS, JACKETS, JERSEYS, JOGGING SUITS, KNIT SHIRTS, PAJAMAS, POLO SHIRTS, PONCHOS, PULLOVERS, RAIN COATS, RAINWEAR, SWEATERS, SWEAT PANTS, SWEAT SHIRTS, SWEAT SUITS, SOCKS, SPORT SHIRTS, T-SHIRTS, TANK TOPS, TIES, VISORS, WIND RESISTANT JACKETS AND WRISTBANDS (U.S. CLS. 22 AND 39).  
FIRST USE 2-0-2004; IN COMMERCE 3-11-2004.  
MONTIA G. PRESSEY, EXAMINING ATTORNEY

SN 78-397,653. MARK TUCKER INC., NEW YORK, NY. FILED 4-7-2004.

ANGELS 4 MY SOLE

THE MARK CONSISTS OF STANDARD CHARACTERS WITHOUT CLAIM TO ANY PARTICULAR FONT, STYLE, SIZE, OR COLOR.  
FOR FOOTWEAR (U.S. CLS. 22 AND 39).  
ANN E. SAPPENFIELD, EXAMINING ATTORNEY

SN 78-397,895. LOWE, ROBERT L., SOUTHAVEN, MS. FILED 4-7-2004.



FOR CLOTHING, NAMELY TANK TOPS, JACKETS, PANTS, SWEAT SHIRTS, AND SWEAT SUITS; HEADGEAR, NAMELY HATS AND CAPS (U.S. CLS. 22 AND 39).  
NANCY CLARKE, EXAMINING ATTORNEY

**CLASS 25—(Continued).**

SN 78-398,547. SOHK SPORTSWEAR, INC., CORONA, NY.  
FILED 4-8-2004.



THE COLOR(S) RED IS/ARE CLAIMED AS A FEATURE OF THE MARK.

THE MARK CONSISTS OF THE STYLIZATION OF A RAM'S HORN SET AGAINST A RED BACKDROP. THE RAM'S HORN APPEARS IN WHITE, AND THE BACKGROUND IS RED.

FOR CLOTHING, NAMELY, SWEATSHIRTS, PANTS, SWEATPANTS, JEANS, SHIRTS, T-SHIRTS, HATS, CAPS, JACKETS, COATS, TANK TOPS, SKIRTS, BOXER SHORTS, BANDANAS, SHORTS, ANORAKS, JERSEYS; FOOTWEAR (U.S. CLS. 22 AND 39).

ANN E. SAPPENFIELD, EXAMINING ATTORNEY

SN 78-399,025. DREAM LAB, INC., ROWLAND HEIGHTS, CA. FILED 4-8-2004.

# HUETOPIA

THE MARK CONSISTS OF STANDARD CHARACTERS WITHOUT CLAIM TO ANY PARTICULAR FONT, STYLE, SIZE, OR COLOR.

FOR CLOTHING, NAMELY, SHIRTS, T-SHIRTS, TANK TOPS, PANTS, GYM PANTS, SWEAT PANTS, SWEAT SUITS, JACKETS, HOODED JACKETS, ZIP-FRONT JACKETS, SHORTS, GYM SHORTS, JERSEY SHORTS, BELTS, DENIM JEANS, COATS, CAPS, HATS; FOOTWEAR, NAMELY, SHOES SOCKS, SLIPPERS, BOOTS AND SNEAKERS (U.S. CLS. 22 AND 39).

ALEXANDER L. POWERS, EXAMINING ATTORNEY

**CLASS 25—(Continued).**

SN 78-400,139. BLUETONGUE INCORPORATED, GREEN'S FARMS, CT. FILED 4-12-2004.

# RooRoo

THE MARK CONSISTS OF STANDARD CHARACTERS WITHOUT CLAIM TO ANY PARTICULAR FONT, STYLE, SIZE, OR COLOR.

FOR CLOTHING NAMELY COATS, HANDBAGS, HATS, VESTS (U.S. CLS. 22 AND 39).

INGA ERVIN, EXAMINING ATTORNEY

SN 78-400,231. BRADEN, PATRICIA WELMAN, HUNTINGTON BEACH, CA. FILED 4-12-2004.



NO CLAIM IS MADE TO THE EXCLUSIVE RIGHT TO USE "CLOTHING", APART FROM THE MARK AS SHOWN. THE COLOR(S) BLACK AND PINK IS/ARE CLAIMED AS A FEATURE OF THE MARK.

THE MARK CONSISTS OF BLACK STYLIZED LETTERING AND A PINK THREE DIMENSIONAL BOX.

FOR CLOTHING, NAMELY, SHORTS, PANTS, DRESSES, SKIRTS, SHIRTS, TOPS, JACKETS, SCARVES, SOCKS AND SHOES (U.S. CLS. 22 AND 39).

INGRID C. EULIN, EXAMINING ATTORNEY

SN 78-400,355. WD VENTURES, INC., OKLAHOMA CITY, OK. FILED 4-12-2004.

# WORMY DOG SALOON

THE MARK CONSISTS OF STANDARD CHARACTERS WITHOUT CLAIM TO ANY PARTICULAR FONT, STYLE, SIZE, OR COLOR.

OWNER OF U.S. REG. NO. 2,171,210.  
FOR CLOTHING, NAMELY HATS, T-SHIRTS, CAPS, SWEAT SHIRTS AND SWEAT PANTS (U.S. CLS. 22 AND 39).

FIRST USE 8-6-1992; IN COMMERCE 8-6-1992.

GEOFFREY FOSDICK, EXAMINING ATTORNEY

**CLASS 25—(Continued).**

SN 78-400,527. MARBLE SPORTSWEAR, INC., BEVERLY HILLS, CA. FILED 4-12-2004.

**MUCHO SUCKO**

THE MARK CONSISTS OF STANDARD CHARACTERS WITHOUT CLAIM TO ANY PARTICULAR FONT, STYLE, SIZE, OR COLOR.

THE ENGLISH TRANSLATION OF THE WORD "MUCHO" IS "MUCH." THERE IS NO KNOWN TRANSLATION FOR THE WORD "SUCKO."

FOR BATHING SUITS, BLAZERS, BLOUSES, BOOTS, BRAS, BRIEFS, CAMISOLES, CAPS, COATS, DRESSES, GLOVES, HATS, JACKETS, JEANS, JUMPSUITS, LEOTARDS, NECKTIES, NIGHTGOWNS, OVERALLS, PAJAMAS, PANTS, PANTYHOSE, RAINCOATS, ROBES, SANDALS, SHIRTS, SHOES, SHORTALLS, SHORTS, SKIRTS, SLIPPERS, SLIPS, SOCKS, STOCKINGS, SUITS, SWEATERS, SWEATPANTS, SWEATSHIRTS, T-SHIRTS, TIGHTS, TUXEDOS, VESTS, AND WARM-UP SUITS (U.S. CLS. 22 AND 39).

ANDREW RHIM, EXAMINING ATTORNEY

**CLASS 25—(Continued).**

SN 78-401,141. DONNA ANN GAMBARDELLA AND CHRISTOPHER TONE STORER PARTNERSHIP, THE, WARREN, RI. FILED 4-13-2004.

**BETTER THAN A BOYFRIEND**

THE MARK CONSISTS OF STANDARD CHARACTERS WITHOUT CLAIM TO ANY PARTICULAR FONT, STYLE, SIZE, OR COLOR.

FOR CLOTHING, NAMELY, SKIRTS, SCARVES, PANTS, SHIRTS, BLOUSES, SOCKS, JACKETS, DRESSES, HATS, GLOVES (U.S. CLS. 22 AND 39).

SUSAN STIGLITZ, EXAMINING ATTORNEY

SN 78-401,178. GREDICO FOOTWEAR LIMITED, MISSISSAUGA, ONTARIO, CANADA, FILED 4-13-2004.

**TERRAIN PARK**

SN 78-401,115. FAVOLOSA, WARREN, RI. AND CHRISTOPHER TONE STORER AND DONNA ANN GAMBARDELLA PARTNERSHIP, THE, WARREN, RI. FILED 4-13-2004.

**FAVOLOSA**

THE MARK CONSISTS OF STANDARD CHARACTERS WITHOUT CLAIM TO ANY PARTICULAR FONT, STYLE, SIZE, OR COLOR.

FOR FOOTWEAR, NAMELY, BOOTS, SANDALS AND SHOES (U.S. CLS. 22 AND 39).

VERNA BETH RIRIE, EXAMINING ATTORNEY

SN 78-401,522. JONESHEIRS, INC., ATLANTA, GA. FILED 4-14-2004.

**BOBBY JONES STROKE OF GENIUS**

THE MARK CONSISTS OF STANDARD CHARACTERS WITHOUT CLAIM TO ANY PARTICULAR FONT, STYLE, SIZE, OR COLOR.

OWNER OF U.S. REG. NO. 2,067,668.

THE FOREIGN WORDING IN THE MARK TRANSLATES INTO ENGLISH AS FABULOUS.

SEC. 2(F).

FOR CLOTHING, NAMELY SKIRTS, SCARVES, PANTS, SHIRTS, BLOUSES, SWEATERS, JACKETS (U.S. CLS. 22 AND 39).

FIRST USE 8-28-1995; IN COMMERCE 8-28-1995.

MARK T. MULLEN, EXAMINING ATTORNEY

THE MARK CONSISTS OF STANDARD CHARACTERS WITHOUT CLAIM TO ANY PARTICULAR FONT, STYLE, SIZE, OR COLOR.

"BOBBY JONES" DOES NOT IDENTIFY A PARTICULAR LIVING INDIVIDUAL.

FOR CLOTHING, NAMELY BASEBALL CAPS (U.S. CLS. 22 AND 39).

FIRST USE 3-15-2004; IN COMMERCE 3-15-2004.

THEODORE MCBRIDE, EXAMINING ATTORNEY

**CLASS 25—(Continued).**

SN 78-402,880. HUNG, MARK, TAICHUNG, TAIWAN, FILED 4-16-2004.



THE MARK CONSISTS OF A BELLHOP CARRYING BAGGAGES.

FOR MEN'S AND WOMEN'S CLOTHING, NAMELY, JACKETS, SHIRTS, TROUSERS, SUITS, SHOES, SANDALS, AND SLIPPERS, CLOTHING BELTS, HATS, SCARVES, GLOVES, SOCKS, TIES, NECKTIES, BOOTS (U.S. CLS. 22 AND 39).

TONI HICKEY, EXAMINING ATTORNEY

**CLASS 25—(Continued).**

SN 78-408,227. UNIVERSITY OF PITTSBURGH OF THE COMMONWEALTH SYSTEM OF HIGHER EDUCATION, PITTSBURGH, PA. FILED 4-26-2004.



**University of Pittsburgh**

OWNER OF U.S. REG. NOS. 1,275,248, 2,355,189 AND OTHERS.

FOR SHIRTS, NAMELY T-SHIRTS, BASEBALL SHIRTS, FOOTBALL JERSEYS, SWEATSHIRTS AND PANTS NAMELY SHORTS AND SWEATPANTS (U.S. CLS. 22 AND 39).

WON TEAK OH, EXAMINING ATTORNEY

SN 78-403,655. PORTABLE JOHN, INC., NEW YORK, NY. FILED 4-17-2004.



FOR CLOTHING, NAMELY HATS AND T-SHIRTS (U.S. CLS. 22 AND 39).

IRA J. GOODSAD, EXAMINING ATTORNEY

SN 78-410,345. SCOTT, LYNETTE WINDHAM, NEW ORLEANS, LA. FILED 4-29-2004.

**This Child belongs  
to me T Shirt**

THE MARK CONSISTS OF STANDARD CHARACTERS WITHOUT CLAIM TO ANY PARTICULAR FONT, STYLE, SIZE, OR COLOR.

FOR T SHIRTS (U.S. CLS. 22 AND 39).

JASON TURNER, EXAMINING ATTORNEY

**CLASS 25—(Continued).**

SN 78-412,479. HARPE, KRISTA DE LA, DALLAS, TX. FILED 5-3-2004.

# 12 Hour Heel

THE MARK CONSISTS OF STANDARD CHARACTERS WITHOUT CLAIM TO ANY PARTICULAR FONT, STYLE, SIZE, OR COLOR.  
NO CLAIM IS MADE TO THE EXCLUSIVE RIGHT TO USE HEEL, APART FROM THE MARK AS SHOWN.  
FOR SHOES (U.S. CLS. 22 AND 39).  
JOHN HWANG, EXAMINING ATTORNEY

**CLASS 25—(Continued).**

SN 78-412,793. MOOSEJAW MOUNTAINEERING AND BACKCOUNTRY TRAVEL, INC., CHICAGO, IL. FILED 5-4-2004.



THE MARK CONSISTS OF THE LETTER "W" WITH MOOSE ANTLERS PROTRUDING FROM THE TOP OF BOTH SIDES OF THE LETTER.  
FOR CLOTHING, NAMELY, BASEBALL CAPS; CAPS; HATS; HEAD BANDS; JERSEYS; SHIRTS; SHORTS; SWEAT BANDS; SWEAT PANTS; SWEAT SHIRTS; SWEAT SHORTS; TANK TOPS; T-SHIRTS; UNDERCLOTHES; AND WRIST BANDS (U.S. CLS. 22 AND 39).  
FIRST USE 3-1-2003; IN COMMERCE 3-1-2003.  
HELEN BRYAN, EXAMINING ATTORNEY

SN 78-414,367. KATE PULITZER LTD., CAMBRIDGE, MA. FILED 5-6-2004.

# ROSA DEI VENTI

THE MARK CONSISTS OF STANDARD CHARACTERS WITHOUT CLAIM TO ANY PARTICULAR FONT, STYLE, SIZE, OR COLOR.  
THE ENGLISH TRANSLATION OF ROSA DEI VENTI IS ROSE OF THE WIND.  
FOR SHOES (U.S. CLS. 22 AND 39).  
CIMMERIAN COLEMAN, EXAMINING ATTORNEY

SN 78-412,503. URBAN PLAYGROUND, INC., LOS ANGELES, CA. FILED 5-3-2004.

# THE DRUNKEN T-SHIRT

THE MARK CONSISTS OF STANDARD CHARACTERS WITHOUT CLAIM TO ANY PARTICULAR FONT, STYLE, SIZE, OR COLOR.  
NO CLAIM IS MADE TO THE EXCLUSIVE RIGHT TO USE T-SHIRT, APART FROM THE MARK AS SHOWN.  
FOR CLOTHING NAMELY T-SHIRTS, UNDERWEAR AND SLEEPWEAR (U.S. CLS. 22 AND 39).  
JOHN HWANG, EXAMINING ATTORNEY

SN 78-414,399. TRISTAR PRODUCTS, INC., EAST FAIRFIELD, NJ. FILED 5-6-2004.

# SLIMMING SHAPERS

THE MARK CONSISTS OF STANDARD CHARACTERS WITHOUT CLAIM TO ANY PARTICULAR FONT, STYLE, SIZE, OR COLOR.  
NO CLAIM IS MADE TO THE EXCLUSIVE RIGHT TO USE "SHAPERS", APART FROM THE MARK AS SHOWN.  
FOR FOUNDATION GARMENTS (U.S. CLS. 22 AND 39).  
CAROLINE WOOD, EXAMINING ATTORNEY

**CLASS 25—(Continued).**

SN 78-414,733. CLUETT PEABODY RESOURCES CORPORATION, NEW YORK, NY. FILED 5-7-2004.



OWNER OF U.S. REG. NOS. 1,736,718, 1,833,378 AND 1,879,843.  
FOR SKIRTS, SKORTS, DRESSES, JUMPERS, BLOUSES, CARDIGANS (U.S. CLS. 22 AND 39).  
EVELYN BRADLEY, EXAMINING ATTORNEY

SN 78-415,289. TRISTAR PRODUCTS, INC., FAIRFIELD, NJ. FILED 5-7-2004.

**SIMPLY SHAPERS**

THE MARK CONSISTS OF STANDARD CHARACTERS WITHOUT CLAIM TO ANY PARTICULAR FONT, STYLE, SIZE, OR COLOR.

NO CLAIM IS MADE TO THE EXCLUSIVE RIGHT TO USE "SHAPERS", APART FROM THE MARK AS SHOWN. FOR FOUNDATION GARMENTS (U.S. CLS. 22 AND 39).

FIRST USE 11-30-2003; IN COMMERCE 11-30-2003.  
CAROLINE WOOD, EXAMINING ATTORNEY

SN 78-415,517. GOTHE, AXEL, NEW YORK, NY. FILED 5-8-2004.



FOR CLOTHING, NAMELY, T-SHIRTS, SWEATSUITS, HEAD WEAR, DRESS SHIRTS, JACKETS, COATS (U.S. CLS. 22 AND 39).

DANIELLE MATTESSICH, EXAMINING ATTORNEY

**CLASS 25—(Continued).**

SN 78-416,206. JR HOLDINGS, INC., HUNTINGTON PARK, CA. FILED 5-10-2004.

**MVF**

THE MARK CONSISTS OF STANDARD CHARACTERS WITHOUT CLAIM TO ANY PARTICULAR FONT, STYLE, SIZE, OR COLOR.

FOR CLOTHING NAMELY, DRESSES, ATHLETIC WEAR NAMELY, JOGGING SUITS AND SWEATSHIRTS, PANTS, JEANS, OVERALLS, SLACKS, SHIRTS, TOPS, SHORTS, SKIRTS, SWEATERS, SWEAT SHIRTS, SWEAT PANTS, SWEAT SHORTS, COATS, PARKAS, VESTS, CAPS, HATS, BELTS, BOXER SHORTS, UNDERWEAR, SHOES, FOOTWEAR, BATHING SUITS, BATHING TRUNKS, SWIM WEAR, SWIM SUITS, BEACHWEAR, BEACH COVERUPS, GLOVES, PAJAMAS, SLEEPWEAR, ROBES, BATHROBES, SKI WEAR, SKI SUITS, SNOW PANTS, SNOWBOARD BOOTS, SNOWBOARD GLOVES, SOCKS, HOSIERY, RAIN WEAR, RAIN COATS, RAIN JACKETS, RAIN SUITS, AND RAIN BOOTS (U.S. CLS. 22 AND 39).

KHANH LE, EXAMINING ATTORNEY

SN 78-416,471. SARAMAR, L.L.C., CHICAGO, IL. FILED 5-11-2004.

**BREATHE. FOCUS.  
AND RELAX.**

THE MARK CONSISTS OF STANDARD CHARACTERS WITHOUT CLAIM TO ANY PARTICULAR FONT, STYLE, SIZE, OR COLOR.

FOR YOGA CLOTHING, NAMELY PANTS, T-SHIRTS AND JACKETS (U.S. CLS. 22 AND 39).

CAROL SPILS, EXAMINING ATTORNEY

**CLASS 25—(Continued).**

SN 78-418,011. BROWN, JEFF, TETON VILLAGE, WY. FILED 5-13-2004.

fat end first.

THE MARK CONSISTS OF STANDARD CHARACTERS WITHOUT CLAIM TO ANY PARTICULAR FONT, STYLE, SIZE, OR COLOR.

FOR CLOTHING, NAMELY HATS, T-SHIRTS, AND SWEATSHIRTS (U.S. CLS. 22 AND 39).

RAMONA ORTIGA, EXAMINING ATTORNEY

**CLASS 25—(Continued).**

SN 78-418,330. VIACOM INTERNATIONAL INC., NEW YORK, NY. FILED 5-13-2004.

DRESS-UP CHEST

THE MARK CONSISTS OF STANDARD CHARACTERS WITHOUT CLAIM TO ANY PARTICULAR FONT, STYLE, SIZE, OR COLOR.

FOR CLOTHING, NAMELY, BATHING SUITS, BELTS, HALLOWEEN COSTUMES, COATS, SOCKS, CLOTHING BELTS, FOOTWEAR, BANDANNAS, DRESSES, GLOVES, GYM SHORTS, EAR MUFFS, NECK WEAR, JACKETS, PAJAMAS, PANTS, SHIRTS, SHORTS, SKI WEAR, SLACKS, SUN VISORS, SUSPENDERS, SWEATERS, TURTLENECKS, UNDERCLOTHES, VESTS, WARM-UP SUITS, SWEATSHIRTS, HEADWEAR, BATHROBES, BEACHWEAR (U.S. CLS. 22 AND 39).

CHARLES L. JENKINS, EXAMINING ATTORNEY

SN 78-418,032. HAMMOCK CARDS, INC., LEVITTOWN, NY. FILED 5-13-2004.

HAMMOCK

THE MARK CONSISTS OF STANDARD CHARACTERS WITHOUT CLAIM TO ANY PARTICULAR FONT, STYLE, SIZE, OR COLOR.

FOR CLOTHING, NAMELY, SHIRTS, T-SHIRTS, POLO SHIRTS, GOLF SHIRTS, NIGHT SHIRTS, SLEEP SHIRTS, SPORT SHIRTS, BLOUSES, TOPS, TANK TOPS, SWEATERS, SWEAT SHIRTS, SWEAT PANTS, WARM UP SUITS, BOTTOMS, PANTS, SLACKS, JEANS, OVERALLS, SHORTS, SKIRTS, DRESSES, JERSEYS, CARDIGANS, VESTS, JACKETS, COATS, SUITS, BLAZERS, TIES, UNDERWEAR, HOSIERY, SOCKS, HATS AND CAPS (U.S. CLS. 22 AND 39).

KENNETH D. BATTLE, EXAMINING ATTORNEY

SN 78-418,542. L.C. LICENSING, INC., NEW YORK, NY. FILED 5-13-2004.



THE MARK CONSISTS OF THE IMAGE OF A DOG. FOR CLOTHING AND CLOTHING ACCESSORIES, NAMELY, SHIRTS, PANTS, SWEATERS, SKIRTS, DRESSES, COATS, SUITS, NECKTIES, BELTS, SWIMWEAR, UNDERWEAR, BRAS, LINGERIE, HOSIERY, PAJAMAS, GLOVES, MITTENS AND SCARVES; FOOTWEAR; HEADWEAR (U.S. CLS. 22 AND 39).

ZACHARY BELLO, EXAMINING ATTORNEY

**CLASS 25—(Continued).**

SN 78-419,224. BROWN, ERIC F., DETROIT, MI. FILED 5-14-2004.

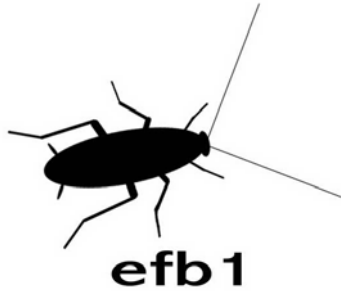

THE MARK CONSISTS OF A SILHOUETTE OF A COCKROACH.

FOR CLOTHING, NAMELY JEANS, PANTS, TOPS, JACKETS, SHORTS, SWEATSHIRTS, SWEATPANTS, BELTS, HATS, AND UNDERWEAR (U.S. CLS. 22 AND 39).

GRETTA YAO, EXAMINING ATTORNEY

---

SN 78-419,524. HGI VENTURES, INC., SANTA MONICA, CA. FILED 5-16-2004.

**I'M OUT**

THE MARK CONSISTS OF STANDARD CHARACTERS WITHOUT CLAIM TO ANY PARTICULAR FONT, STYLE, SIZE, OR COLOR.

FOR CLOTHING FOR MEN, WOMEN AND CHILDREN, NAMELY, HATS, SHIRTS, PAJAMAS, T-SHIRTS, JERSEYS, SWEATSHIRTS, TOPS, SWEATERS, DRESSES, SKIRTS, BELTS, TIES, STOCKINGS, PANTS, SHORTS, BATHING SUITS, ROBES, JUMPSUITS, JACKETS, AND COATS (U.S. CLS. 22 AND 39).

MARIA-VICTORIA SUAREZ, EXAMINING ATTORNEY

**CLASS 25—(Continued).**

SN 78-419,526. TUPIS, ERIC M., ELLICOTT CITY, MD. AND DEMPSEY, JOHN T. JR., EDGEWATER, MD. FILED 5-16-2004.

**PHENOTYPE**

THE MARK CONSISTS OF STANDARD CHARACTERS WITHOUT CLAIM TO ANY PARTICULAR FONT, STYLE, SIZE, OR COLOR.

FOR CLOTHING, NAMELY SHIRTS, T-SHIRTS, SWEATSHIRTS, TANK TOPS, SWEATERS, JERSEYS, JACKETS, SNOW PANTS, RASH GUARDS, SOCKS, PANTS, SHORTS, SWEAT PANTS, JEANS, SWIMSUITS, UNDERWEAR, SWEAT BANDS; HEADGEAR, NAMELY HATS, CAPS, VISORS; WET SUITS, SNOWBOARD GLOVES, SNOWBOARD BOOTS, BELTS, SHOES, ATHLETIC SHOES, SANDALS (U.S. CLS. 22 AND 39).

MARIA-VICTORIA SUAREZ, EXAMINING ATTORNEY

---

SN 78-420,338. UNIVERSE KNOWS, INC., THE, GLEN COVE, NY. FILED 5-17-2004.

**celebrate you**

THE MARK CONSISTS OF STANDARD CHARACTERS WITHOUT CLAIM TO ANY PARTICULAR FONT, STYLE, SIZE, OR COLOR.

FOR CLOTHING, NAMELY, T-SHIRTS, SWEATSHIRTS, TANK TOPS, POLO SHIRTS, JERSEYS, SPORT SHIRTS, KNIT SHIRTS, OVER JACKETS, WIND-RESISTANT JACKETS, INSULATED JACKETS, WARM-UP SUITS, ATHLETIC UNIFORMS, TRACKSUITS, PANTS, SHORTS, SWEATPANTS, INSULATED PANTS, GYM SHORTS, CAPS, HATS, SWEAT BANDS, HEAD BANDS, NECK BANDS, WRISTBANDS, BASKETBALL FOOTWEAR, ATHLETIC FOOTWEAR, SOCKS, AND SWEAT SOCKS (U.S. CLS. 22 AND 39).

ELLEN B. AWRICH, EXAMINING ATTORNEY



**CLASS 25—(Continued).**

SN 78-420,345. UNIVERSE KNOWS, INC, THE, GLEN COVE, NY. FILED 5-17-2004.

**CLASS 25—(Continued).**

SN 78-421,716. NATIONAL HOCKEY LEAGUE, NEW YORK, NY. FILED 5-19-2004.

hold your vision

CUP CRAZY

THE MARK CONSISTS OF STANDARD CHARACTERS WITHOUT CLAIM TO ANY PARTICULAR FONT, STYLE, SIZE, OR COLOR.

FOR CLOTHING, NAMELY, T-SHIRTS, SWEATSHIRTS, TANK TOPS, POLO SHIRTS, JERSEYS, SPORT SHIRTS, KNIT SHIRTS, OVER JACKETS, WIND-RESISTANT JACKETS, INSULATED JACKETS, WARM-UP SUITS, ATHLETIC UNIFORMS, TRACKSUITS, PANTS, SHORTS, SWEATPANTS, INSULATED PANTS, GYM SHORTS, CAPS, HATS, SWEAT BANDS, HEAD BANDS, NECK BANDS, WRISTBANDS, BASKETBALL FOOTWEAR, ATHLETIC FOOTWEAR, SOCKS, AND SWEAT SOCKS (U.S. CLS. 22 AND 39).

DORITT L. CARROLL, EXAMINING ATTORNEY

THE MARK CONSISTS OF STANDARD CHARACTERS WITHOUT CLAIM TO ANY PARTICULAR FONT, STYLE, SIZE, OR COLOR.

OWNER OF U.S. REG. NOS. 2,116,826 AND 2,191,055.  
FOR CLOTHING, NAMELY, SHIRTS, JERSEYS, JACKETS, SWEATSHIRTS, T-SHIRTS, CAPS AND HATS (U.S. CLS. 22 AND 39).

CHERYL CLAYTON, EXAMINING ATTORNEY

SN 78-421,676. GIBSON, MICHELE N., PALM DESERT, CA. FILED 5-19-2004.

SN 78-421,797. BASEBALL ACQUISITION CORPORATION, WILSONVILLE, OR. FILED 5-19-2004.

POCKET ROCKETS

COMFORT CHALLENGE

THE MARK CONSISTS OF STANDARD CHARACTERS WITHOUT CLAIM TO ANY PARTICULAR FONT, STYLE, SIZE, OR COLOR.

FOR CLOTHING, NAMELY, T-SHIRTS, POLO SHIRTS, HATS, TIES, SWEAT SHIRTS, PULLOVERS, SWEAT PANTS AND JACKETS (U.S. CLS. 22 AND 39).

CHERYL CLAYTON, EXAMINING ATTORNEY

THE MARK CONSISTS OF STANDARD CHARACTERS WITHOUT CLAIM TO ANY PARTICULAR FONT, STYLE, SIZE, OR COLOR.

FOR FOOTWEAR (U.S. CLS. 22 AND 39).  
CHERYL CLAYTON, EXAMINING ATTORNEY

**CLASS 25—(Continued).**

SN 78-422,313. SAERA CO., LTD., SEOUL, DEM REP OF KOREA, FILED 5-20-2004.

# SAERA

THE MARK CONSISTS OF STANDARD CHARACTERS WITHOUT CLAIM TO ANY PARTICULAR FONT, STYLE, SIZE, OR COLOR.

FOR FOOTWEAR, NAMELY, WOMEN'S SHOES, LOW SHOES, RUBBER SHOES, LACED BOOTS, RAIN SHOES, HIKING SHOES, ARTIC BOOTS, SLIPPERS, GOLF SHOES, BOOTS, BASKETBALL SHOES, JOGGING SHOES AND SANDALS (U.S. CLS. 22 AND 39).

FIRST USE 12-13-1999; IN COMMERCE 12-13-1999.  
KEVON CHISOLM, EXAMINING ATTORNEY

SN 79-001,524. WENZHOU CHENGBO GOOR SHOES CO., LTD., CHINA, FILED 3-16-2004.

# GOOR

OWNER OF INTERNATIONAL REGISTRATION 0810779 DATED 8-19-2003, EXPIRES 8-19-2013.

FOR SHOES, HATS; HOSIERY, CLOTHING, NAMELY, SHIRTS, TROUSERS, SUITS, OVERCOATS, T-SHIRTS, UNDERWEAR, PANTS, BRASSIERES, PAJAMAS, FUR COATS, KNIT SHIRTS, SKIRTS (U.S. CLS. 22 AND 39).  
JACQUELINE A. LAVINE, EXAMINING ATTORNEY

**CLASS 26—FANCY GOODS**

SN 76-587,265. SOHO FASHION, INC., LOS ANGELES, CA. FILED 4-19-2004.

# SOHO FASHIONS

THE MARK CONSISTS OF STANDARD CHARACTERS WITHOUT CLAIM TO ANY PARTICULAR FONT, STYLE, SIZE, OR COLOR.

OWNER OF U.S. REG. NO. 2,618,011.

NO CLAIM IS MADE TO THE EXCLUSIVE RIGHT TO USE "FASHION", APART FROM THE MARK AS SHOWN.

FOR HAIR ACCESSORIES, NAMELY, HAIR EXTENSIONS, HAIR CLIPS AND COMB ATTACHMENTS THEREOF, PONYTAIL HOLDERS, HAIR BANDS, BARRETTES, SCRUNCHIES AND HAIR ORNAMENTS (U.S. CLS. 37, 39, 40, 42 AND 50).

FIRST USE 4-0-1998; IN COMMERCE 4-0-1998.  
MAUREEN DALL, EXAMINING ATTORNEY

SN 76-588,200. BENSUSAN RESTAURANT CORPORATION, NEW YORK, NY. FILED 4-23-2004.

# BLUE NOTE

THE MARK CONSISTS OF STANDARD CHARACTERS WITHOUT CLAIM TO ANY PARTICULAR FONT, STYLE, SIZE, OR COLOR.

OWNER OF U.S. REG. NOS. 2,158,939, 2,161,943 AND 2,209,141.

FOR BELT BUCKLES NOT OF PRECIOUS METAL (U.S. CLS. 37, 39, 40, 42 AND 50).

FIRST USE 8-0-1984; IN COMMERCE 8-0-1984.  
STEVEN BERK, EXAMINING ATTORNEY

SN 78-265,264. CELEBRITY SIGNATURES INTERNATIONAL, INC., KANSAS CITY, MO. FILED 6-20-2003.

# GEMINI CLIP

OWNER OF U.S. REG. NOS. 2,105,926, 2,741,840 AND OTHERS.

NO CLAIM IS MADE TO THE EXCLUSIVE RIGHT TO USE CLIP, APART FROM THE MARK AS SHOWN.

FOR WIGS, HAIR PIECES COMPRISED OF HUMAN HAIR AND HAIRPIECES COMPRISED OF SYNTHETIC HAIR; ADD-IN AND ADD-ON HAIR ACCESSORIES, NAMELY, CLAW CLIPS (U.S. CLS. 37, 39, 40, 42 AND 50).  
CHARLES L. JENKINS, EXAMINING ATTORNEY

**CLASS 26—(Continued).**

SN 78-313,547. GOODY PRODUCTS, INC., FREEPORT, IL. FILED 10-14-2003.

**CLASS 26—(Continued).**

SN 78-411,506. ELVIS PRESLEY ENTERPRISES, INC., MEMPHIS, TN. FILED 4-30-2004.

**GOODY 2 IN 1**

**Elvis Presley**

OWNER OF U.S. REG. NOS. 238,896, 1,296,349 AND OTHERS.

NO CLAIM IS MADE TO THE EXCLUSIVE RIGHT TO USE "2 IN 1", APART FROM THE MARK AS SHOWN.

FOR HAIR ACCESSORIES, NAMELY, HAIR CLIPS, HAIR CLAMPS, HAIR BANDS AND BARRETTES (U.S. CLS. 37, 39, 40, 42 AND 50).

BILL DAWE, EXAMINING ATTORNEY

THE MARK CONSISTS OF STANDARD CHARACTERS WITHOUT CLAIM TO ANY PARTICULAR FONT, STYLE, SIZE, OR COLOR.

THE NAME ELVIS PRESLEY DOES NOT IDENTIFY A LIVING INDIVIDUAL.

FOR CLOTH PATCHES FOR CLOTHING, ORNAMENTAL NOVELTY BUTTONS, EMBROIDERED EMBLEMS, BELT BUCKLES NOT MADE OF PRECIOUS METAL FOR CLOTHING AND EMBROIDERY AND CROSS STITCH KITS COMPRISED OF NEEDLES, THREAD, INSTRUCTIONS AND PATTERN CLOTH (U.S. CLS. 37, 39, 40, 42 AND 50).

FIRST USE 7-6-1992; IN COMMERCE 7-6-1992. CHRISIE B. KING, EXAMINING ATTORNEY

SN 78-401,104. JANE & COMPANY, LLC, BALTIMORE, MD. FILED 4-13-2004.

SN 78-416,019. REYNOLDS, PAUL, VISTA, CA. FILED 5-10-2004.

**JANE**

**EASIHAI**

THE MARK CONSISTS OF STANDARD CHARACTERS WITHOUT CLAIM TO ANY PARTICULAR FONT, STYLE, SIZE, OR COLOR.

FOR HAIR ACCESSORIES, NAMELY, CLIPS, PINS, TWISTS, BANDS AND BARRETTES (U.S. CLS. 37, 39, 40, 42 AND 50).

SUSAN LESLIE DUBOIS, EXAMINING ATTORNEY

THE MARK CONSISTS OF STANDARD CHARACTERS WITHOUT CLAIM TO ANY PARTICULAR FONT, STYLE, SIZE, OR COLOR.

OWNER OF U.S. REG. NO. 1,421,660. FOR WIGS AND HAIR PIECES (U.S. CLS. 37, 39, 40, 42 AND 50).

FIRST USE 3-30-2001; IN COMMERCE 3-30-2001. ERNEST SHOSHO, EXAMINING ATTORNEY

**CLASS 26—(Continued).**

SN 78-422,299. PRODUCTMASTERS, INC., PERRY HALL, MD. FILED 5-20-2004.

# NORIDERS

THE MARK CONSISTS OF STANDARD CHARACTERS WITHOUT CLAIM TO ANY PARTICULAR FONT, STYLE, SIZE, OR COLOR.

FOR IRON-ON PATCHES WITH STAYS FOR INTERNAL ATTACHMENT TO SHORTS/PANTS (U.S. CLS. 37, 39, 40, 42 AND 50).

KEVON CHISOLM, EXAMINING ATTORNEY

**CLASS 27—FLOOR COVERINGS**

SN 76-521,732. L & P PROPERTY MANAGEMENT COMPANY, SOUTH GATE, CA. FILED 6-10-2003.

# HOLD PLUS

OWNER OF U.S. REG. NO. 2,346,055. SEC. 2(F) AS TO "HOLD". FOR NON-SLIP AND CUSHIONING RUG UNDERLAY PADS (U.S. CLS. 19, 20, 37, 42 AND 50).

FIRST USE 12-0-1999; IN COMMERCE 12-0-1999. DOMINICK J. SALEMI, EXAMINING ATTORNEY

SN 78-330,949. O'CONNOR INVESTMENTS CORPORATION, WINNIPEG, MANITOBA, CANADA, FILED 11-20-2003.



**DeckSTRIP**  
Carpet Comfort For Your Deck

FOR CARPETING (U.S. CLS. 19, 20, 37, 42 AND 50). DAWN FELDMAN, EXAMINING ATTORNEY

**CLASS 27—(Continued).**

SN 78-330,954. O'CONNOR INVESTMENTS CORPORATION, WINNIPEG, MANITOBA, CANADA, FILED 11-20-2003.



**DeckSTRIP**  
Carpet Comfort For Your Deck

FOR CARPETING (U.S. CLS. 19, 20, 37, 42 AND 50). DAWN FELDMAN, EXAMINING ATTORNEY

SN 78-333,764. LUCITE INTERNATIONAL, INC., CORDOVA, TN. FILED 11-26-2003.

# LUCITE

THE MARK CONSISTS OF STANDARD CHARACTERS WITHOUT CLAIM TO ANY PARTICULAR FONT, STYLE, SIZE, OR COLOR.

FOR FLOOR COVERINGS; PROTECTIVE COVERINGS FOR EXISTING FLOORS; AND INSULATING FLOOR COVERINGS (U.S. CLS. 19, 20, 37, 42 AND 50).

JIM RINGLE, EXAMINING ATTORNEY

SN 78-367,802. SBEMCO INTERNATIONAL, INC., ALGONA, IA. FILED 2-13-2004.

# FLEXI-PLUS

THE MARK CONSISTS OF STANDARD CHARACTERS WITHOUT CLAIM TO ANY PARTICULAR FONT, STYLE, SIZE, OR COLOR.

OWNER OF U.S. REG. NO. 2,794,996. FOR FLOOR MATS FOR COMMERCIAL USE FOR COVERING EXISTING FLOORS (U.S. CLS. 19, 20, 37, 42 AND 50).

BARNEY CHARLON, EXAMINING ATTORNEY

**CLASS 28—TOYS AND SPORTING GOODS**

SN 76-288,435. SPORT COURT INTERNATIONAL, INC.,  
SALT LAKE CITY, UT. FILED 7-18-2001.

**SLAM SYSTEM**

FOR SPORTS EQUIPMENT, NAMELY, BASKETBALL  
STANDARDS AND BACKBOARDS, RIMS, NETS AND  
POLES FOR USE WITH BASKETBALL STANDARDS  
(U.S. CLS. 22, 23, 38 AND 50).

MONIQUE MILLER, EXAMINING ATTORNEY

SN 76-344,951. TUNED IN SPORTS, INC., OSTERVILLE, MA.  
FILED 12-5-2001.

**INDUSTRY**

FOR SPORTS EQUIPMENT, NAMELY, BODYBOARDS,  
SURFBOARDS, AND SKIM BOARDS (U.S. CLS. 22, 23, 38  
AND 50).

KHANH LE, EXAMINING ATTORNEY

SN 76-531,843. WASN'T THAT A PARTY INC., BRAMPTON,  
ONTARIO, CANADA, FILED 7-24-2003.



NO CLAIM IS MADE TO THE EXCLUSIVE RIGHT TO  
USE "BASEBALL DICE GAME", APART FROM THE MARK  
AS SHOWN.

FOR BOARD GAMES AND TABLE TOP GAMES (U.S.  
CLS. 22, 23, 38 AND 50).

FIRST USE 6-13-2003; IN COMMERCE 7-21-2003.  
MONIQUE MILLER, EXAMINING ATTORNEY

SN 76-537,580. ITOYS INC., TORONTO, CANADA, FILED 8-  
15-2003.

**DOODLE WRITER**

FOR CHILDREN'S TOYS, NAMELY, CHILDREN'S  
DRAWING TOYS (U.S. CLS. 22, 23, 38 AND 50).

MITCHELL FRONT, EXAMINING ATTORNEY

**CLASS 28—(Continued).**

SN 76-541,420. BE'COZZ INTERNATIONAL, INC., SAN  
DIEGO, CA. FILED 8-20-2003.

**TRAVEL PLAY**

OWNER OF U.S. REG. NO. 2,607,711.

FOR GOLF BAGS (U.S. CLS. 22, 23, 38 AND 50).

FIRST USE 11-0-2003; IN COMMERCE 11-0-2003.

TRACY CROSS, EXAMINING ATTORNEY

SN 76-562,681. WILSON, THOMAS M., LOVELAND, OH.  
FILED 12-2-2003.

**HIP HOP RAPPITS**

THE MARK CONSISTS OF STANDARD CHARACTERS  
WITHOUT CLAIM TO ANY PARTICULAR FONT, STYLE,  
SIZE, OR COLOR.

NO CLAIM IS MADE TO THE EXCLUSIVE RIGHT TO  
USE HIP HOP, APART FROM THE MARK AS SHOWN.

FOR TOYS AND GAMES, NAMELY, RUBBER AC-  
TION BALLS, SPORTS BALLS, ACTION FIGURES,  
PLUSH DOLLS, MULTIPLE ACTIVITY TOYS FOR BA-  
BIES, BALLOONS, BANKS, BATH TOYS, BOARD  
GAMES, CARD GAMES, DOLL ACCESSORIES; PARTY  
FAVORS IN THE NATURE OF SMALL TOYS AND  
NOISEMAKERS, JIGSAW PUZZLES, KITES, COSTUME  
MASKS, PAPER DOLLS, PUPPETS, ROLLER SKATES  
AND IN-LINE SKATES, EXERCISE BALLS FOR RE-  
LIEVING STRESS AND CHRISTMAS TREE ORNA-  
MENTS (U.S. CLS. 22, 23, 38 AND 50).

ANDREA SAUNDERS, EXAMINING ATTORNEY

SN 76-571,065. HASBRO, INC., PAWTUCKET, RI. FILED 1-  
21-2004.

**BUTTERFLY SURPRISE**

THE MARK CONSISTS OF STANDARD CHARACTERS  
WITHOUT CLAIM TO ANY PARTICULAR FONT, STYLE,  
SIZE, OR COLOR.

NO CLAIM IS MADE TO THE EXCLUSIVE RIGHT TO  
USE BUTTERFLY, APART FROM THE MARK AS SHOWN.

FOR TOY PONIES AND ACCESSORIES FOR USE  
THEREWITH (U.S. CLS. 22, 23, 38 AND 50).

NANCY CLARKE, EXAMINING ATTORNEY

**CLASS 28—(Continued).**

SN 76-571,072. HANDSONTOYS, INC., WILMINGTON, MA. FILED 1-21-2004.

**3D MASTERPIECE**

THE MARK CONSISTS OF STANDARD CHARACTERS WITHOUT CLAIM TO ANY PARTICULAR FONT, STYLE, SIZE, OR COLOR.

NO CLAIM IS MADE TO THE EXCLUSIVE RIGHT TO USE "3D", APART FROM THE MARK AS SHOWN.

FOR HOBBY CRAFT KITS COMPRISING PRINTED IMAGES THAT ARE ARRANGED BY THE USER TO CREATE A SCENE (U.S. CLS. 22, 23, 38 AND 50).

JOHN DALIER, EXAMINING ATTORNEY

---

SN 76-573,241. MAKSER, S.A., 48150-SONDIKA, BIZKAIA, SPAIN, FILED 1-30-2004.

**LADY ONE**

THE MARK CONSISTS OF STANDARD CHARACTERS WITHOUT CLAIM TO ANY PARTICULAR FONT, STYLE, SIZE, OR COLOR.

NO CLAIM IS MADE TO THE EXCLUSIVE RIGHT TO USE "LADY", APART FROM THE MARK AS SHOWN.

FOR GOLF SPORTING ARTICLES, NAMELY, GOLF CLUBS, GOLF BALLS AND GOLF BAGS (U.S. CLS. 22, 23, 38 AND 50).

CHRISTOPHER BUONGIORNO, EXAMINING ATTORNEY

---

SN 76-573,621. EVANS, ROBERT SCOTT, SUNLAND, CA. FILED 1-30-2004.

**BETTER BODY BETTER GAME**

FOR EXERCISE EQUIPMENT NAMELY MANUALLY OPERATED EXERCISE EQUIPMENT (U.S. CLS. 22, 23, 38 AND 50).

PAULA MAYS, EXAMINING ATTORNEY

**CLASS 28—(Continued).**

SN 76-578,344. MARLOTH, GILLIAN, LOS ANGELES, CA. FILED 3-1-2004.

**YOGA  
BOOTY  
BALLET**

OWNER OF U.S. REG. NO. 2,752,330.

NO CLAIM IS MADE TO THE EXCLUSIVE RIGHT TO USE "YOGA" AND "BALLET", APART FROM THE MARK AS SHOWN.

FOR EXERCISE EQUIPMENT, NAMELY, MACHINES, EXERCISE BALLS, ELASTIC BANDS FOR EXERCISE, BENCHES, TABLES, TRAMPOLINES, AND WEIGHTS (U.S. CLS. 22, 23, 38 AND 50).

RUDY R. SINGLETON, EXAMINING ATTORNEY

---

SN 76-583,464. HASBRO, INC., PAWTUCKET, RI. FILED 3-29-2004.

**LI'L BUSY BOX**

THE MARK CONSISTS OF STANDARD CHARACTERS WITHOUT CLAIM TO ANY PARTICULAR FONT, STYLE, SIZE, OR COLOR.

FOR CHILDREN'S MULTIPLE ACTIVITY TOYS (U.S. CLS. 22, 23, 38 AND 50).

FIRST USE 2-8-1988; IN COMMERCE 2-8-1988.

MATTHEW KLINE, EXAMINING ATTORNEY

---

SN 76-583,729. HASBRO, INC., PAWTUCKET, RI. FILED 3-29-2004.

**OPERATION NAVY STING**

FOR TOY VEHICLES, TOY VEHICLE PLAYSETS AND ACCESSORIES FOR USE THEREWITH (U.S. CLS. 22, 23, 38 AND 50).

JOHN SCHUYLER YARD, EXAMINING ATTORNEY

**CLASS 28—(Continued).**

SN 76-590,151. THE HARTZ MOUNTAIN CORPORATION, SECAUCUS, NJ. FILED 5-3-2004.

**MIDNIGHT CRAZIES**

FOR PET TOYS (U.S. CLS. 22, 23, 38 AND 50).  
FIRST USE 11-0-1996; IN COMMERCE 11-0-1996.  
WON TEAK OH, EXAMINING ATTORNEY

SN 76-590,552. JADA TOYS, INC., CITY OF INDUSTRY, CA. FILED 5-5-2004.

**\$HOWTIME**

THE MARK CONSISTS OF STANDARD CHARACTERS WITHOUT CLAIM TO ANY PARTICULAR FONT, STYLE, SIZE, OR COLOR.  
FOR DIECAST TOY CARS, TOY TRUCKS, AND TOY VEHICLES (U.S. CLS. 22, 23, 38 AND 50).  
NAAKWAMA ANKRAH, EXAMINING ATTORNEY

SN 76-591,090. TYR SPORT, INC., HUNTINGTON BEACH, CA. FILED 5-7-2004.

**CATALYST**

FOR SWIM TRAINING DEVICES, NAMELY, SWIM PADDLES, TRAINING PADDLES, AND HAND PADDLES (U.S. CLS. 22, 23, 38 AND 50).  
FIRST USE 1-0-1996; IN COMMERCE 1-0-1996.  
KELLEY WELLS, EXAMINING ATTORNEY

SN 76-591,378. SILVERS, STEVEN A., WEST PALM BEACH, FL. FILED 5-7-2004.

**GOOBOO**

THE MARK CONSISTS OF STANDARD CHARACTERS WITHOUT CLAIM TO ANY PARTICULAR FONT, STYLE, SIZE, OR COLOR.  
FOR TOYS, NAMELY STUFFED AND PLUSH TOYS (U.S. CLS. 22, 23, 38 AND 50).  
ERNEST SHOSHO, EXAMINING ATTORNEY

**CLASS 28—(Continued).**

SN 76-591,381. SILVERS, STEVEN A., WEST PALM BEACH, FL. FILED 5-7-2004.

**GOOROO**

FOR TOYS, NAMELY STUFFED AND PLUSH TOYS (U.S. CLS. 22, 23, 38 AND 50).  
KELLEY WELLS, EXAMINING ATTORNEY

SN 76-591,438. FINANCIAL INSTITUTE FOR KIDS, LLC, BRENTWOOD, TN. FILED 5-10-2004.

**EXECUKID**

THE MARK CONSISTS OF STANDARD CHARACTERS WITHOUT CLAIM TO ANY PARTICULAR FONT, STYLE, SIZE, OR COLOR.  
FOR BOARD GAMES, CARD GAMES, EQUIPMENT SOLD AS A UNIT FOR PLAYING BOARD GAMES, EQUIPMENT SOLD AS A UNIT FOR PLAYING CARD GAMES, ROLE PLAYING GAMES, CHILDREN'S MULTIPLE ACTIVITY TOYS, ELECTRONIC EDUCATIONAL GAME MACHINES FOR CHILDREN, PROMOTIONAL GAME MATERIALS, ROLE PLAYING GAME EQUIPMENT IN THE NATURE OF GAME BOOK MANUALS, STAND ALONE VIDEO GAME MACHINES (U.S. CLS. 22, 23, 38 AND 50).  
C. DIONNE CLYBURN, EXAMINING ATTORNEY

SN 76-591,439. FINANCIAL INSTITUTE FOR KIDS, LLC, BRENTWOOD, TN. FILED 5-10-2004.

**EXECUTEEN**

THE MARK CONSISTS OF STANDARD CHARACTERS WITHOUT CLAIM TO ANY PARTICULAR FONT, STYLE, SIZE, OR COLOR.  
FOR BOARD GAMES, CARD GAMES, EQUIPMENT SOLD AS A UNIT FOR PLAYING BOARD GAMES, EQUIPMENT SOLD AS A UNIT FOR PLAYING CARD GAMES, ROLE PLAYING GAMES, CHILDREN'S MULTIPLE ACTIVITY TOYS, ELECTRONIC EDUCATIONAL GAME MACHINES FOR CHILDREN, PROMOTIONAL GAME MATERIALS, ROLE PLAYING GAME EQUIPMENT IN THE NATURE OF GAME BOOK MANUALS, STAND ALONE VIDEO GAME MACHINES (U.S. CLS. 22, 23, 38 AND 50).  
C. DIONNE CLYBURN, EXAMINING ATTORNEY

**CLASS 28—(Continued).**

SN 76-591,688. AMERISTEP, INC., CLIO, MI. FILED 5-12-2004.

**SUPER CAM**

THE MARK CONSISTS OF STANDARD CHARACTERS WITHOUT CLAIM TO ANY PARTICULAR FONT, STYLE, SIZE, OR COLOR.

NO CLAIM IS MADE TO THE EXCLUSIVE RIGHT TO USE "CAM", APART FROM THE MARK AS SHOWN.

FOR HUNTING TREE STANDS (U.S. CLS. 22, 23, 38 AND 50).

VIVIAN MICZNIK FIRST, EXAMINING ATTORNEY

---

SN 76-591,848. WOOSTER PRODUCTS, INC., WOOSTER, OH. FILED 5-12-2004.

**NEGATIVE ONE**

FOR FLEXIBLE, NON-SLIP SAFETY TAPE, SOLD IN VARYING SIZES FOR USE ON SKATEBOARDS, SCOOTERS AND SNOWBOARDS (U.S. CLS. 22, 23, 38 AND 50). FIRST USE 7-0-2002; IN COMMERCE 7-0-2002. CHERYL CLAYTON, EXAMINING ATTORNEY

---

SN 76-592,661. DAIWA SEIKO, INC., HIGASHIKURUMECITY, TOKYO, JAPAN, FILED 5-18-2004.

**SALTIST**

THE MARK CONSISTS OF STANDARD CHARACTERS WITHOUT CLAIM TO ANY PARTICULAR FONT, STYLE, SIZE, OR COLOR.

FOR FISHING REELS, FISHING RODS, FISHING LURES, FISHING SINKERS, FISHING FLOATS, FISHING TACKLE BOXES AND FISHING LINES (U.S. CLS. 22, 23, 38 AND 50).

GINNY ISAACSON, EXAMINING ATTORNEY

**CLASS 28—(Continued).**

SN 76-602,216. JADA TOYS, INC., CITY OF INDUSTRY, CA. FILED 7-14-2004.

**TOYS FOR BIG BOYS!**

THE MARK CONSISTS OF STANDARD CHARACTERS WITHOUT CLAIM TO ANY PARTICULAR FONT, STYLE, SIZE, OR COLOR.

FOR DIECAST TOY VEHICLES; RADIO-CONTROLLED TOY VEHICLES; FRICTION TOY VEHICLES; WIND-UP TOY VEHICLES AND TOY FIGURES; TOY ACTION FIGURES AND ACCESSORIES FOR USE THEREWITH; DOLLS, DOLL CLOTHING AND DOLL ACCESSORIES; CHILDREN'S AND INFANT'S MULTIPLE ACTIVITY TOYS; PLUSH TOYS; STUFFED TOYS; PLASTIC AND VINYL TOY CHARACTERS AND TOY ANIMALS; TOY FIGURES; RIDE-ON TOYS; WIND-UP TOYS; BATTERY-OPERATED TOY VEHICLES; PUSH TOYS; PULL TOYS; MECHANICAL TOYS; TOY CONSTRUCTION SETS; BUILDING TOYS; BUILDING BLOCKS; WATER SQUIRTING TOYS; MUSICAL TOYS; INFLATABLE TOYS; INFANT TOY RATTLES; JIGSAW PUZZLES; BOARD GAMES; ELECTRONIC HAND-HELD UNIT FOR PLAYING VIDEO GAMES; SKATEBOARDS; TOY SCOOTERS; TOY SPORTING EQUIPMENT, NAMELY, FOOTBALLS, BASEBALLS, SOCCER BALLS, BASEBALL BATS, GOLF CLUBS, HOCKEY STICKS AND PUCKS, BASKETBALLS, VOLLEYBALLS, GOLF BALLS AND GOLF DIVOT REPAIR TOOLS, TOY FOAM DISC AND BALL SHOOTERS AND FOAM TOY DISCS AND BALLS FOR USE THEREWITH (U.S. CLS. 22, 23, 38 AND 50).

KHANH LE, EXAMINING ATTORNEY

---

SN 78-175,907. PAMELA DRAKE IMPORTS, INC., BERKELEY, CA. FILED 10-18-2002.

**IT'S BY...PDI**

FOR DOLLS; TOYS; WOODEN TOYS, PUSH TOYS, PULL TOYS, SPINNING TOYS, RATTLES; PUZZLES; GAMES, NAMELY RING-TOSS GAMES, CARD GAMES, DOMINOES; AND PLAYTHINGS, NAMELY SANDWICH-BOARD TYPE DRESS-UP TOYS AND ACTIVITY TOY KITS CONSISTING OF HINGED BOARDS AND ONE OR MORE OF THE FOLLOWING— TOY FIGURES, PUZZLE PIECES, FABRIC PIECES, BUTTONS, TOY GEMS, TOY FURNITURE AND SCENERY, DECORATIVE ITEMS, PLASTIC DECORATIVE SHEETS, THREAD, SCISSORS, AND INSTRUCTION SHEETS AND REPLACEMENT PARTS THEREFOR; HOBBY CRAFT KITS CONSISTING PRIMARILY OF TOY FIGURES, PAINTS, BRUSHES, AND INSTRUCTIONS; HOBBY CRAFT PAINTING KITS CONSISTING PRIMARILY OF FABRICS, PAINTS, BRUSHES AND INSTRUCTIONS; HOBBY CRAFT KITS FOR TIE-DYING CONSISTING PRIMARILY OF DYES, CONTAINERS AND INSTRUCTIONS; HOBBY CRAFT KITS CONSISTING PRIMARILY OF STAMPS, PAINTS, STAMP PADS AND INSTRUCTIONS FOR STAMPING DIFFERENT SURFACES; HOBBY CRAFT WIRE ART KITS CONSISTING PRIMARILY OF WIRE, STICKS, BEADS AND THE LIKE FOR CREATING JEWELRY, SCULPTURE, ART AND TOYS; HOBBY CRAFT KNITTING KITS CONSISTING PRIMARILY OF YARN, KNITTING NEEDLES, PATTERNS AND INSTRUCTIONS (U.S. CLS. 22, 23, 38 AND 50).

DOMINICK J. SALEMI, EXAMINING ATTORNEY



**CLASS 28—(Continued).**

SN 78-177,479. OUTRAGEOUS INT. HONG KONG LTD., NEW YORK, NY. FILED 10-23-2002.

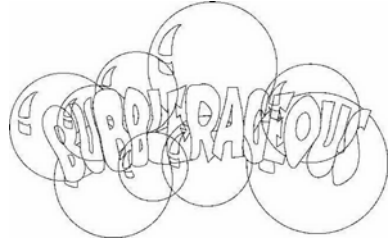

THE MARK CONSISTS OF THE WORD BUBBLERA-GEOUS IN A STYLIZED LETTERING DESIGN ACROSS A GROUP OF BUBBLES.

FOR FULL LINE OF TOY BUBBLE SOLUTIONS, TOY BUBBLE-MAKING MACHINES AND BUBBLE ACCESSORIES, NAMELY, BUBBLE-MAKING WANDS, BLOWERS AND DIPPING PLATES (U.S. CLS. 22, 23, 38 AND 50).

HOWARD B. LEVINE, EXAMINING ATTORNEY

SN 78-182,049. SPORTSPRAY EQUIPMENT, INC., ST. LOUIS, MO. FILED 11-5-2002.

**TOT TOWN**

NO CLAIM IS MADE TO THE EXCLUSIVE RIGHT TO USE "TOT", APART FROM THE MARK AS SHOWN.

FOR CHILDREN'S TOYS AND PLAYTHINGS, NAMELY, PLAYHOUSES; TOY EASELS; NAMELY A SELF-CONTAINED TOY EASEL FOR ART WORK COMPRISED OF A STAND AND PAINTING SURFACE; SAND AND WATER PLAY TABLES CONSISTING OF A TABLE WITH TWO TRAYS, ONE FOR SAND AND ONE FOR WATER SET AMONG, PAILS AND SHOVELS; SANDBOXES; SPRING RIDERS, NAMELY A DECORATIVE SEAT MOUNTED ON A LARGE SPRING FOR RIDING BY CHILDREN; CRAWL TUNNELS, NAMELY PLAY TUNNELS; AND MODULAR PLAY UNITS COMPRISED OF SWINGS, CLIMBING UNITS AND SLIDES (U.S. CLS. 22, 23, 38 AND 50).

FIRST USE 1-1-2002; IN COMMERCE 3-1-2002.

RUDY R. SINGLETON, EXAMINING ATTORNEY

SN 78-222,340. ENTERTAINMENT PROGRAMMES PTY LTD, PERTH WESTERN AUSTRALIA, AUSTRALIA, FILED 3-6-2003.

**GRAND SLAM STUD**

NO CLAIM IS MADE TO THE EXCLUSIVE RIGHT TO USE STUD, APART FROM THE MARK AS SHOWN.

FOR EQUIPMENT SOLD AS A UNIT FOR PLAYING A CASINO TABLE GAME (U.S. CLS. 22, 23, 38 AND 50).

G. MAYERSCHOFF, EXAMINING ATTORNEY

**CLASS 28—(Continued).**

SN 78-275,025. MCCURRY, BRAD, IRVING, TX. FILED 7-16-2003.

**ONE SHOT**

FOR HUNTER'S SCENT LURES AND HUNTER'S SCENT CAMOUFLAGE (U.S. CLS. 22, 23, 38 AND 50).  
JEFFREY S. MOLINOFF, EXAMINING ATTORNEY

SN 78-288,894. AXIAN TECHNOLOGY, INC., PHOENIX, AZ. FILED 8-18-2003.

**AXIAN TACTICAL**

FOR RAPPEL DEVICE WHICH IS DESIGNED TO SLOW OR STOP A CLIMBER ATTACHED TO OR DESCENDING FROM A ROPE, CLIMBING ROPES (U.S. CLS. 22, 23, 38 AND 50).

HOWARD SMIGA, EXAMINING ATTORNEY

SN 78-321,238. P. C. WOO, INC., DBA MEGATOYS, LOS ANGELES, CA. FILED 10-30-2003.

**ANIMAL NATION**

NO CLAIM IS MADE TO THE EXCLUSIVE RIGHT TO USE "ANIMAL", APART FROM THE MARK AS SHOWN.

FOR PLASTIC TOY ANIMALS, STUFFED TOY ANIMALS, PLASTIC WILDLIFE SETS COMPRISED OF PLASTIC ANIMALS AND PLANTS, WILDLIFE RELATED TOY PLAY SETS COMPRISED OF PLASTIC ANIMALS AND PLASTIC HABITATS (U.S. CLS. 22, 23, 38 AND 50).

FIRST USE 10-15-2003; IN COMMERCE 10-15-2003.

JANICE L. MCMORROW, EXAMINING ATTORNEY

SN 78-322,908. RUOCCHIO, ALBERT C., RALEIGH, NC. FILED 11-4-2003.

**PENNSYLVANIA  
RAILROAD**

THE MARK CONSISTS OF STANDARD CHARACTERS WITHOUT CLAIM TO ANY PARTICULAR FONT, STYLE, SIZE, OR COLOR.

NO CLAIM IS MADE TO THE EXCLUSIVE RIGHT TO USE "RAILROAD", APART FROM THE MARK AS SHOWN.

FOR ELECTRIC TOY MODEL TRAINS AND ACCESSORIES, NAMELY, TRAIN SETS, TRAIN ENGINES, TRAIN CARS, TRAIN TRACK AND TRANSFORMERS, TRAIN MOTORS, TRAIN LAYOUT FIGURES, TRAIN LAYOUT VEHICLES, AND TRAIN LAYOUT BUILDINGS (U.S. CLS. 22, 23, 38 AND 50).

CAROLINE WOOD, EXAMINING ATTORNEY

**CLASS 28—(Continued).**

SN 78-322,915. RUOCCHIO, ALBERT C., RALEIGH, NC.  
FILED 11-4-2003.

**PRR**

THE MARK CONSISTS OF STANDARD CHARACTERS  
WITHOUT CLAIM TO ANY PARTICULAR FONT, STYLE,  
SIZE, OR COLOR.

FOR ELECTRIC TOY MODEL TRAINS AND ACCES-  
SORIES, NAMELY, TRAIN SETS, TRAIN ENGINES,  
TRAIN CARS, TRAIN TRACK AND TRANSFORMERS,  
TRAIN MOTORS, TRAIN LAYOUT FIGURES, TRAIN  
LAYOUT VEHICLES, AND TRAIN LAYOUT BUILD-  
INGS (U.S. CLS. 22, 23, 38 AND 50).

CAROLINE WOOD, EXAMINING ATTORNEY

SN 78-329,273. NORDICA S.P.A., TREVIGNANO(TV), ITALY,  
FILED 11-18-2003.

**MICROBLADE**

THE MARK CONSISTS OF STANDARD CHARACTERS  
WITHOUT CLAIM TO ANY PARTICULAR FONT, STYLE,  
SIZE, OR COLOR.

FOR IN-LINE ROLLER SKATES (U.S. CLS. 22, 23, 38  
AND 50).

JILL C. ALT, EXAMINING ATTORNEY

**CLASS 28—(Continued).**

SN 78-330,466. MATTEL, INC., EL SEGUNDO, CA. FILED 11-  
19-2003.

**RED MOON**

THE MARK CONSISTS OF STANDARD CHARACTERS  
WITHOUT CLAIM TO ANY PARTICULAR FONT, STYLE,  
SIZE, OR COLOR.

FOR TOYS, GAMES AND PLAYTHINGS, NAMELY,  
DOLLS, DOLL CLOTHING AND DOLL ACCESSORIES  
(U.S. CLS. 22, 23, 38 AND 50).

ANN E. SAPPENFIELD, EXAMINING ATTORNEY

SN 78-330,467. MATTEL, INC., EL SEGUNDO, CA. FILED 11-  
19-2003.

**RED SUNSET**

THE MARK CONSISTS OF STANDARD CHARACTERS  
WITHOUT CLAIM TO ANY PARTICULAR FONT, STYLE,  
SIZE, OR COLOR.

FOR TOYS, GAMES AND PLAYTHINGS, NAMELY,  
DOLLS, DOLL CLOTHING AND DOLL ACCESSORIES  
(U.S. CLS. 22, 23, 38 AND 50).

ANN E. SAPPENFIELD, EXAMINING ATTORNEY

SN 78-330,471. MATTEL, INC., EL SEGUNDO, CA. FILED 11-  
19-2003.

**SALON SENSATION**

THE MARK CONSISTS OF STANDARD CHARACTERS  
WITHOUT CLAIM TO ANY PARTICULAR FONT, STYLE,  
SIZE, OR COLOR.

FOR TOYS, GAMES AND PLAYTHINGS, NAMELY,  
DOLL HAIR STYLING HEAD AND STYLING ACCES-  
SORIES THEREFOR (U.S. CLS. 22, 23, 38 AND 50).

ANN E. SAPPENFIELD, EXAMINING ATTORNEY

**CLASS 28—(Continued).**

SN 78-330,476. MATTEL, INC., EL SEGUNDO, CA. FILED 11-19-2003.

**CLASS 28—(Continued).**

SN 78-339,250. RUOCCHIO, ALBERT C., RALEIGH, NC. FILED 12-11-2003.

**SILKSTONE**

**CNJ**

THE MARK CONSISTS OF STANDARD CHARACTERS WITHOUT CLAIM TO ANY PARTICULAR FONT, STYLE, SIZE, OR COLOR.

FOR TOYS, GAMES AND PLAYTHINGS, NAMELY, DOLLS AND FIGURINES MADE FROM PLASTIC RESIN AND PORCELAIN (U.S. CLS. 22, 23, 38 AND 50).

ANN E. SAPPENFIELD, EXAMINING ATTORNEY

THE MARK CONSISTS OF STANDARD CHARACTERS WITHOUT CLAIM TO ANY PARTICULAR FONT, STYLE, SIZE, OR COLOR.

FOR TOYS, NAMELY, MODEL TOY TRAINS AND MODEL TOY TRAIN LAYOUT ACCESSORIES, NAMELY, TRAIN LAYOUT FIGURES, TRAIN LAYOUT VEHICLES, AND TRAIN LAYOUT BUILDINGS (U.S. CLS. 22, 23, 38 AND 50).

FIRST USE 2-15-1988; IN COMMERCE 2-15-1988.  
CAROLINE WOOD, EXAMINING ATTORNEY

SN 78-330,484. MATTEL, INC., EL SEGUNDO, CA. FILED 11-19-2003.

SN 78-363,602. GULLO PROPERTIES, L.C., OGDEN, VA. FILED 2-6-2004.

**TORPEDO ATTACK**

**The Ghost Monster  
Truck**

THE MARK CONSISTS OF STANDARD CHARACTERS WITHOUT CLAIM TO ANY PARTICULAR FONT, STYLE, SIZE, OR COLOR.

FOR TOYS, GAMES AND PLAYTHINGS, NAMELY, TOY VEHICLE TRACK SETS AND ACCESSORIES THEREFOR (U.S. CLS. 22, 23, 38 AND 50).

ANN E. SAPPENFIELD, EXAMINING ATTORNEY

THE MARK CONSISTS OF STANDARD CHARACTERS WITHOUT CLAIM TO ANY PARTICULAR FONT, STYLE, SIZE, OR COLOR.

NO CLAIM IS MADE TO THE EXCLUSIVE RIGHT TO USE MONSTER TRUCK, APART FROM THE MARK AS SHOWN.

FOR TOY VEHICLES AND MODEL HOBBY VEHICLES (U.S. CLS. 22, 23, 38 AND 50).

ANNE MADDEN, EXAMINING ATTORNEY

**CLASS 28—(Continued).**

SN 78-368,933. THE SAUL ZAENTZ COMPANY, DBA TOLKIEN ENTERPRISES, BERKELEY, CA. FILED 2-17-2004.

**THE ONE RING**

THE MARK CONSISTS OF STANDARD CHARACTERS WITHOUT CLAIM TO ANY PARTICULAR FONT, STYLE, SIZE, OR COLOR.

FOR GAMES AND PLAYTHINGS, NAMELY, ACTION FIGURES, ACTION SKILL GAMES, ACTION-TYPE TARGET GAMES, AMUSEMENT PARK RIDES, ARCADE GAMES, BACKGAMMON SETS, BALLOONS, BALLS, BATH TOYS, BOARD GAMES, BOWS, CARD GAMES, CHESS BOARDS, CHESS GAMES, CHESS PIECES PACKAGED SEPARATELY AND AS A SET, CHILDREN'S TOY MAZES, CHRISTMAS TREE ORNAMENTS EXCEPT CONFECTIONERY ITEMS AND ILLUMINATION ARTICLES, COIN OPERATED PINBALL MACHINES, COIN-OPERATED VIDEO GAME MACHINES, COLLECTIBLE MARBLES, COLLECTIBLE TOY FIGURES, CONSTRUCTION TOYS, COSTUME MASKS, DARTS, DOLL CLOTHING, DOLLS, ELECTRONIC ACTION TOYS, ELECTRONIC EDUCATIONAL GAME MACHINES FOR CHILDREN, EQUIPMENT PACKAGED AS A UNIT FOR PLAYING ACTION TYPE TARGET GAMES, EQUIPMENT PACKAGED AS A UNIT FOR PLAYING BOARD GAMES, EQUIPMENT PACKAGED AS A UNIT FOR PLAYING CARD GAMES, EQUIPMENT PACKAGED AS A UNIT FOR PLAYING HAND HELD ELECTRONIC GAMES, FANTASY CHARACTER TOYS, FLYING DISCS, HAND HELD ELECTRONIC TOYS, HAND HELD UNITS FOR PLAYING VIDEO GAMES, HOBBY CRAFT SETS FOR DECORATING HAIR, HOBBY CRAFT SETS FOR MAKING BEADS, HOBBY CRAFT SETS FOR MAKING CRYSTALS, HOBBY CRAFT SETS FOR MAKING DECORATIVE OBJECTS WITH MAGNETS, HOBBY CRAFT SETS FOR MAKING MODEL BUILDINGS, HOBBY CRAFT SETS FOR MAKING MODEL FIGURES, HOBBY CRAFT SETS FOR MAKING SAND ART, HOBBY CRAFT SETS FOR MAKING SOAP, HOBBY CRAFT SETS FOR MAKING TOY JEWELRY, HOBBY CRAFT SETS FOR MOLDING CHOCOLATE, HOBBY CRAFT SETS CONSISTING OF PLAY COSMETICS, INFLATABLE TOYS, IN-LINE SKATES, JIGSAW PUZZLES, KALEIDOSCOPIES, KITES, LCD GAME MACHINES, MARBLES, MAZE GAMES, MECHANICAL ACTION TOYS, NON-COIN OPERATED MACHINES, NON-MOTORIZED TOY SCOOTERS, PAPER FACE MASKS, PARLOR GAMES, PINBALL GAMES, PINBALL MACHINES, PLAY KITS CONSISTING OF PLAY COSMETICS, PLAY SETS FOR ACTION FIGURES, PLAY SETS FOR MASQUERADE GAMES, PLAYING CARDS, PLUSH DOLLS WITH SOUND, PLUSH DOLLS WITHOUT SOUND, PLUSH TOYS, POOL RINGS, POSITIONABLE TOY FIGURES, PUPPETS, RAG DOLLS WITH SOUND, RAG DOLLS WITHOUT SOUND, REMOTE CONTROLLED ACTION FIGURES, ROLE-PLAYING GAMES, ROLE-PLAYING TOYS, ROLLER SKATES, SAND TOYS, SKATEBOARDS, SOCCER BALLS, SOFT SCULPTURE TOYS, STAND ALONE VIDEO GAME MACHINES, SURF BOARDS, SWIM FLOATS FOR RECREATIONAL USE, TALKING TOYS, THREE-DIMENSIONAL PUZZLES, TOY ACTION FIGURE ACCESSORIES, TOY ACTION FIGURES, TOY ARMOR, TOY AXES, TOY BANKS, TOY BOWS, TOY ARROWS, TOY BOBBING HEAD FIGURES, TOY BOXES, TOY BUILDING BLOCKS AND CONNECTING LINKS FOR THE SAME, TOY CANDY DISPENSERS, TOY CANDY HOLDERS, TOY COIN BANKS, TOY COSMETIC KITS, TOY DAGGERS, TOY ENGINE POWERED MODEL VEHICLES, TOY FIGURES, TOY HELMETS, TOY KNI-

**CLASS 28—(Continued).**

VES, TOY MACES, TOY MODELING COMPOUNDS AND DOUGH, TOY PEDAL CARS, TOY RADIO CONTROLLED VEHICLES, TOY SCOOTERS, TOY SNOW GLOBES, TOY STRUCTURE ACCESSORIES, NAMELY, TOY FENCES, TREES, AND LADDERS, TOY STRUCTURES, NAMELY, TOY CASTLES AND FORTS, TOY SWORDS, TOY THROWING DISCS, TOY VEHICLE ACCESSORIES, TOY VEHICLES, TOY WATCHES, TOY WEAPONS, TRANSFORMING ROBOTIC TOYS, TWO-DIMENSIONAL PUZZLES, EXCEPT CROSSWORD PUZZLES, TOY WHISTLES, WIND-UP TOYS, YO-YOS (U.S. CLS. 22, 23, 38 AND 50).

KEVON CHISOLM, EXAMINING ATTORNEY

SN 78-373,636. SUPER DUPER INC., DBA SUPER DUPER PUBLICATIONS, GREENVILLE, SC. FILED 2-25-2004.

**PHONICS FUNNEL**

THE MARK CONSISTS OF STANDARD CHARACTERS WITHOUT CLAIM TO ANY PARTICULAR FONT, STYLE, SIZE, OR COLOR.

NO CLAIM IS MADE TO THE EXCLUSIVE RIGHT TO USE "PHONICS", APART FROM THE MARK AS SHOWN.

FOR GAME EQUIPMENT- NAMELY, GAME EQUIPMENT FOR PLAYING A WORD GAME THAT DEALS PRIMARILY WITH LANGUAGE, READING, AND VOCABULARY FOR USE BY THE GENERAL PUBLIC, PUBLIC AND PRIVATE TEACHERS, HEALTH PROFESSIONALS OR THERAPISTS (U.S. CLS. 22, 23, 38 AND 50).

CAROL SPILS, EXAMINING ATTORNEY

SN 78-387,491. TY INC., WESTMONT, IL. FILED 3-19-2004.

**CHARITEE**

THE MARK CONSISTS OF STANDARD CHARACTERS WITHOUT CLAIM TO ANY PARTICULAR FONT, STYLE, SIZE, OR COLOR.

FOR PLUSH TOYS (U.S. CLS. 22, 23, 38 AND 50).

ERNEST SHOSHO, EXAMINING ATTORNEY

**CLASS 28—(Continued).**

SN 78-393,318. ROSE ART INDUSTRIES, INC., LIVINGSTON, NJ. FILED 3-30-2004.

**CLASS 28—(Continued).**

SN 78-394,636. STEWARD, JAMES C, SAINT LOUIS, MO. FILED 4-1-2004.

# LITESTRUCATION

THE MARK CONSISTS OF STANDARD CHARACTERS WITHOUT CLAIM TO ANY PARTICULAR FONT, STYLE, SIZE, OR COLOR.  
FOR MULTI-PART CONSTRUCTION TOYS (U.S. CLS. 22, 23, 38 AND 50).  
DAVID MURRAY, EXAMINING ATTORNEY

# Ignore the water

THE MARK CONSISTS OF STANDARD CHARACTERS WITHOUT CLAIM TO ANY PARTICULAR FONT, STYLE, SIZE, OR COLOR.  
FOR GOLF BALLS (U.S. CLS. 22, 23, 38 AND 50).  
AMY ALFIERI, EXAMINING ATTORNEY

SN 78-394,106. SILL & SONS SERVICES, GAINESVILLE, FL. FILED 3-31-2004.



SN 78-395,616. THRESHOLD NOVELTIES, INC., ROCK-WALL, TX. FILED 4-2-2004.

FOR POOL CUE SHAFTS (U.S. CLS. 22, 23, 38 AND 50).  
FIRST USE 12-15-2003; IN COMMERCE 12-15-2003.  
HENRY S. ZAK, EXAMINING ATTORNEY

# WILD CLINGS

# Ignore The Sand

THE MARK CONSISTS OF STANDARD CHARACTERS WITHOUT CLAIM TO ANY PARTICULAR FONT, STYLE, SIZE, OR COLOR.  
FOR GOLF BALLS (U.S. CLS. 22, 23, 38 AND 50).  
AMY ALFIERI, EXAMINING ATTORNEY

THE MARK CONSISTS OF STANDARD CHARACTERS WITHOUT CLAIM TO ANY PARTICULAR FONT, STYLE, SIZE, OR COLOR.  
FOR TOYS AND NOVELTY ITEMS, NAMELY 3-D SPORTS BALL NOVELTY ITEMS (U.S. CLS. 22, 23, 38 AND 50).  
MATTHEW PAPPAS, EXAMINING ATTORNEY

**CLASS 28—(Continued).**

SN 78-395,743. SILSTAR CORPORATION OF AMERICA, INC., WEST COLUMBIA, SC. FILED 4-2-2004.

**CLASS 28—(Continued).**

SN 78-397,128. RADICA GAMES LTD., HAMILTON, BERMUDA, FILED 4-6-2004.

# LUCILLE

# HIT ME 21

THE MARK CONSISTS OF STANDARD CHARACTERS WITHOUT CLAIM TO ANY PARTICULAR FONT, STYLE, SIZE, OR COLOR.

FOR FISHING REELS (U.S. CLS. 22, 23, 38 AND 50).  
FIRST USE 12-18-2003; IN COMMERCE 12-18-2003.  
JENNIFER KRISP, EXAMINING ATTORNEY

THE MARK CONSISTS OF STANDARD CHARACTERS WITHOUT CLAIM TO ANY PARTICULAR FONT, STYLE, SIZE, OR COLOR.

NO CLAIM IS MADE TO THE EXCLUSIVE RIGHT TO USE "21", APART FROM THE MARK AS SHOWN.  
FOR HANDHELD ELECTRONIC GAME (U.S. CLS. 22, 23, 38 AND 50).  
CHARLES JOYNER, EXAMINING ATTORNEY

---

SN 78-396,857. TLC ANGELS, LLC, NEW YORK, NY. FILED 4-6-2004.

---

SN 78-397,581. THOSE CHARACTERS FROM CLEVELAND, INC., CLEVELAND, OH. FILED 4-7-2004.

# AMAZING ANGELS

# PAPAYA PARROT

THE MARK CONSISTS OF STANDARD CHARACTERS WITHOUT CLAIM TO ANY PARTICULAR FONT, STYLE, SIZE, OR COLOR.

FOR DOLLS, DOLL ACCESSORIES, PLUSH TOYS AND ACCESSORIES THERETO (U.S. CLS. 22, 23, 38 AND 50).  
ARETHA SOMERVILLE, EXAMINING ATTORNEY

THE MARK CONSISTS OF STANDARD CHARACTERS WITHOUT CLAIM TO ANY PARTICULAR FONT, STYLE, SIZE, OR COLOR.

NO CLAIM IS MADE TO THE EXCLUSIVE RIGHT TO USE "PARROT", APART FROM THE MARK AS SHOWN.  
FOR TOY FIGURES (U.S. CLS. 22, 23, 38 AND 50).  
MONTIA G. PRESSEY, EXAMINING ATTORNEY

**CLASS 28—(Continued).**

SN 78-397,590. THOSE CHARACTERS FROM CLEVELAND, INC., CLEVELAND, OH. FILED 4-7-2004.

# BERRYKINS

THE MARK CONSISTS OF STANDARD CHARACTERS WITHOUT CLAIM TO ANY PARTICULAR FONT, STYLE, SIZE, OR COLOR.  
FOR TOY FIGURES AND PLAYSETS THEREFOR (U.S. CLS. 22, 23, 38 AND 50).  
BRETT J. GOLDEN, EXAMINING ATTORNEY

---

SN 78-397,593. THOSE CHARACTERS FROM CLEVELAND, INC., CLEVELAND, OH. FILED 4-7-2004.

# SEA SWEETIES

THE MARK CONSISTS OF STANDARD CHARACTERS WITHOUT CLAIM TO ANY PARTICULAR FONT, STYLE, SIZE, OR COLOR.  
FOR TOY FIGURES AND PLAYSETS THEREFOR (U.S. CLS. 22, 23, 38 AND 50).  
KIM SAITO, EXAMINING ATTORNEY

---

SN 78-397,594. THOSE CHARACTERS FROM CLEVELAND, INC., CLEVELAND, OH. FILED 4-7-2004.

# SEABERRY DELIGHT

THE MARK CONSISTS OF STANDARD CHARACTERS WITHOUT CLAIM TO ANY PARTICULAR FONT, STYLE, SIZE, OR COLOR.  
FOR TOY FIGURES (U.S. CLS. 22, 23, 38 AND 50).  
KIM SAITO, EXAMINING ATTORNEY

**CLASS 28—(Continued).**

SN 78-397,598. THOSE CHARACTERS FROM CLEVELAND, INC., CLEVELAND, OH. FILED 4-7-2004.

# BANANA BONGO

THE MARK CONSISTS OF STANDARD CHARACTERS WITHOUT CLAIM TO ANY PARTICULAR FONT, STYLE, SIZE, OR COLOR.  
FOR TOY FIGURES (U.S. CLS. 22, 23, 38 AND 50).  
KIM SAITO, EXAMINING ATTORNEY

---

SN 78-399,738. MICROSOFT CORPORATION, REDMOND, WA. FILED 4-9-2004.

# FORZA MOTORSPORT

THE MARK CONSISTS OF STANDARD CHARACTERS WITHOUT CLAIM TO ANY PARTICULAR FONT, STYLE, SIZE, OR COLOR.  
NO CLAIM IS MADE TO THE EXCLUSIVE RIGHT TO USE "MOTORSPORT", APART FROM THE MARK AS SHOWN.  
THE FOREIGN WORDING IN THE MARK TRANSLATES INTO ENGLISH AS FORCE.  
FOR TOY VEHICLES (U.S. CLS. 22, 23, 38 AND 50).  
BARNEY CHARLON, EXAMINING ATTORNEY

---

SN 78-403,041. JAESENT INC., GOLETA, CA. FILED 4-16-2004.

# BINGOTENDER

THE MARK CONSISTS OF STANDARD CHARACTERS WITHOUT CLAIM TO ANY PARTICULAR FONT, STYLE, SIZE, OR COLOR.  
FOR HAND HELD ELECTRONIC DEVICE FOR ASSISTING IN PLAYING OF BINGO GAMES (U.S. CLS. 22, 23, 38 AND 50).  
BRIAN BROWN, EXAMINING ATTORNEY

**CLASS 28—(Continued).**

SN 78-406,473. SUMMERS, JOHN C., CARLSBAD, CA. FILED 4-22-2004.

**SLING BLADE**

THE MARK CONSISTS OF STANDARD CHARACTERS WITHOUT CLAIM TO ANY PARTICULAR FONT, STYLE, SIZE, OR COLOR.

FOR ARCHERY EQUIPMENT, NAMELY, ARROWHEADS, ARROWHEAD COVERS, ARROWHEADS FOR HUNTING, BROAD POINT ARROWHEADS, FLETCHING, AND ARROWS (U.S. CLS. 22, 23, 38 AND 50).

JANICE L. MCMORROW, EXAMINING ATTORNEY

**CLASS 28—(Continued).**

SN 78-408,081. EBSCO INDUSTRIES INC., BIRMINGHAM, AL. FILED 4-26-2004.

**CRAWBUG**

THE MARK CONSISTS OF STANDARD CHARACTERS WITHOUT CLAIM TO ANY PARTICULAR FONT, STYLE, SIZE, OR COLOR.

FOR ARTIFICIAL FISHING LURES (U.S. CLS. 22, 23, 38 AND 50).

FIRST USE 1-1-2001; IN COMMERCE 1-1-2001.

CAROLYN CATALDO, EXAMINING ATTORNEY

SN 78-406,483. HOIST FITNESS SYSTEMS, INC., SAN DIEGO, CA. FILED 4-22-2004.

**HOIST**

THE MARK CONSISTS OF STANDARD CHARACTERS WITHOUT CLAIM TO ANY PARTICULAR FONT, STYLE, SIZE, OR COLOR.

OWNER OF U.S. REG. NOS. 1,568,568 AND 2,676,514.

FOR EXERCISE EQUIPMENT, NAMELY STATIONARY EXERCISE MACHINES AND STATIONARY WEIGHT LIFTING MACHINES; STRENGTH AND CARDIOVASCULAR EQUIPMENT AND EXERCISE EQUIPMENT AND ACCESSORIES, NAMELY EXERCISE MATS AND PADS, WEIGHT BENCHES AND BENCH ACCESSORIES, DUMBBELLS, DUMBBELL RACKS, EXERCISE WEIGHTS, ABDOMINAL ROLLERS, CRUNCH BALLS AND WEIGHT LIFTING GLOVES (U.S. CLS. 22, 23, 38 AND 50).

FIRST USE 5-15-1984; IN COMMERCE 5-15-1984.

DANIEL BRODY, EXAMINING ATTORNEY

SN 78-414,109. DC COMICS, NEW YORK, NY. FILED 5-6-2004.



FOR TOYS AND SPORTING GOODS, INCLUDING GAMES AND PLAYTHINGS—NAMELY, ACTION FIGURES AND ACCESSORIES THEREFOR; PLUSH TOYS; BALLOONS; BATHTUB TOYS; RIDE-ON TOYS; EQUIPMENT SOLD AS A UNIT FOR PLAYING CARD GAMES; TOY VEHICLES; DOLLS; FLYING DISCS; ELECTRONIC HAND-HELD GAME UNIT; GAME EQUIPMENT SOLD AS A UNIT FOR PLAYING A BOARD GAME, A CARD GAME, A MANIPULATIVE GAME, A PARLOR GAME AND AN ACTION TYPE TARGET GAME; STAND ALONE VIDEO OUTPUT GAME MACHINES; JIGSAW AND MANIPULATIVE PUZZLES; PAPER FACE MASKS; ICE SKATES; WATER SQUIRTING TOYS; BALLS—NAMELY, PLAYGROUND BALLS, SOCCER BALLS, BASEBALLS, BASKETBALLS; BASEBALL GLOVES; SWIMMING FLOATS FOR RECREATIONAL USE; KICKBOARD FLOTATION DEVICES FOR RECREATIONAL USE; SURFBOARDS; SWIM BOARDS FOR RECREATIONAL USE; SWIM FINS; TOY BAKEWARE AND TOY COOKWARE; TOY BANKS; TOY SNOW GLOBES; AND CHRISTMAS TREE ORNAMENTS (U.S. CLS. 22, 23, 38 AND 50).

CHERYL STEPLIGHT, EXAMINING ATTORNEY



**CLASS 28—(Continued).**

SN 78-415,105. ATOLL HOLDINGS, INC., SAN LUIS OBISPO, CA. FILED 5-7-2004.

**CLASS 28—(Continued).**

SN 78-418,598. FLOPPY DISC ROYALTY CORP., BOULDER, CO. FILED 5-14-2004.

V GYM

Soft Bite Floppy  
Disc

THE MARK CONSISTS OF STANDARD CHARACTERS WITHOUT CLAIM TO ANY PARTICULAR FONT, STYLE, SIZE, OR COLOR.

NO CLAIM IS MADE TO THE EXCLUSIVE RIGHT TO USE "GYM", APART FROM THE MARK AS SHOWN.

FOR EXERCISE EQUIPMENT FOR VERTICAL MOVEMENT, NAMELY A POLE CONFIGURED FOR CLIMBING (U.S. CLS. 22, 23, 38 AND 50).

RICHARD WHITE, EXAMINING ATTORNEY

THE MARK CONSISTS OF STANDARD CHARACTERS WITHOUT CLAIM TO ANY PARTICULAR FONT, STYLE, SIZE, OR COLOR.

OWNER OF U.S. REG. NO. 1,662,592.

FOR FLYING DISCS, NAMELY FLYING DISC TOSS TOYS FOR PEOPLE AND PETS (U.S. CLS. 22, 23, 38 AND 50).

FIRST USE 2-10-1990; IN COMMERCE 3-23-1990.

RONALD MCMORROW, EXAMINING ATTORNEY

SN 78-418,603. FLOPPY DISC ROYALTY CORP., BOULDER, CO. FILED 5-14-2004.

SN 78-416,208. MATT, THOMAS J., TUCSON, AZ. FILED 5-10-2004.



Soft Bite

THE COLOR(S) RED, YELLOW, BLUE, GREEN, ORANGE, PURPLE, PINK IS/ARE CLAIMED AS A FEATURE OF THE MARK.

THE MARK CONSISTS OF A GRAY MAILBOX WITH RED FLAG UPRIGHT ON BROWN POST GARNISHED WITH GREEN GRASS FOLLOWED BY A STYLIZED LETTER R EMBEDDED IN A RED BLOCK, A STYLIZED LETTER E EMBEDDED IN A YELLOW BLOCK, A STYLIZED LETTER D EMBEDDED IN A BLUE BLOCK, A STYLIZED LETTER N EMBEDDED IN A GREEN BLOCK, A STYLIZED LETTER E EMBEDDED IN AN ORANGE BLOCK, A STYLIZED LETTER C EMBEDDED IN A PURPLE BLOCK, A STYLIZED LETTER K EMBEDDED IN A PINK BLOCK ENDING WITH STYLIZED CURSIVE "LIFE".

FOR BOARD GAME (U.S. CLS. 22, 23, 38 AND 50).  
MELVIN AXILBUND, EXAMINING ATTORNEY

THE MARK CONSISTS OF STANDARD CHARACTERS WITHOUT CLAIM TO ANY PARTICULAR FONT, STYLE, SIZE, OR COLOR.

OWNER OF U.S. REG. NO. 1,662,592.

FOR PET TOYS; NAMELY, CAT TOYS, DOG TOYS, PET TOYS CONTAINING CATNIP, PET TOYS MADE OF ROPE, PET PLUSH TOYS, PET SOFT SCULPTURE TOYS, PET SOFT SCULPTURE PLUSH TOYS, PET SQUEEZE TOYS, PET SQUEEZABLE SQUEAKING TOYS, PET STUFFED TOYS, AND FLYING DISC TOSS TOYS FOR PEOPLE AND PETS (U.S. CLS. 22, 23, 38 AND 50).

FIRST USE 2-10-1990; IN COMMERCE 3-23-1990.

GIANCARLO CASTRO, EXAMINING ATTORNEY

**CLASS 28—(Continued).**

SN 78-419,010. FLOPPY DISC ROYALTY CORP., BOULDER, CO. FILED 5-14-2004.

Floppy Disc

THE MARK CONSISTS OF STANDARD CHARACTERS WITHOUT CLAIM TO ANY PARTICULAR FONT, STYLE, SIZE, OR COLOR.

OWNER OF U.S. REG. NO. 1,662,592.  
FOR FLYING DISCS; NAMELY FLYING DISC TOSS TOYS FOR PEOPLE AND PETS (U.S. CLS. 22, 23, 38 AND 50).

FIRST USE 2-10-1990; IN COMMERCE 3-23-1990.  
BARBARA BROWN, EXAMINING ATTORNEY

SN 78-419,318. SPORTSFX, SEATTLE, WA. FILED 5-14-2004.

SPRINGSKATE

THE MARK CONSISTS OF STANDARD CHARACTERS WITHOUT CLAIM TO ANY PARTICULAR FONT, STYLE, SIZE, OR COLOR.

FOR IN-LINE SKATES (U.S. CLS. 22, 23, 38 AND 50).  
MARK T. MULLEN, EXAMINING ATTORNEY

**CLASS 28—(Continued).**

SN 78-419,559. WILDER, ERIC C., DBA WILDER ART GROUP, ARCHDALE, NC. FILED 5-16-2004.

*elemeno*

FOR PLAYING CARDS (U.S. CLS. 22, 23, 38 AND 50).  
SUSAN STIGLITZ, EXAMINING ATTORNEY

SN 78-420,562. BRINE, INC., MILFORD, MA. FILED 5-18-2004.

OZMO

THE MARK CONSISTS OF STANDARD CHARACTERS WITHOUT CLAIM TO ANY PARTICULAR FONT, STYLE, SIZE, OR COLOR.

FOR SOCCER BALLS, SOCCER SHINGUARDS, LACROSSE STICKS, LACROSSE STICK HEADS, LACROSSE HANDLES, LACROSSE POCKET COMPONENTS, LACROSSE BALL STOPS, LACROSSE BALLS, LACROSSE GLOVES, LACROSSE ARM PADS, LACROSSE SHOULDER PADS, LACROSSE RIB PADS, LACROSSE CHEST PROTECTORS (U.S. CLS. 22, 23, 38 AND 50).

CATHERINE FAINT, EXAMINING ATTORNEY

**CLASS 28—(Continued).**

SN 78-421,390. NDM, LLC, DBA COURAGE TO CHANGE,  
FAIRFAX, VA. FILED 5-19-2004.

## HEY, DAD - LET'S TALK

THE MARK CONSISTS OF STANDARD CHARACTERS  
WITHOUT CLAIM TO ANY PARTICULAR FONT, STYLE,  
SIZE, OR COLOR.

FOR TOYS, NAMELY, BOARD GAMES (U.S. CLS. 22,  
23, 38 AND 50).  
NELSON SNYDER, EXAMINING ATTORNEY

SN 78-454,829. X CONCEPTS, LLC, ESCONDIDO, CA. FILED  
7-22-2004.

## WATER WORM MUTANT

THE MARK CONSISTS OF STANDARD CHARACTERS  
WITHOUT CLAIM TO ANY PARTICULAR FONT, STYLE,  
SIZE, OR COLOR.

FOR TOYS, NAMELY WATER SQUIRTING TOYS  
AND ACCESSORIES FOR WATER SQUIRTING TOYS  
(U.S. CLS. 22, 23, 38 AND 50).

G. MAYERSCHOFF, EXAMINING ATTORNEY

SN 78-476,140. BRIDGESTONE SPORTS CO., LTD., TOKYO,  
JAPAN, FILED 8-31-2004.

## X-DRIVE

THE MARK CONSISTS OF STANDARD CHARACTERS  
WITHOUT CLAIM TO ANY PARTICULAR FONT, STYLE,  
SIZE, OR COLOR.

FOR GOLF CLUBS; GOLF CLUB HEAD COVERS (U.S.  
CLS. 22, 23, 38 AND 50).

KIMBERLY PERRY, EXAMINING ATTORNEY

**CLASS 29—MEATS AND PROCESSED FOODS**

SN 76-509,105. FRANKLIN CONNECTIONS, L.P., EL PASO,  
TX. FILED 4-24-2003.

## POWER SNACKS

NO CLAIM IS MADE TO THE EXCLUSIVE RIGHT TO  
USE "SNACK", APART FROM THE MARK AS SHOWN.

FOR PROCESSED FRUITS, NUTS, AND SEEDS (U.S.  
CL. 46).

FIRST USE 4-15-2002; IN COMMERCE 4-15-2002.  
JOHN HWANG, EXAMINING ATTORNEY

SN 76-517,870. ROBERT'S AMERICAN GOURMET, SEA  
CLIFF, NY. FILED 5-5-2003.

## PLUNDERED BOOTY

FOR POTATO-BASED SNACK FOODS (U.S. CL. 46).

FIRST USE 3-1-2003; IN COMMERCE 3-1-2003.

LAURA KOVAISKY, EXAMINING ATTORNEY

SN 76-543,390. JENNIE-O TURKEY STORE, LLC, WILLMAR,  
MN. FILED 9-8-2003.



OWNER OF U.S. REG. NOS. 1,472,521, 2,795,630 AND  
OTHERS.

NO CLAIM IS MADE TO THE EXCLUSIVE RIGHT TO  
USE TURKEY, APART FROM THE MARK AS SHOWN.

THE COLOR(S) DARK GREEN, LIGHT GREEN, GOLD,  
YELLOW, WHITE AND BLACK ARE CLAIMED AS A  
FEATURE OF THE MARK.

THE COLORS DARK GREEN AND LIGHT GREEN  
APPEAR ALTERNATIVELY IN THE AWNING PORTION  
OF THE MARK. THE COLOR DARK GREEN ALSO  
APPEARS AS A BACKGROUND COLOR IN THE CIRCLE  
THAT STATES "JENNIE-O TURKEY STORE". THE COLOR  
GOLD APPEARS AS THE OUTLINING OF THE CIRCLE  
PORTION OF THE MARK THAT CONTAINS A DARK  
GREEN BACKGROUND AND STATES "JENNIE-O TUR-  
KEY STORE". THE COLOR YELLOW APPEARS IN THE  
PORTION OF THE MARK THAT STATES "JENNIE-O". THE  
COLOR WHITE APPEARS IN THE PORTION OF THE  
MARK THAT STATES "TURKEY STORE". THE WORDING  
"JENNIE-O TURKEY STORE" IS OUTLINED IN BLACK.

FOR POULTRY (U.S. CL. 46).

FIRST USE 2-5-2003; IN COMMERCE 2-5-2003.

YONG KIM, EXAMINING ATTORNEY

**CLASS 29—(Continued).**

SN 76-545,147. OCEANIC BEVERAGES CO., INC., SAN CHUNG CITY, TAIPEI HSIEN, TAIWAN, FILED 9-16-2003.



NO CLAIM IS MADE TO THE EXCLUSIVE RIGHT TO USE "MILK", APART FROM THE MARK AS SHOWN.

THE FOLLOWING IS THE TRANSLITERATION AND TRANSLATION OF THE CHINESE WORDS IN THE MARK. CHWEN-PURE; NAE-MILK; SHI-WEST; DAA-DOZEN; MILK-SIDRA.

FOR MILK, CREAM, CREAM CHEESE, BUTTER, BUTTER SUBSTITUTES, MILK-BASED BEVERAGE CONTAINING COFFEE, MILK POWDER, LACTOBACILLUS-BASED BEVERAGES, NAMELY, FERMENTED MILK, AND FRUIT PECTIN (U.S. CL. 46).

INGRID C. EULIN, EXAMINING ATTORNEY

**CLASS 29—(Continued).**

SN 76-549,641. INTERNATIONAL FROZEN FOODS, LLC., CASTROVILLE, CA. FILED 9-22-2003.



NO CLAIM IS MADE TO THE EXCLUSIVE RIGHT TO USE "OMELET STARTERS", APART FROM THE MARK AS SHOWN.

THE STIPPLING IS FOR SHADING PURPOSES ONLY. THE MARK CONSISTS OF THE WORDS "OMELET STARTERS" IN STYLIZED FONT WITH THE DESIGN OF A SUN BEHIND THE BEGINNING OF THE WORD "OMELET", AND SHADING WITHIN THE SUN DESIGN AND WORDS, DENOTED IN THE DRAWING BY STIPPLING DOTS SHOWING THE DARKEST SHADING WHERE STIPPLING IS MORE DENSE AND LIGHTER SHADING WHERE STIPPLING IS LESS DENSE.

FOR PRE-PACKAGED PRE-COOKED COMBINATIONS OF MEATS WITH VEGETABLES AND SPICES, OR FISH WITH VEGETABLES AND SPICES, OR VEGETABLES AND SPICES, FOR USE IN PREPARING A VARIETY OF RECIPES (U.S. CL. 46).

FIRST USE 9-5-2003; IN COMMERCE 9-5-2003.

ELIZABETH HUGHITT, EXAMINING ATTORNEY

SN 76-565,644. LA MONTSERRATINA C.A., MARACAY, ESTADO ARAGUA, VENEZUELA, FILED 12-17-2003.

SN 76-545,572. TOWNSENDS, INC., WILMINGTON, DE. FILED 9-17-2003.

**RUBY DRAGON**

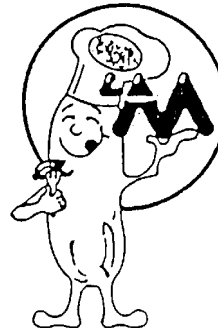

FOR CHICKEN PRODUCTS- NAMELY CHICKEN (U.S. CL. 46).

FIRST USE 6-0-2003; IN COMMERCE 6-0-2003.

KIM SAITO, EXAMINING ATTORNEY

OWNER OF VENEZUELA REG. NO. P-212114, DATED 6-18-1999, EXPIRES 6-18-2009.

FOR SAUSAGES, POULTRY, MEATS AND HAMS, COLD CUTS, PRESERVED MEATS AND MEAT EXTRACTS (U.S. CL. 46).

ESTHER BELENKER, EXAMINING ATTORNEY

**CLASS 29—(Continued).**

SN 76-578,400. NOGRAINS, INC., SHERMAN OAKS, CA.  
FILED 3-1-2004.

# NØGRAINS

NO CLAIM IS MADE TO THE EXCLUSIVE RIGHT TO USE "NO GRAINS", APART FROM THE MARK AS SHOWN.  
FOR HOUSE MARK FOR SNACK FOODS, NAMELY PEPPERONI CHIPS, CHEESE CHIPS AND TOFU CHIPS (U.S. CL. 46).

GINA FINK, EXAMINING ATTORNEY

SN 76-579,490. DENNIS KASPAR, SHINER, TX. FILED 3-5-2004.

# TEXAS PREMIER

THE MARK CONSISTS OF STANDARD CHARACTERS WITHOUT CLAIM TO ANY PARTICULAR FONT, STYLE, SIZE, OR COLOR.

NO CLAIM IS MADE TO THE EXCLUSIVE RIGHT TO USE "TEXAS", APART FROM THE MARK AS SHOWN.

FOR MEATS, THEREFORE NAMELY BEEF, RED MEAT, GAME BIRDS, VENISON, ELK, PORK, POULTRY, LAMB (U.S. CL. 46).

KAREN BRACEY, EXAMINING ATTORNEY

SN 76-580,605. ANDRESEN, CAROL, CHICAGO, IL. FILED 3-11-2004.

# BUFFALO IN HEAT

THE MARK CONSISTS OF STANDARD CHARACTERS WITHOUT CLAIM TO ANY PARTICULAR FONT, STYLE, SIZE, OR COLOR.

NO CLAIM IS MADE TO THE EXCLUSIVE RIGHT TO USE "BUFFALO", APART FROM THE MARK AS SHOWN.

FOR FAST FOOD CHICKEN AND CHICKEN WINGS (U.S. CL. 46).

SEAN DWYER, EXAMINING ATTORNEY

SN 76-586,331. RUGGIERO SEAFOOD, INC., NEWARK, NJ.  
FILED 4-2-2004.

# OCEAN MAJESTY

THE MARK CONSISTS OF STANDARD CHARACTERS WITHOUT CLAIM TO ANY PARTICULAR FONT, STYLE, SIZE, OR COLOR.

NO CLAIM IS MADE TO THE EXCLUSIVE RIGHT TO USE OCEAN, APART FROM THE MARK AS SHOWN.

FOR FISH AND FROZEN FISH (U.S. CL. 46).

FIRST USE 8-15-2003; IN COMMERCE 8-15-2003.

KAREN K. BUSH, EXAMINING ATTORNEY

**CLASS 29—(Continued).**

SN 76-586,387. JOHNSON, LEWIS WALLACE, OROVILLE, CA. FILED 4-8-2004.

# BUTTE VIEW

THE MARK CONSISTS OF STANDARD CHARACTERS WITHOUT CLAIM TO ANY PARTICULAR FONT, STYLE, SIZE, OR COLOR.

FOR FLAVORED AND UNFLAVORED OLIVE OIL (U.S. CL. 46).

FIRST USE 2-17-2000; IN COMMERCE 2-17-2000.

SEAN DWYER, EXAMINING ATTORNEY

SN 76-587,065. INTERSTATE MEAT DIST., INC., CLACKAMAS, OR. FILED 4-16-2004.



NO CLAIM IS MADE TO THE EXCLUSIVE RIGHT TO USE FINEST, APART FROM THE MARK AS SHOWN.

FOR BEEF (U.S. CL. 46).

FIRST USE 3-23-2004; IN COMMERCE 3-23-2004.

AMY HELLA, EXAMINING ATTORNEY

SN 76-588,595. GLANBIA PLC, KILKENNY, IRELAND,  
FILED 4-26-2004.



FOR WHEY PROTEIN CONCENTRATE USED AS A WATER BINDING AGENT IN YOGURT (U.S. CL. 46).

DOUGLAS LEE, EXAMINING ATTORNEY

**CLASS 29—(Continued).**

SN 76-589,742. WEAVER MEATS, PAINESVILLE, OH. FILED 4-30-2004.



FOR MEAT SNACKS; NAMELY, BEEF JERKY AND MEAT SNACK STICKS (U.S. CL. 46).  
SONYA STEPHENS, EXAMINING ATTORNEY

SN 76-592,052. CZINGULA, JOHN, DENVER, CO. FILED 5-13-2004.

**YOGONÉZ**

THE MARK CONSISTS OF STANDARD CHARACTERS WITHOUT CLAIM TO ANY PARTICULAR FONT, STYLE, SIZE, OR COLOR.  
FOR YOGURT AND MAYONNAISE MIX (U.S. CL. 46).  
FIRST USE 5-1-2004; IN COMMERCE 5-1-2004.  
DOMINIC J. FERRAIUOLO, EXAMINING ATTORNEY

SN 76-592,670. WASHINGTON, LENDA P., WASHINGTON, DC. FILED 5-14-2004.

**DR. GEORGE WASHINGTON CARVER**

"DR. GEORGE WASHINGTON CARVER" IS NOT A LIVING INDIVIDUAL.  
FOR CANNED VEGETABLES, PROCESSED LEGUMES, AND PROCESSED SWEET POTATOES (U.S. CL. 46).  
FIRST USE 4-21-1973; IN COMMERCE 4-21-1973.  
PAULA MAYS, EXAMINING ATTORNEY

**CLASS 29—(Continued).**

SN 78-255,967. ARMANDINO'S SALUMI, INC., SEATTLE, WA. FILED 5-29-2003.

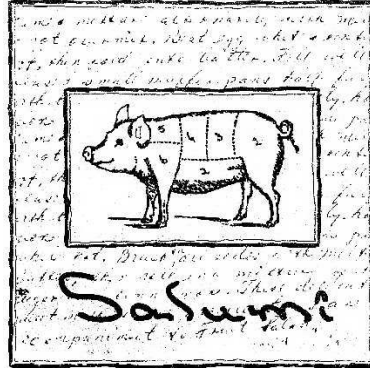

NO CLAIM IS MADE TO THE EXCLUSIVE RIGHT TO USE "SALUMI", APART FROM THE MARK AS SHOWN. THE STIPPLING IS FOR SHADING PURPOSES.  
THE MARK CONSISTS OF A DRAWING OF A PIG IN A BOX INSIDE A LARGER SQUARE BOX WHICH INCLUDES THE WORD SALUMI AND ILLEGIBLE CURSIVE WRITING IN THE BACKGROUND.  
THE FOREIGN WORDING IN THE MARK TRANSLATES INTO ENGLISH AS CURED MEATS.  
FOR MEAT, NAMELY, CURED PORK, BEEF AND LAMB (U.S. CL. 46).  
FIRST USE 4-23-2003; IN COMMERCE 4-23-2003.  
PAULA MAYS, EXAMINING ATTORNEY

SN 78-268,783. MAX-PRO FEEDS LTD., WINNIPEG, MANITOBA, CANADA, FILED 6-30-2003.



NO CLAIM IS MADE TO THE EXCLUSIVE RIGHT TO USE "FARMS", APART FROM THE MARK AS SHOWN.  
FOR FRESH MEAT; FROZEN MEAT; PROCESSED MEAT; AND CURED MEAT (U.S. CL. 46).  
TONJA GASKINS, EXAMINING ATTORNEY

SN 78-290,290. PIERRE FOODS, INC., CINCINNATI, OH. FILED 8-21-2003.

**SMOKIE GRILL**

NO CLAIM IS MADE TO THE EXCLUSIVE RIGHT TO USE "GRILL", APART FROM THE MARK AS SHOWN.  
FOR PROCESSED MEAT PRODUCTS, NAMELY, SHAPED PATTIES AND NUGGETS COMPOSED OF PORK OR BEEF (U.S. CL. 46).  
FIRST USE 7-0-2003; IN COMMERCE 7-0-2003.  
CURTIS FRENCH, EXAMINING ATTORNEY

**CLASS 29—(Continued).**

SN 78-293,372. ALIKI FOODS LLC, OLD LYME, CT. FILED 8-28-2003.

**I LIKE IT**

FOR FROZEN-REFRIGERATED, PACKAGED AND PREPARED ITEMS NAMELY, APPETIZERS, MEALS, MEAL ENTREES, CONSISTING PRIMARILY OF CHEESE, MEAT, SEAFOOD, AND/OR PROCESSED FRUIT (U.S. CL. 46).

PAULA MAYS, EXAMINING ATTORNEY

SN 78-306,561. ARBY'S IP HOLDER TRUST, A DELAWARE BUSINESS TRUST, THE TRUSTEES COMPRISING THE CORPORATE TRUST ADMINISTRATOR, WILMINGTON TRUST COMPANY, A DELAWARE CORPORATION, THE, FT. LAUDERDALE, FL. FILED 9-29-2003.

**BUFFALO DOUBLE DIPPIN'  
FINGERS**

NO CLAIM IS MADE TO THE EXCLUSIVE RIGHT TO USE BUFFALO AND FINGERS, APART FROM THE MARK AS SHOWN.

FOR PREPARED MEALS COMPRISED OF CHICKEN AND SERVED AT A FAST FOOD RESTAURANT (U.S. CL. 46).

FIRST USE 12-0-2001; IN COMMERCE 12-0-2001.  
CHERYL CLAYTON, EXAMINING ATTORNEY

SN 78-307,044. LONG AN FOOD PROCESSING EXPORT JOINT STOCK COMPANY (LAFOOCO), LONG AN PROVINCE, VIETNAM, FILED 9-30-2003.



PRIORITY CLAIMED UNDER SEC. 44(D) ON VIETNAM APPLICATION NO. 4-2003-03851, FILED 5-26-2003, REG. NO. 56467, DATED 8-19-2004, EXPIRES 5-26-2013.

THE COLOR(S) BLUE, RED, YELLOW AND WHITE IS/ARE CLAIMED AS A FEATURE OF THE MARK.

THE MARK CONSISTS OF A BLUE GLOBE, YELLOW MERIDIANS AND PARELLETS OF LATITUDE THEREON, THE RED WORD LAFOOCO IS SITUATED ON THE GLOBE.

FOR AQUATIC AND SEAFOOD PRODUCTS, NAMELY, LOBSTER, CRAB, SHRIMP, CUTTLE FISH, SHELL-FISH, CLAMS, OYSTERS; PROCESSED AGRICULTURE PRODUCTS, NAMELY, CASHEW KERNELS, SALTED CASHEW NUTS, SALTED PEANUTS, CANNED SOY BEANS; PROCESSED FOODS, NAMELY, MEAT, FISH, POULTRY BEAST; MEAT AND FISH EXTRACTS; PRESERVED, DRIED OR COOKED VEGETABLES AND FRUITS; EGGS; MILK AND MILK PRODUCTS, NAMELY CREAM, NOT ICE CREAM, MILK CREAM, BUTTER, CHEESE; YAOURT; VEGETABLE OILS AND FATS (U.S. CL. 46).

INGA ERVIN, EXAMINING ATTORNEY

**CLASS 29—(Continued).**

SN 78-312,693. COMPAGNIE GERVAIS DANONE, LEVAL-LOIS-PERRET, FRANCE, FILED 10-13-2003.

**FRUIX**

OWNER OF FRANCE REG. NO. 13092144, DATED 3-29-2001, EXPIRES 3-29-2011.

FOR YOGURTS; YOGURT-BASED BEVERAGES; MILK-BASED BEVERAGES COMPRISING FRUITS; FERMENTED FLAVORED MILK-BASED BEVERAGE (U.S. CL. 46).

FRED MANDIR, EXAMINING ATTORNEY

SN 78-371,513. N K HURST CO INC, INDIANAPOLIS, IN. FILED 2-20-2004.



THE MARK CONSISTS OF A STYLIZED POT FOR DRIED BEANS (U.S. CL. 46).

ALICE BENMAMAN, EXAMINING ATTORNEY

SN 78-374,331. MARDER TRAWLING INC., NEW BEDFORD, MA. FILED 2-26-2004.

**SIMPLY RIGHT**

THE MARK CONSISTS OF STANDARD CHARACTERS WITHOUT CLAIM TO ANY PARTICULAR FONT, STYLE, SIZE, OR COLOR.

FOR FROZEN FISH AND SEAFOOD (U.S. CL. 46).

KELLEY WELLS, EXAMINING ATTORNEY

**CLASS 29—(Continued).**

SN 78-395,619. KOIPE CORPORACION, S.L., GUIPUZCOA, SPAIN, FILED 4-2-2004.



THE COLOR(S) DARK GREEN, LIGHT GREEN, OLIVE GREEN, RED, BLACK, ORANGE, YELLOW, OCHRE, BROWN, BLUE IS/ARE CLAIMED AS A FEATURE OF THE MARK.

THE WORD FIGARO IN RED AGAINST A YELLOW BACKGROUND WITH A REPRESENTATION OF A MAN IN GREEN AND BLUE BEATING AN OLIVER TREE AND A STOOPING WOMAN IN RED AND GREEN WEARING A BLUE SCARF PICKING UP OLIVES FROM THE GROUND.

FOR OLIVE OIL (U.S. CL. 46).  
FIRST USE 1-4-1960; IN COMMERCE 1-1-1985.  
CHRIS DONINGER, EXAMINING ATTORNEY

**CLASS 29—(Continued).**

SN 78-409,277. DREYER'S GRAND ICE CREAM, INC., OAKLAND, CA. FILED 4-28-2004.



OWNER OF U.S. REG. NOS. 2,324,506 AND 2,578,432.  
FOR MILK AND MILK SUBSTITUTES (U.S. CL. 46).  
KIMBERLY FRYE, EXAMINING ATTORNEY

SN 78-414,557. KRAFT FOODS HOLDINGS, INC., NORTHFIELD, IL. FILED 5-6-2004.

SN 78-409,273. DREYER'S GRAND ICE CREAM, INC., OAKLAND, CA. FILED 4-28-2004.



**CREAMFIT**

OWNER OF U.S. REG. NOS. 2,324,506 AND 2,578,432.  
FOR MILK AND MILK SUBSTITUTES (U.S. CL. 46).  
KIMBERLY FRYE, EXAMINING ATTORNEY

THE MARK CONSISTS OF STANDARD CHARACTERS WITHOUT CLAIM TO ANY PARTICULAR FONT, STYLE, SIZE, OR COLOR.  
FOR DAIRY PRODUCTS, EXCLUDING ICE CREAM, ICE MILK AND FROZEN YOGURT (U.S. CL. 46).  
GENE MACIOL, EXAMINING ATTORNEY



**CLASS 29—(Continued).**

SN 78-418,749. CARGILL MEAT SOLUTIONS CORPORATION, WICHITA, KS. FILED 5-14-2004.

# SAVOR THE DIFFERENCE

THE MARK CONSISTS OF STANDARD CHARACTERS WITHOUT CLAIM TO ANY PARTICULAR FONT, STYLE, SIZE, OR COLOR.  
FOR BEEF, PORK AND TURKEY (U.S. CL. 46).  
MICHAEL HALL, EXAMINING ATTORNEY

SN 78-418,889. SUPREME OIL COMPANY, ENGLEWOOD, NJ. FILED 5-14-2004.

# ROYAL SCARLET

THE MARK CONSISTS OF STANDARD CHARACTERS WITHOUT CLAIM TO ANY PARTICULAR FONT, STYLE, SIZE, OR COLOR.  
FOR SALAD OIL AND PEANUT OIL (U.S. CL. 46).  
FIRST USE 2-8-1991; IN COMMERCE 2-8-1991.  
GEORGE LORENZO, EXAMINING ATTORNEY

SN 78-421,653. J & B WHOLESALE DISTRIBUTING, INC., ST. MICHAEL, MN. FILED 5-19-2004.

# STEAK WAS JUST OUR APPETIZER

THE MARK CONSISTS OF STANDARD CHARACTERS WITHOUT CLAIM TO ANY PARTICULAR FONT, STYLE, SIZE, OR COLOR.  
FOR FISH; POULTRY; BEEF; PORK; HOT DOGS; SAUSAGES; AND BACON (U.S. CL. 46).  
CHERYL CLAYTON, EXAMINING ATTORNEY

**CLASS 29—(Continued).**

SN 78-484,813. WELLS' DAIRY, INC., LE MARS, IA. FILED 9-16-2004.

# RHAPSODY DIP

THE MARK CONSISTS OF STANDARD CHARACTERS WITHOUT CLAIM TO ANY PARTICULAR FONT, STYLE, SIZE, OR COLOR.

NO CLAIM IS MADE TO THE EXCLUSIVE RIGHT TO USE "DIP", APART FROM THE MARK AS SHOWN.  
FOR DIPS (U.S. CL. 46).  
GRETTA YAO, EXAMINING ATTORNEY

SN 79-000,161. LIDL STIFTUNG & CO. KG, D-74167 NECK-ARSULM, FED REP GERMANY, FILED 11-6-2003.



OWNER OF INTERNATIONAL REGISTRATION 0579344 DATED 11-19-1991, EXPIRES 11-19-2011.

OWNER OF U.S. REG. NO. 2,908,528.  
FOR CANNED MEAT AND SAUSAGES; MILK AND DAIRY PRODUCTS NAMELY- BUTTER, CHEESE, FRESH AND SOUR CREAM, YOGURT, POWDERED MILK, SOFT WHITE CHEESES, CURD, KEFIR, PASTEURIZED AND FRESH MILK AND DESSERTS MAKE OF YOGURT, SOFT WHITE CHEESE AND CREAM (U.S. CL. 46).

ESTHER BELENKER, EXAMINING ATTORNEY

**CLASS 30—STAPLE FOODS**

SN 76-163,860. INTERSTATE BAKERIES CORPORATION, KANSAS CITY, MO. FILED 11-13-2000.

# BANANA FLIP

OWNER OF U.S. REG. NOS. 1,553,927 AND 1,610,705.  
NO CLAIM IS MADE TO THE EXCLUSIVE RIGHT TO USE "BANANA", APART FROM THE MARK AS SHOWN.  
FOR SNACK CAKES (U.S. CL. 46).  
FIRST USE 0-0-1941; IN COMMERCE 0-0-1941.  
ZHALEH DELANEY, EXAMINING ATTORNEY

**CLASS 30—(Continued).**

SN 76-222,931. SOCIETE DES PRODUITS NESTLE S.A., 1800 VEVEY, SWITZERLAND, FILED 3-12-2001.

**FRUBETTO**

FOR ICE CREAM, FROZEN ICE CREAM NOVELTIES, AND FROZEN NOVELTIES, NAMELY FROZEN CONFECTIONS (U.S. CL. 46).

SAMUEL E. SHARPER JR., EXAMINING ATTORNEY

SN 76-497,706. COLOSSUS INT'L TRADING(USA), INC., UPLAND, CA. FILED 3-17-2003.



THE COLOR(S) BLUE, NAVY BLUE, INDIGO, FLUORESCENT GREEN AND YELLOW IS/ARE CLAIMED AS A FEATURE OF THE MARK.

THE MARK CONSISTS OF A FLUORESCENT GREEN LEAF WITH YELLOW OUTLINE ENCIRCLED BY AN INDIGO CIRCLE WITH THE BLUE "CIT" LETTERS IN THE CENTER OF THE FLUORESCENT GREEN LEAF. THE BLUE "CIT" LETTERS HAVE NAVY BLUE OUTLINE AND NAVY BLUE SHADOWS OF "CIT".

FOR TEA, HERBAL TEA FOR FOOD PURPOSES, PROCESSED GINGSENG FOR USE AS AN HERB, SPICE OR FLAVORING (U.S. CL. 46).

FIRST USE 8-2-2002; IN COMMERCE 8-2-2002.

CHARLES L. JENKINS, EXAMINING ATTORNEY

**CLASS 30—(Continued).**

SN 76-535,290. BRISCIANI, ROBERTO, 46700, GANDIA, VALENICA, SPAIN, FILED 8-7-2003.



PRIORITY CLAIMED UNDER SEC. 44(D) ON ERPNTY TM OFC APPLICATION NO. 3073723, FILED 2-6-2003, REG. NO. 003073723, DATED 6-7-2004, EXPIRES 2-6-2013.

NO CLAIM IS MADE TO THE EXCLUSIVE RIGHT TO USE FOOD, APART FROM THE MARK AS SHOWN.

THE DESIGN PORTION OF THE MARK CONSISTS OF A HOOK OR A BRACELET.

FOR FLOUR AND PREPARATIONS MADE FROM CEREALS, BREAD, PASTRY AND CONFECTIONERY; YEAST; BAKING POWDER; SAUCES; SPICES; FROZEN PREPARATIONS MADE FROM FLOUR OR CEREALS FOR BAKED PRODUCTS, BREAD, PASTRY AND CONFECTIONERY; FROZEN PRE-COOKED ENTREES MADE FROM FLOUR OR CEREALS AND CONSISTING PRIMARILY OF MEAT, FISH, POULTRY, GAME, LEGUMES, VEGETABLES, POTATO OR RICE (U.S. CL. 46).

CATHERINE FAINT, EXAMINING ATTORNEY

SN 76-536,336. PRAIRIE FARMS DAIRY, INC., CARLINVILLE, IL. FILED 8-11-2003.

*Sweet  
Wise*

NO CLAIM IS MADE TO THE EXCLUSIVE RIGHT TO USE SWEET, APART FROM THE MARK AS SHOWN.

FOR FROZEN CONFECTIONS (U.S. CL. 46).

CAROLINE WEIMER, EXAMINING ATTORNEY

**CLASS 30—(Continued).**

SN 76-550,865. BAY AREA COFFEE, INC., SUISUN, CA. FILED 10-14-2003.



OWNER OF U.S. REG. NO. 2,119,975.  
NO CLAIM IS MADE TO THE EXCLUSIVE RIGHT TO USE "GOURMET COFFEE", APART FROM THE MARK AS SHOWN.

THE MARK CONSISTS OF THE WORDS "BOONDOCK BAY GOURMET COFFEE" OVER A BACKGROUND SHOWING SOME SKY, A BODY OF WATER, A BRIDGE WITH A TRIANGLE WITH A LEAFED FLOWER SUPERIMPOSED OVER IT, A SHIP, AND A DOCK ON WHICH A NUMBER OF LARGE BAGS LABELED "COFFEE" ARE PILED, WITH A PERSON LIFTING ONE OF THOSE BAGS.

FOR COFFEE (U.S. CL. 46).  
FIRST USE 4-3-2003; IN COMMERCE 4-3-2003.  
HEATHER THOMPSON, EXAMINING ATTORNEY

**CLASS 30—(Continued).**

SN 76-554,455. ANN'S NUT & FRUIT CAKE, INC., ORLANDO, FL. FILED 10-27-2003.



NO CLAIM IS MADE TO THE EXCLUSIVE RIGHT TO USE "INC." OR "CARROT RAISIN COOKIES", APART FROM THE MARK AS SHOWN.  
THE COLOR(S) LIGHT GRAY IS/ARE CLAIMED AS A FEATURE OF THE MARK.

THE COLOR GRAY IS A FEATURE OF THE MARK. THE COLOR GRAY APPEARS ON THE COOKIE DRAWING PORTION OF THE MARK, LIGHTER GRAY PORTIONS REPRESENTING THE COOKIE AND THE DARKER GRAY PORTIONS REPRESENTING THE RAISINS ON THE COOKIES.

THE MARK CONSISTS OF THE APPLICANT'S NAME, "ANN'S NUT & FRUIT CAKE, INC." AND WORDS "GLADYS TREAT," "CARROT RAISEN COOKIES," AND "TASTE THE DREAM," ALONG WITH A PICTURE OF AN ANIMATED SMILING ORANGE CARROT WITH A GREEN LEAF AND A BROWN COOKIE WITH DARK BROWN SPOTS WITH ONE BITE MARK.

FOR COOKIES (U.S. CL. 46).  
MICHAEL WEBSTER, EXAMINING ATTORNEY

SN 76-555,927. K. BOWMAN & ASSOCIATES LLC, TACOMA, WA. FILED 11-3-2003.

**BEDDA-BELLA!**

FOR PACKAGED COOKIE CRUMBS; PACKAGED FLAVORED SUGARS (U.S. CL. 46).  
CHERYL STEPLIGHT, EXAMINING ATTORNEY

**CLASS 30—(Continued).**

SN 76-559,371. FOOD TALK, INC., ROGERS, AR. FILED 11-13-2003.

**NORMA BEA'S KITCHEN**

OWNER OF U.S. REG. NO. 2,356,309.  
"NORMA BEA" REFERS TO NORMA BEATRICE YOUNG, A/K/A NORMA BEA YOUNG, WHOSE CONSENT IS SUBMITTED HEREWITH.

FOR FROZEN BREAKFAST SANDWICHES, FROZEN MICROWAVEABLE BISCUITS, FROZEN MICROWAVEABLE BISCUITS WITH GRAVY, FROZEN MICROWAVEABLE CINNAMON ROLLS (U.S. CL. 46).  
JOHN HWANG, EXAMINING ATTORNEY

---

SN 76-563,050. ROBERT CONSULTING GROUP LTD., INWOOD, NY. FILED 12-3-2003.

**MODUS MINTS**

THE MARK CONSISTS OF STANDARD CHARACTERS WITHOUT CLAIM TO ANY PARTICULAR FONT, STYLE, SIZE, OR COLOR.

NO CLAIM IS MADE TO THE EXCLUSIVE RIGHT TO USE MINTS, APART FROM THE MARK AS SHOWN.

FOR CANDY, NAMELY, BREATH MINTS AND CANDY MINTS (U.S. CL. 46).

TARAH HARDY, EXAMINING ATTORNEY

---

SN 76-563,930. SUNNY BROOK FARMS, INC., HEBRON, KY. FILED 12-5-2003.

**SUNNY BROOK FARMS, INC.**

THE MARK CONSISTS OF STANDARD CHARACTERS WITHOUT CLAIM TO ANY PARTICULAR FONT, STYLE, SIZE, OR COLOR.

NO CLAIM IS MADE TO THE EXCLUSIVE RIGHT TO USE FARMS, INC., APART FROM THE MARK AS SHOWN. FOR HOT SAUCES, MUSTARD, KETCHUP, SPICES (U.S. CL. 46).

FIRST USE 6-10-2002; IN COMMERCE 6-10-2002.  
ELISSA GARBER KON, EXAMINING ATTORNEY

**CLASS 30—(Continued).**

SN 76-574,031. JOHN & RHONDA MCKINNON PARTNERSHIP, THE, UPLAND, CA. FILED 1-22-2004.



THE LINING IS A FEATURE OF THE MARK AND DOES NOT INDICATE COLOR.

FOR GOURMET COOKIES (U.S. CL. 46).  
RON FAIRBANKS, EXAMINING ATTORNEY

---

SN 76-586,000. THEODORA'S TEA, INC., SUMMIT, NJ. FILED 4-9-2004.

**THEODORA'S TEA**

THE MARK CONSISTS OF STANDARD CHARACTERS WITHOUT CLAIM TO ANY PARTICULAR FONT, STYLE, SIZE, OR COLOR.

NO CLAIM IS MADE TO THE EXCLUSIVE RIGHT TO USE "TEA", APART FROM THE MARK AS SHOWN.

FOR TEA, ICED TEA, TEA BASED BEVERAGES, TEA BASED BEVERAGES WITH FRUIT FLAVORING, BOTTLED ICED TEA AND ICED TEA IN CANS (U.S. CL. 46).

CHARLES L. JENKINS, EXAMINING ATTORNEY

---

SN 76-590,712. TRIAD GROUP, LLC, DALLAS, TX. FILED 5-6-2004.

**TASTE OF FAITH**

THE MARK CONSISTS OF STANDARD CHARACTERS WITHOUT CLAIM TO ANY PARTICULAR FONT, STYLE, SIZE, OR COLOR.

FOR COOKIES (U.S. CL. 46).  
TANYA AMOS, EXAMINING ATTORNEY

**CLASS 30—(Continued).**

SN 76-591,128. G. T. JAPAN, INC., IRVINE, CA. FILED 5-10-2004.



OWNER OF U.S. REG. NOS. 2,011,681 AND 2,021,824.  
THE INDIVIDUAL SOUND IN THE FOREIGN WORDING IN THE MARK TRANSLATES INTO ENGLISH AS "FRONT FIELD GARDEN".  
FOR (BASED ON INTENT TO USE) ICE CREAM; (BASED ON USE IN COMMERCE) TEA (U.S. CL. 46).  
FIRST USE 4-14-2004; IN COMMERCE 4-14-2004.  
TRICIA SONNEBORN, EXAMINING ATTORNEY

SN 76-591,802. KRAVE'S FINE FOODS INC., WINNIPEG, MANITOBA R2J 3T1, CANADA, FILED 5-12-2004.

**CLODHOPPER-MANIAC**

THE MARK CONSISTS OF STANDARD CHARACTERS WITHOUT CLAIM TO ANY PARTICULAR FONT, STYLE, SIZE, OR COLOR.

OWNER OF U.S. REG. NO. 2,124,819.  
FOR CONFECTIONERY PRODUCTS, NAMELY, CANDIES; PREPACKAGED HARD FROZEN ICE CREAM AND HARD FROZEN YOGURT; PRE-PACKAGED HARD FROZEN ICE CREAM AND HARD FROZEN YOGURT NOVELTY PRODUCTS (U.S. CL. 46).  
PAM WILLIS, EXAMINING ATTORNEY

SN 78-270,672. GAUGHEN HOLDINGS LLC, OXNARD, CA. FILED 7-4-2003.

**GH BRANDS CALIFORNIA ALMOND BAR**

OWNER OF U.S. REG. NO. 2,786,536.  
NO CLAIM IS MADE TO THE EXCLUSIVE RIGHT TO USE "BRANDS" AND "CALIFORNIA ALMOND BAR", APART FROM THE MARK AS SHOWN.  
FOR CONFECTIONERY MADE IN WHOLE OR PART OF CALIFORNIA ALMONDS; NAMELY CHOCOLATE AND NOUGAT MADE WITH OR WITHOUT INCLUSION SUCH AS FRUIT OR FLAVORINGS (U.S. CL. 46).  
FIRST USE 6-21-2003; IN COMMERCE 6-21-2003.  
ROBERT C. CLARK JR., EXAMINING ATTORNEY

**CLASS 30—(Continued).**

SN 78-273,420. YUNNAN TEA IMPORT & EXPORT COMPANY, KAOHSIUNG, TAIWAN, R.O.C., TAIWAN, FILED 7-11-2003.



THE NON-LATIN CHARACTERS IN THE MARK TRANSLITERATE TO "EIGHT CENTRAL TEAHOUSE" IN ENGLISH AND TRANSLATE TO "TRADITIONAL TASTES FROM ANCIENT MIDDLE LAND".

FOR DRIED TEA LEAFS FOR MAKING BEVERAGES (U.S. CL. 46).  
IRENE D. WILLIAMS, EXAMINING ATTORNEY

SN 78-278,201. KOON CHUN HING KEE SOY & SAUCE FACTORY LIMITED, 19-25 MERCER STREET, HONG KONG, FILED 7-24-2003.



OWNER OF U.S. REG. NO. 1,410,790.

NO CLAIM IS MADE TO THE EXCLUSIVE RIGHT TO USE "HOISIN SAUCE, SAUCE, JEUNG AND HOI SIN JEUNG", APART FROM THE MARK AS SHOWN.

THE MARK CONSISTS OF A LABEL BORDERED IN GREEN WITH YELLOW THREADS. THE COLORING INSIDE THE LABEL PROGRESSES FROM BOTTOM TO TOP FROM WHITE TO YELLOW. THE TOP OF THE LABEL CONTAINS A FOUR SIDED GEOMETRIC DESIGN IN BLUE. THE WORDS KOON CHUN AND THE CHINESE CHARACTERS WITHIN THIS DESIGN ARE IN ORANGE ON A YELLOW BACKGROUND. THE CHINESE CHARACTERS AS WELL AS THE WORDS HOISIN SAUCE IN THE MIDDLE OF THE LABEL ARE RED. THE WORD SAUCE IS WITHIN AN GREEN OVAL DEVICE. THE REPRESENTATION OF THE SOY BEANS IS YELLOW.

THE WORDS AT THE TOP OF THE MARK TRANSLATE TO "CORONET, TO EXCEL, TO TOP THE REST", "RARE VALUABLES, TREASURE", "SAUCE", AND "FACTORY", RESPECTIVELY. THE WORDS IN THE MIDDLE OF THE MARK WHEN READ TOGETHER MEAN "HOISIN SAUCE".

THE CHINESE CHARACTERS AT THE TOP OF THE MARK TRANSLITERATE TO KOON CHUN JEUNG YUEN. THE CHINESE CHARACTERS IN THE MIDDLE OF THE MARK TRANSLITERATE TO HOI SIN JEUNG.

FOR CHINESE COOKING AND SEASONING SAUCES (U.S. CL. 46).  
FIRST USE 5-1-2003; IN COMMERCE 5-1-2003.  
KATHLEEN M. VANSTON, EXAMINING ATTORNEY

**CLASS 30—(Continued).**

SN 78-278,212. KOON CHUN HING KEE SOY & SAUCE FACTORY LIMITED, 19-25 MERCER STREET, HONG KONG, FILED 7-24-2003.



OWNER OF U.S. REG. NO. 1,410,790.  
NO CLAIM IS MADE TO THE EXCLUSIVE RIGHT TO USE "CHILI SAUCE", SAUCE, JEUNG AND LAAT JIU JEUNG, APART FROM THE MARK AS SHOWN.

THE MARK CONSISTS OF A LABEL BORDERED IN ORANGE WITH YELLOW THREADS. THE COLORING INSIDE THE LABEL PROGRESSES FROM BOTTOM TO TOP FROM WHITE TO YELLOW. THE TOP OF THE LABEL CONTAINS A FOUR SIDED GEOMETRIC DESIGN IN BLUE. THE WORDS KOON CHUN AND THE CHINESE CHARACTERS WITHIN THIS DESIGN ARE IN ORANGE ON A YELLOW BACKGROUND. THE CHINESE CHARACTERS AS WELL AS THE WORDS CHILI SAUCE IN THE MIDDLE OF THE LABEL ARE RED. THE WORD SAUCE IS WITHIN AN ORANGE OVAL DEVICE. THE REPRESENTATION OF THE PEPPERS IS YELLOW.

THE CHINESE CHARACTERS AT THE TOP OF THE MARK transliterate to KOON CHUN JEUNG YUEN, WHICH TRANSLATE TO "CORONET, TO EXCEL, TO TOP THE REST"; "RARE VALUABLES, TREASURE"; "SAUCE"; AND "FACTORY", RESPECTIVELY.

THE CHINESE CHARACTERS IN THE MIDDLE OF THE MARK transliterate to LAAT JIU JEUNG, WHICH WHEN READ TOGETHER MEAN "CHILI SAUCE".

FOR CHINESE COOKING AND SEASONING SAUCES (U.S. CL. 46).

FIRST USE 5-1-2003; IN COMMERCE 5-1-2003.  
KATHLEEN M. VANSTON, EXAMINING ATTORNEY

**CLASS 30—(Continued).**

SN 78-322,977. HEALTHY HANDFULS, LLC, SAN FRANCISCO, CA. FILED 11-4-2003.

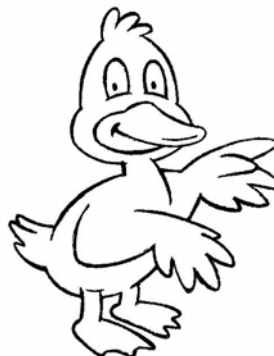

THE MARK CONSISTS OF A STYLIZED DUCK. FOR BAKERY GOODS; COOKIES; CRACKERS; PRETZELS (U.S. CL. 46).

CAROLINE WOOD, EXAMINING ATTORNEY

SN 78-323,335. KELSENBISCA A/S, NORRE-SNEDE, DENMARK, FILED 11-5-2003.



OWNER OF U.S. REG. NOS. 1,259,572 AND 2,547,539.  
NO CLAIM IS MADE TO THE EXCLUSIVE RIGHT TO USE "DANSK" AND "DANISH BUTTER COOKIES", APART FROM THE MARK AS SHOWN.

THE STIPPLING IN THE MARK IS NOT A FEATURE OF THE MARK BUT IS INTENDED TO INDICATE SHADING AND COLOR.

THE MARK CONSISTS OF THE WORDS ROYAL DANSK ABOVE THE WORDS DANISH BUTTER COOKIES WHICH APPEAR IN THE MIDDLE OF A CIRCLE. DIFFERENT COOKIES MADE BY APPLICANT APPEAR BELOW THE WORDS AND A COUNTRY HOME AND TREES APPEAR ABOVE THE WORDS.

THE FOREIGN WORDING IN THE MARK TRANSLATES INTO ENGLISH AS DANISH.

FOR BAKERY GOODS, NAMELY BUTTER COOKIES (U.S. CL. 46).

FIRST USE 0-0-1980; IN COMMERCE 0-0-1980.  
SEAN DWYER, EXAMINING ATTORNEY

SN 78-298,128. ACECOOK VIETNAM COMPANY LIMITED, HO CHI MINH CITY, VIETNAM, FILED 9-9-2003.

**KINGCOOK**

FOR INSTANT NOODLES (U.S. CL. 46).  
FIRST USE 3-0-2004; IN COMMERCE 3-0-2004.  
REBECCA GILBERT, EXAMINING ATTORNEY

**CLASS 30—(Continued).**

SN 78-348,112. PIZZA HUT, INC., DALLAS, TX. FILED 1-6-2004.

**CLASS 30—(Continued).**

SN 78-367,032. DANIEL COHEN, ITHACA, NY. FILED 2-12-2004.

**44ALL**

**Salt Works**

THE MARK CONSISTS OF STANDARD CHARACTERS WITHOUT CLAIM TO ANY PARTICULAR FONT, STYLE, SIZE, OR COLOR.

OWNER OF U.S. REG. NOS. 2,844,044 AND 2,844,054.  
FOR PIZZA; PIZZA PIE CRUSTS; PIZZA SAUCES;  
PIZZA DOUGH (U.S. CL. 46).  
JULIE WATSON, EXAMINING ATTORNEY

THE MARK CONSISTS OF STANDARD CHARACTERS WITHOUT CLAIM TO ANY PARTICULAR FONT, STYLE, SIZE, OR COLOR.

NO CLAIM IS MADE TO THE EXCLUSIVE RIGHT TO USE "SALT", APART FROM THE MARK AS SHOWN.  
FOR SALT USED FOR FOOD (U.S. CL. 46).  
FIRST USE 1-1-1999; IN COMMERCE 1-1-1999.  
SOPHIA S. KIM, EXAMINING ATTORNEY

SN 78-363,981. STAR KAY WHITE, INC., CONGERS, NY.  
FILED 2-6-2004.

SN 78-369,215. GINGERBREAD CONSTRUCTION CO., INC.,  
WAKEFIELD, MA. FILED 2-17-2004.

**GRAHAM CENTRAL  
STATION**



THE MARK CONSISTS OF STANDARD CHARACTERS WITHOUT CLAIM TO ANY PARTICULAR FONT, STYLE, SIZE, OR COLOR.

FOR ICE CREAM, FROZEN CONFECTIONS; FLAVORING SYRUPS, FOOD FLAVORINGS NOT MADE OF ESSENTIAL OILS, FOOD ADDITIVES FOR NON-NUTRITIONAL PURPOSES FOR USE AS A FLAVORING, INGREDIENT OR FILLER (U.S. CL. 46).  
THEODORE MCBRIDE, EXAMINING ATTORNEY

NO CLAIM IS MADE TO THE EXCLUSIVE RIGHT TO USE "GINGERBREAD" OR "CO", APART FROM THE MARK AS SHOWN.

FOR GINGERBREAD HOUSES, COOKIES AND MUFFINS (U.S. CL. 46).  
FIRST USE 3-1-1995; IN COMMERCE 3-1-1995.  
ELLEN PERKINS, EXAMINING ATTORNEY

**CLASS 30—(Continued).**

SN 78-369,385. NAPCO, INC., BATAVIA, IL. FILED 2-17-2004.

**PAPA PODS**

THE MARK CONSISTS OF STANDARD CHARACTERS WITHOUT CLAIM TO ANY PARTICULAR FONT, STYLE, SIZE, OR COLOR.

OWNER OF U.S. REG. NO. 2,763,216.  
NO CLAIM IS MADE TO THE EXCLUSIVE RIGHT TO USE "PODS", APART FROM THE MARK AS SHOWN.

FOR COFFEE AND PRE-PACKAGED COFFEE PODS (U.S. CL. 46).

WENDY GOODMAN, EXAMINING ATTORNEY

---

SN 78-370,607. COMPASS GROUP USA, INC., CHARLOTTE, NC. FILED 2-19-2004.

**LAKE STREET BLEND**

THE MARK CONSISTS OF STANDARD CHARACTERS WITHOUT CLAIM TO ANY PARTICULAR FONT, STYLE, SIZE, OR COLOR.

NO CLAIM IS MADE TO THE EXCLUSIVE RIGHT TO USE "BLEND", APART FROM THE MARK AS SHOWN.  
FOR COFFEE (U.S. CL. 46).

THEODORE MCBRIDE, EXAMINING ATTORNEY

---

SN 78-389,014. CAFE BELMONDO, LLC, TAMPA, FL. FILED 3-23-2004.

**CAFE ZANZIBAR**

THE MARK CONSISTS OF STANDARD CHARACTERS WITHOUT CLAIM TO ANY PARTICULAR FONT, STYLE, SIZE, OR COLOR.

NO CLAIM IS MADE TO THE EXCLUSIVE RIGHT TO USE "CAFE", APART FROM THE MARK AS SHOWN.

THE FOREIGN WORDING IN THE MARK TRANSLATES INTO ENGLISH AS COFFEE.

FOR COFFEE (U.S. CL. 46).

ANDREA K. NADELMAN, EXAMINING ATTORNEY

**CLASS 30—(Continued).**

SN 78-392,955. CLINIQUE LABORATORIES, INC., NEW YORK, NY. FILED 3-30-2004.

**MAKEOVER MINTS**

THE MARK CONSISTS OF STANDARD CHARACTERS WITHOUT CLAIM TO ANY PARTICULAR FONT, STYLE, SIZE, OR COLOR.

NO CLAIM IS MADE TO THE EXCLUSIVE RIGHT TO USE "MINTS", APART FROM THE MARK AS SHOWN.

FOR MINT CANDY (U.S. CL. 46).

GRETTA YAO, EXAMINING ATTORNEY

---

SN 78-393,329. DYNAMIC COMMODITIES (PTY) LIMITED, PORT ELIZABETH, SOUTH AFRICA, FILED 3-30-2004.

**CREAMBERRY**

THE MARK CONSISTS OF STANDARD CHARACTERS WITHOUT CLAIM TO ANY PARTICULAR FONT, STYLE, SIZE, OR COLOR.

FOR FROZEN CONFECTIONS AND PASTRIES, NAMELY SORBETS, ICE CREAM, AND FRUIT SHELLS WITH SORBET OR ICE CREAM FILLINGS (U.S. CL. 46).

DAVID MURRAY, EXAMINING ATTORNEY

---

SN 78-394,081. U.S. MILLS, INC., NEEDHAM, MA. FILED 3-31-2004.

**UNCLE SAM**

THE MARK CONSISTS OF STANDARD CHARACTERS WITHOUT CLAIM TO ANY PARTICULAR FONT, STYLE, SIZE, OR COLOR.

FOR CEREAL BARS (U.S. CL. 46).

RICHARD WHITE, EXAMINING ATTORNEY



**CLASS 30—(Continued).**

SN 78-394,184. BETTER RESULTS INC., NORTH EAST, PA. FILED 3-31-2004.

**CLASS 30—(Continued).**

SN 78-399,268. AQUABREW, INC., SANTA ANA, CA. FILED 4-9-2004.

Cinn A Licious

Caféjo

THE MARK CONSISTS OF STANDARD CHARACTERS WITHOUT CLAIM TO ANY PARTICULAR FONT, STYLE, SIZE, OR COLOR.

FOR BAKERY SWEET GOODS (U.S. CL. 46).  
DAVID MURRAY, EXAMINING ATTORNEY

THE MARK CONSISTS OF STANDARD CHARACTERS WITHOUT CLAIM TO ANY PARTICULAR FONT, STYLE, SIZE, OR COLOR.

FOR COMMERCIAL SINGLE CUP COFFEE POD BREWING SYSTEM (U.S. CL. 46).  
C. DIONNE CLYBURN, EXAMINING ATTORNEY

SN 78-394,332. MONDE M.Y. SAN CORPORATION, CAINTA RIZAL, PHILIPPINES, FILED 3-31-2004.

SN 78-400,286. S&S BRANDS, INC., WILMINGTON, DE. FILED 4-12-2004.



YOU'LL BE COOKIN'  
UP A GOOD TIME IN  
NO TIME!

NO CLAIM IS MADE TO THE EXCLUSIVE RIGHT TO USE "CRACKERS", APART FROM THE MARK AS SHOWN. THE COLOR(S) BLUE AND RED IS/ARE CLAIMED AS A FEATURE OF THE MARK.

THE MARK CONSISTS OF A HORIZONTALLY ORIENTED OVAL WITH FLATTENED AND PARALLEL TOP AND BOTTOM SURFACES; THE UPPER HALF OF THE OVAL FORMS A BLUE BACKGROUND FOR THE WHITE STYLIZED LETTERING OF THE WORDING "M.Y. SAN SKYFLAKES"; THE BOTTOM HALF OF THE OVAL CONSISTS OF VERTICAL RED STRIPES ALTERNATING WITH WHITE STRIPES FORMING A BACKGROUND FOR A SMALLER HORIZONTAL WHITE OVAL PRESENTING THE RED AND MODESTLY STYLIZED LETTERING OF THE WORD "CRACKERS".

FOR CRACKERS, COOKIES AND WAFERS (U.S. CL. 46).  
FIRST USE 1-1-1970; IN COMMERCE 2-5-1975.  
STEVEN JACKSON, EXAMINING ATTORNEY

THE MARK CONSISTS OF STANDARD CHARACTERS WITHOUT CLAIM TO ANY PARTICULAR FONT, STYLE, SIZE, OR COLOR.

FOR FROZEN APPETIZERS CONSISTING PRIMARILY OF BREAD, PASTA OR RICE (U.S. CL. 46).  
JOHN GARTNER, EXAMINING ATTORNEY

**CLASS 30—(Continued).**

SN 78-401,314. TWENTIETH CENTURY FOX FILM CORPORATION, LOS ANGELES, CA. FILED 4-13-2004.



FOR CANDY; CANDY CAKE DECORATIONS; CANDY AND A DISPENSING CONTAINER THEREFOR SOLD AS A UNIT; CAKES; BREAKFAST CEREALS; BISCUITS; BUBBLE GUM AND CHEWING GUM (U.S. CL. 46).  
STEVEN R. FOSTER, EXAMINING ATTORNEY

SN 78-404,131. NUTRASWEET PROPERTY HOLDINGS, INC., CHICAGO, IL. FILED 4-19-2004.

## SUGAR2

THE MARK CONSISTS OF STANDARD CHARACTERS WITHOUT CLAIM TO ANY PARTICULAR FONT, STYLE, SIZE, OR COLOR.  
FOR SUGAR SUBSTITUTES, NAMELY, COMBINATIONS OF NATURAL AND ARTIFICIAL SWEETENERS (U.S. CL. 46).  
GEORGIA CARTY, EXAMINING ATTORNEY

**CLASS 30—(Continued).**

SN 78-404,139. NUTRASWEET PROPERTY HOLDINGS, INC., CHICAGO, IL. FILED 4-19-2004.

## SUGARII

THE MARK CONSISTS OF STANDARD CHARACTERS WITHOUT CLAIM TO ANY PARTICULAR FONT, STYLE, SIZE, OR COLOR.

FOR SUGAR SUBSTITUTES, NAMELY, COMBINATIONS OF NATURAL AND ARTIFICIAL SWEETENERS (U.S. CL. 46).

GEORGIA CARTY, EXAMINING ATTORNEY

SN 78-412,744. A HERD OF LAUGHTER ICE CREAM COMPANY, LLC, SPRINGFIELD, OR. FILED 5-4-2004.

## BUTTERKNUCKLE

THE MARK CONSISTS OF STANDARD CHARACTERS WITHOUT CLAIM TO ANY PARTICULAR FONT, STYLE, SIZE, OR COLOR.

FOR ICE CREAM AND FROZEN CONFECTIONS (U.S. CL. 46).

KELLY CHOE, EXAMINING ATTORNEY

SN 78-416,525. KABUSHIKI KAISHA FUKUJUN, DBA FUKUJUN COMPANY LIMITED, SORAKU-GUN KYO-TU-FU, JAPAN, FILED 5-11-2004.

## 伊右衛門

THE MARK CONSISTS OF JAPANESE KANJI CHARACTERS.

THE NON-LATIN CHARACTERS IN THE MARK TRANSLITERATE TO "IEMON", WHICH HAS NO MEANING IN ENGLISH. IT IS THE GIVEN NAME OF THE APPLICANT'S FOUNDER.

FOR TEA (U.S. CL. 46).

MARCIE MILONE, EXAMINING ATTORNEY

**CLASS 30—(Continued).**

SN 78-416,869. TODD'S SNAX, INC., DBA SHULTZ FOODS COMPANY, HANOVER, PA. FILED 5-11-2004.

**CLASS 30—(Continued).**

SN 78-456,863. WELLS' DAIRY, INC., LE MARS, IA. FILED 7-26-2004.

**SHULTZ**

THE MARK CONSISTS OF STANDARD CHARACTERS WITHOUT CLAIM TO ANY PARTICULAR FONT, STYLE, SIZE, OR COLOR.

NO CLAIM IS MADE TO THE EXCLUSIVE RIGHT TO USE "FUDGE", APART FROM THE MARK AS SHOWN.

FOR FROZEN CONFECTION NOVELTY ON A STICK (U.S. CL. 46).

GRETTA YAO, EXAMINING ATTORNEY

THE MARK CONSISTS OF STANDARD CHARACTERS WITHOUT CLAIM TO ANY PARTICULAR FONT, STYLE, SIZE, OR COLOR.

SEC. 2(F).

FOR SNACK FOODS, NAMELY PRETZELS (U.S. CL. 46).

FIRST USE 12-31-1965; IN COMMERCE 12-31-1965.

ANGELA M. MICHELI, EXAMINING ATTORNEY

SN 78-484,845. WELLS' DAIRY, INC., LE MARS, IA. FILED 9-16-2004.

**ULTIMATE REWARDS**

THE MARK CONSISTS OF STANDARD CHARACTERS WITHOUT CLAIM TO ANY PARTICULAR FONT, STYLE, SIZE, OR COLOR.

FOR FROZEN CONFECTIONS (U.S. CL. 46).

GRETTA YAO, EXAMINING ATTORNEY

SN 78-418,027. A&G FINE FOODS, LLC, SAUSALITO, CA. FILED 5-13-2004.



FOR SAUCES (U.S. CL. 46).  
STEPHANIE DAVIS, EXAMINING ATTORNEY

SN 78-494,514. BARONET COFFEE, INC., HARTFORD, CT. FILED 10-5-2004.

**One Cup, Why Not  
Make It Two?**

THE MARK CONSISTS OF STANDARD CHARACTERS WITHOUT CLAIM TO ANY PARTICULAR FONT, STYLE, SIZE, OR COLOR.

FOR COFFEE (U.S. CL. 46).

EVELYN BRADLEY, EXAMINING ATTORNEY

**CLASS 30—(Continued).**

SN 79-001,931. INTERCOOKIES GEBÄCK-; UND KUCHEN-SPEZIALITÄTEN GMBH, FED REP GERMANY, FILED 3-9-2004.

# CREAMERO

THE MARK CONSISTS OF STANDARD CHARACTERS WITHOUT CLAIM TO ANY PARTICULAR FONT, STYLE, SIZE, OR COLOR.

PRIORITY DATE OF 11-24-2003 IS CLAIMED.  
OWNER OF INTERNATIONAL REGISTRATION 0822493 DATED 3-9-2004, EXPIRES 3-9-2014.  
FOR CHOCOLATE, BARS OF CHOCOLATE, PASTRIES, BISCUITS, BAKERY GOODS, FANCY BISCUITS, CAKE, WAFFLES (U.S. CL. 46).  
PRISCILLA MILTON, EXAMINING ATTORNEY

**CLASS 31—NATURAL AGRICULTURAL PRODUCTS**

SN 76-585,257. TURF-SEED, INC., HUBBARD, OR. FILED 4-6-2004.

# SLT

THE MARK CONSISTS OF STANDARD CHARACTERS WITHOUT CLAIM TO ANY PARTICULAR FONT, STYLE, SIZE, OR COLOR.

FOR GRASS SEED (U.S. CLS. 1 AND 46).  
FIRST USE 8-22-2001; IN COMMERCE 8-22-2001.  
STEVEN JACKSON, EXAMINING ATTORNEY

SN 76-590,380. PENNINGTON SEED, INC. OF NEBRASKA, MADISON, GA. FILED 5-4-2004.

# WINGMASTER

THE MARK CONSISTS OF STANDARD CHARACTERS WITHOUT CLAIM TO ANY PARTICULAR FONT, STYLE, SIZE, OR COLOR.

FOR SEEDS FOR GROWING PLANTS IN THE WILD THAT PROVIDE SUPPLEMENTAL FOOD SOURCES FOR GAME (U.S. CLS. 1 AND 46).  
FIRST USE 4-7-2004; IN COMMERCE 4-7-2004.  
SUE LAWRENCE, EXAMINING ATTORNEY

**CLASS 31—(Continued).**

SN 76-590,944. CORNELL RESEARCH FOUNDATION, INC., ITHACA, NY. FILED 5-7-2004.

# Blackyork

THE MARK CONSISTS OF STANDARD CHARACTERS WITHOUT CLAIM TO ANY PARTICULAR FONT, STYLE, SIZE, OR COLOR.

FOR LIVE CHERRY TREES (U.S. CLS. 1 AND 46).  
FIRST USE 4-30-2003; IN COMMERCE 4-30-2003.  
CHRISTOPHER BUONGIORNO, EXAMINING ATTORNEY

SN 76-591,645. PROCACCI BROTHERS SALES CORP., PHILADELPHIA, PA. FILED 5-11-2004.

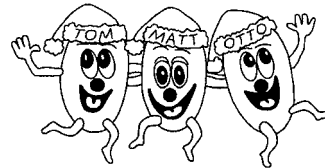

FOR FRESH TOMATOES (U.S. CLS. 1 AND 46).  
FIRST USE 7-26-2002; IN COMMERCE 7-26-2002.  
BILL DAWE, EXAMINING ATTORNEY

SN 78-246,701. MARTINDALE, CHRISTINE, MIAMI, FL. FILED 5-7-2003.



NO CLAIM IS MADE TO THE EXCLUSIVE RIGHT TO USE "ROSA", APART FROM THE MARK AS SHOWN.  
APPLICANT SUBMITS THAT ENGLISH TRANSLATION OF "ROSA VOLANTE" IS "FLYING ROSE."  
FOR CUT FLOWERS (U.S. CLS. 1 AND 46).  
JOSETTE BEVERLY, EXAMINING ATTORNEY

**CLASS 31—(Continued).**

SN 78-263,576. OMS INVESTMENTS, INC., SANTA MONICA, CA. FILED 6-17-2003.

**CLASS 31—(Continued).**

SN 78-385,333. JOHN BODGER & SONS COMPANY, SOUTH EL MONTE, CA. FILED 3-16-2004.

**LAWN BUILDER**

OWNER OF U.S. REG. NOS. 1,574,096 AND 2,636,529.  
NO CLAIM IS MADE TO THE EXCLUSIVE RIGHT TO USE "LAWN", APART FROM THE MARK AS SHOWN.  
FOR AGRICULTURAL, HORTICULTURAL AND FORESTRY PRODUCTS, NAMELY MULCH AND CHIPPED AND COMPOSTED BARK FOR USE AS A MULCH, AND SEEDS, SEEDLINGS AND LIVE FLOWERING PLANTS AND SHRUBS, GRASS SEED AND NON-ARTIFICIAL TURF (U.S. CLS. 1 AND 46).  
TRACY WHITAKER-BOWN, EXAMINING ATTORNEY

**BARCELONA**

SN 78-273,016. FRANK'S NURSERY & CRAFTS, INC., TROY, MI. FILED 7-11-2003.

THE MARK CONSISTS OF STANDARD CHARACTERS WITHOUT CLAIM TO ANY PARTICULAR FONT, STYLE, SIZE, OR COLOR.  
FOR LIVE PLANTS, NAMELY, LAVENDERS (U.S. CLS. 1 AND 46).  
FIRST USE 4-15-2003; IN COMMERCE 4-15-2003.  
DOMINIC J. FERRAIUOLO, EXAMINING ATTORNEY

**FRANKS NURSERY**

NO CLAIM IS MADE TO THE EXCLUSIVE RIGHT TO USE "NURSERY", APART FROM THE MARK AS SHOWN.  
FOR NATURAL AGRICULTURAL PRODUCTS, NAMELY, GRASS SEED, BIRD SEED, ROSES, SHRUBS, BULBS, AND LIVE PLANTS, INCLUDING FLOWERS (U.S. CLS. 1 AND 46).  
BRIAN NEVILLE, EXAMINING ATTORNEY

SN 78-385,340. JOHN BODGER & SONS COMPANY, SOUTH EL MONTE, CA. FILED 3-16-2004.

SN 78-385,291. LES TOURBES NIROM PEAT MOSS INC., RIVIERE-DU-LOUP, QUEBEC, CANADA, FILED 3-16-2004.

**PARIS**



THE COLOR(S) GREEN AND BLUE IS/ARE CLAIMED AS A FEATURE OF THE MARK.  
THE WORD NATURE AND THE LEFT HALF OF THE LEAF DESIGN ARE GREEN. THE WORD SORB AND THE RIGHT SIDE OF THE LEAF DESIGN ARE BLUE.  
FOR PEAT MOSS (U.S. CLS. 1 AND 46).  
AISHA CLARKE, EXAMINING ATTORNEY

THE MARK CONSISTS OF STANDARD CHARACTERS WITHOUT CLAIM TO ANY PARTICULAR FONT, STYLE, SIZE, OR COLOR.  
FOR LIVE PLANTS, NAMELY, LAVENDERS (U.S. CLS. 1 AND 46).  
FIRST USE 4-15-2003; IN COMMERCE 4-15-2003.  
DOMINIC J. FERRAIUOLO, EXAMINING ATTORNEY

**CLASS 31—(Continued).**

SN 78-397,361. MARTIN, WILLIAM, SANTA BARBARA, CA.  
FILED 4-6-2004.

**CLASS 31—(Continued).**

SN 78-416,097. COOMES, NANCY, ATLANTA, GA. FILED 5-  
10-2004.

## FROM THE SEED TO YOUR TABLE

THE MARK CONSISTS OF STANDARD CHARACTERS  
WITHOUT CLAIM TO ANY PARTICULAR FONT, STYLE,  
SIZE, OR COLOR.

FOR FRUIT SEEDS, VEGETABLE SEEDS, FLOWER  
SEEDS AND HERB SEEDS (U.S. CLS. 1 AND 46).  
FIRST USE 11-11-2003; IN COMMERCE 11-11-2003.  
TONJA GASKINS, EXAMINING ATTORNEY

## LICK A LOTS

THE MARK CONSISTS OF STANDARD CHARACTERS  
WITHOUT CLAIM TO ANY PARTICULAR FONT, STYLE,  
SIZE, OR COLOR.

FOR EDIBLE DOG TREATS (U.S. CLS. 1 AND 46).  
FIRST USE 5-4-2004; IN COMMERCE 5-4-2004.  
DORITT L. CARROLL, EXAMINING ATTORNEY

SN 78-398,172. SUNKIST GROWERS, INC., SHERMAN  
OAKS, CA. FILED 4-7-2004.

## PALS

THE MARK CONSISTS OF STANDARD CHARACTERS  
WITHOUT CLAIM TO ANY PARTICULAR FONT, STYLE,  
SIZE, OR COLOR.

FOR FRESH FRUIT (U.S. CLS. 1 AND 46).  
JOHN GARTNER, EXAMINING ATTORNEY

SN 78-421,678. ASPEN TREE ACQUISITIONS, INC., MUR-  
RAY, UT. FILED 5-19-2004.

[www.flowerpatch.com](http://www.flowerpatch.com)

SN 78-412,877. S&M NUTEC, LLC, NORTH KANSAS CITY,  
MO. FILED 5-4-2004.

## SMARTCHEW

THE MARK CONSISTS OF STANDARD CHARACTERS  
WITHOUT CLAIM TO ANY PARTICULAR FONT, STYLE,  
SIZE, OR COLOR.

FOR PET FOOD AND PET TREATS (U.S. CLS. 1 AND  
46).  
MARCIE MILONE, EXAMINING ATTORNEY

THE MARK CONSISTS OF STANDARD CHARACTERS  
WITHOUT CLAIM TO ANY PARTICULAR FONT, STYLE,  
SIZE, OR COLOR.

FOR FRESH CUT FLOWERS AND FLORAL GIFTS  
NAMELY, FLOWER ARRANGEMENTS, FLOWERING  
PLANTS, AND CUT FLOWER BOUQUETS (U.S. CLS. 1  
AND 46).  
CHERYL CLAYTON, EXAMINING ATTORNEY

**CLASS 31—(Continued).**

SN 78-461,341. POUX, BONNIE, WHITEFISH, MT. FILED 8-3-2004.

**Access Organics**

THE MARK CONSISTS OF STANDARD CHARACTERS WITHOUT CLAIM TO ANY PARTICULAR FONT, STYLE, SIZE, OR COLOR.

NO CLAIM IS MADE TO THE EXCLUSIVE RIGHT TO USE "ORGANICS", APART FROM THE MARK AS SHOWN. FOR FRESH ORGANICALLY GROWN FRUITS AND VEGETABLES EXCEPT LETTUCE, PEAS AND BEETS (U.S. CLS. 1 AND 46).

MARK RADEMACHER, EXAMINING ATTORNEY

**CLASS 32—(Continued).**

SN 76-560,516. NAKED JUICE COMPANY, NEWARK, NJ. FILED 11-6-2003.

**BLUE MACHINE**

THE MARK CONSISTS OF STANDARD CHARACTERS WITHOUT CLAIM TO ANY PARTICULAR FONT, STYLE, SIZE, OR COLOR.

FOR FRUIT AND VEGETABLE JUICES AND SMOOTHIES, AND COMBINATIONS THEREOF, AND FRUIT BASED AND VEGETABLE JUICE BASED BEVERAGES, WHETHER PASTEURIZED OR UNPASTEURIZED (U.S. CLS. 45, 46 AND 48).

KARANENDRA S. CHHINA, EXAMINING ATTORNEY

SN 76-560,517. NAKED JUICE COMPANY, NEWARK, NJ. FILED 11-6-2003.

**CLASS 32—LIGHT BEVERAGES**

SN 75-329,080. BRAND NAME MANAGEMENT, INC., NEW YORK, NY. FILED 7-23-1997.

**VOLT**

FOR ELECTROLYTE REPLACEMENT SOFT DRINKS (U.S. CLS. 45, 46 AND 48).

ELIZABETH HUGHITT, EXAMINING ATTORNEY

SN 76-496,038. ROMANCO LLC, DBA HAPPY VALLEY BREWING CO., SOMERSET, CA. FILED 3-10-2003.

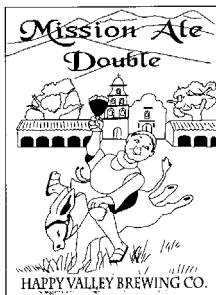

NO CLAIM IS MADE TO THE EXCLUSIVE RIGHT TO USE ALE AND HAPPY VALLEY BREWING CO., APART FROM THE MARK AS SHOWN.

THE LINING IS A FEATURE OF THE MARK AND DOES NOT INDICATE COLOR.

FOR BEER (U.S. CLS. 45, 46 AND 48).  
FIRST USE 7-19-2002; IN COMMERCE 7-19-2002.  
PRISCILLA MILTON, EXAMINING ATTORNEY

**RED MACHINE**

THE MARK CONSISTS OF STANDARD CHARACTERS WITHOUT CLAIM TO ANY PARTICULAR FONT, STYLE, SIZE, OR COLOR.

FOR FRUIT AND VEGETABLE JUICES AND SMOOTHIES, AND COMBINATIONS THEREOF, AND FRUIT BASED AND VEGETABLE JUICE BASED BEVERAGES, WHETHER PASTEURIZED OR UNPASTEURIZED (U.S. CLS. 45, 46 AND 48).

KARANENDRA S. CHHINA, EXAMINING ATTORNEY

SN 76-564,121. THE LAST TWIST, INC., CONSHOHOCKEN, PA. FILED 12-8-2003.

**PONY PUNCH**

THE MARK CONSISTS OF STANDARD CHARACTERS WITHOUT CLAIM TO ANY PARTICULAR FONT, STYLE, SIZE, OR COLOR.

NO CLAIM IS MADE TO THE EXCLUSIVE RIGHT TO USE "PUNCH", APART FROM THE MARK AS SHOWN.

FOR NON-ALCOHOLIC AND NON-CARBONATED BEVERAGES, NAMELY SOFT DRINKS, NON-ALCOHOLIC COCKTAIL DRINK MIXES, FRUIT DRINKS, FRUIT JUICE DRINKS, AND SLUSH-TYPE SOFT DRINKS, NON-CARBONATED ICE AND BLENDED BEVERAGES, NAMELY, COFFEE-FLAVORED SOFT DRINKS, FRUIT-FLAVORED SOFT DRINKS, GRANITA DRINKS, SMOOTHIES, DRINKING WATER AND FLAVORED DRINKING WATER (U.S. CLS. 45, 46 AND 48).

STACY WAHLBERG, EXAMINING ATTORNEY

**CLASS 32—(Continued).**

SN 76-571,417. KAGOME CO., LTD., NAKA-KU, NAGOYA, JAPAN, FILED 1-21-2004.

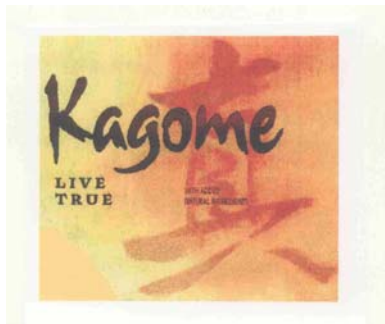

OWNER OF U.S. REG. NOS. 1,589,138, 2,315,177 AND 2,561,772.

NO CLAIM IS MADE TO THE EXCLUSIVE RIGHT TO USE "WITH ADDED NATURAL INGREDIENTS", APART FROM THE MARK AS SHOWN.

THE COLOR(S) BROWN, YELLOW AND ORANGE IS/ ARE CLAIMED AS A FEATURE OF THE MARK.

THE ENGLISH WORDING IN THE MARK IS COLORED BROWN, THE JAPANESE CHARACTER IS COLORED ORANGE, AND THESE APPEAR AGAINST A BACKGROUND OF YELLOW AND ORANGE.

THE JAPANESE WORD "KAGOME" TRANSLATES INTO ENGLISH AS "WOVEN BAMBOO PATTERN".

THE JAPANESE CHARACTERS APPEARING IN THE MARK MEANS "TRUE" AND THE TRANSLITERATION THEREOF IS "MAKOTO".

FOR FRUIT AND VEGETABLE JUICE (U.S. CLS. 45, 46 AND 48).

NICHOLAS ALTREE, EXAMINING ATTORNEY

SN 76-592,335. CERVECERIA MODELO, S.A. DE C.V., 11320 MEXICO, D.F., MEXICO, FILED 5-17-2004.

**LET IT SUN. LET IT SUN. LET IT SUN.**

THE MARK CONSISTS OF STANDARD CHARACTERS WITHOUT CLAIM TO ANY PARTICULAR FONT, STYLE, SIZE, OR COLOR.

FOR BEER (U.S. CLS. 45, 46 AND 48).

FIRST USE 6-0-2003; IN COMMERCE 6-0-2003.

REBECCA SMITH, EXAMINING ATTORNEY

SN 78-174,265. OLD EUROPEAN BREWERY COMPANY, SAN DIEGO, CA. FILED 10-14-2002.

**LAMESA**

THE ENGLISH TRANSLATION OF THE SPANISH MEANING OF THE MARK "LA MESA" IS "THE TABLE".

FOR BEER (U.S. CLS. 45, 46 AND 48).

FLORENTINA BLANDU, EXAMINING ATTORNEY

**CLASS 32—(Continued).**

SN 78-291,372. JAMBA JUICE COMPANY, SAN FRANCISCO, CA. FILED 8-22-2003.

**BERRY LIME SUBLIME**

NO CLAIM IS MADE TO THE EXCLUSIVE RIGHT TO USE BERRY LIME, APART FROM THE MARK AS SHOWN. FOR FRUIT AND VEGETABLE JUICES AND SMOOTHIES (U.S. CLS. 45, 46 AND 48).

FIRST USE 3-0-2001; IN COMMERCE 3-0-2001.

TONI HICKEY, EXAMINING ATTORNEY

SN 78-307,749. OTT, A. TRUE, DBA MOTHER EARTH MINERALS, NORTH OGDEN, UT. FILED 9-30-2003.

**MOTHER EARTH MINERALS**

NO CLAIM IS MADE TO THE EXCLUSIVE RIGHT TO USE "MINERALS", APART FROM THE MARK AS SHOWN. FOR MINERAL WATER (U.S. CLS. 45, 46 AND 48).

FIRST USE 11-0-1999; IN COMMERCE 11-0-1999.

INGA ERVIN, EXAMINING ATTORNEY

SN 78-313,353. TIPTONE & MAGLIONE, INC., NEW YORK, NY. FILED 10-14-2003.

**NATIONAL SUSHI MONTH**

FOR BEER (U.S. CLS. 45, 46 AND 48).

MICHAEL KAZAZIAN, EXAMINING ATTORNEY

SN 78-331,964. HARVEST MOON BREWING, MONTANA CITY, MT. FILED 11-23-2003.

**Pigs Ass Porter**

THE MARK CONSISTS OF STANDARD CHARACTERS WITHOUT CLAIM TO ANY PARTICULAR FONT, STYLE, SIZE, OR COLOR.

NO CLAIM IS MADE TO THE EXCLUSIVE RIGHT TO USE "PORTER", APART FROM THE MARK AS SHOWN.

FOR BEER (U.S. CLS. 45, 46 AND 48).

FIRST USE 0-0-1998; IN COMMERCE 0-0-1998.

SUSAN HAYASH, EXAMINING ATTORNEY



**CLASS 32—(Continued).**

SN 78-404,198. MJ ANDERSEN, INC., WINSTON-SALEM, NC. FILED 4-19-2004.

**Fruit Smak**

THE MARK CONSISTS OF STANDARD CHARACTERS WITHOUT CLAIM TO ANY PARTICULAR FONT, STYLE, SIZE, OR COLOR.

NO CLAIM IS MADE TO THE EXCLUSIVE RIGHT TO USE "FRUIT", APART FROM THE MARK AS SHOWN.

THE FOREIGN WORDING IN THE MARK TRANSLATES INTO ENGLISH AS "TASTE". (SMAK IS THE SWEDISH WORD FOR "TASTE").

FOR BEVERAGES, NAMELY DRINKING WATERS, BOTTLED WATERS, MINERAL AND AERATED WATERS; AND OTHER NON-ALCOHOLIC BEVERAGES, NAMELY, SOFT DRINKS, ENERGY DRINKS, AND SPORTS DRINKS; FRUIT DRINKS AND JUICES; SYRUPS, CONCENTRATES AND POWDERS FOR MAKING BEVERAGES, NAMELY, MINERAL AND AERATED WATERS, SOFT DRINKS, ENERGY DRINKS, SPORTS DRINKS, FRUIT DRINKS AND JUICES (U.S. CLS. 45, 46 AND 48).

PRISCILLA MILTON, EXAMINING ATTORNEY



SN 78-404,780. ALOE FARMS, INC., HARLINGEN, TX. FILED 4-20-2004.

**ALOE FARMS**

THE MARK CONSISTS OF STANDARD CHARACTERS WITHOUT CLAIM TO ANY PARTICULAR FONT, STYLE, SIZE, OR COLOR.

OWNER OF U.S. REG. NO. 1,255,761.

NO CLAIM IS MADE TO THE EXCLUSIVE RIGHT TO USE "ALOE", APART FROM THE MARK AS SHOWN.

FOR BEVERAGES, NAMELY, JUICES AND GEL-LIKE JUICES DERIVED FROM THE ALOE VERA PLANT (U.S. CLS. 45, 46 AND 48).

FIRST USE 12-1-1983; IN COMMERCE 12-1-1983.  
RAMONA ORTIGA, EXAMINING ATTORNEY

**CLASS 32—(Continued).**

SN 78-416,648. RHEINGOLD BREWING COMPANY, INC., NEW YORK, NY. FILED 5-11-2004.

**DON'T SLEEP**

THE MARK CONSISTS OF STANDARD CHARACTERS WITHOUT CLAIM TO ANY PARTICULAR FONT, STYLE, SIZE, OR COLOR.

FOR BEER (U.S. CLS. 45, 46 AND 48).

MICHAEL ENGEL, EXAMINING ATTORNEY



SN 78-420,126. USA MILLENNIUM, L.P., BEAUMONT, TX. FILED 5-17-2004.

**SPEED ZONE**

THE MARK CONSISTS OF STANDARD CHARACTERS WITHOUT CLAIM TO ANY PARTICULAR FONT, STYLE, SIZE, OR COLOR.

FOR NON-ALCOHOLIC BEVERAGES, NAMELY, ENERGY DRINKS (U.S. CLS. 45, 46 AND 48).

FIRST USE 10-11-2004; IN COMMERCE 10-11-2004.  
MICHAEL ENGEL, EXAMINING ATTORNEY

**CLASS 32—(Continued).**

SN 78-462,754. FOREMOST FARMS USA, COOPERATIVE, BARABOO, WI. FILED 8-5-2004.

IT'S BETTER THAN  
GOOD, IT'S  
FOREMOST

THE MARK CONSISTS OF STANDARD CHARACTERS WITHOUT CLAIM TO ANY PARTICULAR FONT, STYLE, SIZE, OR COLOR.

FOR FRUIT JUICES (U.S. CLS. 45, 46 AND 48).  
CAROLINE WOOD, EXAMINING ATTORNEY

**CLASS 33—WINES AND SPIRITS**

SN 75-692,633. OASIS VINEYARD, INC., HUME, VA. FILED 4-27-1999.

**CELEBRATION 2001**

FOR WINE AND CHAMPAGNE (U.S. CLS. 47 AND 49).  
FIRST USE 2-0-1993; IN COMMERCE 2-0-1999.  
MITCHELL FRONT, EXAMINING ATTORNEY

SN 76-513,577. HAKKAI-JYOZO SAKE BREWING CO., LTD., NIIGATA, JAPAN, FILED 5-13-2003.

海山

OWNER OF JAPAN REG. NO. 3167035, DATED 6-28-1996, EXPIRES 6-28-2006.

THE NON-LATIN CHARACTERS IN THE MARK TRANSLITERATE TO HAKKAISAN, WHICH HAS NO ENGLISH TRANSLATION BUT IDENTIFIES A MOUNTAIN IN THE MUIKAMACHI AREA OF JAPAN.

FOR SAKE (U.S. CLS. 47 AND 49).  
FIRST USE 10-0-1986; IN COMMERCE 1-0-1999.  
STEVEN R. FINE, EXAMINING ATTORNEY

**CLASS 33—(Continued).**

SN 76-513,817. HAKKAI-JYOZO SAKE BREWING CO., LTD., NIIGATA, JAPAN, FILED 5-13-2003.



THE MARK CONSISTS OF THE JAPANESE CHARACTERS PRONOUNCED HONJYOZO MEANING A METHOD OF BREWING SAKE ATOP A DESIGN OF THE MUIKAMACHI MOUNTAINS; IN THE MIDST OF THE MOUNTAINS IN THE CENTER OF THE MARK APPEAR THE JAPANESE CHARACTERS PRONOUNCED HAKKAJSAN, WHICH IS THE NAME OF A MOUNTAIN IN THE MUIKAMACHI AREA OF JAPAN WITH NO TRANSLATION INTO ENGLISH; BELOW THE MOUNTAINS ON THE LEFT ARE THE JAPANESE CHARACTERS PRONOUNCED KINJYO MEANING RESPECTFULLY AND BREWING; AND ON THE RIGHT ARE TWO LINES WITH THE JAPANESE CHARACTERS PRONOUNCED HAKKAI-JYOZO KABUSHIKI KAISHA, 1051 NAGAMORI MUIKAMACHI MINAMI-ONUMA-GUN NIIGATA JAPAN, WHICH IS THE COMPANY NAME AND ADDRESS OF THE APPLICANT; BELOW ARE TWO RECTANGLES, ONE FLUSH LEFT WITH A CURVED RIGHT SIDE AND THE OTHER FLUSH RIGHT WITH A CURVED LEFT SIDE, BOTH CONTAINING SPORADIC SHADING THAT IS A FEATURE OF THE MARK; AND IN THE BOTTOM LEFT CORNER ARE THE JAPANESE CHARACTERS FOR HAKKAISAN, WITH THE SAME PRONUNCIATION AS HAKKAJSAN.

THE NON-LATIN CHARACTERS IN THE MARK TRANSLITERATE TO "HAKKAISAN" WHICH IS THE NAME OF A MOUNTAIN IN THE MUIKAMACHI REGION OF JAPAN.

FOR SAKE (U.S. CLS. 47 AND 49).  
FIRST USE 0-0-1955; IN COMMERCE 3-0-2002.  
LAURA KOVAISKY, EXAMINING ATTORNEY

SN 76-563,225. GONZALEZ, FRANCISCO, COLORADO, SONORA, MEXICO, FILED 11-14-2003.

**El Cucuy**

THE MARK CONSISTS OF STANDARD CHARACTERS WITHOUT CLAIM TO ANY PARTICULAR FONT, STYLE, SIZE, OR COLOR.

CUCUY MEANS "CUKOO" OR THE COCO IN ENGLISH. FOR ALCOHOLIC BEVERAGES, NAMELY TEQUILA (U.S. CLS. 47 AND 49).

ANDREA SAUNDERS, EXAMINING ATTORNEY

**CLASS 33—(Continued).**

SN 76-565,802. STOLLER WHOLESALE WINES & SPIRITS, INC., DBA MARSALLE COMPANY, FRANKLIN PARK, IL. FILED 12-4-2003.

**KNOTTINGHAM**

THE MARK CONSISTS OF STANDARD CHARACTERS WITHOUT CLAIM TO ANY PARTICULAR FONT, STYLE, SIZE, OR COLOR.

FOR GIN (U.S. CLS. 47 AND 49).  
ALICE BENMAMAN, EXAMINING ATTORNEY

SN 76-572,027. O'BRIEN, HOWARD E., JR., RESTON, VA. FILED 1-21-2004.

**CHATEAU O'BRIEN at NORTHPOINT**

NO CLAIM IS MADE TO THE EXCLUSIVE RIGHT TO USE "CHATEAU", APART FROM THE MARK AS SHOWN.

FOR WINES (U.S. CLS. 47 AND 49).  
BARBARA BROWN, EXAMINING ATTORNEY

SN 76-581,809. THE HESS COLLECTION WINERY, NAPA, CA. FILED 3-18-2004.

**HESS  
SELECT**

OWNER OF U.S. REG. NOS. 1,596,732, 2,677,359 AND OTHERS.

NO CLAIM IS MADE TO THE EXCLUSIVE RIGHT TO USE "SELECT", APART FROM THE MARK AS SHOWN.

FOR WINE (U.S. CLS. 47 AND 49).  
FIRST USE 0-0-1993; IN COMMERCE 0-0-1994.  
WILLIAM BRECKENFELD, EXAMINING ATTORNEY

**CLASS 33—(Continued).**

SN 76-589,209. PIO CESARE S.R.L., 12051 ALBA (CUNEO), ITALY, FILED 4-27-2004.

**PIO CESARE**

THE MARK CONSISTS OF STANDARD CHARACTERS WITHOUT CLAIM TO ANY PARTICULAR FONT, STYLE, SIZE, OR COLOR.

FOR WINE (U.S. CLS. 47 AND 49).  
FIRST USE 1-1-1940; IN COMMERCE 1-1-1940.  
MARK RADEMACHER, EXAMINING ATTORNEY

SN 76-590,248. GEERLINGS & WADE, INC., CANTON, MA. FILED 5-3-2004.

**GW WINEWORKS**

THE MARK CONSISTS OF STANDARD CHARACTERS WITHOUT CLAIM TO ANY PARTICULAR FONT, STYLE, SIZE, OR COLOR.

NO CLAIM IS MADE TO THE EXCLUSIVE RIGHT TO USE "WINEWORKS", APART FROM THE MARK AS SHOWN.

FOR WINES (U.S. CLS. 47 AND 49).  
EVELYN BRADLEY, EXAMINING ATTORNEY

SN 76-591,186. PEJU PROVINCE, RUTHERFORD, CA. FILED 5-10-2004.

**MISTERY**

THE MARK CONSISTS OF STANDARD CHARACTERS WITHOUT CLAIM TO ANY PARTICULAR FONT, STYLE, SIZE, OR COLOR.

FOR WINES (U.S. CLS. 47 AND 49).  
WILLIAM P. SHANAHAN, EXAMINING ATTORNEY

SN 76-591,187. PEJU PROVINCE, RUTHERFORD, CA. FILED 5-10-2004.

**PERSEPHONE**

THE MARK CONSISTS OF STANDARD CHARACTERS WITHOUT CLAIM TO ANY PARTICULAR FONT, STYLE, SIZE, OR COLOR.

FOR WINES (U.S. CLS. 47 AND 49).  
GEORGE LORENZO, EXAMINING ATTORNEY

**CLASS 33—(Continued).**

SN 78-070,911. JAMES R. SAUNDERS AND DEBORAH A. SAUNDERS PARTNERSHIP, THE, PASO ROBLES, CA. FILED 6-25-2001.

**MIRASOL**

THE ENGLISH TRANSLATION OF "MIRASOL" IS "REFLECTIVE OR SHINING SUN".  
FOR WINE (U.S. CLS. 47 AND 49).  
SUSAN HAYASH, EXAMINING ATTORNEY

SN 78-154,260. DESTINY BAY VINEYARDS LIMITED, AUCKLAND, NEW ZEALAND, FILED 8-14-2002.

**DESTINY BAY**

PRIORITY CLAIMED UNDER SEC. 44(D) ON NEW ZEALAND APPLICATION NO. 662244, FILED 8-8-2002, REG. NO. 662244, DATED 2-13-2003, EXPIRES 8-8-2009.  
FOR ALCOHOLIC BEVERAGES, NAMELY, WINES, DISTILLED SPIRITS, AND DISTILLED LIQUOR (U.S. CLS. 47 AND 49).  
JULIA HARDY COFIELD, EXAMINING ATTORNEY

SN 78-156,997. HARLAN ESTATE WINERY, INC., OAKVILLE, CA. AND SLAWSON, PAUL S., SAN FRANCISCO, CA. AND SLAWSON, MARY C, SAN FRANCISCO, CA. FILED 8-22-2002.

**MELBURY**

FOR WINE (U.S. CLS. 47 AND 49).  
CAROLYN GRAY, EXAMINING ATTORNEY

SN 78-196,393. BODEGAS CONCAVINS, S.A., 43400 MONTEBLANC, SPAIN, FILED 12-19-2002.



THE ENGLISH TRANSLATION OF THE WORD PROYECTO IN THE MARK IS "PLAN."  
FOR WINES (U.S. CLS. 47 AND 49).  
HOWARD B. LEVINE, EXAMINING ATTORNEY

**CLASS 33—(Continued).**

SN 78-217,689. SOLOURO - VINHOS, S.A., VILA NOVA DE FAMALICAO, PORTUGAL, FILED 2-21-2003.

**TERRAS DE SA**

THE ENGLISH TRANSLATION OF "TERRAS DE SA" IS "LANDS OF SA".  
FOR RED AND WHITE TABLE WINE (U.S. CLS. 47 AND 49).  
MICHAEL SOUDERS, EXAMINING ATTORNEY

SN 78-299,889. VINA MORANDÉ S.A., SANTIAGO, CHILE, FILED 9-12-2003.

**MORANDÉ**

SEC. 2(F).  
FOR WINES (U.S. CLS. 47 AND 49).  
FIRST USE 1-1-1999; IN COMMERCE 1-1-1999.  
RICHARD WHITE, EXAMINING ATTORNEY

SN 78-319,931. SUTTER HOME WINERY, INC., ST. HELENA, CA. FILED 10-28-2003.

**VISTA MONTONE**

THE FOREIGN WORDING IN THE MARK TRANSLATES INTO ENGLISH AS RAM'S VIEW.  
FOR WINE (U.S. CLS. 47 AND 49).  
FIRST USE 7-1-2004; IN COMMERCE 7-1-2004.  
SUE LAWRENCE, EXAMINING ATTORNEY

SN 78-320,040. OZEKI CORPORATION, HYOGO, JAPAN, FILED 10-29-2003.



OWNER OF U.S. REG. NO. 1,755,632.  
THE NON-LATIN CHARACTERS SHOWN IN THE PREDOMINANT CENTER PORTION OF THE MARK TRANSLITERATE TO "TYAMADA-MISHIKI", WHICH IS A

**CLASS 33—(Continued).**

PROPER NAME OF A VARIETY OF RICE; THE NON-LATIN CHARACTERS SHOWN ON THE LEFT SIDE OF THE MARK TRANSLITERATE TO 'HOUJUN-KARAKUCHI', WHICH MEANS "MELLOW AND DRY" IN ENGLISH; AND THE NON-LATIN CHARACTERS SHOWN ON THE RIGHT SIDE OF THE MARK TRANSLITERATE TO "TO-KUBETSU-JUNMAI-SHU" WHICH IS A TERM DEFINED UNDER THE LIQUOR TAX LAW OF JAPAN RELATING TO "SAKE MADE FROM RICE, MALTED RICE AND WATER WITH NO EXTRA ALCOHOL ADDED".

FOR SAKE (U.S. CLS. 47 AND 49).  
FIRST USE 11-30-2000; IN COMMERCE 3-31-2001.  
DAWN FELDMAN, EXAMINING ATTORNEY

**CLASS 33—(Continued).**

SN 78-355,713. LANDSTROM, JOE, NEWPORT BEACH, CA. FILED 1-22-2004.



SN 78-329,772. MACCHU PISCO LLC, BETHESDA, MD. FILED 11-18-2003.



NO CLAIM IS MADE TO THE EXCLUSIVE RIGHT TO USE "PREMIUM RUM", APART FROM THE MARK AS SHOWN.

FOR RUM (U.S. CLS. 47 AND 49).  
DEZMONA MIZELLE, EXAMINING ATTORNEY

FOR ALCOHOLIC BEVERAGE SPECIFICALLY DISTILLED SPIRITS (U.S. CLS. 47 AND 49).  
ESTHER A. BORSUK, EXAMINING ATTORNEY

SN 78-378,811. BODEGAS EL NIDO, S.L., 30520 JUMILLA (MURCIA), SPAIN, FILED 3-4-2004.

SN 78-338,250. CALERA WINE COMPANY, HOLLISTER, CA. FILED 12-9-2003.

**RYAN**

**EL NIDO**

THE MARK CONSISTS OF STANDARD CHARACTERS WITHOUT CLAIM TO ANY PARTICULAR FONT, STYLE, SIZE, OR COLOR.

FOR WINES (U.S. CLS. 47 AND 49).  
JOHN DALIER, EXAMINING ATTORNEY

THE MARK CONSISTS OF STANDARD CHARACTERS WITHOUT CLAIM TO ANY PARTICULAR FONT, STYLE, SIZE, OR COLOR.

THE ENGLISH TRANSLATION OF "EL NIDO" IN THE MARK IS "THE NEST".  
FOR WINES (U.S. CLS. 47 AND 49).  
JEFFREY S. MOLINOFF, EXAMINING ATTORNEY

**CLASS 33—(Continued).**

SN 78-380,864. THE LITTLE WINE COMPANY LTD., GLEN COVE, NY. FILED 3-9-2004.

**CLASS 33—(Continued).**

SN 78-397,200. GOLDEN STATE VINTNERS, NAPA, CA. FILED 4-6-2004.

**CABZILLA**

**LANDFALL**

THE MARK CONSISTS OF STANDARD CHARACTERS WITHOUT CLAIM TO ANY PARTICULAR FONT, STYLE, SIZE, OR COLOR.  
FOR WINE AND DISTILLED SPIRITS (U.S. CLS. 47 AND 49).  
BRIDGETT SMITH, EXAMINING ATTORNEY

THE MARK CONSISTS OF STANDARD CHARACTERS WITHOUT CLAIM TO ANY PARTICULAR FONT, STYLE, SIZE, OR COLOR.  
FOR WINE (U.S. CLS. 47 AND 49).  
KIMBERLY PERRY, EXAMINING ATTORNEY

SN 78-397,161. GOLDEN STATE VINTNERS, NAPA, CA. FILED 4-6-2004.

SN 78-397,208. GOLDEN STATE VINTNERS, NAPA, CA. FILED 4-6-2004.

**TAILWIND**

**CATBIRD**

THE MARK CONSISTS OF STANDARD CHARACTERS WITHOUT CLAIM TO ANY PARTICULAR FONT, STYLE, SIZE, OR COLOR.  
FOR WINE (U.S. CLS. 47 AND 49).  
KIMBERLY PERRY, EXAMINING ATTORNEY

THE MARK CONSISTS OF STANDARD CHARACTERS WITHOUT CLAIM TO ANY PARTICULAR FONT, STYLE, SIZE, OR COLOR.  
FOR WINE (U.S. CLS. 47 AND 49).  
KIMBERLY PERRY, EXAMINING ATTORNEY

**CLASS 33—(Continued).**

SN 78-397,247. GOLDEN STATE VINTNERS, NAPA, CA. FILED 4-6-2004.

**FISHEYE**

THE MARK CONSISTS OF STANDARD CHARACTERS WITHOUT CLAIM TO ANY PARTICULAR FONT, STYLE, SIZE, OR COLOR.  
FOR WINE (U.S. CLS. 47 AND 49).  
STEVEN JACKSON, EXAMINING ATTORNEY

SN 78-398,259. APAN WINE COMPANY LLC, PT. RICHMOND, CA. FILED 4-7-2004.

**Apan**

THE MARK CONSISTS OF STANDARD CHARACTERS WITHOUT CLAIM TO ANY PARTICULAR FONT, STYLE, SIZE, OR COLOR.  
FOR WINE (U.S. CLS. 47 AND 49).  
FIRST USE 8-1-2003; IN COMMERCE 8-1-2003.  
WON TEAK OH, EXAMINING ATTORNEY

**CLASS 33—(Continued).**

SN 78-398,810. DIAGEO NORTH AMERICA, INC., STAMFORD, CT. FILED 4-8-2004.

**WHAT'LL IT BE?**

THE MARK CONSISTS OF STANDARD CHARACTERS WITHOUT CLAIM TO ANY PARTICULAR FONT, STYLE, SIZE, OR COLOR.  
FOR ALCOHOLIC BEVERAGES, NAMELY WHISKY (U.S. CLS. 47 AND 49).  
FLORENTINA BLANDU, EXAMINING ATTORNEY

SN 78-400,310. DIAGEO NORTH AMERICA, INC., STAMFORD, CT. FILED 4-12-2004.

**ENSEMBLE**

THE MARK CONSISTS OF STANDARD CHARACTERS WITHOUT CLAIM TO ANY PARTICULAR FONT, STYLE, SIZE, OR COLOR.  
FOR ALCOHOLIC BEVERAGES, NAMELY WINE (U.S. CLS. 47 AND 49).  
FIRST USE 6-12-1996; IN COMMERCE 6-12-1996.  
APRIL L. RADEMACHER, EXAMINING ATTORNEY

SN 78-405,623. BENOIT & VALERIE CALVET S.A., BORDEAUX, FRANCE, FILED 4-21-2004.

**VILLA MALIZIA**

THE MARK CONSISTS OF STANDARD CHARACTERS WITHOUT CLAIM TO ANY PARTICULAR FONT, STYLE, SIZE, OR COLOR.  
THE ENGLISH TRANSLATION OF THE WORDING VILLA IN THE MARK IS "VILLA" AND THE ENGLISH TRANSLATION OF THE WORDINGS MALIZIA IN THE MARK IS "TRICK" OR "MALICE".  
FOR WINES (U.S. CLS. 47 AND 49).  
ANNE E. GUSTASON, EXAMINING ATTORNEY

**CLASS 33—(Continued).**

SN 78-414,958. LEMELSON WINERY LLC, CARLTON, OR. FILED 5-7-2004.

**NATURE TRADITION  
INNOVATION**

THE MARK CONSISTS OF STANDARD CHARACTERS WITHOUT CLAIM TO ANY PARTICULAR FONT, STYLE, SIZE, OR COLOR.  
FOR WINES (U.S. CLS. 47 AND 49).  
FIRST USE 11-25-2000; IN COMMERCE 11-25-2000.  
DORITT L. CARROLL, EXAMINING ATTORNEY

---

SN 78-415,643. LA INVERSORA SOCIEDAD ANONIMA, COMERCIAL, INDUSTRIAL INMOBILIARIA, CONSTRUCTORA, AGROPECUARIA Y FINANCIERA, NEUQUEN, PROVINCIA DE NEUQUEN, ARGENTINA, FILED 5-10-2004.

**END OF THE WORLD**

THE MARK CONSISTS OF STANDARD CHARACTERS WITHOUT CLAIM TO ANY PARTICULAR FONT, STYLE, SIZE, OR COLOR.  
FOR WINES, DISTILLED SPIRITS, WHISKEY, BRANDY, COGNAC, CORDIALS, LIQUEURS AND APERITIFS WITH A WINE BASE (U.S. CLS. 47 AND 49).  
PAUL F. GAST, EXAMINING ATTORNEY

---

SN 78-416,897. EINIG-ZENZEN GMBH & CO. KG, KAISERSCH, FED REP GERMANY, FILED 5-11-2004.

**BASIC ELEMENTS**

THE MARK CONSISTS OF STANDARD CHARACTERS WITHOUT CLAIM TO ANY PARTICULAR FONT, STYLE, SIZE, OR COLOR.  
FOR WINE, PREPARED WINE COCKTAILS AND SPARKLING WINES (U.S. CLS. 47 AND 49).  
DEZMONA MIZELLE, EXAMINING ATTORNEY

**CLASS 33—(Continued).**

SN 78-417,750. BROWN-FORMAN CORPORATION, LOUISVILLE, KY. FILED 5-12-2004.

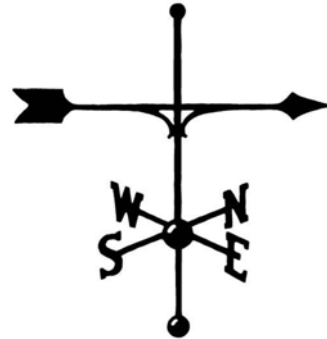

THE MARK CONSISTS OF THE DESIGN OF A WEATHERVANE.  
FOR ALCOHOLIC BEVERAGES, NAMELY WINE (U.S. CLS. 47 AND 49).  
MICHAEL ENGEL, EXAMINING ATTORNEY

---

SN 78-418,798. WINERY ASSOCIATES OF SONOMA COUNTY, INC., HEALDSBURG, CA. FILED 5-14-2004.

**friends.cab**

THE MARK CONSISTS OF STANDARD CHARACTERS WITHOUT CLAIM TO ANY PARTICULAR FONT, STYLE, SIZE, OR COLOR.  
FOR WINES (U.S. CLS. 47 AND 49).  
MIDGE BUTLER, EXAMINING ATTORNEY



**CLASS 33—(Continued).**

SN 78-421,120. FORTRESS GROUP LIMITED, LARKSPUR, CO. FILED 5-18-2004.

SPRUCE MOUNTAIN  
MEADERY

THE MARK CONSISTS OF STANDARD CHARACTERS WITHOUT CLAIM TO ANY PARTICULAR FONT, STYLE, SIZE, OR COLOR.

NO CLAIM IS MADE TO THE EXCLUSIVE RIGHT TO USE MEADERY, APART FROM THE MARK AS SHOWN.

FOR WINE AND MEAD (U.S. CLS. 47 AND 49).

FIRST USE 4-1-2002; IN COMMERCE 2-24-2004.

CATHERINE FAINT, EXAMINING ATTORNEY

SN 78-481,982. WINERY ASSOCIATES OF SONOMA COUNTY, INC., HEALDSBURG, CA. FILED 9-10-2004.

friends.zin

THE MARK CONSISTS OF STANDARD CHARACTERS WITHOUT CLAIM TO ANY PARTICULAR FONT, STYLE, SIZE, OR COLOR.

FOR WINES (U.S. CLS. 47 AND 49).

FIRST USE 9-1-2004; IN COMMERCE 9-1-2004.

MIDGE BUTLER, EXAMINING ATTORNEY

**CLASS 33—(Continued).**

SN 79-000,677. R. LOPEZ DE HEREDIA, VIÑA TONDONIA, S.A., SPAIN, FILED 12-10-2003.



OWNER OF INTERNATIONAL REGISTRATION 0817609 DATED 12-10-2003, EXPIRES 12-10-2013.

NO CLAIM IS MADE TO THE EXCLUSIVE RIGHT TO USE VIÑA, VINOS FINOS DE RIOJA, DENOMINACION DE ORIGEN CALIFICADA, EMBOTELLADO POR, 75 CL, 12% VOL., VIÑEDOS Y BODEGAS EN HARO (RIOJA ALTA, ESPAÑA), PRODUCTO DE ESPAÑA, OR FUNDADA EN 1877, APART FROM THE MARK AS SHOWN.

THE MARK CONSISTS OF A DESIGN OF A DWELLING, A STAMP AND THE TERMS: VINOS FINOS DE RIOJA DENOMINACION DE ORIGEN CALIFICADA EMBOTELLADO POR 75CL 12% VOL. VIÑEDOS Y BODEGAS EN HARO (RIOJA ALTA, ESPAÑA) PRODUCTO DE ESPAÑA FUNDADA EN 1877 VIÑA.

THE WORDS VIÑA TONDONIA TRANSLATES AS TONDONIA WINE; TONDONIA IS A COINED TERM. OTHERS TERMS MAY BE TRANSLATED AS FOLLOWS: VINOS FINOS DE RIOJA, DENOMINACION DE ORIGEN CALIFICADA, EMBOTELLADO POR, VIÑEDOS Y BODEGAS EN HARO (RIOJA ALTA, ESPAÑA) PRODUCTO DE ESPAÑA; FUNDADA EN 1877 IN THE MARK IS RIOJA QUALITY WINE, QUALIFIED DESIGNATION OF ORIGIN, BOTTLED BY, VINEYARD AND CELLARS IN HARO (RIOJA ALTA, SPAIN) PRODUCT OF SPAIN, FOUNDED IN 1877.

FOR WINES (U.S. CLS. 47 AND 49).

CAROLINE WOOD, EXAMINING ATTORNEY

SN 79-001,647. LES VIGNERONS DU SIEUR D'ARQUES; SOCIETE COOPERATIVE AGRICOLE, FRANCE, FILED 2-17-2004.

L'IMPERTINENTE

THE MARK CONSISTS OF STANDARD CHARACTERS WITHOUT CLAIM TO ANY PARTICULAR FONT, STYLE, SIZE, OR COLOR.

PRIORITY DATE OF 9-26-2003 IS CLAIMED.

OWNER OF INTERNATIONAL REGISTRATION 0821624 DATED 2-17-2004, EXPIRES 2-17-2014.

FOR WINES, LOCAL WINES, WINES OF GUARANTEED LABEL OF ORIGIN, SPARKLING WINES, NATURAL SWEET WINES; CIDERS, NAMELY, HARD CIDERS, APERITIFS AND EAUX-DE-VIE; LIQUEURS AND SPIRITS, NAMELY, BRANDY SPIRITS, DISTILLED SPIRITS (U.S. CLS. 47 AND 49).

MARLENE BELL, EXAMINING ATTORNEY

**CLASS 33—(Continued).**

SN 79-002,559. SANTIAGO IJALBA, S.A., SPAIN, FILED 4-6-2004.

**OGGA**

THE MARK CONSISTS OF STANDARD CHARACTERS WITHOUT CLAIM TO ANY PARTICULAR FONT, STYLE, SIZE, OR COLOR.

OWNER OF INTERNATIONAL REGISTRATION 0824843 DATED 4-6-2004, EXPIRES 4-6-2014.

FOR WINES, LIQUEURS AND OTHER ALCOHOLIC BEVERAGES (EXCLUDING BEER) (U.S. CLS. 47 AND 49).

STEVEN JACKSON, EXAMINING ATTORNEY

**CLASS 34—(Continued).**

SN 78-392,600. GMB, INC., KING, NC. FILED 3-29-2004.

**KARMELITA**

THE MARK CONSISTS OF STANDARD CHARACTERS WITHOUT CLAIM TO ANY PARTICULAR FONT, STYLE, SIZE, OR COLOR.

FOR CIGARETTES (U.S. CLS. 2, 8, 9 AND 17).  
SCOTT OSLICK, EXAMINING ATTORNEY

SN 78-397,662. BWT BRANDS, INC., MACON, GA. FILED 4-7-2004.

**CLASS 34—SMOKERS' ARTICLES**

SN 78-302,917. NEW CENTURY TOBACCO GROUP, LLC, MIAMI, FL. FILED 9-19-2003.

**OL' TIMER**

FOR TOBACCO, CIGARS, CIGARETTES (U.S. CLS. 2, 8, 9 AND 17).  
GWEN STOKOLS, EXAMINING ATTORNEY



OWNER OF U.S. REG. NOS. 998,632 AND 2,789,181.  
FOR CIGARETTES (U.S. CLS. 2, 8, 9 AND 17).  
ERNEST SHOSHO, EXAMINING ATTORNEY

SN 78-397,664. BWT BRANDS, INC., MACON, GA. FILED 4-7-2004.

**ADVANCE**

SN 78-388,049. ROSENTHAL, JOSHUA, BEVERLY HILLS, CA. FILED 3-21-2004.

**Inspiration**

FOR SMOKING URN, NAMELY, A DEVICE USED FOR THE VAPORIZATION AND INHALATION OF TOBACCO, HERBS AND OTHER SUBSTANCES AND ADAPTOR DEVICES FOR CONVERTING OTHER SMOKING IMPLEMENTS INTO DEVICES USED FOR THE VAPORIZATION AND INHALATION OF TOBACCO, HERBS AND OTHER SUBSTANCES (U.S. CLS. 2, 8, 9 AND 17).  
JASON TURNER, EXAMINING ATTORNEY



OWNER OF U.S. REG. NOS. 998,632 AND 2,789,181.  
FOR CIGARETTES (U.S. CLS. 2, 8, 9 AND 17).  
ERNEST SHOSHO, EXAMINING ATTORNEY

**CLASS 34—(Continued).**

SN 78-402,170. TEGAKY CORPORATION, MIAMI, FL. FILED 4-15-2004.

**CLASS 34—(Continued).**

SN 78-418,098. VALUE BRAND CIGARETTES CORP., MIAMI, FL. FILED 5-13-2004.

**BVC BEST VALUE  
CIGARETTES**

**Arrow**

THE MARK CONSISTS OF STANDARD CHARACTERS WITHOUT CLAIM TO ANY PARTICULAR FONT, STYLE, SIZE, OR COLOR.

NO CLAIM IS MADE TO THE EXCLUSIVE RIGHT TO USE "BEST VALUE CIGARETTES", APART FROM THE MARK AS SHOWN.

FOR CIGARETTES (U.S. CLS. 2, 8, 9 AND 17).  
GRETTA YAO, EXAMINING ATTORNEY

THE MARK CONSISTS OF STANDARD CHARACTERS WITHOUT CLAIM TO ANY PARTICULAR FONT, STYLE, SIZE, OR COLOR.

FOR CIGARETTES (U.S. CLS. 2, 8, 9 AND 17).  
TRACY WHITAKER-BOWN, EXAMINING ATTORNEY

SN 78-411,190. TRADEMARK HOLDINGS CORPORATION, MIAMI, FL. FILED 4-30-2004.

SN 79-001,327. AGIO SIGARENFABRIEKEN N.V., NL-5525 AR DUIZEL, NETHERLANDS, FILED 12-29-2003.



**BALMORAL**

THE MARK CONSISTS OF STANDARD CHARACTERS WITHOUT CLAIM TO ANY PARTICULAR FONT, STYLE, SIZE, OR COLOR.

OWNER OF INTERNATIONAL REGISTRATION 0221788 DATED 7-9-1959, EXPIRES 7-9-2009.

OWNER OF U.S. REG. NOS. 539,932, 1,032,485 AND 2,338,974.

FOR TOBACCO, CIGARS, CIGARETTES, CIGARILLOS, CHEWING TOBACCO, SNUFF; MATCHES (U.S. CLS. 2, 8, 9 AND 17).

HOWARD SMIGA, EXAMINING ATTORNEY

OWNER OF U.S. REG. NO. 2,811,347.  
FOR CIGARETTES (U.S. CLS. 2, 8, 9 AND 17).  
FIRST USE 1-0-2002; IN COMMERCE 6-0-2002.  
DEZMONA MIZELLE, EXAMINING ATTORNEY

**CLASS 35—(Continued).**

**SERVICE MARKS**

**CLASS 35—ADVERTISING AND BUSINESS**

SN 74-475,613. ACCU PERSONNEL, INC., PENNSAUKEN, NJ. FILED 12-30-1993.



NO CLAIM IS MADE TO THE EXCLUSIVE RIGHT TO USE "GROUP" AND "PERSONNEL COMPANIES", APART FROM THE MARK AS SHOWN.

FOR PERSONNEL PLACEMENT SERVICES AND TEMPORARY PERSONNEL STAFFING SERVICES (U.S. CL. 101).

FIRST USE 7-1-1989; IN COMMERCE 7-1-1989.  
DAVID H. STINE, EXAMINING ATTORNEY

SN 76-164,893. E4E, INC., SANTA CLARA, CA. FILED 11-13-2000.



FOR BUSINESS CONSULTATION AND BUSINESS OPERATIONAL MANAGEMENT SERVICES FOR TECHNOLOGY COMPANIES, ELECTRONIC COMMERCE COMPANIES, GLOBAL COMPUTER NETWORK BASED COMPANIES AND EXCHANGES, AND INFRASTRUCTURE SERVICE PROVIDERS (U.S. CLS. 100, 101 AND 102).

ALICE BENMAMAN, EXAMINING ATTORNEY

**CLASS 35—(Continued).**

SN 76-182,868. HEALTHCAREMOONLIGHTERS.COM, INC., HOMEWOOD, AL. FILED 12-13-2000.



NO CLAIM IS MADE TO THE EXCLUSIVE RIGHT TO USE ".COM", APART FROM THE MARK AS SHOWN.

FOR PROVIDING ON-LINE INFORMATION CONCERNING EMPLOYMENT AND RECRUITMENT IN THE FIELD OF THE PRACTICE OF MEDICINE; PROVIDING ON-LINE EMPLOYMENT PLACEMENT SERVICES IN THE FIELD OF THE PRACTICE OF MEDICINE, NAMELY, POTENTIAL EMPLOYER-EMPLOYEE MATCHING SERVICES VIA A GLOBAL COMPUTER NETWORK (U.S. CLS. 100, 101 AND 102).

BARBARA GAYNOR, EXAMINING ATTORNEY

SN 76-182,869. HEALTHCAREMOONLIGHTERS.COM, INC., HOMEWOOD, AL. FILED 12-13-2000.

**MOONLIGHTINGDR.COM**

FOR PROVIDING ON-LINE INFORMATION CONCERNING EMPLOYMENT AND RECRUITMENT IN THE FIELD OF THE PRACTICE OF MEDICINE; PROVIDING ON-LINE EMPLOYMENT PLACEMENT SERVICES IN THE FIELD OF THE PRACTICE OF MEDICINE, NAMELY, POTENTIAL EMPLOYER-EMPLOYEE MATCHING SERVICES VIA A GLOBAL COMPUTER NETWORK (U.S. CLS. 100, 101 AND 102).

BARBARA GAYNOR, EXAMINING ATTORNEY

SN 76-223,868. TEKGRAF CORPORATION, GREENVILLE, SC. FILED 3-9-2001.

**TEKGRAF**

FOR DISTRIBUTORSHIP IN THE FIELD OF COMPUTER GRAPHICS TECHNOLOGIES, NAMELY COMPUTER EQUIPMENT AND ACCESSORIES (U.S. CLS. 100, 101 AND 102).

FIRST USE 6-1-1997; IN COMMERCE 6-1-1997.  
JOHN LINCOSKI, EXAMINING ATTORNEY

**CLASS 35—(Continued).**

SN 76-264,316. RESILIEN WORLDWIDE LLC, MELVILLE, NY. FILED 5-29-2001.



FOR DISTRIBUTORSHIP FEATURING ELECTRONIC COMPONENTS, COMPUTER HARDWARE, COMPUTER SOFTWARE AND COMPUTER PRODUCTS OF OTHERS; PURCHASING OF ELECTRONIC COMPONENTS, COMPUTER HARDWARE, COMPUTER SOFTWARE AND COMPUTER PRODUCTS FOR OTHERS (U.S. CLS. 100, 101 AND 102).

FIRST USE 4-18-2001; IN COMMERCE 4-18-2001.  
CURTIS FRENCH, EXAMINING ATTORNEY

---

SN 76-323,948. PRODUCTLAB, INC., CARDIFF, CA. FILED S.R. 10-11-2001; AM. P.R. 12-13-2004.

**PRODUCTLAB**

FOR CONSULTATION REGARDING MARKET POSITIONING FOR THE PRODUCTS AND SERVICES OF OTHERS; BUSINESS MARKETING CONSULTING SERVICES (U.S. CLS. 100, 101 AND 102).

FIRST USE 9-25-2001; IN COMMERCE 9-25-2001.  
DANIEL CAPSHAW, EXAMINING ATTORNEY

---

SN 76-327,441. CENTIENT CONSULTING, INC., DANVILLE, CA. FILED 10-17-2001.

**CENTIENT**

FOR BUSINESS PLANNING AND BUSINESS MANAGEMENT CONSULTATION IN THE FIELD OF BIOINFORMATICS (U.S. CLS. 100, 101 AND 102).

HOWARD B. LEVINE, EXAMINING ATTORNEY

---

SN 76-346,627. TOTAL FITNESS, INC., SOUTH WINDSOR, CT. FILED 12-6-2001.

**TOTAL FITNESS - THE  
RIGHT EQUIPMENT. THE  
RIGHT PEOPLE.**

NO CLAIM IS MADE TO THE EXCLUSIVE RIGHT TO USE "TOTAL FITNESS" AND "EQUIPMENT", APART FROM THE MARK AS SHOWN.

FOR RETAIL STORE SERVICES FEATURING FITNESS EQUIPMENT (U.S. CLS. 100, 101 AND 102).  
FIRST USE 10-29-2001; IN COMMERCE 12-1-2001.  
CATHERINE CAIN, EXAMINING ATTORNEY

**CLASS 35—(Continued).**

SN 76-430,464. TIDEWATER PHYSICAL THERAPY AND REHABILITATION ASSOCIATION, P.A., EASTON, MD. FILED 7-11-2002.

**TIDEWATER CONSULTING**

OWNER OF U.S. REG. NOS. 176,452, 2,557,385 AND OTHERS.

NO CLAIM IS MADE TO THE EXCLUSIVE RIGHT TO USE "CONSULTING", APART FROM THE MARK AS SHOWN.

FOR BUSINESS DEVELOPMENT AND BUSINESS MANAGEMENT SERVICES, NAMELY, MANAGEMENT OF GENERAL HEALTHCARE PRACTICES OF OTHERS, MANAGEMENT OF HUMAN RESOURCE DEPARTMENTS OF OTHERS; BILL MANAGEMENT, NAMELY, BILLING OF HEALTH CARE PATIENTS, MARKETING FOR PROFESSIONALS PROVIDING HEALTH CARE, NAMELY, PLACING ADVERTISEMENTS FOR OTHERS TO SEEK QUALIFIED HEALTH CARE, NAMELY, PLACING ADVERTISEMENTS FOR OTHERS TO SEEK QUALIFIED HEALTH CARE PROFESSIONALS, AND EMPLOYMENT RECRUITMENT OF CONTRACTING PROFESSIONALS PROVIDING HEALTH CARE, PHYSICAL THERAPY AND REHABILITATION SERVICES (U.S. CLS. 100, 101 AND 102).

FIRST USE 2-1-2001; IN COMMERCE 2-1-2001.  
TRICIA THOMPSON, EXAMINING ATTORNEY

---

SN 76-454,357. ADAMS ENTERPRISES, INC., CARSON CITY, NV. FILED 10-1-2002.

**AD TABS MONEY**

OWNER OF U.S. REG. NO. 2,618,600.

FOR PROMOTING THE SALE OF GOODS AND SERVICES OF OTHER BY PROVIDING DISCOUNTS AND INCENTIVES IN THE NATURE OF SWEEPSTAKES, DISCOUNTS, REBATES, VALUE ADDED OFFERS OR THE DISTRIBUTION OF PREMIUMS OR COUPONS, FOR THOSE USING PAYMENT CARDS TO PAY FOR SUCH (U.S. CLS. 100, 101 AND 102).

FIRST USE 4-16-2002; IN COMMERCE 4-16-2002.  
LESLEY LAMOTHE, EXAMINING ATTORNEY

---

SN 76-486,627. FOUNTAIN PARK ACADEMY, INC., LAWRENCEVILLE, GA. FILED 2-3-2003.

**FOUNTAIN PARK ACADEMY**

NO CLAIM IS MADE TO THE EXCLUSIVE RIGHT TO USE "ACADEMY", APART FROM THE MARK AS SHOWN.

FOR FRANCHISING, NAMELY, OFFERING TECHNICAL ASSISTANCE IN THE ESTABLISHMENT AND OPERATION OF NURSERY SCHOOLS, NURSERIES, AND DAYCARE CENTERS (U.S. CLS. 100, 101 AND 102).

FIRST USE 4-1-2004; IN COMMERCE 4-1-2004.  
ALLISON HOLTZ, EXAMINING ATTORNEY

**CLASS 35—(Continued).**

SN 76-500,823. TOTAL GRAPHIC SOLUTIONS, LLC., RED BANK, NJ. FILED 3-3-2003.

## Total Graphic Solutions

NO CLAIM IS MADE TO THE EXCLUSIVE RIGHT TO USE "GRAPHIC SOLUTIONS", APART FROM THE MARK AS SHOWN.

MARK IS SHOWN IN BLUE. CLAIM IS MADE AS TO COLOR.

FOR MARKETING AND ADVERTISING SERVICES, NAMELY SERVING AS A MANUFACTURING REPRESENTATIVE IN THE FIELD OF COMMERCIAL GRAPHIC DESIGN; BUSINESS MANAGEMENT SERVICES, NAMELY MANAGING THE PRODUCTION LOGISTICS OF CUSTOM COMMERCIAL GRAPHIC DESIGNS FOR BUSINESSES TO PROMOTE THEIR PRODUCT SALES TO THE GENERAL PUBLIC, WHEREIN SAID CUSTOM COMMERCIAL GRAPHIC DESIGNS ARE MANUFACTURED BY THIRD PARTIES (U.S. CLS. 100, 101 AND 102).

FIRST USE 1-3-2000; IN COMMERCE 1-3-2000.  
MICHAEL KAZAZIAN, EXAMINING ATTORNEY

SN 76-500,824. TOTAL GRAPHIC SOLUTIONS, LLC., RED BANK, NJ. FILED 3-3-2003.

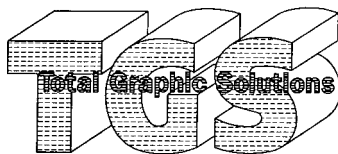

NO CLAIM IS MADE TO THE EXCLUSIVE RIGHT TO USE "GRAPHIC SOLUTIONS", APART FROM THE MARK AS SHOWN.

THREE DIMENSIONAL MARK IS SHOWN IN GRAY AND BLUE. CLAIM IS MADE AS TO COLOR.

FOR MARKETING AND ADVERTISING SERVICES, NAMELY SERVING AS A MANUFACTURING REPRESENTATIVE IN THE FIELD OF COMMERCIAL GRAPHIC DESIGN; BUSINESS MANAGEMENT SERVICES, NAMELY MANAGING THE PRODUCTION LOGISTICS OF CUSTOM COMMERCIAL GRAPHIC DESIGNS FOR BUSINESSES TO PROMOTE THEIR PRODUCT SALES TO THE GENERAL PUBLIC, WHEREIN SAID CUSTOM COMMERCIAL GRAPHIC DESIGNS ARE MANUFACTURED BY THIRD PARTIES (U.S. CLS. 100, 101 AND 102).

FIRST USE 1-3-2000; IN COMMERCE 1-3-2000.  
MICHAEL KAZAZIAN, EXAMINING ATTORNEY

**CLASS 35—(Continued).**

SN 76-501,227. RPMC, INC., CALABASAS, CA. FILED 3-19-2003.

## THE EXCITEMENT AGENCY

NO CLAIM IS MADE TO THE EXCLUSIVE RIGHT TO USE "AGENCY", APART FROM THE MARK AS SHOWN.

FOR PROMOTING THE GOODS AND SERVICES OF OTHERS THROUGH CONTESTS, SWEEPSTAKES, RADIO CAMPAIGNS, TELEVISION CAMPAIGNS, DISCOUNT CARDS FOR TRAVEL, AND COUPONS FOR TRAVEL; ARRANGING FOR SPONSORS TO AFFILIATE THEIR GOODS AND SERVICES WITH SPORTING EVENTS, CONCERTS, AND ENTERTAINMENT EVENTS; AND DEVELOPING PROMOTIONAL CAMPAIGNS FOR BUSINESSES (U.S. CLS. 100, 101 AND 102).

FIRST USE 12-1-2001; IN COMMERCE 12-1-2001.  
SHARI SHEFFIELD, EXAMINING ATTORNEY

SN 76-509,218. C2B MULTIMEDIA SOLUTIONS, INC., AURORA, IL. FILED 4-10-2003.



NO CLAIM IS MADE TO THE EXCLUSIVE RIGHT TO USE "E-ROUTE59.COM YOUR INTERNET GUIDE TO ROUTE 59", APART FROM THE MARK AS SHOWN.

FOR BASED ON USE ON-LINE BUSINESS DIRECTORIES FOR SHOPPING AND BUSINESS CENTERS; PROMOTING THE GOODS AND SERVICES OF OTHERS BY PROVIDING A WEB SITE FEATURING ADVERTISING FOR SHOPPING AND BUSINESS CENTERS, INCLUDING CONTACT AND PRODUCT INFORMATION; BASED ON INTENT TO USE ON-LINE RETAIL AND ORDERING SERVICES FEATURING CONSUMER GOODS, NAMELY, AUTOMOBILES, PET PRODUCTS, CLOTHES, FOOD, SPORTING GOODS, HEALTH CARE PRODUCTS AND HOME IMPROVEMENT PRODUCTS (U.S. CLS. 100, 101 AND 102).

FIRST USE 2-1-2003; IN COMMERCE 3-8-2003.  
RONALD MCMORROW, EXAMINING ATTORNEY

SN 76-513,273. ART A. S. A. P. KIDS INC., NEW YORK, NY. FILED 5-12-2003.

## ART:ASAP KIDS

NO CLAIM IS MADE TO THE EXCLUSIVE RIGHT TO USE "ART" AND "KIDS", APART FROM THE MARK AS SHOWN.

FOR MAIL ORDER SERVICES FEATURING ART PRINTS AND FRAMES FOR CHILDREN PROVIDED VIA PRINT AND ONLINE CATALOGUES (U.S. CLS. 100, 101 AND 102).

FIRST USE 12-19-2001; IN COMMERCE 12-19-2001.  
GWEN STOKOLS, EXAMINING ATTORNEY

**CLASS 35—(Continued).**

SN 76-520,364. NATURAL ENERGY LABORATORY OF HAWAII AUTHORITY (NELHA), KAILUA-KONA, HI. FILED 5-29-2003.



FOR PROMOTING THE RESEARCH, DEVELOPMENT, AND COMMERCIALIZATION OF NATURAL ENERGY RESOURCES AND OCEAN-RELATED RESEARCH, TECHNOLOGY, AND INDUSTRY IN HAWAII (U.S. CLS. 100, 101 AND 102).  
FIRST USE 1-11-1994; IN COMMERCE 4-30-1996.  
TRICIA THOMPSON, EXAMINING ATTORNEY

**CLASS 35—(Continued).**

SN 76-525,836. GEORGIA BREAST CANCER COALITION FUND, ATLANTA, GA. FILED 6-5-2003.



FOR PROMOTING PUBLIC AWARENESS OF THE NEED FOR BREAST CANCER EDUCATION AND BREAST CANCER TREATMENT VIA THE INTERNET (U.S. CLS. 100, 101 AND 102).  
FIRST USE 4-23-2003; IN COMMERCE 4-23-2003.  
BILL DAWE, EXAMINING ATTORNEY

SN 76-526,927. PRICE, CATHY, LOS ANGELES, CA. FILED 6-30-2003.



NO CLAIM IS MADE TO THE EXCLUSIVE RIGHT TO USE "DENTALWORKERS" OR "WWW.DENTALWORKERS.COM", APART FROM THE MARK AS SHOWN.  
THE MARK CONSISTS OF A HAND HOLDING A DENTAL INSTRUMENT ABOVE THE LITERAL ELEMENT OF THE MARK.  
FOR ONLINE CLASSIFIED ADS FOR DENTAL JOBS AND RESUME POSTING FOR WORKERS (U.S. CLS. 100, 101 AND 102).  
FIRST USE 8-1-2001; IN COMMERCE 8-1-2001.  
ROBERT COGGINS, EXAMINING ATTORNEY

**CLASS 35—(Continued).**

SN 76-528,709. THE OPEN ENVELOPE, LLC, GREENVILLE, SC. FILED 7-9-2003.

**THE OPEN ENVELOPE**

NO CLAIM IS MADE TO THE EXCLUSIVE RIGHT TO USE "ENVELOPE", APART FROM THE MARK AS SHOWN. FOR ADDRESSING OF ENVELOPES; MAIL SORTING AND HANDLING (U.S. CLS. 100, 101 AND 102). FIRST USE 6-1-2003; IN COMMERCE 6-1-2003. KIM SAITO, EXAMINING ATTORNEY

---

SN 76-532,876. CHARLOTTE RUSSE MERCHANDISING, INC., SAN DIEGO, CA. FILED 7-15-2003.

**REFERENCE**

FOR RETAIL STORE SERVICES SPECIALIZING IN WOMEN'S APPAREL AND ACCESSORIES (U.S. CLS. 100, 101 AND 102). RONALD MCMORROW, EXAMINING ATTORNEY

---

SN 76-536,913. WAHL, KATHERINE A., BELLMORE, NY. FILED 7-28-2003.

**CARING IS CONTAGIOUS**

FOR PROMOTING PUBLIC AWARENESS OF THE NEED FOR THE DOING OF KIND ACTS FOR OTHERS (U.S. CLS. 100, 101 AND 102). MIDGE BUTLER, EXAMINING ATTORNEY

---

SN 76-539,902. A.S.A.P. PERSONNEL SERVICES, INC., SMITHTOWN, NY. FILED 8-12-2003.

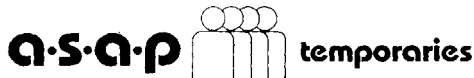

OWNER OF U.S. REG. NOS. 1,515,726 AND 1,575,441. NO CLAIM IS MADE TO THE EXCLUSIVE RIGHT TO USE "TEMPORARIES", APART FROM THE MARK AS SHOWN. SEC. 2(F). FOR TEMPORARY PERSONNEL SERVICES (U.S. CLS. 100, 101 AND 102). FIRST USE 3-12-1981; IN COMMERCE 3-23-1982. DOMINIC J. FERRAIUOLO, EXAMINING ATTORNEY

**CLASS 35—(Continued).**

SN 76-540,951. ORBITEL S.A. E.S.P., MEDELLIN, COLOMBIA, FILED 8-29-2003.



APPLICANT CLAIMS COLOR AS A FEATURE OF THE MARK.

THE MARK FEATURES THE WORD "ORBITEL" IN THE COLOR YELLOW, THE BACKGROUND AROUND THE WORD "ORBITEL" IN THE COLOR BLUE, AND THE STAR AND CIRCLE DESIGN THROUGH THE LETTER "O" IN THE COLOR YELLOW.

FOR OPERATION OF TELEPHONE CALL CENTERS FOR OTHERS; FRANCHISING, NAMELY, OFFERING TECHNICAL ASSISTANCE IN THE ESTABLISHMENT AND/OR OPERATION OF TELECOMMUNICATIONS BUSINESS, NAMELY, TELEPHONE STORES AND FIXED AND WIRELESS TELEPHONE SERVICE PROVIDERS; AND LICENSING FOR THE RENDERING OF TELECOMMUNICATIONS SERVICES, NAMELY TELEPHONE STORES AND FIXED AND WIRELESS TELEPHONE SERVICE PROVIDERS (U.S. CLS. 100, 101 AND 102).

INGRID C. EULIN, EXAMINING ATTORNEY

---

SN 76-542,126. TWINKLEDIAM INC., NEW YORK, NY. FILED 9-2-2003.



THE ENGLISH TRANSLATION OF THE WORD ADORA IN THE MARK IS "IT ADORES".

FOR WHOLESALE AND RETAIL STORE SERVICES FEATURING GOLD, PLATINUM, DIAMOND AND COLOR STONE JEWELRY (U.S. CLS. 100, 101 AND 102). JOHN LINCOSKI, EXAMINING ATTORNEY

---

SN 76-545,680. HUSKER AUTO GROUP, INC., LINCOLN, NE. FILED 9-22-2003.

**It's Worth the Drive!**

THE MARK CONSISTS OF STANDARD CHARACTERS WITHOUT CLAIM TO ANY PARTICULAR FONT, STYLE, SIZE, OR COLOR.

FOR RETAIL STORE SERVICES FEATURING NEW AND USED AUTOMOBILES AND CAR DEALERSHIP SERVICES (U.S. CLS. 100, 101 AND 102).

FIRST USE 11-0-2002; IN COMMERCE 11-0-2002. DEZMONA MIZELLE, EXAMINING ATTORNEY



**CLASS 35—(Continued).**

SN 76-546,838. ZETA SIGMA PHI SORORITY, GLENDALE, CA. FILED 9-8-2003.

## **KNOWLEDGE-COLOR -BEAUTY-POWER**

FOR ASSOCIATION SERVICES, NAMELY, ORGANIZING CHAPTERS AND REGIONAL GROUPS, MAINTENANCE OF MEMBERSHIP IN A COLLEGIATE SORORITY, AND PROMOTING THE INTERESTS OF THE MEMBERS THEREOF; ASSOCIATION SERVICES, NAMELY, PROMOTING THE INTERESTS OF MEMBERS OF A COMMUNITY SERVICES SORORITY; ASSOCIATION SERVICES, NAMELY, PROMOTING THE MENTAL, MORAL, RELIGIOUS IMPROVEMENT, SOCIAL ENJOYMENT AND GENERAL WELFARE OF SORORITY MEMBERS; CONSULTING SERVICES RELATING TO SORORITY ACTIVITIES AND PROCEDURES; AND ESTABLISHMENT AND MAINTENANCE OF MEMBERSHIP IN A NATIONAL COLLEGIATE SORORITY (U.S. CLS. 100, 101 AND 102).

FIRST USE 9-16-1994; IN COMMERCE 9-16-1994.  
MARY CRAWFORD, EXAMINING ATTORNEY

SN 76-546,840. ZETA SIGMA PHI SORORITY, GLENDALE, CA. FILED 9-8-2003.

## **SOME GIRLS DEFINE THEIR LIVES BY A SORORITY, BUT THIS SORORITY IS DEFINED BY OUR LIVES**

FOR ASSOCIATION SERVICES, NAMELY, ORGANIZING CHAPTERS AND REGIONAL GROUPS, MAINTENANCE OF MEMBERSHIP IN A COLLEGIATE SORORITY, AND PROMOTING THE INTERESTS OF THE MEMBERS THEREOF; ASSOCIATION SERVICES, NAMELY, PROMOTING THE INTERESTS OF MEMBERS OF A COMMUNITY SERVICES SORORITY; ASSOCIATION SERVICES, NAMELY, PROMOTING THE MENTAL, MORAL, RELIGIOUS IMPROVEMENT, SOCIAL ENJOYMENT AND GENERAL WELFARE OF SORORITY MEMBERS; CONSULTING SERVICES RELATING TO SORORITY ACTIVITIES AND PROCEDURES; AND ESTABLISHMENT AND MAINTENANCE OF MEMBERSHIP IN A NATIONAL COLLEGIATE SORORITY (U.S. CLS. 100, 101 AND 102).

FIRST USE 9-16-1994; IN COMMERCE 9-16-1994.  
MARY CRAWFORD, EXAMINING ATTORNEY

SN 76-548,381. BARNARD ASSOCIATES, INC., INDIANAPOLIS, IN. FILED 9-15-2003.

## **GRAYMATTERS NETWORK**

NO CLAIM IS MADE TO THE EXCLUSIVE RIGHT TO USE NETWORK, APART FROM THE MARK AS SHOWN.

FOR CONSULTING SERVICES, NAMELY, HUMAN CAPITAL DEPLOYMENT SERVICES IN THE FIELD OF TECHNICAL, ENGINEERING, SCIENTIFIC, AND BUSINESS SERVICES (U.S. CLS. 100, 101 AND 102).

TRACY CROSS, EXAMINING ATTORNEY

**CLASS 35—(Continued).**

SN 76-549,876. TIMMERMAN, WARREN M., DBA LOCKWOOD LEADERSHIP INTERNATIONAL, SIMPSONVILLE, SC. AND BLECHA, DIANE L., DBA LOCKWOOD LEADERSHIP INTERNATIONAL, SIMPSONVILLE, SC. FILED 10-8-2003.

## **INTERACTION STYLE**

OWNER OF U.S. REG. NO. 2,538,706.  
SEC. 2(F).

FOR PROVIDING PROFESSIONAL BUSINESS CONSULTATIONS IN THE AREA OF MANAGEMENT LEADERSHIP ASSESSMENT THAT INCLUDE BUSINESS EVALUATIONS AND REPORTS (U.S. CLS. 100, 101 AND 102).

FIRST USE 1-1-1999; IN COMMERCE 1-1-1999.  
DAWN FELDMAN, EXAMINING ATTORNEY

SN 76-554,440. HUDGINS, GARY A., BRUNSWICK, GA. FILED 10-27-2003.

## **TRUCKS 4 U**

NO CLAIM IS MADE TO THE EXCLUSIVE RIGHT TO USE "TRUCKS", APART FROM THE MARK AS SHOWN. THE MARK CONSISTS OF THE WORD "TRUCKS 4 U" PRINTED IN UPPER CASE LETTERS. COLOR IS NOT A FEATURE OF THE MARK.

FOR TRUCK DEALERSHIPS FEATURING NEW AND USED TRUCKS, AND RETAIL STORE SERVICES FEATURING NEW AND USED TRUCK PARTS (U.S. CLS. 100, 101 AND 102).

FIRST USE 10-14-2003; IN COMMERCE 10-14-2003.  
KATHERINE STOIDES, EXAMINING ATTORNEY

SN 76-555,045. MOORE NORTH AMERICA, INC., STAMFORD, CT. FILED 10-29-2003.

## **MOORE WALLACE MAILTRACKER**

NO CLAIM IS MADE TO THE EXCLUSIVE RIGHT TO USE "MAILTRACKER", APART FROM THE MARK AS SHOWN.

FOR BUSINESS MANAGEMENT SERVICES, NAMELY, GENERATING REPORTS RELATING TO PRODUCTION AND DELIVERY OF MAIL (U.S. CLS. 100, 101 AND 102).

FIRST USE 5-15-2003; IN COMMERCE 5-15-2003.  
GINA HAYES, EXAMINING ATTORNEY

**CLASS 35—(Continued).**

SN 76-556,501. FAZENDA ANA PAULA LTDA, NOVO HAMBURGO, RS - 93320-010, BRAZIL, FILED 10-17-2003.

**FAZENDA ANA PAULA**

NO CLAIM IS MADE TO THE EXCLUSIVE RIGHT TO USE "FAZENDA", APART FROM THE MARK AS SHOWN. THE NAME ANA PAULA DOES NOT IDENTIFY A LIVING INDIVIDUAL.

1. THE ENGLISH TRANSLATION OF THE WORD FAZENDA IN THE MARK IS "FARM."

FOR RETAIL STORE SERVICES AND WHOLESALE DISTRIBUTORSHIP SERVICES FEATURING FOOD PRODUCTS, NAMELY, BEEF, PORK, FOWL, CHICKEN AND FISH, MEAT EXTRACTS, FRUIT AND CONSERVED VEGETABLES BOTH DRIED AND COOKED, JELLY, CANDY, EGGS, COMPOTE, PRESERVED FRUIT, MILK AND DAIRY PRODUCTS, EDIBLE FAT AND OILS (U.S. CLS. 100, 101 AND 102).

FIRST USE 11-18-1998; IN COMMERCE 11-18-1998.

YSA DEJESUS, EXAMINING ATTORNEY

SN 76-559,351. BILLY BLOCKS INCORPORATED, HUNTINGTON, NY. FILED 11-14-2003.



NO CLAIM IS MADE TO THE EXCLUSIVE RIGHT TO USE INCORPORATED, APART FROM THE MARK AS SHOWN.

FOR WHOLESALE DISTRIBUTORSHIP AND LICENSING SERVICES FEATURING WALL DECOR, PICTURE FRAMES, MIRRORS, ARTWORK, ART, CRAFT AND HOBBY PRODUCTS, SPORT PRODUCTS, BATHROOM PRODUCTS, FOOD AND BEVERAGE CONTAINER PRODUCTS, FURNITURE, APPAREL, BEDDING, TOY PRODUCTS, NOVELTY PRODUCTS, STATIONERY PRODUCTS, JUVENILE AND INFANT PRODUCTS (U.S. CLS. 100, 101 AND 102).

SEAN DWYER, EXAMINING ATTORNEY

SN 76-559,812. SCHOLASTIC INC., NEW YORK, NY. FILED 10-30-2003.

**GO MACHINES GO CLUB**

NO CLAIM IS MADE TO THE EXCLUSIVE RIGHT TO USE CLUB, APART FROM THE MARK AS SHOWN.

FOR MAIL ORDER BOOK CLUB SERVICES FEATURING BOOKS AND TOYS FOR CHILDREN (U.S. CLS. 100, 101 AND 102).

WILLIAM P. SHANAHAN, EXAMINING ATTORNEY

**CLASS 35—(Continued).**

SN 76-561,162. INTERNATIONAL GEM & JEWELRY SHOW, INC., ROCKVILLE, MD. FILED 11-20-2003.

**FABULOUS JEWELRY OF THE STARS**

THE MARK CONSISTS OF STANDARD CHARACTERS WITHOUT CLAIM TO ANY PARTICULAR FONT, STYLE, SIZE, OR COLOR.

NO CLAIM IS MADE TO THE EXCLUSIVE RIGHT TO USE "JEWELRY", APART FROM THE MARK AS SHOWN. SEC. 2(F).

FOR ON-LINE RETAIL STORE SERVICES FEATURING JEWELRY (U.S. CLS. 100, 101 AND 102).

FIRST USE 0-0-1996; IN COMMERCE 0-0-1996.

INGA ERVIN, EXAMINING ATTORNEY

SN 76-562,709. PROJECT INNOVATIONS, INC., FARMINGTON HILLS, MI. FILED 11-17-2003.

**THE INDIVIDUAL AND ORGANIZATIONAL PATH TO DISCOVERY**

THE MARK CONSISTS OF STANDARD CHARACTERS WITHOUT CLAIM TO ANY PARTICULAR FONT, STYLE, SIZE, OR COLOR.

FOR BUSINESS MANAGEMENT CONSULTING SERVICES (U.S. CLS. 100, 101 AND 102).

FIRST USE 5-27-2003; IN COMMERCE 5-27-2003.

JENNIFER CHICOSKI, EXAMINING ATTORNEY

SN 76-563,605. SILVERMAN, LORI L., MADISON, WI. FILED 11-21-2003.

**SAY IT WITH A STORY**

THE MARK CONSISTS OF STANDARD CHARACTERS WITHOUT CLAIM TO ANY PARTICULAR FONT, STYLE, SIZE, OR COLOR.

FOR BUSINESS CONSULTATION SERVICES, NAMELY, AIDING BUSINESS ORGANIZATIONS IN ACHIEVING AND MAINTAINING A COMPETITIVE ADVANTAGE THROUGH INSPIRATIONAL WORKPLACE STORIES AND INFORMATION (U.S. CLS. 100, 101 AND 102).

FIRST USE 4-11-2003; IN COMMERCE 4-11-2003.

SUE LAWRENCE, EXAMINING ATTORNEY

**CLASS 35—(Continued).**

SN 76-566,308. JUST THE THING, INC., ATLANTA, GA. FILED 12-22-2003.

# JUST THE THING

THE MARK CONSISTS OF STANDARD CHARACTERS WITHOUT CLAIM TO ANY PARTICULAR FONT, STYLE, SIZE, OR COLOR.

FOR RETAIL STORE SERVICES AND ON-LINE RETAIL STORE SERVICES OF PERSONAL ACCESSORIES, NAMELY, JEWELRY, NECKLACES, PINS, BRACELETS, EARRINGS, RINGS, HANDBAGS, WALLETS, SCARVES, SHAWLS, BELTS, WATCHES, UMBRELLAS, GIFT BAGS, DECORATIVE ACCESSORIES, KEY RINGS, NAPKINS, NOTEPADS, PICTURES, WINE CORKS, WINE BAGS, AND COSMETIC BAGS (U.S. CLS. 100, 101 AND 102).

FIRST USE 9-30-1991; IN COMMERCE 9-30-1991.  
CURTIS FRENCH, EXAMINING ATTORNEY

**CLASS 35—(Continued).**

SN 76-568,660. PHARMED STAFFING, LLC, NEW YORK, NY. FILED 12-24-2003.

# PharMed

THE MARK CONSISTS OF STANDARD CHARACTERS WITHOUT CLAIM TO ANY PARTICULAR FONT, STYLE, SIZE, OR COLOR.

FOR PERSONNEL PLACEMENT SERVICES, NAMELY, RECRUITING, AND EMPLOYMENT PLACEMENT OF PERSONNEL HAVING PHARMACEUTICAL INDUSTRY-RELATED ADVERTISING, MARKETING, AND ADMINISTRATIVE RESOURCES EXPERIENCE IN THE MEDICAL COMMUNICATIONS INDUSTRY ON A FREELANCE BASIS (U.S. CLS. 100, 101 AND 102).

FIRST USE 4-15-2002; IN COMMERCE 4-15-2002.  
DAWN HAN, EXAMINING ATTORNEY

SN 76-566,858. MELAMED, SHANA, BEVERLY HILLS, CA. FILED 12-5-2003.

# ROX-SAN PHARMACY

THE MARK CONSISTS OF STANDARD CHARACTERS WITHOUT CLAIM TO ANY PARTICULAR FONT, STYLE, SIZE, OR COLOR.

NO CLAIM IS MADE TO THE EXCLUSIVE RIGHT TO USE "PHARMACY", APART FROM THE MARK AS SHOWN.

FOR RETAIL PHARMACY SERVICES (U.S. CLS. 100, 101 AND 102).

FIRST USE 1-1-1973; IN COMMERCE 1-1-1973.  
SUELLEN HICKEY, EXAMINING ATTORNEY

SN 76-568,661. PHARMED STAFFING, LLC, NEW YORK, NY. FILED 12-24-2003.

# PharMed

FOR PERSONNEL PLACEMENT SERVICES, NAMELY, RECRUITING, AND EMPLOYMENT PLACEMENT OF PERSONNEL HAVING PHARMACEUTICAL INDUSTRY-RELATED ADVERTISING, MARKETING, AND ADMINISTRATIVE RESOURCES EXPERIENCE IN THE MEDICAL COMMUNICATIONS INDUSTRY ON A FREELANCE BASIS (U.S. CLS. 100, 101 AND 102).

FIRST USE 4-15-2002; IN COMMERCE 4-15-2002.  
DAWN HAN, EXAMINING ATTORNEY

SN 76-567,841. PNC BANK, NATIONAL ASSOCIATION, EAST BRUNSWICK, NJ. FILED 12-31-2003.



FOR BUSINESS CONSULTING SERVICES RELATING TO THE FOLLOWING— PRODUCT DISTRIBUTION, OPERATIONS MANAGEMENT SERVICES, LOGISTICS, REVERSE LOGISTICS, SUPPLY CHAIN, AND PRODUCTION SYSTEMS AND DISTRIBUTION SOLUTIONS; AND BUSINESS MANAGEMENT SERVICES, NAMELY, MANAGING ALL OF THE FOLLOWING— LOGISTICS, REVERSE LOGISTICS, SUPPLY CHAIN SERVICES, SUPPLY CHAIN VISIBILITY AND SYNCHRONIZATION, SUPPLY AND DEMAND FORECASTING AND PRODUCT DISTRIBUTION PROCESSES FOR OTHERS (U.S. CLS. 100, 101 AND 102).

TONJA GASKINS, EXAMINING ATTORNEY

SN 76-571,410. DEE CEE LABORATORIES, INC., WHITE HOUSE, TN. FILED 1-22-2004.



FOR RETAIL STORE SERVICES FEATURING DIETARY SUPPLEMENTS AND HOMEOPATHIC PREPARATIONS, NAMELY, VITAMINS, NUTRITIONAL SUPPLEMENTS, HERBAL SUPPLEMENTS, APPETITE SUPPRESSANTS, MUSCLE RELAXANTS, LAXATIVES, STOOL SOFTENERS, PAIN RELIEVERS, NASAL DECONGESTANTS, INTERNAL DEODORANTS AND SLEEP AIDS VIA MAIL-ORDER AND TELEPHONE CATALOG SALES AND VIA THE GLOBAL COMPUTER NETWORK (U.S. CLS. 100, 101 AND 102).

FIRST USE 12-31-1990; IN COMMERCE 12-31-1990.  
TRACY CROSS, EXAMINING ATTORNEY

**CLASS 35—(Continued).**

SN 76-572,918. GEEHAN ADVISORY GROUP, INC., DAYTON, OH. FILED 1-28-2004.

**LIVING WHAT YOU'RE SELLING**

THE MARK CONSISTS OF STANDARD CHARACTERS WITHOUT CLAIM TO ANY PARTICULAR FONT, STYLE, SIZE, OR COLOR.

FOR BUSINESS MANAGEMENT AND CONSULTATION, NAMELY ORGANIZATIONAL CONSULTING SERVICES RELATED TO DEVELOPMENT OF STRATEGIES FOR BUILDING, MANAGING AND IMPROVING COMPANY ADVISORY BOARDS (U.S. CLS. 100, 101 AND 102).

FIRST USE 1-20-2003; IN COMMERCE 4-16-2003.  
NANCY CLARKE, EXAMINING ATTORNEY

SN 76-574,701. OFFICE OF 21ST CENTURY WORKFORCE, WASHINGTON, DC. FILED 2-9-2004.



NO CLAIM IS MADE TO THE EXCLUSIVE RIGHT TO USE WOMEN ENTREPRENEURSHIP, APART FROM THE MARK AS SHOWN.

FOR PROVIDING INFORMATION IN THE FIELD OF WORKING WOMEN (U.S. CLS. 100, 101 AND 102).  
DAWN FELDMAN, EXAMINING ATTORNEY

SN 76-575,796. SNAP AUCTIONS, INC., AUSTIN, TX. FILED 2-17-2004.



FOR BUSINESS CONSULTATION IN THE FIELD OF ONLINE CONSIGNMENT SHOPPING SERVICES; ADVERTISING SERVICES FOR ONLINE CONSIGNMENT SHOPPING SERVICES, NAMELY, ADVERTISING FOR THE ACCEPTANCE AND LISTING OF GOODS AND SERVICES FROM SELLERS FOR SALE ON CONSIGNMENT ON THIRD PARTY COMPUTER NETWORKS TO CUSTOMERS WORLDWIDE; BILLING AND COOPERATIVE MARKETING IN THE FIELD OF ONLINE CONSIGNMENT SHOPPING SERVICES (U.S. CLS. 100, 101 AND 102).

FIRST USE 1-21-2004; IN COMMERCE 1-21-2004.  
SHARON MEIER, EXAMINING ATTORNEY

**CLASS 35—(Continued).**

SN 76-575,797. SNAP AUCTIONS, INC., AUSTIN, TX. FILED 2-17-2004.

# SNAP

FOR BUSINESS CONSULTATION IN THE FIELD OF ONLINE CONSIGNMENT SHOPPING SERVICES; ADVERTISING SERVICES FOR ONLINE CONSIGNMENT SHOPPING SERVICES, NAMELY, ADVERTISING FOR THE ACCEPTANCE AND LISTING OF GOODS AND SERVICES FROM SELLERS FOR SALE ON CONSIGNMENT ON THIRD PARTY COMPUTER NETWORKS TO CUSTOMERS WORLDWIDE; BILLING AND COOPERATIVE MARKETING IN THE FIELD OF ONLINE CONSIGNMENT SHOPPING SERVICES (U.S. CLS. 100, 101 AND 102).

FIRST USE 1-21-2004; IN COMMERCE 1-21-2004.  
SHARON MEIER, EXAMINING ATTORNEY

SN 76-576,256. KINDRED HEALTHCARE, INC., LOUISVILLE, KY. FILED 2-19-2004.

ONE PRESCRIPTION AT A TIME, ONE PERSON AT A TIME

THE MARK CONSISTS OF STANDARD CHARACTERS WITHOUT CLAIM TO ANY PARTICULAR FONT, STYLE, SIZE, OR COLOR.

FOR RETAIL PHARMACY SERVICES DIRECTED PRIMARILY TO INSTITUTIONS, NAMELY HOSPITALS, SKILLED NURSING CARE CENTERS, REHABILITATION CENTERS AND OTHER MANAGED CARE FACILITIES. (U.S. CLS. 100, 101 AND 102).

ALICE BENMAMAN, EXAMINING ATTORNEY

SN 76-578,823. ALAMO GROUP INC., SEGUIN, TX. FILED 3-1-2004.



OWNER OF U.S. REG. NOS. 2,203,979, 2,218,430 AND OTHERS.

NO CLAIM IS MADE TO THE EXCLUSIVE RIGHT TO USE GROUP, APART FROM THE MARK AS SHOWN.

FOR DISTRIBUTORSHIP SERVICES IN THE FIELD OF MACHINERY, NAMELY, AGRICULTURAL, INDUSTRIAL, AND CONSUMER MOWERS OF ROTARY, FLAIL AND SICKLE BAR TYPES, POWER POSTHOLE DIGGERS, BOOM MOUNTED MOWERS, DITCH DIGGERS AND TREE TRIMMERS, LEVELING BLADES FOR MACHINES FOR SOIL MOVING (U.S. CLS. 100, 101 AND 102).

FIRST USE 6-30-1997; IN COMMERCE 6-30-1997.  
AMY HELLA, EXAMINING ATTORNEY

**CLASS 35—(Continued).**

SN 76-578,967. NETLINK REALTY ONLINE MAGAZINE, LLC, PHOENIX, AZ. FILED 3-3-2004.

**NETLINK**

THE MARK CONSISTS OF STANDARD CHARACTERS WITHOUT CLAIM TO ANY PARTICULAR FONT, STYLE, SIZE, OR COLOR.

OWNER OF U.S. REG. NOS. 2,350,592 AND 2,727,672.  
FOR ONLINE BUSINESS DIRECTORY FEATURING REAL ESTATE LISTINGS (U.S. CLS. 100, 101 AND 102).  
FIRST USE 1-0-2003; IN COMMERCE 1-0-2003.  
ALICIA COLLINS, EXAMINING ATTORNEY

SN 76-581,994. AMERICAN VETERINARY MEDICAL ASSOCIATION, SCHAUMBURG, IL. FILED 3-17-2004.

**NATIONAL PET WEEK**

THE MARK CONSISTS OF STANDARD CHARACTERS WITHOUT CLAIM TO ANY PARTICULAR FONT, STYLE, SIZE, OR COLOR.

NO CLAIM IS MADE TO THE EXCLUSIVE RIGHT TO USE WEEK, APART FROM THE MARK AS SHOWN.  
SEC. 2(F).

FOR ASSOCIATION SERVICES NAMELY PROMOTING AWARENESS OF THE BENEFITS OF PET OWNERSHIP (U.S. CLS. 100, 101 AND 102).

FIRST USE 0-0-1981; IN COMMERCE 0-0-1981.  
DORITT L. CARROLL, EXAMINING ATTORNEY

SN 76-582,570. R & B REALTY GROUP, DBA OAKWOOD WORLDWIDE, LOS ANGELES, CA. FILED 3-19-2004.

THE MOST TRUSTED NAME IN SERVICED APARTMENTS WORLDWIDE

THE MARK CONSISTS OF STANDARD CHARACTERS WITHOUT CLAIM TO ANY PARTICULAR FONT, STYLE, SIZE, OR COLOR.

OWNER OF U.S. REG. NO. 2,245,997.  
FOR HOTEL MANAGEMENT SERVICES FOR OTHERS (U.S. CLS. 100, 101 AND 102).  
FIRST USE 12-31-1997; IN COMMERCE 12-31-1997.  
RONALD MCMORROW, EXAMINING ATTORNEY

**CLASS 35—(Continued).**

SN 76-583,474. PREST-O-FIT MFG., INC., CHANDLER, AZ. FILED 3-29-2004.

**THE WORLD IS YOUR BACKYARD**

THE MARK CONSISTS OF STANDARD CHARACTERS WITHOUT CLAIM TO ANY PARTICULAR FONT, STYLE, SIZE, OR COLOR.

FOR RETAIL STORE SERVICES, MAIL ORDER SERVICES AND ONLINE RETAIL STORE SERVICES IN THE FIELD OF EQUIPMENT, NAMELY, SEWER ELBOWS, PUSHOVER QUICK CONNECTORS, STRAIGHT HOSE COUPLERS, SEWER HOSE ADAPTERS, PUSHOVER TERMINATION CAPS, ELBOW STORAGE FITTINGS, SEWER HOSES, SEWER HOSE SUPPORTS AND PROTECTORS, HOSE COUPLER KITS, QUICK CONNECT SEWER KITS, SEWER KITS, TERMINATION KITS, STAINLESS CLAMPS, STEP RUGS, DOOR MATS, PATIO RUGS, RV INDOOR RUGS, BATHROOM MATS, KITCHEN MATS, HALL RUNNERS, WELCOME MATS AND SPRINGS, FOR USE WITH RECREATIONAL VEHICLES (U.S. CLS. 100, 101 AND 102).

DOUGLAS LEE, EXAMINING ATTORNEY

SN 76-583,605. VIAMEDIC, INC., TEMPE, AZ. FILED 3-29-2004.

**VIAMEDIC**

THE MARK CONSISTS OF STANDARD CHARACTERS WITHOUT CLAIM TO ANY PARTICULAR FONT, STYLE, SIZE, OR COLOR.

FOR ON LINE ORDERING AND RETAIL STORE SERVICES IN THE FIELD OF PHARMACEUTICAL PRODUCTS AND PRESCRIPTION DRUGS (U.S. CLS. 100, 101 AND 102).

FIRST USE 10-30-1998; IN COMMERCE 10-30-1998.  
BRENDAN REGAN, EXAMINING ATTORNEY

SN 76-584,236. EVA-TONE, INC., CLEARWATER, FL. FILED 3-31-2004.

**SUBSEEKER**

THE MARK CONSISTS OF STANDARD CHARACTERS WITHOUT CLAIM TO ANY PARTICULAR FONT, STYLE, SIZE, OR COLOR.

FOR ANALYZING A PUBLICATION'S SUBSCRIPTION DATABASE AS TO THE TYPE OF SUBSCRIBERS AND DESIGNING PROMOTIONAL MATERIAL TARGETING THAT TYPE OF SUBSCRIBER TO ENCOURAGE THEM TO SUBSCRIBE TO THE PUBLICATION (U.S. CLS. 100, 101 AND 102).

BRETT J. GOLDEN, EXAMINING ATTORNEY

**CLASS 35—(Continued).**

SN 76-584,261. EXTREME AUTO & TRUCK INC, POMPANO BEACH, FL. FILED 3-29-2004.

**GET CUSTOMIZED**

THE MARK CONSISTS OF STANDARD CHARACTERS WITHOUT CLAIM TO ANY PARTICULAR FONT, STYLE, SIZE, OR COLOR.

NO CLAIM IS MADE TO THE EXCLUSIVE RIGHT TO USE "CUSTOMIZED", APART FROM THE MARK AS SHOWN.

FOR PRODUCT MARKETING SERVICES FOR OTHERS FOR THE SALE OF VEHICLE ACCESSORY PACKAGES BASED ON CONSUMER LIFESTYLES AND DRIVING HABITS OFFERED THROUGH PARTICIPATING NEW AND USED CAR DEALERSHIPS (U.S. CLS. 100, 101 AND 102).

FIRST USE 1-2-2003; IN COMMERCE 1-2-2003.  
ERNEST SHOSHO, EXAMINING ATTORNEY

---

SN 76-585,323. BANNER ASSOCIATES, INC., CHEVY CHASE, MD. FILED 4-6-2004.

**YOUR HR LIFELINE**

THE MARK CONSISTS OF STANDARD CHARACTERS WITHOUT CLAIM TO ANY PARTICULAR FONT, STYLE, SIZE, OR COLOR.

NO CLAIM IS MADE TO THE EXCLUSIVE RIGHT TO USE HR, APART FROM THE MARK AS SHOWN.

FOR BUSINESS CONSULTING SERVICES RELATING TO HUMAN RESOURCE MANAGEMENT, RECRUITMENT FOR ALL LEVELS OF PERSONNEL, AND EMPLOYEE TRAINING PROGRAMS (U.S. CLS. 100, 101 AND 102).

FIRST USE 12-1-2003; IN COMMERCE 12-1-2003.  
YSA DEJESUS, EXAMINING ATTORNEY

---

SN 76-585,324. BANNER ASSOCIATES, INC., CHEVY CHASE, MD. FILED 4-6-2004.

**BANNER ASSOCIATES YOUR HR LIFELINE**

THE MARK CONSISTS OF STANDARD CHARACTERS WITHOUT CLAIM TO ANY PARTICULAR FONT, STYLE, SIZE, OR COLOR.

NO CLAIM IS MADE TO THE EXCLUSIVE RIGHT TO USE ASSOCIATES AND HR, APART FROM THE MARK AS SHOWN.

FOR BUSINESS CONSULTING SERVICES RELATING TO HUMAN RESOURCE MANAGEMENT, RECRUITMENT FOR ALL LEVELS OF PERSONNEL, AND EMPLOYEE TRAINING PROGRAMS (U.S. CLS. 100, 101 AND 102).

FIRST USE 12-1-2003; IN COMMERCE 12-1-2003.  
YSA DEJESUS, EXAMINING ATTORNEY

**CLASS 35—(Continued).**

SN 76-585,909. HMS NATIONAL, INC., FT. LAUDERDALE, FL. FILED 4-9-2004.

**THE REAL ESTATE SUPPORT SOLUTION**

THE MARK CONSISTS OF STANDARD CHARACTERS WITHOUT CLAIM TO ANY PARTICULAR FONT, STYLE, SIZE, OR COLOR.

OWNER OF U.S. REG. NOS. 2,155,046 AND 2,156,993.

NO CLAIM IS MADE TO THE EXCLUSIVE RIGHT TO USE "REAL ESTATE SUPPORT", APART FROM THE MARK AS SHOWN.

FOR MARKETING AND ADVERTISING SUPPORT SERVICES FOR REAL ESTATE BROKERS AND AGENTS (U.S. CLS. 100, 101 AND 102).

FIRST USE 0-0-1997; IN COMMERCE 0-0-1997.  
SUELLEN HICKEY, EXAMINING ATTORNEY

---

SN 76-586,346. FORJOCKS, INC., ANAHEIM, CA. FILED 4-5-2004.

**FORJOCKS.**

THE MARK CONSISTS OF STANDARD CHARACTERS WITHOUT CLAIM TO ANY PARTICULAR FONT, STYLE, SIZE, OR COLOR.

FOR PROMOTING THE SPORTS PRODUCTS, NAMELY, CLOTHING OF OTHERS VIA ADVERTISEMENTS ON THE INTERNET (U.S. CLS. 100, 101 AND 102).

MICHELE SWAIN, EXAMINING ATTORNEY

---

SN 76-586,764. IHMA TECHNOLOGIES, LLC, HOUSTON, TX. FILED 4-14-2004.

**IHMA**

THE MARK CONSISTS OF STANDARD CHARACTERS WITHOUT CLAIM TO ANY PARTICULAR FONT, STYLE, SIZE, OR COLOR.

FOR PROVIDING INFORMATION TO HEALTHCARE PROVIDERS, VENDORS AND CONSULTANTS IN THE FIELD OF HEALTH CARE COST AND MANAGING HEALTHCARE FACILITIES (U.S. CLS. 100, 101 AND 102).

STACY WAHLBERG, EXAMINING ATTORNEY

**CLASS 35—(Continued).**

SN 76-586,934. STRATHMORE PARTNERS LP, CONCORD, NH. FILED 4-13-2004.

**CLASS 35—(Continued).**

SN 76-588,770. DUMANEE, LLC, AUGUSTA, GA. FILED 4-26-2004.

**PROFOODS RESTAURANT SUPPLY**

THE MARK CONSISTS OF STANDARD CHARACTERS WITHOUT CLAIM TO ANY PARTICULAR FONT, STYLE, SIZE, OR COLOR.

NO CLAIM IS MADE TO THE EXCLUSIVE RIGHT TO USE "RESTAURANT SUPPLY", APART FROM THE MARK AS SHOWN.

FOR RETAIL BUYING CLUB SERVICES FEATURING FOOD, EQUIPMENT AND FURNISHINGS FOR RESTAURANTS AND CATERERS (U.S. CLS. 100, 101 AND 102).

FIRST USE 4-3-2004; IN COMMERCE 4-3-2004.  
MICHELE SWAIN, EXAMINING ATTORNEY

**DUMANEE**

THE MARK CONSISTS OF STANDARD CHARACTERS WITHOUT CLAIM TO ANY PARTICULAR FONT, STYLE, SIZE, OR COLOR.

FOR RETAIL STORE SERVICES FEATURING CHILDREN'S CLOTHING AND ACCESSORIES (U.S. CLS. 100, 101 AND 102).

FIRST USE 11-0-2003; IN COMMERCE 11-0-2003.  
WON TEAK OH, EXAMINING ATTORNEY

SN 76-587,543. BROKER'S RESOURCE CENTER, INC., DBA LITTELL CONSULTING SERVICES, ATLANTA, GA. FILED 4-20-2004.

SN 76-588,779. AMERICAN APPAREL & FOOTWEAR ASSOCIATION, ARLINGTON, VA. FILED 4-26-2004.

**DATEWEAVING**

THE MARK CONSISTS OF STANDARD CHARACTERS WITHOUT CLAIM TO ANY PARTICULAR FONT, STYLE, SIZE, OR COLOR.

FOR BUSINESS CONSULTING SERVICES (U.S. CLS. 100, 101 AND 102).

MICHAEL SOUDERS, EXAMINING ATTORNEY

*We Dress the World!*

FOR ASSOCIATION SERVICES, NAMELY PROMOTING THE INTERESTS OF INDIVIDUALS WORKING IN THE FIELDS OF FASHION, APPAREL AND FOOTWEAR MANUFACTURING AND THE INTERESTS OF THE FASHION, APPAREL AND FOOTWEAR INDUSTRY (U.S. CLS. 100, 101 AND 102).

FIRST USE 3-0-2003; IN COMMERCE 3-0-2003.  
DANIEL BRODY, EXAMINING ATTORNEY

SN 76-588,275. COUNTRY OAKS LANDSCAPE SUPPLY, CLARKSTON, MI. FILED 4-21-2004.

SN 76-588,780. AMERICAN APPAREL & FOOTWEAR ASSOCIATION, ARLINGTON, VA. FILED 4-26-2004.

**GO WHERE THE CONTRACTORS GO**

THE MARK CONSISTS OF STANDARD CHARACTERS WITHOUT CLAIM TO ANY PARTICULAR FONT, STYLE, SIZE, OR COLOR.

FOR RETAIL OUTLETS AND WHOLESALE STORES FEATURING LANDSCAPING AND NURSERY SUPPLIES, NAMELY DECORATIVE GRAVEL, BRICK PAVERS, MULCH, WOODCHIPS, HYDROSEED SUPPLIES, FLAGSTONE, RETAINING WALL BLOCKS AND SUPPLIES, NURSERY STOCK AND RELATED ITEMS (U.S. CLS. 100, 101 AND 102).

MARIA-VICTORIA SUAREZ, EXAMINING ATTORNEY

**WE DRESS THE WORLD!**

THE MARK CONSISTS OF STANDARD CHARACTERS WITHOUT CLAIM TO ANY PARTICULAR FONT, STYLE, SIZE, OR COLOR.

FOR ASSOCIATION SERVICES, NAMELY PROMOTING THE INTERESTS OF INDIVIDUALS WORKING IN THE FIELDS OF FASHION, APPAREL AND FOOTWEAR MANUFACTURING AND THE INTERESTS OF THE FASHION, APPAREL AND FOOTWEAR INDUSTRY (U.S. CLS. 100, 101 AND 102).

FIRST USE 3-0-2003; IN COMMERCE 3-0-2003.  
DANIEL BRODY, EXAMINING ATTORNEY

**CLASS 35—(Continued).**

SN 76-590,569. OKLAHOMA PUBLISHING COMPANY, THE, OKLAHOMA CITY, OK. FILED 5-5-2004.

**CLASS 35—(Continued).**

SN 76-591,276. TICKETSAGE, INC., FAYETTEVILLE, AR. FILED 5-10-2004.

**THE OKLAHOMAN DIRECT**

THE MARK CONSISTS OF STANDARD CHARACTERS WITHOUT CLAIM TO ANY PARTICULAR FONT, STYLE, SIZE, OR COLOR.

OWNER OF U.S. REG. NO. 2,299,554.

NO CLAIM IS MADE TO THE EXCLUSIVE RIGHT TO USE "DIRECT", APART FROM THE MARK AS SHOWN.

FOR DIRECT MARKETING ADVERTISING FOR OTHERS (U.S. CLS. 100, 101 AND 102).

FIRST USE 4-0-2001; IN COMMERCE 4-0-2001.

MARCIE MILONE, EXAMINING ATTORNEY

**TICKETSAGE**

THE MARK CONSISTS OF STANDARD CHARACTERS WITHOUT CLAIM TO ANY PARTICULAR FONT, STYLE, SIZE, OR COLOR.

FOR TICKET AGENCY SERVICES FOR PERFORMING ARTS, CONCERTS, FAIRS, RODEOS, FESTIVALS AND MISCELLANEOUS EVENTS (U.S. CLS. 100, 101 AND 102).

FIRST USE 10-3-1999; IN COMMERCE 5-5-2000.

JOHN DWYER, EXAMINING ATTORNEY

SN 76-590,711. HARRIS VENTURES, INC., ROSWELL, GA. FILED 5-6-2004.

**STAFF ZONE**

THE MARK CONSISTS OF STANDARD CHARACTERS WITHOUT CLAIM TO ANY PARTICULAR FONT, STYLE, SIZE, OR COLOR.

NO CLAIM IS MADE TO THE EXCLUSIVE RIGHT TO USE "STAFF", APART FROM THE MARK AS SHOWN.

FOR FURNISHING TEMPORARY LABOR FOR LIGHT INDUSTRIAL WORK (U.S. CLS. 100, 101 AND 102).

TANYA AMOS, EXAMINING ATTORNEY

SN 76-591,532. THE DALLAS CONVENTION & VISITORS BUREAU, DALLAS, TX. FILED 4-30-2004.

SN 76-590,721. AMERICAN SPORTS LICENSING, INC., WILMINGTON, DE. FILED 5-6-2004.

**HOOPTOWN**

FOR RETAIL STORE SERVICES IN THE FIELD OF BASKETBALL SPORTING GOODS AND BASKETBALL CLOTHING, NAMELY, BALLS, NETS, HOOPS, BACKBOARDS, JERSEYS, SHORTS, WARMUP SUITS, ATHLETIC SUPPORTERS, SHOES (U.S. CLS. 100, 101 AND 102).

DORITT L. CARROLL, EXAMINING ATTORNEY

THE MARK CONSISTS IN PART STAR DESIGN. SEC. 2(F).

FOR ADVERTISING AND BUSINESS SERVICES, NAMELY, PROMOTING BUSINESS, CONVENTIONS AND TOURISM IN THE CITY OF DALLAS, TEXAS (U.S. CLS. 100, 101 AND 102).

FIRST USE 10-0-1998; IN COMMERCE 10-0-1998.

ANN E. SAPPENFIELD, EXAMINING ATTORNEY



**CLASS 35—(Continued).**

SN 76-591,534. THE DALLAS CONVENTION & VISITORS BUREAU, DALLAS, TX. FILED 4-30-2004.



NO CLAIM IS MADE TO THE EXCLUSIVE RIGHT TO USE "DALLAS", APART FROM THE MARK AS SHOWN. THE MARK CONSISTS IN PART OF A STAR AND LEAVES WITHIN A CIRCLE DESIGN. FOR ADVERTISING AND BUSINESS SERVICES, NAMELY, PROMOTING BUSINESS, CONVENTIONS AND TOURISM IN THE CITY OF DALLAS, TEXAS (U.S. CLS. 100, 101 AND 102). FIRST USE 2-26-2004; IN COMMERCE 2-26-2004. ANN E. SAPPENFIELD, EXAMINING ATTORNEY

SN 76-591,595. UNITED COMMUNICATIONS GROUP LIMITED PARTNERSHIP, ROCKVILLE, MD. FILED 5-11-2004.

**DECISIONCODER**

THE MARK CONSISTS OF STANDARD CHARACTERS WITHOUT CLAIM TO ANY PARTICULAR FONT, STYLE, SIZE, OR COLOR. FOR ON-LINE SERVICES ON A GLOBAL COMPUTER NETWORK PROVIDING INFORMATION RELATING TO MEDICAL BILLING, CODING, AND COMPLIANCE (U.S. CLS. 100, 101 AND 102). FIRST USE 4-4-2004; IN COMMERCE 4-4-2004. ARETHA SOMERVILLE, EXAMINING ATTORNEY

SN 76-591,640. STRATAMED, LLC, CHARLOTTE, NC. FILED 5-11-2004.

**STRATAMED**

THE MARK CONSISTS OF STANDARD CHARACTERS WITHOUT CLAIM TO ANY PARTICULAR FONT, STYLE, SIZE, OR COLOR. FOR EMPLOYMENT HIRING, RECRUITING, PLACEMENT AND STAFFING FOR MEDICAL SERVICES (U.S. CLS. 100, 101 AND 102). FIRST USE 3-23-2004; IN COMMERCE 3-23-2004. JOHN DALIER, EXAMINING ATTORNEY

**CLASS 35—(Continued).**

SN 76-591,991. PAGOSA TECHNOLOGIES, INC., DALLAS, TX. FILED 5-13-2004.

**EXTRASERVE**

OWNER OF U.S. REG. NOS. 2,490,281 AND 2,509,019. FOR MANAGEMENT SERVICES, NAMELY, MANAGING THE PROCUREMENT AND INSTALLATION OF LABOR AND MATERIALS FOR PROPERTY AND CASUALTY INSURANCE CARRIERS (U.S. CLS. 100, 101 AND 102). FIRST USE 9-0-2003; IN COMMERCE 9-0-2003. CAROLYN CATALDO, EXAMINING ATTORNEY

SN 76-592,072. DETROIT NEWSPAPER AGENCY, DETROIT, MI. FILED 5-13-2004.



THE SHADING IN THE MARK IS A STYLIZED REPRESENTATION OF A WINDING ROAD. IS A PART OF THE MARK, AND DOES NOT INDICATE COLOR. FOR ADVERTISING SERVICES, NAMELY, PROVIDING ADVERTISING SPACE IN A NEWSPAPER AND ON AN INTERNET WEB SITE (U.S. CLS. 100, 101 AND 102). FIRST USE 1-0-2003; IN COMMERCE 1-0-2003. DOMINIC J. FERRAIUOLO, EXAMINING ATTORNEY

SN 76-592,073. DETROIT NEWSPAPER AGENCY, DETROIT, MI. FILED 5-13-2004.



FOR ADVERTISING SERVICES, NAMELY, PROVIDING ADVERTISING SPACE IN A NEWSPAPER AND ON AN INTERNET WEB SITE (U.S. CLS. 100, 101 AND 102). FIRST USE 1-0-2003; IN COMMERCE 1-0-2003. DOMINIC J. FERRAIUOLO, EXAMINING ATTORNEY

**CLASS 35—(Continued).**

SN 76-592,680. WALGREEN CO., DEERFIELD, IL. FILED 5-17-2004.

**WALGREENS...SIEMPRE CERCA PARA DARLE UNA MANO**

THE ENGLISH TRANSLATION OF WALGREENS...SIEMPRE CERCA PARA DARLE UNA MANO IS WALGREENS...ALWAYS CLOSE TO GIVE YOU A (HELPING) HAND.

FOR PHARMACY, RETAIL DRUG STORE AND GENERAL MERCHANDISE STORE SERVICES (U.S. CLS. 100, 101 AND 102).

ANNE MADDEN, EXAMINING ATTORNEY

SN 78-094,570. WINDSOR, WILLIAM M., DBA HOTTIES DONUTS, ATLANTA, GA. FILED 11-21-2001.

**HOTTIES**

FOR RESTAURANT FRANCHISING SERVICES; MAIL ORDER SERVICES FEATURING FOOD AND DRINK; ON-LINE RETAIL STORE FEATURING FOOD AND DRINK; RETAIL STORE FEATURING FOOD AND DRINK (U.S. CLS. 100, 101 AND 102).

CAROLYN CATALDO, EXAMINING ATTORNEY

SN 78-196,428. MIZUNO USA, INC., NORCROSS, GA. FILED 12-19-2002.

**MIZUNO DIRECT.CONNECT**

FOR PROVIDING AN INTERACTIVE WEBSITE ACCESSIBLE OVER THE INTERNET FEATURING BUSINESS-TO-BUSINESS RETAIL AND WHOLESALE DISTRIBUTION OF PRODUCTS AND SERVICES IN THE FIELD OF SPORTING GOODS (U.S. CLS. 100, 101 AND 102).

FIRST USE 4-1-2003; IN COMMERCE 7-1-2003.  
TRACY FLETCHER, EXAMINING ATTORNEY

SN 78-229,048. PHI GAMMA DELTA EDUCATIONAL FOUNDATION, INC., LEXINGTON, KY. FILED 3-24-2003.

**THE PERGE! SOCIETY**

NO CLAIM IS MADE TO THE EXCLUSIVE RIGHT TO USE "SOCIETY", APART FROM THE MARK AS SHOWN.

FOR PROMOTING PUBLIC AWARENESS OF THE NEED FOR ACADEMIC ACHIEVEMENT, FRATERNAL AFFAIRS, MORALITY, LIFE LONG LEARNING, PHYSICAL, MENTAL AND SOCIAL PERSONAL DEVELOPMENT OF STUDENTS (U.S. CLS. 100, 101 AND 102).

FIRST USE 8-1-1998; IN COMMERCE 8-1-1998.  
HOWARD B. LEVINE, EXAMINING ATTORNEY

**CLASS 35—(Continued).**

SN 78-230,658. QUEBIT CONSULTING LLC, SCARSDALE, NY. FILED 3-27-2003.

# QUEBIT

FOR BUSINESS CONSULTING REGARDING BUDGETING, FORECASTING AND STRATEGIC PLANNING (U.S. CLS. 100, 101 AND 102).

FIRST USE 12-29-2001; IN COMMERCE 12-29-2001.  
JERI J. FICKES, EXAMINING ATTORNEY

SN 78-249,326. THE COLUMBIA HOUSE COMPANY, NEW YORK, NY. FILED 5-13-2003.

**THE FAMILY AISLE**

FOR DIRECT MARKETING ADVERTISING SERVICES AND RETAIL SERVICES FEATURING VIDEOS, DVDS AND AUDIO VISUAL RECORDINGS OF OTHERS BY MEANS OF TELEPHONE, MAIL, AND THE INTERNET (U.S. CLS. 100, 101 AND 102).

FIRST USE 5-6-2003; IN COMMERCE 5-6-2003.  
PAULA MAHONEY, EXAMINING ATTORNEY

SN 78-266,171. GAETANO, DRAKE, MANLIUS, NY. FILED 6-24-2003.

**PJ AMBASSADOR PROGRAM**

NO CLAIM IS MADE TO THE EXCLUSIVE RIGHT TO USE "PROGRAM", APART FROM THE MARK AS SHOWN.

FOR RETAIL SHOP-AT-HOME PARTY SERVICES IN THE FIELD OF BEAUTY PRODUCTS AND HAND-MADE JEWELRY ACCESSORIES, NOT INCLUDING WATCHES (U.S. CLS. 100, 101 AND 102).

JASON TURNER, EXAMINING ATTORNEY

SN 78-275,654. ILLINOIS INSTITUTE OF TECHNOLOGY, CHICAGO, IL. FILED 7-17-2003.

**CUBIC**

FOR FACILITATING CAREER OPPORTUNITIES IN SCIENTIFIC RESEARCH, NAMELY, EMPLOYMENT HIRING, RECRUITING, PLACEMENT, STAFFING AND CAREER NETWORKING SERVICES FOR BIOMEDICAL ENGINEERING; FACILITATING BUSINESS IN SCIENTIFIC RESEARCH REGARDING BIOMEDICAL ENGINEERING, NAMELY, BUSINESS DEVELOPMENT CONSISTING OF PROVIDING START-UP SUPPORT FOR BIOMEDICAL ENGINEERING BUSINESSES OF OTHERS (U.S. CLS. 100, 101 AND 102).

FIRST USE 3-0-2002; IN COMMERCE 3-0-2002.  
INGRID C. EULIN, EXAMINING ATTORNEY

**CLASS 35—(Continued).**

SN 78-278,540. MYCOACH, L.L.C., CEDAR KNOLLS, NJ. FILED 7-24-2003.



FOR CONSULTING SERVICES IN THE FIELD OF BUSINESS (U.S. CLS. 100, 101 AND 102).  
FIRST USE 7-0-2003; IN COMMERCE 7-0-2003.  
KIMBERLY PERRY, EXAMINING ATTORNEY

SN 78-282,886. TREE CARE INDUSTRY ASSOCIATION, INC., MANCHESTER, NH. FILED 8-4-2003.

**TREE CARE INDUSTRY ASSOCIATION**

NO CLAIM IS MADE TO THE EXCLUSIVE RIGHT TO USE "ASSOCIATION", APART FROM THE MARK AS SHOWN.

SEC. 2(F).  
FOR ASSOCIATION SERVICES, NAMELY, PROMOTING THE INTERESTS OF THOSE IN THE TREE CARE INDUSTRY (U.S. CLS. 100, 101 AND 102).  
FIRST USE 4-0-2003; IN COMMERCE 4-0-2003.  
CHRISTOPHER BUONGIORNO, EXAMINING ATTORNEY

SN 78-286,888. THE AGENCY GROUP LIMITED, LONDON, UNITED KINGDOM, FILED 8-13-2003.



NO CLAIM IS MADE TO THE EXCLUSIVE RIGHT TO USE "LTD", APART FROM THE MARK AS SHOWN.  
FOR MANAGEMENT OF PERFORMING ARTISTS (U.S. CLS. 100, 101 AND 102).  
FIRST USE 0-0-1992; IN COMMERCE 0-0-1992.  
BARBARA A. LOUGHRAN, EXAMINING ATTORNEY

**CLASS 35—(Continued).**

SN 78-288,041. AAA TENT & AWNING COMPANY, SALT LAKE CITY, UT. FILED 8-15-2003.

**KIRKHAM'S**

SEC. 2(F).  
FOR RETAIL STORES SERVICES FEATURING CAMPING EQUIPMENT, NAMELY, TENTS, BACKPACKS, COOKING STOVES AND UTENSILS, HIKING SHOES, CAMPING CHAIRS AND TABLES, BACKPACKING FOODS AND DRINKS, SLEEPING BAGS, NAVIGATION COMPASSES AND EQUIPMENT (U.S. CLS. 100, 101 AND 102).  
FIRST USE 4-1-1977; IN COMMERCE 4-1-1977.  
DOMINIC J. FERRAIUOLO, EXAMINING ATTORNEY

SN 78-291,602. AHOLA CORPORATION, BRECKSVILLE, OH. FILED 8-25-2003.



OWNER OF U.S. REG. NO. 1,894,278.  
NO CLAIM IS MADE TO THE EXCLUSIVE RIGHT TO USE "PAYROLL SERVICES", APART FROM THE MARK AS SHOWN.  
FOR PAYROLL PREPARATION AND PROCESSING SERVICES (U.S. CLS. 100, 101 AND 102).  
FIRST USE 1-31-2001; IN COMMERCE 1-31-2001.  
CHERYL CLAYTON, EXAMINING ATTORNEY

SN 78-297,613. JANGSOO INDUSTRY CO., LTD., SEOUL, REPUBLIC OF KOREA, FILED 9-8-2003.

**JANGSOO JADEBED**

ENGLISH TRANSLATION OF NON-ENGLISH TERMS—"JANGSOO" TRANSLATES TO "LONGEVITY". "JADEBED" IS COMBINATION OF ENGLISH TERMS, JADE AND BED. HENCE, JADEBED IS A TERM COINED BY THE APPLICANT MEANING BEDS MADE OUT OF JADE.  
FOR INTERNATIONAL DISTRIBUTORSHIP SERVICES IN THE FIELD OF FURNITURE, ELECTRICAL DEVICES, MEDICAL DEVICES, BEDS AND MATS; RETAIL STORE SERVICES FEATURING FURNITURE, ELECTRICAL DEVICES, MEDICAL DEVICES, BEDS AND MATS (U.S. CLS. 100, 101 AND 102).  
KATHRYN COWARD, EXAMINING ATTORNEY

**CLASS 35—(Continued).**

SN 78-303,760. FEDERATION OF AMERICAN HOSPITALS, INC., WASHINGTON, DC. FILED 9-22-2003.



NO CLAIM IS MADE TO THE EXCLUSIVE RIGHT TO USE "FEDERATION OF AMERICAN HOSPITALS", APART FROM THE MARK AS SHOWN.

SEC. 2(F) AS TO "FEDERATION OF AMERICAN HOSPITALS".

FOR ASSOCIATION SERVICES, NAMELY, PROMOTING THE INTERESTS OF HOSPITALS, HEALTH CARE SYSTEMS AND OTHER HEALTH CARE PROVIDERS AND INSTITUTIONS (U.S. CLS. 100, 101 AND 102).

FIRST USE 7-20-2000; IN COMMERCE 7-20-2000.  
BRIAN NEVILLE, EXAMINING ATTORNEY

SN 78-311,450. SCHOOL SPECIALTY, INC., APPLETON, WI. FILED 10-9-2003.

## SCHOOL SPECIALTY EDUCATOR'S MARKETPLACE

OWNER OF U.S. REG. NOS. 2,086,842 AND 2,351,297.  
NO CLAIM IS MADE TO THE EXCLUSIVE RIGHT TO USE "EDUCATOR'S MARKETPLACE", APART FROM THE MARK AS SHOWN.

SEC. 2(F) AS TO "SCHOOL SPECIALTY".  
FOR MAIL ORDER CATALOG SERVICES AND ONLINE ORDERING SERVICES, ALL FEATURING EDUCATIONAL MATERIALS FOR ELEMENTARY AND SECONDARY SCHOOLS (U.S. CLS. 100, 101 AND 102).

TINA L. SNAPP, EXAMINING ATTORNEY

**CLASS 35—(Continued).**

SN 78-314,181. MCKESSON CORPORATION, SAN FRANCISCO, CA. FILED 10-15-2003.



NO CLAIM IS MADE TO THE EXCLUSIVE RIGHT TO USE "REWARDS", APART FROM THE MARK AS SHOWN.  
FOR WHOLESALE DISTRIBUTORSHIP SERVICES IN THE FIELD OF MEDICAL AND SURGICAL SUPPLIES FEATURING A CUSTOMER INCENTIVE PROGRAM (U.S. CLS. 100, 101 AND 102).

FIRST USE 4-30-2003; IN COMMERCE 4-30-2003.  
DAVID TAYLOR, EXAMINING ATTORNEY

SN 78-317,855. AUTOBYTEL INC., IRVINE, CA. FILED 10-23-2003.

## AUTOBYTEL CONNECT

OWNER OF U.S. REG. NOS. 2,028,377, 2,861,329 AND OTHERS.

FOR ADVERTISING SERVICES, NAMELY, ASSISTING IN THE SALE OF GOODS AND SERVICES OF OTHERS BY FACILITATING COMMUNICATION BETWEEN INDIVIDUALS AND RETAILERS THROUGH THE DISSEMINATION OF ADVERTISING THROUGH A GLOBAL COMPUTER NETWORK AND BY PROVIDING RETAILERS WITH A MEANS FOR TRACKING CONSUMER CALLS AND CONSUMER INTEREST (U.S. CLS. 100, 101 AND 102).

FIRST USE 5-0-2003; IN COMMERCE 5-0-2003.  
DOMINIC J. FERRAIUOLO, EXAMINING ATTORNEY

SN 78-318,471. TCC, LLC, BIRMINGHAM, AL. FILED 10-24-2003.

## COMING SOON TO A MAILBOX NEAR YOU

FOR DIRECT MAIL ADVERTISING, NAMELY, DIRECT MARKETING ADVERTISING FOR OTHERS (U.S. CLS. 100, 101 AND 102).

FIRST USE 8-11-2003; IN COMMERCE 8-12-2003.  
GEORGE LORENZO, EXAMINING ATTORNEY

**CLASS 35—(Continued).**

SN 78-322,936. ADJUNCT LLC, SAN FRANCISCO, CA. FILED 11-4-2003.

**CLASS 35—(Continued).**

SN 78-324,570. INTERNATIONAL DATA GROUP, INC., FRAMINGHAM, MA. FILED 11-7-2003.

**+ADJUNCT**

**CAM**

THE MARK CONSISTS OF STANDARD CHARACTERS WITHOUT CLAIM TO ANY PARTICULAR FONT, STYLE, SIZE, OR COLOR.  
FOR BUSINESS CONSULTATION (U.S. CLS. 100, 101 AND 102).  
FIRST USE 10-15-2000; IN COMMERCE 10-15-2000.  
MICHAEL WEBSTER, EXAMINING ATTORNEY

THE MARK CONSISTS OF STANDARD CHARACTERS WITHOUT CLAIM TO ANY PARTICULAR FONT, STYLE, SIZE, OR COLOR.  
FOR DIRECT MARKETING ADVERTISING FOR OTHERS IN THE NATURE OF DEVELOPING MARKETING PROGRAMS AND CAMPAIGNS (U.S. CLS. 100, 101 AND 102).  
FIRST USE 9-23-2002; IN COMMERCE 9-23-2002.  
ALLISON HOLTZ, EXAMINING ATTORNEY

SN 78-322,958. ADJUNCT LLC, SAN FRANCISCO, CA. FILED 11-4-2003.

SN 78-330,324. BLAKE BROS. INTERNATIONAL, INC., AMHERST, NH. FILED 11-19-2003.

**ARNie Adjunct  
Risk Number**

**BLAKE BROTHERS**

THE MARK CONSISTS OF STANDARD CHARACTERS WITHOUT CLAIM TO ANY PARTICULAR FONT, STYLE, SIZE, OR COLOR.  
NO CLAIM IS MADE TO THE EXCLUSIVE RIGHT TO USE "RISK NUMBER", APART FROM THE MARK AS SHOWN.  
FOR BUSINESS RISK CONSULTATION, NAMELY EXAMINATION OF OPERATIONAL PROCEDURES AND FINANCIAL STATEMENT ANALYSIS FOR BUSINESSES AND ORGANIZATIONS (U.S. CLS. 100, 101 AND 102).  
FIRST USE 10-15-2003; IN COMMERCE 10-15-2003.  
MICHAEL WEBSTER, EXAMINING ATTORNEY

THE MARK CONSISTS OF STANDARD CHARACTERS WITHOUT CLAIM TO ANY PARTICULAR FONT, STYLE, SIZE, OR COLOR.  
SEC. 2(F).  
FOR WHOLESALE DISTRIBUTORSHIP FEATURING JEWELRY; MAIL ORDER SERVICES AND MAIL ORDER CATALOG SERVICES FEATURING JEWELRY (U.S. CLS. 100, 101 AND 102).  
FIRST USE 1-0-1977; IN COMMERCE 1-0-1977.  
SEAN DWYER, EXAMINING ATTORNEY

**CLASS 35—(Continued).**

SN 78-337,065. HAYES, PAUL T., ORLANDO, FL. FILED 12-5-2003.

**CYCLESHOWPLACE**

THE MARK CONSISTS OF STANDARD CHARACTERS WITHOUT CLAIM TO ANY PARTICULAR FONT, STYLE, SIZE, OR COLOR.

FOR ADVERTISING SERVICES FOR OTHERS, NAMELY, PREPARING AND PLACING OF ADVERTISING, DISSEMINATION OF ADVERTISING FOR OTHERS VIA THE INTERNET, PROVIDING A WEB SITE WHICH FEATURES ADVERTISEMENTS FOR THE GOODS AND SERVICES OF OTHERS ON A GLOBAL COMPUTER NETWORK IN THE FIELDS OF MOTORCYCLES AND MOTORCYCLE ACCESSORIES (U.S. CLS. 100, 101 AND 102).

AMY HELLA, EXAMINING ATTORNEY

SN 78-338,148. REGENT PRODUCTS, INC., VIRGINIA BEACH, VA. FILED 12-9-2003.



OWNER OF U.S. REG. NO. 1,799,804.

NO CLAIM IS MADE TO THE EXCLUSIVE RIGHT TO USE "STONE PRODUCTS", "EQUIPMENT", "SUPPLIES" AND "SERVICE", APART FROM THE MARK AS SHOWN.

FOR RETAIL STORE SERVICES, MAIL ORDER CATALOG SERVICES, ON-LINE RETAIL STORE AND ORDERING SERVICES, AND DISTRIBUTORSHIPS FEATURING INDUSTRIAL AND COMMERCIAL DIAMOND TOOLS, EQUIPMENT, AND SUPPLIES FOR USE IN MARBLE, GRANITE, STONE, AND BRICK FABRICATION, RESTORATION, OR MAINTENANCE; PROMOTING THE GOODS OF OTHERS THROUGH ON-LINE ORDERING AND CATALOGING OF THOSE GOODS; PROVIDING AN ON-LINE SHOWROOM FOR THE GOODS OF OTHERS IN THE FIELD OF INDUSTRIAL AND COMMERCIAL DIAMOND TOOLS, EQUIPMENT, AND SUPPLIES FOR USE IN MARBLE, GRANITE, STONE, AND BRICK FABRICATION, RESTORATION, OR MAINTENANCE (U.S. CLS. 100, 101 AND 102).

FIRST USE 9-0-1998; IN COMMERCE 9-0-1998.  
REBECCA SMITH, EXAMINING ATTORNEY

**CLASS 35—(Continued).**

SN 78-339,343. BEVERAGEBISTRO.COM, REDMOND, WA. FILED 12-11-2003.

**Executive Club**

THE MARK CONSISTS OF STANDARD CHARACTERS WITHOUT CLAIM TO ANY PARTICULAR FONT, STYLE, SIZE, OR COLOR.

NO CLAIM IS MADE TO THE EXCLUSIVE RIGHT TO USE "CLUB", APART FROM THE MARK AS SHOWN.

FOR ONLINE FOOD CLUB SERVICES, NAMELY, PERIODICALLY SENDING TO CLUB MEMBERS BEVERAGES, INCLUDING WINE, BEER, AND COFFEE, AS WELL AS GOURMET FOODS, SUCH AS CHEESE AND CONSUMER INFORMATION CONCERNING SUCH BEVERAGE AND GOURMET FOOD PRODUCTS (U.S. CLS. 100, 101 AND 102).

SEAN DWYER, EXAMINING ATTORNEY

SN 78-345,234. ALPHA INTERNET CONSULTING LLC, SPOKANE, WA. FILED 12-23-2003.

**Internet Marketing  
Pro**

THE MARK CONSISTS OF STANDARD CHARACTERS WITHOUT CLAIM TO ANY PARTICULAR FONT, STYLE, SIZE, OR COLOR.

NO CLAIM IS MADE TO THE EXCLUSIVE RIGHT TO USE INTERNET MARKETING, APART FROM THE MARK AS SHOWN.

FOR INTERNET WEBSITE FEATURING ONLINE ARTICLES AND INFORMATION IN THE FIELD OF INTERNET MARKETING (U.S. CLS. 100, 101 AND 102).

GWEN STOKOLS, EXAMINING ATTORNEY

**CLASS 35—(Continued).**

SN 78-349,346. FULL-O-PEP APPLIANCES, INC., BLOOMINGTON, IN. FILED 1-8-2004.



THE MARK CONSISTS IN PART OF A STYLIZED LETTER "A" LOGO.

SEC. 2(F) AS TO "AMERICAN RENTAL".  
FOR RETAIL STORE SERVICES AND RETAIL STORE SERVICES FEATURING RENTAL PURCHASE PLANS IN THE FIELD OF HOME FURNISHINGS, DOMESTIC APPLIANCES, FURNITURE, CONSUMER ELECTRONICS, COMPUTERS AND JEWELRY (U.S. CLS. 100, 101 AND 102).

FIRST USE 0-0-1994; IN COMMERCE 0-0-1994.  
DAVID H. STINE, EXAMINING ATTORNEY

**CLASS 35—(Continued).**

SN 78-351,701. SDO ENTERPRISES, CHARLESTON, WV. FILED 1-14-2004.

**Wonderful World of  
Wireless**

THE MARK CONSISTS OF STANDARD CHARACTERS WITHOUT CLAIM TO ANY PARTICULAR FONT, STYLE, SIZE, OR COLOR.

NO CLAIM IS MADE TO THE EXCLUSIVE RIGHT TO USE WIRELESS, APART FROM THE MARK AS SHOWN.

FOR RETAIL STORE SERVICES FEATURING WIRELESS TELEPHONES (U.S. CLS. 100, 101 AND 102).  
CAROLINE WEIMER, EXAMINING ATTORNEY

SN 78-358,828. LITIGATION MANAGEMENT, INC., MAYFIELD HEIGHTS, OH. FILED 1-28-2004.

**LMI**

THE MARK CONSISTS OF STANDARD CHARACTERS WITHOUT CLAIM TO ANY PARTICULAR FONT, STYLE, SIZE, OR COLOR.

FOR RECORDS AND CASE MANAGEMENT SERVICES, NAMELY INDEXING OF DOCUMENTS AND EVIDENCE FOR LITIGATION MATTERS AND DOCKET MANAGEMENT FOR LITIGATION MATTERS FOR OTHERS. (U.S. CLS. 100, 101 AND 102).

MICHAEL HALL, EXAMINING ATTORNEY

SN 78-349,779. BISON ADVERTISING, INC., EDEN PRAIRIE, MN. FILED 1-9-2004.

**BISON.COM**

THE MARK CONSISTS OF STANDARD CHARACTERS WITHOUT CLAIM TO ANY PARTICULAR FONT, STYLE, SIZE, OR COLOR.

OWNER OF U.S. REG. NO. 2,509,756.  
NO CLAIM IS MADE TO THE EXCLUSIVE RIGHT TO USE "COM", APART FROM THE MARK AS SHOWN.

FOR DISSEMINATION OF FRANCHISE, DISTRIBUTORSHIP, DEALERSHIP AFFILIATE AND LICENSING AGREEMENT ADVERTISING AND INFORMATION FOR OTHERS VIA AN ONLINE COMPUTER NETWORK (U.S. CLS. 100, 101 AND 102).

FIRST USE 6-0-1999; IN COMMERCE 6-0-1999.  
DEZMONA MIZELLE, EXAMINING ATTORNEY

SN 78-364,580. I LOVE SANTA BARBARA, INC., SANTA BARBARA, CA. FILED 2-9-2004.

**I ♥ SB**

FOR PROMOTING SANTA BARBARA, CALIFORNIA AS A PLACE TO LIVE AND VISIT AND THE ECONOMIC DEVELOPMENT THEREOF (U.S. CLS. 100, 101 AND 102).

FIRST USE 3-1-2002; IN COMMERCE 3-1-2002.  
ANDREW BENZMILLER, EXAMINING ATTORNEY

**CLASS 35—(Continued).**

SN 78-366,128. INTELLISEEK, INC., CINCINNATI, OH. FILED 2-11-2004.

**BRANDPULSE**

THE MARK CONSISTS OF STANDARD CHARACTERS WITHOUT CLAIM TO ANY PARTICULAR FONT, STYLE, SIZE, OR COLOR.

FOR MARKET RESEARCH SERVICES THAT MONITOR, AGGREGATE AND ANALYZE MESSAGES POSTED BY CONSUMERS ON THE GLOBAL COMPUTER NETWORK, INTERACTIONS BETWEEN CONSUMERS AND COMPANIES IN THE FORM OF CALL CENTER LOGS, MAIL, FAX, E-MAIL COMMUNICATIONS, PURCHASE INFORMATION, WARRANTY CLAIMS AND INFORMATION FROM NEW SOURCES ON CONSUMER BEHAVIOR (U.S. CLS. 100, 101 AND 102).

FIRST USE 1-10-2001; IN COMMERCE 1-10-2001.  
CHARLES L. JENKINS, EXAMINING ATTORNEY

**CLASS 35—(Continued).**

SN 78-370,692. SADDLE HILL PARTNERS, LLC, LOS ANGELES, CA. FILED 2-19-2004.

**Pasteleria La Monarca**

THE MARK CONSISTS OF STANDARD CHARACTERS WITHOUT CLAIM TO ANY PARTICULAR FONT, STYLE, SIZE, OR COLOR.

NO CLAIM IS MADE TO THE EXCLUSIVE RIGHT TO USE "PASTELERIA", APART FROM THE MARK AS SHOWN.

THE ENGLISH TRANSLATION OF PASTELERIA LA MONARCA IS THE MONARCH CAKE SHOP.

FOR BAKERY RETAIL SHOP (U.S. CLS. 100, 101 AND 102).

GWEN STOKOLS, EXAMINING ATTORNEY

---

SN 78-369,424. BERNSTEIN, SUE, SHERMAN OAKS, CA. AND BENOUN, ANNGEL, SHERMAN OAKS, CA. FILED 2-17-2004.

**THE CALIFORNIA CONNECTION**

THE MARK CONSISTS OF STANDARD CHARACTERS WITHOUT CLAIM TO ANY PARTICULAR FONT, STYLE, SIZE, OR COLOR.

NO CLAIM IS MADE TO THE EXCLUSIVE RIGHT TO USE "CALIFORNIA", APART FROM THE MARK AS SHOWN.

FOR BUSINESS SERVICES, NAMELY, PROVIDING OUTSOURCE MANAGEMENT SERVICES AND INFORMATION TO OTHERS IN THE FIELD OF REAL ESTATE (U.S. CLS. 100, 101 AND 102).

ARETHA SOMERVILLE, EXAMINING ATTORNEY

---

SN 78-372,354. VIX DESIGN PRODUCTS, INC., FOREST CITY, IA. FILED 2-23-2004.

**THREE KEYS**

THE MARK CONSISTS OF STANDARD CHARACTERS WITHOUT CLAIM TO ANY PARTICULAR FONT, STYLE, SIZE, OR COLOR.

FOR BUSINESS MANAGEMENT; AND BUSINESS DEVELOPMENT SERVICES, NAMELY, PROVIDING STARTUP SUPPORT FOR BUSINESSES OF OTHERS, AND PROVIDING SUPPORT FOR BUSINESSES OF OTHERS. (U.S. CLS. 100, 101 AND 102).

ELLEN B. AWRICH, EXAMINING ATTORNEY



**CLASS 35—(Continued).**

SN 78-372,893. IRVIN ALAN FABRICS, INC., GRAND RAPIDS, MI. FILED 2-24-2004.

**CLASS 35—(Continued).**

SN 78-376,042. SYNERGY COMPUTING BUSINESS GROUP, INC., LAGUNA HILLS, CA. FILED 3-1-2004.

**KIMBERLY PAIGE**

**Kindertrains**

THE MARK CONSISTS OF STANDARD CHARACTERS WITHOUT CLAIM TO ANY PARTICULAR FONT, STYLE, SIZE, OR COLOR.

THE NAME(S), PORTRAIT(S), AND/OR SIGNATURE(S) SHOWN IN THE MARK IDENTIFIES KIMBERLY PAIGE CORNETET , WHOSE CONSENT(S) TO REGISTER IS SUBMITTED.

FOR WHOLESALE DISTRIBUTORSHIP SERVICES IN THE FIELD OF UPHOLSTERY FABRICS (U.S. CLS. 100, 101 AND 102).

HOWARD SMIGA, EXAMINING ATTORNEY

THE MARK CONSISTS OF STANDARD CHARACTERS WITHOUT CLAIM TO ANY PARTICULAR FONT, STYLE, SIZE, OR COLOR.

NO CLAIM IS MADE TO THE EXCLUSIVE RIGHT TO USE "TRAINS", APART FROM THE MARK AS SHOWN.

FOR ON-LINE RETAIL STORE SERVICES FEATURING WOODEN TOY TRAINS AND ACCESSORIES THEREOF (U.S. CLS. 100, 101 AND 102).

FIRST USE 5-1-2003; IN COMMERCE 5-1-2003.  
GRETTA YAO, EXAMINING ATTORNEY

SN 78-372,898. IRVIN ALAN FABRICS, INC., GRAND RAPIDS, MI. FILED 2-24-2004.

SN 78-379,982. GEOFFREY, INC., WAYNE, NJ. FILED 3-8-2004.

**PETER JAMES**

**G DISCOVER  
GIRAFFIC FUN  
TOGETHER**

THE MARK CONSISTS OF STANDARD CHARACTERS WITHOUT CLAIM TO ANY PARTICULAR FONT, STYLE, SIZE, OR COLOR.

THE NAME(S), PORTRAIT(S), AND/OR SIGNATURE(S) SHOWN IN THE MARK IDENTIFIES PETER JAMES CORNETET , WHOSE CONSENT(S) TO REGISTER IS SUBMITTED.

FOR WHOLESALE DISTRIBUTORSHIP SERVICES IN THE FIELD OF UPHOLSTERY FABRICS (U.S. CLS. 100, 101 AND 102).

HOWARD SMIGA, EXAMINING ATTORNEY

THE MARK CONSISTS OF STANDARD CHARACTERS WITHOUT CLAIM TO ANY PARTICULAR FONT, STYLE, SIZE, OR COLOR.

OWNER OF U.S. REG. NOS. 2,843,268 AND 2,856,049.  
FOR RETAIL DEPARTMENT STORE SERVICES (U.S. CLS. 100, 101 AND 102).

GWEN STOKOLS, EXAMINING ATTORNEY

**CLASS 35—(Continued).**

SN 78-380,612. ECOMPEX, INC., MCLEAN, VA. FILED 3-8-2004.

**THE MORE PAPERLESS**

THE MARK CONSISTS OF STANDARD CHARACTERS WITHOUT CLAIM TO ANY PARTICULAR FONT, STYLE, SIZE, OR COLOR.

NO CLAIM IS MADE TO THE EXCLUSIVE RIGHT TO USE "PAPERLESS", APART FROM THE MARK AS SHOWN.

FOR RECORDS DOCUMENT MANAGEMENT, NAMELY, DOCUMENT IMAGING FOR OTHERS (U.S. CLS. 100, 101 AND 102).

FIRST USE 1-28-2004; IN COMMERCE 1-28-2004.  
 GEORGIA CARTY, EXAMINING ATTORNEY

**CLASS 35—(Continued).**

SN 78-384,821. OFF ROAD, INC., BLANCO, TX. FILED 3-16-2004.



NO CLAIM IS MADE TO THE EXCLUSIVE RIGHT TO USE "PERFORMANCE CAR AND TRUCK", APART FROM THE MARK AS SHOWN.

FOR RETAIL STORES IN THE FIELD OF CAR AND TRUCK ACCESSORIES; FRANCHISING SERVICES, NAMELY, OFFERING TECHNICAL ASSISTANCE IN THE ESTABLISHMENT AND/OR OPERATION OF RETAIL STORES FOR CAR AND TRUCK ACCESSORIES; FRANCHISING, NAMELY, CONSULTATION AND ASSISTANCE IN BUSINESS MANAGEMENT, ORGANIZATION AND PROMOTION IN THE FIELD OF RETAIL STORES FOR CAR AND TRUCK ACCESSORIES (U.S. CLS. 100, 101 AND 102).

EVELYN BRADLEY, EXAMINING ATTORNEY

SN 78-385,329. ELECTRICAL SAFETY AUTHORITY, MISSISSAUGA, ONTARIO, CANADA, FILED 3-16-2004.



FOR PROMOTION OF PUBLIC SAFETY AWARENESS (U.S. CLS. 100, 101 AND 102).

DOMINIC J. FERRAIUOLO, EXAMINING ATTORNEY

SN 78-382,037. NATIONAL LOGISTICS MANAGEMENT, INC., DETROIT, MI. FILED 3-10-2004.



NO CLAIM IS MADE TO THE EXCLUSIVE RIGHT TO USE "NATIONAL LOGISTICS MANAGEMENT", APART FROM THE MARK AS SHOWN.

THE MARK CONSISTS OF A GLOBE WITH ARROWS SURROUNDING THE WORDS "NATIONAL LOGISTICS MANAGEMENT".

FOR ARRANGING FOR PICKUP, DELIVERY, STORAGE AND TRANSPORTATION OF FREIGHT AND PARCELS VIA GROUND, AIR AND SEA TRANSPORTATION USING THE INTERNET TO SELECT CARRIERS AND DELIVER STATUS NOTIFICATIONS (U.S. CLS. 100, 101 AND 102).

PAULA MAYS, EXAMINING ATTORNEY

SN 78-389,221. CARVEL CORPORATION, ATLANTA, GA. FILED 3-23-2004.



FOR RECRUITMENT SERVICES FOR FRANCHISEES (U.S. CLS. 100, 101 AND 102).

FIRST USE 1-1-2004; IN COMMERCE 1-1-2004.  
 CAROLYN GRAY, EXAMINING ATTORNEY

**CLASS 35—(Continued).**

SN 78-389,295. ASSOCIATION OF UNIVERSITY TECHNOLOGY MANAGERS, NORTHBROOK, IL. FILED 3-23-2004.

**CLASS 35—(Continued).**

SN 78-389,364. ORION FOOD SYSTEMS, LLC, SIOUX FALLS, SD. FILED 3-23-2004.

**C-STREET CAFE**

OWNER OF U.S. REG. NOS. 1,592,439, 2,712,949 AND OTHERS.

NO CLAIM IS MADE TO THE EXCLUSIVE RIGHT TO USE "INC.", APART FROM THE MARK AS SHOWN.

THE MARK CONSISTS OF THE ACRONYM "AUTM" IN LARGE, BOLD PRINT WITH THE WORDS "ASSOCIATION OF UNIVERSITY TECHNOLOGY MANAGERS, INC." BELOW A "SWOOSH" WITH A TRIANGLE AT THE END.

SEC. 2(F) AS TO "ASSOCIATION OF UNIVERSITY TECHNOLOGY MANAGERS".

FOR ASSOCIATION SERVICES, NAMELY PROMOTING THE ACQUISITION AND TRANSFER OF ACADEMIC INTELLECTUAL PROPERTY FOR THE BENEFIT OF THE PUBLIC (U.S. CLS. 100, 101 AND 102).

FIRST USE 3-1-2001; IN COMMERCE 3-1-2001.  
MARY ROSSMAN, EXAMINING ATTORNEY

THE MARK CONSISTS OF STANDARD CHARACTERS WITHOUT CLAIM TO ANY PARTICULAR FONT, STYLE, SIZE, OR COLOR.

NO CLAIM IS MADE TO THE EXCLUSIVE RIGHT TO USE "CAFE", APART FROM THE MARK AS SHOWN.

FOR FRANCHISING SERVICES; NAMELY, OFFERING TECHNICAL ASSISTANCE IN THE ESTABLISHMENT AND/OR OPERATION OF RESTAURANTS, BAKERIES, CAFES, AND KIOSKS SERVING FOOD AND DRINK (U.S. CLS. 100, 101 AND 102).

STANLEY I. OSBORNE, EXAMINING ATTORNEY

SN 78-389,346. ORION FOOD SYSTEMS, LLC, SIOUX FALLS, SD. FILED 3-23-2004.

SN 78-389,735. RETAIL SOLUTIONS PROVIDERS ASSOCIATION, INC., CHARLOTTE, NC. FILED 3-24-2004.

**C-STREET BAKERY**

THE MARK CONSISTS OF STANDARD CHARACTERS WITHOUT CLAIM TO ANY PARTICULAR FONT, STYLE, SIZE, OR COLOR.

NO CLAIM IS MADE TO THE EXCLUSIVE RIGHT TO USE "BAKERY", APART FROM THE MARK AS SHOWN.

FOR FRANCHISING SERVICES; NAMELY, OFFERING TECHNICAL ASSISTANCE IN THE ESTABLISHMENT AND/OR OPERATION OF RESTAURANTS, BAKERIES, CAFES, AND KIOSKS SERVING FOOD AND DRINK (U.S. CLS. 100, 101 AND 102).

STANLEY I. OSBORNE, EXAMINING ATTORNEY

NO CLAIM IS MADE TO THE EXCLUSIVE RIGHT TO USE "RETAIL SOLUTIONS PROVIDERS ASSOCIATION", APART FROM THE MARK AS SHOWN.

THE MARK CONSISTS OF THE LETTERS RSPA IN A FANCIFUL FONT WHICH ARE BELOW A LINE DRAWING OF AN ARC AND ABOVE THE WORDS RETAIL SOLUTIONS PROVIDERS ASSOCIATION.

FOR ASSOCIATION SERVICES, NAMELY, PROMOTING THE INTERESTS OF DEALERS OF CASH REGISTERS AND OTHER POINT OF SALE EQUIPMENT (U.S. CLS. 100, 101 AND 102).

FIRST USE 9-0-2003; IN COMMERCE 9-0-2003.  
ODESSA BIBBINS, EXAMINING ATTORNEY

**CLASS 35—(Continued).**

SN 78-389,795. CARLETTI, BRENDA, BOOTHWYN, PA.  
FILED 3-24-2004.

DBC Collectibles

THE MARK CONSISTS OF STANDARD CHARACTERS WITHOUT CLAIM TO ANY PARTICULAR FONT, STYLE, SIZE, OR COLOR.

NO CLAIM IS MADE TO THE EXCLUSIVE RIGHT TO USE "COLLECTIBLES", APART FROM THE MARK AS SHOWN.

FOR RETAIL GIFT SHOPS (U.S. CLS. 100, 101 AND 102).

KHANH LE, EXAMINING ATTORNEY

**CLASS 35—(Continued).**

SN 78-392,963. GUIDESOFT, INC., DBA KNOWLEDGE SERVICES, INDIANAPOLIS, IN. FILED 3-30-2004.



THE MARK CONSISTS OF A LOWER CASE WHITE D WITHIN A BLACK CIRCLE, FOLLOWED BY THE LETTERS O AND T IN BLACK, WITH THE WORD STAFF IN BLACK BELOW.

FOR PROVIDING A WEB SITE WHEREBY BUYERS OF GOODS OR SERVICES LOCATE AND RECEIVE QUOTATIONS FROM MULTIPLE COMPETITIVE SOURCES AND SELLERS OF GOODS OR SERVICES IDENTIFY AND BID ON MULTIPLE NEW SALES OPPORTUNITIES (U.S. CLS. 100, 101 AND 102).

FIRST USE 3-1-2004; IN COMMERCE 3-1-2004.

MICHAEL ENGEL, EXAMINING ATTORNEY

SN 78-393,120. AMBRION, INC., BLOOMINGTON, MN.  
FILED 3-30-2004.

AMBRION

SN 78-392,952. REDEEM THE VOTE, INC., MONTGOMERY, AL. FILED 3-30-2004.

REDEEM THE VOTE

THE MARK CONSISTS OF STANDARD CHARACTERS WITHOUT CLAIM TO ANY PARTICULAR FONT, STYLE, SIZE, OR COLOR.

FOR PROMOTING PUBLIC AWARENESS OF POLITICAL ISSUES AND ENCOURAGING THE PUBLIC TO PARTICIPATE IN THE VOTING PROCESS AND REGISTER TO VOTE (U.S. CLS. 100, 101 AND 102).

FIRST USE 12-16-2003; IN COMMERCE 12-16-2003.

ANDREA SAUNDERS, EXAMINING ATTORNEY

THE MARK CONSISTS OF STANDARD CHARACTERS WITHOUT CLAIM TO ANY PARTICULAR FONT, STYLE, SIZE, OR COLOR.

FOR EMPLOYMENT COUNSELING, HIRING, RECRUITING, EXECUTIVE SEARCH SERVICES, PLACEMENT, STAFFING AND CAREER NETWORKING SERVICES (U.S. CLS. 100, 101 AND 102).

FIRST USE 8-1-1999; IN COMMERCE 8-1-1999.

MONIQUE MILLER, EXAMINING ATTORNEY

**CLASS 35—(Continued).**

SN 78-393,260. BUSINESS PROCESS CONSULTING INC., LITTLETON, CO. FILED 3-30-2004.



THE STIPPLING IS FOR SHADING PURPOSES ONLY. THE COLOR(S) BURGUNDY IS/ARE CLAIMED AS A FEATURE OF THE MARK.

THE COLOR BURGUNDY IS PART OF THE MARK. THE MARK CONSISTS OF A CURVED ARROW COLORED IN BURGUNDY THAT SURROUNDS THE LETTERS "BPCG". THE LETTERS ARE IN ITALICS AND ARE SHADED. TAG LINE "YOUR SOURCE FOR THE FLOW PROCESSING ADVANTAGE" APPEARS BELOW THE CURVED ARROW.

FOR BUSINESS CONSULTING SERVICES RELATING TO PRODUCT DISTRIBUTION, OPERATIONS MANAGEMENT SERVICES, LOGISTICS, REVERSE LOGISTICS, SUPPLY CHAIN, AND PRODUCTION SYSTEMS AND DISTRIBUTION SOLUTIONS (U.S. CLS. 100, 101 AND 102).

KIM SAITO, EXAMINING ATTORNEY

**CLASS 35—(Continued).**

SN 78-393,559. HEATHER & LAUREN TALARICO, HILTON HEAD, SC. FILED 3-30-2004.

## I Love Hilton Head

THE MARK CONSISTS OF STANDARD CHARACTERS WITHOUT CLAIM TO ANY PARTICULAR FONT, STYLE, SIZE, OR COLOR.

NO CLAIM IS MADE TO THE EXCLUSIVE RIGHT TO USE "HILTON HEAD", APART FROM THE MARK AS SHOWN.

FOR ADVERTISING SERVICES NAMELY PROVIDING ADVERTISING SPACE ON OUR WEBSITE AND PROMOTIONS (U.S. CLS. 100, 101 AND 102).

BARNEY CHARLON, EXAMINING ATTORNEY

SN 78-393,443. POTENTIAL COMMUNICATION, INC., SAN FRANCISCO, CA. FILED 3-30-2004.

## improved and new

THE MARK CONSISTS OF STANDARD CHARACTERS WITHOUT CLAIM TO ANY PARTICULAR FONT, STYLE, SIZE, OR COLOR.

FOR ADVERTISING AGENCIES, PROVIDING TELEVISION ADVERTISING FOR OTHERS, TELEVISION ADVERTISING AGENCIES, DIRECT MAIL ADVERTISING, DIRECT MARKETING ADVERTISING FOR OTHERS, DISSEMINATION OF ADVERTISING FOR OTHERS VIA THE INTERNET, DISSEMINATION OF ADVERTISING MATTER, ELECTRONIC BILLBOARD ADVERTISING, PREPARING AUDIO-VISUAL PRESENTATIONS FOR USE IN ADVERTISING (U.S. CLS. 100, 101 AND 102).

STANLEY I. OSBORNE, EXAMINING ATTORNEY

SN 78-393,745. VOY ENTERPRISES, LLC, NEW YORK, NY. FILED 3-31-2004.

## LIFE IN ACTION

THE MARK CONSISTS OF STANDARD CHARACTERS WITHOUT CLAIM TO ANY PARTICULAR FONT, STYLE, SIZE, OR COLOR.

FOR PROVIDING TELEVISION ADVERTISING FOR OTHERS; DISSEMINATION OF ADVERTISING FOR OTHERS VIA LOCAL AND GLOBAL COMPUTER NETWORKS; DISSEMINATION OF ADVERTISING MATTER (U.S. CLS. 100, 101 AND 102).

GEORGIA CARTY, EXAMINING ATTORNEY

**CLASS 35—(Continued).**

SN 78-394,411. THE MAGIC HAT, INC., ASHLAND, MA.  
FILED 3-31-2004.

**CLASS 35—(Continued).**

SN 78-397,018. RFD INSIGHT, INC., ANN ARBOR, MI.  
FILED 4-6-2004.

# FUNUSUAL

# RFD INSIGHT

THE MARK CONSISTS OF STANDARD CHARACTERS  
WITHOUT CLAIM TO ANY PARTICULAR FONT, STYLE,  
SIZE, OR COLOR.

FOR ON-LINE RETAIL STORE SERVICES FEATUR-  
ING A VARIETY OF CONSUMER HOME GOODS AND  
NOVELTY ITEMS (U.S. CLS. 100, 101 AND 102).  
JULIE WATSON, EXAMINING ATTORNEY

THE MARK CONSISTS OF STANDARD CHARACTERS  
WITHOUT CLAIM TO ANY PARTICULAR FONT, STYLE,  
SIZE, OR COLOR.

FOR BUSINESS CONSULTING SERVICES (U.S. CLS.  
100, 101 AND 102).  
FIRST USE 1-31-2004; IN COMMERCE 1-31-2004.  
ROBERT LORENZO, EXAMINING ATTORNEY

---

SN 78-395,758. VENFIN LIMITED, STELLENBOSCH, SOUTH  
AFRICA, FILED 4-2-2004.

---

SN 78-398,002. SULTAN CHEMISTS, INC., ENGLEWOOD,  
NJ. FILED 4-7-2004.

# VENFIN



THE MARK CONSISTS OF STANDARD CHARACTERS  
WITHOUT CLAIM TO ANY PARTICULAR FONT, STYLE,  
SIZE, OR COLOR.

FOR BUSINESS MANAGEMENT SERVICES IN THE  
FIELDS OF INFORMATION TECHNOLOGY, TELECOM-  
MUNICATIONS, AND MEDIA (U.S. CLS. 100, 101 AND  
102).  
JENNIFER KRISP, EXAMINING ATTORNEY

FOR PROMOTING THE SALE OF DENTAL PRO-  
DUCTS THROUGH THE ADMINISTRATION OF AN  
INCENTIVE REWARDS PROGRAM (U.S. CLS. 100, 101  
AND 102).  
JOHN E. MICHOS, EXAMINING ATTORNEY

**CLASS 35—(Continued).**

SN 78-399,658. SHAKER ADVERTISING AGENCY, INC.,  
OAK PARK, IL. FILED 4-9-2004.

**GET IT TOGETHER**

THE MARK CONSISTS OF STANDARD CHARACTERS WITHOUT CLAIM TO ANY PARTICULAR FONT, STYLE, SIZE, OR COLOR.

FOR PROVIDING ON-LINE EMPLOYMENT PLACEMENT SERVICES; PROVIDING SEARCHABLE ON-LINE DATABASES OF RESUMES AND EMPLOYMENT OPPORTUNITIES; PROVIDING ON-LINE INFORMATION IN THE FIELDS OF EMPLOYMENT, RECRUITMENT, JOB PLACEMENT, CAREERS, JOB RESOURCES, JOB LISTINGS AND RESUMES (U.S. CLS. 100, 101 AND 102).

FIRST USE 1-12-2004; IN COMMERCE 1-12-2004.  
MARK T. MULLEN, EXAMINING ATTORNEY

**CLASS 35—(Continued).**

SN 78-403,010. HAROLD THEURER, JR., BROOKLYN, NY.  
FILED 4-16-2004.

**Your Business  
Makeover**

THE MARK CONSISTS OF STANDARD CHARACTERS WITHOUT CLAIM TO ANY PARTICULAR FONT, STYLE, SIZE, OR COLOR.

NO CLAIM IS MADE TO THE EXCLUSIVE RIGHT TO USE "BUSINESS", APART FROM THE MARK AS SHOWN.  
FOR BUSINESS CONSULTATION (U.S. CLS. 100, 101 AND 102).

WON TEAK OH, EXAMINING ATTORNEY

SN 78-410,236. ITALIAN TRADE COMMISSION, LOS ANGELES, CA. FILED 4-29-2004.

SN 78-400,603. ARKET LLC, LITTLE FALLS, NJ. FILED 4-12-2004.

**ARKET**

THE MARK CONSISTS OF STANDARD CHARACTERS WITHOUT CLAIM TO ANY PARTICULAR FONT, STYLE, SIZE, OR COLOR.

FOR BUSINESS MARKETING CONSULTING SERVICES (U.S. CLS. 100, 101 AND 102).

KARLA PERKINS, EXAMINING ATTORNEY



NO CLAIM IS MADE TO THE EXCLUSIVE RIGHT TO USE "ORIGINAL ITALIAN SLATE", APART FROM THE MARK AS SHOWN.

THE COLOR(S) BLUE AND GREEN IS/ARE CLAIMED AS A FEATURE OF THE MARK.

THE COLOR GREEN APPEARS IN THE LETTERING AND OUTLINE OF THE CIRCLE AND THE COLOR BLUE APPEARS OUTSIDE OF THE CIRCLE AND INSIDE THE SQUARE

THE MARK CONSISTS OF A CIRCLE WITH THE WORD "ORIGINAL" ON THE INSIDE TOP OF THE CIRCLE, THE WORD "ITALIAN SLATE" ON THE INSIDE BOTTOM OF THE CIRCLE AND THE WORD "OIS" IN THE MIDDLE OF THE CIRCLE .

FOR ORGANIZATION, PROMOTION AND CONDUCT OF TRADE SHOWS RELATING TO BILLIARD TABLES MADE FROM ITALIAN SLATE (U.S. CLS. 100, 101 AND 102).

FIRST USE 1-1-1997; IN COMMERCE 1-1-1997.  
JOHN E. MICHOS, EXAMINING ATTORNEY

**CLASS 35—(Continued).**

SN 78-410,860. RT SOURCING USA, INC., ADDISON, TX.  
FILED 4-29-2004.

## RTS PARTNERSHIP PROMISE

THE MARK CONSISTS OF STANDARD CHARACTERS WITHOUT CLAIM TO ANY PARTICULAR FONT, STYLE, SIZE, OR COLOR.

NO CLAIM IS MADE TO THE EXCLUSIVE RIGHT TO USE PARTNERSHIP, APART FROM THE MARK AS SHOWN.

FOR PROCUREMENT FOR OTHERS, NAMELY, OBTAINING PARTS AND MATERIALS FOR PRODUCTS FROM OTHER BUSINESSES, COUNTRIES, OR LOCALS FOR OTHERS FOR MANUFACTURE, DELIVERY, TRANSPORTING, IMPORTING AND DISTRIBUTING BY OTHERS; INVENTORY CONTROL (U.S. CLS. 100, 101 AND 102).

ANNE MADDEN, EXAMINING ATTORNEY

**CLASS 35—(Continued).**

SN 78-414,013. VANITY FAIR, INC., WILMINGTON, DE.  
FILED 5-6-2004.

## VANITY FAIR

THE MARK CONSISTS OF STANDARD CHARACTERS WITHOUT CLAIM TO ANY PARTICULAR FONT, STYLE, SIZE, OR COLOR.

OWNER OF U.S. REG. NOS. 116,092, 918,102 AND OTHERS.

FOR RETAIL STORE SERVICES IN THE FIELD OF APPAREL; PROVIDING CONSUMER PRODUCT INFORMATION VIA THE INTERNET (U.S. CLS. 100, 101 AND 102).

ODESSA BIBBINS, EXAMINING ATTORNEY

SN 78-412,790. RED APPLE SCHOOL SUPPLY, INC., SALT LAKE CITY, UT. FILED 5-4-2004.

## STRETCH MINDS, NOT BUDGETS

THE MARK CONSISTS OF STANDARD CHARACTERS WITHOUT CLAIM TO ANY PARTICULAR FONT, STYLE, SIZE, OR COLOR.

FOR MAIL ORDER SERVICES FEATURING CUSTOM SCHOOL KITS CONTAINING VARIOUS COMBINATIONS OF SELECTED SCHOOL SUPPLIES, SUCH AS PENS, PENCILS, PAPER, RULER, FOLDERS, SCISSORS, ERASERS, PROTRACTORS, PAPER CLIPS, PENCIL SHARPENERS, CRAYONS; ON-LINE RETAIL STORE SERVICES FEATURING CUSTOM SCHOOL KITS CONTAINING VARIOUS COMBINATIONS OF SELECTED SCHOOL SUPPLIES, SUCH AS PENS, PENCILS, PAPER, RULER, FOLDERS, SCISSORS, ERASERS, PROTRACTORS, PAPER CLIPS, PENCIL SHARPENERS, CRAYONS; PACKAGING OF CUSTOM SCHOOL KITS CONTAINING VARIOUS COMBINATIONS OF SELECTED SCHOOL SUPPLIES, SUCH AS PENS, PENCILS, PAPER, RULER, FOLDERS, SCISSORS, ERASERS, PROTRACTORS, PAPER CLIPS, PENCIL SHARPENERS, CRAYONS TO THE ORDER AND SPECIFICATION OF OTHERS (U.S. CLS. 100, 101 AND 102).

FIRST USE 4-23-2004; IN COMMERCE 4-23-2004.

HELEN BRYAN, EXAMINING ATTORNEY

SN 78-414,038. VANITY FAIR, INC., WILMINGTON, DE.  
FILED 5-6-2004.

## BARBIZON

THE MARK CONSISTS OF STANDARD CHARACTERS WITHOUT CLAIM TO ANY PARTICULAR FONT, STYLE, SIZE, OR COLOR.

OWNER OF U.S. REG. NOS. 628,352, 1,233,666 AND OTHERS.

FOR RETAIL SERVICES IN THE FIELD OF APPAREL; PROVIDING CONSUMER PRODUCT INFORMATION VIA THE INTERNET (U.S. CLS. 100, 101 AND 102).

JILL C. ALT, EXAMINING ATTORNEY



**CLASS 35—(Continued).**

SN 78-414,073. VANITY FAIR, INC., WILMINGTON, DE.  
FILED 5-6-2004.

**CLASS 35—(Continued).**

SN 78-415,321. BLUBLOCKER CORPORATION, LAS VEGAS,  
NV. FILED 5-7-2004.

# CURVATION

# DIAL-A-BARGAIN

THE MARK CONSISTS OF STANDARD CHARACTERS  
WITHOUT CLAIM TO ANY PARTICULAR FONT, STYLE,  
SIZE, OR COLOR.

OWNER OF U.S. REG. NO. 2,757,539.  
FOR RETAIL STORE SERVICES FEATURING APPA-  
REL; PROVIDING CONSUMER PRODUCT INFORMA-  
TION VIA THE INTERNET (U.S. CLS. 100, 101 AND 102).  
BRIDGETT SMITH, EXAMINING ATTORNEY

THE MARK CONSISTS OF STANDARD CHARACTERS  
WITHOUT CLAIM TO ANY PARTICULAR FONT, STYLE,  
SIZE, OR COLOR.

OWNER OF U.S. REG. NO. 983,510.  
FOR RETAIL STORE SERVICES FEATURING GEN-  
ERAL MERCHANDISE PROVIDED VIA THE INTER-  
NET, TELEPHONE ORDER TAKING, MAIL-ORDER  
CATALOGS, AND DIRECT RESPONSE INFOMERCIALS,  
PRINT SOLICITATIONS, AND ELECTRONIC SOLICITA-  
TIONS (U.S. CLS. 100, 101 AND 102).  
CATHERINE CAIN, EXAMINING ATTORNEY

---

SN 78-415,309. VALENTINE HORSE FARM INC., SORREN-  
TO, FL. FILED 5-7-2004.

---

SN 78-416,028. TRUSERV CORPORATION, CHICAGO, IL.  
FILED 5-10-2004.

# GROSS TO NET

# SIMPLY STATED

THE MARK CONSISTS OF STANDARD CHARACTERS  
WITHOUT CLAIM TO ANY PARTICULAR FONT, STYLE,  
SIZE, OR COLOR.

FOR ADVERTISING AND PROMOTION SERVICES  
AND RELATED CONSULTING FOR THE PROMOTION  
OF AUTOMOBILES ON BEHALF OF THIRD PARTY  
AUTOMOBILE DEALERSHIPS (U.S. CLS. 100, 101 AND  
102).  
FIRST USE 10-1-2000; IN COMMERCE 3-16-2001.  
KATHLEEN M. VANSTON, EXAMINING ATTORNEY

THE MARK CONSISTS OF STANDARD CHARACTERS  
WITHOUT CLAIM TO ANY PARTICULAR FONT, STYLE,  
SIZE, OR COLOR.

FOR RETAIL HARDWARE STORE SERVICES (U.S.  
CLS. 100, 101 AND 102).  
FIRST USE 10-23-2003; IN COMMERCE 10-23-2003.  
ERNEST SHOSHO, EXAMINING ATTORNEY

**CLASS 35—(Continued).**

SN 78-416,029. LONGFELLOW STAFFING, INC., BOSTON, MA. FILED 5-10-2004.

**MARC Z**

THE MARK CONSISTS OF STANDARD CHARACTERS WITHOUT CLAIM TO ANY PARTICULAR FONT, STYLE, SIZE, OR COLOR.

FOR STAFFING SERVICES (U.S. CLS. 100, 101 AND 102).

FIRST USE 1-0-2004; IN COMMERCE 1-0-2004.  
ERNEST SHOSHO, EXAMINING ATTORNEY

**CLASS 35—(Continued).**

SN 78-417,847. SWEET COCESSIONS, INC., NEW YORK, NY. FILED 5-13-2004.

**SWEET CONCESSIONS**

THE MARK CONSISTS OF STANDARD CHARACTERS WITHOUT CLAIM TO ANY PARTICULAR FONT, STYLE, SIZE, OR COLOR.

SEC. 2(F).

FOR CONCESSION STANDS FEATURING FOOD (U.S. CLS. 100, 101 AND 102).

FIRST USE 4-0-1989; IN COMMERCE 4-0-1989.

ALEXANDER L. POWERS, EXAMINING ATTORNEY

SN 78-418,472. PRESS HERE INC., LOS ANGELES, CA. FILED 5-13-2004.

**PRESS HERE**

**ASK MAX**

THE MARK CONSISTS OF STANDARD CHARACTERS WITHOUT CLAIM TO ANY PARTICULAR FONT, STYLE, SIZE, OR COLOR.

FOR ADVERTISING SERVICES, NAMELY, PROVIDING INFORMATION ABOUT THE GOODS AND SERVICES OF OTHERS TO CONSUMERS IN RETAIL STORES USING AUDIO-VISUAL PRESENTATIONS (U.S. CLS. 100, 101 AND 102).

ELLEN PERKINS, EXAMINING ATTORNEY

THE MARK CONSISTS OF STANDARD CHARACTERS WITHOUT CLAIM TO ANY PARTICULAR FONT, STYLE, SIZE, OR COLOR.

FOR PUBLIC RELATIONS SERVICES, MARKET RESEARCH SERVICES, MARKET ANALYSIS SERVICES, AND DIRECT MAIL ADVERTISING SERVICES; ONLINE RETAIL STORE SERVICES IN THE FIELD OF ENTERTAINMENT FEATURING MUSICAL SOUND AND AUDIOVISUAL RECORDINGS, AND MUSIC RELATED CONSUMER AND BUSINESS-TO-BUSINESS ELECTRONIC PRODUCTS PROVIDED VIA THE INTERNET AND OTHER ELECTRONIC COMMUNICATIONS NETWORKS (U.S. CLS. 100, 101 AND 102).

WENDY GOODMAN, EXAMINING ATTORNEY

**CLASS 35—(Continued).**

SN 78-418,476. PRESS HERE INC., LOS ANGELES, CA. FILED 5-13-2004.

**PRESS HEAR**

THE MARK CONSISTS OF STANDARD CHARACTERS WITHOUT CLAIM TO ANY PARTICULAR FONT, STYLE, SIZE, OR COLOR.

FOR PUBLIC RELATIONS SERVICES, MARKET RESEARCH SERVICES, MARKET ANALYSIS SERVICES, AND DIRECT MAIL ADVERTISING SERVICES; ON-LINE RETAIL STORE SERVICES IN THE FIELD OF ENTERTAINMENT FEATURING MUSICAL SOUND AND AUDIOVISUAL RECORDINGS, AND MUSIC RELATED CONSUMER AND BUSINESS-TO-BUSINESS ELECTRONIC PRODUCTS PROVIDED VIA THE INTERNET AND OTHER ELECTRONIC COMMUNICATIONS NETWORKS (U.S. CLS. 100, 101 AND 102).

WENDY GOODMAN, EXAMINING ATTORNEY

**CLASS 35—(Continued).**

SN 78-418,662. NRS, LTD., CARROLLTON, TX. FILED 5-14-2004.

**NRS**

THE MARK CONSISTS OF STANDARD CHARACTERS WITHOUT CLAIM TO ANY PARTICULAR FONT, STYLE, SIZE, OR COLOR.

FOR ACCOUNTS RECEIVABLE MANAGEMENT SERVICES (U.S. CLS. 100, 101 AND 102).

TARAH HARDY, EXAMINING ATTORNEY

SN 78-418,887. HOOPS L.P., MEMPHIS, TN. FILED 5-14-2004.



OWNER OF U.S. REG. NOS. 2,100,590, 2,749,331 AND OTHERS.

NO CLAIM IS MADE TO THE EXCLUSIVE RIGHT TO USE "MEMPHIS", APART FROM THE MARK AS SHOWN.

FOR COMPUTERIZED ON-LINE RETAIL STORE, ORDERING, RETAIL, ELECTRONIC RETAILING, CATALOG AND MAIL ORDER CATALOG SERVICES FEATURING AN ARRAY OF BASKETBALL-THEMED MERCHANDISE; PROMOTING THE GOODS AND SERVICES OF OTHERS BY ALLOWING SPONSORS TO AFFILIATE THESE GOODS AND SERVICES WITH A BASKETBALL PROGRAM; PROMOTING THE SALE OF GOODS AND SERVICES OF OTHERS THROUGH THE DISTRIBUTION OF PROMOTIONAL CONTESTS PROVIDED OVER THE INTERNET; CONDUCTING PUBLIC OPINION POLL SURVEYS AND PUBLIC OPINION POLL SURVEYS IN THE FIELD OF BASKETBALL FOR NON-BUSINESS, NON-MARKETING PURPOSES OVER THE INTERNET (U.S. CLS. 100, 101 AND 102).

GEORGE LORENZO, EXAMINING ATTORNEY

SN 78-418,627. H.A. BRUNO, LLC, PARAMUS, NJ. FILED 5-14-2004.



NO CLAIM IS MADE TO THE EXCLUSIVE RIGHT TO USE "CPP EXPO", APART FROM THE MARK AS SHOWN. THE COLOR(S) RED AND BLUE IS/ARE CLAIMED AS A FEATURE OF THE MARK.

THE MARK CONSISTS OF THE LETTERS CPP IN WHITE ON A BLUE-GRAY BACKGROUND WITH A REPRESENTATION OF A ROLL OF PAPER IN RED WINDING THROUGH THE LETTERS AND THE WORD EXPO IN RED.

FOR ARRANGING AND CONDUCTING TRADE SHOWS AND EXPOSITIONS IN THE FIELD OF CONVERTING, PACKAGING AND PRINTING (U.S. CLS. 100, 101 AND 102).

ROBIN CHOSID, EXAMINING ATTORNEY

**CLASS 35—(Continued).**

SN 78-419,518. GALLERY ONE, LTD., COMPANY, MENTOR, OH. FILED 5-16-2004.

**CLASS 35—(Continued).**

SN 78-422,228. PROTECH COMMUNICATIONS, INC., MIDLAND, VA. FILED 5-20-2004.

**MASTERVISIONS**

THE MARK CONSISTS OF STANDARD CHARACTERS WITHOUT CLAIM TO ANY PARTICULAR FONT, STYLE, SIZE, OR COLOR.

FOR ART GALLERY SERVICES (U.S. CLS. 100, 101 AND 102).

FIRST USE 10-31-1993; IN COMMERCE 10-31-1993.  
ELLEN B. AWRICH, EXAMINING ATTORNEY



FOR BUSINESS MANAGEMENT SERVICES; BUSINESS CONSULTATION SERVICES, NAMELY, CONSULTATION SERVICES RELATING TO IMPROVING BUSINESS PROCESSES AND METHODS (U.S. CLS. 100, 101 AND 102).

LESLEY LAMOTHE, EXAMINING ATTORNEY

SN 78-421,686. AQUANTIVE, INC., SEATTLE, WA. FILED 5-19-2004.

SN 78-476,570. AMERICAN INTERNATIONAL GROUP, INC., NEW YORK, NY. FILED 8-31-2004.

**SELECTOR**

THE MARK CONSISTS OF STANDARD CHARACTERS WITHOUT CLAIM TO ANY PARTICULAR FONT, STYLE, SIZE, OR COLOR.

FOR ADVERTISING AGENCY SERVICES; BUSINESS AND ADVERTISING SERVICES, NAMELY, ADVERTISING SERVICES THAT ALLOW OTHERS TO DIRECT ONLINE ADVERTISEMENTS TO A NETWORK OF ONLINE MEDIA PUBLISHERS OR TO A CUSTOMIZED TARGET AUDIENCE, THAT DEFINES TARGET AUDIENCES BASED ON A VARIETY OF FACTORS, AND THAT IDENTIFIES WHETHER A RESPONSE TO AN ADVERTISEMENT IS FROM THE TARGETED AUDIENCE; MANAGING, TRACKING AND EVALUATING MEDIA PLANNING; MEDIA BUYING AND THE SUCCESS OF MARKETING EFFORTS OF OTHERS; CONSULTING SERVICES IN THE FIELD OF ADVERTISING (U.S. CLS. 100, 101 AND 102).

CHERYL CLAYTON, EXAMINING ATTORNEY

**THE AIG EDGE**

THE MARK CONSISTS OF STANDARD CHARACTERS WITHOUT CLAIM TO ANY PARTICULAR FONT, STYLE, SIZE, OR COLOR.

FOR PROMOTING INVESTMENT AND INSURANCE CLIENT SERVICES THROUGH THE ADMINISTRATION OF AN INCENTIVE AWARDS PROGRAM, NAMELY, FREE AND DISCOUNTED FINANCIAL, EDUCATIONAL, AND LIFESTYLE SERVICES (U.S. CLS. 100, 101 AND 102).

FIRST USE 10-1-2004; IN COMMERCE 10-1-2004.  
WENDY GOODMAN, EXAMINING ATTORNEY

**CLASS 35—(Continued).**

SN 78-502,931. LIMCO, INC., WILMINGTON, DE. FILED 10-20-2004.

**CLASS 36—INSURANCE AND FINANCIAL**

SN 75-912,442. HIGHLAND CAPITAL PARTNERS, INC., BOSTON, MA. FILED 2-8-2000.

**HIGHLAND**  
**CAPITAL PARTNERS**

**ONLY AT THE  
LIMITED AND NO  
WHERE ELSE**

NO CLAIM IS MADE TO THE EXCLUSIVE RIGHT TO USE "CAPITAL PARTNERS", APART FROM THE MARK AS SHOWN.

FOR BUSINESS MANAGEMENT SERVICES RENDERED TO INSURANCE AGENCIES AND OTHERS IN THE FIELDS OF INSURANCE, EXECUTIVE COMPENSATION AND BENEFIT PLANNING, BUSINESS SUCCESSION PLANNING, ESTATE PLANNING, RETIREMENT PLANNING, EMPLOYEE BENEFIT PLANNING, QUALIFIED PLAN ADMINISTRATION, DISABILITY PLANNING, ASSET MANAGEMENT OUTSIDE THE FIELDS OF VENTURE CAPITAL, PRIVATE EQUITY, AND FUNDS OF FUNDS, AND FINANCIAL ADVISORY SERVICES OUTSIDE THE FIELDS OF VENTURE CAPITAL, PRIVATE EQUITY, AND FUNDS OF FUNDS; MANAGEMENT OF MARKETING FUNCTIONS, NAMELY, SALES LEAD GENERATION, DEVELOPING PROMOTIONAL CAMPAIGNS, AND BUSINESS MARKETING CONSULTING SERVICES, RENDERED TO INSURANCE AGENCIES AND OTHERS IN THE FIELDS OF INSURANCE, EXECUTIVE COMPENSATION AND BENEFIT PLANNING, BUSINESS SUCCESSION PLANNING, ESTATE PLANNING, RETIREMENT PLANNING, EMPLOYEE BENEFIT PLANNING, QUALIFIED PLAN ADMINISTRATION, DISABILITY PLANNING, ASSET MANAGEMENT OUTSIDE THE FIELDS OF VENTURE CAPITAL, PRIVATE EQUITY, AND FUNDS OF FUNDS, AND FINANCIAL ADVISORY SERVICES OUTSIDE THE FIELDS OF VENTURE CAPITAL, PRIVATE EQUITY, AND FUNDS OF FUNDS (U.S. CLS. 100, 101 AND 102).

FIRST USE 7-0-1999; IN COMMERCE 7-0-1999.  
DEZMONA MIZELLE, EXAMINING ATTORNEY

---

SN 76-095,747. INDIGO CAPITAL, LLC, NEW YORK, NY. FILED 7-24-2000.

**INDIGO CAPITAL**

NO CLAIM IS MADE TO THE EXCLUSIVE RIGHT TO USE "CAPITAL", APART FROM THE MARK AS SHOWN.

FOR FINANCIAL ANALYSIS AND CONSULTATION IN THE STRUCTURING AND EXECUTION OF ACQUISITION, DIVESTITURES, MERGERS, JOINT VENTURES, PRIVATE EQUITY PLACEMENTS AND RELATED STRATEGIES FOR INTERNATIONAL FINANCIAL TRANSACTIONS (U.S. CLS. 100, 101 AND 102).

FIRST USE 10-1-1998; IN COMMERCE 10-1-1998.  
KATHLEEN M. VANSTON, EXAMINING ATTORNEY

THE MARK CONSISTS OF STANDARD CHARACTERS WITHOUT CLAIM TO ANY PARTICULAR FONT, STYLE, SIZE, OR COLOR.

OWNER OF U.S. REG. NOS. 1,020,794, 2,234,267 AND OTHERS.

FOR RETAIL STORE SERVICES, MAIL ORDER CATALOG SERVICES AND ON-LINE RETAIL STORE SERVICES FEATURING CLOTHING (U.S. CLS. 100, 101 AND 102).

DARRYL SPRUILL, EXAMINING ATTORNEY

**CLASS 36—(Continued).**

SN 76-289,983. CIPHER INVESTMENT MANAGEMENT COMPANY, INC., CORAL GABLES, FL. FILED 7-25-2001.

**CIPHER**

FOR FINANCIAL MANAGEMENT AND INVESTMENT MANAGEMENT SERVICES (U.S. CLS. 100, 101 AND 102).

FIRST USE 5-12-1994; IN COMMERCE 5-12-1994.  
CURTIS FRENCH, EXAMINING ATTORNEY

**CLASS 36—(Continued).**

SN 76-501,462. THE TICKET RESERVE, INC., CHICAGO, IL. FILED 3-27-2003.



FOR COMMODITY TRADING SERVICES FOR OTHERS IN CONNECTION WITH EVENT TICKETS AND FORWARD CONTRACTS ON EVENT TICKETS (U.S. CLS. 100, 101 AND 102).

FIRST USE 3-1-2002; IN COMMERCE 3-1-2002.  
ELIZABETH J. WINTER, EXAMINING ATTORNEY

SN 76-495,657. WASHINGTON BALALAIIKA SOCIETY, SPRINGFIELD, VA. FILED 3-7-2003.

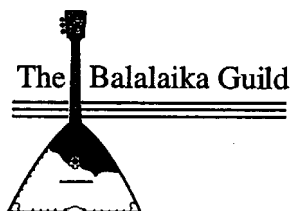

NO CLAIM IS MADE TO THE EXCLUSIVE RIGHT TO USE "THE BALALAIIKA GUILD" AND THE REPRESENTATION OF THE BALALAIIKA INSTRUMENT, APART FROM THE MARK AS SHOWN.

FOR PHILANTHROPIC/ELEEMOSYNARY SERVICES WHICH ENCOURAGE MUSICAL ACTIVITIES AND THE INTERESTS OF MUSICIANS, NAMELY, PROVIDING FINANCIAL ASSISTANCE TO ORCHESTRAS, MUSICIANS, CONDUCTORS, TEACHERS, AND GUEST ARTISTS (U.S. CLS. 100, 101 AND 102).

TRICIA SONNEBORN, EXAMINING ATTORNEY

SN 76-525,835. GEORGIA BREAST CANCER COALITION FUND, ATLANTA, GA. FILED 6-5-2003.



FOR CHARITABLE FUND RAISING SERVICES (U.S. CLS. 100, 101 AND 102).

FIRST USE 4-23-2003; IN COMMERCE 4-23-2003.  
BILL DAWE, EXAMINING ATTORNEY

SN 76-499,362. NETWORK COMMUNICATIONS, INC., LAWRENCEVILLE, GA. FILED 3-11-2003.

**LIVINGCHOICES**

FOR PROVIDING REAL ESTATE, APARTMENT, CONDOMINIUM, INTERIM HOUSING, AND RETIREMENT COMMUNITY PROPERTY INFORMATION OF INTEREST TO RESIDENTIAL RENTERS AND HOME PURCHASERS VIA AN ONLINE ELECTRONIC COMMUNICATIONS NETWORK (U.S. CLS. 100, 101 AND 102).

FIRST USE 3-1-2000; IN COMMERCE 3-1-2000.  
ASMAT KHAN, EXAMINING ATTORNEY

SN 76-537,276. HORICON BANK, HORICON, WI. FILED 8-13-2003.



SEC. 2(F) AS TO "HORICON STATE BANK".  
FOR BANKING (U.S. CLS. 100, 101 AND 102).  
FIRST USE 3-0-1999; IN COMMERCE 3-0-1999.  
SHARI SHEFFIELD, EXAMINING ATTORNEY

**CLASS 36—(Continued).**

SN 76-553,497. BLUE VISTA CAPITAL PARTNERS, LLC, CHICAGO, IL. FILED 10-23-2003.

**BLUE VISTA**

FOR INVESTMENT BANKING SERVICES AND INVESTMENT MANAGEMENT FOCUSED ON REAL ESTATE (U.S. CLS. 100, 101 AND 102).  
FIRST USE 2-22-2002; IN COMMERCE 2-22-2002.  
KEVON CHISOLM, EXAMINING ATTORNEY

**CLASS 36—(Continued).**

SN 76-560,588. GENERAL ELECTRIC COMPANY, SCHECTADY, NY. FILED 11-17-2003.

**GE PRE-AUTHORIZATION SYSTEM**

THE MARK CONSISTS OF STANDARD CHARACTERS WITHOUT CLAIM TO ANY PARTICULAR FONT, STYLE, SIZE, OR COLOR.

OWNER OF U.S. REG. NOS. 1,111,065, 2,201,003 AND OTHERS.

NO CLAIM IS MADE TO THE EXCLUSIVE RIGHT TO USE "PRE-AUTHORIZATION SYSTEM", APART FROM THE MARK AS SHOWN.

FOR FINANCIAL SERVICES, NAMELY, PROVIDING CRITERIA-BASED MANAGEMENT AND CONTROL OF TRANSACTIONS BY WAY OF A COMPUTERIZED CREDIT CARD AUTHORIZATION SYSTEM (U.S. CLS. 100, 101 AND 102).

FIRST USE 2-0-1998; IN COMMERCE 9-0-1998.  
DOUGLAS LEE, EXAMINING ATTORNEY

SN 76-556,566. HIWAY FEDERAL CREDIT UNION, ST. PAUL, MN. FILED 11-3-2003.

**HIWAY CU SERVICES**

THE MARK CONSISTS OF STANDARD CHARACTERS WITHOUT CLAIM TO ANY PARTICULAR FONT, STYLE, SIZE, OR COLOR.

NO CLAIM IS MADE TO THE EXCLUSIVE RIGHT TO USE "CU SERVICES", APART FROM THE MARK AS SHOWN.

FOR FINANCIAL SERVICES, NAMELY, LOAN FINANCING, MORTGAGE BANKING AND INVESTMENT BANKING (U.S. CLS. 100, 101 AND 102).

FIRST USE 9-30-2003; IN COMMERCE 9-30-2003.  
KATHERINE STOIDES, EXAMINING ATTORNEY

SN 76-556,901. APPALACHIAN EDUCATION INITIATIVE FOUNDATION, MORGANTOWN, WV. FILED 10-22-2003.

**AEI DONOR DIRECT**

NO CLAIM IS MADE TO THE EXCLUSIVE RIGHT TO USE DONOR, APART FROM THE MARK AS SHOWN.

FOR CHARITABLE FUND RAISING, NAMELY, FUND RAISING FOR EDUCATIONAL INSTITUTIONS (U.S. CLS. 100, 101 AND 102).

MARIA-VICTORIA SUAREZ, EXAMINING ATTORNEY

SN 76-561,215. GC SERVICES, LP, HOUSTON, TX. FILED 11-24-2003.

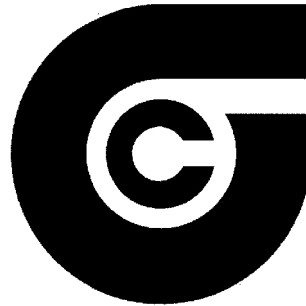

SN 76-559,015. HOME DISCOVERE REAL ESTATE SERVICES CORPORATION, TAMPA, FL. FILED 11-13-2003.

**HOME DISCOVERE**

THE MARK CONSISTS OF STANDARD CHARACTERS WITHOUT CLAIM TO ANY PARTICULAR FONT, STYLE, SIZE, OR COLOR.

NO CLAIM IS MADE TO THE EXCLUSIVE RIGHT TO USE HOME, APART FROM THE MARK AS SHOWN.

FOR REAL ESTATE SERVICES, NAMELY, BROKERAGE, MORTGAGE LENDING, PROPERTY MANAGEMENT, AND TITLE SERVICES, NAMELY, PROVIDING TITLE INSURANCE (U.S. CLS. 100, 101 AND 102).

FIRST USE 9-0-2002; IN COMMERCE 9-0-2002.  
PRISCILLA MILTON, EXAMINING ATTORNEY

FOR FINANCIAL SERVICES, NAMELY, PROVIDING DEBT COLLECTION SERVICES AND CUSTOMER ASSISTANCE ACCOUNT INFORMATION CALLING CARD SERVICES (U.S. CLS. 100, 101 AND 102).

FIRST USE 11-1-1971; IN COMMERCE 11-1-1971.  
JULIA HARDY COFIELD, EXAMINING ATTORNEY

**CLASS 36—(Continued).**

SN 76-561,342. SECURIAN FINANCIAL GROUP, INC., ST. PAUL, MN. FILED 11-21-2003.

**PLAN ON US**

THE MARK CONSISTS OF STANDARD CHARACTERS WITHOUT CLAIM TO ANY PARTICULAR FONT, STYLE, SIZE, OR COLOR.

FOR FINANCIAL SERVICES, NAMELY ADMINISTRATION OF RETIREMENT PLANS (U.S. CLS. 100, 101 AND 102).

FIRST USE 9-1-2003; IN COMMERCE 9-1-2003.  
KAREN BRACEY, EXAMINING ATTORNEY

**CLASS 36—(Continued).**

SN 76-574,372. OHANESSIAN, SHAHAN, DBA CLAIMWIZ, GLENDALE, CA. FILED 2-6-2004.

**CLAIMWIZ**

THE MARK CONSISTS OF STANDARD CHARACTERS WITHOUT CLAIM TO ANY PARTICULAR FONT, STYLE, SIZE, OR COLOR.

FOR INSURANCE CLAIM ADMINISTRATION (U.S. CLS. 100, 101 AND 102).

VIVIAN MICZNIK FIRST, EXAMINING ATTORNEY

SN 76-561,516. CAMCO, INC., LAS VEGAS, NV. FILED 11-10-2003.

**MAX CASH**

THE MARK CONSISTS OF STANDARD CHARACTERS WITHOUT CLAIM TO ANY PARTICULAR FONT, STYLE, SIZE, OR COLOR.

NO CLAIM IS MADE TO THE EXCLUSIVE RIGHT TO USE "CASH", APART FROM THE MARK AS SHOWN.

FOR CHECK CASHING, NAMELY, CASHING OF PAYCHECKS; MONEY LENDING; ELECTRONIC FUNDS TRANSFER (U.S. CLS. 100, 101 AND 102).

FIRST USE 8-20-2003; IN COMMERCE 10-20-2003.  
MICHAEL HALL, EXAMINING ATTORNEY

SN 76-578,786. MORGAN STANLEY, NEW YORK, NY. FILED 3-1-2004.

**PROPELS**

FOR FINANCIAL SERVICES IN THE NATURE OF AN INVESTMENT SECURITY AND TRADING, PURCHASING AND STRUCTURING INVESTMENT SECURITIES, AND ADVISORY SERVICES RELATING THERETO (U.S. CLS. 100, 101 AND 102).

FIRST USE 2-20-2004; IN COMMERCE 2-20-2004.  
AMY HELLA, EXAMINING ATTORNEY

SN 76-572,499. THE BEAR STEARNS COMPANIES INC., NEW YORK, NY. FILED 1-26-2004.

**BEAR STEARNS ADVISORY SERVICES ALLIANCE**

THE MARK CONSISTS OF STANDARD CHARACTERS WITHOUT CLAIM TO ANY PARTICULAR FONT, STYLE, SIZE, OR COLOR.

OWNER OF U.S. REG. NOS. 1,868,600, 2,119,742 AND 2,491,490.

NO CLAIM IS MADE TO THE EXCLUSIVE RIGHT TO USE "ADVISORY SERVICES ALLIANCE", APART FROM THE MARK AS SHOWN.

FOR FINANCIAL SERVICES, NAMELY, PROVIDING WEALTH AND ASSET MANAGEMENT SERVICES (U.S. CLS. 100, 101 AND 102).

STEVEN BERK, EXAMINING ATTORNEY

SN 76-579,472. CIGNA INTELLECTUAL PROPERTY, INC., CLAYMONT, DE. FILED 3-5-2004.

**SIGNATURE – YOUR PLAN. YOUR CHOICE.**

THE MARK CONSISTS OF STANDARD CHARACTERS WITHOUT CLAIM TO ANY PARTICULAR FONT, STYLE, SIZE, OR COLOR.

OWNER OF U.S. REG. NOS. 1,270,224 AND 2,578,084.  
FOR UNDERWRITING AND ADMINISTRATION OF CUSTOMIZED HEALTH CARE INSURANCE (U.S. CLS. 100, 101 AND 102).

FIRST USE 2-19-2004; IN COMMERCE 2-19-2004.  
GEOFFREY FOSDICK, EXAMINING ATTORNEY



**CLASS 36—(Continued).**

SN 76-583,025. ASPERION, LLC, NEW YORK, NY. FILED 3-25-2004.

# ASPERION

THE MARK CONSISTS OF STANDARD CHARACTERS WITHOUT CLAIM TO ANY PARTICULAR FONT, STYLE, SIZE, OR COLOR.

FOR FINANCIAL SERVICES, NAMELY, INVESTMENT MANAGEMENT, FINANCIAL MANAGEMENT, ASSET MANAGEMENT, BROKER AND DEALER ADVISORY AND HEDGE FUND MANAGEMENT SERVICES (U.S. CLS. 100, 101 AND 102).

STEVEN BERK, EXAMINING ATTORNEY



SN 76-583,224. ASSURED GUARANTY LTD., HAMILTON HM 08, BERMUDA, FILED 3-22-2004.

## ASSURED GUARANTY LTD.

THE MARK CONSISTS OF STANDARD CHARACTERS WITHOUT CLAIM TO ANY PARTICULAR FONT, STYLE, SIZE, OR COLOR.

NO CLAIM IS MADE TO THE EXCLUSIVE RIGHT TO USE GUARANTY LTD, APART FROM THE MARK AS SHOWN.

FOR INSURANCE SERVICES, NAMELY, UNDERWRITING FINANCIAL GUARANTY INSURANCE AND REINSURANCE FOR MUNICIPAL AND STRUCTURED FINANCE OBLIGATIONS AND MORTGAGE GUARANTY INSURANCE AND REINSURANCE (U.S. CLS. 100, 101 AND 102).

KAREN BRACEY, EXAMINING ATTORNEY



SN 76-583,855. BROADWAY BANCSHARES, INC., SAN ANTONIO, TX. FILED 3-26-2004.

## BROADWAY BANK

THE MARK CONSISTS OF STANDARD CHARACTERS WITHOUT CLAIM TO ANY PARTICULAR FONT, STYLE, SIZE, OR COLOR.

OWNER OF U.S. REG. NOS. 1,284,601, 2,752,480 AND OTHERS.

NO CLAIM IS MADE TO THE EXCLUSIVE RIGHT TO USE BANK, APART FROM THE MARK AS SHOWN. FOR BANKING SERVICES (U.S. CLS. 100, 101 AND 102).

FIRST USE 9-1-1996; IN COMMERCE 9-1-1996.  
KELLEY WELLS, EXAMINING ATTORNEY

**CLASS 36—(Continued).**

SN 76-584,769. THE BEAR STEARNS COMPANIES INC., NEW YORK, NY. FILED 4-5-2004.

# HYCUS

THE MARK CONSISTS OF STANDARD CHARACTERS WITHOUT CLAIM TO ANY PARTICULAR FONT, STYLE, SIZE, OR COLOR.

FOR FINANCIAL SERVICES IN THE NATURE OF AN INVESTMENT SECURITY (U.S. CLS. 100, 101 AND 102). FIRST USE 12-18-2003; IN COMMERCE 12-18-2003.  
WARREN L. OLANDRIA, EXAMINING ATTORNEY



SN 76-584,954. ONEBEACON INSURANCE COMPANY, BOSTON, MA. FILED 4-2-2004.

### OneBeacon International Marine Insurance Co.

THE MARK CONSISTS OF STANDARD CHARACTERS WITHOUT CLAIM TO ANY PARTICULAR FONT, STYLE, SIZE, OR COLOR.

OWNER OF U.S. REG. NO. 2,780,433.  
NO CLAIM IS MADE TO THE EXCLUSIVE RIGHT TO USE "INTERNATIONAL MARINE INSURANCE CO.", APART FROM THE MARK AS SHOWN.

FOR MARINE INSURANCE UNDERWRITING (U.S. CLS. 100, 101 AND 102).  
AMY ALFIERI, EXAMINING ATTORNEY



SN 76-586,622. GALLAGHER'S HEATING AND AIR CONDITIONING, INC., LOS MOLINOS, CA. FILED 4-12-2004.

## SHAMROCK PRIVILEGE+

FOR PREPAID PREVENTATIVE MAINTENANCE SERVICE PLANS FOR HEATING, VENTILATING AND AIR CONDITIONING SYSTEMS (U.S. CLS. 100, 101 AND 102).

TIMOTHY FINNEGAN, EXAMINING ATTORNEY

**CLASS 36—(Continued).**

SN 76-586,914. CORPORATE FINANCIAL VENTURES, INC., ORLANDO, FL. FILED 4-15-2004.

**CFO STRATEGIC PARTNERS**

THE MARK CONSISTS OF STANDARD CHARACTERS WITHOUT CLAIM TO ANY PARTICULAR FONT, STYLE, SIZE, OR COLOR.

NO CLAIM IS MADE TO THE EXCLUSIVE RIGHT TO USE "CFO" AND "PARTNERS", APART FROM THE MARK AS SHOWN.

FOR FINANCIAL CONSULTING SERVICES PROVIDED TO BUSINESSES (U.S. CLS. 100, 101 AND 102).

FIRST USE 9-0-2001; IN COMMERCE 9-0-2001.

GIANCARLO CASTRO, EXAMINING ATTORNEY

---

SN 76-586,916. CORPORATE FINANCIAL VENTURES, INC., ORLANDO, FL. FILED 4-15-2004.



NO CLAIM IS MADE TO THE EXCLUSIVE RIGHT TO USE "CFO" AND "PARTNERS", APART FROM THE MARK AS SHOWN.

FOR FINANCIAL CONSULTING SERVICES PROVIDED TO BUSINESSES (U.S. CLS. 100, 101 AND 102).

FIRST USE 12-0-2002; IN COMMERCE 12-0-2002.

GIANCARLO CASTRO, EXAMINING ATTORNEY

---

SN 76-587,747. LYRIC ADVISORS, INC, WEST PALM BEACH, FL. FILED 4-21-2004.

**LYRIC ADVISORS**

THE MARK CONSISTS OF STANDARD CHARACTERS WITHOUT CLAIM TO ANY PARTICULAR FONT, STYLE, SIZE, OR COLOR.

NO CLAIM IS MADE TO THE EXCLUSIVE RIGHT TO USE "ADVISORS", APART FROM THE MARK AS SHOWN.

FOR FINANCIAL SERVICES, NAMELY PROVIDING VENTURE CAPITAL AND GROWTH CAPITAL FUNDING SERVICES TO EMERGING AND START-UP COMPANIES, INVESTMENT BANKING, MERCHANT BANKING AND FINANCIAL CONSULTATION SERVICES (U.S. CLS. 100, 101 AND 102).

STEPHANIE DAVIS, EXAMINING ATTORNEY

**CLASS 36—(Continued).**

SN 76-588,741. OSMOND FOUNDATION, FOR THE CHILDREN OF THE WORLD, DBA CHILDREN'S MIRACLE NETWORK, SALT LAKE CITY, UT. FILED 4-26-2004.



OWNER OF U.S. REG. NOS. 1,343,289, 2,445,434 AND OTHERS.

NO CLAIM IS MADE TO THE EXCLUSIVE RIGHT TO USE "CHILDREN'S" AND "NETWORK", APART FROM THE MARK AS SHOWN.

FOR CHARITABLE FUND RAISING AND ELEEMOSYNARY SERVICES IN THE FIELD OF MONETARY DONATIONS (U.S. CLS. 100, 101 AND 102).

FIRST USE 0-0-1999; IN COMMERCE 0-0-1999.

MICHAEL TANNER, EXAMINING ATTORNEY

---

SN 76-589,132. GMAC MORTGAGE CORPORATION, HORSHAM, PA. FILED 4-28-2004.

**SU PRÉSTAMO HIPOTECARIO ¡FÁCIL!**

THE MARK CONSISTS OF STANDARD CHARACTERS WITHOUT CLAIM TO ANY PARTICULAR FONT, STYLE, SIZE, OR COLOR.

THE ENGLISH TRANSLATION OF THE MARK IS: "YOUR MORTGAGE SOLUTION. DELIVERED."

FOR REAL ESTATE MORTGAGE BANKING AND LENDING SERVICES (U.S. CLS. 100, 101 AND 102).

CHARLES L. JENKINS, EXAMINING ATTORNEY

---

SN 76-589,417. PASSPORT HEALTH COMMUNICATIONS, INC., FRANKLIN, TN. FILED 4-29-2004.



FOR PROVIDING HEALTH CARE FINANCIAL AND INSURANCE INFORMATION VIA THE INTERNET, TELEPHONE AND POINT TO POINT COMMUNICATIONS CIRCUITS (U.S. CLS. 100, 101 AND 102).

FIRST USE 4-1-1998; IN COMMERCE 4-1-1998.

MARK T. MULLEN, EXAMINING ATTORNEY

**CLASS 36—(Continued).**

SN 76-590,568. CITY & COUNTY CREDIT UNION, ST. PAUL, MN. FILED 5-5-2004.

**A UNION OF EQUALS**

THE MARK CONSISTS OF STANDARD CHARACTERS WITHOUT CLAIM TO ANY PARTICULAR FONT, STYLE, SIZE, OR COLOR.  
FOR CREDIT UNION SERVICES (U.S. CLS. 100, 101 AND 102).  
MARCIE MILONE, EXAMINING ATTORNEY

SN 76-590,727. THE LAREDO NATIONAL BANK, LAREDO, TX. FILED 5-6-2004.

**LNB**

THE MARK CONSISTS OF STANDARD CHARACTERS WITHOUT CLAIM TO ANY PARTICULAR FONT, STYLE, SIZE, OR COLOR.  
FOR BANKING AND FINANCIAL SERVICES, NAMELY RETAIL BANKING (U.S. CLS. 100, 101 AND 102).  
FIRST USE 3-0-1994; IN COMMERCE 3-0-1994.  
RICHARD A. STRASER, EXAMINING ATTORNEY

SN 76-590,730. ANHEUSER-BUSCH EMPLOYEES' CREDIT UNION, SAINT LOUIS, MO. FILED 5-6-2004.

**FREEDOM TO GROW**

THE MARK CONSISTS OF STANDARD CHARACTERS WITHOUT CLAIM TO ANY PARTICULAR FONT, STYLE, SIZE, OR COLOR.  
OWNER OF U.S. REG. NO. 1,194,441.  
FOR CREDIT UNION SERVICES (U.S. CLS. 100, 101 AND 102).  
FIRST USE 3-30-2003; IN COMMERCE 3-30-2003.  
GRETTA YAO, EXAMINING ATTORNEY

**CLASS 36—(Continued).**

SN 76-590,731. ANHEUSER-BUSCH EMPLOYEES' CREDIT UNION, SAINT LOUIS, MO. FILED 5-6-2004.



OWNER OF U.S. REG. NOS. 1,194,441 AND 2,306,880.  
FOR CREDIT UNION SERVICES (U.S. CLS. 100, 101 AND 102).  
FIRST USE 3-30-2003; IN COMMERCE 3-30-2003.  
GRETTA YAO, EXAMINING ATTORNEY

SN 76-590,761. KEYS FEDERAL CREDIT UNION, KEY WEST, FL. FILED 5-6-2004.

**WORK LIVE JOIN**

THE MARK CONSISTS OF STANDARD CHARACTERS WITHOUT CLAIM TO ANY PARTICULAR FONT, STYLE, SIZE, OR COLOR.  
FOR FINANCIAL SERVICES, NAMELY, CREDIT UNION SERVICES AND BANKING SERVICES (U.S. CLS. 100, 101 AND 102).  
FIRST USE 6-0-2000; IN COMMERCE 6-0-2000.  
MARY CRAWFORD, EXAMINING ATTORNEY

SN 76-591,098. DELTA DENTAL PLANS ASSOCIATION, OAK BROOK, IL. FILED 5-7-2004.

**DELTA DENTAL CONNECT**

OWNER OF U.S. REG. NOS. 1,060,976, 1,760,270 AND OTHERS.  
NO CLAIM IS MADE TO THE EXCLUSIVE RIGHT TO USE "DENTAL", APART FROM THE MARK AS SHOWN.  
FOR PROVIDING INSURANCE CONSULTATION SERVICES TO BROKERS IN CONNECTION WITH SMALL BUSINESS' DENTAL INSURANCE NEEDS (U.S. CLS. 100, 101 AND 102).  
MICHAEL KEATING, EXAMINING ATTORNEY

**CLASS 36—(Continued).**

SN 76-591,127. 1ST COMMUNITY FEDERAL CREDIT UNION, SAN ANGELO, TX. FILED 5-10-2004.



FOR CREDIT UNION SERVICES (U.S. CLS. 100, 101 AND 102).  
FIRST USE 7-27-1983; IN COMMERCE 7-27-1983.  
ANNE E. GUSTASON, EXAMINING ATTORNEY

SN 76-591,192. WELDON CAPITAL FUNDS, INC., LEAWOOD, KS. FILED 5-10-2004.



FOR MUTUAL FUND INVESTMENT, BROKERAGE AND DISTRIBUTION SERVICES (U.S. CLS. 100, 101 AND 102).  
FIRST USE 3-1-2004; IN COMMERCE 4-1-2004.  
GEORGE LORENZO, EXAMINING ATTORNEY

SN 76-591,449. ADVANCE MAGAZINE PUBLISHERS INC., NEW YORK, NY. FILED 5-10-2004.

## WIRED 40

THE MARK CONSISTS OF STANDARD CHARACTERS WITHOUT CLAIM TO ANY PARTICULAR FONT, STYLE, SIZE, OR COLOR.

FOR FINANCIAL SERVICES IN THE NATURE OF A STOCK INDEX, NAMELY DETERMINATION OF STOCK PRICES, THE CALCULATION OF STOCK INDEXES AND INFORMATION SERVICES RELATED THERETO; FINANCIAL INVESTMENT SERVICES, NAMELY A MUTUAL FUND DESIGNED TO TRACK STOCK INDEXES (U.S. CLS. 100, 101 AND 102).

RAMONA ORTIGA, EXAMINING ATTORNEY

**CLASS 36—(Continued).**

SN 76-591,792. PRIME SITES, INC., COCONUT GROVE, FL. FILED 5-12-2004.

Connecting great brands with great locations

THE MARK CONSISTS OF STANDARD CHARACTERS WITHOUT CLAIM TO ANY PARTICULAR FONT, STYLE, SIZE, OR COLOR.

FOR REAL ESTATE LEASING SERVICES (U.S. CLS. 100, 101 AND 102).

FIRST USE 4-1-2004; IN COMMERCE 4-1-2004.

PATRICIA EVANKO, EXAMINING ATTORNEY

SN 76-591,872. KANSAS CITY AVIATION DEPARTMENT, KANSAS CITY, MO. FILED 5-12-2004.

## KCI QUICKTAG

THE MARK CONSISTS OF STANDARD CHARACTERS WITHOUT CLAIM TO ANY PARTICULAR FONT, STYLE, SIZE, OR COLOR.

FOR ELECTRONIC PAYMENT COLLECTION SERVICES, NAMELY, COLLECTION OF PARKING FEES THROUGH USE OF AN ELECTRONIC SYSTEM TO IDENTIFY VEHICLES AND AUTOMATICALLY CHARGE PARKING FEES TO THE VEHICLE OWNER'S ACCOUNT (U.S. CLS. 100, 101 AND 102).

EVELYN BRADLEY, EXAMINING ATTORNEY

SN 76-592,103. BUDROS, RUHLIN & ROE, INC., COLUMBUS, OH. FILED 5-13-2004.

**INDEPENDENT WISDOM FOR WEALTH**

THE MARK CONSISTS OF STANDARD CHARACTERS WITHOUT CLAIM TO ANY PARTICULAR FONT, STYLE, SIZE, OR COLOR.

FOR FINANCIAL ANALYSIS AND CONSULTATION SERVICES (U.S. CLS. 100, 101 AND 102).

FIRST USE 3-1-2004; IN COMMERCE 3-1-2004.

STEPHANIE DAVIS, EXAMINING ATTORNEY

SN 76-592,330. DISCOVERY COLLEGIATE ADVISORS, INC., TOMS RIVER, NJ. FILED 5-17-2004.

**DISCOVER YOUR POTENTIAL**

THE MARK CONSISTS OF STANDARD CHARACTERS WITHOUT CLAIM TO ANY PARTICULAR FONT, STYLE, SIZE, OR COLOR.

FOR FINANCIAL CONSULTING FOR FUNDING EDUCATIONAL EXPENSES (U.S. CLS. 100, 101 AND 102).

FIRST USE 8-26-1998; IN COMMERCE 8-26-1998.

G. MAYERSCHOFF, EXAMINING ATTORNEY

**CLASS 36—(Continued).**

SN 76-594,457. ANNUITY BOARD OF THE SOUTHERN BAPTIST CONVENTION, DALLAS, TX. FILED 5-28-2004.

**CLASS 36—(Continued).**

SN 78-037,006. PCCW-HKT DATACOM SERVICES LIMITED, QUARRY BAY, HONG KONG, FILED 11-29-2000.

# 電訊盈科



FOR FINANCIAL SERVICES, NAMELY, DIRECTLY AND INDIRECTLY PROVIDING INVESTMENT AND EMPLOYEE BENEFIT PROGRAMS, NAMELY, ADMINISTERING RETIREMENT, DEFERRED COMPENSATION AND SEVERANCE PAY PLANS AND PROGRAMS; UNDERWRITING AND ADMINISTRATION OF MEDICAL, DENTAL, DISABILITY, LIFE, ACCIDENT AND PROPERTY AND CASUALTY INSURANCE; INVESTMENT OF FUNDS FOR OTHERS, NAMELY, PARTICIPANTS AND THEIR DEPENDENTS; AND ADMINISTRATION OF BENEFIT PLANS DESIGNED TO PROVIDE ADDITIONAL FINANCIAL RESOURCES TO INDIVIDUALS WITH LIMITED FINANCIAL RESOURCES AND SPECIAL NEEDS (U.S. CLS. 100, 101 AND 102).

FIRST USE 8-4-2004; IN COMMERCE 8-4-2004.  
DOMINIC J. FERRAIUOLO, EXAMINING ATTORNEY

PRIORITY CLAIMED UNDER SEC. 44(D) ON HONG KONG APPLICATION NO. 200016478, FILED 7-25-2000, REG. NO. 200310824, DATED 7-25-2000, EXPIRES 7-25-2007.

THE FOREIGN WORDING OF THE MARK TRANSLATES INTO ENGLISH AS "ELECTRICITY", "MESSAGE", "SURPLUS", "SUBJECT".

THE NON-LATIN CHARACTERS IN THE MARK TRANSLITERATE TO DIN SHUN YING FOUR AND THIS MEANS "ELECTRICITY", "MESSAGE", "SURPLUS", "SUBJECT" IN ENGLISH.

FOR FINANCIAL INFORMATION PROVIDED BY ELECTRONIC MEANS; FINANCIAL ANALYSIS AND CONSULTATION; FINANCIAL MANAGEMENT SERVICES; FINANCIAL CLEARING HOUSE SERVICES; INSURANCE SERVICES, NAMELY, INSURANCE BROKERAGE, INSURANCE CLAIMS ADMINISTRATION, INSURANCE CLAIMS PROCESSING AND INSURANCE CONSULTATION SERVICES; BANKING SERVICES PROVIDED VIA A GLOBAL COMPUTER INFORMATION NETWORK; AUTOMATED SECURITIES BROKERAGE; STOCK EXCHANGE PRICE QUOTATIONS; STOCKS AND BONDS BROKERAGE SERVICES; CREDIT AND DEBIT CARD SERVICES; CHARGE CARD AND CHECK GUARANTEE SERVICES; SAVINGS BANK SERVICES; INVESTMENT BROKERAGE AND CONSULTATION SERVICES; CREDIT CARD VERIFICATION SERVICES ADMINISTERED VIA A GLOBAL COMPUTER INFORMATION NETWORK; CREDIT CARD RISK MANAGEMENT SERVICES ADMINISTERED VIA A GLOBAL COMPUTER INFORMATION NETWORK; ELECTRONIC PAYMENT, NAMELY, ELECTRONIC PROCESSING AND TRANSMISSION OF BILL PAYMENT DATA; DEBIT AND CREDIT ACCOUNT SERVICES FEATURING COMPUTER READABLE CARDS AND SCANNABLE WRIST BANDS; ISSUANCE OF VALUE CARDS, CREDIT AND DEBIT CARDS; PROVIDING FINANCIAL AND INSURANCE INFORMATION VIA A GLOBAL COMPUTER INFORMATION NETWORK; PROVIDING AN ON-LINE DATABASE IN THE FIELD OF INVESTMENT, REAL ESTATE, INSURANCE AND FINANCE (U.S. CLS. 100, 101 AND 102).

HOWARD SMIGA, EXAMINING ATTORNEY

**CLASS 36—(Continued).**

SN 78-222,631. BRINK'S NETWORK, INC., WILMINGTON, DE. FILED 3-6-2003.



OWNER OF U.S. REG. NOS. 529,622, 2,646,784 AND OTHERS.

FOR HOLDING COMPANY SERVICES FOR SECURITY COMPANIES AND LOGISTICS AND COURIER COMPANIES, NAMELY, PROVIDING COMMON OWNERSHIP, COMMON FINANCIAL CONTROL AND FINANCIAL REPORTING AND SECURITIES LAWS AND REGULATORY COMPLIANCE REPORTING OF INSTITUTIONS ENGAGED IN THE SECURITY, COURIER AND LOGISTICS INDUSTRIES (U.S. CLS. 100, 101 AND 102).

FIRST USE 5-5-2003, THE "BRINK" PORTION OF THE MARK ANYWHERE WAS FIRST USED IN ANOTHER FORM AT LEAST AS EARLY AS JANUARY 1, 1912.; IN COMMERCE 5-5-2003, THE "BRINK" PORTION OF THE MARK IN COMMERCE WAS FIRST USED IN ANOTHER FORM AT LEAST AS EARLY AS JANUARY 1, 1912..  
GINA FINK, EXAMINING ATTORNEY



SN 78-232,898. UNITED AMERICAN MORTGAGE CORPORATION, IRVINE, CA. FILED 4-2-2003.

**UNITED AMERICAN MORTGAGE**

NO CLAIM IS MADE TO THE EXCLUSIVE RIGHT TO USE "MORTGAGE", APART FROM THE MARK AS SHOWN.

SEC. 2(F) AS TO "AMERICAN MORTGAGE". FOR MORTGAGE BANKING SERVICES ON RESIDENTIAL REAL ESTATE (U.S. CLS. 100, 101 AND 102). FIRST USE 2-2-1993; IN COMMERCE 2-2-1993.  
KARANENDRA S. CHHINA, EXAMINING ATTORNEY



SN 78-252,868. WIRB, INC., SPOKANE, WA. FILED 5-21-2003.



NO CLAIM IS MADE TO THE EXCLUSIVE RIGHT TO USE "WESTERN INTERNATIONAL RECOVERY BUREAU", APART FROM THE MARK AS SHOWN.

FOR VEHICLE AND PROPERTY REPOSSESSION SERVICES AND SKIP TRACING FOR CREDITORS (U.S. CLS. 100, 101 AND 102). FIRST USE 6-30-2002; IN COMMERCE 6-30-2002.  
ANDREA SAUNDERS, EXAMINING ATTORNEY

**CLASS 36—(Continued).**

SN 78-259,294. LEASECOMM CORPORATION, WOBURN, MA. FILED 6-6-2003.



FOR LEASE PURCHASE FINANCING FOR EQUIPMENT, NAMELY, OFFICE EQUIPMENT, ATM MACHINES, CREDIT CARD PROCESSING MACHINES, MEDICAL EQUIPMENT AND SECURITY EQUIPMENT (U.S. CLS. 100, 101 AND 102).

FIRST USE 8-1-1994; IN COMMERCE 8-1-1994.  
CAROLYN GRAY, EXAMINING ATTORNEY



SN 78-259,295. LEASECOMM CORPORATION, WOBURN, MA. FILED 6-6-2003.

**LEASECOMM**

FOR LEASE PURCHASE FINANCING FOR EQUIPMENT, NAMELY, OFFICE EQUIPMENT, ATM MACHINES, CREDIT CARD PROCESSING MACHINES, MEDICAL EQUIPMENT AND SECURITY EQUIPMENT (U.S. CLS. 100, 101 AND 102).

FIRST USE 8-26-1985; IN COMMERCE 8-26-1985.  
CAROLYN GRAY, EXAMINING ATTORNEY

**CLASS 36—(Continued).**

SN 78-260,243. BANK FOR INVESTMENT AND DEVELOPMENT OF VIETNAM (BIDV), DBA VIETINDEBANK, HA NOI, VIETNAM, FILED 6-10-2003.



THE COLOR(S) RED AND BLUE IS/ARE CLAIMED AS A FEATURE OF THE MARK.

THE MARK CONSISTS, IN PART, OF THE STYLIZED LETTER IDV. THE BLUE COLOR APPEARS IN THE WORD PART BIDV AND THE STYLIZED LETTER D. THE RED COLOR APPEARS IN THE EDGES OF THE DEVICE PART AND THE STYLIZED LETTERS I AND V.

FOR BANKING SERVICES, NAMELY, CHECKING AND SAVING ACCOUNT SERVICES; LOAN FINANCING AND LOANS IN THE NATURE OF DISCOUNTING COMMERCIAL PAPERS AND OTHER VALUABLE PAPERS; FINANCIAL GUARANTEE AND SURETY; ELECTRONIC PAYMENT, NAMELY, ELECTRONIC PROCESSING AND TRANSMISSION OF BILL PAYMENT DATA; FINANCIAL SERVICES, NAMELY, CREDIT UNIONS; MONEY MARKET FUNDS; CURRENCY EXCHANGES AND GOLD BROKERAGE; TRUSTEESHIP REPRESENTATIVE IN BANKING AND BANKING-RELATED FIELD, NAMELY, ASSET AND PORTFOLIO MANAGEMENT; STOCK AND SECURITY BROKERAGE; LEASE PURCHASE FINANCING; SAFETY DEPOSIT BOX SERVICES, NAMELY, CUSTODY VALUABLE OBJECTS OR PAPERS; FINANCIAL AND MONETARY CONSULTANCY; FINANCIAL MANAGEMENT OF CUSTOMER'S COLLATERAL ASSETS (U.S. CLS. 100, 101 AND 102).

FIRST USE 4-26-1992; IN COMMERCE 7-0-1994.  
KATHLEEN M. VANSTON, EXAMINING ATTORNEY

SN 78-274,204. OPTCAPITAL, LLC, CHARLOTTE, NC. FILED 7-15-2003.

**OPTION PLAN TRUST**

NO CLAIM IS MADE TO THE EXCLUSIVE RIGHT TO USE "TRUST", APART FROM THE MARK AS SHOWN.

FOR ADMINISTRATION OF EMPLOYEE BENEFIT PLANS (U.S. CLS. 100, 101 AND 102).

FIRST USE 5-1-2002; IN COMMERCE 5-1-2002.  
GEOFFREY FOSDICK, EXAMINING ATTORNEY

**CLASS 36—(Continued).**

SN 78-280,565. STANCORP FINANCIAL GROUP, INC., PORTLAND, OR. FILED 7-29-2003.

**THE EXPECTED. AND MORE.**

FOR PROVIDING INVESTMENT AND ASSET MANAGEMENT SERVICES; UNDERWRITING OF ANNUITIES; INVESTMENT MANAGEMENT OF AND DISTRIBUTION OF ANNUITIES; UNDERWRITING OF INSURANCE, NAMELY, LIFE, ACCIDENTAL DEATH AND DISMEMBERMENT, DISABILITY, DISABILITY INCOME, LONG TERM CARE, DENTAL AND MEDICAL; ADMINISTRATION OF DISABILITY AND LIFE INSURANCE CLAIMS; FINANCIAL SERVICES IN THE NATURE OF PROVIDING FUNDING OPTIONS FOR RETIREMENT PLANS, FOR PROVIDING AND ADMINISTERING ANNUITIES, AND FOR ADMINISTERING RETIREMENT PLANS; INSURANCE ADMINISTRATION; INSURANCE BROKERAGE SERVICES; INSURANCE CONSULTATION; REGISTERED INVESTMENT ADVISER SERVICES PROVIDING PERFORMANCE ANALYSIS, FUND SUPPORT AND MODEL PORTFOLIOS; INVESTMENT BROKERAGE SERVICES; MORTGAGE LENDING (U.S. CLS. 100, 101 AND 102).

TINA L. SNAPP, EXAMINING ATTORNEY

SN 78-280,567. STANCORP FINANCIAL GROUP, INC., PORTLAND, OR. FILED 7-29-2003.

**YOUR EXPECTATIONS. AND MORE.**

FOR PROVIDING INVESTMENT AND ASSET MANAGEMENT SERVICES; UNDERWRITING OF ANNUITIES; INVESTMENT MANAGEMENT OF AND DISTRIBUTION OF ANNUITIES; UNDERWRITING OF INSURANCE, NAMELY, LIFE, ACCIDENTAL DEATH AND DISMEMBERMENT, DISABILITY, DISABILITY INCOME, LONG TERM CARE, DENTAL AND MEDICAL; ADMINISTRATION OF DISABILITY AND LIFE INSURANCE CLAIMS; FINANCIAL SERVICES IN THE NATURE OF PROVIDING FUNDING OPTIONS FOR RETIREMENT PLANS, FOR PROVIDING AND ADMINISTERING ANNUITIES, AND FOR ADMINISTERING RETIREMENT PLANS; INSURANCE ADMINISTRATION; INSURANCE BROKERAGE SERVICES; INSURANCE CONSULTATION; REGISTERED INVESTMENT ADVISER SERVICES PROVIDING PERFORMANCE ANALYSIS, FUND SUPPORT AND MODEL PORTFOLIOS; INVESTMENT BROKERAGE SERVICES; MORTGAGE LENDING (U.S. CLS. 100, 101 AND 102).

TINA L. SNAPP, EXAMINING ATTORNEY

**CLASS 36—(Continued).**

SN 78-282,079. BANIF - SGPS, S.A., 9004-509 FUNCHAL CODEX, PORTUGAL, FILED 8-1-2003.

**BANIF**

OWNER OF PORTUGAL REG. NO. 245.666, DATED 4-5-1993, EXPIRES 4-5-2013.

FOR BANKING SERVICES; FINANCING SERVICES; FINANCIAL SERVICES, NAMELY, LOAN GUARANTEES, DEPOSIT AND SAVINGS ACCOUNTS, PERSONAL CREDIT BUREAUS, BUSINESS CREDIT BUREAUS AND HYPOTHECARY CREDIT BUREAUS, FINANCIAL CONSULTANCY, AGENCIES IN THE FIELD OF BONDS AND OTHER SECURITIES, NAMELY, STOCK MARKET OPERATIONS AND CAPITAL MARKET, FOREIGN OPERATIONS, ELECTRONIC PAYMENT, NAMELY, ELECTRONIC PROCESSING AND TRANSMISSION OF EXTERNAL BUSINESS AND INTERNATIONAL BILL PAYMENTS, FINANCIAL EXCHANGES, DEBIT AND CREDIT CARD SERVICES, INVESTMENT ADMINISTRATION, NAMELY, ASSET MANAGEMENT FOR CLIENTS OF THE BANIF GROUP, MANAGEMENT OF INVESTMENT FUNDS AND PENSION FUNDS, FINANCIAL EVALUATIONS, NAMELY, VALUATION OF COMPANIES, ESTIMATES AND STUDIES OF BUSINESS, VARIOUS BUSINESS AREAS AND GENERAL VALUATIONS OF DIFFERENT KINDS OF BUSINESS AND ANALYSES OF INVESTMENT PROJECTS, CUSTODY OF BONDS, EXCHANGE OPERATIONS AND OPERATIONS WITH FINANCIAL DERIVATIVES (U.S. CLS. 100, 101 AND 102).

THEODORE MCBRIDE, EXAMINING ATTORNEY

**CLASS 36—(Continued).**

SN 78-282,100. BANIF - SGPS, S.A., 9004-509 FUNCHAL CODEX, PORTUGAL, FILED 8-1-2003.

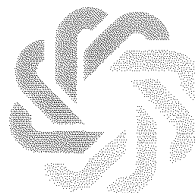

OWNER OF PORTUGAL REG. NO. 313433, DATED 8-16-1996, EXPIRES 8-16-2006.

THE STIPPLING IN THE DRAWING IS FOR SHADING PURPOSES ONLY.

FOR BANKING SERVICES; FINANCING SERVICES; FINANCIAL SERVICES, NAMELY, LOAN GUARANTEES, DEPOSIT AND SAVINGS ACCOUNTS, PERSONAL CREDIT BUREAUS, BUSINESS CREDIT BUREAUS AND HYPOTHECARY CREDIT BUREAUS, FINANCIAL CONSULTANCY, AGENCIES IN THE FIELD OF BONDS AND OTHER SECURITIES, NAMELY, STOCK MARKET OPERATIONS AND CAPITAL MARKET, FOREIGN OPERATIONS, ELECTRONIC PAYMENT, NAMELY, ELECTRONIC PROCESSING AND TRANSMISSION OF EXTERNAL BUSINESS AND INTERNATIONAL BILL PAYMENTS, FINANCIAL EXCHANGES, DEBIT AND CREDIT CARD SERVICES, INVESTMENT ADMINISTRATION, NAMELY, ASSET MANAGEMENT FOR CLIENTS OF THE BANIF GROUP, MANAGEMENT OF INVESTMENT FUNDS AND PENSION FUNDS, FINANCIAL EVALUATIONS, NAMELY, VALUATION OF COMPANIES, ESTIMATES AND STUDIES OF BUSINESS, VARIOUS BUSINESS AREAS AND GENERAL VALUATIONS OF DIFFERENT KINDS OF BUSINESS AND ANALYSES OF INVESTMENT PROJECTS, CUSTODY OF BONDS, EXCHANGE OPERATIONS AND OPERATIONS WITH FINANCIAL DERIVATIVES (U.S. CLS. 100, 101 AND 102).

THEODORE MCBRIDE, EXAMINING ATTORNEY

SN 78-291,613. METROPOLITAN LIFE INSURANCE COMPANY, NEW YORK, NY. FILED 8-25-2003.

**WSS SELECT FUNDS**

NO CLAIM IS MADE TO THE EXCLUSIVE RIGHT TO USE "SELECT FUNDS", APART FROM THE MARK AS SHOWN.

FOR FINANCIAL SERVICES, NAMELY, THE ADMINISTRATION OF A MUTUAL FUND BASED RETIREMENT PROGRAM DESIGNED FOR SCHOOL EMPLOYEES (U.S. CLS. 100, 101 AND 102).

FIRST USE 8-25-2003; IN COMMERCE 8-25-2003.

CHARLES JOYNER, EXAMINING ATTORNEY



**CLASS 36—(Continued).**

SN 78-306,414. MCMULLEN, MICHAEL, CUMBERLAND, RI. FILED 9-28-2003.

**SALONDOMINIUM**

FOR PROVIDING INDIVIDUAL HAIR STYLING, SKIN CARE, NAIL CARE, AND OTHER BEAUTY RELATED SERVICE SUITES THAT ARE MINI SALONS IN ONE BUILDING, NAMELY RENTAL OF SPACE TO BEAUTY, NAIL, SKIN AND HAIR STYLISTS FOR PROVIDING HAIRDRESSING AND SKIN CARE SALON SERVICES (U.S. CLS. 100, 101 AND 102).

FIRST USE 9-1-2003; IN COMMERCE 9-1-2003.  
JENNIFER KRISP, EXAMINING ATTORNEY

**CLASS 36—(Continued).**

SN 78-321,079. HUDSON CASTLE GROUP INC., TARRY-TOWN, NY. FILED 10-30-2003.

**HUDSON CASTLE**

FOR FINANCIAL SERVICES, NAMELY, ASSISTING OTHERS IN THE ACQUISITION OF SECURED FINANCING; FINANCIAL ADMINISTRATION AND MANAGEMENT OF COMMERCIAL PAPER CONDUITS (U.S. CLS. 100, 101 AND 102).

FIRST USE 12-30-2002; IN COMMERCE 12-30-2002.  
TRICIA SONNEBORN, EXAMINING ATTORNEY

SN 78-308,857. NORTH AMERICAN ACCEPTANCE CORPORATION, COSTA MESA, CA. FILED 10-2-2003.



FOR FINANCIAL SERVICES, NAMELY, PROVIDING CONSUMER LOANS (U.S. CLS. 100, 101 AND 102).  
FIRST USE 9-8-2003; IN COMMERCE 10-1-2003.  
BRIAN NEVILLE, EXAMINING ATTORNEY

SN 78-323,456. LONGSHIP ALTERNATIVE ASSET MANAGEMENT LLC, WILMINGTON, DE. FILED 11-5-2003.

**Longship**

SN 78-316,573. ARGONAUT INSURANCE COMPANY, MENLO PARK, CA. FILED 10-21-2003.

**SECURING THE FUTURE**

FOR UNDERWRITING IN THE FIELDS OF COMMERCIAL PROPERTY AND CASUALTY INSURANCE (U.S. CLS. 100, 101 AND 102).  
GWEN STOKOLS, EXAMINING ATTORNEY

SN 78-321,021. ALPHA OMICRON PI FOUNDATION, BRENTWOOD, TN. FILED 10-30-2003.

**ALPHA OMICRON PI STRIKE OUT ARTHRITIS!**

NO CLAIM IS MADE TO THE EXCLUSIVE RIGHT TO USE ARTHRITIS, APART FROM THE MARK AS SHOWN. FOR CHARITABLE FUND RAISING SERVICES (U.S. CLS. 100, 101 AND 102).  
FIRST USE 3-2-2003; IN COMMERCE 3-2-2003.  
STEVEN BERK, EXAMINING ATTORNEY

THE MARK CONSISTS OF STANDARD CHARACTERS WITHOUT CLAIM TO ANY PARTICULAR FONT, STYLE, SIZE, OR COLOR.  
FOR FINANCIAL SERVICES, NAMELY, INVESTMENT MANAGEMENT (U.S. CLS. 100, 101 AND 102).  
FIRST USE 10-19-2001; IN COMMERCE 3-28-2003.  
MITCHELL FRONT, EXAMINING ATTORNEY

**CLASS 36—(Continued).**

SN 78-329,340. GENWORTH FINANCIAL, INC., RICHMOND, VA. FILED 11-18-2003.



NO CLAIM IS MADE TO THE EXCLUSIVE RIGHT TO USE "FINANCIAL", APART FROM THE MARK AS SHOWN.

FOR FINANCIAL SERVICES IN THE NATURE OF INVESTMENT SECURITY AND FINANCIAL PLANNING IN THE FIELDS OF ANNUITIES, CONSUMER INVESTMENT PRODUCTS, EDUCATION FUNDING, ESTATE PLANNING, FUNDING AGREEMENTS, GUARANTEED INVESTMENT CONTRACTS, INVESTMENTS, MUTUAL FUNDS, RETIREMENT PLANNING, STRUCTURED SETTLEMENTS, AND WRAP ACCOUNTS; INSURANCE ADMINISTRATION, INSURANCE CONSULTATION AND INSURANCE UNDERWRITING SERVICES IN THE FIELDS OF LIFE, HEALTH, SUPPLEMENTAL HEALTH, ACCIDENT, DISMEMBERMENT, DENTAL, VISION, LONG-TERM CARE, DISABILITY, RETIREMENT, AUTOMOBILE, CREDIT, MORTGAGE, INDEMNITY, HOMEOWNERS, HOUSEHOLD EMERGENCY, WORKSITE BENEFITS, AND TRAVEL INSURANCE, AND REINSURANCE; FINANCIAL EVALUATION FOR INSURANCE PURPOSES; INSURANCE ACTUARIAL SERVICES; INSURANCE AGENCIES; INSURANCE AGENCY AND BROKERAGE; INSURANCE CLAIMS ADMINISTRATION; INSURANCE CLAIMS PROCESSING; INSURANCE PREMIUM RATE COMPUTING (U.S. CLS. 100, 101 AND 102).  
MIDGE BUTLER, EXAMINING ATTORNEY

**CLASS 36—(Continued).**

SN 78-344,540. STANCORP FINANCIAL GROUP, INC., PORTLAND, OR. FILED 12-22-2003.

**THE STANDARD**

THE MARK CONSISTS OF STANDARD CHARACTERS WITHOUT CLAIM TO ANY PARTICULAR FONT, STYLE, SIZE, OR COLOR.

FOR PROVIDING INVESTMENT AND ASSET MANAGEMENT SERVICES; UNDERWRITING OF ANNUITIES; INVESTMENT MANAGEMENT OF AND DISTRIBUTION OF ANNUITIES; UNDERWRITING OF INSURANCE, NAMELY, LIFE, ACCIDENTAL DEATH AND DISMEMBERMENT, DISABILITY, DISABILITY INCOME, LONG TERM CARE, DENTAL AND MEDICAL; ADMINISTRATION OF DISABILITY AND LIFE INSURANCE CLAIMS; FINANCIAL SERVICES IN THE NATURE OF PROVIDING FUNDING OPTIONS FOR RETIREMENT PLANS, FOR PROVIDING AND ADMINISTERING ANNUITIES, AND FOR ADMINISTERING RETIREMENT PLANS; INSURANCE ADMINISTRATION; INSURANCE BROKERAGE SERVICES; INSURANCE CONSULTATION; REGISTERED INVESTMENT ADVISER SERVICES PROVIDING PERFORMANCE ANALYSIS, FUND SUPPORT AND MODEL PORTFOLIOS; INVESTMENT BROKERAGE SERVICES; MORTGAGE LENDING (U.S. CLS. 100, 101 AND 102).  
FIRST USE 8-0-1999; IN COMMERCE 8-0-1999.  
SHARON MEIER, EXAMINING ATTORNEY

SN 78-339,684. FIRST-CITIZENS BANK & TRUST COMPANY, RALEIGH, NC. FILED 12-11-2003.

THE COLOR(S) RED IS/ARE CLAIMED AS A FEATURE OF THE MARK.

THE COLOR RED APPEARS IN THE LETTERS OF THE WORDING "SMART-LOCKS".

FOR BANKING SERVICES, NAMELY, A REAL-TIME PRICING SYSTEM DESIGNED TO POST MULTIPLE INVESTORS' PRICING AND RATES FOR MORTGAGE LOAN PRODUCTS THAT PROVIDES MORTGAGE LOAN ORIGINATORS WITH THE CAPABILITY TO VIEW CURRENT RATE INDICATORS, TO OBTAIN MULTIPLE QUOTES, TO TRACK THEIR RATE LOCKS AND EXPIRING LOCKS, TO LOCK RATES WITH INVESTORS, AND/OR TO COMPARE LOAN INFORMATION (U.S. CLS. 100, 101 AND 102).

FIRST USE 10-10-2003; IN COMMERCE 10-10-2003.  
WON TEAK OH, EXAMINING ATTORNEY

SN 78-388,435. DEWITT STERN GROUP, INC., NEW YORK, NY. FILED 3-22-2004.

THE MARK CONSISTS OF STANDARD CHARACTERS WITHOUT CLAIM TO ANY PARTICULAR FONT, STYLE, SIZE, OR COLOR.

NO CLAIM IS MADE TO THE EXCLUSIVE RIGHT TO USE "GROUP", APART FROM THE MARK AS SHOWN.

FOR INSURANCE BROKERAGE SERVICES (U.S. CLS. 100, 101 AND 102).

FIRST USE 4-30-1994; IN COMMERCE 4-30-1994.  
MONTIA G. PRESSEY, EXAMINING ATTORNEY

**CLASS 36—(Continued).**

SN 78-391,839. AMERICAN INTERNATIONAL GROUP, INC., NEW YORK, NY. FILED 3-26-2004.

**CLASS 36—(Continued).**

SN 78-392,173. BANK ONE CORPORATION, CHICAGO, IL. FILED 3-29-2004.



**WE BUILD YOUR CARD  
FROM THE BRAND UP**

FOR INSURANCE UNDERWRITING SERVICES, NAMELY PROPERTY AND CASUALTY INSURANCE (U.S. CLS. 100, 101 AND 102).  
ANN E. SAPPENFIELD, EXAMINING ATTORNEY

THE MARK CONSISTS OF STANDARD CHARACTERS WITHOUT CLAIM TO ANY PARTICULAR FONT, STYLE, SIZE, OR COLOR.  
FOR BANKING SERVICES (U.S. CLS. 100, 101 AND 102).  
MONIQUE MILLER, EXAMINING ATTORNEY

SN 78-391,890. AURARIAN CAPITAL MANAGEMENT, LLC, NEW YORK, NY. FILED 3-26-2004.

SN 78-393,129. KAISER, DAVID J., STUDIO CITY, CA. FILED 3-30-2004.

**AURARIAN**



THE MARK CONSISTS OF STANDARD CHARACTERS WITHOUT CLAIM TO ANY PARTICULAR FONT, STYLE, SIZE, OR COLOR.  
FOR INVESTMENT OF FUNDS FOR OTHERS IN SMALL CAPITALIZATION TECHNOLOGY STOCKS (U.S. CLS. 100, 101 AND 102).  
FIRST USE 3-1-2004; IN COMMERCE 3-1-2004.  
CYNTHIA SLOAN, EXAMINING ATTORNEY

THE COLOR(S) RED, GRAY, GOLD, BLACK, WHITE IS/ ARE CLAIMED AS A FEATURE OF THE MARK.  
WINGS, GRAY AND RED, PLAQUE GOLD, BLACK RIBBON ACROSS.  
THE MARK CONSISTS OF AN ANGEL WINGED PLAQUE WITH A STAR/HALO AT BOTTOM.  
FOR FUND RAISERS FOR VARIOUS CHILDREN'S CHARITIES (U.S. CLS. 100, 101 AND 102).  
ARETHA SOMERVILLE, EXAMINING ATTORNEY

**CLASS 36—(Continued).**

SN 78-393,425. MORGAN STANLEY, NEW YORK, NY.  
FILED 3-30-2004.

**CLASS 36—(Continued).**

SN 78-396,242. METALMARK CAPITAL LLC, NEW YORK,  
NY. FILED 4-5-2004.

# FORCES

THE MARK CONSISTS OF STANDARD CHARACTERS  
WITHOUT CLAIM TO ANY PARTICULAR FONT, STYLE,  
SIZE, OR COLOR.

FOR FINANCIAL SERVICES IN THE NATURE OF  
TRADING, PURCHASING, SELLING AND STRUCTUR-  
ING INVESTMENT SECURITIES, AND ADVISORY SER-  
VICES RELATING THERETO (U.S. CLS. 100, 101 AND  
102).

DAVID MURRAY, EXAMINING ATTORNEY

# METALMARK

THE MARK CONSISTS OF STANDARD CHARACTERS  
WITHOUT CLAIM TO ANY PARTICULAR FONT, STYLE,  
SIZE, OR COLOR.

FOR FINANCIAL SERVICES, NAMELY INVESTMENT  
BANKING, PRIVATE EQUITY AND PUBLIC MARKETS  
INVESTMENT SERVICES (U.S. CLS. 100, 101 AND 102).

KATHY DE JONGE, EXAMINING ATTORNEY

SN 78-396,815. VIRGIN ENTERPRISES LIMITED, LONDON,  
UNITED KINGDOM, FILED 4-6-2004.

SN 78-394,127. CARPENTER, JR., WILLIAM H., ANNAPO-  
LIS, MD. FILED 3-31-2004.

# SHIP SHOPPING

THE MARK CONSISTS OF STANDARD CHARACTERS  
WITHOUT CLAIM TO ANY PARTICULAR FONT, STYLE,  
SIZE, OR COLOR.

FOR LEASING OF SHOPPING MALL SPACE ON A  
SHIP (U.S. CLS. 100, 101 AND 102).

FIRST USE 4-1-2003; IN COMMERCE 4-1-2003.

ESTHER A. BORSUK, EXAMINING ATTORNEY

# VIRGIN

THE MARK CONSISTS OF STANDARD CHARACTERS  
WITHOUT CLAIM TO ANY PARTICULAR FONT, STYLE,  
SIZE, OR COLOR.

OWNER OF U.S. REG. NO. 2,622,510 AND OTHERS.

FOR INSURANCE CONSULTANCY SERVICES; LIFE,  
HEALTH, HOME, AUTOMOBILE AND GENERAL IN-  
SURANCE UNDERWRITING; FINANCIAL CONSUL-  
TANCY AND MANAGEMENT SERVICES; CAPITAL  
INVESTMENT CONSULTATION; FUNDS INVESTMENT;  
ELECTRONIC FUNDS TRANSFER; INVESTMENT OF  
FUNDS FOR OTHERS; MUTUAL FUND INVESTMENT  
SERVICES; FINANCIAL ANALYSIS AND CONSULTA-  
TION; CREDIT CARD AND DEBIT CARD SERVICES  
(U.S. CLS. 100, 101 AND 102).

TARAH HARDY, EXAMINING ATTORNEY

**CLASS 36—(Continued).**

SN 78-398,095. CHICAGO CLIMATE EXCHANGE, INC., CHICAGO, IL. FILED 4-7-2004.

**GCX**

THE MARK CONSISTS OF STANDARD CHARACTERS WITHOUT CLAIM TO ANY PARTICULAR FONT, STYLE, SIZE, OR COLOR.

FOR COMMODITY EXCHANGE SERVICES, NAMELY, CARBON DIOXIDE AND OTHER GREENHOUSE GAS EMISSIONS EXCHANGE SERVICES THAT FACILITATE THE TRADING OR SALE OF CARBON DIOXIDE AND OTHER GREENHOUSE GAS EMISSIONS ALLOWANCES AND OFFSETS BETWEEN BUSINESS AND OTHER MARKET PARTICIPANTS (U.S. CLS. 100, 101 AND 102). DANIELLE MATTESSICH, EXAMINING ATTORNEY

SN 78-398,889. HORST GROUP, LANCASTER, PA. FILED 4-8-2004.

**Understanding what matters to you**

THE MARK CONSISTS OF STANDARD CHARACTERS WITHOUT CLAIM TO ANY PARTICULAR FONT, STYLE, SIZE, OR COLOR.

FOR REAL ESTATE PROPERTY MANAGEMENT (U.S. CLS. 100, 101 AND 102). KARANENDRA S. CHHINA, EXAMINING ATTORNEY

**CLASS 36—(Continued).**

SN 78-399,244. FEDERATED MUTUAL INSURANCE COMPANY, OWATONNA, MN. FILED 4-9-2004.

**FEDERATED DIRECT**

THE MARK CONSISTS OF STANDARD CHARACTERS WITHOUT CLAIM TO ANY PARTICULAR FONT, STYLE, SIZE, OR COLOR.

OWNER OF U.S. REG. NOS. 2,013,918, 2,816,614 AND OTHERS.

NO CLAIM IS MADE TO THE EXCLUSIVE RIGHT TO USE "DIRECT", APART FROM THE MARK AS SHOWN.

FOR INSURANCE UNDERWRITING SERVICES IN THE FIELD OF CASUALTY AND PROPERTY (U.S. CLS. 100, 101 AND 102).

FIRST USE 11-1-2002; IN COMMERCE 1-2-2003. DAVID C. REIHNER, EXAMINING ATTORNEY

SN 78-400,759. MARC LUSTGARTEN PANCREATIC CANCER FOUNDATION, BETHPAGE, NY. FILED 4-13-2004.

**IN MY COMMUNITY**

THE MARK CONSISTS OF STANDARD CHARACTERS WITHOUT CLAIM TO ANY PARTICULAR FONT, STYLE, SIZE, OR COLOR.

FOR CHARITABLE FUND RAISING SERVICES INVOLVING ORGANIZING AND CONDUCTING WALKS TO RAISE MONEY FOR PANCREATIC CANCER RESEARCH AND AWARENESS PROGRAMS (U.S. CLS. 100, 101 AND 102).

STEVEN JACKSON, EXAMINING ATTORNEY

SN 78-406,538. AMERICAN INTERNATIONAL GROUP, INC., NEW YORK, NY. FILED 4-22-2004.

**VENUE LIABILITY PROTECTOR**

THE MARK CONSISTS OF STANDARD CHARACTERS WITHOUT CLAIM TO ANY PARTICULAR FONT, STYLE, SIZE, OR COLOR.

NO CLAIM IS MADE TO THE EXCLUSIVE RIGHT TO USE "VENUE LIABILITY", APART FROM THE MARK AS SHOWN.

FOR INSURANCE UNDERWRITING SERVICES, NAMELY GENERAL LIABILITY INSURANCE FOR PERFORMANCE AND HOSPITALITY VENUES (U.S. CLS. 100, 101 AND 102).

FIRST USE 4-1-2004; IN COMMERCE 4-1-2004. WINSTON FOLMAR, EXAMINING ATTORNEY

**CLASS 36—(Continued).**

SN 78-406,556. AMERICAN INTERNATIONAL GROUP, INC., NEW YORK, NY. FILED 4-22-2004.

**EPL HOSPITALITY  
SELECT**

THE MARK CONSISTS OF STANDARD CHARACTERS WITHOUT CLAIM TO ANY PARTICULAR FONT, STYLE, SIZE, OR COLOR.

OWNER OF U.S. REG. NOS. 2,180,677, 2,646,903 AND OTHERS.

NO CLAIM IS MADE TO THE EXCLUSIVE RIGHT TO USE "EPL HOSPITALITY", APART FROM THE MARK AS SHOWN.

FOR INSURANCE UNDERWRITING SERVICES, NAMELY EMPLOYMENT PRACTICES LIABILITY (U.S. CLS. 100, 101 AND 102).

FIRST USE 1-1-2001; IN COMMERCE 1-1-2001.

WENDY GOODMAN, EXAMINING ATTORNEY

**CLASS 36—(Continued).**

SN 78-412,881. CLK MANAGEMENT, LLC, OVERLAND PARK, KS. FILED 5-4-2004.

**CASHBOYS**

THE MARK CONSISTS OF STANDARD CHARACTERS WITHOUT CLAIM TO ANY PARTICULAR FONT, STYLE, SIZE, OR COLOR.

FOR FINANCIAL SERVICES IN THE FIELD OF SHORT TERM LOANS PROVIDED AS PAYDAY LOAN ADVANCES (U.S. CLS. 100, 101 AND 102).

MARCIE MILONE, EXAMINING ATTORNEY

SN 78-414,987. SUNTRUST BANKS, INC., ORLANDO, FL. FILED 5-7-2004.

SN 78-410,463. CONDUIT CAPITAL PARTNERS, LLC, NEW YORK, NY. FILED 4-29-2004.

**LATIN POWER**

THE MARK CONSISTS OF STANDARD CHARACTERS WITHOUT CLAIM TO ANY PARTICULAR FONT, STYLE, SIZE, OR COLOR.

SEC. 2(F).

FOR FINANCIAL INVESTMENT IN THE FIELD OF PRIVATE EQUITY (U.S. CLS. 100, 101 AND 102).

FIRST USE 10-0-1994; IN COMMERCE 10-0-1994.

MICHELE SWAIN, EXAMINING ATTORNEY

THE MARK CONSISTS OF STANDARD CHARACTERS WITHOUT CLAIM TO ANY PARTICULAR FONT, STYLE, SIZE, OR COLOR.

FOR FINANCIAL SERVICES, NAMELY, STUDENT LOAN INFORMATION INCLUDING APPLYING FOR LOANS, OBTAINING PRE-APPROVALS, CHECKING ON LOAN STATUS, CERTIFYING LOANS, UPDATING LOANS, REVIEWING LOAN DECISION STATUS, AND REVIEWING MULTIPLE AND SINGLE BORROWER REPORTS FOR STUDENT FINANCIAL AID OFFICES, STUDENTS AND PARENTS VIA A GLOBAL COMPUTER NETWORK (U.S. CLS. 100, 101 AND 102).

TINA L. SNAPP, EXAMINING ATTORNEY

**Ask Eli**

**CLASS 36—(Continued).**

SN 78-415,024. PREMIER BANCSHARES, INC., JEFFERSON CITY, MO. FILED 5-7-2004.

**CLASS 36—(Continued).**

SN 78-417,842. THE CHUBB CORPORATION, WARREN, NJ. FILED 5-13-2004.



**Relax...your client  
is insured with  
Chubb.**

FOR BANKING SERVICES, FINANCING SERVICES, LOAN FINANCING SERVICES, COMMERCIAL LENDING SERVICES, CONSUMER LENDING SERVICES, MORTGAGE LENDING SERVICES, SAVINGS ACCOUNT SERVICES, AND CHECKING ACCOUNT SERVICES (U.S. CLS. 100, 101 AND 102).  
FIRST USE 5-15-1995; IN COMMERCE 5-15-1995.  
CAROLINE WOOD, EXAMINING ATTORNEY

SN 78-416,199. UNITED GUARANTY CORPORATION, GREENSBORO, NC. FILED 5-10-2004.

**DPI UNDERWRITING**

THE MARK CONSISTS OF STANDARD CHARACTERS WITHOUT CLAIM TO ANY PARTICULAR FONT, STYLE, SIZE, OR COLOR.  
NO CLAIM IS MADE TO THE EXCLUSIVE RIGHT TO USE "UNDERWRITING", APART FROM THE MARK AS SHOWN.  
FOR MORTGAGE GUARANTY INSURANCE UNDERWRITING (U.S. CLS. 100, 101 AND 102).  
FIRST USE 5-1-2004; IN COMMERCE 5-1-2004.  
SEAN DWYER, EXAMINING ATTORNEY

THE MARK CONSISTS OF STANDARD CHARACTERS WITHOUT CLAIM TO ANY PARTICULAR FONT, STYLE, SIZE, OR COLOR.

OWNER OF U.S. REG. NOS. 998,842, 2,558,418 AND OTHERS.

FOR INSURANCE UNDERWRITING SERVICES, NAMELY, HOMEOWNERS INSURANCE, AUTOMOBILE INSURANCE, VALUABLE ARTICLES INSURANCE, YACHT INSURANCE, PERSONAL EXCESS LIABILITY INSURANCE, PACKAGE INSURANCE, MULTINATIONAL INSURANCE, POLITICAL RISK INSURANCE, MONOLINE PROPERTY INSURANCE, MACHINERY BREAKDOWN INSURANCE, OCEAN MARINE INSURANCE, INLAND MARINE INSURANCE, ENVIRONMENTAL INSURANCE, ENTERTAINMENT INSURANCE, CONTINGENCY INSURANCE, EQUINE INSURANCE, MONOLINE GENERAL LIABILITY INSURANCE, WORKERS COMPENSATION INSURANCE, COMMERCIAL AUTOMOBILE INSURANCE, INTELLECTUAL PROPERTY AND COMMUNICATIONS LIABILITY INSURANCE, ENERGY INDUSTRIES INSURANCE, UMBRELLA INSURANCE, EXCESS LIABILITY INSURANCE, REPUTATIONAL DAMAGES INSURANCE, SUCCESSOR LIABILITY INSURANCE, RETROACTIVE LIMITS OF LIABILITY INSURANCE, DISCONTINUED PRODUCTS LIABILITY INSURANCE, LIABILITY TRIGGER CONVERSION INSURANCE, MARINE LIABILITIES INSURANCE, ERRORS AND OMISSIONS INSURANCE, ALTERNATIVE RISK TRANSFER INSURANCE, CRIME INSURANCE, DIRECTORS AND OFFICERS LIABILITY INSURANCE, EMPLOYMENT PRACTICES LIABILITY INSURANCE, EMPLOYERS STOP LOSS INSURANCE, FAMILY OFFICE MANAGEMENT INSURANCE, FIDUCIARY LIABILITY INSURANCE, GENERAL PARTNERS LIABILITY INSURANCE, HMO REINSURANCE, INTERNET LIABILITY INSURANCE, KIDNAP/RANSOM AND EXTORTION INSURANCE, MANAGEMENT LIABILITY INSURANCE, MEDIA LIABILITY INSURANCE, OUTSIDE DIRECTORS LIABILITY INSURANCE, PROFESSIONAL LIABILITY INSURANCE, PROVIDER EXCESS INSURANCE, VENTURE CAPITAL ASSET PROTECTION INSURANCE, WORKPLACE VIOLENCE EXPENSE INSURANCE, CONSTRUCTION SURETY BONDS, PERFORMANCE AND PAYMENT BONDS INSURANCE, BID BONDS, COMMERCIAL SURETY, LICENSE AND PERMIT BONDS, FIDUCIARY BONDS, COURT BONDS, MISCELLANEOUS BONDS TRADE CREDIT, CONDOMINIUMS AND COOPERATIVES INSURANCE, RENTER'S INSURANCE, FAMILY PROTECTION INSURANCE AND COLLECTOR VEHICLES INSURANCE (U.S. CLS. 100, 101 AND 102).

FIRST USE 4-0-2004; IN COMMERCE 4-0-2004.  
ALEXANDER L. POWERS, EXAMINING ATTORNEY

**CLASS 36—(Continued).**

SN 78-417,843. THE CHUBB CORPORATION, WARREN, NJ.  
FILED 5-13-2004.

Relax. You're  
insured with  
Chubb.

THE MARK CONSISTS OF STANDARD CHARACTERS WITHOUT CLAIM TO ANY PARTICULAR FONT, STYLE, SIZE, OR COLOR.

OWNER OF U.S. REG. NOS. 998,842, 2,558,418 AND OTHERS.

FOR INSURANCE UNDERWRITING SERVICES, NAMELY, HOMEOWNERS INSURANCE, AUTOMOBILE INSURANCE, VALUABLE ARTICLES INSURANCE, YACHT INSURANCE, PERSONAL EXCESS LIABILITY INSURANCE, PACKAGE INSURANCE, MULTINATIONAL INSURANCE, POLITICAL RISK INSURANCE, MONOLINE PROPERTY INSURANCE, MACHINERY BREAKDOWN INSURANCE, OCEAN MARINE INSURANCE, INLAND MARINE INSURANCE, ENVIRONMENTAL INSURANCE, ENTERTAINMENT INSURANCE, CONTINGENCY INSURANCE, EQUINE INSURANCE, MONOLINE GENERAL LIABILITY INSURANCE, WORKERS COMPENSATION INSURANCE, COMMERCIAL AUTOMOBILE INSURANCE, INTELLECTUAL PROPERTY AND COMMUNICATIONS LIABILITY INSURANCE, ENERGY INDUSTRIES INSURANCE, UMBRELLA INSURANCE, EXCESS LIABILITY INSURANCE, REPUTATIONAL DAMAGES INSURANCE, SUCCESSOR LIABILITY INSURANCE, RETROACTIVE LIMITS OF LIABILITY INSURANCE, DISCONTINUED PRODUCTS LIABILITY INSURANCE, LIABILITY TRIGGER CONVERSION INSURANCE, MARINE LIABILITIES INSURANCE, ERRORS AND OMISSIONS INSURANCE, ALTERNATIVE RISK TRANSFER INSURANCE, CRIME INSURANCE, DIRECTORS AND OFFICERS LIABILITY INSURANCE, EMPLOYMENT PRACTICES LIABILITY INSURANCE, EMPLOYERS STOP LOSS INSURANCE, FAMILY OFFICE MANAGEMENT INSURANCE, FIDUCIARY LIABILITY INSURANCE, GENERAL PARTNERS LIABILITY INSURANCE, HMO REINSURANCE, INTERNET LIABILITY INSURANCE, KIDNAP/RANSOM AND EXTORTION INSURANCE, MANAGEMENT LIABILITY INSURANCE, MEDIA LIABILITY INSURANCE, OUTSIDE DIRECTORS LIABILITY INSURANCE, PROFESSIONAL LIABILITY INSURANCE, PROVIDER EXCESS INSURANCE, VENTURE CAPITAL ASSET PROTECTION INSURANCE, WORKPLACE VIOLENCE EXPENSE INSURANCE, CONSTRUCTION SURETY BONDS, PERFORMANCE AND PAYMENT BONDS INSURANCE, BID BONDS, COMMERCIAL SURETY, LICENSE AND PERMIT BONDS, FIDUCIARY BONDS, COURT BONDS, MISCELLANEOUS BONDS TRADE CREDIT, CONDOMINIUMS AND COOPERATIVES INSURANCE, RENTER'S INSURANCE, FAMILY PROTECTION INSURANCE AND COLLECTOR VEHICLES INSURANCE (U.S. CLS. 100, 101 AND 102).

FIRST USE 4-0-2004; IN COMMERCE 4-0-2004.

ALEXANDER L. POWERS, EXAMINING ATTORNEY

**CLASS 36—(Continued).**

SN 78-421,511. WACHOVIA CORPORATION, CHARLOTTE, NC. FILED 5-19-2004.



OWNER OF U.S. REG. NOS. 2,744,554, 2,744,626 AND 2,805,546.

THE COLOR(S) BLUE AND GREEN IS/ARE CLAIMED AS A FEATURE OF THE MARK.

THE MARK CONSISTS OF A STYLIZED RENDERING OF A PORTION OF A GOLF COURSE. THE FEATURES REPRESENTING THE SKY APPEAR ABOVE A CURVING HORIZON LINE, AND THE COLOR CLAIMED FOR THAT PORTION OF MARK IS BLUE. THE FEATURES REPRESENTING THE GOLF COURSE APPEAR BELOW THE CURVING HORIZON LINE, AND THE COLOR CLAIMED FOR THAT PORTION OF THE MARK IS GREEN. AN AREA, WHICH IS VOID OF COLOR, APPEARS WITHIN THE FOREGROUND OF THE DESIGN AND FORMS THE SHAPE OF A GOLF FLAG. A CIRCULAR AREA, IN THE COLOR BLUE, AT THE BOTTOM END OF THE GOLF FLAG REPRESENTS A GOLF HOLE.

FOR FINANCIAL SPONSORSHIP OF GOLF TOURNAMENTS (U.S. CLS. 100, 101 AND 102).

FIRST USE 5-6-2002; IN COMMERCE 5-6-2002.

SEAN DWYER, EXAMINING ATTORNEY

SN 78-421,672. THE COASTAL BANK, SAVANNAH, GA.  
FILED 5-19-2004.



THE COLOR(S) PANTONE GREEN # 5825 AND PANTONE BLUE # 5415 IS/ARE CLAIMED AS A FEATURE OF THE MARK.

THE MARK CONSISTS OF A DRAWING OF A DOLPHIN. THE AREA ABOVE THE DOLPHIN IS PANTONE GREEN # 5825, THE AREA BELOW THE DOLPHIN IS PANTONE BLUE # 5415, AND THE BELLY OF THE DOLPHIN IS 23% OF PANTONE BLUE # 5415.

FOR BANKING SERVICES AND MORTGAGE LENDING (U.S. CLS. 100, 101 AND 102).

FIRST USE 4-29-2004; IN COMMERCE 4-29-2004.

CHERYL CLAYTON, EXAMINING ATTORNEY



**CLASS 36—(Continued).**

SN 78-422,302. MORGAN STANLEY, NEW YORK, NY. FILED 5-20-2004.

**CLASS 36—(Continued).**

SN 78-463,315. AMERICAN INTERNATIONAL GROUP, INC., NEW YORK, NY. FILED 8-6-2004.

# TILES

THE MARK CONSISTS OF STANDARD CHARACTERS WITHOUT CLAIM TO ANY PARTICULAR FONT, STYLE, SIZE, OR COLOR.

FOR FINANCIAL SERVICES IN THE NATURE OF TRADING, PURCHASING, SELLING AND STRUCTURING INVESTMENT SECURITIES, AND ADVISORY SERVICES RELATING THERETO (U.S. CLS. 100, 101 AND 102).

KEVON CHISOLM, EXAMINING ATTORNEY

# AIG WORLDRISK

THE MARK CONSISTS OF STANDARD CHARACTERS WITHOUT CLAIM TO ANY PARTICULAR FONT, STYLE, SIZE, OR COLOR.

OWNER OF U.S. REG. NOS. 1,151,229, 2,165,906 AND OTHERS.

FOR INSURANCE UNDERWRITING SERVICES, NAMELY, TRAVEL INSURANCE, GENERAL LIABILITY COVERAGE, AUTOMOBILE COVERAGE, FOREIGN VOLUNTARY WORKERS' COMPENSATION FOR EMPLOYEES TRAVELING AND/OR ASSIGNED OVERSEAS, TRAVEL ACCIDENT AND SICKNESS COVERAGE, KIDNAP, RANSOM AND EXTORTION, PROPERTY INSURANCE, CRIME COVERAGE, POLITICAL RISK COVERAGE, AND MARINE CARGO INSURANCE (U.S. CLS. 100, 101 AND 102).

FIRST USE 2-1-1996; IN COMMERCE 2-1-1996.  
WENDY GOODMAN, EXAMINING ATTORNEY

SN 78-463,631. AMERICAN INTERNATIONAL GROUP, INC., NEW YORK, NY. FILED 8-6-2004.

SN 78-463,248. AMERICAN INTERNATIONAL GROUP, INC., NEW YORK, NY. FILED 8-6-2004.

# WORLDRISK TRAVELPAK

THE MARK CONSISTS OF STANDARD CHARACTERS WITHOUT CLAIM TO ANY PARTICULAR FONT, STYLE, SIZE, OR COLOR.

FOR INSURANCE UNDERWRITING SERVICES, NAMELY, TRAVEL INSURANCE (U.S. CLS. 100, 101 AND 102).

FIRST USE 7-26-2004; IN COMMERCE 7-26-2004.  
WENDY GOODMAN, EXAMINING ATTORNEY

# WORLDRISK

THE MARK CONSISTS OF STANDARD CHARACTERS WITHOUT CLAIM TO ANY PARTICULAR FONT, STYLE, SIZE, OR COLOR.

FOR INSURANCE UNDERWRITING SERVICES, NAMELY, TRAVEL INSURANCE, GENERAL LIABILITY INSURANCE, AUTOMOBILE COVERAGE, FOREIGN VOLUNTARY WORKERS' COMPENSATION FOR EMPLOYEES TRAVELING AND/OR ASSIGNED OVERSEAS, TRAVEL ACCIDENT AND SICKNESS COVERAGE, KIDNAP, RANSOM AND EXTORTION, PROPERTY INSURANCE, CRIME COVERAGE, POLITICAL RISK COVERAGE, AND MARINE CARGO INSURANCE (U.S. CLS. 100, 101 AND 102).

FIRST USE 2-1-1996; IN COMMERCE 2-1-1996.  
WENDY GOODMAN, EXAMINING ATTORNEY

**CLASS 36—(Continued).**

SN 78-475,028. AMERICAN INTERNATIONAL GROUP, INC., NEW YORK, NY. FILED 8-27-2004.

## AIGC SCAN

THE MARK CONSISTS OF STANDARD CHARACTERS WITHOUT CLAIM TO ANY PARTICULAR FONT, STYLE, SIZE, OR COLOR.

FOR INSURANCE UNDERWRITING SERVICES, NAMELY, PROPERTY AND CASUALTY INSURANCE RELATED TO WATER INTRUSION (U.S. CLS. 100, 101 AND 102).

WENDY GOODMAN, EXAMINING ATTORNEY

---

SN 78-496,845. AMERICAN INTERNATIONAL GROUP, INC., NEW YORK, NY. FILED 10-8-2004.

## AGLAFLEX PRO PLUS

THE MARK CONSISTS OF STANDARD CHARACTERS WITHOUT CLAIM TO ANY PARTICULAR FONT, STYLE, SIZE, OR COLOR.

FOR INSURANCE UNDERWRITING SERVICES, NAMELY, LIFE AND ACCIDENT INSURANCE (U.S. CLS. 100, 101 AND 102).

WENDY GOODMAN, EXAMINING ATTORNEY

---

SN 78-496,852. AMERICAN INTERNATIONAL GROUP, INC., NEW YORK, NY. FILED 10-8-2004.

## AGLAFLEX PRO

THE MARK CONSISTS OF STANDARD CHARACTERS WITHOUT CLAIM TO ANY PARTICULAR FONT, STYLE, SIZE, OR COLOR.

FOR INSURANCE UNDERWRITING SERVICES, NAMELY, LIFE AND ACCIDENT INSURANCE (U.S. CLS. 100, 101 AND 102).

WENDY GOODMAN, EXAMINING ATTORNEY

**CLASS 36—(Continued).**

SN 78-496,856. AMERICAN INTERNATIONAL GROUP, INC., NEW YORK, NY. FILED 10-8-2004.

## AGLAFLEX SELECT

THE MARK CONSISTS OF STANDARD CHARACTERS WITHOUT CLAIM TO ANY PARTICULAR FONT, STYLE, SIZE, OR COLOR.

FOR INSURANCE UNDERWRITING SERVICES, NAMELY, LIFE AND ACCIDENT INSURANCE (U.S. CLS. 100, 101 AND 102).

WENDY GOODMAN, EXAMINING ATTORNEY

---

SN 78-524,261. AMERICAN INTERNATIONAL GROUP, INC., NEW YORK, NY. FILED 11-30-2004.

## AIG VALIC'S INCOMEDGE

THE MARK CONSISTS OF STANDARD CHARACTERS WITHOUT CLAIM TO ANY PARTICULAR FONT, STYLE, SIZE, OR COLOR.

FOR FINANCIAL SERVICES, NAMELY, RETIREMENT AND FINANCIAL PLANNING (U.S. CLS. 100, 101 AND 102).

WENDY GOODMAN, EXAMINING ATTORNEY

**CLASS 36—(Continued).**

SN 79-001,431. JCB CO., LTD., JAPAN, FILED 1-16-2004.



PRIORITY DATE OF 12-2-2003 IS CLAIMED.  
OWNER OF INTERNATIONAL REGISTRATION 0820765  
DATED 1-16-2004, EXPIRES 1-16-2014.

FOR CREDIT CARD SERVICES; DEBIT CARD SERVICES; DEBT COLLECTION AGENCIES; ACQUISITION AND TRANSFER OF MONETARY CLAIMS; FINANCIAL CLEARING HOUSES; MONEY EXCHANGE; FACTORING AGENCIES; FINANCING SERVICES; ELECTRONIC FUNDS TRANSFER; LIABILITY GUARANTEE AND ACCEPTABLE OF BILLS; INSTALLMENT LOANS; HIRE-PURCHASE FINANCING; BROKERAGE FOR HIRE-PURCHASE; ISSUE OF TRAVELERS CHECKS; AGENCIES FOR COLLECTING GAS AND ELECTRIC POWER UTILITY CHARGES AND TELEPHONE CHARGES OR PUBLIC UTILITY CHARGES, AND PROVIDING INFORMATION RELATING THERETO; LENDING AGAINST SECURITY; SAVINGS BANKS; BILL PAYMENT SERVICES PROVIDED VIA THE INTERNET; AUTHENTICATION AND VERIFICATION SERVICES FOR USE OF CREDIT CARDS AND DEBIT CARDS (U.S. CLS. 100, 101 AND 102).

LINDA E. BLOHM, EXAMINING ATTORNEY

**CLASS 37—(Continued).**

SN 76-535,919. B & H MANUFACTURING COMPANY, INC., CERES, CA. FILED 8-11-2003.



FOR REPAIR AND MAINTENANCE OF COMMERCIAL AND INDUSTRIAL MACHINES (U.S. CLS. 100, 103 AND 106).

GINA FINK, EXAMINING ATTORNEY

SN 76-547,368. RUBINO ENTERPRISES INC., COLUMBIA, MD. FILED 9-26-2003.



NO CLAIM IS MADE TO THE EXCLUSIVE RIGHT TO USE "ENTERPRISES INC"., APART FROM THE MARK AS SHOWN.

FOR CONSTRUCTION SERVICES, NAMELY PROJECT MANAGEMENT AND CONSULTING IN THE NATURE OF NEW AND EXISTING CONSTRUCTION INSPECTION FOR OTHERS (U.S. CLS. 100, 103 AND 106).

CAROLINE WOOD, EXAMINING ATTORNEY

SN 76-547,959. EPOCH CORPORATION, THE, MIAMI, FL. FILED 9-29-2003.

**CLASS 37—CONSTRUCTION AND REPAIR**

SN 76-452,598. CAT MBX, SACRAMENTO, CA. FILED 9-17-2002.

**CAT MBX**



FOR COMMERCIAL INSTALLATION OF AUDIO VIDEO DISTRIBUTION SYSTEMS AND COMPONENTS, NAMELY, AUDIO SPEAKERS, SUB-WOOFERS, SUB-WOOFER SYSTEMS, SATELLITE SPEAKERS, PROFESSIONAL MONITORING/PLAYBACK LOUD SPEAKERS, DIGITAL SIGNAL PROCESSORS, TUNERS, AMPLIFIERS, PRE-AMPLIFIERS, ISOLATION AMPLIFIERS, SURROUND SOUND DECODERS, SWITCHERS, ROUTERS, KEYPADS, REMOTE CONTROL DEVICES, AND ON-SCREEN DISPLAY DEVICES, FOR USE IN HOME THEATER SYSTEMS, HOME ENTERTAINMENT SYSTEMS, MULTI-ROOM HOME ENTERTAINMENT SYSTEMS, AND COMMERCIAL AUDIO AND VIDEO DISTRIBUTION SYSTEMS (U.S. CLS. 100, 103 AND 106).

FIRST USE 9-9-2001; IN COMMERCE 1-1-2002.  
CHARLES L. JENKINS, EXAMINING ATTORNEY

FOR REAL ESTATE DEVELOPMENT SERVICES; GENERAL CONTRACTOR AND CONSTRUCTION MANAGEMENT SERVICES, NAMELY CONSTRUCTION, REPAIR AND CONSTRUCTION MANAGEMENT OF RESIDENTIAL BUILDINGS AND COMMUNITIES, OFFICE BUILDINGS AND OFFICE PARKS, INDUSTRIAL FACILITIES AND INDUSTRIAL PARKS, AND RETAIL BUILDINGS AND MALLS (U.S. CLS. 100, 103 AND 106).

FIRST USE 0-0-1980; IN COMMERCE 0-0-1980.  
PAULA MAYS, EXAMINING ATTORNEY

**CLASS 37—(Continued).**

SN 76-550,003. LANGLEY PAINT AND BODY INC., BLOOMINGTON, IN. FILED 9-12-2003.

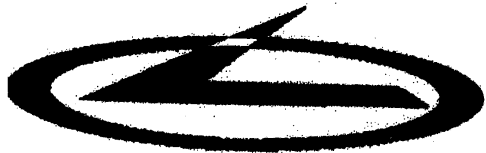

THE MARK CONSISTS OF A STYLIZED L DISPLAYED OVER THE TOP AND MIDDLE OF A STYLIZED OVAL.

FOR AUTOMOBILE SERVICE STATION SERVICES, NAMELY, AUTO COLLISION AND PAINTING SERVICES (U.S. CLS. 100, 103 AND 106).

FIRST USE 7-21-2002; IN COMMERCE 7-21-2002.  
INGA ERVIN, EXAMINING ATTORNEY

SN 76-561,297. BOLAND TRANE SERVICES, INC., DBA BOLAND SERVICES, ROCKVILLE, MD. FILED 11-24-2003.

**BOLAND SERVICES**

THE MARK CONSISTS OF STANDARD CHARACTERS WITHOUT CLAIM TO ANY PARTICULAR FONT, STYLE, SIZE, OR COLOR.

NO CLAIM IS MADE TO THE EXCLUSIVE RIGHT TO USE SERVICES, APART FROM THE MARK AS SHOWN. SEC. 2(F).

FOR INSTALLATION, REPAIR, AND MAINTENANCE OF AIR CONDITIONING, HEATING, AND VENTILATION EQUIPMENT FOR RESIDENTIAL AND COMMERCIAL PROPERTIES (U.S. CLS. 100, 103 AND 106).

FIRST USE 7-0-1985; IN COMMERCE 7-0-1985.  
CHRISIE B. KING, EXAMINING ATTORNEY

SN 76-567,242. WORKPLACE ESSENTIALS, INC., WOBURN, MA. FILED 12-24-2003.

**ESSENTIAL ELEMENTS FOR THE IDEAL WORKPLACE**

THE MARK CONSISTS OF STANDARD CHARACTERS WITHOUT CLAIM TO ANY PARTICULAR FONT, STYLE, SIZE, OR COLOR.

NO CLAIM IS MADE TO THE EXCLUSIVE RIGHT TO USE "ESSENTIAL" AND "ELEMENTS" AND "IDEAL" AND "WORKPLACE", APART FROM THE MARK AS SHOWN.

FOR INSTALLATION, MAINTENANCE AND SERVING OF SANITARY NAPKIN AND TAMPON VENDING DISPENSERS AND DISPOSAL UNITS, AUTOMATIC TOILET AND URINAL FLUSH VALVES, URINAL AND TOILET MATS, TOILET SEAT COVER DISPENSING UNITS, AIR FRESHENER UNITS FOR LAVATORIES, LAVATORY SOAP DISPENSERS, LAVATORY HAND DRIERS, BABY CHANGES TABLES FOR LAVATORIES, CHILD SAFETY SEATS FOR LAVATORIES, DIAPER DISPOSAL UNITS, IN-LINE SANITIZER UNITS FOR TOILETS, AND TOILET SEAT SANITIZER UNITS (U.S. CLS. 100, 103 AND 106).

FIRST USE 4-0-2002; IN COMMERCE 4-0-2002.  
JASON TURNER, EXAMINING ATTORNEY

**CLASS 37—(Continued).**

SN 76-567,926. D.R. HORTON MANAGEMENT COMPANY, LTD., ARLINGTON, TX. FILED 1-2-2004.



OWNER OF U.S. REG. NO. 2,644,920.  
NO CLAIM IS MADE TO THE EXCLUSIVE RIGHT TO USE AMERICA'S BUILDER, APART FROM THE MARK AS SHOWN.

THE NAME IN THE MARK IDENTIFIES A LIVING INDIVIDUAL WHOSE CONSENT IS OF RECORD. FOR CUSTOM CONSTRUCTION OF HOMES (U.S. CLS. 100, 103 AND 106).

FIRST USE 8-0-2003; IN COMMERCE 8-0-2003.  
TRACY CROSS, EXAMINING ATTORNEY

SN 76-578,006. VICTORY HEATING & AIR CONDITIONING, INC., BELLINGHAM, MA. FILED 2-25-2004.

**VICTORY HEATING & AIR CONDITIONING**

THE MARK CONSISTS OF STANDARD CHARACTERS WITHOUT CLAIM TO ANY PARTICULAR FONT, STYLE, SIZE, OR COLOR.

NO CLAIM IS MADE TO THE EXCLUSIVE RIGHT TO USE HEATING & AIR CONDITIONING, APART FROM THE MARK AS SHOWN.

FOR HEATING, AIR CONDITIONING AND VENTILATION CONTRACTOR SERVICES NAMELY, INSTALLATION, REPAIR AND MAINTENANCE OF HEATING, AIR CONDITIONING AND VENTILATION EQUIPMENT (U.S. CLS. 100, 103 AND 106).

FIRST USE 4-2-1993; IN COMMERCE 4-2-1993.  
GWEN STOKOLS, EXAMINING ATTORNEY

SN 76-581,423. MAID TO PERFECTION CORPORATION, HAGERSTOWN, MD. FILED 3-15-2004.

**FACILITIES TO PERFECTION**

THE MARK CONSISTS OF STANDARD CHARACTERS WITHOUT CLAIM TO ANY PARTICULAR FONT, STYLE, SIZE, OR COLOR.

FOR COMMERCIAL AND OFFICE CLEANING SERVICES (U.S. CLS. 100, 103 AND 106).

FIRST USE 10-0-1991; IN COMMERCE 12-0-1991.  
RONALD AIKENS, EXAMINING ATTORNEY

**CLASS 37—(Continued).**

SN 76-586,167. JOHN E. BARRY PLUMBING & HEATING CORP., CAPITOL HEIGHTS, MD. FILED 4-12-2004.



NO CLAIM IS MADE TO THE EXCLUSIVE RIGHT TO USE "PLUMBING AND HEATING", APART FROM THE MARK AS SHOWN.

FOR COMMERCIAL AND RESIDENTIAL PLUMBING SERVICES AND COMMERCIAL AND RESIDENTIAL INSTALLATION, REPAIR AND MAINTENANCE OF HEATING EQUIPMENT (U.S. CLS. 100, 103 AND 106).

FIRST USE 3-1-1989; IN COMMERCE 3-1-1989.  
DAVID C. REIHNER, EXAMINING ATTORNEY

SN 76-592,002. PURSUIT REAL ESTATE SERVICE, INC., CARSON CITY, NV. FILED 5-11-2004.

**PURSUIT**

THE MARK CONSISTS OF STANDARD CHARACTERS WITHOUT CLAIM TO ANY PARTICULAR FONT, STYLE, SIZE, OR COLOR.

FOR REAL ESTATE DEVELOPMENT AND COMMERCIAL BUILDING CONSTRUCTION (U.S. CLS. 100, 103 AND 106).

FIRST USE 1-22-2002; IN COMMERCE 1-22-2002.  
EVELYN BRADLEY, EXAMINING ATTORNEY

SN 78-161,357. EMPIRE GLASS COMPANIES, INC., PHOENIX, AZ. FILED 9-6-2002.

**EMPIRE GLASS**

NO CLAIM IS MADE TO THE EXCLUSIVE RIGHT TO USE GLASS, APART FROM THE MARK AS SHOWN.

FOR INSTALLATION OF GLASS IN AUTOMOTIVE TYPE VEHICLES, NAMELY, AUTOMOBILES AND TRUCKS. (U.S. CLS. 100, 103 AND 106).

FIRST USE 11-30-1990; IN COMMERCE 11-30-1990.  
KAREN BRACEY, EXAMINING ATTORNEY

**CLASS 37—(Continued).**

SN 78-210,710. FAPS, INC., PORT NEWARK, NJ. FILED 2-4-2003.

**INSPIRED BY TRADITION,  
NOT BOUND BY IT**

OWNER OF U.S. REG. NO. 2,627,151.

FOR PROCESSING SERVICES FOR AUTOMOBILE MANUFACTURERS, DISTRIBUTORS AND DEALERS, NAMELY, PAINTING, DETAILING, REPAIRING AND FINISHING, AND INSTALLING MISCELLANEOUS OPTIONAL AND STANDARD EQUIPMENT, ALL FOR IMPORT, EXPORT AND FLEET AUTOMOBILES (U.S. CLS. 100, 103 AND 106).

BRETT J. GOLDEN, EXAMINING ATTORNEY

SN 78-278,660. ENERGY CRANES LLC, HOUSTON, TX. FILED 7-24-2003.



OWNER OF U.S. REG. NO. 1,930,037.

FOR RENTAL AND REPAIR OF CRANES AND STRUCTURAL COMPONENTS THEREFOR (U.S. CLS. 100, 103 AND 106).

FIRST USE 0-0-1990; IN COMMERCE 0-0-1990.  
LINDA MICKLEBURGH, EXAMINING ATTORNEY

SN 78-293,966. GENESIS COMMUNICATIONS CONTRACTING, INC., SHIRLEY, NY. FILED 8-29-2003.

**DORMER DOCTOR**

NO CLAIM IS MADE TO THE EXCLUSIVE RIGHT TO USE "DORMER", APART FROM THE MARK AS SHOWN.

FOR HOME IMPROVEMENT, MORE SPECIFICALLY THE BUILDING OF DORMERS AND EXTENSIONS FOR RESIDENTIAL HOUSES (U.S. CLS. 100, 103 AND 106).

MARY ROSSMAN, EXAMINING ATTORNEY

SN 78-295,696. JLT GROUP INC., ST. PAUL, MN. FILED 9-3-2003.

**THE BRIDGES OF SAINT  
PAUL**

NO CLAIM IS MADE TO THE EXCLUSIVE RIGHT TO USE "ST. PAUL", APART FROM THE MARK AS SHOWN.

FOR REAL ESTATE DEVELOPMENT SERVICES FEATURING MIXED-USE REAL ESTATE, HOUSING, RETAIL STORES, OFFICES AND RECREATIONAL AREAS (U.S. CLS. 100, 103 AND 106).

TRACY FLETCHER, EXAMINING ATTORNEY

**CLASS 37—(Continued).**

SN 78-315,164. XENERGY, CARLSBAD, CA. FILED 10-17-2003.

**XENERGY**

FOR MECHANICAL CONTRACTOR SERVICES (U.S. CLS. 100, 103 AND 106).

FIRST USE 10-2-2001; IN COMMERCE 10-2-2001.  
ANGELA M. MICHELI, EXAMINING ATTORNEY

SN 78-326,537. CLIMATE CARE, LEAWOOD, KS. FILED 11-12-2003.



NO CLAIM IS MADE TO THE EXCLUSIVE RIGHT TO USE "CLIMATE CARE", APART FROM THE MARK AS SHOWN.

THE COLOR(S) YELLOW, ORANGE, RED ON TEAL IS/ ARE CLAIMED AS A FEATURE OF THE MARK.

THE MARK CONSISTS OF THE WORDS CLIMATE CARE IN COLOR YELLOW TO ORANGE IN ITALIC STYLE CIRCLED BY A OVAL, FADING RED SWISH ON TEAL BACKGROUND.

FOR HEATING, VENTILATION AND AIR CONDITIONING CONTRACTOR SERVICES; INSTALLATION, REPAIR AND MAINTENANCE OF HEATING, REFRIGERATION, AIR CONDITIONING, VENTILATION, AIR CLEANING AND AIR PURIFICATION EQUIPMENT AND APPLIANCES (U.S. CLS. 100, 103 AND 106).

FIRST USE 1-29-2002; IN COMMERCE 7-25-2002.  
ALEXANDER L. POWERS, EXAMINING ATTORNEY

SN 78-373,898. OCH INTERNATIONAL, INC., PORTLAND, OR. FILED 2-25-2004.

**BOWTIE SERVICE**

THE MARK CONSISTS OF STANDARD CHARACTERS WITHOUT CLAIM TO ANY PARTICULAR FONT, STYLE, SIZE, OR COLOR.

NO CLAIM IS MADE TO THE EXCLUSIVE RIGHT TO USE "SERVICE", APART FROM THE MARK AS SHOWN.

FOR AUTOMOBILE LUBRICATION AND OIL CHANGING SERVICES (U.S. CLS. 100, 103 AND 106).

HOWARD B. LEVINE, EXAMINING ATTORNEY

**CLASS 37—(Continued).**

SN 78-376,127. ARBORWOOD HOMES, INC., SPRING ARBOR, MI. FILED 3-1-2004.

**ArborWood Homes**

THE MARK CONSISTS OF STANDARD CHARACTERS WITHOUT CLAIM TO ANY PARTICULAR FONT, STYLE, SIZE, OR COLOR.

NO CLAIM IS MADE TO THE EXCLUSIVE RIGHT TO USE "HOMES", APART FROM THE MARK AS SHOWN.

FOR REPAIR AND CONSTRUCTION OF RESIDENTIAL HOMES AND BUILDINGS (U.S. CLS. 100, 103 AND 106).

FIRST USE 5-24-2001; IN COMMERCE 5-24-2001.  
JOSETTE BEVERLY, EXAMINING ATTORNEY

SN 78-383,126. WISCONSIN LIFT TRUCK CORP., BROOKFIELD, WI. FILED 3-12-2004.

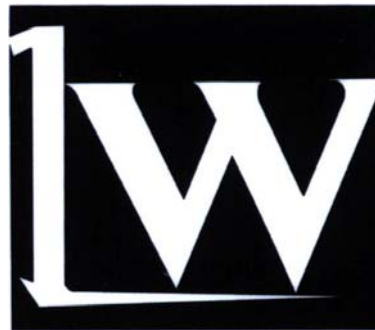

OWNER OF U.S. REG. NO. 1,844,741.

THE MARK CONSISTS OF STYLIZED LETTERS "L" AND "W" CARRIED BY A SHADED BLACK SQUARE. COLOR IS NOT A PART OF THE MARK.

FOR LEASING OF INDUSTRIAL EQUIPMENT FOR MATERIAL HANDLING, NAMELY, CONVEYORS, JACKS, LIFTS, LIFT TABLES AND STACKERS AND ACCESSORIES THEREFORE, LOADING DOCK EQUIPMENT, CABINETS, SHELVING, SCRUBBERS, PRESSES, RAMPS AND WALKWAYS, BENCHES AND WORK TABLES, RACKING AND STRIP DOORS; MAINTENANCE AND REPAIR OF PERSONNEL VEHICLES AND MATERIAL HANDLING VEHICLES; REBUILDING INDUSTRIAL ENGINES (U.S. CLS. 100, 103 AND 106).

FIRST USE 3-1-2002; IN COMMERCE 3-1-2002.  
SONYA STEPHENS, EXAMINING ATTORNEY

**CLASS 37—(Continued).**

SN 78-387,812. GAMBRO LUNDIA AB, LUND, SWEDEN, FILED 3-19-2004.



OWNER OF U.S. REG. NOS. 2,553,624, 2,586,049 AND OTHERS.

THE MARK CONSISTS OF FIGURATIVE TRADEMARK CONSISTS OF TWO CIRCULAR AREAS EACH HAVE A SUBSTANTIALLY TRIANGULAR RECESS.

FOR REPAIR AND MAINTENANCE OF MEDICAL APPARATUS AND INSTRUMENTS; SPECIFICALLY, APPARATUS AND INSTRUMENTS FOR BLOOD COMPONENT COLLECTION AND FOR BLOOD TREATMENT, NAMELY, DIALYSIS MONITORS, APPARATUS FOR EXTRACORPOREAL BLOOD HANDLING RELATED TO BONE MARROW PROCESSING, CELL PROCESSING, APHERESIS, BLOOD SEPARATION AND FILTERING, WATER TREATMENT EQUIPMENT INTENDED FOR MEDICAL USE, NAMELY, RO MACHINES, CENTRAL SOLUTION PREPARATION MACHINES (U.S. CLS. 100, 103 AND 106).

FIRST USE 8-31-2000; IN COMMERCE 8-31-2000.  
MICHAEL WEBSTER, EXAMINING ATTORNEY

SN 78-420,022. MIDDLETON, RICHARD, COLUMBIA, SC. FILED 5-17-2004.

# PERCLESS

THE MARK CONSISTS OF STANDARD CHARACTERS WITHOUT CLAIM TO ANY PARTICULAR FONT, STYLE, SIZE, OR COLOR.

FOR DRY CLEANING (U.S. CLS. 100, 103 AND 106).  
JULIA HARDY COFIELD, EXAMINING ATTORNEY

**CLASS 38—COMMUNICATION**

SN 75-812,876. GOAMERICA COMMUNICATIONS CORPORATION, HACKENSACK, NJ. FILED 10-1-1999.

# GOAMERICA WIRELESS E-MAIL AND INTERNET TO GO

NO CLAIM IS MADE TO THE EXCLUSIVE RIGHT TO USE "WIRELESS E-MAIL AND INTERNET", APART FROM THE MARK AS SHOWN.

FOR PROVIDING WIRELESS TELECOMMUNICATIONS CONNECTIONS TO A GLOBAL COMPUTER NETWORK; PROVIDING WIRELESS ELECTRONIC MAIL SERVICES VIA A GLOBAL INFORMATION NETWORK FEATURING MANAGEMENT, FILTERING, STORING, FORWARDING, ROUTING AND PREVIEW CAPABILITIES; PROVIDING WIRELESS MULTIPLE-USER ACCESS TO A GLOBAL COMPUTER INFORMATION NETWORK (U.S. CLS. 100, 101 AND 104).

FIRST USE 9-16-1999; IN COMMERCE 9-21-1999.  
VIVIAN MICZNIK FIRST, EXAMINING ATTORNEY

SN 76-271,154. LEADER TECHNOLOGIES, LLC, WESTERVILLE, OH. FILED 6-14-2001.

# Click2Lead

FOR TELECOMMUNICATIONS SERVICES, NAMELY ELECTRONIC TRANSMISSION OF VOICE, DATA, INFORMATION AND IMAGES (U.S. CLS. 100, 101 AND 104).

MICHAEL KAZAZIAN, EXAMINING ATTORNEY

SN 76-513,425. FTTH COMMUNICATIONS, L.L.C., ROSEMOUNT, MN. FILED 5-8-2003.

# TECHNOLOGY OF TOMORROW, SERVICE OF YESTERDAY

NO CLAIM IS MADE TO THE EXCLUSIVE RIGHT TO USE "TECHNOLOGY" OR "SERVICE", APART FROM THE MARK AS SHOWN.

FOR TELECOMMUNICATIONS SERVICES, NAMELY, LOCAL AND LONG DISTANCE TRANSMISSION OF VOICE, VIDEO AND DATA BY MEANS OF TELEPHONE, TELEGRAPHIC, CABLE AND SATELLITE TRANSMISSIONS (U.S. CLS. 100, 101 AND 104).

FIRST USE 6-1-2002; IN COMMERCE 6-1-2002.  
JOHN HWANG, EXAMINING ATTORNEY

**CLASS 38—(Continued).**

SN 76-545,761. ORBITEL S.A. E.S.P., MEDELLIN, COLOMBIA, FILED 9-17-2003.

**ORBITEL**

FOR TELEPHONE COMMUNICATIONS SERVICES; DIGITAL TRANSMISSION OF VOICE, DATA, IMAGES, SIGNALS AND MESSAGES; FACSIMILE TRANSMISSION SERVICES; TELECOMMUNICATION GATEWAY SERVICES; PROVIDING TELECOMMUNICATIONS CONNECTION TO A GLOBAL COMPUTER NETWORK; TELECOMMUNICATIONS SERVICES, NAMELY, ISDN SERVICES; TELECOMMUNICATIONS SERVICES, NAMELY, PERSONAL COMMUNICATION SERVICES ENABLING PEOPLE TO COMMUNICATION WITH ONE ANOTHER; LONG DISTANCE SERVICES; TELEPHONE TELECOMMUNICATIONS SERVICES PROVIDED VIA PREPAID TELEPHONE CALLING CARDS (U.S. CLS. 100, 101 AND 104).  
INGRID C. EULIN, EXAMINING ATTORNEY

SN 76-584,573. VARTEC BUSINESS TRUST, COMPRISING MICHAEL G. HOFFMAN AND A. JOE MITCHELL, JR., BOTH U.S. CITIZENS, DALLAS, TX. FILED 4-2-2004.

**ZIPPER**

THE MARK CONSISTS OF STANDARD CHARACTERS WITHOUT CLAIM TO ANY PARTICULAR FONT, STYLE, SIZE, OR COLOR.

FOR PROVIDING TELECOMMUNICATIONS SERVICES, NAMELY, MULTIPLE USER DIAL-UP AND DEDICATED ACCESS TO THE GLOBAL COMPUTER INFORMATION NETWORK, TELECOMMUNICATIONS CONNECTIONS TO GLOBAL COMPUTER NETWORKS, LOCAL, LONG DISTANCE AND WIRELESS TELECOMMUNICATIONS SERVICES FOR THE TRANSMISSION OF VOICE, AUDIO, DATA, TEXT AND FACSIMILE (U.S. CLS. 100, 101 AND 104).

DAVID MURRAY, EXAMINING ATTORNEY

SN 76-588,740. OSMOND FOUNDATION, FOR THE CHILDREN OF THE WORLD, DBA CHILDREN'S MIRACLE NETWORK, SALT LAKE CITY, UT. FILED 4-26-2004.



OWNER OF U.S. REG. NOS. 1,343,289, 2,445,434 AND OTHERS.

NO CLAIM IS MADE TO THE EXCLUSIVE RIGHT TO USE "CHILDREN'S" AND "NETWORK", APART FROM THE MARK AS SHOWN.

FOR RADIO AND TELEVISION BROADCASTING IN THE FIELD OF CHILDREN AND CHILDREN'S ISSUES (U.S. CLS. 100, 101 AND 104).

FIRST USE 1-0-2000; IN COMMERCE 1-0-2000.  
MICHAEL TANNER, EXAMINING ATTORNEY

**CLASS 38—(Continued).**

SN 78-245,680. PEGASUS COMMUNICATIONS CORPORATION, BALA CYNWYD, PA. FILED 5-5-2003.

**PEGASUS WIBAND**

FOR WIRELESS INTERNET SERVICE PROVIDER SERVICES; LEASING OF TELECOMMUNICATION EQUIPMENT; AND PROVIDING MULTIPLE-USER ACCESS TO A GLOBAL COMPUTER INFORMATION NETWORK (U.S. CLS. 100, 101 AND 104).

GLENN CLARK, EXAMINING ATTORNEY

SN 78-273,935. SKYCOMM INTERNATIONAL, INC., HOUSTON, TX. FILED 7-14-2003.

**SKYPORT**

FOR SATELLITE VOICE DATA AND BROADBAND COMMUNICATIONS, NAMELY, ELECTRONIC AND DIGITAL TRANSMISSION OF VOICE, DATA, IMAGES, SIGNALS AND MESSAGES (U.S. CLS. 100, 101 AND 104).  
FIRST USE 8-28-2003; IN COMMERCE 8-28-2003.  
BARBARA BROWN, EXAMINING ATTORNEY

SN 78-284,618. LEVEL 3 COMMUNICATIONS, INC., BROOMFIELD, CO. FILED 8-7-2003.

**(3)VOIP TOLL FREE**

NO CLAIM IS MADE TO THE EXCLUSIVE RIGHT TO USE "TOLL FREE", APART FROM THE MARK AS SHOWN. FOR TELECOMMUNICATIONS SERVICES, NAMELY, TRANSMISSION OF VOICE VIA ELECTRONIC MEANS; TELECOMMUNICATIONS SERVICES, NAMELY, TRANSMISSION OF VOICE VIA FIBER OPTIC NETWORKING (U.S. CLS. 100, 101 AND 104).

MARK T. MULLEN, EXAMINING ATTORNEY

SN 78-304,361. MEDIA 3 LTD., NEW YORK, NY. FILED 9-23-2003.

**BUREAUCAM**

FOR PROVIDING FACILITIES AND EQUIPMENT FOR LIVE SHOT VIDEO BROADCASTING; WEBCASTING SERVICES AND STREAMING OF VIDEO MATERIAL ON THE INTERNET; VIDEO BROADCASTING VIA SATELLITE AND FIBER OPTIC NETWORKS; VIDEO WEBCASTING AND STREAMING VIA THE INTERNET; VIDEO-ON-DEMAND TRANSMISSION SERVICES (U.S. CLS. 100, 101 AND 104).

FIRST USE 4-5-2003; IN COMMERCE 4-5-2003.  
GINA HAYES, EXAMINING ATTORNEY



**CLASS 38—(Continued).**

SN 78-310,119. CELLCO PARTNERSHIP, DBA VERIZON WIRELESS, BEDMINSTER, NJ. FILED 10-7-2003.

**CLASS 38—(Continued).**

SN 78-343,011. HANOUN MEDICAL, (II) U.S., INC., GREENWOOD VILLAGE, CO. FILED 12-18-2003.



**OSCARLINK**

NO CLAIM IS MADE TO THE EXCLUSIVE RIGHT TO USE "REPRESENTATION OF THE UNITED STATES", APART FROM THE MARK AS SHOWN.

FOR TELECOMMUNICATIONS SERVICES, NAMELY, WIRELESS PERSONAL COMMUNICATION SERVICES; PROVIDING WIRELESS MULTIPLE-USER ACCESS TO A GLOBAL COMPUTER INFORMATION NETWORK (U.S. CLS. 100, 101 AND 104).

CHARLES L. JENKINS, EXAMINING ATTORNEY

THE MARK CONSISTS OF STANDARD CHARACTERS WITHOUT CLAIM TO ANY PARTICULAR FONT, STYLE, SIZE, OR COLOR.

FOR SECURE ELECTRONIC TRANSMISSION OF DATA AND DOCUMENTS BETWEEN MEDICAL PROVIDERS, EMPLOYERS AND INSURANCE CARRIERS (U.S. CLS. 100, 101 AND 104).

FIRST USE 2-18-2000; IN COMMERCE 2-18-2000.  
ELLEN PERKINS, EXAMINING ATTORNEY

SN 78-328,950. WESTERN WIRELESS CORPORATION, BELLEVUE, WA. FILED 11-17-2003.

SN 78-353,703. XOD, LLC, WARMINSTER, PA. FILED 1-19-2004.



**XONDEMAND**

THE MARK CONSISTS OF THE WORD "HELLO" IN CURSIVE SCRIPT.

FOR TELECOMMUNICATIONS SERVICES, NAMELY, RADIO, TELEPHONE AND CELLULAR TELEPHONE SERVICES; WIRELESS ELECTRONIC TRANSMISSION OF VOICE AND DATA; PROVIDING USERS THE ABILITY TO ACCESS EMAIL, INTRANET AND; NETWORK APPLICATIONS VIA REMOTE ACCESS; WIRELESS INTERNET ACCESS SERVICES; ELECTRONIC MESSAGING SERVICE ENABLING USERS TO RECEIVE VOICE, FAX, EMAIL AND OTHER FORMS OF MESSAGES VIA WIRELESS DEVICES OR ANY DEVICE CONNECTED TO THE TELECOMMUNICATIONS NETWORK (U.S. CLS. 100, 101 AND 104).

FIRST USE 7-13-2003; IN COMMERCE 7-13-2003.  
MICHAEL ENGEL, EXAMINING ATTORNEY

THE MARK CONSISTS OF STANDARD CHARACTERS WITHOUT CLAIM TO ANY PARTICULAR FONT, STYLE, SIZE, OR COLOR.

FOR ELECTRONIC TRANSMISSION OF ADULT ORIENTED ENTERTAINMENT IN THE NATURE OF STREAMING AUDIO, STREAMING VIDEO, AND STREAMING MEDIA TRANSMITTED VIA A GLOBAL COMMUNICATIONS NETWORK (U.S. CLS. 100, 101 AND 104).

FIRST USE 1-1-2004; IN COMMERCE 1-1-2004.  
STANLEY I. OSBORNE, EXAMINING ATTORNEY

**CLASS 38—(Continued).**

SN 78-357,471. AGL, PARIS, 75008, FRANCE, FILED 1-26-2004.

# FITZEN

THE MARK CONSISTS OF STANDARD CHARACTERS WITHOUT CLAIM TO ANY PARTICULAR FONT, STYLE, SIZE, OR COLOR.

OWNER OF FRANCE REG. NO. 3071900, DATED 12-11-2000, EXPIRES 12-11-2010.

FOR COMMUNICATIONS BY COMPUTER TERMINALS, COMPUTER AIDED TRANSMISSION OF MESSAGES AND IMAGES, ELECTRONIC MAIL SERVICES, TELECOMMUNICATIONS BY EMAIL, TELEPHONE COMMUNICATION SERVICES, PROVIDING MULTIPLE-USER ACCESS TO A GLOBAL COMPUTER NETWORK (U.S. CLS. 100, 101 AND 104).

INGA ERVIN, EXAMINING ATTORNEY

**CLASS 38—(Continued).**

SN 78-415,920. IMAGINATION INTERACTIVE, INC., COLORADO SPRINGS, CO. FILED 5-10-2004.



NO CLAIM IS MADE TO THE EXCLUSIVE RIGHT TO USE "TV.COM", APART FROM THE MARK AS SHOWN.

THE COLOR(S) BLACK, RED, AND YELLOW IS/ARE CLAIMED AS A FEATURE OF THE MARK

THE MARK CONSISTS OF THREE RINGS; ONE YELLOW AND TWO BLACK. THE DOT IN NAME APPEARS IN RED.

FOR TELECOMMUNICATIONS SERVICES, NAMELY, TRANSMISSION OF VOICE, DATA, AUDIO, GRAPHICS BY MEANS OF CABLE AND SATELLITE TRANSMISSIONS, INTERNET PROTOCOL; TELEVISION BROADCASTING SERVICES; TRANSMISSION OF DATA VIA COMPUTER TERMINALS, NAMELY, ELECTRONIC, ELECTRIC AND DIGITAL TRANSMISSION OF VOICE, DATA, IMAGES, AUDIO AND VIDEO SIGNALS AND MESSAGES VIA COMPUTER TERMINALS AND/OR INTERACTIVE TELEVISION BROADCASTING SERVICES (U.S. CLS. 100, 101 AND 104).

VIVIAN MICZNIK FIRST, EXAMINING ATTORNEY

SN 78-420,128. WEBEX COMMUNICATIONS, INC., SAN JOSE, CA. FILED 5-17-2004.

# WEBEX JAMBO

SN 78-399,534. KHWHY, INC., LOS ANGELES, CA. FILED 4-9-2004.

# HIGHWAY RADIO

THE MARK CONSISTS OF STANDARD CHARACTERS WITHOUT CLAIM TO ANY PARTICULAR FONT, STYLE, SIZE, OR COLOR.

NO CLAIM IS MADE TO THE EXCLUSIVE RIGHT TO USE "RADIO", APART FROM THE MARK AS SHOWN.

FOR RADIO BROADCASTING SERVICES (U.S. CLS. 100, 101 AND 104).

FIRST USE 12-31-1981; IN COMMERCE 12-31-1981.

TRACY WHITAKER-BOWN, EXAMINING ATTORNEY

THE MARK CONSISTS OF STANDARD CHARACTERS WITHOUT CLAIM TO ANY PARTICULAR FONT, STYLE, SIZE, OR COLOR.

FOR WEB-BASED MULTIMEDIA TELECONFERENCING SERVICES, AND WEB-BASED REAL-TIME MULTIMEDIA COMMUNICATIONS SERVICES, WHICH ALLOW USERS TO SIMULTANEOUSLY VIEW ELECTRONIC DATA, DOCUMENTS AND APPLICATIONS USING A STANDARD WEB BROWSER, AND WHICH ALLOW ANY USER THE ABILITY TO EDIT SUCH DATA OR DOCUMENTS AND CONTROL SUCH APPLICATIONS, EVEN WHEN SUCH DATA, DOCUMENTS OR APPLICATIONS ARE RESIDING ON ANOTHER USER'S COMPUTER (U.S. CLS. 100, 101 AND 104).

JULIA HARDY COFIELD, EXAMINING ATTORNEY

**CLASS 39—TRANSPORTATION AND STORAGE**

SN 76-560,709. ROADWAY EXPRESS, INC., AKRON, OH. FILED 11-17-2003.

**REIMER EXPRESS LINES LTD.**

THE MARK CONSISTS OF STANDARD CHARACTERS WITHOUT CLAIM TO ANY PARTICULAR FONT, STYLE, SIZE, OR COLOR.

NO CLAIM IS MADE TO THE EXCLUSIVE RIGHT TO USE "EXPRESS LINES LTD", APART FROM THE MARK AS SHOWN.

SEC. 2(F).

FOR TRANSPORTATION OF GENERAL FREIGHT BY TRUCK (U.S. CLS. 100 AND 105).

FIRST USE 0-0-1957; IN COMMERCE 0-0-1957.

CAROLINE WOOD, EXAMINING ATTORNEY

SN 76-572,448. VICTORY AIRLINES CORPORATION, MEMPHIS, TN. FILED 1-23-2004.



NO CLAIM IS MADE TO THE EXCLUSIVE RIGHT TO USE AIRLINES, APART FROM THE MARK AS SHOWN.

FOR AIR TRANSPORTATION SERVICES (U.S. CLS. 100 AND 105).

ASMAT KHAN, EXAMINING ATTORNEY

SN 76-579,464. CHAMPION PARKING CORP., NEW YORK, NY. FILED 3-5-2004.



NO CLAIM IS MADE TO THE EXCLUSIVE RIGHT TO USE PARKING, APART FROM THE MARK AS SHOWN.

FOR PARKING GARAGES SERVICES (U.S. CLS. 100 AND 105).

FIRST USE 9-15-2003; IN COMMERCE 9-15-2003.

CHERYL CLAYTON, EXAMINING ATTORNEY

SN 76-584,673. ROADWAY EXPRESS, INC., AKRON, OH. FILED 3-29-2004.

**BECAUSE ONE SHIPMENT MATTERS. YOURS.**

THE MARK CONSISTS OF STANDARD CHARACTERS WITHOUT CLAIM TO ANY PARTICULAR FONT, STYLE, SIZE, OR COLOR.

FOR FREIGHT TRANSPORTATION SERVICES BY TRUCK (U.S. CLS. 100 AND 105).

KIMBERLY PERRY, EXAMINING ATTORNEY

**CLASS 39—(Continued).**

SN 76-584,677. ROADWAY EXPRESS, INC., AKRON, OH. FILED 3-29-2004.

**BECAUSE ONE CUSTOMER MATTERS. YOU.**

THE MARK CONSISTS OF STANDARD CHARACTERS WITHOUT CLAIM TO ANY PARTICULAR FONT, STYLE, SIZE, OR COLOR.

FOR FREIGHT TRANSPORTATION SERVICES BY TRUCK (U.S. CLS. 100 AND 105).

KIMBERLY PERRY, EXAMINING ATTORNEY

SN 76-591,064. C.V.I., INC., PAWTUCKET, RI. FILED 5-7-2004.



THE MARK CONSISTS OF STANDARD CHARACTERS WITHOUT CLAIM TO ANY PARTICULAR FONT, STYLE, SIZE, OR COLOR.

FOR ORGANIZING, BOOKING AND ARRANGEMENT OF TRIPS FOR CORPORATIONS AND OTHER ORGANIZATIONS WHO PROVIDE THE TRIPS TO THEIR CUSTOMERS AND EMPLOYEES AS AN INCENTIVE OR REWARD (U.S. CLS. 100 AND 105).

DANIEL CAPSHAW, EXAMINING ATTORNEY

SN 76-591,425. NAUTICO VENTURES, L.L.C., MIAMI BEACH, FL. FILED 5-10-2004.

**CLUB NAUTICO**

THE MARK CONSISTS OF STANDARD CHARACTERS WITHOUT CLAIM TO ANY PARTICULAR FONT, STYLE, SIZE, OR COLOR.

NO CLAIM IS MADE TO THE EXCLUSIVE RIGHT TO USE "CLUB", APART FROM THE MARK AS SHOWN.

FOR PROVIDING RENTAL AND MARITIME CHARTER OF VESSELS (U.S. CLS. 100 AND 105).

FIRST USE 12-16-1983; IN COMMERCE 12-16-1983.

JERI J. FICKES, EXAMINING ATTORNEY

**CLASS 39—(Continued).**

SN 76-591,581. FLIGHT MAKER JET CHARTER CLUB, BEVERLY HILLS, CA. FILED 5-11-2004.



NO CLAIM IS MADE TO THE EXCLUSIVE RIGHT TO USE "FLIGHT" AND "JET CHARTER CLUB", APART FROM THE MARK AS SHOWN.

FOR CHARTER FLIGHT COORDINATION AND AGGREGATION MEMBER SERVICES, INCLUDING ON-LINE CHARTER FLIGHT COORDINATION AND AGGREGATION MEMBER SERVICES (U.S. CLS. 100 AND 105).

ELLEN B. AWRICH, EXAMINING ATTORNEY

SN 78-186,254. FREY, MARK, J, OCEANO, CA. FILED 11-18-2002.

**ASAP MOVERS**

NO CLAIM IS MADE TO THE EXCLUSIVE RIGHT TO USE "MOVERS", APART FROM THE MARK AS SHOWN.

FOR TRANSPORTATION OF GOODS TO AND FROM HOME AND BUSINESS LOCATIONS BY MEANS OF TRUCK; PACKING OF ARTICLES FOR OTHERS FOR TRANSPORTATION (U.S. CLS. 100 AND 105).

FIRST USE 9-12-2002; IN COMMERCE 9-12-2002.

KELLY BOULTON, EXAMINING ATTORNEY

SN 78-202,263. DIGIOVANNA, LEONARD, WEST HEMPSTEAD, NY. AND RAGNO, PHILIP D, BROOKVILLE, NY. FILED 1-10-2003.

**LIFEDRIVE**

FOR ELECTRONIC STORAGE OF MEDICAL IMAGING DATA; STORAGE SERVICES FOR ARCHIVING MEDICAL IMAGING DATA (U.S. CLS. 100 AND 105).

MARIA-VICTORIA SUAREZ, EXAMINING ATTORNEY

SN 78-238,152. ALASKA TRAVEL INDUSTRY ASSOCIATION, ANCHORAGE, AK. FILED 4-15-2003.

**BEYOND YOUR DREAMS.  
WITHIN YOUR REACH.**

FOR TRAVEL INDUSTRY SERVICES, NAMELY, MAKING RESERVATIONS AND BOOKINGS FOR TRANSPORTATION; TRAVEL INFORMATION SERVICES; TRAVEL BOOKING AGENCIES; TRAVEL PLANNING, NAMELY, ARRANGING TRAVEL TOURS AND ITINERARIES (U.S. CLS. 100 AND 105).

FIRST USE 12-0-2002; IN COMMERCE 12-0-2002.

CIMMERIAN COLEMAN, EXAMINING ATTORNEY

**CLASS 39—(Continued).**

SN 78-239,690. TONS CONSOLIDATORS, INC., LOS ANGELES, CA. FILED 4-18-2003.

**TCONS**

FOR PROVIDES FREIGHT FORWARDING SERVICES WORLDWIDE (U.S. CLS. 100 AND 105).

FIRST USE 5-1-2002; IN COMMERCE 5-1-2002.

ODESSA BIBBINS, EXAMINING ATTORNEY

SN 78-311,383. SECUREFLIGHT, INC., WEST CHESTER, PA. FILED 10-9-2003.



FOR AIRPLANE CHARTERING AND AIR TRANSPORTATION SERVICES (U.S. CLS. 100 AND 105).

FIRST USE 1-2-2002; IN COMMERCE 1-2-2002.

ALICE BENMAMAN, EXAMINING ATTORNEY

SN 78-314,517. AMERICAN EXPRESS COMPANY, NEW YORK, NY. FILED 10-16-2003.

**CENTURION VILLAS**

NO CLAIM IS MADE TO THE EXCLUSIVE RIGHT TO USE "VILLAS", APART FROM THE MARK AS SHOWN.

FOR ARRANGING TRAVEL TOURS (U.S. CLS. 100 AND 105).

DOMINIC J. FERRAIUOLO, EXAMINING ATTORNEY

**CLASS 39—(Continued).**

SN 78-333,291. A LIMO 4 YOU, INC., FRESNO, CA. FILED 11-25-2003.

Limo for You

THE MARK CONSISTS OF STANDARD CHARACTERS WITHOUT CLAIM TO ANY PARTICULAR FONT, STYLE, SIZE, OR COLOR.

NO CLAIM IS MADE TO THE EXCLUSIVE RIGHT TO USE LIMO, APART FROM THE MARK AS SHOWN.

FOR TRANSPORTATION OF PASSENGERS BY SEDANS, VANS, SUVs, LIMOUSINES, AND/OR BUSES (U.S. CLS. 100 AND 105).

KIM SAITO, EXAMINING ATTORNEY

**CLASS 39—(Continued).**

SN 78-385,973. PROLIANCE ENERGY, INC., INDIANAPOLIS, IN. FILED 3-17-2004.

RELIUS ENERGY

THE MARK CONSISTS OF STANDARD CHARACTERS WITHOUT CLAIM TO ANY PARTICULAR FONT, STYLE, SIZE, OR COLOR.

NO CLAIM IS MADE TO THE EXCLUSIVE RIGHT TO USE "ENERGY", APART FROM THE MARK AS SHOWN.

FOR CONSULTING SERVICES IN THE FIELD OF ENERGY SUPPLY (U.S. CLS. 100 AND 105).

LAURA KOVAISKY, EXAMINING ATTORNEY

SN 78-397,799. PATTERSON, GADDIEL L., SAINT LOUIS, MO. FILED 4-7-2004.



FOR UTILITY SERVICES, NAMELY, TRANSMISSION OF ELECTRICITY AND SOLAR ENERGY (U.S. CLS. 100 AND 105).

MONTIA G. PRESSEY, EXAMINING ATTORNEY

SN 78-383,066. PROLIANCE ENERGY INC., INDIANAPOLIS, IN. FILED 3-12-2004.

RELIUS

THE MARK CONSISTS OF STANDARD CHARACTERS WITHOUT CLAIM TO ANY PARTICULAR FONT, STYLE, SIZE, OR COLOR.

FOR CONSULTING SERVICES IN THE FIELD OF ENERGY SUPPLY (U.S. CLS. 100 AND 105).

LAURA KOVAISKY, EXAMINING ATTORNEY

SN 78-404,144. THE SOUTHERN COMPANY, ATLANTA, GA. FILED 4-19-2004.

SETRANS GRID COMPANY

THE MARK CONSISTS OF STANDARD CHARACTERS WITHOUT CLAIM TO ANY PARTICULAR FONT, STYLE, SIZE, OR COLOR.

NO CLAIM IS MADE TO THE EXCLUSIVE RIGHT TO USE "GRID COMPANY", APART FROM THE MARK AS SHOWN.

FOR TRANSMISSION AND DISTRIBUTION OF ENERGY (U.S. CLS. 100 AND 105).

MARC LEIPZIG, EXAMINING ATTORNEY

**CLASS 39—(Continued).**

SN 78-407,217. EVANS, STEVEN W., ORLANDO, FL. FILED 4-23-2004.

## Stars at Sea

THE MARK CONSISTS OF STANDARD CHARACTERS WITHOUT CLAIM TO ANY PARTICULAR FONT, STYLE, SIZE, OR COLOR.

FOR TRAVEL AGENCY SERVICES, NAMELY, ARRANGING CRUISE VACATION PACKAGES AND MAKING RESERVATIONS AND BOOKINGS FOR TRANSPORTATION (U.S. CLS. 100 AND 105).

FIRST USE 4-1-1997; IN COMMERCE 4-1-1997.  
SKYE YOUNG, EXAMINING ATTORNEY

SN 78-413,544. SILVER CP II, LLC, FREDERICKSBURG, VA. FILED 5-5-2004.

## CELEBRATE VIRGINIA

THE MARK CONSISTS OF STANDARD CHARACTERS WITHOUT CLAIM TO ANY PARTICULAR FONT, STYLE, SIZE, OR COLOR.

OWNER OF U.S. REG. NOS. 2,367,896, 2,367,898 AND OTHERS.

NO CLAIM IS MADE TO THE EXCLUSIVE RIGHT TO USE "VIRGINIA", APART FROM THE MARK AS SHOWN.

FOR TRAVEL INFORMATION SERVICES; ARRANGING TRAVEL TOURS; TRAVEL AGENCY SERVICES, NAMELY, MAKING RESERVATIONS FOR TRANSPORTATION; ARRANGING AND CONDUCTING BOATING, CANOEING, AND KAYAKING EXPEDITIONS; AND ARRANGING AND CONDUCTING FISHING EXPEDITIONS (U.S. CLS. 100 AND 105).

ANNE E. GUSTASON, EXAMINING ATTORNEY

**CLASS 39—(Continued).**

SN 78-414,325. PRIMARIS AIRLINES, INC., LAS VEGAS, NV. FILED 5-6-2004.

## Professional Class

THE MARK CONSISTS OF STANDARD CHARACTERS WITHOUT CLAIM TO ANY PARTICULAR FONT, STYLE, SIZE, OR COLOR.

NO CLAIM IS MADE TO THE EXCLUSIVE RIGHT TO USE CLASS, APART FROM THE MARK AS SHOWN.

FOR AIRLINE TRANSPORTATION SERVICES (U.S. CLS. 100 AND 105).

MELVIN AXILBUND, EXAMINING ATTORNEY

SN 78-421,197. MEADOWS, LEWIS G, DUNKIRK, MD. FILED 5-19-2004.

## TaxiCrab

THE MARK CONSISTS OF STANDARD CHARACTERS WITHOUT CLAIM TO ANY PARTICULAR FONT, STYLE, SIZE, OR COLOR.

FOR FOOD DELIVERY (U.S. CLS. 100 AND 105).

THEODORE MCBRIDE, EXAMINING ATTORNEY

**CLASS 39—(Continued).**

SN 78-421,345. FRONTIER AIRLINES, INC., DENVER, CO. FILED 5-19-2004.

**THE FAST TRACK TO  
FREE TRAVEL**

THE MARK CONSISTS OF STANDARD CHARACTERS WITHOUT CLAIM TO ANY PARTICULAR FONT, STYLE, SIZE, OR COLOR.

FOR AIR TRANSPORTATION SERVICES, IN THE NATURE OF A FREQUENT FLIER PROGRAM, INCLUDING AWARDS AND SPECIALIZED SERVICES FOR FREQUENT AIR TRAVELERS, NAMELY PRIORITY BOARDING, SEAT SELECTION AND RESERVATIONS, TICKET UPGRADES AND DISCOUNTS (U.S. CLS. 100 AND 105).

ERNEST SHOSHO, EXAMINING ATTORNEY

**CLASS 40—(Continued).**

SN 76-562,026. HINSON, KAREN, SINKING SPRING, PA. FILED 11-26-2003.



THE LIKENESS (OR, "PORTRAIT") IN THE MARK DOES NOT IDENTIFY A LIVING INDIVIDUAL.

THE LITERAL ELEMENT OF THE MARK CONSISTS OF MARJORIE FREDERIC.

FOR CUSTOM MANUFACTURE OF APPAREL (U.S. CLS. 100, 103 AND 106).

LAURA KOVAISKY, EXAMINING ATTORNEY

**CLASS 40—MATERIAL TREATMENT**

SN 76-484,882. PHOENIX COLOR CORP., HAGERSTOWN, MD. FILED 1-24-2003.

**INTERACTIVE ILLUSION**

NO CLAIM IS MADE TO THE EXCLUSIVE RIGHT TO USE INTERACTIVE, APART FROM THE MARK AS SHOWN.

FOR PRINTING SERVICES, NAMELY USING INKS OR COATINGS TO CREATE THE EFFECT OF EMBOSSED (U.S. CLS. 100, 103 AND 106).

FIRST USE 1-22-2003; IN COMMERCE 1-22-2003.  
SCOTT OSLICK, EXAMINING ATTORNEY

SN 76-571,138. BRENNER ASSOCIATES, DBA NATIONAL MARKETING SERVICES, EDISON, NJ. FILED 1-20-2004.



NO CLAIM IS MADE TO THE EXCLUSIVE RIGHT TO USE "NATIONAL ASSEMBLY SERVICES", APART FROM THE MARK AS SHOWN.

FOR RETAIL AND CONSUMER ON-PREMISE ASSEMBLY OF PRODUCTS FOR OTHERS (U.S. CLS. 100, 103 AND 106).

YONG KIM, EXAMINING ATTORNEY

SN 76-505,826. PUBLIC SERVICE ENTERPRISE GROUP INCORPORATED, NEWARK, NJ. FILED 4-11-2003.



OWNER OF U.S. REG. NOS. 943,409, 943,410 AND 1,626,321.

NO CLAIM IS MADE TO THE EXCLUSIVE RIGHT TO USE NUCLEAR LLC, APART FROM THE MARK AS SHOWN.

THE ENERGY BURST DESIGN IS IN THE COLOR ORANGE. THE LETTERS ARE LINED FOR THE COLOR GRAY. THE PHRASE "NUCLEAR LLC" IS IN THE COLOR ORANGE.

FOR GENERATION OF ELECTRICITY (U.S. CLS. 100, 103 AND 106).

TONI HICKEY, EXAMINING ATTORNEY

SN 76-589,269. ENXNET, INC., TULSA, OK. FILED 4-29-2004.

**ENXMEDIA**

THE MARK CONSISTS OF STANDARD CHARACTERS WITHOUT CLAIM TO ANY PARTICULAR FONT, STYLE, SIZE, OR COLOR.

FOR MEDIA REPLICATION AND DUPLICATION OF DIGITAL AND ANALOG INFORMATION (U.S. CLS. 100, 103 AND 106).

FIRST USE 3-11-2004; IN COMMERCE 3-11-2004.  
NAAKWAMA ANKRAH, EXAMINING ATTORNEY

**CLASS 40—(Continued).**

SN 76-593,060. R AND K SALES, INC., KELLER, TX. FILED 5-17-2004.

**CREATIVE HEARTS**

THE MARK CONSISTS OF STANDARD CHARACTERS WITHOUT CLAIM TO ANY PARTICULAR FONT, STYLE, SIZE, OR COLOR.

FOR CUSTOM REPRODUCTION OF THIRD PARTIES' ORIGINAL ARTWORK ONTO VARIOUS GIFT AND NOVELTY ITEMS IN CONNECTION WITH SCHOOL FUNDRAISING PROGRAMS (U.S. CLS. 100, 103 AND 106).

FIRST USE 7-18-2003; IN COMMERCE 7-18-2003.  
NICHOLAS ALTREE, EXAMINING ATTORNEY

**CLASS 40—(Continued).**

SN 78-329,500. WALDWICK PLASTICS CORPORATION, WALDWICK, NJ. FILED 11-18-2003.

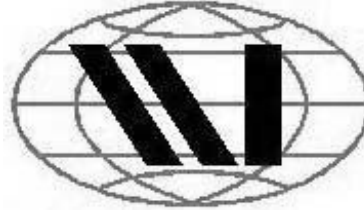

THE MARK CONSISTS OF A DARK AND THICK LETTER W IN STYLIZED FORM, INSIDE A MUCH LIGHTER LARGE OVAL WITH HORIZONTAL LINES, A SUBSIDIARY OVAL AND SOME FURTHER LINING, ALL OF WHICH GIVES AN ABSTRACT SUGGESTION OF A GLOBE.

FOR PRIVATE LABEL MANUFACTURING OF AIR FRESHENERS, SCENTED CANDLES, TOILET BOWL CLEANERS AND OTHER CLEANING PRODUCTS (U.S. CLS. 100, 103 AND 106).

FIRST USE 1-1-1978; IN COMMERCE 1-1-1978.  
ALICE SUE CARRUTHERS, EXAMINING ATTORNEY

SN 78-210,522. NUTRASEP LLC, AUSTIN, TX. FILED 2-4-2003.

**NUTRASEP**

FOR MANUFACTURE AND CUSTOM MANUFACTURE OF GENERAL PRODUCT LINES IN THE FIELDS OF VITAMINS, DIETARY NUTRITIONAL, FOOD AND HERBAL SUPPLEMENTS, POWDERED MIXES FOR USE AS SNACKS AND MEAL REPLACEMENTS, PROTEIN POWDERS, CAPSULES, TABLETS, COATED AND ENTERICALLY COATED TABLETS, HARD GEL CAPSULES AND A WIDE VARIETY OF RELATED GOODS TO THE ORDER AND SPECIFICATION OF OTHERS; AND BOTTLING (U.S. CLS. 100, 103 AND 106).

CIMMERIAN COLEMAN, EXAMINING ATTORNEY

SN 78-390,744. COLONIAL PRESS, INC., OMAHA, NE. FILED 3-25-2004.



THE COLOR(S) RED, YELLOW, BLUE, BLACK, TAN IS/ ARE CLAIMED AS A FEATURE OF THE MARK.

THE MARK CONSISTS OF CORN COAST IN TAN; OFFENSE IN YELLOW, BLACK CORN; YELLOW SUN; OCEAN WAVE IN RED, YELLOW, BLUE AND BLACK.

FOR PRINTING (U.S. CLS. 100, 103 AND 106).  
GIANCARLO CASTRO, EXAMINING ATTORNEY

SN 78-238,468. LTL WHOLESALE, INC., DBA LTL HOME PRODUCTS, INC., SCHUYLKILL HAVEN, PA. FILED 4-16-2003.

**CUSTOM DOORS IN DAYS**

OWNER OF U.S. REG. NO. 1,940,275.  
NO CLAIM IS MADE TO THE EXCLUSIVE RIGHT TO USE "CUSTOM DOORS", APART FROM THE MARK AS SHOWN.

SEC. 2(F).  
FOR CUSTOM MANUFACTURE OF DOORS FOR BUILDINGS (U.S. CLS. 100, 103 AND 106).

FIRST USE 1-31-1994; IN COMMERCE 1-31-1994.  
TRACY WHITAKER-BOWN, EXAMINING ATTORNEY

SN 78-450,175. IMAGEMASTER, INC., ANN ARBOR, MI. FILED 7-13-2004.

**THE WORKING GROUP'S CHOICE**

THE MARK CONSISTS OF STANDARD CHARACTERS WITHOUT CLAIM TO ANY PARTICULAR FONT, STYLE, SIZE, OR COLOR.

NO CLAIM IS MADE TO THE EXCLUSIVE RIGHT TO USE WORKING GROUP'S, APART FROM THE MARK AS SHOWN.

FOR PRINTING SERVICES FOR CORPORATE AND MUNICIPAL DOCUMENTS (U.S. CLS. 100, 103 AND 106).  
FIRST USE 7-1-2003; IN COMMERCE 7-1-2003.

STEVEN BERK, EXAMINING ATTORNEY



**CLASS 41—EDUCATION AND ENTERTAINMENT**

SN 75-529,073. TIVOLI A/S, 1630 COPENHAGEN V, DENMARK, FILED 7-29-1998.

**TIVOLI**

OWNER OF DENMARK REG. NO. VR200304146, DATED 12-16-2003, EXPIRES 12-16-2013.

FOR EDUCATION AND TRAINING SERVICES, NAMELY CLASSES, WORKSHOPS AND INDIVIDUALIZED INSTRUCTION IN THE FIELDS OF AMUSEMENT PARK PERSONAL MANAGEMENT, DESIGNING, PLANNING AND OPERATION; ENTERTAINMENT, NAMELY AMUSEMENT PARKS, CIRCUSES, PRODUCTION OF RADIO AND TELEVISION PROGRAMS, THEATER PRODUCTIONS AND LIVE PERFORMANCES BY MUSICAL SINGERS, GROUPS, VOCALISTS, ORCHESTRAS AND BANDS ALL IN RELATION TO AMUSEMENT PARKS; ENTERTAINMENT IN THE NATURE OF LIVE VARIETY SHOW PERFORMANCES (U.S. CLS. 100, 101 AND 107).

CAROLYN CATALDO, EXAMINING ATTORNEY

SN 76-418,851. TRIGGER STREET PRODUCTIONS, INC., LOS ANGELES, CA. FILED 5-18-2002.



THE MARK CONSISTS, IN PART, OF A SEGMENT OF MOTION PICTURE REEL FILM FEATURING A WIDE-ANGLE VIEW OF A DESERTED ROAD.

FOR ENTERTAINMENT SERVICES, NAMELY, PRODUCTION AND DISTRIBUTION OF MOTION PICTURES, STAGE AND THEATRICAL PERFORMANCES, FILMS, RADIO PROGRAMS, MUSICAL PERFORMANCES, TELEVISION SHOWS AND PROGRAMS; ENTERTAINMENT SERVICES, NAMELY, PROVIDING ENTERTAINMENT CONTENT ACCESSIBLE VIA ELECTRONIC MEANS WHEREBY USERS CAN VIEW AND LISTEN TO AUDIOVISUAL ENTERTAINMENT IN THE NATURE OF MOTION PICTURES, CLIPS, STILLS AND SOUND; AND PROVIDING ON-LINE INFORMATION IN THE FIELD OF ENTERTAINMENT AND ENTERTAINMENT NEWS (U.S. CLS. 100, 101 AND 107).

BARBARA GAYNOR, EXAMINING ATTORNEY

SN 76-502,849. PARADISE ARTISTS, INC., OJAI, CA. FILED 4-1-2003.

**ROYAL CIRCUS OF MOSCOW ON ICE**

NO CLAIM IS MADE TO THE EXCLUSIVE RIGHT TO USE CIRCUS OF MOSCOW ON ICE, APART FROM THE MARK AS SHOWN.

FOR ENTERTAINMENT SERVICES, NAMELY, ICE EXHIBITIONS AND EXHIBITIONS INVOLVING CIRCUS PERFORMERS (U.S. CLS. 100, 101 AND 107).

AMY GEARIN, EXAMINING ATTORNEY

**CLASS 41—(Continued).**

SN 76-509,688. ISLAS, AARON PEDRAZA, COLONIA EJIDO DE SAN JUAN DE ARUGON, MEXICO, FILED 4-28-2003.

**SUPER GRUPO COLOMBIA**

NO CLAIM IS MADE TO THE EXCLUSIVE RIGHT TO USE "SUPER", APART FROM THE MARK AS SHOWN.

THE FOREIGN WORDING IN THE MARK TRANSLATES INTO ENGLISH AS GROUP.

SEC. 2(F).

FOR ENTERTAINMENT, NAMELY LIVE PERFORMANCES BY A MUSICAL BAND (U.S. CLS. 100, 101 AND 107).

FIRST USE 11-0-1977; IN COMMERCE 2-0-1988.

INGA ERVIN, EXAMINING ATTORNEY

SN 76-510,223. RISTANO, MICHAEL A., SR., NEWARK, DE. FILED 4-28-2003.

**SHOCK TRIP**

FOR ENTERTAINMENT, NAMELY, LIVE PERFORMANCES BY A MUSICAL BAND (U.S. CLS. 100, 101 AND 107).

FIRST USE 12-19-2001; IN COMMERCE 8-25-2002.

DEZMONA MIZELLE, EXAMINING ATTORNEY

SN 76-513,131. PAINT N POTTERY, INC., DOYLESTOWN, PA. FILED 4-22-2003.



NO CLAIM IS MADE TO THE EXCLUSIVE RIGHT TO USE "PAINT N POTTERY", APART FROM THE MARK AS SHOWN.

FOR PAINT IT YOURSELF POTTERY STUDIO SERVICES INCLUDING INSTRUCTION IN THE FIELD OF PAINTING AND POTTERY (U.S. CLS. 100, 101 AND 107).

FIRST USE 10-1-1997; IN COMMERCE 10-1-1997.

TRACY FLETCHER, EXAMINING ATTORNEY

**CLASS 41—(Continued).**

SN 76-514,338. SPICE ENTERTAINMENT, INC., CHICAGO, IL. FILED 5-15-2003.

**CJ**

FOR ENTERTAINMENT IN THE NATURE OF ONGOING TELEVISION PROGRAMS FEATURING PERFORMANCES BY ADULT PERSONALITIES IN THE FIELD OF ADULT ENTERTAINMENT (U.S. CLS. 100, 101 AND 107).

FIRST USE 12-1-2002; IN COMMERCE 12-1-2002.  
ALICE BENMAMAN, EXAMINING ATTORNEY

SN 76-515,729. ASSOCIATION OF AMERICAN MEDICAL COLLEGES, WASHINGTON, DC. FILED 5-20-2003.



OWNER OF U.S. REG. NO. 1,946,740.  
NO CLAIM IS MADE TO THE EXCLUSIVE RIGHT TO USE "MEDICAL COLLEGE ADMISSION TEST", APART FROM THE MARK AS SHOWN.

FOR PROVIDING SERVICES IN CONNECTION WITH THE PREPARATION, ADMINISTRATION, AND ANALYSIS OF STANDARDIZED TESTS TO ASSESS MASTERY OF BASIC CONCEPTS IN BIOLOGY, CHEMISTRY, PHYSICS, FACILITY WITH PROBLEM SOLVING, CRITICAL THINKING AND WRITING SKILLS (U.S. CLS. 100, 101 AND 107).

FIRST USE 0-0-2000; IN COMMERCE 0-0-2000.  
PAULA MAYS, EXAMINING ATTORNEY

SN 76-541,967. COLUMBIA ATHLETIC CLUBS, INC., KIRKLAND, WA. FILED 8-22-2003.



NO CLAIM IS MADE TO THE EXCLUSIVE RIGHT TO USE "ATHLETIC CLUBS", APART FROM THE MARK AS SHOWN.

THE MARK CONSISTS OF THE PHRASE "COLUMBIA ATHLETIC CLUBS". THE WORD "COLUMBIA" IS WRITTEN IN ALL CAPS WITH A FONT USED OF ZURICH XBLK BT. THE WORDS "ATHLETIC CLUBS" ARE IN LOWER CASE LETTERS WITH A FONT OF SQUARE SLAB 711 BD BT 190% WIDTH. THERE IS ALSO AN ABSTRACTED DESIGN OF A BALL FLYING THROUGH THE AIR IN AN

**CLASS 41—(Continued).**

ARC THAT STARTS FROM UNDER THE "C" IN COLUMBIA, CURVES OUT TO THE LEFT AND SWINGS UP AND OVER THE "COL" IN COLUMBIA. THE ARC STARTS SMALL AND BECOMES LARGER TOWARDS THE TOP. THE "BALL" LEADING THE ARC IS OVAL IN SHAPE AND TILTED FORWARD TO GIVE THE APPEARANCE THAT IT IS IN MOTION. THE COLOR USED IN THE WORDS COLUMBIA ATHLETIC CLUBS IS PMS 286 (BLUE) AND THE COLOR USED FOR THE ARC AND BALL IS PMS 187 (RED).

FOR SPORT AND FITNESS CENTERS OFFERING INSTRUCTION AND HEALTH AND FITNESS FOCUSED CLASSES AND PROGRAMS (U.S. CLS. 100, 101 AND 107).

FIRST USE 1-1-1999; IN COMMERCE 1-1-1999.  
LEIGH CAROLINE CASE, EXAMINING ATTORNEY

SN 76-541,988. COLUMBIA ATHLETIC CLUBS, INC., KIRKLAND, WA. FILED 8-22-2003.



NO CLAIM IS MADE TO THE EXCLUSIVE RIGHT TO USE "FITNESS", APART FROM THE MARK AS SHOWN.

THE MARK CONSISTS OF THE PHRASE "COLUMBIA FITNESS". THE WORD "COLUMBIA" IS WRITTEN IN ALL CAPS WITH A FONT USED OF ZURICH XBLK BT. THE WORD "FITNESS" IS IN LOWER CASE LETTERS WITH A FONT OF SQUARE SLAB 711 BD BT 180% WIDTH. THERE IS ALSO AN ABSTRACTED DESIGN OF A BALL FLYING THROUGH THE AIR IN AN ARC THAT STARTS FROM UNDER THE "C" IN COLUMBIA, CURVES OUT TO THE LEFT AND SWINGS UP AND OVER THE "COL" IN COLUMBIA. THE ARC STARTS SMALL AND BECOMES LARGER TOWARDS THE TOP. THE "BALL" LEADING THE ARC IS OVAL IN SHAPE AND TILTED FORWARD TO GIVE THE APPEARANCE THAT IT IS IN MOTION. THE COLOR USED IN THE WORDS COLUMBIA FITNESS IS PMS 286 (BLUE) AND THE COLOR USED FOR THE ARC AND BALL IS PMS 187 (RED).

FOR SPORT AND FITNESS CENTERS OFFERING INSTRUCTION AND HEALTH AND FITNESS FOCUSED CLASSES AND PROGRAMS (U.S. CLS. 100, 101 AND 107).

FIRST USE 1-1-1999; IN COMMERCE 1-1-1999.  
LEIGH CAROLINE CASE, EXAMINING ATTORNEY

SN 76-542,388. INSTITUTE FOR INTERNATIONAL RESEARCH, NEW YORK, NY. FILED 9-3-2003.



THE LINING IN THE DRAWING IS FOR SHADING PURPOSES ONLY.

FOR ARRANGING AND CONDUCTING SEMINARS, EXPOSITIONS AND EDUCATIONAL CONFERENCES RELATING TO PHARMACEUTICAL AND BIOTECHNOLOGY TREATMENT AND CLINICAL TRIALS (U.S. CLS. 100, 101 AND 107).

INGRID C. EULIN, EXAMINING ATTORNEY

**CLASS 41—(Continued).**

SN 76-545,207. VIRGIN ENTERPRISES LIMITED, LONDON, W8 7AR, ENGLAND, FILED 9-17-2003.



OWNER OF U.S. REG. NOS. 1,517,801, 2,689,097 AND OTHERS.

FOR ARRANGING AND CONDUCTING ENTERTAINMENT EVENTS IN THE FORM OF MUSICAL PERFORMANCES AND EVENTS. (U.S. CLS. 100, 101 AND 107).  
STEVEN BERK, EXAMINING ATTORNEY

SN 76-545,209. VIRGIN ENTERPRISES LIMITED, LONDON, W8 7AR, ENGLAND, FILED 9-17-2003.

**VFESTIVAL**

PRIORITY CLAIMED UNDER SEC. 44(D) ON ERPN CMNTY TM OFC APPLICATION NO. 3223153, FILED 6-12-2003.

FOR ARRANGING AND CONDUCTING ENTERTAINMENT EVENTS IN THE FORM OF MUSICAL PERFORMANCES AND EVENTS. (U.S. CLS. 100, 101 AND 107).  
STEVEN BERK, EXAMINING ATTORNEY

SN 76-547,962. CULTURE CLASH, LOS ANGELES, CA. FILED 9-29-2003.

**CULTURE CLASH**

FOR ENTERTAINMENT SERVICES, NAMELY, LIVE APPEARANCES IN THEATER PRODUCTIONS, NIGHT CLUBS AND CONCERTS, ON RADIO PROGRAMS, AND TELEVISED APPEARANCES BY PROFESSIONAL ENTERTAINERS PERFORMING POLITICAL SATIRE AND COMEDY (U.S. CLS. 100, 101 AND 107).

FIRST USE 5-0-1984; IN COMMERCE 5-0-1984.  
ALEX KEAM, EXAMINING ATTORNEY

SN 76-551,204. FISCHBACHER, SIEGFRIED, LAS VEGAS, NV. AND HORN, UWE, LAS VEGAS, NV. FILED 9-22-2003.

**JUNGLE PALACE**

FOR ENTERTAINMENT SERVICES, NAMELY, PROVIDING AMUSEMENT CENTERS TO THE GENERAL PUBLIC FOR ENTERTAINMENT AND EDUCATIONAL PURPOSES AND TO ENHANCE PUBLIC AWARENESS AND APPRECIATION FOR ANIMALS, PARTICULARLY LARGE CARNIVOROUS CATS (U.S. CLS. 100, 101 AND 107).

DANIEL CAPSHAW, EXAMINING ATTORNEY

**CLASS 41—(Continued).**

SN 76-552,811. CARROLL, TRACI, JOHNSON CITY, TN. FILED 10-20-2003.

**KUDZU YOGA**

NO CLAIM IS MADE TO THE EXCLUSIVE RIGHT TO USE "YOGA", APART FROM THE MARK AS SHOWN.

FOR YOGA INSTRUCTION AND PROVIDING FITNESS AND EXERCISE FACILITIES (U.S. CLS. 100, 101 AND 107).

FIRST USE 7-1-2003; IN COMMERCE 7-1-2003.  
SAMUEL E. SHARPER JR., EXAMINING ATTORNEY

SN 76-554,433. ATLANTA RHYTHM SECTION, MADISON, GA. FILED 10-27-2003.

**ATLANTA RHYTHM SECTION**

SEC. 2(F).

FOR ENTERTAINMENT SERVICES IN THE NATURE OF LIVE PERFORMANCES BY A MUSICAL GROUP (U.S. CLS. 100, 101 AND 107).

FIRST USE 12-15-1976; IN COMMERCE 12-15-1976.  
MICHAEL WEBSTER, EXAMINING ATTORNEY

SN 76-557,319. CARTER COMMUNICATIONS LLC, NEW YORK, NY. FILED 10-23-2003.

**COMEDY CLINIC**

NO CLAIM IS MADE TO THE EXCLUSIVE RIGHT TO USE "COMEDY", APART FROM THE MARK AS SHOWN.

FOR ENTERTAINMENT SERVICES NAMELY ONGOING RADIO AND TELEVISION TALK SHOW PROGRAMS FEATURING VARIETY, HEALTH, FITNESS, CELEBRITIES AND LIFESTYLES (U.S. CLS. 100, 101 AND 107).

MICHAEL HALL, EXAMINING ATTORNEY

SN 76-560,297. HELICKSON, MICHAEL, SUMNER, WA. FILED 11-17-2003.

**CLUB WEALTH**

THE MARK CONSISTS OF STANDARD CHARACTERS WITHOUT CLAIM TO ANY PARTICULAR FONT, STYLE, SIZE, OR COLOR.

FOR EDUCATIONAL SERVICES, NAMELY, CONDUCTING PROGRAMS, CLASSES, SEMINARS IN THE FIELD OF REAL ESTATE (U.S. CLS. 100, 101 AND 107).

LINDA E. BLOHM, EXAMINING ATTORNEY

**CLASS 41—(Continued).**

SN 76-561,773. REVIEW AND HERALD PUBLISHING ASSOCIATION, HAGERSTOWN, MD. FILED 11-25-2003.

**AUTUMN HOUSE**

THE MARK CONSISTS OF STANDARD CHARACTERS WITHOUT CLAIM TO ANY PARTICULAR FONT, STYLE, SIZE, OR COLOR.

FOR PUBLISHING SERVICES, NAMELY, PUBLICATION OF BOOKS AND MAGAZINES (U.S. CLS. 100, 101 AND 107).

FIRST USE 8-0-1990; IN COMMERCE 8-0-1990.  
LINDA E. BLOHM, EXAMINING ATTORNEY

SN 76-562,680. WILSON, THOMAS M., LOVELAND, OH. FILED 12-2-2003.

**HIP HOP RAPPITS**

THE MARK CONSISTS OF STANDARD CHARACTERS WITHOUT CLAIM TO ANY PARTICULAR FONT, STYLE, SIZE, OR COLOR.

NO CLAIM IS MADE TO THE EXCLUSIVE RIGHT TO USE HIP HOP, APART FROM THE MARK AS SHOWN.

FOR ENTERTAINMENT SERVICES IN THE NATURE OF AN ANIMATED TELEVISION SERIES (U.S. CLS. 100, 101 AND 107).

ANDREA SAUNDERS, EXAMINING ATTORNEY

SN 76-567,136. RACETOWN, INC., INDEPENDENCE, OH. FILED 12-29-2003.

**RACE-BILL**

THE MARK CONSISTS OF STANDARD CHARACTERS WITHOUT CLAIM TO ANY PARTICULAR FONT, STYLE, SIZE, OR COLOR.

FOR ENTERTAINMENT SERVICES, NAMELY, ORGANIZING AND CONDUCTING AUTOMOBILE RACES (U.S. CLS. 100, 101 AND 107).

AMY HELLA, EXAMINING ATTORNEY

**CLASS 41—(Continued).**

SN 76-567,137. RACETOWN, INC., INDEPENDENCE, OH. FILED 12-29-2003.

**COMP DXTREME**

THE MARK CONSISTS OF STANDARD CHARACTERS WITHOUT CLAIM TO ANY PARTICULAR FONT, STYLE, SIZE, OR COLOR.

NO CLAIM IS MADE TO THE EXCLUSIVE RIGHT TO USE "COMP", APART FROM THE MARK AS SHOWN.

FOR ENTERTAINMENT SERVICES, NAMELY, ORGANIZING AND CONDUCTING AUTOMOBILE RACES (U.S. CLS. 100, 101 AND 107).

AMY HELLA, EXAMINING ATTORNEY

SN 76-567,972. CASTLE WORLDWIDE, INC., RESEARCH TRIANGLE PARK, NC. FILED 1-2-2004.

**CT<sup>3</sup>**

FOR EDUCATIONAL SERVICES TO TRADE AND PROFESSIONAL ASSOCIATIONS, CORPORATIONS, EDUCATIONAL INSTITUTIONS AND GOVERNMENTAL AGENCIES, NAMELY, DEVELOPMENT, DELIVERY, AND DEMONSTRATION OF CUSTOMIZED TRAINING AND ASSESSMENTS VIA A WORLDWIDE COMPUTER NETWORK FOR CERTIFICATION AND LICENSURE IN THE FIELDS OF ACADEMIA, ARCHITECTURE/DESIGN, AUTOMOTIVE SYSTEMS AND MANUFACTURING, CHEMICAL MANUFACTURING, COMMERCIAL/HEAVY INDUSTRY CONSTRUCTION, CONCRETE/GLASS/STONE/CLAY MANUFACTURING, ECONOMICS/FINANCE, ELECTRICAL/ELECTRONIC MANUFACTURING, ENGINEERING, FORESTRY RESOURCES, HEALTHCARE SYSTEMS AND MANUFACTURING, MACHINERY/METALS MANUFACTURING, PHARMACEUTICAL MANUFACTURING, PUBLIC AFFAIRS/GOVERNMENT, REAL ESTATE/INSURANCE, RESIDENTIAL CONSTRUCTION, TELECOMMUNICATIONS, AND TRANSPORTATION (U.S. CLS. 100, 101 AND 107).

BRIAN BROWN, EXAMINING ATTORNEY

SN 76-569,907. MEDICAL EDUCATION DEVELOPMENT SERVICES, INC., BURTONSVILLE, MD. FILED 12-31-2003.

**MEDS**

FOR EDUCATIONAL SERVICES, NAMELY PROVIDING COURSES OF INSTRUCTION IN NURSING (U.S. CLS. 100, 101 AND 107).

FIRST USE 2-2-1982; IN COMMERCE 2-2-1982.

TONJA GASKINS, EXAMINING ATTORNEY

**CLASS 41—(Continued).**

SN 76-571,658. THE UNIVERSITY OF HARTFORD, WEST HARTFORD, CT. FILED 1-23-2004.

**UNIVERSITY OF HARTFORD**

THE MARK CONSISTS OF STANDARD CHARACTERS WITHOUT CLAIM TO ANY PARTICULAR FONT, STYLE, SIZE, OR COLOR.

NO CLAIM IS MADE TO THE EXCLUSIVE RIGHT TO USE "UNIVERSITY", APART FROM THE MARK AS SHOWN.

SEC. 2(F).

FOR EDUCATIONAL SERVICES, NAMELY, PROVIDING COURSES OF INSTRUCTION AT THE UNDER-GRADUATE, POST-GRADUATE AND PROFESSIONAL LEVELS; AND PROVIDING EDUCATIONAL LECTURES IN THE FIELD OF ARTS AND SCIENCES; AND ENTERTAINMENT SERVICES, NAMELY, ARRANGING AND CONDUCTING ATHLETIC COMPETITIONS AND EXHIBITIONS, LIVE MUSIC CONCERTS, AND THEATER PRODUCTIONS (U.S. CLS. 100, 101 AND 107).

FIRST USE 1-1-1958; IN COMMERCE 1-1-1958.

MARC LEIPZIG, EXAMINING ATTORNEY

**CLASS 41—(Continued).**

SN 76-577,916. CHILD HEALTH CORPORATION OF AMERICA, SHAWNEE MISSION, KS. FILED 2-23-2004.

**CHEX KNOWLEDGE EXCHANGE**

THE MARK CONSISTS OF STANDARD CHARACTERS WITHOUT CLAIM TO ANY PARTICULAR FONT, STYLE, SIZE, OR COLOR.

OWNER OF U.S. REG. NO. 2,445,716.

NO CLAIM IS MADE TO THE EXCLUSIVE RIGHT TO USE "KNOWLEDGE", APART FROM THE MARK AS SHOWN.

FOR PROVIDING EDUCATIONAL SERVICES, NAMELY, CREATING ELECTRONICALLY-DELIVERED COURSES, CURRICULA, SEMINARS, CONFERENCES, AND ON-THE-JOB TRAINING IN THE FIELD OF HEALTH CARE, NAMELY, PROVIDING TRAINING FOR HOSPITAL STAFF AND AFFILIATE EMPLOYEES IN CLINICAL STAFF DEVELOPMENT, BUSINESS, LEADERSHIP, CONTINUING EDUCATION AND TECHNICAL TRAINING (U.S. CLS. 100, 101 AND 107).

FIRST USE 1-0-2000; IN COMMERCE 1-0-2000.

ANN E. SAPPENFIELD, EXAMINING ATTORNEY

SN 76-572,636. PUBLIUS PRESS, INC., LOOKOUT MOUNTAIN, TN. FILED 1-26-2004.

**THE FEDERALIST PATRIOT**

THE MARK CONSISTS OF STANDARD CHARACTERS WITHOUT CLAIM TO ANY PARTICULAR FONT, STYLE, SIZE, OR COLOR.

FOR COMPUTER SERVICES, NAMELY, PROVIDING A DAILY QUOTATION OF HISTORICAL FIGURES DISTRIBUTED VIA E-MAIL (U.S. CLS. 100, 101 AND 107).

FIRST USE 8-10-2003; IN COMMERCE 8-10-2003.

SEAN DWYER, EXAMINING ATTORNEY

SN 76-579,335. THE LEWIS FOUNDATION, INC., SHORT HILLS, NJ. FILED 3-4-2004.

**PASSING THE PASSION**

THE MARK CONSISTS OF STANDARD CHARACTERS WITHOUT CLAIM TO ANY PARTICULAR FONT, STYLE, SIZE, OR COLOR.

FOR CONCERT BOOKING; AUDIO RECORDING; MUSIC PRODUCTION SERVICES; AND ENTERTAINMENT SERVICES, NAMELY LIVE MUSIC CONCERTS (U.S. CLS. 100, 101 AND 107).

EVELYN BRADLEY, EXAMINING ATTORNEY

SN 76-577,606. DEVRY EDUCATIONAL DEVELOPMENT CORP., OAKBROOK TERRACE, IL. FILED 2-25-2004.

**ONE STEP**

THE MARK CONSISTS OF STANDARD CHARACTERS WITHOUT CLAIM TO ANY PARTICULAR FONT, STYLE, SIZE, OR COLOR.

FOR EDUCATIONAL SERVICES, NAMELY, PROVIDING COURSES OF INSTRUCTION AT THE UNDER-GRADUATE AND GRADUATE LEVELS, INCLUDING THE FIELDS OF MEDICAL AND VETERINARY SCIENCES (U.S. CLS. 100, 101 AND 107).

SUSAN STIGLITZ, EXAMINING ATTORNEY

SN 76-579,779. UNIVERSAL CITY STUDIOS LLLP, UNIVERSAL CITY, CA. FILED 3-5-2004.

**REVENGE OF THE MUMMY**

THE MARK CONSISTS OF STANDARD CHARACTERS WITHOUT CLAIM TO ANY PARTICULAR FONT, STYLE, SIZE, OR COLOR.

FOR AMUSEMENT PARK SERVICES (U.S. CLS. 100, 101 AND 107).

CAROLINE WOOD, EXAMINING ATTORNEY

**CLASS 41—(Continued).**

SN 76-579,891. SALSEDA, LOUIS, NORTHRIDGE, CA.  
FILED 3-8-2004.



NO CLAIM IS MADE TO THE EXCLUSIVE RIGHT TO USE "TACTICAL GRAPPLING SYSTEM" AND "BRAZILIAN JIU-JITSU", APART FROM THE MARK AS SHOWN. FOR PROVIDING MARTIAL ARTS, SELF DEFENSE, AND PHYSICAL FITNESS TRAINING, INSTRUCTION, CONSULTING AND SEMINARS (U.S. CLS. 100, 101 AND 107).

MARTHA FROMM, EXAMINING ATTORNEY

SN 76-581,033. SCHUMAN, JESSICA, PACIFIC PALISADES, CA. FILED 3-12-2004.

**PROSPECT AND PROSPER**

THE MARK CONSISTS OF STANDARD CHARACTERS WITHOUT CLAIM TO ANY PARTICULAR FONT, STYLE, SIZE, OR COLOR.

FOR EDUCATIONAL TRAINING SERVICES, NAMELY, ONE-ON-ONE TUTORING, AND SEMINARS AND WORKSHOPS IN THE FIELD OF SALES (U.S. CLS. 100, 101 AND 107).

FIRST USE 11-16-1995; IN COMMERCE 11-16-1995.  
SUELLEN HICKEY, EXAMINING ATTORNEY

SN 76-582,352. ANYWHERE, ANYTIME FITNESS, CHICAGO, IL. FILED 3-22-2004.

**FOOD CIRCLE OF LIFE**

THE MARK CONSISTS OF STANDARD CHARACTERS WITHOUT CLAIM TO ANY PARTICULAR FONT, STYLE, SIZE, OR COLOR.

NO CLAIM IS MADE TO THE EXCLUSIVE RIGHT TO USE FOOD, APART FROM THE MARK AS SHOWN.

FOR EDUCATIONAL SERVICES, NAMELY, PROVIDING INSTRUCTION IN WEIGHT REDUCTION AND CONTROL, EXERCISE BALANCED NUTRITION AND GOOD HEALTH AND PROVIDING COURSES OF INSTRUCTION IN TECHNIQUES OF COUNSELING AND EDUCATING CUSTOMERS IN WEIGHT REDUCTION AND CONTROL, EXERCISE BALANCED NUTRITION AND HEALTH (U.S. CLS. 100, 101 AND 107).

TRACY CROSS, EXAMINING ATTORNEY

**CLASS 41—(Continued).**

SN 76-583,525. GRUNER + JAHR PRINTING & PUBLISHING CO., NEW YORK, NY. FILED 3-26-2004.

**WINK**

THE MARK CONSISTS OF STANDARD CHARACTERS WITHOUT CLAIM TO ANY PARTICULAR FONT, STYLE, SIZE, OR COLOR.

OWNER OF U.S. REG. NO. 2,622,853.  
FOR PROVIDING AN ON-LINE GENERAL INTEREST WOMEN'S MAGAZINE (U.S. CLS. 100, 101 AND 107).  
BILL DAWE, EXAMINING ATTORNEY

SN 76-584,090. POLLAN, STEPHEN M., NEW YORK, NY.  
FILED 3-29-2004.

**LIFESCRIPTS**

THE MARK CONSISTS OF STANDARD CHARACTERS WITHOUT CLAIM TO ANY PARTICULAR FONT, STYLE, SIZE, OR COLOR.

OWNER OF U.S. REG. NO. 2,289,662.  
FOR CONDUCTING WORKSHOPS AND SEMINARS IN THE FIELD OF PERSONAL AND PROFESSIONAL AWARENESS AND GROWTH AND DISTRIBUTING COURSE MATERIALS IN CONNECTION THEREWITH (U.S. CLS. 100, 101 AND 107).

FIRST USE 3-8-2004; IN COMMERCE 3-8-2004.  
IRA J. GOODSaid, EXAMINING ATTORNEY

**CLASS 41—(Continued).**

SN 76-585,151. EPHESIANS 4 NETWORK, INC., BELPRE, OH. FILED 4-6-2004.

**EPHESIANS 4 NETWORK**

THE MARK CONSISTS OF STANDARD CHARACTERS WITHOUT CLAIM TO ANY PARTICULAR FONT, STYLE, SIZE, OR COLOR.

NO CLAIM IS MADE TO THE EXCLUSIVE RIGHT TO USE "NETWORK", APART FROM THE MARK AS SHOWN.

FOR EDUCATIONAL SERVICES, NAMELY ARRANGING AND CONDUCTING EDUCATIONAL CONFERENCES, CHURCH PLANTING SEMINARS, CHURCH GROWTH CLASSES, WORKSHOPS IN THE FIELD OF RELIGION; ONE-ON-ONE MENTORING IN THE FIELD OF RELIGION; PROVIDING MOTIVATIONAL AND EDUCATIONAL SPEAKERS FOR BUILDING, EQUIPPING, AND STRENGTHENING MINISTERS; PROVIDING TUTORIAL SESSIONS IN PLANTING NEW CHURCHES AND HELPING EXISTING CHURCHES TO GROW; INSTRUCTIONAL CLASSES IN AND HOLDING YOUTH CAMPS, MISSION AND MISSIONARY OPPORTUNITIES; HOLDING AREA/REGIONAL MEETINGS FOR TRAINING INTERCESSORS IN THE FIELD OF RELIGION AND DISTRIBUTING COURSE MATERIALS IN CONNECTION THEREWITH (U.S. CLS. 100, 101 AND 107).

FIRST USE 7-3-2001; IN COMMERCE 7-3-2001.  
MICHAEL KEATING, EXAMINING ATTORNEY

SN 76-585,332. CHAINDRUGSTORE.NET INCORPORATED, ALEXANDRIA, VA. FILED 4-6-2004.

**PHARMACIST NEWS @-A-GLANCE**

THE MARK CONSISTS OF STANDARD CHARACTERS WITHOUT CLAIM TO ANY PARTICULAR FONT, STYLE, SIZE, OR COLOR.

NO CLAIM IS MADE TO THE EXCLUSIVE RIGHT TO USE "PHARMACIST NEWS", APART FROM THE MARK AS SHOWN.

THE MARK CONSISTS OF STANDARD CHARACTERS AND NO CLAIM IS MADE AS TO A PARTICULAR FONT STYLE, SIZE OR COLOR.

FOR ON-LINE NEWSLETTER FEATURING NEWS AND INFORMATION OF INTEREST TO PHARMACISTS AND THE PHARMACY INDUSTRY (U.S. CLS. 100, 101 AND 107).

CHARLES L. JENKINS, EXAMINING ATTORNEY

**CLASS 41—(Continued).**

SN 76-587,228. CITY OF HOPE, DUARTE, CA. FILED 4-16-2004.



OWNER OF U.S. REG. NOS. 1,307,558, 2,409,053 AND OTHERS.

FOR ORGANIZING EXHIBITIONS FOR NATION-WIDE FITNESS WORKOUT TO FIGHT ACQUIRED IMMUNE DEFICIENCY SYNDROME (AIDS) AND RELATED CANCERS (U.S. CLS. 100, 101 AND 107).

SALLY SHIN, EXAMINING ATTORNEY

SN 76-587,236. DEVRY EDUCATIONAL DEVELOPMENT CORP., OAKBROOK TERRACE, IL. FILED 4-16-2004.

**ADVANTAGE ACADEMY**

THE MARK CONSISTS OF STANDARD CHARACTERS WITHOUT CLAIM TO ANY PARTICULAR FONT, STYLE, SIZE, OR COLOR.

NO CLAIM IS MADE TO THE EXCLUSIVE RIGHT TO USE "ACADEMY", APART FROM THE MARK AS SHOWN.

FOR EDUCATIONAL SERVICES, NAMELY, PROVIDING COURSES OF INSTRUCTION AT THE SECONDARY AND COLLEGE LEVEL (U.S. CLS. 100, 101 AND 107).

LAURA KOVAISKY, EXAMINING ATTORNEY

SN 76-587,238. DEVRY EDUCATIONAL DEVELOPMENT CORP., OAKBROOK TERRACE, IL. FILED 4-16-2004.

**DEVRY ADVANTAGE ACADEMY**

THE MARK CONSISTS OF STANDARD CHARACTERS WITHOUT CLAIM TO ANY PARTICULAR FONT, STYLE, SIZE, OR COLOR.

OWNER OF U.S. REG. NOS. 1,196,476, 2,686,285 AND OTHERS.

NO CLAIM IS MADE TO THE EXCLUSIVE RIGHT TO USE "ACADEMY", APART FROM THE MARK AS SHOWN.

FOR EDUCATIONAL SERVICES, NAMELY, PROVIDING COURSES OF INSTRUCTION AT THE SECONDARY AND COLLEGE LEVEL (U.S. CLS. 100, 101 AND 107).

LAURA KOVAISKY, EXAMINING ATTORNEY

**CLASS 41—(Continued).**

SN 76-587,748. THE JOFFREY BALLET OF CHICAGO, INC., CHICAGO, IL. FILED 4-21-2004.

**JOFFREY BALLET**

THE MARK CONSISTS OF STANDARD CHARACTERS WITHOUT CLAIM TO ANY PARTICULAR FONT, STYLE, SIZE, OR COLOR.

NO CLAIM IS MADE TO THE EXCLUSIVE RIGHT TO USE "BALLET", APART FROM THE MARK AS SHOWN.

FOR ENTERTAINMENT SERVICES, NAMELY PRESENTING PERFORMANCES BY A DANCE COMPANY (U.S. CLS. 100, 101 AND 107).

FIRST USE 8-0-1983; IN COMMERCE 8-0-1983.  
STEPHANIE DAVIS, EXAMINING ATTORNEY

---

SN 76-588,739. OSMOND FOUNDATION, FOR THE CHILDREN OF THE WORLD, DBA CHILDREN'S MIRACLE NETWORK, SALT LAKE CITY, UT. FILED 4-26-2004.



OWNER OF U.S. REG. NOS. 1,343,289, 2,445,434 AND OTHERS.

NO CLAIM IS MADE TO THE EXCLUSIVE RIGHT TO USE "CHILDREN'S" AND "NETWORK", APART FROM THE MARK AS SHOWN.

FOR RADIO AND TELEVISION PROGRAMMING AND PRODUCTION OF RADIO AND TELEVISION PROGRAMS IN THE FIELD OF CHILDREN AND CHILDREN'S ISSUES (U.S. CLS. 100, 101 AND 107).

FIRST USE 1-0-2000; IN COMMERCE 1-0-2000.  
MICHAEL TANNER, EXAMINING ATTORNEY

---

SN 76-589,831. MARIAH MEDIA, INC., SANTA FE, NM. FILED 4-30-2004.

**OUTSIDE MAGAZINE'S ULTIMATE TOP TEN**

THE MARK CONSISTS OF STANDARD CHARACTERS WITHOUT CLAIM TO ANY PARTICULAR FONT, STYLE, SIZE, OR COLOR.

OWNER OF U.S. REG. NOS. 1,507,125, 2,025,585 AND OTHERS.

NO CLAIM IS MADE TO THE EXCLUSIVE RIGHT TO USE MAGAZINE'S ULTIMATE TOP TEN, APART FROM THE MARK AS SHOWN.

FOR ENTERTAINMENT IN THE NATURE OF ONGOING TELEVISION PROGRAMS IN THE FIELD OF SPORTS, TRAVEL, FITNESS, RECREATION ACTIVITIES AND RELATED EQUIPMENT (U.S. CLS. 100, 101 AND 107).

KATHERINE STOIDES, EXAMINING ATTORNEY

**CLASS 41—(Continued).**

SN 76-590,307. CITYLIT PROJECT, INC., BALTIMORE, MD. FILED 5-3-2004.

**CITYLIT PROJECT, INC.**

THE MARK CONSISTS OF STANDARD CHARACTERS WITHOUT CLAIM TO ANY PARTICULAR FONT, STYLE, SIZE, OR COLOR.

NO CLAIM IS MADE TO THE EXCLUSIVE RIGHT TO USE "PROJECT, INC.", APART FROM THE MARK AS SHOWN.

FOR EDUCATIONAL SERVICES, NAMELY WORKSHOPS AND SEMINARS IN THE FIELD OF LITERARY ARTS, INCLUDING EDUCATIONAL PROGRAMS FOR WRITERS AND PUBLISHERS (U.S. CLS. 100, 101 AND 107).

FIRST USE 12-6-2003; IN COMMERCE 12-6-2003.  
DAVID MURRAY, EXAMINING ATTORNEY

---

SN 76-590,570. THE OKLAHOMA PUBLISHING COMPANY, OKLAHOMA CITY, OK. FILED 5-5-2004.

**NEWSOK.COM**

THE MARK CONSISTS OF STANDARD CHARACTERS WITHOUT CLAIM TO ANY PARTICULAR FONT, STYLE, SIZE, OR COLOR.

FOR PROVIDING ON-LINE NEWS IN THE NATURE OF CURRENT NEWS (U.S. CLS. 100, 101 AND 107).

FIRST USE 8-19-2001; IN COMMERCE 8-19-2001.  
KIM SAITO, EXAMINING ATTORNEY

---

SN 76-591,134. WESTERN CAROLINA PRODUCTIONS, INCORPORATED, FAIRVIEW, NC. FILED 5-10-2004.

**MONSTER TRUCK SHOOTOUT**

THE MARK CONSISTS OF STANDARD CHARACTERS WITHOUT CLAIM TO ANY PARTICULAR FONT, STYLE, SIZE, OR COLOR.

NO CLAIM IS MADE TO THE EXCLUSIVE RIGHT TO USE MONSTER TRUCK, APART FROM THE MARK AS SHOWN.

FOR ENTERTAINMENT IN THE NATURE OF MOTOR SPORTS SHOWS (U.S. CLS. 100, 101 AND 107).

FIRST USE 2-0-1992; IN COMMERCE 2-0-1992.  
DAWN FELDMAN, EXAMINING ATTORNEY



**CLASS 41—(Continued).**

SN 76-591,190. DEJA VU CONSULTING, INC., LANSING, MI.  
FILED 5-10-2004.

1000'S OF BEAUTIFUL GIRLS AND 3 UGLY ONES

FOR COMPUTER SERVICES, NAMELY, PROVIDING  
ON-LINE MAGAZINES IN THE FIELD OF ADULT  
ENTERTAINMENT (U.S. CLS. 100, 101 AND 107).  
FIRST USE 3-23-2004; IN COMMERCE 3-23-2004.  
GEORGE LORENZO, EXAMINING ATTORNEY

SN 76-591,255. DIGITIMES PUBLICATION INC., TAIPEI 114,  
TAIWAN, FILED 5-10-2004.



OWNER OF U.S. REG. NO. 2,901,190.  
NO CLAIM IS MADE TO THE EXCLUSIVE RIGHT TO  
USE "DOT-COM", APART FROM THE MARK AS SHOWN.  
THE DESIGN PORTION OF THE MARK IS A REPRESENTATION  
OF A COMPUTER CHIP.  
FOR NEWS REPORTING SERVICES, NAMELY, PROVIDING  
ON-LINE NEWS IN THE FIELD OF HIGH TECH  
INDUSTRY (U.S. CLS. 100, 101 AND 107).  
FIRST USE 5-30-2000; IN COMMERCE 5-30-2000.  
EVELYN BRADLEY, EXAMINING ATTORNEY

SN 76-591,315. BOYD GAMING CORPORATION, LAS VEGAS,  
NV. FILED 5-6-2004.

**GOLDEN ARM**

THE MARK CONSISTS OF STANDARD CHARACTERS  
WITHOUT CLAIM TO ANY PARTICULAR FONT, STYLE,  
SIZE, OR COLOR.  
FOR CASINO SERVICES (U.S. CLS. 100, 101 AND 107).  
FIRST USE 5-28-1999; IN COMMERCE 5-28-1999.  
REGINA DRUMMOND, EXAMINING ATTORNEY

**CLASS 41—(Continued).**

SN 76-591,433. PILATES CENTER OF NEW YORK, INC.,  
NEW YORK, NY. FILED 5-10-2004.

**CARDIOLATES**

THE MARK CONSISTS OF STANDARD CHARACTERS  
WITHOUT CLAIM TO ANY PARTICULAR FONT, STYLE,  
SIZE, OR COLOR.  
FOR CONDUCTING EXERCISE CLASSES; HEALTH  
CLUB SERVICES, NAMELY, PROVIDING INSTRUCTION  
AND EQUIPMENT IN THE FIELD OF PHYSICAL  
EXERCISE (U.S. CLS. 100, 101 AND 107).  
FIRST USE 3-0-2004; IN COMMERCE 3-0-2004.  
H. M. FISHER, EXAMINING ATTORNEY

SN 76-591,737. BUSINESS RESULTS, INC., DALLAS, TX.  
FILED 5-11-2004.

**THE PROSEN CENTER FOR BUSINESS ADVANCEMENT**

THE MARK CONSISTS OF STANDARD CHARACTERS  
WITHOUT CLAIM TO ANY PARTICULAR FONT, STYLE,  
SIZE, OR COLOR.  
NO CLAIM IS MADE TO THE EXCLUSIVE RIGHT TO  
USE CENTER FOR BUSINESS ADVANCEMENT, APART  
FROM THE MARK AS SHOWN.  
THE NAME PROSEN IDENTIFIES A LIVING INDIVIDUAL  
WHOSE CONSENT IS OF RECORD.  
FOR EDUCATIONAL SERVICES, NAMELY, CONDUCTING  
SEMINARS AND WORKSHOPS IN THE FIELD OF  
IMPROVING CORPORATE FINANCIAL AND OPERATIONAL  
PERFORMANCE AND DISTRIBUTING COURSE MATERIALS  
IN CONNECTION THEREWITH (U.S. CLS. 100, 101 AND 107).  
FIRST USE 12-0-2003; IN COMMERCE 12-0-2003.  
MELVIN AXILBUND, EXAMINING ATTORNEY

SN 76-591,759. WYLE LABORATORIES, EL SEGUNDO, CA.  
FILED 5-10-2004.

**TRAIN LIKE YOU FLY**

THE MARK CONSISTS OF STANDARD CHARACTERS  
WITHOUT CLAIM TO ANY PARTICULAR FONT, STYLE,  
SIZE, OR COLOR.  
FOR FLIGHT TRAINING SERVICES (U.S. CLS. 100,  
101 AND 107).  
CYNTHIA SLOAN, EXAMINING ATTORNEY

**CLASS 41—(Continued).**

SN 76-591,828. PATRIOT HARLEY-DAVIDSON, INC., FAIRFAX, VA. FILED 5-12-2004.

**RIDE OF THE PATRIOTS**

THE MARK CONSISTS OF STANDARD CHARACTERS WITHOUT CLAIM TO ANY PARTICULAR FONT, STYLE, SIZE, OR COLOR.

FOR ORGANIZING OF RECREATIONAL ACTIVITIES, NAMELY, A MOTORCYCLE RIDE ATTRACTING NUMEROUS PARTICIPANTS WHO RIDE THEIR MOTORCYCLES IN AN ORGANIZED PARADE (U.S. CLS. 100, 101 AND 107).

FIRST USE 5-27-2001; IN COMMERCE 5-27-2001.  
TARAH HARDY, EXAMINING ATTORNEY

**CLASS 41—(Continued).**

SN 76-592,484. XM SATELLITE RADIO INC., WASHINGTON, DC. FILED 5-17-2004.

**THEN...AGAIN.**

THE MARK CONSISTS OF STANDARD CHARACTERS WITHOUT CLAIM TO ANY PARTICULAR FONT, STYLE, SIZE, OR COLOR.

FOR ENTERTAINMENT SERVICES, NAMELY, PROVIDING ON-GOING RADIO PROGRAMS FEATURING TALK AND MUSIC (U.S. CLS. 100, 101 AND 107).  
AMY GEARIN, EXAMINING ATTORNEY

SN 76-592,102. VICTORY VOLLEYBALL CLUB, FRISCO, TX. FILED 5-13-2004.

**VOLLEYKIDZ**

THE MARK CONSISTS OF STANDARD CHARACTERS WITHOUT CLAIM TO ANY PARTICULAR FONT, STYLE, SIZE, OR COLOR.

FOR EDUCATION AND ENTERTAINMENT SERVICES, NAMELY, CONDUCTING SPORTS CAMPS AND VOLLEYBALL INSTRUCTION (U.S. CLS. 100, 101 AND 107).

PAULA MAYS, EXAMINING ATTORNEY

SN 76-592,486. NATIONAL COUNCIL OF YOUNG MEN'S CHRISTIAN ASSOCIATIONS OF THE UNITED STATES OF AMERICA, CHICAGO, IL. FILED 5-17-2004.

**IMPACT PLUS**

THE MARK CONSISTS OF STANDARD CHARACTERS WITHOUT CLAIM TO ANY PARTICULAR FONT, STYLE, SIZE, OR COLOR.

FOR EDUCATIONAL SERVICES, NAMELY, CONDUCTING CLASSES, SEMINARS, AND WORKSHOPS IN THE FIELD OF CIVICS (U.S. CLS. 100, 101 AND 107).

FIRST USE 2-1-2004; IN COMMERCE 2-1-2004.  
SUSAN LESLIE DUBOIS, EXAMINING ATTORNEY

SN 76-592,272. SUSAN PETERSON PRODUCTIONS INC., WASHINGTON, DC. FILED 5-14-2004.

**COMMUNICATION: IT'S YOUR BUSINESS**

THE MARK CONSISTS OF STANDARD CHARACTERS WITHOUT CLAIM TO ANY PARTICULAR FONT, STYLE, SIZE, OR COLOR.

FOR EDUCATIONAL SERVICES, NAMELY CONDUCTING SEMINARS, LECTURES AND WORKSHOPS IN THE FIELD OF COMMUNICATION SKILLS USING MEDIA AND COMMUNICATIONS TECHNOLOGY (U.S. CLS. 100, 101 AND 107).

ARETHA SOMERVILLE, EXAMINING ATTORNEY

SN 76-592,708. BROWN, MARK, LOS ANGELES, CA. FILED 5-17-2004.

**HIP HOP KITCHEN**

THE MARK CONSISTS OF STANDARD CHARACTERS WITHOUT CLAIM TO ANY PARTICULAR FONT, STYLE, SIZE, OR COLOR.

NO CLAIM IS MADE TO THE EXCLUSIVE RIGHT TO USE "KITCHEN", APART FROM THE MARK AS SHOWN.

FOR ENTERTAINMENT SERVICES IN THE NATURE OF AN ON-GOING TELEVISION PROGRAM FEATURING CELEBRITY PERSONALITIES AND COOKING INTERESTS (U.S. CLS. 100, 101 AND 107).

DORITT L. CARROLL, EXAMINING ATTORNEY

**CLASS 41—(Continued).**

SN 78-183,477. FUNDACION TELETON MEXICO, A.C., MEXICO, DF, MEXICO, FILED 11-9-2002.

**TEVETON**

PRIORITY CLAIMED UNDER SEC. 44(D) ON MEXICO APPLICATION NO. 0568708, FILED 10-1-2002.

FOR ARRANGING AND CONDUCTING EDUCATIONAL CONFERENCES -AWARDS PROGRAM FOR MAJOR CORPORATIONS AND INDIVIDUALS WHO HAVE MADE SIGNIFICANT CHARITABLE CONTRIBUTIONS -CHARITABLE SERVICES, NAMELY ACADEMIC MENTORING OF SCHOOL AGE CHILDREN -CHARITABLE SERVICES, NAMELY PROVIDING TRAINING FOR THE CARING, REHABILITATION, EDUCATION AND SPECIAL LEARNING TECHNIQUES OF HANDICAPPED CHILDREN - CONDUCTING ENTERTAINMENT EXHIBITIONS IN THE NATURE OF TELEVISION EVENTS TO COLLECT CHARITABLE CONTRIBUTIONS FOR HANDICAPPED CHILDREN - CONDUCTING WORKSHOPS AND SEMINARS IN THE FIELD OF REHABILITATION OF HANDICAPPED CHILDREN -DEVELOPING EDUCATIONAL MANUALS FOR OTHERS IN THE FIELD OF REHABILITATION OF HANDICAPPED CHILDREN -DEVELOPING EDUCATIONAL MANUALS FOR OTHERS IN THE FIELD OF CHARITABLE SERVICES FOR HANDICAPPED CHILDREN -DEVELOPMENT AND DISSEMINATION OF EDUCATIONAL MATERIALS OF OTHERS IN THE FIELD OF HANDICAPPED CHILDREN -EDUCATIONAL SERVICES, NAMELY CONDUCTING CLASSES, AWARENESS PROGRAMS AND EDUCATIONAL SEMINARS IN THE NATURE OF HUMAN VALUES AND ON CARING, REHABILITATING, EDUCATING AND THE SPECIAL NEEDS OF PHYSICALLY OR MENTALLY HANDICAPPED CHILDREN AS WELL AS CONDUCTING CLASSES ON PERSONAL IMPROVEMENT AND DEVELOPMENT FOR MENTALLY AND PHYSICALLY HANDICAPPED CHILDREN (U.S. CLS. 100, 101 AND 107).

ESTHER A. BORSUK, EXAMINING ATTORNEY

**CLASS 41—(Continued).**

SN 78-218,672. PUBLIC BROADCASTING SERVICE, ALEXANDRIA, VA. FILED 2-25-2003.



OWNER OF U.S. REG. NOS. 2,530,112, 2,735,443 AND OTHERS.

FOR EDUCATIONAL AND ENTERTAINMENT SERVICES IN THE NATURE OF CHILDREN'S TELEVISION PROGRAMS PROMOTING LANGUAGE SKILLS AND LITERACY; PROVIDING INFORMATION VIA THE INTERNET RELATING TO THE DEVELOPMENT AND PROMOTION OF CHILDREN'S LANGUAGE SKILLS AND LITERACY; EDUCATIONAL SERVICES, NAMELY, LIVE AND ONLINE EDUCATIONAL AND ENTERTAINMENT DEMONSTRATIONS, PROGRAMS, WORKSHOPS, EXHIBITIONS, DISPLAYS, AND INTERACTIVE EXHIBITS RELATING TO THE DEVELOPMENT AND PROMOTION OF CHILDREN'S LANGUAGE SKILLS AND LITERACY; AND DISTRIBUTION OF PRINTED MATERIALS IN CONNECTION THEREWITH (U.S. CLS. 100, 101 AND 107).

IRA J. GOODSAD, EXAMINING ATTORNEY

SN 78-210,342. LEWISTON ROUNDUP ASSOCIATION, INC., LEWISTON, ID. FILED 2-3-2003.

**LEWISTON ROUNDUP**

SEC. 2(F).  
FOR ENTERTAINMENT SERVICES, NAMELY, ARRANGING AND CONDUCTING RODEOS, ANIMAL EXHIBITIONS; CONDUCTING LIVE EXHIBITIONS IN THE FIELD OF ANIMAL CARE AND HANDLING; CONDUCTING LIVE MUSICAL, VARIETY AND COMEDY SHOWS; PARADES AND DANCES AND RENTAL OF STADIUM FACILITIES (U.S. CLS. 100, 101 AND 107).  
FIRST USE 0-0-1935; IN COMMERCE 0-0-1935.

TRACY WHITAKER-BOWN, EXAMINING ATTORNEY

SN 78-220,668. FANTASY MEDIA GROUP, LLC, SEATTLE, WA. FILED 3-2-2003.

**FANTASY MEDIA GROUP**

NO CLAIM IS MADE TO THE EXCLUSIVE RIGHT TO USE "MEDIA GROUP", APART FROM THE MARK AS SHOWN.

FOR PRODUCTION OF DIGITAL VIDEO DISCS FOR OTHERS (U.S. CLS. 100, 101 AND 107).

JAMES A. RAUEN, EXAMINING ATTORNEY

**CLASS 41—(Continued).**

SN 78-222,480. VIACOM INTERNATIONAL INC., NEW YORK, NY. FILED 3-6-2003.

**NOGGIN SHOW AND TELL**

OWNER OF U.S. REG. NOS. 2,263,341, 2,451,381 AND OTHERS.

NO CLAIM IS MADE TO THE EXCLUSIVE RIGHT TO USE "SHOW AND TELL", APART FROM THE MARK AS SHOWN.

FOR ENTERTAINMENT SERVICES IN THE NATURE OF A SERIES OF INTERSTITIAL TELEVISION PROGRAMS FEATURING ANIMATION, LIVE ACTION, COMEDY AND MUSIC; PROVIDING INFORMATION IN THE FIELD OF ENTERTAINMENT RELATING TO A SERIES OF INTERSTITIAL TELEVISION PROGRAMS FEATURING ANIMATION, LIVE ACTION, COMEDY AND MUSIC BY MEANS OF GLOBAL COMPUTER NETWORK (U.S. CLS. 100, 101 AND 107).  
TANYA AMOS, EXAMINING ATTORNEY

**CLASS 41—(Continued).**

SN 78-277,558. ADDISON, GARY L., ANDERSON, IN. FILED 7-22-2003.

**STREIGHT POOL**

NO CLAIM IS MADE TO THE EXCLUSIVE RIGHT TO USE "POOL", APART FROM THE MARK AS SHOWN.

FOR ENTERTAINMENT SERVICES IN THE NATURE OF POCKET BILLIARDS GAME TOURNAMENTS AND EVENTS; PROVIDING PLAYER RANKINGS BASED ON PRIOR PERFORMANCE FOR POCKET BILLIARDS GAME TOURNAMENTS AND EVENTS (U.S. CLS. 100, 101 AND 107).

FIRST USE 1-1-1996; IN COMMERCE 6-1-2003.

STANLEY I. OSBORNE, EXAMINING ATTORNEY

SN 78-222,974. ZESTY LIFESTYLE, L.P., NEW YORK, NY. FILED 3-7-2003.

**THE CHILE PEPPER SHOW**

OWNER OF U.S. REG. NO. 2,359,976.

NO CLAIM IS MADE TO THE EXCLUSIVE RIGHT TO USE "SHOW", APART FROM THE MARK AS SHOWN.

FOR ENTERTAINMENT AND EDUCATIONAL SERVICES, NAMELY, PRODUCTION AND DISTRIBUTION OF A SERIES OF TELEVISION SHOWS, RADIO SHOWS AND MOTION PICTURES (U.S. CLS. 100, 101 AND 107).  
STEVEN BERK, EXAMINING ATTORNEY

SN 78-283,254. NATIONAL COUNCIL ON YOUTH LEADERSHIP, WEST LIBERTY, IA. FILED 8-5-2003.

**YOUTH SALUTE**

NO CLAIM IS MADE TO THE EXCLUSIVE RIGHT TO USE YOUTH, APART FROM THE MARK AS SHOWN.

FOR EDUCATIONAL SERVICES - NAMELY CONDUCTING WORKSHOPS, SEMINARS, CONFERENCES, AND RETREATS IN LEADERSHIP, TEAM BUILDING, POSITIVE ATTITUDES, CHOICES, AND SELF-ESTEEM; DISTRIBUTION OF COURSE MATERIALS IN CONNECTION WITH SAID EDUCATIONAL SERVICES; RECOGNITION OF PARTICIPANTS FOR LEADERSHIP ROLES WITHIN COMMUNITY THROUGH DISPLAY OF PICTURES OF YOUTH LEADERS AND THEIR BIOGRAPHIES, CEREMONIES, AND MEDIA COVERAGE OF WORKSHOPS, SEMINARS, AND RETREATS; PROVIDING RECOGNITION AND INCENTIVES BY WAY OF AWARDS AND SCHOLARSHIPS TO DEMONSTRATE EXCELLENCE IN THE FIELD OF LEADERSHIP (U.S. CLS. 100, 101 AND 107).

FIRST USE 12-14-1981; IN COMMERCE 12-14-1981.

BRIAN NEVILLE, EXAMINING ATTORNEY

SN 78-227,124. IMEDEX, INC., ALPHARETTA, GA. FILED 3-18-2003.

**EDUCATION IS THE BEST  
MEDICINE**

FOR MEDICAL EDUCATION SERVICES FOR HEALTHCARE PROFESSIONALS IN THE NATURE OF MEDICAL CLASSES OR MEETINGS (U.S. CLS. 100, 101 AND 107).

FIRST USE 1-1-2001; IN COMMERCE 1-1-2001.

ESTHER BELENKER, EXAMINING ATTORNEY

SN 78-287,593. QWEST COMMUNICATIONS INTERNATIONAL INC., DENVER, CO. FILED 8-14-2003.

**QWEST CENTER OMAHA**

SN 78-264,069. CONCEPTIS TECHNOLOGIES INC., MONTREAL, QUEBEC, CANADA, FILED 6-18-2003.

**RHEUMANATIONS**

FOR EDUCATIONAL SERVICES, NAMELY, CONDUCTING INTERACTIVE AND REAL-TIME CONFERENCES AND SEMINARS VIA THE INTERNET ON THE SUBJECT OF MEDICAL AND CLINICAL PRACTICE (U.S. CLS. 100, 101 AND 107).

FIRST USE 10-0-2000; IN COMMERCE 10-0-2000.

LINDA ESTRADA, EXAMINING ATTORNEY

NO CLAIM IS MADE TO THE EXCLUSIVE RIGHT TO USE OMAHA, APART FROM THE MARK AS SHOWN.

FOR PRODUCTION OF BUSINESS, SPORTS AND ENTERTAINMENT EVENTS FOR PUBLIC EXHIBITION AND TELEVISION AND RADIO BROADCAST (U.S. CLS. 100, 101 AND 107).

JULIA HARDY COFIELD, EXAMINING ATTORNEY

**CLASS 41—(Continued).**

SN 78-287,873. GREENTREKS NETWORK, INC., PHILADELPHIA, PA. FILED 8-15-2003.

**NATURAL HEROES**

FOR ENTERTAINMENT SERVICES, NAMELY PROVIDING ON-LINE INFORMATION AND NEWS IN THE FIELD OF ENVIRONMENTAL EDUCATION; ENTERTAINMENT SERVICES, NAMELY, INTERACTIVE EXHIBITS IN THE FIELD OF ENVIRONMENTAL ISSUES, AND PROVIDING TELEVISION AND RADIO PROGRAMS IN THE FIELD OF ENVIRONMENTAL ISSUES; PRODUCTION OF RADIO AND TELEVISION PROGRAMS; PRODUCTION AND DISTRIBUTION OF MOTION PICTURES (U.S. CLS. 100, 101 AND 107).  
MARY ROSSMAN, EXAMINING ATTORNEY

SN 78-295,121. TASEIS HOLDING CORP., FISHERS, IN. FILED 9-2-2003.

**TASEIS**

THE ENGLISH TRANSLATION OF "TASEIS" IS "FORUM".  
FOR PRODUCTION AND RECORDING OF PRE-RECORDED MUSIC, NAMELY, COMPACT DISCS, AUDIO CASSETTES AND PHONOGRAPH RECORDS (U.S. CLS. 100, 101 AND 107).  
MELVIN AXILBUND, EXAMINING ATTORNEY

SN 78-297,527. TOSE CO., LTD., OTOKUNI-GUN, JAPAN, FILED 9-8-2003.

**TOSE**

FOR ENTERTAINMENT SERVICES, NAMELY, PROVIDING ON-LINE COMPUTER GAMES; PROVIDING COMPUTER GAMES VIA A WIRELESS COMMUNICATIONS NETWORK; PROVIDING INFORMATION ON-LINE RELATING TO COMPUTER GAMES AND COMPUTER ENHANCEMENTS FOR GAMES (U.S. CLS. 100, 101 AND 107).  
PAULA MAHONEY, EXAMINING ATTORNEY

SN 78-303,000. TREASURE HD COMPANY LLC, BETHPAGE, NY. FILED 9-19-2003.

**ON THE BLOCK**

FOR ENTERTAINMENT SERVICES, NAMELY, AN ON-GOING TELEVISION PROGRAM IN THE FIELD OF AUCTIONS (U.S. CLS. 100, 101 AND 107).  
GWEN STOKOLS, EXAMINING ATTORNEY

**CLASS 41—(Continued).**

SN 78-307,994. NATIONAL TECHNOLOGY TRANSFER, INC., ENGLEWOOD, CO. FILED 10-1-2003.

**PERFORMANCE TRAINING ASSOCIATES, INC.**

NO CLAIM IS MADE TO THE EXCLUSIVE RIGHT TO USE "TRAINING", APART FROM THE MARK AS SHOWN. SEC. 2(F).  
FOR EDUCATIONAL SERVICES, NAMELY, CONDUCTING SEMINARS, LECTURES, AND INSTRUCTION SESSIONS TO TRAIN PERSONNEL IN REPAIR, OPERATION AND MAINTENANCE FACILITIES IN THE INDUSTRIAL SECTORS (U.S. CLS. 100, 101 AND 107).  
FIRST USE 7-23-1993; IN COMMERCE 8-31-1993.  
BRIAN NEVILLE, EXAMINING ATTORNEY

SN 78-310,741. INSPIRATIONAL NETWORK, THE, CHARLOTTE, NC. FILED 10-8-2003.

**BELLS AND WHISTLES**

FOR AUDIO RECORDING AND PRODUCTION; AUDIO TAPE EDITING (U.S. CLS. 100, 101 AND 107).  
BERYL GARDNER, EXAMINING ATTORNEY

SN 78-311,304. LIPSON ASSOCIATES, INC., DBA LIPSON-ALPORT-GLASS & ASSOCIATES, NORTHBROOK, IL. FILED 10-9-2003.



NO CLAIM IS MADE TO THE EXCLUSIVE RIGHT TO USE "QUARTERLY", APART FROM THE MARK AS SHOWN.

FOR ONLINE PUBLICATION OF NEWSLETTER DISCUSSING MARKETING, ADVERTISING AND BRANDING ISSUES AND STRATEGIES (U.S. CLS. 100, 101 AND 107).  
FIRST USE 12-1-2002; IN COMMERCE 12-1-2002.  
GINA HAYES, EXAMINING ATTORNEY

**CLASS 41—(Continued).**

SN 78-311,919. BOOKER, FELISHA A., DBA DYNAMIC PRODUCER, NEW YORK, NY. FILED 10-10-2003.

**DYNAMIC PRODUCER**

FOR EDUCATIONAL SERVICES, NAMELY, CONDUCTING CONFERENCES, SEMINARS, AND WORKSHOPS IN THE FIELD OF THE MUSIC BUSINESS (U.S. CLS. 100, 101 AND 107).

FIRST USE 9-1-2003; IN COMMERCE 9-1-2003.  
JEFFREY S. MOLINOFF, EXAMINING ATTORNEY

SN 78-314,237. BITTERLICH, R/TERRY, PUEBLO WEST, CO. AND BITTERLICH, KRISTINE, PUEBLO WEST, CO. FILED 10-15-2003.

**WWW.CONTRACTOR ORIENTATION.COM**

SEC. 2(F).  
FOR EDUCATIONAL SERVICES, NAMELY, CONDUCTING CERTIFICATION COURSES VIA THE INTERNET, IN THE FIELD OF SAFETY EDUCATION FOR RAILROADS AND RAILROAD CONTRACTORS (U.S. CLS. 100, 101 AND 107).

FIRST USE 3-1-2000; IN COMMERCE 3-1-2000.  
HEATHER THOMPSON, EXAMINING ATTORNEY

SN 78-315,171. KIP MCGRATH EDUCATION CENTRES CORPORATION, NEWCASTLE, NSW, AUSTRALIA, FILED 10-17-2003.

**KIP MCGRATH EDUCATION CENTERS**

OWNER OF U.S. REG. NOS. 1,813,156 AND 1,820,822.  
NO CLAIM IS MADE TO THE EXCLUSIVE RIGHT TO USE "EDUCATION CENTERS", APART FROM THE MARK AS SHOWN.

THE NAME SHOWN IN THE MARK IDENTIFIES KIP MCGRATH WHOSE CONSENT IS OF RECORD.

FOR PROVIDING CLASSES, INDIVIDUAL INSTRUCTION AND GROUP INSTRUCTION IN THE FIELD OF EDUCATION (U.S. CLS. 100, 101 AND 107).

FIRST USE 10-1-1991; IN COMMERCE 10-1-1992.  
TRACY CROSS, EXAMINING ATTORNEY

**CLASS 41—(Continued).**

SN 78-318,371. VIACOM INTERNATIONAL INC., NEW YORK, NY. FILED 10-24-2003.

**M7**

FOR TELEVISION AND ENTERTAINMENT SERVICES, NAMELY THE TELEVISION PRODUCTION OF A BROAD SPECTRUM OF TELEVISION PROGRAMS INCLUDING THOSE WHICH FEATURE OR ARE ON THE TOPICS OF MUSIC, ENTERTAINMENT, ANIMATION, CURRENT EVENTS, SOCIAL ISSUES, SPORTS EVENTS, TALENT CONTESTS, CONCERTS, COMEDY SHOWS, SITUATION COMEDIES, GAMES, AWARDS, DANCES, NEWS, STYLE AND FASHION. (U.S. CLS. 100, 101 AND 107).

CAROLINE WOOD, EXAMINING ATTORNEY

SN 78-324,790. ORCHESTRA PARENTS/PATRONS' UNITED SUPPORT ASSOCIATION, NAPERVILLE, IL. FILED 11-7-2003.



NO CLAIM IS MADE TO THE EXCLUSIVE RIGHT TO USE "STRINGS CAMP", APART FROM THE MARK AS SHOWN.

FOR MUSIC CAMP FOR AGES 8 THROUGH 18 THE PURPOSE OF EXPANDING STUDENTS' INSTRUMENTAL SKILLS IN VIOLIN, VIOLA, CELLO AND STRING DOUBLE BASS THROUGH PERFORMANCE OF STRING ORCHESTRA AND CHAMBER MUSIC LITERATURE (U.S. CLS. 100, 101 AND 107).

FIRST USE 3-0-2003; IN COMMERCE 3-0-2003.  
RENEE MCCRAY, EXAMINING ATTORNEY

SN 78-329,227. PALMER, DIANE L., SAN MARCOS, TX. FILED 11-17-2003.



THE COLORS BLACK, PURPLE AND RED ARE CLAIMED AS A FEATURE OF THE MARK.

THE BOWLING BALL AND THE WORD, "STRIKING," APPEAR IN BLACK. THE PERIMETER OF THE BOWLING BALL, THE WORD, "POWER," INNER SECTION OF FLAME AND SMALL FLAME FLICKERS ARE PURPLE. THE BOWLING BALL FINGER HOLES AND LARGE PART OF THE FLAME ARE RED.

FOR BOWLING INSTRUCTION AND PERSONAL COACHING OF BOWLING (U.S. CLS. 100, 101 AND 107).

FIRST USE 10-1-2003; IN COMMERCE 11-1-2003.  
IRA J. GOODSaid, EXAMINING ATTORNEY

**CLASS 41—(Continued).**

SN 78-331,813. LUTHERANS AT MISSION BODY AND SOUL (LAMBS), INC., ELK GROVE, CA. FILED 11-22-2003.

**CLASS 41—(Continued).**

SN 78-340,590. JUMPNASTICS, LLC, MT. PLEASANT, SC. FILED 12-14-2003.

## The Sending Place

THE MARK CONSISTS OF STANDARD CHARACTERS WITHOUT CLAIM TO ANY PARTICULAR FONT, STYLE, SIZE, OR COLOR.

FOR TRAINING SERVICES IN THE FIELD OF RELIGIOUS MISSIONS (U.S. CLS. 100, 101 AND 107).  
FIRST USE 2-8-2002; IN COMMERCE 2-8-2002.  
GEOFFREY FOSDICK, EXAMINING ATTORNEY

## Jumpnastics!

SN 78-338,209. RJR PRODUÇÕES LTDA., RIO DE JANEIRO - RJ, BRAZIL. FILED 12-9-2003.

## AMAZON WARRIORS

THE MARK CONSISTS OF STANDARD CHARACTERS WITHOUT CLAIM TO ANY PARTICULAR FONT, STYLE, SIZE, OR COLOR.

FOR HEALTH CLUB SERVICES, NAMELY, PROVIDING INSTRUCTION AND EQUIPMENT IN THE FIELD OF PHYSICAL EXERCISE (U.S. CLS. 100, 101 AND 107).  
FIRST USE 7-7-1990; IN COMMERCE 7-7-1990.  
ALICIA COLLINS, EXAMINING ATTORNEY

THE MARK CONSISTS OF STANDARD CHARACTERS WITHOUT CLAIM TO ANY PARTICULAR FONT, STYLE, SIZE, OR COLOR.

FOR SCHEDULING TELEVISION PROGRAMMING FEATURING CARTOONS; ENTERTAINMENT IN THE NATURE OF ON-GOING TELEVISION PROGRAMS IN THE FIELD OF CARTOONS (U.S. CLS. 100, 101 AND 107).

TRICIA SONNEBORN, EXAMINING ATTORNEY

SN 78-343,205. MEDIARAZZI, INC., DELRAY BEACH, FL. FILED 12-19-2003.

SN 78-339,405. GEIGER, KRAIG, NORTH MIAMI BEACH, FL. FILED 12-11-2003.

## Contographer

THE MARK CONSISTS OF STANDARD CHARACTERS WITHOUT CLAIM TO ANY PARTICULAR FONT, STYLE, SIZE, OR COLOR.

FOR CONCERT PHOTOGRAPHY SERVICES (U.S. CLS. 100, 101 AND 107).

FIRST USE 1-4-1994; IN COMMERCE 1-4-1994.  
SEAN DWYER, EXAMINING ATTORNEY

THE MARK CONSISTS OF THE STYLIZED WORD MEDIARAZZI, AND A STAR WITH A TAIL.

FOR PHOTOGRAPHY, NEWS REPORTING, AND CUSTOM WRITING AND EDITING SERVICES FOR OTHERS (U.S. CLS. 100, 101 AND 107).

FIRST USE 5-29-2003; IN COMMERCE 5-29-2003.  
JOSETTE BEVERLY, EXAMINING ATTORNEY

**CLASS 41—(Continued).**

SN 78-343,495. CENTER FOR LEADERSHIP IN SCHOOL REFORM INC., LOUISVILLE, KY. FILED 12-19-2003.

## CENTER FOR LEADERSHIP IN SCHOOL REFORM

THE MARK CONSISTS OF STANDARD CHARACTERS WITHOUT CLAIM TO ANY PARTICULAR FONT, STYLE, SIZE, OR COLOR.

NO CLAIM IS MADE TO THE EXCLUSIVE RIGHT TO USE "CENTER" AND "SCHOOL REFORM", APART FROM THE MARK AS SHOWN.

FOR PROVIDING PROFESSIONAL DEVELOPMENT COURSES AND TRAINING SERVICES FOR TEACHERS, EDUCATIONAL LEADERS, SCHOOLS, AND SCHOOL DISTRICTS IN THE FIELDS OF EDUCATION AND SCHOOL REFORM; FACILITATING INFORMATION EXCHANGE BETWEEN EDUCATORS AND OTHER INTERESTED IN SCHOOL REFORM; ARRANGING AND CONDUCTING EDUCATIONAL CONFERENCES AND EDUCATIONAL DEMONSTRATIONS; EDUCATIONAL AND ENTERTAINMENT SERVICES, NAMELY, PROVIDING MOTIVATIONAL AND EDUCATIONAL SPEAKERS; EDUCATIONAL RESEARCH; DESIGNING AND IMPLEMENTING DISTRICT-WIDE AND SCHOOL-WIDE LONG-TERM TEACHER IMPROVEMENT PLANS; EDUCATIONAL CONSULTING SERVICES, NAMELY, PROVIDING CURRICULUM VISIONING, DEVELOPMENT, ANALYSIS, AND ASSESSMENT AND ADVISING EDUCATORS, SCHOOLS, SCHOOL BOARDS, SCHOOL ADMINISTRATORS AND SCHOOL DISTRICTS ON CURRICULUM DEVELOPMENT, STAFF DEVELOPMENT AND STRUCTURAL SCHOOL REFORM (U.S. CLS. 100, 101 AND 107).

FIRST USE 5-3-1988; IN COMMERCE 5-3-1988.  
MICHAEL HALL, EXAMINING ATTORNEY

SN 78-348,917. PILATES BY THE SEA, BALBOA ISLAND, CA. FILED 1-7-2004.

## PILATES BY THE SEA

THE MARK CONSISTS OF STANDARD CHARACTERS WITHOUT CLAIM TO ANY PARTICULAR FONT, STYLE, SIZE, OR COLOR.

NO CLAIM IS MADE TO THE EXCLUSIVE RIGHT TO USE "PILATES", APART FROM THE MARK AS SHOWN.

FOR PHYSICAL EDUCATION SERVICES AND PHYSICAL FITNESS INSTRUCTION UTILIZING ORIGINAL PILATES METHODS (U.S. CLS. 100, 101 AND 107).

FIRST USE 3-1-2002; IN COMMERCE 3-1-2002.  
BARBARA GAYNOR, EXAMINING ATTORNEY

**CLASS 41—(Continued).**

SN 78-349,533. UNITED AIR LINES, INC., ELK GROVE TOWNSHIP, IL. FILED 1-8-2004.

## TEDEVISION

THE MARK CONSISTS OF STANDARD CHARACTERS WITHOUT CLAIM TO ANY PARTICULAR FONT, STYLE, SIZE, OR COLOR.

FOR PROVIDING IN-FLIGHT ENTERTAINMENT SERVICES, NAMELY AUDIO-VISUAL BROADCASTS, VIDEOS AND FILMS FOR PERSONAL LISTENING AND VIEWING (U.S. CLS. 100, 101 AND 107).

REGINA DRUMMOND, EXAMINING ATTORNEY

SN 78-354,562. WALKER ENTERTAINMENT GROUP, FRESNO, CA. FILED 1-20-2004.

## ROCKIN' AMERICA

THE MARK CONSISTS OF STANDARD CHARACTERS WITHOUT CLAIM TO ANY PARTICULAR FONT, STYLE, SIZE, OR COLOR.

FOR ENTERTAINMENT SERVICES IN THE NATURE OF TELEVISION BROADCASTS OF PRE-RECORDED COMEDY AND MUSICAL PRODUCTIONS (U.S. CLS. 100, 101 AND 107).

FIRST USE 1-4-2004; IN COMMERCE 1-4-2004.  
CAROLINE WEIMER, EXAMINING ATTORNEY



**CLASS 41—(Continued).**

SN 78-361,161. FERLAND, DONALD F., SEEKONK, MA. FILED 2-2-2004.

**SIMUNIVERSITY**

THE MARK CONSISTS OF STANDARD CHARACTERS WITHOUT CLAIM TO ANY PARTICULAR FONT, STYLE, SIZE, OR COLOR.  
FOR EDUCATIONAL SERVICES, NAMELY, CONDUCTING INTERACTIVE CLASSES IN THE FIELD OF HUMANITIES, BUSINESS AND SOCIAL SCIENCES (U.S. CLS. 100, 101 AND 107).  
FIRST USE 1-1-2002; IN COMMERCE 1-5-2002.  
CAROLYN CATALDO, EXAMINING ATTORNEY

SN 78-367,992. THOMAS, STAYVE, NEW YORK, NY. FILED 2-13-2004.

**slim thug**

THE MARK CONSISTS OF STANDARD CHARACTERS WITHOUT CLAIM TO ANY PARTICULAR FONT, STYLE, SIZE, OR COLOR.  
FOR ENTERTAINMENT SERVICES, NAMELY, LIVE MUSICAL PERFORMANCES BY A SOLO VOCALIST (U.S. CLS. 100, 101 AND 107).  
DAVID ELTON, EXAMINING ATTORNEY

**CLASS 41—(Continued).**

SN 78-368,312. SOUTH DAKOTA STATE UNIVERSITY, BROOKINGS, SD. FILED 2-15-2004.



THE MARK CONSISTS OF IN PART A DRAWING OF A STETHOSCOPE.  
FOR EDUCATION AND ENTERTAINMENT SERVICES IN THE NATURE OF AN ONGOING TELEVISION PROGRAM ALL IN THE FIELD OF HEALTH AND MEDICINE; PRODUCTION OF A TELEVISION PROGRAM; EDUCATION AND ENTERTAINMENT SERVICES IN THE NATURE OF AN ONGOING TELEVISION PROGRAM IN THE FIELD OF HEALTH AND MEDICINE PROVIDED VIA THE INTERNET (U.S. CLS. 100, 101 AND 107).  
FIRST USE 7-20-2003; IN COMMERCE 7-20-2003.  
GWEN STOKOLS, EXAMINING ATTORNEY

SN 78-371,032. CASEY, DENNIS M., MOUNTAIN VIEW, CA. AND CASEY, CAROLYN D., MOUNTAIN VIEW, CA. FILED 2-20-2004.

**CaseyStudios -  
Making Memories,  
one pixel at a time.**

THE MARK CONSISTS OF STANDARD CHARACTERS WITHOUT CLAIM TO ANY PARTICULAR FONT, STYLE, SIZE, OR COLOR.  
FOR PHOTOGRAPHY SERVICES (U.S. CLS. 100, 101 AND 107).  
ANN E. SAPPENFIELD, EXAMINING ATTORNEY

**CLASS 41—(Continued).**

SN 78-371,925. SODEXHO OPERATIONS, LLC, GAITHERSBURG, MD. FILED 2-22-2004.

## SPIRIT OF EXCELLENCE AWARDS

THE MARK CONSISTS OF STANDARD CHARACTERS WITHOUT CLAIM TO ANY PARTICULAR FONT, STYLE, SIZE, OR COLOR.

NO CLAIM IS MADE TO THE EXCLUSIVE RIGHT TO USE "AWARDS", APART FROM THE MARK AS SHOWN. SEC. 2(F).

FOR CONDUCTING AN AWARDS PROGRAM TO HONOR HEALTH CARE ORGANIZATIONS' CREATIVE AND INNOVATIVE PROGRAMS THAT SUPPORT ORGANIZATIONAL EXCELLENCE, PATIENT SATISFACTION, CUSTOMER SERVICE, EMPLOYEE SATISFACTION AND COMMITMENT, AND COMMUNITY PARTICIPATION (U.S. CLS. 100, 101 AND 107).

FIRST USE 0-0-1992; IN COMMERCE 0-0-1992.

PATRICIA EVANKO, EXAMINING ATTORNEY

**CLASS 41—(Continued).**

SN 78-374,170. AMS FRANCHISE CORPORATION, SANTA BARBARA, CA. FILED 2-25-2004.

## AMS Entertainment

THE MARK CONSISTS OF STANDARD CHARACTERS WITHOUT CLAIM TO ANY PARTICULAR FONT, STYLE, SIZE, OR COLOR.

NO CLAIM IS MADE TO THE EXCLUSIVE RIGHT TO USE "ENTERTAINMENT", APART FROM THE MARK AS SHOWN.

FOR MOBILE DISC JOCKEY SERVICES; CASINO ENTERTAINMENT, NAMELY SET UP AND OPERATION OF CRAPS, BLACKJACK AND ROULETTE TABLES; AUDIO AND VISUAL EQUIPMENT RENTALS; MASTER OF CEREMONY SERVICES; KARAOKE SERVICES; AND PROVIDING LIVE ENTERTAINMENT, NAMELY PERFORMANCES BY MUSICAL GROUPS, THEATRICAL TROUPES, CLOWNS, MAGICIANS, HYPNOTISTS, CARICATURE ARTISTS, DANCERS AND DANCE INSTRUCTORS (U.S. CLS. 100, 101 AND 107).

FIRST USE 5-11-1994; IN COMMERCE 5-11-1994.  
MELVIN AXILBUND, EXAMINING ATTORNEY

SN 78-372,176. PRODUCTION ASSOCIATES, INC., HOUSTON, TX. FILED 2-23-2004.

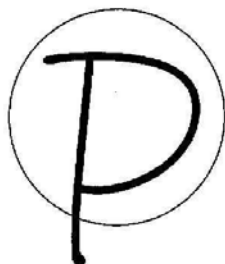

THE MARK CONSISTS OF A STYLIZED LETTER P SUBSTANTIALLY WITHIN A CIRCLE.

FOR TRAINING SERVICES IN THE FIELD OF OIL AND GAS PRODUCTION AND PROCESSING; EDUCATIONAL SERVICES, NAMELY, CONDUCTING ONLINE INTERACTIVE CLASSES IN THE FIELD OF COMPUTER SOFTWARE VIA THE INTERNET; COMPUTER EDUCATION TRAINING SERVICES, NAMELY, TRAINING IN THE FIELD OF COMPUTER SOFTWARE (U.S. CLS. 100, 101 AND 107).

BERYL GARDNER, EXAMINING ATTORNEY

SN 78-374,351. DEPARTMENT OF VETERANS AFFAIRS, WASHINGTON, DC. FILED 2-26-2004.



THE MARK CONSISTS OF A DANCING PERSON AND A PALLETTE WITH BRUSH, IN PART.

FOR ORGANIZING AND CONDUCTING WORKSHOPS, COMPETITIONS, AND FESTIVALS IN THE FIELDS OF MUSIC, VISUAL ARTS, AND CREATIVE ARTS (U.S. CLS. 100, 101 AND 107).

FIRST USE 8-30-2000; IN COMMERCE 9-30-2000.  
CHRISTOPHER BUONGIORNO, EXAMINING ATTORNEY

**CLASS 41—(Continued).**

SN 78-375,191. ALS SCAN, INC., COLUMBIA, MD. FILED 2-27-2004.

**CLASS 41—(Continued).**

SN 78-379,631. ZIZZO, THOMAS F, JERSEY CITY, NJ. FILED 3-5-2004.

# ALS ANGELS

# All Men Are NOT Created Equal

THE MARK CONSISTS OF STANDARD CHARACTERS WITHOUT CLAIM TO ANY PARTICULAR FONT, STYLE, SIZE, OR COLOR.

THE NAME AL DOES NOT IDENTIFY A LIVING INDIVIDUAL.

FOR ADULT ENTERTAINMENT SERVICES, NAMELY, PROVIDING A WEB SITE FEATURING IMAGES, PHOTOGRAPHS, EDUCATION, INFORMATION, AND MULTIMEDIA MATERIALS IN THE FIELD OF ADULT ENTERTAINMENT (U.S. CLS. 100, 101 AND 107).

FIRST USE 7-12-1999; IN COMMERCE 7-12-1999.  
PAULA MAYS, EXAMINING ATTORNEY

THE MARK CONSISTS OF STANDARD CHARACTERS WITHOUT CLAIM TO ANY PARTICULAR FONT, STYLE, SIZE, OR COLOR.

FOR ENTERTAINMENT SERVICES, NAMELY, A LIVE MALE DANCE REVIEW, WHICH IS PERFORMED IN NIGHTCLUBS (U.S. CLS. 100, 101 AND 107).

FIRST USE 1-1-2001; IN COMMERCE 2-1-2001.  
KATHRYN COWARD, EXAMINING ATTORNEY

SN 78-380,138. KAPLAN HIGHER EDUCATION CORPORATION, ROSWELL, GA. FILED 3-8-2004.

SN 78-379,550. LORE INTERNATIONAL INSTITUTE, INC., DURANGO, CO. FILED 3-5-2004.

# LEADERSHIP BALANCE SHEET

# MARIC COLLEGE

THE MARK CONSISTS OF STANDARD CHARACTERS WITHOUT CLAIM TO ANY PARTICULAR FONT, STYLE, SIZE, OR COLOR.

NO CLAIM IS MADE TO THE EXCLUSIVE RIGHT TO USE "LEADERSHIP", APART FROM THE MARK AS SHOWN.

FOR EDUCATIONAL SERVICES, NAMELY CONDUCTING CLASSES IN THE FIELD OF ORGANIZATIONAL LEADERSHIP (U.S. CLS. 100, 101 AND 107).

RICHARD WHITE, EXAMINING ATTORNEY

THE MARK CONSISTS OF STANDARD CHARACTERS WITHOUT CLAIM TO ANY PARTICULAR FONT, STYLE, SIZE, OR COLOR.

NO CLAIM IS MADE TO THE EXCLUSIVE RIGHT TO USE "COLLEGE", APART FROM THE MARK AS SHOWN.

FOR PROVIDING EDUCATIONAL COURSES AT THE COLLEGE LEVEL (U.S. CLS. 100, 101 AND 107).

FIRST USE 0-0-1976; IN COMMERCE 0-0-1976.  
DOMINIC J. FERRAIUOLO, EXAMINING ATTORNEY

**CLASS 41—(Continued).**

SN 78-380,149. NATIONAL HOT ROD ASSOCIATION, GLEN-DORA, CA. FILED 3-8-2004.

**CLASS 41—(Continued).**

SN 78-385,371. BATYGIN, YURI K., SAN JOSE, CA. FILED 3-16-2004.

**SPORTSNATIONALS**

THE MARK CONSISTS OF STANDARD CHARACTERS WITHOUT CLAIM TO ANY PARTICULAR FONT, STYLE, SIZE, OR COLOR.

OWNER OF U.S. REG. NO. 1,262,002.

FOR ENTERTAINMENT SERVICES, NAMELY, ARRANGING AND CONDUCTING AUTOMOBILE RACES AND SPORTING EVENTS; CAR SHOWS, CAR CONTESTS AND SPORTING CONTESTS; PROVIDING INFORMATION CONCERNING AUTOMOBILE RACING AND SPORTING EVENTS ON A GLOBAL COMPUTER NETWORK; ENTERTAINMENT, NAMELY, A CONTINUING AUTOMOBILE RACING AND SPORTING EVENTS SHOW BROADCAST OVER TELEVISION, SATELLITE, AUDIO AND VIDEO MEDIA (U.S. CLS. 100, 101 AND 107).

DOMINIC J. FERRAIUOLO, EXAMINING ATTORNEY

**The Seventh Season**

THE MARK CONSISTS OF STANDARD CHARACTERS WITHOUT CLAIM TO ANY PARTICULAR FONT, STYLE, SIZE, OR COLOR.

FOR ENTERTAINMENT IN THE NATURE OF VISUAL AND AUDIO PERFORMANCES, NAMELY, MUSICAL BAND, ROCK GROUP (U.S. CLS. 100, 101 AND 107).

ANNE FARRELL, EXAMINING ATTORNEY

SN 78-387,638. NOAHS ARK ANIMAL WORKSHOP, CRESTWOOD, IL. FILED 3-19-2004.

SN 78-382,197. MONOS, SHARON, WEST NEW YORK, NJ. FILED 3-11-2004.

**Stuff-N-Fluff****Mommy Goddess**

THE MARK CONSISTS OF STANDARD CHARACTERS WITHOUT CLAIM TO ANY PARTICULAR FONT, STYLE, SIZE, OR COLOR.

FOR EDUCATIONAL SUPPORT SERVICES, NAMELY CLASSES AND LECTURES IN THE FIELD OF PSYCHOLOGY (U.S. CLS. 100, 101 AND 107).

SUSAN LESLIE DUBOIS, EXAMINING ATTORNEY

THE MARK CONSISTS OF STANDARD CHARACTERS WITHOUT CLAIM TO ANY PARTICULAR FONT, STYLE, SIZE, OR COLOR.

FOR CONDUCTING WORKSHOPS IN THE NATURE OF PARTIES FOR CREATING STUFFED TOY ANIMALS, PLUSH TOY ANIMALS, STUFFED TOYS DOLLS, PLUSH TOY DOLLS, STUFFED PLUSH ANIMAL PILLOWS, AND STUFFED AND PLUSH TOY ANIMAL AND DOLL ACCESSORIES, NAMELY BANDANNAS, T-SHIRTS, CLOTHING, SUNGLASSES, SOUND CHIPS, JEWELRY, SHOES, BACKPACKS, HAND BAGS, TOTE BAGS, PURSES, ANIMAL AND DOLL CARRYING CASES, BIRTH CERTIFICATE, WISH STARS (U.S. CLS. 100, 101 AND 107).

ERNEST SHOSHO, EXAMINING ATTORNEY

**CLASS 41—(Continued).**

SN 78-388,000. HURLY BURLY PARTNERSHIP, SIMI VALLEY, CA. FILED 3-20-2004.

**CLASS 41—(Continued).**

SN 78-390,511. ABBE, DAKKAN, BROOKLYN, NY. FILED 3-25-2004.

**Inside the Tuscan Hills**

**Hurly Burly**

THE MARK CONSISTS OF STANDARD CHARACTERS WITHOUT CLAIM TO ANY PARTICULAR FONT, STYLE, SIZE, OR COLOR.

NO CLAIM IS MADE TO THE EXCLUSIVE RIGHT TO USE "TUSCAN", APART FROM THE MARK AS SHOWN. FOR ENTERTAINMENT IN THE NATURE OF A TELEVISION TRAVEL SERIES (U.S. CLS. 100, 101 AND 107).

RENEE MCCRAY, EXAMINING ATTORNEY

THE MARK CONSISTS OF STANDARD CHARACTERS WITHOUT CLAIM TO ANY PARTICULAR FONT, STYLE, SIZE, OR COLOR.

FOR ENTERTAINMENT SERVICES, NAMELY, LIVE MUSICAL PERFORMANCES; PROVIDING INFORMATION ABOUT PERFORMANCES, RECORDINGS, APPEARANCES, THE BIOGRAPHY AND OTHER INFORMATION ABOUT A MUSIC GROUP VIA WEBSITES ON A GLOBAL COMPUTER NETWORK (U.S. CLS. 100, 101 AND 107).

FIRST USE 10-31-1999; IN COMMERCE 3-17-2000. ERNEST SHOSHO, EXAMINING ATTORNEY

SN 78-390,541. TRIVERITY CORPORATION, CHANTILLY, VA. FILED 3-25-2004.

**RACINGSCHOOLZ RULZ**

THE MARK CONSISTS OF STANDARD CHARACTERS WITHOUT CLAIM TO ANY PARTICULAR FONT, STYLE, SIZE, OR COLOR.

FOR PROVIDING INFORMATION REGARDING AUTOMOBILE RACING SCHOOLS (U.S. CLS. 100, 101 AND 107).

KARANENDRA S. CHHINA, EXAMINING ATTORNEY

SN 78-389,118. BLACK ENTERTAINMENT TELEVISION, INC., WASHINGTON, DC. FILED 3-23-2004.

**BET ARABESQUE FILMS**

SN 78-393,486. DISCOVERY COMMUNICATIONS, INC., SILVER SPRING, MD. FILED 3-30-2004.

**MAKE ROOM FOR BABY**

THE MARK CONSISTS OF STANDARD CHARACTERS WITHOUT CLAIM TO ANY PARTICULAR FONT, STYLE, SIZE, OR COLOR.

OWNER OF U.S. REG. NOS. 1,511,259, 2,602,285 AND OTHERS.

NO CLAIM IS MADE TO THE EXCLUSIVE RIGHT TO USE "FILMS", APART FROM THE MARK AS SHOWN.

FOR MOTION PICTURE FILM PRODUCTION (U.S. CLS. 100, 101 AND 107).

DANIEL BRODY, EXAMINING ATTORNEY

THE MARK CONSISTS OF STANDARD CHARACTERS WITHOUT CLAIM TO ANY PARTICULAR FONT, STYLE, SIZE, OR COLOR.

FOR ENTERTAINMENT, NAMELY, AN ONGOING TELEVISION SERIES RELATING TO INFANTS AND CHILDREN (U.S. CLS. 100, 101 AND 107).

SONYA STEPHENS, EXAMINING ATTORNEY

**CLASS 41—(Continued).**

SN 78-394,142. CAREER IMAGING, BRENTWOOD, TN.  
FILED 3-31-2004.

**CLASS 41—(Continued).**

SN 78-395,317. COMPLETE COLLEGE COUNSELING, LLC,  
BALTIMORE, MD. FILED 4-2-2004.

Bringing your  
resume alive

OMNI COLLEGE  
COUNSELING

THE MARK CONSISTS OF STANDARD CHARACTERS  
WITHOUT CLAIM TO ANY PARTICULAR FONT, STYLE,  
SIZE, OR COLOR.

FOR CAREER COUNSELING SERVICE UTILIZING  
VIDEO IMAGING (U.S. CLS. 100, 101 AND 107).  
FIRST USE 1-5-2004; IN COMMERCE 1-5-2004.  
REBECCA GILBERT, EXAMINING ATTORNEY

THE MARK CONSISTS OF STANDARD CHARACTERS  
WITHOUT CLAIM TO ANY PARTICULAR FONT, STYLE,  
SIZE, OR COLOR.

NO CLAIM IS MADE TO THE EXCLUSIVE RIGHT TO  
USE COLLEGE COUNSELING, APART FROM THE MARK  
AS SHOWN.

FOR EDUCATIONAL SERVICES, NAMELY, CON-  
DUCTING CLASSES, WORKSHOPS, AND INDIVIDUAL  
INSTRUCTION TO COLLEGE BOUND STUDENTS IN  
THE PREPARATION FOR COLLEGE TESTING, IN-  
CLUDING SAT TEST PREPARATION, AND APPLICA-  
TION STRATEGIES FOR APPLYING TO COLLEGES AND  
UNIVERSITIES, AS WELL AS THE DISTRIBUTION OF  
COURSE MATERIALS IN CONNECTION THEREWITH  
(U.S. CLS. 100, 101 AND 107).

JANICE L. MCMORROW, EXAMINING ATTORNEY

SN 78-394,538. CORDAIRE & PARTNERS COMPANY INC.,  
ZONA 3, PANAMA CITY, PANAMA, FILED 4-1-2004.

SN 78-395,583. MASQUE PUBLISHING, INC., ENGLEWOOD,  
CO. FILED 4-2-2004.

FEEL THE  
DIFFERENCE

TOP 5 POKER

THE MARK CONSISTS OF STANDARD CHARACTERS  
WITHOUT CLAIM TO ANY PARTICULAR FONT, STYLE,  
SIZE, OR COLOR.

FOR BETTING SERVICES (U.S. CLS. 100, 101 AND  
107).  
FIRST USE 1-0-1999; IN COMMERCE 1-0-1999.  
ODESSA BIBBINS, EXAMINING ATTORNEY

THE MARK CONSISTS OF STANDARD CHARACTERS  
WITHOUT CLAIM TO ANY PARTICULAR FONT, STYLE,  
SIZE, OR COLOR.

NO CLAIM IS MADE TO THE EXCLUSIVE RIGHT TO  
USE "POKER", APART FROM THE MARK AS SHOWN.

FOR CASINO GAME SERVICES (U.S. CLS. 100, 101  
AND 107).

MATTHEW PAPPAS, EXAMINING ATTORNEY

**CLASS 41—(Continued).**

SN 78-396,057. DIETERLE, NANETTE, OXFORD, CT. FILED 4-5-2004.



THE MARK CONSISTS OF THE WORD 'KINDERFOALS' WITH A STYLIZED "K" WITH THE UPPER RIGHT HAND PART OF THE LETTER THAT HAS BEEN MODIFIED TO APPEAR AS THE ABBREVIATED PROFILE OF A HORSE, AND STYLIZED LETTERING OF THE REMAINDER OF THE CHARACTERS TO SUGGEST A HAND WRITTEN CHILD-LIKE AUTHOR.

FOR HORSE TRAINING FOR FOALS (U.S. CLS. 100, 101 AND 107).

FIRST USE 10-1-2003; IN COMMERCE 10-1-2003.  
MITCHELL FRONT, EXAMINING ATTORNEY

---

SN 78-396,366. KUPIEC, BRIAN M., HAMDEN, CT. FILED 4-5-2004.

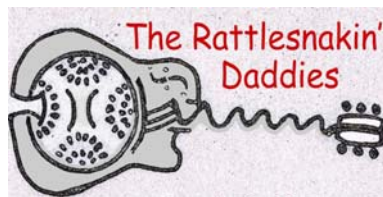

THE STIPLING IS A FEATURE OF THE MARK.  
THE COLORS RED, BLACK AND GRAY ARE CLAIMED AS A FEATURE OF THE MARK.

THE COLOR BLACK APPEARS IN THE OUTLINE OF THE GUITAR; THE COLOR GRAY APPEARS IN THE INTERIOR DESIGN OF THE GUITAR AND THE COLOR RED APPEARS IN THE LETTERING.

THE MARK CONSISTS OF A STYLIZED RESONATOR-TYPE GUITAR WITH A SNAKE-LIKE NECK. ABOVE THE GUITAR ARE THE WORDS "THE RATTLESNAKIN' DADDIES".

FOR ENTERTAINMENT NAMELY, LIVE PERFORMANCES BY A MUSICAL BAND (U.S. CLS. 100, 101 AND 107).

KAREN K. BUSH, EXAMINING ATTORNEY

**CLASS 41—(Continued).**

SN 78-396,438. DC COMICS, NEW YORK, NY. FILED 4-5-2004.

**KRYPTO THE SUPERDOG**

THE MARK CONSISTS OF STANDARD CHARACTERS WITHOUT CLAIM TO ANY PARTICULAR FONT, STYLE, SIZE, OR COLOR.

FOR ENTERTAINMENT SERVICES IN THE NATURE OF LIVE-ACTION, COMEDY, DRAMA AND ANIMATED TELEVISION SERIES; PRODUCTION OF LIVE-ACTION, COMEDY, DRAMA AND ANIMATED TELEVISION SERIES; DISTRIBUTION AND DISPLAY OF LIVE-ACTION, COMEDY, DRAMA AND ANIMATED MOTION PICTURE THEATRICAL FILMS; PRODUCTION OF LIVE-ACTION, COMEDY, DRAMA AND ANIMATED MOTION PICTURE THEATRICAL FILMS; THEATRICAL PERFORMANCES BOTH ANIMATED AND LIVE ACTION; INTERNET SERVICES PROVIDING INFORMATION VIA AN ELECTRONIC GLOBAL COMPUTER NETWORK IN THE FIELD OF ENTERTAINMENT RELATING SPECIFICALLY TO MUSIC, MOVIES, AND TELEVISION; PROVIDING GENERAL INTEREST NEWS, ENTERTAINMENT, AND EDUCATIONAL INFORMATION VIA A GLOBAL COMPUTER NETWORK; AND PROVIDING INFORMATION FOR AND ACTUAL ENTERTAINMENT VIA ELECTRONIC GLOBAL COMMUNICATIONS NETWORK IN THE NATURE OF LIVE-ACTION, COMEDY, DRAMA AND ANIMATED PROGRAMS AND PRODUCTION OF LIVE-ACTION COMEDY, ACTION AND ANIMATED MOTION FILMS FOR DISTRIBUTION VIA A GLOBAL COMPUTER NETWORK (U.S. CLS. 100, 101 AND 107).

CHERYL STEPLIGHT, EXAMINING ATTORNEY

---

SN 78-396,796. HUNDAHL, MARK, STUDIO CITY, CA. FILED 4-6-2004.

**Psyched Out**

THE MARK CONSISTS OF STANDARD CHARACTERS WITHOUT CLAIM TO ANY PARTICULAR FONT, STYLE, SIZE, OR COLOR.

FOR ENTERTAINMENT AND EDUCATIONAL SERVICES, NAMELY, SEMINARS AND TELEVISION AND RADIO PROGRAMS IN THE FIELD OF PSYCHOLOGICAL AND RELATIONSHIP ISSUES (U.S. CLS. 100, 101 AND 107).

MONTIA G. PRESSEY, EXAMINING ATTORNEY

**CLASS 41—(Continued).**

SN 78-396,932. NASHVILLE SYMPHONY ASSOCIATION, INC., NASHVILLE, TN. FILED 4-6-2004.

**AMERICAN ENCORES**

THE MARK CONSISTS OF STANDARD CHARACTERS WITHOUT CLAIM TO ANY PARTICULAR FONT, STYLE, SIZE, OR COLOR.

NO CLAIM IS MADE TO THE EXCLUSIVE RIGHT TO USE "AMERICAN", APART FROM THE MARK AS SHOWN. FOR RADIO AND TELEVISION PROGRAMMING (U.S. CLS. 100, 101 AND 107).

JOHN HWANG, EXAMINING ATTORNEY

---

SN 78-396,939. SMITHBAKER, JOHN, RIVERTON, WY. FILED 4-6-2004.

**FATHERS IN THE FIELD**

THE MARK CONSISTS OF STANDARD CHARACTERS WITHOUT CLAIM TO ANY PARTICULAR FONT, STYLE, SIZE, OR COLOR.

FOR EDUCATIONAL SERVICES, NAMELY, CONDUCTING PROGRAMS FOR YOUNG PEOPLE TO HELP THEM DEVELOP HUNTING, FISHING AND OUTDOOR APPRECIATION SKILLS (U.S. CLS. 100, 101 AND 107).

CHARLES JOYNER, EXAMINING ATTORNEY

---

SN 78-397,596. SCHLUETER, GREGORY R., DBA ID VIDEO PRODUCTIONS, ERIE, PA. FILED 4-7-2004.

**Treasure your world**

THE MARK CONSISTS OF STANDARD CHARACTERS WITHOUT CLAIM TO ANY PARTICULAR FONT, STYLE, SIZE, OR COLOR.

FOR DIGITAL VIDEO PRODUCTION; VIDEO EDITING (U.S. CLS. 100, 101 AND 107).

KIM SAITO, EXAMINING ATTORNEY

**CLASS 41—(Continued).**

SN 78-397,859. HEARTS ON FIRE COMPANY LLC, BOSTON, MA. FILED 4-7-2004.

**HOFU**

THE MARK CONSISTS OF STANDARD CHARACTERS WITHOUT CLAIM TO ANY PARTICULAR FONT, STYLE, SIZE, OR COLOR.

FOR ARRANGING AND CONDUCTING EDUCATIONAL CONFERENCES, SEMINARS, WORKSHOPS AND CLASSES IN THE FIELD OF DIAMONDS AND JEWELRY AND THE RETAIL THEREOF; DEVELOPMENT AND DISSEMINATION OF EDUCATIONAL MATERIALS IN THE FIELD OF DIAMONDS AND JEWELRY AND THE RETAIL THEREOF; EDUCATIONAL SERVICES, NAMELY, PROVIDING INCENTIVES TO INDIVIDUALS AND ORGANIZATIONS TO DEMONSTRATE EXCELLENCE IN THE FIELD OF RETAIL SALES OF DIAMONDS AND JEWELRY (U.S. CLS. 100, 101 AND 107).

FIRST USE 9-0-1997; IN COMMERCE 9-0-1997.

NANCY CLARKE, EXAMINING ATTORNEY

---

SN 78-398,452. HEARTS ON FIRE COMPANY LLC, BOSTON, MA. FILED 4-8-2004.



OWNER OF U.S. REG. NOS. 2,119,886, 2,811,443 AND OTHERS.

NO CLAIM IS MADE TO THE EXCLUSIVE RIGHT TO USE "UNIVERSITY" AND "EST. 1997", APART FROM THE MARK AS SHOWN.

THE MARK CONSISTS OF TWO CONCENTRIC CIRCLES. THE OUTER CIRCLE CONTAINS THE WORDING "HEARTS ON FIRE" IN ITS UPPER HALF AND "UNIVERSITY" IN ITS LOWER HALF. A SMALL SHADED CIRCLE APPEARS PRIOR TO THE WORD "HEARTS" AND FOLLOWING THE WORD "FIRE". THE UPPER HALF OF THE



**CLASS 41—(Continued).**

INNER CIRCLE, WHICH IS SHADED, CONTAINS A CHEVRON-TYPE DESIGN CONSISTING OF THREE SEPARATE PORTIONS, THE PORTION ON THE RIGHT AND THE LEFT OF THE DESIGN HAVING THREE POINTS EACH AND THE MIDDLE PORTION HAVING TWO POINTS ONLY. THE CHEVRON-TYPE DESIGN IS IMMEDIATELY ABOVE THE WORDING "HOFU" IN LARGE LETTERS IN THE CIRCLE'S CENTER. THE WORDING "EST. 1997" APPEARS BELOW THE WORDING "HOFU" IN THE LOWER HALF OF THE INNER CIRCLE.

FOR ARRANGING AND CONDUCTING EDUCATIONAL CONFERENCES, SEMINARS, WORKSHOPS AND CLASSES IN THE FIELD OF DIAMONDS AND JEWELRY AND CONCERNING THE RETAIL THEREOF; DEVELOPMENT AND DISSEMINATION OF EDUCATIONAL MATERIALS OF OTHERS IN THE FIELD OF DIAMONDS AND JEWELRY AND CONCERNING THE RETAIL THEREOF; EDUCATIONAL SERVICES, NAMELY, PROVIDING INCENTIVES TO INDIVIDUALS AND ORGANIZATIONS TO DEMONSTRATE EXCELLENCE IN THE FIELD OF RETAIL SALES OF DIAMONDS AND JEWELRY (U.S. CLS. 100, 101 AND 107).

FIRST USE 9-1-1997; IN COMMERCE 9-1-1997.  
SONYA STEPHENS, EXAMINING ATTORNEY

**CLASS 41—(Continued).**

SN 78-399,149. STARMARK HOLDINGS, LLC, DENVER, CO. FILED 4-9-2004.

**JOIN IN**

THE MARK CONSISTS OF STANDARD CHARACTERS WITHOUT CLAIM TO ANY PARTICULAR FONT, STYLE, SIZE, OR COLOR.

FOR HEALTH CLUB SERVICES; PHYSICAL FITNESS INSTRUCTION AND TRAINING SERVICES; EDUCATIONAL SERVICES, NAMELY CONDUCTING COURSES AND SEMINARS IN THE FIELDS OF EXERCISE, DIET AND BALANCED NUTRITION (U.S. CLS. 100, 101 AND 107).

FIRST USE 1-31-2002; IN COMMERCE 1-31-2002.  
C. DIONNE CLYBURN, EXAMINING ATTORNEY

SN 78-398,960. PARISI SPORTS, INC., FAIR LAWN, NJ. FILED 4-8-2004.

**FAST FIT FUN**

THE MARK CONSISTS OF STANDARD CHARACTERS WITHOUT CLAIM TO ANY PARTICULAR FONT, STYLE, SIZE, OR COLOR.

FOR EDUCATIONAL SERVICES IN THE NATURE OF PHYSICAL FITNESS AND SPEED TRAINING, NAMELY, COACHING INDIVIDUALS TO RUN FASTER TO IMPROVE GENERAL ATHLETIC PERFORMANCE; TRAINING IN THE NATURE OF TESTING, EVALUATION AND COUNSELING ABOUT PHYSICAL FITNESS AND SPEED (U.S. CLS. 100, 101 AND 107).

FLORENTINA BLANDU, EXAMINING ATTORNEY

SN 78-399,739. MICROSOFT CORPORATION, REDMOND, WA. FILED 4-9-2004.

**FORZA MOTORSPORT**

THE MARK CONSISTS OF STANDARD CHARACTERS WITHOUT CLAIM TO ANY PARTICULAR FONT, STYLE, SIZE, OR COLOR.

NO CLAIM IS MADE TO THE EXCLUSIVE RIGHT TO USE "MOTORSPORT", APART FROM THE MARK AS SHOWN.

THE FOREIGN WORDING IN THE MARK TRANSLATES INTO ENGLISH AS FORCE.

FOR PROVIDING AN ON-LINE MAGAZINE AND WEB SITE FEATURING INFORMATION IN THE FIELD OF COMPUTER GAMES, SCIENCE FICTION, GAMES AND HOME ENTERTAINMENT; PROVIDING INFORMATION ON-LINE RELATING TO COMPUTER GAMES AND COMPUTER ENHANCEMENTS FOR GAMES; AND ENTERTAINMENT SERVICES, NAMELY, PROVIDING AN ON-LINE COMPUTER GAME (U.S. CLS. 100, 101 AND 107).

BARNEY CHARLON, EXAMINING ATTORNEY

**CLASS 41—(Continued).**

SN 78-399,898. FREY, RUSSELL E., DBA EDHELPER, ALEXANDRIA, VA. FILED 4-11-2004.

# edHelper

THE MARK CONSISTS OF STANDARD CHARACTERS WITHOUT CLAIM TO ANY PARTICULAR FONT, STYLE, SIZE, OR COLOR.

FOR EDUCATIONAL SERVICES, NAMELY, PROVIDING A WEB SITE THAT CAN BE CUSTOMIZED BY TEACHERS, FEATURING WORKSHEETS, PUZZLES, READING COMPREHENSIONS, LESSON PLANS, WRITING PROMPTS, MATERIALS FOR TEACHERS TO POST TO BULLETIN BOARDS, AND TEST PREP MATERIALS (U.S. CLS. 100, 101 AND 107).

FIRST USE 7-25-2000; IN COMMERCE 7-25-2000.  
GRETTA YAO, EXAMINING ATTORNEY

**CLASS 41—(Continued).**

SN 78-401,395. MADISON, ROBERT B., MILWAUKEE, WI. FILED 4-14-2004.

# Talossa

THE MARK CONSISTS OF STANDARD CHARACTERS WITHOUT CLAIM TO ANY PARTICULAR FONT, STYLE, SIZE, OR COLOR.

FOR ENTERTAINMENT SERVICES, NAMELY, PROVIDING HISTORICAL, CULTURAL AND POLITICAL INFORMATION ABOUT AN ORGANIZATION IN THE NATURE OF A FICTIONAL NATION (U.S. CLS. 100, 101 AND 107).

FIRST USE 12-26-1979; IN COMMERCE 7-1-1985.  
NANCY CLARKE, EXAMINING ATTORNEY

SN 78-403,500. WORLD WRESTLING ENTERTAINMENT, INC., STAMFORD, CT. FILED 4-16-2004.

SN 78-400,465. FEDERATION OF INDEPENDENT TRAINERS, INC., CASTAIC, CA. FILED 4-12-2004.

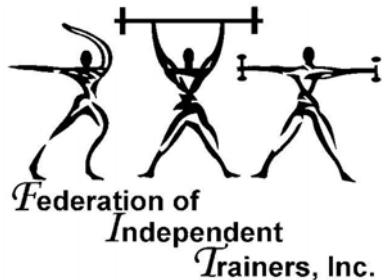

NO CLAIM IS MADE TO THE EXCLUSIVE RIGHT TO USE "FEDERATION OF INDEPENDENT TRAINERS, INC.", APART FROM THE MARK AS SHOWN.

FOR PERSONAL TRAINING SERVICES, NAMELY, STRENGTH AND CONDITIONING TRAINING (U.S. CLS. 100, 101 AND 107).

STEVEN R. FOSTER, EXAMINING ATTORNEY

# MAVEN

THE MARK CONSISTS OF STANDARD CHARACTERS WITHOUT CLAIM TO ANY PARTICULAR FONT, STYLE, SIZE, OR COLOR.

FOR ENTERTAINMENT SERVICES, NAMELY WRESTLING EXHIBITIONS AND PERFORMANCES BY A PROFESSIONAL WRESTLER AND ENTERTAINER; PROVIDING WRESTLING NEWS AND INFORMATION VIA A GLOBAL COMPUTER NETWORK (U.S. CLS. 100, 101 AND 107).

ZACHARY BELLO, EXAMINING ATTORNEY

**CLASS 41—(Continued).**

SN 78-404,004. MONTALVO, SARAH A, AUSTIN, TX. FILED 4-19-2004.

**CLASS 41—(Continued).**

SN 78-406,470. KAHN FITNESS AND HEALTH, LLC, MEADOWBROOK, PA. FILED 4-22-2004.

sonata

FLY

THE MARK CONSISTS OF STANDARD CHARACTERS WITHOUT CLAIM TO ANY PARTICULAR FONT, STYLE, SIZE, OR COLOR.

FOR ENTERTAINMENT NAMELY, LIVE PERFORMANCES BY A MUSICAL BAND (U.S. CLS. 100, 101 AND 107).

FIRST USE 7-1-2002; IN COMMERCE 7-1-2002.  
IRA J. GOODSaid, EXAMINING ATTORNEY

THE MARK CONSISTS OF STANDARD CHARACTERS WITHOUT CLAIM TO ANY PARTICULAR FONT, STYLE, SIZE, OR COLOR.

FOR PROVIDING YOUTH FITNESS AND EXERCISE INSTRUCTION (U.S. CLS. 100, 101 AND 107).

JANICE L. MCMORROW, EXAMINING ATTORNEY

SN 78-406,034. FORKLIFT SAFETY TRAINING SERVICES, INC., BOULDER CITY, NV. FILED 4-21-2004.

SN 78-411,475. FREMANTLE MEDIA NORTH AMERICA, INC., SANTA MONICA, CA. FILED 4-30-2004.



NO CLAIM IS MADE TO THE EXCLUSIVE RIGHT TO USE "FORKLIFTSAFETY.COM", APART FROM THE MARK AS SHOWN.

THE MARK CONSISTS OF THE WORDS FORKLIFTSAFETY.COM TO THE LEFT SIDE OF A STYLIZED FORKLIFT.

FOR EDUCATIONAL SERVICES, NAMELY CONDUCTING CLASSES, SEMINARS AND WORKSHOPS IN THE FIELD OF SAFETY TRAINING ON THE OPERATION OF POWERED INDUSTRIAL TRUCKS (U.S. CLS. 100, 101 AND 107).

FIRST USE 1-31-2003; IN COMMERCE 1-31-2003.  
RAMONA ORTIGA, EXAMINING ATTORNEY

OWNER OF U.S. REG. NOS. 2,715,725, 2,751,431 AND 2,863,808.

FOR ENTERTAINMENT SERVICES IN THE NATURE OF SWEEPSTAKES (U.S. CLS. 100, 101 AND 107).

FIRST USE 11-1-2002; IN COMMERCE 11-1-2002.  
HEATHER THOMPSON, EXAMINING ATTORNEY

**CLASS 41—(Continued).**

SN 78-411,601. THE EDIBLE SCHOOLYARD, BERKELEY, CA. FILED 4-30-2004.



THE EDIBLE SCHOOLYARD

NO CLAIM IS MADE TO THE EXCLUSIVE RIGHT TO USE "THE", APART FROM THE MARK AS SHOWN.

THE MARK CONSISTS OF A STYLIZED STEM OF ARUGULA.

FOR EDUCATIONAL SERVICES OF A NONPROFIT EDUCATIONAL ORGANIZATION, NAMELY, DEVELOPING PROGRAMS, CURRICULA, MATERIALS AND SITES FOR GARDENING FOR OTHERS IN THE FIELDS OF ORGANIC GARDENING AND COOKING, FOR TEACHING YOUNG PEOPLE, NAMELY, SCHOOL CHILDREN, THROUGH EXPERIMENTAL LEARNING OPPORTUNITIES, NAMELY, SUSTAINABLE ORGANIC GARDENING AND COOKING, AND THROUGH COLLABORATION WITH OTHER ENTITIES, NAMELY, EDUCATIONAL INSTITUTIONS, GOVERNMENTAL ORGANIZATIONS, COMMUNITY ORGANIZATIONS, BUSINESSES, FOUNDATIONS, AND MEMBERS OF THE PUBLIC, TO SUPPORT THOSE SERVICES (U.S. CLS. 100, 101 AND 107).

FIRST USE 11-19-1994; IN COMMERCE 10-0-1995.

RONALD AIKENS, EXAMINING ATTORNEY

---

SN 78-412,073. MALONE, RICHARD W., RESTON, VA. FILED 5-3-2004.

## The Wise Investor

THE MARK CONSISTS OF STANDARD CHARACTERS WITHOUT CLAIM TO ANY PARTICULAR FONT, STYLE, SIZE, OR COLOR.

NO CLAIM IS MADE TO THE EXCLUSIVE RIGHT TO USE "INVESTOR", APART FROM THE MARK AS SHOWN.

FOR ENTERTAINMENT IN THE NATURE OF AN ONGOING RADIO SHOW IN THE FIELD OF FINANCIAL ADVICE (U.S. CLS. 100, 101 AND 107).

FIRST USE 2-15-1985; IN COMMERCE 2-15-1985.

KAREN BRACEY, EXAMINING ATTORNEY

**CLASS 41—(Continued).**

SN 78-413,414. PASCUA YAQUI TRIBE, TUCSON, AZ. FILED 5-5-2004.

## DONDE TUCSON JUEGA

THE MARK CONSISTS OF STANDARD CHARACTERS WITHOUT CLAIM TO ANY PARTICULAR FONT, STYLE, SIZE, OR COLOR.

OWNER OF U.S. REG. NO. 2,774,046.

THE FOREIGN WORDING IN THE MARK TRANSLATES INTO ENGLISH AS WHERE TUCSON PLAYS.

FOR PROVIDING CASINO FACILITIES; CASINO SERVICES (U.S. CLS. 100, 101 AND 107).

FIRST USE 12-13-2002; IN COMMERCE 12-13-2002.

MICHAEL ENGEL, EXAMINING ATTORNEY

---

SN 78-415,255. GERACI, CRAIG E., CORONA, CA. FILED 5-7-2004.

## CLUBACHILLES

THE MARK CONSISTS OF STANDARD CHARACTERS WITHOUT CLAIM TO ANY PARTICULAR FONT, STYLE, SIZE, OR COLOR.

FOR HEALTH AND FITNESS CLUB SERVICES, NAMELY, PROVIDING INSTRUCTION AND EQUIPMENT IN THE FIELD OF PHYSICAL EXERCISE (U.S. CLS. 100, 101 AND 107).

EVELYN BRADLEY, EXAMINING ATTORNEY

---

SN 78-415,858. PAGE ONE NDI, LLC, EVANSTON, IL. FILED 5-10-2004.

## PAGE ONE NDI

THE MARK CONSISTS OF STANDARD CHARACTERS WITHOUT CLAIM TO ANY PARTICULAR FONT, STYLE, SIZE, OR COLOR.

FOR EDUCATIONAL SERVICES, NAMELY CONSULTATION REGARDING EDUCATIONAL MATERIALS AND HOW THEY RELATE TO CLASSROOM LEARNING (U.S. CLS. 100, 101 AND 107).

MELVIN AXILBUND, EXAMINING ATTORNEY

**CLASS 41—(Continued).**

SN 78-416,015. LEE, RYAN, DENTON, TX. FILED 5-10-2004.

**GARGANTUAN FIESTA**

THE MARK CONSISTS OF STANDARD CHARACTERS WITHOUT CLAIM TO ANY PARTICULAR FONT, STYLE, SIZE, OR COLOR.

NO CLAIM IS MADE TO THE EXCLUSIVE RIGHT TO USE "FIESTA", APART FROM THE MARK AS SHOWN.

FOR ENTERTAINMENT SERVICES, NAMELY A FAMILY ORIENTED FESTIVAL FEATURING LIVE MUSICAL PERFORMANCES BY A MUSICAL ARTIST OR MUSICAL GROUP, WATER SPORTS, ARTS, AND RECREATION (U.S. CLS. 100, 101 AND 107).

ERNEST SHOSHO, EXAMINING ATTORNEY

SN 78-416,272. JORGE CRUISE, INC., SAN DIEGO, CA. FILED 5-10-2004.

**3 HOUR DIET**

THE MARK CONSISTS OF STANDARD CHARACTERS WITHOUT CLAIM TO ANY PARTICULAR FONT, STYLE, SIZE, OR COLOR.

NO CLAIM IS MADE TO THE EXCLUSIVE RIGHT TO USE "DIET", APART FROM THE MARK AS SHOWN.

FOR PHYSICAL FITNESS INSTRUCTION TRAINING SERVICES; WEIGHT LOSS TRAINING SERVICES; EDUCATIONAL SERVICES IN THE FIELD OF NUTRITION, HEALTH AND WELLNESS (U.S. CLS. 100, 101 AND 107).

ANNE E. GUSTASON, EXAMINING ATTORNEY

SN 78-416,662. ISI BRANDS, INC., GRAND RAPIDS, MI. FILED 5-11-2004.

**LIVE LIKE A PRO**

THE MARK CONSISTS OF STANDARD CHARACTERS WITHOUT CLAIM TO ANY PARTICULAR FONT, STYLE, SIZE, OR COLOR.

FOR ENTERTAINMENT SERVICES IN THE NATURE OF CONDUCTING A SWEEPSTAKES CONTEST (U.S. CLS. 100, 101 AND 107).

KATHLEEN M. VANSTON, EXAMINING ATTORNEY

**CLASS 41—(Continued).**

SN 78-418,450. EMPIRE BEAUTY SCHOOL, INC., POTTSVILLE, PA. FILED 5-13-2004.

**STYLE YOUR OWN SUCCESS.**

THE MARK CONSISTS OF STANDARD CHARACTERS WITHOUT CLAIM TO ANY PARTICULAR FONT, STYLE, SIZE, OR COLOR.

FOR EDUCATIONAL SERVICES IN THE NATURE OF COSMETOLOGY SCHOOLS; EDUCATIONAL SERVICES, NAMELY, CONDUCTING CLASSES, SEMINARS, CONFERENCES, AND WORKSHOPS IN THE FIELD OF COSMETOLOGY, AND DISTRIBUTION OF COURSE MATERIALS IN CONNECTION THEREWITH (U.S. CLS. 100, 101 AND 107).

FIRST USE 3-0-2004; IN COMMERCE 3-0-2004. TRACY CROSS, EXAMINING ATTORNEY

SN 78-418,951. WARNER BROS. ENTERTAINMENT INC., BURBANK, CA. FILED 5-14-2004.

**THE SINGING SORCERESS**

THE MARK CONSISTS OF STANDARD CHARACTERS WITHOUT CLAIM TO ANY PARTICULAR FONT, STYLE, SIZE, OR COLOR.

FOR ENTERTAINMENT SERVICES IN THE NATURE OF LIVE-ACTION, COMEDY, DRAMA AND ANIMATED TELEVISION SERIES; PRODUCTION OF LIVE-ACTION, COMEDY, DRAMA AND ANIMATED TELEVISION SERIES; DISTRIBUTION AND DISPLAY OF LIVE-ACTION, COMEDY, DRAMA AND ANIMATED MOTION PICTURE THEATRICAL FILMS; PRODUCTION OF LIVE-ACTION, COMEDY, DRAMA AND ANIMATED MOTION PICTURE THEATRICAL FILMS; THEATRICAL PERFORMANCES BOTH ANIMATED AND LIVE ACTION; INTERNET SERVICES PROVIDING INFORMATION VIA AN ELECTRONIC GLOBAL COMPUTER NETWORK IN THE FIELD OF ENTERTAINMENT RELATING SPECIFICALLY TO MUSIC, MOVIES, AND TELEVISION; PROVIDING GENERAL INTEREST NEWS, ENTERTAINMENT, AND EDUCATIONAL INFORMATION VIA A GLOBAL COMPUTER NETWORK; AND PROVIDING INFORMATION FOR AND ACTUAL ENTERTAINMENT VIA ELECTRONIC GLOBAL COMMUNICATIONS NETWORK IN THE NATURE OF LIVE-ACTION, COMEDY, DRAMA AND ANIMATED PROGRAMS AND PRODUCTION OF LIVE-ACTION COMEDY, ACTION AND ANIMATED MOTION FILMS FOR DISTRIBUTION VIA A GLOBAL COMPUTER NETWORK (U.S. CLS. 100, 101 AND 107).

RUDY R. SINGLETON, EXAMINING ATTORNEY

**CLASS 41—(Continued).**

SN 78-418,954. WARNER BROS. ENTERTAINMENT INC.,  
BURBANK, CA. FILED 5-14-2004.

**THE QUIBLER**

THE MARK CONSISTS OF STANDARD CHARACTERS WITHOUT CLAIM TO ANY PARTICULAR FONT, STYLE, SIZE, OR COLOR.

FOR ENTERTAINMENT SERVICES IN THE NATURE OF LIVE-ACTION, COMEDY, DRAMA AND ANIMATED TELEVISION SERIES; PRODUCTION OF LIVE-ACTION, COMEDY, DRAMA AND ANIMATED TELEVISION SERIES; DISTRIBUTION AND DISPLAY OF LIVE-ACTION, COMEDY, DRAMA AND ANIMATED MOTION PICTURE THEATRICAL FILMS; PRODUCTION OF LIVE-ACTION, COMEDY, DRAMA AND ANIMATED MOTION PICTURE THEATRICAL FILMS; THEATRICAL PERFORMANCES BOTH ANIMATED AND LIVE ACTION; INTERNET SERVICES PROVIDING INFORMATION VIA AN ELECTRONIC GLOBAL COMPUTER NETWORK IN THE FIELD OF ENTERTAINMENT RELATING SPECIFICALLY TO MUSIC, MOVIES, AND TELEVISION; PROVIDING GENERAL INTEREST NEWS, ENTERTAINMENT, AND EDUCATIONAL INFORMATION VIA A GLOBAL COMPUTER NETWORK; AND PROVIDING INFORMATION FOR AND ACTUAL ENTERTAINMENT VIA ELECTRONIC GLOBAL COMMUNICATIONS NETWORK IN THE NATURE OF LIVE-ACTION, COMEDY, DRAMA AND ANIMATED PROGRAMS AND PRODUCTION OF LIVE-ACTION COMEDY, ACTION AND ANIMATED MOTION FILMS FOR DISTRIBUTION VIA A GLOBAL COMPUTER NETWORK (U.S. CLS. 100, 101 AND 107).

RUDY R. SINGLETON, EXAMINING ATTORNEY

SN 78-419,145. MCGEE, SHERENE, ALLEN, TX. FILED 5-14-2004.



FOR TRAINING SERVICES IN THE FIELD OF NEURO FEEDBACK (U.S. CLS. 100, 101 AND 107).

C. DIONNE CLYBURN, EXAMINING ATTORNEY

**CLASS 41—(Continued).**

SN 78-419,349. LANSKY, MARGO JOY, BOCA RATON, FL.  
FILED 5-14-2004.

**Margo Joy**

THE MARK CONSISTS OF STANDARD CHARACTERS WITHOUT CLAIM TO ANY PARTICULAR FONT, STYLE, SIZE, OR COLOR.

THE NAME MARGO JOY IDENTIFIES A LIVING INDIVIDUAL WHOSE CONSENT IS OF RECORD.

FOR ENTERTAINMENT SERVICES IN THE NATURE OF LIVE MUSICAL PERFORMANCES (U.S. CLS. 100, 101 AND 107).

BARNEY CHARLON, EXAMINING ATTORNEY

SN 78-419,522. BRYAN, JONES WOODROW, JR., GAITHERSBURG, MD. FILED 5-16-2004.

**PharmaSkills**

THE MARK CONSISTS OF STANDARD CHARACTERS WITHOUT CLAIM TO ANY PARTICULAR FONT, STYLE, SIZE, OR COLOR.

FOR PERSONAL COACHING SERVICES IN THE FIELD OF THE PHARMACEUTICAL, BIOTECH, AND PHARMACEUTICAL SERVICES INDUSTRY (U.S. CLS. 100, 101 AND 107).

MARIA-VICTORIA SUAREZ, EXAMINING ATTORNEY

**CLASS 41—(Continued).**

SN 78-419,539. VILLAR, CHEILA, K, NEW YORK, NY. AND REGAN, MARYBETH, NEW YORK, NY. FILED 5-16-2004.

**CLASS 41—(Continued).**

SN 78-419,725. CGTV MEDIA GROUP, INC., LAS VEGAS, NV. FILED 5-17-2004.

Sudor

Main Stage

THE MARK CONSISTS OF STANDARD CHARACTERS WITHOUT CLAIM TO ANY PARTICULAR FONT, STYLE, SIZE, OR COLOR.

THE ENGLISH TRANSLATION OF THE WORD "SUDOR" IN THE MARK IS "SWEAT."

FOR FITNESS CLASS COMPRISED OF CALISTHENICS, CARDIO VASCULAR ACTIVITIES AND RESISTANCE TUBING (U.S. CLS. 100, 101 AND 107).

DORITT L. CARROLL, EXAMINING ATTORNEY

THE MARK CONSISTS OF STANDARD CHARACTERS WITHOUT CLAIM TO ANY PARTICULAR FONT, STYLE, SIZE, OR COLOR.

FOR TELEVISION SHOW PRODUCTION (U.S. CLS. 100, 101 AND 107).

CHRISTOPHER ADKINS, EXAMINING ATTORNEY

SN 78-419,549. YOUNG, JAMES, AARON, STEPHENVILLE, TX. FILED 5-16-2004.

SN 78-420,133. EDITORIAL PRENSA IBERICA, S.A., BARCELONA, SPAIN, FILED 5-17-2004.

SUBMURSE 

ALLISON & BUSBY

FOR ENTERTAINMENT SERVICES, NAMELY, LIVE MUSIC PERFORMANCES BY A MUSICAL GROUP; PROVIDING INFORMATION ABOUT MUSICAL GROUPS VIA A COMPUTER COMMUNICATIONS NETWORK; AUDIO RECORDING AND PRODUCTION; AND ENTERTAINMENT, NAMELY, PRODUCTION OF LIVE MUSIC SHOWS AND MUSIC VIDEOS FEATURING MUSICAL PERFORMANCES FOR OTHERS (U.S. CLS. 100, 101 AND 107).

FIRST USE 12-1-2001; IN COMMERCE 12-1-2001.  
ELLEN PERKINS, EXAMINING ATTORNEY

THE MARK CONSISTS OF STANDARD CHARACTERS WITHOUT CLAIM TO ANY PARTICULAR FONT, STYLE, SIZE, OR COLOR.

OWNER OF ERPN CMNTY TM OFC REG. NO. 683110, DATED 4-26-1999, EXPIRES 11-18-2007.

FOR SERVICES PROVIDED BY A PUBLISHING HOUSE, NAMELY PUBLICATION OF TEXTS AND BOOKS (U.S. CLS. 100, 101 AND 107).

JULIA HARDY COFIELD, EXAMINING ATTORNEY

**CLASS 41—(Continued).**

SN 78-420,184. DELMARVA PAINTBALL, SALISBURY, MD.  
FILED 5-17-2004.

**ABSOLUTE EVIL EAST  
COAST INDOOR 5  
MAN CHAMPIONSHIPS**

THE MARK CONSISTS OF STANDARD CHARACTERS  
WITHOUT CLAIM TO ANY PARTICULAR FONT, STYLE,  
SIZE, OR COLOR.

NO CLAIM IS MADE TO THE EXCLUSIVE RIGHT TO  
USE EAST COAST INDOOR 5 MAN CHAMPIONSHIPS,  
APART FROM THE MARK AS SHOWN.

FOR PAINTBALL TOURNAMENT (U.S. CLS. 100, 101  
AND 107).

FIRST USE 10-30-2003; IN COMMERCE 10-30-2003.  
LINDA E. BLOHM, EXAMINING ATTORNEY

SN 78-420,908. FRANKLIN, JUDITH, SMYRNA, GA. AND  
FRANKLIN, JAMEAKA, SMYRNA, GA. FILED 5-18-2004.

**Laughlin Drive**

THE MARK CONSISTS OF STANDARD CHARACTERS  
WITHOUT CLAIM TO ANY PARTICULAR FONT, STYLE,  
SIZE, OR COLOR.

FOR ENTERTAINMENT, IN THE NATURE OF LIVE  
PERFORMANCES BY MUSICAL GROUP (U.S. CLS. 100,  
101 AND 107).

KEVON CHISOLM, EXAMINING ATTORNEY

**CLASS 41—(Continued).**

SN 78-421,423. UNIVISION COMMUNICATIONS INC., LOS  
ANGELES, CA. FILED 5-19-2004.

**LO VEREMOS TODO**

THE MARK CONSISTS OF STANDARD CHARACTERS  
WITHOUT CLAIM TO ANY PARTICULAR FONT, STYLE,  
SIZE, OR COLOR.

THE FOREIGN WORDING IN THE MARK TRANSLATES  
INTO ENGLISH AS WE WILL SEE IT ALL.

FOR ENTERTAINMENT SERVICES, NAMELY, A RE-  
CURRING TELEVISION PROGRAM CONCERNING THE  
DAILY LIVES OF TWO CELEBRITIES (U.S. CLS. 100, 101  
AND 107).

NELSON SNYDER, EXAMINING ATTORNEY

SN 78-421,558. TURNER BROADCASTING SYSTEM, INC.,  
ATLANTA, GA. FILED 5-19-2004.

**GAMETAP**

THE MARK CONSISTS OF STANDARD CHARACTERS  
WITHOUT CLAIM TO ANY PARTICULAR FONT, STYLE,  
SIZE, OR COLOR.

FOR ENTERTAINMENT SERVICES, NAMELY, PRO-  
VIDING ON-LINE INTERACTIVE MULTIPLAYER COM-  
PUTER GAMES PLAYED VIA COMPUTER NETWORKS  
AND GLOBAL COMMUNICATIONS NETWORKS; PRO-  
VIDING INFORMATION ON-LINE RELATING TO COM-  
PUTER GAMES, VIDEO GAMES AND COMPUTER AND  
VIDEO GAME RELATED PRODUCTS; AND ORGANIZ-  
ING AND CONDUCTING EXHIBITIONS FOR USERS OF  
VIDEO AND COMPUTER GAMES (U.S. CLS. 100, 101  
AND 107).

GIANCARLO CASTRO, EXAMINING ATTORNEY



**CLASS 41—(Continued).**

SN 78-443,714. MISS UNIVERSE L.P., LLLP, NEW YORK, NY. FILED 6-30-2004.

**MISS IDAHO TEEN  
USA**

THE MARK CONSISTS OF STANDARD CHARACTERS WITHOUT CLAIM TO ANY PARTICULAR FONT, STYLE, SIZE, OR COLOR.  
OWNER OF U.S. REG. NOS. 1,601,484, 1,710,147 AND OTHERS.  
NO CLAIM IS MADE TO THE EXCLUSIVE RIGHT TO USE "IDAHO TEEN", APART FROM THE MARK AS SHOWN.  
SEC. 2(F) AS TO "USA".  
FOR ENTERTAINMENT SERVICES, NAMELY, PAGEANTS (U.S. CLS. 100, 101 AND 107).  
FIRST USE 1-1-1983; IN COMMERCE 1-1-1983.  
TRACY WHITAKER-BOWN, EXAMINING ATTORNEY

SN 78-443,729. MISS UNIVERSE L.P., LLLP, NEW YORK, NY. FILED 6-30-2004.

**MISS IDAHO USA**

THE MARK CONSISTS OF STANDARD CHARACTERS WITHOUT CLAIM TO ANY PARTICULAR FONT, STYLE, SIZE, OR COLOR.  
OWNER OF U.S. REG. NOS. 1,372,745, 1,710,147 AND OTHERS.  
NO CLAIM IS MADE TO THE EXCLUSIVE RIGHT TO USE "IDAHO", APART FROM THE MARK AS SHOWN.  
SEC. 2(F) AS TO "USA".  
FOR ENTERTAINMENT SERVICES, NAMELY, PAGEANTS (U.S. CLS. 100, 101 AND 107).  
FIRST USE 1-1-1965; IN COMMERCE 1-1-1965.  
TRACY WHITAKER-BOWN, EXAMINING ATTORNEY

**CLASS 41—(Continued).**

SN 78-475,482. TIME INC., NEW YORK, NY. FILED 8-30-2004.

**COVERING TIME**

THE MARK CONSISTS OF STANDARD CHARACTERS WITHOUT CLAIM TO ANY PARTICULAR FONT, STYLE, SIZE, OR COLOR.  
OWNER OF U.S. REG. NOS. 629,122, 2,295,771 AND OTHERS.  
FOR ONGOING TELEVISION PROGRAM FEATURING HISTORICAL INFORMATION AND MATERIAL (U.S. CLS. 100, 101 AND 107).  
SUELLEN HICKEY, EXAMINING ATTORNEY

SN 78-513,840. UNITED STATES POSTAL SERVICE, WASHINGTON, DC. FILED 11-9-2004.

**THE POSTAL SERVICE**

THE MARK CONSISTS OF STANDARD CHARACTERS WITHOUT CLAIM TO ANY PARTICULAR FONT, STYLE, SIZE, OR COLOR.  
OWNER OF U.S. REG. NOS. 2,132,892, 2,137,563 AND OTHERS.  
FOR ENTERTAINMENT SERVICES, NAMELY LIVE PERFORMANCES BY A MUSICAL BAND (U.S. CLS. 100, 101 AND 107).  
JEFFERY COWARD, EXAMINING ATTORNEY

**CLASS 42—SCIENTIFIC, COMPUTER AND LEGAL SERVICES**

SN 75-440,787. COBALT, INC., WASHINGTON, DC. FILED 2-16-1998.

**COBALT**

FOR COMPUTER CONSULTING SERVICES; COMPUTER AND COMMUNICATION SERVICES, NAMELY, DESIGNING AND IMPLEMENTING WEBSITES FOR OTHERS (U.S. CLS. 100 AND 101).  
FIRST USE 11-5-1996; IN COMMERCE 11-25-1996.  
JAMES A. RAUEN, EXAMINING ATTORNEY

**CLASS 42—(Continued).**

SN 75-782,352. ACEITUNO, JAVIER MIGUEL, 24049 VERDELLO (BG), ITALY, FILED 8-23-1999.

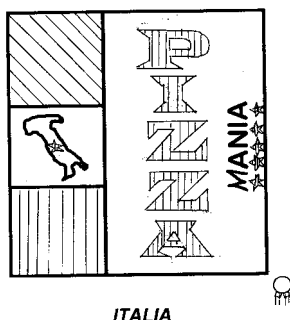

NO CLAIM IS MADE TO THE EXCLUSIVE RIGHT TO USE "PIZZA" AND "ITALIA", APART FROM THE MARK AS SHOWN.

THE MARK IS LINED FOR THE COLORS GREEN, WHITE, RED, BLACK. THE LINING SHOWN IN THE DRAWING IS A FEATURE OF THE MARK.

THE MARK CONSISTS OF A DESIGN WITH THE WORDS PIZZA MANIA ITALIA, PIZZA MANIA WRITTEN ON THE RIGHT PART (WITH FIVE STARS UNDER THE WORD MANIA), ITALIA WRITTEN UNDERNEATH THE LOGO, AND WITH THREE CUBES (COLORS GREEN, WHITE, RED) ON THE LEFT PART OF THE DESIGN WITH THE PROFILE OF THE ITALIAN TERRITORY IN THE WHITE CUBE, ALL ENCLOSED IN BLACK AND WITH AN AWARD DESIGN.

THE ENGLISH TRANSLATION OF THE WORD "ITALIA" IS "ITALY".

FOR RESTAURANT SERVICES (U.S. CLS. 100 AND 101).

ALICE BENMAMAN, EXAMINING ATTORNEY

SN 76-065,422. E4E, INC., SANTA CLARA, CA. FILED 6-6-2000.

**E4E**

FOR PROVIDING TEMPORARY USE OF ON-LINE NON-DOWNLOADABLE SOFTWARE FOR CUSTOMER SUPPORT APPLICATIONS, COMPUTER SOFTWARE APPLICATIONS MANAGEMENT AND COMPUTER NETWORKS MANAGEMENT IN THE FIELD OF COMMERCIAL BUSINESS APPLICATIONS; COMPUTER NETWORK MANAGEMENT SERVICES FOR OTHERS (U.S. CLS. 100 AND 101).

ALICE BENMAMAN, EXAMINING ATTORNEY

**CLASS 42—(Continued).**

SN 76-164,895. E4E, INC., SANTA CLARA, CA. FILED 11-13-2000.



FOR PROVIDING TEMPORARY USE OF ON-LINE NON-DOWNLOADABLE SOFTWARE FOR CUSTOMER SUPPORT APPLICATIONS, COMPUTER SOFTWARE APPLICATIONS MANAGEMENT AND COMPUTER NETWORKS MANAGEMENT IN THE FIELD OF COMMERCIAL BUSINESS APPLICATIONS; COMPUTER NETWORK MANAGEMENT SERVICES FOR OTHERS (U.S. CLS. 100 AND 101).

ALICE BENMAMAN, EXAMINING ATTORNEY

SN 76-300,555. NANOCARRIER CO., LTD., CHIBA 277-0882, JAPAN, FILED 8-15-2001.

**NANOCARRIER**

PRIORITY CLAIMED UNDER SEC. 44(D) ON JAPAN APPLICATION NO. 2001-068373, FILED 7-10-2001, REG. NO. 4679952, DATED 6-6-2003, EXPIRES 6-6-2013.

FOR RESEARCH AND DEVELOPMENT OF PHARMACEUTICAL PRODUCTS AND MEDICAL PRODUCTS (U.S. CLS. 100 AND 101).

HOWARD B. LEVINE, EXAMINING ATTORNEY

SN 76-327,408. CENTIENT CONSULTING, INC., DANVILLE, CA. FILED 10-17-2001.

**CENTIENT**

FOR CONSULTING SERVICES IN THE FIELD OF DESIGN, SELECTION, IMPLEMENTATION, AND USE OF COMPUTER HARDWARE AND SOFTWARE IN THE FIELD OF BIOINFORMATICS; SOFTWARE DEVELOPMENT IN THE FIELD OF BIOINFORMATICS; CONSULTING SERVICES FOR TECHNICAL RESEARCH AND PRODUCT DEVELOPMENT IN THE FIELD OF BIOINFORMATICS (U.S. CLS. 100 AND 101).

HOWARD B. LEVINE, EXAMINING ATTORNEY

**CLASS 42—(Continued).**

SN 76-449,769. QUANTUM CORPORATION, MILPITAS, CA. FILED 9-9-2002.

**TAPECARE**

FOR CONSULTATION IN THE FIELD OF COMPUTER DATA STORAGE, BACK-UP AND ARCHIVE APPARATUS AND MEDIA, COMPUTER SOFTWARE, TAPE DRIVES AND DATA TRANSFER PRODUCTS FOR TAPE DRIVES (U.S. CLS. 100 AND 101).

AMOS T. MATTHEWS, JR., EXAMINING ATTORNEY

**CLASS 42—(Continued).**

SN 76-512,826. CARDONI, JOE, CLARKS SUMMIT, PA. FILED 5-8-2003.

**Exhibit A**

visual aids for the legal profession

NO CLAIM IS MADE TO THE EXCLUSIVE RIGHT TO USE VISUAL AIDS FOR THE LEGAL PROFESSION, APART FROM THE MARK AS SHOWN.

FOR LITIGATION SUPPORT SERVICES INCLUDING DOCUMENT PREPARATION AND VISUAL AIDS (U.S. CLS. 100 AND 101).

FIRST USE 3-1-1998; IN COMMERCE 3-1-1998. CAROL SPILS, EXAMINING ATTORNEY

SN 76-468,006. AFFYMAX, INC., PALO ALTO, CA. FILED 11-12-2002.



**AFFYMAX**

FOR SCIENTIFIC AND MEDICAL RESEARCH FOR THE PURPOSES OF NEW DRUG DISCOVERY (U.S. CLS. 100 AND 101).

GINA FINK, EXAMINING ATTORNEY

SN 76-545,068. PRORESOLUTION LLC, CLEVELAND HEIGHTS, OH. FILED 9-16-2003.

**PRORESOLUTION**

FOR ALTERNATIVE DISPUTE RESOLUTION AND MEDIATION (U.S. CLS. 100 AND 101).

GLENN CLARK, EXAMINING ATTORNEY

SN 76-486,078. PATTERSON, PILAR, BELMONT SHORE, CA. FILED 1-27-2003.

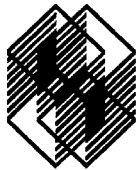

**softopt**

THE PRIMARY GEOMETRIC CUBE IS IN PANTONR PURPLE, SHADOWED BY A GRAY GEOMETRIC CUBE. THE TERM SOFT IS IN GRAY AND OPT IS IN PANTONE PURPLE.

THE MARK CONSIST OF THE TERM SOFTOPT AND A THREE DIMENSIONAL GEOMETRIC CUBE SHADOWED BY A SECOND THREE-DIMENSIONAL CUBE.

FOR DESIGN AND DEVELOPMENT OF EMBEDDED COMPUTER SOFTWARE FOR THE SATELLITE INDUSTRY (U.S. CLS. 100 AND 101).

FIRST USE 2-1-1994; IN COMMERCE 9-1-2002. RUSS HERMAN, EXAMINING ATTORNEY

SN 76-545,427. AIS MEDIA, INC., ATLANTA, GA. FILED 9-17-2003.



NO CLAIM IS MADE TO THE EXCLUSIVE RIGHT TO USE MEDIA, APART FROM THE MARK AS SHOWN.

FOR DESIGN, CREATION, HOSTING AND MAINTENANCE OF INTERNET SITES FOR THIRD PARTIES (U.S. CLS. 100 AND 101).

FIRST USE 1-31-2002; IN COMMERCE 1-31-2002. STEVEN BERK, EXAMINING ATTORNEY

**CLASS 42—(Continued).**

SN 76-546,019. CAMPUS MANAGEMENT CORP, BOCA RATON, FL. FILED 9-22-2003.



NO CLAIM IS MADE TO THE EXCLUSIVE RIGHT TO USE "CAMPUS MANAGEMENT CORP", APART FROM THE MARK AS SHOWN.

SEC. 2(F).

FOR TECHNICAL SUPPORT SERVICES, NAMELY, TROUBLESHOOTING OF COMPUTER HARDWARE, SOFTWARE AND NETWORK PROBLEMS VIA E-MAIL, TELEPHONE IN PERSON AND VIA A GLOBAL COMPUTER NETWORK; COMPUTER SOFTWARE DESIGN FOR OTHERS, NAMELY, CREATING A PROVIDING ADMINISTRATIVE COMPUTER SOFTWARE PROGRAMS FOR OTHERS; INSTALLATION AND SERVICING OF SOFTWARE FOR EDUCATIONAL INSTITUTIONS (U.S. CLS. 100 AND 101).

FIRST USE 10-2-1995; IN COMMERCE 10-2-1995.

RONALD MCMORROW, EXAMINING ATTORNEY

SN 76-550,450. REVISION EYEWEAR INC., MONTREAL, CANADA, FILED 10-9-2003.

**REVISION**

FOR DEVELOPMENT, CREATION AND DESIGN SERVICES FOR OTHERS, NAMELY DEVELOPMENT, CREATION AND DESIGN OF PAINTBALL MASKS, EYE PROTECTION GLASSES, AND GLASSES FOR SPORTS AND RECREATIONAL ACTIVITIES (U.S. CLS. 100 AND 101).

FIRST USE 2-0-2002; IN COMMERCE 2-0-2002.

TRICIA SONNEBORN, EXAMINING ATTORNEY

SN 76-554,216. CIRRUS TECHNOLOGY, INC., HUNTSVILLE, AL. FILED 10-27-2003.

**CIRRUS**

FOR DEFENSE SYSTEMS ENGINEERING SERVICES, NAMELY MODELING, SIMULATION, TESTING, EVALUATION AND VALIDATION; INTELLIGENCE DATA ANALYSIS IN THE FIELD OF NATIONAL SECURITY; CUSTOM DESIGN AND DEVELOPMENT SERVICES FOR OTHERS IN THE FIELD OF SECURITY SYSTEMS; DEFENSE COMPUTER SYSTEMS ANALYSIS, NAMELY OPERATIONS, REQUIREMENTS, LIFE CYCLES, OBSOLESCENCE, TRANSFORMATION, MODERNIZATION AND FIELD SUPPORT SYSTEMS (U.S. CLS. 100 AND 101).

FIRST USE 11-12-1998; IN COMMERCE 11-12-1998.

SCOTT OSICK, EXAMINING ATTORNEY

**CLASS 42—(Continued).**

SN 76-557,659. BYTE SIZE TOOLS LLC, ARGYLE, TX. FILED 10-27-2003.

**BYTESIZENEWS**

FOR PROVIDING TEMPORARY USE OF ONLINE NON-DOWNLOADABLE SOFTWARE FOR CREATING, UPDATING, ARCHIVING, PUBLISHING AND DISTRIBUTING ELECTRONIC NEWSLETTERS (U.S. CLS. 100 AND 101).

FIRST USE 1-1-2003; IN COMMERCE 4-1-2003.

SEAN DWYER, EXAMINING ATTORNEY

SN 76-558,371. THE GCRH CORPORATION, MIDLAND, MI. FILED 11-12-2003.

**One Great Answer After Another**

THE MARK CONSISTS OF STANDARD CHARACTERS WITHOUT CLAIM TO ANY PARTICULAR FONT, STYLE, SIZE, OR COLOR.

FOR PROVIDING TEMPORARY USE OF ON-LINE NON-DOWNLOADABLE SOFTWARE FOR CREATING, IMAGING, ARCHIVING, RETRIEVING, PRINTING AND MANAGING DOCUMENTS (U.S. CLS. 100 AND 101).

FIRST USE 2-13-2002; IN COMMERCE 2-13-2002.

ODESSA BIBBINS, EXAMINING ATTORNEY

SN 76-565,836. RJ LEE GROUP, INCORPORATED, MONROEVILLE, PA. FILED 12-18-2003.

**RJ LEE GROUP**

THE MARK CONSISTS OF STANDARD CHARACTERS WITHOUT CLAIM TO ANY PARTICULAR FONT, STYLE, SIZE, OR COLOR.

OWNER OF U.S. REG. NO. 1,539,754.

NO CLAIM IS MADE TO THE EXCLUSIVE RIGHT TO USE "GROUP", APART FROM THE MARK AS SHOWN.

THE NAME RJ LEE IDENTIFIES A LIVING INDIVIDUAL WHOSE CONSENT IS OF RECORD.

FOR SCIENTIFIC AND TECHNOLOGICAL SERVICES, NAMELY, CONSULTING, CONTRACT RESEARCH, ANALYTICAL LABORATORY SERVICES IN THE FIELD OF MATERIALS CHARACTERIZATION, AND ANALYTICAL LABORATORY SERVICES ADDRESSING INDUSTRIAL HYGIENE, ENVIRONMENTAL, FORENSIC, MATERIALS FAILURE, CONSTRUCTION DEFECT AND OTHER SIMILAR MATERIAL PROBLEMS (U.S. CLS. 100 AND 101).

FIRST USE 2-0-1988; IN COMMERCE 2-0-1988.

SUSAN HAYASH, EXAMINING ATTORNEY

**CLASS 42—(Continued).**

SN 76-572,680. CHILDREN'S HOSPITAL, COLUMBUS, OH. FILED 1-26-2004.



OWNER OF U.S. REG. NOS. 2,394,877, 2,600,109 AND 2,727,657.  
NO CLAIM IS MADE TO THE EXCLUSIVE RIGHT TO USE CHILD LAB, APART FROM THE MARK AS SHOWN, FOR MEDICAL LABORATORY SERVICES (U.S. CLS. 100 AND 101).  
FIRST USE 12-17-2003; IN COMMERCE 12-17-2003.  
KELLY BOULTON, EXAMINING ATTORNEY

SN 76-584,549. SPATIAL DATA ANALYTICS CORPORATION, MCLEAN, VA. FILED 3-30-2004.

THE LEADER IN GEOSPATIAL INTELLIGENCE

THE MARK CONSISTS OF STANDARD CHARACTERS WITHOUT CLAIM TO ANY PARTICULAR FONT, STYLE, SIZE, OR COLOR.  
FOR COMPUTER SOFTWARE DEVELOPMENT AND DESIGN FOR OTHERS; COMPUTER CONSULTATION PERTAINING TO SPATIAL DATA AND DATABASE SYSTEMS (U.S. CLS. 100 AND 101).  
FIRST USE 3-17-2004; IN COMMERCE 3-17-2004.  
ERNEST SHOSHO, EXAMINING ATTORNEY

SN 76-585,409. SEMCO ENTERPRISES, INC., CASSELBERY, FL. FILED 4-7-2004.

**TECHREF**

THE MARK CONSISTS OF STANDARD CHARACTERS WITHOUT CLAIM TO ANY PARTICULAR FONT, STYLE, SIZE, OR COLOR.  
FOR PROVIDING AN ON-LINE COMPUTER DATABASE FEATURING INFORMATION IN THE FIELD OF COMPUTERS (U.S. CLS. 100 AND 101).  
FIRST USE 8-0-2001; IN COMMERCE 8-0-2001.  
MITCHELL FRONT, EXAMINING ATTORNEY

**CLASS 42—(Continued).**

SN 76-586,912. DEVICEIQ, INC., NEW YORK, NY. FILED 4-15-2004.

**DEVICEIQ**

FOR CUSTOM MOBILE AND EMBEDDED COMPUTER SOFTWARE DESIGN AND DEVELOPMENT FOR OTHERS (U.S. CLS. 100 AND 101).  
FIRST USE 4-14-2003; IN COMMERCE 4-14-2003.  
GIANCARLO CASTRO, EXAMINING ATTORNEY

SN 76-587,899. BLUE RIDGE NETWORKS, INC., CHANTILLY, VA. FILED 4-21-2004.

**BORDERGUARD**

THE MARK CONSISTS OF STANDARD CHARACTERS WITHOUT CLAIM TO ANY PARTICULAR FONT, STYLE, SIZE, OR COLOR.  
FOR COMPUTER CONSULTATION SERVICES IN THE FIELD OF DESIGN AND IMPLEMENTATION OF COMPUTER HARDWARE AND SOFTWARE AS PART OF A NETWORK SECURITY SYSTEM FOR OTHERS (U.S. CLS. 100 AND 101).  
FIRST USE 8-0-1997; IN COMMERCE 2-0-2002.  
KATHERINE STOIDES, EXAMINING ATTORNEY

SN 76-588,025. PORTICOS, INC., MORRISVILLE, NC. FILED 4-22-2004.

**PORTICOS**

THE MARK CONSISTS OF STANDARD CHARACTERS WITHOUT CLAIM TO ANY PARTICULAR FONT, STYLE, SIZE, OR COLOR.  
FOR ENGINEERING AND PRODUCT DEVELOPMENT SERVICES (U.S. CLS. 100 AND 101).  
FIRST USE 9-10-2003; IN COMMERCE 9-10-2003.  
REGINA DRUMMOND, EXAMINING ATTORNEY

**CLASS 42—(Continued).**

SN 76-588,026. PORTICOS, INC., MORRISVILLE, NC. FILED 4-22-2004.

**WE TURN GOOD IDEAS INTO GREAT PRODUCTS**

THE MARK CONSISTS OF STANDARD CHARACTERS WITHOUT CLAIM TO ANY PARTICULAR FONT, STYLE, SIZE, OR COLOR.

FOR ENGINEERING AND PRODUCT DEVELOPMENT SERVICES (U.S. CLS. 100 AND 101).

FIRST USE 12-16-2003; IN COMMERCE 12-16-2003.  
REGINA DRUMMOND, EXAMINING ATTORNEY

**CLASS 42—(Continued).**

SN 76-591,013. NEWBOLD, ROBERT J., CANTON, OH. FILED 5-7-2004.

**FRANRITE**

THE MARK CONSISTS OF STANDARD CHARACTERS WITHOUT CLAIM TO ANY PARTICULAR FONT, STYLE, SIZE, OR COLOR.

FOR LEGAL CONSULTING SERVICES (U.S. CLS. 100 AND 101).

MARLENE BELL, EXAMINING ATTORNEY

SN 76-588,051. COONEY, MICHAEL J., GRANT JUNCTION, CO. FILED 4-19-2004.



NO CLAIM IS MADE TO THE EXCLUSIVE RIGHT TO USE "AMERICA", APART FROM THE MARK AS SHOWN. THE STIPPLING IS FOR SHADING PURPOSES.

FOR COMMERCIAL AND GRAPHIC ART DESIGN IN THE FIELD OF COMPANY AND ORGANIZATION LOGOS AND SLOGANS (U.S. CLS. 100 AND 101).

FIRST USE 7-1-2000; IN COMMERCE 7-1-2000.  
STEVEN JACKSON, EXAMINING ATTORNEY

SN 76-590,403. NEXTACE, ORANGE, CA. FILED 5-4-2004.

**Title EDGE**

NO CLAIM IS MADE TO THE EXCLUSIVE RIGHT TO USE "TITLE", APART FROM THE MARK AS SHOWN.

FOR PROVIDING PRELIMINARY TITLE REPORTS VIA A GLOBAL INFORMATION NETWORK (U.S. CLS. 100 AND 101).

FIRST USE 8-1-2003; IN COMMERCE 8-1-2003.  
RICHARD A. STRASER, EXAMINING ATTORNEY

SN 78-229,674. AMERICAN ASSOCIATION FOR ACCREDITATION OF AMBULATORY SURGERY FACILITIES, INC., MUNDELEIN, IL. FILED 3-25-2003.



SEC. 2(F).  
FOR TESTING, ANALYSIS AND EVALUATION OF THE GOODS AND SERVICES OF OTHERS FOR THE PURPOSE OF ACCREDITATION, NAMELY, DEVELOPING AND SETTING STANDARDS FOR OUTPATIENT SINGLE OR MULTI-SPECIALTY SURGERY FACILITIES OWNED AND/OR OPERATED BY BOARD CERTIFIED SURGEONS IN APPROVED AMERICAN BOARD OF MEDICAL SPECIALISTS (ABMS) SURGICAL SPECIALTIES (U.S. CLS. 100 AND 101).

KARLA PERKINS, EXAMINING ATTORNEY

SN 78-249,174. MEDIA IMAGE, INC., REDMOND, WA. FILED 5-13-2003.

**SCHOOL KEYS**

NO CLAIM IS MADE TO THE EXCLUSIVE RIGHT TO USE "SCHOOL", APART FROM THE MARK AS SHOWN.

FOR CREATION, DEVELOPMENT, HOSTING AND MAINTENANCE OF WEB SITES FOR OTHERS ON A COMPUTER SERVER FOR A GLOBAL COMPUTER NETWORK, IN THE FIELD OF ONLINE RETAIL SALES (U.S. CLS. 100 AND 101).

CYNTHIA SLOAN, EXAMINING ATTORNEY

**CLASS 42—(Continued).**

SN 78-275,232. PATTON BOGGS LLP, WASHINGTON, DC. FILED 7-16-2003.



**CLASS 42—(Continued).**

SN 78-293,578. PHENOMENOME DISCOVERIES INC., SAS-KATOON, CANADA, FILED 8-28-2003.



NO CLAIM IS MADE TO THE EXCLUSIVE RIGHT TO USE "LLP", APART FROM THE MARK AS SHOWN. THE MARK CONSISTS OF THREE BOXES IN FRONT OF THE WORD MARK. FOR LEGAL SERVICES; PROVIDING INFORMATION IN THE FIELD OF LAW AND PUBLIC POLICY BY MEANS OF THE INTERNET (U.S. CLS. 100 AND 101). FIRST USE 7-31-2001; IN COMMERCE 7-31-2001. JOHN SCHUYLER YARD, EXAMINING ATTORNEY

PRIORITY CLAIMED UNDER SEC. 44(D) ON CANADA APPLICATION NO. 1176974, FILED 5-14-2003. FOR PROVIDING CONSULTING, RESEARCH, AND INFORMATION SERVICES IN THE FIELD OF BIOTECHNOLOGY AND BIOCHEMISTRY (U.S. CLS. 100 AND 101). FIRST USE 11-29-2001; IN COMMERCE 11-29-2001. CAROLINE WEIMER, EXAMINING ATTORNEY

SN 78-303,436. CODECORRECT, YAKIMA, WA. FILED 9-22-2003.

**ABN MANAGER PRO**

SN 78-293,507. PHENOMENOME DISCOVERIES, INC., SAS-KATOON, CANADA, FILED 8-28-2003.

NO CLAIM IS MADE TO THE EXCLUSIVE RIGHT TO USE "MANAGER", APART FROM THE MARK AS SHOWN. FOR PROVIDING TEMPORARY USE OF ON-LINE, NON-DOWNLOADABLE SOFTWARE AND DATA USED TO RESEARCH MEDICAL CODING INFORMATION FOR MEDICAL PROFESSIONALS IN MEDICAL OFFICES AND HOSPITALS (U.S. CLS. 100 AND 101). FIRST USE 7-1-2003; IN COMMERCE 7-1-2003. KAREN K. BUSH, EXAMINING ATTORNEY

**PHENOMENOME  
DISCOVERIES**

SN 78-306,469. HARRINGTON, BERNELL, LAMONT, WOODBRODGE, VA. FILED 9-29-2003.

**AdaptableLogic**

PRIORITY CLAIMED UNDER SEC. 44(D) ON CANADA APPLICATION NO. 1176971, FILED 5-14-2003. NO CLAIM IS MADE TO THE EXCLUSIVE RIGHT TO USE "DISCOVERIES", APART FROM THE MARK AS SHOWN. FOR PROVIDING CONSULTING, RESEARCH, ANALYSIS, AND INFORMATION SERVICES IN THE FIELD OF BIOTECHNOLOGY AND BIOCHEMISTRY (U.S. CLS. 100 AND 101). FIRST USE 11-29-2001; IN COMMERCE 11-29-2001. GLENN CLARK, EXAMINING ATTORNEY

THE MARK CONSISTS OF STANDARD CHARACTERS WITHOUT CLAIM TO ANY PARTICULAR FONT, STYLE, SIZE, OR COLOR. FOR TECHNOLOGY CONSULTING SERVICES FOR BUSINESS, EDUCATIONAL, HEALTHCARE, AND GOVERNMENT ORGANIZATIONS IN THE FIELDS OF FINANCIAL SERVICES, ENGINEERING (COMPUTER HARDWARE AND SOFTWARE), E-LEARNING, AND KNOWLEDGE MANAGEMENT (U.S. CLS. 100 AND 101). REBECCA SMITH, EXAMINING ATTORNEY

**CLASS 42—(Continued).**

SN 78-310,033. WICKFORD EQUITIES, LLC, MINDEN, NV.  
FILED 10-6-2003.

**MR. CORPORATION**

FOR INCORPORATING SERVICES, NAMELY, CORPORATE FORMATION AND MAINTENANCE OF THE CORPORATE FORMATION, FOR NEWLY INCORPORATED CORPORATIONS (U.S. CLS. 100 AND 101).  
BILL DAWE, EXAMINING ATTORNEY

**CLASS 42—(Continued).**

SN 78-353,303. TRILLIUM CREATIVE LLC, CHICAGO, IL.  
FILED 1-16-2004.

**COMMUNICATION  
BEYOND DESIGN**

SN 78-314,197. AXONWAVE SOFTWARE, INC., BURNABY,  
BC V5G 4C9, CANADA, FILED 10-15-2003.

**AXONWAVE**

FOR COMPUTER SERVICES, NAMELY, PROVIDING INTERNET AND INTRANET SEARCH ENGINES FOR OBTAINING INFORMATION FROM COMPUTER NETWORKS (U.S. CLS. 100 AND 101).  
FIRST USE 6-16-2003; IN COMMERCE 6-16-2003.  
BRETT J. GOLDEN, EXAMINING ATTORNEY

THE MARK CONSISTS OF STANDARD CHARACTERS WITHOUT CLAIM TO ANY PARTICULAR FONT, STYLE, SIZE, OR COLOR.

NO CLAIM IS MADE TO THE EXCLUSIVE RIGHT TO USE DESIGN, APART FROM THE MARK AS SHOWN.

FOR GRAPHIC DESIGN SERVICES, NAMELY, WEB DESIGN, DESIGN OF LOGOS, MARKETING COLLATERAL, SIGNAGE, ANNUAL REPORTS, BROCHURES AND VISUAL STRATEGY (U.S. CLS. 100 AND 101).

FIRST USE 6-6-2003; IN COMMERCE 6-6-2003.

SEAN DWYER, EXAMINING ATTORNEY

SN 78-341,403. MONTEFIORE MEDICAL CENTER, BRONX,  
NY. FILED 12-16-2003.

**CLINICAL LOOKING  
GLASS**

THE MARK CONSISTS OF STANDARD CHARACTERS WITHOUT CLAIM TO ANY PARTICULAR FONT, STYLE, SIZE, OR COLOR.

NO CLAIM IS MADE TO THE EXCLUSIVE RIGHT TO USE "CLINICAL", APART FROM THE MARK AS SHOWN.

FOR PROVIDING TEMPORARY ONLINE USE OF NONDOWNLOADABLE SOFTWARE IN THE FIELD OF HEALTH CARE TO ALLOW USERS TO TRACK PATIENT CARE AND PROGRESS AND THE PROCESSES AND EFFICIENCY OF A HEALTH CARE SYSTEM THROUGH ALL STAGES OF MEDICAL TREATMENTS, HOSPITAL VISITS, LABORATORY SERVICES, REHABILITATION AND ANY OTHER ASPECT OF THE CONTINUUM OF CARE AND TO PROVIDE DATA AND STATISTICS IN CONNECTION WITH MEDICAL TREATMENT AND HEALTH CARE REGARDING PATIENTS, PATIENT DIAGNOSIS, PATIENT DEMOGRAPHICS, FACILITY/CARE CENTERS AND MANAGED HEALTH CARE PROGRAMS (U.S. CLS. 100 AND 101).

FIRST USE 5-0-2002; IN COMMERCE 11-25-2002.

GINA HAYES, EXAMINING ATTORNEY

SN 78-367,631. NEW WIRELESS SERVICES, INC., BEDFORD,  
MA. FILED 2-13-2004.

**ACTIVE TRACK**

THE MARK CONSISTS OF STANDARD CHARACTERS WITHOUT CLAIM TO ANY PARTICULAR FONT, STYLE, SIZE, OR COLOR.

NO CLAIM IS MADE TO THE EXCLUSIVE RIGHT TO USE "TRACK", APART FROM THE MARK AS SHOWN.

FOR ELECTRONIC MONITORING AND CONTROL SERVICES IN THE FIELD OF WIRELESS TELEPHONE USAGE, PROVIDED TO CELLULAR TELEPHONE SERVICE PROVIDERS (U.S. CLS. 100 AND 101).

PAULA MAYS, EXAMINING ATTORNEY



**CLASS 42—(Continued).**

SN 78-373,482. CLEVER MACHINE, INC., SAN FRANCISCO, CA. FILED 2-24-2004.



THE MARK CONSISTS OF DESIGN OF "CM" FORMING A HUMAN TORSO & HEAD, WITH AN IDEA BUBBLE. FOR CONSULTING SERVICES IN THE FIELD OF DESIGN, SELECTION, DEVELOPMENT, IMPLEMENTATION AND OPERATION OF COMPUTER HARDWARE AND SOFTWARE SYSTEMS FOR OTHERS; COMPUTER SOFTWARE DEVELOPMENT; AND COMPUTER PROJECT MANAGEMENT SERVICES (U.S. CLS. 100 AND 101).  
STANLEY I. OSBORNE, EXAMINING ATTORNEY

SN 78-376,835. EZ PUBLISHING, INC., DAVIS, CA. FILED 3-2-2004.

**EZ PUBLISHING**

THE MARK CONSISTS OF STANDARD CHARACTERS WITHOUT CLAIM TO ANY PARTICULAR FONT, STYLE, SIZE, OR COLOR. FOR HOSTING THE WEB SITES AND STREAMING MEDIA OF OTHERS ON A COMPUTER SERVER (U.S. CLS. 100 AND 101). FIRST USE 1-1-1998; IN COMMERCE 1-1-1998. JEFFREY S. MOLINOFF, EXAMINING ATTORNEY

**CLASS 42—(Continued).**

SN 78-381,882. AUSTRALIA MEAT HOLDINGS PTY LIMITED, DINMORE, QUEENSLAND, AUSTRALIA, FILED 3-10-2004.



PRIORITY CLAIMED UNDER SEC. 44(D) ON AUSTRALIA APPLICATION NO. 972132, FILED 9-26-2003, REG. NO. 972132, DATED 9-26-2003, EXPIRES 9-26-2013. THE STIPPLING SHOWN IN THE DRAWING IS A FEATURE OF THE MARK AND DOES NOT INDICATE COLOR. THE MARK CONSISTS OF THE TERM "QTRAC" WITH THE LETTER "Q" IN LARGER SIZE AND CURVED ARROW DESIGNS ORIENTED COUNTERCLOCKWISE AROUND THE LETTER "Q" IN THE MARK. FOR QUALITY CONTROL AND QUALITY ASSURANCE SERVICES FOR OTHERS IN THE FIELD OF MEAT AND MEAT PRODUCTS (U.S. CLS. 100 AND 101). JASON TURNER, EXAMINING ATTORNEY

SN 78-385,743. ELECTRONIC EVIDENCE DISCOVERY, INC., SEATTLE, WA. FILED 3-17-2004.

**Marginal Discovery  
Utility**

THE MARK CONSISTS OF STANDARD CHARACTERS WITHOUT CLAIM TO ANY PARTICULAR FONT, STYLE, SIZE, OR COLOR. NO CLAIM IS MADE TO THE EXCLUSIVE RIGHT TO USE "DISCOVERY", APART FROM THE MARK AS SHOWN. FOR LITIGATION SUPPORT SERVICES IN THE FIELD OF DISCOVERY AND CONSULTING SERVICES IN CONNECTION THEREWITH (U.S. CLS. 100 AND 101). GEOFFREY FOSDICK, EXAMINING ATTORNEY

**CLASS 42—(Continued).**

SN 78-388,757. IGXGLOBAL, ROCKY HILL, CT. FILED 3-22-2004.

ihavebeenhacked

THE MARK CONSISTS OF STANDARD CHARACTERS WITHOUT CLAIM TO ANY PARTICULAR FONT, STYLE, SIZE, OR COLOR.

FOR COMPUTER CONSULTATION IN THE FIELD OF COMPUTER SECURITY (U.S. CLS. 100 AND 101).  
NICHOLAS ALTREE, EXAMINING ATTORNEY

**CLASS 42—(Continued).**

SN 78-395,744. RENTAL AVENUE, INC., SAN DIEGO, CA. FILED 4-2-2004.

Rental Avenue

THE MARK CONSISTS OF STANDARD CHARACTERS WITHOUT CLAIM TO ANY PARTICULAR FONT, STYLE, SIZE, OR COLOR.

FOR APPLICATION SERVICE PROVIDER ASP FEATURING SOFTWARE IN THE FIELD OF ROOM AND FACILITIES RESERVATIONS AND BOOKING FOR THE TEMPORARY ACCOMMODATIONS INDUSTRY (U.S. CLS. 100 AND 101).  
JENNIFER KRISP, EXAMINING ATTORNEY

SN 78-389,269. CORNERSTONE LOGIC, INC., NEW SMYRNA BEACH, FL. FILED 3-23-2004.

Cornerstone  
*Logic* inc.

FOR COMPUTER SOFTWARE AND HARDWARE DESIGN, UPDATING, INSTALLING AND MAINTENANCE FOR OTHERS IN THE FIELD OF AVIATION, AIRPORT MANAGEMENT, FUELING, ENVIRONMENTAL, AND INFORMATION MANAGEMENT; CONSULTING SERVICES IN THE FIELD OF AVIATION, AIRPORT MANAGEMENT, FUELING, ENVIRONMENTAL, AND INFORMATION MANAGEMENT (U.S. CLS. 100 AND 101).

FIRST USE 5-1-1996; IN COMMERCE 5-1-1996.  
CAROLYN GRAY, EXAMINING ATTORNEY

SN 78-396,385. LEVANT TECHNOLOGIES, LLC., NORMAN, OK. FILED 4-5-2004.

LEVANT  
TECHNOLOGIES

THE MARK CONSISTS OF STANDARD CHARACTERS WITHOUT CLAIM TO ANY PARTICULAR FONT, STYLE, SIZE, OR COLOR.

NO CLAIM IS MADE TO THE EXCLUSIVE RIGHT TO USE TECHNOLOGIES, APART FROM THE MARK AS SHOWN.

FOR GRAPHIC ART DESIGN SERVICES, NAMELY LOGO DESIGN, DESIGN, CREATION, HOSTING, DEVELOPMENT AND MAINTENANCE OF WEB SITES FOR OTHERS; DATABASE DEVELOPMENT SERVICES, COMPUTER DATABASE MAINTENANCE FOR OTHERS (U.S. CLS. 100 AND 101).

FIRST USE 10-25-2003; IN COMMERCE 10-27-2003.  
TRICIA SONNEBORN, EXAMINING ATTORNEY

**CLASS 42—(Continued).**

SN 78-397,995. ZELESKEY, CORNELIUS, HALLMARK, RO-  
PER & HICKS, L.L.P., LUFKIN, TX. FILED 4-7-2004.

**CLASS 42—(Continued).**

SN 78-399,607. BANNER PHARMACAPS, INC., HIGH POINT,  
NC. FILED 4-9-2004.

**IDEAS ANSWERS LIFE**



THE MARK CONSISTS OF STANDARD CHARACTERS  
WITHOUT CLAIM TO ANY PARTICULAR FONT, STYLE,  
SIZE, OR COLOR.

FOR RESEARCH, DEVELOPMENT AND CUSTOM  
FORMULATION OF PRODUCTS FOR OTHERS FOR  
THE PHARMACEUTICAL, NUTRITIONAL, HERBAL,  
MINERAL, VITAMIN AND FOOD INDUSTRIES (U.S.  
CLS. 100 AND 101).

FIRST USE 11-12-2002; IN COMMERCE 11-12-2002.  
MARY CRAWFORD, EXAMINING ATTORNEY

FOR LEGAL SERVICES (U.S. CLS. 100 AND 101).  
FIRST USE 6-1-2001; IN COMMERCE 6-1-2001.  
CHRISTOPHER BUONGIORNO, EXAMINING ATTOR-  
NEY

SN 78-411,881. MATTHEWS, ROBERT C., ORANGE, CA.  
FILED 5-2-2004.

SN 78-398,139. HUCKABEE & ASSOCIATES, INC., FORT  
WORTH, TX. FILED 4-7-2004.

**HUCKABEE**

**structsource**

THE MARK CONSISTS OF STANDARD CHARACTERS  
WITHOUT CLAIM TO ANY PARTICULAR FONT, STYLE,  
SIZE, OR COLOR.

FOR ARCHITECTURAL, ENGINEERING AND PRO-  
JECT MANAGEMENT FOR DESIGNING AND CON-  
STRUCTING EDUCATIONAL FACILITIES (U.S. CLS.  
100 AND 101).

FIRST USE 5-0-1991; IN COMMERCE 5-0-1991.  
INGA ERVIN, EXAMINING ATTORNEY

THE MARK CONSISTS OF STANDARD CHARACTERS  
WITHOUT CLAIM TO ANY PARTICULAR FONT, STYLE,  
SIZE, OR COLOR.

FOR PROVIDING ONLINE INFORMATION FOR THE  
DESIGN OF BUILDINGS, BRIDGES, RETAINING  
WALLS, UNDERGROUND STRUCTURES AND AERO-  
SPACE STRUCTURES. (U.S. CLS. 100 AND 101).

FIRST USE 6-1-1999; IN COMMERCE 6-1-1999.  
KAREN BRACEY, EXAMINING ATTORNEY

**CLASS 42—(Continued).**

SN 78-413,167. FOURTHOUGHT, INC., LOUISVILLE, CO.  
FILED 5-4-2004.

# RIGEL

THE MARK CONSISTS OF STANDARD CHARACTERS WITHOUT CLAIM TO ANY PARTICULAR FONT, STYLE, SIZE, OR COLOR.

FOR COMPUTER SOFTWARE CONSULTATION, TECHNICAL SUPPORT, INSTALLATION, CUSTOMIZATION, AND INTEGRATION (U.S. CLS. 100 AND 101).  
MITCHELL FRONT, EXAMINING ATTORNEY

SN 78-415,372. BOTTLEROCKET ENTERTAINMENT, INC.,  
DEL MAR, CA. FILED 5-7-2004.



OWNER OF U.S. REG. NOS. 2,298,684, 2,312,311 AND 2,350,547.

THE MARK CONSISTS OF STYLIZED LOWERCASE LETTERS B AND R.

FOR COMPUTER PROGRAMMING FOR OTHERS, NAMELY PROGRAMMING COMPUTER GAMES, VIDEO GAMES, GAMES FOR VIDEO OR GAME CONSOLES, IMAGE PROCESSING AND SOFTWARE TOOLS FOR IMAGE PROCESSING AND DESIGNING COMPUTER GAMES OR GAMES FOR VIDEO OR GAME CONSOLES; CONSULTING AND TECHNICAL SUPPORT SERVICES IN THE FIELD OF THE DESIGN AND PROGRAMMING OF COMPUTER GAMES, VIDEO GAMES, GAMES FOR VIDEO OR GAME CONSOLES, IMAGE PROCESSING AND SOFTWARE TOOLS FOR IMAGE PROCESSING AND DESIGNING COMPUTER GAMES OR GAMES FOR VIDEO OR GAME CONSOLES (U.S. CLS. 100 AND 101).

BARBARA BROWN, EXAMINING ATTORNEY

**CLASS 42—(Continued).**

SN 78-415,618. SHARP IMPACT, INC., NEW YORK, NY.  
FILED 5-10-2004.

# SHARP IMPACT

THE MARK CONSISTS OF STANDARD CHARACTERS WITHOUT CLAIM TO ANY PARTICULAR FONT, STYLE, SIZE, OR COLOR.

FOR FASHION DESIGN AND GRAPHIC DESIGN SERVICES; CONSULTING IN THE FIELDS OF FASHION DESIGN AND GRAPHIC DESIGN (U.S. CLS. 100 AND 101).

FIRST USE 1-1-2001; IN COMMERCE 1-1-2001.  
JOHN DWYER, EXAMINING ATTORNEY

SN 78-418,494. MEDIA IMAGE, INC., REDMOND, WA.  
FILED 5-13-2004.

# KEYS TO COMMUNITY

THE MARK CONSISTS OF STANDARD CHARACTERS WITHOUT CLAIM TO ANY PARTICULAR FONT, STYLE, SIZE, OR COLOR.

FOR CREATION, DEVELOPMENT, HOSTING AND MAINTENANCE OF WEB SITES FOR OTHERS ON A COMPUTER SERVER FOR A GLOBAL COMPUTER NETWORK, IN THE FIELD OF ONLINE RETAIL SALES (U.S. CLS. 100 AND 101).

WENDY GOODMAN, EXAMINING ATTORNEY

SN 78-421,443. CONJUGON, INC., MADISON, WI. FILED 5-19-2004.

# CONJUGON

THE MARK CONSISTS OF STANDARD CHARACTERS WITHOUT CLAIM TO ANY PARTICULAR FONT, STYLE, SIZE, OR COLOR.

FOR SCIENTIFIC RESEARCH (U.S. CLS. 100 AND 101).

FIRST USE 4-15-2001; IN COMMERCE 5-9-2002.  
JIM RINGLE, EXAMINING ATTORNEY

**CLASS 42—(Continued).**

SN 78-421,693. AQUANTIVE, INC., SEATTLE, WA. FILED 5-19-2004.

**SELECTOR**

THE MARK CONSISTS OF STANDARD CHARACTERS WITHOUT CLAIM TO ANY PARTICULAR FONT, STYLE, SIZE, OR COLOR.

FOR PROVIDING TEMPORARY USE OF ONLINE NON-DOWNLOADABLE SOFTWARE FOR MANAGING, TRACKING AND EVALUATING MEDIA PLANNING, MEDIA BUYING AND THE SUCCESS OF MARKETING EFFORTS OF OTHERS, FOR DEFINING TARGET AUDIENCES AND DIRECTING ONLINE ADVERTISEMENTS TO A NETWORK OF ONLINE MEDIA PUBLISHERS OR TO A CUSTOMIZED TARGET AUDIENCE, AND FOR COMPILING AND MANIPULATING MULTIPLE VARIABLES TO MANAGE AND TARGET ONLINE ADVERTISEMENTS (U.S. CLS. 100 AND 101).

CHERYL CLAYTON, EXAMINING ATTORNEY

**CLASS 42—(Continued).**

SN 78-421,809. CEPHALON, INC., WEST CHESTER, PA. FILED 5-19-2004.

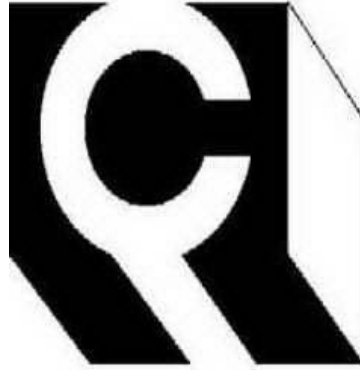

OWNER OF U.S. REG. NO. 1,983,615.

THE MARK CONSISTS OF THE LETTER C IN A CUBE DESIGN.

FOR PHARMACEUTICAL AND BIOTECHNOLOGY RESEARCH AND DEVELOPMENT SERVICES, NAMELY DEVELOPING DIAGNOSTIC AND THERAPEUTIC AGENTS TO DIAGNOSE AND TREAT NEUROLOGICAL AND PSYCHIATRIC DISEASES, CANCER, SLEEP DISORDERS AND PAIN, AND PROVIDE INFORMATION BY MEANS OF A GLOBAL COMPUTER NETWORK REGARDING PHARMACEUTICAL AND BIOTECHNOLOGY RESEARCH AND DEVELOPMENT (U.S. CLS. 100 AND 101).

FIRST USE 3-15-2004; IN COMMERCE 3-15-2004.

HEATHER THOMPSON, EXAMINING ATTORNEY

SN 78-421,794. CEPHALON, INC., WEST CHESTER, PA. FILED 5-19-2004.



OWNER OF U.S. REG. NOS. 1,589,506, 1,983,615 AND 2,202,158.

THE MARK CONSISTS OF THE LETTER C IN A CUBE DESIGN, THE WORD CEPHALON, ALONG WITH THE WORD DELIVER MORE AND A GREATER THAN SYMBOL.

FOR PHARMACEUTICAL AND BIOTECHNOLOGY RESEARCH AND DEVELOPMENT SERVICES, NAMELY DEVELOPING DIAGNOSTIC AND THERAPEUTIC AGENTS TO DIAGNOSE AND TREAT NEUROLOGICAL AND PSYCHIATRIC DISEASES, CANCER, SLEEP DISORDERS AND PAIN, AND PROVIDE INFORMATION BY MEANS OF A GLOBAL COMPUTER NETWORK REGARDING PHARMACEUTICAL AND BIOTECHNOLOGY RESEARCH AND DEVELOPMENT (U.S. CLS. 100 AND 101).

FIRST USE 3-15-2004; IN COMMERCE 3-15-2004.

HEATHER THOMPSON, EXAMINING ATTORNEY

SN 78-422,307. DYER, LYNN HARRISON, FORT LAUDERDALE, FL. FILED 5-20-2004.

**The Grand Finale**

THE MARK CONSISTS OF STANDARD CHARACTERS WITHOUT CLAIM TO ANY PARTICULAR FONT, STYLE, SIZE, OR COLOR.

FOR INTERIOR DECORATING SERVICES FOR OTHERS SPECIALIZING IN ACCESSORIZING (U.S. CLS. 100 AND 101).

KEVON CHISOLM, EXAMINING ATTORNEY

**CLASS 43—HOTEL AND RESTAURANT SERVICES**

SN 76-437,488. MANGANARO'S HERO BOY INC., NEW YORK, NY. FILED 8-5-2002.

**MANGANARO'S HERO BOY**

OWNER OF U.S. REG. NOS. 863,993 AND 1,164,282. SEC. 2(F) AS TO "HERO BOY". FOR RESTAURANT AND CATERING (U.S. CLS. 100 AND 101). FIRST USE 3-28-1956; IN COMMERCE 3-28-1956. CAROLYN GRAY, EXAMINING ATTORNEY

SN 76-496,818. RRI FINANCIAL, INC., LAS VEGAS, NV. FILED 3-13-2003.

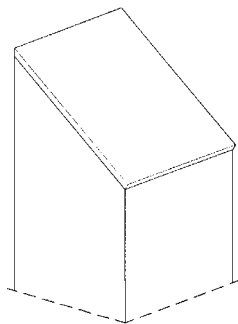

THE MARK CONSISTS OF THE THREE-DIMENSIONAL SLANTED ROOF PORTION OF THE EXTERIOR OF A BUILDING IN WHICH THE SERVICES ARE PROVIDED. SEC. 2(F). FOR HOTEL AND MOTEL SERVICES (U.S. CLS. 100 AND 101). FIRST USE 12-31-1972; IN COMMERCE 12-31-1972. REBECCA SMITH, EXAMINING ATTORNEY

SN 76-553,269. HEARST-ARGYLE STATIONS, INC., NEW YORK, NY. FILED 10-2-2003.

**FOOD FOR FAMILIES**

SEC. 2(F). FOR CHARITABLE SERVICES, NAMELY, PROVIDING FOOD TO NEEDY PEOPLE (U.S. CLS. 100 AND 101). FIRST USE 11-0-1978; IN COMMERCE 11-0-1978. TARAH HARDY, EXAMINING ATTORNEY

**CLASS 43—(Continued).**

SN 76-559,860. CANAL GROUP, INC., CHICAGO, IL. FILED 11-14-2003.

**BELLY MORONGO**

THE MARK CONSISTS OF STANDARD CHARACTERS WITHOUT CLAIM TO ANY PARTICULAR FONT, STYLE, SIZE, OR COLOR. FOR RESTAURANT AND COCKTAIL LOUNGE SERVICES (U.S. CLS. 100 AND 101). GRETTA YAO, EXAMINING ATTORNEY

SN 76-559,861. CANAL GROUP, INC., CHICAGO, IL. FILED 11-14-2003.

**BELLY AT THE PALMS**

THE MARK CONSISTS OF STANDARD CHARACTERS WITHOUT CLAIM TO ANY PARTICULAR FONT, STYLE, SIZE, OR COLOR. FOR RESTAURANT AND COCKTAIL LOUNGE SERVICES (U.S. CLS. 100 AND 101). GRETTA YAO, EXAMINING ATTORNEY

SN 76-561,950. FOODCRAFT, LLC, NEW YORK, NY. FILED 11-25-2003.

**CRAFTBAR**

THE MARK CONSISTS OF STANDARD CHARACTERS WITHOUT CLAIM TO ANY PARTICULAR FONT, STYLE, SIZE, OR COLOR. FOR RESTAURANT AND BAR SERVICES (U.S. CLS. 100 AND 101). FIRST USE 1-12-2002; IN COMMERCE 1-12-2002. ALEX KEAM, EXAMINING ATTORNEY

**CLASS 43—(Continued).**

SN 76-562,453. OUELLETTE, MICHAEL, ST. HELENA, CA. FILED 11-12-2003.

# SEADISH

THE MARK CONSISTS OF STANDARD CHARACTERS WITHOUT CLAIM TO ANY PARTICULAR FONT, STYLE, SIZE, OR COLOR.

FOR RESTAURANT SERVICES (U.S. CLS. 100 AND 101).  
INGA ERVIN, EXAMINING ATTORNEY

**CLASS 43—(Continued).**

SN 76-590,094. PACHTER, JEAN, NEW YORK, NY. FILED 4-30-2004.

# BELLYBEE

THE MARK CONSISTS OF STANDARD CHARACTERS WITHOUT CLAIM TO ANY PARTICULAR FONT, STYLE, SIZE, OR COLOR.

FOR RESTAURANT SERVICES (U.S. CLS. 100 AND 101).  
KATHERINE STOIDES, EXAMINING ATTORNEY

SN 76-567,135. RACETOWN, INC., INDEPENDENCE, OH. FILED 12-29-2003.

# TURN 5

THE MARK CONSISTS OF STANDARD CHARACTERS WITHOUT CLAIM TO ANY PARTICULAR FONT, STYLE, SIZE, OR COLOR.

FOR RESTAURANT SERVICES. (U.S. CLS. 100 AND 101).  
AMY HELLA, EXAMINING ATTORNEY

SN 76-590,565. KENT QUALITY FOODS, INC., GRAND RAPIDS, MI. FILED 5-5-2004.

# DESIGN A DOG

THE MARK CONSISTS OF STANDARD CHARACTERS WITHOUT CLAIM TO ANY PARTICULAR FONT, STYLE, SIZE, OR COLOR.

FOR RESTAURANT SERVICES (U.S. CLS. 100 AND 101).  
MARCIE MILONE, EXAMINING ATTORNEY

SN 76-568,290. HMSHOST CORPORATION, BETHESDA, MD. FILED 12-19-2003.



NO CLAIM IS MADE TO THE EXCLUSIVE RIGHT TO USE "SAVANNAH" AND "GRILL & DELI", APART FROM THE MARK AS SHOWN.

FOR RESTAURANT SERVICES (U.S. CLS. 100 AND 101).  
KATHERINE STOIDES, EXAMINING ATTORNEY

SN 76-590,698. STIMSON LANE LTD., WOODINVILLE, WA. FILED 5-4-2004.

# CHATEAU STE MICHELLE

THE MARK CONSISTS OF STANDARD CHARACTERS WITHOUT CLAIM TO ANY PARTICULAR FONT, STYLE, SIZE, OR COLOR.

OWNER OF U.S. REG. NOS. 1,092,925, 1,978,120 AND OTHERS.  
FOR WINE BAR SERVICES AND RESTAURANT SERVICES (U.S. CLS. 100 AND 101).  
KELLY CHOE, EXAMINING ATTORNEY

**CLASS 43—(Continued).**

SN 76-590,746. HAMPSHIRE HOTELS & RESORTS, LLC,  
NEW YORK, NY. FILED 5-6-2004.

**CLASS 43—(Continued).**

SN 78-318,313. SUKAN INVESTMENTS, INC., NORTH LIT-  
TLE ROCK, AR. FILED 10-24-2003.

**SUBCONSCIOUS**

THE MARK CONSISTS OF STANDARD CHARACTERS  
WITHOUT CLAIM TO ANY PARTICULAR FONT, STYLE,  
SIZE, OR COLOR.

FOR RESTAURANT, BAR AND COCKTAIL LOUNGE  
SERVICES (U.S. CLS. 100 AND 101).

RONALD MCMORROW, EXAMINING ATTORNEY



SN 76-591,221. BUONGIORNO PIZZA AND PASTA, INC.,  
PALM BEACH GARDENS, FL. FILED 5-10-2004.

**BUONGIORNO PIZZA & PASTA**

THE MARK CONSISTS OF STANDARD CHARACTERS  
WITHOUT CLAIM TO ANY PARTICULAR FONT, STYLE,  
SIZE, OR COLOR.

NO CLAIM IS MADE TO THE EXCLUSIVE RIGHT TO  
USE "PIZZA PASTA", APART FROM THE MARK AS  
SHOWN.

FOREIGN LANGUAGE WORDS: BUONGIORNO ENG-  
LISH TRANSLATION: GOOD DAY

FOR RESTAURANT SERVICES (U.S. CLS. 100 AND  
101).

FIRST USE 3-1-2004; IN COMMERCE 3-1-2004.

ARETHA SOMERVILLE, EXAMINING ATTORNEY

NO CLAIM IS MADE TO THE EXCLUSIVE RIGHT TO  
USE SAN FRANCISCO BREAD CO. AND BAKERY CAFE,  
APART FROM THE MARK AS SHOWN.

FOR RESTAURANT SERVICES (U.S. CLS. 100 AND  
101).

FIRST USE 1-3-2002; IN COMMERCE 1-3-2002.

ALICE BENMAMAN, EXAMINING ATTORNEY

SN 78-283,420. MPF MANAGEMENT, LLC., HOUSTON, TX.  
FILED 8-5-2003.

SN 78-364,154. THE GRAND LODGE RETIREMENT COM-  
MUNITY, INC., DES MOINES, IA. FILED 2-6-2004.

**GRAND LODGE AT THE  
PRESERVE**

NO CLAIM IS MADE TO THE EXCLUSIVE RIGHT TO  
USE "JAZZ CAFÉ", APART FROM THE MARK AS SHOWN.  
THE LINING IS A FEATURE OF THE MARK AND DOES  
NOT INDICATE COLOR.

THE COLOR(S) RED IS/ARE CLAIMED AS A FEATURE  
OF THE MARK.

THE DESIGN OF THE CAT AND THE WORDING RED  
CAT APPEAR IN THE LETTER RED.

FOR RESTAURANT SERVICES (U.S. CLS. 100 AND  
101).

FIRST USE 6-1-2001; IN COMMERCE 6-1-2001.

PATRICIA EVANKO, EXAMINING ATTORNEY

THE MARK CONSISTS OF STANDARD CHARACTERS  
WITHOUT CLAIM TO ANY PARTICULAR FONT, STYLE,  
SIZE, OR COLOR.

NO CLAIM IS MADE TO THE EXCLUSIVE RIGHT TO  
USE LODGE, APART FROM THE MARK AS SHOWN.

FOR RETIREMENT HOME COMMUNITY SERVICES  
(U.S. CLS. 100 AND 101).

FIRST USE 9-1-2001; IN COMMERCE 9-1-2001.

KARLA PERKINS, EXAMINING ATTORNEY



**CLASS 43—(Continued).**

SN 78-381,276. MARSHALL, CRAIG STEPHAN, SHERMAN OAKS, CA. FILED 3-9-2004.

**CLASS 43—(Continued).**

SN 78-391,697. ARBY'S IP HOLDER TRUST, A DELAWARE BUSINESS TRUST, THE TRUSTEES COMPRISING THE CORPORATE TRUST ADMINISTRATOR, WILMINGTON TRUST COMPANY, A DELAWARE CORPORATION, THE, FT. LAUDERDALE, FL. FILED 3-26-2004.

**FETCH hot dogs**

**TRY THE THAI**

THE MARK CONSISTS OF STANDARD CHARACTERS WITHOUT CLAIM TO ANY PARTICULAR FONT, STYLE, SIZE, OR COLOR.

NO CLAIM IS MADE TO THE EXCLUSIVE RIGHT TO USE "HOT DOGS", APART FROM THE MARK AS SHOWN. FOR RESTAURANT (U.S. CLS. 100 AND 101).

JOHN DWYER, EXAMINING ATTORNEY

THE MARK CONSISTS OF STANDARD CHARACTERS WITHOUT CLAIM TO ANY PARTICULAR FONT, STYLE, SIZE, OR COLOR.

NO CLAIM IS MADE TO THE EXCLUSIVE RIGHT TO USE "THAI", APART FROM THE MARK AS SHOWN.

FOR PREPARATION OF SALADS FOR CONSUMPTION ON AND OFF BUSINESS PREMISES (U.S. CLS. 100 AND 101).

DAWN HAN, EXAMINING ATTORNEY

---

SN 78-389,996. HILTON HOSPITALITY, INC., BEVERLY HILLS, CA. FILED 3-24-2004.

---

SN 78-392,759. AMERICA'S DRIVE-IN CORP., WICHITA, KS. FILED 3-29-2004.

**HOMWOOD FOR THE HOLIDAYS**

**COOL DOWN. DRINK UP.**

THE MARK CONSISTS OF STANDARD CHARACTERS WITHOUT CLAIM TO ANY PARTICULAR FONT, STYLE, SIZE, OR COLOR.

OWNER OF U.S. REG. NOS. 1,513,176, 1,821,850 AND OTHERS. FOR HOTEL AND MOTEL SERVICES (U.S. CLS. 100 AND 101).

FIRST USE 11-10-2000; IN COMMERCE 11-10-2000. REBECCA GILBERT, EXAMINING ATTORNEY

THE MARK CONSISTS OF STANDARD CHARACTERS WITHOUT CLAIM TO ANY PARTICULAR FONT, STYLE, SIZE, OR COLOR.

FOR RESTAURANT SERVICES (U.S. CLS. 100 AND 101).

FIRST USE 7-1-2003; IN COMMERCE 7-1-2003. SCOTT OSLICK, EXAMINING ATTORNEY

**CLASS 43—(Continued).**

SN 78-395,050. KOHLMEIER, JOHN G., KENDALLVILLE, IN. FILED 4-1-2004.

Turnpointe  
Communities

THE MARK CONSISTS OF STANDARD CHARACTERS WITHOUT CLAIM TO ANY PARTICULAR FONT, STYLE, SIZE, OR COLOR.

NO CLAIM IS MADE TO THE EXCLUSIVE RIGHT TO USE "COMMUNITIES", APART FROM THE MARK AS SHOWN.

FOR RETIREMENT HOMES FOR THOSE AGED 55 AND OLDER (U.S. CLS. 100 AND 101).

DAVID MURRAY, EXAMINING ATTORNEY

**CLASS 43—(Continued).**

SN 78-397,601. COSTA, KIM, FT. MYERS, FL. FILED 4-7-2004.

FOOD THAT MADE THE  
JERSEY SHORE  
FAMOUS

THE MARK CONSISTS OF STANDARD CHARACTERS WITHOUT CLAIM TO ANY PARTICULAR FONT, STYLE, SIZE, OR COLOR.

FOR RESTAURANT SERVICES (U.S. CLS. 100 AND 101).

BRETT J. GOLDEN, EXAMINING ATTORNEY

SN 78-397,736. MCCUBBIN, STACEY L., DBA FROZEN 2 PERFECTION, HOUSTON, TX. FILED 4-7-2004.

FROZEN 2  
PERFECTION

SN 78-395,510. GRILL, SARA, APPLETON, WI. FILED 4-2-2004.

SEÑOR TEQUILA'S

THE MARK CONSISTS OF STANDARD CHARACTERS WITHOUT CLAIM TO ANY PARTICULAR FONT, STYLE, SIZE, OR COLOR.

FOR MEXICAN RESTAURANT AND BAR INCLUDING DINE IN, TO GO AND NIGHTLIFE (U.S. CLS. 100 AND 101).

FIRST USE 9-5-2003; IN COMMERCE 9-12-2003.  
MELISSA SHELLA, EXAMINING ATTORNEY

THE MARK CONSISTS OF STANDARD CHARACTERS WITHOUT CLAIM TO ANY PARTICULAR FONT, STYLE, SIZE, OR COLOR.

FOR RENTAL OF FROZEN DRINK MACHINES (U.S. CLS. 100 AND 101).

FIRST USE 2-0-2004; IN COMMERCE 2-0-2004.  
KIM SAITO, EXAMINING ATTORNEY

**CLASS 43—(Continued).**

SN 78-408,483. EL MESON DE FELIPE INC., MAYAGUEZ, PUERTO RICO, FILED 4-27-2004.

**Meso**

THE MARK CONSISTS OF STANDARD CHARACTERS WITHOUT CLAIM TO ANY PARTICULAR FONT, STYLE, SIZE, OR COLOR.  
THE FOREIGN WORDING IN THE MARK TRANSLATES INTO ENGLISH AS I PULL.  
FOR RESTAURANT SERVICES; RESTAURANT TAKE OUT SERVICES AND CATERING SERVICES (U.S. CLS. 100 AND 101).  
FIRST USE 1-1-1994; IN COMMERCE 1-1-1994.  
JOHN E. MICHOŠ, EXAMINING ATTORNEY

SN 78-412,044. PARK HOSPITALITY LLC, PLYMOUTH, MN. FILED 5-3-2004.

**LITE ON THE GO  
BREAKFAST**

THE MARK CONSISTS OF STANDARD CHARACTERS WITHOUT CLAIM TO ANY PARTICULAR FONT, STYLE, SIZE, OR COLOR.  
NO CLAIM IS MADE TO THE EXCLUSIVE RIGHT TO USE "BREAKFAST", APART FROM THE MARK AS SHOWN.  
FOR RESTAURANT SERVICES (U.S. CLS. 100 AND 101).  
JIM RINGLE, EXAMINING ATTORNEY

**CLASS 43—(Continued).**

SN 78-415,648. BARCELO DESTINATION SERVICES, S.L., PALMA DE MALLORCA, SPAIN, FILED 5-10-2004.



THE COLOR(S) BLUE, RED, WHITE IS/ARE CLAIMED AS A FEATURE OF THE MARK.  
TWO RED RECTANGLES ON A BLUE GROUND WITH THE WORDING HOTELOPIA APPEARING IN WHITE TO THE RIGHT.  
FOR TRAVEL AGENCY SERVICES, NAMELY, MAKING RESERVATIONS AND BOOKING FOR TEMPORARY LODGING (U.S. CLS. 100 AND 101).  
GRETTA YAO, EXAMINING ATTORNEY

SN 78-416,803. L. MILLER GROUP, LLC, ST. LOUIS, MO. FILED 5-11-2004.

**NANTUCKET COVE**

THE MARK CONSISTS OF STANDARD CHARACTERS WITHOUT CLAIM TO ANY PARTICULAR FONT, STYLE, SIZE, OR COLOR.  
FOR RESTAURANT AND BAR SERVICES (U.S. CLS. 100 AND 101).  
ANGELA M. MICHELI, EXAMINING ATTORNEY

SN 78-418,675. POGUE, MELODIE, WOOLWINE, VA. FILED 5-14-2004.

**The Mountain Rose  
Inn**

THE MARK CONSISTS OF STANDARD CHARACTERS WITHOUT CLAIM TO ANY PARTICULAR FONT, STYLE, SIZE, OR COLOR.  
NO CLAIM IS MADE TO THE EXCLUSIVE RIGHT TO USE "INN", APART FROM THE MARK AS SHOWN.  
FOR HOTEL AND RESTAURANT SERVICES (U.S. CLS. 100 AND 101).  
FIRST USE 0-0-1997; IN COMMERCE 0-0-1997.  
CHRISTOPHER BUONGIORNO, EXAMINING ATTORNEY

**CLASS 43—(Continued).**

SN 78-418,823. ELEPHANT & CASTLE GROUP, INC., VANCOUVER, BRITISH COLUMBIA, CANADA, FILED 5-14-2004.

**CLASS 43—(Continued).**

SN 78-421,262. CARR, SUSAN, MIAMI BEACH, FL. FILED 5-19-2004.

**BANG ON**

THE MARK CONSISTS OF STANDARD CHARACTERS WITHOUT CLAIM TO ANY PARTICULAR FONT, STYLE, SIZE, OR COLOR.

FOR RESTAURANT SERVICES (U.S. CLS. 100 AND 101).

FIRST USE 4-5-2004; IN COMMERCE 4-5-2004.

JOANNA DUKOVIC, EXAMINING ATTORNEY

**Goody Two's**

THE MARK CONSISTS OF STANDARD CHARACTERS WITHOUT CLAIM TO ANY PARTICULAR FONT, STYLE, SIZE, OR COLOR.

FOR RESTAURANT SERVICES (U.S. CLS. 100 AND 101).

CHRISIE B. KING, EXAMINING ATTORNEY

SN 78-423,649. BARCELO DESTINATION SERVICES, S.L., 07006 PALMA DE MALLORCA, SPAIN, FILED 5-24-2004.

**TRAVELOPIA**

THE MARK CONSISTS OF STANDARD CHARACTERS WITHOUT CLAIM TO ANY PARTICULAR FONT, STYLE, SIZE, OR COLOR.

FOR TRAVEL AGENCY SERVICES, NAMELY, MAKING RESERVATIONS AND BOOKINGS FOR TEMPORARY LODGING (U.S. CLS. 100 AND 101).

GRETTA YAO, EXAMINING ATTORNEY

SN 78-418,994. ROUSSEL, ERROL, LOS ANGELES, CA. FILED 5-14-2004.

**CINESPACE****CLASS 44—MEDICAL, BEAUTY AND AGRICULTURAL SERVICES**

SN 76-433,424. JULIEN FAREL LLC, NEW YORK, NY. FILED 7-16-2002.

**JULIEN FAREL**

THE MARK CONSISTS OF STANDARD CHARACTERS WITHOUT CLAIM TO ANY PARTICULAR FONT, STYLE, SIZE, OR COLOR.

FOR RESTAURANTS (U.S. CLS. 100 AND 101).

DOUGLAS LEE, EXAMINING ATTORNEY

THE NAME SHOWN IN THE MARK IDENTIFIES A LIVING INDIVIDUAL WHOSE CONSENT IS ATTACHED HERETO.

FOR HAIR AND BEAUTY SALON SERVICES (U.S. CLS. 100 AND 101).

FIRST USE 12-1-2001; IN COMMERCE 12-1-2001.

KIM SAITO, EXAMINING ATTORNEY

**CLASS 44—(Continued).**

SN 76-504,201. HOUSTON RADIOLOGY, HOUSTON, TX. AND RMI PHYSICIAN SERVICES CORPORATION, HOUSTON, TX. FILED 4-4-2003.

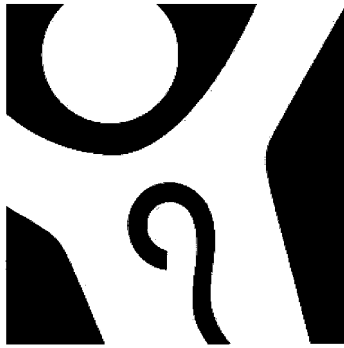

FOR MEDICAL SERVICES (U.S. CLS. 100 AND 101).  
FIRST USE 7-15-2002; IN COMMERCE 7-15-2002.  
LAURA KOVAISKY, EXAMINING ATTORNEY

**CLASS 44—(Continued).**

SN 76-504,203. HOUSTON RADIOLOGY, HOUSTON, TX. AND RMI PHYSICIAN SERVICES CORPORATION, HOUSTON, TX. FILED 4-4-2003.

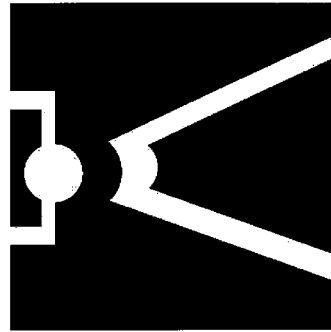

FOR MEDICAL SERVICES (U.S. CLS. 100 AND 101).  
FIRST USE 7-15-2002; IN COMMERCE 7-15-2002.  
LAURA KOVAISKY, EXAMINING ATTORNEY

SN 76-504,202. HOUSTON RADIOLOGY, HOUSTON, TX. AND RMI PHYSICIAN SERVICES CORPORATION, HOUSTON, TX. FILED 4-4-2003.

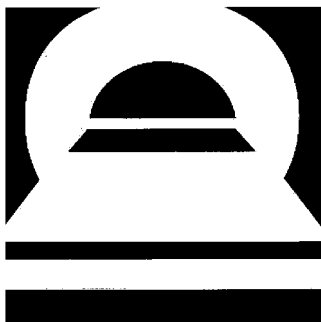

FOR MEDICAL SERVICES (U.S. CLS. 100 AND 101).  
FIRST USE 7-15-2002; IN COMMERCE 7-15-2002.  
LAURA KOVAISKY, EXAMINING ATTORNEY

SN 76-504,204. HOUSTON RADIOLOGY, HOUSTON, TX. AND RMI PHYSICIAN SERVICES CORPORATION, HOUSTON, TX. FILED 4-4-2003.



FOR MEDICAL SERVICES (U.S. CLS. 100 AND 101).  
FIRST USE 7-15-2002; IN COMMERCE 7-15-2002.  
LAURA KOVAISKY, EXAMINING ATTORNEY

**CLASS 44—(Continued).**

SN 76-504,205. HOUSTON RADIOLOGY, HOUSTON, TX. AND RMI PHYSICIAN SERVICES CORPORATION, HOUSTON, TX. FILED 4-4-2003.

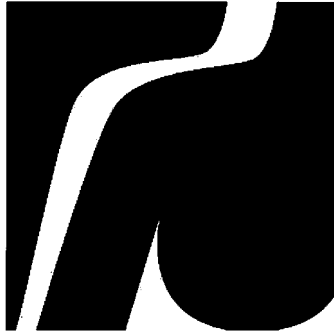

**CLASS 44—(Continued).**

SN 76-551,217. NEXUS HEALTH SYSTEMS, LTD., HOUSTON, TX. FILED 9-22-2003.

**BEACON SPECIALTY HOSPITAL**

NO CLAIM IS MADE TO THE EXCLUSIVE RIGHT TO USE "SPECIALTY HOSPITAL", APART FROM THE MARK AS SHOWN.

FOR MEDICAL SERVICES, NAMELY, MEDICAL AND REHABILITATION SERVICES FOR INDIVIDUALS WITH PULMONARY AND TRACHEOTOMY NEEDS, AND INDIVIDUALS WHO HAVE SUFFERED SEVERE HEAD OR BRAIN INJURIES, NEUROPSYCHOLOGICAL AND NEUROBEHAVIORIAL CONDITIONS, STROKES, ANEURYSMS, BURNS, AND WOUNDS (U.S. CLS. 100 AND 101).

FIRST USE 4-7-2003; IN COMMERCE 4-7-2003.  
VIVIAN MICZNIK FIRST, EXAMINING ATTORNEY

FOR MEDICAL SERVICES (U.S. CLS. 100 AND 101).  
FIRST USE 7-15-2002; IN COMMERCE 7-15-2002.  
LAURA KOVAISKY, EXAMINING ATTORNEY

SN 76-561,651. UNITED SITE SERVICES, INC., MANSFIELD, MA. FILED 11-12-2003.



SN 76-504,206. HOUSTON RADIOLOGY, HOUSTON, TX. AND RMI PHYSICIAN SERVICES CORPORATION, HOUSTON, TX. FILED 4-4-2003.

OWNER OF U.S. REG. NO. 2,489,123.  
NO CLAIM IS MADE TO THE EXCLUSIVE RIGHT TO USE "SITE SERVICES", APART FROM THE MARK AS SHOWN.

FOR RENTAL OF SANITARY FACILITIES AND PORTABLE WATER SUPPLY UNITS (U.S. CLS. 100 AND 101).  
FIRST USE 2-0-2003; IN COMMERCE 3-0-2003.  
DAVID H. STINE, EXAMINING ATTORNEY

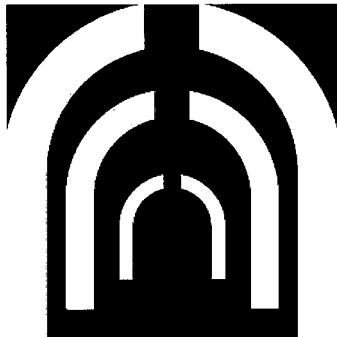

SN 76-561,652. UNITED SITE SERVICES, INC., MANSFIELD, MA. FILED 11-12-2003.



FOR MEDICAL SERVICES (U.S. CLS. 100 AND 101).  
FIRST USE 7-15-2002; IN COMMERCE 7-15-2002.  
LAURA KOVAISKY, EXAMINING ATTORNEY

OWNER OF U.S. REG. NO. 2,489,123.  
NO CLAIM IS MADE TO THE EXCLUSIVE RIGHT TO USE "SITE SERVICES", APART FROM THE MARK AS SHOWN.

FOR RENTAL OF SANITARY FACILITIES AND PORTABLE WATER SUPPLY UNITS (U.S. CLS. 100 AND 101).  
FIRST USE 11-0-2000; IN COMMERCE 11-0-2000.  
DAVID H. STINE, EXAMINING ATTORNEY

**CLASS 44—(Continued).**

SN 76-561,657. UNITED SITE SERVICES, INC., MANSFIELD, MA. FILED 11-12-2003.



OWNER OF U.S. REG. NO. 2,489,123.  
NO CLAIM IS MADE TO THE EXCLUSIVE RIGHT TO USE "SITE SERVICES", APART FROM THE MARK AS SHOWN.  
FOR RENTAL OF SANITARY FACILITIES AND POTABLE WATER SUPPLY UNITS (U.S. CLS. 100 AND 101).  
FIRST USE 10-0-2002; IN COMMERCE 12-0-2002.  
DAVID H. STINE, EXAMINING ATTORNEY

SN 76-565,863. BAYLOR HEALTH CARE SYSTEM, DALLAS COUNTY, TX. FILED 12-18-2003.



THE MARK CONSISTS OF STANDARD CHARACTERS WITHOUT CLAIM TO ANY PARTICULAR FONT, STYLE, SIZE, OR COLOR.  
FOR CONSULTING SERVICES PROVIDED TO HEALTH CARE ORGANIZATIONS TO ASSIST THEM IN IMPROVING MEDICAL CARE AND SERVICES THROUGH IMPROVEMENTS IN SAFETY, TIMELINESS, EFFECTIVENESS, EFFICIENCY, EQUITABLE PRINCIPALS AND A FOCUS ON PATIENT NEEDS (U.S. CLS. 100 AND 101).  
HELEN BRYAN, EXAMINING ATTORNEY

SN 76-579,299. AQUAHAB, L.P., CHERRY HILL, NJ. FILED 3-5-2004.

**AQUAHAB REHABILITATION**

THE MARK CONSISTS OF STANDARD CHARACTERS WITHOUT CLAIM TO ANY PARTICULAR FONT, STYLE, SIZE, OR COLOR.  
OWNER OF U.S. REG. NO. 2,028,146.  
NO CLAIM IS MADE TO THE EXCLUSIVE RIGHT TO USE REHABILITATION, APART FROM THE MARK AS SHOWN.  
FOR PHYSICAL AND OCCUPATIONAL REHABILITATION SERVICES (U.S. CLS. 100 AND 101).  
FIRST USE 2-12-2004; IN COMMERCE 2-12-2004.  
AMY GEARIN, EXAMINING ATTORNEY

**CLASS 44—(Continued).**

SN 76-582,508. EVELYN R. EDELMUTH, MD, INDIAN WELLS, CA. FILED 3-22-2004.

**THE SATORI INSTITUTE & RETREAT**

THE MARK CONSISTS OF STANDARD CHARACTERS WITHOUT CLAIM TO ANY PARTICULAR FONT, STYLE, SIZE, OR COLOR.  
NO CLAIM IS MADE TO THE EXCLUSIVE RIGHT TO USE "INSTITUTE & RETREAT", APART FROM THE MARK AS SHOWN.  
THE ENGLISH TRANSLATION OF THE JAPANESE WORD SATORI IN THE MARK IS SPIRITUAL ENLIGHTENMENT.  
FOR HEALTH AND MEDICAL SERVICES (U.S. CLS. 100 AND 101).  
SHARON MEIER, EXAMINING ATTORNEY

SN 76-588,687. CARON FOUNDATION OF NEW YORK, INC., NEW YORK, NY. FILED 4-26-2004.

**CARON NEW YORK RECOVERY CENTER**

THE MARK CONSISTS OF STANDARD CHARACTERS WITHOUT CLAIM TO ANY PARTICULAR FONT, STYLE, SIZE, OR COLOR.  
OWNER OF U.S. REG. NO. 2,486,951.  
NO CLAIM IS MADE TO THE EXCLUSIVE RIGHT TO USE "NEW YORK RECOVERY CENTER", APART FROM THE MARK AS SHOWN.  
FOR HEALTH CARE SERVICES, NAMELY COUNSELING, CONSULTATION, MEDICAL EVALUATIONS AND THE PROVISION OF RESIDENTIAL AND OUTPATIENT CARE FACILITIES TO ASSIST INDIVIDUALS AND FAMILIES WITH CHEMICAL DEPENDENCIES (U.S. CLS. 100 AND 101).  
FIRST USE 6-2-2003; IN COMMERCE 6-2-2003.  
BARBARA A. GOLD, EXAMINING ATTORNEY

SN 76-588,942. HANSEN'S TREE, LAWN AND LANDSCAPING SERVICES, INC., ST. CHARLES, MO. FILED 4-27-2004.



FOR TREE CARE AND REMOVAL SERVICES; LAWN CARE AND MOWING SERVICES; LANDSCAPING SERVICES, NAMELY, LANDSCAPE GARDENING SERVICES (U.S. CLS. 100 AND 101).  
FIRST USE 0-0-1993, 1989.; IN COMMERCE 0-0-1993, 1989 ..  
RON FAIRBANKS, EXAMINING ATTORNEY

**CLASS 44—(Continued).**

SN 76-590,284. ALAN I. ROSENBLATT, MD, SC, CHICAGO, IL. FILED 5-3-2004.



FOR MEDICAL SERVICES (U.S. CLS. 100 AND 101).  
FIRST USE 1-15-2004; IN COMMERCE 3-18-2004.  
INGA ERVIN, EXAMINING ATTORNEY

SN 76-592,057. PERI, CHARLES E., NOVATO, CA. FILED 5-13-2004.

**ACU-GLOW**

THE MARK CONSISTS OF STANDARD CHARACTERS WITHOUT CLAIM TO ANY PARTICULAR FONT, STYLE, SIZE, OR COLOR.

FOR HEALTHCARE SERVICES USING ACUPUNCTURE TREATMENT AND HERBAL PRESCRIPTION (U.S. CLS. 100 AND 101).

FIRST USE 3-16-2004; IN COMMERCE 3-16-2004.  
DOMINIC J. FERRAIUOLO, EXAMINING ATTORNEY

SN 78-218,246. CENTRAL TEXAS ONCOLOGY ASSOCIATION, AUSTIN, TX. FILED 2-24-2003.



NO CLAIM IS MADE TO THE EXCLUSIVE RIGHT TO USE "AUSTIN CANCER CENTERS RADIATION ONCOLOGY", APART FROM THE MARK AS SHOWN.

FOR MEDICAL SERVICES, NAMELY RADIATION ONCOLOGY CANCER TREATMENT SERVICES. (U.S. CLS. 100 AND 101).

VERNA BETH RIRIE, EXAMINING ATTORNEY

**CLASS 44—(Continued).**

SN 78-300,306. VIDEO TREATS INC., POUGHKEEPSIE, NY. FILED 9-15-2003.

**Better Tan**

NO CLAIM IS MADE TO THE EXCLUSIVE RIGHT TO USE "BETTER", APART FROM THE MARK AS SHOWN. FOR TANNING SALON SERVICES (U.S. CLS. 100 AND 101).

FIRST USE 3-1-2001; IN COMMERCE 3-1-2001.  
ODESSA BIBBINS, EXAMINING ATTORNEY

SN 78-317,842. ANKONY LAND, INC., CLARKESVILLE, GA. FILED 10-23-2003.

**ANKONY**

FOR BREEDING AND STUD SERVICES FOR CATTLE (U.S. CLS. 100 AND 101).

FIRST USE 12-31-1935; IN COMMERCE 12-31-1935.  
DOMINIC J. FERRAIUOLO, EXAMINING ATTORNEY

SN 78-327,291. LOYOLA UNIVERSITY OF CHICAGO, CHICAGO, IL. FILED 11-13-2003.

**LOYOLA UNIVERSITY  
MEDICAL CENTER**

THE MARK CONSISTS OF STANDARD CHARACTERS WITHOUT CLAIM TO ANY PARTICULAR FONT, STYLE, SIZE, OR COLOR.

OWNER OF U.S. REG. NOS. 1,643,970 AND 2,726,969.

NO CLAIM IS MADE TO THE EXCLUSIVE RIGHT TO USE "UNIVERSITY" AND "MEDICAL CENTER", APART FROM THE MARK AS SHOWN.

FOR HEALTH CARE SERVICES (U.S. CLS. 100 AND 101).

FIRST USE 0-0-1969; IN COMMERCE 0-0-1969.  
JIM RINGLE, EXAMINING ATTORNEY



**CLASS 44—(Continued).**

SN 78-327,298. LOYOLA UNIVERSITY OF CHICAGO, CHICAGO, IL. FILED 11-13-2003.

**LOYOLA UNIVERSITY  
HEALTH SYSTEM**

THE MARK CONSISTS OF STANDARD CHARACTERS WITHOUT CLAIM TO ANY PARTICULAR FONT, STYLE, SIZE, OR COLOR.

OWNER OF U.S. REG. NOS. 1,643,970 AND 2,726,969. NO CLAIM IS MADE TO THE EXCLUSIVE RIGHT TO USE "UNIVERSITY" AND "HEALTH SYSTEM", APART FROM THE MARK AS SHOWN. FOR HEALTH CARE SERVICES (U.S. CLS. 100 AND 101). FIRST USE 5-0-1996; IN COMMERCE 5-0-1996. JIM RINGLE, EXAMINING ATTORNEY

SN 78-360,918. THOMAS, BORIS, CHICAGO, IL. FILED 2-2-2004.



NO CLAIM IS MADE TO THE EXCLUSIVE RIGHT TO USE LCSW, MSW, JD PSYCHOTHERAPY AND CONSULTATION, APART FROM THE MARK AS SHOWN.

THE COLOR(S) YELLOW, GREEN AND IVORY IS/ARE CLAIMED AS A FEATURE OF THE MARK. THE COLORS GREEN & YELLOW APPEAR IN THE LEAVES

THE MARK CONSISTS OF AN ANIMATION DEPICTING THREE FALLING YELLOW LEAVES. ON EACH RESPECTIVE LEAF, THE WORD MARKS ASPIRE, CHANGE AND UNDERSTAND APPEAR; THE WORD MARK ASPIRE APPEARS IN GREEN, WHILE THE MARKS CHANGE AND UNDERSTAND BOTH APPEAR IN WHITE ON EACH OF THEIR RESPECTIVE LEAVES. THE YELLOW LEAF BEARING THE WORD MARK UNDERSTAND LANDS FIRST ON THE BOTTOM; IT IS FOLLOWED BY THE YELLOW LEAF WITH THE WORD ASPIRE WHICH SETTLES ON TOP OF THE FIRST LEAF. AS THE THIRD LEAF BEARING THE WORD MARK CHANGE FALLS, IT FADES INTO GREEN AND SETTLES ON THE LEFT SIDE OF THE FIRST TWO LEAVES. THE LEAVES DO NOT TOUCH OR

**CLASS 44—(Continued).**

OVERLAP, AND THEY ARE LAID OUT ON AN IVORY BACKGROUND. THE STEM OF THE LEAF BEARING THE WORD MARK CHANGE FACES LEFT; THE STEMS OF THE OTHER TWO LEAVES POINT TO THE RIGHT. AT THE END OF THIS FALLING LEAF SEQUENCE, THE WORD MARKS BORIS THOMAS LCSW, MSW, JD APPEAR IN GREEN TO THE RIGHT OF THE LEAVES; FOLLOWING THIS, THE WORDS PSYCHOTHERAPY AND CONSULTATION APPEAR IN YELLOW AT THE BOTTOM OF THE ABOVE WORD MARKS.

FOR PSYCHOTHERAPY AND CONSULTATION SERVICES, NAMELY, PROFESSIONAL PSYCHOLOGICAL COUNSELING (U.S. CLS. 100 AND 101). FIRST USE 10-1-2003; IN COMMERCE 10-1-2003. TARAH HARDY, EXAMINING ATTORNEY

SN 78-369,324. MARIA, WELCH, Y., BALTIMORE, MD. FILED 2-17-2004.



NO CLAIM IS MADE TO THE EXCLUSIVE RIGHT TO USE "MEDICAL AND RESPIRATORY AND HOME MEDICAL SPECIALISTS", APART FROM THE MARK AS SHOWN.

THE COLOR(S) BLUE IS/ARE CLAIMED AS A FEATURE OF THE MARK.

THE MARK CONSISTS OF STYLIZED LETTERS "RESPIRA MEDICAL" IN A BLUE FONT.

FOR RENTAL OF MEDICAL EQUIPMENT AND HOME HEALTH CARE SERVICES (U.S. CLS. 100 AND 101).

FIRST USE 3-15-2001; IN COMMERCE 3-15-2001. MARGERY A. TIERNEY, EXAMINING ATTORNEY

SN 78-386,277. SABINE GRANDKE-BAYER, SAN RAFAEL, CA. FILED 3-17-2004.



THE COLOR(S) PURPLE IS/ARE CLAIMED AS A FEATURE OF THE MARK.

THE COLOR PURPLE APPEARS IN THE DRAWING OF THE MARK AND THE TEXT BELOW IT.

SEC. 2(F). FOR MASSAGE SERVICES (U.S. CLS. 100 AND 101). FIRST USE 1-1-2002; IN COMMERCE 1-1-2002. INGRID C. EULIN, EXAMINING ATTORNEY

**CLASS 44—(Continued).**

SN 78-391,925. RICHARD A. GANGNES M.D., INC., SAN CLEMENTE, CA. FILED 3-26-2004.



NO CLAIM IS MADE TO THE EXCLUSIVE RIGHT TO USE "AESTHETIC", APART FROM THE MARK AS SHOWN. THE MARK CONSISTS IN PART OF A NAUTILUS SHELL WITH FACES SHOWN INSIDE THE SHELL. FOR MEDICAL SKIN CARE SERVICES (U.S. CLS. 100 AND 101).  
FIRST USE 7-16-1989; IN COMMERCE 7-16-1989.  
FRED MANDIR, EXAMINING ATTORNEY

SN 78-396,626. MARKS, SHELDON H., TUCSON, AZ. FILED 4-5-2004.

**INTERNATIONAL  
CENTER FOR  
VASECTOMY  
REVERSAL**

THE MARK CONSISTS OF STANDARD CHARACTERS WITHOUT CLAIM TO ANY PARTICULAR FONT, STYLE, SIZE, OR COLOR.  
NO CLAIM IS MADE TO THE EXCLUSIVE RIGHT TO USE "VASECTOMY REVERSAL", APART FROM THE MARK AS SHOWN.  
SEC. 2(F).  
FOR MEDICAL SERVICES, NAMELY TREATMENT, TESTING, AND COUNSELING IN MALE FERTILITY HEALTH CARE; VASECTOMY REVERSALS (U.S. CLS. 100 AND 101).  
FIRST USE 12-1-1998; IN COMMERCE 12-0-1998.  
CAROLINE WOOD, EXAMINING ATTORNEY

**CLASS 44—(Continued).**

SN 78-408,176. MEDICAL MUTUAL OF OHIO, CLEVELAND, OH. FILED 4-26-2004.



OWNER OF U.S. REG. NOS. 2,685,935 AND 2,692,633.  
NO CLAIM IS MADE TO THE EXCLUSIVE RIGHT TO USE "HEALTH MANAGEMENT PROGRAMS" AND "COMPANY", APART FROM THE MARK AS SHOWN.  
FOR HEALTH MANAGEMENT PROGRAMS, NAMELY, PROVIDING HEALTH INFORMATION; HEALTH CARE, NAMELY, PREVENTATIVE HEALTH MAINTENANCE PROGRAMS (U.S. CLS. 100 AND 101).  
THEODORE MCBRIDE, EXAMINING ATTORNEY

SN 78-415,823. MEDIMETRIX GROUP, INC., CLEVELAND, OH. FILED 5-10-2004.

**WHAT WOMEN PUT UP  
WITH**

THE MARK CONSISTS OF STANDARD CHARACTERS WITHOUT CLAIM TO ANY PARTICULAR FONT, STYLE, SIZE, OR COLOR.  
FOR MEDICAL SERVICES, HEALTH CARE SERVICES, HOSPITAL SERVICES (U.S. CLS. 100 AND 101).  
DANIELLE MATTESSICH, EXAMINING ATTORNEY

SN 78-416,073. TAKEDA PHARMACEUTICAL COMPANY LIMITED, CHOU-KU, OSAKA, JAPAN, FILED 5-10-2004.

**TAKEDA ENGAGE**

THE MARK CONSISTS OF STANDARD CHARACTERS WITHOUT CLAIM TO ANY PARTICULAR FONT, STYLE, SIZE, OR COLOR.  
FOR MEDICAL AND HEALTH CARE SERVICES IN THE FIELD OF DIABETES (U.S. CLS. 100 AND 101).  
HENRY S. ZAK, EXAMINING ATTORNEY

**CLASS 44—(Continued).**

SN 78-419,089. THOMAS, HERBERT, BALTIMORE, MD.  
FILED 5-14-2004.

Anatripsis

THE MARK CONSISTS OF STANDARD CHARACTERS  
WITHOUT CLAIM TO ANY PARTICULAR FONT, STYLE,  
SIZE, OR COLOR.  
FOR MASSAGE (U.S. CLS. 100 AND 101).  
STANLEY I. OSBORNE, EXAMINING ATTORNEY

SN 78-421,665. TARALAN CORPORATION, BUFFALO, MN.  
FILED 5-19-2004.

CropRx

THE MARK CONSISTS OF STANDARD CHARACTERS  
WITHOUT CLAIM TO ANY PARTICULAR FONT, STYLE,  
SIZE, OR COLOR.  
FOR AGRICULTURAL ADVICE (U.S. CLS. 100 AND  
101).  
FIRST USE 4-24-2000; IN COMMERCE 9-9-2002.  
SEAN DWYER, EXAMINING ATTORNEY

SN 78-975,512. ARES TRADING S.A., CH-1170 AUBONNE,  
SWITZERLAND, FILED 2-19-2003.

XILENTO

FOR MEDICAL SERVICES; PROVIDING MEDICAL  
INFORMATION; MEDICAL COUNSELING (U.S. CLS.  
100 AND 101).  
STEVEN BERK, EXAMINING ATTORNEY

**CLASS 45—PERSONAL SERVICES**

SN 76-583,473. TRUSTMARK INSURANCE COMPANY,  
LAKE FOREST, IL. FILED 3-29-2004.

**THE SENTINEL GROUP**

THE MARK CONSISTS OF STANDARD CHARACTERS  
WITHOUT CLAIM TO ANY PARTICULAR FONT, STYLE,  
SIZE, OR COLOR.  
NO CLAIM IS MADE TO THE EXCLUSIVE RIGHT TO  
USE GROUP, APART FROM THE MARK AS SHOWN.  
FOR INVESTIGATIVE SERVICES FOR FRAUDULENT  
INSURANCE CLAIMS (U.S. CLS. 100 AND 101).  
FIRST USE 4-30-1999; IN COMMERCE 4-30-1999.  
DOUGLAS LEE, EXAMINING ATTORNEY

SN 78-293,869. LAKEWOOD CHURCH, HOUSTON, TX.  
FILED 8-29-2003.

**LAKWOOD  
INTERNATIONAL CENTER**

NO CLAIM IS MADE TO THE EXCLUSIVE RIGHT TO  
USE "INTERNATIONAL CENTER", APART FROM THE  
MARK AS SHOWN.  
FOR MINISTERIAL SERVICES, NAMELY, PROVID-  
ING RELIGIOUS WORSHIP SERVICES; PROVIDING A  
PLACE OF ASSEMBLY FOR PRAYER AND WORSHIP  
(U.S. CLS. 100 AND 101).  
CAROLYN GRAY, EXAMINING ATTORNEY

SN 78-325,361. KESSLER, CRAIG, IRVING, TX. FILED 11-10-  
2003.

**US OneSEARCH**

THE MARK CONSISTS OF STANDARD CHARACTERS  
WITHOUT CLAIM TO ANY PARTICULAR FONT, STYLE,  
SIZE, OR COLOR.  
NO CLAIM IS MADE TO THE EXCLUSIVE RIGHT TO  
USE "US", APART FROM THE MARK AS SHOWN.  
FOR BACKGROUND CHECK SERVICE (U.S. CLS. 100  
AND 101).  
FIRST USE 10-1-2003; IN COMMERCE 10-1-2003.  
JAMES A. RAUEN, EXAMINING ATTORNEY

**CLASS 45—(Continued).**

SN 78-339,751. CELEBRATION OF LIGHT CHURCH, INC., SAN FRANCISCO, CA. FILED 12-11-2003.

**CELEBRATION OF  
LIGHT CHURCH**

THE MARK CONSISTS OF STANDARD CHARACTERS WITHOUT CLAIM TO ANY PARTICULAR FONT, STYLE, SIZE, OR COLOR.

NO CLAIM IS MADE TO THE EXCLUSIVE RIGHT TO USE "CHURCH", APART FROM THE MARK AS SHOWN, FOR SPIRITUAL AND MINISTERIAL SERVICES (U.S. CLS. 100 AND 101).

FIRST USE 5-4-2003; IN COMMERCE 5-4-2003.  
GRETTA YAO, EXAMINING ATTORNEY

SN 78-378,241. CENTER FOR GLOBAL MINISTRIES, PLANO, TX. FILED 3-4-2004.

**Matching Your  
Potential To God's  
Passion**

THE MARK CONSISTS OF STANDARD CHARACTERS WITHOUT CLAIM TO ANY PARTICULAR FONT, STYLE, SIZE, OR COLOR.

FOR MINISTERIAL SERVICES IN THE FORM OF AN USA MISSIONARY AGENCY (U.S. CLS. 100 AND 101).  
FIRST USE 1-0-2003; IN COMMERCE 1-0-2003.  
INGRID C. EULIN, EXAMINING ATTORNEY

**CLASS 45—(Continued).**

SN 78-382,220. PINCHECK, L.C., DES MOINES, IA. FILED 3-11-2004.

**PINCHECK**

THE MARK CONSISTS OF STANDARD CHARACTERS WITHOUT CLAIM TO ANY PARTICULAR FONT, STYLE, SIZE, OR COLOR.

FOR IDENTITY THEFT PROTECTION NAMELY PROTECTING AN INDIVIDUAL FROM THEFT OF PERSONAL, COMMERCIAL, PAYROLL, AND ACCOUNTS PAYABLE ACCOUNTS (U.S. CLS. 100 AND 101).

FIRST USE 11-18-2003; IN COMMERCE 11-18-2003.  
DOUGLAS LEE, EXAMINING ATTORNEY

SN 78-398,859. FDS, INC., FORT WORTH, TX. FILED 4-8-2004.

**COMPLYCHEK**

THE MARK CONSISTS OF STANDARD CHARACTERS WITHOUT CLAIM TO ANY PARTICULAR FONT, STYLE, SIZE, OR COLOR.

FOR PROVIDING ANALYSIS OF PRESCRIPTION DRUG DATA IN ORDER TO DETECT POSSIBLE NON-COMPLIANCE BY THOSE PRESCRIBED PRESCRIPTION DRUGS, AND ALERTING THE PHARMACIST (U.S. CLS. 100 AND 101).

FIRST USE 3-1-2004; IN COMMERCE 3-1-2004.  
MICHAEL HALL, EXAMINING ATTORNEY

**CLASS 45—(Continued).**

SN 78-410,397. JOHN J CLEMONS, MOUND, MN. FILED 4-29-2004.

**CLASS 45—(Continued).**

SN 78-417,972. CHURCH AND CHAPEL FUNERAL SERVICES, INC., WAUKESHA, WI. FILED 5-13-2004.

LoveLinkUp.Net



THE MARK CONSISTS OF STANDARD CHARACTERS WITHOUT CLAIM TO ANY PARTICULAR FONT, STYLE, SIZE, OR COLOR.  
FOR COMPUTER DATING SERVICES INDEPENDENT MATCHMAKER (U.S. CLS. 100 AND 101).  
ANNE MADDEN, EXAMINING ATTORNEY

THE MARK CONSISTS OF A LILY SUPERIMPOSED OVER A STAINED GLASS WINDOW.  
FOR UNDERTAKING SERVICES AND FUNERAL SERVICES, NAMELY, PLANNING, ARRANGING AND CONDUCTING FUNERAL AND MEMORIAL SERVICES (U.S. CLS. 100 AND 101).  
FIRST USE 2-1-1993; IN COMMERCE 2-1-1993.  
C. DIONNE CLYBURN, EXAMINING ATTORNE

\* \* \* \* \*

SECTION 4.—PRIOR UNITED STATES CLASSIFICATION

APPLICATION IN ONE CLASS

COLLECTIVE MEMBERSHIP MARKS

SN 78-417,273. RETAIL SOLUTIONS PROVIDERS ASSOCIATION, INC., CHARLOTTE, NC. FILED 5-12-2004.

CLASS 200—COLLECTIVE MEMBERSHIP  
SN 78-244,629. SOCIETY FOR HUMAN RESOURCE MANAGEMENT, ALEXANDRIA, VA. FILED 5-1-2003.

MEMBER, SOCIETY FOR  
HUMAN RESOURCE  
MANAGEMENT



OWNER OF U.S. REG. NOS. 1,802,392, 2,264,940 AND 2,324,158.

NO CLAIM IS MADE TO THE EXCLUSIVE RIGHT TO USE "MEMBER", APART FROM THE MARK AS SHOWN.

SEC. 2(F) AS TO "SOCIETY FOR HUMAN RESOURCE MANAGEMENT".

FOR INDICATING MEMBERSHIP IN AN ASSOCIATION FOR PROMOTING THE INTERESTS OF THOSE IN THE FIELD OF HUMAN RESOURCE MANAGEMENT.

NORA BUCHANAN WILL, EXAMINING ATTORNEY

NO CLAIM IS MADE TO THE EXCLUSIVE RIGHT TO USE "RETAIL SOLUTIONS PROVIDERS ASSOCIATION", APART FROM THE MARK AS SHOWN.

THE MARK CONSISTS OF THE LETTERS RSPA IN A FANCIFUL FONT WHICH ARE BELOW A LINE DRAWING OF AN ARC AND ABOVE THE WORDS RETAIL SOLUTIONS PROVIDERS ASSOCIATION.

FOR INDICATING MEMBERSHIP IN AN ASSOCIATION OF DEALERS OF CASH REGISTERS AND POINT OF SALE EQUIPMENT .

FIRST USE 11-1-2003; IN COMMERCE 11-1-2003.  
ODESSA BIBBINS, EXAMINING ATTORNEY

SN 78-373,411. OLE TYMERS RETIRED CHICAGO FIREFIGHTERS, CHICAGO, IL. FILED 2-24-2004.

CERTIFICATION MARKS

CLASS A—GOODS

SN 76-552,937. OREGON TILTH, INC., SALEM, OR. FILED 10-2-2003.



NO CLAIM IS MADE TO THE EXCLUSIVE RIGHT TO USE OLD-TIMERS CHICAGO FIREFIGHTERS-PARAMEDICS, APART FROM THE MARK AS SHOWN.

THE MARK CONSISTS OF A STYLIZED BADGE CONTAINING A CLOCK COMPRISED OF A FIREHOSE, FIREFIGHTER'S BOOTS, FIREFIGHTER'S HAT, WITH FIREFIGHTER'S AXE AND PICK AS THE HANDS OF THE CLOCK AND FIREHOUSE NUMBERS AS THE NUMERALS ON THE CLOCK FACE.

FOR INDICATING MEMBERSHIP OF AN ASSOCIATION OF FIREFIGHTERS AND PARAMEDICS WITH MORE THAN 20 YEARS OF SERVICE.

MARIA-VICTORIA SUAREZ, EXAMINING ATTORNEY



THE MARK CONSISTS OF AN ARBITRARY DESIGN WITH THE WORD OTCO.

THE CERTIFICATION MARK, AS USED BY AUTHORIZED PERSONS, CERTIFIES THAT THE PRODUCTS ARE ORGANICALLY GROWN OR PROCESSED

FOR ORGANICALLY GROWN OR PROCESSED AGRICULTURE PRODUCTS, INCLUDING FRUITS, VEGETABLES, NUTS, LIVESTOCK AND DAIRY PRODUCTS FOR HUMAN AND ANIMAL CONSUMPTION.

FIRST USE 2-1-1988; IN COMMERCE 5-1-1988.  
IRENE D. WILLIAMS, EXAMINING ATTORNEY

SN 78-225,159. TRANSACTION PROCESSING PERFORMANCE COUNCIL, SAN FRANCISCO, CA. FILED 3-13-2003.

BARNEY CHARLON, EXAMINING ATTORNEY

**TPC-C**

THE CERTIFICATION MARK, AS USED BY AUTHORIZED PERSONS, CERTIFIES PERFORMANCE AND COST OF OWNERSHIP OF COMPUTER HARDWARE AND SOFTWARE BASED ON THE SPEED AT WHICH SUCH HARDWARE AND SOFTWARE PROCESSES COMMERCIAL TRANSACTIONS.  
 FOR COMPUTER HARDWARE AND SOFTWARE.  
 FIRST USE 6-22-1992; IN COMMERCE 8-13-1992.  
 JOHN LINCOSKI, EXAMINING ATTORNEY

**CLASS B—SERVICES**

SN 76-493,276. INTERNATIONAL CYANIDE MANAGEMENT INSTITUTE, SAN RAMON, CA. FILED 2-27-2003.

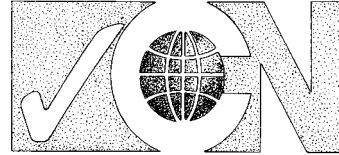

SN 78-225,177. TRANSACTION PROCESSING PERFORMANCE COUNCIL, SAN FRANCISCO, CA. FILED 3-13-2003.

**TPC BENCHMARK**

NO CLAIM IS MADE TO THE EXCLUSIVE RIGHT TO USE "BENCHMARK", APART FROM THE MARK AS SHOWN.  
 THE CERTIFICATION MARK, AS USED BY AUTHORIZED PERSONS, CERTIFIES PERFORMANCE AND COST OF OWNERSHIP OF COMPUTER HARDWARE AND SOFTWARE BASED ON THE SPEED AT WHICH SUCH HARDWARE AND SOFTWARE PROCESSES COMMERCIAL TRANSACTIONS.  
 FOR COMPUTER HARDWARE AND SOFTWARE.  
 FIRST USE 11-10-1989; IN COMMERCE 11-10-1989.  
 JOHN LINCOSKI, EXAMINING ATTORNEY

THE STIPLING IN THE DRAWING IS FOR SHADING PURPOSES ONLY.  
 THE CERTIFICATION MARK, AS INTENDED TO BE USED BY AUTHORIZED PERSONS, CERTIFIES THAT THE PRODUCTION AND DISTRIBUTION OF CYANIDE, AND THE USE OF CYANIDE IN THE RECOVERY OF GOLD, WAS PROPERLY CARRIED OUT IN ACCORDANCE WITH THE INTERNATIONAL CYANIDE MANAGEMENT CODE.  
 FOR PRODUCTION AND DISTRIBUTION OF CYANIDE; USE OF CYANIDE IN THE RECOVERY OF GOLD.  
 INGA ERVIN, EXAMINING ATTORNEY

SN 78-381,394. MYERS, JUDY A, PHILADELPHIA, PA. FILED 3-10-2004.

SN 76-545,299. CAREQUEST, INC., DBA CAREQUEST UNIVERSITY, PLYMOUTH, MN. FILED 9-17-2003.



**Diet Friendly Seal**

OWNER OF U.S. REG. NO. 2,761,303.  
 NO CLAIM IS MADE TO THE EXCLUSIVE RIGHT TO USE "DIET FRIENDLY SEAL", APART FROM THE MARK AS SHOWN.  
 THE CERTIFICATION MARK, AS USED BY AUTHORIZED PERSONS, CERTIFIES THAT THEIR GOODS COMPLY AND/OR ARE CONSISTENT WITH A CERTIFIER'S DIETARY OR OTHER APPLICABLE GUIDELINES OR CRITERIA RELATING TO DIET, HEALTH AND/OR FITNESS.  
 FOR FOODS, BEVERAGES, MEAL REPLACEMENT PRODUCTS AND SUPPLEMENTS.

**LTCRS**

THE MARK CONSISTS OF STANDARD CHARACTERS WITHOUT CLAIM TO ANY PARTICULAR FONT, STYLE, SIZE, OR COLOR.  
 OWNER OF U.S. REG. NO. 2,679,625.  
 THE MARK IS PRESENTED IN STANDARD CHARACTERS WITHOUT ANY CLAIM TO ANY PARTICULAR FONT STYLE, SIZE OR COLOR.  
 THE CERTIFICATION MARK, AS INTENDED TO BE USED BY PERSONS LICENSED BY THE APPLICANT, IS INTENDED TO CERTIFY THAT THE PERSON DISPLAYING SAID MARK HAS TAKEN AND SUCCESSFULLY COMPLETED EDUCATIONAL COURSE WORK REQUIREMENTS BY APPLICANT, AND HAS AGREED TO ADHERE TO APPLICANT'S CODE OF ETHICS, CONTINUING EDUCATION AND OTHER POST- CERTIFICATION REQUIREMENTS, AND IS OTHERWISE COMPETENT IN THE FIELD OF LONG-TERM HEALTH CARE AND ELDER CARE ISSUES AND RESOURCES CONDUCTED BY APPLICANT, C.I. B.  
 FOR CONSULTING SERVICES IN THE FIELD OF LONG-TERM HEALTH CARE AND ELDER CARE ISSUES AND RESOURCES.

TM 516

OFFICIAL GAZETTE

MARCH 1, 2005

VERNA BETH RIRIE, EXAMINING ATTORNE

\* \* \* \* \*



# TRADEMARK REGISTRATIONS ISSUED

## PRINCIPAL REGISTER

### SECTION 1.— INTERNATIONAL CLASSIFICATION

The short titles associated below with the international class numbers are terms designed merely for quick identification and are not an official part of the international classification. The full names of international classes are given in section 6.1 of the trademark rules of practice.

The designation "U.S. Cl." appearing in this section refers to the U.S. class in effect prior to Sep. 1, 1973 rather than the international class which applies to applications filed on or after that date. For adoption of international classification see notice in the OFFICIAL GAZETTE of Jun. 26, 1973 (911 O.G. TM 210).

#### CLASS 1—CHEMICALS

- 2,928,566. **4G10 (BLOCK FORM)**. UPSTATE GROUP, INC., (U.S. CLS. 1, 5, 6, 10, 26 AND 46). SN 76-566,927. PUB. 12-7-2004. FILED 12-10-2003.
- 2,928,567. **TFL AND DESIGN**. TFL LEDERTECHNIK GMBH, MULTIPLE CLASS, (INT. CLS. 1 AND 2), (U.S. CLS. 1, 5, 6, 10, 11, 16, 26 AND 46). SN 76-567,215. PUB. 12-7-2004. FILED 12-24-2003.
- 2,928,571. **ALUFER (BLOCK FORM)**. CANADA/EAGLEBROOK, INC. DU CANADA, (U.S. CLS. 1, 5, 6, 10, 26 AND 46). SN 76-567,474. PUB. 12-7-2004. FILED 12-31-2003.
- 2,928,654. **NODULEST**. LABORATORIOS BIAGRO S.A., (U.S. CLS. 1, 5, 6, 10, 26 AND 46). SN 78-170,020. PUB. 12-7-2004. FILED 10-1-2002.
- 2,928,712. **TRIKLONE**. INEOS CHLOR LIMITED, (U.S. CLS. 1, 5, 6, 10, 26 AND 46). SN 78-279,571. PUB. 12-7-2004. FILED 7-28-2003.
- 2,928,724. **MARLOPHEN**. SASOL GERMANY GMBH, (U.S. CLS. 1, 5, 6, 10, 26 AND 46). SN 78-282,645. PUB. 12-7-2004. FILED 8-4-2003.
- 2,928,756. **TETRATAG (BLOCK FORM)**. STEMCELL TECHNOLOGIES INC., (U.S. CLS. 1, 5, 6, 10, 26 AND 46). SN 78-297,229. PUB. 12-7-2004. FILED 9-8-2003.
- 2,928,777. **ARABAN**. ENOLOGICA VASON S.R.L., (U.S. CLS. 1, 5, 6, 10, 26 AND 46). SN 78-313,882. PUB. 12-7-2004. FILED 10-15-2003.
- 2,928,784. **TEMPO**. BIOMERIEUX, MULTIPLE CLASS, (INT. CLS. 1 AND 9), (U.S. CLS. 1, 5, 6, 10, 21, 23, 26, 36, 38 AND 46). SN 78-315,696. PUB. 12-7-2004. FILED 10-20-2003.
- 2,928,837. **V SEAL (BLOCK FORM)**. TARA DISTRIBUTION GROUP, L.L.C., (U.S. CLS. 1, 5, 6, 10, 26 AND 46). SN 78-339,871. PUB. 12-7-2004. FILED 12-12-2003.
- 2,928,873. **VERTEX CSS-16 (BLOCK FORM)**. VERTEX CHEMICAL CORPORATION, (U.S. CLS. 1, 5, 6, 10, 26 AND 46). SN 78-359,516. PUB. 12-7-2004. FILED 1-29-2004.
- 2,928,889. **TURF-N-TEE (BLOCK FORM)**. SEQUOIA BARK SALES, (U.S. CLS. 1, 5, 6, 10, 26 AND 46). SN 78-366,061. PUB. 12-7-2004. FILED 2-11-2004.
- 2,928,912. **PRO-ACT MICROBIAL (BLOCK FORM)**. PRO-ACT MICROBIAL, INC., (U.S. CLS. 1, 5, 6, 10, 26 AND 46). SN 78-372,135. PUB. 12-7-2004. FILED 2-23-2004.
- 2,928,935. **NANOSPECTRA (BLOCK FORM)**. NANOSPECTRA BIOSCIENCES, INC., (U.S. CLS. 1, 5, 6, 10, 26 AND 46). SN 78-376,012. PUB. 12-7-2004. FILED 2-29-2004.
- 2,928,998. **SURSIL (BLOCK FORM)**. AGXPLORE INTERNATIONAL, LLC, (U.S. CLS. 1, 5, 6, 10, 26 AND 46). SN 78-380,813. PUB. 12-7-2004. FILED 3-9-2004.
- 2,929,010. **RENSHAPE (BLOCK FORM)**. HUNTSMAN ADVANCED MATERIALS AMERICAS INC., (U.S. CLS. 1, 5, 6, 10, 26 AND 46). SN 78-381,159. PUB. 12-7-2004. FILED 3-9-2004.
- 2,929,018. **ONE-PUTT (BLOCK FORM)**. HELENA HOLDING COMPANY, (U.S. CLS. 1, 5, 6, 10, 26 AND 46). SN 78-384,476. PUB. 12-7-2004. FILED 3-15-2004.

#### CLASS 2—PAINTS

- 2,928,567 ( See Class 1 for this trademark).
- 2,928,745. **VERSAPRINT**. ILLINOIS TOOL WORKS INC., (U.S. CLS. 6, 11 AND 16). SN 78-292,754. PUB. 12-7-2004. FILED 8-27-2003.
- 2,928,800. **WHAT A STICK (BLOCK FORM)**. CHIRI ENTERPRISE INC., (U.S. CLS. 6, 11 AND 16). SN 78-324,809. PUB. 12-7-2004. FILED 11-7-2003.
- 2,928,858. **PRO-LINER (BLOCK FORM)**. PRO-LINER, INC., (U.S. CLS. 6, 11 AND 16). SN 78-348,430. PUB. 9-21-2004. FILED 1-6-2004.

#### CLASS 3—COSMETICS AND CLEANING PREPARATIONS

- 2,928,459. **PROVOCATION**. MAURER + WIRTZ GMBH & CO. KG, (U.S. CLS. 1, 4, 6, 50, 51 AND 52). SN 76-218,015. PUB. 10-9-2001. FILED 3-1-2001.
- 2,928,464. **LUST**. NATIONAL CORSET SUPPLY HOUSE, (U.S. CLS. 1, 4, 6, 50, 51 AND 52). SN 76-273,039. PUB. 9-21-2004. FILED 6-18-2001.
- 2,928,491. **CUB CARE**. TULIP BOUTIQUE, INC., (U.S. CLS. 1, 4, 6, 50, 51 AND 52). SN 76-437,953. PUB. 5-27-2003. FILED 8-5-2002.
- 2,928,492. **FOOTLOVERS**. OTC CONNECTION, INC., DBA FOOTWORLD USA, MULTIPLE CLASS, (INT. CLS. 3 AND 10), (U.S. CLS. 1, 4, 6, 26, 39, 44, 50, 51 AND 52). SN 76-439,690. PUB. 12-7-2004. FILED 8-13-2002.
- 2,928,579. **X-100 (BLOCK FORM)**. CLEANLOOK CHEMICAL CORP., (U.S. CLS. 1, 4, 6, 50, 51 AND 52). SN 76-568,556. PUB. 12-7-2004. FILED 1-7-2004.
- 2,928,610. **LIFT VISAGE (BLOCK FORM)**. EMULGEN LABORATORIES, INC., (U.S. CLS. 1, 4, 6, 50, 51 AND 52). SN 76-576,878. PUB. 12-7-2004. FILED 2-20-2004.
- 2,928,700. **BRILLIANT BLONDES**. MARC ANTHONY VENTURE CORPORATION, (U.S. CLS. 1, 4, 6, 50, 51 AND 52). SN 78-275,631. PUB. 12-7-2004. FILED 7-17-2003.
- 2,928,709. **PAIN D'ALEP THE MESOPOTAMIAN SOAP AND DESIGN**. TADE PAYS DU LEVANT S.A.R.L., (U.S. CLS. 1, 4, 6, 50, 51 AND 52). SN 78-278,899. PUB. 12-7-2004. FILED 7-25-2003.
- 2,928,751. **OLEO-MILK**. BEAUTE CREATEURS (SOCIETE ANONYME), (U.S. CLS. 1, 4, 6, 50, 51 AND 52). SN 78-294,886. PUB. 12-7-2004. FILED 9-2-2003.
- 2,928,771. **BEN TUDA**. TATHO MATERIALS, INC., (U.S. CLS. 1, 4, 6, 50, 51 AND 52). SN 78-311,542. PUB. 12-7-2004. FILED 10-9-2003.
- 2,928,776. **WORKMATES**. MCKESSON CORPORATION, MULTIPLE CLASS, (INT. CLS. 3, 5, 9 AND 10), (U.S. CLS. 1, 4, 6, 18, 21, 23, 26, 36, 38, 39, 44, 46, 50, 51 AND 52). SN 78-313,605. PUB. 12-7-2004. FILED 10-14-2003.
- 2,928,817. **HYDRAFUSION TECHNOLOGY (BLOCK FORM)**. ONE WORLD NETWORKS INTEGRATED TECHNOLOGIES, INC., (U.S. CLS. 1, 4, 6, 50, 51 AND 52). SN 78-332,587. PUB. 12-7-2004. FILED 11-24-2003.
- 2,928,859. **ACID SHOCK (BLOCK FORM)**. BEAUTY HOLD-

- ING COMPANY, INC., (U.S. CLS. 1, 4, 6, 50, 51 AND 52). SN 78-349,191. PUB. 12-7-2004. FILED 1-8-2004.
- 2,928,869. **INCHARGEPLUS (BLOCK FORM)**. PUREOLOGY RESEARCH, LLC. (U.S. CLS. 1, 4, 6, 50, 51 AND 52). SN 78-357,457. PUB. 12-7-2004. FILED 1-26-2004.
- 2,928,875. **CRUDE CONTROL (BLOCK FORM)**. RENATURE SKIN CARE INC., (U.S. CLS. 1, 4, 6, 50, 51 AND 52). SN 78-360,101. PUB. 12-7-2004. FILED 1-30-2004.
- 2,928,900. **PUCKER PROTECTOR (BLOCK FORM)**. RAINING ROSE, INC., (U.S. CLS. 1, 4, 6, 50, 51 AND 52). SN 78-370,653. PUB. 12-7-2004. FILED 2-19-2004.
- 2,928,903. **SCENTARETTES (BLOCK FORM)**. STACKED STYLE, INC., (U.S. CLS. 1, 4, 6, 50, 51 AND 52). SN 78-370,824. PUB. 12-7-2004. FILED 2-19-2004.
- 2,928,956. **ERGONIQUE (BLOCK FORM)**. MIX, DEANN, MULTIPLE CLASS, (INT. CLS. 3 AND 44), (U.S. CLS. 1, 4, 6, 50, 51, 52, 100 AND 101). SN 78-377,389. PUB. 12-7-2004. FILED 3-2-2004.
- 2,928,963. **WHITE GOLD (BLOCK FORM)**. DENTSPLY INTERNATIONAL INC., (U.S. CLS. 1, 4, 6, 50, 51 AND 52). SN 78-378,338. PUB. 12-7-2004. FILED 3-4-2004.
- 2,928,999. **SURPIK II (BLOCK FORM)**. AGXPLORE INTERNATIONAL, LLC. (U.S. CLS. 1, 4, 6, 50, 51 AND 52). SN 78-380,818. PUB. 12-7-2004. FILED 3-9-2004.
- 2,929,001. **SPARKLING WHITE (BLOCK FORM)**. COLGATE-PALMOLIVE COMPANY, (U.S. CLS. 1, 4, 6, 50, 51 AND 52). SN 78-380,823. PUB. 12-7-2004. FILED 3-9-2004.

---

#### CLASS 4—LUBRICANTS AND FUELS

- 2,928,744. **MISCELLANEOUS DESIGN**. SHELL TRADE-MARK MANAGEMENT B.V., (U.S. CLS. 1, 6 AND 15). SN 78-291,679. PUB. 12-7-2004. FILED 8-25-2003.
- 2,928,877. **PACIFIC BIODIESEL (BLOCK FORM)**. PACIFIC BIODIESEL, INC., (U.S. CLS. 1, 6 AND 15). SN 78-360,696. PUB. 12-7-2004. FILED 2-1-2004.

---

#### CLASS 5—PHARMACEUTICALS

- 2,928,480. **CORIFEO ERLSENE DRAGEES AUS RHEDE AND DESIGN**. SCHOKO-DRAGEE GMBH, MULTIPLE CLASS, (INT. CLS. 5, 29 AND 30), (U.S. CLS. 6, 18, 44, 46, 51 AND 52). SN 76-398,745. PUB. 12-7-2004. FILED 4-22-2002.
- 2,928,539. **MISCELLANEOUS DESIGN**. BIOPORT CORPORATION, (U.S. CLS. 6, 18, 44, 46, 51 AND 52). SN 76-541,524. PUB. 12-7-2004. FILED 8-25-2003.
- 2,928,540. **BIOTHRAX (STYLIZED)**. BIOPORT CORPORATION, (U.S. CLS. 6, 18, 44, 46, 51 AND 52). SN 76-541,650. PUB. 12-7-2004. FILED 8-25-2003.
- 2,928,600. **PRO SEAL (BLOCK FORM)**. RELIANCE ORTHODONTIC PRODUCTS, INC., (U.S. CLS. 6, 18, 44, 46, 51 AND 52). SN 76-572,975. PUB. 12-7-2004. FILED 1-29-2004.
- 2,928,607. **CHEMFREE+ (BLOCK FORM)**. CHEM FREE LAWN, INC., (U.S. CLS. 6, 18, 44, 46, 51 AND 52). SN 76-575,444. PUB. 12-7-2004. FILED 2-12-2004.
- 2,928,618. **SPEED CLOT (BLOCK FORM)**. THE TRANZONIC COMPANIES, (U.S. CLS. 6, 18, 44, 46, 51 AND 52). SN 76-578,195. PUB. 12-7-2004. FILED 2-26-2004.
- 2,928,625. **SOURCE E (STYLIZED)**. AMERICAN FARM PRODUCTS, INC., (U.S. CLS. 6, 18, 44, 46, 51 AND 52). SN 76-579,071. PUB. 12-7-2004. FILED 3-4-2004.
- 2,928,680. **FUSIONCHIP**. IPSOGEN, (U.S. CLS. 6, 18, 44, 46, 51 AND 52). SN 78-249,506. PUB. 12-7-2004. FILED 5-14-2003.
- 2,928,716. **KANION AND DESIGN**. JIANGSU KANION PHARMACEUTICAL CO., LTD., (U.S. CLS. 6, 18, 44, 46, 51 AND 52). SN 78-280,590. PUB. 12-7-2004. FILED 7-29-2003.
- 2,928,739. **THE HEALING STORE "NATURAL REMEDIES, NATURAL RESULTS" AND DESIGN**. THE HEALING STORE, LLC, (U.S. CLS. 6, 18, 44, 46, 51 AND 52). SN 78-289,759. PUB. 12-7-2004. FILED 8-20-2003.
- 2,928,754. **TOTAL-ZYMES**. NATURAL WELLNESS CENTERS OF AMERICA, DBA ULTRA-PET PRODUCTS, AND BRANNEN, ROGER, (U.S. CLS. 6, 18, 44, 46, 51

- AND 52). SN 78-296,018. PUB. 12-7-2004. FILED 9-4-2003.
- 2,928,773. **LEXIVA**. SMITHKLINE BEECHAM P.L.C., (U.S. CLS. 6, 18, 44, 46, 51 AND 52). SN 78-312,751. PUB. 7-20-2004. FILED 10-13-2003.
- 2,928,776 ( *See Class 3 for this trademark*).
- 2,928,799. **BENICAR HCT (STYLIZED)**. SANKYO COMPANY LIMITED, (U.S. CLS. 6, 18, 44, 46, 51 AND 52). SN 78-323,613. PUB. 12-7-2004. FILED 11-5-2003.
- 2,928,833. **SPECIALTY INJECTABLES FOR LIFE (BLOCK FORM)**. SICOR INC., (U.S. CLS. 6, 18, 44, 46, 51 AND 52). SN 78-338,542. PUB. 12-7-2004. FILED 12-9-2003.
- 2,928,855. **PROTECT PLUS (BLOCK FORM)**. SOCIETE DES PRODUITS NESTLE S.A., (U.S. CLS. 6, 18, 44, 46, 51 AND 52). SN 78-347,820. PUB. 12-7-2004. FILED 1-5-2004.
- 2,928,876. **HERPTIVITE (BLOCK FORM)**. THE ORUP COMPANY, INC., DBA REP-CAL RESEARCH LABS, (U.S. CLS. 6, 18, 44, 46, 51 AND 52). SN 78-360,593. PUB. 12-7-2004. FILED 1-31-2004.
- 2,928,916. **BASIC NUTRIENT SUPPORT (BLOCK FORM)**. NATURAL ALTERNATIVES INTERNATIONAL, INC., (U.S. CLS. 6, 18, 44, 46, 51 AND 52). SN 78-372,715. PUB. 12-7-2004. FILED 2-23-2004.
- 2,928,966. **THE BIRD CONTROL X-PERTS (BLOCK FORM)**. BIRD-X, INC., (U.S. CLS. 6, 18, 44, 46, 51 AND 52). SN 78-378,655. PUB. 12-7-2004. FILED 3-4-2004.

---

#### CLASS 6—METAL GOODS

- 2,928,458. **ALUGLASS**. PROFORMA INTERIORS LTD., MULTIPLE CLASS, (INT. CLS. 6 AND 20), (U.S. CLS. 2, 12, 13, 14, 22, 23, 25, 32 AND 50). SN 76-195,359. PUB. 12-7-2004. FILED 1-17-2001.
- 2,928,500. **PRESSPART**. PRESSPART GMBH & CO., KG, (U.S. CLS. 2, 12, 13, 14, 23, 25 AND 50). SN 76-467,244. PUB. 12-7-2004. FILED 11-6-2002.
- 2,928,508. **TOM CHAMBERS**. TOM CHAMBERS LIMITED, MULTIPLE CLASS, (INT. CLS. 6, 22 AND 28), (U.S. CLS. 1, 2, 7, 12, 13, 14, 19, 22, 23, 25, 38, 42 AND 50). SN 76-506,372. PUB. 12-7-2004. FILED 4-15-2003.
- 2,928,531. **HEFTY**. THE UNIMAX CORPORATION, (U.S. CLS. 2, 12, 13, 14, 23, 25 AND 50). SN 76-538,059. PUB. 12-7-2004. FILED 8-4-2003.
- 2,928,538. **THE OLDE PROVIDENCE HARDWARE COMPANY AND DESIGN**. PROVIDENCE HARDWARE COMPANY, THE, (U.S. CLS. 2, 12, 13, 14, 23, 25 AND 50). SN 76-540,734. PUB. 12-7-2004. FILED 8-14-2003.
- 2,928,596. **LAS VEGAS CENTENNIAL 1905-2005 AND DESIGN**. COMMISSION FOR THE LAS VEGAS CENTENNIAL, (U.S. CLS. 2, 12, 13, 14, 23, 25 AND 50). SN 76-572,375. PUB. 12-7-2004. FILED 1-26-2004.
- 2,928,655. **GRANDE FORGE**. SCHUTT GRANDE FORGE, (U.S. CLS. 2, 12, 13, 14, 23, 25 AND 50). SN 78-171,693. PUB. 12-7-2004. FILED 10-7-2002.
- 2,928,685. **CUREF**. CUREF HOLDING BV, (U.S. CLS. 2, 12, 13, 14, 23, 25 AND 50). SN 78-261,031. PUB. 12-7-2004. FILED 6-11-2003.
- 2,928,808. **YUAN CUT (STYLIZED)**. YUANG JIA FU INDUSTRIAL CORP., (U.S. CLS. 2, 12, 13, 14, 23, 25 AND 50). SN 78-328,489. PUB. 12-7-2004. FILED 11-14-2003.
- 2,929,029. **MISCELLANEOUS DESIGN**. ENVIRON-METAL, INC., MULTIPLE CLASS, (INT. CLS. 6, 13 AND 28), (U.S. CLS. 2, 9, 12, 13, 14, 22, 23, 25, 38 AND 50). SN 78-386,966. PUB. 12-7-2004. FILED 3-18-2004.

---

#### CLASS 7—MACHINERY

- 2,928,473. **STRUCTURED DIAPHRAGM AND DESIGN**. KNF NEUBERGER GMBH, (U.S. CLS. 13, 19, 21, 23, 31, 34 AND 35). SN 76-382,028. PUB. 7-13-2004. FILED 3-13-2002.
- 2,928,475. **DIGITAL MATRIX**. DIGITAL MATRIX CORPORATION, (U.S. CLS. 13, 19, 21, 23, 31, 34 AND 35). SN 76-387,090. PUB. 12-7-2004. FILED 3-25-2002.
- 2,928,488. **ISS**. BERU AG, MULTIPLE CLASS, (INT. CLS. 7

- AND 12), (U.S. CLS. 13, 19, 21, 23, 31, 34, 35 AND 44). SN 76-434,440. PUB. 12-7-2004. FILED 7-24-2002.
- 2,928,550. **DYNAMIC (STYLIZED)**. BROWN, REBECCA A., (U.S. CLS. 13, 19, 21, 23, 31, 34 AND 35). SN 76-548,417. PUB. 12-7-2004. FILED 9-15-2003.
- 2,928,565. **VIKING INCORPORATED AND DESIGN**. VIKING ENGINEERING & DEVELOPMENT, INCORPORATED, (U.S. CLS. 13, 19, 21, 23, 31, 34 AND 35). SN 76-565,713. PUB. 12-7-2004. FILED 12-8-2003.
- 2,928,599. **AI CARDONE AND DESIGN**. CARDONE INDUSTRIES, INC., MULTIPLE CLASS, (INT. CLS. 7, 9 AND 12), (U.S. CLS. 13, 19, 21, 23, 26, 31, 34, 35, 36, 38 AND 44). SN 76-572,749. PUB. 12-7-2004. FILED 1-29-2004.
- 2,928,602. **EZSPlice (BLOCK FORM)**. WIRE BELT COMPANY OF AMERICA, (U.S. CLS. 13, 19, 21, 23, 31, 34 AND 35). SN 76-573,767. PUB. 12-7-2004. FILED 2-3-2004.
- 2,928,603. **EZSPlice AND DESIGN**. WIRE BELT COMPANY OF AMERICA, (U.S. CLS. 13, 19, 21, 23, 31, 34 AND 35). SN 76-573,771. PUB. 12-7-2004. FILED 2-3-2004.
- 2,928,677. **YINGANG AND DESIGN**. INTERNATIONAL HOBBYCRAFT CO., INC., MULTIPLE CLASS, (INT. CLS. 7 AND 12), (U.S. CLS. 13, 19, 21, 23, 31, 34, 35 AND 44). SN 78-244,072. PUB. 12-7-2004. FILED 4-30-2003.
- 2,928,711. **HPI**. HEARTECH PRECISION, INC., (U.S. CLS. 13, 19, 21, 23, 31, 34 AND 35). SN 78-279,060. PUB. 12-7-2004. FILED 7-25-2003.
- 2,928,831. **ROCKY MOUNTAIN BIT (BLOCK FORM)**. MOAB BIT & TOOL CO., INC., (U.S. CLS. 13, 19, 21, 23, 31, 34 AND 35). SN 78-337,361. PUB. 12-7-2004. FILED 12-5-2003.
- 2,928,846. **SCORPION (BLOCK FORM)**. SCORPION FASTENERS, INC., MULTIPLE CLASS, (INT. CLS. 7 AND 8), (U.S. CLS. 13, 19, 21, 23, 28, 31, 34, 35 AND 44). SN 78-345,070. PUB. 12-7-2004. FILED 12-23-2003.
- 2,928,904. **POWERSCOPE (BLOCK FORM)**. WEATHERFORD/LAMB, INC., (U.S. CLS. 13, 19, 21, 23, 31, 34 AND 35). SN 78-370,855. PUB. 12-7-2004. FILED 2-19-2004.
- 2,928,914. **PIVOT DRIVER AND DESIGN**. BLACK AND DECKER CORPORATION, THE, (U.S. CLS. 13, 19, 21, 23, 31, 34 AND 35). SN 78-372,199. PUB. 12-7-2004. FILED 2-23-2004.
- 2,928,918. **ARTISTA (BLOCK FORM)**. CREATIVE INDUSTRIES, INC., (U.S. CLS. 13, 19, 21, 23, 31, 34 AND 35). SN 78-372,722. PUB. 12-7-2004. FILED 2-23-2004.
- 2,928,954. **BULLET (BLOCK FORM)**. SEALED UNIT PARTS CO., INC., (U.S. CLS. 13, 19, 21, 23, 31, 34 AND 35). SN 78-377,196. PUB. 12-7-2004. FILED 3-2-2004.
- 2,928,962. **TURBORAMJET (BLOCK FORM)**. EXHAUST TECH, DIVN OF DYNAFLEX, (U.S. CLS. 13, 19, 21, 23, 31, 34 AND 35). SN 78-378,335. PUB. 12-7-2004. FILED 3-4-2004.
- 2,929,036. **SLICKBORE PLUS (BLOCK FORM)**. HALLIBURTON ENERGY SERVICES, INC., (U.S. CLS. 13, 19, 21, 23, 31, 34 AND 35). SN 78-419,626. PUB. 12-7-2004. FILED 5-17-2004.

## CLASS 8—HAND TOOLS

- 2,928,457. **BIRAMBEAU AND DESIGN**. BIRAMBEAU, S.A., MULTIPLE CLASS, (INT. CLS. 8 AND 21), (U.S. CLS. 2, 13, 23, 28, 29, 30, 33, 40, 44 AND 50). SN 76-181,547. PUB. 12-7-2004. FILED 12-15-2000.
- 2,928,469. **GEARWRENCH**. EASCO HAND TOOLS, INC., (U.S. CLS. 23, 28 AND 44). SN 76-362,016. PUB. 7-20-2004. FILED 1-23-2002.
- 2,928,668. **IBIS AND DESIGN**. SILHOUET-TONE LTD., (U.S. CLS. 23, 28 AND 44). SN 78-226,461. PUB. 12-7-2004. FILED 3-17-2003.
- 2,928,846 ( *See Class 7 for this trademark*).
- 2,928,870. **TITAN (BLOCK FORM)**. L.P.I. CONSUMER PRODUCTS, INC., (U.S. CLS. 23, 28 AND 44). SN 78-357,994. PUB. 12-7-2004. FILED 1-27-2004.
- 2,928,940. **POINT BLANK (BLOCK FORM)**. LMT-FETTE, (U.S. CLS. 23, 28 AND 44). SN 78-376,233. PUB. 12-7-2004. FILED 3-1-2004.

## CLASS 9—ELECTRICAL AND SCIENTIFIC APPARATUS

- 2,928,451. **WINDOWBGA (STYLIZED)**. ULTRATERA CORPORATION, (U.S. CLS. 21, 23, 26, 36 AND 38). SN 75-787,063. PUB. 12-7-2004. FILED 8-27-1999.
- 2,928,452. **MATRIX-HUB (STYLIZED)**. LANTRONIX, INC., (U.S. CLS. 21, 23, 26, 36 AND 38). SN 75-811,718. PUB. 12-7-2004. FILED 9-29-1999.
- 2,928,455. **ISERIES**. INTERNATIONAL BUSINESS MACHINES CORPORATION, MULTIPLE CLASS, (INT. CLS. 9, 16, 37 AND 42), (U.S. CLS. 2, 5, 21, 22, 23, 26, 29, 36, 37, 38, 50, 100, 101, 103 AND 106). SN 76-130,495. PUB. 12-7-2004. FILED 9-18-2000.
- 2,928,460. **SMACKDOWN**. WORLD WRESTLING ENTERTAINMENT, INC., MULTIPLE CLASS, (INT. CLS. 9, 16, 28 AND 41), (U.S. CLS. 2, 5, 21, 22, 23, 26, 29, 36, 37, 38, 50, 100, 101 AND 107). SN 76-219,422. PUB. 12-7-2004. FILED 3-2-2001.
- 2,928,461. **CDV AND DESIGN**. CDV SOFTWARE ENTERTAINMENT AG, MULTIPLE CLASS, (INT. CLS. 9, 16, 28, 35, 38, 41 AND 42), (U.S. CLS. 2, 5, 21, 22, 23, 26, 29, 36, 37, 38, 50, 100, 101, 102, 104 AND 107). SN 76-222,360. PUB. 12-7-2004. FILED 3-7-2001.
- 2,928,462. **INQUIRE**. MELLON BANK, N.A., (U.S. CLS. 21, 23, 26, 36 AND 38). SN 76-235,537. PUB. 12-7-2004. FILED 4-4-2001.
- 2,928,466. **CYWING AND DESIGN**. MEERAE TECH., INC., (U.S. CLS. 21, 23, 26, 36 AND 38). SN 76-290,386. PUB. 4-13-2004. FILED 7-24-2001.
- 2,928,467. **LSF ACTIVECLUSTER**. PLATFORM COMPUTING CORPORATION, (U.S. CLS. 21, 23, 26, 36 AND 38). SN 76-319,043. PUB. 12-7-2004. FILED 9-26-2001.
- 2,928,477. **HEAD VISION SYSTEM**. HEAD SPORT AG, (U.S. CLS. 21, 23, 26, 36 AND 38). SN 76-395,521. PUB. 12-7-2004. FILED 4-12-2002.
- 2,928,489. **LORIS**. KEMIRA GROWHOW OY, MULTIPLE CLASS, (INT. CLS. 9, 42 AND 44), (U.S. CLS. 21, 23, 26, 36, 38, 100 AND 101). SN 76-436,262. PUB. 12-7-2004. FILED 7-30-2002.
- 2,928,494. **TAKSTAR (STYLIZED)**. GUANGDONG TAKSTAR ELECTRONIC CO., LTD., (U.S. CLS. 21, 23, 26, 36 AND 38). SN 76-441,907. PUB. 12-7-2004. FILED 8-14-2002.
- 2,928,513. **CASINO INC. AND DESIGN**. KONAMI CORPORATION, (U.S. CLS. 21, 23, 26, 36 AND 38). SN 76-516,664. PUB. 7-20-2004. FILED 4-22-2003.
- 2,928,514. **JOY OF PAINTING**. BOB ROSS, INC., MULTIPLE CLASS, (INT. CLS. 9 AND 41), (U.S. CLS. 21, 23, 26, 36, 38, 100, 101 AND 107). SN 76-518,707. PUB. 12-7-2004. FILED 5-8-2003.
- 2,928,515. **ACCESS GRID AND DESIGN**. THE UNIVERSITY OF CHICAGO, (U.S. CLS. 21, 23, 26, 36 AND 38). SN 76-520,728. PUB. 12-7-2004. FILED 5-27-2003.
- 2,928,524. **DIRECTORY OF CONVENIENCE STORES**. TRADE DIMENSIONS INTERNATIONAL, INC., MULTIPLE CLASS, (INT. CLS. 9 AND 16), (U.S. CLS. 2, 5, 21, 22, 23, 26, 29, 36, 37, 38 AND 50). SN 76-534,012. PUB. 12-7-2004. FILED 8-1-2003.
- 2,928,529. **TLSI SILICON DRIVEN AND DESIGN**. TLSI INCORPORATED, MULTIPLE CLASS, (INT. CLS. 9 AND 42), (U.S. CLS. 21, 23, 26, 36, 38, 100 AND 101). SN 76-537,409. PUB. 12-7-2004. FILED 8-14-2003.
- 2,928,530. **MAS**. TROPICAL MUSIC EXPORT ENTERPRISES, INC., (U.S. CLS. 21, 23, 26, 36 AND 38). SN 76-537,413. PUB. 12-7-2004. FILED 8-14-2003.
- 2,928,532. **INTUITION**. VITALWORKS INC., (U.S. CLS. 21, 23, 26, 36 AND 38). SN 76-538,141. PUB. 12-7-2004. FILED 8-1-2003.
- 2,928,533. **TRIPPAK ONLINE (STYLIZED)**. TRUCKLOAD MANAGEMENT, INC., DBA TMI, MULTIPLE CLASS, (INT. CLS. 9 AND 40), (U.S. CLS. 21, 23, 26, 36, 38, 100, 103 AND 106). SN 76-538,142. PUB. 12-7-2004. FILED 8-1-2003.
- 2,928,537. **RXASSIST PLUS**. THE MEMORIAL HOSPITAL, (U.S. CLS. 21, 23, 26, 36 AND 38). SN 76-539,374. PUB. 12-7-2004. FILED 7-21-2003.
- 2,928,559. **IMOD AND DESIGN**. BOARD OF REGENTS OF THE UNIVERSITY SYSTEM OF GEORGIA, (U.S. CLS. 21, 23, 26, 36 AND 38). SN 76-559,833. PUB. 12-7-2004. FILED 10-29-2003.

- 2,928,560. **SYNTHETIX**. SYNGENCE, L.L.C., (U.S. CLS. 21, 23, 26, 36 AND 38). SN 76-559,835. PUB. 12-7-2004. FILED 10-29-2003.
- 2,928,568. **NISC (BLOCK FORM)**. NATIONAL INFORMATION SOLUTIONS COOPERATIVE, INC., MULTIPLE CLASS, (INT. CLS. 9, 35, 41 AND 42), (U.S. CLS. 21, 23, 26, 36, 38, 100, 101, 102 AND 107). SN 76-567,293. PUB. 12-7-2004. FILED 12-29-2003.
- 2,928,570. **CAPITAL MATTERS (BLOCK FORM)**. GENERAL RE CORPORATION, MULTIPLE CLASS, (INT. CLS. 9 AND 16), (U.S. CLS. 2, 5, 21, 22, 23, 26, 29, 36, 37, 38 AND 50). SN 76-567,414. PUB. 12-7-2004. FILED 12-29-2003.
- 2,928,595. **STAGINGDIRECTOR (BLOCK FORM)**. RAPISTAN SYSTEMS ADVERTISING CORP., (U.S. CLS. 21, 23, 26, 36 AND 38). SN 76-572,000. PUB. 12-7-2004. FILED 1-20-2004.
- 2,928,599 ( *See Class 7 for this trademark*).
- 2,928,605. **DOOM3 (BLOCK FORM)**. ID SOFTWARE, INC., (U.S. CLS. 21, 23, 26, 36 AND 38). SN 76-575,353. PUB. 12-7-2004. FILED 2-13-2004.
- 2,928,620. **READYON (STYLIZED)**. VENTURCOM, INC., (U.S. CLS. 21, 23, 26, 36 AND 38). SN 76-578,419. PUB. 12-7-2004. FILED 3-1-2004.
- 2,928,637. **DXTREME (BLOCK FORM)**. FRONTIER FASHION, INC., (U.S. CLS. 21, 23, 26, 36 AND 38). SN 76-579,954. PUB. 12-7-2004. FILED 3-8-2004.
- 2,928,638. **UIDM (BLOCK FORM)**. INNOVATIVE CONCEPTS INC., (U.S. CLS. 21, 23, 26, 36 AND 38). SN 76-579,988. PUB. 12-7-2004. FILED 3-8-2004.
- 2,928,646. **MASKTOOLS (BLOCK FORM)**. ASML MASK-TOOLS B.V., MULTIPLE CLASS, (INT. CLS. 9, 41 AND 42), (U.S. CLS. 21, 23, 26, 36, 38, 100, 101 AND 107). SN 76-598,086. PUB. 12-7-2004. FILED 6-18-2004.
- 2,928,652. **COKTEL AND DESIGN**. VIVENDI UNIVERSAL INTERACTIVE PUBLISHING INTERNATIONAL, MULTIPLE CLASS, (INT. CLS. 9, 16, 28, 38, 41 AND 42), (U.S. CLS. 2, 5, 21, 22, 23, 26, 29, 36, 37, 38, 50, 100, 101, 104 AND 107). SN 78-146,276. PUB. 5-4-2004. FILED 7-22-2002.
- 2,928,659. **DOSE**. ST TRAINING & SIMULATION PTE LTD, MULTIPLE CLASS, (INT. CLS. 9, 41 AND 42), (U.S. CLS. 21, 23, 26, 36, 38, 100, 101 AND 107). SN 78-210,824. PUB. 9-14-2004. FILED 2-4-2003.
- 2,928,661. **EZ TALKING IMAGES**. CASCADE RESTORATION & CONSTRUCTION, INC., (U.S. CLS. 21, 23, 26, 36 AND 38). SN 78-217,378. PUB. 7-20-2004. FILED 2-21-2003.
- 2,928,707. **METAL SHELL**. TANTALUS INTERACTIVE PTY LTD, MULTIPLE CLASS, (INT. CLS. 9, 16 AND 28), (U.S. CLS. 2, 5, 21, 22, 23, 26, 29, 36, 37, 38 AND 50). SN 78-278,775. PUB. 12-7-2004. FILED 7-25-2003.
- 2,928,727. **MAP2**. SODEXHO OPERATIONS, LLC, (U.S. CLS. 21, 23, 26, 36 AND 38). SN 78-284,766. PUB. 12-7-2004. FILED 8-8-2003.
- 2,928,729. **TIMEWARE RMS**. TIMEWARE INCORPORATED, (U.S. CLS. 21, 23, 26, 36 AND 38). SN 78-285,356. PUB. 12-7-2004. FILED 8-9-2003.
- 2,928,731. **MAGICTUNE AND DESIGN**. SAMSUNG ELECTRONICS CO., LTD., (U.S. CLS. 21, 23, 26, 36 AND 38). SN 78-286,211. PUB. 12-7-2004. FILED 8-12-2003.
- 2,928,755. **PLANET COOK**. PLATINUM FILMS LIMITED, MULTIPLE CLASS, (INT. CLS. 9, 16, 21, 24, 25, 28, 29, 30, 32 AND 41), (U.S. CLS. 2, 5, 13, 21, 22, 23, 26, 29, 30, 33, 36, 37, 38, 39, 40, 42, 45, 46, 48, 50, 100, 101 AND 107). SN 78-296,873. PUB. 12-7-2004. FILED 9-5-2003.
- 2,928,763. **MISCELLANEOUS DESIGN**. ENERGY SOLUTIONS, (U.S. CLS. 21, 23, 26, 36 AND 38). SN 78-304,671. PUB. 7-20-2004. FILED 9-24-2003.
- 2,928,772. **S AND DESIGN**. STORACTIVE, INC., MULTIPLE CLASS, (INT. CLS. 9 AND 42), (U.S. CLS. 21, 23, 26, 36, 38, 100 AND 101). SN 78-311,846. PUB. 12-7-2004. FILED 10-9-2003.
- 2,928,776 ( *See Class 3 for this trademark*).
- 2,928,783. **SAFE-T**. SAFE-T PRODUCTS, INC., MULTIPLE CLASS, (INT. CLS. 9 AND 16), (U.S. CLS. 2, 5, 21, 22, 23, 26, 29, 36, 37, 38 AND 50). SN 78-315,125. PUB. 12-7-2004. FILED 10-17-2003.
- 2,928,784 ( *See Class 1 for this trademark*).
- 2,928,785. **FITNESS FOR KEEPS TRAIN RIGHT WORK HARD SEE RESULTS AND DESIGN**. THUNDER DYNAMICS INC., (U.S. CLS. 21, 23, 26, 36 AND 38). SN 78-316,480. PUB. 12-7-2004. FILED 10-21-2003.
- 2,928,803. **NEXMINER (BLOCK FORM)**. NEXIDIA, INC., (U.S. CLS. 21, 23, 26, 36 AND 38). SN 78-326,277. PUB. 7-20-2004. FILED 11-11-2003.
- 2,928,804. **NEXIDIA (BLOCK FORM)**. NEXIDIA, INC., MULTIPLE CLASS, (INT. CLS. 9 AND 42), (U.S. CLS. 21, 23, 26, 36, 38, 100 AND 101). SN 78-326,283. PUB. 7-20-2004. FILED 11-11-2003.
- 2,928,819. **KREG INFORMATION SYSTEMS (BLOCK FORM)**. KREG CORPORATION, MULTIPLE CLASS, (INT. CLS. 9, 35 AND 42), (U.S. CLS. 21, 23, 26, 36, 38, 100, 101 AND 102). SN 78-333,387. PUB. 12-7-2004. FILED 11-26-2003.
- 2,928,820. **KREG INFORMATION SYSTEMS AND DESIGN**. KREG CORPORATION, MULTIPLE CLASS, (INT. CLS. 9, 35 AND 42), (U.S. CLS. 21, 23, 26, 36, 38, 100, 101 AND 102). SN 78-333,389. PUB. 12-7-2004. FILED 11-26-2003.
- 2,928,826. **OUTLAW VOLLEYBALL (BLOCK FORM)**. VIA-COM INTERNATIONAL INC., (U.S. CLS. 21, 23, 26, 36 AND 38). SN 78-336,337. PUB. 12-7-2004. FILED 12-4-2003.
- 2,928,832. **VC (STYLIZED)**. BRUNSWICK CORPORATION, (U.S. CLS. 21, 23, 26, 36 AND 38). SN 78-338,184. PUB. 12-7-2004. FILED 12-9-2003.
- 2,928,836. **OCS OPEN CONTROL SOLUTIONS AND DESIGN**. DATA FLOW SYSTEMS, INC., (U.S. CLS. 21, 23, 26, 36 AND 38). SN 78-339,642. PUB. 12-7-2004. FILED 12-11-2003.
- 2,928,856. **PERVASIVE (BLOCK FORM)**. PERVASIVE SOFTWARE INC., (U.S. CLS. 21, 23, 26, 36 AND 38). SN 78-347,942. PUB. 12-7-2004. FILED 1-5-2004.
- 2,928,863. **SMARTLINK AND DESIGN**. SMART DOCUMENT SOLUTIONS, LLC, (U.S. CLS. 21, 23, 26, 36 AND 38). SN 78-351,849. PUB. 12-7-2004. FILED 1-14-2004.
- 2,928,887. **LIMELIGHT (BLOCK FORM)**. ACTIMETRICS, INC., (U.S. CLS. 21, 23, 26, 36 AND 38). SN 78-365,037. PUB. 12-7-2004. FILED 2-9-2004.
- 2,928,925. **TEL-RAY (BLOCK FORM)**. AVID TECHNOLOGY, INC., (U.S. CLS. 21, 23, 26, 36 AND 38). SN 78-373,236. PUB. 12-7-2004. FILED 2-24-2004.
- 2,928,933. **SILOS (BLOCK FORM)**. SIMUCAD, INC., (U.S. CLS. 21, 23, 26, 36 AND 38). SN 78-375,796. PUB. 12-7-2004. FILED 2-27-2004.
- 2,928,934. **MEKKO (STYLIZED)**. CHU, VICTOR W., (U.S. CLS. 21, 23, 26, 36 AND 38). SN 78-375,934. PUB. 12-7-2004. FILED 2-29-2004.
- 2,928,937. **TCACCESS AND DESIGN**. GT SOFTWARE, INC., (U.S. CLS. 21, 23, 26, 36 AND 38). SN 78-376,138. PUB. 12-7-2004. FILED 3-1-2004.
- 2,928,939. **BMS/GT AND DESIGN**. GT SOFTWARE, INC., (U.S. CLS. 21, 23, 26, 36 AND 38). SN 78-376,159. PUB. 12-7-2004. FILED 3-1-2004.
- 2,928,953. **MOVE YA! (BLOCK FORM)**. PURE PLEASURE MUSIC GMBH, MULTIPLE CLASS, (INT. CLS. 9 AND 35), (U.S. CLS. 21, 23, 26, 36, 38, 100, 101 AND 102). SN 78-377,063. PUB. 12-7-2004. FILED 3-2-2004.
- 2,928,960. **PMCLOGIC (BLOCK FORM)**. COMPUTERLOGIC, INC., (U.S. CLS. 21, 23, 26, 36 AND 38). SN 78-378,017. PUB. 12-7-2004. FILED 3-3-2004.
- 2,928,961. **AFB (BLOCK FORM)**. V-CORP TECHNOLOGIES, INC., (U.S. CLS. 21, 23, 26, 36 AND 38). SN 78-378,301. PUB. 12-7-2004. FILED 3-4-2004.
- 2,928,974. **COMFORT ALERT (BLOCK FORM)**. COPELAND CORPORATION, (U.S. CLS. 21, 23, 26, 36 AND 38). SN 78-378,790. PUB. 12-7-2004. FILED 3-4-2004.
- 2,928,981. **EXACTLY WHAT YOU NEED TO KNOW...TO GROW (BLOCK FORM)**. NUEDGE SYSTEMS, LLC, MULTIPLE CLASS, (INT. CLS. 9 AND 35), (U.S. CLS. 21, 23, 26, 36, 38, 100, 101 AND 102). SN 78-379,157. PUB. 12-7-2004. FILED 3-5-2004.
- 2,928,996. **SPEAK TO ME (BLOCK FORM)**. MERRILL, JOSEPH, AND MERRILL, CHRISTEL, (U.S. CLS. 21, 23, 26, 36 AND 38). SN 78-380,779. PUB. 12-7-2004. FILED 3-9-2004.
- 2,929,005. **S C SAFECASH AND DESIGN**. SECURITY ARMORED EXPRESS, INC., (U.S. CLS. 21, 23, 26, 36 AND 38). SN 78-380,915. PUB. 12-7-2004. FILED 3-9-2004.
- 2,929,006. **JREPOSITORY (BLOCK FORM)**. XPDIATE CONSULTING, LLC, (U.S. CLS. 21, 23, 26, 36 AND 38). SN 78-380,963. PUB. 12-7-2004. FILED 3-9-2004.
- 2,929,019. **SCHEMASERVER (BLOCK FORM)**. SCHEMALO-

- GIC, INC., (U.S. CLS. 21, 23, 26, 36 AND 38). SN 78-384,506. PUB. 12-7-2004. FILED 3-15-2004.  
 2,929,024. **CORSTRATEGY (BLOCK FORM)**. CORVU CORPORATION, (U.S. CLS. 21, 23, 26, 36 AND 38). SN 78-385,116. PUB. 12-7-2004. FILED 3-16-2004.  
 2,929,026. **HOMEBEST (BLOCK FORM)**. SUPERVALU HOLDINGS, INC., (U.S. CLS. 21, 23, 26, 36 AND 38). SN 78-385,941. PUB. 12-7-2004. FILED 3-17-2004.

---

### CLASS 10—MEDICAL APPARATUS

- 2,928,474. **SOFTSCAN AND DESIGN**. ART ADVANCED RESEARCH TECHNOLOGIES INC./ART RECHERCHES ET TECHNOLOGIES AVANCEES INC., (U.S. CLS. 26, 39 AND 44). SN 76-383,328. PUB. 8-17-2004. FILED 3-19-2002.  
 2,928,487. **US BABY AND DESIGN**. AMERICAN US BABY CORP., (U.S. CLS. 26, 39 AND 44). SN 76-430,903. PUB. 12-7-2004. FILED 7-15-2002.  
 2,928,492 ( *See Class 3 for this trademark*).  
 2,928,546. **GCS**. FOOT LEVELERS, INC., (U.S. CLS. 26, 39 AND 44). SN 76-545,999. PUB. 12-7-2004. FILED 9-22-2003.  
 2,928,577. **OX-GEN FLEXIBLE LIFE SYSTEMS (STYLIZED)**. OX-GEN, INC., (U.S. CLS. 26, 39 AND 44). SN 76-568,547. PUB. 12-7-2004. FILED 12-22-2003.  
 2,928,578. **OX-GEN FLEXIBLE O2 GENERATOR (STYLIZED)**. OX-GEN, INC., (U.S. CLS. 26, 39 AND 44). SN 76-568,548. PUB. 12-7-2004. FILED 12-22-2003.  
 2,928,632. **COMFORTIP (BLOCK FORM)**. C.B. FLEET INVESTMENT CORPORATION, (U.S. CLS. 26, 39 AND 44). SN 76-579,737. PUB. 12-7-2004. FILED 3-8-2004.  
 2,928,681. **AMSSY AND DESIGN**. BEIJING AMSSY ELECTRONIC SCIENCE & TECHNOLOGY CO., LTD., (U.S. CLS. 26, 39 AND 44). SN 78-252,374. PUB. 12-7-2004. FILED 5-20-2003.  
 2,928,683. **OOT**. OTICON A/S, (U.S. CLS. 26, 39 AND 44). SN 78-255,691. PUB. 12-7-2004. FILED 5-29-2003.  
 2,928,706. **QUICK-CROSS (BLOCK FORM)**. THE SPECTRANETICS CORPORATION, (U.S. CLS. 26, 39 AND 44). SN 78-278,418. PUB. 12-7-2004. FILED 7-24-2003.  
 2,928,742. **INVIVO)MDE**. INVIVO RESEARCH INC., (U.S. CLS. 26, 39 AND 44). SN 78-290,278. PUB. 12-7-2004. FILED 8-21-2003.  
 2,928,776 ( *See Class 3 for this trademark*).  
 2,928,779. **LSMP**. LONE STAR MEDICAL PRODUCTS, INC., (U.S. CLS. 26, 39 AND 44). SN 78-314,348. PUB. 12-7-2004. FILED 10-16-2003.  
 2,928,780. **REFINING THE ART OF SURGERY**. LONE STAR MEDICAL PRODUCTS, INC., (U.S. CLS. 26, 39 AND 44). SN 78-314,352. PUB. 12-7-2004. FILED 10-16-2003.  
 2,928,781. **MISCELLANEOUS DESIGN**. LONE STAR MEDICAL PRODUCTS, INC., (U.S. CLS. 26, 39 AND 44). SN 78-314,354. PUB. 12-7-2004. FILED 10-16-2003.  
 2,928,878. **LEVIA (BLOCK FORM)**. LERNER MEDICAL DEVICES, INC., (U.S. CLS. 26, 39 AND 44). SN 78-360,749. PUB. 12-7-2004. FILED 2-2-2004.  
 2,928,947. **DIAMOND-DRIVE (BLOCK FORM)**. SNOWDEN PENCER, INC., (U.S. CLS. 26, 39 AND 44). SN 78-376,739. PUB. 12-7-2004. FILED 3-2-2004.

---

### CLASS 11—ENVIRONMENTAL CONTROL APPARATUS

- 2,928,478. **NO-RING**. MEISSNER FILTRATION PRODUCTS, INC., (U.S. CLS. 13, 21, 23, 31 AND 34). SN 76-396,060. PUB. 12-7-2004. FILED 4-16-2002.  
 2,928,499. **THERMOTEK**. CAPTIVE-AIRE SYSTEMS, INC., (U.S. CLS. 13, 21, 23, 31 AND 34). SN 76-458,951. PUB. 7-20-2004. FILED 10-17-2002.  
 2,928,527. **GRILLS BY NC**. NATURAL CREATIONS, CORP., (U.S. CLS. 13, 21, 23, 31 AND 34). SN 76-536,444. PUB. 12-7-2004. FILED 8-11-2003.  
 2,928,549. **POCKET PRO**. ZUCCHERO, VINCENT W., (U.S. CLS. 13, 21, 23, 31 AND 34). SN 76-547,632. PUB. 7-20-2004.

- FILED 9-29-2003.  
 2,928,564. **KRYO (BLOCK FORM)**. KRYOGENIFEX, INC., (U.S. CLS. 13, 21, 23, 31 AND 34). SN 76-563,707. PUB. 12-7-2004. FILED 11-24-2003.  
 2,928,580. **S-NO-ICE (BLOCK FORM)**. VIEGA N.A., INC., (U.S. CLS. 13, 21, 23, 31 AND 34). SN 76-568,643. PUB. 12-7-2004. FILED 12-22-2003.  
 2,928,592. **THE SCIENCE OF INNOVATION. THE ART OF INVIGORATION. (BLOCK FORM)**. DIMENSION ONE SPAS, INC., (U.S. CLS. 13, 21, 23, 31 AND 34). SN 76-571,257. PUB. 12-7-2004. FILED 1-9-2004.  
 2,928,662. **REMOSKA**. INTERTRADE AVENUE INC., (U.S. CLS. 13, 21, 23, 31 AND 34). SN 78-219,964. PUB. 12-7-2004. FILED 2-27-2003.  
 2,928,663. **GLIDE & COOK**. LG ELECTRONICS INC., (U.S. CLS. 13, 21, 23, 31 AND 34). SN 78-223,602. PUB. 12-7-2004. FILED 3-10-2003.  
 2,928,674. **AQUAFIER AND DESIGN**. CULLIGAN INTERNATIONAL COMPANY, (U.S. CLS. 13, 21, 23, 31 AND 34). SN 78-233,743. PUB. 12-7-2004. FILED 4-3-2003.  
 2,928,713. **AMMENS**. HELEN OF TROY LIMITED, (U.S. CLS. 13, 21, 23, 31 AND 34). SN 78-279,784. PUB. 12-7-2004. FILED 7-28-2003.  
 2,928,788. **ACCU-THERM**. PAUL MUELLER COMPANY, (U.S. CLS. 13, 21, 23, 31 AND 34). SN 78-318,815. PUB. 12-7-2004. FILED 10-27-2003.  
 2,928,812. **ICEBOOSTER (BLOCK FORM)**. CHEATWOOD, HARRY, T., (U.S. CLS. 13, 21, 23, 31 AND 34). SN 78-329,409. PUB. 12-7-2004. FILED 11-18-2003.  
 2,929,044. **OTT-LITE VISION SAVER PLUS (BLOCK FORM)**. ENVIRONMENTAL LIGHTING CONCEPTS, INC., (U.S. CLS. 13, 21, 23, 31 AND 34). SN 78-474,159. PUB. 12-7-2004. FILED 8-26-2004.  
 2,929,045. **OTT-LITE HDLT AND DESIGN**. ENVIRONMENTAL LIGHTING CONCEPTS, INC., (U.S. CLS. 13, 21, 23, 31 AND 34). SN 78-474,312. PUB. 12-7-2004. FILED 8-26-2004.

---

### CLASS 12—VEHICLES

- 2,928,488 ( *See Class 7 for this trademark*).  
 2,928,523. **MISCELLANEOUS DESIGN**. SUPER LAWN TRUCK, INC., (U.S. CLS. 19, 21, 23, 31, 35 AND 44). SN 76-533,859. PUB. 12-7-2004. FILED 8-1-2003.  
 2,928,599 ( *See Class 7 for this trademark*).  
 2,928,631. **ZACK SHACK (BLOCK FORM)**. ZACHMEIER MANUFACTURING, INC., (U.S. CLS. 19, 21, 23, 31, 35 AND 44). SN 76-579,689. PUB. 12-7-2004. FILED 3-8-2004.  
 2,928,669. **POLAR SPORT SPORT & UTILITY PRODUCTS AND DESIGN**. THIELEN MARKETING, INC., (U.S. CLS. 19, 21, 23, 31, 35 AND 44). SN 78-228,431. PUB. 12-7-2004. FILED 3-21-2003.  
 2,928,677 ( *See Class 7 for this trademark*).  
 2,928,806. **AH-1Z (BLOCK FORM)**. BELL HELICOPTER TEXTRON INC., (U.S. CLS. 19, 21, 23, 31, 35 AND 44). SN 78-327,346. PUB. 12-7-2004. FILED 11-13-2003.  
 2,928,841. **TRAILSTAR (BLOCK FORM)**. TRACKER MARINE, L.L.C., (U.S. CLS. 19, 21, 23, 31, 35 AND 44). SN 78-341,399. PUB. 12-7-2004. FILED 12-16-2003.  
 2,928,943. **COGAPA AND DESIGN**. MICROSYSTEMS DEVELOPMENT, (U.S. CLS. 19, 21, 23, 31, 35 AND 44). SN 78-376,605. PUB. 12-7-2004. FILED 3-1-2004.  
 2,928,964. **CONTRACTOR'S CHOICE (STYLIZED)**. HARBOR SALES COMPANY, (U.S. CLS. 19, 21, 23, 31, 35 AND 44). SN 78-378,429. PUB. 12-7-2004. FILED 3-4-2004.  
 2,928,968. **TRAIL HORSE (BLOCK FORM)**. BISON MANUFACTURING, LLC, (U.S. CLS. 19, 21, 23, 31, 35 AND 44). SN 78-378,715. PUB. 12-7-2004. FILED 3-4-2004.  
 2,928,986. **UNIVERSAL TRAILER AND DESIGN**. UNIVERSAL TRAILER HOLDINGS CORP., (U.S. CLS. 19, 21, 23, 31, 35 AND 44). SN 78-379,614. PUB. 12-7-2004. FILED 3-5-2004.  
 2,929,014. **A UNIVERSAL TRAILER CORP. AND DESIGN**. UNIVERSAL TRAILER HOLDINGS CORP., (U.S. CLS. 19, 21, 23, 31, 35 AND 44). SN 78-381,957. PUB. 12-7-2004. FILED 3-10-2004.

**CLASS 13—FIREARMS**

- 2,928,765. **OTTR. SIROIS, MICHAEL A., DBA ON TARGET TECHNOLOGIES, LLC.** (U.S. CLS. 2 AND 9). SN 78-305,959. PUB. 12-7-2004. FILED 9-26-2003.
- 2,929,027. **INFINITY (BLOCK FORM), STRAYER-VOIGT INC.** (U.S. CLS. 2 AND 9). SN 78-386,525. PUB. 12-7-2004. FILED 3-18-2004.
- 2,929,029 ( *See Class 6 for this trademark.*)

**CLASS 14—JEWELRY**

- 2,928,630. **RESURRECTION POWER (BLOCK FORM), MA-GUIRE, THOMAS J.,** (U.S. CLS. 2, 27, 28 AND 50). SN 76-579,663. PUB. 12-7-2004. FILED 3-8-2004.
- 2,928,643. **ORIGO (BLOCK FORM), OTEVAN S.A.,** (U.S. CLS. 2, 27, 28 AND 50). SN 76-581,176. PUB. 12-7-2004. FILED 3-16-2004.
- 2,928,702. **MONO. LIFESTYLE GROUP GMBH,** (U.S. CLS. 2, 27, 28 AND 50). SN 78-276,035. PUB. 12-7-2004. FILED 7-18-2003.
- 2,928,798. **TKE (BLOCK FORM), TAU KAPPA EPSILON FRATERNITY, MULTIPLE CLASS, (INT. CLS. 14 AND 25),** (U.S. CLS. 2, 22, 27, 28, 39 AND 50). SN 78-323,542. PUB. 7-20-2004. FILED 11-5-2003.
- 2,929,032. **BAKED BEADS (BLOCK FORM), BAKED BEADS, INC.,** (U.S. CLS. 2, 27, 28 AND 50). SN 78-388,017. PUB. 12-7-2004. FILED 3-20-2004.

**CLASS 16—PAPER GOODS AND PRINTED MATTER**

- 2,928,455 ( *See Class 9 for this trademark.*)
- 2,928,456. **AUTOEUROPE, AUTO EUROPE, LLC, MULTIPLE CLASS, (INT. CLS. 16, 36, 39 AND 42),** (U.S. CLS. 2, 5, 22, 23, 29, 37, 38, 50, 100, 101, 102 AND 105). SN 76-145,351. PUB. 12-7-2004. FILED 10-12-2000.
- 2,928,460 ( *See Class 9 for this trademark.*)
- 2,928,461 ( *See Class 9 for this trademark.*)
- 2,928,468. **TUI. TUI AG, MULTIPLE CLASS, (INT. CLS. 16, 39, 41 AND 42),** (U.S. CLS. 2, 5, 22, 23, 29, 37, 38, 50, 100, 101, 105 AND 107). SN 76-337,074. PUB. 4-20-2004. FILED 11-8-2001.
- 2,928,496. **SPC AND DESIGN, SPECIALTY POLYMER COATINGS, INC., MULTIPLE CLASS, (INT. CLS. 16, 25, 28 AND 37),** (U.S. CLS. 2, 5, 22, 23, 29, 37, 38, 39, 50, 100, 103 AND 106). SN 76-450,886. PUB. 12-7-2004. FILED 9-17-2002.
- 2,928,501. **TONGUE TAT-2 AND DESIGN, MONOGRAM INTERNATIONAL, INC.,** (U.S. CLS. 2, 5, 22, 23, 29, 37, 38 AND 50). SN 76-472,214. PUB. 7-8-2003. FILED 12-5-2002.
- 2,928,507. **SKILLS FOR ADOLESCENCE, THE INTERNATIONAL ASSOCIATION OF LIONS CLUBS,** (U.S. CLS. 2, 5, 22, 23, 29, 37, 38 AND 50). SN 76-505,743. PUB. 12-7-2004. FILED 4-11-2003.
- 2,928,510. **TPR. TECHNOLOGY & PATENT RESEARCH INTERNATIONAL, INC.,** (U.S. CLS. 2, 5, 22, 23, 29, 37, 38 AND 50). SN 76-513,408. PUB. 12-7-2004. FILED 5-7-2003.
- 2,928,524 ( *See Class 9 for this trademark.*)
- 2,928,555. **AQUA FOREST, SQUARE FOREST, INC.,** (U.S. CLS. 2, 5, 22, 23, 29, 37, 38 AND 50). SN 76-552,011. PUB. 7-20-2004. FILED 10-15-2003.
- 2,928,556. **POP ZONE AND DESIGN, SCHOLASTIC INC.,** (U.S. CLS. 2, 5, 22, 23, 29, 37, 38 AND 50). SN 76-554,810. PUB. 7-20-2004. FILED 10-14-2003.
- 2,928,563. **THE RODALE INSTITUTE FARMING SYSTEMS TRIAL (BLOCK FORM), THE RODALE INSTITUTE,** (U.S. CLS. 2, 5, 22, 23, 29, 37, 38 AND 50). SN 76-563,466. PUB. 12-7-2004. FILED 12-5-2003.
- 2,928,570 ( *See Class 9 for this trademark.*)
- 2,928,572. **THE BACK BONES OF CHARACTER (BLOCK FORM), CRAZY PET, LLC,** (U.S. CLS. 2, 5, 22, 23, 29, 37, 38 AND 50). SN 76-567,622. PUB. 12-7-2004. FILED 12-30-2003.
- 2,928,626. **CONNECT THE THOUGHTS AND DESIGN, CONNECT THE THOUGHTS, INC.,** (U.S. CLS. 2, 5, 22, 23, 29, 37, 38 AND 50). SN 76-579,077. PUB. 12-7-2004. FILED 3-4-2004.
- 2,928,641. **CRA (BLOCK FORM), CRA FOUNDATION,** (U.S. CLS. 2, 5, 22, 23, 29, 37, 38 AND 50). SN 76-580,815. PUB. 12-7-2004. FILED 3-11-2004.
- 2,928,651. **HVB ALTERNATIVES AND DESIGN, BAYERISCHE HYPO-UND VEREINSBANK AG, MULTIPLE CLASS, (INT. CLS. 16, 35 AND 36),** (U.S. CLS. 2, 5, 22, 23, 29, 37, 38, 50, 100, 101 AND 102). SN 78-142,507. PUB. 5-18-2004. FILED 7-10-2002.
- 2,928,652 ( *See Class 9 for this trademark.*)
- 2,928,666. **Q QUALITY PARTNERS OF RHODE ISLAND (STYLIZED), RHODE ISLAND QUALITY PARTNERS, MULTIPLE CLASS, (INT. CLS. 16 AND 35),** (U.S. CLS. 2, 5, 22, 23, 29, 37, 38, 50, 100, 101 AND 102). SN 78-225,674. PUB. 12-7-2004. FILED 3-14-2003.
- 2,928,684. **REALPTURE (BLOCK FORM), CORIMAX, INC.,** (U.S. CLS. 2, 5, 22, 23, 29, 37, 38 AND 50). SN 78-259,689. PUB. 10-19-2004. FILED 6-8-2003.
- 2,928,693. **VARBUSINESS 500, CMP MEDIA LLC, MULTIPLE CLASS, (INT. CLS. 16 AND 41),** (U.S. CLS. 2, 5, 22, 23, 29, 37, 38, 50, 100, 101 AND 107). SN 78-272,837. PUB. 12-7-2004. FILED 7-10-2003.
- 2,928,707 ( *See Class 9 for this trademark.*)
- 2,928,725. **BIBLE BASKETS, LLC AND DESIGN, LUCAS, MAKEEBA J, AND LUCAS, ADERO R, MULTIPLE CLASS, (INT. CLS. 16 AND 35),** (U.S. CLS. 2, 5, 22, 23, 29, 37, 38, 50, 100, 101 AND 102). SN 78-283,624. PUB. 12-7-2004. FILED 8-6-2003.
- 2,928,740. **SHARPERIMAGE.COM, SHARPER IMAGE CORPORATION, MULTIPLE CLASS, (INT. CLS. 16 AND 35),** (U.S. CLS. 2, 5, 22, 23, 29, 37, 38, 50, 100, 101 AND 102). SN 78-289,909. PUB. 12-7-2004. FILED 8-20-2003.
- 2,928,755 ( *See Class 9 for this trademark.*)
- 2,928,759. **SUCCESEEDGE, VERMILLION CONSULTING, INC.,** (U.S. CLS. 2, 5, 22, 23, 29, 37, 38 AND 50). SN 78-299,944. PUB. 12-7-2004. FILED 9-12-2003.
- 2,928,761. **INTACT, SEALED AIR CORPORATION (US), MULTIPLE CLASS, (INT. CLS. 16 AND 17),** (U.S. CLS. 1, 2, 5, 12, 13, 22, 23, 29, 35, 37, 38 AND 50). SN 78-301,615. PUB. 12-7-2004. FILED 9-17-2003.
- 2,928,768. **SNAP-IN, MENASHA CORPORATION,** (U.S. CLS. 2, 5, 22, 23, 29, 37, 38 AND 50). SN 78-309,043. PUB. 12-7-2004. FILED 10-3-2003.
- 2,928,783 ( *See Class 9 for this trademark.*)
- 2,928,795. **HR HERO, M. LEE SMITH PUBLISHERS, MULTIPLE CLASS, (INT. CLS. 16, 35 AND 41),** (U.S. CLS. 2, 5, 22, 23, 29, 37, 38, 50, 100, 101, 102 AND 107). SN 78-321,734. PUB. 12-7-2004. FILED 10-31-2003.
- 2,928,805. **BRUSH VALET (BLOCK FORM), S&F PRODUCTS,** (U.S. CLS. 2, 5, 22, 23, 29, 37, 38 AND 50). SN 78-327,148. PUB. 12-7-2004. FILED 11-12-2003.
- 2,928,810. **RUSHMORE (BLOCK FORM), SIMPSON PRINT LIMITED,** (U.S. CLS. 2, 5, 22, 23, 29, 37, 38 AND 50). SN 78-329,122. PUB. 12-7-2004. FILED 11-17-2003.
- 2,928,827. **PLANET ZOO AND DESIGN, PLANET ZOO, LLC,** (U.S. CLS. 2, 5, 22, 23, 29, 37, 38 AND 50). SN 78-336,667. PUB. 12-7-2004. FILED 12-4-2003.
- 2,928,848. **A REASON TO WRITE (BLOCK FORM), ELLEN KATHERINE WEEREN,** (U.S. CLS. 2, 5, 22, 23, 29, 37, 38 AND 50). SN 78-346,412. PUB. 12-7-2004. FILED 12-30-2003.
- 2,928,882. **ENTERPRISE GROUP AND DESIGN, WEYERHAEUSER COMPANY,** (U.S. CLS. 2, 5, 22, 23, 29, 37, 38 AND 50). SN 78-362,529. PUB. 12-7-2004. FILED 2-4-2004.
- 2,928,884. **QUIK-TRAX (BLOCK FORM), ALDRICH, JOHN F.,** (U.S. CLS. 2, 5, 22, 23, 29, 37, 38 AND 50). SN 78-364,090. PUB. 12-7-2004. FILED 2-6-2004.
- 2,928,902. **FLORI-DUH (BLOCK FORM), SCHULTENOVER, JAMES D., AND JACOBS, LARRY,** (U.S. CLS. 2, 5, 22, 23, 29, 37, 38 AND 50). SN 78-370,697. PUB. 12-7-2004. FILED 2-19-2004.
- 2,928,905. **VICTORIA ELIZABETH (BLOCK FORM), ALL IN THE CARDS, INC.,** (U.S. CLS. 2, 5, 22, 23, 29, 37, 38 AND 50). SN 78-371,080. PUB. 12-7-2004. FILED 2-20-2004.
- 2,928,909. **CINCINNATI (BLOCK FORM), EMMIS PUBLISHING, L.P.,** (U.S. CLS. 2, 5, 22, 23, 29, 37, 38 AND 50). SN 78-371,457. PUB. 12-7-2004. FILED 2-20-2004.
- 2,928,955. **SPYRO (BLOCK FORM), UNIVERSAL INTERACTIVE, INC.,** (U.S. CLS. 2, 5, 22, 23, 29, 37, 38 AND 50). SN 78-

377,344. PUB. 12-7-2004. FILED 3-2-2004.  
 2,928,957. **FONS & PORTER'S (BLOCK FORM)**. LOVE OF QUILTING, INC., (U.S. CLS. 2, 5, 22, 23, 29, 37, 38 AND 50). SN 78-377,454. PUB. 12-7-2004. FILED 3-3-2004.  
 2,928,969. **GOVCONNECTION (BLOCK FORM)**. PC CONNECTION, INC., MULTIPLE CLASS, (INT. CLS. 16 AND 35), (U.S. CLS. 2, 5, 22, 23, 29, 37, 38, 50, 100, 101 AND 102). SN 78-378,717. PUB. 12-7-2004. FILED 3-4-2004.  
 2,928,971. **TOP JOB (BLOCK FORM)**. HERITAGE BRANDS, LLC, (U.S. CLS. 2, 5, 22, 23, 29, 37, 38 AND 50). SN 78-378,753. PUB. 12-7-2004. FILED 3-4-2004.  
 2,929,017. **ALL YOU (BLOCK FORM)**. TIME INC., (U.S. CLS. 2, 5, 22, 23, 29, 37, 38 AND 50). SN 78-382,499. PUB. 12-7-2004. FILED 3-11-2004.  
 2,929,022. **FLEXI-TAPE (BLOCK FORM)**. WORLD EMBLEM INTERNATIONAL, INC., (U.S. CLS. 2, 5, 22, 23, 29, 37, 38 AND 50). SN 78-384,634. PUB. 12-7-2004. FILED 3-15-2004.  
 2,929,028. **GOOD 'N TUFF (BLOCK FORM)**. CHELSEA INDUSTRIES, INC., DBA WEBSTER INDUSTRIES, (U.S. CLS. 2, 5, 22, 23, 29, 37, 38 AND 50). SN 78-386,527. PUB. 12-7-2004. FILED 3-18-2004.  
 2,929,038. **READER'S DIGEST (BLOCK FORM)**. THE READER'S DIGEST ASSOCIATION, INC., (U.S. CLS. 2, 5, 22, 23, 29, 37, 38 AND 50). SN 78-421,699. PUB. 12-7-2004. FILED 5-19-2004.  
 2,929,042. **GRUBBY LITTLE HANDZ AND DESIGN**. WEST, GREG, (U.S. CLS. 2, 5, 22, 23, 29, 37, 38 AND 50). SN 78-453,640. PUB. 12-7-2004. FILED 7-20-2004.

---

#### CLASS 17—RUBBER GOODS

2,928,761 ( *See Class 16 for this trademark*).  
 2,928,946. **INSTA-SNOW (BLOCK FORM)**. STEVE SPANGLER, INC., (U.S. CLS. 1, 5, 12, 13, 35 AND 50). SN 78-376,664. PUB. 12-7-2004. FILED 3-1-2004.

---

#### CLASS 18—LEATHER GOODS

2,928,658. **NORDICROSS**. ATOMIC AUSTRIA GMBH, MULTIPLE CLASS, (INT. CLS. 18, 25 AND 28), (U.S. CLS. 1, 2, 3, 22, 23, 38, 39, 41 AND 50). SN 78-208,733. PUB. 7-20-2004. FILED 1-30-2003.  
 2,928,682. **HONEY OCEAN/EARTH (STYLIZED)**. CREGAN, BRIAN LESLIE, AND CREGAN, THOMAS JOSEPH, AND CREGAN, MYRA INA, MULTIPLE CLASS, (INT. CLS. 18, 25 AND 28), (U.S. CLS. 1, 2, 3, 22, 23, 38, 39, 41 AND 50). SN 78-254,373. PUB. 9-7-2004. FILED 5-27-2003.  
 2,928,789. **FLEX-LITE (BLOCK FORM)**. CIRCLE Y SADDLES, INC., (U.S. CLS. 1, 2, 3, 22 AND 41). SN 78-319,254. PUB. 12-7-2004. FILED 10-27-2003.  
 2,928,796. **MISCELLANEOUS DESIGN**. BEIJING SUNSHINE SUREN-CRAFT LEATHER MAKING CO., LTD., MULTIPLE CLASS, (INT. CLS. 18 AND 25), (U.S. CLS. 1, 2, 3, 22, 39 AND 41). SN 78-322,526. PUB. 12-7-2004. FILED 11-3-2003.  
 2,928,823. **MASTA AND DESIGN**. MATCHMAKERS INTERNATIONAL LIMITED, (U.S. CLS. 1, 2, 3, 22 AND 41). SN 78-334,815. PUB. 12-7-2004. FILED 12-1-2003.  
 2,928,936. **CREST RIDGE SADDLERY (BLOCK FORM)**. RACHETER, DEBRA K, (U.S. CLS. 1, 2, 3, 22 AND 41). SN 78-376,103. PUB. 12-7-2004. FILED 3-1-2004.  
 2,929,011. **P AND DESIGN**. YANG, ROGER, (U.S. CLS. 1, 2, 3, 22 AND 41). SN 78-381,224. PUB. 12-7-2004. FILED 3-9-2004.  
 2,929,012. **POROTA (BLOCK FORM)**. YANG, ROGER, (U.S. CLS. 1, 2, 3, 22 AND 41). SN 78-381,229. PUB. 12-7-2004. FILED 3-9-2004.

---

#### CLASS 19—NON-METALLIC BUILDING MATERIALS

2,928,551. **PAR-KY**. DECOSPAN N.V., (U.S. CLS. 1, 12, 33 AND 50). SN 76-550,508. PUB. 12-7-2004. FILED 9-16-2003.

2,928,582. **FLEXURA AND DESIGN**. FLEXURA N.V., MULTIPLE CLASS, (INT. CLS. 19 AND 35), (U.S. CLS. 1, 12, 33, 50, 100, 101 AND 102). SN 76-569,419. PUB. 12-7-2004. FILED 1-2-2004.  
 2,928,601. **DURACLASSIC (BLOCK FORM)**. MELTON CLASSICS INCORPORATED, (U.S. CLS. 1, 12, 33 AND 50). SN 76-573,549. PUB. 12-7-2004. FILED 2-2-2004.  
 2,928,714. **BEAUTIFUL, DURABLE, RENEWABLE BAMBOO**. TERAGREN LLC, (U.S. CLS. 1, 12, 33 AND 50). SN 78-279,918. PUB. 12-7-2004. FILED 7-28-2003.  
 2,928,715. **BUILDING A COMPANY THAT IS ENVIRONMENTALLY, SOCIALLY, AND ECONOMICALLY RESPONSIBLE**. TERAGREN LLC, (U.S. CLS. 1, 12, 33 AND 50). SN 78-279,920. PUB. 12-7-2004. FILED 7-28-2003.  
 2,928,802. **CARBONCAST (BLOCK FORM)**. OLDCASTLE PRECAST, INC., (U.S. CLS. 1, 12, 33 AND 50). SN 78-325,993. PUB. 12-7-2004. FILED 11-11-2003.

---

#### CLASS 20—FURNITURE AND ARTICLES NOT OTHERWISE CLASSIFIED

2,928,458 ( *See Class 6 for this trademark*).  
 2,928,838. **G AND DESIGN**. GARDNER TECHNOLOGIES, INC., MULTIPLE CLASS, (INT. CLS. 20 AND 21), (U.S. CLS. 2, 13, 22, 23, 25, 29, 30, 32, 33, 40 AND 50). SN 78-340,713. PUB. 12-7-2004. FILED 12-15-2003.  
 2,928,861. **DEUBLÉ (STYLIZED)**. KINGSDOWN, INC., (U.S. CLS. 2, 13, 22, 25, 32 AND 50). SN 78-351,211. PUB. 12-7-2004. FILED 1-13-2004.

---

#### CLASS 21—HOUSEWARES AND GLASS

2,928,457 ( *See Class 8 for this trademark*).  
 2,928,755 ( *See Class 9 for this trademark*).  
 2,928,838 ( *See Class 20 for this trademark*).  
 2,928,908. **POT LUX (BLOCK FORM)**. REYNOLDS METALS COMPANY, (U.S. CLS. 2, 13, 23, 29, 30, 33, 40 AND 50). SN 78-371,418. PUB. 12-7-2004. FILED 2-20-2004.  
 2,928,913. **CHILLIN' DIVAS (BLOCK FORM)**. YOUR HATS DESIRE, INC., DBA NEW DIMENSIONS, (U.S. CLS. 2, 13, 23, 29, 30, 33, 40 AND 50). SN 78-372,179. PUB. 12-7-2004. FILED 2-23-2004.  
 2,929,025. **CHUTNEY (BLOCK FORM)**. WKI HOLDING COMPANY, INC., (U.S. CLS. 2, 13, 23, 29, 30, 33, 40 AND 50). SN 78-385,904. PUB. 12-7-2004. FILED 3-17-2004.  
 2,929,043. **AQUAFRESH AND DESIGN**. SMITHKLINE BEECHAM CORPORATION, (U.S. CLS. 2, 13, 23, 29, 30, 33, 40 AND 50). SN 78-460,244. PUB. 12-7-2004. FILED 8-2-2004.

---

#### CLASS 22—CORDAGE AND FIBERS

2,928,508 ( *See Class 6 for this trademark*).  
 2,928,774. **NORDIC ICE FISHING OUTFITTERS AND DESIGN**. THIELEN MARKETING INC., (U.S. CLS. 1, 2, 7, 19, 22, 42 AND 50). SN 78-312,797. PUB. 12-7-2004. FILED 10-13-2003.  
 2,928,895. **DURANGO (BLOCK FORM)**. THE COLEMAN COMPANY, INC., (U.S. CLS. 1, 2, 7, 19, 22, 42 AND 50). SN 78-368,477. PUB. 12-7-2004. FILED 2-16-2004.

---

#### CLASS 24—FABRICS

2,928,755 ( *See Class 9 for this trademark*).  
 2,928,941. **HIKE-UP-YOUR SKIRT (BLOCK FORM)**. VERATEX, INC., (U.S. CLS. 42 AND 50). SN 78-376,530. PUB. 12-7-2004. FILED 3-1-2004.

**CLASS 25—CLOTHING**

- 2,928,449. **GET A GRIP SLIP**. WARNACO U.S., INC., (U.S. CLS. 22 AND 39). SN 75-339,758. PUB. 12-7-2004. FILED 8-12-1997.
- 2,928,471. **MISCELLANEOUS DESIGN**. OLYMPIA ENTERTAINMENT, INC., MULTIPLE CLASS, (INT. CLS. 25 AND 41), (U.S. CLS. 22, 39, 100, 101 AND 107). SN 76-366,507. PUB. 7-29-2003. FILED 2-5-2002.
- 2,928,476. **O.TITUDE AND DESIGN**. TOVAR, JOAO VASCO CASSIO, (U.S. CLS. 22 AND 39). SN 76-387,567. PUB. 9-14-2004. FILED 3-26-2002.
- 2,928,496 ( *See Class 16 for this trademark*).
- 2,928,503. **HULK HIDES**. WORK FORCE, INC., (U.S. CLS. 22 AND 39). SN 76-483,897. PUB. 9-21-2004. FILED 1-17-2003.
- 2,928,521. **SUOMY AND DESIGN**. VIGANO' ACCESSORI S.P.A., (U.S. CLS. 22 AND 39). SN 76-533,601. PUB. 12-7-2004. FILED 7-30-2003.
- 2,928,543. **ENC. KIM, MYUNG BO**, (U.S. CLS. 22 AND 39). SN 76-543,361. PUB. 12-7-2004. FILED 9-8-2003.
- 2,928,562. **THE NEW FARM (BLOCK FORM)**. THE RODALE INSTITUTE, MULTIPLE CLASS, (INT. CLS. 25, 35 AND 41), (U.S. CLS. 22, 39, 100, 101, 102 AND 107). SN 76-563,464. PUB. 12-7-2004. FILED 12-5-2003.
- 2,928,574. **DAVENPORT UNIVERSITY PANTHERS AND DESIGN**. DAVENPORT UNIVERSITY, MULTIPLE CLASS, (INT. CLS. 25 AND 41), (U.S. CLS. 22, 39, 100, 101 AND 107). SN 76-567,847. PUB. 12-7-2004. FILED 12-31-2003.
- 2,928,597. **LAS VEGAS CENTENNIAL 1905-2005 AND DESIGN**. COMMISSION FOR THE LAS VEGAS CENTENNIAL, (U.S. CLS. 22 AND 39). SN 76-572,529. PUB. 12-7-2004. FILED 1-26-2004.
- 2,928,608. **MISCELLANEOUS DESIGN**. THOMPSON, KELSEN D., (U.S. CLS. 22 AND 39). SN 76-576,023. PUB. 12-7-2004. FILED 2-17-2004.
- 2,928,613. **J. K. ACID (BLOCK FORM)**. SHOE MAKER S.R.L., (U.S. CLS. 22 AND 39). SN 76-577,226. PUB. 12-7-2004. FILED 2-18-2004.
- 2,928,636. **CLIMB LIKE A GIRL AND DESIGN**. LAYERS, INC., (U.S. CLS. 22 AND 39). SN 76-579,886. PUB. 12-7-2004. FILED 3-8-2004.
- 2,928,649. **PACUNA**. COTTON, GARY A., MULTIPLE CLASS, (INT. CLS. 25, 31 AND 44), (U.S. CLS. 1, 22, 39, 46, 100 AND 101). SN 78-121,530. PUB. 9-21-2004. FILED 4-13-2002.
- 2,928,658 ( *See Class 18 for this trademark*).
- 2,928,664. **EVERYTHING FOR THE SUN**. BRAND EXPERIENCE LLC, THE, (U.S. CLS. 22 AND 39). SN 78-223,627. PUB. 12-7-2004. FILED 3-10-2003.
- 2,928,671. **MISCELLANEOUS DESIGN**. GLOBAL SPORTS CONSULTANTS, LLC, DBA JET SET SPORTS, (U.S. CLS. 22 AND 39). SN 78-228,630. PUB. 12-7-2004. FILED 3-21-2003.
- 2,928,679. **EMORY CLAIRE**. LUXURY APPAREL GROUP, L.L.C., (U.S. CLS. 22 AND 39). SN 78-245,078. PUB. 12-7-2004. FILED 5-2-2003.
- 2,928,682 ( *See Class 18 for this trademark*).
- 2,928,688. **PEORIA CHIEFS AND DESIGN**. PEORIA CHIEFS COMMUNITY BASEBALL CLUB, (U.S. CLS. 22 AND 39). SN 78-265,951. PUB. 7-20-2004. FILED 6-23-2003.
- 2,928,696. **M I D LIFE SKATEBOARDS**. TIDWELL, COLTEN, (U.S. CLS. 22 AND 39). SN 78-274,862. PUB. 12-7-2004. FILED 7-16-2003.
- 2,928,704. **FRIENDS WITH BENEFITS**. CARNELL, BRIAN, MULTIPLE CLASS, (INT. CLS. 25 AND 28), (U.S. CLS. 22, 23, 38, 39 AND 50). SN 78-277,640. PUB. 12-7-2004. FILED 7-23-2003.
- 2,928,722. **E AND DESIGN**. THE NAVIGATORS, (U.S. CLS. 22 AND 39). SN 78-282,126. PUB. 12-7-2004. FILED 8-1-2003.
- 2,928,728. **SCAM-CO.'S TOO SKINNY? NEW SCIENTIFIC DISCOVERY HELPS YOU PUT ON WEIGHT! PUT ON WEIGHT WITH HEALTH AID TABLETS. IMPROVE YOUR FIGURE AND LOOKS BY ADDING A FEW POUNDS AND INCES IN THE RIGHT PLACES. DON'T BE SKINNY BECAUSE OF BAD EATING HABITS. GAIN AS MUCH WEIGHT AS YOU LIKE. SATISFACTION GUARANTEED OR RETURN TABLETS FOR REFUND. RUSH YOUR ORDER NOW... NO. 643... \$2.95 AND DESIGN**. OLLIEVANA LICENSING GROUP, LLC, (U.S. CLS. 22 AND 39). SN 78-285,251. PUB. 12-7-2004. FILED 8-8-2003.
- 2,928,746. **BODY NATURALS**. GELMART INDUSTRIES,

- INC., (U.S. CLS. 22 AND 39). SN 78-292,931. PUB. 12-7-2004. FILED 8-27-2003.
- 2,928,755 ( *See Class 9 for this trademark*).
- 2,928,782. **GOT MOTO?**. MILLER, STEVEN, (U.S. CLS. 22 AND 39). SN 78-314,504. PUB. 12-7-2004. FILED 10-16-2003.
- 2,928,796 ( *See Class 18 for this trademark*).
- 2,928,798 ( *See Class 14 for this trademark*).
- 2,928,809. **SHARTEX AND DESIGN**. SHARTEX INTERNATIONAL TRADING CO., LTD., (U.S. CLS. 22 AND 39). SN 78-328,951. PUB. 12-7-2004. FILED 11-17-2003.
- 2,928,829. **GIVER (BLOCK FORM)**. DEBUS, STEVEN S., (U.S. CLS. 22 AND 39). SN 78-336,947. PUB. 12-7-2004. FILED 12-5-2003.
- 2,928,857. **TURTLE KRAALS (BLOCK FORM)**. SMITHBURG, INC., MULTIPLE CLASS, (INT. CLS. 25 AND 43), (U.S. CLS. 22, 39, 100 AND 101). SN 78-348,116. PUB. 12-7-2004. FILED 1-6-2004.
- 2,928,883. **SCATTEREDWEAR (BLOCK FORM)**. PATH, ROBERT, (U.S. CLS. 22 AND 39). SN 78-363,022. PUB. 12-7-2004. FILED 2-5-2004.
- 2,928,892. **BÜTI (BLOCK FORM)**. SABATE, BRIAN, (U.S. CLS. 22 AND 39). SN 78-367,419. PUB. 12-7-2004. FILED 2-12-2004.
- 2,928,949. **SEXY CHOCOLATE (BLOCK FORM)**. IVERY, LISA MARIE, (U.S. CLS. 22 AND 39). SN 78-376,869. PUB. 12-7-2004. FILED 3-2-2004.
- 2,928,970. **THOM BROWN (BLOCK FORM)**. THOM BROWN OF BOSTON, INC., (U.S. CLS. 22 AND 39). SN 78-378,744. PUB. 12-7-2004. FILED 3-4-2004.
- 2,929,030. **BEAUTY FIEND (STYLIZED)**. CJLF, INC., (U.S. CLS. 22 AND 39). SN 78-386,991. PUB. 12-7-2004. FILED 3-18-2004.
- 2,929,034. **CURVATION (STYLIZED)**. VANITY FAIR, INC., (U.S. CLS. 22 AND 39). SN 78-416,014. PUB. 12-7-2004. FILED 5-10-2004.
- 2,929,037. **THOM BROWN (STYLIZED)**. THOM BROWN OF BOSTON, INC., MULTIPLE CLASS, (INT. CLS. 25 AND 35), (U.S. CLS. 22, 39, 100, 101 AND 102). SN 78-420,893. PUB. 12-7-2004. FILED 5-18-2004.
- 2,929,041. **SQ MENS (BLOCK FORM)**. KO, JAY Y., (U.S. CLS. 22 AND 39). SN 78-452,262. PUB. 12-7-2004. FILED 7-16-2004.

**CLASS 26—FANCY GOODS**

- 2,928,520. **ZIPCAP**. YKK CORPORATION, (U.S. CLS. 37, 39, 40, 42 AND 50). SN 76-533,564. PUB. 9-14-2004. FILED 7-30-2003.

**CLASS 27—FLOOR COVERINGS**

- 2,928,686. **COLDGON**. COLDGON PRODUCTS INTERNATIONAL, INC., (U.S. CLS. 19, 20, 37, 42 AND 50). SN 78-263,903. PUB. 12-7-2004. FILED 6-18-2003.

**CLASS 28—TOYS AND SPORTING GOODS**

- 2,928,460 ( *See Class 9 for this trademark*).
- 2,928,461 ( *See Class 9 for this trademark*).
- 2,928,496 ( *See Class 16 for this trademark*).
- 2,928,498. **MAURER**. MAURER SOHNE GMBH & CO. KG, (U.S. CLS. 22, 23, 38 AND 50). SN 76-458,608. PUB. 12-7-2004. FILED S.R. 10-16-2002; AM. P.R. 9-26-2003.
- 2,928,506. **DEEP BLUE**. THOMPSON, DAWN, (U.S. CLS. 22, 23, 38 AND 50). SN 76-505,250. PUB. 12-7-2004. FILED 4-9-2003.
- 2,928,508 ( *See Class 6 for this trademark*).
- 2,928,615. **POCKET HOPPER (BLOCK FORM)**. CRAFT HOUSE CORPORATION, (U.S. CLS. 22, 23, 38 AND 50). SN 76-577,869. PUB. 12-7-2004. FILED 2-26-2004.
- 2,928,621. **SUNRAY (BLOCK FORM)**. RAINBOW PLAY SYSTEMS, INC., (U.S. CLS. 22, 23, 38 AND 50). SN 76-578,742. PUB. 12-7-2004. FILED 3-1-2004.



2,928,652 ( *See Class 9 for this trademark* ).  
 2,928,658 ( *See Class 18 for this trademark* ).  
 2,928,678. **PARMATE**. LIM, TERRY KIA NGEE, (U.S. CLS. 22, 23, 38 AND 50). SN 78-244,952. PUB. 12-7-2004. FILED 5-2-2003.  
 2,928,682 ( *See Class 18 for this trademark* ).  
 2,928,704 ( *See Class 25 for this trademark* ).  
 2,928,707 ( *See Class 9 for this trademark* ).  
 2,928,733. **MASK**. JACKALL, INC., (U.S. CLS. 22, 23, 38 AND 50). SN 78-287,177. PUB. 12-7-2004. FILED 8-14-2003.  
 2,928,755 ( *See Class 9 for this trademark* ).  
 2,928,814. **D-BALL (BLOCK FORM)**. D-BALL MANUFACTURING, (U.S. CLS. 22, 23, 38 AND 50). SN 78-330,845. PUB. 12-7-2004. FILED 11-20-2003.  
 2,928,815. **SPARQ (BLOCK FORM)**. BC SPORTS, INC., (U.S. CLS. 22, 23, 38 AND 50). SN 78-332,147. PUB. 12-7-2004. FILED 11-24-2003.  
 2,928,894. **SPEED TU-BE (BLOCK FORM)**. DRUM, TOM, (U.S. CLS. 22, 23, 38 AND 50). SN 78-367,754. PUB. 12-7-2004. FILED 2-13-2004.  
 2,928,897. **KOLSTOF (STYLIZED)**. EBERT, KENNETH R, DBA EBERT ENT., (U.S. CLS. 22, 23, 38 AND 50). SN 78-368,611. PUB. 12-7-2004. FILED 2-16-2004.  
 2,928,901. **MAKE A SAND MONSTER (BLOCK FORM)**. LITTLE KIDS, INC., (U.S. CLS. 22, 23, 38 AND 50). SN 78-370,661. PUB. 12-7-2004. FILED 2-19-2004.  
 2,928,924. **PROCUSTOM (BLOCK FORM)**. TRUE TEMPER SPORTS, INC., (U.S. CLS. 22, 23, 38 AND 50). SN 78-373,174. PUB. 12-7-2004. FILED 2-24-2004.  
 2,928,973. **B AND DESIGN**. BREAKER, RICHARD, (U.S. CLS. 22, 23, 38 AND 50). SN 78-378,773. PUB. 12-7-2004. FILED 3-4-2004.  
 2,928,988. **TEE-MATES (BLOCK FORM)**. MCDEVITT, DAVID P., (U.S. CLS. 22, 23, 38 AND 50). SN 78-380,000. PUB. 12-7-2004. FILED 3-8-2004.  
 2,929,029 ( *See Class 6 for this trademark* ).  
 2,929,040. **BIG BEN (BLOCK FORM)**. CALLAWAY GOLF COMPANY, (U.S. CLS. 22, 23, 38 AND 50). SN 78-442,155. PUB. 12-7-2004. FILED 6-28-2004.

---

#### CLASS 29—MEATS AND PROCESSED FOODS

2,928,453. **VESPA AND DESIGN**. PIAGGIO & C. S.P.A., MULTIPLE CLASS, (INT. CLS. 29, 30, 32, 33, 35 AND 42), (U.S. CLS. 45, 46, 47, 48, 49, 100, 101 AND 102). SN 75-832,421. PUB. 7-13-2004. FILED 10-27-1999.  
 2,928,480 ( *See Class 5 for this trademark* ).  
 2,928,697. **THE SOUP MARKET**. THE SOUP MARKET, LTD., (U.S. CL. 46). SN 78-275,115. PUB. 12-7-2004. FILED 7-16-2003.  
 2,928,730. **MISCELLANEOUS DESIGN**. SEBASTIANI VINEYARDS INC., MULTIPLE CLASS, (INT. CLS. 29, 30 AND 33), (U.S. CLS. 46, 47 AND 49). SN 78-286,111. PUB. 12-7-2004. FILED 8-12-2003.  
 2,928,755 ( *See Class 9 for this trademark* ).  
 2,928,818. **FISHWELLBRAND AND DESIGN**. CHONGQING YUQUAN INDUSTRIAL (GROUP) CO., LTD., (U.S. CL. 46). SN 78-332,749. PUB. 12-7-2004. FILED 11-25-2003.  
 2,928,844. **CALAMARS MAMA NINA'S (BLOCK FORM)**. PERE JEANTY, LLC, (U.S. CL. 46). SN 78-342,471. PUB. 12-7-2004. FILED 12-17-2003.  
 2,928,845. **A BETTER ALTERNATIVE AND DESIGN**. THE FEDERATED GROUP, INC., (U.S. CL. 46). SN 78-344,288. PUB. 12-7-2004. FILED 12-22-2003.  
 2,928,907. **MOUNTAIN MANNA (BLOCK FORM)**. MOUNTAIN MANNA EXOTIC JELLIES, (U.S. CL. 46). SN 78-371,415. PUB. 12-7-2004. FILED 2-20-2004.  
 2,929,007. **MISCELLANEOUS DESIGN**. LAZIO, LAWRENCE G., (U.S. CL. 46). SN 78-380,965. PUB. 12-7-2004. FILED 3-9-2004.

#### CLASS 30—STAPLE FOODS

2,928,453 ( *See Class 29 for this trademark* ).  
 2,928,480 ( *See Class 5 for this trademark* ).  
 2,928,497. **SASSY SOURS**. COPPER KETTLE CANDY, INC., (U.S. CL. 46). SN 76-452,961. PUB. 12-7-2004. FILED 9-24-2002.  
 2,928,535. **RIB AND BUTT RUB AND DESIGN**. TIME FOR GOOD FOOD INC., (U.S. CL. 46). SN 76-538,320. PUB. 12-7-2004. FILED 8-18-2003.  
 2,928,604. **CUP EXPRESS (BLOCK FORM)**. CUP EXPRESS PARIS, INC., (U.S. CL. 46). SN 76-573,928. PUB. 12-7-2004. FILED 2-4-2004.  
 2,928,612. **TAGANROG (BLOCK FORM)**. PASTIFICIO AZIENDA AGRARIA LATINI S.R.L., (U.S. CL. 46). SN 76-577,225. PUB. 12-7-2004. FILED 2-18-2004.  
 2,928,642. **HONOLULU COOKIE COMPANY (BLOCK FORM)**. K & S HAWAIIAN CREATIONS, INCORPORATED, DBA HONOLULU COOKIE COMPANY, (U.S. CL. 46). SN 76-581,069. PUB. 12-7-2004. FILED 3-12-2004.  
 2,928,660. **MONSTER TAQUITO**. DON MIGUEL MEXICAN FOODS, INC., (U.S. CL. 46). SN 78-212,233. PUB. 7-20-2004. FILED 2-7-2003.  
 2,928,665. **LA MAISON DU CHOCOLAT PARIS AND DESIGN**. LA MAISON DU CHOCOLAT, (U.S. CL. 46). SN 78-225,182. PUB. 12-7-2004. FILED 3-13-2003.  
 2,928,692. **MC BARBEQUE WITH STYLE MCHALES CHOPHOUSE AND DESIGN**. THE TUSCAN OVEN, INC., (U.S. CL. 46). SN 78-272,678. PUB. 12-7-2004. FILED 7-10-2003.  
 2,928,730 ( *See Class 29 for this trademark* ).  
 2,928,732. **MISCELLANEOUS DESIGN**. IMAGININGS 3, INC., (U.S. CL. 46). SN 78-286,338. PUB. 12-7-2004. FILED 8-12-2003.  
 2,928,755 ( *See Class 9 for this trademark* ).  
 2,928,787. **DEBRA ANN**. CORBI, DEBRA ANN, (U.S. CL. 46). SN 78-318,089. PUB. 12-7-2004. FILED 10-24-2003.  
 2,928,851. **SHRIRAM QUALITY GUARANTEED AND DESIGN**. SHRIRAM FOODS, (U.S. CL. 46). SN 78-347,145. PUB. 12-7-2004. FILED 12-31-2003.  
 2,928,860. **MOUNT OF OLIVES TREASURES AND DESIGN**. MOUNT OF OLIVES TREASURES, LLC, (U.S. CL. 46). SN 78-349,806. PUB. 12-7-2004. FILED 1-9-2004.  
 2,928,865. **ISLAND TRADER COFFEE COMPANY (BLOCK FORM)**. L & K COFFEE COMPANY, L.L.C., (U.S. CL. 46). SN 78-353,935. PUB. 12-7-2004. FILED 1-20-2004.  
 2,928,872. **LEMON'S BEST AND DESIGN**. RMK, INCORPORATED, (U.S. CL. 46). SN 78-359,300. PUB. 12-7-2004. FILED 1-29-2004.  
 2,928,938. **TLCS (BLOCK FORM)**. KASHI COMPANY, (U.S. CL. 46). SN 78-376,156. PUB. 12-7-2004. FILED 3-1-2004.  
 2,928,945. **BAKERS FAYRE (BLOCK FORM)**. PLOGHOFT, PHILIP R., (U.S. CL. 46). SN 78-376,663. PUB. 12-7-2004. FILED 3-1-2004.  
 2,928,958. **LIGHT DONE RIGHT! (BLOCK FORM)**. KRAFT FOODS HOLDINGS, INC., (U.S. CL. 46). SN 78-377,581. PUB. 12-7-2004. FILED 3-3-2004.  
 2,928,982. **G.M. 44 (BLOCK FORM)**. GENERAL MILLS, INC., (U.S. CL. 46). SN 78-379,204. PUB. 12-7-2004. FILED 3-5-2004.  
 2,928,994. **HEART OF DARKNESS (BLOCK FORM)**. THE SANTA CRUZ COFFEE ROASTING COMPANY, (U.S. CL. 46). SN 78-380,473. PUB. 12-7-2004. FILED 3-8-2004.  
 2,929,031. **EAS AND DESIGN**. NATURAL SUPPLEMENT ASSOCIATION, INCORPORATED, DBA EXPERIMENTAL AND APPLIED SCIENCES, INC., (U.S. CL. 46). SN 78-387,827. PUB. 12-7-2004. FILED 3-19-2004.  
 2,929,033. **OD AND DESIGN**. HOP KEE INC., DBA ORIENTAL DELICACIES INC., (U.S. CL. 46). SN 78-391,663. PUB. 12-7-2004. FILED 3-26-2004.  
 2,929,046. **CUCINA ANTICA AND DESIGN**. CUCINA ANTICA FOODS CORPORATION, (U.S. CL. 46). SN 78-975,524. PUB. 12-7-2004. FILED 9-5-2002.

---

#### CLASS 31—NATURAL AGRICULTURAL PRODUCTS

2,928,536. **SCOULAR AND DESIGN**. THE SCOULAR COM-

- PANY, (U.S. CLS. 1 AND 46). SN 76-538,382. PUB. 12-7-2004. FILED 7-28-2003.
- 2,928,575. **DRAGON HEARTS (BLOCK FORM)**. FRANK A. LOGOLUSO FARMS, INC., (U.S. CLS. 1 AND 46). SN 76-567,950. PUB. 12-7-2004. FILED 1-2-2004.
- 2,928,649 ( *See Class 25 for this trademark*).
- 2,928,813. **BLACK SALTY (BLOCK FORM)**. I.F. ANDERSON FARMS, INC., (U.S. CLS. 1 AND 46). SN 78-329,861. PUB. 12-7-2004. FILED 11-19-2003.
- 2,928,864. **C AND S AND DESIGN**. C & S PRODUCTS CO., INC., (U.S. CLS. 1 AND 46). SN 78-352,013. PUB. 12-7-2004. FILED 1-14-2004.
- 2,928,891. **SIMPLY GOOD (BLOCK FORM)**. EAGLE EYE DISTRIBUTING, INC., (U.S. CLS. 1 AND 46). SN 78-366,597. PUB. 12-7-2004. FILED 2-11-2004.
- 2,928,995. **MISCELLANEOUS DESIGN**. MORARI SPECIALTIES, INC., (U.S. CLS. 1 AND 46). SN 78-380,474. PUB. 12-7-2004. FILED 3-8-2004.
- 2,929,020. **PINK PARASOLS (BLOCK FORM)**. SPRING MEADOW NURSERY, INC., (U.S. CLS. 1 AND 46). SN 78-384,522. PUB. 12-7-2004. FILED 3-15-2004.

---

### CLASS 32—LIGHT BEVERAGES

- 2,928,453 ( *See Class 29 for this trademark*).
- 2,928,755 ( *See Class 9 for this trademark*).
- 2,928,980. **CAPT'N ELI'S ROOT BEER (BLOCK FORM)**. SHIPYARD BREWING COMPANY, LLC, (U.S. CLS. 45, 46 AND 48). SN 78-379,124. PUB. 12-7-2004. FILED 3-5-2004.
- 2,929,039. **LIQUID PLANET (BLOCK FORM)**. LIQUID PLANET, INC., MULTIPLE CLASS, (INT. CLS. 32 AND 43), (U.S. CLS. 45, 46, 48, 100 AND 101). SN 78-422,949. PUB. 12-7-2004. FILED 5-21-2004.

---

### CLASS 33—WINES AND SPIRITS

- 2,928,453 ( *See Class 29 for this trademark*).
- 2,928,511. **B BRIDGEVIEW AND DESIGN**. BRIDGEVIEW VINEYARDS, INC., (U.S. CLS. 47 AND 49). SN 76-515,285. PUB. 12-7-2004. FILED 5-19-2003.
- 2,928,519. **MISCELLANEOUS DESIGN**. VOLOROSSO S.R.L., (U.S. CLS. 47 AND 49). SN 76-532,621. PUB. 12-7-2004. FILED 7-25-2003.
- 2,928,657. **MENTRIDA MENTRIDA DENOMINACION DE ORIGEN DON CECILIO TEMPRANILLO (70%) Y GARNACHA VIEJA (30%) 2001 ESTATE BOTTLED ELABORADO Y EMBOTELLADO EN LA PROPIEDAD BODEGAS LA CERCA, S.A.- CASARRUBIOS DEL MONTE - TOLEDO R.E.C.L.M. 260-T0 ROBLES 750 ML. ALC. 12.5% BY VOL. PRODUCT OF SPAIN AND DESIGN**. PRIMOS TRADING COMPANY, LLC ON BEHALF OF BODEGAS LA CERCA, (U.S. CLS. 47 AND 49). SN 78-188,698. PUB. 12-7-2004. FILED 11-25-2002.
- 2,928,730 ( *See Class 29 for this trademark*).
- 2,928,736. **THE ORIGINAL WHITE ZINFANDEL**. SUTTER HOME WINERY, INC., (U.S. CLS. 47 AND 49). SN 78-288,214. PUB. 12-7-2004. FILED 8-15-2003.
- 2,928,749. **A WINE ANGEL SELECTION AND DESIGN**. THE WINE ANGEL, INC., (U.S. CLS. 47 AND 49). SN 78-294,157. PUB. 12-7-2004. FILED 8-29-2003.
- 2,928,978. **RAMSAY (BLOCK FORM)**. THE TRUSTEES OF THE KENT A. RASMUSSEN AND CELIE E. RAMSAY REVOCABLE TRUST, A CALIFORNIA TRUST, THE TRUSTEES COMPRISING KENT A. RASMUSSEN, A U.S. CITIZEN, AND CELIE E. RAMSAY, A U.S. CITIZEN., (U.S. CLS. 47 AND 49). SN 78-379,072. PUB. 12-7-2004. FILED 3-5-2004.
- 2,929,013. **WHAT'S UNDER YOUR KILT? (BLOCK FORM)**. CRAUFORD WINE COMPANY LLC, (U.S. CLS. 47 AND 49). SN 78-381,917. PUB. 12-7-2004. FILED 3-10-2004.

### CLASS 34—SMOKERS' ARTICLES

- 2,928,482. **BORKUM RIFF PREMIUM PIPE TOBACCO AND DESIGN**. SWEDISH MATCH NORTH EUROPE AB, (U.S. CLS. 2, 8, 9 AND 17). SN 76-404,229. PUB. 12-7-2004. FILED 5-6-2002.

---

### SERVICE MARKS

### CLASS 35—ADVERTISING AND BUSINESS

- 2,928,453 ( *See Class 29 for this trademark*).
- 2,928,461 ( *See Class 9 for this trademark*).
- 2,928,470. **ERNST & YOUNG WEALTH MANAGEMENT SOLUTIONS**. EYGN LIMITED, MULTIPLE CLASS, (INT. CLS. 35 AND 36), (U.S. CLS. 100, 101 AND 102). SN 76-364,370. PUB. 12-7-2004. FILED 1-29-2002.
- 2,928,481. **EDGEWALKERS**. CYNTHIA L. KEMPER, MULTIPLE CLASS, (INT. CLS. 35 AND 41), (U.S. CLS. 100, 101, 102 AND 107). SN 76-403,313. PUB. 12-7-2004. FILED 5-2-2002.
- 2,928,483. **TODAY'S WASTE, TOMORROW'S RESOURCES AND DESIGN**. GEPTEK, INC., MULTIPLE CLASS, (INT. CLS. 35 AND 40), (U.S. CLS. 100, 101, 102, 103 AND 106). SN 76-404,581. PUB. 12-7-2004. FILED 5-3-2002.
- 2,928,484. **THE STAIN STATION**. THE SANSIN CORPORATION, (U.S. CLS. 100, 101 AND 102). SN 76-405,735. PUB. 12-7-2004. FILED 5-10-2002.
- 2,928,486. **ATM OUTSOURCES, INC. AND DESIGN**. ATM OUTSOURCES, INC., (U.S. CLS. 100, 101 AND 102). SN 76-424,485. PUB. 12-7-2004. FILED 6-24-2002.
- 2,928,495. **RPM RIGHT PLACE MEDIA AND DESIGN**. RIGHT PLACE MEDIA, LLC, (U.S. CLS. 100, 101 AND 102). SN 76-442,368. PUB. 12-7-2004. FILED 8-22-2002.
- 2,928,502. **MISCELLANEOUS DESIGN**. GARTMORE INVESTMENT MANAGEMENT PLC, MULTIPLE CLASS, (INT. CLS. 35 AND 36), (U.S. CLS. 100, 101 AND 102). SN 76-478,455. PUB. 12-7-2004. FILED 12-20-2002.
- 2,928,505. **FOREMAN FUNCTION**. DATACULT, INC., (U.S. CLS. 100, 101 AND 102). SN 76-497,787. PUB. 12-7-2004. FILED 3-17-2003.
- 2,928,512. **THE KESSLER COLLECTION**. KESSLER ENTERPRISE, INC., THE, MULTIPLE CLASS, (INT. CLS. 35 AND 43), (U.S. CLS. 100, 101 AND 102). SN 76-516,146. PUB. 12-7-2004. FILED 4-29-2003.
- 2,928,518. **CANADIAN MED SERVICE AND DESIGN**. TAGA HOLDINGS INC., DBA FORT GARRY PHARMACY, (U.S. CLS. 100, 101 AND 102). SN 76-531,769. PUB. 12-7-2004. FILED 7-24-2003.
- 2,928,528. **OVERBREAK**. OVERBREAK, L.L.C., (U.S. CLS. 100, 101 AND 102). SN 76-536,505. PUB. 12-7-2004. FILED 8-11-2003.
- 2,928,552. **CONNECTING THE BUSINESS TRAVEL WORLD**. NATIONAL BUSINESS TRAVEL ASSOCIATION, INC., MULTIPLE CLASS, (INT. CLS. 35 AND 41), (U.S. CLS. 100, 101, 102 AND 107). SN 76-551,618. PUB. 12-7-2004. FILED 10-16-2003.
- 2,928,553. **NBTA**. NATIONAL BUSINESS TRAVEL ASSOCIATION, INC., MULTIPLE CLASS, (INT. CLS. 35 AND 41), (U.S. CLS. 100, 101, 102 AND 107). SN 76-551,619. PUB. 12-7-2004. FILED 10-16-2003.
- 2,928,554. **NBTA AND DESIGN**. NATIONAL BUSINESS TRAVEL ASSOCIATION, INC., MULTIPLE CLASS, (INT. CLS. 35 AND 41), (U.S. CLS. 100, 101, 102 AND 107). SN 76-551,621. PUB. 12-7-2004. FILED 10-16-2003.
- 2,928,562 ( *See Class 25 for this trademark*).
- 2,928,568 ( *See Class 9 for this trademark*).
- 2,928,582 ( *See Class 19 for this trademark*).
- 2,928,588. **HSD (BLOCK FORM)**. DWYER, DEBORAH R., DBA HUMAN SYSTEMS DEVELOPMENT, (U.S. CLS. 100, 101 AND 102). SN 76-570,654. PUB. 12-7-2004. FILED 1-7-2004.
- 2,928,598. **EXPRESS YOUR LOVE (BLOCK FORM)**. NEILL CORPORATION, (U.S. CLS. 100, 101 AND 102). SN 76-572,597. PUB. 12-7-2004. FILED 1-28-2004.
- 2,928,611. **EFOCUS (BLOCK FORM)**. PEPCOM INC., (U.S.

- CLS. 100, 101 AND 102). SN 76-577,180. PUB. 12-7-2004. FILED 2-18-2004.
- 2,928,623. **RAPID TEAM ALIGNMENT (STYLIZED)**. EXECUTIVE LEADERSHIP GROUP, INC., (U.S. CLS. 100, 101 AND 102). SN 76-578,965. PUB. 12-7-2004. FILED 3-3-2004.
- 2,928,635. **EDIBLENATURE (BLOCK FORM)**. LUNSFORD, BRIAN J., (U.S. CLS. 100, 101 AND 102). SN 76-579,805. PUB. 12-7-2004. FILED 3-8-2004.
- 2,928,639. **PASSIONATE SHOES FOR PASSIONATE SOLES (BLOCK FORM)**. SOLEMATES LLC, (U.S. CLS. 100, 101 AND 102). SN 76-579,989. PUB. 12-7-2004. FILED 3-8-2004.
- 2,928,651 ( *See Class 16 for this trademark*).
- 2,928,656. **NEW YORK STATE RECREATIONAL VEHICLE SHOW**. EAST COAST SHOWS, INC., (U.S. CLS. 100, 101 AND 102). SN 78-186,898. PUB. 12-7-2004. FILED 11-20-2002.
- 2,928,666 ( *See Class 16 for this trademark*).
- 2,928,672. **FP SOLUTIONS (STYLIZED)**. TCH CANADA INC., MULTIPLE CLASS, (INT. CLS. 35, 36, 38 AND 39), (U.S. CLS. 100, 101, 102, 104 AND 105). SN 78-229,876. PUB. 12-7-2004. FILED 3-25-2003.
- 2,928,673. **CONSUMER FIRST**. DEGAN, ROY E. III, (U.S. CLS. 100, 101 AND 102). SN 78-233,348. PUB. 12-7-2004. FILED 4-3-2003.
- 2,928,687. **BGL BARSAN GLOBAL LOJSTIK AND DESIGN**. BARSAN GLOBAL LOJSTIK ANONIM SIRKETI, (U.S. CLS. 100, 101 AND 102). SN 78-264,670. PUB. 12-7-2004. FILED 6-19-2003.
- 2,928,691. **POWER. PERFORMANCE. FUN TO DRIVE..** INTERNATIONAL TRUCK INTELLECTUAL PROPERTY COMPANY, LLC, (U.S. CLS. 100, 101 AND 102). SN 78-271,816. PUB. 12-7-2004. FILED 7-8-2003.
- 2,928,694. **FRICS**. ROYAL INSTITUTION OF CHARTERED SURVEYORS, THE, MULTIPLE CLASS, (INT. CLS. 35, 36, 37, 41 AND 42), (U.S. CLS. 100, 101, 102, 103, 106 AND 107). SN 78-272,861. PUB. 12-7-2004. FILED 7-10-2003.
- 2,928,695. **TECHRICS (STYLIZED)**. ROYAL INSTITUTION OF CHARTERED SURVEYORS, THE, MULTIPLE CLASS, (INT. CLS. 35, 36, 37, 41 AND 42), (U.S. CLS. 100, 101, 102, 103, 106 AND 107). SN 78-272,896. PUB. 12-7-2004. FILED 7-10-2003.
- 2,928,703. **POWER SHOTS**. INTERNATIONAL TRUCK INTELLECTUAL PROPERTY COMPANY, LLC., (U.S. CLS. 100, 101 AND 102). SN 78-276,457. PUB. 12-7-2004. FILED 7-20-2003.
- 2,928,705. **WEBPROWORLD**. IENTRY, INC., (U.S. CLS. 100, 101 AND 102). SN 78-277,814. PUB. 12-7-2004. FILED 7-23-2003.
- 2,928,725 ( *See Class 16 for this trademark*).
- 2,928,735. **STREETWISE AND DESIGN**. STREETWISE MAPS INC., (U.S. CLS. 100, 101 AND 102). SN 78-288,113. PUB. 12-7-2004. FILED 8-15-2003.
- 2,928,738. **EXTREMELURES**. IZUMI, GEORGE, (U.S. CLS. 100, 101 AND 102). SN 78-289,482. PUB. 12-7-2004. FILED 8-19-2003.
- 2,928,740 ( *See Class 16 for this trademark*).
- 2,928,743. **REPO MAXX**. SARLEY MEDIA CORP., (U.S. CLS. 100, 101 AND 102). SN 78-290,336. PUB. 12-7-2004. FILED 8-21-2003.
- 2,928,747. **CATTLELOGOS**. CATTLELOGOS BRAND MANAGEMENT SYSTEMS LLC, (U.S. CLS. 100, 101 AND 102). SN 78-293,327. PUB. 12-7-2004. FILED 8-28-2003.
- 2,928,753. **ANSWER AUTOMATION AND DESIGN**. ICIM CORPORATION, DBA PLANET TELECOM, (U.S. CLS. 100, 101 AND 102). SN 78-295,677. PUB. 12-7-2004. FILED 9-3-2003.
- 2,928,764. **SPAFIT**. SPAFIT, LLC, (U.S. CLS. 100, 101 AND 102). SN 78-304,947. PUB. 12-7-2004. FILED 9-24-2003.
- 2,928,767. **CAKLEBERRY FARM**. SHOWCASE MANAGEMENT, INC., MULTIPLE CLASS, (INT. CLS. 35 AND 36), (U.S. CLS. 100, 101 AND 102). SN 78-308,592. PUB. 12-7-2004. FILED 10-2-2003.
- 2,928,769. **O&I SHOES SHOES SHOES AND DESIGN**. PIGGY TOES, A CHILDREN'S SHOE BOUTIQUE, LLC, (U.S. CLS. 100, 101 AND 102). SN 78-309,298. PUB. 7-20-2004. FILED 10-3-2003.
- 2,928,775. **BRING IT ALL HOME!**. THE KROGER CO. OF MICHIGAN, (U.S. CLS. 100, 101 AND 102). SN 78-313,007. PUB. 12-7-2004. FILED 10-13-2003.
- 2,928,778. **SAVIN DIAMOND**. SAVIN DIAMOND CORPORATION, (U.S. CLS. 100, 101 AND 102). SN 78-313,980. PUB. 12-7-2004. FILED 10-15-2003.
- 2,928,790. **1 ONE CALL HOME MANAGEMENT SERVICE, LLC (STYLIZED)**. ONE CALL HOME MANAGEMENT SERVICE, LLC., (U.S. CLS. 100, 101 AND 102). SN 78-319,563. PUB. 12-7-2004. FILED 10-28-2003.
- 2,928,795 ( *See Class 16 for this trademark*).
- 2,928,819 ( *See Class 9 for this trademark*).
- 2,928,820 ( *See Class 9 for this trademark*).
- 2,928,821. **RELEVANT ASSETS (BLOCK FORM)**. CRE TECHNOLOGIES, INC., MULTIPLE CLASS, (INT. CLS. 35 AND 42), (U.S. CLS. 100, 101 AND 102). SN 78-333,610. PUB. 12-7-2004. FILED 11-26-2003.
- 2,928,824. **TTC THE TRAVELER'S CHANNEL (BLOCK FORM)**. TTC INC., TA TRAVELER'S CHANNEL, (U.S. CLS. 100, 101 AND 102). SN 78-335,106. PUB. 12-7-2004. FILED 12-2-2003.
- 2,928,825. **STYLEMAP (BLOCK FORM)**. LUXTON ENTERPRISES, INC., (U.S. CLS. 100, 101 AND 102). SN 78-335,542. PUB. 12-7-2004. FILED 12-3-2003.
- 2,928,834. **THOMAS GRAPHICS INC AND DESIGN**. THOMAS GRAPHICS, INC., MULTIPLE CLASS, (INT. CLS. 35 AND 40), (U.S. CLS. 100, 101, 102, 103 AND 106). SN 78-338,954. PUB. 12-7-2004. FILED 12-10-2003.
- 2,928,835. **COHORT MANAGEMENT SYSTEM (BLOCK FORM)**. EDFUND, (U.S. CLS. 100, 101 AND 102). SN 78-339,075. PUB. 12-7-2004. FILED 12-10-2003.
- 2,928,840. **MOXIE MOMS (BLOCK FORM)**. MOXIE MOMS LLC, MULTIPLE CLASS, (INT. CLS. 35, 41 AND 45), (U.S. CLS. 100, 101, 102 AND 107). SN 78-341,079. PUB. 12-7-2004. FILED 12-15-2003.
- 2,928,849. **AMME WORLDWIDE ASSOCIATION OF MEXICANS ABROAD AND DESIGN**. ASSOCIACION MUNDIAL DE MEXICANOS EN EL EXTERIOR, (U.S. CLS. 100, 101 AND 102). SN 78-346,976. PUB. 12-7-2004. FILED 12-31-2003.
- 2,928,862. **GEXA (BLOCK FORM)**. GEXA CORPORATION, MULTIPLE CLASS, (INT. CLS. 35 AND 36), (U.S. CLS. 100, 101 AND 102). SN 78-351,213. PUB. 12-7-2004. FILED 1-13-2004.
- 2,928,881. **SULLIVAN-SCHEIN (BLOCK FORM)**. HSI SERVICE CORP., (U.S. CLS. 100, 101 AND 102). SN 78-362,226. PUB. 12-7-2004. FILED 2-4-2004.
- 2,928,911. **BUSINESS WOMEN FOR SUCCESS (BLOCK FORM)**. SLAUGHTER, CARECE H., (U.S. CLS. 100, 101 AND 102). SN 78-371,670. PUB. 12-7-2004. FILED 2-20-2004.
- 2,928,917. **ASHLAR-STONE (BLOCK FORM)**. ASHLAR-STONE, INC., (U.S. CLS. 100, 101 AND 102). SN 78-372,718. PUB. 12-7-2004. FILED 2-23-2004.
- 2,928,922. **TOUR & TRAVEL EXCHANGE (BLOCK FORM)**. NATIONAL TOUR ASSOCIATION, INC., (U.S. CLS. 100, 101 AND 102). SN 78-372,956. PUB. 12-7-2004. FILED 2-24-2004.
- 2,928,929. **JOE KNOWS (BLOCK FORM)**. HONDO COMMUNICATIONS INC., (U.S. CLS. 100, 101 AND 102). SN 78-374,537. PUB. 12-7-2004. FILED 2-26-2004.
- 2,928,931. **THE UNEXPECTED WISCONSIN (BLOCK FORM)**. CHIPPEWA VALLEY CONVENTION & VISITORS BUREAU, INC., (U.S. CLS. 100, 101 AND 102). SN 78-375,327. PUB. 12-7-2004. FILED 2-27-2004.
- 2,928,932. **TRENDWATCH (BLOCK FORM)**. TEENAGE RESEARCH UNLIMITED, INC., (U.S. CLS. 100, 101 AND 102). SN 78-375,540. PUB. 12-7-2004. FILED 2-27-2004.
- 2,928,953 ( *See Class 9 for this trademark*).
- 2,928,959. **DIALAMERICA MAGAZINE CENTER (BLOCK FORM)**. DIALAMERICA MARKETING, INC., (U.S. CLS. 100, 101 AND 102). SN 78-377,964. PUB. 12-7-2004. FILED 3-3-2004.
- 2,928,969 ( *See Class 16 for this trademark*).
- 2,928,981 ( *See Class 9 for this trademark*).
- 2,928,990. **LOCALLAUNCH!COM (BLOCK FORM)**. MEDIARY GROUP, INC., (U.S. CLS. 100, 101 AND 102). SN 78-380,125. PUB. 12-7-2004. FILED 3-8-2004.
- 2,928,992. **10 SPOT (BLOCK FORM)**. 618 MAIN CLOTHING CORP., (U.S. CLS. 100, 101 AND 102). SN 78-380,213. PUB. 12-7-2004. FILED 3-8-2004.
- 2,928,993. **BEEFLEXIBLE (BLOCK FORM)**. NATIONAL CATTLEMEN'S BEEF ASSOCIATION, AND CATTLEMEN'S

BEEF PROMOTION AND RESEARCH BOARD, (U.S. CLS. 100, 101 AND 102). SN 78-380,468. PUB. 12-7-2004. FILED 3-8-2004.

2,929,003. **PAT ALLEN ASSOCIATES, INC. (BLOCK FORM)**. PAT ALLEN ASSOCIATES, INC., (U.S. CLS. 100, 101 AND 102). SN 78-380,849. PUB. 12-7-2004. FILED 3-9-2004.

2,929,008. **INTERNATIONAL ASSOCIATION FOR ORTHODONTICS AND DESIGN**. INTERNATIONAL ASSOCIATION FOR ORTHODONTICS, (U.S. CLS. 100, 101 AND 102). SN 78-381,040. PUB. 12-7-2004. FILED 3-9-2004.

2,929,015. **APARTMENTCAREERS.COM (BLOCK FORM)**. REALESTATECAREERS.COM, L.L.C., (U.S. CLS. 100, 101 AND 102). SN 78-381,971. PUB. 12-7-2004. FILED 3-10-2004.

2,929,037 ( *See Class 25 for this trademark*).

---

### CLASS 36—INSURANCE AND FINANCIAL

2,928,456 ( *See Class 16 for this trademark*).

2,928,470 ( *See Class 35 for this trademark*).

2,928,472. **PROFITABLE FINANCIAL STRATEGIES**. JAVELIN ENTERPRISES, INC., (U.S. CLS. 100, 101 AND 102). SN 76-370,784. PUB. 12-7-2004. FILED 2-15-2004.

2,928,479. **ROAD LOANS AND DESIGN**. TRIAD FINANCIAL, INC., (U.S. CLS. 100, 101 AND 102). SN 76-398,505. PUB. 12-7-2004. FILED 4-22-2002.

2,928,485. **ONEFEE**. ABN AMRO MORTGAGE GROUP, INC., (U.S. CLS. 100, 101 AND 102). SN 76-410,965. PUB. 3-23-2004. FILED 5-20-2002.

2,928,502 ( *See Class 35 for this trademark*).

2,928,516. **TIME FOR A CURE**. THE AMYOTROPHIC LATERAL SCLEROSIS ASSOCIATION, (U.S. CLS. 100, 101 AND 102). SN 76-526,985. PUB. 12-7-2004. FILED 6-30-2003.

2,928,586. **LIFE: ACT 2 (BLOCK FORM)**. UNITED WAY OF NORTHEAST FLORIDA, (U.S. CLS. 100, 101 AND 102). SN 76-570,149. PUB. 12-7-2004. FILED 1-12-2004.

2,928,591. **GCC SERVICING SYSTEMS AND DESIGN**. GLENN COMPUTER CORPORATION, (U.S. CLS. 100, 101 AND 102). SN 76-571,198. PUB. 12-7-2004. FILED 1-21-2004.

2,928,624. **COLLATERAL INSIGHT (BLOCK FORM)**. THE BEAR STEARNS COMPANIES INC., (U.S. CLS. 100, 101 AND 102). SN 76-579,047. PUB. 12-7-2004. FILED 3-1-2004.

2,928,628. **CALDIRECT (BLOCK FORM)**. GMAC MORTGAGE CORPORATION, (U.S. CLS. 100, 101 AND 102). SN 76-579,614. PUB. 12-7-2004. FILED 3-8-2004.

2,928,634. **FAIRFEE (BLOCK FORM)**. ONEWORLD MARKETING, INC., (U.S. CLS. 100, 101 AND 102). SN 76-579,777. PUB. 12-7-2004. FILED 3-8-2004.

2,928,640. **DITECH RACING (BLOCK FORM)**. GMAC MORTGAGE CORPORATION, (U.S. CLS. 100, 101 AND 102). SN 76-580,149. PUB. 12-7-2004. FILED 3-10-2004.

2,928,647. **DITECH.COM HOME LOANS (BLOCK FORM)**. GMAC MORTGAGE CORPORATION, (U.S. CLS. 100, 101 AND 102). SN 76-603,778. PUB. 12-7-2004. FILED 7-23-2004.

2,928,648. **DITECH.COM HOME LOANS AND DESIGN**. GMAC MORTGAGE CORPORATION, (U.S. CLS. 100, 101 AND 102). SN 76-603,959. PUB. 12-7-2004. FILED 7-26-2004.

2,928,651 ( *See Class 16 for this trademark*).

2,928,672 ( *See Class 35 for this trademark*).

2,928,689. **403(B) ACCELERATOR**. KNIGHT, DAVID MC, (U.S. CLS. 100, 101 AND 102). SN 78-267,410. PUB. 12-7-2004. FILED 6-26-2003.

2,928,694 ( *See Class 35 for this trademark*).

2,928,695 ( *See Class 35 for this trademark*).

2,928,720. **SINCERELY FREE CHECKING**. NORTH FORK BANCORPORATION, INC., AKA NORTH FORK BANK, (U.S. CLS. 100, 101 AND 102). SN 78-281,623. PUB. 12-7-2004. FILED 7-31-2003.

2,928,721. **ST. PAUL 1ST CHOICE**. THE ST. PAUL TRAVELERS COMPANIES, INC., (U.S. CLS. 100, 101 AND 102). SN 78-281,649. PUB. 9-21-2004. FILED 7-31-2003.

2,928,726. **YOUR CONFIDENCE IS SHOWING**. THE MCGRAW-HILL COMPANIES, INC., (U.S. CLS. 100, 101 AND 102). SN 78-283,919. PUB. 12-7-2004. FILED 8-6-2003.

2,928,734. **VANGUARD LIFETIME INCOME PROGRAM**. VANGUARD GROUP, INC., THE, (U.S. CLS. 100, 101 AND 102). SN 78-287,210. PUB. 12-7-2004. FILED 8-14-2003.

2,928,758. **CCISITES**. CROWN CASTLE INTERNATIONAL CORP., MULTIPLE CLASS, (INT. CLS. 36, 37 AND 38), (U.S. CLS. 100, 101, 102, 103, 104 AND 106). SN 78-299,649. PUB. 12-7-2004. FILED 9-12-2003.

2,928,760. **METRO SPIRE**. METRO SPIRE L.L.C., (U.S. CLS. 100, 101 AND 102). SN 78-301,114. PUB. 5-18-2004. FILED 9-16-2003.

2,928,767 ( *See Class 35 for this trademark*).

2,928,791. **21ST CENTURY HEALTHCARE MANAGEMENT AND DESIGN**. 21ST CENTURY HEALTHCARE MANAGEMENT, INC., (U.S. CLS. 100, 101 AND 102). SN 78-319,740. PUB. 12-7-2004. FILED 10-28-2003.

2,928,816. **LENDCO AND DESIGN**. LENDCO, INC., (U.S. CLS. 100, 101 AND 102). SN 78-332,530. PUB. 12-7-2004. FILED 11-24-2003.

2,928,862 ( *See Class 35 for this trademark*).

2,928,867. **TEXAS MORTGAGE COMPANY CUSTOM LOANS TO YOUR NEEDS AND DESIGN**. TMC MORTGAGE CORPORATION, (U.S. CLS. 100, 101 AND 102). SN 78-355,215. PUB. 12-7-2004. FILED 1-21-2004.

2,928,888. **IPIYA (BLOCK FORM)**. IPIYA, INC., (U.S. CLS. 100, 101 AND 102). SN 78-365,648. PUB. 12-7-2004. FILED 2-10-2004.

2,928,899. **DENALI DENTAL (BLOCK FORM)**. DIRECT BENEFITS, INC., (U.S. CLS. 100, 101 AND 102). SN 78-370,017. PUB. 12-7-2004. FILED 2-18-2004.

2,928,926. **PRESCENDO (BLOCK FORM)**. PRESCENDO CONSULTING LP, (U.S. CLS. 100, 101 AND 102). SN 78-373,376. PUB. 12-7-2004. FILED 2-24-2004.

2,928,950. **THE STANDARD IN ALGORITHMIC TRADING (BLOCK FORM)**. CREDIT SUISSE FIRST BOSTON LLC, (U.S. CLS. 100, 101 AND 102). SN 78-376,894. PUB. 12-7-2004. FILED 3-2-2004.

2,928,977. **CREDITSTOP (BLOCK FORM)**. INTERNET TRUCKSTOP LLC, (U.S. CLS. 100, 101 AND 102). SN 78-378,917. PUB. 12-7-2004. FILED 3-4-2004.

2,929,016. **AMHERST (BLOCK FORM)**. AMHERST SECURITIES GROUP, L.P., (U.S. CLS. 100, 101 AND 102). SN 78-382,048. PUB. 12-7-2004. FILED 3-10-2004.

2,929,035. **MISCELLANEOUS DESIGN**. PRAIRIE BANK AND TRUST COMPANY, (U.S. CLS. 100, 101 AND 102). SN 78-418,442. PUB. 12-7-2004. FILED 5-13-2004.

---

### CLASS 37—CONSTRUCTION AND REPAIR

2,928,448. **QUESTAR HOMEWORKS**. QUESTAR ENERGY SERVICES, INC., (U.S. CLS. 100, 103 AND 106). SN 75-272,554. PUB. 12-7-2004. FILED 4-10-1997.

2,928,455 ( *See Class 9 for this trademark*).

2,928,496 ( *See Class 16 for this trademark*).

2,928,542. **GUTTERGARD AND DESIGN**. THE GUTTER GUYS, INC., (U.S. CLS. 100, 103 AND 106). SN 76-542,239. PUB. 12-7-2004. FILED 9-2-2003.

2,928,544. **MASTERCARE (STYLIZED)**. BFS RETAIL & COMMERCIAL OPERATIONS, LLC, (U.S. CLS. 100, 103 AND 106). SN 76-545,099. PUB. 12-7-2004. FILED 9-3-2003.

2,928,576. **FLUENTDESIGN (STYLIZED)**. FLUENT DESIGN, INC., (U.S. CLS. 100, 103 AND 106). SN 76-568,274. PUB. 12-7-2004. FILED 12-22-2003.

2,928,584. **WE DESIGN IT. WE INSTALL IT. YOU ENJOY IT. (BLOCK FORM)**. GARAGETEK, INC., MULTIPLE CLASS, (INT. CLS. 37 AND 42), (U.S. CLS. 100, 101, 103 AND 106). SN 76-569,829. PUB. 12-7-2004. FILED 1-13-2004.

2,928,594. **SHREDMOBILE (BLOCK FORM)**. NORTHEAST MOBILE SHREDDING, LLC, MULTIPLE CLASS, (INT. CLS. 37 AND 40), (U.S. CLS. 100, 103 AND 106). SN 76-571,564. PUB. 12-7-2004. FILED 1-15-2004.

2,928,622. **IT'S GOOD TO BE GREEN (STYLIZED)**. WCI COMMUNITIES, INC., (U.S. CLS. 100, 103 AND 106). SN 76-578,810. PUB. 12-7-2004. FILED 3-2-2004.

2,928,645. **STEP UP, STEP IN (BLOCK FORM)**. MHO, LLC, (U.S. CLS. 100, 103 AND 106). SN 76-582,923. PUB. 12-7-2004. FILED 3-18-2004.

2,928,694 ( *See Class 35 for this trademark*).

2,928,695 ( *See Class 35 for this trademark*).

2,928,698. **QUANTM**. QUANTM LIMITED, MULTIPLE

CLASS. (INT. CLS. 37 AND 42), (U.S. CLS. 100, 101, 103 AND 106). SN 78-275,220. PUB. 12-7-2004. FILED 7-16-2003. 2,928,758 ( *See Class 36 for this trademark*).

2,928,801. **INTEGRITY SYSTEMS (BLOCK FORM)**. INTEGRITY SYSTEMS, INC., (U.S. CLS. 100, 103 AND 106). SN 78-325,314. PUB. 12-7-2004. FILED 11-10-2003.

2,928,853. **THE MAIDS AND DESIGN**. THE MAIDS INTERNATIONAL, INC., (U.S. CLS. 100, 103 AND 106). SN 78-347,622. PUB. 12-7-2004. FILED 1-5-2004.

2,928,854. **PRO BLAST COATINGS REMOVAL SPECIALIST AND DESIGN**. LAWRENCE, STEVEN ROBERT, (U.S. CLS. 100, 103 AND 106). SN 78-347,762. PUB. 12-7-2004. FILED 1-5-2004.

2,928,880. **MISCELLANEOUS DESIGN**. GENERAL BUSINESS CORP., (U.S. CLS. 100, 103 AND 106). SN 78-361,337. PUB. 12-7-2004. FILED 2-2-2004.

2,928,893. **BLAZE RESTORATION, INC. (BLOCK FORM)**. BLAZE RESTORATION, INC., (U.S. CLS. 100, 103 AND 106). SN 78-367,643. PUB. 12-7-2004. FILED 2-13-2004.

2,928,944. **1-888-NEVERPAINT (BLOCK FORM)**. 1-888 NEVER PAINT, (U.S. CLS. 100, 103 AND 106). SN 78-376,614. PUB. 12-7-2004. FILED 3-1-2004.

2,928,948. **YOUR OEM ALTERNATIVE (BLOCK FORM)**. AVCOM AVIONICS AND INSTRUMENTS, INC., (U.S. CLS. 100, 103 AND 106). SN 78-376,758. PUB. 12-7-2004. FILED 3-2-2004.

2,928,975. **THE BENCHMARK OF PROFESSIONALISM (BLOCK FORM)**. LIFESTYLES CUSTOM HOMES & REMODELING, LLC, (U.S. CLS. 100, 103 AND 106). SN 78-378,858. PUB. 12-7-2004. FILED 3-4-2004.

2,928,985. **CRAWLSPACE DOCTOR (BLOCK FORM)**. CRAWLSPACE DOCTOR, INC., (U.S. CLS. 100, 103 AND 106). SN 78-379,557. PUB. 12-7-2004. FILED 3-5-2004.

### CLASS 38—COMMUNICATION

2,928,461 ( *See Class 9 for this trademark*).

2,928,526. **VFL VARSITY FOOTBALL LEAGUE FRIDAY NIGHT FOOTBALL**. VTV: VARSITY TELEVISION, INC., (U.S. CLS. 100, 101 AND 104). SN 76-536,262. PUB. 7-20-2004. FILED 6-11-2003.

2,928,561. **NETSPOKE AND DESIGN**. NETSPOKE, INC., (U.S. CLS. 100, 101 AND 104). SN 76-562,749. PUB. 12-7-2004. FILED 11-17-2003.

2,928,617. **INDIA IS CLOSER THAN YOU THINK (BLOCK FORM)**. RELIANCE COMMUNICATIONS, INC., (U.S. CLS. 100, 101 AND 104). SN 76-578,121. PUB. 12-7-2004. FILED 2-27-2004.

2,928,652 ( *See Class 9 for this trademark*).

2,928,667. **F P AND DESIGN**. CIS INTERNET LTD, TA FACEPARTY.COM, (U.S. CLS. 100, 101 AND 104). SN 78-226,200. PUB. 7-20-2004. FILED 3-17-2003.

2,928,670. **VMDIRECT**. VMDIRECT LLC, (U.S. CLS. 100, 101 AND 104). SN 78-228,463. PUB. 12-7-2004. FILED 3-21-2003.

2,928,672 ( *See Class 35 for this trademark*).

2,928,708. **MINI MESSAGE BOARD**. VERIZON COMMUNICATIONS INC., (U.S. CLS. 100, 101 AND 104). SN 78-278,832. PUB. 12-7-2004. FILED 7-25-2003.

2,928,758 ( *See Class 36 for this trademark*).

2,928,786. **PELAGIC NETWORKS**. SNR TECHNOLOGIES GROUP, LLC, (U.S. CLS. 100, 101 AND 104). SN 78-316,759. PUB. 12-7-2004. FILED 10-21-2003.

2,928,906. **ARROW 93.1 THE BEST CLASSIC ROCK AND DESIGN**. INFINITY BROADCASTING CORPORATION, (U.S. CLS. 100, 101 AND 104). SN 78-371,218. PUB. 12-7-2004. FILED 2-20-2004.

2,928,910. **LIBERTY WIRELESS AND DESIGN**. STARNUMBER, INC., (U.S. CLS. 100, 101 AND 104). SN 78-371,483. PUB. 12-7-2004. FILED 2-20-2004.

2,928,927. **KANOKLA (BLOCK FORM)**. KANOKLA TELEPHONE ASSOCIATION, (U.S. CLS. 100, 101 AND 104). SN 78-373,854. PUB. 12-7-2004. FILED 2-25-2004.

### CLASS 39—TRANSPORTATION AND STORAGE

2,928,456 ( *See Class 16 for this trademark*).

2,928,468 ( *See Class 16 for this trademark*).

2,928,672 ( *See Class 35 for this trademark*).

2,928,701. **CRUISEDRIVE**. HICKS JASON F, (U.S. CLS. 100 AND 105). SN 78-275,712. PUB. 12-7-2004. FILED 7-17-2003.

2,928,886. **MYLEISURETRIP.COM (BLOCK FORM)**. HILTON HOSPITALITY, INC., (U.S. CLS. 100 AND 105). SN 78-364,920. PUB. 12-7-2004. FILED S.R. 2-9-2004; AM. P.R. 9-14-2004.

2,928,928. **BAGS TO GO (BLOCK FORM)**. WIATER, KEITH, (U.S. CLS. 100 AND 105). SN 78-374,033. PUB. 12-7-2004. FILED 2-25-2004.

2,928,989. **NO BOOKING FEES. NO BRAINER. (BLOCK FORM)**. US AIRWAYS, INC., (U.S. CLS. 100 AND 105). SN 78-380,065. PUB. 12-7-2004. FILED 3-8-2004.

### CLASS 40—MATERIAL TREATMENT

2,928,483 ( *See Class 35 for this trademark*).

2,928,533 ( *See Class 9 for this trademark*).

2,928,594 ( *See Class 37 for this trademark*).

2,928,834 ( *See Class 35 for this trademark*).

2,928,866. **STUDIO Z MENDOCINO (BLOCK FORM)**. ZBL, INC., (U.S. CLS. 100, 103 AND 106). SN 78-355,145. PUB. 12-7-2004. FILED 1-21-2004.

### CLASS 41—EDUCATION AND ENTERTAINMENT

2,928,454. **LE SKRATCH**. 3398889 CANADA INC., MULTIPLE CLASS, (INT. CLS. 41 AND 42), (U.S. CLS. 100, 101 AND 107). SN 76-087,086. PUB. 10-1-2002. FILED 7-10-2000.

2,928,460 ( *See Class 9 for this trademark*).

2,928,461 ( *See Class 9 for this trademark*).

2,928,468 ( *See Class 16 for this trademark*).

2,928,471 ( *See Class 25 for this trademark*).

2,928,481 ( *See Class 35 for this trademark*).

2,928,490. **PS AND DESIGN**. JASPER PRODUCTIONS, INC., (U.S. CLS. 100, 101 AND 107). SN 76-436,491. PUB. 12-7-2004. FILED 7-31-2002.

2,928,493. **MISCELLANEOUS DESIGN**. CITY OF SANTA ROSA, (U.S. CLS. 100, 101 AND 107). SN 76-440,737. PUB. 12-7-2004. FILED 8-15-2002.

2,928,504. **EPAC**. EICHELBERGER PERFORMING ARTS CENTER, (U.S. CLS. 100, 101 AND 107). SN 76-491,134. PUB. 12-7-2004. FILED 2-19-2003.

2,928,514 ( *See Class 9 for this trademark*).

2,928,517. **JACKSON RANCHERIA**. JACKSON RANCHERIA BAND OF MIWUK INDIANS, DBA JACKSON RANCHERIA, MULTIPLE CLASS, (INT. CLS. 41 AND 43), (U.S. CLS. 100, 101 AND 107). SN 76-530,966. PUB. 12-7-2004. FILED 7-21-2003.

2,928,522. **EPISCOPAL NEWS SERVICE**. THE EPISCOPAL CHURCH, (U.S. CLS. 100, 101 AND 107). SN 76-533,652. PUB. 12-7-2004. FILED 7-31-2003.

2,928,541. **DR-K (STYLIZED)**. THE DYCKMAN HOUSE RESTAURANT, INC., MULTIPLE CLASS, (INT. CLS. 41 AND 43), (U.S. CLS. 100, 101 AND 107). SN 76-541,893. PUB. 12-7-2004. FILED 8-21-2003.

2,928,548. **MADTAP**. THQ WIRELESS INC., (U.S. CLS. 100, 101 AND 107). SN 76-546,919. PUB. 12-7-2004. FILED 9-10-2003.

2,928,552 ( *See Class 35 for this trademark*).

2,928,553 ( *See Class 35 for this trademark*).

2,928,554 ( *See Class 35 for this trademark*).

2,928,562 ( *See Class 25 for this trademark*).

2,928,568 ( *See Class 9 for this trademark*).

2,928,569. **ACCORDING TO THE SCRIPTURES (BLOCK FORM)**. CALVARY CHAPEL OF MODESTO, INC., (U.S. CLS. 100, 101 AND 107). SN 76-567,329. PUB. 12-7-2004. FILED 12-29-2003.

2,928,573. **DU DAVENPORT UNIVERSITY AND DESIGN**.

- DAVENPORT UNIVERSITY, (U.S. CLS. 100, 101 AND 107). SN 76-567,827. PUB. 12-7-2004. FILED 12-31-2003.
- 2,928,574 ( *See Class 25 for this trademark*).
- 2,928,583. **NETIP NORTH AMERICA (BLOCK FORM)**. NETWORK OF INDIAN PROFESSIONALS OF NORTH AMERICA, INC., (U.S. CLS. 100, 101 AND 107). SN 76-569,680. PUB. 12-7-2004. FILED 12-29-2003.
- 2,928,585. **UNIVERSITY OF THE FAMILY (BLOCK FORM)**. UNIVERSITY OF THE FAMILY, INC., (U.S. CLS. 100, 101 AND 107). SN 76-569,882. PUB. 12-7-2004. FILED 1-12-2004.
- 2,928,589. **THE JCONNECTION (BLOCK FORM)**. POPKIN, JEFF, (U.S. CLS. 100, 101 AND 107). SN 76-570,663. PUB. 12-7-2004. FILED 1-7-2004.
- 2,928,590. **SEBONACK GOLF CLUB (BLOCK FORM)**. SEBONACK NECK HOLDINGS LLC, (U.S. CLS. 100, 101 AND 107). SN 76-571,083. PUB. 12-7-2004. FILED 1-15-2004.
- 2,928,593. **SUN DAY ON THE MILE (STYLIZED)**. KIWANIS CLUB OF LITTLE HAVANA, INC., (U.S. CLS. 100, 101 AND 107). SN 76-571,362. PUB. 12-7-2004. FILED 1-22-2004.
- 2,928,609. **LEADERSHIP LEARNING (STYLIZED)**. LAKE FOREST GRADUATE SCHOOL OF MANAGEMENT, (U.S. CLS. 100, 101 AND 107). SN 76-576,877. PUB. 12-7-2004. FILED 2-20-2004.
- 2,928,619. **FUR REAL (BLOCK FORM)**. E. C. DITTRICH AND CO., INC., (U.S. CLS. 100, 101 AND 107). SN 76-578,303. PUB. 12-7-2004. FILED 2-27-2004.
- 2,928,629. **EAGLE ROCK ART GUILD AND DESIGN**. EAGLE ROCK ART GUILD, INC., (U.S. CLS. 100, 101 AND 107). SN 76-579,640. PUB. 12-7-2004. FILED 3-8-2004.
- 2,928,646 ( *See Class 9 for this trademark*).
- 2,928,650. **THE NETWORK**. ICBC BROADCAST HOLDINGS, INC., (U.S. CLS. 100, 101 AND 107). SN 78-130,991. PUB. 12-7-2004. FILED 5-24-2002.
- 2,928,652 ( *See Class 9 for this trademark*).
- 2,928,653. **TIB TICKER**. TIB THE INDEPENDENT BANKERSBANK, (U.S. CLS. 100, 101 AND 107). SN 78-155,894. PUB. 12-7-2004. FILED 8-20-2002.
- 2,928,659 ( *See Class 9 for this trademark*).
- 2,928,675. **ETRAFFIC SOLUTIONS, INC. AND DESIGN**. ETRAFFIC SOLUTIONS, INC., MULTIPLE CLASS, (INT. CLS. 41 AND 42), (U.S. CLS. 100, 101 AND 107). SN 78-237,394. PUB. 12-7-2004. FILED 4-14-2003.
- 2,928,676. **INSTINCTIVE TRAINING**. HAY, IAN M., (U.S. CLS. 100, 101 AND 107). SN 78-241,197. PUB. 12-7-2004. FILED 4-23-2003.
- 2,928,693 ( *See Class 16 for this trademark*).
- 2,928,694 ( *See Class 35 for this trademark*).
- 2,928,695 ( *See Class 35 for this trademark*).
- 2,928,699. **AMERICA'S AWARD WINNING MEAL IDEAS**. THE PILLSBURY COMPANY, (U.S. CLS. 100, 101 AND 107). SN 78-275,561. PUB. 12-7-2004. FILED 7-17-2003.
- 2,928,710. **PSYCHIATRYMATTERS.MD**. N.V. ORGANON, MULTIPLE CLASS, (INT. CLS. 41 AND 44), (U.S. CLS. 100, 101 AND 107). SN 78-279,005. PUB. 12-7-2004. FILED 7-25-2003.
- 2,928,717. **YOUNG LEARNERS SCHOOL AND DESIGN**. LEADERS IN EDUCATION, INC., (U.S. CLS. 100, 101 AND 107). SN 78-281,014. PUB. 12-7-2004. FILED 7-30-2003.
- 2,928,719. **THE CHILLBILLIES, LLC (RHYTHM, BOOGIE, AND BLUES) AND DESIGN**. THE CHILLBILLIES, LLC, (U.S. CLS. 100, 101 AND 107). SN 78-281,578. PUB. 12-7-2004. FILED 7-31-2003.
- 2,928,723. **PANTHER TRAIL**. THE WOODLANDS COMMERCIAL PROPERTIES COMPANY L.P., (U.S. CLS. 100, 101 AND 107). SN 78-282,133. PUB. 12-7-2004. FILED 8-1-2003.
- 2,928,755 ( *See Class 9 for this trademark*).
- 2,928,762. **IVY SUPERSONIC**. SILBERSTEIN, IVY, (U.S. CLS. 100, 101 AND 107). SN 78-304,343. PUB. 12-7-2004. FILED 9-23-2003.
- 2,928,766. **STRIPSEARCH USA (BLOCK FORM)**. MARKIR ONE, INC., (U.S. CLS. 100, 101 AND 107). SN 78-306,614. PUB. 12-7-2004. FILED 9-29-2003.
- 2,928,792. **WEBTRANSFORM**. COLON, ALBERT, (U.S. CLS. 100, 101 AND 107). SN 78-319,977. PUB. 12-7-2004. FILED 10-29-2003.
- 2,928,793. **TORRIE WILSON**. WORLD WRESTLING ENTERTAINMENT, INC., (U.S. CLS. 100, 101 AND 107). SN 78-320,179. PUB. 12-7-2004. FILED 10-29-2003.
- 2,928,794. **ANCORA (BLOCK FORM)**. MONTI & ASSOCIATES, INC., (U.S. CLS. 100, 101 AND 107). SN 78-320,931. PUB. 12-7-2004. FILED 10-30-2003.
- 2,928,795 ( *See Class 16 for this trademark*).
- 2,928,797. **CHOCTAW RACING SERVICES L.L.C. (BLOCK FORM)**. CHOCTAW RACING SERVICES L.L.C., (U.S. CLS. 100, 101 AND 107). SN 78-323,345. PUB. 12-7-2004. FILED 11-5-2003.
- 2,928,807. **CHANGE RX (BLOCK FORM)**. MILUS, THOMAS BAKER, (U.S. CLS. 100, 101 AND 107). SN 78-328,430. PUB. 12-7-2004. FILED 11-14-2003.
- 2,928,811. **I RUN THIS TOWN (BLOCK FORM)**. INDY FESTIVALS, INC., DBA 500 FESTIVAL ASSOCIATES, (U.S. CLS. 100, 101 AND 107). SN 78-329,278. PUB. 12-7-2004. FILED 11-18-2003.
- 2,928,828. **AMERICA'S THANKSGIVING PARADE (BLOCK FORM)**. THE PARADE COMPANY, (U.S. CLS. 100, 101 AND 107). SN 78-336,868. PUB. 12-7-2004. FILED 12-5-2003.
- 2,928,839. **TECHPRESS (BLOCK FORM)**. TECHPRESS, INC., (U.S. CLS. 100, 101 AND 107). SN 78-340,914. PUB. 12-7-2004. FILED 12-15-2003.
- 2,928,840 ( *See Class 35 for this trademark*).
- 2,928,843. **GETTING CHILDREN WELL ON THEIR WAY (BLOCK FORM)**. THE VANDERBILT UNIVERSITY, MULTIPLE CLASS, (INT. CLS. 41 AND 44), (U.S. CLS. 100, 101 AND 107). SN 78-342,205. PUB. 12-7-2004. FILED 12-17-2003.
- 2,928,847. **ELEGANT MUSIC FOR EVERY OCCASION (BLOCK FORM)**. HOLLY PRATT, (U.S. CLS. 100, 101 AND 107). SN 78-345,701. PUB. 12-7-2004. FILED 12-26-2003.
- 2,928,852. **MATHPATH (BLOCK FORM)**. THOMAS, GEORGE R., (U.S. CLS. 100, 101 AND 107). SN 78-347,161. PUB. 12-7-2004. FILED 12-31-2003.
- 2,928,868. **THE BATTER'S BOX ACADEMY & SPORTS COMPLEX AND DESIGN**. THE BATTER'S BOX ACADEMY, INC., (U.S. CLS. 100, 101 AND 107). SN 78-356,308. PUB. 12-7-2004. FILED 1-23-2004.
- 2,928,871. **JOEY AND MARIA'S COMEDY ITALIAN WEDDING (BLOCK FORM)**. DILLSTAR PRODUCTIONS, INC., (U.S. CLS. 100, 101 AND 107). SN 78-358,077. PUB. 12-7-2004. FILED 1-27-2004.
- 2,928,874. **CERTIFIED TRADE SHOW MARKETER (BLOCK FORM)**. EXHIBITOR PUBLICATIONS, INC., (U.S. CLS. 100, 101 AND 107). SN 78-359,988. PUB. 12-7-2004. FILED 1-30-2004.
- 2,928,879. **TODD TV AND DESIGN**. FX NETWORKS, LLC, (U.S. CLS. 100, 101 AND 107). SN 78-361,326. PUB. 12-7-2004. FILED 2-2-2004.
- 2,928,885. **HOT HAIR (BLOCK FORM)**. MEREDITH CORPORATION, (U.S. CLS. 100, 101 AND 107). SN 78-364,203. PUB. 12-7-2004. FILED 2-6-2004.
- 2,928,898. **RHIANNON (BLOCK FORM)**. LEPORE, TRACEY, (U.S. CLS. 100, 101 AND 107). SN 78-368,631. PUB. 12-7-2004. FILED 2-16-2004.
- 2,928,930. **VEGAS GIRLS (BLOCK FORM)**. SORANNO, RICHARD S., (U.S. CLS. 100, 101 AND 107). SN 78-375,154. PUB. 12-7-2004. FILED 2-27-2004.
- 2,928,942. **5 MINUTE BRIEFING: DATA CENTER (BLOCK FORM)**. UNISPHERE MEDIA, L.L.C., (U.S. CLS. 100, 101 AND 107). SN 78-376,556. PUB. 12-7-2004. FILED 3-1-2004.
- 2,928,965. **BEHOLDEN (BLOCK FORM)**. WEAVER, AIMEE, (U.S. CLS. 100, 101 AND 107). SN 78-378,623. PUB. 12-7-2004. FILED 3-4-2004.
- 2,928,976. **CBS SPORTS (BLOCK FORM)**. CBS BROADCASTING INC., (U.S. CLS. 100, 101 AND 107). SN 78-378,897. PUB. 12-7-2004. FILED 3-4-2004.
- 2,928,984. **MINNEAPPLEPRESS (BLOCK FORM)**. STAUFFER, DENNIS A., (U.S. CLS. 100, 101 AND 107). SN 78-379,354. PUB. 12-7-2004. FILED 3-5-2004.
- 2,928,987. **LANDSHARKS BAND (BLOCK FORM)**. ROLAND, GARY, (U.S. CLS. 100, 101 AND 107). SN 78-379,630. PUB. 12-7-2004. FILED 3-5-2004.
- 2,928,997. **MISCELLANEOUS DESIGN**. CHAMP CONCEPTS, INC., (U.S. CLS. 100, 101 AND 107). SN 78-380,799. PUB. 12-7-2004. FILED 3-9-2004.
- 2,929,000. **MISCELLANEOUS DESIGN**. REGENTS OF THE UNIVERSITY OF MINNESOTA, (U.S. CLS. 100, 101 AND 107). SN 78-380,819. PUB. 12-7-2004. FILED 3-9-2004.

**CLASS 42—SCIENTIFIC, COMPUTER AND LEGAL SERVICES**

2,928,447. **GUILTLESS DELIGHTS**. DW FOOD CENTERS, INC., (U.S. CLS. 100 AND 101). SN 75-029,780. PUB. 12-7-2004. FILED 12-8-1995.

2,928,450. **ELIXIR AND DESIGN**. ELIXIR JUICE BAR, LLC, (U.S. CLS. 100 AND 101). SN 75-734,071. PUB. 12-7-2004. FILED 6-22-1999.

2,928,453 ( *See Class 29 for this trademark*).

2,928,454 ( *See Class 41 for this trademark*).

2,928,455 ( *See Class 9 for this trademark*).

2,928,456 ( *See Class 16 for this trademark*).

2,928,461 ( *See Class 9 for this trademark*).

2,928,463. **INTRINSYC**. INTRINSYC SOFTWARE, INC., (U.S. CLS. 100 AND 101). SN 76-264,572. PUB. 12-7-2004. FILED 5-31-2001.

2,928,465. **HEALTHPRINT**. SUPERIOR CONSULTING SERVICES, INC., (U.S. CLS. 100 AND 101). SN 76-280,321. PUB. 12-7-2004. FILED 7-3-2001.

2,928,468 ( *See Class 16 for this trademark*).

2,928,489 ( *See Class 9 for this trademark*).

2,928,509. **T R P AND DESIGN**. TECHNOLOGY & PATENT RESEARCH INTERNATIONAL, INC., (U.S. CLS. 100 AND 101). SN 76-513,407. PUB. 12-7-2004. FILED 5-7-2003.

2,928,525. **USIGHT**. USIGHT, LLC, (U.S. CLS. 100 AND 101). SN 76-534,568. PUB. 12-7-2004. FILED 8-5-2003.

2,928,529 ( *See Class 9 for this trademark*).

2,928,547. **EXECUPOINT**. UNISYS CORPORATION, (U.S. CLS. 100 AND 101). SN 76-546,218. PUB. 12-7-2004. FILED 9-8-2003.

2,928,558. **HEMALOGIC AND DESIGN**. BLUERIDGE SOLUTIONS, LC, (U.S. CLS. 100 AND 101). SN 76-555,954. PUB. 12-7-2004. FILED 10-16-2003.

2,928,568 ( *See Class 9 for this trademark*).

2,928,584 ( *See Class 37 for this trademark*).

2,928,606. **WHAT WHEN WHERE...DEFINED. (BLOCK FORM)**. SPATIAL DATA ANALYTICS CORPORATION, (U.S. CLS. 100 AND 101). SN 76-575,442. PUB. 12-7-2004. FILED 2-12-2004.

2,928,616. **H2O, YOUR IT TALENT POOL (BLOCK FORM)**. HOME2OFFICE COMPUTING SOLUTIONS, INC., (U.S. CLS. 100 AND 101). SN 76-578,118. PUB. 12-7-2004. FILED 2-27-2004.

2,928,646 ( *See Class 9 for this trademark*).

2,928,652 ( *See Class 9 for this trademark*).

2,928,659 ( *See Class 9 for this trademark*).

2,928,675 ( *See Class 41 for this trademark*).

2,928,690. **COMPUTER KNOW HOW**. COMPUTER KNOW HOW, INC., (U.S. CLS. 100 AND 101). SN 78-271,472. PUB. 12-7-2004. FILED 7-8-2003.

2,928,694 ( *See Class 35 for this trademark*).

2,928,695 ( *See Class 35 for this trademark*).

2,928,698 ( *See Class 37 for this trademark*).

2,928,772 ( *See Class 9 for this trademark*).

2,928,804 ( *See Class 9 for this trademark*).

2,928,819 ( *See Class 9 for this trademark*).

2,928,820 ( *See Class 9 for this trademark*).

2,928,821 ( *See Class 35 for this trademark*).

2,928,822. **NEWT (BLOCK FORM)**. TELECOMMUNICATIONS RESEARCH LABORATORIES, (U.S. CLS. 100 AND 101). SN 78-333,802. PUB. 12-7-2004. FILED 11-26-2003.

2,928,830. **PHOTOBIRD AND DESIGN**. EDMUND F. KRIMEN, DBA PHOTOBIRD.COM, (U.S. CLS. 100 AND 101). SN 78-337,290. PUB. 12-7-2004. FILED 12-5-2003.

2,928,915. **SEGUE (BLOCK FORM)**. SEGUE SOFTWARE, INC., (U.S. CLS. 100 AND 101). SN 78-372,449. PUB. 12-7-2004. FILED 2-23-2004.

2,928,919. **INFERENCEAL RISK MODEL (BLOCK FORM)**. UPSTREAM SOLUTIONS, LLC, (U.S. CLS. 100 AND 101). SN 78-372,778. PUB. 12-7-2004. FILED 2-23-2004.

2,928,920. **IRM (BLOCK FORM)**. UPSTREAM SOLUTIONS, LLC, (U.S. CLS. 100 AND 101). SN 78-372,779. PUB. 12-7-2004. FILED 2-23-2004.

2,928,921. **OLD AGE IS NO PLACE FOR SISSIES (BLOCK FORM)**. WARNER, JAN L., (U.S. CLS. 100 AND 101). SN 78-372,869. PUB. 12-7-2004. FILED 2-24-2004.

2,928,979. **"TODAY'S SOLUTIONS FOR TOMORROW'S NEEDS" (BLOCK FORM)**. DOX ELECTRONICS, INC.,

(U.S. CLS. 100 AND 101). SN 78-379,084. PUB. 12-7-2004. FILED 3-5-2004.

2,929,002. **MISCELLANEOUS DESIGN**. REGENTS OF THE UNIVERSITY OF MINNESOTA, (U.S. CLS. 100 AND 101). SN 78-380,825. PUB. 12-7-2004. FILED 3-9-2004.

2,929,009. **EGO AND DESIGN**. EGOSUM, INC., (U.S. CLS. 100 AND 101). SN 78-381,158. PUB. 12-7-2004. FILED 3-9-2004.

2,929,023. **PROFIT FROM INVENTION (BLOCK FORM)**. IPSG, P.C., (U.S. CLS. 100 AND 101). SN 78-384,641. PUB. 12-7-2004. FILED 3-15-2004.

**CLASS 43—HOTEL AND RESTAURANT SERVICES**

2,928,512 ( *See Class 35 for this trademark*).

2,928,517 ( *See Class 41 for this trademark*).

2,928,534. **HOME PARTNERSHIPS-CUSTOMIZED**. TREE OF CONCERN INTERNATIONAL FOUNDATION, INC., (U.S. CLS. 100 AND 101). SN 76-538,202. PUB. 12-7-2004. FILED 8-18-2003.

2,928,541 ( *See Class 41 for this trademark*).

2,928,545. **SIMPLY FISH AND DESIGN**. FARES, INC., TA SIMPLY FISH, (U.S. CLS. 100 AND 101). SN 76-545,352. PUB. 12-7-2004. FILED 9-4-2003.

2,928,581. **THE TERM GROUP (BLOCK FORM)**. THE EVENT MANAGEMENT GROUP, INC., (U.S. CLS. 100 AND 101). SN 76-569,301. PUB. 12-7-2004. FILED 12-29-2003.

2,928,587. **HONG MIN (BLOCK FORM)**. TAM, WILLIAM, (U.S. CLS. 100 AND 101). SN 76-570,653. PUB. 12-7-2004. FILED 1-7-2004.

2,928,614. **D AND DESIGN**. OCINOMLED, LTD, (U.S. CLS. 100 AND 101). SN 76-577,251. PUB. 12-7-2004. FILED 2-23-2004.

2,928,633. **MISCELLANEOUS DESIGN**. MFP FRANCHISE SYSTEMS, INC., DBA MY FRIEND'S PLACE, (U.S. CLS. 100 AND 101). SN 76-579,775. PUB. 12-7-2004. FILED 3-8-2004.

2,928,718. **D DANIEL AND DESIGN**. THE DINEX GROUP, LLC, (U.S. CLS. 100 AND 101). SN 78-281,308. PUB. 12-7-2004. FILED 7-31-2003.

2,928,741. **TULLY'S COFFEE AND DESIGN**. TULLY'S COFFEE CORPORATION, (U.S. CLS. 100 AND 101). SN 78-290,044. PUB. 12-7-2004. FILED 8-20-2003.

2,928,752. **BAD BRAD'S BAR-B-Q**. BARTON, BRAD, R., (U.S. CLS. 100 AND 101). SN 78-295,318. PUB. 12-7-2004. FILED 9-3-2003.

2,928,770. **PICCADILLY TO-GO AND DESIGN**. PICCADILLY RESTAURANTS, LLC, (U.S. CLS. 100 AND 101). SN 78-310,555. PUB. 7-20-2004. FILED 10-7-2003.

2,928,850. **T THOMPSON HOSPITALITY AND DESIGN**. THOMPSON HOSPITALITY CORPORATION, (U.S. CLS. 100 AND 101). SN 78-347,035. PUB. 12-7-2004. FILED 12-31-2003.

2,928,857 ( *See Class 25 for this trademark*).

2,928,890. **SWEETWATERS AND DESIGN**. SWEET WATERS CAFE INC., (U.S. CLS. 100 AND 101). SN 78-366,572. PUB. 12-7-2004. FILED 2-11-2004.

2,928,896. **PAYBACKS (STYLIZED)**. K & S ENTERPRISES, (U.S. CLS. 100 AND 101). SN 78-368,604. PUB. 12-7-2004. FILED 2-16-2004.

2,928,951. **THE HARV (BLOCK FORM)**. MTR GAMING GROUP, INC., (U.S. CLS. 100 AND 101). SN 78-377,004. PUB. 12-7-2004. FILED 3-2-2004.

2,928,952. **THE HARV AND DESIGN**. MTR GAMING GROUP, INC., (U.S. CLS. 100 AND 101). SN 78-377,007. PUB. 12-7-2004. FILED 3-2-2004.

2,928,972. **MISCELLANEOUS DESIGN**. BRONX PIZZA, INC., (U.S. CLS. 100 AND 101). SN 78-378,756. PUB. 12-7-2004. FILED 3-4-2004.

2,928,983. **FAMILY TABLE (BLOCK FORM)**. VILLAGER OF STORM LAIE, INC., (U.S. CLS. 100 AND 101). SN 78-379,261. PUB. 12-7-2004. FILED 3-5-2004.

2,929,004. **U.B.U. LOUNGE (BLOCK FORM)**. ARAMARK CORPORATION, (U.S. CLS. 100 AND 101). SN 78-380,895. PUB. 12-7-2004. FILED 3-9-2004.

2,929,039 ( *See Class 32 for this trademark.* )

---

**CLASS 44—MEDICAL, BEAUTY AND AGRICULTURAL SERVICES**

2,928,489 ( *See Class 9 for this trademark.* )

2,928,557. **THE CARE CENTER FOR WOMEN AND DESIGN.** UHS OF DELAWARE, INC., (U.S. CLS. 100 AND 101). SN 76-554,861. PUB. 12-7-2004. FILED 10-9-2003.

2,928,627. **A PEEK IN THE POD (BLOCK FORM).** A PEEK IN THE POD, LLC, (U.S. CLS. 100 AND 101). SN 76-579,361. PUB. 12-7-2004. FILED 3-4-2004.

2,928,644. **IF YOU THINK THE COST OF BRACES IS HIGH, WE'D LIKE TO STRAIGHTEN YOU OUT (BLOCK FORM).** E. GLENN GLASSMAN, D.D.S., P.C., DBA ORTHOCARE SYSTEMS, (U.S. CLS. 100 AND 101). SN 76-581,204. PUB. 12-7-2004. FILED 3-16-2004.

2,928,649 ( *See Class 25 for this trademark.* )

2,928,710 ( *See Class 41 for this trademark.* )

2,928,748. **EVERY CONCEIVABLE CHANCE FOR SUCCESS.** INTEGRATED AMERICA, INC., (U.S. CLS. 100 AND 101). SN 78-294,031. PUB. 12-7-2004. FILED 8-29-2003.

2,928,842. **WELLNESS IQ (BLOCK FORM).** SHARON REDD INC, (U.S. CLS. 100 AND 101). SN 78-341,423. PUB. 12-7-2004. FILED 12-16-2003.

2,928,843 ( *See Class 41 for this trademark.* )

2,928,956 ( *See Class 3 for this trademark.* )

2,928,967. **HAIRY'S AND DESIGN.** VUKOTICH, DENISE M., (U.S. CLS. 100 AND 101). SN 78-378,661. PUB. 12-7-2004. FILED 3-4-2004.

2,928,991. **MUTUAL WELLNESS (BLOCK FORM).** MEDICAL MUTUAL OF OHIO, (U.S. CLS. 100 AND 101). SN 78-380,159. PUB. 12-7-2004. FILED 3-8-2004.

2,929,021. **HERSPACE (BLOCK FORM).** BREAST IMAGING AND BIOPSY SPECIALISTS, LLC, (U.S. CLS. 100 AND 101). SN 78-384,543. PUB. 12-7-2004. FILED 3-15-2004.

---

**CLASS 45—PERSONAL SERVICES**

2,928,750. **GRAPH THEORETIC ANOMALY DETECTION.** ID ANALYTICS, INC., (U.S. CLS. 100 AND 101). SN 78-294,810. PUB. 12-7-2004. FILED 9-2-2003.

2,928,840 ( *See Class 35 for this trademark.* )

2,928,923. **CSI CONTINUOUS SERVICE IMPROVEMENT (BLOCK FORM).** STANLEY SMITH SECURITY, INC., DBA INITIAL SECURITY, (U.S. CLS. 100 AND 101). SN 78-372,957. PUB. 12-7-2004. FILED 2-24-2004.

\* \* \* \* \*



SECTION 2.—PRIOR UNITED STATES CLASSIFICATION

COLLECTIVE MEMBERSHIP MARKS

**CLASS 200—COLLECTIVE MEMBERSHIP**

2,928,757. MISCELLANEOUS DESIGN. SIGMA DELTA PI,  
NATIONAL COLLEGIATE HISPANIC HONOR SOCIETY,  
SN 78-298,510. PUB. 12-7-2004. FILED 9-10-2003.

CERTIFICATION MARKS

CLASS A—GOODS

2,928,737. SPEED MEASUREMENT LABS. INC. PERFOR-  
MANCE CERTIFIED AND DESIGN. SPEED MEASURE-  
MENT LABORATORIES, INC., SN 78-288,391. PUB. 12-7-  
2004. FILED 8-17-2003.

\* \* \* \* \*

# TRADEMARK REGISTRATIONS ISSUED UNDER SECTION 1(d)

The following marks have registered on the Principal Register pursuant to the intent-to-use provisions of Section 1(d) of the Trademark Act of 1946, as amended.

## SECTION 1.— INTERNATIONAL CLASSIFICATION

The short titles associated below with the international class numbers are terms designed merely for quick identification and are not an official part of the international classification. The full names of international classes are given in section 6.1 of the trademark rules of practice.

The designation "U.S. Cl." appearing in this section refers to the U.S. class in effect prior to Sep. 1, 1973 rather than the international class which applies to applications filed on or after that date. For adoption of international classification see notice in the OFFICIAL GAZETTE of Jun. 26, 1973 (911 O.G. TM 210).

### Application in more than one class

2,929,052. APPLIED FORMAL METHODS INSTITUTE INC.,  
8003 ZURICH, SWITZERLAND. SN 75-428,585. PUB. 2-5-  
2002, FILED 2-4-1998.

## MONTAGES

PRIORITY CLAIMED UNDER SEC. 44(D) ON SWITZERLAND APPLICATION NO. 06622/1997, FILED 8-15-1997, REG. NO. 453153, DATED 8-17-1998, EXPIRES 8-15-2007.

### CLASS 9—ELECTRICAL AND SCIENTIFIC APPARATUS

FOR SOFTWARE FOR THE ANALYZING AND CREATING COMPUTER-RELATED LANGUAGES; SOFTWARE IN THE FIELD OF ANALYSIS OR DESCRIPTION OF COMPUTER-RELATED LANGUAGES, NAMELY, DATABASE MANAGEMENT SOFTWARE AND COMPUTER SOFTWARE DEVELOPMENT TOOLS; CONFIGURATION SOFTWARE AND CONFIGURATION MAINTENANCE SOFTWARE FOR CONFIGURING DATA, MEMORIES STORING DATA, INPUT AND OUTPUT DEVICES, DRIVERS, GRAPHIC USER INTERFACES AND NETWORK COMMUNICATION MODEMS, NETWORK CIRCUIT BOARDS AND NETWORK CONNECTORS; FINANCIAL ACCOUNTING SOFTWARE; COMPUTER OPERATING SYSTEM SOFTWARE; SOFTWARE INTERFACES FOR COMMUNICATING WITH OTHERS AND TRANSMITTING DATA FOR OTHERS; DRIVER SOFTWARE FOR CONTROLLING COMMUNICATION, TRANSMISSION AND RECEPTION OF DATA; TEXT EDITING SOFTWARE; SEARCH ENGINE SOFTWARE; COMPUTERS, DATA PROCESSORS; COMPUTER ACCESSORIES FOR USE IN THE FIELD OF ANALYSIS OR DESCRIPTION OF COMPUTER-RELATED LANGUAGES, NAMELY, INTEGRATED CIRCUITS; MICROPROCESSORS; AND USER MANUALS RELATING TO ALL OF THE AFOREMENTIONED GOODS SOLD AS A UNIT THEREWITH (U.S. CLS. 21, 23, 26, 36 AND 38).

FIRST USE 1-1-2001; IN COMMERCE 1-31-2001.

### CLASS 16—PAPER GOODS AND PRINTED MATTER

FOR BOOKS AND MANUALS IN THE FIELD OF ANALYSIS AND DESCRIPTION OF COMPUTER-RELATED LANGUAGES (U.S. CLS. 2, 5, 22, 23, 29, 37, 38 AND 50).

FIRST USE 1-1-2001; IN COMMERCE 1-31-2001.

### CLASS 41—EDUCATION AND ENTERTAINMENT

FOR PUBLICATION OF BOOKS; INSTRUCTION AND TEACHING OF SOFTWARE AND SYSTEM ENGINEERS, NAMELY, CONDUCTING CLASSES, SEMINARS AND TUTORIALS IN THE FIELD OF ANALYSIS AND DESCRIPTION OF COMPUTER-RELATED LANGUAGES, NAMELY, DATABASE SOFTWARE, MAINTENANCE AND DEVELOPMENT TOOLS, CONFIGURATION AND CONFIGURATION MAINTENANCE SOFTWARE, NETWORK SOFTWARE, MAINTENANCE AND DEVELOPMENT TOOLS, SERVER SOFTWARE MAINTENANCE AND DEVELOPMENT TOOLS, SOFTWARE TO COLLECT AND EDIT MEASURING DATA, FINANCIAL ACCOUNTING SOFTWARE, OPERATING SYSTEM SOFTWARE TO COLLECT AND EDIT MEASURING DATE, FINANCIAL ACCOUNTING SOFTWARE, OPERATING SYSTEM SOFTWARE, MAINTENANCE AND DEVELOPMENT TOOLS, SOFTWARE INTERFACES, DRIVER AND DRIVER MAINTENANCE SOFTWARE, SPECIFICATION SOFTWARE AND SOFTWARE TOOLS TO MAINTAIN, EDIT AND DEVELOP SPECIFICATIONS, INTERNET SOFTWARE, CONTROL AND ADJUSTING SOFTWARE, TRANSLATION SOFTWARE AND TOOLS, METACOMPLIERS, TEXT EDITING SOFTWARE AND TEXT EDITING DEVELOPMENT TOOLS, SEARCH ENGINES, DATA SEARCH AND DATA ORGANIZATION SOFTWARE (U.S. CLS. 100, 101 AND 107).

FIRST USE 1-1-2001; IN COMMERCE 1-31-2001.

### CLASS 42—SCIENTIFIC, COMPUTER AND LEGAL SERVICES

FOR CONSULTATION IN THE FIELD OF COMPUTER SOFTWARE; COMPUTER SYSTEMS ANALYSIS, SOFTWARE ENGINEERING, COMPUTER SOFTWARE DESIGN FOR OTHERS, AND DESIGN OF COMPUTER-RELATED LANGUAGES FOR OTHERS (U.S. CLS. 100 AND 101).

FIRST USE 1-1-2001; IN COMMERCE 1-31-2001.

2,929,053. MATTEL, INC., EL SEGUNDO, CA. SN 75-514,854.  
PUB. 9-4-2001, FILED 7-7-1998.

## TINY TEARS

### CLASS 20—FURNITURE AND ARTICLES NOT OTHERWISE CLASSIFIED

FOR NON-METAL COLLECTIBLE AND DECORATIVE FIGURINES, NAMELY FIGURINES MADE WHOLLY OR SUBSTANTIALLY OF FABRIC, BONE, IVORY, PLASTER, PLASTIC, WAX, AND SYNTHETIC RESIN (U.S. CLS. 2, 13, 22, 25, 32 AND 50).

FIRST USE 2-17-1950; IN COMMERCE 2-17-1950.

### CLASS 21—HOUSEWARES AND GLASS

FOR NON-METAL COLLECTIBLE AND DECORATIVE FIGURINES, NAMELY FIGURINES MADE WHOLLY OR SUBSTANTIALLY OF CHINA, CRYSTAL, EARTH-ENWARE, GLASS, PORCELAIN, AND TERRA COTTA (U.S. CLS. 2, 13, 23, 29, 30, 33, 40 AND 50).

FIRST USE 9-0-1999; IN COMMERCE 9-0-1999.

2,929,054. SUZUKA FUJI XEROX KABUSHIKI KAISHA, DBA SUZUKA FUJI XEROX CO., LTD., SUZUKA-SHI, MIE, JAPAN. SN 75-574,289. PUB. 8-1-2000, FILED 10-21-1998.

## REPELLE

### CLASS 1—CHEMICALS

FOR SYNTHETIC AND UNPROCESSED ARTIFICIAL THERMOPLASTIC RESINS FOR GENERAL INDUSTRIAL USE (U.S. CLS. 1, 5, 6, 10, 26 AND 46).

FIRST USE 6-0-2003; IN COMMERCE 6-0-2003.

### CLASS 16—PAPER GOODS AND PRINTED MATTER

FOR WRITING INK AND DUPLICATING INK (U.S. CLS. 2, 5, 22, 23, 29, 37, 38 AND 50).

FIRST USE 6-0-2003; IN COMMERCE 6-0-2003.

### CLASS 40—MATERIAL TREATMENT

FOR WASTE TREATMENT (U.S. CLS. 100, 103 AND 106).

FIRST USE 6-0-2003; IN COMMERCE 6-0-2003.

2,929,055. SOLAGRAN PTY LTD, MELBOURNE VICTORIA, AUSTRALIA. SN 75-581,800. PUB. 10-16-2001, FILED 11-16-1998.

## BIOEFFECTIVE

OWNER OF AUSTRALIA REG. NO. 760976, DATED 5-1-1998, EXPIRES 5-1-2008.

### CLASS 3—COSMETICS AND CLEANING PREPARATIONS

FOR SOAPS, NAMELY, SKIN SOAPS, LIQUID SOAPS FOR THE SKIN, FACE, HANDS AND BODY, AND SHOWER GELS FOR THE BODY, BATH AND FEET; PERFUMES AND COLOGNES AND EAU DE TOILETTE; ESSENTIAL OILS INTENDED FOR PERSONAL USE AND FOR USE IN THE MANUFACTURE OF SCENTED PRODUCTS; COSMETICS, NAMELY, FACE TONERS, CLEANSERS, SCRUBS AND MASKS; FACE CREAMS, LOTIONS AND GELS; BODY LOTIONS, CREAMS AND GELS; HAND AND NAIL CREAMS, LOTIONS AND GELS; BODY DEODORANTS AND PERSONAL DEODORANTS; BATH AND PERSONAL WASH; FOOT BATHS SALVES, LOTIONS, CREAMS AND POWDERS; LIPSTICKS, LIP PENCILS, LIP LINERS, LIP GLOSS; MASCARA; EYE LINER AND EYE PENCIL; EYE SHADOW AND EYE SHADOW PENCIL; EYEBROW PENCILS; BLUSHES; FOUNDATION MAKE UP AND CONCEALERS; FACE POWDERS; HAIR LOTIONS FOR USE AS SHAMPOOS AND CONDITIONERS; MOUTHWASHES AND TOOTHPASTES; BREATH FRESHENERS, MOUTHWASHES AND TOOTHPASTES; LAUNDRY DETERGENTS IN LIQUID AND POWDER FORM CONTAINING DISINFECTANT; AND DISHWASHING LIQUID CONTAINING DISINFECTANTS (U.S. CLS. 1, 4, 6, 50, 51 AND 52).

FIRST USE 5-23-1998; IN COMMERCE 5-23-2000.

### CLASS 5—PHARMACEUTICALS

FOR PHARMACEUTICAL PREPARATIONS FOR USE IN THE TREATMENT AND PREVENTION OF - COLDS AND FLU; SORE THROATS; TONSILLITIS; ANAEMIA; LEUCOPOENIA; TINEA; THRUSH; COLPITIS; SINUSITIS; BURNS; WOUNDS; ECZEMA, ENDOCRINE DISORDERS, AND IMMUNOLOGICAL DISORDERS, NAMELY, RHEUMATOID ARTHRITIS AND IMMUNODEFICIENCY RESULTING FROM ORGAN TRANSPLANTS, RADIOTHERAPY AND CHEMOTHERPY AND VIRAL INFECTIONS; ORAL HYGIENE PREPARATIONS FOR USE IN THE TREATMENT OF - GINGIVITIS; PERIODONTITIS; CARIES; GELATINE PLATES FOR BLEEDING AND RECEDING GUMS; BAD BREATH/HALITOSIS; MEDICATED MOUTHWASHES; MEDICAL TOOTHPASTES; MEDICATED PLAQUE REMOVERS, NAMELY ANTI-PLAQUE MOUTH RINSES AND ORAL PLAQUE REMOVAL PREPARATIONS; MEDICATED LOZENGES; MEDICATED CHEWING GUMS WITH ANTI VIRAL AND ANTI BACTERIAL PROPERTIES; DIETETIC SUBSTANCES ADAPTED FOR MEDICINAL USE, NAMELY, DIETARY SUPPLEMENTS IN THE FORM OF - DIET PILLS; NUTRITIONAL SUPPLEMENTS; METABOLIC ENHANCERS, MEAL REPLACEMENT DRINKS; MEAL REPLACEMENT BARS; MULTIVITAMIN TONICS; WOUND DRESSINGS, SURGICAL DRESSINGS, AND BURN DRESSINGS; DISINFECTANTS, NAMELY ALL PURPOSE DISINFECTANTS, HOSPITAL GRADE DISINFECTANTS, AND DISINFECTANTS FOR CONTACT LENSES; FUNGICIDES AND HERBICIDES FOR DOMESTIC AND AGRICULTURAL USE (U.S. CLS. 6, 18, 44, 46, 51 AND 52).

FIRST USE 5-23-1998; IN COMMERCE 5-23-2000.

2,929,064. SARCOS INVESTMENTS LC, SALT LAKE CITY, UT. SN 75-758,018. PUB. 12-4-2001, FILED 7-22-1999.

## FREEMAN

OWNER OF U.S. REG. NO. 2,080,089.

### CLASS 7—MACHINERY

FOR MOBILE ROBOTS FOR USE IN TRANSPORTING AND MOVING OBJECTS FOR INDUSTRIAL USE (U.S. CLS. 13, 19, 21, 23, 31, 34 AND 35).

FIRST USE 11-21-2003; IN COMMERCE 4-9-2004.

**CLASS 9—ELECTRICAL AND SCIENTIFIC APPARATUS**

FOR MOBILE ROBOTS FOR USE IN LABORATORY AND ENTERTAINMENT PURPOSES (U.S. CLS. 21, 23, 26, 36 AND 38).

FIRST USE 11-21-2003; IN COMMERCE 4-9-2004.

2,929,067. LUKENS, WILLIAM W., MERRITT ISLAND, FL. SN 75-824,238. PUB. 2-24-2004, FILED 10-15-1999.



NO CLAIM IS MADE TO THE EXCLUSIVE RIGHT TO USE "ROOFBALL", APART FROM THE MARK AS SHOWN.

**CLASS 9—ELECTRICAL AND SCIENTIFIC APPARATUS**

FOR PRERECORDED VIDEO CASSETTE WHICH TEACHES AND DESCRIBES A GAME TO BE PLAYED USING THE ROOF OF A BUILDING, PADDLES AND A BALL (U.S. CLS. 21, 23, 26, 36 AND 38).

FIRST USE 9-17-1999; IN COMMERCE 12-0-2000.

**CLASS 16—PAPER GOODS AND PRINTED MATTER**

FOR PAPER GOODS, NAMELY PRINTED NON-FICTION BOOKS OR MANUALS WHICH DESCRIBE AND ILLUSTRATE A GAME TO BE PLAYED USING THE ROOF OF A BUILDING, BUMPER STICKERS, PENS, PENCILS, PENCIL TOPPERS, PAPER MILK CAPS FOR TRADING, LOOSE LEAF BINDERS, CALENDARS, BOOKMARKS AND POSTERS (U.S. CLS. 2, 5, 22, 23, 29, 37, 38 AND 50).

FIRST USE 9-17-1999; IN COMMERCE 12-0-2000.

**CLASS 25—CLOTHING**

FOR CLOTHING, NAMELY TEE SHIRTS, GOLF SHIRTS, JACKETS, HATS, SHORTS, SWEAT SHIRTS, APRONS, BABY CLOTH BIBS, GLOVES, SOCKS AND UNDERCLOTHES (U.S. CLS. 22 AND 39).

FIRST USE 11-12-2001; IN COMMERCE 11-12-2001.

**CLASS 35—ADVERTISING AND BUSINESS**

FOR ON-LINE RETAIL STORE SERVICES OF GAMES VIA THE WORLDWIDE WEB; PROMOTION OF A GAME FOR ENTERTAINMENT PURPOSES ON A WEB PAGE (U.S. CLS. 100, 101 AND 102).

FIRST USE 9-17-1999; IN COMMERCE 12-0-2000.

**CLASS 41—EDUCATION AND ENTERTAINMENT**

FOR ENTERTAINMENT SERVICES, NAMELY, PROVIDING AN ON-LINE COMPUTER GAME; ENTERTAINMENT SERVICES IN THE NATURE OF SPORTS EXHIBITIONS INVOLVING GAMES PLAYED USING THE ROOF OF A BUILDING; AND PROVIDING FACILITIES FOR TOURNAMENTS IN SAID GAMES; PROVIDING INFORMATION ON GAMES FOR ENTERTAINMENT PURPOSES VIA AN ON-LINE COMPUTER WEB SITE; INFORMATION ON A GAME FOR ENTERTAINMENT PURPOSES ON A WEB PAGE (U.S. CLS. 100, 101 AND 107).

FIRST USE 9-17-1999; IN COMMERCE 12-0-2000.

2,929,068. MAJOR LEAGUE BASEBALL PLAYERS ASSOCIATION, NEW YORK, NY. SN 75-825,894. PUB. 4-2-2002, FILED 10-18-1999.

**PLAYERS CHOICE****CLASS 9—ELECTRICAL AND SCIENTIFIC APPARATUS**

FOR VIDEO GAME PROGRAMS RELATED TO BASEBALL, COMPUTER GAME PROGRAMS RELATED TO BASEBALL (U.S. CLS. 21, 23, 26, 36 AND 38).

FIRST USE 8-1-2004; IN COMMERCE 8-1-2004.

**CLASS 28—TOYS AND SPORTING GOODS**

FOR BASEBALLS, HANDHELD UNITS FOR PLAYING VIDEO GAMES RELATED TO BASEBALL, HANDHELD UNITS FOR PLAYING ELECTRONIC GAMES RELATED TO BASEBALL, CARD GAMES RELATED TO BASEBALL, BOARD GAMES RELATED TO BASEBALL, ACTION FIGURES, DOLLS, STUFFED TOYS, JIGSAW PUZZLES (U.S. CLS. 22, 23, 38 AND 50).

FIRST USE 11-1-2004; IN COMMERCE 11-1-2004.

2,929,069. KORN, MICHELLE, NEW YORK, NY. SN 75-828,158. PUB. 1-30-2001, FILED 10-22-1999.

**MICHELLE KORN**

THE NAME "MICHELLE KORN" IDENTIFIES A LIVING INDIVIDUAL WHOSE CONSENT IS OF RECORD.

**CLASS 3—COSMETICS AND CLEANING PREPARATIONS**

FOR AFTER-SHAVE LOTIONS, ASTRINGENTS FOR COSMETIC PURPOSES, SHAVING BALM, NON-MEDICATED LIP BALM, BATH OIL, BATH POWDER, NON-MEDICATED BATH SALTS, BLUSHER, BODY CREAM, BODY OIL, BODY POWDER, COLD CREAM, COLOGNE, COSMETIC COMPACTS CONTAINING MAKEUP, HAIR CONDITIONERS, COSMETIC PENCILS, EYE CREAM, HAND CREAM, NIGHT CREAM, SHAVING CREAM, SKIN-CLEANSING CREAM, SKIN CREAM, VANISHING CREAM, DEODORANT SOAP, PERSONAL DEODORANTS, PERFUME, ANTIPERSPIRANTS, ESSENTIAL OILS FOR PERSONAL USE, EYE MAKEUP, EYE MAKEUP REMOVER, EYE SHADOW, FACE POWDER, FACIAL SCRUBS, FOUNDATION MAKEUP, BATH GEL, HAIR GEL, SHAVING GEL, SHOWER GEL, TOOTH GEL, LIP GLOSS, LIPSTICK, HAIR SPRAY, MAKEUP, MASCARA, MASSAGE OIL, SKIN MOISTURIZER, NAIL POLISH, ROUGE, SACHETS, HAIR SHAMPOO, TOILET WATER, SUNSCREEN PREPARATIONS, SUN BLOCK PREPARATIONS, WRINKLE REMOVING SKIN CARE PREPARATIONS (U.S. CLS. 1, 4, 6, 50, 51 AND 52).

FIRST USE 9-26-2001; IN COMMERCE 9-26-2001.

**CLASS 18—LEATHER GOODS**

FOR BABY BACKPACKS, ATHLETIC BAGS, BEACH BAGS, ATTACHE CASES, ALL PURPOSE SPORTS BAGS, BOOK BAGS, BOSTON BAGS, CARRY-ON BAGS, CLUTCH BAGS, DIAPER BAGS, DUFFEL BAGS, GYM BAGS, OVERNIGHT BAGS, LEATHER SHOPPING BAGS, MESH SHOPPING BAGS, TEXTILE SHOPPING BAGS, SCHOOL BAGS, SHOULDER BAGS, TOTE BAGS, TRAVEL BAGS, GARMENT BAGS, BRIEFCASES, CHANGE PURSES, COIN PURSES, FANNY PACKS, FELT POUCHES, HANDBAGS, KEY CASES, KNAPSACKS, LUGGAGE, WAIST PACKS, POCKETBOOKS, BRIEFCASE TYPE PORTFOLIOS, DRAWSTRING POUCHES, FELT POUCHES, PURSES, VALISES AND WALLETS (U.S. CLS. 1, 2, 3, 22 AND 41).

FIRST USE 9-26-2001; IN COMMERCE 9-26-2001.

**CLASS 25—CLOTHING**

FOR SKI BOOTS, ANKLETS, ATHLETIC FOOTWEAR, ATHLETIC SHOES, ATHLETIC UNIFORMS, HEAD BANDS, NECK BANDS, SWEAT BANDS, WRIST BANDS, BATHING CAPS, BATHING SUITS, BATHING TRUNKS, BATHROBES, BEACHWEAR, BEACH COVERUPS, MONEY BELTS, BELTS MADE OF CLOTH, BERETS, BERMUDA SHORTS, CLOTH BIBS, SKI BIBS, BIKINIS, BLAZERS, BLOUSES, BODY SUITS, BOOTIES, BOOTS, HIKING BOOTS, BOXER SHORTS, BATHING CAPS, SHOWER CAPS, HATS OF ALL KINDS, COATS OF ALL KINDS, DRESSES, JEAN SLACKS AND DUNGAREES, EAR MUFFS, FOOTWEAR, GLOVES, SKI-GLOVES, GOLF SHIRTS, GOWNS, GYM SUITS, HOSIERY; INFANTWEAR, INSOLES, JACKETS OF ALL KINDS, JERSEYS, JOGGING SUITS, JUMPERS, JUMPSUITS, KNEE HIGHS, LEG WARMERS, LEGGINGS, LEOTARDS, MITTENS, EAR MUFFS AND HAND MUFFS, NECKTIES, OVERALLS, PAJAMAS, PANTIES, ALL TYPES OF PANTS, PANTSUITS, RAINWEAR, ROBES, RUBBERS, SANDALS, SCARVES, SHIRTS OF ALL KINDS, INCLUDING POLO SHIRTS, SPORT SHIRTS, SWEAT SHIRTS, NIGHTSHIRTS, UNDERSHIRTS, T-SHIRTS, BOXER SHORTS, SWEAT SHORTS, SKIWEAR, SKIRTS, SLACKS, SLEEPWEAR, SNEAKERS, SNOW PANTS, SOCKS, SUITS, FLIGHT SUITS, PLAY SUITS, SKI SUITS, SNOW SUITS, SWEAT SUITS, WARM UP SUITS, WET SUITS, SUN VISORS, SUSPENDERS, TURTLE NECK SWEATERS AND V-NECK SWEATERS, TENNIS WEAR, TIGHTS, HALTER TOPS AND TANK TOPS, TRACK SUITS, UNDERWEAR, UNIFORMS VESTS, FOUL WEATHER GEAR (U.S. CLS. 22 AND 39).  
FIRST USE 11-9-2000; IN COMMERCE 9-26-2001.

2,929,070. TATA SONS LIMITED, MUMBAI 400 001, INDIA.  
SN 75-831,987. PUB. 2-18-2003, FILED 10-26-1999.

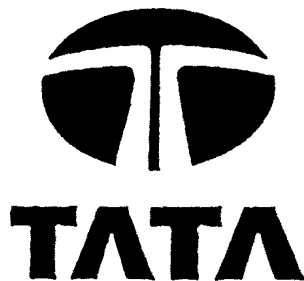
**CLASS 6—METAL GOODS**

FOR HOT ROLLED STEEL BARS, PLATES, SHEETS AND COILS; COLD ROLLED STEEL SHEETS AND COILS; GALVANIZED STEEL WIRE; STAINLESS STEEL BARS; HIGH CARBON STEEL WIRE; STEEL ROPES; STEEL RODS, STEEL IN BILLET FORM; METAL FASTENERS, NAMELY NAILS, METAL PIPES AND STEEL PLATES (U.S. CLS. 2, 12, 13, 14, 23, 25 AND 50).  
FIRST USE 1-0-1999; IN COMMERCE 6-0-1999.

**CLASS 9—ELECTRICAL AND SCIENTIFIC APPARATUS**

FOR COMPUTER PROGRAMS FOR WIRELESS COMMUNICATIONS FOR USE IN BANKING, SECURITIES, MANUFACTURING, FINANCIAL SERVICE INDUSTRY, PAYMENT SYSTEMS APPLICATIONS, INSURANCE, HEALTHCARE, RETAIL, ELECTRONIC COMMERCE, LOCATION IDENTIFICATION AND E-GOVERNANCE APPLICATIONS, A FULL LINE OF COMPUTER SOFTWARE FOR BUSINESS, HOME, EDUCATION, AND DEVELOPER USE, NAMELY, COMPUTER PROGRAMS FOR USE IN BANKING, SECURITIES, MANUFACTURING, FINANCIAL SERVICE INDUSTRY, PAYMENT SYSTEMS APPLICATIONS, INSURANCE, HEALTHCARE, AND RETAIL INDUSTRIES, COMPUTER PROGRAMS FOR DEVELOPING SYSTEM MANAGEMENT SOLUTIONS, COMPUTER PROGRAMS FOR SYSTEMS MANAGEMENT NAMELY, NETWORK MANAGEMENT, ASSET MANAGEMENT, CONFIGURATION MANAGEMENT, PERFORMANCE MANAGEMENT, FAULT MANAGEMENT, DISTRIBUTION MANAGEMENT, SECURITY MANAGEMENT AND ADMINISTRATION; COMPUTER SYSTEMS COMPRISED OF OPERATING PROGRAMS, SOFTWARE AND APPLICATIONS, DATABASE MANAGEMENT PROGRAMS, APPLICATION SOFTWARE, TRANSACTION PROCESSING PROGRAMS, SECURITY SOFTWARE, PRE-RECORDED COMPUTER PROGRAMS FOR USE IN BANKING, SECURITIES, MANUFACTURING, FINANCIAL SERVICE INDUSTRY, PAYMENT SYSTEMS APPLICATIONS, INSURANCE, HEALTHCARE, AND RETAIL INDUSTRIES, ELECTRONIC COMMERCE, LOCATION IDENTIFICATION AND E-GOVERNANCE APPLICATIONS; COMPACT DISCS FEATURING COMPUTER PROGRAMS FOR USE IN BANKING, SECURITIES, MANUFACTURING, FINANCIAL SERVICE INDUSTRY, PAYMENT SYSTEMS APPLICATIONS, INSURANCE, HEALTHCARE, AND RETAIL INDUSTRIES, ELECTRONIC COMMERCE, LOCATION IDENTIFICATION AND E-GOVERNANCE APPLICATIONS; COMPUTER OPERATING SYSTEM SOFTWARE TO FACILITATE COMPUTER USE AND OPERATION COMPUTER OPERATING SYSTEM SOFTWARE; COMPUTER OPERATING PROGRAMS; COMPUTER HARDWARE AND SOFTWARE FOR THE DEVELOPMENT, MAINTENANCE, AND USE OF LOCAL AND WIDE AREA COMPUTER NETWORKS; SOFTWARE FOR USE IN OPERATING AND MAINTAINING COMPUTER SYSTEM SUCH AS OPERATING SYSTEMS, DATABASE MANAGEMENT SYSTEM, TRANSACTION PROCESSING SYSTEM, SECURITY SOFTWARE; ALGORITHM SOFTWARE PROGRAMS FOR THE OPERATION AND CONTROL OF COMPUTERS; PARTS, FITTINGS, AND TESTING APPARATUS FOR ALL THE AFORESAID GOODS; AND USER MANUALS FOR USE WITH, AND SOLD AS A UNIT WITH, ALL THE AFORESAID GOODS (U.S. CLS. 21, 23, 26, 36 AND 38).

FIRST USE 7-1-1999; IN COMMERCE 10-1-1999.

**CLASS 16—PAPER GOODS AND PRINTED MATTER**

FOR BUSINESS FORMS; COMPUTER PRINTOUT PAPER AND NOTE PADS, COMPOSITOR AND TYPEWRITER RIBBONS; IMAGE TRANSFER PAPER; COMPUTER PROGRAMS IN THE FORM OF PRINT; PERIODICAL PUBLICATIONS CONTAINING ARTICLES ABOUT DATA PROCESSING AND SUBJECTS OF GENERAL INTEREST; INSTRUCTION BOOKS FOR THE DESIGN, CONSTRUCTION, MAINTENANCE, OPERATION AND PROGRAMMING OF DATA PROCESSING EQUIPMENT; ELECTRIC TYPEWRITERS; MAGNETIC MEDIA TYPEWRITERS; TYPE; AD TYPING ELEMENTS; ELECTRIC AND MAGNETIC DIRECT IMPRESSION TYPING AND COMPOSING MACHINES; PRINTED MATTER, NAMELY, INSTRUCTIONAL MANUALS FOR COMPUTER PROGRAMS, MAGAZINES, NEWSLETTERS, NEWSPAPER INSERTS AND BOOKLETS, ALL IN THE FIELDS OF COMPUTER SOFTWARE, COMPUTERS, COMPUTER SYSTEM HARDWARE, NETWORK HARDWARE, TELECOMMUNICATIONS, INFORMATION TECHNOLOGY, WORD PROCESSING,

DATABASE MANAGEMENT, MULTIMEDIA, ENTERTAINMENT EQUIPMENT AND E-COMMERCE; PRINTED MATTER, NAMELY, INSTRUCTIONAL MANUALS FOR COMPUTER PROGRAMS, MAGAZINES, NEWSLETTERS, NEWSPAPER INSERTS AND BOOKLETS, ALL IN THE FIELDS OF DESIGNING, CREATING, IMPLEMENTING AND MAINTAINING WEB SITES FOR OTHERS, COMPUTER SYSTEMS AND NETWORKS, AND COMPUTER PROGRAMMING FOR OTHERS, ALL IN RELATION TO COMMERCIAL INTERACTIONS OVER A GLOBAL COMPUTER NETWORK (U.S. CLS. 2, 5, 22, 23, 29, 37, 38 AND 50).  
FIRST USE 10-0-1999; IN COMMERCE 1-0-2000.

### CLASS 30—STAPLE FOODS

FOR TEA, COFFEE, RICE, SPICES, FLOUR AND PREPARATIONS MADE FROM CEREALS NAMELY, PROCESSED CEREALS AND BREAKFAST CEREALS; BREAD, PASTRY AND CONFECTIONERY ITEMS NAMELY PASTRIES, CHOCOLATES AND FUDGE BARS; HONEY, MUSTARD AND SAUCES (U.S. CL. 46).  
FIRST USE 1-1-1999; IN COMMERCE 6-3-2003.

2,929,075. VAZIRANI, MINAL, ANAHEIM HILLS, CA. SN 75-885,245. PUB. 4-9-2002, FILED 1-7-2000.

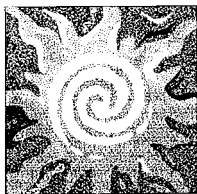

saffronart.com

### CLASS 35—ADVERTISING AND BUSINESS

FOR PROVIDING BUSINESS CONSULTATION ADVICE IN THE FIELD OF THE SALE OF ART; ON-LINE ART GALLERIES AND PROVIDING INFORMATION REGARDING ART GALLERIES AND ART GALLERY SERVICES; ON-LINE AUCTIONEERING IN THE FIELD OF ART AND PROVIDING INFORMATION ON ART AUCTIONS; COMPUTERIZED ON-LINE RETAIL SERVICES IN THE FIELD OF ART (U.S. CLS. 100, 101 AND 102).  
FIRST USE 4-0-2000; IN COMMERCE 5-0-2000.

### CLASS 41—EDUCATION AND ENTERTAINMENT

FOR PROVIDING EDUCATION AND ENTERTAINMENT INFORMATION REGARDING ART EXHIBITIONS, ART TRAINING COURSES, ARTIST INTERVIEWS AND ARTIST PROFILES VIA A GLOBAL COMPUTER INFORMATION NETWORK; CONDUCTING ART EXHIBITIONS ON-LINE; EDUCATIONAL SERVICES, NAMELY, PROVIDING HYPERLINKS TO THE ART WEB SITES OF OTHERS VIA GLOBAL COMPUTER NETWORK; PROVIDING INFORMATION RELATING TO ART AND DECORATIVE OBJECTS AND INFORMATION RELATING TO THE ARTISTS WHO CREATED THE ART OR OBJECTS; PROVIDING ART NEWS AND ART CONSULTATION SERVICES VIA A GLOBAL COMPUTER NETWORK (U.S. CLS. 100, 101 AND 107).  
FIRST USE 5-0-2000; IN COMMERCE 5-0-2000.

2,929,079. SK ENTERPRISES, INC., NEWBURGH, NY. SN 75-926,065. PUB. 12-10-2002, FILED 2-23-2000.

## INVENTEK

### CLASS 7—MACHINERY

FOR POWER DRILL KITS COMPRISING OF POWER DRILLS AND ASSORTED BITS; POWER OPERATED CUTTING TOOL KITS COMPRISING OF POWER SAWS; POWER WASHERS, NAMELY, POWER PRESSURE WASHERS FOR WASHING HOUSES, BOATS, SIDEWALKS AND PATIOS, POWER OPERATED CHAIN SAWS, AUTOMATIC ELECTRIC SCISSORS; ELECTRIC FOOD PROCESSORS; SEWING MACHINES; AUXILIARY CAR ENGINE STARTERS AND IMPACT WRENCH KITS (U.S. CLS. 13, 19, 21, 23, 31, 34 AND 35).  
FIRST USE 2-1-2001; IN COMMERCE 3-10-2002.

### CLASS 8—HAND TOOLS

FOR HAND TOOLS, NAMELY, SOCKETS DRIVER SETS, SCREWDRIVERS, HAMMERS, WRENCHES, CUTTING TOOL KITS COMPRISING OF SAWS, METAL CUTTERS AND SCISSORS, SANDERS, GRINDERS, SAWS, PIPE AND DRAIN CLEANER SNAKES, DRILL BITS AND SCISSORS (U.S. CLS. 23, 28 AND 44).  
FIRST USE 2-1-2001; IN COMMERCE 3-10-2002.

2,929,080. MEDCALLBACKS, INC., FULLERTON, CA. SN 75-928,330. PUB. 3-18-2003, FILED 2-26-2000.

## MEDCALLBACKS

### CLASS 9—ELECTRICAL AND SCIENTIFIC APPARATUS

FOR COMPUTER SOFTWARE FOR USE IN PERSONAL COMPUTERS, PERSONAL COMPUTER NETWORKS OR LARGER NETWORKS USED TO FACILITATE THE CALLING BACK OF PATIENTS FOR NECESSARY FUTURE SCREENING AND PREVENTATIVE HEALTH SERVICES (U.S. CLS. 21, 23, 26, 36 AND 38).  
FIRST USE 8-1-2001; IN COMMERCE 8-1-2001.

### CLASS 42—SCIENTIFIC, COMPUTER AND LEGAL SERVICES

FOR COMPUTER CONSULTATION REGARDING THE INSTALLATION AND USE OF COMPUTER SOFTWARE FOR USE IN PERSONAL COMPUTERS, PERSONAL COMPUTER NETWORKS OR LARGER NETWORKS USED TO FACILITATE THE CALLING BACK OF PATIENTS FOR NECESSARY FUTURE SCREENING AND PREVENTATIVE HEALTH SERVICES (U.S. CLS. 100 AND 101).  
FIRST USE 8-1-2000; IN COMMERCE 8-1-2001.

2,929,085. ACE MOTORCYCLE CORPORATION, NEW YORK, NY. SN 75-977,727. PUB. 7-15-1997, FILED 12-22-1994.



THE STIPPLING SHOWN IN THE DRAWING IS A FEATURE OF THE MARK AND IS NOT INTENDED TO INDICATE COLOR.

#### CLASS 12—VEHICLES

FOR MOTORCYCLES AND STRUCTURAL PARTS THEREFOR (U.S. CLS. 19, 21, 23, 31, 35 AND 44).  
FIRST USE 11-4-1997; IN COMMERCE 11-4-1997.

#### CLASS 14—JEWELRY

FOR JEWELRY, NAMELY, BRACELETS, NECKLACES, ANKLE BRACELETS, TIE TACKS, CUFF LINKS AND WATCH BANDS (U.S. CLS. 2, 27, 28 AND 50).  
FIRST USE 11-0-1998; IN COMMERCE 11-0-1998.

2,929,088. I-TRAX HEALTH MANAGEMENT SOLUTIONS, INC., PHILADELPHIA, PA. SN 75-983,537. PUB. 1-20-2004, FILED 9-1-1999.

MyFamilyMD

#### CLASS 41—EDUCATION AND ENTERTAINMENT

FOR EDUCATIONAL SERVICES, NAMELY, CONDUCTING ON-LINE EXHIBITIONS AND DISPLAYS AND INTERACTIVE EXHIBITS IN THE FIELD OF MEDICINE; ELECTRONIC PUBLISHING SERVICES, NAMELY, ON-LINE PUBLICATION OF TEXT AND GRAPHIC WORKS OF OTHERS FEATURING HEALTH CARE ISSUES (U.S. CLS. 100, 101 AND 107).  
FIRST USE 1-0-2000; IN COMMERCE 5-0-2001.

#### CLASS 44—MEDICAL, BEAUTY AND AGRICULTURAL SERVICES

FOR PROVIDING INFORMATION REGARDING MEDICAL ISSUES OVER A GLOBAL COMMUNICATIONS NETWORK (U.S. CLS. 100 AND 101).  
FIRST USE 1-0-2000; IN COMMERCE 5-0-2001.

2,929,089. AVENIDA AMERICA, INC., DULUTH, GA. SN 76-014,853. PUB. 5-22-2001, FILED 3-31-2000.

## COMMERCEAVENUE

#### CLASS 35—ADVERTISING AND BUSINESS

FOR PROVIDING A WEBSITE ON GLOBAL COMPUTER NETWORKS FEATURING LISTINGS OF THE GOODS AND SERVICES OF OTHERS (U.S. CLS. 100, 101 AND 102).  
FIRST USE 7-20-2004; IN COMMERCE 7-20-2004.

#### CLASS 42—SCIENTIFIC, COMPUTER AND LEGAL SERVICES

FOR PROVIDING AN ON-LINE BUSINESS CHAT ROOM FOR TRANSMISSION OF MESSAGES AMONG GOODS AND SERVICES PROVIDERS TO COMMUNICATE AND TRANSACT BUSINESS WITH CONSUMERS AND OTHER GOODS AND SERVICES PROVIDERS (U.S. CLS. 100 AND 101).  
FIRST USE 7-20-2004; IN COMMERCE 7-20-2004.

2,929,091. AVENTIS HOLDINGS, INC., GREENVILLE, DE. SN 76-025,860. PUB. 5-22-2001, FILED 3-21-2000.

## DIABETESWATCH

#### CLASS 38—COMMUNICATION

FOR PROVIDING ONLINE CHAT ROOMS FOR THE TRANSMISSION OF MESSAGES AMONG COMPUTER USERS CONCERNING HEALTH AND WELLNESS-RELATED TOPICS (U.S. CLS. 100, 101 AND 104).  
FIRST USE 8-15-2000; IN COMMERCE 8-15-2000.

#### CLASS 42—SCIENTIFIC, COMPUTER AND LEGAL SERVICES

FOR PROVIDING ONLINE HEALTH INFORMATION SERVICES AND CONTENT IN THE FIELD OF DIABETES; PROVIDING ON LINE SERVICES, NAMELY A CALENDAR AND DIARY SYSTEM (U.S. CLS. 100 AND 101).  
FIRST USE 8-15-2000; IN COMMERCE 8-15-2000.

2,929,092. KABUSHIKI KAISHA SOFT 99 CORPORATION, CHUO-KU, OSAKA, JAPAN. SN 76-028,453. PUB. 9-18-2001, FILED 4-18-2000.

## QUICK ONE

#### CLASS 3—COSMETICS AND CLEANING PREPARATIONS

FOR GLASS CLEANING PREPARATIONS, AUTOMOBILE CLEANING PREPARATIONS, DETERGENTS FOR GLASS CLEANING; POLISHING WAX FOR AUTOMOBILES; FURNITURE, HOME APPLIANCES AND FLOORS; AUTOMOBILE WAX; DISPOSABLE WIPES IMPREGNATED WITH DETERGENTS FOR HOUSEHOLD USE OR FOR AUTOMOBILES; DISPOSABLE WIPES IMPREGNATED WITH POLISHING PREPARATIONS FOR HOUSEHOLD USE OR FOR AUTOMOBILES; DISPOSABLE WIPES IMPREGNATED WITH DETERGENTS AND POLISHING PREPARATIONS FOR HOUSEHOLD USE OR FOR AUTOMOBILES (U.S. CLS. 1, 4, 6, 50, 51 AND 52).  
FIRST USE 1-1-1979; IN COMMERCE 6-30-2003.

**CLASS 21—HOUSEWARES AND GLASS**

FOR CLEANING AND POLISHING CLOTHS; IMPREGNATED CLEANING CLOTHS, IMPREGNATED POLISHING CLOTHS, IMPREGNATED CLEANING AND POLISHING CLOTHS (U.S. CLS. 2, 13, 23, 29, 30, 33, 40 AND 50).

FIRST USE 1-1-2003; IN COMMERCE 6-30-2003.

---

2,929,094. GLOBALWARE SOLUTIONS MASSACHUSETTS, INC., HAVERHILL, MA. SN 76-036,578. PUB. 1-2-2001, FILED 4-27-2000.

**GWS****CLASS 35—ADVERTISING AND BUSINESS**

FOR SOFTWARE PACKAGING, NAMELY PACKAGING SOFTWARE TO THE ORDER AND SPECIFICATION OF OTHERS; SOFTWARE DISTRIBUTION, NAMELY DISTRIBUTORSHIPS FEATURING SOFTWARE (U.S. CLS. 100, 101 AND 102).

FIRST USE 3-16-2000; IN COMMERCE 3-16-2000.

**CLASS 39—TRANSPORTATION AND STORAGE**

FOR SOFTWARE PACKAGING, NAMELY PACKAGING SOFTWARE FOR TRANSPORTATION (U.S. CLS. 100 AND 105).

FIRST USE 3-16-2000; IN COMMERCE 3-16-2000.

---

2,929,095. RISE LEARNING SOLUTIONS, INC., CINCINNATI, OH. SN 76-048,164. PUB. 4-24-2001, FILED 5-12-2000.

**RLS****CLASS 9—ELECTRICAL AND SCIENTIFIC APPARATUS**

FOR PRE-RECORDED VIDEO TAPES, CONTAINING AUDIOVISUAL PROGRAMMING, WITH USER INSTRUCTION MANUALS SOLD AS A UNIT THEREWITH, ON THE SUBJECTS OF EDUCATION, NAMELY, LITERACY, CHILD BEHAVIOR, AND TEACHING PRACTICES (U.S. CLS. 21, 23, 26, 36 AND 38).

FIRST USE 2-17-2004; IN COMMERCE 2-17-2004.

**CLASS 16—PAPER GOODS AND PRINTED MATTER**

FOR PRINTED MATERIALS, BOOKS, TEACHER'S GUIDES AND INSTRUCTION MANUALS ON THE SUBJECT OF TRAINING ADULTS, PARENTS, TEACHERS, AND CHILD CARE GIVERS, IN THE AREA OF TEACHING AND CARING FOR CHILDREN OF ALL AGES, INFANTS, PRE-SCHOOL AGE CHILDREN, CHILDREN IN CHILD CARE CENTERS AND GOVERNMENT APPROVED FACILITIES; PRINTED MATERIALS, BOOKS, TEACHER'S GUIDES AND INSTRUCTION MANUALS ON THE SUBJECTS OF EDUCATION, NAMELY, LITERACY, CHILD BEHAVIOR, AND TEACHING PRACTICES (U.S. CLS. 2, 5, 22, 23, 29, 37, 38 AND 50).

FIRST USE 2-1-2003; IN COMMERCE 2-1-2003.

**CLASS 41—EDUCATION AND ENTERTAINMENT**

FOR PROVIDING EDUCATIONAL SERVICES BY WAY OF DISTANCE LEARNING USING TELEVISION BROADCASTS OVER SATELLITE TV, FOR ELEMENTARY SCHOOL-LEVEL COURSES; PROVIDING EDUCATIONAL SERVICES BY WAY OF CLASSROOM INSTRUCTION FOR ELEMENTARY SCHOOL-LEVEL COURSES; PROVIDING EDUCATIONAL SERVICES BY WAY OF CONDUCTING SEMINARS ON THE SUBJECTS OF EDUCATION, NAMELY, LITERACY, CHILD BEHAVIOR, AND TEACHING PRACTICES (U.S. CLS. 100, 101 AND 107).

FIRST USE 3-8-2002; IN COMMERCE 3-8-2002.

---

2,929,107. IT&E GLOBAL, INC., PALO ALTO, CA. SN 76-093,616. PUB. 5-14-2002, FILED 7-20-2000.

**NEXTSET EVOLUTION****CLASS 9—ELECTRICAL AND SCIENTIFIC APPARATUS**

FOR COMPUTER SOFTWARE USED FOR MANAGING AND PROCESSING COMMERCIAL TRANSACTIONS VIA COMMUNICATIONS AND COMPUTER NETWORKS (U.S. CLS. 21, 23, 26, 36 AND 38).

FIRST USE 6-1-2001; IN COMMERCE 6-1-2001.

**CLASS 35—ADVERTISING AND BUSINESS**

FOR COMPUTER SERVICES, NAMELY LINKING BUYERS AND SELLERS FOR COMMERCIAL TRANSACTIONS AND MANAGING AND PROCESSING COMMERCIAL TRANSACTIONS BY MEANS OF COMMUNICATIONS AND COMPUTER NETWORKS (U.S. CLS. 100, 101 AND 102).

FIRST USE 6-1-2001; IN COMMERCE 6-1-2001.

---

2,929,108. BLACK MAX DOWNHOLE TOOLS LTD., NISKU, ALBERTA, CANADA. SN 76-098,874. PUB. 8-27-2002, FILED 7-28-2000.

**RIG RATTLER**

PRIORITY CLAIMED UNDER SEC. 44(D) ON CANADA APPLICATION NO. 1044377, FILED 1-28-2000, REG. NO. TMA533077, DATED 10-29-2001, EXPIRES 10-29-2016.

NO CLAIM IS MADE TO THE EXCLUSIVE RIGHT TO USE "RIG", APART FROM THE MARK AS SHOWN.

**CLASS 7—MACHINERY**

FOR POWER OPERATED DOWNHOLE WELL DRILLING TOOLS, NAMELY JARS (U.S. CLS. 13, 19, 21, 23, 31, 34 AND 35).

FIRST USE 3-29-1999; IN COMMERCE 8-26-2002.

**CLASS 37—CONSTRUCTION AND REPAIR**

FOR LEASING OF POWER OPERATED WELL DRILLING TOOLS (U.S. CLS. 100, 103 AND 106).

FIRST USE 3-29-1999; IN COMMERCE 8-26-2002.



2,929,113. ENDEMANN, INGO, D-41466 NEUSS, FED REP GERMANY. SN 76-138,640. PUB. 6-4-2002, FILED 10-2-2000.

## ABACHO

PRIORITY CLAIMED UNDER SEC. 44(D) ON FED REP GERMANY APPLICATION NO. 30033782.5, FILED 11-14-1998, REG. NO. 39865847, DATED 12-2-1999, EXPIRES 11-30-2008.

### CLASS 9—ELECTRICAL AND SCIENTIFIC APPARATUS

FOR (BASED ON 44(E)) VIDEO TAPE RECORDERS, DIGITAL VIDEO RECORDERS, EVENT RECORDERS, AUDIO TAPE RECORDERS, BLANK OPTICAL AND MAGNETIC DATA CARRIERS, RADIO TRANSMITTERS, CDS AND DVDS FEATURING SOFTWARE FOR SEARCH ENGINES; DATA PROCESSING DEVICES AND COMPUTERS; COMPUTER SOFTWARE USED FOR SEARCH ENGINES; DATA ADMINISTRATION AND ADVERTISEMENT APPLICATIONS IN CONNECTION WITH INFORMATION SERVICES IN A COMPUTER NETWORK; COMPUTER SOFTWARE FOR SEARCHES AND CALLING UP INFORMATION, SITES AND OTHER SOURCES AVAILABLE ON COMPUTER NETWORKS; COMPUTER SOFTWARE FOR DATA ADMINISTRATION, SEARCH ENGINES, SOFTWARE FOR DATA SELECTION INFORMATION, PREPARATION OF DATA, LINKING OF DATA, COMPUTER SOFTWARE FOR FACILITATING ELECTRONIC MAIL TRANSMISSION; COMPUTER SOFTWARE FOR FACILITATING MULTIPLE USER ACCESS TO COMPUTER NETWORKS, COMPUTER SOFTWARE FOR CREATING AND DESIGNING WEB SITES; COMPUTER SOFTWARE FOR CREATING WEB CATALOGS; COMMUNICATION SOFTWARE FOR FACILITATING ACCESS TO INFORMATION ON A GLOBAL COMPUTER NETWORK (U.S. CLS. 21, 23, 26, 36 AND 38).

### CLASS 16—PAPER GOODS AND PRINTED MATTER

FOR (BASED ON 44(E)) PRINTED MATTER AND PUBLICATIONS, NAMELY, MANUALS FOR COMPUTER HARDWARE AND COMPUTER SOFTWARE FOR DATA ADMINISTRATION, SEARCH ENGINES, SOFTWARE FOR DATA SELECTION, INFORMATION, PREPARATION OF DATA, LINKING OF DATA; PHOTOGRAPHS; PLAYING CARDS; TEACHING AND INSTRUCTIONAL MATERIALS FOR SEARCH ENGINES, SEARCH ENGINE TECHNOLOGY, SOFTWARE, APPLICATIONS AND WORK WITH DATA BANKS (U.S. CLS. 2, 5, 22, 23, 29, 37, 38 AND 50).

### CLASS 35—ADVERTISING AND BUSINESS

FOR ADVERTISING SERVICES; NAMELY, ADVERTISING CONSULTATION, TARGET GROUP CONSULTATION, COST CONSULTATION, CREATING ADVERTISING CAMPAIGNS, CARRYING OUT ADVERTISING CAMPAIGNS, CREATION OF ADVERTISING FORMS FOR THE INTERNET, MAINTENANCE, OPERATION AND MANAGEMENT OF COMMERCIAL ON-LINE SITES WITH A WIDE RANGE OF TOPICS; ADVERTISING AND MARKETING SERVICES RELATED TO COMMERCIAL ON-LINE SITES, NAMELY, ADVERTISING CONSULTATION, TARGET GROUP CONSULTATION, COST CONSULTATION, CREATING ADVERTISING CAMPAIGNS, CARRYING OUT ADVERTISING CAMPAIGNS, CREATION OF ADVERTISING FORMS FOR THE INTERNET (U.S. CLS. 100, 101 AND 102).

FIRST USE 9-17-1998; IN COMMERCE 9-17-1998.

### CLASS 38—COMMUNICATION

FOR COMMUNICATION AND TELECOMMUNICATION SERVICES, NAMELY TELEPHONE COMMUNICATION VIA COMPUTER NETWORKS; ELECTRONIC MAIL SERVICES; TELEPHONE SERVICES; ELECTRONIC TRANSMISSION OF DATA, IMAGES AND DOCUMENTS VIA COMPUTER TERMINALS AND NETWORKS; PROVIDING DISCUSSION FORUMS AND CHAT ROOMS CONCERNING A WIDE RANGE OF TOPICS BY OFFERING ON-LINE ARRANGEMENT FOR REAL-TIME INTERACTION WITH OTHER COMPUTER USERS; PROVIDING COMPUTER MAIL BOXES AND MESSAGE DISPLAYS ON TOPICS OF GENERAL INTEREST; PROVIDING MULTIPLE USER ACCESS TO COMPUTER NETWORKS FOR THE TRANSMISSION AND DISTRIBUTION OF INFORMATION (U.S. CLS. 100, 101 AND 104).

FIRST USE 9-17-1998; IN COMMERCE 9-17-1998.

### CLASS 41—EDUCATION AND ENTERTAINMENT

FOR (BASED ON 44(E)) EDUCATION AND TRAINING SERVICES, NAMELY, COURSES, CLASSES AND SEMINARS FOR THE USE OF SEARCH ENGINES, SEARCH ENGINE TECHNOLOGY, SOFTWARE, APPLICATIONS AND WORK WITH DATA BANKS; ENTERTAINMENT SERVICES VIA THE INTERNET, NAMELY, PROVIDING INFORMATION AND DRAMATIC WORKS ON THE TOPICS OF LIFESTYLE, SPORTS, EROTICA, GAMES, MOTOR VEHICLES, FILM AND MUSIC; PROVIDING ON-LINE COMPETITIONS AND BETTING ON SPORTS EVENTS; PUBLICATION OF ON-LINE MAGAZINES COVERING THE TOPICS OF LIFESTYLES, NEWS, FINANCE, REAL ESTATE, SPORTS, EROTICA, BUSINESS, TRAVEL, MOTOR VEHICLES, HEALTH, FILM, TV AND MUSIC (U.S. CLS. 100, 101 AND 107).

### CLASS 42—SCIENTIFIC, COMPUTER AND LEGAL SERVICES

FOR CREATION OF COMPUTER PROGRAMS FOR DATA PROCESSING AND HEALTH AND BEAUTY CARE; PROVIDING INFORMATION ON TOPICS OF GENERAL INTEREST; DESIGN, CREATION AND HOSTING WEBSITES OF OTHERS, NAMELY, ENABLING WEBSITES OF OTHERS TO BE MADE AVAILABLE AS PART OF A SINGLE WEBSITE; DEVELOPMENT AND MAINTENANCE OF WEB SITES FOR OTHERS; COMPUTER CONSULTATION AND TECHNICAL SUPPORT SERVICES RELATING TO THE DESIGN, CREATION AND TAKEOVER OF HOST FUNCTIONS; ON-LINE LODGING RESERVATION SERVICES; ESTABLISHING LISTS FOR ASSISTING SEARCHES FOR PERSONS, PLACES, ORGANIZATIONS, TELEPHONE NUMBERS, HOME PAGES AND E-MAIL ADDRESSES; CREATION OF LINKS TO WEB SITES OF OTHERS; PROVIDING ON-LINE NEWS, WEATHER AND SPORTS INFORMATION; OPERATING INTERNET CLUBS (U.S. CLS. 100 AND 101).

FIRST USE 9-17-1998; IN COMMERCE 9-17-1998.

2,929,117. BASELL TECHNOLOGY COMPANY B.V., 2132 MS HOOFDDORP, NETHERLANDS. SN 76-140,917. PUB. 1-21-2003, FILED 10-4-2000.

## BASELL

PRIORITY CLAIMED UNDER SEC. 44(D) ON FED REP GERMANY APPLICATION NO. 30026515.8/0, FILED 4-5-2000, REG. NO. 30026515, DATED 5-29-2000, EXPIRES 4-30-2010.

**CLASS 1—CHEMICALS**

FOR CHEMICAL PRODUCTS FOR USE IN INDUSTRY, NAMELY, PLASTICS IN RAW STATE IN THE FORM OF POWDERS, GRANULES, CHIPS, DISPERSIONS, LIQUIDS OR PASTES FOR GENERAL INDUSTRIAL AND COMMERCIAL USES; UNPROCESSED ARTIFICIAL RESINS AND SYNTHETIC RESINS FOR GENERAL INDUSTRIAL AND COMMERCIAL USES; CHEMICAL AUXILIARIES FOR USE IN THE PRODUCTION AND PROCESSING OF PLASTICS; METALLOGENES AND CATALYSTS FOR GENERAL INDUSTRIAL AND COMMERCIAL USES (U.S. CLS. 1, 5, 6, 10, 26 AND 46).

FIRST USE 10-2-2000; IN COMMERCE 10-2-2000.

**CLASS 17—RUBBER GOODS**

FOR SEMI PROCESSED PLASTIC MATERIALS IN THE FORM OF PLATES, PIPES, BARS, RODS, PELLETS, FILMS OR MOLDED ARTICLES FOR GENERAL INDUSTRIAL AND COMMERCIAL USES AND FOR FURTHER MANUFACTURE (U.S. CLS. 1, 5, 12, 13, 35 AND 50).

FIRST USE 10-2-2000; IN COMMERCE 10-2-2000.

**CLASS 42—SCIENTIFIC, COMPUTER AND LEGAL SERVICES**

FOR CHEMISTRY SERVICES, NAMELY, LABORATORY SERVICES IN THE FIELD OF CHEMISTRY, LABORATORY RESEARCH IN THE FIELD OF CHEMISTRY, DEVELOPMENT SERVICES IN THE FIELD OF CHEMISTRY AND TECHNICAL AND ANALYTICAL SERVICES IN THE FIELD OF CHEMISTRY, AND TECHNICAL CONSULTATION IN THE FIELD OF CHEMISTRY; SERVICES IN THE FIELD OF CHEMICAL ENGINEERING AND DESIGN PROCESS, NAMELY, TECHNICAL CONSULTATION, TECHNICAL ADVICE, TECHNICAL RESEARCH AND DESIGN SERVICES; AND PROVISION OF EXPERT OPINIONS IN THE FIELD OF CHEMICAL ENGINEERING (U.S. CLS. 100 AND 101).

FIRST USE 10-2-2000; IN COMMERCE 10-2-2000.

---

2,929,121. DATALEX LIMITED, DUBLIN, IRELAND. SN 76-151,189. PUB. 12-3-2002, FILED 10-20-2000.

**DATALEX****CLASS 9—ELECTRICAL AND SCIENTIFIC APPARATUS**

FOR COMPUTER SOFTWARE AND COMPUTER SOFTWARE PACKAGES FOR USE IN THE PROVISION OF SERVICES RELATED TO THE TRAVEL INDUSTRY, NAMELY FOR USE IN BOOKING TRAVEL RESERVATIONS AND FOR USE IN GENERATING TRAVEL ITINERARIES, AND COMPUTER MANUALS SOLD THEREWITH (U.S. CLS. 21, 23, 26, 36 AND 38).

FIRST USE 12-0-1996; IN COMMERCE 12-0-1996.

**CLASS 16—PAPER GOODS AND PRINTED MATTER**

FOR SERIES OF NON-FICTION BOOKS RELATING TO THE OPERATION OF COMPUTERS, TRAVEL INDUSTRY SOFTWARE, AND THE TRAVEL INDUSTRY; NEWSLETTERS RELATING TO THE BUSINESS ACTIVITIES OF THE COMPANY, THE OPERATION OF COMPUTERS, TRAVEL INDUSTRY SOFTWARE, AND THE TRAVEL INDUSTRY (U.S. CLS. 2, 5, 22, 23, 29, 37, 38 AND 50).

FIRST USE 12-0-1996; IN COMMERCE 12-0-1996.

**CLASS 35—ADVERTISING AND BUSINESS**

FOR LICENSING OF COMPUTER SOFTWARE (U.S. CLS. 100, 101 AND 102).

FIRST USE 12-0-1996; IN COMMERCE 12-0-1996.

**CLASS 41—EDUCATION AND ENTERTAINMENT**

FOR EDUCATIONAL SERVICES IN THE NATURE OF SEMINARS AND CLASSES ON THE OPERATION OF COMPUTERS, ON TRAVEL INDUSTRY SOFTWARE, AND ON THE TRAVEL INDUSTRY, AND CORRESPONDENCE BOOKLETS DISTRIBUTED THEREWITH, AND TESTING IN THE FIELDS OF THE OPERATION OF COMPUTERS, ON TRAVEL INDUSTRY SOFTWARE, AND ON THE TRAVEL INDUSTRY (U.S. CLS. 100, 101 AND 107).

FIRST USE 12-0-1996; IN COMMERCE 12-0-1996.

**CLASS 42—SCIENTIFIC, COMPUTER AND LEGAL SERVICES**

FOR COMPUTER SERVICES, NAMELY CONSULTATION SERVICES IN THE FIELD OF COMPUTER SOFTWARE, THE DESIGN AND DEVELOPMENT IN THE FIELD OF COMPUTER SOFTWARE; PROVIDING TECHNICAL SUPPORT AND UPDATING COMPUTER SOFTWARE VIA ALL TYPES OF TELECOMMUNICATIONS MEANS AND/OR IN PERSON, COMPUTER SOFTWARE RENTAL SERVICES, AND DESIGNING AND HOSTING THE WEBSITES OF OTHERS (U.S. CLS. 100 AND 101).

FIRST USE 12-0-1996; IN COMMERCE 12-0-1996.

---

2,929,124. ADHERENT TECHNOLOGIES, INC., ALBUQUERQUE, NM. SN 76-155,135. PUB. 3-12-2002, FILED 10-27-2000.

**RIGIDIZATION ON COMMAND****CLASS 9—ELECTRICAL AND SCIENTIFIC APPARATUS**

FOR INFLATABLE COMMUNICATION ANTENNAS (U.S. CLS. 21, 23, 26, 36 AND 38).

FIRST USE 10-7-1997; IN COMMERCE 10-0-1998.

**CLASS 12—VEHICLES**

FOR INFLATABLE SPACE VEHICLES (U.S. CLS. 19, 21, 23, 31, 35 AND 44).

FIRST USE 10-7-1997; IN COMMERCE 10-0-1998.

**CLASS 42—SCIENTIFIC, COMPUTER AND LEGAL SERVICES**

FOR INDUSTRIAL DESIGN FOR OTHERS IN THE FIELD OF INFLATABLE SPACE VEHICLES AND INFLATABLE COMMUNICATIONS ANTENNA (U.S. CLS. 100 AND 101).

FIRST USE 10-7-1997; IN COMMERCE 10-7-1997.

---

2,929,128. BIRCHFIELD INTERNET PLC, CARDIFF, UNITED KINGDOM. SN 76-164,331. PUB. 5-28-2002, FILED 11-14-2000.

**ACE MONKEY**

PRIORITY CLAIMED UNDER SEC. 44(D) ON UNITED KINGDOM APPLICATION NO. 2242575, FILED 8-15-2000, REG. NO. 2242575, DATED 2-2-2001, EXPIRES 8-15-2010.

2,929,132. BASELL TECHNOLOGY COMPANY B.V., 2132 MS HOOFDDORP, NETHERLANDS. SN 76-175,402. PUB. 1-21-2003, FILED 12-4-2000.

### CLASS 9—ELECTRICAL AND SCIENTIFIC APPARATUS

FOR EDUCATIONAL SOFTWARE FEATURING INSTRUCTION IN PERSONAL EDUCATION, SOCIAL EDUCATION; DOWNLOADABLE ELECTRONIC PUBLICATIONS IN THE NATURE OF BOOKS, MAGAZINES, MANUALS, SOFTWARE AND WEB PAGES IN THE FIELDS OF PERSONAL EDUCATION, SOCIAL EDUCATION, GAMES, ENTERTAINMENT, INTERACTIVE TELEVISION, INTERNET BROWSING, INTERNET FILTERING; COMPUTER SOFTWARE DOWNLOADED FROM A GLOBAL COMPUTER NETWORK, PROVIDED ON CD-ROM, PROVIDED ON FLOPPY DISC, OR PROVIDED ON MAGNETIC MEDIA, NAMELY SOFTWARE FOR BROWSING THE GLOBAL COMPUTER NETWORK AND SECURE PRIVATE NETWORKS, SOFTWARE USED TO FILTER INFORMATION FROM GLOBAL COMPUTER NETWORKS OR OTHER PUBLICLY ACCESSIBLE COMPUTER NETWORKS, SOFTWARE USED TO MONITOR THE TRANSFER OF INFORMATION THROUGH THE INTERNET TO RESTRICT ACCESS TO OBSCENE OR UNSUITABLE MATERIAL, COMPUTER GAME SOFTWARE, VIDEO GAME SOFTWARE, ENTERTAINMENT SOFTWARE, AND INTERACTIVE TELEVISION SOFTWARE, IN THE FIELDS OF PERSONAL EDUCATION, SOCIAL EDUCATION, AND CHILDREN'S FICTION; PRE-RECORDED AUDIO TAPES, CASSETTES, COMPACT DISCS, MAGNETIC CODED CARDS, FLOPPY DISCS, CD-ROMS, AND VIDEO GAME CARTRIDGES FEATURING CONTENT IN THE FIELDS OF PERSONAL EDUCATION, SOCIAL EDUCATION, AND GAMES, ALL BEING FOR USE IN BEARING SOUND OR VIDEO RECORDING OR RECORDED DATA OR IMAGES, GRAPHICS, TEXT, PROGRAMS, OR INFORMATION; AND BLANK FLOPPY DISCS AND/OR CD-ROM DISCS FOR COMPUTERS (U.S. CLS. 21, 23, 26, 36 AND 38).

FIRST USE 7-1-2004; IN COMMERCE 7-1-2004.

### CLASS 41—EDUCATION AND ENTERTAINMENT

FOR ELECTRONIC ENTERTAINMENT, NAMELY A CONTINUING SERIES OF SHOWS FEATURING STORIES IN THE NATURE OF CHILDREN'S FICTION, PERSONAL EDUCATION, SOCIAL EDUCATION DISTRIBUTED IN AUDIO AND VIDEO FORM OVER THE INTERNET (U.S. CLS. 100, 101 AND 107).

FIRST USE 7-1-2004; IN COMMERCE 7-1-2004.

### CLASS 42—SCIENTIFIC, COMPUTER AND LEGAL SERVICES

FOR COMPUTER SERVICES, NAMELY PROVIDING ONLINE BOOKS, MAGAZINES, MANUALS, SOFTWARE AND WEB PAGES FEATURING STORIES IN THE FIELD OF PERSONAL EDUCATION, SOCIAL EDUCATION, AND CHILDREN'S FICTION; PROVIDING TEMPORARY USE OF NON-DOWNLOADABLE EDUCATIONAL SOFTWARE FEATURING INSTRUCTION IN PERSONAL EDUCATION, SOCIAL EDUCATION VIA THE INTERNET; COMPUTER SERVICES, NAMELY PROVIDING ONLINE PUBLICATIONS, NAMELY BOOKS, MAGAZINES, MANUALS, AND WEB PAGES IN THE FIELDS OF PERSONAL SOCIAL EDUCATION, GAMES, ENTERTAINMENT, INTERACTIVE TELEVISION, INTERNET BROWSING, INTERNET FILTERING THAT MAY BE DOWNLOADED FROM A GLOBAL COMPUTER NETWORK; COMPUTER SERVICES, NAMELY UPDATING COMPUTER SOFTWARE; PROVIDING TEMPORARY USE OF ONLINE NON-DOWNLOADABLE SOFTWARE, NAMELY COMPUTER GAME SOFTWARE AND INTERACTIVE TELEVISION SOFTWARE, IN THE FIELDS OF CHILDREN'S FICTION, PERSONAL EDUCATION, SOCIAL EDUCATION (U.S. CLS. 100 AND 101).

FIRST USE 7-1-2004; IN COMMERCE 7-1-2004.

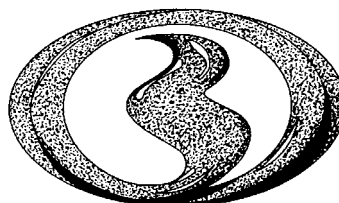

PRIORITY CLAIMED UNDER SEC. 44(D) ON FED REP GERMANY APPLICATION NO. 30042657.7/0, FILED 6-5-2000, REG. NO. 30042657, DATED 8-1-2000, EXPIRES 6-30-2010.

THE STIPPLING IS A FEATURE OF THE MARK AND DOES NOT INTENDED TO INDICATE COLOR.

THE MARK CONSISTS, IN PART, OF THE STYLIZED LETTER "B".

### CLASS 1—CHEMICALS

FOR CHEMICAL PRODUCTS FOR USE IN INDUSTRY, NAMELY, PLASTICS IN RAW STATE IN THE FORM OF POWDERS, GRANULES, CHIPS, DISPERSIONS, LIQUIDS OR PASTES FOR GENERAL INDUSTRIAL AND COMMERCIAL USES; UNPROCESSED ARTIFICIAL RESINS AND SYNTHETIC RESINS FOR GENERAL INDUSTRIAL AND COMMERCIAL USE; CHEMICAL AUXILIARIES FOR USE IN THE PRODUCTION AND PROCESSING OF PLASTICS; METALLOGENES AND CATALYSTS FOR GENERAL INDUSTRIAL AND COMMERCIAL USES (U.S. CLS. 1, 5, 6, 10, 26 AND 46).

FIRST USE 10-2-2000; IN COMMERCE 10-2-2000.

### CLASS 17—RUBBER GOODS

FOR SEMI PROCESSED PLASTIC MATERIALS IN THE FORM OF PLATES, PIPES, BARS, RODS, PELLETS, FILMS OR MOLDED ARTICLES FOR GENERAL INDUSTRIAL AND COMMERCIAL USES AND FOR FURTHER MANUFACTURE (U.S. CLS. 1, 5, 12, 13, 35 AND 50).

FIRST USE 10-2-2000; IN COMMERCE 10-2-2000.

### CLASS 42—SCIENTIFIC, COMPUTER AND LEGAL SERVICES

FOR CHEMISTRY SERVICES, NAMELY, LABORATORY SERVICES IN THE FIELD OF CHEMISTRY, LABORATORY RESEARCH IN THE FIELD OF CHEMISTRY, DEVELOPMENT SERVICES IN THE FIELD OF CHEMISTRY AND TECHNICAL AND ANALYTICAL SERVICES IN THE FIELD OF CHEMISTRY, AND TECHNICAL CONSULTATION IN THE FIELD OF CHEMISTRY; SERVICES IN THE FIELD OF CHEMICAL ENGINEERING AND DESIGN PROCESSES, NAMELY, TECHNICAL CONSULTATION, TECHNICAL ADVICE, TECHNICAL RESEARCH AND DESIGN SERVICES; AND PROVISION OF EXPERT OPINIONS IN THE FIELD OF CHEMICAL ENGINEERING (U.S. CLS. 100 AND 101).

FIRST USE 10-2-2000; IN COMMERCE 10-2-2000.

2,929,134. MARY KAY INC., DALLAS, TX. SN 76-178,543.  
PUB. 10-8-2002, FILED 12-11-2000.

## BREAK THE SILENCE

### CLASS 16—PAPER GOODS AND PRINTED MATTER

FOR BROCHURES, LEAFLETS, INFORMATIONAL FLYERS, NEWSLETTERS, MAGAZINES, BOOKS, PAMPHLETS, AND COLUMNS FOR PERIODICALS, NEWSPAPERS AND MAGAZINES CONCERNING DOMESTIC VIOLENCE AND ABUSE OF WOMEN AND CHILDREN (U.S. CLS. 2, 5, 22, 23, 29, 37, 38 AND 50).  
FIRST USE 7-16-2001; IN COMMERCE 7-16-2001.

### CLASS 25—CLOTHING

FOR T-SHIRTS (U.S. CLS. 22 AND 39).  
FIRST USE 7-16-2001; IN COMMERCE 7-16-2001.

### CLASS 41—EDUCATION AND ENTERTAINMENT

FOR EDUCATIONAL INSTRUCTIONAL SERVICES, NAMELY, PROVIDING INFORMATION CONCERNING VIOLENCE AND ABUSE OF WOMEN AND CHILDREN AND WAYS TO PREVENT OR COMBAT VIOLENCE AND ABUSE AND ITS CONSEQUENCES DISTRIBUTED BY VIDEO TAPES AND THE PRINT MEDIA AND VIA TELEVISED BROADCASTS AND THE GLOBAL COMPUTER NETWORK (U.S. CLS. 100, 101 AND 107).  
FIRST USE 7-16-2001; IN COMMERCE 7-16-2001.

2,929,139. I.C.E.D. MANAGEMENT, INC., WILMINGTON, DE. SN 76-193,874. PUB. 5-28-2002, FILED 1-12-2001.

## CARGO PLUS

NO CLAIM IS MADE TO THE EXCLUSIVE RIGHT TO USE "CARGO", APART FROM THE MARK AS SHOWN.

### CLASS 35—ADVERTISING AND BUSINESS

FOR PHOTOCOPYING SERVICES; FRANCHISING, NAMELY, OFFERING TECHNICAL AND BUSINESS MANAGEMENT ASSISTANCE IN THE PURCHASING, ESTABLISHMENT, AND/OR OPERATION OF A PACKAGING, SHIPPING, DELIVERY, COURIER AND/OR STORAGE BUSINESS; PACKAGING OF ARTICLES AND GOODS TO THE ORDER AND SPECIFICATION OF OTHERS; ARRANGING FOR SHIPPING ARTICLES AND GOODS TO THE ORDER AND SPECIFICATION OF OTHERS; ORDER TAKING, PROCESSING OF ORDERS, AND/OR FULFILLMENT OF ORDERS FOR OTHERS; AND RECEIVING, ASSEMBLING, PICKING, PACKING, CONSOLIDATING AND/OR PREPARING MERCHANDISE ORDERS FOR SHIPMENT (U.S. CLS. 100, 101 AND 102).  
FIRST USE 10-1-1999; IN COMMERCE 10-1-1999.

### CLASS 39—TRANSPORTATION AND STORAGE

FOR PACKAGING OF ARTICLES AND GOODS OF OTHERS FOR TRANSPORTATION; ARRANGING THE PACKING, SHIPPING, FORWARDING, RECEIPT AND/OR DELIVERY OF ARTICLES AND GOODS OF OTHERS FOR TRANSPORT; PREPARING PACKAGES OF OTHERS FOR SHIPPING; SHIPPING AND/OR DELIVERY BY TRUCK AND AIR OF ARTICLES AND GOODS OF OTHERS; TRANSPORTATION OF ARTICLES AND GOODS OF OTHERS BY TRUCK AND AIR; PARCEL DELIVERY SERVICES; PARCEL PICKUP SERVICES; COURIER SERVICES; STORAGE OF ARTICLES AND GOODS OF OTHERS; WAREHOUSE STORAGE; POSTAL SERVICES, NAMELY, MAILBOX RENTAL SERVICES AND MAIL FORWARDING SERVICES; PREPARATION AND COMPLETION OF DOCUMENT, PACKAGE AND FREIGHT SHIPPING TRANSACTIONS OFFERED THROUGH A GLOBAL COMPUTER NETWORK; AND PROVIDING SHIPPING AND TRANSPORTATION INFORMATION VIA A GLOBAL COMPUTER NETWORK (U.S. CLS. 100 AND 105).  
FIRST USE 1-1-1996; IN COMMERCE 1-1-1996.

2,929,146. INTERHEALTH NUTRACEUTICALS, BENICIA, CA. SN 76-200,482. PUB. 11-5-2002, FILED 1-26-2001.

## UC-II

### CLASS 1—CHEMICALS

FOR NUTRITIONAL CHEMICAL ADDITIVES IN BULK POWDER, FERMENTATION EXTRACT, TABLET, CAPSULE, GEL, POWDER, AND LIQUID USED IN THE MANUFACTURE OF FOOD PRODUCTS AND NUTRITIONAL SUPPLEMENTS (U.S. CLS. 1, 5, 6, 10, 26 AND 46).  
FIRST USE 3-22-2001; IN COMMERCE 3-22-2001.

### CLASS 5—PHARMACEUTICALS

FOR NUTRITIONAL SUPPLEMENTS SOLD AS AN INTEGRAL INGREDIENT OF DIETARY SUPPLEMENTS FOR MEDICALLY RESTRICTED DIETS (U.S. CLS. 6, 18, 44, 46, 51 AND 52).  
FIRST USE 3-22-2001; IN COMMERCE 3-22-2001.

2,929,162. BOY'S FARMERS MARKET, INC., THE, DELRAY BEACH, FL. SN 76-230,936. PUB. 8-21-2001, FILED 3-27-2001.

## THE BOYS

### CLASS 36—INSURANCE AND FINANCIAL

FOR REAL ESTATE MANAGEMENT, INVESTMENT, BROKERAGE AND LISTING SERVICES; AND FINANCIAL MANAGEMENT, PLANNING, PORTFOLIO AND RESEARCH SERVICES (U.S. CLS. 100, 101 AND 102).  
FIRST USE 11-15-2004; IN COMMERCE 11-15-2004.

### CLASS 42—SCIENTIFIC, COMPUTER AND LEGAL SERVICES

FOR RESTAURANTS; AND RESTAURANT SERVICES, NAMELY, A SERVER OF FOOD AND BEVERAGES (U.S. CLS. 100 AND 101).  
FIRST USE 11-15-2004; IN COMMERCE 11-15-2004.

2,929,167. SIERRA HOLDINGS, LLC, GREENSBORO, NC. SN 76-241,825. PUB. 3-19-2002, FILED 4-17-2001.

## TWOSMART

### CLASS 35—ADVERTISING AND BUSINESS

FOR SALES REPRESENTATION AND CONSULTATION FEATURING HEATING, AIR CONDITIONING AND VENTILATION EQUIPMENT (U.S. CLS. 100, 101 AND 102).

FIRST USE 3-5-2004; IN COMMERCE 3-5-2004.

### CLASS 37—CONSTRUCTION AND REPAIR

FOR INSTALLATION AND REPAIR OF HEATING, AIR CONDITIONING AND VENTILATION EQUIPMENT (U.S. CLS. 100, 103 AND 106).

FIRST USE 3-5-2004; IN COMMERCE 3-5-2004.

2,929,168. EXECUTIVE LAW GROUP, INC., NEWPORT BEACH, CA. SN 76-242,840. PUB. 3-9-2004, FILED 4-18-2001.

## 6 STEPS

### CLASS 9—ELECTRICAL AND SCIENTIFIC APPARATUS

FOR DOWNLOADABLE ELECTRONIC PUBLICATIONS, NAMELY, BOOKS, BOOKLETS, BROCHURES, LEAFLETS, NEWSLETTERS, PERIODICAL PUBLICATIONS, PRINTED INSTRUCTIONAL AND TEACHING MATERIALS, PRINTED REPORTS, WORKSHEETS, AND WORKBOOKS IN THE FIELDS OF EMPLOYMENT LAW AND LABOR LAW (U.S. CLS. 21, 23, 26, 36 AND 38).

FIRST USE 3-4-2001; IN COMMERCE 3-20-2001.

### CLASS 16—PAPER GOODS AND PRINTED MATTER

FOR PRINTED MATTER, NAMELY, BOOKS, BOOKLETS, BROCHURES, LEAFLETS, NEWSLETTERS, PERIODICAL PUBLICATIONS, PRINTED INSTRUCTIONAL AND TEACHING MATERIALS, PRINTED REPORTS, WORKSHEETS, AND WORKBOOKS IN THE FIELDS OF EMPLOYMENT LAW AND LABOR LAW (U.S. CLS. 2, 5, 22, 23, 29, 37, 38 AND 50).

FIRST USE 3-4-2001; IN COMMERCE 3-20-2001.

### CLASS 41—EDUCATION AND ENTERTAINMENT

FOR EDUCATIONAL SERVICES, NAMELY, PROVIDING SEMINARS, CLASSES, WORKSHOPS, CONFERENCES AND COURSES IN THE FIELDS OF EMPLOYMENT LAW AND LABOR LAW (U.S. CLS. 100, 101 AND 107).

FIRST USE 3-4-2001; IN COMMERCE 3-20-2001.

### CLASS 42—SCIENTIFIC, COMPUTER AND LEGAL SERVICES

FOR LEGAL CONSULTATION SERVICES IN THE FIELDS OF EMPLOYMENT LAW AND LABOR LAW; PROVIDING AN ON-LINE PUBLICATION, NAMELY, BOOKS, BOOKLETS, BROCHURES, LEAFLETS, NEWSLETTERS, PERIODICAL PUBLICATIONS, PRINTED INSTRUCTIONAL AND TEACHING MATERIALS, PRINTED REPORTS, WORKSHEETS, AND WORKBOOKS IN THE FIELDS OF EMPLOYMENT LAW AND LABOR LAW (U.S. CLS. 100 AND 101).

FIRST USE 3-4-2001; IN COMMERCE 3-20-2001.

2,929,172. LIFETOUCH INC., EDEN PRAIRIE, MN. SN 76-244,049. PUB. 4-9-2002, FILED 4-20-2001.

## THE SMILE STATION

### CLASS 35—ADVERTISING AND BUSINESS

FOR ON-LINE ORDERING SERVICES FEATURING PORTRAIT PHOTOGRAPHY (U.S. CLS. 100, 101 AND 102).

FIRST USE 10-15-2004; IN COMMERCE 10-15-2004.

### CLASS 42—SCIENTIFIC, COMPUTER AND LEGAL SERVICES

FOR PROVIDING AN INTERACTIVE GLOBAL NETWORK SITE WHERE PHOTOGRAPHS CAN BE VIEWED, CUSTOMIZED, MANIPULATED, DOWNLOADED, OR E-MAILED (U.S. CLS. 100 AND 101).

FIRST USE 10-15-2004; IN COMMERCE 10-15-2004.

2,929,173. ALIMENTATION COUCHE-TARD INC., LAVAL, QUEBEC, CANADA. SN 76-247,369. PUB. 6-17-2003, FILED 4-26-2001.



### CLASS 21—HOUSEWARES AND GLASS

FOR DISPOSABLE BEVERAGE CUPS; REFILLABLE/REUSABLE BEVERAGE CUPS; REFILLABLE/REUSABLE BOTTLES SOLD EMPTY (U.S. CLS. 2, 13, 23, 29, 30, 33, 40 AND 50).

FIRST USE 4-0-1996; IN COMMERCE 1-0-1999.

### CLASS 32—LIGHT BEVERAGES

FOR NON-CARBONATED AND NON-ALCOHOLIC FROZEN FLAVORED BEVERAGES (U.S. CLS. 45, 46 AND 48).

FIRST USE 4-0-1996; IN COMMERCE 1-0-1999.

2,929,174. ALIMENTATION COUCHE-TARD INC., LAVAL, QUEBEC, CANADA. SN 76-247,370. PUB. 6-17-2003, FILED 4-26-2001.

## FROSTER

### CLASS 21—HOUSEWARES AND GLASS

FOR DISPOSABLE BEVERAGE CUPS; REFILLABLE/REUSABLE BEVERAGE CUPS; REFILLABLE/REUSABLE BOTTLES SOLD EMPTY (U.S. CLS. 2, 13, 23, 29, 30, 33, 40 AND 50).

FIRST USE 4-0-1996; IN COMMERCE 1-0-1999.

### CLASS 32—LIGHT BEVERAGES

FOR NON-CARBONATED AND NON-ALCOHOLIC FROZEN FLAVORED BEVERAGES (U.S. CLS. 45, 46 AND 48).

FIRST USE 4-0-1996; IN COMMERCE 1-0-1999.

2,929,183. BIRKO ORTHOPAEDIE GMBH, 53545 LINZ, FED REP GERMANY. SN 76-262,922. PUB. 7-30-2002, FILED 5-23-2001.

2,929,190. WORLD ACCESS, INC., RICHMOND, VA. SN 76-267,595. PUB. 11-18-2003, FILED 6-6-2001.

# BirkoActive

OWNER OF FED REP GERMANY REG. NO. 30059935, DATED 6-6-2001, EXPIRES 8-31-2010.

## CLASS 10—MEDICAL APPARATUS

FOR (BASED ON 44(E)) ORTHOPEDIC FOOTWEAR, ORTHOPEDIC HEEL INSERTS; (BASED ON USE IN COMMERCE) ORTHOPEDIC SOLES, ORTHOPEDIC INSOLES, ORTHOPEDIC FOOTBEDS, ORTHOPEDIC ARCH SUPPORTS; (BASED ON 44(E)) PREFORMED ORTHOPEDIC FOOTWEAR SHELLS AND HEEL INSERTS; ORTHOPEDIC PADDINGS FOR FOOTWEAR (U.S. CLS. 26, 39 AND 44).

FIRST USE 8-11-2000; IN COMMERCE 3-27-2002.

## CLASS 25—CLOTHING

FOR (BASED ON 44(E)) FOOTWEAR, HEEL INSERTS FOR FOOTWEAR; (BASED ON USE IN COMMERCE) INSOLES, FOOTBEDS, PREFORMED SHELLS AND INSOLE SHELLS FOR FOOTWEAR; (BASED ON 44(E)) PART AND FITTINGS FOR FOOTWEAR (U.S. CLS. 22 AND 39).

FIRST USE 8-11-2000; IN COMMERCE 3-27-2002.

2,929,184. BIRKO ORTHOPAEDIE GMBH, 53545 LINZ, FED REP GERMANY. SN 76-263,031. PUB. 7-30-2002, FILED 5-23-2001.

# BirkoClassic

OWNER OF FED REP GERMANY REG. NO. 30059933, DATED 6-6-2001, EXPIRES 8-31-2010.

## CLASS 10—MEDICAL APPARATUS

FOR (BASED ON 44(E)) ORTHOPEDIC FOOTWEAR; (BASED ON USE IN COMMERCE) ORTHOPEDIC SOLES AND HEEL INSERTS, ORTHOPEDIC INSOLES, ORTHOPEDIC FOOTBEDS, ORTHOPEDIC ARCH SUPPORTS, PREFORMED ORTHOPEDIC FOOTWEAR SHELLS AND HEEL INSERTS; (BASED ON 44(E)) ORTHOPEDIC PADDINGS FOR FOOTWEAR (U.S. CLS. 26, 39 AND 44).

FIRST USE 8-11-2000; IN COMMERCE 6-18-2001.

## CLASS 25—CLOTHING

FOR (BASED ON 44(E)) FOOTWEAR, PART AND FITTINGS FOR FOOTWEAR; (BASED ON USE IN COMMERCE) INSOLES AND HEEL INSERTS FOR FOOTWEAR, FOOTBEDS, PREFORMED SHELLS AND INSOLE SHELLS FOR FOOTWEAR (U.S. CLS. 22 AND 39).

FIRST USE 8-11-2000; IN COMMERCE 6-18-2001.



OWNER OF U.S. REG. NOS. 1,519,286, 1,520,216, AND 2,120,828.

THE DESIGN ELEMENT OF THE COMBINATION MARK CONSISTS OF A SPHERICAL IMAGE RESEMBLING A GLOBE, SHADED TOWARD THE LEFT-HAND AND UPPER PORTIONS, SUPERIMPOSED ON WHICH APPEAR TWO ARCHING LINES, APPEARING TO ORBIT THE GLOBE FROM THE LOWER LEFT-HAND SIDE TO THE UPPER RIGHT-HAND SIDE.

## CLASS 35—ADVERTISING AND BUSINESS

FOR PROVIDING ASSISTANCE TO TRAVELERS THROUGH THE PROVISIONS OF REFERRALS TO MEDICAL AND LEGAL PROFESSIONALS AND INSTITUTIONS; OPERATION OF CALL CENTERS FOR OTHERS; ORDER FULFILLMENT SERVICES IN THE FIELDS OF TRAVEL INSURANCE, COLLISION DAMAGE WAIVER INSURANCE, EXTENDED WARRANTY SERVICES, PURCHASE PRICE PROTECTION INSURANCE, NAMELY, PURCHASE SECURITY FOR CERTAIN PRODUCTS PURCHASED WITH A CREDIT CARD THAT MAY, UNDER CERTAIN CIRCUMSTANCES, BE LOST OR DAMAGED (U.S. CLS. 100, 101 AND 102).

FIRST USE 11-1-1999; IN COMMERCE 1-1-2000.

## CLASS 36—INSURANCE AND FINANCIAL

FOR TRAVEL INSURANCE BROKERAGE SERVICES; EXTENDED WARRANTY CLAIMS ADMINISTRATION SERVICES, NAMELY, PROCESSING CLAIMS RECEIVED ON A WIDE RANGE OF TYPES OF EXTENDED WARRANTIES ISSUED BY OTHERS, SUCH AS EXTENDED WARRANTIES FOR AUTOMOBILES, AUTOMOBILE PARTS, APPLIANCES, CLOTHING, COMPUTER PARTS, ELECTRONICS, EYEWEAR, FURNITURE, HOUSEWARES, JEWELRY, SPORTING GOODS AND TOYS; INSURANCE UNDERWRITING SERVICES IN THE FIELD OF HOME AND AUTO INSURANCE DEDUCTIBLE REIMBURSEMENT, AND PRICE AND PURCHASE PROTECTION (U.S. CLS. 100, 101 AND 102).

FIRST USE 11-1-1999; IN COMMERCE 1-1-2000.

## CLASS 39—TRANSPORTATION AND STORAGE

FOR PROVIDING AMBULANCE TRANSPORT SERVICES, INCLUDING THE PROVISION OF EMERGENCY EVACUATION SERVICES SUCH AS THE TRANSPORT OF ILL OR INJURED TRAVELERS TO A MEDICAL FACILITY FOR PURPOSES OF OBTAINING ADEQUATE MEDICAL TREATMENT, THE RETURN OF TRAVELERS, AND, IN THE CASE OF DECEASED TRAVELERS, THEIR REMAINS (U.S. CLS. 100 AND 105).

FIRST USE 11-1-1999; IN COMMERCE 1-1-2000.

**CLASS 42—SCIENTIFIC, COMPUTER AND LEGAL SERVICES**

FOR CONCIERGE SERVICES FOR OTHERS, COMPRISING OF MAKING REQUESTED PERSONAL ARRANGEMENTS FOR THE PROVISION OF GOODS AND SERVICES BY THIRD PARTIES, MAKING RESERVATIONS AND PROVIDING CUSTOMER-SPECIFIC INFORMATION TO MEET INDIVIDUAL NEEDS FOR A WIDE VARIETY OF TYPES OF USERS, SUCH AS INDIVIDUAL, HOUSEHOLD, BUSINESS, AND TRAVELER; PROVIDING ASSISTANCE TO TRAVELERS, NAMELY, THE PROVISION OF MEDICAL SERVICES AND LEGAL CONSULTATION SERVICES; NURSE TRIAGE SERVICES; PROVIDING CONCIERGE SERVICES FOR TRAVELERS, NAMELY, MAKING TRAVEL ARRANGEMENTS, RESTAURANT RESERVATION, EVENT TICKET PURCHASES, BUSINESS MEETING ARRANGEMENTS, FLORAL AND GIFT PURCHASES, GIFT REMINDER SERVICES AND GIFT LOCATER SERVICES, PERSONAL SHOPPING SERVICES FOR OTHERS SERVICES (U.S. CLS. 100 AND 101).

FIRST USE 11-1-1999; IN COMMERCE 1-1-2000.

---

2,929,192. GAME TRACKER, INC., THE, FLUSHING, MI. SN 76-268,479. PUB. 8-13-2002, FILED 6-8-2001.

**OUTDOOR GOURMET**

NO CLAIM IS MADE TO THE EXCLUSIVE RIGHT TO USE "OUTDOOR", APART FROM THE MARK AS SHOWN.

**CLASS 11—ENVIRONMENTAL CONTROL APPARATUS**

FOR OUTDOOR COOKING GRILLS, NAMELY, GAS GRILLS AND BARBECUE GRILLS (U.S. CLS. 13, 21, 23, 31 AND 34).

FIRST USE 10-1-2001; IN COMMERCE 10-1-2001.

**CLASS 21—HOUSEWARES AND GLASS**

FOR COOKING UTENSILS, NAMELY, COOKING POTS, PANS, FRYING PANS, BASTING SPOONS, AND UTENSILS FOR BARBECUES, NAMELY, FORKS, SPATULAS AND TONGS (U.S. CLS. 2, 13, 23, 29, 30, 33, 40 AND 50).

FIRST USE 10-1-2001; IN COMMERCE 10-1-2001.

**CLASS 30—STAPLE FOODS**

FOR SPICES AND MARINADES FOR SEASONING MEAT, POULTRY, FISH AND STEWS (U.S. CL. 46).

FIRST USE 10-1-2000; IN COMMERCE 10-1-2000.

---

2,929,196. WORLD ACCESS, INC., RICHMOND, VA. SN 76-274,928. PUB. 11-18-2003, FILED 6-21-2001.

**WORLD ACCESS**

OWNER OF U.S. REG. NOS. 1,519,286, 1,520,216, AND 2,120,828.

**CLASS 35—ADVERTISING AND BUSINESS**

FOR PROVIDING ASSISTANCE TO TRAVELERS THROUGH THE PROVISIONS OF REFERRALS TO MEDICAL AND LEGAL PROFESSIONALS AND INSTITUTIONS; OPERATION OF CALL CENTERS FOR OTHERS; ORDER FULFILLMENT SERVICES IN THE FIELDS OF TRAVEL INSURANCE, COLLISION DAMAGE WAIVER INSURANCE, EXTENDED WARRANTY SERVICES PURCHASE PRICE PROTECTION INSURANCE, NAMELY, PURCHASE SECURITY FOR CERTAIN PRODUCTS PURCHASED WITH A CREDIT CARD THAT MAY, UNDER CERTAIN CIRCUMSTANCES, BE LOST OR DAMAGED (U.S. CLS. 100, 101 AND 102).

FIRST USE 11-1-1999; IN COMMERCE 1-1-2000.

**CLASS 36—INSURANCE AND FINANCIAL**

FOR TRAVEL INSURANCE BROKERAGE SERVICES; EXTENDED WARRANTY CLAIMS ADMINISTRATION SERVICES, NAMELY, PROCESSING CLAIMS RECEIVED ON A WIDE RANGE OF TYPES OF EXTENDED WARRANTIES ISSUED BY OTHERS, SUCH AS EXTENDED WARRANTIES FOR AUTOMOBILES, AUTOMOBILE PARTS, APPLIANCES, CLOTHING, COMPUTER PARTS, ELECTRONICS, EYEWEAR, FURNITURE, HOUSEWARES, JEWELRY, SPORTING GOODS AND TOYS; INSURANCE UNDERWRITING SERVICES IN THE FIELD OF HOME AND AUTO INSURANCE DEDUCTIBLE REIMBURSEMENT, AND PRICE AND PURCHASE PROTECTION (U.S. CLS. 100, 101 AND 102).

FIRST USE 11-1-1999; IN COMMERCE 1-1-2000.

**CLASS 39—TRANSPORTATION AND STORAGE**

FOR PROVIDING AMBULANCE TRANSPORT SERVICES, INCLUDING THE PROVISION OF EMERGENCY EVACUATION SERVICES SUCH AS THE TRANSPORT OF ILL OR INJURED TRAVELERS TO A MEDICAL FACILITY FOR PURPOSES OF OBTAINING ADEQUATE MEDICAL TREATMENT, THE RETURN OF TRAVELERS, AND, IN THE CASE OF DECEASED TRAVELERS, THEIR REMAINS (U.S. CLS. 100 AND 105).

FIRST USE 11-1-1999; IN COMMERCE 1-1-2000.

**CLASS 42—SCIENTIFIC, COMPUTER AND LEGAL SERVICES**

FOR CONCIERGE SERVICES FOR OTHERS, COMPRISING OF MAKING REQUESTED PERSONAL ARRANGEMENTS FOR THE PROVISION OF GOODS AND SERVICES BY THIRD PARTIES, MAKING RESERVATIONS AND PROVIDING CUSTOMER-SPECIFIC INFORMATION TO MEET INDIVIDUAL NEEDS FOR A WIDE VARIETY OF TYPES OF USERS, SUCH AS INDIVIDUAL, HOUSEHOLD, BUSINESS, AND TRAVELER; PROVIDING ASSISTANCE TO TRAVELERS, NAMELY, THE PROVISION OF MEDICAL SERVICES AND LEGAL CONSULTATION SERVICES; NURSE TRIAGE SERVICES; PROVIDING CONCIERGE SERVICES FOR TRAVELERS, NAMELY, MAKING TRAVEL ARRANGEMENTS, RESTAURANT RESERVATION, EVENT TICKET PURCHASES, BUSINESS MEETING ARRANGEMENTS, FLORAL AND GIFT PURCHASES, GIFT REMINDER SERVICES AND GIFT LOCATER SERVICES, PERSONAL SHOPPING SERVICES FOR OTHERS SERVICES (U.S. CLS. 100 AND 101).

FIRST USE 11-1-1999; IN COMMERCE 1-1-2000.

---

2,929,200. EMERGENETICS, LLC, CASTLE ROCK, CO. SN 76-291,843. PUB. 1-8-2002, FILED 7-27-2001.

**STEP (STUDENT/TEACHER EMERGENETICS PROFILE)**

OWNER OF U.S. REG. NO. 1,966,244.  
NO CLAIM IS MADE TO THE EXCLUSIVE RIGHT TO USE "PROFILE", APART FROM THE MARK AS SHOWN.

#### **CLASS 41—EDUCATION AND ENTERTAINMENT**

FOR EDUCATIONAL AND TRAINING SERVICES, NAMELY CONDUCTING LECTURES, SEMINARS, AND WORKSHOPS IN THE AREA OF STUDENT DEVELOPMENT BASED ON BEHAVIORAL TRAITS AND THOUGHT PATTERNS AND INSTRUCTIONAL MATERIALS DISTRIBUTED THEREWITH (U.S. CLS. 100, 101 AND 107).

FIRST USE 4-0-2001; IN COMMERCE 4-0-2001.

#### **CLASS 42—SCIENTIFIC, COMPUTER AND LEGAL SERVICES**

FOR CONSULTING SERVICES, NAMELY ADMINISTERING A QUESTIONNAIRE USED TO PROFILE THE LEARNING AND BEHAVIORAL ATTRIBUTES OF CHILDREN, ASSESSING, ANALYZING AND REPORTING THE RESULTS, AND COUNSELING AND TRAINING TEACHERS REGARDING STUDENT PERFORMANCE AND STUDENT/TEACHER RELATIONSHIPS (U.S. CLS. 100 AND 101).

FIRST USE 4-0-2001; IN COMMERCE 4-0-2001.

---

2,929,203. KLIMAN, DEBORAH S., DBA CHILD AND FAMILY STUDY TEAM, CHADDS FORD, PA. SN 76-297,755. PUB. 12-24-2002, FILED 8-13-2001.

#### **CFST: The Child & Family Study Team**

NO CLAIM IS MADE TO THE EXCLUSIVE RIGHT TO USE "THE CHILD & FAMILY STUDY TEAM", APART FROM THE MARK AS SHOWN.

THE MARK CONSISTS OF THE TERM "CFST: THE CHILD & FAMILY STUDY TEAM" WITH THE LETTERS "CFST, T, C, F, S" AND "T" APPEARING IN CAPITAL LETTERS AND THE OTHERS IN LOWER CASE, A COLON FOLLOWING THE LETTERS "CFST" AND THE USE OF THE "&" IN PLACE OF THE WORD "AND".

#### **CLASS 41—EDUCATION AND ENTERTAINMENT**

FOR EDUCATIONAL TESTING SERVICES (U.S. CLS. 100, 101 AND 107).

FIRST USE 7-17-2001; IN COMMERCE 8-4-2001.

#### **CLASS 42—SCIENTIFIC, COMPUTER AND LEGAL SERVICES**

FOR PSYCHOLOGICAL TESTING SERVICES (U.S. CLS. 100 AND 101).

FIRST USE 7-17-2001; IN COMMERCE 8-4-2001.

---

2,929,205. DOLBY LABORATORIES LICENSING CORPORATION, SAN FRANCISCO, CA. SN 76-300,661. PUB. 9-17-2002, FILED 8-16-2001.

#### **SURROUND IN MOTION**

OWNER OF U.S. REG. NOS. 1,645,844, 1,989,524, AND OTHERS.  
NO CLAIM IS MADE TO THE EXCLUSIVE RIGHT TO

USE "SURROUND", APART FROM THE MARK AS SHOWN.

#### **CLASS 9—ELECTRICAL AND SCIENTIFIC APPARATUS**

FOR APPARATUS FOR USE IN CONNECTION WITH THE PROCESSING, RECORDING, REPRODUCTION, TRANSMISSION AND RECEPTION OF AUDIO SIGNALS IN MOTOR VEHICLES, IN-FLIGHT ENTERTAINMENT, AND PORTABLE PRODUCTS NAMELY—MULTI-CHANNEL SOUND PROCESSORS; PORTABLE AUDIO EQUIPMENT, NAMELY, CASSETTE RECORDERS, COMPACT-DISC PLAYERS AND DIGITAL MEMORY PLAYERS AND DIGITAL AUDIO PLAYERS (U.S. CLS. 21, 23, 26, 36 AND 38).

FIRST USE 8-25-2001; IN COMMERCE 8-25-2001.

#### **CLASS 42—SCIENTIFIC, COMPUTER AND LEGAL SERVICES**

FOR TECHNICAL CONSULTING AND PRODUCT DESIGN AND DEVELOPMENT IN THE FIELD OF AUDIO SIGNAL PROCESSING (U.S. CLS. 100 AND 101).

FIRST USE 8-25-2001; IN COMMERCE 8-25-2001.

---

2,929,206. MINNESOTA LAWYERS MUTUAL INSURANCE COMPANY, MINNEAPOLIS, MN. SN 76-302,334. PUB. 5-6-2003, FILED 8-21-2001.

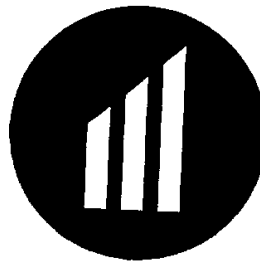

#### **CLASS 35—ADVERTISING AND BUSINESS**

FOR BUSINESS MANAGEMENT; BUSINESS MANAGEMENT CONSULTATION; BUSINESS AUDITING; INSURANCE CLAIMS AUDITING SERVICES (U.S. CLS. 100, 101 AND 102).

FIRST USE 11-0-2001; IN COMMERCE 11-0-2001.

#### **CLASS 36—INSURANCE AND FINANCIAL**

FOR INSURANCE UNDERWRITING IN THE FIELD OF PROFESSIONAL LIABILITY FOR ATTORNEYS; UNDERWRITING INSURANCE FOR PRE-PAID LEGAL SERVICES; BONDING SERVICES; RISK MANAGEMENT SERVICES; CLAIMS ADJUSTMENT IN THE FIELD OF INSURANCE; INSURANCE CONSULTATION (U.S. CLS. 100, 101 AND 102).

FIRST USE 11-0-2001; IN COMMERCE 11-0-2001.



**CLASS 41—EDUCATION AND ENTERTAINMENT**

FOR COMPUTER EDUCATION TRAINING SERVICES FOR LAW FIRMS; EDUCATIONAL SERVICES, NAMELY CONDUCTING SEMINARS, CONFERENCES AND WORKSHOPS FOR LAWYERS IN THE FIELDS OF PREVENTING MALPRACTICE AND COMPUTER TECHNOLOGY USED IN LAW FIRMS (U.S. CLS. 100, 101 AND 107).

FIRST USE 11-0-2001; IN COMMERCE 11-0-2001.

**CLASS 42—SCIENTIFIC, COMPUTER AND LEGAL SERVICES**

FOR COMPUTER CONSULTATION (U.S. CLS. 100 AND 101).

FIRST USE 11-0-2001; IN COMMERCE 11-0-2001.

**CLASS 28—TOYS AND SPORTING GOODS**

FOR NOVELTY ITEMS, NAMELY, TOY PLASTIC EGGS; DECORATIVE WINDSOCKS; WIND UP TOY CHICKS AND BUNNIES; PLUSH TOY ANIMALS; YO-YOS; GAMES, NAMELY, JIGSAW PUZZLES, JACKS AND RING TOSS; AND ARTIFICIAL EASTER TREES AND ORNAMENTS ASSOCIATED THEREWITH (U.S. CLS. 22, 23, 38 AND 50).

FIRST USE 10-13-2001; IN COMMERCE 10-13-2001.

2,929,218. WARRI INTERNATIONAL, INC., NEW YORK, NY. SN 76-330,244. PUB. 9-2-2003, FILED 10-29-2001.

2,929,212. FOUR STAR INTERNATIONAL TRADING COMPANY, TAIPEI, TAIWAN. SN 76-314,398. PUB. 12-9-2003, FILED 9-19-2001.

**HOPPY HOLLOW COLLECTIBLES**

NO CLAIM IS MADE TO THE EXCLUSIVE RIGHT TO USE "COLLECTIBLES", APART FROM THE MARK AS SHOWN.

**CLASS 16—PAPER GOODS AND PRINTED MATTER**

FOR GIFT BAGS MADE OF PAPER (U.S. CLS. 2, 5, 22, 23, 29, 37, 38 AND 50).

FIRST USE 10-13-2001; IN COMMERCE 10-13-2001.

**CLASS 20—FURNITURE AND ARTICLES NOT OTHERWISE CLASSIFIED**

FOR EASTER DECORATIONS, NAMELY, EGG ORNAMENTS AND DECORATIVE EASTER HOUSES MADE OF POLYRESIN; SEPARABLE PLASTIC EGGS (U.S. CLS. 2, 13, 22, 25, 32 AND 50).

FIRST USE 10-13-2001; IN COMMERCE 10-13-2001.

**CLASS 21—HOUSEWARES AND GLASS**

FOR BASKETS MADE OF WICKER AND STRAW; TRINKET BOXES MADE OF WOOD AND PORCELAIN; WIND CHIMES; EASTER HOUSES MADE OF PORCELAIN AND ACCESSORIES THEREOF, NAMELY, BUNNIES, TREES, BRIDGES, GAZEBOS, FENCES, GATES, AND BALLOONS, ALL MADE OF PORCELAIN, DECORATIVE BIRD HOUSES; DECORATIVE GARDEN ORNAMENTS; DECORATIVE WREATHS AND WALL HANGINGS MADE OF WOOD, PORCELAIN, TERRA COTTA AND POLYRESIN; GLASS BALLS FILLED WITH WATER AND GLITTER OR ARTIFICIAL SNOW THAT DEPICT EASTER SCENES; TABLE TOP CERAMICS, NAMELY, MUGS, EGG PLATES AND HOLDER, SALT AND PEPPER SHAKERS AND CANDY DISHES; AND WOODEN AND MELAMINE DECORATIVE SERVING TRAYS (U.S. CLS. 2, 13, 23, 29, 30, 33, 40 AND 50).

FIRST USE 10-13-2001; IN COMMERCE 10-13-2001.

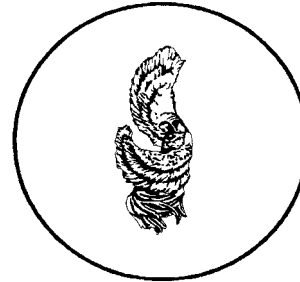
**ANGEL OF PEACE**

THE MARK CONSISTS OF THE WORDS "ANGEL OF PEACE" AND A DESIGN OF A WINGED ANGEL.

**CLASS 18—LEATHER GOODS**

FOR TOTE BAGS, HAND-BAGS, ALL-PURPOSE SPORTS BAGS, TRAVELING BAGS (U.S. CLS. 1, 2, 3, 22 AND 41).

FIRST USE 9-0-2004; IN COMMERCE 9-0-2004.

**CLASS 20—FURNITURE AND ARTICLES NOT OTHERWISE CLASSIFIED**

FOR DECORATIVE ACCENT PIECES, NAMELY, PILLOWS (U.S. CLS. 2, 13, 22, 25, 32 AND 50).

FIRST USE 9-0-2004; IN COMMERCE 9-0-2004.

**CLASS 24—FABRICS**

FOR CURTAINS AND BEDSPREADS (U.S. CLS. 42 AND 50).

FIRST USE 9-0-2004; IN COMMERCE 9-0-2004.

**CLASS 25—CLOTHING**

FOR CLOTHING FOR MEN, WOMEN AND CHILDREN, NAMELY, PANTS, SHIRTS, SKIRTS, BLOUSES, SCARVES AND DRESSES (U.S. CLS. 22 AND 39).

FIRST USE 9-0-2004; IN COMMERCE 9-0-2004.

2,929,230. JASON FOUNDATION FOR EDUCATION, NEEDHAM HEIGHTS, MA. SN 76-350,015. PUB. 7-6-2004, FILED 12-17-2001.

## JASON XIV: FROM SHORE TO SEA

### CLASS 9—ELECTRICAL AND SCIENTIFIC APPARATUS

FOR PRERECORDED VIDEO TAPES FOR PRE-SCHOOL THROUGH TWELFTH GRADE STUDENTS COVERING TOPICS RELATING TO EARTH AND LIFE SCIENCES (U.S. CLS. 21, 23, 26, 36 AND 38).  
FIRST USE 7-1-2002; IN COMMERCE 7-1-2002.

### CLASS 16—PAPER GOODS AND PRINTED MATTER

FOR PRINTED EDUCATIONAL MATERIALS, NAMELY, BOOKS, WORKBOOKS AND MAGAZINES FOR PRE-SCHOOL THROUGH TWELFTH GRADE STUDENTS, PARENTS AND TEACHERS COVERING TOPICS RELATING TO EARTH AND LIFE SCIENCES; POSTERS; PENS; PENCILS (U.S. CLS. 2, 5, 22, 23, 29, 37, 38 AND 50).  
FIRST USE 7-1-2002; IN COMMERCE 7-1-2002.

2,929,246. NANOSCALE MATERIALS, INC., MANHATTAN, KS. SN 76-373,593. PUB. 10-14-2003, FILED 2-22-2002.

## NANOACTIVE

### CLASS 1—CHEMICALS

FOR NANOPARTICLES OF METAL OXIDES, NAMELY CALCIUM OXIDE, CERIUM OXIDE, MAGNESIUM OXIDE, TITANIUM OXIDE, ZINC OXIDE, ALUMINUM OXIDE AND COPPER OXIDE FOR SCIENTIFIC USE, FOR SURFACE DECONTAMINATION AND PROTECTION FROM TOXIC PARTICLES, PURIFICATION OF AIR AND WATER, SCRUBBING OF ACID GASES, SEQUESTERING OF ODORS AND TOXIC GASES, ENHANCING PHYSICAL PROPERTIES OF PAINTS AND INDUSTRIAL COATINGS, AND FOR USE IN A WIDE VARIETY OF INDUSTRIAL AND MANUFACTURING APPLICATIONS (U.S. CLS. 1, 5, 6, 10, 26 AND 46).  
FIRST USE 5-7-2002; IN COMMERCE 5-7-2002.

### CLASS 6—METAL GOODS

FOR NANOPARTICLES OF METALS FOR SCIENTIFIC USE, FOR SURFACE DECONTAMINATION AND PROTECTION FROM TOXIC PARTICLES, PURIFICATION OF AIR AND WATER, SCRUBBING OF ACID GASES, SEQUESTERING OF ODORS AND TOXIC GASES, ENHANCING PHYSICAL PROPERTIES OF PAINTS AND INDUSTRIAL COATINGS, AND FOR USE IN A WIDE VARIETY OF INDUSTRIAL AND MANUFACTURING APPLICATIONS (U.S. CLS. 2, 12, 13, 14, 23, 25 AND 50).  
FIRST USE 5-7-2002; IN COMMERCE 5-7-2002.

2,929,248. ARAMARK CORPORATION, PHILADELPHIA, PA. SN 76-377,806. PUB. 3-25-2003, FILED 3-4-2002.

## TMMY YMMY'S

### CLASS 30—STAPLE FOODS

FOR BAKERY PRODUCTS AND BAKERY DESSERTS; DESSERTS, NAMELY, PIES, CAKES, CUPCAKES, COOKIES, MUFFINS (U.S. CL. 46).  
FIRST USE 12-12-2003; IN COMMERCE 12-12-2003.

### CLASS 43—HOTEL AND RESTAURANT SERVICES

FOR RESTAURANTS, RESTAURANT SERVICES, AND CONTRACT FOOD SERVICES (U.S. CLS. 100 AND 101).  
FIRST USE 12-12-2003; IN COMMERCE 12-12-2003.

2,929,245. REAL ENTERTAINMENT GROUP, PHILADELPHIA, PA. SN 76-370,903. PUB. 2-18-2003, FILED 2-13-2002.

## LIVE MUSIC FOR GROWNUPS

NO CLAIM IS MADE TO THE EXCLUSIVE RIGHT TO USE "LIVE MUSIC", APART FROM THE MARK AS SHOWN.

### CLASS 41—EDUCATION AND ENTERTAINMENT

FOR ENTERTAINMENT SERVICES, IN THE NATURE OF PERFORMING ARTS AND CONCERTS (U.S. CLS. 100, 101 AND 107).  
FIRST USE 11-10-2004; IN COMMERCE 11-10-2004.

### CLASS 43—HOTEL AND RESTAURANT SERVICES

FOR RESTAURANT AND BAR SERVICES (U.S. CLS. 100 AND 101).  
FIRST USE 11-10-2004; IN COMMERCE 11-10-2004.

2,929,252. FLOETRY, PHILADELPHIA, PA. SN 76-381,647. PUB. 4-29-2003, FILED 3-12-2002.

## FLOETRY

### CLASS 9—ELECTRICAL AND SCIENTIFIC APPARATUS

FOR SERIES OF MUSICAL SOUND RECORDINGS; A SERIES OF VIDEO RECORDINGS FEATURING MUSIC AND MUSICAL BASED ENTERTAINMENT; DOWNLOADABLE MUSICAL SOUND RECORDINGS; DOWNLOADABLE VISUAL RECORDINGS FEATURING MUSIC AND MUSICAL BASED ENTERTAINMENT (U.S. CLS. 21, 23, 26, 36 AND 38).  
FIRST USE 10-0-2002; IN COMMERCE 10-0-2002.

**CLASS 41—EDUCATION AND ENTERTAINMENT**

FOR ENTERTAINMENT SERVICES, NAMELY LIVE MUSICAL PERFORMANCES; PROVIDING A WEBSITE ON A GLOBAL COMPUTER NETWORK FEATURING INFORMATION ON A MUSICAL GROUP AND ITS MUSICAL PERFORMANCES, TOURS, BIOGRAPHIES, SOUND AND VIDEO RECORDINGS, AND APPEARANCES (U.S. CLS. 100, 101 AND 107).

FIRST USE 5-0-1999; IN COMMERCE 5-0-1999.

**CLASS 42—SCIENTIFIC, COMPUTER AND LEGAL SERVICES**

FOR ANIMATION DESIGN FOR OTHERS; GRAPHIC ILLUSTRATION SERVICES FOR OTHERS (U.S. CLS. 100 AND 101).

FIRST USE 6-3-2004; IN COMMERCE 6-3-2004.

2,929,253. HELENE CURTIS, INC., WILMINGTON, DE. SN 76-383,278. PUB. 8-6-2002, FILED 3-11-2002.



OWNER OF U.S. REG. NOS. 613,664, 1,970,064, AND OTHERS.

**CLASS 25—CLOTHING**

FOR HEAD BANDS AND HEAD WRAPS (U.S. CLS. 22 AND 39).

FIRST USE 12-31-2003; IN COMMERCE 12-31-2003.

**CLASS 26—FANCY GOODS**

FOR HAIR ACCESSORIES, NAMELY, PINS, CLIPS, FASTENERS, DECORATIVE COMBS, BOBBY PINS, PONY TAIL HOLDERS, BARRETTES, HAIR NETS, HAIR BONNETS, NON-ELECTRIC HAIR ROLLERS, HAIR ROLLER CLIPS, AND NON-ELECTRIC HAIR CURLERS (U.S. CLS. 37, 39, 40, 42 AND 50).

FIRST USE 12-31-2003; IN COMMERCE 12-31-2003.

2,929,263. WALLACE, DONALD, PORTLAND, OR. SN 76-394,983. PUB. 12-9-2003, FILED 4-12-2002.

**WALLYHOOD****CLASS 9—ELECTRICAL AND SCIENTIFIC APPARATUS**

FOR ILLUSTRATIONS AND ANIMATIONS CONTAINED ON ELECTRONICALLY READABLE DIGITAL MEDIA, NAMELY, DIGITAL MAGNETIC TAPES, COMPACT DISC AND VIDEO TAPES, ALL FEATURING ANIMATION AND ILLUSTRATIONS; ELECTRONIC DATABASE IN THE FIELD OF ILLUSTRATION AND ANIMATION ACCESSIBLE ON THE GLOBAL COMMUNICATIONS NETWORK (U.S. CLS. 21, 23, 26, 36 AND 38).

FIRST USE 8-16-2004; IN COMMERCE 8-16-2004.

**CLASS 41—EDUCATION AND ENTERTAINMENT**

FOR ANIMATION PRODUCTION SERVICES (U.S. CLS. 100, 101 AND 107).

FIRST USE 4-15-2004; IN COMMERCE 4-15-2004.

2,929,266. SCHWAN'S IP LLC, MARSHALL, MN. SN 76-403,935. PUB. 2-24-2004, FILED 5-3-2002.



OWNER OF U.S. REG. NOS. 1,190,856, 1,208,783, AND 2,243,064.

**CLASS 29—MEATS AND PROCESSED FOODS**

FOR FOOD PRODUCTS, NAMELY, PROCESSED SEAFOOD; PROCESSED SHRIMP; PROCESSED FRUITS AND VEGETABLES; POTATOES STUFFED WITH SOUR CREAM, BACON PIECES, AND CHIVES; CREAMED CHIPPED BEEF; BEEF TIPS AND GRAVY; CHICKEN AND GRAVY; PROCESSED ONION RINGS; AND ENTREES CONSISTING PRIMARILY OF MEAT OR POULTRY AND VEGETABLES; PROCESSED FOODS, NAMELY, PROCESSED POULTRY; PROCESSED MEAT; CHEESE SLICES; PROCESSED CHEESE; PROCESSED POTATOES; CHICKEN, CHILI AND CHEESE ENTREES; MILK; FROZEN PREPARED ENTREES CONSISTING PRIMARILY OF CHICKEN, TURKEY, PORK, MEATLOAF, OR FISH, AND CONTAINING ONE OR MORE OF THE FOLLOWING— PROCESSED POTATOES, PROCESSED VEGETABLES, BISCUITS, ROLLS, RICE, OR EGG ROLLS; GOULASH CONSISTING PRIMARILY OF HAMBURGER, AND ALSO CONTAINING PASTA AND TOMATO SAUCE; CORN DOGS (U.S. CL. 46).

FIRST USE 7-0-2003; IN COMMERCE 7-0-2003.

**CLASS 30—STAPLE FOODS**

FOR PASTA AND PASTA ENTREES, INCLUDING, VEGETABLE PASTA ENTREES; GOULASH CONSISTING PRIMARILY OF PASTA, AND ALSO CONTAINING HAMBURGER AND TOMATO SAUCE; FROZEN FOOD PRODUCTS, NAMELY EGG ROLLS; MEXICAN FOOD PRODUCTS, NAMELY, TAQUITOS, TAMALES, BURRITOS AND ENCHILADAS; PREPARED ENTREES CONSISTING OF MEAT, CHEESE, AND/OR VEGETABLES WRAPPED IN A CORN-MEAL CRUST; FROZEN PREPARED ENTREES CONSISTING PRIMARILY OF PASTA WITH ONE OR MORE OF THE FOLLOWING— ROLLS, RICE, EGG ROLLS, PROCESSED POTATOES, PROCESSED VEGETABLES, CHEESECAKE, OR DESSERT PIES PRIMARILY CONSISTING OF PUDDINGS OR CUSTARD; LASAGNA; RAVIOLI; TORTELLINI; PASTA SHELLS STUFFED WITH CHEESE; PANCAKES; WAFFLES; FRENCH TOAST STICKS; COOKIE DOUGH; CINNAMON ROLL DOUGH; FRUIT PIES; APPLE FLAUTAS; SANDWICHES, INCLUDING, SANDWICHES CONSISTING OF HAM AND CHEESE; ENTREES CONSISTING PRIMARILY OF RICE, AND ALSO CONTAINING MEAT OR POULTRY AND VEGETABLES; PRETZELS STUFFED WITH CHEESE OR PEANUT BUTTER AND JELLY; BREAD DOUGH; BREAD, INCLUDING, CHEESE GARLIC BREAD, STUFFED BREAD AND PRE-COOKED, READY-TO-EAT FROZEN BREAD WITH MEAT, CHEESE, SAUCE AND/OR VEGETABLE FILLING; CROISSANTS; PIZZA; ICE CREAM, ICE CREAM BASED DESSERTS, FROZEN ICE MILK, FROZEN YOGURT, FROZEN SHERBET CONFECTIONS, AND CHOCOLATE TOPPING, PIEROGIES (U.S. CL. 46).  
FIRST USE 7-0-2003; IN COMMERCE 7-0-2003.

**CLASS 32—LIGHT BEVERAGES**

FOR CONCENTRATES USED IN THE PREPARATION OF FRUIT-FLAVORED AND FRUIT JUICE DRINKS CONTAINING WATER; AND ORANGE JUICE (U.S. CLS. 45, 46 AND 48).  
FIRST USE 7-0-2003; IN COMMERCE 7-0-2003.

2,929,274. WILLIAM DETTMAN ENTERPRISES, INC., CYPRESS, CA. SN 76-421,417. PUB. 8-12-2003, FILED 6-10-2002.



OWNER OF U.S. REG. NO. 2,496,239.  
NO CLAIM IS MADE TO THE EXCLUSIVE RIGHT TO USE "PRO SOUND", APART FROM THE MARK AS SHOWN.  
THE MARK CONSISTS OF A STYLIZED "P" AND THE LITERAL ELEMENTS "PROSOUND".

**CLASS 9—ELECTRICAL AND SCIENTIFIC APPARATUS**

FOR PRERECORDED VIDEO TAPES FEATURING DISC JOCKEY RELATED MATERIALS (U.S. CLS. 21, 23, 26, 36 AND 38).  
FIRST USE 11-2-2004; IN COMMERCE 11-2-2004.

**CLASS 18—LEATHER GOODS**

FOR TRAVELING BAGS FOR EQUIPMENT AND MERCHANDISE, ALL PURPOSE ATHLETIC BAGS, SCHOOL BAGS, SCHOOL BOOK BAGS, SHOULDER BAGS AND SOUVENIR BAGS (U.S. CLS. 1, 2, 3, 22 AND 41).  
FIRST USE 3-1-1989; IN COMMERCE 3-1-1989.

**CLASS 25—CLOTHING**

FOR CLOTHING, NAMELY SHIRTS, SWEATSHIRTS, JACKETS AND HATS (U.S. CLS. 22 AND 39).  
FIRST USE 3-1-1989; IN COMMERCE 3-1-1989.

**CLASS 35—ADVERTISING AND BUSINESS**

FOR ADVERTISING FOR OTHERS VIA CATALOG AND AN ON-LINE ELECTRONIC COMMUNICATION NETWORK; RETAIL SERVICES VIA CATALOG AND ON-LINE ELECTRONIC COMMUNICATION NETWORK FEATURING DISC JOCKEY GEAR, PROFESSIONAL AUDIO EQUIPMENT, NAMELY LOUDSPEAKERS, AMPLIFIERS, GRAPHIC EQUALIZERS, MIXING CONSOLES, MIXING AMPLIFIERS, SPEAKERS, PAS, MICROPHONES, RECORDING EQUIPMENT, ELECTRONICS, STAGE LIGHTING, AND MOUNTING STRUCTURES AND EQUIPMENT FOR STAGE LIGHTING (U.S. CLS. 100, 101 AND 102).  
FIRST USE 6-25-2004; IN COMMERCE 6-25-2004.

2,929,278. YOUNG CHAMPIONS RECREATION PROGRAMS, INC., SANTA ANA, CA. SN 76-429,230. PUB. 6-1-2004, FILED 7-9-2002.

**DOUBLE DRAGON**

**CLASS 18—LEATHER GOODS**

FOR MARTIAL ARTS AND CHEERLEADING ACCESSORIES, NAMELY, DUFFEL BAGS AND ALL-PURPOSE SPORT BAGS (U.S. CLS. 1, 2, 3, 22 AND 41).  
FIRST USE 1-0-2002; IN COMMERCE 5-0-2002.

**CLASS 25—CLOTHING**

FOR MARTIAL ARTS AND CHEERLEADING CLOTHING AND ACCESSORIES, NAMELY, HEADWEAR, SHIRTS, PANTS, SWEATPANTS, SHORTS, UNIFORMS, VESTS, UNDERWEAR, SKIRTS, AND BELTS (U.S. CLS. 22 AND 39).  
FIRST USE 1-0-2002; IN COMMERCE 5-0-2002.

**CLASS 28—TOYS AND SPORTING GOODS**

FOR MARTIAL ARTS AND CHEERLEADING ACCESSORIES, NAMELY, STRIKING BAGS, POM-POMS, MARTIAL ARTS HEAD GUARDS, AND HAND PADS FOR ATHLETIC USE (U.S. CLS. 22, 23, 38 AND 50).  
FIRST USE 1-0-2002; IN COMMERCE 5-0-2002.

2,929,280. DICK IDOL VENTURES, LLC, LEXINGTON, NC. SN 76-430,503. PUB. 2-24-2004, FILED 7-15-2002.

2,929,281. TURNING TECHNOLOGIES, LLC, YOUNGSTOWN, OH. SN 76-434,662. PUB. 8-26-2003, FILED 7-26-2002.



**CLASS 11—ENVIRONMENTAL CONTROL APPARATUS**

FOR ELECTRIC LAMPS; WALL SCONCE LIGHTING FIXTURES; AND CHANDELIERS (U.S. CLS. 13, 21, 23, 31 AND 34).

FIRST USE 8-31-2000; IN COMMERCE 8-31-2000.

**CLASS 16—PAPER GOODS AND PRINTED MATTER**

FOR FRAMED PICTORIAL PRINTS (U.S. CLS. 2, 5, 22, 23, 29, 37, 38 AND 50).

FIRST USE 2-28-2002; IN COMMERCE 2-28-2002.

**CLASS 20—FURNITURE AND ARTICLES NOT OTHERWISE CLASSIFIED**

FOR FURNITURE; PILLOWS; COLD CAST SCULPTURES MADE OF RESIN; DECORATIVE PILLOWS; BED PILLOWS (U.S. CLS. 2, 13, 22, 25, 32 AND 50).

FIRST USE 1-31-2002; IN COMMERCE 1-31-2002.

**CLASS 24—FABRICS**

FOR TEXTILE GOODS, NAMELY, TEXTILE WALL HANGINGS AND DECORATIVE BLANKET THROWS, FABRIC TABLE RUNNERS; BEDDING, NAMELY COMFORTERS AND BED SPREADS, SELF CONTAINED COORDINATED BEDDING PRODUCTS, NAMELY, COMFORTERS, SHEETS, PILLOWCASES, BED SKIRTS, AND PILLOW SHAMS, SOFT WINDOW TREATMENTS, NAMELY, CURTAINS, VALENCES (U.S. CLS. 42 AND 50).

FIRST USE 1-31-2002; IN COMMERCE 1-31-2002.

**CLASS 27—FLOOR COVERINGS**

FOR AREA RUGS; AND BATH RUGS (U.S. CLS. 19, 20, 37, 42 AND 50).

FIRST USE 1-31-2002; IN COMMERCE 1-31-2002.

**CLASS 31—NATURAL AGRICULTURAL PRODUCTS**

FOR DRIED FLORAL ARRANGEMENTS (U.S. CLS. 1 AND 46).

FIRST USE 1-31-2002; IN COMMERCE 1-31-2002.

**TURNING IDEAS INTO SOLUTIONS**

**CLASS 9—ELECTRICAL AND SCIENTIFIC APPARATUS**

FOR COMPUTER SOFTWARE AND HARDWARE FOR CAPTURING, MANIPULATING, STORING AND MINING RESPONSES TO STIMULI IN THE FIELD OF RESPONSE TECHNOLOGY (U.S. CLS. 21, 23, 26, 36 AND 38).

FIRST USE 3-10-2002; IN COMMERCE 3-10-2002.

**CLASS 42—SCIENTIFIC, COMPUTER AND LEGAL SERVICES**

FOR COMPUTER CONSULTATION SERVICES, NAMELY, PROVIDING SOFTWARE, HARDWARE AND APPLICATION CONSULTING FOR RESPONSE TECHNOLOGY (U.S. CLS. 100 AND 101).

FIRST USE 3-10-2002; IN COMMERCE 3-10-2002.

2,929,282. TURNING TECHNOLOGIES, LLC, YOUNGSTOWN, OH. SN 76-434,679. PUB. 8-26-2003, FILED 7-26-2002.

**TURNINGPOINT**

**CLASS 9—ELECTRICAL AND SCIENTIFIC APPARATUS**

FOR COMPUTER SOFTWARE AND HARDWARE FOR CAPTURING, MANIPULATING, STORING AND MINING RESPONSES TO STIMULI IN THE FIELD OF RESPONSE TECHNOLOGY (U.S. CLS. 21, 23, 26, 36 AND 38).

FIRST USE 3-10-2002; IN COMMERCE 3-10-2002.

**CLASS 42—SCIENTIFIC, COMPUTER AND LEGAL SERVICES**

FOR COMPUTER CONSULTATION SERVICES, NAMELY, PROVIDING SOFTWARE, HARDWARE AND APPLICATION CONSULTING FOR RESPONSE TECHNOLOGY (U.S. CLS. 100 AND 101).

FIRST USE 3-10-2002; IN COMMERCE 3-10-2002.

2,929,285. MOVING MENTOR, INC., AMHERST, MA. SN 76-441,905. PUB. 4-1-2003, FILED 8-14-2002.

**MOVING MENTOR**

NO CLAIM IS MADE TO THE EXCLUSIVE RIGHT TO USE "MOVING", APART FROM THE MARK AS SHOWN.

**CLASS 9—ELECTRICAL AND SCIENTIFIC APPARATUS**

FOR PRE-RECORDED VIDEOTAPES, CD-ROMS AND COMPUTER SOFTWARE FOR TEACHING RELOCATION SKILLS TO SENIORS AND THEIR FAMILIES (U.S. CLS. 21, 23, 26, 36 AND 38).

FIRST USE 9-12-2002; IN COMMERCE 9-12-2002.

**CLASS 16—PAPER GOODS AND PRINTED MATTER**

FOR BOOKS, PAMPHLETS, AND NOTEBOOKS IN THE FIELD OF RELOCATION ASSISTANCE (U.S. CLS. 2, 5, 22, 23, 29, 37, 38 AND 50).

FIRST USE 9-12-2002; IN COMMERCE 9-12-2002.

**CLASS 35—ADVERTISING AND BUSINESS**

FOR RELOCATION ASSISTANCE SERVICES PROVIDED TO SENIORS, EMPLOYEES, PERSONNEL, AND RESIDENTIAL REAL ESTATE PURCHASERS AND RENTERS; BUSINESS RELOCATION ASSISTANCE SERVICES (U.S. CLS. 100, 101 AND 102).

FIRST USE 9-7-2002; IN COMMERCE 9-7-2002.

2,929,292. JDLA, LLC, KNOXVILLE, TN. SN 76-446,640. PUB. 6-15-2004, FILED 9-3-2002.

**MEDMAPS****CLASS 35—ADVERTISING AND BUSINESS**

FOR PREPARATION FOR OTHERS OF CUSTOM ADVERTISEMENTS AND CUSTOM PROMOTIONAL PRODUCTS, NAMELY PUBLIC SERVICE BROCHURES AND PAMPHLETS FEATURING MAPS AND WAYFINDING AIDS FOR HOSPITALS, MEDICAL CENTERS, AND OTHER LARGE COMPLEX ENVIRONMENTS (U.S. CLS. 100, 101 AND 102).

FIRST USE 8-3-2001; IN COMMERCE 8-3-2001.

**CLASS 40—MATERIAL TREATMENT**

FOR CUSTOM PRINTING OF MARKETING AND PUBLIC SERVICE BROCHURES AND PAMPHLETS FEATURING MAPS AND WAYFINDING AIDS FOR HOSPITALS, MEDICAL CENTERS, AND OTHER LARGE COMPLEX ENVIRONMENTS (U.S. CLS. 100, 103 AND 106).

FIRST USE 8-3-2001; IN COMMERCE 8-3-2001.

2,929,305. PROVIDA LIFE SCIENCES, INC., LOS ANGELES, CA. SN 76-464,790. PUB. 8-26-2003, FILED 11-6-2002.

**LISTEN AND LOSE****CLASS 9—ELECTRICAL AND SCIENTIFIC APPARATUS**

FOR SERIES OF PRE-RECORDED VIDEOTAPES, DIGITAL VIDEO DISCS AND DVDS FEATURING EXERCISE, NUTRITION AND WEIGHT LOSS (U.S. CLS. 21, 23, 26, 36 AND 38).

FIRST USE 4-15-2002; IN COMMERCE 4-15-2002.

**CLASS 16—PAPER GOODS AND PRINTED MATTER**

FOR PRINTED MATERIALS, NAMELY, BOOKS, MAGAZINES, PERIODICALS AND NEWSLETTERS IN THE FIELDS OF HEALTH, NUTRITION, WEIGHT LOSS AND RELATED CONSUMER PRODUCT AND SERVICES (U.S. CLS. 2, 5, 22, 23, 29, 37, 38 AND 50).

FIRST USE 4-15-2002; IN COMMERCE 4-15-2002.

**CLASS 35—ADVERTISING AND BUSINESS**

FOR DIRECT RESPONSE RETAIL SERVICES BY MEANS OF INFOMERCIALS IN THE FIELD OF SERIES OF PRE-RECORDED VIDEOTAPES, DIGITAL VIDEO DISCS AND DVDS FEATURING EXERCISE, NUTRITION AND WEIGHT LOSS AND PRINTED MATERIALS, NAMELY, BOOKS, MAGAZINES, PERIODICALS AND NEWSLETTERS IN THE FIELDS OF HEALTH, NUTRITION, WEIGHT LOSS AND RELATED CONSUMER PRODUCT AND SERVICES (U.S. CLS. 100, 101 AND 102).

FIRST USE 4-15-2002; IN COMMERCE 4-15-2002.

2,929,312. SKELETAL KINETICS, LLC, CUPERTINO, CA. SN 76-470,168. PUB. 12-16-2003, FILED 11-25-2002.

**CALLOS****CLASS 5—PHARMACEUTICALS**

FOR BONE CEMENT FOR MEDICAL PURPOSES, NAMELY, CALCIUM PHOSPHATE CEMENT COMPOSITIONS FOR USE AS BONE CEMENT (U.S. CLS. 6, 18, 44, 46, 51 AND 52).

FIRST USE 7-31-2003; IN COMMERCE 11-28-2003.

**CLASS 10—MEDICAL APPARATUS**

FOR SURGICAL IMPLANT COMPOSITIONS COMPOSED OF ARTIFICIAL MATERIAL, NAMELY, CALCIUM PHOSPHATE COMPOSITIONS FOR USE AS IMPLANTABLE MATERIALS (U.S. CLS. 26, 39 AND 44).

FIRST USE 7-31-2003; IN COMMERCE 11-28-2003.

2,929,317. THE SEBRANEK GROUP, INC., BURLINGTON, WI. SN 76-472,459. PUB. 3-23-2004, FILED 12-5-2002.

**WE MAKE WRITING WORK FOR YOU****CLASS 9—ELECTRICAL AND SCIENTIFIC APPARATUS**

FOR ELECTRONIC PUBLICATIONS, NAMELY, PAMPHLETS, BINDERS, BROCHURES, BOOKS IN THE FIELD OF BUSINESS WRITING RECORDED ON COMPACT DISCS (U.S. CLS. 21, 23, 26, 36 AND 38).

FIRST USE 5-19-2004; IN COMMERCE 5-19-2004.

**CLASS 16—PAPER GOODS AND PRINTED MATTER**

FOR PRINTED PUBLICATIONS, NAMELY, PAMPHLETS, BINDERS, BROCHURES, BOOKS IN THE FIELD OF BUSINESS WRITING (U.S. CLS. 2, 5, 22, 23, 29, 37, 38 AND 50).

FIRST USE 5-19-2004; IN COMMERCE 5-19-2004.

**CLASS 41—EDUCATION AND ENTERTAINMENT**

FOR ONLINE PUBLICATIONS, NAMELY, PAMPHLETS, BINDERS, BROCHURES, BOOKS IN THE FIELD OF BUSINESS WRITING; EDUCATIONAL SERVICES, NAMELY, CONDUCTING SEMINARS, CONFERENCES, WORKSHOPS IN THE FIELD OF BUSINESS WRITING (U.S. CLS. 100, 101 AND 107).

FIRST USE 5-19-2004; IN COMMERCE 5-19-2004.

2,929,323. FAMILY TIME CAPSULES, LLC, AMELIA ISLAND, FL. SN 76-477,357. PUB. 6-15-2004, FILED 12-23-2002.



NO CLAIM IS MADE TO THE EXCLUSIVE RIGHT TO USE FAMILY, APART FROM THE MARK AS SHOWN.

THE STIPPLING IS FOR SHADING PURPOSES ONLY AND DOES NOT INDICATE COLOR.

#### CLASS 9—ELECTRICAL AND SCIENTIFIC APPARATUS

FOR PRE-RECORDED VIDEOTAPES, CD'S AND DVD'S FEATURING PERSONAL, FAMILY AND GROUP HISTORIES (U.S. CLS. 21, 23, 26, 36 AND 38).

FIRST USE 8-10-2003; IN COMMERCE 8-10-2003.

#### CLASS 35—ADVERTISING AND BUSINESS

FOR ONLINE RETAIL STORE SERVICES FEATURING CD'S, DVD'S AND VIDEOTAPES FEATURING PERSONAL, FAMILY AND GROUP HISTORIES, NAMELY, CUSTOM PRODUCED DOCUMENTARIES MADE TO THE SPECIFICATIONS OF THE CONSUMER (U.S. CLS. 100, 101 AND 102).

FIRST USE 8-10-2003; IN COMMERCE 8-10-2003.

#### CLASS 41—EDUCATION AND ENTERTAINMENT

FOR PRODUCTION OF VIDEOTAPES, CD'S AND DVD'S FOR OTHERS FEATURING PERSONAL, FAMILY AND GROUP HISTORIES, NAMELY, CUSTOM PRODUCED DOCUMENTARIES MADE TO THE SPECIFICATIONS OF THE CONSUMER (U.S. CLS. 100, 101 AND 107).

FIRST USE 8-10-2003; IN COMMERCE 8-10-2003.

2,929,329. UNITED STEEL PRODUCTS COMPANY, MONTGOMERY, MN. SN 76-483,041. PUB. 5-11-2004, FILED 1-14-2003.

## USP STRUCTURAL CONNECTORS

NO CLAIM IS MADE TO THE EXCLUSIVE RIGHT TO USE STRUCTURAL CONNECTORS, APART FROM THE MARK AS SHOWN.

#### CLASS 6—METAL GOODS

FOR METAL CONNECTORS, PLATES AND BRACKETS FOR STRUCTURAL FRAMING; METAL SAWHORSE BRACKETS; METAL FRAMING AND JUNCTION PLATES USED IN THE CONSTRUCTION OF GEODESIC AND OTHER BUILDINGS (U.S. CLS. 2, 12, 13, 14, 23, 25 AND 50).

FIRST USE 12-31-2002; IN COMMERCE 12-31-2002.

#### CLASS 9—ELECTRICAL AND SCIENTIFIC APPARATUS

FOR COMPUTER SOFTWARE FOR THE DESIGN OF BUILDINGS UTILIZING METAL PLATES, BRACKETS AND CONNECTORS IN THEIR CONSTRUCTION (U.S. CLS. 21, 23, 26, 36 AND 38).

FIRST USE 2-28-2003; IN COMMERCE 2-28-2003.

2,929,338. OPTIVE RESEARCH, INC., AUSTIN, TX. SN 76-487,730. PUB. 9-23-2003, FILED 2-6-2003.

## OPTIVE

#### CLASS 9—ELECTRICAL AND SCIENTIFIC APPARATUS

FOR SOFTWARE FOR MOLECULAR DESIGN, MOLECULAR DISCOVERY AND MOLECULAR MODELING; SOFTWARE FOR PERFORMING DRUG DISCOVERY; SOFTWARE FOR PERFORMING CHEMICAL COMPUTATIONS AND ANALYSIS; COMPUTER SOFTWARE FOR PROVIDING GRAPHICAL REPRESENTATIONS OF MOLECULAR STRUCTURE (U.S. CLS. 21, 23, 26, 36 AND 38).

FIRST USE 7-9-2003; IN COMMERCE 7-9-2003.

#### CLASS 42—SCIENTIFIC, COMPUTER AND LEGAL SERVICES

FOR TECHNICAL SUPPORT SERVICES, NAMELY, TROUBLESHOOTING PROBLEMS WITH COMPUTER SOFTWARE USED FOR MOLECULAR DESIGN, MOLECULAR DISCOVERY, MOLECULAR MODELING, DRUG DISCOVERY, CHEMICAL COMPUTATIONS AND ANALYSIS AND GRAPHICAL REPRESENTATIONS (U.S. CLS. 100 AND 101).

FIRST USE 7-9-2003; IN COMMERCE 7-9-2003.

2,929,339. SHELL ARTISTREE LLC, FAIRFAX, VA. SN 76-488,274. PUB. 4-20-2004, FILED 2-7-2003.

## LIFE'STILES

#### CLASS 16—PAPER GOODS AND PRINTED MATTER

FOR FINE ART, NAMELY FINE ART PAINTINGS, FINE ART PRINTS AND REPRODUCTIONS, PRINTED JEWISH MARRIAGE CERTIFICATES, COMMERCIAL ART, JUDAIC ART NAMELY FINE ART PAINTINGS; GIFTS AND WEDDING GIFTS, NAMELY JEWISH FINE ART (U.S. CLS. 2, 5, 22, 23, 29, 37, 38 AND 50).

FIRST USE 1-0-2003; IN COMMERCE 9-0-2003.

#### CLASS 35—ADVERTISING AND BUSINESS

FOR ART GALLERIES, RETAIL STORE SERVICES AND ONLINE RETAIL STORE SERVICES FEATURING FINE ART, ART PRINTS, REPRODUCTIONS, JEWISH MARRIAGE CERTIFICATES, JUDAIC ARTWORK IN THE NATURE OF PAINTINGS, COMMERCIAL PAINTINGS, FINE ART PAINTINGS CONTAINING POETIC PHRASES, AND GIFTS, NAMELY WEDDING GIFTS (U.S. CLS. 100, 101 AND 102).

FIRST USE 1-0-2003; IN COMMERCE 9-0-2003.

2,929,349. CHEFWORKS INC., PALOS VERDES ESTATES, CA. SN 76-495,081. PUB. 3-16-2004, FILED 3-6-2003.

## CHEF TRENDS

NO CLAIM IS MADE TO THE EXCLUSIVE RIGHT TO USE CHEF, APART FROM THE MARK AS SHOWN.

### CLASS 8—HAND TOOLS

FOR CUTLERY, NAMELY KNIVES, KITCHEN SHEARS AND KITCHEN SCISSORS; FLATWARE FOR HOUSEHOLD USE MADE OF STAINLESS STEEL WITH HANDLE CONTAINING ALL MANNER OF MATERIALS (U.S. CLS. 23, 28 AND 44).

FIRST USE 2-19-2003; IN COMMERCE 2-19-2003.

### CLASS 21—HOUSEWARES AND GLASS

FOR COOKWARE, NAMELY POTS AND PANS, OPEN STOCK POTS AND ACCESSORIES THEREFORE ALL MADE OF STAINLESS STEEL, ALUMINUM AND CARBON STEEL; KITCHEN UTENSILS AND GADGETS MADE OF PLASTIC, NYLON, RUBBER, STAINLESS STEEL, ALUMINUM AND STEEL AND ALUMINUM ALLOYS, NAMELY SPATULAS, SPOONS, LADLES, TONGS, BASTERS, BASTING BRUSHES, POT AND PANS SCRAPERS, WHISKS, MEASURING CUPS, PEELERS, OPENERS, CORERS AND SIFTERS; WINE AND BAR ACCESSORIES, NAMELY WINE RACKS, WINE STOPPERS, COCKTAIL SHAKERS; SALT AND PEPPER SHAKERS; FOIL CUTTERS AND CORK SCREWS MADE OF NYLON, PLASTIC, RUBBER, STAINLESS STEEL, CHROME PLATED STEEL AND STEEL ALLOYS; TEA-KETTLES MADE OF STAINLESS STEEL, ALUMINUM AND CARBON STEEL WITH AND WITHOUT COATINGS OF PAINT, COPPER AND PORCELAIN ENAMEL; PLATE AND DISH RACKS MADE OF CHROME PLATED STEEL, STAINLESS STEEL AND STEEL ALLOYS AND PLASTIC; TRASH CANS FOR HOUSEHOLD USE MADE OF STAINLESS STEEL OR PLASTIC; STRAINERS AND SIEVES MADE OF STAINLESS STEEL, CHROME PLATED STEEL AND PLASTIC; DINNER SETS, NAMELY PLATES, BOWLS, CUPS, DRINKING GLASSES, SAUCERS; UTENSILS, PLACE MATS, SERVING BOWLS, SERVING PLATTERS, SERVERWARE AND FLATWARE AND OPEN STOCK POTS MADE OF PORCELAIN, STONE WARE, EARTHEN WARE AND DOLOMITE; ALL NON-ELECTRIC KITCHENWARE MADE OF ANY MATERIALS, NAMELY POTS, PANS, UTENSILS, PLATES, CUPS, BOWLS AND KITCHEN ACCESSORIES (U.S. CLS. 2, 13, 23, 29, 30, 33, 40 AND 50).

FIRST USE 2-19-2003; IN COMMERCE 2-19-2003.

2,929,385. APPLIANZ TECHNOLOGIES, INC., WICHITA, KS. SN 76-507,021. PUB. 5-25-2004, FILED 4-15-2003.



### CLASS 9—ELECTRICAL AND SCIENTIFIC APPARATUS

FOR COMPUTER SOFTWARE AND HARDWARE FOR THE CREATION AND MANAGEMENT OF SPECIAL PURPOSE COMPUTER NETWORK SERVERS (U.S. CLS. 21, 23, 26, 36 AND 38).

FIRST USE 5-29-2003; IN COMMERCE 5-29-2003.

### CLASS 42—SCIENTIFIC, COMPUTER AND LEGAL SERVICES

FOR CONSULTING SERVICES IN THE FIELD OF DESIGN, SELECTION, IMPLEMENTATION AND USE OF COMPUTER HARDWARE AND SOFTWARE SYSTEMS FOR OTHERS; TECHNICAL SUPPORT SERVICES, NAMELY TROUBLE SHOOTING OF COMPUTER SOFTWARE AND HARDWARE; TECHNICAL CONSULTING SERVICE IN THE FIELD OF MAINTAINING AND UPGRADING COMPUTER NETWORK SERVICES (U.S. CLS. 100 AND 101).

FIRST USE 5-29-2003; IN COMMERCE 5-29-2003.

2,929,397. BIOPHILE CORPORATION, LTD., PATUMWAN, BANGKOK 10330, THAILAND. SN 76-511,474. PUB. 3-16-2004, FILED 5-6-2003.

## NU-ENCAP

### CLASS 3—COSMETICS AND CLEANING PREPARATIONS

FOR COSMETIC AND NON-MEDICATED SKINCARE PREPARATIONS (U.S. CLS. 1, 4, 6, 50, 51 AND 52).

FIRST USE 7-3-2004; IN COMMERCE 7-3-2004.

### CLASS 5—PHARMACEUTICALS

FOR COSMECEUTICAL AND PHARMACEUTICAL PREPARATIONS FOR THE TREATMENT OF ACNE VULGARIS, SEBORRHEIC DERMATITIS, ATOPIC DERMATITIS, PHOTOAGING, PSORIASIS, DRY SKIN, ROSACEA, HAIR DISORDERS, NAIL DISORDERS, HAIR LOSS, ABNORMAL KERATINIZATION OF THE SKIN, FUNGAL INFECTIONS, WRINKLES, MELASMA AND ABNORMAL PIGMENTATION (U.S. CLS. 6, 18, 44, 46, 51 AND 52).

FIRST USE 7-3-2004; IN COMMERCE 7-3-2004.

2,929,435. BLES, THOMAS G., TEMPE, AZ. SN 76-527,840. PUB. 3-16-2004, FILED 6-26-2003.

# Rikoshea

### CLASS 12—VEHICLES

FOR BOATS AND MOORING COVERS THEREFORE (U.S. CLS. 19, 21, 23, 31, 35 AND 44).

FIRST USE 6-27-2003; IN COMMERCE 7-2-2003.

### CLASS 44—MEDICAL, BEAUTY AND AGRICULTURAL SERVICES

FOR HAIR STYLING, HAIR CUTTING, COSMETICIAN SERVICES, MASSAGE, MANICURING, HEALTH SPA SERVICES, NAMELY, COSMETIC BODY CARE SERVICES (U.S. CLS. 100 AND 101).

FIRST USE 6-27-2003; IN COMMERCE 7-31-2003.



2,929,437. MWH AMERICAS, INC., BROOMFIELD, CO. SN 76-529,020. PUB. 2-10-2004, FILED 7-11-2003.

## THE MONTGOMERY GROUP

NO CLAIM IS MADE TO THE EXCLUSIVE RIGHT TO USE "GROUP", APART FROM THE MARK AS SHOWN.

### CLASS 35—ADVERTISING AND BUSINESS

FOR PROCUREMENT, NAMELY, PURCHASING OF EQUIPMENT FOR UTILITY, INDUSTRIAL, AND GOVERNMENTAL FACILITIES; BUSINESS MANAGEMENT CONSULTATION, NAMELY, ORGANIZATIONAL AND PROJECT DEVELOPMENT CONSULTANCY SERVICES FOR INDUSTRIAL FIRMS AND WATER, WASTEWATER AND ENERGY SERVICE COMPANIES; MANAGEMENT SERVICES IN THE NATURE OF ACQUISITION, OPERATION OF INDUSTRIAL FIRMS, WATER, WASTEWATER AND ENERGY SERVICE COMPANIES; CONSULTING SERVICES IN THE FIELD OF MERGERS AND ACQUISITIONS, INCLUDING DUE DILIGENCE FOR INDUSTRIAL FIRMS AND WATER, WASTEWATER AND ENERGY SERVICE COMPANIES; STRATEGIC PLANNING, VALUATION AND RISK MANAGEMENT, AND VALUATION OF CAPITAL ASSETS FOR INDUSTRIAL FIRMS AND WATER, WASTEWATER, AND ENERGY SERVICE COMPANIES (U.S. CLS. 100, 101 AND 102).

FIRST USE 7-0-2003; IN COMMERCE 1-0-2004.

### CLASS 36—INSURANCE AND FINANCIAL

FOR CAPITAL ASSET MANAGEMENT SERVICES, VALUATION AND RISK MANAGEMENT, AND VALUATION OF CAPITAL ASSETS FOR INDUSTRIAL FIRMS AND WATER, WASTEWATER, AND ENERGY SERVICE COMPANIES; AND FINANCIAL CONSULTANCY SERVICES FOR INDUSTRIAL FIRMS AND WATER, WASTEWATER AND ENERGY SERVICE COMPANIES; FINANCING, AND OPERATION OF INDUSTRIAL FIRMS, WATER, WASTEWATER AND ENERGY SERVICE COMPANIES; ASSET VALUATION, FOR INDUSTRIAL FIRMS AND WATER, WASTEWATER AND ENERGY SERVICE COMPANIES; INDUSTRIAL ASSET MANAGEMENT SERVICES, NAMELY, LIQUIDATING AND REMARKETING CAPITAL ASSETS OF OTHERS (U.S. CLS. 100, 101 AND 102).

FIRST USE 7-0-2003; IN COMMERCE 1-0-2004.

2,929,441. PEP BOYS MANNY, MOE & JACK OF CALIFORNIA, THE, PHILADELPHIA, PA. SN 76-529,963. PUB. 4-27-2004, FILED 7-15-2003.



OWNER OF U.S. REG. NOS. 310,199, 2,408,968, AND OTHERS.

NO CLAIM IS MADE TO THE EXCLUSIVE RIGHT TO USE "PRODUCT REPLACEMENT PLAN", APART FROM THE MARK AS SHOWN.

THE LINING IS A FEATURE OF THE MARK AND DOES NOT INDICATE COLOR.

### CLASS 36—INSURANCE AND FINANCIAL

FOR EXTENDED WARRANTY SERVICES FOR VEHICLE PARTS AND ACCESSORIES AND FOR VEHICLE MAINTENANCE, REPAIR AND REPLACEMENT SERVICES (U.S. CLS. 100, 101 AND 102).

FIRST USE 12-0-2003; IN COMMERCE 12-0-2003.

### CLASS 37—CONSTRUCTION AND REPAIR

FOR VEHICLE MAINTENANCE AND REPAIR SERVICES (U.S. CLS. 100, 103 AND 106).

FIRST USE 12-0-2003; IN COMMERCE 12-0-2003.

2,929,442. PEP BOYS MANNY, MOE & JACK OF CALIFORNIA, THE, PHILADELPHIA, PA. SN 76-529,964. PUB. 4-20-2004, FILED 7-15-2003.

## PEP GUARD

OWNER OF U.S. REG. NOS. 310,199, 2,408,968, AND OTHERS.

### CLASS 36—INSURANCE AND FINANCIAL

FOR EXTENDED WARRANTY SERVICES FOR VEHICLE PARTS AND ACCESSORIES AND FOR VEHICLE MAINTENANCE, REPAIR AND REPLACEMENT SERVICES (U.S. CLS. 100, 101 AND 102).

FIRST USE 12-0-2003; IN COMMERCE 12-0-2003.

### CLASS 37—CONSTRUCTION AND REPAIR

FOR VEHICLE MAINTENANCE AND REPAIR SERVICES (U.S. CLS. 100, 103 AND 106).

FIRST USE 12-0-2003; IN COMMERCE 12-0-2003.

2,929,447. TOUCH YO SELF RECORDS, L.L.C., LAKEWOOD, CA. SN 76-532,420. PUB. 5-4-2004, FILED 7-25-2003.

## TOUCH YO SELF

### CLASS 9—ELECTRICAL AND SCIENTIFIC APPARATUS

FOR MUSICAL SOUND RECORDINGS, MUSICAL VIDEO RECORDINGS; COMPACT DISCS, CD-ROMS, DVDS, AUDIO CASSETTES, VIDEO TAPES, PHONOGRAPH ALBUMS, ALL FEATURING MUSIC (U.S. CLS. 21, 23, 26, 36 AND 38).

FIRST USE 7-18-2003; IN COMMERCE 8-15-2003.

### CLASS 41—EDUCATION AND ENTERTAINMENT

FOR MUSIC PRODUCTION SERVICES, MUSIC PUBLISHING SERVICES; ENTERTAINMENT SERVICES, NAMELY, LIVE PERFORMANCES BY MUSICAL BANDS; ENTERTAINMENT SERVICES, NAMELY, PROVIDING A WEB SITE FEATURING MUSICAL PERFORMANCES, MUSICAL VIDEOS, RELATED FILM CLIPS, PHOTOGRAPHS, AND RELATED MULTIMEDIA MATERIALS (U.S. CLS. 100, 101 AND 107).

FIRST USE 7-18-2003; IN COMMERCE 8-15-2003.

2,929,476. SISTERS OF THE SEA, JACKSONVILLE BEACH, FL. SN 76-544,781. PUB. 8-10-2004, FILED 9-15-2003.



#### CLASS 25—CLOTHING

FOR CLOTHING, NAMELY SHIRTS AND SWEATSHIRTS (U.S. CLS. 22 AND 39).  
FIRST USE 6-1-1998; IN COMMERCE 9-1-1999.

#### CLASS 41—EDUCATION AND ENTERTAINMENT

FOR EDUCATIONAL SERVICES, NAMELY CONDUCTING SEMINARS ON BREAST CANCER; ARRANGING AND CONDUCTING SURF COMPETITIONS (U.S. CLS. 100, 101 AND 107).  
FIRST USE 6-1-1998; IN COMMERCE 8-1-1999.

2,929,501. PLAY CAFE, LLC, SALEM, MA. SN 76-556,312. PUB. 8-3-2004, FILED 11-3-2003.

# BRUJITOS

THE FOREIGN WORDING IN THE MARK TRANSLATES INTO ENGLISH AS LITTLE WIZARDS/WITCHES.

#### CLASS 41—EDUCATION AND ENTERTAINMENT

FOR PROVIDING INDOOR PLAYGROUND FACILITIES FOR CHILDREN AND PARENTS AND PROVIDING EDUCATIONAL AND ENTERTAINING ACTIVITIES IN THE NATURE OF PUPPET SHOWS, ARTS AND CRAFTS WORKSHOPS, CHILDREN'S MUSIC CONCERTS AND BOOK READING AND STORY TIME SESSIONS (U.S. CLS. 100, 101 AND 107).  
FIRST USE 3-8-2004; IN COMMERCE 3-8-2004.

#### CLASS 43—HOTEL AND RESTAURANT SERVICES

FOR RESTAURANT SERVICES (U.S. CLS. 100 AND 101).  
FIRST USE 3-8-2004; IN COMMERCE 3-8-2004.

2,929,508. UNIQUELY ME, INC., ROCKVILLE CENTRE, NY. SN 76-976,425. PUB. 3-4-2003, FILED 11-23-2001.

## UNIQUELY ME

#### CLASS 25—CLOTHING

FOR T-SHIRTS (U.S. CLS. 22 AND 39).  
FIRST USE 6-24-2002; IN COMMERCE 6-24-2002.

#### CLASS 41—EDUCATION AND ENTERTAINMENT

FOR ARRANGING AND CONDUCTING EDUCATIONAL CLASSES, SEMINARS, WORKSHOPS, CONFERENCES AND DEMONSTRATIONS IN THE FIELD OF EDUCATION, CHILDHOOD DEVELOPMENT AND THE DEVELOPMENT OF SELF-AWARENESS AND SELF-ESTEEM, GOAL SETTING, COMMUNICATION, CONFLICT RESOLUTION AND POSITIVE IDENTITY FOR CHILDREN AND DISTRIBUTING COURSE MATERIALS IN CONNECTION THEREWITH; ORGANIZING EXHIBITIONS FOR EDUCATIONAL PURPOSES IN THE FIELD OF EDUCATION, CHILDHOOD DEVELOPMENT AND THE DEVELOPMENT OF SELF-AWARENESS AND SELF-ESTEEM, GOAL SETTING, COMMUNICATION, CONFLICT RESOLUTION AND POSITIVE IDENTITY FOR CHILDREN; EDUCATIONAL SERVICES, NAMELY, PROVIDING INCENTIVES TO INDIVIDUALS AND ORGANIZATIONS TO DEMONSTRATE EXCELLENCE IN THE FIELD OF TEACHING THROUGH THE ISSUANCE OF AWARDS; PROVIDING COURSES OF INSTRUCTION AT THE PRE-SCHOOL, ELEMENTARY AND SECONDARY LEVELS IN THE FIELD OF DEVELOPMENT OF EDUCATION, CHILDHOOD DEVELOPMENT AND THE DEVELOPMENT OF SELF-AWARENESS AND SELF-ESTEEM, GOAL SETTING, COMMUNICATION, CONFLICT RESOLUTION AND POSITIVE IDENTITY FOR CHILDREN; DEVELOPMENT AND DISSEMINATION OF EDUCATIONAL MATERIALS OF OTHERS IN THE FIELD OF DEVELOPMENT OF SELF-AWARENESS AND SELF-ESTEEM; ENTERTAINMENT IN THE NATURE OF LIVE PERFORMANCES BY A MUSICAL BAND (U.S. CLS. 100, 101 AND 107).  
FIRST USE 10-0-1995; IN COMMERCE 10-0-1995.

2,929,510. BAB SPORTS SA, SIERRE, SWITZERLAND. SN 76-976,860. PUB. 6-18-2002, FILED 3-6-2001.



PRIORITY CLAIMED UNDER SEC. 44(D) ON SWITZERLAND APPLICATION NO. 00625/2001, FILED 1-15-2001, REG. NO. 486921, DATED 1-15-2001, EXPIRES 1-15-2011.

#### CLASS 9—ELECTRICAL AND SCIENTIFIC APPARATUS

FOR OPTICAL GOODS, NAMELY, EYEGLASSES, SPECTACLE FRAMES; SPECTACLES; SPECTACLE CASES; SUNGLASSES; AVIATION GOGGLES; MOTORCYCLE GOGGLES; PROTECTIVE MASKS, NAMELY, MASKS TO PREVENT DUST AND PARTICLES FROM CONTACTING THE USER'S EYES (U.S. CLS. 21, 23, 26, 36 AND 38).  
FIRST USE 4-18-2002; IN COMMERCE 4-18-2002.

**CLASS 25—CLOTHING**

FOR CLOTHING, NAMELY, SHIRTS, AND HEAD WEAR (U.S. CLS. 22 AND 39).  
FIRST USE 4-18-2002; IN COMMERCE 4-18-2002.

2,929,512. VITO, ROBERT, BERWYN, PA. SN 76-977,076.  
PUB. 6-3-2003, FILED 11-1-2002.

**UNEQUAL****CLASS 16—PAPER GOODS AND PRINTED MATTER**

FOR PAPER PRODUCTS, NAMELY BUMPER STICKERS, STICKERS (U.S. CLS. 2, 5, 22, 23, 29, 37, 38 AND 50).  
FIRST USE 10-25-2002; IN COMMERCE 10-25-2002.

**CLASS 21—HOUSEWARES AND GLASS**

FOR BEVERAGE GLASSWARE (U.S. CLS. 2, 13, 23, 29, 30, 33, 40 AND 50).  
FIRST USE 10-25-2002; IN COMMERCE 10-25-2002.

2,929,517. LIFEMASTERS SUPPORTED SELF CARE, INC., IRVINE, CA. SN 76-977,218. PUB. 8-13-2002, FILED 6-20-2001.



OWNER OF U.S. REG. NOS. 1,998,449 AND 2,463,111.

**CLASS 16—PAPER GOODS AND PRINTED MATTER**

FOR SERIES OF PUBLICATIONS IN THE NATURE OF NEWSLETTERS, INSTRUCTIONAL TEACHING MANUALS IN A SERIES TO BE UPDATED REGULARLY, WORKBOOKS, AND PAMPHLETS, IN THE FIELD OF HEALTHCARE MANAGEMENT (U.S. CLS. 2, 5, 22, 23, 29, 37, 38 AND 50).  
FIRST USE 8-1-2001; IN COMMERCE 8-1-2001.

**CLASS 35—ADVERTISING AND BUSINESS**

FOR BUSINESS MANAGEMENT AND CONSULTING SERVICES IN THE FIELDS OF HEALTH CARE PROVISION AND MEDICAL CARE PROVISION (U.S. CLS. 100, 101 AND 102).  
FIRST USE 8-1-2001; IN COMMERCE 8-1-2001.

**CLASS 38—COMMUNICATION**

FOR ELECTRONIC DATA COMMUNICATION SERVICES FOR A PERSONAL HEALTH NETWORK, NAMELY, ELECTRONIC PROCESSING AND TRANSMISSION OF MESSAGES AND DATA (U.S. CLS. 100, 101 AND 104).  
FIRST USE 8-1-2001; IN COMMERCE 8-1-2001.

**CLASS 39—TRANSPORTATION AND STORAGE**

FOR ELECTRONIC DATA COMMUNICATION SERVICES FOR A PERSONAL HEALTH NETWORK, NAMELY, ELECTRONIC COLLECTION AND STORAGE OF MESSAGES AND DATA (U.S. CLS. 100 AND 105).  
FIRST USE 8-1-2001; IN COMMERCE 8-1-2001.

**CLASS 41—EDUCATION AND ENTERTAINMENT**

FOR EDUCATIONAL SERVICES, NAMELY, CONDUCTING CLASSES, SEMINARS, CONFERENCES AND WORKSHOPS AND PROVIDING ONE-TO-ONE INSTRUCTIONS IN THE FIELD OF HEALTH CARE FOR EDUCATING PATIENTS, PHYSICIANS AND CAREGIVERS ABOUT HEALTHCARE, NUTRITION, DISEASE PROCESSES, SELF-GUIDED HEALTHCARE TREATMENT AND SELF-GUIDED DISEASE TREATMENT (U.S. CLS. 100, 101 AND 107).  
FIRST USE 8-1-2001; IN COMMERCE 8-1-2001.

**CLASS 42—SCIENTIFIC, COMPUTER AND LEGAL SERVICES**

FOR HEALTH INFORMATION SERVICES, NAMELY, GENERATING AND MAINTAINING FILES AND PERSONAL MEDICAL HISTORY RECORDS FOR PATIENTS AND HEALTHCARE PROVIDERS; PROVIDING HEALTHCARE CONSULTATION AND INFORMATION SERVICES FOR PATIENTS, PHYSICIANS AND CAREGIVERS IN THE FIELDS OF HEALTHCARE, NUTRITION, DISEASE PROCESSES, SELF-GUIDED HEALTH CARE TREATMENT AND SELF-GUIDED DISEASE MANAGEMENT; DEVELOPMENT AND SUPERVISION OF REHABILITATION AND PREVENTATIVE CARDIOVASCULAR PROGRAMS FOR ADMINISTRATION OF HEALTH CARE BY INDIVIDUAL PATIENTS (U.S. CLS. 100 AND 101).  
FIRST USE 8-1-2001; IN COMMERCE 8-1-2001.

2,929,518. VALUE CITY OF MICHIGAN, INC., WESTLAND, MI. SN 76-977,228. PUB. 8-20-2002, FILED 5-23-2001.

**CREATIVE LIFESTYLES****CLASS 11—ENVIRONMENTAL CONTROL APPARATUS**

FOR TOILET SEATS; ELECTRIC FANS; AND LIGHTING, NAMELY, WALL, CEILING, AND DESK LAMPS; SHOWER HEADS, DECORATIVE WATER FOUNTAINS AND WATERFALLS; ELECTRIC BREAD WARMERS; ELECTRIC PRESSURE COOKERS (U.S. CLS. 13, 21, 23, 31 AND 34).  
FIRST USE 7-24-2004; IN COMMERCE 7-24-2004.

**CLASS 20—FURNITURE AND ARTICLES NOT OTHERWISE CLASSIFIED**

FOR CHAIR PADS; PILLOWS, NAMELY, TOSS PILLOWS, FLOOR PILLOWS, BATH PILLOWS, AND BED PILLOWS; WINDOW BLINDS; WINDOW SHADES; PICTURE FRAMES; CLOTHES HANGERS; WALL DECOR, NAMELY WALL MIRRORS; WALL PLAQUES; WOOD BOXES; LAUNDRY HAMPERS MADE OF PLASTIC, METAL, OR MESH; NONMETAL CLOTHES HOOKS; SHOWER CURTAIN RODS; NONMETAL SHOWER CURTAIN RINGS; SHELVES; CABINETS; DECORATIVE GIFTS MADE OF WOOD AND POLYRESIN, NAMELY, JEWELRY CASES; SHOE RACKS; DRAPERY HARDWARE, NAMELY, DRAPERY RODS, CURTAIN RODS, BRACKETS, SCONCES, SOLD AS A UNIT AND INDIVIDUALLY; MASQUERADE MASKS FOR DECORATIVE PURPOSES OF COLD CAST RESIN, FABRIC, BONE, IVORY, PLASTER, PLASTIC, WAX AND WOOD (U.S. CLS. 2, 13, 22, 25, 32 AND 50).  
FIRST USE 10-12-2004; IN COMMERCE 10-12-2004.

**CLASS 22—CORDAGE AND FIBERS**

FOR GARMENT BAGS FOR STORAGE; LAUNDRY BAGS (U.S. CLS. 1, 2, 7, 19, 22, 42 AND 50).  
FIRST USE 7-1-2004; IN COMMERCE 7-1-2004.

2,929,519. SAMSUNG ELECTRONICS CO., LTD., SUWON-SI, GYEONGGI-DO, LAO PEOPL DEM REP. SN 76-977,231.  
PUB. 8-19-2003, FILED 5-2-2002.

**SAMSUNG**

OWNER OF U.S. REG. NOS. 2,566,413, 2,568,873, AND 2,577,028.

**CLASS 7—MACHINERY**

FOR AGITATORS FOR CIRCULATING LIQUID MEDIA; AERATORS; BEARINGS FOR TRANSMISSION SHAFTS BEING PART OF MACHINES; BORING MACHINES, BULLDOZERS; CENTRIFUGES; POWER-OPERATED COFFEE GRINDERS; CHIP MOUNTING MACHINES; COMPRESSED AIR PUMPS; COMPRESSORS FOR VEHICLES, AIR CONDITIONERS, REFRIGERATORS, AND MACHINES; CONCRETE MIXERS; CONVEYORS; CRANES; DISHWASHERS; DREDGING MACHINES; EARTH MOVING MACHINES, NAMELY, GRADERS, LOADERS, SCARIFIERS, SCRAPERS, AND EXCAVATORS; ELECTRIC BLENDERS FOR HOUSEHOLD PURPOSES; ELECTRIC CAN OPENERS; ELECTRIC GENERATORS; ELECTRIC HAND DRILLS; ELECTRIC IGNITIONS FOR LAND VEHICLES; ELECTRIC JUICERS; ELECTRIC WELDING MACHINES; ELEVATORS; ENGINES FOR BOATS; ENGINES OTHER THAN FOR LAND VEHICLES; ESCALATORS; FILTERS FOR MACHINES, NAMELY, MACHINES USED IN THE PHARMACEUTICAL, FOODS, BEVERAGE, CHEMICAL, PAINT, AND ELECTRONIC INDUSTRIES FOR THE REMOVAL OF IMPURITIES FROM FLUIDS AND OTHER FILTERABLE SUBSTANCES; FILTERS FOR ENGINES, NAMELY, OIL ENGINES AND GAS ENGINES; ELECTRIC FOOD PROCESSORS; FOUNDRY MACHINES FOR CASTING METAL; ELECTRIC FRUIT PRESSES FOR HOUSEHOLD PURPOSES; GARBAGE DISPOSALS; HOISTS; MOTORS OTHER THAN FOR LAND VEHICLES, NAMELY, MOTORS FOR AIRPLANES, BOATS, AND ELECTRIC MOTORS FOR MACHINES; PACKAGING MACHINES; PLOUGHS; PRINTING PRESSES; MACHINES FOR ASSEMBLING PRINTED CIRCUIT BOARDS; INDUSTRIAL ROBOTS; PAPER SHREDDING MACHINES FOR INDUSTRIAL USE; TRANSMISSION GEARS FOR MACHINES; HYDRAULIC TURBINES OTHER THAN FOR LAND VEHICLES; VACUUM CLEANERS; WASHING MACHINES FOR CLOTHES; POWER OPERATED RAMMERS; CRUSHING MACHINES FOR SAWDUST (U.S. CLS. 13, 19, 21, 23, 31, 34 AND 35).

FIRST USE 3-1-1973; IN COMMERCE 12-1-1974.

**CLASS 9—ELECTRICAL AND SCIENTIFIC APPARATUS**

FOR ALUMINUM PARTS FOR ROTATABLE MAGNETRON CATHODE; AMPLIFIERS; APPARATUS FOR GAMES ADAPTED FOR USE WITH TELEVISION RECEIVERS, NAMELY, VIDEO GAME MACHINES FOR USE WITH TELEVISIONS, VIDEO OUTPUT GAME MACHINES FOR USE WITH TELEVISIONS; ASYNCHRONOUS TRANSFER MODE-BROADBAND SWITCHING AND TRANSMISSION TELEPHONE EXCHANGER; AUDIO CASSETTE DECKS FOR AUTOMOBILES; AUDIO CASSETTE RECORDERS; AUDIO RECEIVERS AND VIDEO RECEIVERS; AUTOMATIC VENDING MACHINES; BATTERIES; BATTERY CHARGERS, BINOCULARS; MAGNETIC BUZZERS; CABLE TV CONVERTERS; CALCULATORS; CAMERAS; CAPACITORS; MAGNETIC CARD READERS; CASH REGISTERS; CASSETTE TAPE RECORDERS; CATHODE RAY TUBES; CHARGE COUPLED DEVICE CAMERAS; COLD CATHODE FLUORESCENT TUBES; COLOR FILTERS

FOR LIQUID CRYSTAL DISPLAY; COMPACT DISK DRIVES; COMPACT DISK PLAYERS; BLANK COMPACT DISKS; COMPUTER MEMORIES; COMPUTER MODEMS; COMPUTER MONITORS; COMPUTER PRINTERS; COMPUTER PROGRAMS FOR COMPUTER GAMES; COMPUTER OPERATING PROGRAMS; COMPUTER PROGRAMS FOR USE IN DATABASE MANAGEMENT FOR SPREADSHEET AND WORD PROCESSING FUNCTIONS; COMPUTER WORK STATIONS COMPRISING COMPUTERS AND COMPUTER MONITORS, KEYBOARDS, AND COMPUTERS, AND COMPUTER PERIPHERALS; ELECTRICAL CONTROLLERS FOR MACHINES; CONVERTERS FOR ELECTRIC PLUGS, ELECTRIC CONVERTERS, TV, AND VIDEO CONVERTERS; ELECTRICAL DEFLECTION COILS, DEFLECTION YOKES, DIGITAL CAMERAS; DIGITAL SET-TOP BOXES; COMPUTER DIGITIZERS; DISCHARGE INDICATOR TUBES; DOT MATRIX PRINTERS; DIGITAL VIDEO DISK PLAYERS; EARPHONES; ELECTRIC FLAT IRONS; ELECTRICAL MEASURING DEVICES, NAMELY, THERMOMETERS, PRESSURE GAUGES, SCALES, AND BAROMETERS TO MEASURE TEMPERATURE, PRESSURE, WEIGHT AND HUMIDITY; ELECTRIC VIEW-FINDER TUBES; ELECTRICAL INDUCTORS; ELECTRO-LUMINESCENT DISPLAY PANELS; ELECTRON BEAM ACCELERATORS; ELECTRONIC CALCULATORS; ELECTRONIC TELECOMMUNICATION SWITCHES; FACSIMILE MACHINES; FERRITE CORES FOR THE ROTARY TRANSFORMERS OF VIDEO CASSETTE RECORDERS; FIELD EMISSION DISPLAY PANELS; FIELD EMITTING DIODES; FILTERS FOR FILTERING ELECTRO-MAGNETIC WAVES; FLAT DISPLAY TUBES; FLYBACK TRANSFORMERS; GLASS BULBS FOR CATHODE RAY TUBES; GLASS FOR COLOR TELEVISION PICTURE TUBE BULBS; GLASS FOR LIQUID CRYSTAL DISPLAYS; GLASS SUBSTRATES FOR COMPUTER DISK DRIVES; GLASS SUBSTRATES FOR PLASMA DISPLAY PANEL; HARD DISK DRIVES; HEADPHONES; AUDIO HEADSETS; COMPUTER HEADSETS; TELEPHONE HEADSETS; MAGNETICALLY ENCODED IDENTITY CARD READERS; INDUSTRIAL X-RAY MACHINES FOR OTHER THAN MEDICAL USE; INK-JET PRINTERS; INTEGRATED CIRCUITS; INVERTERS; KEYPHONES; LASER DIODES; BLANK LASER DISCS; LASER DISK PLAYERS; LASER PRINTERS; LASERS NOT FOR MEDICAL PURPOSES; LIQUID CRYSTAL DISPLAYS; LIGHT EMITTING DIODE DISPLAYS; LIQUID CRYSTAL PROJECTORS; LOUD SPEAKERS; MAGNETIC IDENTITY CARDS; BLANK MAGNETIC, FLOPPY, AND OPTICAL DISKS AND DRIVES THEREOF; ROTATABLE MAGNETRON CATHODE; MICROSCOPES; MICROPHONES; MOBILE PHONES; MP3 PLAYERS; PORTABLE DIGITAL MUSIC PLAYERS; MULTIPLEXERS; OPTICAL CABLES; OPTICAL CHARACTER RECOGNITION APPARATUS; OPTICAL FIBERS; OPTICAL LENSES; OPTICAL WAVELENGTH DIVISION MULTIPLEXERS; OSCILLOGRAPHS; PERSONAL DIGITAL ASSISTANTS; PHOTOCOPYING MACHINES; PHOTOGRAPHIC CAMERAS; PHOTOGRAPHIC FLASH BULBS; PHOTOGRAPHIC PROJECTORS; PHOTOGRAPHIC SLIDE TRANSPARENCIES; PHOTOGRAPHIC SHUTTERS; PLASMA ADDRESS LIQUID CRYSTAL DISPLAYS; PLASMA DISPLAY PANELS; POLYMER DISPERSED LIQUID CRYSTAL PANELS; POLYMER NET-WORK LIQUID CRYSTAL PANELS; PORTABLE COMMUNICATION APPARATUS, NAMELY, MOBILE PHONES AND PAGERS; PORTABLE COMPUTERS, PRINTED CIRCUIT BOARDS; PROJECTION TV SETS; PROTECTIVE HELMETS; RF MODULATORS; RADAR SETS; RADIO TELEPHONIC SETS; RADIOS; AUDIO CASSETTE RECORDERS; AUDIO TAPE RECORDERS; DIGITAL AUDIO TAPE RECORDERS; DIGITAL VIDEO RECORDERS; PROGRAMMABLE DIGITAL TELEVISION RECORDERS; VIDEO CASSETTE RECORDERS; VIDEO TAPE RECORDERS; REMOTE CONTROLS FOR RADIOS, TELEVISIONS, AND STEREOS; RESISTORS; SATELLITE BROADCASTING RECEIVERS; SATELLITE TELEPHONES; SEALING GLASSES FOR ELECTRONIC APPARATUS; SEMI-CONDUCTORS; SENSORS FOR MEASURING WEIGHTS OR CHECKING GAS; SILICON WAFERS; STEAM IRONS; STEREO TUNERS; SUPERSONIC WAVE HUMIDIFIERS; TELEPHONES; TELECOMMUNICATIONS EQUIPMENT, NAMELY, MULTI-DIGITAL SUBSCRIBER LINE ACCESS MULTIPLEXER; DIGITAL LOOP CARRIER; VOICE OVER PACKAGE GATEWAY; OPERATING COMPUTER SOFTWARE; TELEVISION SETS; TESTING APPARATUS, NAMELY, ELECTRONIC APPARATUS

FOR TESTING THE STERILITY OF PHARMACEUTICALS AND INJECTABLE SOLUTIONS; ELECTRONIC TESTING EQUIPMENT, NAMELY, SOUND LEVEL METERS AND PROBES FOR TESTING INTEGRATED CIRCUITS; THIN FILM TRANSISTOR LIQUID CRYSTAL DISPLAYS; TRANSISTORS; TRANSFORMERS; TRANSCEIVERS; TRANSMITTERS OF ELECTRONIC SIGNALS; STEREO TUNERS; VACUUM FLUORESCENT DISPLAY TUBES; VIDEO CASSETTE RECORDERS; VIDEO GAME MACHINES FOR USE WITH TELEVISIONS AND VIDEO GAME PROGRAMS; BLANK VIDEO TAPES; WORD PROCESSORS; ELECTRICAL AND FIBER OPTIC CONTROL CABLE FOR MACHINES; ELECTRONIC BEAM PROCESSING MACHINES FOR USE IN CATHODE RAY TUBES IN COLOR MONITORS; ELECTRON GUNS FOR USE IN CATHODE RAY TUBES AND COLOR MONITORS; ELECTRON GUNS FOR USE IN CATHODE RAY TUBES AND COLOR MONITORS; ELECTRONIC COMPONENTS, NAMELY, RESISTORS AND PARTS AND FITTINGS FOR ALL OF THE AFORESAID GOODS (U.S. CLS. 21, 23, 26, 36 AND 38).  
FIRST USE 3-1-1973; IN COMMERCE 12-1-1974.

2,929,521. OR MUSIC LLC, NEW YORK, NY. SN 76-977,236.  
PUB. 12-30-2003, FILED 10-4-2002.



THE STIPPLING SHOWN IN THE DRAWING IS A FEATURE OF THE MARK AND IS NOT INTENDED TO INDICATE COLOR.

#### CLASS 9—ELECTRICAL AND SCIENTIFIC APPARATUS

FOR PRERECORDED COMPACT DISCS, AUDIO TAPES AND PHONOGRAPH RECORDS FEATURING MUSIC (U.S. CLS. 21, 23, 26, 36 AND 38).  
FIRST USE 3-5-2003; IN COMMERCE 3-5-2003.

#### CLASS 25—CLOTHING

FOR CLOTHING, NAMELY, T-SHIRTS, TANK TOPS, CAPS, AND JACKETS (U.S. CLS. 22 AND 39).  
FIRST USE 3-5-2003; IN COMMERCE 3-5-2003.

#### CLASS 11—ENVIRONMENTAL CONTROL APPARATUS

FOR HEAT EXCHANGERS FOR MACHINES; AIR CONDITIONERS FOR VEHICLES; AIR CONDITIONERS; AIR PURIFIERS; BACK-LIGHT LAMPS; FURNACE BOILERS; ACETYLENE BURNERS; CLOTHES DRYERS; COMPACT FLUORESCENT LAMPS; DEHUMIDIFIERS; DISH DRYERS; ELECTRONIC BLANKETS NOT FOR MEDICAL PURPOSES; ELECTRIC COFFEE MAKERS; ELECTRIC COOKERS, NAMELY, ELECTRIC BREAD COOKERS, ELECTRIC EGG COOKERS, ELECTRIC RICE COOKERS, ELECTRIC PRESSURE COOKERS, AND ELECTRIC SLOW COOKERS; ELECTRIC FANS; ELECTRIC SPACE HEATERS FOR HOUSEHOLD USE; ELECTRIC COOKING OVENS; ELECTRIC COFFEE PERCOLATORS; ELECTRIC STOVES; ELECTRIC TOASTERS; ELECTRIC WATER COOLING AND HEATING MACHINES; EXHAUSTED GAS PURIFIERS; AIR FILTERS FOR DOMESTIC USE; AIR FILTERS FOR INDUSTRIAL INSTALLATIONS; FLUORESCENT LIGHTING TUBES; GAS RANGES; HAND-HELD ELECTRIC HAIR DRYERS; HEAT EXCHANGERS; HEATERS FOR VEHICLES; ELECTRIC HEATING APPARATUS, NAMELY, ELECTRIC HEATING FANS, ELECTRIC HEATING CUSHIONS NOT FOR MEDICAL PURPOSES, ELECTRIC RADIATORS FOR HEATING BUILDINGS, AND ELECTRIC RADIATORS NOT FOR MOTORS AND ENGINES; ELECTRIC HOT PLATES; HUMIDIFIERS; ICE BOXES FOR FOOD; INCINERATORS; LAMPS; LAMP FIXTURES; ELECTRIC LANTERNS FOR LIGHTING; LAUNDRY DRIERS; ELECTRIC LIGHT BULBS; METAL HALIDE LAMPS; MICRO WAVE OVENS FOR COOKING; WATER PURIFICATION INSTALLATION FOR SEWAGE; ELECTRIC RADIATORS FOR HEATING BUILDINGS; REFRIGERATORS; SOLAR HEATING COLLECTION PANELS; STEAM GENERATORS; ULTRA HIGH PRESSURE MERCURY LAMPS; WATER PURIFIERS; AND PARTS AND FITTINGS FOR ALL THE AFORESAID GOODS (U.S. CLS. 13, 21, 23, 31 AND 34).  
FIRST USE 3-1-1973; IN COMMERCE 12-1-1974.

2,929,522. RCS LOGISTICS, INC., SPRINGFIELD GARDENS, NY. SN 76-977,240. PUB. 2-24-2004, FILED 1-22-2003.

## RCS LOGISTICS

NO CLAIM IS MADE TO THE EXCLUSIVE RIGHT TO USE LOGISTICS, APART FROM THE MARK AS SHOWN.

#### CLASS 35—ADVERTISING AND BUSINESS

FOR COMPUTERIZED TRACKING AND TRACING OF FREIGHT IN TRANSIT BY LAND, AIR AND WATER (U.S. CLS. 100, 101 AND 102).  
FIRST USE 7-12-2004; IN COMMERCE 4-12-2004.

#### CLASS 39—TRANSPORTATION AND STORAGE

FOR INTERNATIONAL FREIGHT FORWARDING BY LAND, AIR AND WATER (U.S. CLS. 100 AND 105).  
FIRST USE 7-12-2004; IN COMMERCE 7-12-2004.

2,929,523. SAMSUNG ELECTRONICS CO., LTD., SUWON-SI, GYEONGGI-DO, REPUBLIC OF KOREA. SN 76-977,253. PUB. 8-19-2003, FILED 5-2-2002.



OWNER OF U.S. REG. NOS. 2,566,413, 2,568,873, AND 2,577,028.

### CLASS 7—MACHINERY

FOR AGITATORS FOR CIRCULATING LIQUID MEDIA; AERATORS; BEARINGS FOR TRANSMISSION SHAFTS BEING PART OF MACHINES; BORING MACHINES, BULLDOZERS; CENTRIFUGES; POWER-OPERATED COFFEE GRINDERS; CHIP MOUNTING MACHINES; COMPRESSED AIR PUMPS; COMPRESSORS FOR VEHICLES, AIR CONDITIONERS, REFRIGERATORS, AND MACHINES; CONCRETE MIXERS; CONVEYORS; CRANES; DISHWASHERS; DREDGING MACHINES; EARTH MOVING MACHINES, NAMELY, GRADERS, LOADERS, SCARIFIERS, SCRAPERS, AND EXCAVATORS; ELECTRIC BLENDERS FOR HOUSEHOLD PURPOSES; ELECTRIC CAN OPENERS; ELECTRIC GENERATORS; ELECTRIC HAND DRILLS; ELECTRIC IGNITIONS FOR LAND VEHICLES; ELECTRIC JUICERS; ELECTRIC WELDING MACHINES; ELEVATORS; ENGINES FOR BOATS; ENGINES OTHER THAN FOR LAND VEHICLES; ESCALATORS; FILTERS FOR MACHINES, NAMELY, MACHINES USED IN THE PHARMACEUTICAL, FOODS, BEVERAGE, CHEMICAL, PAINT, AND ELECTRONIC INDUSTRIES FOR THE REMOVAL OF IMPURITIES FROM FLUIDS AND OTHER FILTERABLE SUBSTANCES; FILTERS FOR ENGINES, NAMELY, OIL ENGINES AND GAS ENGINES; ELECTRIC FOOD PROCESSORS; FOUNDRY MACHINES FOR CASTING METAL; ELECTRIC FRUIT PRESSES FOR HOUSEHOLD PURPOSES; GARBAGE DISPOSALS; HOISTS; MOTORS OTHER THAN FOR LAND VEHICLES, NAMELY, MOTORS FOR AIRPLANES, BOATS, AND ELECTRIC MOTORS FOR MACHINES; PACKAGING MACHINES; PLOUGHS; PRINTING PRESSES; MACHINES FOR ASSEMBLING PRINTED CIRCUIT BOARDS; INDUSTRIAL ROBOTS; PAPER SHREDDING MACHINES FOR INDUSTRIAL USE; TRANSMISSION GEARS FOR MACHINES; HYDRAULIC TURBINES OTHER THAN FOR LAND VEHICLES; VACUUM CLEANERS; WASHING MACHINES FOR CLOTHES; POWER OPERATED RAMMERS; CRUSHING MACHINES FOR SAWDUST (U.S. CLS. 13, 19, 21, 23, 31, 34 AND 35).

FIRST USE 3-1-1993; IN COMMERCE 3-14-1993.

### CLASS 9—ELECTRICAL AND SCIENTIFIC APPARATUS

FOR ALUMINUM PARTS FOR ROTATABLE MAGNETRON CATHODE; AMPLIFIERS; APPARATUS FOR GAMES ADAPTED FOR USE WITH TELEVISION RECEIVERS, NAMELY, VIDEO GAME MACHINES FOR USE WITH TELEVISIONS, VIDEO OUTPUT GAME MACHINES FOR USE WITH TELEVISIONS; ASYNCHRONOUS TRANSFER MODE-BROADBAND SWITCHING AND TRANSMISSION TELEPHONE EXCHANGER; AUDIO CASSETTE DECKS FOR AUTOMOBILES; AUDIO CASSETTE RECORDERS; AUDIO RECEIVERS AND VIDEO RECEIVERS; AUTOMATIC VENDING MACHINES; BATTERIES; BATTERY CHARGERS, BINOCULARS; MAGNETIC BUZZERS; CABLE TV CONVERTERS; CALCULATORS; CAMERAS; CAPACITORS; MAGNETIC CARD READERS; CASH REGISTERS; CASSETTE TAPE RECORDERS; CATHODE RAY TUBES; CHARGE COUPLED DEVICE CAMERAS; COLD CATHODE FLUORESCENT TUBES; COLOR FILTERS FOR LIQUID CRYSTAL DISPLAY; COMPACT DISK DRIVES; COMPACT DISK PLAYERS; BLANK COMPACT DISKS; COMPUTER MEMORIES; COMPUTER MODEMS; COMPUTER MONITORS; COMPUTER PRINTERS;

COMPUTER PROGRAMS FOR COMPUTER GAMES; COMPUTER OPERATING PROGRAMS; COMPUTER PROGRAMS FOR USE IN DATABASE MANAGEMENT FOR SPREADSHEET AND WORD PROCESSING FUNCTIONS; COMPUTER WORK STATIONS COMPRISING COMPUTERS AND COMPUTER MONITORS, KEYBOARDS, AND COMPUTERS, AND COMPUTER PERIPHERALS; ELECTRICAL CONTROLLERS FOR MACHINES; CONVERTERS FOR ELECTRIC PLUGS, ELECTRIC CONVERTERS, TV, AND VIDEO CONVERTERS; ELECTRICAL DEFLECTION COILS, DEFLECTION YOKES, DIGITAL CAMERAS; DIGITAL SET-TOP BOXES; COMPUTER DIGITIZERS; DISCHARGE INDICATOR TUBES; DOT MATRIX PRINTERS; DIGITAL VIDEO DISK PLAYERS; EARPHONES; ELECTRIC FLAT IRONS; ELECTRICAL MEASURING DEVICES, NAMELY, THERMOMETERS, PRESSURE GAUGES, SCALES, AND BAROMETERS TO MEASURE TEMPERATURE, PRESSURE, WEIGHT AND HUMIDITY; ELECTRIC VIEW-FINDER TUBES; ELECTRICAL INDUCTORS; ELECTRO-LUMINESCENT DISPLAY PANELS; ELECTRON BEAM ACCELERATORS; ELECTRONIC CALCULATORS; ELECTRONIC TELECOMMUNICATION SWITCHES; FACSIMILE MACHINES; FERRITE CORES FOR THE ROTARY TRANSFORMERS OF VIDEO CASSETTE RECORDERS; FIELD EMISSION DISPLAY PANELS; FIELD EMITTING DIODES; FILTERS FOR FILTERING ELECTRO-MAGNETIC WAVES; FIAT DISPLAY TUBES; FLYBACK TRANSFORMERS; GLASS BULBS FOR CATHODE RAY TUBES; GLASS FOR COLOR TELEVISION PICTURE TUBE BULBS; GLASS FOR LIQUID CRYSTAL DISPLAYS; GLASS SUBSTRATES FOR COMPUTER DISK DRIVES; GLASS SUBSTRATES FOR PLASMA DISPLAY PANEL; HARD DISK DRIVES; HEADPHONES; AUDIO HEADSETS; COMPUTER HEADSETS; TELEPHONE HEADSETS; MAGNETICALLY ENCODED IDENTITY CARD READERS; INDUSTRIAL X-RAY MACHINES FOR OTHER THAN MEDICAL USE; INK-JET PRINTERS; INTEGRATED CIRCUITS; INVERTERS; KEYPHONES; LASER DIODES; BLANK LASER DISCS; LASER DISK PLAYERS; LASER PRINTERS; LASERS NOT FOR MEDICAL PURPOSES; LIQUID CRYSTAL DISPLAYS; LIGHT EMITTING DIODE DISPLAYS; LIQUID CRYSTAL PROJECTORS; LOUD SPEAKERS; MAGNETIC IDENTITY CARDS; BLANK MAGNETIC, FLOPPY, AND OPTICAL DISKS AND DRIVES THEREOF; ROTATABLE MAGNETRON CATHODE; MICROSCOPES; MICROPHONES; MOBILE PHONES; MP3 PLAYERS; PORTABLE DIGITAL MUSIC PLAYERS; MULTIPLEXERS; OPTICAL CABLES; OPTICAL CHARACTER RECOGNITION APPARATUS; OPTICAL FIBERS; OPTICAL LENSES; OPTICAL WAVELENGTH DIVISION MULTIPLEXERS; OSCILLOGRAPHS; PERSONAL DIGITAL ASSISTANTS; PHOTOCOPYING MACHINES; PHOTOGRAPHIC CAMERAS; PHOTOGRAPHIC FLASH BULBS; PHOTOGRAPHIC PROJECTORS; PHOTOGRAPHIC SLIDE TRANSPARENCIES; PHOTOGRAPHIC SHUTTERS; PLASMA ADDRESS LIQUID CRYSTAL DISPLAYS; PLASMA DISPLAY PANELS; POLYMER DISPERSED LIQUID CRYSTAL PANELS; POLYMER NET-WORK LIQUID CRYSTAL PANELS; PORTABLE COMMUNICATION APPARATUS, NAMELY, MOBILE PHONES AND PAGERS; PORTABLE COMPUTERS, PRINTED CIRCUIT BOARDS; PROJECTION TV SETS; PROTECTIVE HELMETS; RF MODULATORS; RADAR SETS; RADIO TELEPHONIC SETS; RADIOS; AUDIO CASSETTE RECORDERS; AUDIO TAPE RECORDERS; DIGITAL AUDIO TAPE RECORDERS; DIGITAL VIDEO RECORDERS; PROGRAMMABLE DIGITAL TELEVISION RECORDERS; VIDEO CASSETTE RECORDERS; VIDEO TAPE RECORDERS; REMOTE CONTROLS FOR RADIOS, TELEVISIONS, AND STEREOS; RESISTORS; SATELLITE BROADCASTING RECEIVERS; SATELLITE TELEPHONES; SEALING GLASSES FOR ELECTRONIC APPARATUS; SEMI-CONDUCTORS; SENSORS FOR MEASURING WEIGHTS OR CHECKING GAS; SILICON WAFERS; STEAM IRONS; STEREO TUNERS; SUPERSONIC WAVE HUMIDIFIERS; TELEPHONES; TELECOMMUNICATIONS EQUIPMENT, NAMELY, MULTI-DIGITAL SUBSCRIBER LINE ACCESS MULTIPLEXER; DIGITAL LOOP CARRIER; VOICE OVER PACKAGE GATEWAY; OPERATING COMPUTER SOFTWARE; TELEVISION SETS; TESTING APPARATUS, NAMELY, ELECTRONIC APPARATUS FOR TESTING THE STERILITY OF PHARMACEUTICALS AND INJECTABLE SOLUTIONS; ELECTRONIC TESTING EQUIPMENT, NAMELY, SOUND LEVEL METERS AND PROBES FOR TESTING INTEGRATED

CIRCUITS; THIN FILM TRANSISTOR LIQUID CRYSTAL DISPLAYS; TRANSISTORS; TRANSFORMERS; TRANSCEIVERS; TRANSMITTERS OF ELECTRONIC SIGNALS; STEREO TURNERS; VACUUM FLUORESCENT DISPLAY TUBES; VIDEO CASSETTE RECORDERS; VIDEO GAME MACHINES FOR USE WITH TELEVISIONS AND VIDEO GAME PROGRAMS; BLANK VIDEO TAPES; WORD PROCESSORS; AND PARTS AND FITTINGS FOR ALL OF THE AFORE-SAID GOODS; ELECTRICAL AND FIBER OPTIC CONTROL CABLE FOR MACHINES; ELECTRON BEAM PROCESSING MACHINES FOR USE IN CATHODE RAY TUBES IN COLOR MONITORS; ELECTRON GUNS FOR USE IN CATHODE RAY TUBES AND COLOR MONITORS; ELECTRONIC COMPONENTS, NAMELY, RESISTORS (U.S. CLS. 21, 23, 26, 36 AND 38).

FIRST USE 3-1-1993; IN COMMERCE 3-14-1993.

#### **CLASS 11—ENVIRONMENTAL CONTROL APPARATUS**

FOR HEAT EXCHANGERS FOR MACHINES; AIR CONDITIONERS FOR VEHICLES; AIR CONDITIONERS; AIR PURIFIERS; BACK-LIGHT LAMPS; FURNACE BOILERS; ACETYLENE BURNERS; CLOTHES DRYERS; COMPACT FLUORESCENT LAMPS; DEHUMIDIFIERS; DISH DRYERS; ELECTRONIC BLANKETS NOT FOR MEDICAL PURPOSES; ELECTRIC COFFEE MAKERS; ELECTRIC COOKERS, NAMELY, ELECTRIC BREAD COOKERS, ELECTRIC EGG COOKERS, ELECTRIC RICE COOKERS, ELECTRIC PRESSURE COOKERS, AND ELECTRIC SLOW COOKERS; ELECTRIC FANS; ELECTRIC SPACE HEATERS FOR HOUSEHOLD USE; ELECTRIC COOKING OVENS; ELECTRIC COFFEE PERCOLATORS; ELECTRIC STOVES; ELECTRIC TOASTERS; ELECTRIC WATER COOLING AND HEATING MACHINES; EXHAUSTED GAS PURIFIERS; AIR FILTERS FOR DOMESTIC USE; AIR FILTERS FOR INDUSTRIAL INSTALLATIONS; FLUORESCENT LIGHTING TUBES; GAS RANGES; HAND-HELD ELECTRIC HAIR DRYERS; HEAT EXCHANGERS; HEATERS FOR VEHICLES; ELECTRIC HEATING APPARATUS, NAMELY, ELECTRIC HEATING FANS, ELECTRIC HEATING CUSHIONS NOT FOR MEDICAL PURPOSES, ELECTRIC RADIATORS FOR HEATING BUILDINGS, AND ELECTRIC RADIATORS NOT FOR MOTORS AND ENGINES; ELECTRIC HOT PLATES; HUMIDIFIERS; ICE BOXES FOR FOOD; INCINERATORS; LAMPS; LAMP FIXTURES; ELECTRIC LANTERNS FOR LIGHTING; LAUNDRY DRIERS; ELECTRIC LIGHT BULBS; METAL HALIDE LAMPS, MICRO WAVE OVENS FOR COOKING; WATER PURIFICATION INSTALLATION FOR SEWAGE; ELECTRIC RADIATORS FOR HEATING BUILDINGS; REFRIGERATORS; SOLAR HEATING COLLECTION PANELS, STEAM GENERATORS; ULTRA HIGH PRESSURE MERCURY LAMPS; WATER PURIFIERS; AND PARTS AND FITTINGS FOR ALL THE AFORESAID GOODS (U.S. CLS. 13, 21, 23, 31 AND 34).

FIRST USE 3-1-1993; IN COMMERCE 3-14-1993.

2,929,525. MAYTAG CORPORATION, NEWTON, IA. SN 78-017,614. PUB. 9-17-2002, FILED 7-20-2000.

## **LEGACY**

#### **CLASS 7—MACHINERY**

FOR CLOTHES WASHING MACHINES AND PARTS THEREOF (U.S. CLS. 13, 19, 21, 23, 31, 34 AND 35).

FIRST USE 6-25-2003; IN COMMERCE 6-25-2003.

#### **CLASS 11—ENVIRONMENTAL CONTROL APPARATUS**

FOR CLOTHES DRYERS AND PARTS THEREOF (U.S. CLS. 13, 21, 23, 31 AND 34).

FIRST USE 6-25-2003; IN COMMERCE 6-25-2003.

2,929,539. VICTORY PACKAGING, INC., HOUSTON, TX. SN 78-051,870. PUB. 6-22-2004, FILED 3-7-2001.

## **GOLDEN STATE CONTAINER**

OWNER OF U.S. REG. NO. 2,682,503.

NO CLAIM IS MADE TO THE EXCLUSIVE RIGHT TO USE "CONTAINER", APART FROM THE MARK AS SHOWN.

SEC. 2(F) AS TO "GOLDEN STATE".

#### **CLASS 6—METAL GOODS**

FOR BAILING WIRE; GENERAL PURPOSE METAL STORAGE CONTAINERS; METAL LADDERS; METAL BARS FOR HANGING WARDROBE; METAL CANS SOLD EMPTY; METAL FLOOR RUNNERS (U.S. CLS. 2, 12, 13, 14, 23, 25 AND 50).

FIRST USE 12-31-1976; IN COMMERCE 12-31-1976.

#### **CLASS 16—PAPER GOODS AND PRINTED MATTER**

FOR SINGLE FACE CORRUGATED PAPER ROLLS, CHIPBOARD AND FOLDING CARTONS, CARTON CLOSING STAPLES, SHEETED AND BUNDLED NEWS-PRINT PAPER, PAPER WRAPPING, PACKING LIST ENVELOPES, PLASTIC STRETCH WRAP, PLASTIC SHRINK WRAP AND PLASTIC BUBBLE PACKS FOR PACKAGING OR WRAPPING; FREEZER PAPER, WATERPROOF PAPER AND KRAFT PAPER; STOCK AND PRINTED LABELS; MATTRESS BAGS; PAPER TUBES AND CORES FOR PACKAGING; TISSUE PAPER FOR MOVER'S USE; ADHESIVE TAPE FOR HOUSEHOLD AND STATIONARY USE; BLISTER CARDS; PACKING MATERIAL, NAMELY, PAPER BAGS, GLUE STICKS, AND PAPER TAPE (U.S. CLS. 2, 5, 22, 23, 29, 37, 38 AND 50).

FIRST USE 12-31-1976; IN COMMERCE 12-31-1976.

#### **CLASS 17—RUBBER GOODS**

FOR PACKAGING AND SHIPPING MATERIALS, NAMELY, PLASTIC PACKING AND PADDING FOR SHIPPING CONTAINERS, PACKAGING AND SHIPPING MATERIALS, NAMELY, CELLULOSE ACETATE FILM USED AS AN INDUSTRIAL OR COMMERCIAL PACKING MATERIAL, ADHESIVE TAPE FOR INDUSTRIAL AND COMMERCIAL PACKING USE, MOLDED AND FABRICATED FOAM INSULATED CONTAINER PACKAGING, PACKAGING FOAM, PLASTIC FILM FOR INDUSTRIAL AND COMMERCIAL PACKING USE, PACKING MATERIALS, NAMELY, LOOSE FOAM PIECES AND FOAM PEANUTS (U.S. CLS. 1, 5, 12, 13, 35 AND 50).

FIRST USE 12-31-1976; IN COMMERCE 12-31-1976.

#### **CLASS 20—FURNITURE AND ARTICLES NOT OTHERWISE CLASSIFIED**

FOR PLASTIC CONTAINERS FOR PACKING; LADDERS NOT MADE OF METAL; CORRUGATED PALLETS, PACKAGING AND SHIPPING MATERIALS, NAMELY, NON-METAL PALLETS; FITTED FABRIC FURNITURE COVERS (U.S. CLS. 2, 13, 22, 25, 32 AND 50).

FIRST USE 12-31-1976; IN COMMERCE 12-31-1976.

#### **CLASS 22—CORDAGE AND FIBERS**

FOR WADDING FOR PADDING AND STUFFING, BUNGEE CORDS, TARP, TWINE (U.S. CLS. 1, 2, 7, 19, 22, 42 AND 50).

FIRST USE 12-31-1976; IN COMMERCE 12-31-1976.

**CLASS 35—ADVERTISING AND BUSINESS**

FOR DISTRIBUTORSHIP SERVICES FOR BEVERAGE BOTTLES AND CONTAINERS SOLD EMPTY (U.S. CLS. 100, 101 AND 102).

FIRST USE 12-31-1976; IN COMMERCE 12-31-1976.

2,929,557. AVAYA INC., BASKING RIDGE, NJ. SN 78-097,775. PUB. 6-25-2002, FILED 12-11-2001.

**ACS****CLASS 41—EDUCATION AND ENTERTAINMENT**

FOR EDUCATIONAL SERVICES, NAMELY, CONDUCTING SEMINARS, COURSES AND WORKSHOPS IN THE FIELD OF VOICE NETWORKING, DATA NETWORKING AND THE USE OF RELATED VOICE NETWORKING AND DATA NETWORKING COMPUTER SOFTWARE APPLICATIONS AND PRINTED COURSE PREPARATION MATERIALS INCLUDED THEREWITH (U.S. CLS. 100, 101 AND 107).

FIRST USE 5-1-2002; IN COMMERCE 5-1-2002.

2,929,544. REDDING, SAMUEL F., LINCOLN, IL. SN 78-064,036. PUB. 5-7-2002, FILED 5-16-2001.

**MENTOR GRAHAM****CLASS 16—PAPER GOODS AND PRINTED MATTER**

FOR EDUCATIONAL PRODUCTS, NAMELY POSTERS, MAPS, BOOKS IN THE AREAS OF READING, MATH, SCIENCE, SOCIAL SCIENCES AND STUDY SKILLS, PENS, PRINTED TEACHING MATERIALS IN THE AREAS OF READING, MATH, SCIENCE, SOCIAL SCIENCES AND STUDY SKILLS (U.S. CLS. 2, 5, 22, 23, 29, 37, 38 AND 50).

FIRST USE 6-10-2003; IN COMMERCE 6-10-2003.

**CLASS 42—SCIENTIFIC, COMPUTER AND LEGAL SERVICES**

FOR PROVIDING TESTING TO DETERMINE PROFESSIONAL SKILLS ACQUIRED IN THE FIELD OF VOICE NETWORKING, DATA NETWORKING AND THE USE OF RELATED VOICE NETWORKING AND DATA NETWORKING COMPUTER SOFTWARE APPLICATIONS AND PRINTED INSTRUCTIONAL MATERIALS INCLUDED THEREWITH (U.S. CLS. 100 AND 101).

FIRST USE 5-1-2002; IN COMMERCE 5-1-2002.

**CLASS 35—ADVERTISING AND BUSINESS**

FOR RETAIL STORE SERVICES, NAMELY, WHOLESALE AND ONLINE RETAIL SERVICES FEATURING EDUCATIONAL PRODUCTS INCLUDING POSTERS, MAPS, LESSON BOOKS, CLOTHING, PENS, PRINTED TEACHING MATERIALS, COFFEE MUGS, AND GIFT ITEMS (U.S. CLS. 100, 101 AND 102).

FIRST USE 1-10-2004; IN COMMERCE 1-10-2004.

2,929,558. ELITEGROUP COMPUTER SYSTEMS CO., LTD., TAIPEI, TAIWAN. SN 78-101,514. PUB. 10-14-2003, FILED 1-8-2002.

**CLASS 41—EDUCATION AND ENTERTAINMENT**

FOR PUBLICATION OF BOOKS (U.S. CLS. 100, 101 AND 107).

FIRST USE 6-10-2003; IN COMMERCE 6-10-2003.

**ECS ELITEGROUP**

2,929,556. H.D. LEE COMPANY, INC., THE, WILMINGTON, DE. SN 78-095,165. PUB. 9-9-2003, FILED 11-27-2001.

**LEE**

OWNER OF U.S. REG. NOS. 255,018, 1,459,327, AND OTHERS.

OWNER OF U.S. REG. NOS. 1,727,154 AND 1,727,155. THE MARK CONSISTS OF THE TERMS "ECS ELITEGROUP" WITH A REPRESENTATION OF BLANK TRIANGLE BETWEEN THE LETTERS "E" AND "S".

**CLASS 18—LEATHER GOODS**

FOR LUGGAGE (U.S. CLS. 1, 2, 3, 22 AND 41).  
FIRST USE 12-31-1993; IN COMMERCE 12-31-1993.

**CLASS 9—ELECTRICAL AND SCIENTIFIC APPARATUS**

FOR COMPUTER HARDWARE, NAMELY, COMPUTER DISPLAYING BOARDS, BLANK FLOPPY DISKETTE, BLANK COMPACT DISKS, COMPUTER KEYBOARDS, HARD DISKS, HARD DRIVES COMPUTER MEMORIES, COMPUTER MAIN FRAMES, COMPUTER MOUSE, MICRO PROCESSORS, BLANK DISKS FOR DATA STORAGES, READ ONLY COMPUTER MEMORIES, CENTRAL PROCESSING UNITS, DISK DRIVERS, COMPUTER PLOTTERS, DISK RECORDED WITH COMPUTER PROGRAMS, PERSONAL DIGITAL ASSISTANTS, MOTHER BOARDS, ADD-ON MEMORY CARDS, SEMICONDUCTORS, COMPUTER SOFTWARE FOR APPLICATION AND DATABASE INTEGRATION, AND PORTABLE COMPUTERS (U.S. CLS. 21, 23, 26, 36 AND 38).

FIRST USE 2-5-2001; IN COMMERCE 2-5-2001.

**CLASS 25—CLOTHING**

FOR LEATHER COATS, JACKETS, VESTS, AND GLOVES; AND COATS, JACKETS, VESTS, AND GLOVES MADE OUT OF IMITATION LEATHER, CASUAL PANTS, CHINOS, KHAKIS, BANDANAS, BEACH COVERUPS, NON-LEATHER BELTS, BLAZERS, KNIT HATS, JUMPERS, LEGGINGS, LEOTARDS, WOMEN'S AND CHILDREN'S SLEEPWEAR, RAINWEAR, ROBES, SCARVES, BUTTON-DOWN SHIRTS, KNIT SHIRTS, PULLOVER SHIRTS, HOODED JACKETS, HOODED SHIRTS, SHORTALLS, SKIRTS, SWEATSHIRTS, SWEATPANTS, SWEATSUITS, SWEATERS, NON-LEATHER VESTS, AND WIND-RESISTANT JACKETS (U.S. CLS. 22 AND 39).

FIRST USE 12-31-1993; IN COMMERCE 12-31-1993.

**CLASS 35—ADVERTISING AND BUSINESS**

FOR DISTRIBUTORSHIP SERVICES FEATURING COMPUTER HARDWARE AND COMPUTER SOFTWARE, ADVERTISING AGENCY SERVICES, AND EXPORT AND IMPORT AGENCIES (U.S. CLS. 100, 101 AND 102).

FIRST USE 2-5-2001; IN COMMERCE 2-5-2001.



**CLASS 42—SCIENTIFIC, COMPUTER AND LEGAL SERVICES**

FOR COMPUTER CONSULTATION SERVICES, COMPUTER PROGRAMMING SERVICES FOR OTHERS, RENTAL OF COMPUTERS, AND DESIGN OF COMPUTER SOFTWARE AND HARDWARE FOR OTHERS (U.S. CLS. 100 AND 101).

FIRST USE 2-5-2001; IN COMMERCE 2-5-2001.

**CLASS 37—CONSTRUCTION AND REPAIR**

FOR LAND DEVELOPMENT SERVICES, NAMELY, THE PLANNING, DEVELOPMENT AND LAYING OUT OF RESIDENTIAL AND COMMERCIAL COMMUNITIES; REAL ESTATE DEVELOPMENT SERVICES, INCLUDING THE PLANNING, DEVELOPMENT, LAYING OUT AND CONSTRUCTION OF RESIDENTIAL AND COMMERCIAL COMMUNITIES (U.S. CLS. 100, 103 AND 106).

FIRST USE 6-19-2002; IN COMMERCE 6-19-2002.

2,929,562. D.R. HORTON LOS ANGELES HOLDING COMPANY, INC., ARLINGTON, TX. SN 78-108,065. PUB. 9-23-2003, FILED 2-11-2002.

2,929,573. JAFFE ASSOCIATES LLC, BETHESDA, MD. SN 78-126,599. PUB. 2-24-2004, FILED 5-6-2002.

**SEABRIDGE****CLASS 36—INSURANCE AND FINANCIAL**

FOR REAL ESTATE BROKERAGE OF LAND PARCELS; REAL ESTATE BROKERAGE IN THE NATURE OF RESIDENTIAL AND COMMERCIAL REAL ESTATE (U.S. CLS. 100, 101 AND 102).

FIRST USE 6-19-2002; IN COMMERCE 6-19-2002.

**CLASS 37—CONSTRUCTION AND REPAIR**

FOR LAND DEVELOPMENT SERVICES, NAMELY, THE PLANNING, DEVELOPMENT AND LAYING OUT OF RESIDENTIAL AND COMMERCIAL COMMUNITIES; REAL ESTATE DEVELOPMENT SERVICES, INCLUDING THE PLANNING, DEVELOPMENT, LAYING OUT AND CONSTRUCTION OF RESIDENTIAL AND COMMERCIAL COMMUNITIES (U.S. CLS. 100, 103 AND 106).

FIRST USE 6-19-2002; IN COMMERCE 6-19-2002.

2,929,563. D. R. HORTON LOS ANGELES HOLDING COMPANY, INC., ARLINGTON, TX. SN 78-108,067. PUB. 7-22-2003, FILED 2-11-2002.



NO CLAIM IS MADE TO THE EXCLUSIVE RIGHT TO USE "CHANNEL ISLANDS HARBOR", APART FROM THE MARK AS SHOWN.

**CLASS 36—INSURANCE AND FINANCIAL**

FOR REAL ESTATE BROKERAGE OF LAND PARCELS; REAL ESTATE BROKERAGE IN THE NATURE OF RESIDENTIAL AND COMMERCIAL REAL ESTATE (U.S. CLS. 100, 101 AND 102).

FIRST USE 6-19-2002; IN COMMERCE 6-19-2002.

**PITCHBUILDER****CLASS 35—ADVERTISING AND BUSINESS**

FOR PREPARATION OF CUSTOMIZED MARKETING MATERIALS FOR OTHERS, NAMELY, ADVERTISEMENTS, BROCHURES, PRESS RELEASES, BUSINESS PROPOSALS AND OTHER COLLATERAL PROMOTIONAL PRODUCTS FOR OTHERS; BUSINESS MARKETING SERVICES, NAMELY, PROVIDING BUSINESS MARKETING INFORMATION; BUSINESS MARKETING CONSULTING SERVICES; AND PUBLIC RELATIONS SERVICES (U.S. CLS. 100, 101 AND 102).

FIRST USE 8-0-2002; IN COMMERCE 8-0-2002.

**CLASS 42—SCIENTIFIC, COMPUTER AND LEGAL SERVICES**

FOR ON-LINE COMPUTER APPLICATIONS SERVICES, NAMELY, PROVIDING TEMPORARY USE OF ON-LINE NON-DOWNLOADABLE SOFTWARE FOR USE OVER A GLOBAL COMPUTER NETWORK BY PROFESSIONAL SERVICE FIRMS TO CREATE CUSTOMIZED PRINTED AND ELECTRONIC BROCHURES, WEB PAGES, AND OTHER BUSINESS, MARKETING, ADVERTISING AND COLLATERAL MATERIALS (U.S. CLS. 100 AND 101).

FIRST USE 8-0-2002; IN COMMERCE 8-0-2002.

2,929,575. FEDERAL EXPRESS CORPORATION, MEMPHIS, TN. SN 78-127,071. PUB. 7-1-2003, FILED 5-8-2002.

**FEDEXFORUM**

OWNER OF U.S. REG. NOS. 2,017,855, 2,518,524, AND OTHERS.

**CLASS 25—CLOTHING**

FOR MEN'S, WOMEN'S AND CHILDREN'S CLOTHING AND FOOTWEAR; NAMELY, COACHES CAPS, WOOL HATS, PAINTERS HATS, BASEBALL CAPS, VISORS, HEADBANDS, EARMUFFS, KNIT FACE MASKS, BELTS, WRISTBANDS, T-SHIRTS, TANK TOPS, PAJAMAS, GOLF SHIRTS, DRESS SHIRTS, SWEATERS, SWEATSHIRTS, JACKETS, NECKTIES, CLOTH SKI BIBS, CLOTH BABY BIBS, PLASTIC BABY BIBS, PLASTIC SKI BIBS, JERSEYS, NIGHT SHIRTS, COATS, ROBES, RAINCOATS, PARKAS, PONCHOS, SNEAKERS, GLOVES, SCARVES, MITTENS, APRONS, DOWN JACKETS, LEATHER JACKETS, CLOTH JACKETS, SHORTS, SWEATPANTS, JEANS, PANTS, SOCKS, UNDERWEAR AND BATHING SUITS (U.S. CLS. 22 AND 39).

FIRST USE 9-1-2004; IN COMMERCE 9-1-2004.

**CLASS 41—EDUCATION AND ENTERTAINMENT**

FOR ENTERTAINMENT SERVICES; NAMELY, PROVIDING A FACILITY FOR THE PRESENTATION OF PROFESSIONAL BASKETBALL CONTESTS, EXHIBITIONS AND TEAMS (U.S. CLS. 100, 101 AND 107).

FIRST USE 10-9-2004; IN COMMERCE 10-9-2004.

**CLASS 43—HOTEL AND RESTAURANT SERVICES**

FOR ARENA SERVICES; NAMELY, PROVIDING FACILITIES FOR SPORTS, CONCERTS, CONVENTIONS AND EXHIBITIONS (U.S. CLS. 100 AND 101).

FIRST USE 9-17-2004; IN COMMERCE 9-17-2004.

2,929,582. ARTGLO COMPANY, THE, COLUMBUS, OH. SN 78-135,151. PUB. 3-23-2004, FILED 6-12-2002.

**SMART WALLS**

NO CLAIM IS MADE TO THE EXCLUSIVE RIGHT TO USE "WALLS", APART FROM THE MARK AS SHOWN.

**CLASS 40—MATERIAL TREATMENT**

FOR CUSTOM MANUFACTURE OF MODULAR WALL AND SIGNAGE SYSTEMS (U.S. CLS. 100, 103 AND 106).

FIRST USE 0-0-1998; IN COMMERCE 0-0-1998.

**CLASS 42—SCIENTIFIC, COMPUTER AND LEGAL SERVICES**

FOR DESIGN FOR OTHERS OF MODULAR WALL AND SIGNAGE SYSTEMS (U.S. CLS. 100 AND 101).

FIRST USE 0-0-1998; IN COMMERCE 0-0-1998.

2,929,585. COMPUTER HEALTH NETWORK, INC., SCHAMBURG, IL. AND COMPUTER HEALTH NETWORK, INC., HOFFMAN ESTATES, IL. SN 78-136,717. PUB. 7-15-2003, FILED 6-18-2002.

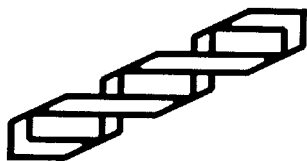
**CLASS 9—ELECTRICAL AND SCIENTIFIC APPARATUS**

FOR MEDICAL DATABASE MANAGEMENT COMPUTER SOFTWARE AND RELATED HARDWARE AND INSTRUCTIONAL MANUALS SOLD AS A UNIT THEREWITH (U.S. CLS. 21, 23, 26, 36 AND 38).

FIRST USE 1-12-2001; IN COMMERCE 1-12-2001.

**CLASS 35—ADVERTISING AND BUSINESS**

FOR BUSINESS MANAGEMENT IN THE FIELD OF HEALTH CARE; MEDICAL COST MANAGEMENT; COMPUTERIZED ACCOUNTING SERVICE; COMPUTER DATABASE MANAGEMENT (U.S. CLS. 100, 101 AND 102).

FIRST USE 4-5-2002; IN COMMERCE 4-5-2002.

**CLASS 36—INSURANCE AND FINANCIAL**

FOR MEDICAL INSURANCE UNDERWRITING; FINANCIAL CLEARINGHOUSE FOR MEDICAL SERVICES TO INSURANCE COMPANIES; FACTORING AGENCIES FOR COLLECTIBLES AND RECEIVABLES IN THE FIELD OF HEALTH CARE (U.S. CLS. 100, 101 AND 102).

FIRST USE 4-5-2002; IN COMMERCE 4-5-2002.

**CLASS 41—EDUCATION AND ENTERTAINMENT**

FOR COMPUTER EDUCATIONAL TRAINING SERVICES IN THE FIELD OF HEALTH CARE AND INSTRUCTIONAL MANUALS SOLD AS A UNIT THEREWITH (U.S. CLS. 100, 101 AND 107).

FIRST USE 4-5-2002; IN COMMERCE 4-5-2002.

**CLASS 42—SCIENTIFIC, COMPUTER AND LEGAL SERVICES**

FOR COMPUTER CONSULTATION IN THE FIELD OF HEALTH CARE (U.S. CLS. 100 AND 101).

FIRST USE 4-5-2002; IN COMMERCE 4-5-2002.

**CLASS 44—MEDICAL, BEAUTY AND AGRICULTURAL SERVICES**

FOR MAINTAINING INDIVIDUAL MEDICAL HISTORY RECORDS AND FILES; PROVIDING MEDICAL INFORMATION AND CONSULTATION IN THE FIELD OF HEALTH CARE (U.S. CLS. 100 AND 101).

FIRST USE 4-5-2002; IN COMMERCE 4-5-2002.

2,929,586. E.T. BROWNE DRUG CO., INC., ENGLEWOOD CLIFFS, NJ. SN 78-137,396. PUB. 12-31-2002, FILED 6-20-2002.

**UN-SCAR****CLASS 3—COSMETICS AND CLEANING PREPARATIONS**

FOR SKIN CARE PRODUCTS, NAMELY, GELS, CREAMS, LOTIONS AND OINTMENTS TO DIMINISH THE APPEARANCE OF AND FOR THE TREATMENT OF SCARS (U.S. CLS. 1, 4, 6, 50, 51 AND 52).

FIRST USE 11-0-2004; IN COMMERCE 11-0-2004.

**CLASS 5—PHARMACEUTICALS**

FOR MEDICATED GELS, CREAMS, LOTIONS AND OINTMENTS FOR THE TREATMENT OF SCARS (U.S. CLS. 6, 18, 44, 46, 51 AND 52).

FIRST USE 11-0-2004; IN COMMERCE 11-0-2004.

2,929,588. PLUSNETMARKETING, INC., WILMINGTON, DE. SN 78-138,523. PUB. 9-2-2003, FILED 6-25-2002.

**DRIVETHRUMEDIA****CLASS 6—METAL GOODS**

FOR NON-LUMINOUS, NON-MECHANICAL, PRIMARILY METAL, OUTDOOR SIGN BOXES FOR HOUSING RENEWABLE PRINTED ADVERTISING MATERIALS (U.S. CLS. 2, 12, 13, 14, 23, 25 AND 50).

FIRST USE 11-0-2003; IN COMMERCE 11-0-2003.

**CLASS 35—ADVERTISING AND BUSINESS**

FOR MARKETING SERVICES, NAMELY, COORDINATION AND MAINTENANCE OF ADVERTISING DISPLAY AND MERCHANDISING PROGRAMS FOR MANUFACTURERS (U.S. CLS. 100, 101 AND 102).  
FIRST USE 12-0-2003; IN COMMERCE 12-0-2003.

---

2,929,603. CATALYST, INC., NEW YORK, NY. SN 78-156,324.  
PUB. 3-11-2003, FILED 8-21-2002.

**CATALYST SPECTRUM**

OWNER OF U.S. REG. NO. 1,265,713.

**CLASS 16—PAPER GOODS AND PRINTED MATTER**

FOR PRINTED PUBLICATIONS, NAMELY, PAMPHLETS DEVOTED TO PROVIDING BUSINESSES WITH ADVICE AND INFORMATION ABOUT CREATING AND PROMOTING DIVERSITY IN THE WORKPLACE (U.S. CLS. 2, 5, 22, 23, 29, 37, 38 AND 50).  
FIRST USE 9-1-2002; IN COMMERCE 9-1-2002.

**CLASS 35—ADVERTISING AND BUSINESS**

FOR BUSINESS INFORMATION AND ADVISORY SERVICES, NAMELY, PROVIDING BUSINESSES WITH ADVICE AND INFORMATION ABOUT CREATING AND PROMOTING DIVERSITY IN THE WORKPLACE, BY MEANS OF A GLOBAL COMPUTER NETWORK (U.S. CLS. 100, 101 AND 102).  
FIRST USE 9-1-2002; IN COMMERCE 9-1-2002.

---

2,929,605. CINETIC AUTOMATION CORPORATION, FARMINGTON HILLS, MI. SN 78-158,059. PUB. 9-9-2003, FILED 8-27-2002.

**AGILOGIX****CLASS 7—MACHINERY**

FOR INDUSTRIAL EQUIPMENT, NAMELY, CONVEYORS, GANTRIES, AND POWER OPERATED FASTENER TIGHTENING TOOLS AND MACHINES; POWER-OPERATED PART HANDLING EQUIPMENT, NAMELY, MACHINES FOR MOVING, REWORKING, TESTING AND INSPECTING PARTS; POWER-OPERATED PART TRANSFER SYSTEMS CONSISTING OF ROLLERS, LIFTS AND ROBOTICS FOR MOVING PARTS; PART ASSEMBLY MACHINES FOR USE IN THE AUTOMOTIVE INDUSTRY; POWER-OPERATED ASSEMBLY LINE AUTOMATION EQUIPMENT, NAMELY, MACHINES OPERABLE TO MOVE, ASSEMBLE, TEST, INSPECT, FASTEN, WASH AND CLEAN PARTS; AND INDUSTRIAL MACHINES OPERABLE TO WASH AND CLEAN INDUSTRIAL PARTS AND PALLETS (U.S. CLS. 13, 19, 21, 23, 31, 34 AND 35).  
FIRST USE 7-31-2004; IN COMMERCE 7-31-2004.

**CLASS 9—ELECTRICAL AND SCIENTIFIC APPARATUS**

FOR ASSEMBLY LINE AUTOMATION EQUIPMENT, NAMELY INDUSTRIAL PROCESS CONTROL SOFTWARE AND HARDWARE FOR USE ON AN ASSEMBLY LINE, COMPUTER SOFTWARE AND HARDWARE FOR AUTOMATED FASTENING EQUIPMENT, AND COMPUTER SOFTWARE AND HARDWARE FOR AUTOMATED INSPECTION AND TESTING EQUIPMENT (U.S. CLS. 21, 23, 26, 36 AND 38).  
FIRST USE 7-31-2004; IN COMMERCE 7-31-2004.

---

2,929,610. CARTAGENA, JOSE MANUEL, WOODBRIDGE, VA. SN 78-166,434. PUB. 11-18-2003, FILED 9-20-2002.

**BORICUA COLLECTION**

NO CLAIM IS MADE TO THE EXCLUSIVE RIGHT TO USE "COLLECTION", APART FROM THE MARK AS SHOWN.

THE ENGLISH TRANSLATION OF BORICUA IS "PUERTO RICAN"

**CLASS 25—CLOTHING**

FOR CLOTHING, NAMELY, ATHLETIC SHOES, BEACH SHOES, SHOES, ANKLETS AND SOCKS, BELTS, JERSEYS, SHORT SETS, TIES, TOPS, WRAPS, JACKETS, DENIM JACKETS, FUR JACKETS, LEATHER JACKETS, RAIN JACKETS, WIND RESISTANT JACKETS, WRAP-AROUNDS, CORSETS, BRIEFS, THONGS AND UNDERWEAR; HEADGEAR, NAMELY, HATS AND CAPS (U.S. CLS. 22 AND 39).  
FIRST USE 9-20-2002; IN COMMERCE 9-20-2002.

**CLASS 35—ADVERTISING AND BUSINESS**

FOR RETAIL STORES FEATURING CLOTHING, DISTRIBUTORSHIPS AND MAIL ORDER SERVICES IN THE FIELD OF CLOTHING; MAIL ORDER CATALOG SERVICES IN THE FIELD OF CLOTHING (U.S. CLS. 100, 101 AND 102).  
FIRST USE 7-7-2003; IN COMMERCE 7-7-2003.

---

2,929,618. GUERRA, RENE HECTOR GARZA, SAN PEDRO GARZA GARCIA, NUEVO LEON, MEXICO. SN 78-171,888. PUB. 3-23-2004, FILED 10-7-2002.

**FOR GLOBAL PLAYERS****CLASS 35—ADVERTISING AND BUSINESS**

FOR PROCUREMENT, NAMELY, PURCHASING AIRCRAFT, AIRPLANES, GLIDERS, BALLOONS, JETS AND HELICOPTERS FOR OTHERS (U.S. CLS. 100, 101 AND 102).  
FIRST USE 1-15-2004; IN COMMERCE 1-15-2004.

**CLASS 36—INSURANCE AND FINANCIAL**

FOR BROKERAGE, NAMELY, THE BUYING AND SELLING FOR OTHERS, IN THE FIELD OF AIRCRAFT, AIRPLANES, GLIDERS, BALLOONS, JETS AND HELICOPTERS (U.S. CLS. 100, 101 AND 102).  
FIRST USE 1-15-2004; IN COMMERCE 1-15-2004.

**CLASS 39—TRANSPORTATION AND STORAGE**

FOR TRANSPORT BY AIR, TRAIN AND RAIL; PACKAGING ARTICLES FOR TRANSPORTATION; TRAVEL ARRANGEMENT, NAMELY, MAKING RESERVATIONS AND BOOKINGS FOR TRANSPORTATION (U.S. CLS. 100 AND 105).

FIRST USE 1-15-2004; IN COMMERCE 1-15-2004.

2,929,624. REAL MEASURE CORPORATION, BOULDER, CO. SN 78-178,700. PUB. 3-16-2004, FILED 10-25-2002.

**REAL MEASURE****CLASS 9—ELECTRICAL AND SCIENTIFIC APPARATUS**

FOR SCIENTIFIC, ELECTRICAL, ELECTRONIC, [AND VIDEO] APPARATUS AND INSTRUMENTS FOR PERFORMING DATA ACQUISITION, ESPECIALLY IN INDUSTRY, SCHOOLS, AND OTHER EDUCATIONAL INSTITUTIONS; NAMELY ACCELEROMETERS, BAROMETER PROBES, CONDUCTIVITY PROBES, CURRENT PROBES, FORCE PROBES, HUMIDITY PROBES, MAGNETIC FIELD PROBES, O<sub>2</sub> GAS PROBES, TEMPERATURE PROBES, LIGHT PROBES, PH PROBES, CO<sub>2</sub> GAS SENSOR PROBES, COLORIMETERS, MICROPHONES, SOUND LEVEL PROBES, ION SELECTIVE ELECTRODE PROBES, VOLTAGE LEADS, OXYGEN PROBES, DISSOLVED OXYGEN PROBES, ROTARY MOTION PROBES, TURBIDITY SENSORS, DISTANCE PROBES UTILIZING SONAR TECHNOLOGY, PRESSURE PROBES, LASER SOURCE FOR USE WITH THE PHOTO EVENT PROBES OR STAND-ALONE APPLICATIONS, BOOSTERS (SIGNAL CONDITIONERS USED IN CONJUNCTION WITH PROBES AND SENSORS); AND CABLES, PROBE ADAPTERS, MOUNTING APPARATUS, MODULAR CONNECTORS, POWER SUPPLIES, BATTERY POWER PACKS, INSTRUMENT AND PROBE CASES, DATA ACQUISITION SYSTEM CONSISTING OF PROBE INPUTS ANALOG TO DIGITAL DATA CONVERTERS DIGITAL INPUT/OUTPUT AND COMPUTER CONNECTIVITY, ALL FOR USE THEREWITH IN CONJUNCTION WITH PERSONAL COMPUTERS, HANDHELD COMPUTERS OR OTHER RELATED DEVICES TO DISPLAY AND ANALYZE THE DATA GATHERED USING THE INCLUDED SENSORS AND PROBES; COMPUTER PROGRAMS, NAMELY OPERATING SYSTEM, APPLICATION AND UTILITY PROGRAMS FOR USE WITH ELECTRONIC TEST AND MEASUREMENT RELATING TO DATA ACQUISITION AND ANALYSIS (U.S. CLS. 21, 23, 26, 36 AND 38).

FIRST USE 5-25-2004; IN COMMERCE 5-25-2004.

**CLASS 16—PAPER GOODS AND PRINTED MATTER**

FOR PRINTED MATTER, NAMELY, ELECTRONIC INSTRUMENT OPERATING, REFERENCE, AND MAINTENANCE MANUALS, AND INSTALLATION MANUALS; ADVERTISING AND PROMOTIONAL MATERIAL NAMELY BOOKLETS, BROCHURES, CATALOGS, FLYERS, DATA SHEETS, CHARTS, MAGAZINE, PERIODICALS, NEWSPAPERS, BOOKS, INSTRUCTIONAL, EDUCATIONAL AND TEACHING MATERIAL ALL RELATING TO DATA ACQUISITION HARDWARE OR COMPUTER PROGRAMS, NAMELY APPLICATION AND UTILITY PROGRAMS FOR USE WITH ELECTRONIC TEST AND MEASUREMENT RELATING TO DATA ACQUISITION AND ANALYSIS; COMPUTER PROGRAM MANUALS PERTAINING TO ELECTRONIC INSTRUMENTS AND PROBES; SHIPPING CARTONS, NAMELY, CARDBOARD BOXES FOR SHIPPING PURPOSES (U.S. CLS. 2, 5, 22, 23, 29, 37, 38 AND 50).

FIRST USE 5-25-2004; IN COMMERCE 5-25-2004.

**CLASS 42—SCIENTIFIC, COMPUTER AND LEGAL SERVICES**

FOR INSTRUMENTATION AND PROBE SERVICES, NAMELY, PROBE AND SOFTWARE DESIGN FOR OTHERS, UPDATING AND MAINTENANCE OF APPLICATION SOFTWARE; INSTRUMENTATION AND PROBE EQUIPMENT RENTAL; DESIGN AND DEVELOPMENT OF MEASUREMENT PROBES AND INSTRUMENTS FOR PERFORMING DATA ACQUISITION; CONSULTING SERVICES IN THE FIELD OF ENGINEERING; SCIENTIFIC RESEARCH (U.S. CLS. 100 AND 101).

FIRST USE 8-6-2004; IN COMMERCE 8-6-2004.

2,929,630. DISNEY ENTERPRISES, INC., BURBANK, CA. SN 78-181,724. PUB. 2-10-2004, FILED 11-5-2002.

**DISNEY'S SARATOGA SPRINGS RESORT & SPA**

NO CLAIM IS MADE TO THE EXCLUSIVE RIGHT TO USE "SARATOGA SPRINGS RESORT & SPA", APART FROM THE MARK AS SHOWN.

**CLASS 36—INSURANCE AND FINANCIAL**

FOR VACATION REAL ESTATE TIME-SHARING SERVICES (U.S. CLS. 100, 101 AND 102).

FIRST USE 5-17-2004; IN COMMERCE 5-17-2004.

**CLASS 43—HOTEL AND RESTAURANT SERVICES**

FOR RESTAURANT SERVICES (U.S. CLS. 100 AND 101).

FIRST USE 5-17-2004; IN COMMERCE 5-17-2004.

2,929,647. ISAKSON/BARNHART RETIREMENT DEVELOPMENT CO., LLC, NORCROSS, GA. SN 78-188,846. PUB. 9-16-2003, FILED 11-26-2002.

**PARK SPRINGS****CLASS 36—INSURANCE AND FINANCIAL**

FOR CONTINUING CARE RETIREMENT COMMUNITY OFFERING INDEPENDENT LIVING, NAMELY THE RENTAL OF SINGLE-FAMILY HOMES, DUPLEXES AND APARTMENTS (U.S. CLS. 100, 101 AND 102).

FIRST USE 1-31-2003; IN COMMERCE 1-31-2003.

**CLASS 43—HOTEL AND RESTAURANT SERVICES**

FOR CONTINUING CARE RETIREMENT COMMUNITY OFFERING ASSISTED LIVING, NAMELY PROVIDING ASSISTED LIVING FACILITIES AND RETIREMENT HOME SERVICES (U.S. CLS. 100 AND 101).

FIRST USE 1-31-2003; IN COMMERCE 1-31-2003.

**CLASS 44—MEDICAL, BEAUTY AND AGRICULTURAL SERVICES**

FOR CONTINUING CARE RETIREMENT COMMUNITY OFFERING SKILLED NURSING CARE, INCLUDING DEMENTIA AND ALZHEIMER'S NURSING CARE (U.S. CLS. 100 AND 101).

FIRST USE 1-31-2003; IN COMMERCE 1-31-2003.

2,929,688. CURRENT COMMUNICATIONS SERVICES, LLC, GERMANTOWN, MD. SN 78-214,015. PUB. 10-14-2003, FILED 2-12-2003.

## SUDDENLY, THE WORLD IS IN YOUR POWER.

### CLASS 9—ELECTRICAL AND SCIENTIFIC APPARATUS

FOR VOICE AND DATA COMMUNICATION DEVICES, NAMELY, MODEMS, TELEPHONES, IP-ENABLED HOUSEHOLD APPLIANCES, NAMELY PERSONAL COMPUTERS, INTERNET BRIDGES, ROUTERS, REPEATERS, IP-ENABLED ELECTRIC METERS, VOLTAGE COUPLERS, POWER LINE SERVERS; TELECOMMUNICATIONS SOFTWARE, NAMELY, DRIVER SOFTWARE FOR THE MODEMS; COMMUNICATIONS SOFTWARE FOR TRANSMITTING INFORMATION VIA POWER LINES, RADIO FREQUENCIES, FIBER, AND COPPER, AND FOR PROVIDING ACCESS TO POWER LINE SERVERS (U.S. CLS. 21, 23, 26, 36 AND 38).  
FIRST USE 8-1-2002; IN COMMERCE 8-1-2002.

### CLASS 38—COMMUNICATION

FOR ELECTRONIC COMMUNICATIONS NETWORK SERVICES, NAMELY, TRANSMISSION OF AUDIO AND VIDEO DATA VIA ELECTRONIC COMMUNICATION NETWORKS (U.S. CLS. 100, 101 AND 104).  
FIRST USE 8-1-2002; IN COMMERCE 8-1-2002.

2,929,693. AMPACET CORP., TARRYTOWN, NY. SN 78-218,767. PUB. 2-3-2004, FILED 2-25-2003.

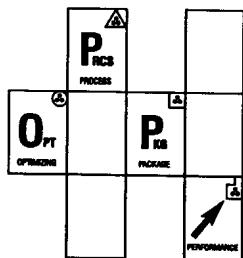

NO CLAIM IS MADE TO THE EXCLUSIVE RIGHT TO USE "PACKAGE" OR "PERFORMANCE", APART FROM THE MARK AS SHOWN.

THE MARK CONSISTS OF THE WORDS AND ABBREVIATIONS OR DESIGNS "OPTIMIZING OPT", "PROCESS PRCS", "PACKAGE PKG", AND "PERFORMANCE" WITH AN ARROW POINTING NORTHWEST, WITH EACH SET OF WORD AND ABBREVIATION AND/OR DESIGN ENCLOSED WITHIN A RECTANGULAR DESIGN. EACH RECTANGULAR DESIGN ALSO CONTAINS A DESIGN IN THE UPPER RIGHT HAND CORNER. THE DESIGN IN THE "OPTIMIZING" RECTANGLE IS OF A CIRCLE WITH THREE SMALL DOTS INSIDE THE CIRCLE IN THE SHAPE OF A TRIANGLE; THE DESIGN IN THE "PROCESS" RECTANGLE IS OF A TRIANGLE WITH THREE SMALL DOTS INSIDE THE TRIANGLE IN THE SHAPE OF A TRIANGLE; THE DESIGN IN THE "PACKAGE" RECTANGLE IS OF A SQUARE WITH THREE SMALL DOTS INSIDE THE SQUARE IN THE SHAPE OF A TRIANGLE; AND THE DESIGN IN THE "PERFORMANCE" RECTANGLE IS OF A STYLIZED STEP WITH THREE SMALL DOTS INSIDE THE STEP IN THE SHAPE OF A TRIANGLE. ALL OF THESE

RECTANGLES ARE CONNECTED TO RESEMBLE A PERIODIC TABLE BUT DO NOT INTERLOCK.

### CLASS 35—ADVERTISING AND BUSINESS

FOR BUSINESS CONSULTATION SERVICES RELATING TO OPERATIONS MANAGEMENT SERVICES, NAMELY, ASSISTING CUSTOMERS IN THE CORRECT USE OF COLOR AND ADDITIVE MASTER BATCH PRODUCTS AND SOLVING PRODUCTION, FINISHED PRODUCT, OTHER CUSTOMER SPECIFIC PROBLEMS RELATING TO COLOR AND MASTER BATCH PRODUCTS (U.S. CLS. 100, 101 AND 102).

FIRST USE 6-23-2004; IN COMMERCE 6-23-2004.

### CLASS 40—MATERIAL TREATMENT

FOR CONSULTATION IN THE FIELD OF MANUFACTURING OF PLASTIC GOODS, NAMELY, OPTIMIZING USE OF COLOR AND ADDITIVE MASTERBATCH PRODUCTS (U.S. CLS. 100, 103 AND 106).

FIRST USE 6-23-2004; IN COMMERCE 6-23-2004.

### CLASS 42—SCIENTIFIC, COMPUTER AND LEGAL SERVICES

FOR ENGINEERING OF PLASTIC GOODS; TECHNICAL CONSULTATION IN THE FIELD OF INGREDIENT FORMULATIONS, COLOR MATCHING, PROCESS CONDITIONS, OPTIMIZING USE OF COLOR AND ADDITIVE MASTER BATCH PRODUCTS; RESEARCH INVOLVING PROPRIETARY BLENDS OF ADDITIVES, RESINS AND PIGMENTS TO PRODUCE UNIQUE OR IMPROVED COLOR AND ADDITIVE MASTER BATCHES FOR THE PLASTICS INDUSTRY; DESIGN AND DEVELOPMENT OF COLOR, BLACK, WHITE AND ADDITIVE CONCENTRATES AND COMPOUNDS FOR PLASTIC APPLICATIONS (U.S. CLS. 100 AND 101).

FIRST USE 6-23-2004; IN COMMERCE 6-23-2004.

2,929,702. KOHLER CO., MINNEAPOLIS, MN. SN 78-228,513. PUB. 1-6-2004, FILED 3-21-2003.

## STILLNESS

OWNER OF U.S. REG. NO. 2,686,661.

### CLASS 6—METAL GOODS

FOR METAL ROBE HOOKS (U.S. CLS. 2, 12, 13, 14, 23, 25 AND 50).

FIRST USE 4-0-2002; IN COMMERCE 4-0-2002.

### CLASS 20—FURNITURE AND ARTICLES NOT OTHERWISE CLASSIFIED

FOR SHELVES MADE OF GLASS OR PORCELAIN FOR BATHROOM USE (U.S. CLS. 2, 13, 22, 25, 32 AND 50).

FIRST USE 4-0-2002; IN COMMERCE 4-0-2002.

### CLASS 21—HOUSEWARES AND GLASS

FOR BATHROOM ACCESSORIES, NAMELY DRINKING GLASSES; WASH BASINS; SOAP DISHES; SOAP DISPENSERS; PAPER TOWEL DISPENSERS; TOILET PAPER HOLDERS AND DISPENSERS; TOWEL BARS AND TOWEL HOLDERS; AND TOOTHBRUSH HOLDERS (U.S. CLS. 2, 13, 23, 29, 30, 33, 40 AND 50).

FIRST USE 4-0-2002; IN COMMERCE 4-0-2002.

2,929,723. INTELLECTUAL PROPERTY RESEARCH, INCORPORATED, ARLINGTON, VA. SN 78-238,313. PUB. 3-16-2004, FILED 4-16-2003.



NO CLAIM IS MADE TO THE EXCLUSIVE RIGHT TO USE IP, APART FROM THE MARK AS SHOWN.

#### **CLASS 35—ADVERTISING AND BUSINESS**

FOR PATENT, TRADEMARK AND COPYRIGHT SUPPORT SERVICES, NAMELY, FILE WRAPPER AND DOCUMENT COPYING SERVICES, DOCUMENT FILING SERVICES (U.S. CLS. 100, 101 AND 102).  
FIRST USE 1-1-2004; IN COMMERCE 1-1-2004.

#### **CLASS 42—SCIENTIFIC, COMPUTER AND LEGAL SERVICES**

FOR INTELLECTUAL PROPERTY RESEARCH SERVICES, NAMELY, CONDUCTING PATENT, TRADEMARK AND COPYRIGHT SEARCHES (U.S. CLS. 100 AND 101).  
FIRST USE 1-1-2004; IN COMMERCE 1-1-2004.

2,929,728. 2000717 ONTARIO LIMITED, BROCKVILLE, ONTARIO, CANADA. SN 78-240,067. PUB. 5-11-2004, FILED 4-21-2003.

## **FINER-THINGS**

PRIORITY CLAIMED UNDER SEC. 44(D) ON CANADA APPLICATION NO. 1168061, FILED 2-19-2003.

#### **CLASS 9—ELECTRICAL AND SCIENTIFIC APPARATUS**

FOR CAMERAS, BINOCULARS, RADIOS, CD PLAYERS, CD RADIOS, MP3 PLAYERS, CD/RADIO ALARMS (U.S. CLS. 21, 23, 26, 36 AND 38).  
FIRST USE 10-1-2002; IN COMMERCE 10-1-2003.

#### **CLASS 10—MEDICAL APPARATUS**

FOR ELECTRIC MASSAGE CHAIR (U.S. CLS. 26, 39 AND 44).  
FIRST USE 10-1-2002; IN COMMERCE 10-1-2003.

#### **CLASS 18—LEATHER GOODS**

FOR LUGGAGE (U.S. CLS. 1, 2, 3, 22 AND 41).  
FIRST USE 10-1-2002; IN COMMERCE 10-1-2003.

2,929,745. WATKINS, INC., WINONA, MN. SN 78-250,378. PUB. 3-2-2004, FILED 5-15-2003.

good  
tastings  
by watkins

OWNER OF U.S. REG. NOS. 1,069,259, 2,661,891, AND OTHERS.

#### **CLASS 16—PAPER GOODS AND PRINTED MATTER**

FOR PUBLICATIONS AND PRINTED MATTER, NAMELY, COOKBOOKS, BOOKS, BOOKLETS, MAGAZINES, PAMPHLETS, PRINTED REPORTS, MANUALS, RECIPE CARDS, BROCHURES, NEWSLETTERS AND JOURNALS, ALL ON THE SUBJECTS OF FOOD AND/OR FOOD PREPARATION, PAPER TABLE CLOTHS, PAPER NAPKINS AND PAPER PLACEMATS (U.S. CLS. 2, 5, 22, 23, 29, 37, 38 AND 50).  
FIRST USE 12-31-2003; IN COMMERCE 12-31-2003.

#### **CLASS 24—FABRICS**

FOR KITCHEN TEXTILE ITEMS, NAMELY, TOWELS, DISH CLOTHS, POTHOLDERS, OVEN MITTS, TABLE-CLOTHS, PLACEMATS AND NAPKINS (U.S. CLS. 42 AND 50).  
FIRST USE 4-1-2004; IN COMMERCE 4-1-2004.

#### **CLASS 41—EDUCATION AND ENTERTAINMENT**

FOR CONDUCTING WORKSHOPS AND SEMINARS IN THE FIELD OF NUTRITION INCLUDING THE SUBJECTS OF FOOD AND FOOD PREPARATION; DEVELOPING EDUCATIONAL MANUALS FOR OTHERS, NAMELY FOR INDEPENDENT BUSINESS CONSULTANTS, IN THE FIELDS OF FOOD AND FOOD PREPARATION; EDUCATIONAL SERVICES, NAMELY CONDUCTING ON-LINE EXHIBITIONS AND DISPLAYS AND INTERACTIVE EXHIBITS IN THE FIELDS OF FOOD AND FOOD PREPARATION (U.S. CLS. 100, 101 AND 107).  
FIRST USE 6-1-2004; IN COMMERCE 6-1-2004.

2,929,747. APPRIZE, INC., EDINA, MN. SN 78-250,865. PUB. 12-2-2003, FILED 5-16-2003.

## **APPRIZE**

#### **CLASS 36—INSURANCE AND FINANCIAL**

FOR REAL ESTATE BROKERAGE, REAL ESTATE MANAGEMENT, REAL ESTATE INVESTMENT AND REAL ESTATE ACQUISITION SERVICES (U.S. CLS. 100, 101 AND 102).  
FIRST USE 5-0-2003; IN COMMERCE 5-0-2003.

#### **CLASS 37—CONSTRUCTION AND REPAIR**

FOR REAL ESTATE DEVELOPMENT (U.S. CLS. 100, 103 AND 106).  
FIRST USE 5-0-2003; IN COMMERCE 5-0-2003.

2,929,754. TCI ENTERPRISES LLC, NEW YORK, NY. SN 78-255,931. PUB. 3-16-2004, FILED 5-29-2003.

2,929,773. FARLAN ENTERTAINMENT, PORT LOUIS, MAURITIUS. SN 78-262,961. PUB. 2-24-2004, FILED 6-16-2003.

## THE COMPLETE INVESTOR

**DNL**

NO CLAIM IS MADE TO THE EXCLUSIVE RIGHT TO USE "INVESTOR", APART FROM THE MARK AS SHOWN.

### CLASS 16—PAPER GOODS AND PRINTED MATTER

FOR PRINTED PUBLICATIONS, NAMELY, NEWSLETTERS IN THE FIELD OF FINANCIAL INFORMATION (U.S. CLS. 2, 5, 22, 23, 29, 37, 38 AND 50).  
FIRST USE 9-0-2003; IN COMMERCE 9-0-2003.

### CLASS 41—EDUCATION AND ENTERTAINMENT

FOR COMPUTER SERVICES, NAMELY, PROVIDING ON-LINE NEWSLETTERS IN THE FIELD OF FINANCIAL INFORMATION (U.S. CLS. 100, 101 AND 107).  
FIRST USE 8-0-2003; IN COMMERCE 8-0-2003.

### CLASS 9—ELECTRICAL AND SCIENTIFIC APPARATUS

FOR COMPUTER AND VIDEO GAME SOFTWARE (U.S. CLS. 21, 23, 26, 36 AND 38).  
FIRST USE 9-21-2004; IN COMMERCE 9-21-2004.

### CLASS 41—EDUCATION AND ENTERTAINMENT

FOR ENTERTAINMENT SERVICES, NAMELY OPERATING AN INTERACTIVE GAME PLAYED BY OTHERS OVER A GLOBAL COMMUNICATIONS NETWORK (U.S. CLS. 100, 101 AND 107).  
FIRST USE 9-21-2004; IN COMMERCE 9-21-2004.

2,929,766. UNITED SERVICE ORGANIZATIONS, INC., WASHINGTON, DC. SN 78-260,259. PUB. 2-10-2004, FILED 6-10-2003.

2,929,777. SAKURA FINETEK, U.S.A., INC., TORRANCE, CA. SN 78-266,653. PUB. 7-27-2004, FILED 6-24-2003.

## UNTIL EVERY ONE COMES HOME

## TISSUE-TEK XPRESS

### CLASS 14—JEWELRY

FOR DECORATIVE COINS (U.S. CLS. 2, 27, 28 AND 50).  
FIRST USE 1-0-2003; IN COMMERCE 1-0-2003.

### CLASS 16—PAPER GOODS AND PRINTED MATTER

FOR PRINTED MATERIALS, NAMELY, PAPER AND PAPER ARTICLES, BROCHURES, PERIODICALS, POSTERS, STATIONERY, AND INSTRUCTIONAL MATERIALS IN THE FIELD OF CHARITABLE FUNDRAISING (U.S. CLS. 2, 5, 22, 23, 29, 37, 38 AND 50).  
FIRST USE 10-0-2002; IN COMMERCE 10-0-2002.

### CLASS 25—CLOTHING

FOR CLOTHING, NAMELY T-SHIRTS (U.S. CLS. 22 AND 39).  
FIRST USE 7-0-2004; IN COMMERCE 7-0-2004.

### CLASS 36—INSURANCE AND FINANCIAL

FOR CHARITABLE FUNDRAISING (U.S. CLS. 100, 101 AND 102).  
FIRST USE 10-0-2002; IN COMMERCE 10-0-2002.

### CLASS 9—ELECTRICAL AND SCIENTIFIC APPARATUS

FOR RESEARCH AND LABORATORY EQUIPMENT AND SUPPLIES, NAMELY VACUUM INFILTRATION PROCESSORS, PARAFFIN INFILTRATION PROCESSORS, TISSUE PROCESSING EQUIPMENT, NAMELY KNIVES, BLADES, FORKS AND TISSUE PROCESSORS FOR PROCESSING BIOLOGICAL SAMPLES FOR SUBSEQUENT TESTING OR EXAMINATION BY FIXATION, DEHYDRATION, CLEARING AND IMPREGNATION, MICROWAVE PROCESSORS, REAGENTS, FIXATIVES, PARAFFIN AND FILTERS (U.S. CLS. 21, 23, 26, 36 AND 38).  
FIRST USE 10-19-2003; IN COMMERCE 2-27-2004.

### CLASS 10—MEDICAL APPARATUS

FOR DIAGNOSTIC MEDICAL LABORATORY AND PATHOLOGY EQUIPMENT AND SUPPLIES, NAMELY VACUUM INFILTRATION PROCESSORS, PARAFFIN INFILTRATION PROCESSORS, TISSUE PROCESSING EQUIPMENT, NAMELY KNIVES, BLADES, FORKS AND TISSUE PROCESSORS FOR PROCESSING BIOLOGICAL SAMPLES FOR SUBSEQUENT TESTING OR EXAMINATION BY FIXATION, DEHYDRATION, CLEARING AND IMPREGNATION, MICROWAVE PROCESSORS, REAGENTS, FIXATIVES, PARAFFIN AND FILTERS (U.S. CLS. 26, 39 AND 44).  
FIRST USE 10-19-2003; IN COMMERCE 2-27-2004.

2,929,784. INNOCORP, LLC, VERONA, WI. SN 78-270,412.  
PUB. 4-13-2004, FILED 7-3-2003.



### CLASS 12—VEHICLES

FOR MOTORIZED LAND VEHICLES NAMELY, VEHICLES USED FOR DEMONSTRATING THE EFFECTS OF IMPAIRED OPERATION OF A VEHICLE (U.S. CLS. 19, 21, 23, 31, 35 AND 44).

FIRST USE 3-13-2003; IN COMMERCE 3-13-2003.

### CLASS 41—EDUCATION AND ENTERTAINMENT

FOR EDUCATIONAL PROGRAMS IN THE FIELD OF IMPAIRED OPERATION OF VEHICLES AND RELATED MATERIALS (U.S. CLS. 100, 101 AND 107).

FIRST USE 8-0-2003; IN COMMERCE 8-0-2003.

2,929,808. GORSTEW LIMITED, KINGSTON 5, JAMAICA.  
SN 78-283,401. PUB. 6-22-2004, FILED 8-5-2003.

## FAMILYMOONS

### CLASS 39—TRANSPORTATION AND STORAGE

FOR ARRANGING FOR TRAVEL TOURS; TRAVEL AGENCY SERVICES, NAMELY, MAKING RESERVATIONS AND BOOKINGS FOR TRANSPORTATION (U.S. CLS. 100 AND 105).

FIRST USE 1-0-2004; IN COMMERCE 1-0-2004.

### CLASS 43—HOTEL AND RESTAURANT SERVICES

FOR TRAVEL AGENCY SERVICES, NAMELY, MAKING RESERVATIONS AND BOOKINGS FOR TEMPORARY LODGING AT HOTELS (U.S. CLS. 100 AND 101).

FIRST USE 1-0-2004; IN COMMERCE 1-0-2004.

2,929,826. SCREENLIFE, LLC, SEATTLE, WA. SN 78-294,020.  
PUB. 6-15-2004, FILED 8-29-2003.

## HAVE YOU SCENEIT?

OWNER OF U.S. REG. NO. 275,131.

### CLASS 9—ELECTRICAL AND SCIENTIFIC APPARATUS

FOR COMPUTER GAME PROGRAMS, COMPUTER GAME SOFTWARE, VIDEO GAME PROGRAMS, VIDEO GAME SOFTWARE, PRE-RECORDED DIGITAL VIDEO DISCS FEATURING VIDEO CLIPS, MOVIE CLIPS AND MOVIE RELATED CLIPS; GAME EQUIPMENT, NAMELY, PRE-RECORDED DIGITAL VIDEO DISCS FEATURING VIDEO CLIPS, MOVIE CLIPS AND MOVIE RELATED CLIPS (U.S. CLS. 21, 23, 26, 36 AND 38).

FIRST USE 10-22-2004; IN COMMERCE 10-22-2004.

### CLASS 28—TOYS AND SPORTING GOODS

FOR EQUIPMENT SOLD AS A UNIT FOR PLAYING A BOARD OR PARLOR GAME (U.S. CLS. 22, 23, 38 AND 50).

FIRST USE 10-22-2004; IN COMMERCE 10-22-2004.

2,929,837. RAZOR & TIE DIRECT, L.L.C., NEW YORK, NY.  
SN 78-301,725. PUB. 6-8-2004, FILED 9-17-2003.

## VIDEOSPACE

### CLASS 35—ADVERTISING AND BUSINESS

FOR ONLINE RETAIL STORE SERVICES PROVIDED VIA A GLOBAL COMPUTER NETWORK FEATURING DVDS, MOVIES, MUSIC, COMPACT DISCS, BOOKS, MAGAZINES, POSTERS, CLOTHING, TOYS, GAMES AND COMPUTER, VIDEO AND ELECTRONIC GAMES (U.S. CLS. 100, 101 AND 102).

FIRST USE 3-28-2003; IN COMMERCE 3-28-2003.

### CLASS 41—EDUCATION AND ENTERTAINMENT

FOR PROVIDING A WEB SITE CONTAINING INFORMATION AND CONTENT ON MOVIES, VIDEOS, MUSIC, TOYS, GAMES AND ELECTRONIC GAMES (U.S. CLS. 100, 101 AND 107).

FIRST USE 3-28-2003; IN COMMERCE 3-28-2003.

2,929,844. MAXWAX INC., NEW YORK, NY. SN 78-305,723.  
PUB. 6-8-2004, FILED 9-26-2003.

## MAXWAX

### CLASS 3—COSMETICS AND CLEANING PREPARATIONS

FOR WAX FOR REMOVING BODY HAIR AND PRODUCTS TO FACILITATE THE WAXING PROCESS NAMELY SOAPS, BODY SCRUBS, TONICS, OILS AND LOTIONS (U.S. CLS. 1, 4, 6, 50, 51 AND 52).

FIRST USE 7-2-2003; IN COMMERCE 7-2-2003.

### CLASS 44—MEDICAL, BEAUTY AND AGRICULTURAL SERVICES

FOR BEAUTY SALONS FEATURING BODY WAXING SERVICES (U.S. CLS. 100 AND 101).

FIRST USE 7-2-2003; IN COMMERCE 7-2-2003.



2,929,845. ASSOCIATED MATERIALS, INC., DBA ALSIDE, CUYAHOGA FALLS, OH. SN 78-306,666. PUB. 7-20-2004, FILED 9-29-2003.

2,929,894. WASHINGTON MUTUAL, INC., SEATTLE, WA. SN 78-975,792. PUB. 3-11-2003, FILED 11-27-2001.

**BECAUSE LIFE IS FOR LIVING**



THE MARK CONSISTS OF A REPRESENTATION OF A COIN WITH A STYLIZED HUMAN FACE.

**CLASS 35—ADVERTISING AND BUSINESS**

FOR WHOLESALE DISTRIBUTORSHIPS IN THE FIELD OF BUILDING MATERIALS, NAMELY, SIDING, WINDOWS, DECKING PRODUCTS, BUILDING TRIM AND BUILDING MATERIAL ACCESSORIES (U.S. CLS. 100, 101 AND 102).

FIRST USE 9-0-2003; IN COMMERCE 9-0-2003.

**CLASS 40—MATERIAL TREATMENT**

FOR MANUFACTURE OF BUILDING MATERIALS, NAMELY, SIDING, WINDOWS, DECKING PRODUCTS, BUILDING TRIM, AND BUILDING MATERIAL ACCESSORIES, TO ORDER AND/OR THE SPECIFICATION OF OTHERS; COLOR MATCHING SERVICES IN THE FIELD OF BUILDING MATERIALS (U.S. CLS. 100, 103 AND 106).

FIRST USE 9-0-2003; IN COMMERCE 9-0-2003.

**CLASS 36—INSURANCE AND FINANCIAL**

FOR PROVIDING AN INTERACTIVE WEBSITE CONTAINING INFORMATION AND SERVICES PRIMARILY RELATING TO BANKING SERVICES AND SCHOOL BANKING PROGRAMS; PHILANTHROPIC SERVICES CONCERNING MONETARY DONATIONS (U.S. CLS. 100, 101 AND 102).

FIRST USE 6-30-1998; IN COMMERCE 6-30-1998.

**CLASS 42—SCIENTIFIC, COMPUTER AND LEGAL SERVICES**

FOR TEMPORARY USE OF NON-DOWNLOADABLE SOFTWARE USED IN CONNECTION WITH BANKING SERVICES AND SCHOOL BANKING PROGRAMS (U.S. CLS. 100 AND 101).

FIRST USE 3-31-2003; IN COMMERCE 3-31-2003.

\* \* \* \* \*

## SECTION 2.— INTERNATIONAL CLASSIFICATION

The short titles associated below with the international class numbers are terms designed merely for quick identification and are not an official part of the international classification. The full names of international classes are given in section 6.1 of the trademark rules of practice.

The designation "U.S. Cl." appearing in this section refers to the U.S. class in effect prior to Sep. 1, 1973 rather than the international class which applies to applications filed on or after that date. For adoption of international classification see notice in the OFFICIAL GAZETTE of Jun. 26, 1973 (911 O.G. TM 210).

### Application in one class

#### CLASS 1—CHEMICALS

2,929,193. J.R. SIMPLOT COMPANY, BOISE, NV. SN 76-270,538. PUB. 8-6-2002, FILED 6-12-2001.

#### SP SUPER CAL FORMULA

NO CLAIM IS MADE TO THE EXCLUSIVE RIGHT TO USE "FORMULA", APART FROM THE MARK AS SHOWN. FOR WATER SOLUBLE FERTILIZER FOR TURF AND ORNAMENTAL APPLICATIONS (U.S. CLS. 1, 5, 6, 10, 26 AND 46).

FIRST USE 3-25-2002; IN COMMERCE 3-25-2002.

2,929,194. J.R. SIMPLOT COMPANY, BOISE, ID. SN 76-270,546. PUB. 8-6-2002, FILED 6-12-2001.

#### SP SUMMER AID

NO CLAIM IS MADE TO THE EXCLUSIVE RIGHT TO USE "SUMMER AID", APART FROM THE MARK AS SHOWN.

FOR WATER SOLUBLE FERTILIZER FOR TURF AND ORNAMENTAL APPLICATIONS (U.S. CLS. 1, 5, 6, 10, 26 AND 46).

FIRST USE 4-17-2002; IN COMMERCE 4-17-2002.

2,929,220. BIOENVELOP AGRO INC., LAVAL, QUEBEC, CANADA. SN 76-331,943. PUB. 7-2-2002, FILED 10-30-2001.

#### BARI-KAD

FOR BIOLOGICAL PREPARATION THAT PREVENTS THE TRANSFER OF HUMIDITY BETWEEN FOODS (U.S. CLS. 1, 5, 6, 10, 26 AND 46).

FIRST USE 5-0-2004; IN COMMERCE 5-0-2004.

#### CLASS 1—(Continued).

2,929,258. CHITEC CHEMICAL CO., LTD., TAIPEI HSIEN, TAIWAN. SN 76-393,062. PUB. 2-24-2004, FILED 4-3-2002.

# Chisorb

FOR NON-PIGMENTED ADDITIVES FOR INKS, PAINTS, COATINGS, AND THIN FILMS FOR IMPROVING AND CONTROLLING THEIR ODOR, CURING, ADHESION, AND RESISTANCE TO VISIBLE AND ULTRAVIOLET LIGHT, AND FOR INITIATING PHOTO-REACTIONS (U.S. CLS. 1, 5, 6, 10, 26 AND 46).

FIRST USE 3-1-2002; IN COMMERCE 9-17-2003.

2,929,279. BUCKMAN LABORATORIES INTERNATIONAL, INC., MEMPHIS, TN. SN 76-429,945. PUB. 1-28-2003, FILED 7-10-2002.

#### OPTIMYZE

FOR CHEMICALS USED IN PROCESSING WOOD PULP AND MANUFACTURING PAPER (U.S. CLS. 1, 5, 6, 10, 26 AND 46).

FIRST USE 11-8-2002; IN COMMERCE 11-8-2002.

2,929,404. AGENCOURT BIOSCIENCE CORPORATION, BEVERLY, MA. SN 76-516,614. PUB. 12-2-2003, FILED 5-23-2003.

#### SPRINTPREP

FOR DNA PURIFICATION KIT CONSISTING OF REAGENTS AND MAGNETIC BEADS USED TO PURIFY PLASMID, COSMID, FOSMID, AND BAC DNA FOR SCIENTIFIC RESEARCH (U.S. CLS. 1, 5, 6, 10, 26 AND 46).

FIRST USE 6-16-2003; IN COMMERCE 6-16-2003.

**CLASS 1—(Continued).**

2,929,481. INTERDYNAMICS, INC., BROOKLYN, NY. SN 76-545,822. PUB. 6-15-2004, FILED 9-22-2003.

**EZ CHILL**

OWNER OF U.S. REG. NO. 2,761,612.  
FOR REFRIGERANT CHEMICAL PREPARATIONS FOR USE IN AUTOMOTIVE AIR CONDITIONERS (U.S. CLS. 1, 5, 6, 10, 26 AND 46).  
FIRST USE 8-1-2003; IN COMMERCE 8-1-2003.

2,929,485. LIFE AUTOMOTIVE PRODUCTS, INC., CORDOVA, TN. SN 76-549,417. PUB. 7-6-2004, FILED 9-15-2003.

**TITANIUM**

FOR CHEMICAL ADDITIVES FOR TRANSMISSION FLUIDS (U.S. CLS. 1, 5, 6, 10, 26 AND 46).  
FIRST USE 3-8-2004; IN COMMERCE 3-11-2004.

2,929,534. COLOR FAST INDUSTRIES INC., COLTON, CA. SN 78-044,475. PUB. 12-31-2002, FILED 1-23-2001.

**FLUOROGUARD**

FOR CHEMICAL COMPOSITION, NAMELY, A WATER, OIL AND STAIN REPELLANT FOR USE ON GROUT, STONE, MARBLE, QUARRY, GRANITE, CEMENT AND CERAMIC TILE, SOLD AS AN INTEGRAL PART OF GROUT COLORANT OR GROUT (U.S. CLS. 1, 5, 6, 10, 26 AND 46).  
FIRST USE 4-1-2001; IN COMMERCE 4-1-2001.

2,929,574. INOLEX INVESTMENT CORPORATION, WILMINGTON, DE. SN 78-126,950. PUB. 11-5-2002, FILED 5-7-2002.

**LEXFEEL**

FOR CHEMICAL ADDITIVES FOR USE IN MANUFACTURE OF COSMETICS (U.S. CLS. 1, 5, 6, 10, 26 AND 46).  
FIRST USE 4-0-2002; IN COMMERCE 8-12-2002.

2,929,636. CEWAL, INC., LOS ANGELES, CA. SN 78-185,316. PUB. 2-3-2004, FILED 11-14-2002.

**HEALING WATERS**

NO CLAIM IS MADE TO THE EXCLUSIVE RIGHT TO USE "WATERS", APART FROM THE MARK AS SHOWN.  
FOR ELECTROLYZED OXIDIZING WATER FOR SANITIZING AND STERILIZING KITCHENS, BATHS, LOCKERS, EATING UTENSILS, OFFICE EQUIPMENT, GYMNASIUM EQUIPMENT, AND OTHER SURFACES (U.S. CLS. 1, 5, 6, 10, 26 AND 46).  
FIRST USE 1-4-2003; IN COMMERCE 1-4-2003.

**CLASS 1—(Continued).**

2,929,697. ULTIMATE OUTDOOR SOLUTIONS, INC., RANGER, GA. SN 78-220,146. PUB. 12-16-2003, FILED 2-28-2003.

**DOWN-WIND**

FOR CHEMICAL ENZYMES FOR USE IN ELIMINATING ODORS (U.S. CLS. 1, 5, 6, 10, 26 AND 46).  
FIRST USE 2-12-2004; IN COMMERCE 2-12-2004.

2,929,713. SEALED AIR CORPORATION (US), SADDLEBROOK, NJ. SN 78-235,170. PUB. 12-2-2003, FILED 4-8-2003.

**INSTAPAK FLOWRITE**

OWNER OF U.S. REG. NOS. 1,066,466, 2,590,241, AND OTHERS.  
FOR CHEMICAL PRECURSORS FOR USE IN PRODUCING POLYURETHANE PACKING FOAM (U.S. CLS. 1, 5, 6, 10, 26 AND 46).  
FIRST USE 5-6-2003; IN COMMERCE 5-6-2003.

2,929,760. UNIGEN PHARMACEUTICALS, INC., LACEY, WA. SN 78-257,801. PUB. 2-10-2004, FILED 6-3-2003.

**DIAFIN**

FOR CHEMICAL ADDITIVES FOR USE AS INGREDIENTS IN THE MANUFACTURE OF NUTRITIONAL SUPPLEMENTS, NAMELY DIETING AIDS (U.S. CLS. 1, 5, 6, 10, 26 AND 46).  
FIRST USE 11-18-2003; IN COMMERCE 11-18-2003.

2,929,761. UNIGEN PHARMACEUTICALS, INC., LACEY, WA. SN 78-257,823. PUB. 2-10-2004, FILED 6-3-2003.

**LASOPERIN**

FOR CHEMICAL ADDITIVES FOR USE AS INGREDIENTS IN THE MANUFACTURE OF DIETARY SUPPLEMENTS AND PHARMACEUTICALS FOR IMPROVING MENTAL ACUITY AND MEMORY (U.S. CLS. 1, 5, 6, 10, 26 AND 46).  
FIRST USE 4-1-2004; IN COMMERCE 4-1-2004.

2,929,792. BARDAHL MANUFACTURING CORPORATION, SEATTLE, WA. SN 78-275,252. PUB. 3-23-2004, FILED 7-16-2003.

**NO-SMOKE WITH SLUDGE GUARD**

FOR CHEMICAL ENGINE OIL ADDITIVE (U.S. CLS. 1, 5, 6, 10, 26 AND 46).  
FIRST USE 1-0-2004; IN COMMERCE 1-0-2004.

**CLASS 1—(Continued).**

2,929,869. ENVIROTECH SERVICES, INC., GREELEY, CO.  
SN 78-318,425. PUB. 8-10-2004, FILED 10-24-2003.

**TEMPROTECT**

FOR CHEMICAL COMPOSITION TO BE SPREAD  
OVER GRASS, TURF AND GOLF COURSES TO PRE-  
VENT FROST (U.S. CLS. 1, 5, 6, 10, 26 AND 46).  
FIRST USE 3-10-2004; IN COMMERCE 3-10-2004.

**CLASS 2—PAINTS**

2,929,197. SAWGRASS SYSTEMS, INC., MT. PLEASANT, SC.  
SN 76-279,675. PUB. 1-1-2002, FILED 7-2-2001.

**NATURALINK**

FOR PHOTOCOPIER TONER; PHOTOCOPIER TONER  
IN CARTRIDGES; COMPUTER PRINTER RIBBONS; INK  
JET PRINTER INK (U.S. CLS. 6, 11 AND 16).  
FIRST USE 5-1-2000; IN COMMERCE 4-1-2002.

2,929,429. DPI CO., LTD., GYOUNGGI-DO, 430-030, REPUB-  
LIC OF KOREA. SN 76-525,907. PUB. 6-8-2004, FILED 6-25-  
2003.



NO CLAIM IS MADE TO THE EXCLUSIVE RIGHT TO  
USE "AUTO-REFINISHES", APART FROM THE MARK AS  
SHOWN.

COLOR IS A SPECIAL FEATURE OF THE MARK.  
APPLICANT INTENDS TO USE THE MARK IN COLOR AS  
FOLLOWS: THE BLOCKS APPEARING WITH THE LET-  
TERS "DPI" ARE RED, BLUE AND GREEN, RESPEC-  
TIVELY, AND THE CAR IS YELLOW. THE LINE  
BENEATH THE BLACK WORDING "AUTO-REFINISHES"  
IS RED, ORANGE AND YELLOW.

FOR CAR PAINT (U.S. CLS. 6, 11 AND 16).  
FIRST USE 7-1-2000; IN COMMERCE 5-1-2003.

2,929,617. SEALSOURCE, LLC, OREM, UT. SN 78-171,046.  
PUB. 7-27-2004, FILED 10-4-2002.

**SEALSOURCE**

NO CLAIM IS MADE TO THE EXCLUSIVE RIGHT TO  
USE SEAL, APART FROM THE MARK AS SHOWN.

FOR SEALER COATINGS, SEALER COATINGS IN  
THE NATURE OF HARDENERS, PENETRATING COL-  
OR SEALER-HARDENERS, AND ANTI-GRAFFITI SEAL-  
ER COATINGS, ALL FOR USE ON CONCRETE AND  
MASONRY SURFACES (U.S. CLS. 6, 11 AND 16).  
FIRST USE 3-3-2003; IN COMMERCE 4-18-2003.

**CLASS 3—COSMETICS AND CLEANING PRE-  
PARATIONS**

2,929,063. PARFUMS VAN CLEEF & ARPELS S. A.,  
NEUILLY SUR SEINE, FRANCE. SN 75-748,629. PUB. 3-  
16-2004, FILED 7-7-1999.

**ZANZIBAR**

OWNER OF U.S. REG. NO. 2,497,410.  
FOR PERFUME, EAU DE PARFUM, EAU DE TOIL-  
ETTE, PERFUMED MILK, CREAM, LOTION AND POW-  
DER FOR BODY CARE, SHAVING CREAMS, PRE-  
SHAVE AND AFTER-SHAVE LOTIONS, BATH AND  
SHOWER GELS, SOAPS, DEODORANTS FOR PERSON-  
AL USE, TALC, SKIN CARE PRODUCTS, NAMELY  
CREAMS AND LOTIONS (U.S. CLS. 1, 4, 6, 50, 51 AND  
52).

FIRST USE 4-0-2001; IN COMMERCE 4-0-2001.

2,929,115. INNOVATIONS – SUCCESSFUL SALON SER-  
VICES, INC., CHATSWORTH, CA. SN 76-139,304. PUB. 2-  
17-2004, FILED 10-3-2000.

**AROMA AESTHETICS**

NO CLAIM IS MADE TO THE EXCLUSIVE RIGHT TO  
USE "AROMA", APART FROM THE MARK AS SHOWN.

FOR BATH AND BODY PRODUCTS, NAMELY, BODY  
LOTIONS, SHOWER GELS, BATH SALTS, BODY AND  
FACIAL SCRUBS AND EXFOLIANTS, BATH CREAM,  
HAND CREAM, BODY AND FACIAL MISTS, MASSAGE  
AND BODY OILS AND PERFUMES, MOISTURIZERS  
AND CLEANERS (U.S. CLS. 1, 4, 6, 50, 51 AND 52).

FIRST USE 5-25-2004; IN COMMERCE 5-25-2004.

2,929,170. LABORATOIRES DE BIOLOGIE VEGETALE YVES  
ROCHER, 56200 LA GACILLY, FRANCE. SN 76-243,563.  
PUB. 7-23-2002, FILED 4-19-2001.

**TOURBILLON**

THE TERM "TOURBILLON" TRANSLATES TO THE  
ENGLISH WORD WHIRLWIND

FOR ESSENTIAL OILS FOR PERSONAL USE,  
NAMELY PERFUMED OILS AND AROMATHERAPY  
OILS (U.S. CLS. 1, 4, 6, 50, 51 AND 52).

FIRST USE 4-10-2003; IN COMMERCE 4-10-2003.

**CLASS 3—(Continued).**

2,929,231. LABORATOIRES M.A.I. (MISS ANTILLES INTERNATIONAL), SAINT SOUPLLETS, FRANCE. SN 76-351,200. PUB. 11-5-2002, FILED 12-19-2001.

**MAITRISE PROFESSIONAL**

NO CLAIM IS MADE TO THE EXCLUSIVE RIGHT TO USE "PROFESSIONAL", APART FROM THE MARK AS SHOWN.

THE ENGLISH TRANSLATION OF "MAITRISE" IS "EXPERTISE", "SPECIALTY" OR "TECHNIQUE".

FOR COSMETICS, NAMELY, SKIN MILKS, BODY LOTIONS, PERFUMED SOAP, PERSONAL DEODORANTS, BATH PRODUCTS, NAMELY, BUBBLE BATH, PERFUMED BODY LOTIONS; HAIR CARE PRODUCTS, NAMELY, HAIR CREAM, HAIR LOTIONS, HAIR POMADES, HAIR CONDITIONERS, HAIR LACQUERS AND HAIR SHAMPOOS (U.S. CLS. 1, 4, 6, 50, 51 AND 52).  
FIRST USE 10-22-1991; IN COMMERCE 6-10-2004.

2,929,232. LABORATOIRES M.A.I. (MISS ANTILLES INTERNATIONAL), SAINT SOUPLLETS, FRANCE. SN 76-351,201. PUB. 11-5-2002, FILED 12-19-2001.

**HAUTE TEC HAIR**

NO CLAIM IS MADE TO THE EXCLUSIVE RIGHT TO USE "HAIR", APART FROM THE MARK AS SHOWN.

THE ENGLISH TRANSLATION OF THE WORD "HAUTE TEC" IS "HIGH TECHNOLOGY" OR "HIGH TECH".

FOR COSMETICS, NAMELY, SKIN MILKS, BODY LOTIONS, PERFUMED SOAP, PERSONAL DEODORANTS, BATH PRODUCTS, NAMELY, BUBBLE BATH, PERFUMED BODY LOTIONS; HAIR CARE PRODUCTS, NAMELY, HAIR CREAM, HAIR LOTIONS, HAIR POMADES, HAIR CONDITIONERS, HAIR LACQUERS AND HAIR SHAMPOOS (U.S. CLS. 1, 4, 6, 50, 51 AND 52).  
FIRST USE 9-19-2000; IN COMMERCE 6-10-2004.

2,929,244. BRAUNER, HOWARD, MANALAPAN, NJ. SN 76-369,739. PUB. 10-29-2002, FILED 2-12-2002.

**BALD GUYZ**

FOR SCALP WIPE, HEAD SHAMPOOS, SCALP MOISTURIZER AND HAIR SPRAY (U.S. CLS. 1, 4, 6, 50, 51 AND 52).

FIRST USE 10-28-2004; IN COMMERCE 10-28-2004.

2,929,318. MARS, INCORPORATED, MCLEAN, VA. SN 76-473,291. PUB. 6-17-2003, FILED 11-20-2002.

**SKITTLES**

OWNER OF U.S. REG. NOS. 1,221,105, 2,279,534, AND OTHERS.

FOR LIPSTICK, LIP BALM, LIP GLOSS AND NON-MEDICATED LIP CARE PREPARATIONS (U.S. CLS. 1, 4, 6, 50, 51 AND 52).

FIRST USE 3-0-2004; IN COMMERCE 3-0-2004.

**CLASS 3—(Continued).**

2,929,322. CLIMACREAM INC., LAS VEGAS, NV. SN 76-476,223. PUB. 5-6-2003, FILED 12-18-2002.

**CLIMA CREME**

NO CLAIM IS MADE TO THE EXCLUSIVE RIGHT TO USE "CREME", APART FROM THE MARK AS SHOWN.

FOR CREAM USED TO STIMULATE SENSITIVITY IN A WOMAN'S CLITORAL AREA (U.S. CLS. 1, 4, 6, 50, 51 AND 52).

FIRST USE 2-15-2003; IN COMMERCE 2-15-2003.

2,929,332. HELEN OF TROY LIMITED, BRIDGETOWN, BARBADOS. SN 76-483,721. PUB. 3-9-2004, FILED 1-21-2003.

**EPIL-TOWELETTE**

OWNER OF U.S. REG. NO. 2,162,229.

FOR HAIR REMOVER LOTIONS, CREAMS, SPRAYS AND WIPES; DEPILATORY LOTIONS, CREAMS, SPRAYS AND WIPES (U.S. CLS. 1, 4, 6, 50, 51 AND 52).

FIRST USE 10-14-2004; IN COMMERCE 10-14-2004.

2,929,333. HELEN OF TROY LIMITED, BRIDGETOWN, BARBADOS. SN 76-483,727. PUB. 3-9-2004, FILED 1-21-2003.

**EPIL-TOWEL**

OWNER OF U.S. REG. NO. 2,162,229.

FOR HAIR REMOVER LOTIONS, CREAMS, SPRAYS AND WIPES; DEPILATORY LOTIONS, CREAMS, SPRAYS AND WIPES (U.S. CLS. 1, 4, 6, 50, 51 AND 52).

FIRST USE 10-14-2004; IN COMMERCE 10-14-2004.

2,929,334. HELEN OF TROY LIMITED, BRIDGETOWN, BARBADOS. SN 76-483,728. PUB. 3-9-2004, FILED 1-21-2003.

**EPIL-STOP WIPES**

OWNER OF U.S. REG. NO. 2,162,229.

NO CLAIM IS MADE TO THE EXCLUSIVE RIGHT TO USE "WIPES", APART FROM THE MARK AS SHOWN.

FOR HAIR REMOVER LOTIONS, CREAMS, SPRAYS AND WIPES; DEPILATORY LOTIONS, CREAMS, SPRAYS AND WIPES (U.S. CLS. 1, 4, 6, 50, 51 AND 52).

FIRST USE 10-14-2004; IN COMMERCE 10-14-2004.

**CLASS 3—(Continued).**

2,929,368. GOLDEN TEMPLE OF OREGON, INC., EUGENE, OR. SN 76-501,009. PUB. 12-23-2003, FILED 3-26-2003.

**SUN SPA**

NO CLAIM IS MADE TO THE EXCLUSIVE RIGHT TO USE "SPA", APART FROM THE MARK AS SHOWN.  
FOR SKIN, BODY AND HAIR CARE PRODUCTS; NAMELY, BODY BUTTERS, SCRUBS, LOTIONS AND CREAMS, SHAMPOOS AND CONDITIONERS (U.S. CLS. 1, 4, 6, 50, 51 AND 52).  
FIRST USE 6-2-2004; IN COMMERCE 6-2-2004.

2,929,446. BIOTHERM, MONACO, MONACO. SN 76-532,020. PUB. 3-16-2004, FILED 7-11-2003.

**ABDO-CHOC**

FOR COSMETICS NAMELY CREAMS, MILKS, LOTIONS, GELS AND POWDERS FOR THE FACE, THE BODY AND THE HANDS (U.S. CLS. 1, 4, 6, 50, 51 AND 52).  
FIRST USE 5-0-2004; IN COMMERCE 5-0-2004.

2,929,449. MUELHENS GMBH & CO. KG, 50828 KÖLN, FED REP GERMANY. SN 76-532,722. PUB. 2-10-2004, FILED 7-28-2003.

**PICCADILLY CIRCUS**

FOR HAIR CARE PREPARATIONS AND HAIR CARE PRODUCTS, NAMELY, SHAMPOO, CONDITIONER, DETANGLER, SPRAYS, LOTIONS, GELS, AND MOUSSE (U.S. CLS. 1, 4, 6, 50, 51 AND 52).  
FIRST USE 10-7-2003; IN COMMERCE 10-7-2003.

2,929,529. STEPHEN BURLINGHAM, INC., PRINCETON, NJ. SN 78-035,517. PUB. 1-22-2002, FILED 11-16-2000.

**TRULY MADLY DEEPLY**

FOR PERFUME; EAU DE PERFUME (U.S. CLS. 1, 4, 6, 50, 51 AND 52).  
FIRST USE 11-4-2004; IN COMMERCE 11-4-2004.

2,929,628. PROCTER & GAMBLE COMPANY, THE, CINCINNATI, OH. SN 78-180,916. PUB. 7-22-2003, FILED 11-1-2002.

**EXTREME HERBAL MINT**

NO CLAIM IS MADE TO THE EXCLUSIVE RIGHT TO USE "HERBAL MINT", APART FROM THE MARK AS SHOWN.  
FOR DENTIFRICES, NON-MEDICATED MOUTHWASHES AND MOUTH RINSES, COSMETIC TOOTH WHITENERS (U.S. CLS. 1, 4, 6, 50, 51 AND 52).  
FIRST USE 8-31-2003; IN COMMERCE 8-31-2003.

**CLASS 3—(Continued).**

2,929,632. NICE ENTERPRISE CO., LTD., CHIA YI, TAIWAN. SN 78-184,597. PUB. 3-23-2004, FILED 11-13-2002.



THE MARK CONSISTS OF THE WORDS "NICE BAIGO" IN ENGLISH AND "BAIGO" IN CHINESE CHARACTERS ACCOMPANIED BY THE DESIGN ELEMENT OF A BIRD WITH A FEATHER IN ITS MOUTH.

THE FOREIGN WORDING IN THE MARK TRANSLATES INTO ENGLISH AS "WHITE DOVE" OR "WHITE PIGEON"; THE NON-LATIN CHARACTER(S) IN THE MARK TRANSLITERATES INTO "BAIGO", AND THIS MEANS "WHITE DOVE" OR "WHITE PIGEON" IN ENGLISH.

FOR SOAPS; FACIAL CLEANSING SOAPS; FACIAL CLEANSING LOTIONS; HAND CLEANSING LOTIONS; SHAMPOOS; LAUNDRY POWDER; LAUNDRY DETERGENTS; LAUNDRY SOAPS; LAUNDRY DETERGENTS FOR USE ON SHIRT COLLARS; TILE DETERGENTS; WOODEN FLOOR AND CARPET DETERGENTS; TOOTH PASTES; DENTAL BLEACHING GEL AND HAIR BLEACHING PREPARATIONS; FLOOR WAXES; POLISHES FOR FURNITURE; POLISHES FOR GLASS; POLISHING WAXES; POWDERS AND LIQUIDS FOR USE ON FLOORS AND FURNITURE; MOUTHWASHES; DENTIFRICES; CARPET DRY-CLEAN POWDER, NAMELY, CARPET CLEANERS WITH DEODORIZER; FABRIC SOFTENERS; LAUNDRY DETERGENTS FOR BABY ARTICLES; TOOTH POLISH, NAMELY, NON-MEDICATED TOOTH SALTS (U.S. CLS. 1, 4, 6, 50, 51 AND 52).

FIRST USE 10-16-2001; IN COMMERCE 8-1-2004.

2,929,644. ECOLAB INC., ST. PAUL, MN. SN 78-187,653. PUB. 9-9-2003, FILED 11-21-2002.

**SOLODIGM**

FOR ALL-PURPOSE DETERGENT FOR USE IN THE DAIRY, FOOD AND BEVERAGE INDUSTRY (U.S. CLS. 1, 4, 6, 50, 51 AND 52).  
FIRST USE 5-27-2004; IN COMMERCE 5-27-2004.

**CLASS 3—(Continued).**

2,929,652. BONNE BELL, INC., LAKEWOOD, OH. SN 78-194,870. PUB. 7-29-2003, FILED 12-16-2002.

**LIP SMACKIN'**

OWNER OF U.S. REG. NOS. 1,087,952, 2,637,184, AND OTHERS.

NO CLAIM IS MADE TO THE EXCLUSIVE RIGHT TO USE "LIP", APART FROM THE MARK AS SHOWN.

FOR LIP COSMETICS, NAMELY LIPSTICK AND LIP GLOSS (U.S. CLS. 1, 4, 6, 50, 51 AND 52).

FIRST USE 8-15-2002; IN COMMERCE 8-15-2002.

2,929,663. RETAIL BRAND ALLIANCE, INC., ENFIELD, CT. SN 78-200,683. PUB. 1-13-2004, FILED 1-7-2003.



**LIME  
JASMINE**

**CASUAL CORNER**

OWNER OF U.S. REG. NOS. 645,435 AND 1,298,161.  
NO CLAIM IS MADE TO THE EXCLUSIVE RIGHT TO USE "LIME JASMINE", APART FROM THE MARK AS SHOWN.

THE MARK CONSISTS OF A STYLIZED LEAF AND WORDS.

FOR FRAGRANCES FOR PERSONAL USE, EAU DE TOILETTE, EAU DE COLOGNE, EAU DE PARFUME, SKIN TREATMENT PREPARATIONS, NAMELY NON-MEDICATED SKIN CREAMS AND LOTIONS, MOISTURIZERS FOR HANDS, BODY AND FACE, SKIN CLARIFIERS, SKIN CLEANSING CREAMS AND LOTIONS (U.S. CLS. 1, 4, 6, 50, 51 AND 52).

FIRST USE 1-31-2003; IN COMMERCE 1-31-2003.

**CLASS 3—(Continued).**

2,929,756. SHISEIDO COMPANY, LTD., TOKYO, JAPAN. SN 78-256,847. PUB. 6-1-2004, FILED 6-2-2003.

**OMBRES QUADRI  
SOYEUSES**

NO CLAIM IS MADE TO THE EXCLUSIVE RIGHT TO USE SHADOWS QUAD, APART FROM THE MARK AS SHOWN.

THE ENGLISH TRANSLATION OF THE WORDING, "OMBRES QUADRI SOYEUSES" IS "SILKY SHADOWS QUAD".

FOR NON-MEDICATED SKIN CARE PREPARATIONS; HAIR CARE PREPARATIONS; BODY CARE PRODUCTS, NAMELY, BODY SOAPS, BODY CREAMS, BODY LOTIONS, BODY POWDERS, NON-MEDICATED DEODORANTS AND ANTI-PERSPIRANTS; SUNCARE PRODUCTS, NAMELY, SUNSCREEN, SUN BLOCK AND SUN TANNING PREPARATIONS; PREPARATIONS TO PROTECT THE SKIN FROM THE SUN, NAMELY, SUN CREAMS AND AFTER-SUN LOTIONS; BATH PRODUCTS, NAMELY, BATH BEADS, BATH FOAM, BATH GELS, BATH LOTION, BATH POWDER, BATH POWDER, AND NON-MEDICATED BATH SALTS; PERFUME, COLOGNE, COSMETICS AND MAKEUP (U.S. CLS. 1, 4, 6, 50, 51 AND 52).

FIRST USE 1-31-2004; IN COMMERCE 1-31-2004.

2,929,771. STEPHAN CO., THE, FORT LAUDERDALE, FL. SN 78-261,739. PUB. 6-8-2004, FILED 6-12-2003.

**INTERLUDE ROMANTIC**

FOR PERFUMES, TOILET WATERS, COLOGNES, AND SKIN CARE PRODUCTS NAMELY, SKIN LOTIONS, EYE CREAMS AND NON-MEDICATED BLENDING CREAMS (U.S. CLS. 1, 4, 6, 50, 51 AND 52).

FIRST USE 10-3-2003; IN COMMERCE 10-3-2003.

2,929,795. CANTRELL, BRAD, D., ALAMOGORDO, NM. SN 78-276,933. PUB. 7-6-2004, FILED 7-21-2003.

**KALEIDOSCOPE COVE**

FOR BATH AND BODY PRODUCTS, NAMELY, BATH SALTS, HAND AND BODY LOTIONS AND CREAMS, HAND AND FACE SOAP, NON-MEDICATED BODY SOAKS FOR THE BATH, BATH BEADS, BUBBLE BATHS, BATH TEAS, BODY SPRAYS, SCENTED LINEN SPRAYS, SHOWER GELS, SHAMPOO, HAIR CONDITIONER, HAIR CARE PREPARATION, NAMELY, DETANGLER, AND PUMICE STONES FOR PERSONAL USE (U.S. CLS. 1, 4, 6, 50, 51 AND 52).

FIRST USE 8-1-2004; IN COMMERCE 8-1-2004.

**CLASS 3—(Continued).**

2,929,802. KAO KABUSHIKI KAISHA, TA KAO CORPORATION, TOKYO, JAPAN. SN 78-281,353. PUB. 4-27-2004, FILED 7-31-2003.

**LIQUID PASTE**

OWNER OF U.S. REG. NO. 2,163,760.  
FOR NON-MEDICATED HAIR CARE PREPARATIONS  
(U.S. CLS. 1, 4, 6, 50, 51 AND 52).  
FIRST USE 10-15-2003; IN COMMERCE 10-15-2003.

2,929,840. REID, PERRI A., ALPHARETTA, GA. SN 78-303,607. PUB. 8-10-2004, FILED 9-22-2003.

**GLORY DEW**

FOR COSMETICS AND HAIR LOTIONS, NAMELY, HAIR SHAMPOOS AND CONDITIONERS, BATH AND HAND SOAPS, BATH SALTS, SOAPS, PERFUMERY, ESSENTIAL OILS FOR PERSONAL USE, SKIN CARE CREAMS, CREAMS FOR CUTICLE, FEET, BODY, FACE, HANDS, EYES, BODY MASSAGE OILS (U.S. CLS. 1, 4, 6, 50, 51 AND 52).  
FIRST USE 12-1-2004; IN COMMERCE 12-1-2004.

2,929,889. BOOTS COMPANY USA HOLDINGS INC., THE, WILMINGTON, DE. SN 78-975,614. PUB. 12-2-2003, FILED 11-30-2002.

**NO 7 POSITIVE ACTION**

OWNER OF U.S. REG. NO. 2,133,895.  
FOR SKIN CARE NAMELY, FACE MASKS, MOISTURIZER, NIGHT CREAM, EYE GEL AND FACIAL FIRMING AND ANTI AGING CREAMS (U.S. CLS. 1, 4, 6, 50, 51 AND 52).  
FIRST USE 2-14-2004; IN COMMERCE 2-14-2004.

**CLASS 3—(Continued).**

2,929,893. BOOTS COMPANY USA HOLDINGS INC., THE, WILMINGTON, DE. SN 78-975,755. PUB. 2-24-2004, FILED 11-29-2002.

**PURE POWER OF PLANTS**

FOR COSMETICS NAMELY; FOUNDATION, TINTED MOISTURIZER, CONCEALER, PRESSED AND LOOSE POWDER, HIGHLIGHTER, BLUSHER, EYE SHADOW, MASCARA, EYE LINER, EYE BROW DEFINER, LIP STICK, LINER AND GLOSS; NAIL VARNISH, PROTECTOR AND NAIL GROWTH AND CUTICLE CREAM; SKINCARE NAMELY, FACE MASKS, CLEANSER, TONER, FACIAL EXFOLIATION, MAKE UP REMOVER, FACIAL WASH, MOISTURIZER, NIGHT CREAM, EYE GEL AND FACIAL FIRMING AND ANTI AGING CREAMS; HAIR CARE NAMELY; SHAMPOO, CONDITIONER, HAIRSPRAY, MOUSSE, SERUM, GEL, WAX, BALM, AND HOT OIL TREATMENTS; BATH AND BODY CARE NAMELY, BATH OILS, FOAMS, INFUSIONS, MILK, BOMBS AND CRYSTALS; BUBBLE BATH, BODY WASH, GEL, SCRUB, AND EXFOLIATIONS; SOAP FREE FACE, BODY AND HAND WASH; SHOWER GEL, BODY MASK LOTION, CREAM, POLISH, BUTTER AND FIRMING GEL; HAND AND NAIL CREAMS AND LOTIONS; LOTIONS, CREAMS, AND SPRITZES FOR THE FEET; ESSENTIAL, MASSAGE OILS AND GELS, INCENSE CONES, AROMATHERAPY CAPSULES CONTAINING ESSENTIAL OILS FOR PERSONAL USE (U.S. CLS. 1, 4, 6, 50, 51 AND 52).  
FIRST USE 2-14-2004; IN COMMERCE 2-14-2004.

**CLASS 4—LUBRICANTS AND FUELS**

2,929,182. USA METRO, INC., NORTH BRUNSWICK, NJ. SN 76-262,322. PUB. 7-13-2004, FILED 5-24-2001.

**MELON DELIGHT**

NO CLAIM IS MADE TO THE EXCLUSIVE RIGHT TO USE "MELON", APART FROM THE MARK AS SHOWN.  
FOR CANDLES (U.S. CLS. 1, 6 AND 15).  
FIRST USE 10-18-2001; IN COMMERCE 10-18-2001.

2,929,341. ALDI INC., BATAVIA, IL. SN 76-488,449. PUB. 12-16-2003, FILED 2-10-2003.

**RANGE MASTER**

OWNER OF U.S. REG. NOS. 1,475,176 AND 2,404,172.  
NO CLAIM IS MADE TO THE EXCLUSIVE RIGHT TO USE "RANGE", APART FROM THE MARK AS SHOWN.  
FOR CHARCOAL BRIQUETTES (U.S. CLS. 1, 6 AND 15).  
FIRST USE 5-28-2003; IN COMMERCE 5-28-2003.

2,929,890. S. C. JOHNSON & SON, INC., RACINE, WI. SN 78-975,658. PUB. 6-17-2003, FILED 11-8-2002.

**SUDDENLY SPRING**

FOR CANDLES (U.S. CLS. 1, 6 AND 15).  
FIRST USE 7-1-2004; IN COMMERCE 7-1-2004.



**CLASS 5—PHARMACEUTICALS**

2,929,049. AVAX INTERNATIONAL IP HOLDINGS, INC., OVERLAND PARK, MO. SN 75-342,391. PUB. 6-9-1998, FILED 8-18-1997.

**MVAX**

FOR MELANOMA CANCER VACCINE FOR HUMANS (U.S. CLS. 6, 18, 44, 46, 51 AND 52).  
FIRST USE 8-20-1998; IN COMMERCE 8-20-1998.

2,929,056. HERAEUS KULZER GMBH & CO. KG, D-63450 HANAU, FED REP GERMANY. SN 75-602,002. PUB. 12-16-2003, FILED 12-9-1998.

**EFFECT COLOR**

PRIORITY CLAIMED UNDER SEC. 44(D) ON FED REP GERMANY APPLICATION NO. 39845032.3, FILED 8-8-1998. NO CLAIM IS MADE TO THE EXCLUSIVE RIGHT TO USE "COLOR", APART FROM THE MARK AS SHOWN.

FOR CHEMICAL PREPARATIONS FOR DENTAL AND DENTAL-TECHNICAL PURPOSES, NAMELY, FILLING MATERIALS, TOOTH COLORED PLASTICS; DENTAL SYNTHETIC MATERIALS, NAMELY, DENTAL PLASTICS IN LIQUID FORM FOR PRODUCTION AND RECONSTRUCTION OF CROWNS, BRIDGES, DENTURES AND DENTURE PARTS (U.S. CLS. 6, 18, 44, 46, 51 AND 52).

FIRST USE 12-0-1999; IN COMMERCE 12-0-1999.

2,929,060. CARE-TECH LABORATORIES, INC., ST. LOUIS, MO. SN 75-669,262. PUB. 1-18-2000, FILED 3-29-1999.

**NEX-GEN**

FOR PHARMACEUTICAL PREPARATIONS, NAMELY, ANTI-MICROBIAL SOLUTIONS FOR THE TREATMENT OF BACTERIAL, YEAST AND FUNGI INFECTIONS, AND VISCERAL INFECTION ENCOUNTERED BY THE TRANSPLANT PATIENT, AND FOR COMBATING AGAINST OTHER ANTIBIOTIC RESISTANT STRAINS (U.S. CLS. 6, 18, 44, 46, 51 AND 52).

FIRST USE 11-1-1997; IN COMMERCE 11-1-1997.

2,929,062. MAHARISHI AYUR-VED PRODUCTS INTERNATIONAL, INC., COLORADO SPRINGS, CO. SN 75-736,022. PUB. 2-10-2004, FILED 6-24-1999.

**REGEN**

FOR HERBAL NUTRITIONAL SUPPLEMENTS (U.S. CLS. 6, 18, 44, 46, 51 AND 52).  
FIRST USE 4-0-2000; IN COMMERCE 4-0-2000.

**CLASS 5—(Continued).**

2,929,065. XEL HERBACEUTICALS, INC., SALT LAKE CITY, UT. SN 75-811,313. PUB. 9-4-2001, FILED 9-30-1999.

**TEATECH**

FOR PHARMACEUTICALS, NAMELY, ANTIHYPERTENSION AGENTS, DIURETICS, ANOREXIGENICS, FUNGISTATIC AND FUNGICIDAL AGENTS, ANALGESICS, HORMONAL AGENTS, ANTITUSSIVE AGENTS, SEDATIVES, CARDIAC AGENTS, ANTIMICROBIAL AND ANTIBACTERIAL AGENTS, ANTICANCER AGENTS, HERBAL DIETARY NUTRITIONAL SUPPLEMENTS AND VITAMINS, AND MEDICINE FILLED PATCHES FOR USE IN THE TREATMENT OF SKIN DISORDERS AND DISEASES, NAMELY, ACNE, AGED SKIN, AGE SPOTS; MEDICINE FILLED PATCHES FOR USE IN THE TREATMENT OF OBESITY, CANCER, HEART DISEASE AND FUNGI INFECTIONS (U.S. CLS. 6, 18, 44, 46, 51 AND 52).

FIRST USE 11-18-2004; IN COMMERCE 11-18-2004.

2,929,102. YUNNAN BAIYAO GROUP COMPANY LIMITED, KUNMING, YUNNAN, CHINA. SN 76-071,742. PUB. 9-30-2003, FILED 6-15-2000.

云南白药  
YUNNAN BAIYAO

NO CLAIM IS MADE TO THE EXCLUSIVE RIGHT TO USE "YAO", APART FROM THE MARK AS SHOWN.

THE NON-LATIN CHARACTERS IN THE MARK TRANSLITERATE TO "YUNNAN BAIYAO" AND THIS MEANS "YUNNAN (A SOUTHERN PROVINCE IN CHINA) WHITE MEDICINE" IN ENGLISH.

FOR PHARMACEUTICAL PREPARATIONS FOR THE TREATMENT OF HEADACHE, FEVER, DIARRHEA, COUGHING WITH SORE THROAT, INFLUENZA, TONSILLITIS, MEASLES, MUMPS, HEPATITIS, CHEST CONGESTION, POOR BREAST SECRETION, PALENESS, THINNESS, FEEBLENESS, SHORTNESS OF BREATH, DIZZINESS, VOMITING, NAUSEA, INDIGESTION, SEASICKNESS, CONSTIPATION, IRREGULAR MENSTRUATION, TINNITUS, LUMBAGO, TOOTHACHES, EARACHE, POOR APPETITE, STOMACHACHE, ARTHRALGIA, INFARCTION, PAIN IN THE HEPATIC REGION, IMPOTENCE AND SEMINAL EMISSION, BLOCKED NOSE, VERTIGO, INSOMNIA, HYPERTENSION; MEDICINAL TONIC FOR GENERAL WELL-BEING; PHARMACEUTICAL PREPARATIONS FOR SKINCARE; MEDICAL PREPARATIONS FOR SLIMMING PURPOSES; MEDICATED BATH SALTS; ANALGESICS, ASTRINGENTS FOR MEDICINAL PURPOSES, FEBRIFUGES, MEDICAL ADHESIVE PLASTERS, MEDICINAL MATERIALS OF TRADITIONAL CHINESE MEDICINES, NAMELY, MEDICINAL HERBS, MEDICINAL BARK AND ROOTS OF PLANTS, MEDICINAL FLOUR, MEDICINAL STARCH; WINE FOR MEDICINAL PURPOSES FOR USE IN THE TREATMENT OF RHEUMATISM AND WEAKNESS IN BODY; DIETARY FOOD SUPPLEMENTS, BANDAGES FOR WOUNDS (U.S. CLS. 6, 18, 44, 46, 51 AND 52).

FIRST USE 12-31-1902; IN COMMERCE 12-31-1970.

**CLASS 5—(Continued).**

2,929,112. TRIARCO INDUSTRIES, INC., WAYNE, NJ. SN 76-135,988. PUB. 7-31-2001, FILED 9-27-2000.

**Bend-Again**

FOR VITAMINS, MINERAL SUPPLEMENTS, AND NUTRITIONAL AND DIETARY SUPPLEMENTS (U.S. CLS. 6, 18, 44, 46, 51 AND 52).  
FIRST USE 9-27-2000; IN COMMERCE 9-27-2000.

2,929,130. INTERVET, INC., MILLSBORO, DE. SN 76-165,056. PUB. 8-21-2001, FILED 11-14-2000.

**VETSULIN**

FOR INSULIN FOR DOGS AND CATS (U.S. CLS. 6, 18, 44, 46, 51 AND 52).  
FIRST USE 11-9-2004; IN COMMERCE 11-9-2004.

2,929,140. CHEMOFORMA AG, 4302 AUGST, SWITZERLAND. SN 76-194,890. PUB. 9-17-2002, FILED 1-17-2001.

**NUCELL**

FOR NUTRACEUTICALS FOR USE AS A DIETARY SUPPLEMENT AND NUTRITIONAL DIETARY SUPPLEMENTS (U.S. CLS. 6, 18, 44, 46, 51 AND 52).  
FIRST USE 2-0-1998; IN COMMERCE 12-4-2003.

2,929,181. SYNTRION GMBH, CALW, FED REP GERMANY. SN 76-261,053. PUB. 9-25-2001, FILED 5-24-2001.

**SYNTRION**

FOR DIETARY SUPPLEMENTS AND HOMEOPATHIC AND HERBAL PREPARATIONS FOR USE IN THE TREATMENT OF VIRAL, FUNGAL AND BACTERIAL INFECTIONS, FLU AND COMMON COLD SYMPTOMS, NAMELY CONGESTION, COUGHS, SORE THROAT, FEVER, SWOLLEN GLANDS, AND DISORDERS OF THE CIRCULATORY, GASTROINTESTINAL, RESPIRATORY AND URINARY TRACT SYSTEMS (U.S. CLS. 6, 18, 44, 46, 51 AND 52).  
FIRST USE 1-1-2001; IN COMMERCE 7-1-2001.

**CLASS 5—(Continued).**

2,929,255. KUDOS PHARMACEUTICALS LIMITED, CAMBRIDGE CB4 0WG, UNITED KINGDOM. SN 76-385,370. PUB. 2-24-2004, FILED 3-21-2002.

**PATRIN**

PRIORITY CLAIMED UNDER SEC. 44(D) ON ERPN CMNTY TM OFC APPLICATION NO. 002560068, FILED 1-29-2002, REG. NO. 002560068, DATED 7-18-2003, EXPIRES 1-29-2012.

FOR PHARMACEUTICALS FOR DNA REPAIR FOR USE IN ONCOLOGY (U.S. CLS. 6, 18, 44, 46, 51 AND 52).  
FIRST USE 2-27-2004; IN COMMERCE 2-27-2004.

2,929,310. INTEGRATED PEST MANAGEMENT TECHNOLOGIES, INC., HONOLULU, HI. SN 76-468,872. PUB. 2-24-2004, FILED 11-21-2002.

**DOOM-STONE TERRITORY**

FOR PEST CONTROL PRODUCTS, NAMELY, PESTICIDES, RODENTICIDES, RAT POISON, PESTICIDE TRAPS, BAITS AND BAIT STATIONS ALL FOR COMMERCIAL, RESIDENTIAL, INDUSTRIAL, AGRICULTURAL AND ZOOLOGICAL USE (U.S. CLS. 6, 18, 44, 46, 51 AND 52).  
FIRST USE 8-13-2004; IN COMMERCE 8-13-2004.

2,929,340. STRATFORD VENTURES, LITHIA SPRINGS, GA. SN 76-488,390. PUB. 12-9-2003, FILED 2-10-2003.



THE MARK CONSISTS OF THE WORD "XSCAPE" IN A GREEN, STYLIZED FONT. A GREEN OVAL IS DEPICTED ABOVE THE "X". UNDER THE LETTER "E" IS A GREEN SAILBOAT.

FOR DIETARY SUPPLEMENTS (U.S. CLS. 6, 18, 44, 46, 51 AND 52).  
FIRST USE 8-26-2003; IN COMMERCE 8-26-2003.

**CLASS 5—(Continued).**

2,929,415. VALERA PHARMACEUTICALS, INC., CRANBURY, NJ. SN 76-522,929. PUB. 3-16-2004, FILED 6-17-2003.

**VANTAS**

FOR PHARMACEUTICAL PREPARATION FOR USE IN THE TREATMENT OF CANCER (U.S. CLS. 6, 18, 44, 46, 51 AND 52).

FIRST USE 11-8-2004; IN COMMERCE 11-8-2004.

2,929,416. RIDLEY BLOCK OPERATIONS, INC., MANKATO, MN. SN 76-523,385. PUB. 5-25-2004, FILED 6-11-2003.

**STC**

FOR FEED SUPPLEMENTS FOR LIVESTOCK (U.S. CLS. 6, 18, 44, 46, 51 AND 52).

FIRST USE 10-14-2004; IN COMMERCE 10-14-2004.

2,929,452. WINDOW ROCK ENTERPRISES, INC., YORBA LINDA, CA. SN 76-534,489. PUB. 2-10-2004, FILED 8-4-2003.

**CORTIPLEX**

FOR DIETARY SUPPLEMENTS (U.S. CLS. 6, 18, 44, 46, 51 AND 52).

FIRST USE 7-20-2003; IN COMMERCE 7-20-2003.

2,929,475. KINETIC TECHNOLOGIES, LLC, LEXINGTON, KY. SN 76-543,100. PUB. 8-3-2004, FILED 8-21-2003.

**CONQUER**

FOR ORAL SUPPLEMENT FOR HUMANS CONTAINING HYALURONIC ACID (U.S. CLS. 6, 18, 44, 46, 51 AND 52).

FIRST USE 6-0-2001; IN COMMERCE 6-0-2001.

2,929,483. BIO-BOTANICA, INC., HAUPPAUGE, NY. SN 76-547,812. PUB. 6-22-2004, FILED 9-25-2003.

**PERIORUB**

FOR ANALGESIC TOOTH AND GUM GEL (U.S. CLS. 6, 18, 44, 46, 51 AND 52).

FIRST USE 3-0-2002; IN COMMERCE 3-0-2003.

**CLASS 5—(Continued).**

2,929,496. KBRESEARCH LLC, SCOTTSDALE, AZ. SN 76-555,237. PUB. 8-24-2004, FILED 10-30-2003.

**INFLAMAX**

FOR NATURAL ANTI-INFLAMMATORY DIETARY SUPPLEMENT (U.S. CLS. 6, 18, 44, 46, 51 AND 52).

FIRST USE 2-15-2004; IN COMMERCE 3-15-2004.

2,929,498. C.B. FLEET COMPANY, INCORPORATED, LYNCHBURG, VA. SN 76-555,326. PUB. 2-17-2004, FILED 10-27-2003.

**FLEET ENEMA EXTRA**

OWNER OF U.S. REG. NOS. 315,097, 827,120, AND OTHERS.

NO CLAIM IS MADE TO THE EXCLUSIVE RIGHT TO USE "ENEMA", APART FROM THE MARK AS SHOWN.

FOR ENEMAS, LAXATIVES, AND BOWEL CLEANSING PREPARATIONS (U.S. CLS. 6, 18, 44, 46, 51 AND 52).

FIRST USE 9-8-2003; IN COMMERCE 5-21-2004.

2,929,499. C.B. FLEET COMPANY, INCORPORATED, LYNCHBURG, VA. SN 76-555,327. PUB. 3-23-2004, FILED 10-27-2003.

**Fleet**  
**enema**  
**EXTRA**

OWNER OF U.S. REG. NOS. 315,097, 827,120, AND OTHERS.

NO CLAIM IS MADE TO THE EXCLUSIVE RIGHT TO USE "ENEMA", APART FROM THE MARK AS SHOWN.

FOR ENEMAS, LAXATIVES, AND BOWEL CLEANSING PREPARATIONS (U.S. CLS. 6, 18, 44, 46, 51 AND 52).

FIRST USE 9-8-2003; IN COMMERCE 5-21-2004.

**CLASS 5—(Continued).**

2,929,506. W. R. RAYSON COMPANY, INC., BURGAW, NC.  
SN 76-562,042. PUB. 6-15-2004, FILED 11-26-2003.



FOR ALL PURPOSE DISINFECTANTS (U.S. CLS. 6, 18, 44, 46, 51 AND 52).  
FIRST USE 6-1-2004; IN COMMERCE 6-1-2004.

2,929,514. NEWLINK GENETICS CORPORATION, AMES, IA.  
SN 76-977,123. PUB. 5-21-2002, FILED 5-4-2000.

**NEWLINK GENETICS**

NO CLAIM IS MADE TO THE EXCLUSIVE RIGHT TO USE GENETICS, APART FROM THE MARK AS SHOWN.  
FOR PHARMACEUTICAL PREPARATIONS, NAMELY, PROPRIETARY GENOMIC AND THERAPEUTIC PREPARATIONS FOR THE PREVENTION AND TREATMENT OF HUMAN DISEASES, NAMELY, CANCER, NEUROGENERATIVE DISORDERS, SUCH AS PARKINSON'S DISEASE AND ALZHEIMER'S DISEASE AND AUTOIMMUNE DISORDERS, SUCH AS RHEUMATOID ARTHRITIS, DIABETES AND MULTIPLE SCLEROSIS (U.S. CLS. 6, 18, 44, 46, 51 AND 52).  
FIRST USE 2-1-2000; IN COMMERCE 4-1-2004.

2,929,536. CONNAUGHT TECHNOLOGY CORPORATION, GREENVILLE, DE. SN 78-046,899. PUB. 9-18-2001, FILED 2-6-2001.

**MENACTRA**

FOR VACCINES FOR HUMAN USE (U.S. CLS. 6, 18, 44, 46, 51 AND 52).  
FIRST USE 11-22-2004; IN COMMERCE 11-22-2004.

2,929,545. RHEOGENE HOLDINGS, INC., WILMINGTON, DE. SN 78-072,974. PUB. 11-27-2001, FILED 7-9-2001.

**RHEOCHEM**

FOR CHEMICAL INDUCERS OF GENE EXPRESSION IN PLANTS, MAMMALS, FUNGI AND BACTERIA FOR PHARMACEUTICAL, MEDICAL, VETERINARY, AGRICULTURAL AND INDUSTRIAL APPLICATIONS (U.S. CLS. 6, 18, 44, 46, 51 AND 52).  
FIRST USE 11-18-2004; IN COMMERCE 11-18-2004.

**CLASS 5—(Continued).**

2,929,549. E.R. SQUIBB & SONS, L.L.C., PRINCETON, NJ. SN 78-081,620. PUB. 6-25-2002, FILED 8-29-2001.

**HELPING SKIN WIN**

FOR MEDICATED SKIN PROTECTANT PREPARATIONS; MEDICATED PREPARATIONS FOR PROTECTING THE SKIN FROM IRRITATION; MEDICATED PREPARATIONS FOR THE TREATMENT AND PREVENTION OF DIAPER RASH; ANTIFUNGAL OINTMENT AND CREAM; WOUND CLEANSERS; BANDAGES FOR SKIN WOUNDS; WOUND DRESSINGS AND WOUND FILLERS TAKING THE FORM OF POWDERS, GRANULES, SHEETS OR PACKING MATERIAL (U.S. CLS. 6, 18, 44, 46, 51 AND 52).  
FIRST USE 8-31-2001; IN COMMERCE 8-31-2001.

2,929,566. ANDRX LABS, LLC, DAVIE, FL. SN 78-115,656.  
PUB. 2-25-2003, FILED 3-18-2002.

**FORTAMET**

FOR ANTIDIABETIC PHARMACEUTICAL PREPARATIONS, NAMELY, PHARMACEUTICALS CONTAINING A BIGUANIDE ACTIVE INGREDIENT, NAMELY, METFORMIN (U.S. CLS. 6, 18, 44, 46, 51 AND 52).  
FIRST USE 5-0-2004; IN COMMERCE 5-0-2004.

2,929,594. FOREST LABORATORIES, INC., NEW YORK, NY.  
SN 78-147,408. PUB. 9-2-2003, FILED 7-25-2002.

**ISOCHRON**

FOR PHARMACEUTICAL PREPARATIONS FOR THE TREATMENT OF PAIN, HYPERTENSION, CARDIOVASCULAR, RESPIRATORY, CENTRAL NERVOUS SYSTEM AND GASTROINTESTINAL DISEASES AND DISORDERS; ALZHEIMER'S DISEASE, DEMENTIA, AIDS-RELATED DEMENTIA, CNS, NEUROPATHIC PAIN, DIABETIC NEUROPATHY, NEUROLOGICAL DISORDERS, NEURODEGENERATIVE DISORDERS, DEPRESSION AND ALCOHOL ABUSE, ADDICTION AND DEPENDENCE; PHARMACEUTICAL PREPARATIONS IN THE NATURE OF A NEUROPROTECTIVE AGENT AND CORONARY VASODILATOR (U.S. CLS. 6, 18, 44, 46, 51 AND 52).  
FIRST USE 7-10-2003; IN COMMERCE 7-10-2003.

2,929,657. VANMOOR, ARTHUR, BOCA RATON, FL. SN 78-196,068. PUB. 8-19-2003, FILED 12-19-2002.

**FAT FORECLOSURE**

NO CLAIM IS MADE TO THE EXCLUSIVE RIGHT TO USE "FAT", APART FROM THE MARK AS SHOWN.  
FOR VITAMINS AND NUTRITIONAL SUPPLEMENTS FOR REDUCING FAT (U.S. CLS. 6, 18, 44, 46, 51 AND 52).  
FIRST USE 5-31-2004; IN COMMERCE 5-31-2004.

**CLASS 5—(Continued).**

2,929,665. BARLEAN'S ORGANIC OILS, LLC, FERNDALE, WA. SN 78-201,077. PUB. 3-23-2004, FILED 1-8-2003.

**OMEGA MAN**

NO CLAIM IS MADE TO THE EXCLUSIVE RIGHT TO USE "OMEGA", APART FROM THE MARK AS SHOWN.  
FOR NUTRITIONAL SUPPLEMENT CONSISTING OF A FLAXSEED OIL BASE ALONG WITH OTHER PROPRIETARY INGREDIENTS (U.S. CLS. 6, 18, 44, 46, 51 AND 52).

FIRST USE 2-1-2004; IN COMMERCE 2-1-2004.

2,929,672. PEROXSYS LTD., WEST BLOOMFIELD, MI. SN 78-205,915. PUB. 4-27-2004, FILED 1-22-2003.

**PEROXSYS**

FOR PHARMACEUTICAL PREPARATIONS FOR THE TREATMENT OF DERMATOLOGICAL CONDITIONS (U.S. CLS. 6, 18, 44, 46, 51 AND 52).

FIRST USE 3-0-2004; IN COMMERCE 3-0-2004.

2,929,678. TYCO HEALTHCARE RETAIL SERVICES AG, SCHAFFHAUSEN, SWITZERLAND. SN 78-208,704. PUB. 10-7-2003, FILED 1-30-2003.

**SURECHOICE**

FOR ADULT INCONTINENCE GARMENTS, NAMELY, PADS, GUARDS, LINERS AND SHIELDS (U.S. CLS. 6, 18, 44, 46, 51 AND 52).

FIRST USE 9-30-2003; IN COMMERCE 9-30-2003.

2,929,690. TAMBRANDS INC., CINCINNATI, OH. SN 78-217,553. PUB. 6-15-2004, FILED 2-21-2003.

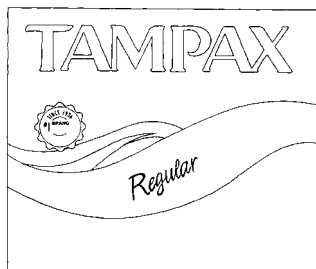

OWNER OF U.S. REG. NOS. 294,959, 2,783,175, AND OTHERS.

NO CLAIM IS MADE TO THE EXCLUSIVE RIGHT TO USE "REGULAR" AND "#1 BRAND SINCE 1936", APART FROM THE MARK AS SHOWN.

FOR TAMPONS (U.S. CLS. 6, 18, 44, 46, 51 AND 52).  
FIRST USE 11-30-2002; IN COMMERCE 11-30-2002.

**CLASS 5—(Continued).**

2,929,739. SYNGENTA PARTICIPATIONS AG, BASEL, SWITZERLAND. SN 78-246,547. PUB. 7-6-2004, FILED 5-7-2003.



THE MARK CONSISTS OF A LEAF DESIGN.  
FOR FUNGICIDE FOR AGRICULTURAL AND COMMERCIAL USE (U.S. CLS. 6, 18, 44, 46, 51 AND 52).  
FIRST USE 3-1-2003; IN COMMERCE 3-1-2003.

2,929,835. NATIONAL STARCH AND CHEMICAL INVESTMENT HOLDING CORPORATION, NEW CASTLE, DE. SN 78-300,857. PUB. 5-18-2004, FILED 9-16-2003.

**HI-MAIZE**

OWNER OF U.S. REG. NO. 2,014,105.  
FOR NUTRITIONAL FOOD SUPPLEMENTS, NAMELY DIETARY FIBRE USED AS AN INGREDIENT IN FOOD PRODUCTS (U.S. CLS. 6, 18, 44, 46, 51 AND 52).  
FIRST USE 1-14-2003; IN COMMERCE 4-14-2003.

2,929,838. NATURES HEALTH SUPPLY, INC., SANTA BARBARA, CA. SN 78-302,170. PUB. 7-27-2004, FILED 9-18-2003.

**PROSTATE MIRACLE**

NO CLAIM IS MADE TO THE EXCLUSIVE RIGHT TO USE "PROSTATE", APART FROM THE MARK AS SHOWN.  
FOR DIETARY SUPPLEMENTS FOR USE IN TREATING ENLARGED PROSTATES (U.S. CLS. 6, 18, 44, 46, 51 AND 52).

FIRST USE 8-0-2004; IN COMMERCE 8-0-2004.

2,929,841. RIDLEY BLOCK OPERATIONS, INC., MANKATO, MN. SN 78-304,026. PUB. 6-15-2004, FILED 9-23-2003.

**IT'S ALL IN THE DELIVERY**

FOR FEED SUPPLEMENTS FOR LIVESTOCK (U.S. CLS. 6, 18, 44, 46, 51 AND 52).  
FIRST USE 11-19-2004; IN COMMERCE 11-19-2004.

**CLASS 5—(Continued).**

2,929,881. SANTARUS, INC., SAN DIEGO, CA. SN 78-332,533.  
PUB. 9-7-2004, FILED 11-24-2003.

**ZEGERID**

THE MARK CONSISTS OF STANDARD CHARACTERS WITHOUT CLAIM TO ANY PARTICULAR FONT, STYLE, SIZE, OR COLOR.

FOR PHARMACEUTICAL PREPARATIONS FOR THE TREATMENT OF GASTROINTESTINAL PROBLEMS AND DISEASES (U.S. CLS. 6, 18, 44, 46, 51 AND 52).  
FIRST USE 9-9-2004; IN COMMERCE 9-9-2004.

**CLASS 6—METAL GOODS**

2,929,445. HANDY & HARMAN, RYE, NY. SN 76-531,103.  
PUB. 3-23-2004, FILED 7-11-2003.

**LEDGERLOK**

FOR METAL SCREWS (U.S. CLS. 2, 12, 13, 14, 23, 25 AND 50).  
FIRST USE 11-25-2003; IN COMMERCE 11-26-2003.

2,929,700. APPLIED ENGINEERED SURFACES INC., ELYRIA, OH. SN 78-225,693. PUB. 5-18-2004, FILED 3-14-2003.

**IS**

THE NAME(S), PORTRAIT(S), AND/OR SIGNATURE(S) SHOWN IN THE MARK IDENTIFIES JOHN A. YOAKAM, WHOSE CONSENT(S) TO REGISTER IS SUBMITTED.

FOR METAL GASKET INCORPORATING A SEAL AND A RETAINER FOR USE WITH FLUID COUPLING COMPONENTS SUCH AS TUBES OR PIPES (U.S. CLS. 2, 12, 13, 14, 23, 25 AND 50).  
FIRST USE 7-15-2004; IN COMMERCE 7-15-2004.

**CLASS 6—(Continued).**

2,929,772. SHIPP, PATRICK, TOLEDO, OH. SN 78-262,709.  
PUB. 2-24-2004, FILED 6-16-2003.

**YOUR GUTTER PROTECTION CONNECTION**

FOR METAL GUTTER COVERS (U.S. CLS. 2, 12, 13, 14, 23, 25 AND 50).  
FIRST USE 8-31-2003; IN COMMERCE 8-31-2003.

**CLASS 7—MACHINERY**

2,929,216. MACHINING TECHNOLOGIES, INC., HEBRON, MD. SN 76-324,879. PUB. 10-29-2002, FILED 10-12-2001.

**AVITECH**

FOR AUTOMATED POULTRY EQUIPMENT, NAMELY, AVIAN EGG INJECTING MACHINES, EGG TRANSFER MACHINES AND CONVEYORS (U.S. CLS. 13, 19, 21, 23, 31, 34 AND 35).  
FIRST USE 5-28-2004; IN COMMERCE 5-28-2004.

2,929,383. HOMELAND HOUSEWARES, LLC, LOS ANGELES, CA. SN 76-506,130. PUB. 4-20-2004, FILED 4-14-2003.

**THE MAGIC BULLET**

THE MARK CONSISTS OF STANDARD CHARACTERS WITHOUT CLAIM TO ANY PARTICULAR FONT, STYLE, SIZE, OR COLOR.

FOR KITCHEN APPLIANCES, NAMELY, ELECTRONIC FOOD BLENDERS (U.S. CLS. 13, 19, 21, 23, 31, 34 AND 35).  
FIRST USE 8-31-2003; IN COMMERCE 10-1-2003.

2,929,453. TRUTH HARDWARE CORPORATION, OWATONA, MN. SN 76-534,501. PUB. 8-17-2004, FILED 8-4-2003.

**SENTRY II**

OWNER OF U.S. REG. NOS. 1,594,909 AND 1,851,876.  
FOR ELECTRICALLY CONTROLLED WINDOW OPERATORS NAMELY, MOTORIZED WINDOW OPERATORS FOR CASEMENT, AWNING AND SKYLIGHT WINDOW SYSTEMS (U.S. CLS. 13, 19, 21, 23, 31, 34 AND 35).  
FIRST USE 11-22-2004; IN COMMERCE 11-22-2004.

**CLASS 7—(Continued).**

2,929,454. TRUTH HARDWARE CORPORATION, OWATON-NA, MN. SN 76-534,502. PUB. 8-17-2004, FILED 8-4-2003.



OWNER OF U.S. REG. NOS. 1,594,909 AND 1,851,876. FOR ELECTRICALLY CONTROLLED WINDOW OPERATORS NAMELY, MOTORIZED WINDOW OPERATORS FOR CASEMENT, AWNING AND SKYLIGHT WINDOW SYSTEMS (U.S. CLS. 13, 19, 21, 23, 31, 34 AND 35).  
FIRST USE 11-22-2004; IN COMMERCE 11-22-2004.

2,929,543. DANA CORPORATION, TOLEDO, OH. SN 78-063,061. PUB. 7-30-2002, FILED 5-11-2001.

**INTELLIGENT COOLING**

NO CLAIM IS MADE TO THE EXCLUSIVE RIGHT TO USE "COOLING", APART FROM THE MARK AS SHOWN. FOR ENGINE COOLING SYSTEMS FOR MOTOR VEHICLES COMPRISING AN ELECTRIC WATER PUMP, A PROPORTIONAL FLOW VALVE, A SPEED CONTROL-LABLE COOLING FAN, AND A SYSTEM CONTROL UNIT (U.S. CLS. 13, 19, 21, 23, 31, 34 AND 35).  
FIRST USE 11-30-2003; IN COMMERCE 11-30-2003.

2,929,658. WASHING EQUIPMENT TECHNOLOGIES, INC., WEBSTER, NY. SN 78-196,561. PUB. 1-27-2004, FILED 12-20-2002.



NO CLAIM IS MADE TO THE EXCLUSIVE RIGHT TO USE "INTELLIGENT WASHING SYSTEM", APART FROM THE MARK AS SHOWN. FOR AUTOMATIC CAR WASHING MACHINES FOR USE BY COMMERCIAL CAR WASH SERVICES (U.S. CLS. 13, 19, 21, 23, 31, 34 AND 35).  
FIRST USE 2-0-2003; IN COMMERCE 2-0-2003.

**CLASS 7—(Continued).**

2,929,675. NTN CORPORATION, OSAKA, JAPAN. SN 78-207,838. PUB. 3-23-2004, FILED 1-28-2003.

**ULTAGE**

FOR METAL WORKING MACHINES NAMELY, LATHES, MILLING MACHINES, GRINDING MACHINES FOR MANUFACTURING BEARINGS, AND MACHINING CENTERS; HIGH FREQUENCY MOTOR SPINDLES WITH HIGH FREQUENCY ELECTRIC CONVERTERS AND POWER SUPPLY UNITS; BEARING FOR TRANSMISSION SHAFTS, BEING PARTS OF MACHINES; BEARINGS FOR BALL SCREW SUPPORTS; SHAFT COUPLINGS FOR MACHINES (U.S. CLS. 13, 19, 21, 23, 31, 34 AND 35).  
FIRST USE 8-6-2002; IN COMMERCE 12-5-2002.

2,929,706. HIGHLIGHT INDUSTRIES, INC., WYOMING, MI. SN 78-230,258. PUB. 7-20-2004, FILED 3-26-2003.

**MAGNUM**

FOR PACKAGING MACHINERY, NAMELY, MACHINES FOR SEALING CARTONS WITH TAPE (U.S. CLS. 13, 19, 21, 23, 31, 34 AND 35).  
FIRST USE 11-0-2002; IN COMMERCE 11-0-2002.

2,929,859. SANYO NORTH AMERICA CORPORATION, CHATSWORTH, CA. SN 78-312,357. PUB. 7-13-2004, FILED 10-10-2003.

**POWER BOY**

FOR VACUUM CLEANERS FOR DOMESTIC USE (U.S. CLS. 13, 19, 21, 23, 31, 34 AND 35).  
FIRST USE 5-6-2004; IN COMMERCE 5-6-2004.

**CLASS 8—HAND TOOLS**

2,929,099. HALKE, ROBERT, BLACKWOOD, NJ. SN 76-059,081. PUB. 12-17-2002, FILED 5-26-2000.

**HIGH BROW SOCIETY**

FOR EYEBROW KIT COMPRISED OF EYEBROW BRUSH, SCISSORS, TWEEZERS AND EYEBROW MAKE-UP. ALL CONTAINED IN A CARRYING CASE, WITH ACCOMPANYING INSTRUCTION BOOKLET (U.S. CLS. 23, 28 AND 44).  
FIRST USE 9-21-2004; IN COMMERCE 9-21-2004.

**CLASS 8—(Continued).**

2,929,516. SAUL ZAENTZ COMPANY, THE, DBA TOLKIEN ENTERPRISES, BERKELEY, CA. SN 76-977,199. PUB. 8-6-2002, FILED 1-28-2002.

**ANDURIL**

FOR SWORDS (U.S. CLS. 23, 28 AND 44).  
FIRST USE 9-22-2004; IN COMMERCE 9-22-2004.

2,929,701. CLIO DESIGNS INCORPORATED, WATERTOWN, MA. SN 78-228,315. PUB. 11-25-2003, FILED 3-21-2003.

**TWIST-N-GO**

FOR RAZORS (U.S. CLS. 23, 28 AND 44).  
FIRST USE 3-1-2003; IN COMMERCE 8-11-2003.

**CLASS 9—ELECTRICAL AND SCIENTIFIC APPARATUS**

2,929,047. TDS ACQUISITION COMPANY, CORVALLIS, OR. SN 74-581,737. PUB. 7-4-1995, FILED 10-4-1994.

**FIELDNOTES MANAGER**

SEC. 2(F).  
FOR COMPUTER SOFTWARE FOR USE IN DATABASE MANAGEMENT IN THE FIELD OF GEOGRAPHIC INFORMATION SYSTEMS AND ACCOMPANYING INSTRUCTIONAL MANUALS (U.S. CLS. 21, 23, 26, 36 AND 38).  
FIRST USE 9-27-1994; IN COMMERCE 10-15-1995.

2,929,050. SUPPORTSOFT, INC., REDWOOD CITY, CA. SN 75-363,859. PUB. 4-10-2001, FILED 9-26-1997.

**DNA**

FOR COMPUTER SOFTWARE FOR ANALYZING AND DIAGNOSING PERSONAL COMPUTER AND NETWORK SERVER CONFIGURATIONS (U.S. CLS. 21, 23, 26, 36 AND 38).  
FIRST USE 10-27-2003; IN COMMERCE 10-27-2003.

2,929,058. WESTELL TECHNOLOGIES, INC., AURORA, IL. SN 75-617,451. PUB. 11-11-2003, FILED 1-8-1999.

**WIRESPEED**

FOR MODEMS AND COMPUTER SOFTWARE USED TO UPGRADE AND ENHANCE VARIOUS OPERATIONS AND FUNCTIONS OF MODEMS (U.S. CLS. 21, 23, 26, 36 AND 38).  
FIRST USE 8-0-1999; IN COMMERCE 8-0-1999.

**CLASS 9—(Continued).**

2,929,072. MOUNT VERNON BUSINESS SYSTEMS INC, ALEXANDRIA, VA. SN 75-843,907. PUB. 6-20-2000, FILED 11-9-1999.

**SNORALYZER**

FOR COMPUTER HARDWARE AND COMPUTER SOFTWARE FOR THE ANALYSIS OF SNORING (U.S. CLS. 21, 23, 26, 36 AND 38).  
FIRST USE 8-21-2003; IN COMMERCE 8-21-2003.

2,929,074. TOUCAN TELL IT PRODUCTIONS, NEW YORK, NY. SN 75-869,169. PUB. 2-18-2003, FILED 12-11-1999.

**MANDY'S MENAGERIE**

FOR SERIES OF PRERECORDED DIGITAL AUDIO OR AUDIO VISUAL RECORDINGS OR REPRODUCTIONS THEREOF, NAMELY, CDS, AUDIO AND AUDIO VISUAL CASSETTES, DVDS AND VIDEO CASSETTES, FEATURING MUSIC FOR CHILDREN (U.S. CLS. 21, 23, 26, 36 AND 38).  
FIRST USE 6-0-1999; IN COMMERCE 3-1-2003.

2,929,077. EMACHINES, INC., IRVINE, CA. SN 75-904,429. PUB. 10-14-2003, FILED 1-28-2000.

**EVIEW**

FOR COMPUTER PERIPHERALS, NAMELY COMPUTER MONITORS (U.S. CLS. 21, 23, 26, 36 AND 38).  
FIRST USE 11-0-1998; IN COMMERCE 11-0-1998.

2,929,093. SONY KABUSHIKI KAISHA, TA SONY CORPORATION, TOKYO 141, JAPAN. SN 76-030,006. PUB. 9-2-2003, FILED 4-18-2000.

**MOVIE SHAKER**

PRIORITY CLAIMED UNDER SEC. 44(D) ON CANADA APPLICATION NO. 1032894, FILED 10-19-1999, REG. NO. TMA569669, DATED 10-28-2002, EXPIRES 10-28-2017.  
NO CLAIM IS MADE TO THE EXCLUSIVE RIGHT TO USE "MOVIE", APART FROM THE MARK AS SHOWN.  
FOR COMPUTER SOFTWARE FOR VIDEO PROCESSING, NAMELY, RE-ARRANGING SCENES, INSERTING CUSTOMIZED TEXT AND AUDIO, OR SELECTING APPROPRIATE TRANSITIONS (U.S. CLS. 21, 23, 26, 36 AND 38).  
FIRST USE 5-31-2000; IN COMMERCE 5-31-2000.



**CLASS 9—(Continued).**

2,929,097. EYE OJO CORP., EL CENTRO, CA. SN 76-050,854. PUB. 1-21-2003, FILED 5-18-2000.



FOR EYEGLASSES AND SUNGLASSES; EYE SHADES, SAFETY GLASSES; EYEGLASS FRAMES; EYE WEAR ACCESSORIES, NAMELY, CASES AND CHAINS (U.S. CLS. 21, 23, 26, 36 AND 38).  
FIRST USE 4-1-2004; IN COMMERCE 4-1-2004.

2,929,100. HEARST COMMUNICATIONS, INC., NEW YORK, NY. SN 76-059,925. PUB. 9-25-2001, FILED 5-30-2000.

**POPULAR MECHANICS FOR KIDS**

OWNER OF U.S. REG. NOS. 2,133,432, 2,276,781, AND OTHERS.  
NO CLAIM IS MADE TO THE EXCLUSIVE RIGHT TO USE "FOR KIDS", APART FROM THE MARK AS SHOWN.  
FOR PRE-RECORDED CD-ROMS AND COMPUTER PROGRAMS FOR INTERACTIVE EDUCATIONAL MATERIAL, NAMELY SIMULATED BUILDING PROJECTS FOR VEHICLES, AIRCRAFT, ROCKETS AND BUILDINGS, AND INSTRUCTION ON THE USE OF TOOLS (U.S. CLS. 21, 23, 26, 36 AND 38).  
FIRST USE 8-1-2004; IN COMMERCE 8-1-2004.

2,929,105. IGT, RENO, NV. SN 76-091,429. PUB. 9-4-2001, FILED 7-18-2000.

**WILD TAXI**

OWNER OF U.S. REG. NOS. 1,754,465, 2,204,544, AND OTHERS.  
FOR GAMING MACHINES, NAMELY, SLOT MACHINES (U.S. CLS. 21, 23, 26, 36 AND 38).  
FIRST USE 10-3-2003; IN COMMERCE 10-3-2003.

2,929,109. LIGHTWAVE SYSTEMS, INC., CARPINTERIA, CA. SN 76-103,226. PUB. 5-15-2001, FILED 8-4-2000.

**HEX F/X**

FOR SIGNAL PROCESSORS FOR USE WITH OPTICAL PICKUPS FOR STRINGED INSTRUMENTS (U.S. CLS. 21, 23, 26, 36 AND 38).  
FIRST USE 6-15-2004; IN COMMERCE 6-15-2004.

**CLASS 9—(Continued).**

2,929,111. GRIDLINE AB, 17141 SOLNA, SWEDEN. SN 76-114,685. PUB. 8-28-2001, FILED 8-22-2000.

**D GRID**

NO CLAIM IS MADE TO THE EXCLUSIVE RIGHT TO USE "GRID", APART FROM THE MARK AS SHOWN.  
FOR ANTI-SCATTER GRIDS FOR X RAY MACHINES (U.S. CLS. 21, 23, 26, 36 AND 38).  
FIRST USE 7-13-2001; IN COMMERCE 1-21-2003.

2,929,120. SYLVAN LEARNING, INC., BALTIMORE, MD. SN 76-149,634. PUB. 2-18-2003, FILED 10-18-2000.



OWNER OF U.S. REG. NOS. 1,303,186 AND 1,331,327.  
FOR COMPUTER EDUCATIONAL SOFTWARE AND PRE-RECORDED CD-ROMS FEATURING INSTRUCTION IN THE FIELD OF SUPPLEMENTAL, REMEDIAL AND VOCATIONAL EDUCATION AND TIME MANAGEMENT SKILLS (U.S. CLS. 21, 23, 26, 36 AND 38).  
FIRST USE 1-0-2003; IN COMMERCE 1-0-2003.

2,929,122. PUBLIC BROADCASTING SERVICE, ALEXANDRIA, VA. SN 76-151,653. PUB. 11-20-2001, FILED 10-23-2000.

**PBS**

OWNER OF U.S. REG. NOS. 1,235,634, 1,562,820, AND OTHERS.  
FOR PRE-RECORDED VIDEOCASSETTES, VIDEO DISCS, CD-ROM'S, AUDIO COMPACT DISCS, DVD'S AND COMPUTER GAME PROGRAMS AND MULTIMEDIA SOFTWARE FEATURING A WIDE RANGE OF CULTURAL, EDUCATIONAL, AND ENTERTAINMENT TOPICS, AND FOR PLAYING GAMES AND ACTIVITIES (U.S. CLS. 21, 23, 26, 36 AND 38).  
FIRST USE 12-31-1983; IN COMMERCE 12-31-1983.

**CLASS 9—(Continued).**

2,929,123. PUBLIC BROADCASTING SERVICE, ALEXANDRIA, VA. SN 76-151,665. PUB. 3-12-2002, FILED 10-23-2000.



OWNER OF U.S. REG. NOS. 1,235,634, 1,562,820, AND OTHERS.

FOR PRE-RECORDED VIDEOCASSETTES, VIDEO DISCS, CD-ROM'S, AUDIO COMPACT DISCS, DVD'S AND COMPUTER GAME PROGRAMS AND MULTIMEDIA SOFTWARE FEATURING A WIDE RANGE OF CULTURAL, EDUCATIONAL, AND ENTERTAINMENT TOPICS, AND FOR PLAYING GAMES AND ACTIVITIES (U.S. CLS. 21, 23, 26, 36 AND 38).

FIRST USE 7-31-1999; IN COMMERCE 7-31-1999.

2,929,125. CASINO DATA SYSTEMS, LAS VEGAS, NV. SN 76-155,360. PUB. 8-14-2001, FILED 10-26-2000.

**VICTORY AT SEA**

FOR GAMING DEVICES, NAMELY, GAMING MACHINES AND COMPUTER GAME SOFTWARE THEREFOR (U.S. CLS. 21, 23, 26, 36 AND 38).

FIRST USE 10-18-2000; IN COMMERCE 10-18-2000.

2,929,131. IGT, RENO, NV. SN 76-174,351. PUB. 4-27-2004, FILED 12-1-2000.

**MS. LITTLE GREEN MEN**

FOR GAMING MACHINES (U.S. CLS. 21, 23, 26, 36 AND 38).

FIRST USE 4-0-2001; IN COMMERCE 4-0-2001.

2,929,136. ALLIED MARKETING GROUP, INC., DALLAS, TX. SN 76-184,368. PUB. 10-1-2002, FILED 12-20-2000.

**ULTRALITE**

FOR VACUUM CLEANERS (U.S. CLS. 21, 23, 26, 36 AND 38).

FIRST USE 9-29-2004; IN COMMERCE 9-29-2004.

**CLASS 9—(Continued).**

2,929,137. TYCO ELECTRONICS LOGISTICS AG, CH 9323 STEINACH/SG, SWITZERLAND. SN 76-187,217. PUB. 3-11-2003, FILED 12-28-2000.

**AXICOM**

FOR ELECTRIC TELECOMMUNICATION RELAYS AND SWITCHES (U.S. CLS. 21, 23, 26, 36 AND 38).  
FIRST USE 10-0-2000; IN COMMERCE 10-0-2000.

2,929,147. KABUSHIKI KAISHA KENWOOD, TA KENWOOD CORPORATION, SHIBUYA-KU, TOKYO, JAPAN. SN 76-201,338. PUB. 10-29-2002, FILED 1-29-2001.

**KENWOOD**  
sovereign

OWNER OF U.S. REG. NOS. 1,355,018, 1,627,607, AND 1,658,049.

NO CLAIM IS MADE TO THE EXCLUSIVE RIGHT TO USE "SOVEREIGN", APART FROM THE MARK AS SHOWN.

THE MARK CONSISTS OF THE WORDS "KENWOOD" IN UPPER CASE AND "SOVEREIGN" IN LOWER CASE WITH A STYLIZED LETTER "V"; THE STYLIZED "V" AND THE FIGURE OF AN INVERTED PYRAMID INSIDE THE LETTER "W" ARE RED.

FOR HOME STEREO EQUIPMENT, NAMELY, RECEIVERS, AUDIO CASSETTE DECKS, CD PLAYERS, DVD PLAYERS, AUDIO SPEAKERS (U.S. CLS. 21, 23, 26, 36 AND 38).

FIRST USE 9-0-2001; IN COMMERCE 9-0-2001.

2,929,148. KABUSHIKI KAISHA KENWOOD, TA KENWOOD CORPORATION, SHIBUYA-KU, TOKYO, JAPAN. SN 76-201,339. PUB. 10-8-2002, FILED 1-29-2001.

**KENWOOD SOVEREIGN**

OWNER OF U.S. REG. NOS. 1,355,018, 1,627,607, AND 1,658,049.

FOR HOME STEREO EQUIPMENT, NAMELY, RECEIVERS, AUDIO CASSETTE DECKS, CD PLAYERS, DVD PLAYERS, AUDIO SPEAKERS AND MP3 PLAYERS (U.S. CLS. 21, 23, 26, 36 AND 38).

FIRST USE 9-0-2001; IN COMMERCE 9-0-2001.

**CLASS 9—(Continued).**

2,929,150. ARQULE INC., WOBURN, MA. SN 76-205,890. PUB. 6-18-2002, FILED 2-5-2001.

**AMAP**

FOR LABORATORY EQUIPMENT, NAMELY, VIAL RACKS, LIQUID DISPENSING VIALS, VIAL HEATERS, NAMELY, THERMALLY CONTROLLED HEATED AND ELECTRICAL RESISTANCE HEATED VIAL HEATERS, VIALS FOR SHAKING AND STIRRING LIQUIDS, VIAL COOLERS, NAMELY, THERMALLY CONTROLLED COOLING VIALS, DEVICE FOR EXTRACTING CONCENTRATES FROM LIQUIDS, DEVICE FOR EXTRACTING SOLID PHASE CONCENTRATES FROM LIQUIDS, CONTAINER CARTRIDGE FOR HOLDING ORGANIC CHEMICAL COMPOUNDS, ORGANIC COMPOUND WEIGHING SCALES, SOLID DISPENSING VIALS, LABORATORY FILTERS, CENTRIFUGAL METERING PUMPS, UV DETECTORS, AND SPECTROMETERS, ALL FOR THE SYNTHESIS, ANALYSIS, AND PURIFICATION OF ORGANIC CHEMICAL COMPOUNDS (U.S. CLS. 21, 23, 26, 36 AND 38).

FIRST USE 11-30-1998; IN COMMERCE 11-30-1998.

2,929,152. CASINO DATA SYSTEMS, LAS VEGAS, NV. SN 76-210,662. PUB. 8-28-2001, FILED 2-13-2001.

**GOLDEN GOOSE**

FOR GAMING DEVICES, NAMELY, GAMING MACHINES AND COMPUTER GAME SOFTWARE THEREFOR (U.S. CLS. 21, 23, 26, 36 AND 38).

FIRST USE 10-1-2001; IN COMMERCE 10-1-2001.

2,929,157. GEORGIANO, JOSEPH, HICKSVILLE, NY. AND MATH, IRWIN, GREENVALE, NY. SN 76-217,057. PUB. 1-27-2004, FILED 2-22-2001.

**FIBERKEY**

FOR ELECTRICAL COMPONENT RACK (U.S. CLS. 21, 23, 26, 36 AND 38).

FIRST USE 2-0-2001; IN COMMERCE 2-0-2001.

2,929,158. ALPS ELECTRIC CO., LTD., OTA-KU, TOKYO, 145-8501, JAPAN. SN 76-219,163. PUB. 5-20-2003, FILED 3-2-2001.

**HAPTIC COMMANDER**

NO CLAIM IS MADE TO THE EXCLUSIVE RIGHT TO USE "HAPTIC", APART FROM THE MARK AS SHOWN.

FOR ELECTRICAL SWITCHES AND ELECTRICAL CONTROLLERS FOR AUTOMOTIVE, AUDIO APPARATUS, NAVIGATION APPARATUS, VIDEO PLAYERS, REMOTE CONTROLLERS, AND MEASURING APPARATUS (U.S. CLS. 21, 23, 26, 36 AND 38).

FIRST USE 12-31-2002; IN COMMERCE 12-31-2002.

**CLASS 9—(Continued).**

2,929,159. CASINO DATA SYSTEMS, LAS VEGAS, NV. SN 76-219,466. PUB. 8-28-2001, FILED 3-1-2001.

**PANDA PAYS**

FOR GAMING DEVICES, NAMELY, GAMING MACHINES AND COMPUTER GAME SOFTWARE THEREFOR (U.S. CLS. 21, 23, 26, 36 AND 38).

FIRST USE 8-25-2004; IN COMMERCE 8-25-2004.

2,929,163. DISNEY ENTERPRISES, INC., BURBANK, CA. SN 76-237,053. PUB. 1-7-2003, FILED 4-6-2001.

**KIM POSSIBLE**

FOR PRE-RECORDED COMPACT DISCS, ALL FEATURING MUSIC; PRE-RECORDED VIDEO CASSETTES, DIGITAL VIDEO DISCS AND DIGITAL VERSATILE DISCS, ALL FEATURING STORIES AND ENTERTAINMENT FOR CHILDREN; COMPUTER GAME PROGRAMS, FEATURING EDUCATION, GAMES, STORIES AND ENTERTAINMENT FOR CHILDREN (U.S. CLS. 21, 23, 26, 36 AND 38).

FIRST USE 11-12-2002; IN COMMERCE 11-12-2002.

2,929,165. SNYDER, DOUGLAS D., BERGHOLZ, OH. SN 76-238,310. PUB. 3-12-2002, FILED 4-10-2001.

**JBS TECHNOLOGIES**

NO CLAIM IS MADE TO THE EXCLUSIVE RIGHT TO USE "TECHNOLOGIES", APART FROM THE MARK AS SHOWN.

FOR AFTERMARKET ELECTRONIC AUTOMOTIVE ACCESSORIES, NAMELY MOBILE ENTERTAINMENT SYSTEMS COMPRISED PRIMARILY OF RADIO RECEIVERS, RECORDED MUSIC PLAYERS AND SPEAKERS FOR MOTOR VEHICLES (U.S. CLS. 21, 23, 26, 36 AND 38).

FIRST USE 6-20-2001; IN COMMERCE 6-30-2001.

2,929,177. SONY KABUSHIKI KAISHA, TA SONY CORPORATION, TOKYO, JAPAN. SN 76-256,348. PUB. 5-28-2002, FILED 5-14-2001.

**LPEC**

FOR DATA STORAGE MEDIA, NAMELY, PACKAGED SEMICONDUCTORS; INTEGRATED CIRCUITS BUILT IN AUDIO PLAYERS/RECORDERS, AUDIO PLAYERS/RECORDERS (U.S. CLS. 21, 23, 26, 36 AND 38).

FIRST USE 3-0-2001; IN COMMERCE 3-0-2001.

**CLASS 9—(Continued).**

2,929,188. NATIONAL VALEDICTORIAN SOCIETY, LOUVIERS, CO. SN 76-266,522. PUB. 10-23-2001, FILED 6-4-2001.

**VALEDICTORIAN PRESS**

OWNER OF U.S. REG. NO. 2,455,630.  
NO CLAIM IS MADE TO THE EXCLUSIVE RIGHT TO USE "PRESS", APART FROM THE MARK AS SHOWN, FOR SOUND RECORDINGS FEATURING INFORMATION ON ACADEMIC RELATED SUBJECTS AND PRINTED MATERIAL RELATED THERETO, SOLD AS A UNIT (U.S. CLS. 21, 23, 26, 36 AND 38).  
FIRST USE 6-30-2004; IN COMMERCE 6-30-2004.

2,929,195. MEASUREMENT SPECIALTIES, INC., FAIRFIELD, NJ. SN 76-271,847. PUB. 12-24-2002, FILED 6-18-2001.

**DURALITH**

FOR ELECTRONIC TOUCH SENSITIVE SWITCHES, ELECTRONIC PANELS FOR INPUTTING INFORMATION, AND KEYPADS (U.S. CLS. 21, 23, 26, 36 AND 38).  
FIRST USE 11-1-2004; IN COMMERCE 11-1-2004.

2,929,201. OLYMPUS OPTICAL CO., LTD., TOKYO, JAPAN. SN 76-293,924. PUB. 9-30-2003, FILED 8-1-2001.

**GX**

FOR MICROSCOPES AND PARTS THEREFOR, ACCESSORIES FOR MICROSCOPES, NAMELY, TRANSMITTED LIGHT ILLUMINATORS, PHOT-UNITS, CALIBRATION SCALES, OBSERVATION TUBES, INTERMEDIATE TUBES AND REVOLVING NOSEPIECES (U.S. CLS. 21, 23, 26, 36 AND 38).  
FIRST USE 10-1-2001; IN COMMERCE 12-14-2001.

2,929,204. IGT, RENO, NV. SN 76-298,243. PUB. 4-27-2004, FILED 8-10-2001.

**LITTLE GREEN MEN  
FAMILY REUNION**

OWNER OF U.S. REG. NOS. 2,439,454 AND 2,439,455.  
FOR GAMING MACHINES, NAMELY, SLOT MACHINES WITH OR WITHOUT A VIDEO OUTPUT (U.S. CLS. 21, 23, 26, 36 AND 38).  
FIRST USE 8-30-2002; IN COMMERCE 9-13-2002.

**CLASS 9—(Continued).**

2,929,210. AUSTRAL VON ROLL ISOLA, INC., DOUGLASVILLE, GA. SN 76-308,926. PUB. 3-19-2002, FILED 9-5-2001.

**AUSTRAVOLT**

FOR MICA TAPE INSULATED COPPER WIRE, MAGNET WIRE (U.S. CLS. 21, 23, 26, 36 AND 38).  
FIRST USE 11-22-2004; IN COMMERCE 11-22-2004.

2,929,228. BACHMANN INDUSTRIES, INC., PHILADELPHIA, PA. SN 76-346,861. PUB. 10-22-2002, FILED 12-10-2001.

**E-Z COMMAND**

OWNER OF U.S. REG. NOS. 2,053,073, 2,225,724, AND OTHERS.  
FOR ELECTRONIC CONTROLLERS FOR TOY TRAIN SETS (U.S. CLS. 21, 23, 26, 36 AND 38).  
FIRST USE 8-15-2004; IN COMMERCE 8-15-2004.

2,929,237. DAEWOO INTERNATIONAL CORPORATION, JOONG-GU, SEOUL, REPUBLIC OF KOREA. SN 76-355,693. PUB. 12-10-2002, FILED 1-4-2002.

**DAEWOO**

OWNER OF U.S. REG. NOS. 1,410,533, 1,421,852, AND OTHERS.

THE ENGLISH TRANSLATION OF "DAEWOO" IS "GREAT WORLD" OR "BIG WORLD".

FOR COMPUTER MONITORS; DESKTOP COMPUTERS; COMPUTER PERIPHERALS; COMPUTER HARDWARE; DIGITAL VERSATILE DISC PLAYERS; MPEG AUDIO LAYER-3 PLAYERS; PERSONAL DIGITAL ASSISTANTS; TELEVISION RECEIVING SETS; TELEVISION RECEIVERS; TELEVISION SETS; REMOTE CONTROLS FOR RADIOS, TELEVISIONS, AND STEREO; MODEMS; PORTABLE COMMUNICATION APPARATUS, NAMELY, MOBILE TELEPHONES; DRY CELL BATTERIES; ELECTRIC FLAT IRONS (U.S. CLS. 21, 23, 26, 36 AND 38).  
FIRST USE 10-0-1979; IN COMMERCE 10-0-1979.

2,929,239. CELION NETWORKS INC., RICHARDSON, TX. SN 76-366,597. PUB. 2-18-2003, FILED 2-4-2002.

**AUTOTOPOLOGY**

FOR OPTICAL NETWORK SOFTWARE, NAMELY, SOFTWARE THAT GRAPHICALLY DEPICTS INTERCONNECTION OF OPTICAL NETWORK COMPONENTS (U.S. CLS. 21, 23, 26, 36 AND 38).  
FIRST USE 5-15-2003; IN COMMERCE 5-15-2003.

**CLASS 9—(Continued).**

2,929,256. UNION BIOMETRICA, INC., SOMERVILLE, MA. SN 76-387,703. PUB. 7-1-2003, FILED 3-27-2002.

**EAZYX**

FOR COMPUTER SOFTWARE FOR DIRECTING OPERATIONS OF AND/OR ANALYZING DATA FROM AN AUTOMATED SYSTEM FOR DETECTING OPTICAL INDICATORS USED IN THE FIELD OF LABORATORY RESEARCH (U.S. CLS. 21, 23, 26, 36 AND 38).  
FIRST USE 9-11-2004; IN COMMERCE 9-11-2004.

2,929,261. BOHLIN INSTRUMENTS LIMITED, CIRENCESTER, GLOUCESTER, GREAT BRITAIN. SN 76-394,281. PUB. 7-8-2003, FILED 4-12-2002.

**ROTONETIC**

FOR MEASURING APPARATUS AND INSTRUMENTS, NAMELY RHEOMETERS, VISCOMETERS, TORQUE TRANSDUCERS; PARTS AND FITTINGS FOR THE AFORESAID GOODS; COMPUTER SOFTWARE AND HARDWARE FOR CONTROLLING SUCH GOODS AND FOR ANALYZING MEASUREMENT MADE BY SUCH GOODS (U.S. CLS. 21, 23, 26, 36 AND 38).  
FIRST USE 4-8-2004; IN COMMERCE 4-8-2004.

2,929,268. LG ELECTRONICS INC., SEOUL, REPUBLIC OF KOREA. SN 76-408,270. PUB. 12-3-2002, FILED 5-13-2002.

**XCANVAS**

FOR TELEVISION SETS, PLASMA DISPLAY PANEL TV, PROJECTION TV, LIQUID CRYSTAL DISPLAYS TV, MONITORS, CATHODE-RAY TUBES (U.S. CLS. 21, 23, 26, 36 AND 38).  
FIRST USE 12-0-2003; IN COMMERCE 12-0-2003.

2,929,276. LAHARCO INC., DBA LACEY-HARMER SUPPLY & MFG. CO., PORTLAND, OR. SN 76-427,626. PUB. 3-4-2003, FILED 7-5-2002.

**SENSE-A-PLATE**

OWNER OF U.S. REG. NO. 1,969,916.  
FOR SENSING SCANNERS THAT IDENTIFY THE LOCATIONS OF METAL PLATES IN AN ASSEMBLED STRUCTURE, NAMELY A TRUSS (U.S. CLS. 21, 23, 26, 36 AND 38).  
FIRST USE 8-10-2004; IN COMMERCE 8-10-2004.

**CLASS 9—(Continued).**

2,929,277. RED STEER GLOVE COMPANY, SALEM, OR. SN 76-427,833. PUB. 1-14-2003, FILED 6-28-2002.

**RED STEER HEATSAVER**

FOR PROTECTIVE GLOVES FOR INDUSTRIAL AND COMMERCIAL USE THAT ARE MADE OF A COMBINATION OF FABRICS AND LEATHER AND THEN LINED FOR PROTECTION FROM COLD CONDITIONS (U.S. CLS. 21, 23, 26, 36 AND 38).  
FIRST USE 8-8-2002; IN COMMERCE 8-26-2002.

2,929,284. IRONCLAD PERFORMANCE WEAR CORP., LOS ANGELES, CA. SN 76-439,823. PUB. 7-20-2004, FILED 8-12-2002.

**GRIPTEC STRIKER**

FOR PROTECTIVE WORK GLOVES, NAMELY GLOVES FOR USE IN THE CONSTRUCTION INDUSTRY (U.S. CLS. 21, 23, 26, 36 AND 38).  
FIRST USE 9-0-2002; IN COMMERCE 9-0-2002.

2,929,288. MULTIMEDIA GAMES, INC., AUSTIN, TX. SN 76-445,365. PUB. 4-8-2003, FILED 8-30-2002.

**LIVE IT UP**

FOR GAMING MACHINES FOR PLAYING ELECTRONIC BINGO GAMES AND GAMES OF CHANCE (U.S. CLS. 21, 23, 26, 36 AND 38).  
FIRST USE 10-5-2004; IN COMMERCE 10-5-2004.

2,929,289. MULTIMEDIA GAMES, INC., AUSTIN, TX. SN 76-445,369. PUB. 7-22-2003, FILED 8-30-2002.

**HIGH VOLTAGE BONUS**

NO CLAIM IS MADE TO THE EXCLUSIVE RIGHT TO USE "BONUS", APART FROM THE MARK AS SHOWN.  
FOR GAMING MACHINES FOR PLAYING ELECTRONIC BINGO GAMES AND GAMES OF CHANCE (U.S. CLS. 21, 23, 26, 36 AND 38).  
FIRST USE 4-2-2004; IN COMMERCE 4-2-2004.

2,929,290. MULTIMEDIA GAMES, INC., AUSTIN, TX. SN 76-445,385. PUB. 4-1-2003, FILED 8-30-2002.

**KRAZY FARM**

FOR GAMING MACHINES FOR PLAYING ELECTRONIC BINGO GAMES AND GAMES OF CHANCE (U.S. CLS. 21, 23, 26, 36 AND 38).  
FIRST USE 10-19-2004; IN COMMERCE 10-19-2004.

**CLASS 9—(Continued).**

2,929,291. MULTIMEDIA GAMES, INC., AUSTIN, TX. SN 76-445,386. PUB. 4-1-2003, FILED 8-30-2002.

**REEL THRILLS**

FOR GAMING MACHINES FOR PLAYING ELECTRONIC BINGO GAMES AND GAMES OF CHANCE (U.S. CLS. 21, 23, 26, 36 AND 38).

FIRST USE 8-5-2004; IN COMMERCE 8-5-2004.

2,929,296. DIGITAL FICTION INC., MONTREAL, QUEBEC, CANADA. SN 76-453,387. PUB. 9-9-2003, FILED 9-20-2002.

**BLACK & BRUISED**

PRIORITY CLAIMED UNDER SEC. 44(D) ON CANADA APPLICATION NO. 1,134,984, FILED 3-21-2002.

FOR INTERACTIVE VIDEO GAME PROGRAMS, COMPUTER GAME PROGRAMS, COMPUTER GAME SOFTWARE, AND COMPUTER GAME DISCS (U.S. CLS. 21, 23, 26, 36 AND 38).

FIRST USE 1-27-2003; IN COMMERCE 1-27-2003.

2,929,304. M/A-COM, INC., LOWELL, MA. SN 76-464,205. PUB. 3-16-2004, FILED 11-5-2002.

**NETWORKFIRST**

FOR INTERNET PROTOCOL BASED NETWORK, COMPRISING HARDWARE AND SOFTWARE FOR INTEROPERABLE COMMUNICATIONS (U.S. CLS. 21, 23, 26, 36 AND 38).

FIRST USE 7-16-2004; IN COMMERCE 7-16-2004.

2,929,308. CHERRY BEKAERT & HOLLAND, L.L.P., RICHMOND, VA. SN 76-466,762. PUB. 8-19-2003, FILED 11-14-2002.

**GO-LINK**

FOR COMPUTER SOFTWARE FOR USE IN ANALYZING, MANAGING, ORGANIZING, AND REPORTING FINANCIAL AND ACCOUNTING DATA AND INFORMATION (U.S. CLS. 21, 23, 26, 36 AND 38).

FIRST USE 5-18-2003; IN COMMERCE 5-18-2003.

**CLASS 9—(Continued).**

2,929,309. CORNERSTONE PROMOTION, INC., NEW YORK, NY. SN 76-468,819. PUB. 8-19-2003, FILED 11-18-2002.

**THE FADER LABEL**

NO CLAIM IS MADE TO THE EXCLUSIVE RIGHT TO USE "LABEL", APART FROM THE MARK AS SHOWN.

FOR MUSICAL SOUND RECORDINGS; AUDIO-VISUAL RECORDINGS, NAMELY, COMPACT DISCS, AUDIO TAPES, AUDIO DISCS, RECORDS, CD-ROMS, VIDEO TAPES, VIDEO CASSETTES, VIDEO DISCS, DVDS, DATS, ALL FEATURING MUSIC; DOWNLOADABLE ELECTRONIC PUBLICATIONS IN THE NATURE OF BOOKS, BOOKLETS, MAGAZINES, JOURNALS, MANUALS, BROCHURES, LEAFLETS, PAMPHLETS AND NEWSLETTERS, ALL IN THE FIELD OF MUSIC; ELECTRONIC PUBLICATIONS, NAMELY, BOOKS, BOOKLETS, MAGAZINES, JOURNALS, MANUALS, BROCHURES, LEAFLETS, PAMPHLETS AND NEWSLETTERS, ALL IN THE FIELD OF MUSIC RECORDED ON CD-ROMS, VIDEO CASSETTES, AND MAGNETIC TAPES; MAGNETS; DECORATIVE MAGNETS; REFRIGERATOR MAGNETS; NOVELTY MAGNETS (U.S. CLS. 21, 23, 26, 36 AND 38).

FIRST USE 9-21-2004; IN COMMERCE 9-21-2004.

2,929,324. SOUTHWEST RESEARCH INSTITUTE, SAN ANTONIO, TX. SN 76-481,505. PUB. 6-15-2004, FILED 1-10-2003.



OWNER OF U.S. REG. NO. 2,552,212.

FOR ELECTRONIC MAGNETOSTRICTIVE EQUIPMENT, NAMELY, A WAVE GENERATOR, A WAVE SENSOR AND A WAVE ANALYZER ALL NOT USED IN THE MEDICAL FIELD (U.S. CLS. 21, 23, 26, 36 AND 38).

FIRST USE 0-0-1998; IN COMMERCE 0-0-1998.

2,929,325. SOUTHWEST RESEARCH INSTITUTE, SAN ANTONIO, TX. SN 76-481,507. PUB. 4-20-2004, FILED 1-10-2003.

**MSSR**

OWNER OF U.S. REG. NO. 2,552,212.

FOR ELECTRONIC MAGNETOSTRICTIVE EQUIPMENT, NAMELY, A WAVE GENERATOR, A WAVE SENSOR AND A WAVE ANALYZER, ALL NOT USED IN THE MEDICAL FIELD (U.S. CLS. 21, 23, 26, 36 AND 38).

FIRST USE 0-0-1998; IN COMMERCE 0-0-1998.

**CLASS 9—(Continued).**

2,929,328. COMDATA NETWORK, INC., BRENTWOOD, TN. SN 76-481,647. PUB. 11-4-2003, FILED 1-10-2003.

**COMDATA**

OWNER OF U.S. REG. NOS. 2,076,541 AND 2,490,355.  
 FOR MAGNETICALLY ENCODED CARDS, NAMELY CREDIT CARDS, DEBIT CARDS, AUTOMATED TELLER MACHINE CARDS, CASH CARDS, PREPAID PURCHASE CARDS, IDENTIFICATION CARDS, GIFT CARDS, SECURITY CARDS, TELEPHONE CALLING CARDS; AND COMPUTER HARDWARE AND SOFTWARE FOR PROCESSING AND READING AUTOMATED CARDS (U.S. CLS. 21, 23, 26, 36 AND 38).  
 FIRST USE 1-0-2002; IN COMMERCE 1-0-2002.

2,929,337. LOGIXML, INC., MCLEAN, VA. SN 76-487,273. PUB. 3-23-2004, FILED 1-31-2003.



FOR COMPUTER SOFTWARE FOR WEB SITE DEVELOPMENT AND DATABASE MANAGEMENT (U.S. CLS. 21, 23, 26, 36 AND 38).  
 FIRST USE 10-1-2002; IN COMMERCE 10-1-2002.

2,929,342. CISCO-LINKSYS LLC, SAN JOSE, CA. SN 76-488,978. PUB. 2-24-2004, FILED 2-10-2003.

**INSTANT GIGABIT**

NO CLAIM IS MADE TO THE EXCLUSIVE RIGHT TO USE GIGABIT, APART FROM THE MARK AS SHOWN.  
 FOR WIRELESS AND WIRED NETWORKING HARDWARE THAT ENABLES COMMUNICATION BETWEEN A COMPUTER AND ANOTHER COMPUTER OR THE INTERNET (U.S. CLS. 21, 23, 26, 36 AND 38).  
 FIRST USE 3-0-2001; IN COMMERCE 3-0-2001.

2,929,354. ARK-LES CORPORATION, STOUGHTON, MA. SN 76-496,299. PUB. 11-11-2003, FILED 3-10-2003.

**INTEGRA-CRIMP**

FOR ELECTRICAL TERMINALS (U.S. CLS. 21, 23, 26, 36 AND 38).  
 FIRST USE 11-1-2003; IN COMMERCE 11-1-2003.

**CLASS 9—(Continued).**

2,929,355. TRANSITCENTER, INC., NEW YORK, NY. SN 76-497,333. PUB. 1-27-2004, FILED 3-7-2003.

**TRANSITCHEK QUICKPAY**

OWNER OF U.S. REG. NO. 1,673,424.  
 FOR MAGNETICALLY ENCODED COMPUTER READABLE CARD USED IN CONNECTION WITH THE PURCHASE OF TRANSIT PASSES, TICKETS AND FARE CARDS FOR PUBLIC TRANSPORTATION (U.S. CLS. 21, 23, 26, 36 AND 38).  
 FIRST USE 4-0-2004; IN COMMERCE 4-0-2004.

2,929,361. EARCRAFT, INC., TOPSHAM, ME. SN 76-498,791. PUB. 5-25-2004, FILED 3-12-2003.



NO CLAIM IS MADE TO THE EXCLUSIVE RIGHT TO USE "FIT", APART FROM THE MARK AS SHOWN.  
 FOR COMPUTER SOFTWARE FOR PROGRAMMING HEARING AIDS (U.S. CLS. 21, 23, 26, 36 AND 38).  
 FIRST USE 3-3-2003; IN COMMERCE 3-3-2003.

2,929,374. PAWS, INCORPORATED, ALBANY, IN. SN 76-502,954. PUB. 2-24-2004, FILED 3-28-2003.

**GARFIELD**

FOR SERIES OF PRERECORDED AUDIO AND VIDEO TAPES, AND COMPACT DISCS, ALL FEATURING CHARACTERS FROM AN ANIMATED CAT COMIC STRIP (U.S. CLS. 21, 23, 26, 36 AND 38).  
 FIRST USE 10-19-2004; IN COMMERCE 10-19-2004.

2,929,375. PAWS, INCORPORATED, ALBANY, IN. SN 76-502,955. PUB. 2-24-2004, FILED 3-28-2003.

**GARFIELD**

FOR MOTION PICTURE FILMS FEATURING CHARACTERS DERIVED FROM AN ANIMATED CAT COMIC STRIP (U.S. CLS. 21, 23, 26, 36 AND 38).  
 FIRST USE 5-1-2004; IN COMMERCE 5-1-2004.

**CLASS 9—(Continued).**

2,929,379. TRANSOMA MEDICAL, INC., ST. PAUL, MN. SN 76-505,225. PUB. 1-6-2004, FILED 4-9-2003.

**TRANSOMA MEDICAL**

NO CLAIM IS MADE TO THE EXCLUSIVE RIGHT TO USE "MEDICAL", APART FROM THE MARK AS SHOWN. FOR COMPUTER HARDWARE AND SOFTWARE FOR USE IN ACQUISITION AND ANALYSIS OF TELEMETERED PHYSIOLOGIC DATA (U.S. CLS. 21, 23, 26, 36 AND 38).

FIRST USE 9-20-2004; IN COMMERCE 9-20-2004.

2,929,389. AERIS ENTERPRISES, INC. RENO, NV. SN 76-509,679. PUB. 4-27-2004, FILED 4-28-2003.

**AEMPOWER SUITE**

NO CLAIM IS MADE TO THE EXCLUSIVE RIGHT TO USE "SUITE", APART FROM THE MARK AS SHOWN. FOR COMPUTER SOFTWARE FOR HUMAN RESOURCES, FINANCIAL, AND USER SECURITY PURPOSES (U.S. CLS. 21, 23, 26, 36 AND 38).

FIRST USE 4-1-2003; IN COMMERCE 4-1-2003.

2,929,395. GENICA CORPORATION, OCEANSIDE, CA. SN 76-511,221. PUB. 12-16-2003, FILED 5-2-2003.

**GEEKBOOK**

FOR NOTEBOOK COMPUTERS AND COMPUTER HARDWARE (U.S. CLS. 21, 23, 26, 36 AND 38).

FIRST USE 8-16-2004; IN COMMERCE 8-16-2004.

2,929,401. GREAT AMERICAN INSURANCE CO., CINCINNATI, OH. SN 76-513,991. PUB. 12-16-2003, FILED 5-5-2003.

**GREATAG**

FOR WEB BASED COMPUTER SOFTWARE FOR QUOTING, DATA ENTRY AND POLICY INSURANCE FOR CROP INSURANCE POLICIES (U.S. CLS. 21, 23, 26, 36 AND 38).

FIRST USE 4-1-2004; IN COMMERCE 4-1-2004.

2,929,413. LEO ELEKTRONENMIKROSKOPIE GMBH, FED REP GERMANY. SN 76-522,678. PUB. 4-20-2004, FILED 6-13-2003.

**SUPRA**

FOR ELECTRON MICROSCOPES AND PARTS THEREOF (U.S. CLS. 21, 23, 26, 36 AND 38).

FIRST USE 8-0-2002; IN COMMERCE 8-0-2002.

**CLASS 9—(Continued).**

2,929,414. LEO ELEKTRONENMIKROSKOPIE GMBH, 73447 OBERKÖCHEN, FED REP GERMANY. SN 76-522,679. PUB. 4-20-2004, FILED 6-13-2003.

**XVP**

PRIORITY CLAIMED UNDER SEC. 44(D) ON FED REP GERMANY APPLICATION NO. 30308852.4, FILED 2-21-2003. FOR ELECTRON MICROSCOPES AND PARTS THEREOF (U.S. CLS. 21, 23, 26, 36 AND 38).

FIRST USE 7-0-2003; IN COMMERCE 7-0-2003.

2,929,417. MQSOFTWARE, INC., MINNEAPOLIS, MN. SN 76-523,726. PUB. 1-13-2004, FILED 6-11-2003.

 The logo for QNami! features a large, stylized letter 'Q' with a thick black outline and a white fill. To the right of the 'Q' is the word 'Nami!' in a bold, black, sans-serif font. The exclamation point is also in a bold, black, sans-serif font.

FOR REAL-TIME COMPUTER MONITORING AND MANAGEMENT SOFTWARE USED FOR TRANSACTION MODELING AND TRACKING PERFORMANCE AND AVAILABILITY OF COMPUTERIZED BUSINESS TRANSACTIONS UTILIZING NETWORKS OF CONNECTED COMPUTERS, DATABASES, WEBSITES, E-COMMERCE SOLUTIONS, INTEGRATION BROKERS AND TOOLS AND BUSINESS PROCESS MANAGEMENT SYSTEMS (U.S. CLS. 21, 23, 26, 36 AND 38).

FIRST USE 5-21-2003; IN COMMERCE 5-21-2003.

2,929,418. DREAMGEAR LLC, TORRANCE, CA. SN 76-523,815. PUB. 5-25-2004, FILED 6-11-2003.

**BIG DEAL PAK**

NO CLAIM IS MADE TO THE EXCLUSIVE RIGHT TO USE PAK, APART FROM THE MARK AS SHOWN.

FOR COMPUTER AND/OR VIDEO GAME SOFTWARE AND COMPUTER, VIDEO GAME AND ELECTRONICS EQUIPMENT AND ACCESSORIES, NAMELY, REMOTE CONTROL UNITS FOR COMPUTERS; HAND HELD JOY STICK AND STEERING WHEEL UNITS FOR PLAYING COMPUTER AND VIDEO GAMES; CABLES TO CONNECT VIDEO GAME MACHINES TO TELEVISIONS, DVD PLAYERS, VCR PLAYERS, AND MULTIPLE USER VIDEO GAME MACHINES COMPRISED OF VIDEO GAME MACHINES, VIDEO GAME SOFTWARE AND PERIPHERALS; ADAPTERS TO CONNECT MULTIPLE VIDEO GAME PLAYERS TO THE SAME VIDEO GAME MACHINE ALLOWING FOR SIMULTANEOUS PLAY; VIDEO GAME BATTERY PACKS; AUTOMOBILE ELECTRICAL POWER ADAPTERS FOR VIDEO GAME MACHINES; HEAD CLEANING TAPES AND COMPACT DISCS FOR VIDEO GAMES; VIDEO GAME ADAPTER SWITCHES TO ALLOW SWITCHING BETWEEN GAME MACHINES, TELEVISION, DVDS AND VCRS WITHOUT HAVING TO DISCONNECT SUCH ITEMS; EXTENSION CABLES, NAMELY CABLES FOR EXTENDING VIDEO GAME MACHINES AND PERIPHERALS TO TELEVISIONS OVER LONG DISTANCES; COMPUTER AND VIDEO GAME MEMORY CARDS; PLASTIC, METAL AND RUBBER DECORATIVE AND PROTECTIVE COVERS FOR HAND HELD VIDEO GAME MACHINES; COMPUTER AND VIDEO GAME STANDS SPECIALLY



**CLASS 9—(Continued).**

DESIGNED FOR HOLDING A COMPUTER AND VIDEO GAME MACHINES; CARRYING CASES FOR VIDEO GAME MACHINES, ACCESSORIES AND GAMES; HEADPHONES; EAR PHONES FOR VIDEO GAME MACHINES, TELEVISIONS, VCRS, DVD PLAYERS AND RADIOS; HIGH-SPEED MEMORY CARDS FOR USE WITH VIDEO GAME MACHINES; HEADSETS FOR VIDEOGAME MACHINES, TELEVISIONS, DVD PLAYERS, CD PLAYERS, MP3 PLAYERS AND RADIOS; PORTABLE STEREO; RADIOS; AUDIO SPEAKERS; WIRELESS AUDIO SPEAKERS; WOOFERS; PORTABLE THEATER PRODUCTS, NAMELY, LCDS, NAMELY, LIQUID CRYSTAL DISPLAYS; AMPLIFIERS; ELECTRICAL SPEAKER WIRE; SWITCHES USED TO CONTROL THE AUDIO LEVEL; VIDEO GAME MACHINE CABLES; VIDEO GAME CARTRIDGES FOR USE WITH TELEVISIONS, VIDEO UNITS, AUDIO UNITS AND VIDEO GAME MACHINES; COMPUTER CARTRIDGES, CASSETTES AND DISCS FEATURING GAMES, MOVIES AND MUSIC, VIDEO CASSETTES FEATURING GAMES, MOVIES AND MUSIC, PROTECTIVE CASES, AUDIO CABLES, AND OPTICAL CABLES FOR VIDEO CAMERAS AND STEREO SYSTEMS (U.S. CLS. 21, 23, 26, 36 AND 38).

FIRST USE 9-15-2003; IN COMMERCE 9-15-2003.

---

2,929,419. DRANTEZ TECHNOLOGIES, INC., DBA DRANETZ-BMI, EDISON, NJ. SN 76-523,983. PUB. 4-20-2004, FILED 6-19-2003.

**POWER XPLORER**

NO CLAIM IS MADE TO THE EXCLUSIVE RIGHT TO USE "POWER", APART FROM THE MARK AS SHOWN.

FOR COMPUTER HARDWARE AND SOFTWARE USED TO MONITOR AND ANALYZE ELECTRIC POWER (U.S. CLS. 21, 23, 26, 36 AND 38).

FIRST USE 11-0-2003; IN COMMERCE 11-0-2003.

---

2,929,428. INFLEXXION, INC., NEWTON, MA. SN 76-525,634. PUB. 3-23-2004, FILED 6-27-2003.

**IQ: THE INFORMED QUITTER**

FOR COMPUTER SOFTWARE ON CD-ROM FEATURING SMOKING CESSATION EDUCATION AND INFORMATION (U.S. CLS. 21, 23, 26, 36 AND 38).

FIRST USE 2-0-1999; IN COMMERCE 3-0-2003.

**CLASS 9—(Continued).**

2,929,433. GREAT AMERICAN INSURANCE CO., CINCINNATI, OH. SN 76-527,550. PUB. 2-17-2004, FILED 7-3-2003.



NO CLAIM IS MADE TO THE EXCLUSIVE RIGHT TO USE "AG", APART FROM THE MARK AS SHOWN.

FOR WEB BASED COMPUTER SOFTWARE FOR QUOTING, DATA ENTRY AND POLICY INSURANCE FOR CROP INSURANCE POLICIES (U.S. CLS. 21, 23, 26, 36 AND 38).

FIRST USE 4-1-2004; IN COMMERCE 4-1-2004.

---

2,929,439. LITEL INSTRUMENTS, SAN DIEGO, CA. SN 76-529,520. PUB. 4-27-2004, FILED 7-14-2003.

**USE THE STANDARD**

FOR METROLOGY TOOLS FOR CHARACTERIZING THE PROPERTIES OF ILLUMINATION SOURCES OF PHOTOLITHOGRAPHY STEPPERS AND STEP-AND-SCAN APPARATUS FOR SEMICONDUCTORS; INTERFEROMETERS FOR FABRICATING SEMICONDUCTORS (U.S. CLS. 21, 23, 26, 36 AND 38).

FIRST USE 9-10-2004; IN COMMERCE 9-10-2004.

---

2,929,451. ADLER & ASSOCIATES, INC., CINCINNATI, OH. SN 76-533,903. PUB. 2-10-2004, FILED 7-21-2003.

**THE WELLNESS MESSAGE**

NO CLAIM IS MADE TO THE EXCLUSIVE RIGHT TO USE "WELLNESS", APART FROM THE MARK AS SHOWN.

FOR PRERECORDED COMPACT DISCS (CDS) AND PRERECORDED DIGITAL AUDIO DISCS FEATURING LECTURES ON THE SUBJECT OF OBESITY IN CHILDREN AND ADULTS AND OTHER AREAS OF PHYSICAL, MENTAL, FINANCIAL AND SPIRITUAL WELLNESS (U.S. CLS. 21, 23, 26, 36 AND 38).

FIRST USE 6-1-2004; IN COMMERCE 6-1-2004.

**CLASS 9—(Continued).**

2,929,461. MITANI USA INC., NEW YORK, NY. SN 76-538,669. PUB. 4-6-2004, FILED 8-15-2003.



O P T I X

NO CLAIM IS MADE TO THE EXCLUSIVE RIGHT TO USE "OPTICS", APART FROM THE MARK AS SHOWN. FOR SPECTACLES, SPECTACLE FRAMES, SUNGLASSES, CASES FOR SPECTACLE FRAMES AND SUNGLASSES (U.S. CLS. 21, 23, 26, 36 AND 38). FIRST USE 8-1-2002; IN COMMERCE 8-1-2002.

2,929,504. MIKRATOM LTD., 37120 NOKIA, FINLAND. SN 76-558,624. PUB. 6-8-2004, FILED 11-10-2003.

## ACEAXE

THE MARK CONSISTS OF STANDARD CHARACTERS WITHOUT CLAIM TO ANY PARTICULAR FONT, STYLE, SIZE, OR COLOR.

FOR SOFTWARE FOR OPERATING A PERSONAL COMPUTER (U.S. CLS. 21, 23, 26, 36 AND 38). FIRST USE 9-20-2004; IN COMMERCE 9-20-2004.

2,929,524. MOWER, TERENCE KELLY, GRAPEVINE, TX. SN 78-001,392. PUB. 9-10-2002, FILED 3-28-2000.

## INLEAGUE

FOR COMPUTER SOFTWARE FOR SCHEDULING OF RESOURCES, NAMELY GROUPS AND INDIVIDUALS, SCHEDULING THE USE OF RESOURCES, NAMELY, FACILITIES AND EQUIPMENT, AND MANAGEMENT OF THOSE RESOURCES FOR EFFICIENCY, USAGE, MAINTENANCE, AND COST (U.S. CLS. 21, 23, 26, 36 AND 38).

FIRST USE 11-28-2004; IN COMMERCE 11-28-2004.

**CLASS 9—(Continued).**

2,929,540. CHIP PC ISRAEL LTD, TIART-CARMEL, ISRAEL. SN 78-053,692. PUB. 6-29-2004, FILED 3-17-2001.

## XTREME PC

NO CLAIM IS MADE TO THE EXCLUSIVE RIGHT TO USE "PC", APART FROM THE MARK AS SHOWN. FOR COMPUTER HARDWARE (U.S. CLS. 21, 23, 26, 36 AND 38).

FIRST USE 10-1-2000; IN COMMERCE 10-1-2000.

2,929,548. HAMAMATSU PHOTONICS K.K., SHIZUOKA, JAPAN. SN 78-078,911. PUB. 10-29-2002, FILED 8-13-2001.

## FOS

FOR SCINTILLATOR-BASED IMAGING PLATES FOR USE IN PRODUCING REAL TIME X-RAY IMAGES FOR A WIDE VARIETY OF INDUSTRIAL AND SCIENTIFIC APPLICATIONS SUCH AS QUALITY CONTROL IN MANUFACTURING, NON-DESTRUCTIVE INSPECTION OF SEMICONDUCTOR DEVICES, CURRENCY EXAMINATION AND VERIFICATION, PACKAGING, ENVIRONMENTAL IMPACT ASSESSMENT AND ENGINEERING (U.S. CLS. 21, 23, 26, 36 AND 38). FIRST USE 5-31-2003; IN COMMERCE 5-31-2003.

2,929,559. GENERAL ELECTRIC CAPITAL CORPORATION, NORWALK, CT. SN 78-105,244. PUB. 8-13-2002, FILED 1-28-2002.

## TOURNEAU

FOR EYEGLASS FRAMES AND SUNGLASSES (U.S. CLS. 21, 23, 26, 36 AND 38).

FIRST USE 8-10-2004; IN COMMERCE 8-10-2004.

2,929,561. BRAINY BABY COMPANY, LLC, THE, ALPHARETTA, GA. SN 78-107,580. PUB. 3-18-2003, FILED 2-8-2002.

## BRAINY CHILD

OWNER OF U.S. REG. NO. 2,315,020.

NO CLAIM IS MADE TO THE EXCLUSIVE RIGHT TO USE "CHILD", APART FROM THE MARK AS SHOWN.

FOR SERIES OF PRERECORDED VIDEOTAPES, AUDIO CASSETTES, COMPACT DISCS AND DIGITAL VIDEO DISCS CONTAINING LIVE AND ANIMATED MATERIALS INTENDED TO DEVELOP AND IMPROVE THE INTELLECTUAL AND CREATIVE FACULTIES OF INFANTS AND CHILDREN (U.S. CLS. 21, 23, 26, 36 AND 38).

FIRST USE 12-1-2004; IN COMMERCE 12-1-2004.

**CLASS 9—(Continued).**

2,929,565. HONEYWELL INTERNATIONAL INC., MORRISTOWN, NJ. SN 78-114,159. PUB. 10-1-2002, FILED 3-12-2002.

**NAV100**

FOR INERTIAL MEASUREMENT UNITS COMPRISED OF GYROS AND ACCELEROMETERS FOR USE IN LAND, AIRCRAFT, SPACE AND MARINE NAVIGATION AND FOR NAVIGATION OF GUIDED OBJECTS (U.S. CLS. 21, 23, 26, 36 AND 38).

FIRST USE 2-27-2003; IN COMMERCE 9-29-2004.

**CLASS 9—(Continued).**

2,929,578. POWER PLUG INC., LATHAM, NY. SN 78-128,598. PUB. 12-3-2002, FILED 5-14-2002.

**GENSYS**

FOR FUEL CELL SYSTEMS, NAMELY, FUEL CELL STACKS, FUEL PROCESSORS, FUEL REFORMERS, POWER CONTROLLERS, POWER INVERTERS, POWER CONDITIONERS, ENERGY STORAGE DEVICES, NAMELY, BATTERIES (U.S. CLS. 21, 23, 26, 36 AND 38).

FIRST USE 11-1-2004; IN COMMERCE 11-1-2004.

2,929,568. SCHOBBER, SCOTT, N, METUCHEN, NJ. SN 78-118,934. PUB. 1-14-2003, FILED 4-2-2002.

**YELLOWJACKET**

FOR HANDHELD ELECTRONIC TEST DEVICE FOR ANALYZING MICROWAVE COMMUNICATIONS NAMELY THE IEEE 802 11B STANDARD (U.S. CLS. 21, 23, 26, 36 AND 38).

FIRST USE 9-15-2002; IN COMMERCE 10-15-2002.

2,929,581. WISE, DANIEL, NEW YORK, NY. SN 78-134,326. PUB. 7-1-2003, FILED 6-10-2002.

**WRONG RECORDS**

NO CLAIM IS MADE TO THE EXCLUSIVE RIGHT TO USE "RECORDS", APART FROM THE MARK AS SHOWN. FOR MUSICAL SOUND RECORDINGS FEATURING ROCK MUSIC (U.S. CLS. 21, 23, 26, 36 AND 38).

FIRST USE 8-26-2003; IN COMMERCE 1-14-2004.

2,929,570. SCIENTIFIC-ATLANTA, INC., LAWRENCEVILLE, GA. SN 78-120,862. PUB. 4-1-2003, FILED 4-10-2002.

**BROADLAN**

FOR TELECOMMUNICATIONS EQUIPMENT, NAMELY, MODEMS, MODEM TERMINATION SYSTEMS, SWITCHES, TRANSCEIVERS, AND ASSOCIATED SOFTWARE, FOR PROVIDING HIGH-SPEED DATA, VIDEO, AND TELEPHONY SERVICES TO BUSINESS SUBSCRIBERS OVER A BROADBAND NETWORK (U.S. CLS. 21, 23, 26, 36 AND 38).

FIRST USE 11-12-2004; IN COMMERCE 11-12-2004.

2,929,583. DUROCHER, BRYAN JAMES, CORAL GABLES, FL. AND TRACY STEVENS, ROCHESTER, NY. SN 78-135,641. PUB. 12-24-2002, FILED 6-13-2002.

**THE SUCCESS CIRCLE FOUR STYLES TO CHAMPIONSHIP COMMUNICATION**

FOR PRE-RECORDED COMPACT DISCS FEATURING COMMUNICATION SKILLS EDUCATION, AND WORKBOOKS IN THE FIELD OF COMMUNICATION SKILLS AND TEAM BUILDING, SOLD TOGETHER AS A UNIT (U.S. CLS. 21, 23, 26, 36 AND 38).

FIRST USE 8-25-2002; IN COMMERCE 8-25-2002.

2,929,571. INSIGHTFUL CORPORATION, SEATTLE, WA. SN 78-121,825. PUB. 2-18-2003, FILED 4-15-2002.

**HUMAN-LIKE INTELLIGENCE**

FOR COMPUTER SOFTWARE IN THE FIELDS OF GENERAL BUSINESS AND DATA AND INFORMATION ANALYSIS, NAMELY, SOFTWARE FOR USE IN CONNECTION WITH E-COMMERCE, INTERNET PORTALS, INFORMATION SEARCHING AND RETRIEVAL, DOCUMENT MANAGEMENT, DATA MINING, INFORMATION EXTRACTION, TEXT NAVIGATION AND CUSTOMER SERVICE (U.S. CLS. 21, 23, 26, 36 AND 38).

FIRST USE 3-31-2004; IN COMMERCE 3-31-2004.

2,929,602. KSC INDUSTRIES, INCORPORATED, SAN DIEGO, CA. SN 78-155,713. PUB. 3-25-2003, FILED 8-19-2002.

**DIGMODA**

FOR ELECTRONIC AUDIO AND VIDEO EQUIPMENT, NAMELY, DIGITAL AMPLIFIERS, WIRED AND WIRELESS AUDIO TRANSMITTERS AND RECEIVERS, AUDIO SPEAKERS AND SPEAKER ENCLOSURES, WIRED AND WIRELESS HEADPHONES, DIGITAL VIDEO PLAYERS AND RECORDERS, DIGITAL AUDIO MEDIA PLAYERS AND RECORDERS, AUDIO TAPE RECORDERS AND PLAYERS (U.S. CLS. 21, 23, 26, 36 AND 38).

FIRST USE 9-0-2004; IN COMMERCE 9-0-2004.

**CLASS 9—(Continued).**

2,929,612. FLIP CHIP TECHNOLOGIES, LLC, PHOENIX, AZ. SN 78-168,486. PUB. 9-2-2003, FILED 9-27-2002.

**SPHERON**

FOR SEMICONDUCTOR PACKAGING FOR MANUFACTURERS OF SEMICONDUCTORS AND DEVICES UTILIZING SEMICONDUCTORS, NAMELY, UNDER BUMP METALIZATION, POLYMER THIN FILM LAYERS AND SOLDER BUMPS CONSTRUCTED ON SEMICONDUCTOR WAFER TO PROTECT THE INTEGRATED CIRCUIT FROM CONTAMINANTS AND MOISTURE AND TO MAKE AN ELECTRICAL CONNECTION BETWEEN THE INTEGRATED CIRCUIT CHIP AND PRINTED CIRCUIT BOARD OR OTHER SUBSTRATES (U.S. CLS. 21, 23, 26, 36 AND 38).

FIRST USE 9-16-2002; IN COMMERCE 9-16-2002.

2,929,615. BOX, LTD., NEW YORK, NY. SN 78-170,515. PUB. 10-28-2003, FILED 10-3-2002.

**BOXWORK**

FOR COMPUTER SOFTWARE FOR THE DEVELOPMENT, SELECTION, REVISION AND CORRECTION OF DIGITAL PHOTOGRAPHS (U.S. CLS. 21, 23, 26, 36 AND 38).

FIRST USE 10-19-2002; IN COMMERCE 10-19-2002.

2,929,629. AUSPICE, INC., FRAMINGHAM, MA. SN 78-181,315. PUB. 5-20-2003, FILED 11-4-2002.

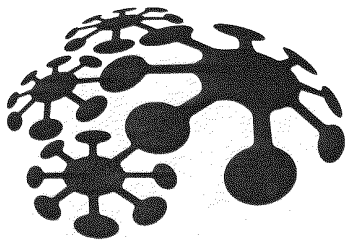

FOR COMPUTER SOFTWARE, NAMELY, COMPUTER OPERATING SYSTEM SOFTWARE; COMPUTER SOFTWARE DEVELOPMENT TOOLS, NAMELY, COMPILER PROGRAMS, DEBUGGER PROGRAMS AND UTILITY PROGRAMS FOR DEVELOPING COMPUTER PROGRAMS; AND COMPUTER SOFTWARE FOR INTEGRATING, MONITORING, ANALYZING, CONTROLLING, RECONFIGURING, AND ACTING ON DATA RETRIEVED ELECTRONICALLY (U.S. CLS. 21, 23, 26, 36 AND 38).

FIRST USE 3-10-2003; IN COMMERCE 3-10-2003.

**CLASS 9—(Continued).**

2,929,638. BATTERY SOLUTIONS, INC., LUBBOCK, TX. SN 78-185,716. PUB. 2-17-2004, FILED 11-15-2002.



NO CLAIM IS MADE TO THE EXCLUSIVE RIGHT TO USE "POWER", APART FROM THE MARK AS SHOWN.

THE MARK CONSISTS OF THE WORDS "ADVANCED POWER" IN STYLIZED FORMAT SUPERPOSED OVER THREE OVERLAPPING OVALS WITH A DOT IN THE MIDDLE OF THE OVALS.

FOR ELECTRIC STORAGE BATTERIES (U.S. CLS. 21, 23, 26, 36 AND 38).

FIRST USE 11-1-2003; IN COMMERCE 11-1-2003.

2,929,639. HARMAN INTERNATIONAL INDUSTRIES, INCORPORATED, NORTHRIDGE, CA. SN 78-185,999. PUB. 7-1-2003, FILED 11-18-2002.

**INFINITY**

OWNER OF U.S. REG. NOS. 1,130,710, 2,503,610, AND OTHERS.

FOR RADIOS (U.S. CLS. 21, 23, 26, 36 AND 38).

FIRST USE 6-30-2003; IN COMMERCE 6-30-2003.

2,929,645. DAKCS SOFTWARE SYSTEMS, OGDEN, UT. SN 78-188,713. PUB. 1-6-2004, FILED 11-25-2002.

**BEYOND.NET**

FOR COMPUTER SOFTWARE PLATFORMS, NAMELY, SOFTWARE FOR TRACKING ACCOUNTS RECEIVABLE AND FOR COMMUNICATING WITH ACCOUNT PAYORS INCLUDING AN INTEGRATED PREDICTIVE DIALER, ONLINE WEB DEBT PAYMENT MODULE, REPORT ARCHIVING AND RETRIEVAL, AND SYSTEM SCHEDULER (U.S. CLS. 21, 23, 26, 36 AND 38).

FIRST USE 4-1-2004; IN COMMERCE 4-1-2004.

**CLASS 9—(Continued).**

2,929,679. PACIFIC SAFETY PRODUCTS INC., KELOWNA BRITISH COLUMBIA, CANADA. SN 78-208,833. PUB. 9-23-2003, FILED 1-30-2003.

**O2B.O.S.S.**

FOR SECURITY SYSTEM CONSISTING OF AN OXYGEN BOTTLE CARRIER, DEPLOYMENT AND MOUNTING EQUIPMENT FABRICATED OF METAL AND PLASTIC USED FOR SECURING BOTTLED OXYGEN TO BUILDING STRUCTURE WALLS, INTERIORS OF VEHICLES AND AIRCRAFT, AND ON PORTABLE STRETCHERS (U.S. CLS. 21, 23, 26, 36 AND 38).

FIRST USE 4-22-2004; IN COMMERCE 10-13-2004.

2,929,707. LITE-ON IT CORPORATION, TAIPEI, TAIWAN. SN 78-231,266. PUB. 2-17-2004, FILED 3-28-2003.

**PHOMASTER**

FOR STEREO AMPLIFIERS; SOUND AMPLIFIERS; DIGITAL AUDIO TAPE PLAYERS; 35MM CAMERAS; PHOTOGRAPHIC CAMERAS; VIDEO CAMERAS; MUSIC COMPACT DISC PLAYERS; COMPUTER GAME DISCS; VIDEO COMPACT DISC PLAYERS; OPTICAL DISCS, NAMELY BLANK RECORDABLE COMPACT DISCS, REWRITABLE COMPACT DISCS, RECORDABLE DIGITAL VERSATILE DISCS AND REWRITABLE DIGITAL VERSATILE DISCS; COMPUTER GAME ACCESSORIES CONTAINING MEMORY DEVICES, COMPUTER DISCS; VIDEO GAME MACHINES FOR USE WITH TELEVISIONS; VIDEO OUTPUT GAME MACHINES FOR USE WITH TELEVISIONS; INTERACTIVE AUDIO GAME DISCS CONTAINING GAMES FEATURING SPORTS, EDUCATION, PUZZLES; ELECTRIC LUMINESCENT DISPLAY PANELS; COMPUTER MONITORS; VIDEO MONITORS; MOTION PICTURE CAMERAS; MUSICAL VIDEO RECORDINGS; COMPUTER PERIPHERALS; PHOTOGRAPHIC PROJECTORS; AUDIO TAPE RECORDERS; VIDEO TAPE RECORDERS; VIDEO CASSETTE RECORDERS; PRE-RECORDED AUDIO CASSETTES, COMPACT DISCS, AUDIO DISCS AND VIDEO DISCS FEATURING GRAPHIC FILES CONVERTED FROM IMAGES CAPTURED BY DIGITAL STILL CAMERA DSC, AND CONVERTED INTO FILES WITH GRAPHIC FORMAT ACCESSIBLE TO VCD (U.S. CLS. 21, 23, 26, 36 AND 38).

FIRST USE 3-31-2003; IN COMMERCE 5-31-2003.

2,929,709. ELITE GROUP INC., MONTREAL, QUEBEC, CANADA. SN 78-232,925. PUB. 7-27-2004, FILED 4-2-2003.

**TECHVIEW**

FOR CONSUMER ELECTRONIC PRODUCTS, NAMELY TELEVISIONS, DVD PLAYERS AND RECORDERS, AUDIO SPEAKERS, SUB-WOOFERS, STEREO RECEIVERS, STEREO TUNERS, AMPLIFIERS, RADIOS, AND CD PLAYERS (U.S. CLS. 21, 23, 26, 36 AND 38).

FIRST USE 5-1-2003; IN COMMERCE 5-1-2003.

**CLASS 9—(Continued).**

2,929,710. LEGEND FILMS, INC., LA JOLLA, CA. SN 78-233,554. PUB. 3-23-2004, FILED 4-3-2003.

**LEGEND FILMS**

NO CLAIM IS MADE TO THE EXCLUSIVE RIGHT TO USE FILMS, APART FROM THE MARK AS SHOWN.

FOR DVDS FEATURING ENTERTAINMENT IN THE FORM OF DRAMATIC MOVIES AND DOCUMENTARIES, PRERECORDED VIDEO TAPES AND DOWNLOADABLE VIDEO RECORDINGS FEATURING ENTERTAINMENT IN THE FORM OF DRAMATIC MOVIES AND DOCUMENTARIES; MOTION PICTURE FILMS FEATURING ENTERTAINMENT IN THE FORM OF DRAMATIC MOVIES AND DOCUMENTARIES; AND VHS VIDEOTAPES FEATURING ENTERTAINMENT IN THE FORM OF DRAMATIC MOVIES AND DOCUMENTARIES (U.S. CLS. 21, 23, 26, 36 AND 38).

FIRST USE 8-9-2001; IN COMMERCE 10-4-2003.

2,929,718. CYBERLINK CORP., SHINDIAN CITY, TAIPEI, TAIWAN. SN 78-237,202. PUB. 3-23-2004, FILED 4-14-2003.

**CLPV**

FOR COMPUTER SOFTWARE FOR AUDIO AND VIDEO PRODUCING, PLAYING AND RECORDING AND COMPUTER PROGRAMS ON COMPACT AND FLOPPY DISCS FOR USE IN AUDIO AND VIDEO EDITING, PRODUCING, PLAYING AND RECORDING (U.S. CLS. 21, 23, 26, 36 AND 38).

FIRST USE 3-1-2003; IN COMMERCE 10-1-2003.

2,929,719. CAPO, INC., ORMOND BEACH, FL. SN 78-237,492. PUB. 2-10-2004, FILED 4-14-2003.

**DR 445**

FOR EYEWEAR, NAMELY, SUNGLASSES (U.S. CLS. 21, 23, 26, 36 AND 38).

FIRST USE 5-13-2004; IN COMMERCE 5-13-2004.

2,929,724. HOMEDICS, INC., COMMERCE TOWNSHIP, MI. SN 78-239,108. PUB. 3-9-2004, FILED 4-17-2003.

**ENVIRASTATION**

FOR DIGITAL INDOOR AND OUTDOOR WEATHER STATION COMPRISED OF WIRELESS REMOTE AIR TEMPERATURE AND HUMIDITY SENSOR, HOME RECEIVER, WEATHER FREEZE ALARM, PRECIPITATION SENSOR AND LCD ALARM CLOCK (U.S. CLS. 21, 23, 26, 36 AND 38).

FIRST USE 6-9-2003; IN COMMERCE 6-9-2003.

**CLASS 9—(Continued).**

2,929,727. 2000717 ONTARIO LIMITED, BROCKVILLE, ONTARIO, CANADA. SN 78-240,061. PUB. 3-16-2004, FILED 4-21-2003.

**V-OPTICS**

FOR OPTICAL INSTRUMENTS, NAMELY BINOCULARS AND TELESCOPES; HOUSEHOLD AND PERSONAL GOODS, NAMELY CAMERAS, DIGITAL GOLF SCOPES, GOLF RANGE FINDERS, RADIO CLOCKS AND ALARMS, MP3 PLAYERS, CD RADIOS, CLOCKS AND SCALES FOR MEASURING WEIGHT AND BODY FAT (U.S. CLS. 21, 23, 26, 36 AND 38).

FIRST USE 5-1-2003; IN COMMERCE 10-1-2003.

2,929,730. SPIELO MANUFACTURING INCORPORATED, MONCTON, NEW BRUNSWICK, CANADA. SN 78-241,046. PUB. 12-16-2003, FILED 4-23-2003.

**DOG AND BONE**

FOR RECONFIGURABLE CASINO AND LOTTERY GAMING EQUIPMENT, NAMELY, SLOT MACHINES AND OPERATIONAL COMPUTER GAME SOFTWARE THEREFOR (U.S. CLS. 21, 23, 26, 36 AND 38).

FIRST USE 3-1-2003; IN COMMERCE 3-1-2003.

2,929,736. CODEMESH, INC., CARLISLE, MA. SN 78-245,771. PUB. 1-13-2004, FILED 5-5-2003.

**JUGGERNET**

FOR SOFTWARE DEVELOPMENT TOOLS FOR USE IN SOFTWARE INTEGRATION (U.S. CLS. 21, 23, 26, 36 AND 38).

FIRST USE 7-8-2003; IN COMMERCE 7-8-2003.

2,929,743. CAPO, INC., ORMOND BEACH, FL. SN 78-249,656. PUB. 2-10-2004, FILED 5-14-2003.

**VARSITY**

FOR EYEWEAR, NAMELY, SUNGLASSES (U.S. CLS. 21, 23, 26, 36 AND 38).

FIRST USE 5-13-2004; IN COMMERCE 5-13-2004.

**CLASS 9—(Continued).**

2,929,746. SAMSUNG ELECTRO-MECHANICS CO., LTD., KYUNGKI-DO, REPUBLIC OF KOREA. SN 78-250,683. PUB. 5-4-2004, FILED 5-16-2003.

**SFC**

FOR PRINTED CIRCUIT BOARDS, PRINTED CIRCUITS, INTEGRATED CIRCUITS, SEMI-CONDUCTORS, LIGHT EMITTING DIODES, SILICON WAFERS (U.S. CLS. 21, 23, 26, 36 AND 38).

FIRST USE 3-0-2004; IN COMMERCE 3-0-2004.

2,929,748. LEADING EDGE MARKETING INC., NASSAU, BAHAMAS. SN 78-250,929. PUB. 2-24-2004, FILED 5-16-2003.

**CRAZYPARTYGIRLS**

FOR PRERECORDED VIDEOTAPES AND DVDS FEATURING PARTY SCENES (U.S. CLS. 21, 23, 26, 36 AND 38).

FIRST USE 8-11-2003; IN COMMERCE 8-11-2003.

2,929,752. REGIONAL ECONOMIC MODELS, INC., AMHERST, MA. SN 78-252,791. PUB. 2-10-2004, FILED 5-21-2003.

**DEVSIGHT**

OWNER OF U.S. REG. NO. 2,603,369.  
FOR COMPUTER SOFTWARE FOR THE ANALYSIS AND STORAGE OF DEMOGRAPHIC, ECONOMIC, STATISTICAL, AND ENGINEERING DATA (U.S. CLS. 21, 23, 26, 36 AND 38).

FIRST USE 10-1-2003; IN COMMERCE 10-1-2003.

2,929,798. SHERPA SOFTWARE GROUP, INC., BRIDGEVILLE, PA. SN 78-279,049. PUB. 4-20-2004, FILED 7-25-2003.

**DISCOVERY ATTENDER**

OWNER OF U.S. REG. NOS. 2,309,124, 2,462,620, AND OTHERS.

FOR COMPUTER SOFTWARE TO SEARCH ELECTRONIC DOCUMENTS AND OTHER ELECTRONIC FILES (U.S. CLS. 21, 23, 26, 36 AND 38).

FIRST USE 3-15-2004; IN COMMERCE 3-15-2004.

**CLASS 9—(Continued).**

2,929,803. KONAMI GAMING, INC., LAS VEGAS, NV. SN 78-281,927. PUB. 4-27-2004, FILED 8-1-2003.

**FLAME JUMPER**

FOR GAMING EQUIPMENT, NAMELY, SLOT MACHINES, GAMING MACHINES, AND GAME SOFTWARE USED THEREWITH (U.S. CLS. 21, 23, 26, 36 AND 38).

FIRST USE 2-2-2004; IN COMMERCE 2-2-2004.

2,929,804. KONAMI GAMING, INC., LAS VEGAS, NV. SN 78-281,932. PUB. 4-27-2004, FILED 8-1-2003.

**SNOW CRYSTAL**

FOR GAMING EQUIPMENT, NAMELY, SLOT MACHINES, GAMING MACHINES, AND GAME SOFTWARE USED THEREWITH (U.S. CLS. 21, 23, 26, 36 AND 38).

FIRST USE 2-6-2004; IN COMMERCE 2-6-2004.

2,929,821. BRANDESS-KALT-AETNA GROUP, INC., VERNON HILLS, IL. SN 78-290,478. PUB. 6-22-2004, FILED 8-21-2003.

**DIGITAL PURSUITS**

NO CLAIM IS MADE TO THE EXCLUSIVE RIGHT TO USE DIGITAL, APART FROM THE MARK AS SHOWN.

FOR LIGHT MODIFIERS, ALSO KNOWN AS LCD SCREEN HOODS, DIFFUSION SCREENS AND REFLECTORS; VOLTAGE SURGE PROTECTORS; DIGITAL CAMERAS; CAMERA MEMORY STORAGE DEVICES, ALSO KNOWN AS FLASH MEMORY CARDS; BLANK STORAGE AND ARCHIVAL MEDIA, NAMELY, CD'S, DVD CARTRIDGES AND FLOPPY DISKS; STORAGE MEDIA CASES; MEMORY STORAGE READERS, ALSO KNOWN AS FLASH MEMORY CARD READERS; ELECTRICAL CABLES AND CORDS; CAMERA CASES; MICROFIBER CLOTHS AND ANTISTATIC CLOTHS FOR CLEANING CAMERA LENSES; CAMERA LENSES, CAMERA ADAPTER RINGS, CAMERA LENS CAPS; BATTERIES, BATTERY CHARGERS, BATTERY TESTERS, ELECTRONIC FLASHES, TRIPODS, MINI TRIPODS, UNIPODS, MAGNIFIERS AND EYE LOUPES; PRINTERS, SCANNERS; ANTISTATIC GLOVES FOR USE IN HANDLING CAMERAS AND DIGITAL EQUIPMENT; MOUSE PADS, IMAGE MANIPULATION SOFTWARE; IMAGE STORAGE AND ARCHIVAL SOFTWARE (U.S. CLS. 21, 23, 26, 36 AND 38).

FIRST USE 1-1-2003; IN COMMERCE 1-1-2003.

2,929,828. SENS CORPORATION, IRVINE, CA. SN 78-296,628. PUB. 5-25-2004, FILED 9-5-2003.

**MOFFICE**

FOR USB STORAGE DRIVE UNITS (U.S. CLS. 21, 23, 26, 36 AND 38).

FIRST USE 10-1-2003; IN COMMERCE 10-1-2003.

**CLASS 9—(Continued).**

2,929,832. ILLICOM, CHATOU CEDEX, FRANCE. SN 78-298,488. PUB. 6-1-2004, FILED 9-10-2003.

**ILLICOM**

FOR COMPUTER SOFTWARE FOR ELECTRONIC DATA INTEGRATION (U.S. CLS. 21, 23, 26, 36 AND 38).  
FIRST USE 1-1-1998; IN COMMERCE 1-1-1998.

2,929,842. RADWARE LTD., TEL AVIV, ISRAEL. SN 78-304,278. PUB. 6-15-2004, FILED 9-23-2003.

**DEFENSEPRO**

FOR COMPUTER HARDWARE AND COMPUTER SOFTWARE THAT DELIVERS ACTIVE APPLICATION SECURITY FOR APPLICATIONS AND NETWORKS (U.S. CLS. 21, 23, 26, 36 AND 38).

FIRST USE 12-2-2003; IN COMMERCE 12-2-2003.

2,929,847. ASCENT TECHNOLOGY, INC., CAMBRIDGE, MA. SN 78-307,537. PUB. 5-11-2004, FILED 9-30-2003.

**ARIS/WORKMODEL**

FOR COMPUTER SOFTWARE FOR DETERMINING STAFFING NEEDS FOR TASK ASSIGNMENTS AND GENERATING STAFFING PLANS THEREFOR (U.S. CLS. 21, 23, 26, 36 AND 38).

FIRST USE 5-17-2004; IN COMMERCE 5-17-2004.

2,929,848. ASCENT TECHNOLOGY, INC., CAMBRIDGE, MA. SN 78-307,544. PUB. 5-11-2004, FILED 9-30-2003.

**ARIS/WORKOPTIMIZE**

FOR COMPUTER SOFTWARE FOR SCHEDULING JOB SHIFTS AND DETERMINING THE NUMBER OF EMPLOYEES NEEDED FOR EACH SHIFT (U.S. CLS. 21, 23, 26, 36 AND 38).

FIRST USE 5-17-2004; IN COMMERCE 5-17-2004.

2,929,849. ASCENT TECHNOLOGY, INC., CAMBRIDGE, MA. SN 78-307,562. PUB. 5-11-2004, FILED 9-30-2003.

**ARIS/WORKPLAN**

FOR COMPUTER SOFTWARE FOR CREATING SPECIFIC PERSONNEL ROSTERS FOR JOB SHIFTS (U.S. CLS. 21, 23, 26, 36 AND 38).

FIRST USE 5-17-2004; IN COMMERCE 5-17-2004.

**CLASS 9—(Continued).**

2,929,851. ASCENT TECHNOLOGY, INC., CAMBRIDGE, MA. SN 78-307,580. PUB. 5-11-2004, FILED 9-30-2003.

**ARIS/WORKRELAY**

FOR COMPUTER SOFTWARE FOR NOTIFYING PERSONNEL OF TASK ASSIGNMENTS AND CHANGES THERETO (U.S. CLS. 21, 23, 26, 36 AND 38).

FIRST USE 5-17-2004; IN COMMERCE 5-17-2004.

2,929,856. ASCENT TECHNOLOGY, INC., CAMBRIDGE, MA. SN 78-310,172. PUB. 5-11-2004, FILED 10-7-2003.

**ARIS/WORKNET**

FOR COMPUTER SOFTWARE ENABLING WORKERS TO BID FOR AND TRADE JOB SHIFTS ONLINE (U.S. CLS. 21, 23, 26, 36 AND 38).

FIRST USE 5-17-2004; IN COMMERCE 5-17-2004.

2,929,857. WUDTIK INDUSTRIES LLC, NEW YORK MILLS, MN. SN 78-310,676. PUB. 6-15-2004, FILED 10-7-2003.

**BUZZMASTER**

FOR WINTER ICE FISHING ALARM, BUZZER (U.S. CLS. 21, 23, 26, 36 AND 38).

FIRST USE 12-23-2003; IN COMMERCE 12-23-2003.

2,929,862. WINNER INTERNATIONAL ROYALTY LLC, SHARON, PA. SN 78-314,521. PUB. 8-17-2004, FILED 10-16-2003.

**SQUEEZE THE MOST OUT OF YOUR PHOTO BATTERY.**

FOR BATTERIES AND BATTERY CHARGERS FOR USE IN CONSUMER ELECTRONIC PRODUCTS (U.S. CLS. 21, 23, 26, 36 AND 38).

FIRST USE 5-14-2004; IN COMMERCE 5-14-2004.

**CLASS 10—MEDICAL APPARATUS****CLASS 10—(Continued).**

2,929,096. SPINAL CONCEPTS, INC., AUSTIN, TX. SN 76-048,628. PUB. 11-27-2001, FILED 5-11-2000.

**SPEEDLINK**

FOR MEDICAL DEVICES, NAMELY, METAL IMPLANTS, ATTACHMENTS AND FASTENERS THAT ARE IMPLANTED IN HUMANS AND COUPLED TO HUMAN BONES FOR THE PURPOSE OF STABILIZING THE SPINE, AND METAL SURGICAL SPINAL IMPLANT TOOLS TO FACILITATE THE IMPLANTATION OF SUCH DEVICES (U.S. CLS. 26, 39 AND 44).

FIRST USE 10-23-2000; IN COMMERCE 10-23-2000.

2,929,226. CARMEDA AB, 113 47 STOCKHOLM, SWEDEN. SN 76-341,669. PUB. 4-22-2003, FILED 11-26-2001.

**CARMEDA**

OWNER OF U.S. REG. NO. 1,891,668.

FOR DISPOSABLE AND IMPLANTABLE MEDICAL DEVICES, NAMELY, VASCULAR GRAFTS AND STENT-GRAFTS COMPRISED OF ARTIFICIAL TISSUE, VASCULAR STENTS, CARDIOPULMONARY BYPASS CIRCUITS USED DURING CARDIAC SURGERY TO REGULATE BLOOD AND OXYGEN FLOW NAMELY BLOOD OXIGENATORS, CENTRIFUGAL BLOOD PUMPS, VENTRICULAR ASSIST DEVICES, CATHETERS, CANNULAE, DISPOSABLE DIALYSIS PRODUCTS, NAMELY, MEDICAL TUBING FOR ADMINISTERING FLUIDS, INTRAVASCULAR AND EXTRACORPOREAL BLOOD SENSORS, INTRAOCULAR LENSES FOR USE IN OPHTHALMOLOGY (U.S. CLS. 26, 39 AND 44).

FIRST USE 12-0-1988; IN COMMERCE 10-0-1994.

2,929,272. THOMMEN MEDICAL AG, CH-4437 WALDENBURG, SWITZERLAND. SN 76-415,635. PUB. 7-8-2003, FILED 6-11-2002.

**SPI**

PRIORITY CLAIMED UNDER SEC. 44(D) ON SWITZERLAND APPLICATION NO. 00818/2002, FILED 1-30-2002, REG. NO. 495968, DATED 1-30-2002, EXPIRES 1-30-2022.

FOR DENTAL IMPLANTS; PROSTHETIC SUPERSTRUCTURES FOR DENTAL IMPLANTS, NAMELY, HEALING CAPS, GINGIVA FORMERS, ABUTMENTS, GOLD BLANKS, GOLD COPINGS, TITANIUM COPINGS, RETENTIVE ANCHORS, AND BARS; PARTS, COMPONENTS, AND INSTRUMENTS FOR DENTAL IMPLANTS AND PROSTHETIC SUPERSTRUCTURES FOR DENTAL IMPLANTS, NAMELY, DRILLS, DRILL EXTENSIONS, BURRS, DEPTH GAUGES, SCREWDRIVERS, SCREWS, RATCHETS, HANDLES, REAMERS, X-RAY REFERENCE SPHERES, GUIDE KEYS, TWEEZERS, ADAPTERS, MUCOSA PUNCHES, SURGICAL CASSETTES, PROSTHETIC CASSETTES, LABORATORY CASSETTES, GUIDE PINS, LABORATORY PINS, SOLDER PINS, IMPRESSION COPINGS, CROWN HOLDERS, INSERTION DEVICES, ANALOGS, REMOVAL TOOLS, AND IMPRESSION CYLINDERS (U.S. CLS. 26, 39 AND 44).

FIRST USE 5-0-2002; IN COMMERCE 7-18-2002.



**CLASS 10—(Continued).**

2,929,301. TYCO HEALTHCARE GROUP LP, NORWALK, CT. SN 76-458,851. PUB. 2-17-2004, FILED 10-4-2002.

**ENDO CATCH GOLD**

FOR MEDICAL DEVICES, NAMELY LAPAROSCOPIC INSTRUMENTS AND PARTS AND ACCESSORIES THEREFOR (U.S. CLS. 26, 39 AND 44).  
FIRST USE 2-28-2003; IN COMMERCE 2-28-2003.

**CLASS 10—(Continued).**

2,929,384. LUIGI, GIANCARLO, AGUADILLA, PUERTO RICO. SN 76-506,485. PUB. 6-29-2004, FILED 4-14-2003.

**LESDIC**

FOR MEDICAL INSTRUMENT, NAMELY AN ELECTROCAUTERIZER, SUCTION, DISSECTOR, IRRIGATOR, AND CUTTER, FOR SURGICAL PURPOSES (U.S. CLS. 26, 39 AND 44).  
FIRST USE 1-1-2004; IN COMMERCE 1-1-2004.

2,929,367. STETHOSCOPE HOLSTER, INC., PINELLAS PARK, IL. SN 76-500,380. PUB. 11-18-2003, FILED 3-18-2003.

**SCOPE-STER**

FOR STETHOSCOPE HOLSTER (U.S. CLS. 26, 39 AND 44).  
FIRST USE 1-31-2004; IN COMMERCE 1-31-2004.

2,929,371. ADVANCED STENT TECHNOLOGIES, INC., PLEASANTON, CA. SN 76-501,825. PUB. 6-8-2004, FILED 3-27-2003.



FOR MEDICAL STENTS AND STENT DELIVERY SYSTEMS (SDS) (U.S. CLS. 26, 39 AND 44).  
FIRST USE 3-11-2003; IN COMMERCE 3-11-2003.

2,929,380. TRANSOMA MEDICAL, INC., ST. PAUL, MN. SN 76-505,650. PUB. 1-6-2004, FILED 4-9-2003.

**TRANSOMA MEDICAL**

FOR WIRELESS IMPLANTABLE PHYSIOLOGIC TELEMETRY TRANSMITTERS, AND RECEIVERS; CATHETERS; CANNULAE (U.S. CLS. 26, 39 AND 44).  
FIRST USE 9-20-2004; IN COMMERCE 9-20-2004.

2,929,507. INVIRO MEDICAL DEVICES LTD., BRIDGETOWN, BARBADOS. SN 76-975,647. PUB. 1-1-2002, FILED 4-6-2000.



FOR MEDICAL DEVICES, NAMELY, MEDICAL, HYPODERMIC, ASPIRATION AND INJECTION SYRINGES (U.S. CLS. 26, 39 AND 44).  
FIRST USE 4-0-2000; IN COMMERCE 4-0-2000.

2,929,597. BIOMET, INC., WARSAW, IN. SN 78-148,410. PUB. 3-11-2003, FILED 7-29-2002.

**SELEX**

FOR ORTHOPEDIC IMPLANTS AND PROSTHESES; NAMELY, AN ACETABULAR CUP AND LINER SYSTEM (U.S. CLS. 26, 39 AND 44).  
FIRST USE 6-9-2004; IN COMMERCE 9-6-2004.

2,929,611. ANSELL HEALTHCARE PRODUCTS, LLC, DBA ANSELL HEALTHCARE, RED BANK, NJ. SN 78-167,669. PUB. 4-15-2003, FILED 9-25-2002.

**ALLURE**

FOR SURGICAL GLOVES (U.S. CLS. 26, 39 AND 44).  
FIRST USE 4-25-2003; IN COMMERCE 4-25-2003.

**CLASS 10—(Continued).**

2,929,699. ALUNG TECHNOLOGIES, INC., PITTSBURGH, PA. SN 78-225,421. PUB. 6-29-2004, FILED 3-13-2003.

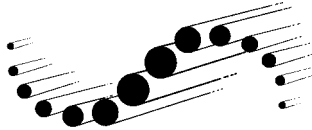

FOR MEDICAL CATHETERS, MEDICAL GUIDE WIRES, MEDICAL GUIDE WIRE INTRODUCERS, CATHETER TIPS, CATHETER SHEATHS, CATHETER INTRODUCERS, HEMOSTATIC SIDE-ARM ADAPTERS, HEMOSTATIC VALVES, VENT TUBES, PRESSURE INDICATOR/REGULATORS, FLUSHING TOOLS, FUNNEL INTRODUCERS, HAND-OPERATED BALLOON INFLATING/DEFLATING DEVICES, MEDICAL APPARATUS SYSTEM CONSISTING OF MEDICAL CATHETERS, MEDIAL GUIDE WIRES, OXYGEN FLOW REGULATORS, TUBING, AN ELECTRIC CONSOLE, COMPUTER SOFTWARE FOR OPERATING ELECTRIC CONSOLE AND INSTRUCTION MANUALS SOLD AS A UNIT; ARTIFICIAL LUNGS AND OXYGENATORS (U.S. CLS. 26, 39 AND 44).

FIRST USE 11-3-2004; IN COMMERCE 11-3-2004.

2,929,725. GAMBRO LUNDIA AB, LUND, SWEDEN. SN 78-239,266. PUB. 8-24-2004, FILED 4-17-2003.

**DIASCAN**

FOR BLOOD TREATMENT APPARATUS, NAMELY DIALYSIS MACHINES EQUIPPED WITH DEVICES FOR DETECTION, MONITORING, DISPLAY OF DIALYSIS TREATMENT PARAMETERS, NAMELY DETECTION, MONITORING AND DISPLAY OF CLEARANCE, DIALYSANCE, AND DIALYSIS DOSE (U.S. CLS. 26, 39 AND 44).

FIRST USE 9-11-2001; IN COMMERCE 9-11-2001.

**CLASS 11—ENVIRONMENTAL CONTROL APPARATUS**

2,929,078. USFILTER CORPORATION, BURLINGTON, MA. SN 75-912,574. PUB. 4-27-2004, FILED 2-8-2000.

**SNAP-LOCK**

FOR FASTENERS FOR SPLIT REMOVABLE IDLER AND DRIVING SPROCKETS, REMOVABLE WEARING SHOES FOR CONVEYOR SCRAPERS, REMOVABLE MOUNTING CLIPS FOR C-RAIL FLOOR MOUNTED WEARING SURFACES AND REMOVABLE CAPS FOR PINS IN CONVEYOR CHAINS, ALL OF THE AFORESAID GOODS BEING USED IN CONNECTION WITH WATER AND WASTEWATER EQUIPMENT (U.S. CLS. 13, 21, 23, 31 AND 34).

FIRST USE 1-19-2000; IN COMMERCE 1-19-2000.

**CLASS 11—(Continued).**

2,929,114. GORDON, JOHN B., GRANGER, IN. SN 76-139,230. PUB. 3-26-2002, FILED 9-29-2000.

**HEADLITES**

FOR BATTERY-FREE, WIRELESS THIRD BRAKE LIGHT FOR MOTORCYCLES, SNOWMOBILES, MOPEDS AND OFF-ROAD 4 WHEEL VEHICLES CARRIED BY A HELMET WORN BY THE USER OF SUCH VEHICLES (U.S. CLS. 13, 21, 23, 31 AND 34).

FIRST USE 8-1-2002; IN COMMERCE 2-19-2003.

2,929,198. CAST LIGHTING LLC, HAWTHORNE, NJ. SN 76-282,972. PUB. 6-4-2002, FILED 7-3-2001.

**CHANGING THE WAY THE WORLD INSTALLS LANDSCAPE LIGHTING**

NO CLAIM IS MADE TO THE EXCLUSIVE RIGHT TO USE "LANDSCAPE LIGHTING", APART FROM THE MARK AS SHOWN.

FOR ELECTRIC LANDSCAPE LIGHTING FIXTURES (U.S. CLS. 13, 21, 23, 31 AND 34).

FIRST USE 1-1-2002; IN COMMERCE 1-1-2002.

2,929,265. TOUCHSTONE ACCENT LIGHTING, LONG LAKE, MN. SN 76-401,499. PUB. 12-10-2002, FILED 4-29-2002.

**LIGHT MY GRILL**

FOR LOW VOLTAGE ELECTRIC LIGHTING FIXTURES ADAPTED FOR NIGHT TIME USE WITH OUTDOOR COOKING GRILLS (U.S. CLS. 13, 21, 23, 31 AND 34).

FIRST USE 7-15-2003; IN COMMERCE 8-10-2003.

2,929,269. MIFAB LIMITED, TORONTO, ONTARIO, CANADA. SN 76-408,786. PUB. 3-2-2004, FILED 5-16-2002.

**HAMMERGARD**

PRIORITY CLAIMED UNDER SEC. 44(D) ON CANADA APPLICATION NO. 1131512, FILED 2-18-2002, REG. NO. TMA589014, DATED 9-5-2003, EXPIRES 9-5-2018.

FOR PLUMBING FITTINGS, NAMELY SHOCK ARRESTORS (U.S. CLS. 13, 21, 23, 31 AND 34).

FIRST USE 6-0-2004; IN COMMERCE 6-0-2004.

**CLASS 11—(Continued).**

2,929,303. THE MONSTER CORP., CHICAGO, IL. SN 76-462,604. PUB. 7-29-2003, FILED 10-28-2002.

**INSTABRONZE**

FOR TANNING BEDS (U.S. CLS. 13, 21, 23, 31 AND 34).  
FIRST USE 10-1-2003; IN COMMERCE 10-1-2003.

---

2,929,326. RALLY MANUFACTURING, INC., MIAMI, FL. SN 76-481,516. PUB. 1-6-2004, FILED 1-10-2003.

**LAZER WHITE**

FOR VEHICLE AUXILIARY LIGHTS, AND ELECTRICAL LIGHTING FIXTURES FOR VEHICLES AND PARTS SOLD TOGETHER AS A UNIT (U.S. CLS. 13, 21, 23, 31 AND 34).  
FIRST USE 11-29-2002; IN COMMERCE 11-29-2002.

---

2,929,344. LARGE HORSE INTERNATIONAL (GROUP) CO., LTD., WANCHAI, HONG KONG. SN 76-491,286. PUB. 2-17-2004, FILED 2-21-2003.

**HORME**

FOR ELECTRIC LAMPS, FLUORESCENT LAMPS, ELECTRIC LANTERNS, INCANDESCENT LAMPS, HALOGEN LAMPS, ELECTRIC LIGHT BULBS; ELECTRIC TOASTERS, ELECTRIC TOASTER OVENS; ELECTRIC SLOW COOKERS; ELECTRIC COOKING OVENS; ELECTRIC SPACE HEATERS; ELECTRIC COFFEE MAKERS, ELECTRIC COFFEE FILTERS; ELECTRIC FANS, VENTILATING EXHAUST FANS; EXHAUST HOODS FOR KITCHENS; AIR PURIFYING MACHINES; DEHUMIDIFIERS; AIR-CONDITIONERS; REFRIGERATORS AND FREEZERS; ELECTRIC BEVERAGE COOLERS; REFRIGERATED WATER DISPENSING UNITS; BARBECUE GRILLS (U.S. CLS. 13, 21, 23, 31 AND 34).  
FIRST USE 10-15-2004; IN COMMERCE 10-15-2004.

**CLASS 11—(Continued).**

2,929,423. BURHAM SERVICES, INC., WILMINGTON, DE. SN 76-525,175. PUB. 2-10-2004, FILED 6-24-2003.

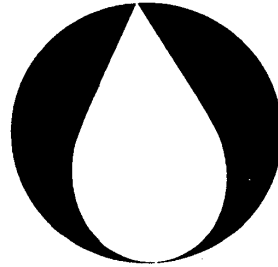

FOR GAS, OIL, AND COMBINATION FUEL-FIRED NATURAL AND FORCED DRAFT FIRE-TUBE BOILERS FOR BOTH LOW AND HIGH PRESSURE STEAM AND WATER; DEAERATORS; BLOW-DOWNS, CHEMICAL FEEDERS, WATER SOFTENERS, CONDENSATE RETURNS, AND FEED WATER PUMPS, ALL FOR COMMERCIAL, INDUSTRIAL, INSTITUTIONAL, AND MARINE APPLICATION (U.S. CLS. 13, 21, 23, 31 AND 34).  
FIRST USE 3-1-2004; IN COMMERCE 3-1-2004.

---

2,929,460. SCOTSMAN GROUP INC., VERNON HILLS, IL. SN 76-538,183. PUB. 5-4-2004, FILED 8-7-2003.

**ICE VALET**

NO CLAIM IS MADE TO THE EXCLUSIVE RIGHT TO USE ICE, APART FROM THE MARK AS SHOWN.  
FOR COMMERCIAL ICE MAKING MACHINES (U.S. CLS. 13, 21, 23, 31 AND 34).  
FIRST USE 1-15-2004; IN COMMERCE 1-15-2004.

---

2,929,468. FORTUNE PRODUCTS, INC., LAKE STEVENS, WA. SN 76-541,931. PUB. 8-10-2004, FILED 8-29-2003.

**DECO CUBE**

FOR ELECTRIC ATMOSPHERIC LIGHTING FIXTURES (U.S. CLS. 13, 21, 23, 31 AND 34).  
FIRST USE 9-15-2003; IN COMMERCE 9-15-2003.

---

2,929,497. MULTIQUIP, INC., CARSON, CA. SN 76-555,268. PUB. 5-25-2004, FILED 10-14-2003.

**NIGHTHAWK**

FOR TRAILERABLE LIGHT TOWERS (U.S. CLS. 13, 21, 23, 31 AND 34).  
FIRST USE 10-16-2003; IN COMMERCE 10-16-2003.

**CLASS 11—(Continued).**

2,929,553. APPROVED AERONAUTICS, L.L.C., SAN DIEGO, CA. SN 78-088,871. PUB. 10-8-2002, FILED 10-17-2001.



NO CLAIM IS MADE TO THE EXCLUSIVE RIGHT TO USE "CHEF", APART FROM THE MARK AS SHOWN. FOR COMMERCIAL COOKING OVENS FOR USE ABOARD AIRCRAFT (U.S. CLS. 13, 21, 23, 31 AND 34). FIRST USE 10-17-2001; IN COMMERCE 1-1-2004.

2,929,572. AROMA FRESH, LLC, COLUMBUS, OH. SN 78-123,199. PUB. 11-19-2002, FILED 4-22-2002.

## ORBITAL BREWING TECHNOLOGY

NO CLAIM IS MADE TO THE EXCLUSIVE RIGHT TO USE "BREWING TECHNOLOGY", APART FROM THE MARK AS SHOWN.

FOR ELECTRIC COFFEE MAKERS FOR DOMESTIC USE, COFFEE PERCOLATORS AND COFFEE POTS (U.S. CLS. 13, 21, 23, 31 AND 34). FIRST USE 9-1-2004; IN COMMERCE 9-1-2004.

2,929,621. TWENTIETH CENTURY FOX FILM CORPORATION, LOS ANGELES, CA. SN 78-175,714. PUB. 3-16-2004, FILED 10-17-2002.

## THE SIMPSONS

OWNER OF U.S. REG. NO. 1,772,911. SEC. 2(F). FOR BARBEQUE GRILLS; LAMPS (U.S. CLS. 13, 21, 23, 31 AND 34). FIRST USE 6-1-2000; IN COMMERCE 6-1-2000.

2,929,623. ROMAR INNOVATIONS, INC., DBA AQUA ULTRAVIOLET, TEMECULA, CA. SN 78-177,709. PUB. 2-24-2004, FILED 10-23-2002.

## AQUA UV

NO CLAIM IS MADE TO THE EXCLUSIVE RIGHT TO USE "UV", APART FROM THE MARK AS SHOWN.

FOR WATER STERILIZERS NAMELY, UV STERILIZERS FOR DRINKING WATER, AQUATIC PONDS, AND FISH TANKS; FILTERS AND FILTER MEDIA FOR AQUATIC PONDS AND FISH TANKS, FOUNTAINS, LAMPS FOR FISH TANKS, NAMELY, UV GERMICIDAL LAMPS FOR FISH TANKS (U.S. CLS. 13, 21, 23, 31 AND 34). FIRST USE 12-0-1975; IN COMMERCE 12-0-1975.

**CLASS 11—(Continued).**

2,929,768. WHIRLPOOL PROPERTIES, INC., ST. JOSEPH, MI. SN 78-260,793. PUB. 3-23-2004, FILED 6-11-2003.

## SMART-MOUNT

FOR BRACKET MOUNTS SOLD AS A COMPONENT OR STRUCTURAL PART OF AIR CONDITIONERS (U.S. CLS. 13, 21, 23, 31 AND 34). FIRST USE 1-18-2004; IN COMMERCE 1-18-2004.

2,929,797. ROTISSER-EEZE BAR-BE-QUE SYSTEMS, LLC, WEST ALLIS, WI. SN 78-278,240. PUB. 5-4-2004, FILED 7-24-2003.



NO CLAIM IS MADE TO THE EXCLUSIVE RIGHT TO USE "BBQ", APART FROM THE MARK AS SHOWN. FOR COOKING UNITS, NAMELY ROTISSERIES AND PARTS THEREFOR (U.S. CLS. 13, 21, 23, 31 AND 34). FIRST USE 8-1-2003; IN COMMERCE 8-1-2003.

2,929,839. VORTECHNICS, INC., SCARBOROUGH, ME. SN 78-302,257. PUB. 7-6-2004, FILED 9-18-2003.

## VORTSENTRY

FOR WATER, WASTEWATER, AND STORMWATER PHYSICAL TREATMENT UNITS FOR COMMERCIAL AND INDUSTRIAL AND MUNICIPAL WATER (U.S. CLS. 13, 21, 23, 31 AND 34). FIRST USE 12-17-2003; IN COMMERCE 12-17-2003.

2,929,885. AROMA FRESH, LLC, COLUMBUS, OH. SN 78-975,055. PUB. 9-23-2003, FILED 4-22-2002.

## AROMA FRESH

FOR ELECTRIC COFFEE MAKERS FOR DOMESTIC USE, AND ELECTRIC COFFEE PERCOLATORS (U.S. CLS. 13, 21, 23, 31 AND 34). FIRST USE 9-1-2004; IN COMMERCE 9-1-2004.

**CLASS 12—VEHICLES**

2,929,178. MICHELIN NORTH AMERICA, INC., GREENVILLE, SC. SN 76-258,669. PUB. 9-4-2001, FILED 5-16-2001.

**LATITUDE**

FOR PNEUMATIC TIRES AND TUBES FOR VEHICLE WHEELS; TREADS FOR RECAPPING TIRES (U.S. CLS. 19, 21, 23, 31, 35 AND 44).  
FIRST USE 5-0-2004; IN COMMERCE 5-0-2004.

2,929,330. LUND INDUSTRIES, INC., ANOKA, MN. SN 76-483,309. PUB. 2-24-2004, FILED 1-16-2003.

**LUND EZ BRACKET**

NO CLAIM IS MADE TO THE EXCLUSIVE RIGHT TO USE BRACKET, APART FROM THE MARK AS SHOWN.  
FOR KITS FOR MOUNTING STEPS AND RUNNING BOARDS TO PICKUP TRUCKS AND SPORT UTILITY VEHICLES, COMPOSED PRIMARILY OF MOUNTING HARDWARE AND MOUNTING BRACKETS (U.S. CLS. 19, 21, 23, 31, 35 AND 44).  
FIRST USE 1-19-2002; IN COMMERCE 1-0-2003.

2,929,362. HOLLANDER, JAMES, PLAINFIELD, NH. SN 76-499,197. PUB. 5-11-2004, FILED 3-7-2003.

**HOT GRIPS**

OWNER OF U.S. REG. NO. 1,264,872.  
NO CLAIM IS MADE TO THE EXCLUSIVE RIGHT TO USE "GRIPS", APART FROM THE MARK AS SHOWN.  
SEC. 2(F).  
FOR SNOWMOBILE, MOTORCYCLE, AND ALL-TERRAIN VEHICLE HANDLE BAR GRIPS (U.S. CLS. 19, 21, 23, 31, 35 AND 44).  
FIRST USE 12-31-1980; IN COMMERCE 12-31-1980.

2,929,372. SURE-FIT TRUCK RACKS, CARSON CITY, NV. SN 76-502,393. PUB. 12-16-2003, FILED 3-31-2003.



NO CLAIM IS MADE TO THE EXCLUSIVE RIGHT TO USE "CUSTOM TRUCK RACKS", APART FROM THE MARK AS SHOWN.  
FOR CARGO CARRIERS CONSTRUCTED OF STEEL PIPE THAT ARE MOUNTED OR PLACED ON TRUCK BEDS (U.S. CLS. 19, 21, 23, 31, 35 AND 44).  
FIRST USE 7-8-2003; IN COMMERCE 7-8-2003.

**CLASS 12—(Continued).**

2,929,431. CASTILLO, JUAN DEL, POTOMAC, MD. SN 76-526,343. PUB. 6-8-2004, FILED 6-27-2003.

**BRIGADE**

FOR AUTOMOBILES (U.S. CLS. 19, 21, 23, 31, 35 AND 44).  
FIRST USE 10-1-2004; IN COMMERCE 10-1-2004.

2,929,456. MATHERNE, BERNARD A., SR., BRANDON, MS. SN 76-535,812. PUB. 3-23-2004, FILED 7-29-2003.

**ADJUST-A-RACK**

FOR APPARATUS FOR INSTALLATION IN VEHICLES AND VEHICLE TRAILERS HAVING AN ADJUSTABLE SECURING MECHANISM FOR SECURING VARIOUS TYPES OF EQUIPMENT AND VEHICLES, SUCH AS ALL TERRAIN VEHICLES (U.S. CLS. 19, 21, 23, 31, 35 AND 44).  
FIRST USE 12-18-2003; IN COMMERCE 12-18-2003.

2,929,484. PEWAG, INC., BURR RIDGE, IL. SN 76-549,361. PUB. 6-15-2004, FILED 9-16-2003.

**V-TRAC**

FOR TIRE CHAINS (U.S. CLS. 19, 21, 23, 31, 35 AND 44).  
FIRST USE 12-31-2003; IN COMMERCE 12-31-2003.

2,929,587. BRITAX CHILD SAFETY INC., CHARLOTTE, NC. SN 78-138,477. PUB. 12-23-2003, FILED 6-25-2002.

**WIZARD**

FOR CHILD SAFETY SEATS FOR USE IN CARS AND VEHICLES; CHILD SAFETY HARNESSSES FOR THE SEATS OF VEHICLES; CHILD SAFETY BELTS FOR THE SEATS OF VEHICLES; CHILD RESTRAINTS FOR USE IN VEHICLES; REPLACEMENT PARTS AND REPLACEMENT FITTINGS FOR CHILD SAFETY SEATS FOR USE IN VEHICLES, CHILD SAFETY HARNESSSES FOR THE SEATS OF VEHICLES, CHILD SAFETY BELTS FOR THE SEATS OF VEHICLES, AND CHILD RESTRAINTS FOR USE IN VEHICLES (U.S. CLS. 19, 21, 23, 31, 35 AND 44).  
FIRST USE 6-27-2003; IN COMMERCE 6-27-2003.

2,929,593. FOX FACTORY, INC., WATSONVILLE, CA. SN 78-147,233. PUB. 4-22-2003, FILED 7-24-2002.

**TERRALOGIC**

FOR VEHICLE PARTS, NAMELY, SHOCK ABSORBERS (U.S. CLS. 19, 21, 23, 31, 35 AND 44).  
FIRST USE 6-1-2002; IN COMMERCE 10-10-2002.

**CLASS 12—(Continued).**

2,929,613. ELEGANT USA, LLC, TOTOWA, NJ. SN 78-169,820.  
PUB. 9-16-2003, FILED 10-1-2002.

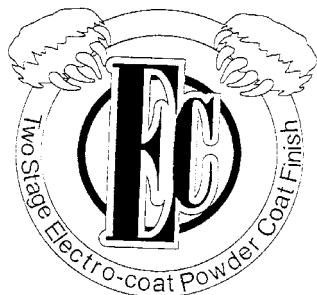

NO CLAIM IS MADE TO THE EXCLUSIVE RIGHT TO USE "TWO STAGE", "ELECTRO COAT", AND "POWDER COAT FINISH", APART FROM THE MARK AS SHOWN. FOR METAL GUARDS MOUNTED TO AUTOMOBILES (U.S. CLS. 19, 21, 23, 31, 35 AND 44).  
FIRST USE 10-1-2004; IN COMMERCE 10-1-2004.

2,929,670. DG PERFORMANCE SPECIALTIES, INC., ANAHEIM, CA. SN 78-204,721. PUB. 9-2-2003, FILED 1-17-2003.

**V PRO**

FOR ALL TERRAIN VEHICLE BUMPERS AND SIDE IMPACT BARS (U.S. CLS. 19, 21, 23, 31, 35 AND 44).  
FIRST USE 2-19-2003; IN COMMERCE 2-19-2003.

2,929,732. BOMBARDIER RECREATIONAL PRODUCTS INC., VALCOURT JOE 2LO, CANADA. SN 78-242,026.  
PUB. 3-23-2004, FILED 4-25-2003.

**3D**

FOR PERSONAL WATERCRAFT, NAMELY, SINGLE AND MULTIPLE PASSENGER RECREATIONAL JET BOATS AND STRUCTURAL PARTS THEREFOR (U.S. CLS. 19, 21, 23, 31, 35 AND 44).  
FIRST USE 2-28-2004; IN COMMERCE 2-28-2004.

2,929,776. ALADI, AZUKA FRANKIE, SUMMERVILLE, SC. SN 78-266,053. PUB. 3-16-2004, FILED 6-23-2003.

**SAFARI RACK**

NO CLAIM IS MADE TO THE EXCLUSIVE RIGHT TO USE "RACK", APART FROM THE MARK AS SHOWN. FOR ALL PURPOSE CARGO AND LUGGAGE RACKS FOR VEHICLES (U.S. CLS. 19, 21, 23, 31, 35 AND 44).  
FIRST USE 5-4-2003; IN COMMERCE 5-10-2003.

**CLASS 12—(Continued).**

2,929,809. YAMAHA HATSUDOKI KABUSHIKI KAISHA, SHIZUOKA-KEN, JAPAN. SN 78-284,010. PUB. 3-9-2004, FILED 8-6-2003.

**RSVENTURE**

OWNER OF U.S. REG. NOS. 1,292,131 AND 2,143,531. FOR SNOWMOBILES AND STRUCTURAL PARTS THEREFOR (U.S. CLS. 19, 21, 23, 31, 35 AND 44).  
FIRST USE 2-0-2004; IN COMMERCE 3-0-2004.

**CLASS 14—JEWELRY**

2,929,410. TXDC, L.P., IRVING, TX. SN 76-521,526. PUB. 2-24-2004, FILED 6-9-2003.

**BODY BY PAGODA**

OWNER OF U.S. REG. NOS. 1,641,670 AND 2,142,348. FOR JEWELRY (U.S. CLS. 2, 27, 28 AND 50).  
FIRST USE 8-1-2004; IN COMMERCE 8-1-2004.

2,929,450. MAYOR'S JEWELER'S, INC., SUNRISE, FL. SN 76-533,618. PUB. 2-24-2004, FILED 7-30-2003.

MAYORS  
MOMENT  
COLLECTION 

OWNER OF U.S. REG. NOS. 1,236,663 AND 1,490,121. FOR JEWELRY (U.S. CLS. 2, 27, 28 AND 50).  
FIRST USE 7-19-2003; IN COMMERCE 7-19-2003.

2,929,465. STATE OF IDAHO, BOISE, ID. SN 76-540,061. PUB. 5-4-2004, FILED 8-14-2003.

**THE LEGACY CONTINUES**

FOR COMMEMORATIVE MEDALLIONS (U.S. CLS. 2, 27, 28 AND 50).  
FIRST USE 3-31-2003; IN COMMERCE 3-31-2003.

**CLASS 14—(Continued).**

2,929,555. PETER STORM COMPANY, BELMONT, CA. SN 78-094,268. PUB. 10-1-2002, FILED 11-20-2001.

**NAKED DIAMONDS**

NO CLAIM IS MADE TO THE EXCLUSIVE RIGHT TO USE "DIAMONDS", APART FROM THE MARK AS SHOWN. FOR DIAMOND JEWELRY, NAMELY, EARRINGS, RINGS, BRACELETS, NECKLACES, PINS, AND VARIOUS OTHER JEWELRY (U.S. CLS. 2, 27, 28 AND 50). FIRST USE 1-20-2002; IN COMMERCE 1-20-2002.

2,929,664. BERTUCCI, MICHAEL, GURNEE, IL. SN 78-200,872. PUB. 9-2-2003, FILED 1-7-2003.

**DURABILITY BY DESIGN**

FOR HOROLOGICAL AND CHRONOMETRIC INSTRUMENTS, NAMELY CLOCKS, WATCHES, TIMEPIECES AND CHRONOMETERS (U.S. CLS. 2, 27, 28 AND 50). FIRST USE 4-0-2004; IN COMMERCE 6-23-2004.

2,929,744. KELLER, THOMAS QUINN, COLORADO SPRINGS, CO. SN 78-249,691. PUB. 1-27-2004, FILED 5-14-2003.

**A-LURE-RING**

FOR RINGS BEING JEWELRY (U.S. CLS. 2, 27, 28 AND 50). FIRST USE 9-29-2004; IN COMMERCE 9-29-2004.

2,929,816. HEARTS ON FIRE COMPANY LLP, BOSTON, MA. SN 78-286,879. PUB. 5-11-2004, FILED 8-13-2003.

**RAPTURE**

FOR GEMSTONES, NAMELY CUT DIAMONDS, AND JEWELRY (U.S. CLS. 2, 27, 28 AND 50). FIRST USE 8-1-2003; IN COMMERCE 9-1-2003.

2,929,817. HEARTS ON FIRE COMPANY LLP, BOSTON, MA. SN 78-286,895. PUB. 5-11-2004, FILED 8-13-2003.

**FLIRTATION**

FOR GEMSTONES, NAMELY CUT DIAMONDS, AND JEWELRY (U.S. CLS. 2, 27, 28 AND 50). FIRST USE 8-1-2003; IN COMMERCE 9-1-2003.

**CLASS 16—PAPER GOODS AND PRINTED MATTER****CLASS 16—(Continued).**

2,929,118. FLOORGRAPHICS, INC., PRINCETON, NJ. SN 76-142,477. PUB. 2-12-2002, FILED 10-6-2000.

**STREETALK PLUS**

FOR ADHESIVES FOR STATIONERY PURPOSES, ANNOUNCEMENT CARDS, PICTURES, ART PRINTS, CONSTRUCTION PAPER, GENERAL PURPOSE PLASTIC BAGS, PAPER BAGS, PAPER BANNERS, PAPER BOXES, BUMPER STICKERS, PEN AND PENCIL CASES, PRINTED CHARTS, PAPER CONTAINERS, COUPONS, DECALS, ETCHINGS, MEMO PADS, LAMINATED PAPER, ILLUSTRATION PAPER, COLOR PRINTS, AND STICKERS (U.S. CLS. 2, 5, 22, 23, 29, 37, 38 AND 50). FIRST USE 3-0-1999; IN COMMERCE 3-0-1999.

2,929,151. CORPORATE EXECUTIVE BOARD COMPANY, THE, WASHINGTON, DC. SN 76-207,762. PUB. 4-29-2003, FILED 2-7-2001.

**CEB**

FOR BOOKS, HANDBOOKS AND PAMPHLETS RELATING TO BUSINESS (U.S. CLS. 2, 5, 22, 23, 29, 37, 38 AND 50). FIRST USE 8-0-2002; IN COMMERCE 8-0-2002.

2,929,154. WAL-MART STORES, INC., BENTONVILLE, AR. SN 76-214,175. PUB. 8-14-2001, FILED 2-22-2001.

**NO BOUNDARIES**

OWNER OF U.S. REG. NO. 2,016,075. FOR PAPER BINDERS, NOTEBOOKS, PENCIL CASES (U.S. CLS. 2, 5, 22, 23, 29, 37, 38 AND 50). FIRST USE 6-30-2001; IN COMMERCE 6-30-2001.

2,929,241. EK SUCCESS, LTD., CLIFTON, NJ. SN 76-368,235. PUB. 9-17-2002, FILED 2-7-2002.

**STICKERSAURUS**

FOR STICKER PRODUCTS, NAMELY, STICKERS, STICKER BOOKS, BINDERS OF STICKERS, AND STICKER POUCHES (U.S. CLS. 2, 5, 22, 23, 29, 37, 38 AND 50). FIRST USE 5-18-2004; IN COMMERCE 5-18-2004.

**CLASS 16—(Continued).**

2,929,243. SOUTHWESTERN VERMONT HEALTH CARE, BENNINGTON, VT. SN 76-369,671. PUB. 12-24-2002, FILED 2-11-2002.

**WELLPRO**

FOR PRINTED GUIDES AND FORMS FOR USE IN ADMINISTERING PERSONAL HEALTH AND WELLNESS PROGRAMS; PRINTED GUIDES AND FORMS FOR USE IN ADMINISTERING HEALTH CARE BENEFIT PLANS FOR EMPLOYEES AND EMPLOYEES OF OTHERS (U.S. CLS. 2, 5, 22, 23, 29, 37, 38 AND 50).  
FIRST USE 1-1-2002; IN COMMERCE 7-1-2004.

2,929,286. NATURAL HAZARDS DISCLOSURE, LLC, LOS ANGELES, CA. SN 76-442,804. PUB. 3-9-2004, FILED 8-21-2002.



NO CLAIM IS MADE TO THE EXCLUSIVE RIGHT TO USE "NATURAL HAZARDS DISCLOSURE, LLC", APART FROM THE MARK AS SHOWN.

FOR RESEARCH REPORTS FEATURING NATURAL HAZARD DISCLOSURE, TAX, AND TITLE INFORMATION REGARDING REAL PROPERTY (U.S. CLS. 2, 5, 22, 23, 29, 37, 38 AND 50).  
FIRST USE 6-1-2002; IN COMMERCE 6-1-2002.

2,929,294. AGC, INC., CLEVELAND, OH. SN 76-450,358. PUB. 7-22-2003, FILED 9-17-2002.

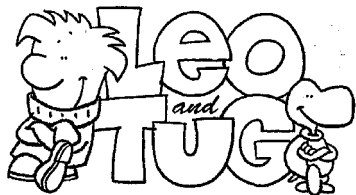

THE NAME "LEO" IN THE MARK DOES NOT IDENTIFY A LIVING INDIVIDUAL.  
FOR GREETING CARDS (U.S. CLS. 2, 5, 22, 23, 29, 37, 38 AND 50).  
FIRST USE 5-31-2004; IN COMMERCE 5-31-2004.

**CLASS 16—(Continued).**

2,929,295. COLBERT PACKAGING CORPORATION, LAKE FOREST, IL. SN 76-450,655. PUB. 2-10-2004, FILED 9-18-2002.

**PHARMA DIAL**

FOR PAPERBOARD BLISTER-PACK CARDS FOR CONTAINING AND DISPENSING PILLS AND TABLETS (U.S. CLS. 2, 5, 22, 23, 29, 37, 38 AND 50).  
FIRST USE 6-0-2003; IN COMMERCE 6-0-2003.

2,929,297. C SQUARED TV LLC, SHERMAN OAKS, CA. SN 76-454,560. PUB. 7-8-2003, FILED 9-23-2002.

**THE FOOD LOVERS FAT LOSS SYSTEM**

NO CLAIM IS MADE TO THE EXCLUSIVE RIGHT TO USE "FOOD" AND "FAT LOSS SYSTEM", APART FROM THE MARK AS SHOWN.

FOR BOOKLETS IN THE FIELD OF WEIGHT LOSS (U.S. CLS. 2, 5, 22, 23, 29, 37, 38 AND 50).  
FIRST USE 4-8-2002; IN COMMERCE 4-8-2002.

2,929,302. BUBB, PATRICIA, PHILADELPHIA, PA. SN 76-460,334. PUB. 6-24-2003, FILED 10-17-2002.

**WORDS LEFT UNSAID**

FOR GREETING CARDS (U.S. CLS. 2, 5, 22, 23, 29, 37, 38 AND 50).  
FIRST USE 9-9-2004; IN COMMERCE 9-9-2004.

2,929,347. LATINA MEDIA VENTURES LLC, NEW YORK, NY. SN 76-493,135. PUB. 3-16-2004, FILED 2-20-2003.

**LATINA MUJERES OF THE YEAR**

NO CLAIM IS MADE TO THE EXCLUSIVE RIGHT TO USE "MUJERES OF THE YEAR", APART FROM THE MARK AS SHOWN.

IN ITS ENGLISH TRANSLATION THE WORDS "LATINA MUJERES" MEAN WOMEN OF HISPANIC ORIGIN.  
SEC. 2(F) AS TO LATINA.

FOR FEATURE OF MAGAZINE RECOGNIZING OUTSTANDING WOMEN OF HISPANIC DESCENT (U.S. CLS. 2, 5, 22, 23, 29, 37, 38 AND 50).  
FIRST USE 12-1-2002; IN COMMERCE 12-1-2002.



**CLASS 16—(Continued).**

2,929,350. WILLIAMSON, NATHANIEL, VALLEJO, CA. SN 76-495,994. PUB. 3-16-2004, FILED 3-10-2003.

**BLENDERR**

FOR COMIC STRIP (U.S. CLS. 2, 5, 22, 23, 29, 37, 38 AND 50).  
FIRST USE 8-1-2002; IN COMMERCE 3-11-2004.

2,929,403. NORTHWEST PUBLICATIONS INC., DULUTH, MN. SN 76-515,136. PUB. 3-30-2004, FILED 5-19-2003.

## Duluth News Tribune

*Stay Sharp.*

NO CLAIM IS MADE TO THE EXCLUSIVE RIGHT TO USE "DULUTH NEWS", APART FROM THE MARK AS SHOWN.

FOR DAILY NEWSPAPER FOR GENERAL CIRCULATION REPORTING NATIONAL, INTERNATIONAL AND LOCAL NEWS, EDITORIALS AND FEATURE ARTICLES (U.S. CLS. 2, 5, 22, 23, 29, 37, 38 AND 50).  
FIRST USE 3-26-2003; IN COMMERCE 3-26-2003.

2,929,478. TANGO PUBLISHING, INC., NEW YORK, NY. SN 76-545,006. PUB. 6-8-2004, FILED 9-3-2003.

FOR MAGAZINE IN THE FIELD OF TOPICS RELATED TO RELATIONSHIPS AND COUPLES (U.S. CLS. 2, 5, 22, 23, 29, 37, 38 AND 50).  
FIRST USE 2-0-2004; IN COMMERCE 2-0-2004.

2,929,541. GOOSEDADDY LLC, PORTLAND, OR. SN 78-061,183. PUB. 9-11-2001, FILED 4-30-2001.

**GOOSEDADDY**

FOR CHILDREN'S BOOKS (U.S. CLS. 2, 5, 22, 23, 29, 37, 38 AND 50).  
FIRST USE 12-1-2004; IN COMMERCE 12-1-2004.

**CLASS 16—(Continued).**

2,929,542. GOOSEDADDY LLC, PORTLAND, OR. SN 78-061,184. PUB. 9-11-2001, FILED 4-30-2001.

**HOW TO BE A KID**

FOR SERIES OF CHILDREN'S BOOKS (U.S. CLS. 2, 5, 22, 23, 29, 37, 38 AND 50).  
FIRST USE 12-1-2004; IN COMMERCE 12-1-2004.

2,929,567. INTERNATIONAL PAPER COMPANY, STAMFORD, CT. SN 78-118,642. PUB. 11-19-2002, FILED 4-1-2002.

**WE PACKAGE EXCELLENCE**

FOR LAMINATED CARDBOARD BULK BOXES FOR SHIPPING BULK FOOD PRODUCTS OR CHEMICAL PRODUCTS (U.S. CLS. 2, 5, 22, 23, 29, 37, 38 AND 50).  
FIRST USE 9-1-2004; IN COMMERCE 9-1-2004.

2,929,626. VIRGINIA BREAST CANCER FOUNDATION, RICHMOND, VA. SN 78-180,523. PUB. 1-6-2004, FILED 10-31-2002.

**EDUCATE. ADVOCATE.  
ERADICATE.**

FOR NEWSLETTER AND BROCHURE (U.S. CLS. 2, 5, 22, 23, 29, 37, 38 AND 50).  
FIRST USE 6-1-2001; IN COMMERCE 6-1-2001.

2,929,634. ASTRAZENECA AB, SODERTALJE, SWEDEN. SN 78-185,160. PUB. 9-9-2003, FILED 11-14-2002.



NO CLAIM IS MADE TO THE EXCLUSIVE RIGHT TO USE "BUDESONIDE", APART FROM THE MARK AS SHOWN.

THE STIPPLING IS A FEATURE OF THE MARK.  
THE MARK CONSISTS OF THE WORD "BUDESONIDE" IN LARGE STYLIZED CAPITAL LETTERS. BELOW IT ARE THE WORDS "CORE OF CONFIDENCE" IN SMALL STYLIZED LOWER-CASE LETTERS. IN THE UPPER RIGHT HAND CORNER IS THREE-QUARTERS OF AN OVAL DESIGN THAT TAPERS ON BOTH ENDS. THE END OF THE RIGHT SIDE OF THE OVAL MEETS THE LETTER.

FOR PRINTED INSTRUCTIONAL MATERIALS IN THE FIELD OF RESPIRATORY DISEASES (U.S. CLS. 2, 5, 22, 23, 29, 37, 38 AND 50).  
FIRST USE 12-1-2003; IN COMMERCE 12-1-2003.

**CLASS 16—(Continued).**

2,929,689. CHRISTIAN ART GIFTS, INC, LOMBARD, IL. SN 78-217,268. PUB. 3-16-2004, FILED 2-21-2003.

**CAG**

FOR BOOKS RELATED TO THE SUBJECT MATTER OF RELIGION, FAITH AND THE BIBLE; STATIONERY; PAPER NOTEPADS; PENS; PENCILS; GIFT CARDS; GREETING CARDS; DIARIES; WRITING JOURNALS; BOOK MARKS; BOOK COVERS; BIBLE COVERS AND CALENDARS (U.S. CLS. 2, 5, 22, 23, 29, 37, 38 AND 50).  
FIRST USE 1-0-2003; IN COMMERCE 5-0-2003.

2,929,765. COSENTINO, RALPH, NORTH OLMSTED, OH. SN 78-260,221. PUB. 2-24-2004, FILED 6-9-2003.

**FUN-BOY**

FOR PAPER AND PAPERBOARD PRODUCTS, NAMELY, CARDBOARD CONTAINERS, STORAGE BOXES, CARTONS AND BOXES; CARDBOARD FLOOR DISPLAY UNITS FOR MERCHANDISING PRODUCTS; PAPER DECORATIVE AND EDUCATIONAL WALL, DOOR, AND WINDOW DECORATIONS; STICKERS USED FOR REWARDS AND DECORATION; PAPER BANNERS; PAPER POSTERS; PAPER BOOKMARKS; COLORING BOOKS; CHILDREN'S PICTURE BOOKS; BLANK SKETCH BOOKS AND ART PADS (U.S. CLS. 2, 5, 22, 23, 29, 37, 38 AND 50).  
FIRST USE 10-25-2004; IN COMMERCE 11-5-2004.

2,929,770. FOOD NETWORK INC., CHATHAM, NJ. SN 78-260,932. PUB. 3-23-2004, FILED 6-11-2003.

**DIGEST THIS**

FOR PERIODICAL NEWSLETTER ABOUT FOOD, HISTORY, PHILOSOPHY, NUTRITION, HEALTH, AND DIET (U.S. CLS. 2, 5, 22, 23, 29, 37, 38 AND 50).  
FIRST USE 9-29-2004; IN COMMERCE 11-8-2004.

2,929,791. HALLMARK LICENSING, INC., KANSAS CITY, MO. SN 78-275,137. PUB. 3-23-2004, FILED 7-16-2003.

**RADIANTE**

FOR GREETING CARDS (U.S. CLS. 2, 5, 22, 23, 29, 37, 38 AND 50).  
FIRST USE 5-1-2004; IN COMMERCE 5-1-2004.

**CLASS 16—(Continued).**

2,929,801. TARQUINE, HENRY E., FORT LAUDERDALE, FL. SN 78-279,925. PUB. 5-4-2004, FILED 7-28-2003.

**KAYO**

FOR TRADING CARDS, STICKERS AND POSTERS (U.S. CLS. 2, 5, 22, 23, 29, 37, 38 AND 50).  
FIRST USE 12-2-2004; IN COMMERCE 12-2-2004.

2,929,823. FORT JAMES OPERATING COMPANY, ATLANTA, GA. SN 78-293,123. PUB. 6-1-2004, FILED 8-27-2003.



OWNER OF U.S. REG. NOS. 1,062,207, 2,165,829, AND 2,635,343.  
FOR PAPER TOWELS, NAPKINS (U.S. CLS. 2, 5, 22, 23, 29, 37, 38 AND 50).  
FIRST USE 10-15-2003; IN COMMERCE 10-15-2003.

2,929,831. MAY DEPARTMENT STORES INTERNATIONAL, INC., ST. LOUIS, MO. SN 78-298,297. PUB. 4-13-2004, FILED 9-10-2003.

**BEAUTY.NOW**

OWNER OF U.S. REG. NO. 2,696,590.  
FOR BEAUTY NEWSLETTERS, MAILERS AND CATALOGS IN THE AREA OF COSMETICS AND FRAGRANCES (U.S. CLS. 2, 5, 22, 23, 29, 37, 38 AND 50).  
FIRST USE 3-1-2002; IN COMMERCE 3-1-2002.

2,929,836. SEARS, PH.D., BARRY D., DANVERS, MA. SN 78-301,657. PUB. 8-10-2004, FILED 9-17-2003.

**ZONERX**

OWNER OF U.S. REG. NO. 2,689,749.  
FOR WORKBOOKS AND PRINTED GUIDES ABOUT DIET, HEALTH, AND NUTRITION (U.S. CLS. 2, 5, 22, 23, 29, 37, 38 AND 50).  
FIRST USE 4-23-2002; IN COMMERCE 4-23-2002.

**CLASS 16—(Continued).**

2,929,861. WONDERLIC, INC., LIBERTYVILLE, IL. SN 78-314,421. PUB. 6-15-2004, FILED 10-16-2003.

**WPI**

FOR PRINTED MATTER, NAMELY, AN EMPLOYMENT TEST FOR THE ASSESSMENT OF PERSON-TO-JOB FIT, MOTIVATION AND INTEGRITY (U.S. CLS. 2, 5, 22, 23, 29, 37, 38 AND 50).  
FIRST USE 7-1-2003; IN COMMERCE 7-1-2003.

2,929,866. ROWE, SHARON L., SOUTHLAKE, TX. SN 78-317,483. PUB. 7-27-2004, FILED 10-23-2003.

**LITERATI**

FOR DECORATIVE BOOKMARKS (U.S. CLS. 2, 5, 22, 23, 29, 37, 38 AND 50).  
FIRST USE 8-21-2003; IN COMMERCE 3-3-2004.

2,929,870. LPG GREETINGS, INC., GURNEE, IL. SN 78-321,395. PUB. 7-20-2004, FILED 10-31-2003.

**CARDMARK**

FOR COMBINATION GREETING CARD AND BOOKMARK (U.S. CLS. 2, 5, 22, 23, 29, 37, 38 AND 50).  
FIRST USE 1-1-2004; IN COMMERCE 1-1-2004.

2,929,875. CHELSEA HOUSE PUBLISHERS LLC, LANGHORNE, PA. SN 78-324,960. PUB. 4-20-2004, FILED 11-7-2003.



THE MARK CONSISTS OF A STYLIZED REPRESENTATION OF THE LETTERS BLC ENCLOSED IN A RECTANGLE.

FOR SERIES OF NON-FICTION BOOKS FOR STUDENTS AND EDUCATORS AT THE SECONDARY AND COLLEGE LEVELS, IN THE FIELDS OF LITERATURE AND LITERARY CRITICISM (U.S. CLS. 2, 5, 22, 23, 29, 37, 38 AND 50).  
FIRST USE 8-0-2003; IN COMMERCE 1-0-2004.

**CLASS 17—RUBBER GOODS**

2,929,283. REEMAY, INC., OLD HICKORY, TN. SN 76-434,887. PUB. 7-1-2003, FILED 7-26-2002.

**TYPAR ROOFWRAP**

OWNER OF U.S. REG. NOS. 1,524,559 AND 1,704,986.  
NO CLAIM IS MADE TO THE EXCLUSIVE RIGHT TO USE "ROOFWRAP", APART FROM THE MARK AS SHOWN.

FOR FLEXIBLE SHEET MATERIAL MADE OF SPUN-BONDED MAN-MADE FIBERS USED AS A ROOFING UNDERLAYMENT (U.S. CLS. 1, 5, 12, 13, 35 AND 50).  
FIRST USE 12-11-2002; IN COMMERCE 12-11-2002.

2,929,513. LINTEC KABUSHIKI KAISHA, TA LINTEC CORPORATION, ITABASHI-KU, TOKYO, JAPAN. SN 76-977,084. PUB. 12-9-2003, FILED 10-30-2002.

**LVIP**

FOR PLASTIC SOLD IN SHEET FORM FOR INDUSTRIAL PRODUCT MANUFACTURE, NAMELY ELECTRICALLY CONDUCTIVE SHEETS, ADHESIVE SHEETS, RELEASE SHEETS AND PRESSURE SENSITIVE ADHESIVE SHEETS; PLASTIC FILMS FOR DECORATING PURPOSES, NAMELY ADHESIVE FILMS, RELEASE FILMS, MARKING FILMS, MASKING FILMS AND VAPOR DEPOSIT FILMS; PLASTIC FILMS, ADHESIVE FILMS AND RELEASE FILMS FOR WRITING, PRINTING AND MARKING; PLASTIC FILMS AND ADHESIVE FILMS FOR USE IN THE FURTHER MANUFACTURE OF LABELS FOR WRITING, PRINTING, AND MARKING; PLASTIC FILMS SOLD IN ROLL OR SHEET FORM FOR INDUSTRIAL PRODUCT MANUFACTURE PURPOSES, NAMELY ELECTRICALLY CONDUCTIVE FILMS, ADHESIVE FILMS, RELEASE FILMS AND PRESSURE SENSITIVE ADHESIVE FILMS (U.S. CLS. 1, 5, 12, 13, 35 AND 50).  
FIRST USE 9-30-1997; IN COMMERCE 9-30-1997.

2,929,729. SHRINKSAFE SYSTEMS LLC, LINCOLN UNIVERSITY, PA. SN 78-240,324. PUB. 5-11-2004, FILED 4-21-2003.



NO CLAIM IS MADE TO THE EXCLUSIVE RIGHT TO USE "SYSTEMS LLC", APART FROM THE MARK AS SHOWN.

FOR PACKAGING, NAMELY, PLASTIC SHRINK FILM FOR PHARMACEUTICAL USE (U.S. CLS. 1, 5, 12, 13, 35 AND 50).  
FIRST USE 12-8-2003; IN COMMERCE 7-21-2004.

**CLASS 17—(Continued).**

2,929,735. EATON AEROQUIP INC., CLEVELAND, OH. SN 78-245,036. PUB. 3-30-2004, FILED 5-2-2003.

**RHINOHIDE**

FOR REINFORCED RUBBER HOSE CONTAINING METAL FOR MEDIUM AND HIGH PRESSURE FLUID APPLICATIONS (U.S. CLS. 1, 5, 12, 13, 35 AND 50).  
FIRST USE 2-1-1999; IN COMMERCE 2-1-1999.

**CLASS 18—LEATHER GOODS**

2,929,090. SANDRA JORDAN COLLECTION, LLC, HEALDSBURG, CA. SN 76-023,658. PUB. 9-11-2001, FILED 4-11-2000.

**SANDRA JORDAN**

THE NAME "SANDRA JORDAN" IDENTIFIES A LIVING INDIVIDUAL WHOSE CONSENT IS OF RECORD.  
FOR TOTE BAGS (U.S. CLS. 1, 2, 3, 22 AND 41).  
FIRST USE 8-0-2004; IN COMMERCE 8-0-2004.

2,929,527. WINDBRELLA PRODUCTS CORP, BOYNTON BEACH, FL. SN 78-026,633. PUB. 7-3-2001, FILED 9-19-2000.

**WINDBRELLA VENTED MESH SYSTEM**

NO CLAIM IS MADE TO THE EXCLUSIVE RIGHT TO USE "VENTED MESH SYSTEM", APART FROM THE MARK AS SHOWN.  
FOR UMBRELLAS (U.S. CLS. 1, 2, 3, 22 AND 41).  
FIRST USE 6-10-2002; IN COMMERCE 6-10-2002.

2,929,651. L.C. INDUSTRIES, LLC, CHICAGO, IL. SN 78-193,277. PUB. 3-23-2004, FILED 12-11-2002.

**WALLET MINDER**

NO CLAIM IS MADE TO THE EXCLUSIVE RIGHT TO USE "WALLET", APART FROM THE MARK AS SHOWN.  
FOR SECURITY DEVICE, NAMELY A COMBINATION OF ELASTIC PANELS AND COATED STEEL CABLE TO FIT AROUND A WALLET FOR PROTECTING AND SECURING PERSONAL ITEMS FROM THEFT AND FOR SECURITY PURPOSES (U.S. CLS. 1, 2, 3, 22 AND 41).  
FIRST USE 1-1-2003; IN COMMERCE 1-1-2003.

**CLASS 18—(Continued).**

2,929,696. VIACOM INTERNATIONAL INC., NEW YORK, NY. SN 78-219,859. PUB. 10-28-2003, FILED 2-27-2003.

**SHOOT FOR THE SKYE**

FOR UMBRELLAS, LUGGAGE, LUGGAGE TAGS, TOTE BAGS, BACKPACKS, FANNY PACKS, MESSENGER BAGS, HANDBAGS, WALLETS AND PURSES, ATHLETIC BAGS, GARMENT BAGS FOR TRAVEL, KNAPSACKS, CHANGE PURSES, DUFFLE BAGS, BEACH BAGS (U.S. CLS. 1, 2, 3, 22 AND 41).  
FIRST USE 7-19-2004; IN COMMERCE 7-19-2004.

2,929,892. GEN-X SPORTS SÁRL, CHATEL ST. DENIS, SWITZERLAND. SN 78-975,748. PUB. 12-16-2003, FILED 8-14-2003.

**TOMMY ARMOUR**

THE NAME "TOMMY ARMOUR" DOES NOT IDENTIFY A LIVING INDIVIDUAL.  
FOR GOLF UMBRELLAS; GOLF TRAVEL BAG CASES (U.S. CLS. 1, 2, 3, 22 AND 41).  
FIRST USE 1-28-2004; IN COMMERCE 1-28-2004.

**CLASS 19—NON-METALLIC BUILDING MATERIALS**

2,929,321. NATIONAL SOLARCRETE, INC., HUNTLEY, IL. SN 76-476,002. PUB. 3-16-2004, FILED 12-17-2002.

**SOLARCRETE**

FOR BUILDING MATERIALS, NAMELY CONCRETE, CONCRETE BLOCKS, CONCRETE RETAINING WALLS, CONCRETE WALLS (U.S. CLS. 1, 12, 33 AND 50).  
FIRST USE 9-0-2002; IN COMMERCE 9-0-2002.

2,929,377. SCHAFER SYSTEMS INC., ADAIR, IA. SN 76-504,547. PUB. 2-17-2004, FILED 4-7-2003.

**MAKE A CONNECTION TO LIFE**

FOR PLASTIC MODULAR FLOATING DOCKS AND ASSOCIATED DECORATIVE PARTS THEREFORE (U.S. CLS. 1, 12, 33 AND 50).  
FIRST USE 8-16-2003; IN COMMERCE 8-16-2003.

**CLASS 19—(Continued).**

2,929,455. ALLIED BUILDING PRODUCTS CORPORATION, EAST RUTHERFORD, NJ. SN 76-535,016. PUB. 4-13-2004, FILED 8-6-2003.

**TRI-BUILT**

FOR ROOFING MEMBRANES (U.S. CLS. 1, 12, 33 AND 50).  
FIRST USE 4-1-2004; IN COMMERCE 4-1-2004.

---

2,929,474. FLORIDA SILICA SAND COMPANY, DANIA, FL. SN 76-542,576. PUB. 5-25-2004, FILED 9-5-2003.

**FLORI-STONE**

FOR STONE AND GRAVEL (U.S. CLS. 1, 12, 33 AND 50).  
FIRST USE 12-31-1965; IN COMMERCE 12-31-1965.

---

2,929,631. SIPLAST, INC., ARKADELPHIA, AR. SN 78-182,203. PUB. 7-6-2004, FILED 11-6-2002.

**TERAFOUNDATION**

FOR BITUMINOUS WATERPROOFING MEMBRANE USED AS AN UNDERLAYMENT FOR ROOF COVERINGS (U.S. CLS. 1, 12, 33 AND 50).  
FIRST USE 1-18-2003; IN COMMERCE 1-18-2003.

---

2,929,815. DURABLE WOOD PRODUCTS USA, INC., MIAMI LAKES, FL. SN 78-286,652. PUB. 6-1-2004, FILED 8-13-2003.

**TURADA**

FOR BUILDING MATERIALS, NAMELY, NATURAL TROPICAL HARDWOODS FOR MARINE, TRANSPORTATION, MANUFACTURING, RECREATIONAL, INDUSTRIAL, COMMERCIAL AND RESIDENTIAL HOUSING APPLICATIONS, IN THE FORM OF LUMBER, NON-METAL RAILROAD TIES, WOOD POSTS AND PILINGS, HARDWOOD TIMBER MATS FOR PROVIDING A STABLE PAD FOR CRANES, DECKING, AND NON-METAL ROOF SHINGLES (U.S. CLS. 1, 12, 33 AND 50).  
FIRST USE 4-1-2003; IN COMMERCE 4-1-2003.

**CLASS 19—(Continued).**

2,929,874. W. L. SNOOK & ASSOCIATES, INC., DBA THE TRAFFIC SAFETY STORE, WEST CHESTER, PA. SN 78-323,738. PUB. 8-3-2004, FILED 11-5-2003.

**New Sentry  
Barricade**

THE MARK CONSISTS OF STANDARD CHARACTERS WITHOUT CLAIM TO ANY PARTICULAR FONT, STYLE, SIZE, OR COLOR.

NO CLAIM IS MADE TO THE EXCLUSIVE RIGHT TO USE BARRICADE, APART FROM THE MARK AS SHOWN. FOR WATER-FILLED TRAFFIC BARRICADES MADE OF PLASTIC (U.S. CLS. 1, 12, 33 AND 50).  
FIRST USE 7-1-2004; IN COMMERCE 7-1-2004.

---

**CLASS 20—FURNITURE AND ARTICLES NOT OTHERWISE CLASSIFIED**

2,929,153. P.J. KIDS, LLC, PRINCETON, NJ. SN 76-213,254. PUB. 7-9-2002, FILED 2-22-2001.

**ROOM TO DREAM**

FOR JUVENILE FURNITURE, NAMELY, CHAIRS, TABLES, DESKS, DRESSERS, NIGHTSTANDS, BEDS AND PILLOWS (U.S. CLS. 2, 13, 22, 25, 32 AND 50).  
FIRST USE 2-0-2003; IN COMMERCE 2-0-2003.

---

2,929,538. L.A. AUDIO VIDEO, INC., LOS ANGELES, CA. SN 78-048,561. PUB. 3-5-2002, FILED 2-15-2001.

**THE CONNOISSEUR**

FOR HOME THEATER FURNITURE AND DECOR PACKAGES, FEATURING SOME OR ALL OF THE FOLLOWING ITEMS, SOLD AS A UNIT; HOME THEATER SEATS AND STRUCTURAL COMPONENTS THEREOF, PROSCENIUM STAGE STRUCTURE, NON-METAL DECORATIVE COLUMNS, NON-METAL DECORATIVE RAIL MOLDING, NON-METAL ACOUSTICAL WALL AND CEILING PANELS AND COMPONENTS THEREOF, LAMINATE FLOORING, AND CARPETING (U.S. CLS. 2, 13, 22, 25, 32 AND 50).  
FIRST USE 2-14-2001; IN COMMERCE 2-15-2001.

**CLASS 20—(Continued).**

2,929,551. SALMANS, SUSANN E., WICHITA, KS. SN 78-084,368. PUB. 1-28-2003, FILED 9-18-2001.

# KeepSocks

FOR NON-METAL SOCK CLIP FOR USE IN KEEPING SOCKS, GLOVES, AND HOSIERY TOGETHER IN THE WASHER AND DRYER (U.S. CLS. 2, 13, 22, 25, 32 AND 50).

FIRST USE 9-30-2001; IN COMMERCE 4-5-2002.

2,929,622. WHITE, RANDOLPH, L. PUNTA GORDA, FL. SN 78-176,449. PUB. 3-2-2004, FILED 10-21-2002.

## SLEEP SENSOR

NO CLAIM IS MADE TO THE EXCLUSIVE RIGHT TO USE SLEEP, APART FROM THE MARK AS SHOWN. FOR PILLOWS, MATTRESSES, MATTRESS CUSHIONS (U.S. CLS. 2, 13, 22, 25, 32 AND 50).

FIRST USE 1-0-2004; IN COMMERCE 1-0-2004.

2,929,637. PORCH PLAYERS, INC., MATTAWAN, MI. SN 78-185,644. PUB. 11-11-2003, FILED 11-15-2002.

## PORCH PLAYER

NO CLAIM IS MADE TO THE EXCLUSIVE RIGHT TO USE "PORCH", APART FROM THE MARK AS SHOWN.

FOR INDOOR AND OUTDOOR STATUARY MADE OF PLASTIC AND WOOD (U.S. CLS. 2, 13, 22, 25, 32 AND 50).

FIRST USE 11-7-2004; IN COMMERCE 11-7-2004.

2,929,640. HALLMARK LICENSING, INC., KANSAS CITY, MO. SN 78-186,190. PUB. 2-17-2004, FILED 11-18-2002.

## HALLMARK STORYKEEPER

OWNER OF U.S. REG. NOS. 380,596, 787,169, AND 821,931. FOR PICTURE FRAMES (U.S. CLS. 2, 13, 22, 25, 32 AND 50).

FIRST USE 1-1-2003; IN COMMERCE 1-1-2003.

**CLASS 20—(Continued).**

2,929,643. DUTCH PIPE LTD., NASSAU, NP, BAHAMAS. SN 78-187,621. PUB. 4-20-2004, FILED 11-21-2002.

RiteSafe



FOR NON-METAL SAFES (U.S. CLS. 2, 13, 22, 25, 32 AND 50).

FIRST USE 7-31-2003; IN COMMERCE 7-31-2003.

2,929,738. HELENE CURTIS, INC., WILMINGTON, DE. SN 78-246,537. PUB. 1-13-2004, FILED 5-7-2003.

## SUAVE

FOR NON-ELECTRIC MAKEUP MIRRORS (U.S. CLS. 2, 13, 22, 25, 32 AND 50).

FIRST USE 12-31-2003; IN COMMERCE 12-31-2003.

**CLASS 21—HOUSEWARES AND GLASS**

2,929,048. PAPER MAGIC GROUP, INC., THE, WILMINGTON, DE. SN 75-288,294. PUB. 1-21-2003, FILED 5-7-1997.

## DUDLEY'S

OWNER OF U.S. REG. NOS. 1,101,859, 1,873,334, AND OTHERS.

FOR EASTER AND HOLIDAY BASKETS COMPOSED OF BAMBOO, WOOD, STRAW, PLASTIC, VINYL AND FABRIC; PLASTIC FILLER EGGS FOR EASTER AND HOLIDAY BASKETS AND FOR DECORATIVE USE (U.S. CLS. 2, 13, 23, 29, 30, 33, 40 AND 50).

FIRST USE 4-0-1993; IN COMMERCE 4-0-1993.

2,929,135. ALDI INC., BATAVIA, IL. SN 76-180,238. PUB. 8-21-2001, FILED 12-14-2000.

## SEALTITE

FOR HOUSEHOLD PLASTIC STORAGE CONTAINERS (U.S. CLS. 2, 13, 23, 29, 30, 33, 40 AND 50).

FIRST USE 1-15-2001; IN COMMERCE 1-15-2001.

**CLASS 21—(Continued).**

2,929,319. ALLTEMPWARE, INC., PIGEON, MI. SN 76-473,686. PUB. 9-9-2003, FILED 12-10-2002.

**ALLTEMPWARE**

FOR COOKWARE AND TABLEWARE, NAMELY, BAKEWARE, BOWLS, ICE CUBE MOLDS, PLATES, SPATULAS, MIXING AND SERVING SPOONS, TRIVETS, AND UTENSIL HOLDERS (U.S. CLS. 2, 13, 23, 29, 30, 33, 40 AND 50).  
FIRST USE 4-1-2004; IN COMMERCE 4-1-2004.



2,929,364. HAUPT, THOMAS M., LINDENHURST, NY. SN 76-499,604. PUB. 6-8-2004, FILED 3-21-2003.

**SNAPKIN**

FOR NAPKIN HOLDERS (U.S. CLS. 2, 13, 23, 29, 30, 33, 40 AND 50).  
FIRST USE 3-0-2004; IN COMMERCE 3-0-2004.



2,929,381. STYLE TREND STUDIOS, INC., DELRAY BEACH, FL. SN 76-505,691. PUB. 12-2-2003, FILED 4-11-2003.

**PETRASTONE**

FOR PLANTERS AND FLOWER POTS (U.S. CLS. 2, 13, 23, 29, 30, 33, 40 AND 50).  
FIRST USE 8-23-2004; IN COMMERCE 8-23-2004.



2,929,382. STYLE TREND STUDIOS, INC., DELRAY BEACH, FL. SN 76-505,693. PUB. 12-2-2003, FILED 4-11-2003.

**POT A PORTER**

FOR PLANTERS AND FLOWER POTS (U.S. CLS. 2, 13, 23, 29, 30, 33, 40 AND 50).  
FIRST USE 8-23-2004; IN COMMERCE 8-23-2004.

**CLASS 21—(Continued).**

2,929,388. WELLS LAMONT CORPORATION, NILES, IL. SN 76-508,083. PUB. 11-25-2003, FILED 4-9-2003.



FOR GARDENING GLOVES (U.S. CLS. 2, 13, 23, 29, 30, 33, 40 AND 50).  
FIRST USE 12-0-2003; IN COMMERCE 12-0-2003.



2,929,394. KLEIN, STANLEY J., LOS ALTOS, CA. SN 76-511,018. PUB. 11-18-2003, FILED 4-16-2003.

**NIMBUS**

FOR TOOTHBRUSHES AND DENTAL FLOSS (U.S. CLS. 2, 13, 23, 29, 30, 33, 40 AND 50).  
FIRST USE 7-0-2003; IN COMMERCE 7-0-2003.



2,929,444. THE CARTOON NETWORK LP, LLLP, ATLANTA, GA. SN 76-530,917. PUB. 2-3-2004, FILED 7-21-2003.

**SAMURAI JACK**

FOR GLASS, CERAMIC AND EARTHENWARE GOODS, NAMELY, BEVERAGE GLASSWARE, COFFEE MUGS, MUGS, JUGS, BOWLS, PLATES, COASTERS, COFFEE CUPS AND CUPS; DEMITASSE SETS CONSISTING OF CUPS AND SAUCERS; SUGAR AND CREAMER SETS; INFANT CUPS; COOKIE JARS; CERAMIC, GLASS AND CHINA FIGURINES; NON-ELECTRIC COFFEE POTS NOT OF PRECIOUS METAL; WASTEPAPER BASKETS; ICE BUCKETS; PLASTIC BUCKETS; SHOWER CADDIES; TEA CADDIES; CAKE MOLDS; SCRAPERS, AND CAKE SERVERS; CANTEENS; CHAMPAGNE BUCKETS; PLASTIC COASTERS, COCKTAIL SHAKERS; THERMAL INSULATED CONTAINERS FOR FOOD OR BEVERAGES; COOKIE CUTTERS, CORK SCREWS; CORN COB HOLDERS; PLASTIC WATER BOTTLES SOLD EMPTY; VACUUM BOTTLES; DECANTERS; DRINKING FLASKS; GARDENING GLOVES; RUBBER HOUSEHOLD GLOVES; DINNERWARE, NAMELY PAPER PLATES AND PAPER CUPS; BRUSHES, NAMELY, HAIR BRUSHES, TOOTH BRUSHES, CLOTHES BRUSHES; KITCHEN UTENSILS, NAMELY ROLLING PINS, SPATULAS, TURNERS, WHISKS, AND KITCHEN CONTAINERS, SOAP CONTAINERS, FOOD CONTAINERS AND LUNCH BOXES; PLASTIC CUPS, PLATES AND COASTERS (U.S. CLS. 2, 13, 23, 29, 30, 33, 40 AND 50).  
FIRST USE 7-1-2002; IN COMMERCE 7-1-2002.

**CLASS 21—(Continued).**

2,929,493. MACLIN & ASSOCIATES, LOUISVILLE, KY. SN 76-553,929. PUB. 5-25-2004, FILED 10-22-2003.

**SOFT GLIDER**

FOR MOPS AND WIPES (U.S. CLS. 2, 13, 23, 29, 30, 33, 40 AND 50).  
FIRST USE 4-0-2004; IN COMMERCE 4-0-2004.

2,929,661. CHEIFTAIN MARKETING, LTD., POOLE, UNITED KINGDOM. SN 78-200,430. PUB. 3-23-2004, FILED 1-6-2003.

**HELPIN' HAND**

FOR PLASTIC BUCKETS, NAMELY, PLASTIC BUCKETS HAVING CLAMPS ON THE UNDERSIDES PERMITTING ATTACHMENT TO VERTICAL OR VERTICALLY ANGLED SURFACES SO THAT ITEMS WITHIN THE CONTAINERS ARE HELD ACCESSIBLE TO PERSONS WORKING NEAR SAID SURFACES (U.S. CLS. 2, 13, 23, 29, 30, 33, 40 AND 50).  
FIRST USE 1-21-2003; IN COMMERCE 1-21-2003.

2,929,758. TV ONE, LLC, SILVER SPRING, MD. SN 78-257,300. PUB. 2-24-2004, FILED 6-2-2003.

**TV ONE**

FOR MUGS, BEER MUGS, CUPS, COFFEE CUPS, BEVERAGE GLASSWARE, DRINKING GLASSES, BEVERAGE WARE, PORTABLE BEVERAGE COOLERS, PLASTIC COASTERS (U.S. CLS. 2, 13, 23, 29, 30, 33, 40 AND 50).  
FIRST USE 1-0-2004; IN COMMERCE 1-0-2004.

2,929,787. RUBBERMAID INCORPORATED, FREEPORT, IL. SN 78-271,192. PUB. 3-23-2004, FILED 7-7-2003.

**HYDROGEAR**

FOR PLASTIC BOTTLES, SOLD EMPTY (U.S. CLS. 2, 13, 23, 29, 30, 33, 40 AND 50).  
FIRST USE 12-1-2003; IN COMMERCE 12-1-2003.

2,929,790. BROWN, STEVE, HESPERIA, CA. SN 78-275,111. PUB. 4-27-2004, FILED 7-16-2003.

**BROWNDOG**

FOR CLEANING CLOTHS (U.S. CLS. 2, 13, 23, 29, 30, 33, 40 AND 50).  
FIRST USE 7-11-2004; IN COMMERCE 7-11-2004.

**CLASS 21—(Continued).**

2,929,822. ERN ENTERPRISES, INC., PALATINE, IL. SN 78-290,663. PUB. 6-15-2004, FILED 8-21-2003.

**BARCLAW**

FOR BEVERAGeware, NAMELY, HAND-HELD TRAYS USED FOR HOLDING AND SERVING DRINKING GLASSES (U.S. CLS. 2, 13, 23, 29, 30, 33, 40 AND 50).  
FIRST USE 11-0-2004; IN COMMERCE 11-0-2004.

**CLASS 22—CORDAGE AND FIBERS**

2,929,138. POP COVER, INC., ST. PAUL, MN. SN 76-190,726. PUB. 2-26-2002, FILED 1-8-2001.

**POP COVER**

NO CLAIM IS MADE TO THE EXCLUSIVE RIGHT TO USE "COVER", APART FROM THE MARK AS SHOWN.  
FOR SELF-DEPLOYING SECURABLE UNFITTED COVERS FOR VEHICLES, AIRPLANES, PLANT BUSHES, SHRUBS, OUTDOOR GRILLS, PICNIC TABLES, AND FURNITURE (U.S. CLS. 1, 2, 7, 19, 22, 42 AND 50).  
FIRST USE 11-19-2004; IN COMMERCE 11-19-2004.

2,929,762. SCHOTT INTERNATIONAL, INC., AKRON, OH. SN 78-258,614. PUB. 2-24-2004, FILED 6-5-2003.

**STAKE-N-RAKE**

FOR FABRIC OR COATED FABRIC BAGS FOR USE IN THE SHORT-TERM STORAGE AND TRANSPORTATION OF LAWN DEBRIS (U.S. CLS. 1, 2, 7, 19, 22, 42 AND 50).  
FIRST USE 10-15-2004; IN COMMERCE 10-15-2004.

2,929,812. OUTLAST TECHNOLOGIES, INC., BOULDER, CO. SN 78-285,902. PUB. 5-4-2004, FILED 8-11-2003.

**NOT TOO HOT NOT TOO COLD**

FOR TEXTILE FIBERS AND TEXTILE FILAMENTS (U.S. CLS. 1, 2, 7, 19, 22, 42 AND 50).  
FIRST USE 8-11-2003; IN COMMERCE 2-1-2004.

**CLASS 23—YARNS AND THREADS**



**CLASS 23—(Continued).**

2,929,813. OUTLAST TECHNOLOGIES, INC., BOULDER, CO.  
SN 78-285,903. PUB. 5-11-2004, FILED 8-11-2003.

## NOT TOO HOT NOT TOO COLD

FOR THREADS AND YARNS (U.S. CL. 43).  
FIRST USE 8-11-2003; IN COMMERCE 2-1-2004.

**CLASS 24—FABRICS**

2,929,217. FABRICTECH 2000, LLC, NEWARK, NJ. SN 76-  
328,153. PUB. 9-3-2002, FILED 10-22-2001.

## BEDBARRIER

FOR SAFE, HYPOALLERGENIC AND SANITARY  
MATTRESS COVERS, BOX SPRING COVERS, FUTON  
COVERS AND CRIB MATTRESS COVERS (U.S. CLS. 42  
AND 50).  
FIRST USE 6-1-2001; IN COMMERCE 10-15-2004.

2,929,335. UMBRA INC., BUFFALO, NY. SN 76-485,341. PUB.  
12-9-2003, FILED 1-27-2003.



OWNER OF U.S. REG. NO. 2,592,472.  
FOR DRAPERY PANELS; WINDOW CURTAINS (U.S.  
CLS. 42 AND 50).  
FIRST USE 9-1-2003; IN COMMERCE 9-1-2003.

**CLASS 24—(Continued).**

2,929,345. S&M NUTEC, LLC, NORTH KANSAS CITY, MO.  
SN 76-491,449. PUB. 4-6-2004, FILED 2-20-2003.



FOR ABSORBENT TOWEL FOR THE CARE AND  
GROOMING OF PETS, MANUFACTURED IN THE  
FORM OF A MICROFIBER GLOVE (U.S. CLS. 42 AND  
50).

FIRST USE 9-10-2003; IN COMMERCE 9-10-2003.

2,929,596. BRUNETTE, BLAKE R, ROCHESTER, MN. SN  
78-147,735. PUB. 9-2-2003, FILED 7-26-2002.

## POWER STRIPES

NO CLAIM IS MADE TO THE EXCLUSIVE RIGHT TO  
USE "STRIPES", APART FROM THE MARK AS SHOWN.  
FOR GOLF TOWELS; HAND TOWELS OF TEXTILE  
(U.S. CLS. 42 AND 50).

FIRST USE 5-18-2004; IN COMMERCE 5-18-2004.

2,929,599. DAVIS, DAYLE M., AKRON, OH. SN 78-148,821.  
PUB. 3-4-2003, FILED 7-30-2002.

## ULTRA-SHAM

FOR MULTI-POCKETED PILLOW SHAM TO INDIVI-  
DUALY HOLD MULTIPLE PILLOWS (U.S. CLS. 42  
AND 50).

FIRST USE 11-8-2004; IN COMMERCE 11-8-2004.

2,929,674. FELTERS COMPANY, THE, ROEBUCK, SC. SN 78-  
206,499. PUB. 3-23-2004, FILED 1-23-2003.

## SAFE-T-BACKER

FOR FELT BACKING MATERIALS, NAMELY SHEETS  
OF NONWOVEN FIBROUS BATTING FOR APPLICA-  
TION TO THE BACK OF FACE FABRICS (U.S. CLS. 42  
AND 50).

FIRST USE 4-30-2003; IN COMMERCE 4-30-2003.

**CLASS 25—CLOTHING**

2,929,081. FLAWLESS RECORDS, INC., NEW YORK, NY. SN 75-937,905. PUB. 8-21-2001, FILED 3-7-2000.

**FLAWLESS RECORDS**

FOR MEN'S, WOMEN'S AND CHILDREN'S APPAREL, NAMELY, PANTS, SHORTS, BOXER SHORTS, JUMPERS, JUMPSUITS, SWEATERS, TANK TOPS, HALTER TOPS, SHIRTS, T-SHIRTS, UNDER SHIRTS, SWEAT SHIRTS, SWEAT PANTS, SWEAT SHORTS, CAPS, HATS, BERETS, HEAD BANDS, PONCHOS; OUTERWEAR IN ALL FABRICATIONS, NAMELY, CLOTH, DENIM, LEATHER AND SUEDE JACKETS, AND RAINWEAR (U.S. CLS. 22 AND 39).

FIRST USE 9-1-2001; IN COMMERCE 11-1-2001.

2,929,082. FLAWLESS RECORDS, INC., NEW YORK, NY. SN 75-937,906. PUB. 8-21-2001, FILED 3-7-2000.



THE MARK CONSISTS OF A JEWELRY DIAMOND DESIGN AND THE STYLIZED WORDING "FLAWLESS RECORDS".

FOR MEN'S, WOMEN'S AND CHILDREN'S APPAREL, NAMELY, PANTS, SHORTS, BOXER SHORTS, JUMPERS, JUMPSUITS, SWEATERS, TANK TOPS, HALTER TOPS, SHIRTS, T-SHIRTS, UNDER SHIRTS, SWEAT SHIRTS, SWEAT PANTS, SWEAT SHORTS, CAPS, HATS, BERETS, HEAD BANDS, AND PONCHOS; OUTERWEAR IN ALL FABRICATIONS, NAMELY, CLOTH, DENIM, LEATHER AND SUEDE JACKETS, AND RAINWEAR (U.S. CLS. 22 AND 39).

FIRST USE 9-1-2001; IN COMMERCE 11-1-2001.

2,929,144. INCHWORM INC., BOSTON, MA. SN 76-198,639. PUB. 8-21-2001, FILED 1-23-2001.

**INCH WORM**

FOR CLOTHING, NAMELY, T-SHIRTS, SWEAT-SHIRTS, SWEATERS, JACKETS, VESTS, PANTS, SKIRTS, HATS, CAPS, VISORS, GLOVES AND SOCKS AND FOOTWEAR (U.S. CLS. 22 AND 39).

FIRST USE 5-0-2002; IN COMMERCE 5-0-2002.

**CLASS 25—(Continued).**

2,929,149. INCHWORM INC., BOSTON, MA. SN 76-203,442. PUB. 8-21-2001, FILED 2-1-2001.



FOR CLOTHING, NAMELY, T-SHIRTS, SWEAT-SHIRTS, SWEATERS, JACKETS, VESTS, PANTS, SKIRTS, HATS, CAPS, VISORS, GLOVES AND SOCKS AND FOOTWEAR (U.S. CLS. 22 AND 39).

FIRST USE 5-0-2002; IN COMMERCE 5-0-2002.

2,929,166. J. CREW INTERNATIONAL, INC., WILMINGTON, DE. SN 76-240,045. PUB. 10-2-2001, FILED 4-12-2001.

**CREWCUTS**

OWNER OF U.S. REG. NO. 1,949,288.  
FOR CHILDREN'S SHIRTS, SWEATERS, HATS, JACKETS (U.S. CLS. 22 AND 39).

FIRST USE 11-13-2004; IN COMMERCE 11-13-2004.

2,929,208. NANO-TEX, LLC, GREENSBORO, NC. SN 76-303,277. PUB. 7-23-2002, FILED 8-22-2001.



nano~tex

THE STIPPLING IS FOR SHADING PURPOSES ONLY AND A FEATURE OF THE MARK.

THE MARK CONSISTS OF FOUR ROUNDED RECTANGLES FORMING A DIAMOND SHAPE.

FOR FABRIC SOLD AS A COMPONENT OF CLOTHING, NAMELY SUITS, BLOUSES, SHIRTS, SKIRTS, PANTS, SHORTS, VESTS, COATS, JACKETS, BLAZERS, COVERALLS, UNIFORMS, ATHLETIC UNIFORMS, MILITARY UNIFORMS, LOUNGEWEAR, SWIMWEAR, ACTIVEWEAR, NAMELY TOPS, BOTTOMS, AND COORDINATED SETS OF TOPS AND BOTTOMS, APRONS AND GLOVES; CLOTHING, NAMELY SUITS, BLOUSES, SHIRTS, SKIRTS, PANTS, SHORTS, VESTS, COATS, JACKETS, BLAZERS, COVERALLS, UNIFORMS, ATHLETIC UNIFORMS, MILITARY UNIFORMS, LOUNGEWEAR, SWIMWEAR, ACTIVEWEAR, NAMELY TOPS, BOTTOMS, AND COORDINATED SETS OF TOPS AND BOTTOMS, APRONS AND GLOVES (U.S. CLS. 22 AND 39).

FIRST USE 4-30-2001; IN COMMERCE 4-30-2001.

**CLASS 25—(Continued).**

2,929,238. PURPLE PIN DESIGNS LIMITED, KWUN TONG, HONG KONG. SN 76-363,071. PUB. 6-25-2002, FILED S.R. 1-28-2002; AM. P.R. 5-10-2002.



FOR CLOTHING, NAMELY, TOPS, BOTTOMS, BANDANAS, BELTS, CAPS, HATS, JERSEYS, NECKTIES, OVERALLS, PANTS, JEANS, PETTICOATS, PULL-OVERS, PAJAMAS, SCARVES, SHIRTS, SKIRTS, CAPS, SOCKS, SPORTS JERSEYS, SUITS, SWEATERS, T-SHIRTS, TROUSERS, UNDERWEAR, VESTS, WAIST-COATS AND WRISTBANDS; OUTERWEAR, NAMELY, JACKETS, COATS, PARKAS; HEADWEAR AND OVERCOATS; AND FOOTWEAR (U.S. CLS. 22 AND 39).  
FIRST USE 12-0-2001; IN COMMERCE 12-31-2002.

2,929,250. CRL GROUP, LLC, LOS ANGELES, CA. SN 76-380,074. PUB. 4-15-2003, FILED 3-8-2002.

**VINCE**

FOR CLOTHING, NAMELY JACKETS, SWEATERS, VESTS, SWEAT SHIRTS, SWEAT PANTS, SHIRTS, BLOUSES, T-SHIRTS, PANTS, SHORTS, SKIRTS, SKORTS, DRESSES, SWIMWEAR, HATS AND SHOES (U.S. CLS. 22 AND 39).  
FIRST USE 6-25-2002; IN COMMERCE 6-25-2002.

2,929,251. WP PRODUCTIONS, INC., RAY CITY, GA. SN 76-381,343. PUB. 6-1-2004, FILED 3-12-2002.



NO CLAIM IS MADE TO THE EXCLUSIVE RIGHT TO USE "OUTFITTER", APART FROM THE MARK AS SHOWN.

FOR CLOTHING, NAMELY, T-SHIRTS, SWEAT SHIRTS, SWEAT SUITS, GOLF SHIRTS, DRESS SHIRTS, SPORT SHIRTS, HUNTING SHIRTS, FISHING SHIRTS, TANK TOPS, BLOUSES, COATS, JACKETS, WIND RESISTANT JACKETS AND SUITS, OVERCOATS, PARKAS, HUNTING VESTS, FISHING VESTS, SNOWSUITS, JEANS, DRESS PANTS, CASUAL PANTS, OVERALLS, COVERALLS, GLOVES, BOOTS, SHOES, SOCKS, SNEAKERS, HATS AND CAPS (U.S. CLS. 22 AND 39).  
FIRST USE 1-0-2000; IN COMMERCE 9-0-2003.

**CLASS 25—(Continued).**

2,929,307. RENA ENTERPRISES, INC., SINKING SPRING, PA. SN 76-465,967. PUB. 10-7-2003, FILED 11-1-2002.

**MEDALIST HUNTGEAR**

OWNER OF U.S. REG. NOS. 1,513,658, 1,869,708, AND OTHERS.

NO CLAIM IS MADE TO THE EXCLUSIVE RIGHT TO USE "HUNTGEAR", APART FROM THE MARK AS SHOWN.

FOR CLOTHING, NAMELY, TOPS, PANTS, SHORTS AND UNDERWEAR (U.S. CLS. 22 AND 39).  
FIRST USE 10-9-2002; IN COMMERCE 10-9-2002.

2,929,311. WAL-MART STORES, INC., BENTONVILLE, AR. SN 76-469,404. PUB. 8-19-2003, FILED 11-15-2002.

**KID CONNECTION**

NO CLAIM IS MADE TO THE EXCLUSIVE RIGHT TO USE "KID", APART FROM THE MARK AS SHOWN.

FOR CHILDREN'S CLOTHING, NAMELY DRESSES, SKIRTS, SWEATSUITS, AND JACKETS (U.S. CLS. 22 AND 39).

FIRST USE 12-0-2003; IN COMMERCE 12-0-2003.

2,929,358. GORDINI U.S.A. INC., ESSEX JUNCTION, VT. SN 76-498,031. PUB. 6-15-2004, FILED 3-10-2003.

**DA GOOSE**

NO CLAIM IS MADE TO THE EXCLUSIVE RIGHT TO USE "GOOSE", APART FROM THE MARK AS SHOWN.

FOR GLOVES, MITTENS, MEN'S, WOMEN'S AND CHILDREN'S CLOTHING, NAMELY, SHIRTS, PANTS, JACKETS, HATS, DRESSES, SOCKS, UNDERWEAR, WARM-UP SUITS, SWEATERS, SWEAT BANDS AND SKI BOOT BAGS (U.S. CLS. 22 AND 39).

FIRST USE 8-19-2003; IN COMMERCE 8-19-2003.

**CLASS 25—(Continued).**

2,929,363. GOVERN, STANLEY, POINT PLEASANT, NJ. SN 76-499,225. PUB. 3-23-2004, FILED 3-19-2003.



NO CLAIM IS MADE TO THE EXCLUSIVE RIGHT TO USE "EAST COAST", APART FROM THE MARK AS SHOWN.

FOR CLOTHING, NAMELY, T-SHIRTS (U.S. CLS. 22 AND 39).

FIRST USE 7-5-2004; IN COMMERCE 7-5-2004.

2,929,376. CRESCENT, INC., NIOTA, TN. SN 76-504,146. PUB. 12-2-2003, FILED 3-31-2003.

**CRESCENT**

OWNER OF U.S. REG. NO. 745,870.  
FOR MEN'S, WOMEN'S AND CHILDREN'S SOCKS, SLIPPER SOCKS, AND FOOTWEAR (U.S. CLS. 22 AND 39).

FIRST USE 6-30-2004; IN COMMERCE 6-30-2004.

2,929,378. CRESCENT, INC., NIOTA, TN. SN 76-505,094. PUB. 12-2-2003, FILED 4-2-2003.



FOR MEN'S, WOMEN'S AND CHILDREN'S SOCKS, SLIPPER SOCKS, AND FOOTWEAR (U.S. CLS. 22 AND 39).

FIRST USE 10-0-2003; IN COMMERCE 10-0-2003.

**CLASS 25—(Continued).**

2,929,409. DILLARD'S, INC., LITTLE ROCK, AR. SN 76-521,115. PUB. 5-25-2004, FILED 6-6-2003.

**Q.U.E**

FOR SLEEPWEAR, NAMELY; CAMISOLES, TEDDIES, NIGHTGOWNS, ROBES, SLEEPSHIRTS, SLEEPSHORTS, BOXERS, CHEMISE, AND TANK TOPS (U.S. CLS. 22 AND 39).

FIRST USE 1-0-2004; IN COMMERCE 1-0-2004.

2,929,411. REFLEX CORPORATION OF AMERICA INC., GARDNERVILLE, NV. SN 76-521,604. PUB. 2-24-2004, FILED 6-10-2003.

**AIRBOX**

FOR FOOTWEAR, NAMELY BOOTS AND SHOES (U.S. CLS. 22 AND 39).

FIRST USE 3-15-2004; IN COMMERCE 3-15-2004.

2,929,412. SPIKE'S HOLDING, LLC, INDIANAPOLIS, IN. SN 76-522,235. PUB. 2-17-2004, FILED 6-12-2003.

**FINL365**

FOR MEN'S, WOMEN'S AND CHILDREN'S CLOTHING, NAMELY, SWEATSHIRTS, T-SHIRTS, KNIT TOPS, SHIRTS, BLOUSES, WARM-UP SUITS, JACKETS, JERSEYS, SWEAT PANTS, PANTS, SHORTS, SKIRTS, DRESSES, RAINWEAR, VISORS, CAPS, SOCKS, AND FOOTWEAR (U.S. CLS. 22 AND 39).

FIRST USE 12-0-2003; IN COMMERCE 12-0-2003.

2,929,421. E.S. ORIGINALS, INC., NEW YORK, NY. SN 76-524,967. PUB. 2-10-2004, FILED 6-23-2003.

**2+2**

FOR FOOTWEAR (U.S. CLS. 22 AND 39).  
FIRST USE 6-1-2004; IN COMMERCE 6-1-2004.

2,929,436. MUNRO & COMPANY, INC., HOT SPRINGS, AR. SN 76-527,934. PUB. 4-20-2004, FILED 7-7-2003.

**COMFORT COMMAND**

NO CLAIM IS MADE TO THE EXCLUSIVE RIGHT TO USE "COMFORT", APART FROM THE MARK AS SHOWN.  
FOR MEN'S, WOMEN'S AND CHILDREN'S FOOTWEAR (U.S. CLS. 22 AND 39).

FIRST USE 11-0-2003; IN COMMERCE 11-0-2003.

**CLASS 25—(Continued).**

2,929,438. WHITE, STEPHEN A., SOMERS POINT, NJ. SN 76-529,355. PUB. 3-23-2004, FILED 7-14-2003.

**SAFE TEE**

FOR MEN'S, WOMEN'S AND CHILDREN'S CLOTHING, NAMELY, SHIRTS (U.S. CLS. 22 AND 39).  
FIRST USE 9-13-2004; IN COMMERCE 9-13-2004.

2,929,443. LUCIANO, STEVE, LOS ANGELES, CA. AND LEO, NICK, LOS ANGELES, CA. AND ROSSI, PAUL, LOS ANGELES, CA. SN 76-530,297. PUB. 3-23-2004, FILED 7-7-2003.

**WASTED YOUTH**

FOR CLOTHING, NAMELY, SHIRTS, T-SHIRTS, SWEAT SHIRTS, TANK TOPS, JACKETS, WIND RESISTANT JACKETS, PANTS, SHORTS, HATS, BEANIES (U.S. CLS. 22 AND 39).  
FIRST USE 12-20-2003; IN COMMERCE 12-20-2003.

2,929,503. BRONER GLOVE COMPANY, AUBURN HILLS, MI. SN 76-557,693. PUB. 8-24-2004, FILED 11-5-2003.

**WEAR IT!**

FOR CLOTHING AND HEADGEAR, NAMELY, BANDANAS, BELTS, BOOTS, BRIEFS, HATS, CAPS, HEADWEAR, COATS, JACKETS, GLOVES, MITTENS, HOODS, JERSEYS, MUFFLERS, SHORTS, SHIRTS, PULLOVERS, SHOES, PANTS, TOPS, WRAPS, SCARVES, SOCKS, SUSPENDERS, SWEAT BANDS, UNDERGARMENTS, FOUL WEATHER GEAR, RAINWEAR, OVERALLS, OVERSHOES, COVERALLS, LAB COATS, APRONS, SMOCKS, LAB SHOE COVERS, AND CLOTH BIBS (U.S. CLS. 22 AND 39).  
FIRST USE 8-1-2004; IN COMMERCE 8-1-2004.

**CLASS 25—(Continued).**

2,929,509. UPPER ROOM, THE, NASHVILLE, TN. SN 76-976,759. PUB. 7-30-2002, FILED 3-7-2001.

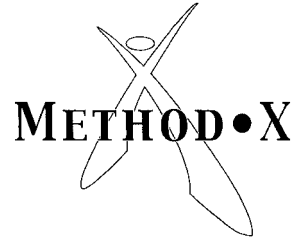

FOR CLOTHING, NAMELY, T-SHIRTS, SWEATSHIRTS, SCARVES, AND CAPS (U.S. CLS. 22 AND 39).  
FIRST USE 10-0-2000; IN COMMERCE 10-0-2000.

2,929,511. SWAN ENTERPRISES, INC., RENO, NV. SN 76-977,060. PUB. 5-28-2002, FILED 12-12-2001.

**DR. SHADE**

FOR CLOTHING, NAMELY, HANDWEAR, NAMELY, GLOVES, HEADWEAR, NAMELY, HATS, CAPS; TEXTILE SHADES FOR HEADWEAR (U.S. CLS. 22 AND 39).  
FIRST USE 12-0-2003; IN COMMERCE 12-0-2003.

2,929,526. WANG, FENGYING, BALTIMORE, MD. SN 78-019,572. PUB. 9-11-2001, FILED 8-3-2000.

**RICHBOSS**

THE MARK CONSISTS OF STANDARD CHARACTERS WITHOUT CLAIM TO ANY PARTICULAR FONT, STYLE, SIZE, OR COLOR.

FOR MEN'S CLOTHING, NAMELY, SHIRTS, SUITS, PANTS, TIES, JACKETS, COATS, SWEATERS, VESTS, T-SHIRTS, BELTS, SHORTS, SHOES, SOCKS, UNDERWEAR, SCARVES, GLOVES AND HATS (U.S. CLS. 22 AND 39).

FIRST USE 4-22-2004; IN COMMERCE 4-22-2004.

2,929,560. SARA LEE CORPORATION, WINSTON-SALEM, NC. SN 78-105,713. PUB. 8-27-2002, FILED 1-30-2002.

**HANES SPORT**

OWNER OF U.S. REG. NO. 2,468,157.  
NO CLAIM IS MADE TO THE EXCLUSIVE RIGHT TO USE "SPORT", APART FROM THE MARK AS SHOWN.  
FOR FOOTWEAR, NAMELY ATHLETIC SHOES, CASUAL SHOES, SANDALS (U.S. CLS. 22 AND 39).  
FIRST USE 7-31-1998; IN COMMERCE 7-31-1998.

**CLASS 25—(Continued).**

2,929,564. ALTABET, JORDAN A., SAN DIEGO, CA. SN 78-110,326. PUB. 9-17-2002, FILED 2-21-2002.

**HEAD BOXER**

FOR CLOTHING FOR MEN, WOMEN, CHILDREN AND INFANTS, NAMELY, HATS, HEAD BANDS, CAPS, HEADWEAR, BOXER, UNDERWEAR (U.S. CLS. 22 AND 39).

FIRST USE 10-2-2004; IN COMMERCE 11-6-2004.

2,929,584. SHORTER, DEANDRE BERNARD, WATER'S EDGE DRIVE, GA. SN 78-136,072. PUB. 1-13-2004, FILED 6-15-2002.



NO CLAIM IS MADE TO THE EXCLUSIVE RIGHT TO USE "CLOTHING COMPANY", APART FROM THE MARK AS SHOWN.

THE NAME SHOWN IN THE MARK DOES NOT IDENTIFY A LIVING INDIVIDUAL.

SEC. 2(F).  
FOR T-SHIRTS; JEANS; JACKETS; SWEAT PANTS; SWEAT SHIRTS; SWEAT SHORTS; SWEAT SUITS (U.S. CLS. 22 AND 39).

FIRST USE 1-1-2003; IN COMMERCE 1-1-2003.

2,929,589. CHARLOTTE DESIGN GROUP, INC., CONCORD, NC. SN 78-141,804. PUB. 2-11-2003, FILED 7-8-2002.

**LIVE & BREATHE**

FOR WEARING APPAREL, NAMELY, T-SHIRTS, SWEATSHIRTS, TANK TOPS, CAPS, SHORTS, AND ATHLETIC JERSEYS (U.S. CLS. 22 AND 39).

FIRST USE 12-9-2003; IN COMMERCE 1-7-2004.

**CLASS 25—(Continued).**

2,929,592. LEFT FIELD NYC, INC., BROOKLYN, NY. SN 78-145,725. PUB. 4-13-2004, FILED 7-19-2002.



NO CLAIM IS MADE TO THE EXCLUSIVE RIGHT TO USE MADE IN NYC USA, APART FROM THE MARK AS SHOWN.

FOR JEANS, JACKETS, SHIRTS, AND SKIRTS (U.S. CLS. 22 AND 39).

FIRST USE 9-1-2002; IN COMMERCE 9-1-2002.

2,929,609. ZOO YORK, LLC, SOUTH RIVER, NJ. SN 78-162,470. PUB. 2-10-2004, FILED 9-10-2002.

**ZOO YORK**

OWNER OF U.S. REG. NO. 1,927,011.

FOR CLOTHING, NAMELY, SPORTS PANTS, KNIT SHIRTS, SHIRTS, POLO SHIRTS, TANK TOPS, SLACKS, OVERALLS, CARGO PANTS, JEANS, SHORTS, UNDERWEAR, SOCKS, SWIMWEAR, COATS, PARKAS, PULL-OVERS, SWEATERS, VESTS, NIGHTWEAR, SWIMWEAR, RAINWEAR, HEADWEAR AND FOOTWEAR (U.S. CLS. 22 AND 39).

FIRST USE 0-0-2001; IN COMMERCE 0-0-2001.

2,929,646. S & R PRODUCTS, LLC, DBA SUMMIT SPORTSWEAR, FOUNTAIN VALLEY, CA. SN 78-188,747. PUB. 9-2-2003, FILED 11-25-2002.

**REVEALED**

FOR CLOTHING, HEADWEAR AND FOOTWEAR (U.S. CLS. 22 AND 39).

FIRST USE 11-19-2004; IN COMMERCE 11-19-2004.

2,929,684. DEER STAGS, INC., NEW YORK, NY. SN 78-211,130. PUB. 12-30-2003, FILED 2-5-2003.

**COMFORT ON DEMAND**

FOR CLOTHING, NAMELY, MEN'S AND WOMEN'S SHOES (U.S. CLS. 22 AND 39).

FIRST USE 4-10-2003; IN COMMERCE 4-10-2003.

**CLASS 25—(Continued).**

2,929,720. SYRACUSE UNIVERSITY, SYRACUSE, NY. SN 78-237,493. PUB. 1-13-2004, FILED 4-14-2003.

## REAL CHAMPIONS WEAR ORANGE

OWNER OF U.S. REG. NOS. 2,268,371, 2,463,628, AND OTHERS.

FOR SHIRTS; T-SHIRTS; JERSEYS; TANK TOPS; SWEAT SHIRTS; SPORT SHIRTS; GOLF SHIRTS; NIGHT SHIRTS; JACKETS; COATS; PARKAS; SWEATERS; PANTS; SHORTS; SWEAT PANTS; SCARVES; HEADWEAR; HEAD BANDS; SWEAT BANDS; CAPS; HATS; BOXER SHORTS; BANDANNAS (U.S. CLS. 22 AND 39).  
FIRST USE 5-0-2003; IN COMMERCE 6-0-2003.

2,929,755. GOMI USA, LLC, ALEXANDRIA, VA. SN 78-256,040. PUB. 1-27-2004, FILED 5-29-2003.

## GOMI

FOR CLOTHING, NAMELY, SHIRTS, T-SHIRTS, JACKETS, HATS, SWEATSHIRTS, APRONS (U.S. CLS. 22 AND 39).

FIRST USE 6-2-2003; IN COMMERCE 6-2-2003.

2,929,759. TV ONE, LLC, SILVER SPRING, MD. SN 78-257,301. PUB. 2-24-2004, FILED 6-2-2003.

## TV ONE

FOR CLOTHING, NAMELY, T-SHIRTS, POLO SHIRTS, SPORTS SHIRTS, GOLF SHIRTS, ATHLETIC JERSEYS, SWEATSHIRTS, HATS, SHORTS, BANDANAS, BATHING SUITS, BATHROBES, BEACHWEAR, BELTS, JACKETS, COATS, SOCKS, FOOTWEAR, SWEATERS, DRESSES, GYM SHORTS, EAR MUFFS, NECKWEAR, PAJAMAS, PANTS, SKIWEAR, SLACKS, SUN VISORS, BASEBALL CAPS, CAPS, SUSPENDERS, TURTLENECKS, UNDERCLOTHES, VESTS, WARM-UP SUITS, HEADWEAR, GLOVES, COSTUMES (U.S. CLS. 22 AND 39).

FIRST USE 10-0-2003; IN COMMERCE 10-0-2003.

2,929,793. VIACOM INTERNATIONAL INC., NEW YORK, NY. SN 78-275,699. PUB. 4-20-2004, FILED 7-17-2003.

## SCOPE OUT WHO YOU ARE!

FOR BATHING SUITS, BATHROBES, BEACHWEAR, CLOTHING BELTS, SHORTS, JACKETS, COATS, SOCKS, FOOTWEAR, BANDANAS, SWEATERS, HALLOWEEN COSTUMES, DRESSES, GLOVES, GYM SHORTS, EAR MUFFS, NECKWEAR, PAJAMAS, PANTS, SHIRTS, SWEAT SHIRTS, SKI WEAR, SLACKS, SUN VISORS, SUSPENDERS, TURTLENECKS, UNDERCLOTHES, VESTS, WARM-UP SUITS, HEADWEAR (U.S. CLS. 22 AND 39).

FIRST USE 7-19-2004; IN COMMERCE 7-19-2004.

**CLASS 25—(Continued).**

2,929,796. MARKS, NEAL, TRENTON, GA. SN 78-277,843. PUB. 4-27-2004, FILED 7-23-2003.

## ALWAYS LEADING YOU IN THE RIGHT DIRECTION

FOR CLOTHING, NAMELY, INFANT UNDERWEAR, CREEPERS, T-SHIRTS, SWEATSHIRTS, JOGGING SUITS, SHIRTS, SOCKS, HOSIERY, SLIPPERS, OVERALLS AND CAPS (U.S. CLS. 22 AND 39).

FIRST USE 9-3-2003; IN COMMERCE 9-3-2003.

2,929,806. SK8MAFIA, SAN DIEGO, CA. SN 78-282,158. PUB. 5-18-2004, FILED 8-1-2003.

## SK8MAFIA

FOR APPAREL NAMELY, SOCKS, BEANIES, HATS, JACKETS, T-SHIRTS, SWEATERS, SWEATSHIRTS, SWEATBANDS, UNDERWEAR, BOXERS, PANTIES, PANTS, JEANS, SHORTS, HEADBANDS, WRISTBANDS, COLLARED SHIRTS, GLOVES (U.S. CLS. 22 AND 39).

FIRST USE 12-1-1999; IN COMMERCE 6-18-2001.

2,929,811. LEWIS, DOUGLAS J, ST. LOUIS, MO. SN 78-285,747. PUB. 6-1-2004, FILED 8-11-2003.

## SECOND PLACE IS THE FIRST LOSER

FOR CLOTHING, NAMELY - T-SHIRTS, SWEATSHIRTS, CAPS, AND JERSEYS (U.S. CLS. 22 AND 39).

FIRST USE 7-10-2003; IN COMMERCE 7-10-2003.

2,929,818. KNIPP, GREGORY, D/DONALD, LEE'S SUMMIT, MO. AND KNIPP, ELIZABETH, D/DELACY, LEE'S SUMMIT, MO. SN 78-287,804. PUB. 5-25-2004, FILED 8-15-2003.

## DILEMMUS

FOR CLOTHING, NAMELY, SHIRTS, T-SHIRTS, SWEATSHIRTS, ATHLETIC SHIRTS, JACKETS, SHORTS, SWEATS, OVERALLS, BALL CAPS, HATS, HEADBANDS, WRISTBANDS (U.S. CLS. 22 AND 39).

FIRST USE 9-1-2004; IN COMMERCE 10-15-2004.

2,929,843. QVC, INC., WEST CHESTER, PA. SN 78-305,236. PUB. 7-27-2004, FILED 9-25-2003.

## ABOUTFACE

FOR APPAREL, NAMELY, SKIRTS, SWEATERS, PANTS, DRESSES, CARDIGANS AND TUNICS (U.S. CLS. 22 AND 39).

FIRST USE 3-3-2004; IN COMMERCE 3-3-2004.

**CLASS 25—(Continued).**

2,929,858. RAYNES, BARBARA J., RENTON, WA. SN 78-311,449. PUB. 6-22-2004, FILED 10-9-2003.

**NIGHTEASE**

FOR SLEEPWEAR (U.S. CLS. 22 AND 39).  
FIRST USE 2-15-2004; IN COMMERCE 2-15-2004.

2,929,871. MG OVERSEAS LTD, KOWLOON, HONG KONG.  
SN 78-322,695. PUB. 7-13-2004, FILED 11-4-2003.

**GAS**

THE MARK CONSISTS OF STANDARD CHARACTERS WITHOUT CLAIM TO ANY PARTICULAR FONT, STYLE, SIZE, OR COLOR.

OWNER OF U.S. REG. NO. 1,552,947.  
FOR MEN'S JEANS, JACKETS, SHIRTS, SHORTS, VESTS AND SWEATERS (U.S. CLS. 22 AND 39).  
FIRST USE 5-19-2004; IN COMMERCE 5-19-2004.

2,929,891. NAN YANG FABRIC CO., LTD., PETCHABURI PROVINCE 76140, THAILAND. SN 78-975,669. PUB. 2-17-2004, FILED 3-13-2003.

**Zorrel**

FOR SHIRTS (U.S. CLS. 22 AND 39).  
FIRST USE 5-15-2004; IN COMMERCE 8-1-2004.

**CLASS 26—FANCY GOODS****CLASS 26—(Continued).**

2,929,104. GENERAL WIG MANUFACTURERS, INC., MIAMI LAKES, FL. SN 76-086,626. PUB. 4-3-2001, FILED 7-11-2000.

**TRESSALLURE**

FOR WIGS AND HAIRPIECES (U.S. CLS. 37, 39, 40, 42 AND 50).  
FIRST USE 2-0-2001; IN COMMERCE 2-0-2001.

2,929,225. WINGET CYC INDUSTRIAL LIMITED, KWAI CHUNG, N.T., HONG KONG. SN 76-338,591. PUB. 3-18-2003, FILED 11-19-2001.

**CYC**

FOR LACE FOR EDGINGS, NAMELY, LACE TRIMMING; ZIPPERS, EMBROIDERY, BELT CLASPS, AND RIBBONS; PINS, NAMELY, SAFETY PINS; FASTENINGS FOR CLOTHING, NAMELY, CLOTHING HOOKS; EDGINGS FOR CLOTHING, NAMELY, LACE TRIMMING; BUTTONS FOR CLOTHING; AND TRIMMINGS FOR CLOTHING, NAMELY, EMBROIDERED PATCHES FOR CLOTHING (U.S. CLS. 37, 39, 40, 42 AND 50).  
FIRST USE 5-0-2002; IN COMMERCE 5-0-2002.

2,929,717. ELASTIC CORPORATION OF AMERICA, INC., COLUMBIANA, AL. SN 78-235,841. PUB. 4-6-2004, FILED 4-9-2003.

**COLOR QUIK**

NO CLAIM IS MADE TO THE EXCLUSIVE RIGHT TO USE "COLOR", APART FROM THE MARK AS SHOWN.  
FOR NARROW ELASTIC WEBS TO BE USED IN THE FURTHER MANUFACTURE OF CLOTHING (U.S. CLS. 37, 39, 40, 42 AND 50).  
FIRST USE 1-29-2004; IN COMMERCE 1-29-2004.

**CLASS 27—FLOOR COVERINGS**

2,929,300. AUTOMOTIVE COMPONENTS LIMITED, MELBOURNE, 3000, VIC, AUSTRALIA. SN 76-458,369. PUB. 4-13-2004, FILED 10-7-2002.

**COMCORK WALK EASY**

FOR FLOOR COVERINGS AND MATS OF CORK AND CORK RUBBER; FLOORING OF RUBBER BONDED SHEET MATERIAL (U.S. CLS. 19, 20, 37, 42 AND 50).  
FIRST USE 7-8-1985; IN COMMERCE 7-8-1985.



**CLASS 27—(Continued).**

2,929,480. MANNINGTON CARPETS, INC., CALHOUN, GA.  
SN 76-545,803. PUB. 5-11-2004, FILED 9-23-2003.

**ARTCRAFT**

FOR CARPET (U.S. CLS. 19, 20, 37, 42 AND 50).  
FIRST USE 11-1-2003; IN COMMERCE 11-1-2003.

---

2,929,742. MAPLES INDUSTRIES, INC., SCOTTSBORO, AL.  
SN 78-248,561. PUB. 7-6-2004, FILED 5-12-2003.

**FLOOR DIMENSIONS**

NO CLAIM IS MADE TO THE EXCLUSIVE RIGHT TO  
USE "FLOOR", APART FROM THE MARK AS SHOWN.  
FOR RUGS (U.S. CLS. 19, 20, 37, 42 AND 50).  
FIRST USE 5-0-2004; IN COMMERCE 5-0-2004.

---

**CLASS 28—TOYS AND SPORTING GOODS**

2,929,083. FONG, PETER SUI LUN, MONTEREY PARK, CA.  
SN 75-938,225. PUB. 3-16-2004, FILED 3-8-2000.

**HOLIDAY ANIMATRONIX**

FOR ELECTRONIC ACTION TOYS (U.S. CLS. 22, 23, 38  
AND 50).  
FIRST USE 8-23-2004; IN COMMERCE 8-23-2004.

---

2,929,084. ZHOU, TAO, HANGZHOU, ZHEJIANG, CHINA.  
SN 75-960,047. PUB. 7-27-2004, FILED 3-14-2000.

**My Doll**

FOR SOFT TOYS, DOLLS, DOLL CLOTHING AND  
DOLL ACCESSORIES, TOY FURNITURE, NAMELY,  
BED, CHAIR, CHEST, CHIFFOROB, TABLE, WARD-  
ROBE, AND VANITY (U.S. CLS. 22, 23, 38 AND 50).  
FIRST USE 8-31-1996; IN COMMERCE 8-31-1996.

**CLASS 28—(Continued).**

2,929,133. ACADEMY, LTD., KATY, TX. SN 76-178,065. PUB.  
11-26-2002, FILED 12-8-2000.

**ROLLIN' ON**

FOR ELBOW, KNEE, AND WRIST PADS, SKATING  
GLOVES, TOY SCOOTER BAGS, TOY SCOOTER  
HORNS, AND WHEELY BARS, NAMELY, ATTACH-  
MENTS PLACED ON THE END OF MANUAL SCOO-  
TERS WHICH ASSIST THE USER IN COMPLETING  
WHEELY TRICKS (U.S. CLS. 22, 23, 38 AND 50).  
FIRST USE 3-4-1999; IN COMMERCE 3-4-1999.

---

2,929,142. RELIANT ENERGY, INC., HOUSTON, TX. SN 76-  
195,448. PUB. 5-28-2002, FILED 1-17-2001.

**RELIANT STADIUM**

FOR TOYS, NAMELY, ACTION FIGURES, BAL-  
LOONS, PROMOTIONAL GAME MATERIALS; SPORT-  
ING GOODS, NAMELY, FOOTBALLS AND SPORTS  
BALLS (U.S. CLS. 22, 23, 38 AND 50).  
FIRST USE 8-0-2002; IN COMMERCE 8-0-2002.

---

2,929,164. DISNEY ENTERPRISES, INC., BURBANK, CA. SN  
76-237,056. PUB. 5-21-2002, FILED 4-6-2001.

**KIM POSSIBLE**

FOR ACTION FIGURES AND ACCESSORIES; PLUSH  
TOYS; BOARD GAMES; DOLLS AND JIGSAW PUZZLES  
(U.S. CLS. 22, 23, 38 AND 50).  
FIRST USE 7-31-2003; IN COMMERCE 7-31-2003.

---

2,929,175. KONAMI CORPORATION, CHIYODA-KU, TO-  
KYO, JAPAN. SN 76-252,601. PUB. 9-18-2001, FILED 5-4-  
2001.

**GATE GUARDIAN**

FOR STAND-ALONE VIDEO GAME MACHINES;  
HAND-HELD UNITS FOR PLAYING ELECTRONIC  
GAMES; BOARD GAMES AND INSTRUCTIONAL MAN-  
UALS SOLD AS A UNIT THEREWITH; CARD GAMES;  
DICE; PROMOTIONAL GAME MATERIALS; GAME  
EQUIPMENT, NAMELY, CHIPS; TOYS, NAMELY, AC-  
TION FIGURES, DOLLS AND PLAYSETS THEREFOR  
(U.S. CLS. 22, 23, 38 AND 50).  
FIRST USE 11-0-2002; IN COMMERCE 11-0-2002.

**CLASS 28—(Continued).**

2,929,209. VICEISZA, FIORELLA L. G., ATLANTA, GA. SN 76-305,112. PUB. 11-5-2002, FILED 8-24-2001.

**EASY PLAY**

FOR BALL PITCHING MACHINES; BASEBALLS; BASEBALL BASES; BASEBALL BATS; BASEBALL BATING GLOVES; BASEBALL BATING TEES; BASEBALL GLOVES; BASEBALL MITTS; SOFTBALL BATS; CATCHER'S MASKS; AND CHEST PROTECTORS FOR SPORTS (U.S. CLS. 22, 23, 38 AND 50).  
FIRST USE 2-0-2002; IN COMMERCE 2-0-2002.

2,929,211. HYPERFLITE, INC., ATLANTA, GA. SN 76-313,070. PUB. 12-30-2003, FILED 9-14-2001.

**ONE DISC**

NO CLAIM IS MADE TO THE EXCLUSIVE RIGHT TO USE "DISC", APART FROM THE MARK AS SHOWN.  
FOR FLYING DISCS (U.S. CLS. 22, 23, 38 AND 50).  
FIRST USE 9-14-2001; IN COMMERCE 9-14-2001.

2,929,214. KONAMI CORPORATION, MINATO-KU, TOKYO, JAPAN. SN 76-319,857. PUB. 5-13-2003, FILED 10-1-2001.

**BLADE OF HONOR**

OWNER OF U.S. REG. NOS. 1,480,912 AND 2,409,360.  
FOR ARCADE GAMES; STAND-ALONE VIDEO GAME MACHINES; HAND-HELD UNITS FOR PLAYING ELECTRONIC GAMES; BOARD GAMES AND INSTRUCTION MANUALS SOLD AS A UNIT THEREWITH; CARD GAMES; DICE; PROMOTIONAL GAME MATERIALS; GAME EQUIPMENT, NAMELY, CHIPS; TOYS, NAMELY ACTION FIGURES; DOLLS AND PLAYSETS THEREFOR (U.S. CLS. 22, 23, 38 AND 50).  
FIRST USE 4-9-2004; IN COMMERCE 4-9-2004.

2,929,223. DATESTONE ASSOCIATES, DBA GAMEGIRLS, NEW HOPE, PA. SN 76-335,685. PUB. 7-16-2002, FILED 11-8-2001.

**DIVIDE & CONQUER**

FOR EDUCATIONAL CARD GAMES (U.S. CLS. 22, 23, 38 AND 50).  
FIRST USE 9-23-2004; IN COMMERCE 9-23-2004.

2,929,233. PROCAPS ENCAPSULATION INC., QUEBEC, CANADA. SN 76-351,500. PUB. 2-10-2004, FILED 12-21-2001.

**HELLFIRE**

FOR PAINTBALLS (U.S. CLS. 22, 23, 38 AND 50).  
FIRST USE 1-0-1999; IN COMMERCE 1-0-1999.

**CLASS 28—(Continued).**

2,929,234. PROCAPS ENCAPSULATION INC., QUEBEC, CANADA. SN 76-351,501. PUB. 1-14-2003, FILED 12-21-2001.

**INFERNO**

FOR PAINTBALLS (U.S. CLS. 22, 23, 38 AND 50).  
FIRST USE 1-0-1999; IN COMMERCE 1-0-1999.

2,929,235. PROCAPS ENCAPSULATION INC., QUEBEC, CANADA. SN 76-351,502. PUB. 1-14-2003, FILED 12-21-2001.

**BLAZE**

FOR PAINTBALLS (U.S. CLS. 22, 23, 38 AND 50).  
FIRST USE 1-0-1999; IN COMMERCE 1-0-1999.

2,929,236. PROCAPS ENCAPSULATION INC., QUEBEC, CANADA. SN 76-351,503. PUB. 1-14-2003, FILED 12-21-2001.

**MIDNIGHT**

FOR PAINTBALLS (U.S. CLS. 22, 23, 38 AND 50).  
FIRST USE 1-0-1999; IN COMMERCE 1-0-1999.

2,929,249. UNISEN, INC., DBA STAR TRAC, IRVINE, CA. SN 76-378,320. PUB. 12-31-2002, FILED 3-4-2002.

**IPULSE**

FOR EXERCISE MACHINES AND EQUIPMENT, NAMELY, STATIONARY EXERCISE BICYCLES, AND TREADMILLS WITH A HEART RATE DETECTION, MONITORING AND DISPLAY SYSTEM, AND PARTS THEREFOR (U.S. CLS. 22, 23, 38 AND 50).  
FIRST USE 3-31-2002; IN COMMERCE 3-31-2002.

2,929,306. HARKRIDER, KENT, CARTHAGE, TX. SN 76-465,947. PUB. 8-19-2003, FILED 11-12-2002.

**Sea Window PSC**

THE MARK CONSISTS OF SEA WINDOW PSC. SEC. 2(F).  
FOR INFLATABLE SWIM FLOATS FOR RECREATIONAL USE WITH UNDERWATER VIEWING AREAS (U.S. CLS. 22, 23, 38 AND 50).  
FIRST USE 9-5-1998; IN COMMERCE 10-8-2003.

**CLASS 28—(Continued).**

2,929,315. SPIN MASTER LTD, TORONTO, ONTARIO M5V 1B6, CANADA. SN 76-471,941. PUB. 1-13-2004, FILED 11-26-2002.

**STROBE F/X**

NO CLAIM IS MADE TO THE EXCLUSIVE RIGHT TO USE "STROBE", APART FROM THE MARK AS SHOWN. FOR TOY WAND FEATURING LIGHT THAT FLASHES DIFFERENT COLORS (U.S. CLS. 22, 23, 38 AND 50).

FIRST USE 2-0-2003; IN COMMERCE 2-0-2003.

2,929,348. BRYCE-N-TOYS, INC., CORNELIUS, NC. SN 76-494,563. PUB. 10-21-2003, FILED 3-4-2003.

**BRYCE-N-TOYS**

FOR SPORTS-RELATED MOBILES FOR INFANTS AND TODDLERS (U.S. CLS. 22, 23, 38 AND 50). FIRST USE 10-15-2003; IN COMMERCE 10-15-2003.

2,929,434. K & M INTERNATIONAL, INC., TWINSBURG, OH. SN 76-527,770. PUB. 3-16-2004, FILED 7-8-2003.

**MAGNAMORPHS**

FOR TOYS, NAMELY PLASTIC ANIMAL TOY FIGURES WITH INTERCHANGEABLE PARTS (U.S. CLS. 22, 23, 38 AND 50).

FIRST USE 9-4-2003; IN COMMERCE 9-4-2003.

2,929,472. M. R. CORKUM ENTERPRISES, INC., SALISBURY, MA. SN 76-542,427. PUB. 4-13-2004, FILED 9-5-2003.

**REVOTARG**

FOR EQUIPMENT, SOLD AS A UNIT, FOR PLAYING AN INDOOR AND OUTDOOR ACTION TYPE TARGET GAME (U.S. CLS. 22, 23, 38 AND 50).

FIRST USE 9-8-2004; IN COMMERCE 9-8-2004.

2,929,477. KID'S CREATIONS, L.L.C., SPRINGHILL, KS. SN 76-544,792. PUB. 6-8-2004, FILED 9-15-2003.

**KID'S CREATIONS**

FOR PLAYGROUND EQUIPMENT; NAMELY, PLAY STRUCTURES COMPRISED OF CLIMBING UNITS, PLATFORMS, SAND BOXES, SWINGSETS, JUNGLE GYMS, PLAYHOUSES, GYMNASISTICS APPARATUS AND SLIDES (U.S. CLS. 22, 23, 38 AND 50).

FIRST USE 3-1-2004; IN COMMERCE 3-1-2004.

**CLASS 28—(Continued).**

2,929,494. UNIQUE INDUSTRIES, INC., PHILADELPHIA, PA. SN 76-554,535. PUB. 6-22-2004, FILED 10-27-2003.

**PEARL RIBBON**

FOR TOYS; NAMELY BUBBLE MAKING WAND AND SOLUTION SET (U.S. CLS. 22, 23, 38 AND 50). FIRST USE 2-24-2004; IN COMMERCE 2-24-2004.

2,929,576. MATTEL, INC., EL SEGUNDO, CA. SN 78-128,192. PUB. 3-23-2004, FILED 5-13-2002.

**VAKKOR**

FOR TOYS, GAMES AND PLAYTHINGS, NAMELY, TOY VEHICLES THAT TRANSFORM INTO ROBOTIC FIGURES AND ACCESSORIES THEREFOR (U.S. CLS. 22, 23, 38 AND 50).

FIRST USE 1-31-2003; IN COMMERCE 1-31-2003.

2,929,601. HOLYBEARS, INC., HOUSTON, TX. SN 78-153,004. PUB. 8-19-2003, FILED 8-9-2002.

**GIFTS WITH MEANING**

NO CLAIM IS MADE TO THE EXCLUSIVE RIGHT TO USE "GIFTS", APART FROM THE MARK AS SHOWN. FOR PLUSH TOYS (U.S. CLS. 22, 23, 38 AND 50). FIRST USE 8-1-2004; IN COMMERCE 8-1-2004.

2,929,607. EXPECTATIONS, LLC, PUYALLUP, WA. SN 78-161,194. PUB. 12-9-2003, FILED 9-5-2002.



NO CLAIM IS MADE TO THE EXCLUSIVE RIGHT TO USE "PORTABLE BACK STRETCHER", APART FROM THE MARK AS SHOWN.

FOR EXERCISE EQUIPMENT, NAMELY PORTABLE STRETCHING EQUIPMENT (U.S. CLS. 22, 23, 38 AND 50).

FIRST USE 10-18-2003; IN COMMERCE 10-18-2003.

**CLASS 28—(Continued).**

2,929,653. CARTOON NETWORK LP, LLLP, THE, ATLANTA, GA. SN 78-194,998. PUB. 4-6-2004, FILED 12-16-2002.

## AQUA TEEN HUNGER FORCE

FOR TOYS, SPORTING GOODS, GAMES AND PLAYTHINGS, NAMELY ACTION FIGURES AND ACCESSORIES THEREFOR, PLUSH TOYS, BALLOONS, BATHTUB TOYS, RIDE-ON TOYS, EQUIPMENT SOLD AS A UNIT FOR PLAYING CARD GAMES, TOY VEHICLES, DOLLS, FLYING DISCS, HAND HELD UNIT FOR PLAYING ELECTRONIC GAMES, GAME EQUIPMENT SOLD AS A UNIT FOR PLAYING A BOARD GAME, CARD GAMES, MANIPULATIVE GAMES, PARLOR GAMES, ACTION TYPE TARGET GAMES, STAND ALONE VIDEO OUTPUT GAME MACHINES, JIGSAW AND MANIPULATIVE PUZZLES, PAPER FACE MASKS, SKATEBOARDS, ICE SKATES, WATER SQUIRTING TOYS, BALLS, NAMELY, PLAYGROUND BALLS, SOCCERBALLS, BASEBALLS, BASKETBALLS, BASEBALL GLOVES, SWIMMING FLOATS FOR RECREATIONAL USE, KICK BOARD FLOTATION DEVICES FOR RECREATIONAL USE, SURFBOARDS, SWIM BOARDS FOR RECREATIONAL USE, SWIM FINS, TOY BAKEWARE, TOY COOKWARE, TOY BANKS, AND CHRISTMAS TREE ORNAMENTS (U.S. CLS. 22, 23, 38 AND 50).  
FIRST USE 9-1-2003; IN COMMERCE 9-1-2003.

2,929,681. A. DAIGGER AND COMPANY, INC., VERNON HILLS, IL. SN 78-210,138. PUB. 9-23-2003, FILED 2-3-2003.

## CENTER STAGE

FOR MANIPULATIVES AND BOOKS, SOLD TOGETHER AS A UNIT FOR TEACHING READING AND MATHEMATICS (U.S. CLS. 22, 23, 38 AND 50).  
FIRST USE 4-26-2004; IN COMMERCE 4-26-2004.

2,929,687. MANDESE, TIM, BRANDON, FL. AND JACKSON, JOHN, TEMPLE TERRACE, FL. SN 78-213,701. PUB. 9-23-2003, FILED 2-12-2003.



FOR BOARD GAMES, CONSISTING OF A GAME BOARD, GAME PIECES AND INSTRUCTIONS, SOLD AS A UNIT (U.S. CLS. 22, 23, 38 AND 50).  
FIRST USE 10-0-2004; IN COMMERCE 10-0-2004.

**CLASS 28—(Continued).**

2,929,715. LOADED BOARDS, INC., BEVERLY HILLS, CA. SN 78-235,335. PUB. 5-4-2004, FILED 4-8-2003.

## LOADED CARVING SYSTEMS

NO CLAIM IS MADE TO THE EXCLUSIVE RIGHT TO USE CARVING SYSTEMS, APART FROM THE MARK AS SHOWN.

FOR SPORTING GOODS, NAMELY, SKATEBOARDS AND SNOW BOARDS; SPORTING GOODS, NAMELY, SURFBOARDS AND WAKEBOARDS (U.S. CLS. 22, 23, 38 AND 50).

FIRST USE 2-1-2003; IN COMMERCE 2-1-2003.

2,929,722. GAMES FOR ALL REASONS, LLC, ARLINGTON, MA. SN 78-237,869. PUB. 11-25-2003, FILED 4-15-2003.

## ONE-TWO PUNCH

FOR BOARD GAMES, CARD GAMES, PARLOR GAMES AND HAND-HELD UNITS FOR PLAYING ELECTRONIC GAMES (U.S. CLS. 22, 23, 38 AND 50).  
FIRST USE 3-24-2004; IN COMMERCE 3-24-2004.

2,929,733. KONAMI CORPORATION, TOKYO, JAPAN. SN 78-242,070. PUB. 12-2-2003, FILED 4-25-2003.

## MAGICIAN'S FORCE

FOR PLAYING CARDS; TRADING CARD GAMES (U.S. CLS. 22, 23, 38 AND 50).  
FIRST USE 10-0-2003; IN COMMERCE 10-0-2003.

2,929,737. SIMPLE WISHES, INC., LA QUINTA, CA. SN 78-246,268. PUB. 1-6-2004, FILED 5-6-2003.

## XTREMZ

FOR TOYS, NAMELY, DIECAST MINIATURE VEHICLES AND ACCESSORIES THEREFOR (U.S. CLS. 22, 23, 38 AND 50).

FIRST USE 11-0-2003; IN COMMERCE 11-0-2003.

2,929,820. FREE MOTION FITNESS, INC., COLORADO SPRINGS, CO. SN 78-290,374. PUB. 7-27-2004, FILED 8-21-2003.

## CABLE CROSS

FOR EXERCISE EQUIPMENT, NAMELY, WEIGHT LIFTING MACHINES (U.S. CLS. 22, 23, 38 AND 50).  
FIRST USE 11-0-1999; IN COMMERCE 11-0-1999.

**CLASS 28—(Continued).**

2,929,825. FOLCIK, KRISTINA MARIE, EAST HAMPTON, CT. SN 78-293,706. PUB. 5-25-2004, FILED 8-28-2003.



FOR WOMEN'S BODY PROTECTIVE GEAR AND OTHER ACCESSORIES ASSOCIATED WITH HIGH IMPACT SPORTS, NAMELY, SPINE AND CHEST PROTECTORS, AND ELBOW, SHOULDER, SHIN AND KNEE PADS, FOR MOTOCROSS, MOUNTAIN BIKING, SNOW BOARDING, PAINTBALL AND KICK BOXING (U.S. CLS. 22, 23, 38 AND 50).

FIRST USE 8-1-2003; IN COMMERCE 8-25-2003.

2,929,829. BRINE, INC., MILFORD, MA. SN 78-296,645. PUB. 5-25-2004, FILED 9-5-2003.

**MONEY**

FOR LACROSSE STICKS, LACROSSE STICK HEADS AND PARTS THEREOF (U.S. CLS. 22, 23, 38 AND 50).

FIRST USE 11-9-2004; IN COMMERCE 11-9-2004.

2,929,864. MONARK GOLF SUPPLY, INC., WALNUT, CA. SN 78-316,771. PUB. 6-8-2004, FILED 10-21-2003.

**MONDEO**

FOR GOLF CLUBS, GOLF CLUB HEADS, GRAPHITE SHAFTS, GRIPS; RELATED GOLF ACCESSORIES, NAMELY, GOLF BAGS, GOLF CLUB COVERS, GOLF GLOVES, AND GOLF HEAD COVERS (U.S. CLS. 22, 23, 38 AND 50).

FIRST USE 1-1-2004; IN COMMERCE 1-1-2004.

**CLASS 28—(Continued).**

2,929,873. ARTIN INDUSTRIAL CO. LTD., SAN POKONG, KOWLOON, HONG KONG, HONG KONG. SN 78-323,388. PUB. 8-10-2004, FILED 11-5-2003.

**POWER PASSERS**

THE MARK CONSISTS OF STANDARD CHARACTERS WITHOUT CLAIM TO ANY PARTICULAR FONT, STYLE, SIZE, OR COLOR.

FOR TOY VEHICLE RACING SETS (U.S. CLS. 22, 23, 38 AND 50).

FIRST USE 8-1-2003; IN COMMERCE 1-10-2004.

2,929,886. CRANIUM, INC., SEATTLE, WA. SN 78-975,569. PUB. 11-4-2003, FILED 3-7-2003.

**THE GAME OF TUNES,  
TWISTS, AND TOPSY-TURVY  
FUN**

FOR BOARD GAMES; EQUIPMENT SOLD AS A UNIT FOR PLAYING A BOARD GAME; PARLOR GAMES (U.S. CLS. 22, 23, 38 AND 50).

FIRST USE 7-0-2003; IN COMMERCE 7-0-2003.

2,929,888. CRANIUM INC., SEATTLE, WA. SN 78-975,607. PUB. 11-25-2003, FILED 4-1-2003.

**MINDREADER**

FOR BOARD GAMES; EQUIPMENT SOLD AS A UNIT FOR PLAYING A BOARD GAME; QUESTION SETS FOR BOARD GAME (U.S. CLS. 22, 23, 38 AND 50).

FIRST USE 9-0-2003; IN COMMERCE 9-0-2003.

**CLASS 29—MEATS AND PROCESSED FOODS**

**CLASS 29—(Continued).**

2,929,073. DERIVADOS DE LECHE LA ESMERALDA, S.A. DE C.V., GUANAJUATO, MEXICO. SN 75-857,644. PUB. 3-20-2001, FILED 11-23-1999.

**ESMERALDA**

THE ENGLISH TRANSLATION OF "ESMERALDA" IS "EMERALD".

FOR DAIRY PRODUCTS, NAMELY, CHEESE, BUTTER, CREAM, YOGURT, MILK; FRUITS AND VEGETABLES, NAMELY, PRESERVED FRUITS AND VEGETABLES, COOKED FRUITS AND VEGETABLES, AND DRIED FRUIT AND VEGETABLES; JAMS AND MARMALADE; EGGS; MEATS; COLD CUTS; PROCESSED DATES; RAISINS (U.S. CL. 46).

FIRST USE 10-1-2004; IN COMMERCE 10-1-2004.

2,929,221. BREWSTER DAIRY, INC., BREWSTER, OH. SN 76-334,291. PUB. 6-25-2002, FILED 11-5-2001.



FOR CHEESE AND CHEESE FOOD (U.S. CL. 46).  
FIRST USE 11-29-2004; IN COMMERCE 11-29-2004.

2,929,222. BREWSTER DAIRY, INC., BREWSTER, OH. SN 76-334,292. PUB. 6-25-2002, FILED 11-5-2001.

**MAKE IT SWISS**

FOR CHEESE AND CHEESE FOOD (U.S. CL. 46).  
FIRST USE 11-26-2004; IN COMMERCE 11-26-2004.

2,929,313. BARON DE LEY, S.A., 31587 MENDAVIA (NAVARRA), SPAIN. SN 76-470,750. PUB. 1-20-2004, FILED 11-29-2002.

**CLUB PRIVADO**

IN THE SPANISH LANGUAGE "CLUB PRIVADO" MEANS "PRIVATE CLUB".

FOR MEAT; MEAT EXTRACT; FISH FOR FOOD PURPOSES; POULTRY, NAMELY CHICKEN AND TURKEY; GAME; PRESERVED, DRIED, COOKED AND GRILLED VEGETABLES; EDIBLE OIL AND EDIBLE FATS (U.S. CL. 46).

FIRST USE 1-1-1985; IN COMMERCE 4-5-2002.

**CLASS 29—(Continued).**

2,929,314. KANESA CO., LTD., AOMORI-SHI, AOMORI-KEN, JAPAN. SN 76-471,057. PUB. 1-6-2004, FILED 11-21-2002.

**MISO ONE**

NO CLAIM IS MADE TO THE EXCLUSIVE RIGHT TO USE "MISO", APART FROM THE MARK AS SHOWN.

FOR INSTANT OR PRE-COOKED MISO SOUP (U.S. CL. 46).

FIRST USE 6-18-2004; IN COMMERCE 6-18-2004.

2,929,327. HERB'S SEAFOOD, INC., MT. HOLLY, NJ. SN 76-481,608. PUB. 9-9-2003, FILED 1-10-2003.

**NEON NUGGETS**

NO CLAIM IS MADE TO THE EXCLUSIVE RIGHT TO USE "NUGGETS", APART FROM THE MARK AS SHOWN. FOR FROZEN PREPARED AND BREADED SEAFOOD, MEAT AND POULTRY (U.S. CL. 46).

FIRST USE 6-11-2004; IN COMMERCE 6-11-2004.

2,929,359. G & R FOODS, INC., REEDSBURG, WI. SN 76-498,271. PUB. 11-18-2003, FILED 3-17-2003.

**TOUCH OF COUNTRY**

FOR MARGARINE AND VEGETABLE-BASED SPREADS (U.S. CL. 46).

FIRST USE 4-30-2003; IN COMMERCE 4-30-2003.

2,929,373. HOUSE FOODS AMERICA CORPORATION, GARDEN GROVE, CA. SN 76-502,579. PUB. 3-16-2004, FILED 3-27-2003.

**SOY TIME**

NO CLAIM IS MADE TO THE EXCLUSIVE RIGHT TO USE SOY, APART FROM THE MARK AS SHOWN.

FOR NON-DAIRY ORGANIC SOY BASED BEVERAGE FOR DISTRIBUTION AND SALE TO RETAIL MARKETS (U.S. CL. 46).

FIRST USE 10-26-2004; IN COMMERCE 10-26-2004.

**CLASS 29—(Continued).**

2,929,391. DAVIS MOUNTAINS ORGANIC BEEF, L.L.C.,  
DALLAS, TX. SN 76-510,908. PUB. 4-6-2004, FILED 5-1-2003.



NO CLAIM IS MADE TO THE EXCLUSIVE RIGHT TO USE "DAVIS MOUNTAINS" AND "100% ORGANIC BEEF", APART FROM THE MARK AS SHOWN.  
FOR BEEF (U.S. CL. 46).  
FIRST USE 2-1-2004; IN COMMERCE 2-1-2004.

2,929,392. DAVIS MOUNTAINS ORGANIC BEEF, L.L.C.,  
DALLAS, TX. SN 76-510,909. PUB. 1-13-2004, FILED 5-1-2003.



NO CLAIM IS MADE TO THE EXCLUSIVE RIGHT TO USE "DAVIS MOUNTAINS" AND "100% ORGANIC BEEF", APART FROM THE MARK AS SHOWN.  
FOR BEEF (U.S. CL. 46).  
FIRST USE 7-1-2003; IN COMMERCE 2-1-2004.

2,929,393. DAVIS MOUNTAINS ORGANIC BEEF, L.L.C.,  
DALLAS, TX. SN 76-510,910. PUB. 1-13-2004, FILED 5-1-2003.



NO CLAIM IS MADE TO THE EXCLUSIVE RIGHT TO USE "DAVIS MOUNTAINS" AND "100% ORGANIC BEEF", APART FROM THE MARK AS SHOWN.  
THE MARK CONSISTS OF THE LITERAL ELEMENT

**CLASS 29—(Continued).**

WITH A BLACKENED COWBOY ON A BLACKENED HORSE IN THE MIDDLE OF IT. THE WORDS "DAVIS MOUNTAINS" ARE IN ORANGE, CAPITALIZED LETTERS. THE REMAINING WORDS ARE IN A SMALLER, BLACK, CAPITALIZED FONT.

FOR BEEF (U.S. CL. 46).  
FIRST USE 4-1-2003; IN COMMERCE 4-1-2003.

2,929,463. WISE FOODS INVESTMENTS, INC., SPARTANBURG, SC. SN 76-539,188. PUB. 6-22-2004, FILED 8-21-2003.

**WISE COTTAGE CUTS**

OWNER OF U.S. REG. NOS. 705,034, 2,351,530, AND OTHERS.

NO CLAIM IS MADE TO THE EXCLUSIVE RIGHT TO USE COTTAGE CUTS, APART FROM THE MARK AS SHOWN.

FOR POTATO BASED SNACK FOODS (U.S. CL. 46).  
FIRST USE 3-0-2004; IN COMMERCE 3-0-2004.

2,929,649. HEB GROCERY COMPANY, LP, SAN ANTONIO, TX. SN 78-190,337. PUB. 1-27-2004, FILED 12-2-2002.

**READY, FRESH, GO!**

FOR PACKAGED PREPARED VEGETABLE PRODUCTS, NAMELY, ONIONS, JICAMA, PEPPERS, CELERY, GARLIC CLOVES, CHOPPED GARLIC AND JALAPENOS (U.S. CL. 46).

FIRST USE 9-0-2003; IN COMMERCE 9-0-2003.

**CLASS 29—(Continued).**

2,929,682. ESTABLECIMIENTOS FELIX GASULL, S.A., REUS, SPAIN. SN 78-210,519. PUB. 10-28-2003, FILED 2-4-2003.



NO CLAIM IS MADE TO THE EXCLUSIVE RIGHT TO USE "ACEITES DE OLIVA", "REUS", "VIRGIN OLIVE OIL" AND "EXTRA", APART FROM THE MARK AS SHOWN.

THE WORD "MARTI" IS THE SURNAME OF ONE OF THE FOUNDERS OF APPLICANT, AND SR. MARTI IS DECEASED. THE NAME "FELIX GASULL" DOES NOT IDENTIFY A LIVING INDIVIDUAL. SR. GASULL WAS ONE OF THE FOUNDERS OF APPLICANT.

THE MARK CONSISTS OF THE OUTER BORDER AND THE BACKGROUND OF THE CIRCULAR BADGE AT THE TOP OF THE MARK ARE IN GOLD. THE INNER BORDERS ARE GREEN AND GOLD. THE WORD "MARTI" IS RED, SURROUNDED IN GOLD AND SHADED IN GREEN. ALL THE WORDING IN THE MARK IS GREEN. THE DESIGN ELEMENTS IN THE BADGE ARE GREEN. THE WORDING "VIRGIN OLIVE OIL EXTRA REUS" IS SHADED IN GOLD.

THE ENGLISH TRANSLATION OF "ACEITES DE OLIVA" IS THE SPANISH EXPRESSION FOR "OLIVE OILS".

FOR EDIBLE OILS (U.S. CL. 46).  
FIRST USE 0-0-1920; IN COMMERCE 0-0-1958.

2,929,698. TRANSPACIFIC FOODS, INC., IRVINE, CA. SN 78-222,676. PUB. 6-29-2004, FILED 3-6-2003.

**IDEAL CHOICE**

FOR CANNED FRUITS, VEGETABLES, AND MUSH-ROOMS (U.S. CL. 46).  
FIRST USE 2-26-2003; IN COMMERCE 3-1-2003.

2,929,731. EMMPAK FOODS, INC., MILWAUKEE, WI. SN 78-241,286. PUB. 12-23-2003, FILED 4-23-2003.

**CULINARY EDGE**

FOR MEAT, NAMELY PORK (U.S. CL. 46).  
FIRST USE 2-6-2004; IN COMMERCE 2-6-2004.

**CLASS 29—(Continued).**

2,929,814. FROMARTHARIE, INC., WARREN, NJ. SN 78-286,323. PUB. 4-20-2004, FILED 8-12-2003.

**CHAMPS ELYSEE**

FOR CHEESE (U.S. CL. 46).  
FIRST USE 10-14-2004; IN COMMERCE 10-14-2004.

2,929,872. KEY SEAFOOD IMPORTS, INC., PERTH AMBOY, NJ. SN 78-323,381. PUB. 8-31-2004, FILED 11-5-2003.

**Intergold**

THE MARK CONSISTS OF STANDARD CHARACTERS WITHOUT CLAIM TO ANY PARTICULAR FONT, STYLE, SIZE, OR COLOR.

FOR SEAFOOD (U.S. CL. 46).  
FIRST USE 7-1-1995; IN COMMERCE 7-1-1995.

**CLASS 30—STAPLE FOODS**

2,929,071. MARTINEZ, ZARELA, NEW YORK, NY. SN 75-833,145. PUB. 5-1-2001, FILED 10-27-1999.

**SALSA MACHA**

NO CLAIM IS MADE TO THE EXCLUSIVE RIGHT TO USE "SALSA", APART FROM THE MARK AS SHOWN.

FOR SAUCES (U.S. CL. 46).  
FIRST USE 6-16-2004; IN COMMERCE 6-16-2004.



**CLASS 30—(Continued).**

2,929,127. LEE KWAN TEA TRADE LIMITED, QUARRY BAY, HONG KONG. SN 76-163,923. PUB. 3-25-2003, FILED 11-13-2000.

**MINGCHA**

THE ENGLISH TRANSLATION OF THE WORD "MING" IS "TO UNDERSTAND" AND THE ENGLISH TRANSLATION OF THE WORD "CHA" IS "TEA".  
FOR TEA FOR FOOD PRODUCTS (U.S. CL. 46).  
FIRST USE 3-7-2000; IN COMMERCE 3-24-2002.

2,929,155. FARAGHER FAMILY FARM, DBA OUR FAMILY FARM, NEWPORT, KY. SN 76-216,578. PUB. 4-9-2002, FILED 2-26-2001.

**SURVIVAL SNACKS**

NO CLAIM IS MADE TO THE EXCLUSIVE RIGHT TO USE "SNACKS", APART FROM THE MARK AS SHOWN.  
FOR BAKED SNACK GOODS, NAMELY COOKIES AND CRACKERS (U.S. CL. 46).  
FIRST USE 10-15-2004; IN COMMERCE 10-15-2004.

2,929,156. FARAGHER FAMILY FARM, DBA OUR FAMILY FARM, NEWPORT, KY. SN 76-216,579. PUB. 2-26-2002, FILED 2-26-2001.

**ISLAND SEA SHELLS**

FOR BAKED SNACK GOODS, NAMELY COOKIES AND CRACKERS (U.S. CL. 46).  
FIRST USE 10-15-2004; IN COMMERCE 10-15-2004.

2,929,169. ALDI INC., BATAVIA, IL. SN 76-242,895. PUB. 10-29-2002, FILED 4-19-2001.

**CINNAMON CRUNCH  
SQUARES**

NO CLAIM IS MADE TO THE EXCLUSIVE RIGHT TO USE "CINNAMON" AND "SQUARES", APART FROM THE MARK AS SHOWN.  
FOR PROCESSED CEREAL (U.S. CL. 46).  
FIRST USE 9-1-2001; IN COMMERCE 9-1-2001.

**CLASS 30—(Continued).**

2,929,179. MARS, INCORPORATED, MCLEAN, VA. SN 76-258,824. PUB. 2-19-2002, FILED 5-16-2001.

**funworks**

FOR CONFECTIONERY, NAMELY, CANDY (U.S. CL. 46).  
FIRST USE 6-0-2001; IN COMMERCE 6-0-2001.

2,929,227. INDUSTRIA DE ALIMENTOS DOS EN UNO S.A., SANTIAGO, CHILE. SN 76-345,760. PUB. 9-3-2002, FILED 12-4-2001.

**OBA OBA**

FOR MARSHMALLOWS, MARSHMALLOWS WITH CHOCOLATE COATINGS, AND CANDY (U.S. CL. 46).  
FIRST USE 1-1-1988; IN COMMERCE 10-6-2003.

2,929,257. SANDY'S VENETIAN GARDEN, L.L.C., NOKOMIS, FL. SN 76-387,766. PUB. 9-30-2003, FILED 3-26-2002.

**SHARK TOOTH**

FOR BAKED GOODS, NAMELY, COOKIES (U.S. CL. 46).  
FIRST USE 10-6-2004; IN COMMERCE 10-6-2004.

2,929,273. ESSENS BRANDS, L.L.C., KENT, WA. SN 76-418,459. PUB. 1-14-2003, FILED 5-29-2002.

**RICE TEETHERS**

NO CLAIM IS MADE TO THE EXCLUSIVE RIGHT TO USE "RICE", APART FROM THE MARK AS SHOWN.  
FOR FOODS, NAMELY, CRACKERS AND COOKIES (U.S. CL. 46).  
FIRST USE 8-25-2004; IN COMMERCE 8-25-2004.

2,929,369. FRITO-LAY NORTH AMERICA, INC., PLANO, TX. SN 76-501,092. PUB. 3-16-2004, FILED 3-19-2003.

**DORITOS ROLLITOS**

OWNER OF U.S. REG. NOS. 792,667, 1,528,348, AND OTHERS.  
FOR CORN-BASED SNACK FOODS, NAMELY, TORTILLA CHIPS (U.S. CL. 46).  
FIRST USE 12-22-2003; IN COMMERCE 12-22-2003.

**CLASS 30—(Continued).**

2,929,502. AQFTM, INC., CAREY, NC. SN 76-556,531. PUB. 7-20-2004, FILED 10-17-2003.

## AUSTIN SINCE 1932 SNACKERZ

OWNER OF U.S. REG. NOS. 1,266,461 AND 1,935,987.  
NO CLAIM IS MADE TO THE EXCLUSIVE RIGHT TO  
USE SINCE 1932, APART FROM THE MARK AS SHOWN.  
FOR COOKIES (U.S. CL. 46).  
FIRST USE 1-15-2004; IN COMMERCE 1-15-2004.

2,929,577. C.A. SUCESORA DE JOSE PUIG & CO., CARACAS,  
VENEZUELA. SN 78-128,245. PUB. 7-29-2003, FILED 5-13-  
2002.



THE ENGLISH TRANSLATION OF THE SPANISH  
WORDING "MORDISQUITOS" IS "LITTLE BITES."  
FOR COFFEE, TEA, COCOA, SUGAR, RICE, TAPIO-  
CA, SAGO, FLOURS, PROCESSED CEREALS, BREAD,  
PASTRY, FROZEN CONFECTIONS, EATABLE ICE  
CREAMS, HONEY, MOLASSES, SYRUP, YEASTS, SALT,  
MUSTARD, VINEGAR, SAUCES AND ICE (U.S. CL. 46).  
FIRST USE 2-21-2000; IN COMMERCE 2-21-2000.

2,929,625. COLE & PARKS, LLC, PITTSFORD, NY. SN 78-  
179,652. PUB. 6-8-2004, FILED 10-29-2002.

## TODAY'S COOKIE

NO CLAIM IS MADE TO THE EXCLUSIVE RIGHT TO  
USE "COOKIE". APART FROM THE MARK AS SHOWN.  
FOR COOKIES AND OTHER BAKERY GOODS; CAN-  
DY; COOKIE DOUGH AND COOKIE MIX (U.S. CL. 46).  
FIRST USE 4-16-2003; IN COMMERCE 11-14-2003.

**CLASS 30—(Continued).**

2,929,642. TOPCO HOLDINGS, INC., SKOKIE, IL. SN 78-  
187,473. PUB. 3-23-2004, FILED 11-21-2002.

## WORLD CLASSICS LA COCINA DE MEXICO

OWNER OF U.S. REG. NOS. 1,690,372, 2,014,460, AND  
OTHERS.

NO CLAIM IS MADE TO THE EXCLUSIVE RIGHT TO  
USE LA COCINA DE MEXICO, APART FROM THE MARK  
AS SHOWN.

THE ENGLISH TRANSLATION OF THE WORDS "LA  
COCINA DE MEXICO" IS THE MEXICAN KITCHEN.  
FOR ENCHILADA SAUCE (U.S. CL. 46).  
FIRST USE 1-0-2002; IN COMMERCE 1-0-2002.

2,929,666. MID-TOWN RECREATION, INC., HOLCOMB,  
MO. SN 78-202,581. PUB. 3-2-2004, FILED 1-13-2003.

## STRAWBERRY'S

FOR SEASONINGS, SAUCES AND MARINADES (U.S.  
CL. 46).  
FIRST USE 2-16-1995; IN COMMERCE 4-10-1995.

2,929,692. INDOPCO, INC., DBA NATIONAL STARCH AND  
CHEMICAL COMPANY, BRIDGEWATER, NJ. SN 78-  
217,962. PUB. 10-28-2003, FILED 2-24-2003.

## ADVANTA-GEL

OWNER OF U.S. REG. NOS. 386,241, 2,434,285, AND  
OTHERS.  
FOR FOOD STARCH USED FOR INSTANT GELLING  
(U.S. CL. 46).  
FIRST USE 6-6-2003; IN COMMERCE 6-6-2003.

2,929,712. BURLWOOD GROUP, INC., BURBANK, CA. SN  
78-234,826. PUB. 2-24-2004, FILED 4-7-2003.

## BLACK PEARL

OWNER OF U.S. REG. NO. 2,595,450.  
FOR COFFEE (U.S. CL. 46).  
FIRST USE 11-3-2004; IN COMMERCE 11-3-2004.

**CLASS 30—(Continued).**

2,929,753. AZTECA FOODS, INC., CHICAGO, IL. SN 78-255,615. PUB. 2-10-2004, FILED 5-29-2003.

## SIMPLY DELECTABLE SALADS

NO CLAIM IS MADE TO THE EXCLUSIVE RIGHT TO USE "SALADS", APART FROM THE MARK AS SHOWN.  
FOR SHELL COMPRISED OF FLOUR FOR USE WITH SALAD FILLINGS (U.S. CL. 46).  
FIRST USE 10-24-2003; IN COMMERCE 10-24-2003.

2,929,775. ROMANCE FOODS, L.L.C., AUSTIN, TX. SN 78-264,805. PUB. 3-16-2004, FILED 6-19-2003.

## SXUL CHOCOLATE

NO CLAIM IS MADE TO THE EXCLUSIVE RIGHT TO USE "CHOCOLATE", APART FROM THE MARK AS SHOWN.  
FOR CHOCOLATE CANDY PIECES, BARS AND SAUCES (U.S. CL. 46).  
FIRST USE 12-22-2003; IN COMMERCE 12-22-2003.

2,929,782. PASSLER, SANDRA, K, LAS CRUCES, NM. AND PASSLER, KENNETH, T., LAS CRUCES, NM. SN 78-270,271. PUB. 4-6-2004, FILED 7-3-2003.

## NUNDUNBETTER

FOR CONDIMENTS, NAMELY MUSTARD (U.S. CL. 46).  
FIRST USE 10-11-2003; IN COMMERCE 10-11-2003.

2,929,834. POWER, JOHN C., THE SEA RANCH, CA. SN 78-300,064. PUB. 6-1-2004, FILED 9-13-2003.

## GOLDEN WEST COFFEE

NO CLAIM IS MADE TO THE EXCLUSIVE RIGHT TO USE "COFFEE", APART FROM THE MARK AS SHOWN.  
FOR COFFEE (U.S. CL. 46).  
FIRST USE 11-1-2004; IN COMMERCE 11-1-2004.

2,929,855. RIVIANA FOODS INC., HOUSTON, TX. SN 78-307,927. PUB. 6-15-2004, FILED 10-1-2003.

## CHINA DOLL GOLD

OWNER OF U.S. REG. NOS. 545,541, 1,815,060, AND OTHERS.  
FOR RICE (U.S. CL. 46).  
FIRST USE 8-2-2004; IN COMMERCE 8-2-2004.

**CLASS 30—(Continued).**

2,929,863. ARCURI, ANTHONY, HILTON HEAD ISLAND, SC. SN 78-314,564. PUB. 7-27-2004, FILED 10-16-2003.

## WEGGIE

FOR FOOD ITEM CONSISTING OF DOUGH FILLED WITH MEAT, VEGETABLES AND CHEESE FOR CONSUMPTION ON OR OFF THE PREMISES (U.S. CL. 46).  
FIRST USE 2-1-1988; IN COMMERCE 2-1-1988.

2,929,878. TONE BROTHERS, INC., ANKENY, IA. SN 78-327,093. PUB. 8-10-2004, FILED 11-12-2003.

## SPRAY IT!

THE MARK CONSISTS OF STANDARD CHARACTERS WITHOUT CLAIM TO ANY PARTICULAR FONT, STYLE, SIZE, OR COLOR.  
FOR EDIBLE CAKE DECORATIONS AND CANDY DECORATIONS FOR CAKES (U.S. CL. 46).  
FIRST USE 7-20-2004; IN COMMERCE 7-20-2004.

**CLASS 31—NATURAL AGRICULTURAL PRODUCTS**

2,929,116. KELLY FOODS CORPORATION, BERLIN, MD. SN 76-140,156. PUB. 8-14-2001, FILED 10-3-2000.

## NUTRI TEMP

FOR DOG AND CAT FOOD; DOG AND CAT TREATS (U.S. CLS. 1 AND 46).  
FIRST USE 10-26-2004; IN COMMERCE 10-26-2004.

**CLASS 31—(Continued).**

2,929,187. PREMIUM NUTRITIONAL PRODUCTS, INC., LENEXA, KS. SN 76-265,592. PUB. 4-9-2002, FILED 6-4-2001.

**AVIAN ENTRÉES**

NO CLAIM IS MADE TO THE EXCLUSIVE RIGHT TO USE "AVIAN", APART FROM THE MARK AS SHOWN. FOR FOOD FOR CAGED BIRDS (U.S. CLS. 1 AND 46). FIRST USE 9-13-2004; IN COMMERCE 9-13-2004.

2,929,254. SOUTHERN GRAIN, UVALDE, TX. SN 76-385,032. PUB. 2-17-2004, FILED 3-20-2002.



THE STIPPLING IS FOR SHADING PURPOSES. FOR FOOD STUFFS FOR ANIMALS, NAMELY GRAIN OR FOOD PELLETS FOR WILDLIFE (U.S. CLS. 1 AND 46). FIRST USE 3-0-2002; IN COMMERCE 3-0-2002.

2,929,520. VALUE CITY OF MICHIGAN, INC., WESTLAND, MI. SN 76-977,232. PUB. 8-20-2002, FILED 5-23-2001.

**TODAY'S LIVING**

FOR LIVE FLORAL ITEMS, NAMELY GARLANDS, WREATHS, BASKET ARRANGEMENTS, SWAGS, CANDLE RINGS, VINES, BUSHES AND STEMS, AND FICUS TREES (U.S. CLS. 1 AND 46). FIRST USE 2-21-2004; IN COMMERCE 2-21-2004.

**CLASS 31—(Continued).**

2,929,550. HAUSSERMANN STAUDEN + GEHOLZE GBR, MOGLINGEN, FED REP GERMANY. SN 78-083,841. PUB. 3-23-2004, FILED 9-13-2001.

**MARCUS**

PRIORITY CLAIMED UNDER SEC. 44(D) ON ERPNTY TM OFC APPLICATION NO. 002327575, FILED 8-3-2001, REG. NO. 002327575, DATED 1-2-2003, EXPIRES 8-3-2011.

FOR LIVING PLANTS AND NATURAL FLOWERS; PROPAGATION MATERIAL OF PLANTS (U.S. CLS. 1 AND 46).

FIRST USE 8-0-2001; IN COMMERCE 9-0-2003.

2,929,579. SYNGENTA PARTICIPATIONS AG, BASEL, SWITZERLAND. SN 78-128,754. PUB. 5-6-2003, FILED 5-15-2002.

**DULCINEA**

FOR UNPROCESSED, RAW AND FRESH, FRUITS, VEGETABLES AND SEEDS THEREOF (U.S. CLS. 1 AND 46).

FIRST USE 10-1-2002; IN COMMERCE 10-1-2002.

2,929,850. COLORFUL HARVEST LLC, MINNETONKA, MN. SN 78-307,567. PUB. 6-15-2004, FILED 9-30-2003.



FOR FRESH FRUITS AND VEGETABLES (U.S. CLS. 1 AND 46). FIRST USE 6-0-2003; IN COMMERCE 6-0-2003.

**CLASS 32—LIGHT BEVERAGES**

2,929,087. STOLLE MILK BIOLOGICS, INC., CINCINNATI, OH. SN 75-983,533. PUB. 2-22-2000, FILED 8-13-1999.

**NUVIM**

FOR NON-CARBONATED SOFT DRINKS FRUIT-FLAVORED SOFT DRINKS, FRUIT JUICES (U.S. CLS. 45, 46 AND 48).

FIRST USE 1-18-2000; IN COMMERCE 5-11-2000.

**CLASS 32—(Continued).**

2,929,143. XTZ INDUSTRIES, INC., EDMONDS, WA. SN 76-197,307. PUB. 8-27-2002, FILED 1-19-2001.

**TATTOO**

FOR LIGHT BEVERAGES, NAMELY, NONALCOHOLIC SOFT DRINKS; AND NON-MEDICATED ENERGY DRINKS (U.S. CLS. 45, 46 AND 48).  
FIRST USE 9-1-2002; IN COMMERCE 9-1-2002.

---

2,929,331. MERCURY GROUP LLC, THE, WILTON, CT. SN 76-483,620. PUB. 4-13-2004, FILED 1-21-2003.



FOR NON-ALCOHOLIC BEVERAGES, NAMELY, ENERGY DRINKS, ISOTONIC DRINKS, AND SPORTS DRINKS; FRUIT DRINKS AND FRUIT JUICES; MINERAL, SPRING, AERATED AND FLAVORED WATERS (U.S. CLS. 45, 46 AND 48).  
FIRST USE 2-0-2003; IN COMMERCE 2-0-2003.

---

2,929,528. WIDGERY, WILLIAM TROY, DENVER, CO. SN 78-029,072. PUB. 1-14-2003, FILED 10-4-2000.

**GO FAST!**

THE MARK CONSISTS OF STANDARD CHARACTERS WITHOUT CLAIM TO ANY PARTICULAR FONT, STYLE, SIZE, OR COLOR.

OWNER OF U.S. REG. NOS. 2,307,671 AND 2,312,114.  
FOR SPORTS/ENERGY DRINK (U.S. CLS. 45, 46 AND 48).  
FIRST USE 11-0-2001; IN COMMERCE 11-0-2001.

**CLASS 32—(Continued).**

2,929,533. HOWARD, MALCOLM B., SCOTTSDALE, AZ. SN 78-039,682. PUB. 8-21-2001, FILED 12-18-2000.

**JUICE 10**

OWNER OF U.S. REG. NO. 1,602,671.  
NO CLAIM IS MADE TO THE EXCLUSIVE RIGHT TO USE "JUICE", APART FROM THE MARK AS SHOWN.  
FOR FRUIT JUICE DRINKS WITH WATER, AND CONCENTRATES FOR MAKING FRUIT JUICE DRINKS (U.S. CLS. 45, 46 AND 48).  
FIRST USE 11-8-2004; IN COMMERCE 11-8-2004.

---

2,929,726. KONA BREWING CO., INC., KAILEU-KONA, HI. SN 78-239,999. PUB. 12-2-2003, FILED 4-21-2003.

**BIG WAVE GOLDEN ALE**

NO CLAIM IS MADE TO THE EXCLUSIVE RIGHT TO USE "GOLDEN ALE", APART FROM THE MARK AS SHOWN.  
FOR BEER (U.S. CLS. 45, 46 AND 48).  
FIRST USE 9-20-2003; IN COMMERCE 9-20-2003.

---

**CLASS 33—WINES AND SPIRITS**

2,929,145. PARSLEY FAMILY ESTATE, INC., NAPA, CA. SN 76-198,813. PUB. 8-21-2001, FILED 1-24-2001.

**SILVER STAG**

FOR WINE (U.S. CLS. 47 AND 49).  
FIRST USE 11-12-2004; IN COMMERCE 11-12-2004.

---

2,929,171. ALLIED MANAGEMENT, INC., LIVINGSTON, NJ. SN 76-243,832. PUB. 5-28-2002, FILED 4-19-2001.

**PRONTO BELLA**

THE ENGLISH TRANSLATION OF "PRONTO" IS "READY, QUICK, FAST". THE ENGLISH TRANSLATION OF "BELLO" IS "BEAUTIFUL".  
FOR WINE (U.S. CLS. 47 AND 49).  
FIRST USE 12-1-2001; IN COMMERCE 12-1-2001.

**CLASS 33—(Continued).**

2,929,180. MIGUEL TORRES, S.A., 08720-VILAFRANCA DEL PENEDES (BARCELONA), SPAIN. SN 76-260,253. PUB. 4-30-2002, FILED 5-21-2001.

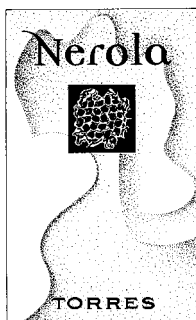

OWNER OF U.S. REG. NOS. 897,048, 1,639,237, AND OTHERS.

FOR WINES (U.S. CLS. 47 AND 49).  
FIRST USE 6-0-2002; IN COMMERCE 6-3-2004.

2,929,287. V&S VIN & SPRIT AKTIEBOLAG, SE-117 97 STOCKHOLM, SWEDEN. SN 76-444,497. PUB. 9-30-2003, FILED 8-26-2002.

**ABSOLUT RASPBERRI**

OWNER OF U.S. REG. NOS. 1,302,003, 2,399,045, AND OTHERS.

NO CLAIM IS MADE TO THE EXCLUSIVE RIGHT TO USE "RASPBERRY", APART FROM THE MARK AS SHOWN.

THE ENGLISH TRANSLATION OF "ABSOLUT" IS "ABSOLUTE".

FOR ALCOHOLIC BEVERAGES NAMELY DISTILLED SPIRITS (U.S. CLS. 47 AND 49).

FIRST USE 8-31-2004; IN COMMERCE 8-31-2004.

2,929,293. WILLIAM GRANT & SONS, INC., EDISON, NJ. SN 76-449,594. PUB. 4-1-2003, FILED 9-9-2002.

**CASALNOVA**

FOR WINES (U.S. CLS. 47 AND 49).  
FIRST USE 6-18-2004; IN COMMERCE 6-18-2004.

2,929,299. THREE CREEK VINEYARD, LLC, SARATOGA, CA. SN 76-457,501. PUB. 9-2-2003, FILED 10-10-2002.

**CIMARONE**

FOR WINES (U.S. CLS. 47 AND 49).  
FIRST USE 9-2-2004; IN COMMERCE 9-29-2004.

**CLASS 33—(Continued).**

2,929,360. BOUTINOT LIMITED, GATLEY, CHESHIRE, UNITED KINGDOM. SN 76-498,314. PUB. 11-11-2003, FILED 3-18-2003.

**OLD TART**

FOR WINES (U.S. CLS. 47 AND 49).  
FIRST USE 7-21-2003; IN COMMERCE 7-21-2003.

2,929,471. GEERLINGS & WADE, INC., CANTON, MA. SN 76-542,236. PUB. 5-18-2004, FILED 9-2-2003.

**GRASS TREE**

FOR WINES (U.S. CLS. 47 AND 49).  
FIRST USE 6-25-2004; IN COMMERCE 6-25-2004.

2,929,490. UNITED STATES DISTILLED PRODUCTS COMPANY, PRINCETON, MN. SN 76-552,153. PUB. 6-22-2004, FILED 10-17-2003.

**TEMPLE**

FOR WINES (U.S. CLS. 47 AND 49).  
FIRST USE 5-0-2004; IN COMMERCE 5-0-2004.

2,929,505. UNITED STATES DISTILLED PRODUCTS COMPANY, PRINCETON, MN. SN 76-559,397. PUB. 7-20-2004, FILED 11-13-2003.

**LE GRAND NOIR**

THE MARK CONSISTS OF STANDARD CHARACTERS WITHOUT CLAIM TO ANY PARTICULAR FONT, STYLE, SIZE, OR COLOR.

"LE GRAND NOIR" IS "THE BIG BLACK".  
FOR WINES (U.S. CLS. 47 AND 49).  
FIRST USE 9-0-2003; IN COMMERCE 9-0-2003.

2,929,530. TWO PONDS, LLC, BEAVERDAM, VA. SN 78-038,294. PUB. 8-28-2001, FILED 12-7-2000.

**TRAILER PARK**

FOR WINE (U.S. CLS. 47 AND 49).  
FIRST USE 10-18-2004; IN COMMERCE 10-18-2004.

**CLASS 33—(Continued).**

2,929,546. DIAGEO NORTH AMERICA, INC., STAMFORD, CT. SN 78-074,252. PUB. 12-31-2002, FILED 7-17-2001.

**RUTHERFORD HOUSE**

NO CLAIM IS MADE TO THE EXCLUSIVE RIGHT TO USE "RUTHERFORD", APART FROM THE MARK AS SHOWN.

FOR ALCOHOLIC BEVERAGES, NAMELY WINES (U.S. CLS. 47 AND 49).  
FIRST USE 8-0-2002; IN COMMERCE 8-0-2002.

2,929,554. M J MUNDY LIMITED, TA WILLOW CREEK VINEYARDS, CHRISTCHURCH, NEW ZEALAND. SN 78-092,365. PUB. 12-9-2003, FILED 11-8-2001.



NO CLAIM IS MADE TO THE EXCLUSIVE RIGHT TO USE "VINEYARD", APART FROM THE MARK AS SHOWN. THE STIPPLING IS A FEATURE OF THE MARK AND IS NOT INTENDED TO INDICATE COLOR.  
FOR WINES (U.S. CLS. 47 AND 49).  
FIRST USE 0-0-1987; IN COMMERCE 12-0-2001.

2,929,711. TRIAUD, FRANCOISE, 33250 PAUILLAC, FRANCE. SN 78-234,157. PUB. 12-30-2003, FILED 4-4-2003.

**CHÂTEAU BEL AIR**

THE MARK CONSISTS OF THE WORD "CHATEAU" WITH A CIRCUMFLEX APPEARING OVER THE LETTER "A" AND THE WORDS "BEL AIR".  
FOR WINES (U.S. CLS. 47 AND 49).  
FIRST USE 0-0-1980; IN COMMERCE 0-0-1980.

**CLASS 33—(Continued).**

2,929,800. AMI GROUP CONSULTING, LLC, SANTA MONICA, CA. SN 78-279,280. PUB. 3-16-2004, FILED 7-26-2003.

**CADEN CREEK**

FOR WINE (U.S. CLS. 47 AND 49).  
FIRST USE 2-16-2004; IN COMMERCE 2-16-2004.

2,929,865. SILVER PINES VINEYARD LLC, SANTA ROSA, CA. SN 78-316,960. PUB. 7-27-2004, FILED 10-22-2003.

**SILVER PINES VINEYARDS**

NO CLAIM IS MADE TO THE EXCLUSIVE RIGHT TO USE "VINEYARDS", APART FROM THE MARK AS SHOWN.

FOR WINE (U.S. CLS. 47 AND 49).  
FIRST USE 4-12-2004; IN COMMERCE 7-2-2004.

**CLASS 34—SMOKERS' ARTICLES**

2,929,199. TECOM SERVICES AG, OB. GERLAFINGEN, SWITZERLAND. SN 76-290,448. PUB. 7-16-2002, FILED 7-26-2001.

**CLIMAGUARD**

FOR HUMIDIFYING SYSTEM FOR CIGAR CASES IN THE NATURE OF A PLASTIC TUBULAR CONTAINER WITH CAP WHICH CONTAINER HOUSES - SPRING, CAPILLARY RESERVOIR MADE OF POLYESTER FIBERS, WRAPPED IN A NON-WOVEN-TISSUE, DEMINERALIZED WATER, HYDROSTATIC SUBSTANCES AND BIOCIDAL AGENTS (U.S. CLS. 2, 8, 9 AND 17).  
FIRST USE 11-12-2001; IN COMMERCE 11-12-2001.

2,929,424. RENEGADE TOBACCO INC., MOCKSVILLE, NC. SN 76-525,463. PUB. 3-16-2004, FILED 6-25-2003.

**TRACKER**

FOR CIGARETTES (U.S. CLS. 2, 8, 9 AND 17).  
FIRST USE 7-1-2003; IN COMMERCE 7-1-2003.

2,929,531. EUROPEAN CIGARETTE IMPORTS, INC., RANDOLPH, NJ. SN 78-038,455. PUB. 7-31-2001, FILED 12-8-2000.

**REGENCY**

FOR CIGARETTES (U.S. CLS. 2, 8, 9 AND 17).  
FIRST USE 10-5-2004; IN COMMERCE 10-5-2004.

**CLASS 34—(Continued).****SERVICE MARKS****CLASS 35—ADVERTISING AND BUSINESS**

2,929,061. ERESMAS INTERACTICA INC., MADRIS, SPAIN.  
SN 75-717,842. PUB. 8-27-2002, FILED 6-1-1999.

**STARMEDIA**

FOR ADVERTISING SERVICES, NAMELY SEARCHING INFORMATION, SITES AND OTHER RESOURCES AVAILABLE ON COMPUTER NETWORKS FOR OTHERS; PROMOTING THE GOODS AND SERVICES OF OTHERS BY PROVIDING ON-LINE LINKS TO NEWS, WEATHER, SPORTS AND CURRENT EVENTS; MAIL ORDER CATALOGS SERVICES IN THE FIELDS OF CLOTHING, CLOTHING ACCESSORIES, FURNITURE, JEWELRY, BEDDING AND TOYS; HOME SHOPPING SERVICES IN THE FIELDS OF CLOTHING, CLOTHING ACCESSORIES, FURNITURE, JEWELRY, BEDDING AND TOYS; DIRECT MARKETING SERVICES; PROMOTING THE GOODS AND SERVICES OF OTHER BY PLACING ADVERTISEMENTS AND PROMOTIONAL DISPLAYS IN AN ELECTRONIC SITE ACCESSED THROUGH COMPUTER NETWORKS; AND PROVIDING INFORMATION REGARDING THE GOODS AND SERVICES OF OTHERS IN THE NATURE OF A BUYERS' GUIDE BY MEANS OF A GLOBAL COMPUTER NETWORK; BUSINESS SERVICES AND RETAIL STORES SERVICES, NAMELY WHOLESALE DISTRIBUTORSHIP SERVICES FEATURING FOOD AND BEVERAGES; WHOLESALE DISTRIBUTORSHIPS FEATURING LASER DISCS, VIDEOTAPES AND AUDIOTAPES; RETAIL STORE SERVICES IN THE FIELD OF CLOTHING, CLOTHING ACCESSORIES, FURNITURE, JEWELRY, BEDDING AND TOYS; CREATING INDICES OF INFORMATION, SITES AND OTHER RESOURCES AVAILABLE ON COMPUTER NETWORKS (U.S. CLS. 100, 101 AND 102).

FIRST USE 7-1-2002; IN COMMERCE 7-1-2002.

2,929,098. YOBILL.COM, INC., JENKINTOWN, PA. SN 76-056,918. PUB. 12-17-2002, FILED 5-15-2000.

**YOUBill**

THE MARK CONSISTS OF STANDARD CHARACTERS WITHOUT CLAIM TO ANY PARTICULAR FONT, STYLE, SIZE, OR COLOR.

FOR PROVIDING BUSINESS SERVICES, NAMELY, ONLINE BILLING AND COLLECTION SERVICES (U.S. CLS. 100, 101 AND 102).

FIRST USE 5-17-2004; IN COMMERCE 5-24-2004.

**CLASS 35—(Continued).**

2,929,101. HUSKY INJECTION MOLDING SYSTEMS LTD., BOLTON, ONTARIO, CANADA. SN 76-063,914. PUB. 10-1-2002, FILED 6-6-2000.

**GREENSHARES**

PRIORITY CLAIMED UNDER SEC. 44(D) ON CANADA APPLICATION NO. 1059860, FILED 5-19-2000.

FOR CONDUCTING EMPLOYEE INCENTIVE AWARD PROGRAMS FOR ENCOURAGING ENVIRONMENTAL AND SOCIAL RESPONSIBILITY, WITH COMPANY SHARE REWARDS (U.S. CLS. 100, 101 AND 102).

FIRST USE 1-1-2000; IN COMMERCE 1-1-2000.

2,929,129. COMMSCOPE PROPERTIES, LLC, SPARKS, NV.  
SN 76-164,359. PUB. 8-28-2001, FILED 11-13-2000.

**ECOMMSCOPE**

OWNER OF U.S. REG. NOS. 898,651, 2,053,255, AND OTHERS.

FOR RETAIL, WHOLESALE AND CATALOG SERVICES FEATURING COMMUNICATIONS CABLE PRODUCTS, NAMELY, COAXIAL, FIBER OPTIC, AND TWISTED PAIR CABLES AND HYBRIDS THEREOF, AND CONNECTORS THEREFOR (U.S. CLS. 100, 101 AND 102).

FIRST USE 11-1-2004; IN COMMERCE 11-1-2004.

2,929,141. RELIANT ENERGY, INC., HOUSTON, TX. SN 76-195,445. PUB. 11-27-2001, FILED 1-17-2001.

**RELIANT STADIUM**

NO CLAIM IS MADE TO THE EXCLUSIVE RIGHT TO USE "STADIUM", APART FROM THE MARK AS SHOWN.

FOR PROMOTING THE GOODS AND SERVICES OF OTHERS BY ARRANGING FOR SPONSORS TO AFFILIATE THEIR GOODS AND SERVICES WITH PROFESSIONAL FOOTBALL; RENTAL OF ADVERTISING SPACE; PROMOTING SPORTS COMPETITIONS AND/OR EVENTS OF OTHERS; DISSEMINATION OF ADVERTISING MATTER AND PROVIDING FACILITIES FOR TRADE SHOWS AND CONVENTIONS; PROMOTING BUSINESS AND TOURISM IN THE AREA OF THE RELIANT STADIUM IN HOUSTON, TEXAS (U.S. CLS. 100, 101 AND 102).

FIRST USE 8-0-2002; IN COMMERCE 8-0-2002.



**CLASS 35—(Continued).**

2,929,161. SCIQUEST, INC., MORRISVILLE, NC. SN 76-223,795. PUB. 2-25-2003, FILED 3-12-2001.

**HIGHERMARKETS**

FOR ON-LINE AUCTION AND BIDDING SERVICES; PROCUREMENT SERVICES, NAMELY PURCHASING GOODS AND SERVICES USED IN EDUCATIONAL INSTITUTIONS FOR OTHERS; ADVERTISING GOODS AND SERVICES FOR OTHERS VIA COMMUNICATIONS NETWORKS; BUSINESS CONSULTATION IN THE FIELDS OF ELECTRONIC COMMERCE AND PROCUREMENT; INFORMATION SERVICES, NAMELY PROVIDING NEWS AND INFORMATION IN THE FIELD OF BUSINESS VIA COMMUNICATIONS NETWORKS; COMPUTER SERVICES, NAMELY, PROVIDING DATABASES FEATURING INFORMATION IN THE FIELD OF BUSINESS VIA COMMUNICATIONS NETWORKS (U.S. CLS. 100, 101 AND 102).

FIRST USE 10-0-2000; IN COMMERCE 3-0-2001.

2,929,189. OFFENBACHER, DOUG, SANTA ROSA, CA. SN 76-266,813. PUB. 8-20-2002, FILED 6-4-2001.

**HEY DOUG WORLDWIDE**

NO CLAIM IS MADE TO THE EXCLUSIVE RIGHT TO USE "WORLDWIDE", APART FROM THE MARK AS SHOWN.

FOR RETAIL STORE SERVICES, MAIL ORDER CATALOG SERVICES, AND ON-LINE RETAIL STORE SERVICES FEATURING CLOTHING, HEADWEAR, SPORTING GOODS, PRINTED PAPER GOODS, GLASSWARE, HOUSEWARES, SOUND RECORDINGS, VIDEO RECORDINGS, TOYS, BOARD GAMES, PUZZLES, SUNGLASSES, CANDY, SNACK FOOD, AND NON-ALCOHOLIC BEVERAGES (U.S. CLS. 100, 101 AND 102).

FIRST USE 11-12-2004; IN COMMERCE 11-12-2004.

2,929,202. PONTES, EDWARD JR., BROOKLINE, MA. SN 76-294,519. PUB. 9-3-2002, FILED 8-6-2001.

**WIREPIKE**

FOR ADVERTISING AGENCIES, NAMELY, PROMOTION SERVICES FOR SMALL AND MIDSIZE COMPANIES THAT PROVIDE TECHNOLOGY-BASED PRODUCTS AND SERVICES THROUGH THE PRODUCTION AND DISTRIBUTION OF PRINTED AND SALES MATERIALS; BUSINESS MANAGEMENT SERVICES, NAMELY, PROVIDING MEDIA PLANNING AND INFORMATION SERVICES OF SMALL AND MIDSIZE COMPANIES THAT PROVIDE TECHNOLOGY-BASED PRODUCTS AND SERVICES; PROMOTING THE GOODS AND SERVICES OF SMALL AND MIDSIZE COMPANIES THAT PROVIDE TECHNOLOGY-BASED PRODUCTS AND SERVICES BY PREPARING AND PLACING ADVERTISEMENTS IN ELECTRONIC MAGAZINES ACCESSED THROUGH A GLOBAL COMPUTER NETWORK; DIRECT MAIL ADVERTISING; PUBLIC RELATIONS (U.S. CLS. 100, 101 AND 102).

FIRST USE 8-1-2001; IN COMMERCE 9-1-2001.

**CLASS 35—(Continued).**

2,929,264. KOCHISS, KERRY DAVID, KAUFMAN, TX. SN 76-400,019. PUB. 3-30-2004, FILED 4-25-2002.

**ALIENALLIANCE.COM**

FOR ELECTRONIC RETAILING SERVICES VIA COMPUTER FEATURING PROMOTIONAL ITEMS, NAMELY, CLOTHING, CALENDARS, MODELS, COFFEE MUGS AND ARTWORK IN THE FIELD OF GIFTS AND NOVELTIES; PROVIDING INFORMATION ABOUT ELECTRONIC RETAILING OF PROMOTIONAL ITEMS, NAMELY CLOTHING, CALENDARS, MODELS, COFFEE MUGS AND ARTWORK (U.S. CLS. 100, 101 AND 102).

FIRST USE 3-26-2002; IN COMMERCE 3-26-2002.

2,929,267. COLONIAL PARKING, INC., WASHINGTON, DC. SN 76-406,067. PUB. 1-27-2004, FILED 5-3-2002.

**PATIENTFIRST PARKING SOLUTIONS**

NO CLAIM IS MADE TO THE EXCLUSIVE RIGHT TO USE "PARKING SOLUTIONS", APART FROM THE MARK AS SHOWN.

FOR BUSINESS CONSULTATION REGARDING THE PARKING FACILITIES OF OTHERS AND BUSINESS MANAGEMENT OF PARKING FACILITIES FOR OTHERS, NAMELY, PARKING ASSET MANAGEMENT AND PARKING EXPERTISE FOR THE OPERATION, ACQUISITION, CONSTRUCTION, PLANNING, CONTRACT NEGOTIATION, REVENUE GENERATION, PROFIT AND EXPENSE SAVING INITIATIVES NAMELY, PERFORMING MARKET STUDIES, EVALUATING AND OBTAINING PROPOSALS AND ASSISTANCE IN THE SELECTION OF SITES AND FACILITIES IN PRESENT AND PLANNED OPERATIONS OF PARKING FACILITIES FOR HOSPITALS, MEDICAL AND DENTAL CLINICS, DOCTOR'S OFFICES AND MEDICAL COMPLEXES, NURSING HOME FACILITIES AND HEALTH CARE FACILITIES (U.S. CLS. 100, 101 AND 102).

FIRST USE 12-29-2002; IN COMMERCE 12-29-2002.

2,929,298. CUDAHY TANNING COMPANY, INC., CUDAHY, WI. SN 76-456,167. PUB. 2-17-2004, FILED 10-7-2002.

**GUIDEAPPROVED**

FOR MAIL-ORDER AND ELECTRONIC CATALOG RETAIL SERVICES, MAIL-ORDER RETAIL SERVICES, ON-LINE ORDERING RETAIL SERVICES AND ARRANGING AND CONDUCTING TRADE SHOW RETAIL SERVICES, ALL FEATURING HIKING, BACKPACKING, CAMPING, FISHING, HUNTING, SHOOTING, CANOEING, KAYAKING AND OTHER OUTDOOR RECREATION AND TRAVEL PRODUCTS, CLOTHING, FOOTWEAR, ACCESSORIES AND OTHER CONSUMER PRODUCTS (U.S. CLS. 100, 101 AND 102).

FIRST USE 2-0-2004; IN COMMERCE 2-0-2004.

**CLASS 35—(Continued).**

2,929,343. FOREIGN AUTO SALVAGE, INC., COVINGTON, KY. SN 76-489,834. PUB. 3-23-2004, FILED 2-12-2003.

**JA AFTERMARKET**

NO CLAIM IS MADE TO THE EXCLUSIVE RIGHT TO USE "AFTERMARKET", APART FROM THE MARK AS SHOWN.

FOR RETAIL SERVICES IN THE NATURE OF RETAIL STORE SERVICES, ONLINE RETAIL STORE SERVICES, ELECTRONIC AND MAIL ORDER CATALOG SERVICES ALL FEATURING VEHICLE PARTS AND A WIDE VARIETY OF HOME, BUSINESS AND VEHICULAR ALARMS (U.S. CLS. 100, 101 AND 102).

FIRST USE 12-13-2004; IN COMMERCE 12-13-2004.

2,929,346. BRASILCONNECTS, NEW YORK, NY. SN 76-492,664. PUB. 11-11-2003, FILED 2-24-2003.



**BrasilConnects**

OWNER OF U.S. REG. NO. 2,736,222.

FOR PROMOTING PUBLIC INTEREST AND AWARENESS IN THE FIELD OF BRAZILIAN AND GLOBAL ART AND CULTURAL AND ENVIRONMENT PRESERVATION; ORGANIZING PUBLIC EXHIBITIONS TO PROMOTE BRAZILIAN AND GLOBAL ART AND CULTURE AND GLOBAL ENVIRONMENTAL PRESERVATION (U.S. CLS. 100, 101 AND 102).

FIRST USE 10-19-2001; IN COMMERCE 10-19-2001.

2,929,356. PMC SERVICE CORP., MOUNT SINAI, NY. SN 76-497,505. PUB. 1-27-2004, FILED 3-10-2003.

**A BETTER CAR FROM A TRUSTED SOURCE**

FOR BUSINESS SERVICES, NAMELY, BUSINESS MANAGEMENT OF NEW VEHICLE AND PREVIOUSLY-OWNED VEHICLE CERTIFICATION AND SALES PROGRAMS FOR OTHERS (U.S. CLS. 100, 101 AND 102).

FIRST USE 4-1-2004; IN COMMERCE 4-1-2004.

**CLASS 35—(Continued).**

2,929,365. CMP MEDIA LLC, MANHASSET, NY. SN 76-499,757. PUB. 3-16-2004, FILED 3-24-2003.

**INTELLIGENTBPM CONFERENCE**

NO CLAIM IS MADE TO THE EXCLUSIVE RIGHT TO USE CONFERENCE, APART FROM THE MARK AS SHOWN.

FOR ARRANGING AND CONDUCTING TRADE SHOWS, CONFERENCES AND EXPOSITIONS IN THE FIELD OF INFORMATION TECHNOLOGY (U.S. CLS. 100, 101 AND 102).

FIRST USE 9-28-2003; IN COMMERCE 9-28-2003.

2,929,386. WIRELESSDEVELOPER, INC., EAST LANSING, MI. SN 76-507,695. PUB. 12-23-2003, FILED 4-18-2003.

**WIRELESS ARTIST**

OWNER OF U.S. REG. NO. 2,670,561.

FOR TALENT AGENCY SERVICES AND CAREER NETWORKING SERVICES; NAMELY, PROMOTION, REPRESENTATION AND MANAGEMENT OF ALL TYPES OF CREATIVE TALENT SUCH AS WRITERS, ACTORS, COMEDIANS, DIRECTORS, PRODUCERS, GRAPHIC ARTISTS, ANIMATORS, MUSICIANS, PRODUCERS COMPUTER SOFTWARE DEVELOPERS, INVENTORS OF NEW TECHNOLOGIES; INDIVIDUALS, GROUPS AND ENTITIES, AND RELATED INNOVATORS AND TECHNOLOGISTS ON HANDHELD WIRELESS DEVICES (U.S. CLS. 100, 101 AND 102).

FIRST USE 8-6-2004; IN COMMERCE 8-6-2004.

2,929,396. APPS OF BOONE, INC., BOONE, NC. SN 76-511,236. PUB. 12-30-2003, FILED 5-2-2003.

**THE TIN CAN**

FOR RETAIL STORE SERVICES FEATURING BEER, WINE, PREPARED SANDWICHES AND SNACKS (U.S. CLS. 100, 101 AND 102).

FIRST USE 4-1-2003; IN COMMERCE 4-1-2003.

2,929,420. SEGEL, ALAN J., BRYN MAWR, PA. SN 76-524,204. PUB. 3-30-2004, FILED 6-19-2003.

**REAL CHEF**

NO CLAIM IS MADE TO THE EXCLUSIVE RIGHT TO USE CHEF, APART FROM THE MARK AS SHOWN.

FOR HOME SHOPPING SERVICES IN THE AREA OF GENERAL MERCHANDISE BY MEANS OF TELEVISION FEATURING CHEFS (U.S. CLS. 100, 101 AND 102).

FIRST USE 5-5-2004; IN COMMERCE 5-5-2004.

**CLASS 35—(Continued).**

2,929,440. LOVE, GLENN H., CONCORD, NC. SN 76-529,623. PUB. 3-23-2004, FILED 6-25-2003.

**MOP ANALYSIS**

NO CLAIM IS MADE TO THE EXCLUSIVE RIGHT TO USE ANALYSIS, APART FROM THE MARK AS SHOWN. FOR BUSINESS MANAGEMENT AND CONSULTATION SERVICES (U.S. CLS. 100, 101 AND 102). FIRST USE 11-1-2004; IN COMMERCE 11-1-2004.

2,929,457. INTERNATIONAL SOCIETY FOR VASCULAR SURGERY, MOUNT ROYAL, NJ. SN 76-535,975. PUB. 6-1-2004, FILED 7-25-2003.

**ISVS INTERNATIONAL SOCIETY FOR VASCULAR SURGERY**

NO CLAIM IS MADE TO THE EXCLUSIVE RIGHT TO USE "INTERNATIONAL SOCIETY FOR VASCULAR SURGERY", APART FROM THE MARK AS SHOWN. FOR ASSOCIATION SERVICES, NAMELY, PROMOTING THE INTEREST OF MEDICAL PROFESSIONALS IN THE FIELD OF VASCULAR SURGERY (U.S. CLS. 100, 101 AND 102). FIRST USE 11-3-2004; IN COMMERCE 11-3-2004.

2,929,458. SAN ANTONIO METROPOLITAN MINISTRY, INC., SAN ANTONIO, TX. SN 76-537,308. PUB. 5-4-2004, FILED 8-14-2003.

**FURNITURE FOR A CAUSE**

NO CLAIM IS MADE TO THE EXCLUSIVE RIGHT TO USE FURNITURE, APART FROM THE MARK AS SHOWN. FOR RETAIL STORE SERVICES FEATURING USED FURNITURE (U.S. CLS. 100, 101 AND 102). FIRST USE 3-2-2004; IN COMMERCE 3-2-2004.

2,929,470. RALEY'S TM, INC., WEST SACRAMENTO, CA. SN 76-542,224. PUB. 7-13-2004, FILED 9-2-2003.

**QUALITY OF LIFE CARD**

NO CLAIM IS MADE TO THE EXCLUSIVE RIGHT TO USE CARD, APART FROM THE MARK AS SHOWN. FOR RETAIL STORE SERVICES FEATURING A BONUS INCENTIVE PROGRAM FOR CUSTOMERS; ADMINISTRATION OF A DISCOUNT PROGRAM FOR ENABLING PARTICIPANTS TO OBTAIN DISCOUNTS ON GOODS AND SERVICES THROUGH USE OF A DISCOUNT MEMBERSHIP CARD (U.S. CLS. 100, 101 AND 102). FIRST USE 7-14-2003; IN COMMERCE 7-14-2003.

**CLASS 35—(Continued).**

2,929,479. MICHAEL EDWARDS COMMUNICATIONS, INC., CHICAGO, IL. SN 76-545,695. PUB. 4-27-2004, FILED 9-22-2003.

**CUSTOMER YEARS**

FOR ADVERTISING AGENCY, NAMELY, PROMOTING THE SERVICES OF FINANCIAL INSTITUTIONS (U.S. CLS. 100, 101 AND 102). FIRST USE 8-1-2004; IN COMMERCE 8-1-2004.

2,929,486. ORLANDO/ORANGE COUNTY CONVENTION & VISITORS BUREAU, INC., ORLANDO, FL. SN 76-549,780. PUB. 7-20-2004, FILED 10-7-2003.

**FAMILY WELCOME PACK**

OWNER OF U.S. REG. NO. 2,829,415. NO CLAIM IS MADE TO THE EXCLUSIVE RIGHT TO USE "PACK", APART FROM THE MARK AS SHOWN. FOR PROMOTING THE SERVICES OF OTHERS IN CONNECTION WITH TOURISM AND CONVENTIONS IN THE ORLANDO, FLORIDA, AREA, THROUGH PRINT, AUDIO AND VIDEO MATERIALS AND THE INTERNET (U.S. CLS. 100, 101 AND 102). FIRST USE 3-31-2004; IN COMMERCE 3-31-2004.

2,929,488. GEORGE LITTLE MANAGEMENT, LLC, WHITE PLAINS, NY. SN 76-550,395. PUB. 7-13-2004, FILED 9-22-2003.

**HOUSE TO HOME**

FOR ORGANIZING AND CONDUCTING TRADE SHOWS IN THE FIELD OF TABLE TOPS, HOME FASHIONS, PERSONAL CARE, KITCHENWARE AND GOURMET HOUSEWARES (U.S. CLS. 100, 101 AND 102). FIRST USE 10-15-2003; IN COMMERCE 10-15-2003.

**CLASS 35—(Continued).**

2,929,491. TECHNOLOGY PROFESSIONALS, INC., BRIDGEWATER, NJ. SN 76-552,674. PUB. 7-27-2004, FILED 10-20-2003.



NO CLAIM IS MADE TO THE EXCLUSIVE RIGHT TO USE "FOOD COURT LIVE.COM", APART FROM THE MARK AS SHOWN.

FOR ONLINE ORDERING SERVICES IN WHICH CONSUMERS CAN ORDER FOOD AND BEVERAGES FROM RESTAURANTS AND HAVE IT DELIVERED (U.S. CLS. 100, 101 AND 102).

FIRST USE 3-15-2004; IN COMMERCE 3-15-2004.

2,929,580. STEPP FOUNDATION, INC., GOLDEN, CO. SN 78-128,893. PUB. 3-9-2004, FILED 5-15-2002.



NO CLAIM IS MADE TO THE EXCLUSIVE RIGHT TO USE "FOUNDATION", APART FROM THE MARK AS SHOWN.

FOR PROVIDING NON-PROFIT CONTRACT MANAGEMENT SERVICES, NAMELY, CONTRACT ADMINISTRATIVE SERVICES OFFERED IN CONNECTION WITH SUPPLEMENTAL ENVIRONMENTAL PROJECTS DESIGNATED IN SETTLEMENTS FROM COMPANIES ALLEGED OR PROVEN TO HAVE VIOLATED ENVIRONMENTAL LAWS OR REGULATIONS IN THE NATURE OF SELECTING AND APPROVING ENERGY EFFICIENCY, RENEWABLE ENERGY AND POLLUTION PREVENTION PROJECTS AROUND THE UNITED STATES (U.S. CLS. 100, 101 AND 102).

FIRST USE 6-0-2002; IN COMMERCE 6-0-2002.

**CLASS 35—(Continued).**

2,929,598. INTERNATIONAL PAPER COMPANY, STAMFORD, CT. SN 78-148,681. PUB. 9-23-2003, FILED 7-30-2002.

**NEXTIER**

FOR BUSINESS MANAGEMENT SERVICES, NAMELY, PROVIDING WEB-BASED, BUSINESS-TO-BUSINESS SUPPLY CHAIN MANAGEMENT SERVICES FOR OTHERS IN THE AREAS OF CATALOG, MAGAZINE, PUBLICATION AND RELATED PAPER PRODUCTS INDUSTRIES (U.S. CLS. 100, 101 AND 102).

FIRST USE 12-7-2000; IN COMMERCE 12-7-2000.

2,929,619. AMERICAN MULTI-CINEMA, INC., KANSAS CITY, MO. SN 78-172,047. PUB. 5-20-2003, FILED 10-8-2002.

**PICTURE PERFECT**

FOR CUSTOMER SERVICES IN THE FIELD OF MOVIE THEATER ENTERTAINMENT AND EMPLOYMENT RECRUITING SERVICES DESIGNED TO EDUCATE POTENTIAL EMPLOYEES OF QUALITY AND CUSTOMER SATISFACTION GOALS (U.S. CLS. 100, 101 AND 102).

FIRST USE 10-19-2004; IN COMMERCE 10-19-2004.

2,929,650. EHRHART, CURTIS, ROY, ANCHORAGE, AK. SN 78-192,155. PUB. 3-23-2004, FILED 12-6-2002.

**BIDALASKA**

FOR ON-LINE TRADING SERVICES IN WHICH SELLER POSTS PRODUCTS FROM ALASKA TO BE AUCTIONED, AND BIDDING IS DONE VIA THE INTERNET (U.S. CLS. 100, 101 AND 102).

FIRST USE 6-16-2004; IN COMMERCE 12-16-2004.

2,929,655. MARKET APPROACH CONSULTING SERVICES, L.P., LORENA, TX. SN 78-195,371. PUB. 3-16-2004, FILED 12-17-2002.

**MARKET APPROACH CONSULTING**

NO CLAIM IS MADE TO THE EXCLUSIVE RIGHT TO USE "MARKET" AND "CONSULTING", APART FROM THE MARK AS SHOWN.

FOR ADVERTISING AND MARKETING CONSULTING SERVICES, ADVERTISING MATERIALS PREPARATION SERVICES, BULK MAILING LIST PREPARATION SERVICES, AND DIRECT MAILING SERVICES (U.S. CLS. 100, 101 AND 102).

FIRST USE 8-4-2004; IN COMMERCE 8-4-2004.

**CLASS 35—(Continued).**

2,929,659. ANIMATION CONTENT, LLC., EAST GRANBY, CT. SN 78-197,603. PUB. 3-16-2004, FILED 12-23-2002.



NO CLAIM IS MADE TO THE EXCLUSIVE RIGHT TO USE ANIMATION CONTENT, APART FROM THE MARK AS SHOWN.

THE DESIGN PORTION OF THE MARK CONSISTS OF A LUNCH BOX WITH STARS AND CLOUDS ON THE FRONT.

FOR PROMOTIONAL, MARKETING AND DISTRIBUTION SERVICES IN THE FIELD OF ENTERTAINMENT, NAMELY PROMOTING THE GOODS AND SERVICES OF OTHERS VIA DISTRIBUTION OF PROMOTIONAL MATERIALS SUCH AS SOUND RECORDINGS AND AUDIOVISUAL RECORDINGS; AND PROMOTING THE GOODS AND SERVICES OF OTHERS VIA THE INTERNET, NAMELY PROVIDING A WEB SITE FEATURING AUDIO AND VIDEO PRESS KITS, PRESS INFORMATION, NEWS, REVIEWS AND OTHER MULTIMEDIA ARTICLES IN CONNECTION THE FIELD OF ENTERTAINMENT (U.S. CLS. 100, 101 AND 102).

FIRST USE 12-0-2002; IN COMMERCE 12-0-2002.

2,929,685. WOLF, GEORGE T., III, LANCASTER, PA. SN 78-212,434. PUB. 3-23-2004, FILED 2-7-2003.

**TRYVISTA**

FOR BUSINESS CONSULTING SERVICES (U.S. CLS. 100, 101 AND 102).  
FIRST USE 9-0-2002; IN COMMERCE 9-0-2002.

2,929,686. KATZ, STEVEN L., POTOMAC, MD. SN 78-212,562. PUB. 3-2-2004, FILED 2-8-2003.

**LION TAMING**

FOR BUSINESS CONSULTATION SERVICES (U.S. CLS. 100, 101 AND 102).  
FIRST USE 6-9-2004; IN COMMERCE 6-9-2004.

**CLASS 35—(Continued).**

2,929,704. SOFA CONNECTION, INC., MADISON, TN. SN 78-229,414. PUB. 12-2-2003, FILED 3-25-2003.

**ALL PLUSH, NO MINUSES**

FOR RETAIL FURNITURE STORE SERVICES (U.S. CLS. 100, 101 AND 102).  
FIRST USE 7-1-2003; IN COMMERCE 7-1-2003.

2,929,716. BEAUMAN, REBECCA L., COLUMBIA, MD. SN 78-235,398. PUB. 6-22-2004, FILED 4-8-2003.

**VIRTUALLY DETAILED**

FOR PROVIDING ADMINISTRATIVE AND BUSINESS SUPPORT SERVICES, NAMELY WORD PROCESSING FOR OTHERS ON AN INTERIM, ON-CALL, AS-NEEDED BASIS (U.S. CLS. 100, 101 AND 102).

FIRST USE 1-1-2004; IN COMMERCE 1-1-2004.

2,929,750. MAGNOLIA HI-FI, INC., KENT, WA. SN 78-252,484. PUB. 4-27-2004, FILED 5-21-2003.

**MAGNOLIA AUDIO VIDEO**

NO CLAIM IS MADE TO THE EXCLUSIVE RIGHT TO USE "AUDIO VIDEO", APART FROM THE MARK AS SHOWN.

FOR RETAIL STORE SERVICE FEATURING CONSUMER ELECTRONICS (U.S. CLS. 100, 101 AND 102).  
FIRST USE 8-1-2003; IN COMMERCE 8-1-2003.

2,929,751. MAGNOLIA HI-FI, INC., KENT, WA. SN 78-252,516. PUB. 4-27-2004, FILED 5-21-2003.



NO CLAIM IS MADE TO THE EXCLUSIVE RIGHT TO USE "AUDIO" OR "VIDEO", APART FROM THE MARK AS SHOWN.

FOR RETAIL STORE SERVICE FEATURING CONSUMER ELECTRONICS (U.S. CLS. 100, 101 AND 102).  
FIRST USE 8-1-2003; IN COMMERCE 8-1-2003.

**CLASS 35—(Continued).**

2,929,774. HICKORY PARK FURNITURE GALLERIES, INC., HICKORY, NC. SN 78-264,609. PUB. 3-2-2004, FILED 6-19-2003.

## CAROLINA PLACE FURNITURE GALLERIES

NO CLAIM IS MADE TO THE EXCLUSIVE RIGHT TO USE "CAROLINA" AND "FURNITURE GALLERIES", APART FROM THE MARK AS SHOWN.  
FOR RETAIL STORE SERVICES IN THE FIELD OF FURNITURE (U.S. CLS. 100, 101 AND 102).  
FIRST USE 9-1-2003; IN COMMERCE 9-1-2003.

2,929,779. HYPER QUALITY, SEATTLE, WA. SN 78-268,060. PUB. 3-16-2004, FILED 6-27-2003.

## HYPERQUALITY

FOR BUSINESS CONSULTING SERVICES WHICH PROVIDE QUALITY AND PERFORMANCE MEASUREMENTS AND ANALYSIS OF BUSINESS PERSONNEL AND BUSINESS METHODS (U.S. CLS. 100, 101 AND 102).  
FIRST USE 9-1-2003; IN COMMERCE 9-1-2003.

2,929,781. HYPER QUALITY, LLC., SEATTLE, WA. SN 78-269,944. PUB. 3-23-2004, FILED 7-2-2003.



THE MARK CONSISTS OF THE DESIGN AND THE COLOR OF THE DESIGN. COLOR IS A FEATURE OF THE MARK, NAMELY THE WREATH IS GOLD; THE LETTERS H AND Q ARE SET IN A CIRCLE HAVING A FILL COLOR OF GOLD WITH HORIZONTAL BLACK LINING AND THE RING OF TRIANGLES POINTS TO AN OUTER GOLD RING.

FOR BUSINESS CONSULTING SERVICES WHICH PROVIDE QUALITY AND PERFORMANCE MEASUREMENTS AND ANALYSIS OF BUSINESS PERSONNEL AND BUSINESS METHODS (U.S. CLS. 100, 101 AND 102).  
FIRST USE 9-1-2003; IN COMMERCE 9-1-2003.

**CLASS 35—(Continued).**

2,929,785. KWIK SHOP, INC., HUTCHINSON, KS. SN 78-270,592. PUB. 9-7-2004, FILED 7-3-2003.

## KWIK QUALITY GASOLINE

NO CLAIM IS MADE TO THE EXCLUSIVE RIGHT TO USE "QUALITY GASOLINE", APART FROM THE MARK AS SHOWN.  
FOR RETAIL GASOLINE SUPPLY SERVICES (U.S. CLS. 100, 101 AND 102).  
FIRST USE 5-0-2003; IN COMMERCE 5-0-2003.

2,929,794. THOMSON, E. CHIP, AUSTIN, TX. SN 78-275,931. PUB. 4-20-2004, FILED 7-18-2003.

## BEZA

FOR WHOLESALE DISTRIBUTORSHIP SERVICES AND ONLINE RETAIL STORE SERVICES IN THE FIELDS OF TOOLS, MONEY CLIPS AND WALLETS, GIFTS AND PERSONAL ACCESSORIES, PERSONAL CARE AND GROOMING ITEMS, LUGGAGE AND SMALL LEATHER GOODS, SPORTING GOODS AND SPORTS TRAINING AIDS, NOVELTY ITEMS, AND PROMOTIONAL ITEMS (U.S. CLS. 100, 101 AND 102).  
FIRST USE 7-0-2004; IN COMMERCE 7-0-2004.

2,929,810. THE TRIPLE-I CORPORATION, OVERLAND PARK, KS. SN 78-285,098. PUB. 6-8-2004, FILED 8-8-2003.

## VALT - VIRTUAL ACTION LEARNING TEAM

NO CLAIM IS MADE TO THE EXCLUSIVE RIGHT TO USE VIRTUAL ACTION LEARNING TEAM, APART FROM THE MARK AS SHOWN.  
FOR BUSINESS MANAGEMENT CONSULTATION SERVICES (U.S. CLS. 100, 101 AND 102).  
FIRST USE 8-4-2003; IN COMMERCE 8-4-2003.

2,929,824. CDC PARTNERS, LLC, IRVINE, CA. SN 78-293,135. PUB. 6-1-2004, FILED 8-27-2003.

## AUCTIONVALET

FOR RETAIL CONSIGNMENT SERVICES FOR CUSTOMERS WISHING TO SELL ITEMS VIA INTERNET AUCTION SITES (U.S. CLS. 100, 101 AND 102).  
FIRST USE 10-1-2003; IN COMMERCE 10-1-2003.

**CLASS 35—(Continued).**

2,929,827. CAREMARK INTERNATIONAL INC., NORTH-BROOK, IL. SN 78-296,094. PUB. 6-1-2004, FILED 9-4-2003.

## SAFE AND EFFECTIVE. BETTER VALUE.

FOR PROMOTING AWARENESS OF THE VALUE OF USING GENERIC DRUGS (U.S. CLS. 100, 101 AND 102).  
FIRST USE 9-0-2003; IN COMMERCE 9-0-2003.

---

2,929,833. BASS PRO TRADEMARKS, L.L.C., SPRINGFIELD, MO. SN 78-299,132. PUB. 7-27-2004, FILED 9-11-2003.

## SPORTSMAN'S CENTER

NO CLAIM IS MADE TO THE EXCLUSIVE RIGHT TO USE SPORTSMAN'S, APART FROM THE MARK AS SHOWN.

FOR RETAIL SPORTING GOODS STORE SERVICES (U.S. CLS. 100, 101 AND 102).  
FIRST USE 6-10-2004; IN COMMERCE 6-10-2004.

---

2,929,846. INTELISTAF HEALTHCARE MANAGEMENT, L.P., DALLAS, TX. SN 78-307,511. PUB. 7-27-2004, FILED 9-30-2003.

## INTELISOURCE

FOR VENDOR MANAGEMENT SERVICES, NAMELY, MONITORING, EVALUATING, AND ANALYZING THE PERFORMANCE OF EMPLOYEE PLACEMENT AND STAFFING PROGRAMS FOR OTHERS IN THE HEALTH CARE FIELD (U.S. CLS. 100, 101 AND 102).  
FIRST USE 10-18-2004; IN COMMERCE 10-18-2004.

---

2,929,860. ORCHARD COUNTRREE MARKET, INC., LA CRESCENT, MN. SN 78-313,588. PUB. 6-29-2004, FILED 10-14-2003.

## THE TWO WORLDS

FOR RETAIL STORES FEATURING FURNITURE AND HOME FURNISHINGS (U.S. CLS. 100, 101 AND 102).  
FIRST USE 11-6-2003; IN COMMERCE 11-11-2003.

**CLASS 35—(Continued).**

2,929,887. GETSMART.COM, INC., SAN FRANCISCO, CA. SN 78-975,601. PUB. 5-20-2003, FILED 6-12-2001.

## GETSMART

OWNER OF U.S. REG. NO. 2,241,814.

FOR PROMOTING THE GOODS AND SERVICES OF OTHERS BY PROVIDING A WEB SITE AT WHICH USERS CAN LINK TO SITES FEATURING FINANCIAL PRODUCTS AND SERVICES, CREDIT REPORTS AND CREDIT SCREENING, AND INFORMATION REGARDING MORTGAGES, REAL ESTATE, HOME PURCHASES AND RELOCATION; PROMOTING THE GOODS AND SERVICES OF OTHERS BY PROVIDING DISCOUNT COUPONS, SPECIAL WEBSITE OFFERS AND PROMOTIONAL OFFERS THROUGH DIRECT MAIL AND ELECTRONIC MAIL; PROMOTING CREDIT CARD USE BY PROVIDING DISCOUNTS ON VARIOUS GOODS AND SERVICES PURCHASED WITH A CREDIT CARD; MONITORING CUSTOMER ACCOUNTS AND PROVIDING AN ALERT AS TO CHANGES THEREIN, AS WELL AS PROVIDING ON-LINE CHARTS AND GRAPHS DOCUMENTING THOSE CHANGES AND ACCOUNT STATUS; COLLECTING AND MAINTAINING A USER'S PERSONAL DATA ON-LINE SO THAT THE USER NEED NOT REENTER THAT DATA FOR SUBSEQUENT ON-LINE PURCHASES OR APPLICATIONS; PROVIDING CONSUMER INFORMATION, NAMELY, PROVIDING ON-LINE DEAL AND PRICE COMPARISON SERVICES THAT COMPARE INFORMATION FROM THE CONSUMER'S AGGREGATED ACCOUNT, NOTIFY THE USER OF COST SAVING OPTIONS AND ALLOW THE USER TO OBTAIN THOSE OPTIONS; CONTESTS AND INCENTIVE AWARD PROGRAMS TO PROMOTE CREDIT CARD USE, THE ELECTRONIC PAYMENT OF CREDIT CARD BILLS, AND THE SALE OF PRODUCTS AND SERVICES OF OTHERS (U.S. CLS. 100, 101 AND 102).

FIRST USE 1-24-1998; IN COMMERCE 1-24-1998.

---

**CLASS 36—INSURANCE AND FINANCIAL**

2,929,059. FINETRE CORPORATION, HERNDON, VA. SN 75-647,371. PUB. 4-25-2000, FILED 2-24-1999.

## VARDS PROFILER

OWNER OF U.S. REG. NOS. 1,541,869 AND 2,158,052.

NO CLAIM IS MADE TO THE EXCLUSIVE RIGHT TO USE "PROFILER", APART FROM THE MARK AS SHOWN. FOR FINANCIAL INFORMATION SERVICES, NAMELY, PROVIDING QUARTERLY AND MONTHLY REPORTS ON THE PERFORMANCE AND OTHER CHARACTERISTICS OF VARIABLE ANNUITIES (U.S. CLS. 100, 101 AND 102).

FIRST USE 2-0-1999; IN COMMERCE 2-0-1999.

---

2,929,076. GREENBLATT, JOEL, DBA GOTHAM CAPITAL, NEW YORK, NY. SN 75-892,614. PUB. 7-30-2002, FILED 1-7-2000.

## GOTHAM FUNDS

NO CLAIM IS MADE TO THE EXCLUSIVE RIGHT TO USE "FUNDS", APART FROM THE MARK AS SHOWN.

FOR FINANCIAL SERVICES, NAMELY INVESTMENT ADVISORY SERVICES AND INVESTMENT MANAGEMENT SERVICES (U.S. CLS. 100, 101 AND 102).  
FIRST USE 4-12-2004; IN COMMERCE 4-12-2004.

**CLASS 36—(Continued).**

2,929,110. BUSINESS BANK OF NEVADA, LAS VEGAS, NV. SN 76-106,382. PUB. 3-5-2002, FILED 8-8-2000.

## ALWAYS ON CASH MANAGEMENT

NO CLAIM IS MADE TO THE EXCLUSIVE RIGHT TO USE "CASH MANAGEMENT", APART FROM THE MARK AS SHOWN.

FOR CASH MANAGEMENT FINANCIAL SERVICES (U.S. CLS. 100, 101 AND 102).  
FIRST USE 9-25-2004; IN COMMERCE 9-25-2004.

2,929,185. CHUBB CORPORATION, THE, WARREN, NJ. SN 76-264,062. PUB. 1-1-2002, FILED 5-30-2001.

## VIRGINIA PLATINUM

NO CLAIM IS MADE TO THE EXCLUSIVE RIGHT TO USE "VIRGINIA", APART FROM THE MARK AS SHOWN.  
FOR INSURANCE UNDERWRITING SERVICES, NAMELY, AUTOMOBILE INSURANCE (U.S. CLS. 100, 101 AND 102).  
FIRST USE 11-1-2004; IN COMMERCE 11-1-2004.

2,929,215. UICI, INC., OKLAHOMA CITY, OK. SN 76-324,835. PUB. 10-15-2002, FILED 10-5-2001.

## BLUEPRINT FOR LIFE

FOR INSURANCE CONSULTATION, NAMELY, ANALYSIS OF A CONSUMER'S INSURANCE NEEDS (U.S. CLS. 100, 101 AND 102).  
FIRST USE 12-18-2001; IN COMMERCE 2-0-2002.

2,929,224. METRIS DIRECT, INC., MINNETONKA, MN. SN 76-336,504. PUB. 4-30-2002, FILED 11-9-2001.

## 90 DAYS TO SAVE

FOR BANKING SERVICES (U.S. CLS. 100, 101 AND 102).  
FIRST USE 1-31-2002; IN COMMERCE 1-31-2002.

2,929,247. SECURITY FINANCIAL LIFE INSURANCE COMPANY, LINCOLN, NE. SN 76-374,196. PUB. 9-16-2003, FILED 2-25-2002.

## ASCENTIAL LIFE

NO CLAIM IS MADE TO THE EXCLUSIVE RIGHT TO USE "LIFE", APART FROM THE MARK AS SHOWN.  
FOR LIFE INSURANCE UNDERWRITING SERVICES, EXCLUDING ELECTRONIC PROCESSING OF UNDERWRITING DATA (U.S. CLS. 100, 101 AND 102).  
FIRST USE 7-10-2002; IN COMMERCE 7-10-2002.

**CLASS 36—(Continued).**

2,929,275. THE S & W AGENCY, INC., NEW YORK, NY. SN 76-422,570. PUB. 1-28-2003, FILED 6-18-2002.

## THE ECONOMIC CONFIDENCE BUILDER

NO CLAIM IS MADE TO THE EXCLUSIVE RIGHT TO USE "ECONOMIC", APART FROM THE MARK AS SHOWN.

FOR FINANCIAL SERVICES, NAMELY FINANCIAL PLANNING SERVICES, INSURANCE BROKERAGE SERVICES, ESTATE PLANNING SERVICES, INVESTMENT COUNSELING SERVICES, AND TAX PLANNING SERVICES (U.S. CLS. 100, 101 AND 102).  
FIRST USE 10-25-2002; IN COMMERCE 10-25-2002.

2,929,316. BROWN INVESTMENT PARTNERSHIP, LTD., KANSAS CITY, MO. SN 76-472,176. PUB. 1-6-2004, FILED 12-3-2002.

## VILLAGE POINTE

FOR SHOPPING CENTER SERVICES, NAMELY, LEASING AND MANAGEMENT OF MALL SPACE TO DEPARTMENT STORES, SPECIALITY STORES, RETAILERS, RESTAURANTS, THEATERS, PARTIES PROVIDING SERVICES TO OTHERS AND LEASING MALL SPACE TO PARTIES PROVIDING MAIL DROP BOXES FOR OTHERS (U.S. CLS. 100, 101 AND 102).  
FIRST USE 5-30-2004; IN COMMERCE 5-30-2004.

2,929,320. XPRESSBET INCORPORATED, WASHINGTON, PA. SN 76-475,175. PUB. 3-9-2004, FILED 12-5-2002.

## XPRESSFUND

FOR PARIMUTUEL WAGERING SERVICES, NAMELY ON-LINE, INTERNET AND ELECTRONIC ADVANCE DEPOSIT AND PRE-PAID ACCOUNT WAGERING, TELEPHONE AND TELEVISION ADVANCE DEPOSIT AND PRE-PAID ACCOUNT WAGERING, OFF-TRACK AND ON-TRACK WAGERING, ALL OFFERED SOLELY THROUGH APPLICANT'S EXCLUSIVE NETWORK (U.S. CLS. 100, 101 AND 102).  
FIRST USE 11-1-2004; IN COMMERCE 11-1-2004.

2,929,351. AUSPEX GROUP, L.P., COS COB, CT. SN 76-496,127. PUB. 12-30-2003, FILED 3-10-2003.

## AUSPEX FUND

NO CLAIM IS MADE TO THE EXCLUSIVE RIGHT TO USE "FUND", APART FROM THE MARK AS SHOWN.  
FOR FINANCIAL SERVICES, NAMELY, INVESTMENT ADVISORY SERVICES, INVESTMENT MANAGEMENT SERVICES AND ASSET MANAGEMENT SERVICES (U.S. CLS. 100, 101 AND 102).  
FIRST USE 7-0-2003; IN COMMERCE 7-0-2003.



**CLASS 36—(Continued).**

2,929,352. AUSPEX GROUP, L.P., COS COB, CT. SN 76-496,128. PUB. 12-30-2003, FILED 3-10-2003.

**AUSPEX GROUP**

NO CLAIM IS MADE TO THE EXCLUSIVE RIGHT TO USE "GROUP", APART FROM THE MARK AS SHOWN.  
FOR FINANCIAL SERVICES, NAMELY, INVESTMENT ADVISORY SERVICES, INVESTMENT MANAGEMENT SERVICES AND ASSET MANAGEMENT SERVICES (U.S. CLS. 100, 101 AND 102).  
FIRST USE 7-0-2003; IN COMMERCE 7-0-2003.

2,929,353. AUSPEX GROUP, L.P., COS COB, CT. SN 76-496,129. PUB. 12-30-2003, FILED 3-10-2003.

**AUSPEX PARTNERS**

NO CLAIM IS MADE TO THE EXCLUSIVE RIGHT TO USE "PARTNERS", APART FROM THE MARK AS SHOWN.  
FOR FINANCIAL SERVICES, NAMELY, INVESTMENT ADVISORY SERVICES, INVESTMENT MANAGEMENT SERVICES AND ASSET MANAGEMENT SERVICES (U.S. CLS. 100, 101 AND 102).  
FIRST USE 7-0-2003; IN COMMERCE 7-0-2003.

2,929,357. FIRST NIAGARA FINANCIAL GROUP, INC., LOCKPORT, NY. SN 76-497,517. PUB. 10-21-2003, FILED 3-10-2003.

**ULTRA FLEX HOME EQUITY**

NO CLAIM IS MADE TO THE EXCLUSIVE RIGHT TO USE "HOME EQUITY", APART FROM THE MARK AS SHOWN.  
FOR BANKING SERVICES, NAMELY, HOME EQUITY LOAN SERVICES AND HOME EQUITY LINE OF CREDIT SERVICES (U.S. CLS. 100, 101 AND 102).  
FIRST USE 6-1-2003; IN COMMERCE 6-1-2003.

2,929,399. INDYMAC BANK, F.S.B., PASADENA, CA. SN 76-512,691. PUB. 1-20-2004, FILED 5-8-2003.

**A HOME LENDER ON A MISSION**

OWNER OF U.S. REG. NO. 2,387,761.  
FOR FINANCIAL SERVICES, NAMELY, BANKING SERVICES; CONSUMER AND MORTGAGE LENDING, NAMELY, LOAN ORIGINATION AND SERVICING; MORTGAGE BROKERAGE SERVICES (U.S. CLS. 100, 101 AND 102).  
FIRST USE 10-22-2004; IN COMMERCE 10-22-2004.

**CLASS 36—(Continued).**

2,929,405. INDYMAC BANK, F.S.B., PASADENA, CA. SN 76-517,323. PUB. 6-1-2004, FILED 5-23-2003.

**POWERED BY HOME CONSTRUCTION LENDING**

NO CLAIM IS MADE TO THE EXCLUSIVE RIGHT TO USE "HOME CONSTRUCTION LENDING", APART FROM THE MARK AS SHOWN.

FOR FINANCIAL SERVICES, NAMELY, CONSTRUCTION LENDING SERVICES; BANKING SERVICES; MORTGAGE AND LOAN ORIGINATION AND SERVICING OF MORTGAGE LOANS; COMMERCIAL AND CONSTRUCTION LENDING SERVICES; REAL ESTATE BROKERAGE AND LENDING; TITLE INSURANCE SERVICES; CREDIT CARD SERVICES; AND PROVIDING FINANCIAL INFORMATION BY MEANS OF A WEB PAGE FEATURING INFORMATION REGARDING THE APPLICATION PROCESS FOR CONSUMER CONSTRUCTION LOANS (U.S. CLS. 100, 101 AND 102).  
FIRST USE 9-1-2004; IN COMMERCE 9-1-2004.

2,929,408. UPTON PYNE ESTATES, LLC, BERNARDSVILLE, NJ. SN 76-519,917. PUB. 3-30-2004, FILED 5-22-2003.

**UPTON PYNE**

FOR REAL ESTATE SERVICES, NAMELY, REAL ESTATE MANAGEMENT, BROKERAGE AND FINANCING (U.S. CLS. 100, 101 AND 102).  
FIRST USE 7-1-2000; IN COMMERCE 6-1-2003.

2,929,462. FORTROSS CAPITAL MANAGEMENT, LLC, SANTA MONICA, CA. SN 76-539,046. PUB. 7-6-2004, FILED 8-20-2003.

**FORTROSS**

FOR INVESTMENT ADVISORY AND MANAGEMENT SERVICES FOR DOMESTIC AND OFFSHORE CLIENTS, NAMELY, INVESTMENT MANAGEMENT; GENERAL PARTNERSHIP SERVICES, NAMELY, FORMATION, OFFERING AND MANAGEMENT OF LIMITED PARTNERSHIPS (U.S. CLS. 100, 101 AND 102).  
FIRST USE 1-1-2004; IN COMMERCE 1-1-2004.

2,929,482. ALSPAUGH, SARAH P., CINCINNATI, OH. SN 76-547,195. PUB. 7-27-2004, FILED 9-26-2003.

**THE CLARUS GROUP**

NO CLAIM IS MADE TO THE EXCLUSIVE RIGHT TO USE GROUP, APART FROM THE MARK AS SHOWN.  
THE ENGLISH TRANSLATION OF CLARUS IS CLEAR.  
FOR FINANCIAL SERVICES, NAMELY CHARITABLE ESTATE PLANNING AND INVESTMENT ADVICE AND MANAGEMENT SERVICES (U.S. CLS. 100, 101 AND 102).  
FIRST USE 1-31-2004; IN COMMERCE 1-31-2004.

**CLASS 36—(Continued).**

2,929,489. ACE CASH EXPRESS, INC., IRVING, TX. SN 78-551,032. PUB. 7-20-2004, FILED 9-22-2003.

**ACE CASH ADVANCE**

OWNER OF U.S. REG. NOS. 1,806,389, 1,831,546, AND 2,155,964.

NO CLAIM IS MADE TO THE EXCLUSIVE RIGHT TO USE CASH ADVANCE, APART FROM THE MARK AS SHOWN.

FOR FINANCIAL SERVICES, NAMELY PROVIDING DEBIT CARD, CASH DISBURSEMENT AND TRANSACTION AUTHORIZATION, CHECK VERIFICATION SERVICES AND DEFERRED DEPOSIT LOANS (U.S. CLS. 100, 101 AND 102).

FIRST USE 10-14-2003; IN COMMERCE 10-14-2003.

2,929,495. MERRILL LYNCH & CO., INC., NEW YORK, NY. SN 76-554,571. PUB. 6-1-2004, FILED 10-27-2003.

**CORPORATE POWER**

FOR FINANCIAL SERVICES, NAMELY, AN EMPLOYEE RELOCATION AND RETENTION PROGRAM OFFERED TO CORPORATE CLIENTS FOR THEIR EMPLOYEES CONSISTING OF A DOWN PAYMENT GUARANTY, PAYMENT SUBSIDIES AND DIRECT BILLING OF CLOSING COSTS (U.S. CLS. 100, 101 AND 102).

FIRST USE 7-1-2003; IN COMMERCE 7-1-2003.

2,929,535. FMR CORP., BOSTON, MA. SN 78-044,492. PUB. 2-24-2004, FILED 1-23-2001.



OWNER OF U.S. REG. NOS. 1,277,373, 1,278,300, AND OTHERS.

NO CLAIM IS MADE TO THE EXCLUSIVE RIGHT TO USE "E 401K", APART FROM THE MARK AS SHOWN.

FOR PROVIDING FINANCIAL INFORMATION, INFORMATION ABOUT INVESTMENT ACCOUNTS, INVESTMENT MANAGEMENT SERVICES AND RETIREMENT FUND INVESTMENT SERVICES, ALL BY MEANS OF THE INTERNET (U.S. CLS. 100, 101 AND 102).

FIRST USE 8-0-2000; IN COMMERCE 8-0-2000.

**CLASS 36—(Continued).**

2,929,595. OAK STREET MORTGAGE, LLC, CARMEL, IN. SN 78-147,504. PUB. 9-30-2003, FILED 7-25-2002.

**OAK STREET**

FOR BILL CONSOLIDATION SERVICES; CONSUMER LENDING SERVICES; FACILITATING AND ARRANGING FOR THE FINANCING OF BUSINESSES, HOMES, AUTOMOBILES, AND PERSONAL PROPERTY; FINANCIAL SERVICES IN THE FIELD OF MONEY LENDING; FINANCIAL SERVICES; HOME EQUITY LOAN SERVICES; LOAN FINANCING SERVICES; MAINTAINING MORTGAGE ESCROW ACCOUNTS SERVICES; MORTGAGE BANKING SERVICES; MORTGAGE BROKERAGE SERVICES; MORTGAGE LENDING SERVICES; AND MORTGAGE PROCUREMENT FOR OTHERS (U.S. CLS. 100, 101 AND 102).

FIRST USE 11-1-2002; IN COMMERCE 11-1-2002.

2,929,600. REAL LIVING, INC., COLUMBUS, OH. SN 78-152,417. PUB. 5-6-2003, FILED 8-8-2002.

**REAL LIVING**

OWNER OF U.S. REG. NO. 2,435,464.  
FOR INSURANCE AGENCIES IN THE FIELDS OF TITLE INSURANCE AND HOME WARRANTY INSURANCE, MORTGAGE BROKERAGE, REAL ESTATE BROKERAGE (U.S. CLS. 100, 101 AND 102).

FIRST USE 3-14-2003; IN COMMERCE 3-14-2003.

2,929,614. IRVINE COMPANY, THE, NEWPORT BEACH, CA. SN 78-170,217. PUB. 4-22-2003, FILED 10-2-2002.

**PACIFIC RIDGE**

FOR REAL ESTATE BROKERAGE AND LEASING SERVICES FOR RESIDENTIAL AND COMMERCIAL PROPERTY (U.S. CLS. 100, 101 AND 102).

FIRST USE 3-31-2004; IN COMMERCE 3-31-2004.

2,929,620. LAZERSON, JEFF, LEGUNA NIGUEL, CA. SN 78-174,263. PUB. 1-20-2004, FILED 10-14-2002.

**EQUALITY PACKAGE**

NO CLAIM IS MADE TO THE EXCLUSIVE RIGHT TO USE "PACKAGE", APART FROM THE MARK AS SHOWN.

FOR MORTGAGE PROCUREMENT FOR OTHERS, NAMELY, SELF-EVALUATED MORTGAGE APPLICATION PROCESSING AND QUALIFICATION SERVICES; MATCHING OF BORROWERS WITH POTENTIAL LENDERS IN THE FIELD OF CONSUMER AND MORTGAGE LENDING AND PROVISION OF INFORMATION REGARDING CONSUMER MORTGAGES VIA THE INTERNET (U.S. CLS. 100, 101 AND 102).

FIRST USE 9-10-2004; IN COMMERCE 9-10-2004.

**CLASS 36—(Continued).**

2,929,654. MARKET APPROACH CONSULTING SERVICES, L.P., LORENA, TX. SN 78-195,368. PUB. 3-16-2004, FILED 12-17-2002.

## PARAMOUNT RECOVERY SYSTEMS

NO CLAIM IS MADE TO THE EXCLUSIVE RIGHT TO USE "RECOVERY SYSTEMS", APART FROM THE MARK AS SHOWN.

FOR COLLECTION AGENCY SERVICES (U.S. CLS. 100, 101 AND 102).

FIRST USE 8-4-2004; IN COMMERCE 8-4-2004.

2,929,668. FMR CORP., BOSTON, MA. SN 78-203,559. PUB. 9-23-2003, FILED 1-15-2003.



## ORGANIZATION OF RETIREMENT LEADERS

NO CLAIM IS MADE TO THE EXCLUSIVE RIGHT TO USE "ORGANIZATION" AND "RETIREMENT", APART FROM THE MARK AS SHOWN.

FOR FINANCIAL SERVICES, NAMELY, RETIREMENT FUND INVESTMENT SERVICES; PROVIDING FINANCIAL INFORMATION IN THE FIELD OF RETIREMENT PLANNING; RETIREMENT PLAN ADMINISTRATION SERVICES; INVESTMENT MANAGEMENT SERVICES; SECURITIES BROKERAGE SERVICES (U.S. CLS. 100, 101 AND 102).

FIRST USE 2-27-2003; IN COMMERCE 2-27-2003.

2,929,671. DIALOGUEDIRECT LTD., OXFORD, UNITED KINGDOM. SN 78-205,913. PUB. 1-27-2004, FILED 1-22-2003.

## DIALOGUEDIRECT

FOR CHARITABLE FUND RAISING (U.S. CLS. 100, 101 AND 102).

FIRST USE 7-14-1995; IN COMMERCE 7-14-1995.

**CLASS 36—(Continued).**

2,929,673. KEYCORP, CLEVELAND, OH. SN 78-206,198. PUB. 6-29-2004, FILED 1-23-2003.

## KEY INVENTORY MANAGEMENT

OWNER OF U.S. REG. NOS. 1,495,327, 2,631,102, AND OTHERS.

NO CLAIM IS MADE TO THE EXCLUSIVE RIGHT TO USE "INVENTORY MANAGEMENT", APART FROM THE MARK AS SHOWN.

FOR FINANCIAL SERVICES ACCESSED VIA A GLOBAL COMPUTER NETWORK, NAMELY ON-LINE MARINE, RECREATIONAL VEHICLE, AND AUTO DEALER WHOLESALE FLOOR PLAN LINES OF CREDIT (U.S. CLS. 100, 101 AND 102).

FIRST USE 2-28-2003; IN COMMERCE 2-28-2003.

2,929,676. NEUBERGER BERMAN MANAGEMENT INC., NEW YORK, NY. SN 78-207,894. PUB. 6-29-2004, FILED 1-28-2003.

## NEUBERGER BERMAN ADVISERS MANAGEMENT TRUST FOCUS PORTFOLIO

OWNER OF U.S. REG. NOS. 1,939,546, 2,651,905, AND OTHERS.

NO CLAIM IS MADE TO THE EXCLUSIVE RIGHT TO USE ADVISERS MANAGEMENT TRUST AND PORTFOLIO, APART FROM THE MARK AS SHOWN.

FOR INVESTMENT ADVISORY AND MUTUAL FUND SERVICES, NAMELY, SPONSORING MUTUAL FUNDS, PROVIDING ADMINISTRATION AND SHAREHOLDER SERVICES TO MUTUAL FUNDS, DISTRIBUTING MUTUAL FUND SHARES AND MANAGING FUNDS AND BONDS AND OTHER INVESTMENTS FOR INSTITUTIONS AND THE GENERAL PUBLIC (U.S. CLS. 100, 101 AND 102).

FIRST USE 8-1-2004; IN COMMERCE 8-1-2004.

2,929,677. NEUBERGER BERMAN MANAGEMENT INC., NEW YORK, NY. SN 78-207,899. PUB. 6-29-2004, FILED 1-28-2003.

## NEUBERGER BERMAN ADVISERS MANAGEMENT TRUST REGENCY PORTFOLIO

OWNER OF U.S. REG. NOS. 1,939,546, 2,651,905, AND OTHERS.

NO CLAIM IS MADE TO THE EXCLUSIVE RIGHT TO USE ADVISERS MANAGEMENT TRUST AND PORTFOLIO, APART FROM THE MARK AS SHOWN.

FOR INVESTMENT ADVISORY AND MUTUAL FUND SERVICES, NAMELY, SPONSORING MUTUAL FUNDS, PROVIDING ADMINISTRATION AND SHAREHOLDER SERVICES TO MUTUAL FUNDS, DISTRIBUTING MUTUAL FUND SHARES AND MANAGING FUNDS AND BONDS AND OTHER INVESTMENTS FOR INSTITUTIONS AND THE GENERAL PUBLIC (U.S. CLS. 100, 101 AND 102).

FIRST USE 8-2-2004; IN COMMERCE 8-2-2004.

**CLASS 36—(Continued).**

2,929,680. AMERICAN COMMUNITY MUTUAL INSURANCE COMPANY, LIVONIA, MI. SN 78-208,868. PUB. 5-11-2004, FILED 1-30-2003.



OWNER OF U.S. REG. NOS. 2,429,348 AND 2,430,876.  
NO CLAIM IS MADE TO THE EXCLUSIVE RIGHT TO USE "AMERICAN COMMUNITY MUTUAL INSURANCE COMPANY", APART FROM THE MARK AS SHOWN.  
FOR INSURANCE UNDERWRITING SERVICES IN THE FIELDS OF LIFE AND HEALTH (U.S. CLS. 100, 101 AND 102).  
FIRST USE 5-16-2002; IN COMMERCE 5-16-2002.

2,929,691. BACA, ENRIQUE, ALPHARETTA, GA. SN 78-217,800. PUB. 7-6-2004, FILED 2-22-2003.

**CHEQUEMATICO**

FOR CHECK CASHING SERVICES, ISSUING STORED VALUE CARDS, DEBIT CARD SERVICES, AND DIRECT DEPOSIT SERVICES (U.S. CLS. 100, 101 AND 102).  
FIRST USE 5-31-2003; IN COMMERCE 5-31-2003.

2,929,694. TRANSWORLD MAGAZINE CORPORATION, OCEANSIDE, CA. SN 78-218,983. PUB. 6-8-2004, FILED 2-26-2003.

**TRANSWORLD  
MOTOCROSS**

OWNER OF U.S. REG. NO. 2,643,634.  
FOR CREDIT CARD SERVICES; DEBIT CARD SERVICES; CASH DISBURSEMENT SERVICES IN THE NATURE OF DISPENSING CASH AGAINST A CREDIT LINE (U.S. CLS. 100, 101 AND 102).  
FIRST USE 6-1-2003; IN COMMERCE 6-1-2003.

**CLASS 36—(Continued).**

2,929,708. INSTINET, LLC, NEW YORK, NY. SN 78-232,320. PUB. 3-16-2004, FILED 4-1-2003.

**BROKERSHARE**

FOR FINANCIAL SERVICES, NAMELY, FINANCIAL PLANNING SERVICES, FINANCIAL PORTFOLIO MANAGEMENT SERVICES, FINANCIAL MANAGEMENT SERVICES, FINANCIAL ANALYSIS AND CONSULTATION, ELECTRONIC TRADING OF SECURITIES AND RESEARCH THEREFOR, ORDER MANAGEMENT SERVICES, NAMELY, MONITORING AND MANAGEMENT OF INDIVIDUAL SECURITIES ORDERS AND LISTS; INVESTMENT SERVICES AND TRADING ADVICE, INVESTMENT AND TRADING CONSULTATION, PROVIDING INFORMATION ABOUT FINANCIAL INVESTMENTS, IMPLEMENTATION EFFECTIVENESS AND TRADING EXECUTION QUALITY VIA ON-LINE GLOBAL COMMUNICATIONS NETWORKS; DISSEMINATION OF INFORMATION VIA AN ON LINE ELECTRONICS NETWORK AND DISTRIBUTING MANUALS AND REPORTS RELATED TO THE ABOVE SERVICES (U.S. CLS. 100, 101 AND 102).  
FIRST USE 6-30-2003; IN COMMERCE 6-30-2003.

2,929,740. SULLIVAN REALTY LLC, PEPPER PIKE, OH. SN 78-247,631. PUB. 1-6-2004, FILED 5-9-2003.

**SMARTEBROCHURE**

FOR REAL ESTATE SERVICES, NAMELY, REAL ESTATE BROKERAGE AND REAL ESTATE AGENCY SERVICES (U.S. CLS. 100, 101 AND 102).  
FIRST USE 8-0-2003; IN COMMERCE 8-0-2003.

2,929,741. LANGLEY, FRED R., KNOXVILLE, TN. SN 78-247,885. PUB. 5-18-2004, FILED 5-9-2003.

**BANKEAST**

FOR BANKING SERVICES (U.S. CLS. 100, 101 AND 102).  
FIRST USE 4-17-2004; IN COMMERCE 4-17-2004.

2,929,763. LOVETT, JAY A., NEW SMYRNA BEACH, FL. SN 78-259,684. PUB. 4-13-2004, FILED 6-8-2003.

**BEACH LIFE REALTY**

NO CLAIM IS MADE TO THE EXCLUSIVE RIGHT TO USE "BEACH" AND "REALTY", APART FROM THE MARK AS SHOWN.  
FOR REAL ESTATE AGENCIES, REAL ESTATE BROKERAGE, LEASING OF REAL ESTATE, AND REAL ESTATE ACQUISITION SERVICES (U.S. CLS. 100, 101 AND 102).  
FIRST USE 11-23-2004; IN COMMERCE 11-23-2004.

**CLASS 36—(Continued).**

2,929,780. BUCHANAN STREET PARTNERS, INC., NEWPORT BEACH, CA. SN 78-268,262. PUB. 2-24-2004, FILED 6-27-2003.

**CAPITAL YOU CAN COUNT ON**

FOR FINANCIAL AND INVESTMENT SERVICES, NAMELY, REAL ESTATE INVESTMENT SERVICES; FINANCING SERVICES, MORTGAGE BROKERAGE SERVICES, FINANCIAL ANALYSIS AND CONSULTATION SERVICES; PROVIDING FINANCIAL AND REAL ESTATE INVESTMENT SERVICES, NAMELY, COMMERCIAL MORTGAGE BROKERAGE SERVICES, REAL ESTATE INVESTMENT SERVICES AND REAL ESTATE MORTGAGE LENDING; FINANCING SERVICES, MORTGAGE BROKERAGE SERVICES, FINANCIAL ANALYSIS AND CONSULTATION SERVICES VIA A GLOBAL COMPUTER NETWORK (U.S. CLS. 100, 101 AND 102).

FIRST USE 1-0-2004; IN COMMERCE 1-0-2004.

2,929,786. NORTHEAST BANK FSB, AUBURN, ME. SN 78-271,021. PUB. 3-23-2004, FILED 7-7-2003.

**NO ORDINARY BANK**

FOR BANKING SERVICES; LOAN FINANCING; MORTGAGE LENDING; MOTOR VEHICLE LOANS; HOME EQUITY LOANS; WORKING CAPITAL LOANS; LOANS FOR MACHINERY AND EQUIPMENT; COMMERCIAL LOANS AND LINES OF CREDIT; CONSUMER LOANS AND LINES OF CREDIT; FINANCIAL MANAGEMENT; FINANCIAL PLANNING AND FINANCIAL ANALYSIS AND CONSULTATION SERVICES; CASH MANAGEMENT SERVICES; ESTATE TRUST MANAGEMENT SERVICES; AND INSURANCE CONSULTATION SERVICES (U.S. CLS. 100, 101 AND 102).

FIRST USE 9-21-2003; IN COMMERCE 9-21-2003.

2,929,805. AMERICAN EXPRESS COMPANY, NEW YORK, NY. SN 78-282,024. PUB. 4-13-2004, FILED 8-1-2003.

**THE OFFICIAL CARD OF TURNING HEADS**

FOR FINANCIAL SERVICES, NAMELY, CHARGE CARD AND CREDIT CARD SERVICES (U.S. CLS. 100, 101 AND 102).

FIRST USE 3-1-2003; IN COMMERCE 3-1-2003.

**CLASS 36—(Continued).**

2,929,819. NATIONAL BANKERS TRUST CORP, MEMPHIS, TN. SN 78-288,267. PUB. 6-15-2004, FILED 8-16-2003.



FOR ACCOUNTS RECEIVABLE FINANCING (U.S. CLS. 100, 101 AND 102).

FIRST USE 4-1-1998; IN COMMERCE 11-1-1998.

2,929,830. FMR CORP., BOSTON, MA. SN 78-297,897. PUB. 6-8-2004, FILED 9-9-2003.

**ONEQ**

FOR FINANCIAL SERVICES, NAMELY, EXCHANGE TRADED FUND INVESTMENT SERVICES; MUTUAL FUND INVESTMENT SERVICES; INVESTMENT OF FUNDS FOR OTHERS (U.S. CLS. 100, 101 AND 102).

FIRST USE 9-25-2003; IN COMMERCE 9-25-2003.

2,929,852. FMR CORP., BOSTON, MA. SN 78-307,642. PUB. 5-25-2004, FILED 9-30-2003.

**FIDELITY FREEDOM 2025 FUND**

OWNER OF U.S. REG. NOS. 2,156,685, 2,568,304, AND OTHERS.

NO CLAIM IS MADE TO THE EXCLUSIVE RIGHT TO USE "2025 FUND", APART FROM THE MARK AS SHOWN. FOR MUTUAL FUND INVESTMENT AND BROKERAGE SERVICES (U.S. CLS. 100, 101 AND 102).

FIRST USE 11-6-2003; IN COMMERCE 11-6-2003.

2,929,853. FMR CORP., BOSTON, MA. SN 78-307,648. PUB. 5-25-2004, FILED 9-30-2003.

**FIDELITY ADVISOR FREEDOM FUNDS**

OWNER OF U.S. REG. NOS. 1,970,099, 2,568,304, AND OTHERS.

NO CLAIM IS MADE TO THE EXCLUSIVE RIGHT TO USE "FUNDS", APART FROM THE MARK AS SHOWN. SEC. 2(F) AS TO "ADVISOR".

FOR MUTUAL FUND INVESTMENT AND BROKERAGE SERVICES (U.S. CLS. 100, 101 AND 102).

FIRST USE 7-24-2003; IN COMMERCE 7-24-2003.

**CLASS 36—(Continued).**

2,929,854. FMR CORP., BOSTON, MA. SN 78-307,650. PUB. 5-25-2004, FILED 9-30-2003.

## FIDELITY ADVISOR FREEDOM INCOME FUND

OWNER OF U.S. REG. NOS. 1,970,099, 2,568,304, AND OTHERS.

NO CLAIM IS MADE TO THE EXCLUSIVE RIGHT TO USE "INCOME FUND", APART FROM THE MARK AS SHOWN.

SEC. 2(F) AS TO "ADVISOR".  
FOR MUTUAL FUND INVESTMENT AND BROKER-AGE SERVICES (U.S. CLS. 100, 101 AND 102).  
FIRST USE 7-24-2003; IN COMMERCE 7-24-2003.

**CLASS 37—CONSTRUCTION AND REPAIR**

2,929,086. HARMAN INTERNATIONAL INDUSTRIES, INCORPORATED, NORTHRIDGE, CA. SN 75-982,878. PUB. 7-27-2004, FILED 8-22-2000.

## BECKER

SEC. 2(F).  
FOR REPAIR AND MAINTENANCE OF ELECTRO-TECHNICAL AND ELECTRONIC ARTICLES, ESPECIALLY OF CAR RADIO EQUIPMENTS, RADIO TELEPHONES, HEATING EQUIPMENTS FOR MOTOR CAR SEATS, SIGNALING DEVICES FOR MOTOR CARS AND OTHER ELECTRIC AND ELECTRONIC PARTS OF AND FOR MOTOR CARS (U.S. CLS. 100, 103 AND 106).  
FIRST USE 12-31-1973; IN COMMERCE 12-31-1973.

2,929,119. OKUMA AMERICA CORPORATION, CHARLOTTE, NC. SN 76-149,291. PUB. 4-16-2002, FILED 10-18-2000.

## TRUE BLUE

FOR PREVENTIVE MAINTENANCE SERVICES FOR MACHINE TOOLS (U.S. CLS. 100, 103 AND 106).  
FIRST USE 9-0-2000; IN COMMERCE 9-0-2000.

2,929,191. MALLO, THOMAS P., MESA, AZ. SN 76-268,256. PUB. 10-23-2001, FILED 6-6-2001.

## BUY DIRECT

FOR AUTOMOBILE REPAIR AND MAINTENANCE SERVICES (U.S. CLS. 100, 103 AND 106).  
FIRST USE 7-11-2004; IN COMMERCE 7-11-2004.

**CLASS 37—(Continued).**

2,929,552. GB 500, INC., NAPLES, FL. SN 78-087,099. PUB. 3-12-2002, FILED 10-5-2001.



## BUILDING EXCELLENCE

OWNER OF U.S. REG. NOS. 2,351,590 AND 2,361,093.  
FOR REAL ESTATE DEVELOPMENT; DEVELOPMENT OF COMMERCIAL AND RESIDENTIAL BUILDINGS; RESIDENTIAL AND COMMERCIAL BUILDING CONSTRUCTION AND REPAIR; LAND DEVELOPMENT SERVICES, NAMELY PLANNING AND LAYING OUT OF RESIDENTIAL AND COMMERCIAL COMMUNITIES; REAL ESTATE DEVELOPMENT AND LAND DEVELOPMENT SERVICES, NAMELY PLANNING AND LAYING OUT OF RESIDENTIAL AND COMMERCIAL COMMUNITIES PROVIDED VIA A GLOBAL COMPUTER NETWORK; AND INFORMATION FOR ALL OF THE FOREGOING PROVIDED VIA A GLOBAL COMPUTER NETWORK (U.S. CLS. 100, 103 AND 106).  
FIRST USE 9-2-2003; IN COMMERCE 9-2-2003.

2,929,604. MOLD BUSTERS, GROVE, OK. SN 78-157,137. PUB. 8-26-2003, FILED 8-23-2002.

## MOLD BUSTERS

NO CLAIM IS MADE TO THE EXCLUSIVE RIGHT TO USE "MOLD", APART FROM THE MARK AS SHOWN.  
FOR CLEANING OF BUILDINGS, NAMELY, ERADICATING MOLD SPORES THROUGH USE OF LOW LEVEL RADIATION MACHINERY (U.S. CLS. 100, 103 AND 106).  
FIRST USE 11-18-2002; IN COMMERCE 11-18-2002.

2,929,669. PALMSOURCE, INC., SUNNYVALE, CA. SN 78-203,676. PUB. 3-2-2004, FILED 1-15-2003.

## PALMONE

OWNER OF U.S. REG. NOS. 2,613,597, 2,653,036, AND OTHERS.  
FOR INSTALLATION, MAINTENANCE AND REPAIR OF COMPUTERS, COMPUTER HARDWARE, COMMUNICATIONS HARDWARE AND COMPUTER PERIPHERALS (U.S. CLS. 100, 103 AND 106).  
FIRST USE 10-28-2003; IN COMMERCE 10-28-2003.

**CLASS 38—COMMUNICATION**

**CLASS 38—(Continued).**

2,929,106. PHOENIX SATELLITE TELEVISION TRADE-MARK LIMITED, ROAD TOWN, TORTOLA, BR.VIRGIN ISLANDS. SN 76-091,446. PUB. 1-6-2004, FILED 7-18-2000.

鳳凰衛視

PRIORITY CLAIMED UNDER SEC. 44(D) ON MALAYSIA APPLICATION NO. 2000-07562, FILED 6-12-2000, REG. NO. 00007562, DATED 6-12-2000, EXPIRES 6-12-2007.

THE MARK, "FENG HUANG WEI SI" IN TRADITIONAL CHINESE CHARACTERS, MEANS "PHOENIX DEFEND VISION".

FOR TELEVISION AND RADIO BROADCASTING SERVICES; DIGITAL TELEVISION TRANSMISSION SERVICES; PROVIDING MULTIPLE USER ACCESS TO COMPUTER DATABASES AND THE INTERNET; TELECOMMUNICATION GATEWAY SERVICES NAMELY, PROVIDING CONNECTIVITY SERVICES FOR THE INTERACTIVE TRANSMISSION OF DATA; TRANSMISSION OF TELEVISION PROGRAMS; OPERATION OF EARTH-TO-SATELLITE TELEVISION TRANSMITTERS FOR TRANSMISSION OF SIGNALS TO SATELLITE; BROADCASTING TELEVISION PROGRAMS BY SATELLITE; SATELLITE TRANSMISSION VIA SATELLITE-TO-EARTH RECEIVER AERIALS; SATELLITE TRANSMISSION VIA FREQUENCY CONVERSION OF MICROWAVE SIGNALS RELAYED BY SATELLITE; BROADCASTING OF TELEVISION PROGRAMS RELAYED BY SATELLITE RECEIVER AERIALS BY CABLE OR BY MICROWAVE LINK TO TELEVISION RECEIVERS OF USERS; CABLE TELEVISION TRANSMISSION, CABLE TELEVISION BROADCASTING; RADIO, TELEPHONE, TELEGRAPH, SATELLITE AND OF CABLE NETWORK COMMUNICATIONS; VIDEOTEXT AND TELETXT TRANSMISSION SERVICES; ELECTRONIC TRANSMISSION OF MESSAGES AND DATA AND TELECOMMUNICATION TRANSMISSION OF MESSAGES AND DATA VIA COMPUTER NETWORKS; ELECTRONIC TRANSMISSION OF DATA AND MESSAGES VIA COMPUTER, CABLE, RADIO, RADIOPAGING, TELEPRINTER, TELELETTER, ELECTRONIC MAIL, FAX MACHINE, TELEVISION, MICROWAVE, LASER BEAM, COMMUNICATIONS SATELLITE PROVIDING ON-LINE CHAT ROOM AND/OR ELECTRONIC BULLETIN BOARDS FOR TRANSMISSION OF MESSAGES AMONG COMPUTER USERS CONCERNING TELEVISION AND RADIO BROADCAST, ENTERTAINMENT, CELEBRITIES, FASHION AND STYLE, PERSONAL DEVELOPMENT; RENTAL OF TELECOMMUNICATION EQUIPMENT; TIME-SHARE RENTAL SERVICES OF COMMUNICATIONS APPARATUS; AND ALL THE ABOVE ALSO PROVIDED ON-LINE FROM A COMPUTER DATABASE OR THE INTERNET; PROVIDING INFORMATION REGARDING TELECOMMUNICATIONS; AND CONSULTATION AND ADVISORY SERVICES RELATED THERETO (U.S. CLS. 100, 101 AND 104).

FIRST USE 3-31-1996; IN COMMERCE 1-1-2001.

**CLASS 38—(Continued).**

2,929,259. A.M. IMAGINATION LIMITED, TORTOLA, BR.VIRGIN ISLANDS. SN 76-393,682. PUB. 5-13-2003, FILED 4-10-2002.

**3DMUSE**

FOR PROVIDING ON-LINE CHAT ROOMS FOR THE TRANSMISSION OF MESSAGES AMONG COMPUTER USERS CONCERNING TOPICS OF GENERAL INTEREST; ELECTRONIC TRANSMISSION OF DOCUMENTS AND DATA VIA COMPUTER TERMINALS (U.S. CLS. 100, 101 AND 104).

FIRST USE 7-1-2003; IN COMMERCE 7-1-2003.

2,929,262. AMERICATEL CORPORATION, MIAMI, FL. SN 76-394,809. PUB. 6-17-2003, FILED 4-12-2002.

**TARJETA VIP DE AMERICATEL**

NO CLAIM IS MADE TO THE EXCLUSIVE RIGHT TO USE "TARJETA", APART FROM THE MARK AS SHOWN. THE ENGLISH TRANSLATION OF "TARJETA VIP DE AMERICATEL" IS "AMERICATEL'S VIP CARD".

FOR TELECOMMUNICATION SERVICES, NAMELY LOCAL, LONG DISTANCE AND INTERNATIONAL VOICE, TEXT, FACSIMILE, VIDEO, IMAGE, DATA AND WIRELESS TRANSMISSION VIA SATELLITE, TERRESTRIAL AND UNDERSEA COMMUNICATION LINKS; TELEPHONE TELECOMMUNICATIONS SERVICES PROVIDED VIA TELEPHONE CALLING CARDS; PROVIDING MULTIPLE USER ACCESS TO A GLOBAL COMPUTER NETWORK (U.S. CLS. 100, 101 AND 104).

FIRST USE 9-13-2004; IN COMMERCE 9-13-2004.

2,929,591. SPRINT COMMUNICATIONS COMPANY L.P., OVERLAND PARK, KS. SN 78-144,415. PUB. 8-3-2004, FILED 7-16-2002.

**PCS READY LINK**

OWNER OF U.S. REG. NOS. 2,170,210, 2,196,343, AND OTHERS.

NO CLAIM IS MADE TO THE EXCLUSIVE RIGHT TO USE "PCS" OR "LINK", APART FROM THE MARK AS SHOWN.

FOR TELECOMMUNICATIONS SERVICES, NAMELY, WIRELESS PERSONAL COMMUNICATION SERVICES FEATURING A DEVICE THAT ALLOWS THE USER TO ACCESS VOICE SERVICES BY PUSHING A BUTTON (U.S. CLS. 100, 101 AND 104).

FIRST USE 11-17-2003; IN COMMERCE 11-17-2003.

**CLASS 38—(Continued).**

2,929,627. AT&T CORP., NEW YORK, NY. SN 78-180,539. PUB. 9-2-2003, FILED 10-31-2002.

**AT&T SERVICEPASS**

OWNER OF U.S. REG. NOS. 1,293,305, 1,970,579, AND 2,110,288.

FOR SECURE ELECTRONIC MAIL AND MESSAGING SERVICES; PROVIDING SECURE ACCESS TO COMPUTER AND TELECOMMUNICATIONS NETWORKS, INCLUDING PROVIDING AUTHENTICATION MEASURES TO ENSURE PROTECTION AND CONFIDENTIALITY OF NETWORK COMMUNICATIONS (U.S. CLS. 100, 101 AND 104).

FIRST USE 12-31-2000; IN COMMERCE 12-31-2000.

2,929,789. BELLSOUTH INTELLECTUAL PROPERTY CORPORATION, WILMINGTON, DE. SN 78-274,909. PUB. 3-23-2004, FILED 7-16-2003.

**WINNING CHOICE PLUS**

FOR TELECOMMUNICATION SERVICES NAMELY, DIGITAL, VOICE, DATA, IMAGES AND MESSAGES TRANSMISSION SERVICES; VOICE, DATA, FACSIMILE, ELECTRONIC MAIL AND VISUAL SIGNALS TRANSMISSION SERVICES; LONG DISTANCE TELEPHONE TRANSMISSION SERVICES; WIRELESS AND DIGITAL PRIVATE BRANCH EXCHANGE (PBX) SERVICES; CENTRAL OFFICE TELEPHONE (CENTREX) SERVICES; TELECOMMUNICATIONS FRAME RELAY AND PACKET SWITCHING SERVICES (U.S. CLS. 100, 101 AND 104).

FIRST USE 7-1-2003; IN COMMERCE 8-25-2003.

**CLASS 39—TRANSPORTATION AND STORAGE**

2,929,260. A.M. IMAGINATION LIMITED, TORTOLA, BR. VIRGIN ISLANDS. SN 76-393,683. PUB. 5-13-2003, FILED 4-10-2002.

**3DMUSE**

FOR ELECTRONIC STORAGE OF IMAGES, TEXT AND DATA (U.S. CLS. 100 AND 105).

FIRST USE 7-1-2003; IN COMMERCE 7-1-2003.

**CLASS 39—(Continued).**

2,929,370. GLOVIS CO. LTD., SEOUL, REPUBLIC OF KOREA. SN 76-501,329. PUB. 12-9-2003, FILED 3-26-2003.

**GLOVIS**

FOR TRANSPORTATION SERVICES, NAMELY, AIR TRANSPORTATION SERVICES, ARRANGING FOR PICKUP, DELIVERY, STORAGE, AND TRANSPORTATION OF DOCUMENTS, PACKAGES, FREIGHT, AND PARCELS VIA GROUND AND AIR CARRIERS, FREIGHT TRANSPORTATION BY TRUCK, AIR, TRAIN, AND BOAT, TRANSPORTATION AND DELIVERY SERVICES, NAMELY, INTERNATIONAL COURIER SERVICES, TRANSPORTATION OF PRODUCTS BY TRUCK, AIR, TRAIN, AND BOAT, MARINE TRANSPORT SERVICES, AND RAILWAY TRANSPORT SERVICES (U.S. CLS. 100 AND 105).

FIRST USE 7-1-2003; IN COMMERCE 7-10-2003.

2,929,616. THE BURLINGTON NORTHERN AND SANTA FE RAILWAY COMPANY, FORT WORTH, TX. SN 78-170,665. PUB. 3-9-2004, FILED 10-3-2002.



NO CLAIM IS MADE TO THE EXCLUSIVE RIGHT TO USE "GLOBAL", APART FROM THE MARK AS SHOWN.

THE STIPPLING IS FOR SHADING PURPOSES ONLY.

FOR CONSULTATION SERVICES IN THE FIELD OF TRANSPORTATION, NAMELY, CONSULTING REGARDING HANDLING, STORAGE, LOADING, BLOCKING AND BRACING, SECUREMENT AND TRANSPORTATION OF CARGO BY THE GLOBAL TRANSPORTATION AND LOGISTICS COMMUNITY, NAMELY A TOTAL EVALUATION OF EACH CLIENTS PRODUCT AS IT MOVES THROUGH THE COMPLETE TRANSPORTATION CYCLE MAKING RECOMMENDATIONS ON ISSUES SUCH AS PACKAGING, WAREHOUSE STORAGE, LOADING, BLOCKING AND BRACING, SECURITY, TRANSPORTATION RIDE QUALITY, UNLOADING AND DESTINATION STORAGE AND DELIVERY (U.S. CLS. 100 AND 105).

FIRST USE 1-1-2003; IN COMMERCE 1-1-2003.



**CLASS 39—(Continued).**

2,929,767. ACE RENT-A-CAR, INC., DES PLAINES, IL. SN 78-260,660. PUB. 1-27-2004, FILED 6-10-2003.



**ACE**  
RENT A CAR

OWNER OF U.S. REG. NOS. 1,420,474 AND 2,107,021.  
NO CLAIM IS MADE TO THE EXCLUSIVE RIGHT TO USE "RENT A CAR", APART FROM THE MARK AS SHOWN.

FOR AUTOMOBILE RENTAL SERVICES (U.S. CLS. 100 AND 105).  
FIRST USE 6-1-2003; IN COMMERCE 6-1-2003.

2,929,783. HERRE, SUSAN, M., WASHINGTON, DC. SN 78-270,361. PUB. 3-23-2004, FILED 7-3-2003.

**REAL KISS-N-RIDE**

FOR TRANSPORTATION OF PASSENGERS BY RAIL AND BUS (U.S. CLS. 100 AND 105).  
FIRST USE 8-5-2002; IN COMMERCE 5-24-2003.

2,929,883. FEDERAL EXPRESS CORPORATION, MEMPHIS, TN. SN 78-335,547. PUB. 7-13-2004, FILED 12-3-2003.

**FEDEX SMARTPOST**

THE MARK CONSISTS OF STANDARD CHARACTERS WITHOUT CLAIM TO ANY PARTICULAR FONT, STYLE, SIZE, OR COLOR.

OWNER OF U.S. REG. NOS. 1,311,503, 2,096,998, AND OTHERS.

FOR PICK-UP, TRANSPORTATION, STORAGE AND DELIVERY OF DOCUMENTS, PACKAGES AND FREIGHT BY LAND AND AIR (U.S. CLS. 100 AND 105).  
FIRST USE 10-21-2004; IN COMMERCE 10-21-2004.

**CLASS 40—MATERIAL TREATMENT****CLASS 40—(Continued).**

2,929,160. MERETEC CORPORATION, EAST CHICAGO, IN. SN 76-223,558. PUB. 2-18-2003, FILED 3-13-2001.

**MERETEC**

FOR METAL EXTRACTION AND RECYCLING, NAMELY, PROVIDING ZINC FREE STEEL STOCK AND PURE ZINC POWDER FOR USE BY OTHERS (U.S. CLS. 100, 103 AND 106).

FIRST USE 9-10-2004; IN COMMERCE 9-10-2004.

2,929,406. ROSEVINE ENTERPRISES, ATLANTA, GA. SN 76-518,082. PUB. 2-24-2004, FILED 5-30-2003.

**LET'S MAKE WINE**

FOR LEASING COMPLETE WINE MAKING FACILITIES TO OTHERS, NAMELY PROVIDING FERMENTING VESSELS, FILTERING AND BOTTLING EQUIPMENT, GRAPE JUICE, BOTTLES, LABELS AND CORKAGE TO ENABLE OTHERS TO MAKE PRIVATE LABEL WINE (U.S. CLS. 100, 103 AND 106).

FIRST USE 3-0-2004; IN COMMERCE 3-0-2004.

2,929,467. DIGIBUG EXPRESS, INC., WALTHAM, MA. SN 76-541,682. PUB. 5-18-2004, FILED 8-25-2003.

**IT'S WHY YOU TAKE PICTURES**

FOR PHOTOGRAPHIC AND IMAGE PROCESSING SERVICES, NAMELY, DEVELOPING, REPRINTING AND MODIFYING IMAGES; TRANSFERRING PHOTOGRAPHIC AND DIGITAL IMAGES FROM PHOTOGRAPHIC NEGATIVES AND UPLOADED DIGITAL IMAGES TO IMPRINTABLE SURFACES; AND PROVIDING ONLINE ACCESS TO PROCESSED DIGITAL IMAGES VIA GLOBAL COMPUTER NETWORK (U.S. CLS. 100, 103 AND 106).

FIRST USE 11-0-2003; IN COMMERCE 11-0-2003.

2,929,492. WRIGHT COATING COMPANY, INC. KALAMAZOO, MI. SN 76-553,594. PUB. 8-24-2004, FILED 10-6-2003.

**WRYLON**

FOR METAL FINISHING SERVICES AND APPLYING PROTECTIVE COATINGS TO METAL THROUGH THE CONTROLLED APPLICATION OF NYLON II (U.S. CLS. 100, 103 AND 106).

FIRST USE 7-15-2004; IN COMMERCE 7-15-2004.

**CLASS 40—(Continued).**

2,929,695. BAJC, MIKE, MISSION VIEJO, CA. SN 78-219,615. PUB. 11-11-2003, FILED 2-27-2003.

**DIGITALARTS + PLUS**

FOR DIGITAL PHOTO PROCESSING, DIGITAL PHOTOGRAPHY, NAMELY, ELECTRONIC IMAGING, SCANNING, DIGITIZING, ALTERATION AND RETOUCHING OF PHOTOGRAPHIC IMAGES (U.S. CLS. 100, 103 AND 106).

FIRST USE 5-23-2003; IN COMMERCE 8-20-2003.

**CLASS 41—EDUCATION AND ENTERTAINMENT**

2,929,057. ASTILEAN, AUREL A., EAST HAMPTON, NY. SN 75-612,494. PUB. 9-25-2001, FILED 12-28-1998.

**SPEED CLASS**

NO CLAIM IS MADE TO THE EXCLUSIVE RIGHT TO USE "CLASS", APART FROM THE MARK AS SHOWN.

FOR HEALTH, FITNESS AND EXERCISE INSTRUCTION (U.S. CLS. 100, 101 AND 107).

FIRST USE 11-25-2004; IN COMMERCE 11-25-2004.

2,929,066. COVENEY, TIM, ATLANTA, GA. SN 75-823,238. PUB. 8-28-2001, FILED 10-14-1999.

**ALLRELAXING.COM**

FOR ENTERTAINMENT SERVICES, NAMELY, PROVISION OF GRAPHIC AND TEXTUAL ENTERTAINMENT CONTENT, NAMELY, ARTWORK, FICTION, AND POEMS, AND INFORMATIONAL STORIES RELATING TO SUBJECTS SUCH AS MEDITATION, YOGA, GARDENING, COOKING, AND TRAVEL, ALL VIA A GLOBAL COMPUTER NETWORK (U.S. CLS. 100, 101 AND 107).

FIRST USE 10-12-2004; IN COMMERCE 10-12-2004.

2,929,103. GUERRILLA NEWS NETWORK, INC., NEW YORK, NY. SN 76-076,443. PUB. 2-17-2004, FILED 6-23-2000.

**GUERRILLA NEWS NETWORK**

NO CLAIM IS MADE TO THE EXCLUSIVE RIGHT TO USE "NEWS NETWORK", APART FROM THE MARK AS SHOWN.

SEC. 2(F).

FOR PRODUCTION AND DISTRIBUTION OF PROGRAMS FEATURING NEWS FOR TRANSMISSION THROUGH RADIO, TELEVISION, INTERNET, MOTION PICTURE FILM, CABLE TELEVISION, SATELLITE, AND WIRELESS; PRODUCTION OF CDS, DVDS, AND VIDEO TAPES FOR OTHERS (U.S. CLS. 100, 101 AND 107).

FIRST USE 6-0-2000; IN COMMERCE 1-0-2001.

**CLASS 41—(Continued).**

2,929,176. SMITH, KEELY, PALM SPRINGS, CA. SN 76-256,142. PUB. 7-2-2002, FILED 5-11-2001.

**LOUIS PRIMA & KEELY SMITH**

OWNER OF U.S. REG. NO. 1,423,348.

FOR ENTERTAINMENT SERVICES, NAMELY, LIVE MUSICAL PERFORMANCES BY AN INDIVIDUAL USING MEMORABILIA ASSOCIATED WITH A DECEASED INDIVIDUAL (U.S. CLS. 100, 101 AND 107).

FIRST USE 5-18-2004; IN COMMERCE 7-1-2004.

2,929,229. IDA CASON CALLAWAY FOUNDATION, PINE MOUNTAIN, GA. SN 76-347,929. PUB. 6-3-2003, FILED 12-11-2001.

**THE GARDENS AT CALLAWAY**

FOR EDUCATIONAL SERVICES, NAMELY, PROVIDING HORTICULTURAL AND NATURE STUDY FACILITIES CONSISTING OF GARDENS, WOODLANDS, GREENHOUSES, NATURE TRAILS AND EDUCATIONAL DISPLAYS, LECTURES, HIKES, FIELD TRIPS, WORKSHOPS, WALKS AND TOURS RELATING TO HORTICULTURE, LANDSCAPING AND GARDENING FOR ADULTS AND CHILDREN; PROVIDING ENTERTAINMENT SERVICES IN THE NATURE OF LIGHT SHOWS, FESTIVALS, AND EXHIBITS (U.S. CLS. 100, 101 AND 107).

FIRST USE 3-0-2001; IN COMMERCE 3-0-2002.

2,929,240. RICHARDSON, MELVIN A., ROANOKE, VA. AND RICHARDSON, MARY C., ROANOKE, VA. SN 76-366,712. PUB. 12-17-2002, FILED 1-24-2002.

**MISS TEEN INTERNATIONAL COMPETITION**

NO CLAIM IS MADE TO THE EXCLUSIVE RIGHT TO USE "TEEN INTERNATIONAL COMPETITION", APART FROM THE MARK AS SHOWN.

FOR ENTERTAINMENT SERVICES, NAMELY, PRESENTATION OF BEAUTY PAGEANTS, CONTESTS, AND COMPETITIONS FOR MARRIED WOMEN; ARRANGING AND CONDUCTING STATE, REGIONAL AND NATIONAL PAGEANTS FOR MARRIED WOMEN (U.S. CLS. 100, 101 AND 107).

FIRST USE 5-0-2003; IN COMMERCE 5-0-2003.

**CLASS 41—(Continued).**

2,929,271. CONSERVATION FOR CENTRAL OREGON, DBA THE RECYCLING TEAM, BEND, OR. SN 76-413,559. PUB. 2-10-2004, FILED 5-29-2002.

**RESOURCE**

FOR EDUCATIONAL SERVICES, NAMELY CONDUCTING CLASSES, CONFERENCES, SEMINARS, AND WORKSHOPS IN THE FIELDS OF RECYCLING, NATURAL RESOURCE CONSERVATION, POLLUTION PREVENTION, AND DISTRIBUTING MATERIALS IN CONNECTION THEREWITH (U.S. CLS. 100, 101 AND 107).

FIRST USE 7-31-2002; IN COMMERCE 7-31-2002.

2,929,336. WISEMAN, ORLY, STATEN ISLAND, NY. SN 76-486,294. PUB. 10-14-2003, FILED 1-31-2003.

**SHOOT IT**

FOR TELEVISION SERIES FEATURING SHORT FILMS AND COMMENTARY BY INDEPENDENT FILM-MAKERS (U.S. CLS. 100, 101 AND 107).

FIRST USE 12-9-2003; IN COMMERCE 12-9-2003.

2,929,387. REECE COACHING, SAN RAFAEL, CA. SN 76-507,757. PUB. 7-6-2004, FILED 4-21-2003.



FOR EDUCATIONAL SERVICES, NAMELY, CONDUCTING LEADERSHIP TRAINING CLASSES, TELECONFERENCES AND SEMINARS (U.S. CLS. 100, 101 AND 107).

FIRST USE 4-1-2003; IN COMMERCE 1-1-2004.

2,929,400. LAKESHORE CENTRE HOLDINGS LLC, CHICAGO, IL. SN 76-513,721. PUB. 3-9-2004, FILED 5-13-2003.

**KIDSHORE**

FOR HEALTH CLUB SERVICES, NAMELY PROVIDING INSTRUCTION AND EQUIPMENT IN THE FIELD OF PHYSICAL EXERCISE, SPECIFICALLY FOR CHILDREN (U.S. CLS. 100, 101 AND 107).

FIRST USE 11-0-2004; IN COMMERCE 11-0-2004.

2,929,402. HEALTH INTERNATIONAL CORPORATION, INDIAN SHORES, FL. SN 76-514,720. PUB. 1-27-2004, FILED 5-16-2003.

**BODY EXPRESS****CLASS 41—(Continued).**

NO CLAIM IS MADE TO THE EXCLUSIVE RIGHT TO USE BODY, APART FROM THE MARK AS SHOWN.

FOR GYMNASIUM, HEALTH CLUB AND FITNESS CENTER SERVICES, NAMELY PROVIDING INSTRUCTION AND EQUIPMENT IN THE FIELD OF PHYSICAL EXERCISE, FITNESS AND HEALTH (U.S. CLS. 100, 101 AND 107).

FIRST USE 7-1-2004; IN COMMERCE 7-1-2004.

2,929,448. OUTDOOR LIFE NETWORK, L.L.C., STAMFORD, CT. SN 76-532,546. PUB. 4-20-2004, FILED 7-25-2003.

**SAMURAI SPORTSMAN**

NO CLAIM IS MADE TO THE EXCLUSIVE RIGHT TO USE "SPORTSMAN", APART FROM THE MARK AS SHOWN.

FOR ENTERTAINMENT IN THE NATURE OF AN ONGOING TELEVISION SERIES IN THE FIELD OF SPORTS (U.S. CLS. 100, 101 AND 107).

FIRST USE 1-31-2004; IN COMMERCE 1-31-2004.

2,929,459. SOLOMON, KAREN, SEBASTOPOL, CA. SN 76-537,810. PUB. 8-10-2004, FILED 8-15-2003.

**MEN SEX & MONEY**

FOR EDUCATIONAL SERVICES, NAMELY, WORKSHOPS AND SEMINARS IN THE FIELD OF INTERPERSONAL RELATIONSHIP BETWEEN MEN AND WOMEN; PROVIDING ONLINE SYNDICATED NEWSPAPER AND MAGAZINE COLUMNS IN THE FIELD OF INTERPERSONAL RELATIONSHIP BETWEEN MEN AND WOMEN; ENTERTAINMENT IN THE NATURE OF ONGOING TELEVISION PROGRAMS AND RADIO PROGRAMS IN THE FIELD OF INTERPERSONAL RELATIONSHIP BETWEEN MEN AND WOMEN; PERSONAL COACHING SERVICES IN THE FIELD OF INTERPERSONAL RELATIONSHIP BETWEEN MEN AND WOMEN (U.S. CLS. 100, 101 AND 107).

FIRST USE 5-0-2003; IN COMMERCE 5-0-2003.

2,929,464. LIFEWAY CHRISTIAN RESOURCES OF THE SOUTHERN BAPTIST, NASHVILLE, TN. SN 76-539,753. PUB. 5-25-2004, FILED 8-25-2003.

**LIFE ADVENTURES FOR MEN**

THE MARK CONSISTS OF STANDARD CHARACTERS WITHOUT CLAIM TO ANY PARTICULAR FONT, STYLE, SIZE, OR COLOR.

FOR RELIGIOUS CONFERENCES AND SEMINARS (U.S. CLS. 100, 101 AND 107).

FIRST USE 2-2-2004; IN COMMERCE 2-2-2004.

**CLASS 41—(Continued).**

2,929,469. MOVIE GALLERY ASSET MANAGEMENT, INC., WILMINGTON, DE. SN 76-542,019. PUB. 5-25-2004, FILED 9-3-2003.



OWNER OF U.S. REG. NOS. 1,432,368, 1,798,262, AND 2,518,769.  
 THE STIPPLING IN THE DRAWING IS FOR SHADING PURPOSES ONLY.  
 FOR EXPRESS RENTAL OF VIDEO CASSETTES, DVDS, VIDEO GAMES AND AUDIO BOOKS (U.S. CLS. 100, 101 AND 107).  
 FIRST USE 11-22-2003; IN COMMERCE 11-22-2003.

---

2,929,500. TENNESSEE EDUCATION LOTTERY CORPORATION, NASHVILLE, TN. SN 76-556,158. PUB. 7-27-2004, FILED 11-3-2003.



FOR LOTTERY SERVICES (U.S. CLS. 100, 101 AND 107).  
 FIRST USE 1-20-2004; IN COMMERCE 1-20-2004.

---

2,929,515. SALEM COMMUNICATIONS HOLDING CORPORATION, CAMARILLO, CA. SN 76-977,133. PUB. 12-23-2003, FILED 3-8-2002.

**FISHFEST**

FOR ENTERTAINMENT SERVICES IN THE NATURE OF A CHRISTIAN MUSIC FESTIVAL (U.S. CLS. 100, 101 AND 107).  
 FIRST USE 7-28-2002; IN COMMERCE 7-28-2002.

**CLASS 41—(Continued).**

2,929,547. INTEGRITY MEDIA, INC., MOBILE, AL. SN 78-075,691. PUB. 9-17-2002, FILED 7-25-2001.



OWNER OF U.S. REG. NOS. 1,742,795, 2,449,741, AND OTHERS.  
 NO CLAIM IS MADE TO THE EXCLUSIVE RIGHT TO USE "TELEVISION", APART FROM THE MARK AS SHOWN.  
 FOR PRODUCTION AND DISTRIBUTION OF TELEVISION PROGRAMS; AND ENTERTAINMENT IN THE NATURE OF ON-GOING EDUCATIONAL TELEVISION PROGRAMS IN THE FIELD OF MUSIC, RELIGION, AND ANIMATION FOR CHILDREN AND FAMILIES (U.S. CLS. 100, 101 AND 107).  
 FIRST USE 7-26-2004; IN COMMERCE 7-26-2004.

---

2,929,590. HEALTHY INSPIRATIONS MANAGEMENT, INC., WAKEFIELD, RI. SN 78-143,271. PUB. 3-23-2004, FILED 7-12-2002.

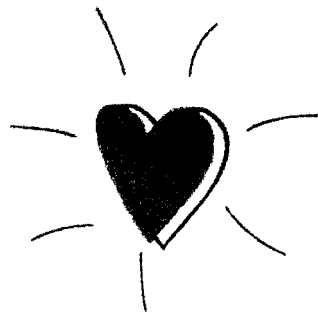

FOR CONDUCTING SEMINARS, CONFERENCES AND WORKSHOPS IN THE FIELD OF WEIGHT LOSS, STRESS REDUCTION AND FITNESS WHICH ARE OFFERED BY HEALTH CLUBS AND HEALTH SPAS (U.S. CLS. 100, 101 AND 107).  
 FIRST USE 1-8-2001; IN COMMERCE 1-8-2001.

**CLASS 41—(Continued).**

2,929,608. AMERICAN SPORTING GOODS CORPORATION, IRVINE, CA. SN 78-161,197. PUB. 10-21-2003, FILED 9-5-2002.



NO CLAIM IS MADE TO THE EXCLUSIVE RIGHT TO USE "FITNESS", APART FROM THE MARK AS SHOWN. FOR ENTERTAINMENT SERVICES, NAMELY, CONDUCTING FOOT RACES (U.S. CLS. 100, 101 AND 107). FIRST USE 5-1-2002; IN COMMERCE 5-25-2002.

2,929,641. CEDAR KNOLL VINEYARDS, INC., SAN ANTONIO, TX. SN 78-186,303. PUB. 3-2-2004, FILED 11-18-2002.

**PALMAZ VINEYARDS**

NO CLAIM IS MADE TO THE EXCLUSIVE RIGHT TO USE VINEYARDS, APART FROM THE MARK AS SHOWN. FOR EDUCATIONAL AND ENTERTAINMENT SERVICES, NAMELY, WINE TASTING, GUIDED TOURS OF WINERY (U.S. CLS. 100, 101 AND 107). FIRST USE 8-11-2003; IN COMMERCE 8-11-2003.

2,929,660. SEGEBRECHT, LINDA, OVERLAND PARK, KS. AND BECICKA, CHRIS, OVERLAND PARK, KS. SN 78-198,171. PUB. 9-16-2003, FILED 12-27-2002.

**SIGNATURE EXPERIENCE**

NO CLAIM IS MADE TO THE EXCLUSIVE RIGHT TO USE "EXPERIENCE", APART FROM THE MARK AS SHOWN.

FOR EDUCATIONAL SERVICES, NAMELY, CONDUCTING SEMINARS IN ART, SCIENCE AND HISTORY AT MUSEUMS, LIBRARIES AND ZOOS (U.S. CLS. 100, 101 AND 107). FIRST USE 4-1-2003; IN COMMERCE 4-1-2003.

**CLASS 41—(Continued).**

2,929,662. MILLER, WILLIAM Z. III, CHARLOTTE, NC. SN 78-200,555. PUB. 11-25-2003, FILED 1-7-2003.

**THE PSYCHE-CENTERED ZONE**

FOR WORKSHOPS AND SEMINARS FEATURING METHODOLOGY ON HOW TO EXPERIENCE PEAK PERFORMANCE IN THE FIELDS OF BUSINESS AND SPORT (U.S. CLS. 100, 101 AND 107). FIRST USE 9-1-2003; IN COMMERCE 9-1-2003.

2,929,667. EDULENCE CORPORATION, FAIRFIELD, NJ. SN 78-202,970. PUB. 6-8-2004, FILED 1-14-2003.

**EDULENCE**

FOR EDUCATIONAL TRAINING SERVICES, NAMELY, PROVIDING ON-LINE CLASSES, SEMINARS, EXHIBITIONS AND DISPLAYS, AND PROVIDING ON-LINE INTERACTIVE TRAINING EXHIBITS AND LEARNING MODULES VIA THE INTERNET SPECIFICALLY FOR THE FINANCIAL SERVICES INDUSTRY (U.S. CLS. 100, 101 AND 107). FIRST USE 12-2-2002; IN COMMERCE 2-2-2003.

2,929,683. PIKE, LEWIS JEFFREY, FOREST PARK, GA. SN 78-211,070. PUB. 2-17-2004, FILED 2-5-2003.



FOR ENTERTAINMENT SERVICES, NAMELY, LIVE PERFORMANCES BY A MUSICAL BAND (U.S. CLS. 100, 101 AND 107). FIRST USE 1-1-1993; IN COMMERCE 1-1-1993.

**CLASS 41—(Continued).**

2,929,714. HANOVER COLLEGE, HANOVER, IN. SN 78-235,225. PUB. 12-16-2003, FILED 4-8-2003.



FOR EDUCATIONAL SERVICES, NAMELY PROVIDING COURSES OF INSTRUCTION AT THE COLLEGE LEVEL; DISTRIBUTION OF COURSE MATERIAL IN CONNECTION THEREWITH (U.S. CLS. 100, 101 AND 107).

FIRST USE 8-5-2003; IN COMMERCE 8-5-2003.

---

2,929,721. AWESOME KIDS, LLC, WHEATON, IL. SN 78-237,802. PUB. 11-4-2003, FILED 4-15-2003.

## **WE ARE A TRADITIONALLY WHOLESOME COMPANY**

FOR ENTERTAINMENT IN THE NATURE OF CHILDREN'S MOTION PICTURE FILM PRODUCTION; ENTERTAINMENT IN THE NATURE OF ON GOING CHILDREN'S TELEVISION PROGRAMS, ALL FEATURING ANIMATION; PRODUCTION AND DISTRIBUTION OF ANIMATED MOTION PICTURES AND ANIMATED FILMS; PRODUCTION AND DISTRIBUTION OF CABLE, SATELLITE, BROADCAST AND DIGITAL TELEVISION ANIMATED CHILDREN'S PROGRAMS; PROVIDING INTERACTIVE COMPUTER GAMES BY MEANS OF A GLOBAL COMPUTER NETWORK (U.S. CLS. 100, 101 AND 107).

FIRST USE 5-3-2003; IN COMMERCE 6-20-2003.

---

2,929,749. FLETCHER, LESLIE R., BENSALEM, PA. SN 78-250,939. PUB. 2-24-2004, FILED 5-16-2003.

## **FEMALE MATTERS**

NO CLAIM IS MADE TO THE EXCLUSIVE RIGHT TO USE "FEMALE", APART FROM THE MARK AS SHOWN.

FOR EDUCATIONAL SERVICES— NAMELY, CLASSES, SEMINARS, CONFERENCES, MENTORING, COACHING, TRAINING SESSIONS AND WORKSHOPS IN THE FIELDS OF SELF DISCOVERY, SELF EMPOWERMENT, LIFE SKILLS, COLLEGE PREPARATION, VOCATION PREPARATION, CHARACTER DEVELOPMENT AND PERSONAL RESPONSIBILITY; ANTI-VIOLENCE TRAINING; AND LITERACY (U.S. CLS. 100, 101 AND 107).

FIRST USE 1-1-2004; IN COMMERCE 1-1-2004.

**CLASS 41—(Continued).**

2,929,769. TRAVELGIRL INC., CHAMBLEE, GA. SN 78-260,850. PUB. 2-17-2004, FILED 6-11-2003.



FOR MAGAZINE PUBLISHING SERVICES (U.S. CLS. 100, 101 AND 107).

FIRST USE 6-26-2003; IN COMMERCE 6-26-2003.

---

2,929,778. AMERICAN PAYROLL INSTITUTE, NEW YORK, NY. SN 78-266,789. PUB. 3-23-2004, FILED 6-25-2003.

## **THE WHITE HOUSE LAS VEGAS**

NO CLAIM IS MADE TO THE EXCLUSIVE RIGHT TO USE "LAS VEGAS", APART FROM THE MARK AS SHOWN. FOR EDUCATIONAL SERVICES, NAMELY PROVIDING EDUCATIONAL CLASSES, SEMINARS AND COURSES OF INSTRUCTION IN THE FIELD OF PAYROLL MANAGEMENT (U.S. CLS. 100, 101 AND 107).

FIRST USE 3-0-2004; IN COMMERCE 3-0-2004.

---

2,929,788. DRUNK'N LEMUR, INC., FREDERICKSBURG, VA. SN 78-273,556. PUB. 4-6-2004, FILED 7-12-2003.

## **DRUNK'N LEMUR**

FOR COMPUTER SERVICES, NAMELY, PROVIDING ON-LINE ENTERTAINMENT SERVICES IN THE NATURE OF PROVIDING ADULT MATERIAL AND VIEWING THEREOF OVER A GLOBAL COMPUTER NETWORK (U.S. CLS. 100, 101 AND 107).

FIRST USE 3-25-2004; IN COMMERCE 3-25-2004.

**CLASS 41—(Continued).**

2,929,799. EATON CORPORATION, CLEVELAND, OH. SN 78-279,114. PUB. 6-8-2004, FILED 7-25-2003.

**EATON UNIVERSITY**

OWNER OF U.S. REG. NOS. 1,216,476, 1,660,297, AND 1,679,823.

NO CLAIM IS MADE TO THE EXCLUSIVE RIGHT TO USE "UNIVERSITY", APART FROM THE MARK AS SHOWN.

FOR EDUCATIONAL SERVICES, NAMELY, INSTRUCTOR AND E-LEARNING EDUCATIONAL SERVICES BY MANNER OF COURSES, WORKSHOPS, AND SEMINARS FOR LEADERSHIP AND PROFESSIONAL DEVELOPMENT FOR LEADERSHIP, MANAGEMENT, PERSONAL PRODUCTIVITY, TEAM EFFECTIVENESS, FUNCTIONAL SKILLS IN VARIOUS PROFESSIONAL DISCIPLINES COMPRISING ENGINEERING, HUMAN RESOURCES, INFORMATION TECHNOLOGY, FINANCE, ACCOUNTING, AND STRATEGIC PLANNING (U.S. CLS. 100, 101 AND 107).

FIRST USE 5-7-2001; IN COMMERCE 5-7-2001.

---

2,929,807. UNDEAD PRODUCTIONS INC., PITTSBURGH, PA. SN 78-282,848. PUB. 4-6-2004, FILED 8-4-2003.

**SCAREHOUSE**

FOR ENTERTAINMENT IN THE NATURE OF AN INTERACTIVE HAUNTED HOUSE/THEME PARK ATTRACTION WITH A HALLOWEEN THEME (U.S. CLS. 100, 101 AND 107).

FIRST USE 5-10-1999; IN COMMERCE 7-15-1999.

---

2,929,877. INTERNATIONAL SWAPS AND DERIVATIVES ASSOCIATION, INC., NEW YORK, NY. SN 78-325,437. PUB. 8-24-2004, FILED 11-10-2003.

**ISDA Symposium**

THE MARK CONSISTS OF STANDARD CHARACTERS WITHOUT CLAIM TO ANY PARTICULAR FONT, STYLE, SIZE, OR COLOR.

NO CLAIM IS MADE TO THE EXCLUSIVE RIGHT TO USE "SYMPOSIUM", APART FROM THE MARK AS SHOWN.

FOR EDUCATIONAL SERVICES, NAMELY, CONDUCTING CONFERENCES RELATING TO LEGAL ISSUES IN THE FIELD OF DERIVATIVES (U.S. CLS. 100, 101 AND 107).

FIRST USE 3-9-2004; IN COMMERCE 3-9-2004.

**CLASS 41—(Continued).**

2,929,879. RATH, WAYNE, MANLIUS, NY. AND RATH, JEAN DUFFY, MANLIUS, NY. SN 78-327,972. PUB. 8-10-2004, FILED 11-14-2003.

**TOOLS TO FIGHT  
BACK**

THE MARK CONSISTS OF STANDARD CHARACTERS WITHOUT CLAIM TO ANY PARTICULAR FONT, STYLE, SIZE, OR COLOR.

FOR INTERACTIVE EDUCATIONAL AND TRAINING PROGRAM FOR THE PREVENTION AND TREATMENT OF MUSCULOSKELETAL AND LIFESTYLE-RELATED DISORDERS AND DISABILITIES (U.S. CLS. 100, 101 AND 107).

FIRST USE 0-0-1985; IN COMMERCE 0-0-1985.

---

2,929,880. RATH, WAYNE, MANLIUS, NY. AND RATH, JEAN DUFFY, MANLIUS, NY. SN 78-328,069. PUB. 8-10-2004, FILED 11-14-2003.

The logo features the words "Tools To Fight Back" in a stylized, hand-drawn font. The word "Tools" is in a simple sans-serif font, while "To Fight Back" is in a more decorative, slightly irregular font. A small graphic of a hand holding a hammer is positioned above the word "Fight".

FOR INTERACTIVE EDUCATIONAL AND TRAINING PROGRAM FOR THE PREVENTION AND TREATMENT OF MUSCULOSKELETAL AND LIFESTYLE-RELATED DISORDERS AND DISABILITIES (U.S. CLS. 100, 101 AND 107).

FIRST USE 9-30-2003; IN COMMERCE 9-30-2003.

**CLASS 41—(Continued).**

2,929,882. HEAVEN HILL DISTILLERIES, INC, BARDS-TOWN, KY. SN 78-333,723. PUB. 8-31-2004, FILED 11-26-2003.

## BOURBON HERITAGE CENTER

THE MARK CONSISTS OF STANDARD CHARACTERS WITHOUT CLAIM TO ANY PARTICULAR FONT, STYLE, SIZE, OR COLOR.

OWNER OF U.S. REG. NO. 1,927,547.

NO CLAIM IS MADE TO THE EXCLUSIVE RIGHT TO USE "CENTER", APART FROM THE MARK AS SHOWN.

FOR EDUCATION AND ENTERTAINMENT SERVICES; NAMELY, OPERATING A VISITOR CENTER FACILITY IN ASSOCIATION WITH A DISTILLER (U.S. CLS. 100, 101 AND 107).

FIRST USE 10-15-2004; IN COMMERCE 10-15-2004.

2,929,884. WORLD TRIATHLON CORPORATION, TARPON SPRINGS, FL. SN 78-377,853. PUB. 7-6-2004, FILED 3-3-2004.

## IRON GIRL IT'S YOUR TURN

THE MARK CONSISTS OF STANDARD CHARACTERS WITHOUT CLAIM TO ANY PARTICULAR FONT, STYLE, SIZE, OR COLOR.

FOR ENTERTAINMENT SERVICES NAMELY ARRANGING AND CONDUCTING ATHLETIC COMPETITIONS (U.S. CLS. 100, 101 AND 107).

FIRST USE 3-1-2004; IN COMMERCE 9-12-2004.

### CLASS 42—SCIENTIFIC, COMPUTER AND LEGAL SERVICES

**CLASS 42—(Continued).**

2,929,051. LIFEMASTER SUPPORTED SELFCARE, INC., IRVINE, CA. SN 75-417,673. PUB. 9-11-2001, FILED 1-14-1998.

## LIFEMASTERS SUPPORTED SELFCARE

OWNER OF U.S. REG. NO. 1,998,449.

NO CLAIM IS MADE TO THE EXCLUSIVE RIGHT TO USE "SUPPORTED SELFCARE", APART FROM THE MARK AS SHOWN.

FOR HEALTH INFORMATION AND MONITORING SERVICES BY WHICH HEALTH CARE PROFESSIONALS CAN MONITOR AND TRACK THROUGH REMOTE AND NON-REMOTE MEANS THE CURRENT HEALTH STATUS OF PATIENTS (U.S. CLS. 100 AND 101).

FIRST USE 10-31-1998; IN COMMERCE 10-31-1998.

2,929,126. GANTTHEAD.COM, INC., FAIRFAX, VA. SN 76-160,185. PUB. 9-11-2001, FILED 11-6-2000.

## PROJECTS@WORK

FOR COMPUTER SERVICES, NAMELY, PROVIDING ONLINE NEWSLETTERS AND MAGAZINES IN THE FIELD OF TECHNOLOGY PROJECT MANAGEMENT (U.S. CLS. 100 AND 101).

FIRST USE 4-1-2004; IN COMMERCE 4-1-2004.

2,929,186. MAZZONE, THOMAS, COWLESVILLE, NY. SN 76-265,353. PUB. 12-25-2001, FILED 6-1-2001.

## HERMEDUS

FOR MEDICAL AND PHARMACEUTICAL INFORMATION PROVIDED TO PATIENTS AND HEALTH CARE PROVIDERS VIA A NETWORK OF COMPUTERS (U.S. CLS. 100 AND 101).

FIRST USE 9-1-2004; IN COMMERCE 9-1-2004.

2,929,207. TREEBONES RESORT LLC, LONG BEACH, CA. SN 76-302,534. PUB. 3-26-2002, FILED 8-21-2001.

## TREEBONES

FOR RESORT SERVICES, NAMELY CAMPGROUND, HOTEL, RESTAURANT, AND YURT FACILITIES (U.S. CLS. 100 AND 101).

FIRST USE 1-2-2002; IN COMMERCE 10-24-2004.



**CLASS 42—(Continued).**

2,929,213. OPTIBRAND LTD., LLC, FORT COLLINS, CO. SN 76-314,772. PUB. 3-11-2003, FILED 9-20-2001.

**OPTIBRAND**

FOR IMAGE ACQUISITION SERVICES, COMPUTER DATABASE MAINTENANCE SERVICES, AND SEARCHING, RETRIEVING, AND MATCHING SERVICES NAMELY OF RETINAL IMAGES OF ANIMALS AND HUMANS FOR IDENTIFICATION, VERIFICATION, AND TRACKING MOVEMENT OF ANIMALS AND HUMANS (U.S. CLS. 100 AND 101).

FIRST USE 11-5-2001; IN COMMERCE 10-23-2002.

2,929,219. ORCHID BIOSCIENCES, INC., PRINCETON, NJ. SN 76-331,130. PUB. 2-17-2004, FILED 10-29-2001.

**ORCHID GENESCREEN**

OWNER OF U.S. REG. NO. 2,068,669.  
FOR RESEARCH, TESTING AND SCREENING SERVICES IN THE FIELD OF BIOLOGY, GENETICS AND THERAPEUTICS; FORENSIC RESEARCH, FORENSIC TESTING, AND FORENSIC IDENTIFICATION SERVICES (U.S. CLS. 100 AND 101).

FIRST USE 6-15-2002; IN COMMERCE 6-15-2002.

2,929,270. NDCHEALTH CORPORATION, ATLANTA, GA. SN 76-411,678. PUB. 10-14-2003, FILED 5-22-2002.

**NDC RXSAFETY ADVISOR**

OWNER OF U.S. REG. NOS. 1,904,601, 2,567,103, AND OTHERS.

NO CLAIM IS MADE TO THE EXCLUSIVE RIGHT TO USE "ADVISOR", APART FROM THE MARK AS SHOWN.

FOR PROVIDING TEMPORARY USE OF ON-LINE NON-DOWNLOADABLE SOFTWARE FOR MONITORING, ANALYZING AND REPORTING OF RETAIL PHARMACY TRANSACTIONS, PRESCRIPTION DRUG TRANSACTIONS AND SALES PATTERNS, AND OVERALL BUSINESS PERFORMANCE AND MARKET SHARE (U.S. CLS. 100 AND 101).

FIRST USE 8-0-2002; IN COMMERCE 8-0-2002.

2,929,430. BUC INTERNATIONAL CORPORATION, FORT LAUDERDALE, FL. SN 76-526,013. PUB. 3-23-2004, FILED 6-17-2003.

**CHARTERQUEST**

FOR PROVIDING ONLINE INFORMATION REGARDING MARINE VESSELS AND OTHER MARINE GOODS AND SERVICES (U.S. CLS. 100 AND 101).

FIRST USE 12-14-2004; IN COMMERCE 12-14-2004.

**CLASS 42—(Continued).**

2,929,532. CHEMGENEX THERAPEUTICS, INC., MENLO PARK, CA. SN 78-039,132. PUB. 8-21-2001, FILED 12-13-2000.

**CHEMOTYPING**

FOR SCIENTIFIC RESEARCH, NAMELY, DRUG DISCOVERY SERVICES (U.S. CLS. 100 AND 101).

FIRST USE 10-12-2004; IN COMMERCE 10-12-2004.

2,929,537. FALL, KEVIN ROLAND, SAN DIEGO, CA. SN 78-048,334. PUB. 7-31-2001, FILED 2-14-2001.

**RCS**

FOR COMPUTER CONSULTATION IN THE FIELD OF SOFTWARE ARCHITECTURE, INCLUDING PERFORMANCE ISSUES OF NETWORKED SYSTEMS (U.S. CLS. 100 AND 101).

FIRST USE 7-31-1993; IN COMMERCE 7-31-1993.

2,929,606. COLLECTORS UNIVERSE, SANTA ANA, CA. SN 78-160,201. PUB. 5-6-2003, FILED 9-3-2002.

**QUICKOPINION**

THE MARK CONSISTS OF STANDARD CHARACTERS WITHOUT CLAIM TO ANY PARTICULAR FONT, STYLE, SIZE, OR COLOR.

FOR AUTHENTICATION IN THE FIELD OF AUTOGRAPHED COLLECTIBLES (U.S. CLS. 100 AND 101).

FIRST USE 10-1-2002; IN COMMERCE 2-1-2003.

2,929,635. ZNOMICS, INC., OREGON CITY, OR. SN 78-185,169. PUB. 8-26-2003, FILED 11-14-2002.

**ZENEMARK**

FOR MAINTAINING A SPERM INSERTIONAL LIBRARY; GENETICS RESEARCH; MAINTAINING AN INDEX OF DRUG TARGETS (U.S. CLS. 100 AND 101).

FIRST USE 11-11-2002; IN COMMERCE 4-15-2003.

**CLASS 42—(Continued).**

2,929,648. ZAZ CORPORATION, BOULDER, CO. SN 78-189,619. PUB. 8-12-2003, FILED 11-27-2002.

**ZAZ**

FOR APPLICATION SERVICE PROVIDER (ASP) FEATURING SOFTWARE FOR THE MANIPULATION OF DATA OVER GLOBAL COMMUNICATION NETWORKS, NAMELY, EDITING SOFTWARE, SORTING SOFTWARE, DATABASE MANAGEMENT SOFTWARE; COMPUTER CONSULTATION; COMPUTER PROGRAMMING FOR OTHERS; COMPUTER SERVICES, NAMELY, CREATING, IMPLEMENTING AND MAINTAINING WEB SITES FOR OTHERS; COMPUTER SYSTEMS ANALYSIS, INTEGRATION OF COMPUTER SYSTEMS AND NETWORKS, COMPUTER PROGRAMMING FOR OTHERS ALL FOR USE IN COMMERCIAL INTERACTIONS OVER GLOBAL COMPUTER NETWORKS; DATA AUTOMATION AND COLLECTION SERVICE USING PROPRIETARY SOFTWARE TO EVALUATE, ANALYZE AND COLLECT SERVICE DATA; DATA ENCRYPTION SERVICES; DATABASE DEVELOPMENT SERVICES; REGISTRATION OF DOMAIN NAMES FOR IDENTIFICATION OF USERS ON A GLOBAL COMPUTER NETWORK (U.S. CLS. 100 AND 101).

FIRST USE 3-3-1996; IN COMMERCE 3-1-2003.

2,929,703. SILVEROFFICE, INC., SAN FRANCISCO, CA. SN 78-229,343. PUB. 6-1-2004, FILED 3-24-2003.

**SILVEROFFICE**

FOR APPLICATION SERVICE PROVIDER, (ASP), NAMELY, HOSTING COMPUTER SOFTWARE APPLICATIONS FOR OTHERS (U.S. CLS. 100 AND 101).

FIRST USE 3-28-2004; IN COMMERCE 3-28-2004.

2,929,705. AETNA INC., BLUE BELL, PA. SN 78-229,666. PUB. 1-13-2004, FILED 3-25-2003.

**AETNA INTEGRATED  
INFORMATICS**

OWNER OF U.S. REG. NOS. 822,577, 1,939,424, AND OTHERS.

NO CLAIM IS MADE TO THE EXCLUSIVE RIGHT TO USE "INTEGRATED INFORMATICS", APART FROM THE MARK AS SHOWN.

FOR PROVIDING AND ADMINISTERING QUALITY CONTROL SYSTEMS FOR OTHERS, NAMELY, FOR HEALTH CARE BENEFITS PROVIDERS, HOSPITALS, HEALTH CLINICS AND DOCTOR'S OFFICES (U.S. CLS. 100 AND 101).

FIRST USE 4-30-2004; IN COMMERCE 4-30-2004.

**CLASS 42—(Continued).**

2,929,757. RAINDANCE COMMUNICATIONS, INC., LOUISVILLE, CO. SN 78-257,280. PUB. 2-24-2004, FILED 6-2-2003.

**SWITCHTOWER**

FOR APPLICATION SERVICE PROVIDER, NAMELY, HOSTING INTERNET-BASED COMPUTER APPLICATIONS TO FACILITATE THE ONLINE INTERACTION OF MULTIPLE USERS AND SHARING OF COMPUTER APPLICATIONS, INFORMATION AND WEB BROWSING (U.S. CLS. 100 AND 101).

FIRST USE 6-0-2003; IN COMMERCE 3-0-2004.

2,929,867. COMPUTER SCIENCES CORPORATION, EL SEGUNDO, CA. SN 78-317,630. PUB. 7-20-2004, FILED 10-23-2003.

**CUSTOMER INTELLIGENCE**

FOR COMPUTER INFORMATION SYSTEM SERVICES, NAMELY, SYSTEM ANALYSIS, DESIGN, AND CONSULTING SERVICES RELATING TO BUSINESS CUSTOMER INFORMATION DATABASES AND CUSTOMER RELATIONSHIP MANAGEMENT PROCESSES (U.S. CLS. 100 AND 101).

FIRST USE 6-1-2003; IN COMMERCE 6-1-2003.

2,929,876. IGNITASITE INC., DALLAS, TX. SN 78-325,328. PUB. 7-27-2004, FILED 11-10-2003.

**IGNITASITE**

THE MARK CONSISTS OF STANDARD CHARACTERS WITHOUT CLAIM TO ANY PARTICULAR FONT, STYLE, SIZE, OR COLOR.

FOR COMPUTER SERVICES, NAMELY, CREATING INDEXES OF INFORMATION, DIRECTORIES, SEARCHABLE DATABASES, WEB SITES AND OTHER RESOURCES OF INTEREST IN THE FIELD OF TRANSPORTATION THAT ARE AVAILABLE ON A GLOBAL COMPUTER NETWORK; PROVIDING AN ON-LINE INFORMATION PORTAL AND A SEARCH ENGINE FOR SEARCHING AND RETRIEVING SPECIFIC INFORMATION IN THE FIELD OF TRANSPORTATION FROM WEB SITES, DIRECTORIES, SEARCHABLE DATABASES AND OTHER RESOURCES THAT ARE AVAILABLE ON A GLOBAL COMPUTER NETWORK; AND PROVIDING ON-LINE WEB PAGES FEATURING USER-DEFINED INFORMATION, WHICH INCLUDES SEARCH ENGINES AND ON-LINE WEB LINKS TO OTHER WEB SITES AND INFORMATION IN THE FIELD OF TRANSPORTATION (U.S. CLS. 100 AND 101).

FIRST USE 6-0-2004; IN COMMERCE 6-0-2004.

**CLASS 43—HOTEL AND RESTAURANT SERVICES**

2,929,398. WHITE CASTLE MANAGEMENT CO., COLUMBUS, OH. SN 76-511,658. PUB. 4-20-2004, FILED 5-5-2003.

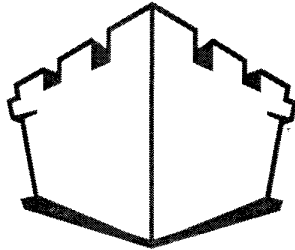

OWNER OF U.S. REG. NOS. 1,808,813 AND 2,603,526. FOR RESTAURANT SERVICES (U.S. CLS. 100 AND 101). FIRST USE 8-0-2003; IN COMMERCE 8-0-2003.

**CLASS 43—(Continued).**

2,929,427. SANTUCCI BROTHERS, INC., PHILADELPHIA, PA. SN 76-525,594. PUB. 3-30-2004, FILED 6-26-2003.



OWNER OF U.S. REG. NOS. 1,907,754 AND 1,922,656. FOR RESTAURANT SERVICES (U.S. CLS. 100 AND 101). FIRST USE 4-0-2003; IN COMMERCE 4-0-2003.

2,929,425. EUGENE & ASSOCIATES, LOS ANGELES, CA. SN 76-525,471. PUB. 6-1-2004, FILED 6-25-2003.

**CHAYA BRASSERIE**

THE ENGLISH TRANSLATION OF THE JAPANESE WORD "CHAYA" IS "TEA HOUSE", "TEA DEALER", OR "TEA BOOTH". FOR RESTAURANT SERVICES (U.S. CLS. 100 AND 101). FIRST USE 7-1-1994; IN COMMERCE 7-1-1994.

2,929,466. IN THE DOUGH, LLC, CALLAWAY, NE. SN 76-540,701. PUB. 6-22-2004, FILED 8-15-2003.

**PANE BELLO**

NO CLAIM IS MADE TO THE EXCLUSIVE RIGHT TO USE PANE, APART FROM THE MARK AS SHOWN. THE ENGLISH TRANSLATION OF THE PANE BELLO MARK IS "BEAUTIFUL BREAD". FOR RESTAURANT SERVICES (U.S. CLS. 100 AND 101). FIRST USE 12-10-2003; IN COMMERCE 12-10-2003.

2,929,426. SANTUCCI BROTHERS, INC., PHILADELPHIA, PA. SN 76-525,593. PUB. 4-27-2004, FILED 6-26-2003.

**SANTUCCI BROTHERS SQUARE PIZZA**

OWNER OF U.S. REG. NOS. 1,907,754 AND 1,922,656. NO CLAIM IS MADE TO THE EXCLUSIVE RIGHT TO USE "SQUARE PIZZA", APART FROM THE MARK AS SHOWN. FOR RESTAURANT SERVICES (U.S. CLS. 100 AND 101). FIRST USE 4-0-2003; IN COMMERCE 4-0-2003.

2,929,473. NANDO'S INTERNATIONAL LIMITED, DUBLIN, IRELAND, UNITED KINGDOM. SN 76-542,545. PUB. 5-18-2004, FILED 9-5-2003.

**NANDO'S CHICKENLAND**

FOR RESTAURANT SERVICES (U.S. CLS. 100 AND 101). FIRST USE 4-0-2003; IN COMMERCE 5-0-2003.

**CLASS 43—(Continued).**

2,929,487. NANDO'S INTERNATIONAL LIMITED, DUBLIN, IRELAND, UNITED KINGDOM. SN 76-549,943. PUB. 6-1-2004, FILED 10-7-2003.



FOR RESTAURANT AND TAKE-AWAY FAST FOOD SERVICES (U.S. CLS. 100 AND 101).  
FIRST USE 4-0-2003; IN COMMERCE 5-0-2003.

2,929,656. TELEVISION FOOD NETWORK, G.P., NEW YORK, NY. SN 78-195,458. PUB. 2-17-2004, FILED 12-17-2002.



OWNER OF U.S. REG. NOS. 2,090,091, 2,771,532, AND OTHERS.  
NO CLAIM IS MADE TO THE EXCLUSIVE RIGHT TO USE "NETWORK", APART FROM THE MARK AS SHOWN. SEC. 2(F) AS TO "FOOD".  
FOR PROVIDING INFORMATION VIA A GLOBAL COMPUTER INFORMATION NETWORK IN THE FIELDS OF COOKING AND CULINARY ARTS (U.S. CLS. 100 AND 101).  
FIRST USE 2-27-2003; IN COMMERCE 2-27-2003.

**CLASS 43—(Continued).**

2,929,764. GREAT CONCEPTS, LLC, PLANTATION, FL. SN 78-259,855. PUB. 2-3-2004, FILED 6-9-2003.

**DANTANNA'S**

FOR STEAK AND SEAFOOD RESTAURANT (U.S. CLS. 100 AND 101).  
FIRST USE 9-30-2003; IN COMMERCE 9-30-2003.

**CLASS 44—MEDICAL, BEAUTY AND AGRICULTURAL SERVICES**

2,929,242. SOUTHWESTERN VERMONT HEALTH CARE, BENNINGTON, VT. SN 76-369,669. PUB. 11-12-2002, FILED 2-11-2002.

**WELLPRO**

FOR HEALTH CARE CONSULTING SERVICES IN THE FIELD OF PERSONAL HEALTH AND WELLNESS PROGRAMS; HEALTH CARE CONSULTING SERVICES IN THE FIELD OF HEALTH CARE BENEFIT PLANS FOR EMPLOYEES AND EMPLOYEES OF OTHERS (U.S. CLS. 100 AND 101).  
FIRST USE 1-1-2002; IN COMMERCE 7-1-2004.

2,929,407. INDEPENDENT HEALTH ASSOCIATION, INC., BUFFALO, NY. SN 76-518,170. PUB. 3-2-2004, FILED 5-30-2003.

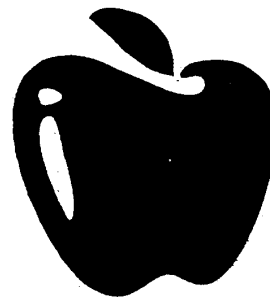

OWNER OF U.S. REG. NOS. 1,451,464, 2,653,308, AND OTHERS.  
FOR HEALTH CARE SERVICES RENDERED BY A HEALTH MAINTENANCE ORGANIZATION (U.S. CLS. 100 AND 101).  
FIRST USE 9-0-2003; IN COMMERCE 9-0-2003.

**CLASS 44—(Continued).**

2,929,422. MERIDIAN HEALTH SYSTEM, INC., NEPTUNE, NJ. SN 76-524,980. PUB. 2-3-2004, FILED 6-23-2003.

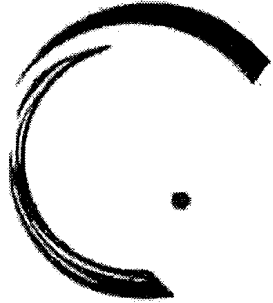

OWNER OF U.S. REG. NO. 2,206,561.  
 THE MARK CONSISTS OF THE DESIGN ELEMENT OF A HEMISPHERE.  
 FOR MEDICAL, HEALTHCARE, HOSPITAL, PHYSICIAN, HOME CARE, REHABILITATION, MENTAL HEALTH, SUBSTANCE ABUSE, NURSING HOME, ASSISTED LIVING, POSTACUTE CARE, LONG-TERM CARE, SKILLED NURSING, OCCUPATIONAL HEALTH, BEHAVIORAL HEALTH, SURGERY CENTER, AMBULANCE, HOSPICE, URG/EMERGI CENTER, AND INTRA VENOUS SERVICES; LEASING OF HOME AND DURABLE MEDICAL EQUIPMENT (U.S. CLS. 100 AND 101).  
 FIRST USE 7-1-2003; IN COMMERCE 7-1-2003.

2,929,432. UHS OF DELAWARE, INC., KING OF PRUSSIA, PA. SN 76-526,827. PUB. 2-24-2004, FILED 7-2-2003.



FOR MEDICAL AND HEALTHCARE SERVICES (U.S. CLS. 100 AND 101).  
 FIRST USE 11-1-2003; IN COMMERCE 11-1-2003.

**CLASS 44—(Continued).**

2,929,569. QUILES, MICHELLE D., JERSEY CITY, NJ. SN 78-119,972. PUB. 12-3-2002, FILED 4-5-2002.



THE MARK CONSISTS IN PART OF A DESIGN OF A WOMAN WITH LIGHT RAYS OVER HER HEAD.  
 FOR HEALTH CARE IN THE NATURE OF HEALTH MAINTENANCE ORGANIZATIONS (U.S. CLS. 100 AND 101).  
 FIRST USE 2-21-2002; IN COMMERCE 5-2-2002.

2,929,633. STAT RADIOLOGY MEDICAL CORPORATION, LA JOLLA, CA. SN 78-184,765. PUB. 12-16-2003, FILED 11-13-2002.



THE STIPPLING IS FOR SHADING PURPOSES ONLY.  
 THE MARK CONSISTS OF THE WORDS "STAT" AND "RAD" WITH A RED HOURGLASS IN THE CENTER OF THE WORDING.  
 FOR PROVIDING MEDICAL INFORMATION, NAMELY, PROVIDING RADIOLOGY INTERPRETATION SERVICES (U.S. CLS. 100 AND 101).  
 FIRST USE 11-13-2002; IN COMMERCE 11-13-2002.

2,929,734. ARBORGUARD, INC., AVONDALE ESTATES, GA. SN 78-244,357. PUB. 11-25-2003, FILED 5-1-2003.



FOR TREE CARE SERVICES, NAMELY SOIL INJECTION APPLICATION OF PRODUCTS TO TREES (U.S. CLS. 100 AND 101).  
 FIRST USE 7-12-2004; IN COMMERCE 7-12-2004.

**CLASS 45—PERSONAL SERVICES**

**CLASS 45—(Continued).**

2,929,390. CONTEMPORARY CONCIERGE, LLC, ORLANDO, FL. SN 76-510,085. PUB. 3-2-2004, FILED 4-28-2003.

**CONTEMPORARY  
CONCIERGE**

NO CLAIM IS MADE TO THE EXCLUSIVE RIGHT TO USE "CONCIERGE", APART FROM THE MARK AS SHOWN.

FOR CONCIERGE SERVICES FOR OTHERS COMPRISING MAKING REQUESTED PERSONAL ARRANGEMENTS, RESERVATIONS AND PROVIDING CUSTOMER-SPECIFIC INFORMATION TO MEET INDIVIDUAL NEEDS IN THE FIELDS OF DINING, SHOPPING, ENTERTAINMENT, TRAVEL, HOUSING, LODGING, SPORTS CULTURE, MEDICINE, CONSTRUCTION, NEIGHBORHOODS AND REAL ESTATE (U.S. CLS. 100 AND 101).

FIRST USE 4-25-2003; IN COMMERCE 4-25-2003.

**CLASS 45—(Continued).**

2,929,868. SOCIALTECH, INC., SAN MATEO, CA. SN 78-318,418. PUB. 7-27-2004, FILED 10-24-2003.

**CRITICAL REACH**

FOR SECURITY SERVICES, NAMELY THE COORDINATION, INTEGRATION AND ANALYSIS OF DATA AND THE NOTIFICATION AND DISSEMINATION OF INFORMATION AND DATA TO COMMUNITY GROUPS AND LAW ENFORCEMENT AGENCIES IN THE FIELD OF LAW ENFORCEMENT AND NATIONAL SECURITY (U.S. CLS. 100 AND 101).

FIRST USE 3-1-2004; IN COMMERCE 3-1-2004.

\* \* \* \* \*

PRIOR UNITED STATES CLASSIFICATION

APPLICATION IN ONE CLASS

CERTIFICATION MARKS

**CLASS B—SERVICES**

2,929,366. INTERNATIONAL INFORMATION SYSTEMS SECURITY CERTIFICATION CONSORTIUM, INC., FRAMINGHAM, MA. SN 76-499,821. PUB. 12-2-2003, FILED 3-24-2003.

**ISSEP**

THE CERTIFICATION MARK, AS INTENDED TO BE USED BY AUTHORIZED PERSONS, IS INTENDED TO CERTIFY COMPLETION OF APPROPRIATE WORK EXPERIENCE AND SUCCESSFULLY PASSING EXAMINATIONS AS ESTABLISHED BY THE CERTIFIER IN THE FIELD OF INFORMATION SYSTEMS SECURITY IN APPLICABLE DOMAINS, INCLUDING BUT NOT LIMITED TO, CERTIFICATION AND ACCREDITATION, GOVERNMENT POLICY AND REGULATION, SYSTEMS SECURITY ENGINEERING PROCESS, AND PROTECTION NEEDS DETERMINATION.

FOR CERTIFICATION OF INDIVIDUALS AS INFORMATION SYSTEMS SECURITY ENGINEERING PROFESSIONALS (U.S. CL. B).

FIRST USE 6-29-2003; IN COMMERCE 6-29-2003.

\* \* \* \* \*

# SUPPLEMENTAL REGISTER

These registrations are not subject to opposition.

## SECTION 1.— INTERNATIONAL CLASSIFICATION

The short titles associated below with the international class numbers are terms designed merely for quick identification and are not an official part of the international classification. The full names of international classes are given in section 6.1 of the trademark rules of practice.

The designation "U.S. Cl." appearing in this section refers to the U.S. class in effect prior to Sep. 1, 1973 rather than the international class which applies to applications filed on or after that date. For adoption of international classification see notice in the OFFICIAL GAZETTE of Jun. 26, 1973 (911 O.G. TM 210).

### Application in more than one class

2,929,895. STRUCTURED DATA SYSTEMS PTY LTD, MELBOURNE, VICTORIA, AUSTRALIA. SN 76-349,861. FILED P.R. 12-17-2001; AM. S.R. 6-2-2003.

## **RACETRAX**

OWNER OF AUSTRALIA REG. NO. 926215, DATED 9-6-2002, EXPIRES 9-6-2012.

### **CLASS 36—INSURANCE AND FINANCIAL**

FOR BETTING AND WAGERING SERVICES ALL IN RELATION TO COMPUTER GENERATED GAMES OF CHANCE (U.S. CLS. 100, 101 AND 102).

### **CLASS 41—EDUCATION AND ENTERTAINMENT**

FOR PROVIDING COMPUTER GENERATED GAMES OF CHANCE THAT MAY BE ACCESSED NETWORK-WIDE BY NETWORK USERS; CASINOS (U.S. CLS. 100, 101 AND 107).

\* \* \* \* \*



# TRADEMARK REGISTRATIONS RENEWED

The designation "U.S. Cl." appearing in this section refers to the U.S. class in effect prior to Sep. 1, 1973 rather than the international class which applies to applications filed on or after that date. For adoption of international classification see notice in the OFFICIAL GAZETTE of Jun. 26, 1973 (911 O.G. TM 210).

26,253.	QUAKER (STYLIZED). U.S. CL. 46. (INT. CL. 30). REG. 3-19-1895.	987,374.	ORS-CHEMIVIC. U.S. CL. 35. (INT. CL. 17). REG. 7-2-1974.
47,154.	CAMPBELL'S AND DESIGN. U.S. CL. 46. (INT. CL. 29). REG. 10-31-1905.	997,453.	LOST ARROW. U.S. CL. 13. (INT. CL. 28). REG. 11-5-1974.
188,718.	TOWN & COUNTRY. U.S. CL. 38. (INT. CLS. 9, 16 AND 28). REG. 9-2-1924.	997,497.	CONSULAB. U.S. CL. 21. (INT. CLS. 9 AND 11). REG. 11-5-1974.
317,588.	UNIVERSAL (STYLIZED). U.S. CL. 46. (INT. CL. 31). REG. 10-2-1934.	997,679.	ORJENE. U.S. CLS. 51 AND 52. (INT. CLS. 3 AND 5). REG. 11-5-1974.
321,014.	GUINNESS. U.S. CL. 48. (INT. CL. 32). REG. 1-15-1935.	998,398.	APT U.S.A. AND DESIGN. INT. CL. 7. (U.S. CL. 23). REG. 11-19-1974.
410,626.	VEL. U.S. CL. 4. (INT. CL. 3). REG. 12-5-1944.	999,170.	PRO-LOK. U.S. CL. 12. (INT. CL. 19). REG. 11-26-1974.
411,294.	SEVENTEEN (STYLIZED). U.S. CL. 38. (INT. CL. 16). REG. 1-9-1945.	1,000,152.	ROPER REPORTS. INT. CL. 42. (U.S. CL. 100). REG. 12-24-1974.
412,286.	F AND DESIGN. U.S. CL. 21. (INT. CLS. 9 AND 11). REG. 2-27-1945.	1,000,478.	NU-THERA. INT. CL. 5. (U.S. CL. 18). REG. 12-31-1974.
599,753.	EKU (STYLIZED). U.S. CL. 48. (INT. CL. 32). REG. 12-21-1954.	1,001,017.	LEER. INT. CL. 12. (U.S. CL. 19). REG. 1-7-1975.
604,422.	GENERAL (STYLIZED). U.S. CL. 21. (INT. CL. 7). REG. 4-12-1955.	1,001,082.	C.D.I. AAAA (STYLIZED). INT. CL. 25. (U.S. CL. 39). REG. 1-7-1975.
605,011.	HASTELLO. U.S. CL. 13. (INT. CL. 6). REG. 4-26-1955.	1,001,109.	BUBBLE YUM. INT. CL. 30. (U.S. CL. 46). REG. 1-7-1975.
614,157.	MOTOROLA (STYLIZED). U.S. CL. 7. (INT. CL. 9). REG. 10-18-1955.	1,002,073.	HALSTON. INT. CLS. 25 AND 42. (U.S. CLS. 39 AND 101). REG. 1-21-1975.
771,219.	KRUN.CHEE AND DESIGN. U.S. CL. 46. (INT. CLS. 29 AND 30). REG. 6-9-1964.	1,003,026.	SCOTIABANK (STYLIZED). INT. CL. 36. (U.S. CL. 102). REG. 1-28-1975.
771,279.	AMERICAN FOOTBALL LEAGUE. U.S. CL. 101. (INT. CL. 35). REG. 6-9-1964.	1,005,211.	LO/OVRAL. INT. CL. 5. (U.S. CL. 18). REG. 2-25-1975.
776,137.	K 21. U.S. CL. 23. (INT. CL. 7). REG. 9-1-1964.	1,005,226.	STREAKERS. INT. CL. 6. (U.S. CL. 13). REG. 2-25-1975.
779,958.	WELLS LAMONT. U.S. CL. 39. (INT. CL. 25). REG. 11-10-1964.	1,006,175.	HYDROLIN. INT. CL. 1. (U.S. CL. 6). REG. 3-11-1975.
780,344.	SPHINX. U.S. CL. 37. (INT. CL. 16). REG. 11-17-1964.	1,006,539.	ARCAIR. U.S. CLS. 6 AND 34 ONLY. (INT. CLS. 1, 7 AND 9). REG. 3-11-1975.
780,345.	MISCELLANEOUS DESIGN. U.S. CL. 37. (INT. CL. 16). REG. 11-17-1964.	1,007,079.	CRYOCART. U.S. CL. 23. (INT. CL. 7). REG. 3-18-1975.
781,359.	THERMILINEAR. U.S. CL. 26. (INT. CL. 9). REG. 12-8-1964.	1,009,552.	CONNECT FOUR. INT. CL. 28. (U.S. CL. 22). REG. 4-29-1975.
781,889.	DURADENE. INT. CL. 1. (U.S. CL. 1). REG. 12-22-1964.	1,009,985.	DON'T SPILL THE BEANS. INT. CL. 28. (U.S. CL. 22). REG. 5-6-1975.
781,948.	UNIJET. U.S. CL. 13. (INT. CL. 6). REG. 12-22-1964.	1,020,031.	MISCELLANEOUS DESIGN. INT. CL. 30. (U.S. CL. 46). REG. 9-9-1975.
782,088.	XTRA-TRAC (STYLIZED). U.S. CL. 35. (INT. CL. 12). REG. 12-22-1964.	1,021,649.	MORE. INT. CL. 34. (U.S. CL. 17). REG. 9-30-1975.
782,574.	CULLIGAN. U.S. CL. 52. (INT. CL. 3). REG. 12-29-1964.	1,247,660.	IMMUNOLOGY ABSTRACTS. INT. CL. 16. (U.S. CL. 38). REG. 8-9-1983.
782,584.	SERVICEMASTER. U.S. CL. 103. (INT. CL. 37). REG. 12-29-1964.	1,252,920.	SEARCH-A-WORD. INT. CL. 16. (U.S. CL. 38). REG. 10-4-1983.
782,838.	ASTROCEL. U.S. CL. 31. (INT. CL. 11). REG. 1-5-1965.	1,276,708.	ENSAR. INT. CLS. 6, 8, 17, 20 AND 21. (U.S. CLS. 13, 23, 24, 25 AND 50). REG. 5-8-1984.
783,475.	SUMITHION AND DESIGN. U.S. CL. 6. (INT. CLS. 1, 2, 3, 4 AND 5). REG. 1-19-1965.	1,281,658.	QUADRO AND DESIGN. INT. CL. 28. (U.S. CL. 22). REG. 6-12-1984.
784,110.	MURDICK'S FAMOUS. U.S. CL. 46. (INT. CL. 30). REG. 1-26-1965.	1,281,793.	ZAPATA. INT. CL. 30. (U.S. CL. 46). REG. 6-12-1984.
784,237.	TUPERSAN. U.S. CL. 6. (INT. CL. 1). REG. 2-2-1965.	1,282,208.	METALERT. INT. CL. 9. (U.S. CL. 26). REG. 6-19-1984.
786,360.	BLACK DIAMOND. U.S. CL. 23. (INT. CL. 7). REG. 3-9-1965.	1,282,478.	M2T. INT. CL. 17. (U.S. CL. 35). REG. 6-19-1984.
787,418.	SUPER-BAR (STYLIZED). U.S. CL. 13. (INT. CL. 6). REG. 3-30-1965.	1,294,900.	BANCO DE LA NACION ARGENTINA AND DESIGN. INT. CL. 36. (U.S. CL. 102). REG. 9-11-1984.
787,571.	TICONDEROGA. U.S. CL. 37. (INT. CL. 16). REG. 3-30-1965.	1,296,281.	KLEARFOLD. INT. CL. 20. (U.S. CL. 2). REG. 9-18-1984.
788,168.	DUCT AXIAL (STYLIZED). U.S. CL. 34. (INT. CL. 11). REG. 4-13-1965.	1,299,918.	ALABAMA (STYLIZED). INT. CL. 41. (U.S. CL. 107). REG. 10-9-1984.
794,244.	CYREZ. INT. CL. 1. (U.S. CL. 1). REG. 8-17-1965.	1,300,063.	SKINNEX. INT. CL. 2. (U.S. CL. 11). REG. 10-16-1984.
978,236.	DQ. U.S. CL. 46. (INT. CLS. 1, 5, 29, 30, 31 AND 32). REG. 2-5-1974.	1,300,962.	ALABAMA. INT. CL. 41. (U.S. CL. 107). REG. 10-16-1984.
986,186.	EXSPEEDITE. U.S. CL. 101. (INT. CL. 35). REG. 6-11-1974.	1,301,451.	NIECO AND DESIGN. INT. CL. 11. (U.S. CLS. 13, 21, 23, 31 AND 34). REG. 10-23-1984.
986,541.	TEXAS PIONEER. U.S. CL. 46. (INT. CL. 30). REG. 6-18-1974.		

- 1,302,422. WHITE BOX. INT. CL. 9. (U.S. CL. 26). REG. 10-30-1984.
- 1,302,423. WITE BOX. INT. CL. 9. (U.S. CL. 26). REG. 10-30-1984.
- 1,303,524. LOCK NEST. INT. CL. 9. (U.S. CL. 21). REG. 11-6-1984.
- 1,304,074. MIDANET (STYLIZED). INT. CL. 35. (U.S. CL. 101). REG. 11-6-1984.
- 1,304,142. NATIONAL TELEWIRE. INT. CL. 38. (U.S. CL. 104). REG. 11-6-1984.
- 1,304,827. MULTISONICS. INT. CL. 9. (U.S. CL. 26). REG. 11-13-1984.
- 1,305,349. FIRST FAMILY OF TRAVEL. INT. CL. 39. (U.S. CL. 105). REG. 11-13-1984.
- 1,305,560. POPE AND YOUNG CLUB. U.S. CL. 200. REG. 11-13-1984.
- 1,306,278. BACCHUS. INT. CL. 32. (U.S. CL. 45). REG. 11-20-1984.
- 1,306,373. TURBINE METAL TECHNOLOGY. INT. CLS. 37 AND 40. (U.S. CLS. 103 AND 106). REG. 11-20-1984.
- 1,306,442. LADIES-IN-WADING AND DESIGN. INT. CL. 41. (U.S. CL. 107). REG. 11-20-1984.
- 1,306,595. SUPER STRAP. INT. CL. 10. (U.S. CL. 44). REG. 11-20-1984.
- 1,306,823. CATHOD-O-FLEX. INT. CL. 9. (U.S. CL. 26). REG. 11-27-1984.
- 1,306,846. AURORA. INT. CL. 9. (U.S. CL. 21). REG. 11-27-1984.
- 1,307,135. ARROW (STYLIZED). INT. CL. 25. (U.S. CL. 39). REG. 11-27-1984.
- 1,307,405. MONEY MULTIPLIER. INT. CL. 36. (U.S. CL. 102). REG. 11-27-1984.
- 1,307,590. ICE BEATER (STYLIZED). INT. CL. 1. (U.S. CL. 6). REG. 12-4-1984.
- 1,307,591. ICE EATER (STYLIZED). INT. CL. 1. (U.S. CL. 6). REG. 12-4-1984.
- 1,307,619. SOLOXINE. INT. CL. 5. (U.S. CL. 18). REG. 12-4-1984.
- 1,307,717. MOBIL-AID. INT. CL. 9. (U.S. CLS. 21 AND 26). REG. 12-4-1984.
- 1,307,895. SAMPLETTE. INT. CL. 10. (U.S. CL. 44). REG. 12-4-1984.
- 1,307,939. FONTAINE. INT. CL. 12. (U.S. CLS. 19 AND 23). REG. 12-4-1984.
- 1,308,002. R2-D2. INT. CLS. 16 AND 28. (U.S. CL. 22). REG. 12-4-1984.
- 1,308,034. SOLID/FLUE. INT. CL. 19. (U.S. CL. 12). REG. 12-4-1984.
- 1,308,606. STARANE. INT. CL. 5. (U.S. CL. 6). REG. 12-11-1984.
- 1,308,621. SPIR-A-FLOW. INT. CL. 7. (U.S. CL. 23). REG. 12-11-1984.
- 1,308,671. GREINER AND DESIGN. INT. CL. 9. (U.S. CL. 26). REG. 12-11-1984.
- 1,308,693. SENNHEISER. INT. CL. 9. (U.S. CLS. 21 AND 26). REG. 12-11-1984.
- 1,308,743. TEMPBADGE (STYLIZED). INT. CL. 9. (U.S. CLS. 26, 37 AND 38). REG. 12-11-1984.
- 1,308,885. ADRIAN HAMERS. INT. CL. 14. (U.S. CL. 28). REG. 12-11-1984.
- 1,308,975. FLEXI-WEAVE. INT. CL. 17. (U.S. CLS. 12 AND 21). REG. 12-11-1984.
- 1,309,042. ASQ. INT. CL. 21. (U.S. CLS. 2 AND 33). REG. 12-11-1984.
- 1,309,117. MORTON BERNARD. INT. CL. 25. (U.S. CL. 39). REG. 12-11-1984.
- 1,309,357. MISCELLANEOUS DESIGN. INT. CL. 37. (U.S. CLS. 100 AND 103). REG. 12-11-1984.
- 1,309,445. WAWA FOOD MARKET AND DESIGN. INT. CL. 42. (U.S. CL. 101). REG. 12-11-1984.
- 1,309,495. A SUITE FOR THE PRICE OF A ROOM. INT. CL. 42. (U.S. CL. 100). REG. 12-11-1984.
- 1,309,631. VON DUPRIN. INT. CL. 6. (U.S. CLS. 12, 13 AND 25). REG. 12-18-1984.
- 1,309,636. MISCELLANEOUS DESIGN. INT. CL. 6. (U.S. CL. 13). REG. 12-18-1984.
- 1,309,644. 302HQ-FM. INT. CL. 6. (U.S. CL. 14). REG. 12-18-1984.
- 1,309,650. GES. INT. CLS. 7, 9, 11 AND 20. (U.S. CLS. 21 AND 32). REG. 12-18-1984.
- 1,309,900. THE WORLD OF TOYS (STYLIZED). INT. CLS. 15, 16, 21 AND 28 ONLY. (U.S. CLS. 2, 22, 26, 36 AND 37). REG. 12-18-1984.
- 1,310,062. IMPERFLEX AND DESIGN. INT. CL. 19. (U.S. CL. 12). REG. 12-18-1984.
- 1,310,230. THE PURIST. INT. CL. 28. (U.S. CL. 22). REG. 12-18-1984.
- 1,310,286. LIFEING. INT. CL. 28. (U.S. CL. 22). REG. 12-18-1984.
- 1,310,297. T.D.L. INT. CL. 29. (U.S. CL. 46). REG. 12-18-1984.
- 1,310,618. MIRANATE. INT. CL. 1. (U.S. CL. 6). REG. 12-25-1984.
- 1,310,623. ULTRA TURF AND DESIGN. INT. CL. 1. (U.S. CL. 10). REG. 12-25-1984.
- 1,310,769. PANNEX AND DESIGN. INT. CL. 6. (U.S. CLS. 12 AND 25). REG. 12-25-1984.
- 1,310,878. BERGPIN. INT. CL. 9. (U.S. CL. 21). REG. 12-25-1984.
- 1,311,116. TEVI-CAPS. INT. CL. 20. (U.S. CL. 2). REG. 12-25-1984.
- 1,311,568. EL COLEGIO BAR (STYLIZED). INT. CL. 42. (U.S. CL. 100). REG. 12-25-1984.
- 1,311,614. HNTB. INT. CL. 42. (U.S. CL. 100). REG. 12-25-1984.
- 1,312,283. THE SIMULATOR. INT. CL. 16. (U.S. CL. 38). REG. 1-1-1985.
- 1,312,587. S T N INTERNATIONAL (STYLIZED). INT. CL. 35. (U.S. CL. 101). REG. 1-1-1985.
- 1,312,760. FROGDESIGN (STYLIZED). INT. CL. 42. (U.S. CL. 100). REG. 1-1-1985.
- 1,313,012. TRIPLE-GUARD. INT. CL. 4. (U.S. CL. 15). REG. 1-8-1985.
- 1,313,319. CLEAN-A-SCREEN. INT. CL. 11. (U.S. CL. 34). REG. 1-8-1985.
- 1,314,605. C AND DESIGN. INT. CL. 17. (U.S. CL. 12). REG. 1-15-1985.
- 1,315,243. SIL TECH (STYLIZED). INT. CL. 1. (U.S. CLS. 5 AND 6). REG. 1-22-1985.
- 1,317,778. VAN DEN HUL. INT. CL. 9. (U.S. CL. 36). REG. 2-5-1985.
- 1,318,150. SUPER 2 (STYLIZED). INT. CL. 19. (U.S. CLS. 1 AND 12). REG. 2-5-1985.
- 1,318,451. WHEAT NUTS. INT. CL. 30. (U.S. CL. 46). REG. 2-5-1985.
- 1,320,238. OFFICIAL NATIONAL SPONSOR OF HIGH SCHOOL SPORTS. INT. CL. 42. (U.S. CLS. 100 AND 107). REG. 2-12-1985.
- 1,322,620. HOLIDAY WORLD. INT. CL. 41. (U.S. CL. 107). REG. 2-26-1985.
- 1,323,300. HEKMAN. INT. CL. 20. (U.S. CL. 32). REG. 3-5-1985.
- 1,324,599. CRAFTMATIC. INT. CL. 20. (U.S. CL. 32). REG. 3-12-1985.
- 1,326,518. TRANS-LA-TEX. INT. CL. 2. (U.S. CL. 16). REG. 3-26-1985.
- 1,327,588. WORLD TANG SOO DO ASSOC. U.S. CL. 200. REG. 3-26-1985.
- 1,328,806. JAKE'S. INT. CL. 30. (U.S. CL. 46). REG. 4-2-1985.
- 1,330,832. DESIGN TODAY. INT. CL. 16. (U.S. CL. 38). REG. 4-16-1985.
- 1,331,341. HACIENDA AND DESIGN. INT. CL. 42. (U.S. CL. 100). REG. 4-16-1985.
- 1,331,577. REDLINE (STYLIZED). INT. CL. 4. (U.S. CL. 15). REG. 4-23-1985.
- 1,331,757. SEKA. INT. CL. 9. (U.S. CLS. 21 AND 38). REG. 4-23-1985.
- 1,332,600. CAFE PACIFIC AND DESIGN. INT. CL. 42. (U.S. CL. 100). REG. 4-23-1985.
- 1,334,204. LYKOS AND DESIGN. INT. CL. 12. (U.S. CL. 19). REG. 5-7-1985.
- 1,334,770. SAWYER BROWN. INT. CL. 41. (U.S. CL. 107). REG. 5-7-1985.
- 1,337,038. MUSTANG. INT. CL. 31. (U.S. CL. 1). REG. 5-21-1985.
- 1,337,887. SHEFFIELD. INT. CL. 16. (U.S. CL. 37). REG. 5-28-1985.
- 1,340,066. TOYODA AND DESIGN. INT. CL. 7. (U.S. CL. 23). REG. 6-11-1985.
- 1,341,743. WORLD TANG SOO DO ASSOC AND DESIGN. U.S. CL. 200. REG. 6-11-1985.
- 1,351,848. CACHE (STYLIZED). INT. CLS. 25 AND 42. (U.S. CLS. 39 AND 101). REG. 7-30-1985.
- 1,353,561. CLEANITE. INT. CLS. 3 AND 5. (U.S. CLS. 4, 6 AND 52). REG. 8-13-1985.
- 1,358,381. HAVANA BLOSSOM FRESHER & TASTIER AND DESIGN. INT. CL. 34. (U.S. CL. 17). REG. 9-3-1985.

- 1,361,176. JOE'S AMERICAN BAR & GRILL AND DESIGN. INT. CL. 42. (U.S. CL. 100). REG. 9-17-1985.
- 1,361,739. THE BUTLER AND DESIGN. INT. CL. 12. (U.S. CLS. 19 AND 23). REG. 9-24-1985.
- 1,364,725. CHEYENNE. INT. CL. 29. (U.S. CL. 46). REG. 10-8-1985.
- 1,365,043. HELSINKI FORMULA. INT. CL. 3. (U.S. CLS. 51 AND 52). REG. 10-8-1985.
- 1,369,214. SHOOTIN' DARTS. INT. CL. 28. (U.S. CL. 22). REG. 11-5-1985.
- 1,371,080. STATA (STYLIZED). INT. CL. 9. (U.S. CL. 38). REG. 11-19-1985.
- 1,372,046. PRECISE. INT. CLS. 3 AND 5. (U.S. CLS. 6 AND 52). REG. 11-26-1985.
- 1,372,857. SUNKIST. INT. CL. 29. (U.S. CL. 46). REG. 11-26-1985.
- 1,714,976. OPTI-DROP. INT. CL. 5. (U.S. CL. 18). REG. 9-15-1992.
- 1,762,527. ANATECH. INT. CL. 9. (U.S. CLS. 21, 26 AND 38). REG. 4-6-1993.
- 1,771,348. KREISLER. INT. CL. 14. (U.S. CL. 27). REG. 5-18-1993.
- 1,804,979. SVP-LITE. INT. CLS. 7 AND 37. (U.S. CLS. 23 AND 103). REG. 11-16-1993.
- 1,808,913. CAFRAMO. INT. CLS. 9 AND 11. (U.S. CLS. 21, 26 AND 34). REG. 12-7-1993.
- 1,819,293. SPERRY TOP-SIDER. INT. CL. 42. (U.S. CL. 101). REG. 2-1-1994.
- 1,819,872. HEALTHY KIDS. INT. CL. 16. (U.S. CL. 38). REG. 2-8-1994.
- 1,823,856. OLEAN. INT. CL. 29. (U.S. CL. 46). REG. 2-22-1994.
- 1,831,728. BOARD OF CERTIFICATION OF GENEALOGISTS 1964 CERTIFIED GENEALOGIST AND DESIGN. U.S. CL. B. REG. 4-19-1994.
- 1,832,285. YAWN. INT. CL. 25. (U.S. CL. 39). REG. 4-19-1994.
- 1,833,894. COMFORTSOFT. INT. CL. 25. (U.S. CL. 39). REG. 5-3-1994.
- 1,834,025. INTERLINK AND DESIGN. INT. CL. 36. (U.S. CL. 102). REG. 5-3-1994.
- 1,835,921. PROFILES. INT. CLS. 3, 9 AND 11 ONLY. (U.S. CLS. 21, 44 AND 51). REG. 5-10-1994.
- 1,837,187. THE GRADY HEALTH SYSTEM. INT. CL. 42. (U.S. CL. 100). REG. 5-17-1994.
- 1,837,891. RESINOL. INT. CL. 17. (U.S. CLS. 5, 6 AND 17). REG. 5-31-1994.
- 1,837,934. GOSSARD. INT. CL. 25. (U.S. CLS. 22 AND 39). REG. 5-31-1994.
- 1,839,747. WORLD FOOT LOCKER. INT. CL. 42. (U.S. CL. 101). REG. 6-14-1994.
- 1,840,053. ALL THE GOODNESS OF HAWAII. INT. CL. 30. (U.S. CL. 46). REG. 6-14-1994.
- 1,840,587. FAB'S SUPERSUEDE II. INT. CL. 24. (U.S. CL. 42). REG. 6-21-1994.
- 1,840,600. SPIEGEL. INT. CL. 25. (U.S. CLS. 22 AND 39). REG. 6-21-1994.
- 1,840,667. MISCELLANEOUS DESIGN. INT. CL. 29. (U.S. CL. 46). REG. 6-21-1994.
- 1,840,922. WLVI-TV. INT. CL. 38. (U.S. CL. 104). REG. 6-21-1994.
- 1,845,798. BREAD DU JOUR AND DESIGN. INT. CL. 30. (U.S. CL. 46). REG. 7-19-1994.
- 1,848,435. WOMEN'S HEALTH BOUTIQUE AND DESIGN. INT. CL. 42. (U.S. CL. 101). REG. 8-2-1994.
- 1,848,461. MISCELLANEOUS DESIGN. INT. CL. 3. (U.S. CLS. 1, 4, 6, 50, 51 AND 52). REG. 8-9-1994.
- 1,848,561. TRACKMAN (STYLIZED). INT. CL. 12. (U.S. CL. 19). REG. 8-9-1994.
- 1,848,717. MISCELLANEOUS DESIGN. INT. CL. 36. (U.S. CL. 102). REG. 8-9-1994.
- 1,850,042. GB AND DESIGN. INT. CL. 36. (U.S. CL. 102). REG. 8-16-1994.
- 1,851,468. SPORTSCAD. INT. CL. 16. (U.S. CLS. 37 AND 38). REG. 8-30-1994.
- 1,851,609. LOU MITCHELL'S RESTAURANT & BAKERY AND DESIGN. INT. CLS. 30 AND 42. (U.S. CLS. 46 AND 100). REG. 8-30-1994.
- 1,851,875. QUANTUM LEAP. INT. CL. 7. (U.S. CL. 23). REG. 8-30-1994.
- 1,852,390. SPORTSCAD AND DESIGN. INT. CL. 16. (U.S. CLS. 37 AND 38). REG. 9-6-1994.
- 1,852,889. WHITETAIL CLASSIC. INT. CL. 9. (U.S. CL. 26). REG. 9-6-1994.
- 1,854,025. COMATRIX. INT. CL. 7. (U.S. CLS. 23 AND 31). REG. 9-13-1994.
- 1,854,353. THE WALKING COMPANY. INT. CL. 42. (U.S. CL. 101). REG. 9-13-1994.
- 1,856,719. HIGH FREQUENCY ECONOMICS. INT. CLS. 16 AND 36. (U.S. CLS. 38 AND 102). REG. 10-4-1994.
- 1,858,072. NJB NATIONAL JUNIOR BASKETBALL AND DESIGN. U.S. CL. 200. REG. 10-11-1994.
- 1,860,604. MAXI-MELT. INT. CL. 1. (U.S. CL. 6). REG. 11-1-1994.
- 1,860,710. R (STYLIZED). INT. CLS. 9 AND 11. (U.S. CLS. 13, 21 AND 26). REG. 11-1-1994.
- 1,860,719. SURVIVOR SERIES. INT. CL. 9. (U.S. CLS. 21, 26 AND 36). REG. 11-1-1994.
- 1,860,943. RADIO FIJI. INT. CLS. 18 AND 25. (U.S. CLS. 3 AND 39). REG. 11-1-1994.
- 1,861,035. TOUR EDITION. INT. CL. 28. (U.S. CL. 22). REG. 11-1-1994.
- 1,861,139. ADDISON! (STYLIZED). INT. CL. 35. (U.S. CL. 101). REG. 11-1-1994.
- 1,861,542. HEALTHCARE FINANCIAL MANAGEMENT ASSOCIATION. INT. CL. 42. (U.S. CL. 100). REG. 11-1-1994.
- 1,861,549. HEALTHCARE FINANCIAL MANAGEMENT ASSOCIATION. U.S. CL. 200. REG. 11-1-1994.
- 1,861,610. VORTOK. INT. CLS. 6 AND 8. (U.S. CLS. 2, 12, 13, 14, 23, 25 AND 50). REG. 11-8-1994.
- 1,861,766. MISCELLANEOUS DESIGN. INT. CLS. 16 AND 25. (U.S. CLS. 2, 5, 22, 23, 29, 37, 38, 39 AND 50). REG. 11-8-1994.
- 1,861,890. BAGPIPER. INT. CL. 25. (U.S. CL. 39). REG. 11-8-1994.
- 1,862,010. WATCH ALL AND DESIGN. INT. CL. 37. (U.S. CL. 103). REG. 11-8-1994.
- 1,862,109. WE MAKE IT PERSONAL. INT. CL. 42. (U.S. CL. 100). REG. 11-8-1994.
- 1,862,129. CAPTO. INT. CL. 42. (U.S. CL. 100). REG. 11-8-1994.
- 1,862,212. MAVIK. INT. CL. 5. (U.S. CLS. 6, 18, 44, 46, 51 AND 52). REG. 11-15-1994.
- 1,862,264. THE LITTLE BUTLER. INT. CL. 7. (U.S. CL. 23). REG. 11-15-1994.
- 1,862,438. OCHSNER. INT. CLS. 12 AND 25. (U.S. CLS. 19, 21, 23, 31, 35, 39 AND 44). REG. 11-15-1994.
- 1,862,837. THE ROAD TO CITY HALL. INT. CL. 41. (U.S. CL. 107). REG. 11-15-1994.
- 1,863,100. BIOSCULPTOR. INT. CL. 9. (U.S. CL. 38). REG. 11-15-1994.
- 1,863,777. AIRSUPPLY. INT. CL. 25. (U.S. CL. 39). REG. 11-22-1994.
- 1,864,140. GERNETIC INTERNATIONAL AND DESIGN. INT. CL. 3. (U.S. CLS. 51 AND 52). REG. 11-22-1994.
- 1,864,186. ARROW. INT. CL. 7. (U.S. CL. 23). REG. 11-22-1994.
- 1,864,262. ENCARTA. INT. CL. 16. (U.S. CL. 38). REG. 11-22-1994.
- 1,864,412. WORLD FOOT LOCKER AND DESIGN. INT. CL. 42. (U.S. CL. 101). REG. 11-22-1994.
- 1,864,541. MISCELLANEOUS DESIGN. INT. CLS. 9, 11 AND 20. (U.S. CLS. 21, 26, 32 AND 34). REG. 11-29-1994.
- 1,864,650. MISCELLANEOUS DESIGN. INT. CLS. 16 AND 25. (U.S. CLS. 2, 5, 22, 23, 29, 37, 38, 39 AND 50). REG. 11-29-1994.
- 1,864,843. BOBOLI. INT. CL. 30. (U.S. CL. 46). REG. 11-29-1994.
- 1,864,871. LEAN ERA. INT. CL. 31. (U.S. CL. 46). REG. 11-29-1994.
- 1,865,024. BOSTON CHICKEN ROTISSERIE AND DESIGN. INT. CL. 42. (U.S. CL. 100). REG. 11-29-1994.
- 1,865,062. MISCELLANEOUS DESIGN. INT. CL. 42. (U.S. CL. 100). REG. 11-29-1994.
- 1,865,063. MISCELLANEOUS DESIGN. INT. CL. 42. (U.S. CL. 100). REG. 11-29-1994.
- 1,865,064. MISCELLANEOUS DESIGN. INT. CL. 42. (U.S. CL. 100). REG. 11-29-1994.
- 1,865,066. MCGUFFEY'S AND DESIGN. INT. CL. 42. (U.S. CL. 100). REG. 11-29-1994.
- 1,865,146. NEUTREXIN. INT. CL. 5. (U.S. CL. 18). REG. 11-29-1994.
- 1,865,193. POLYFORM. INT. CL. 9. (U.S. CL. 26). REG. 11-29-1994.
- 1,865,194. SAFE DOG. INT. CL. 9. (U.S. CL. 21). REG. 11-29-1994.
- 1,865,511. TRIACTIVE. INT. CL. 2. (U.S. CL. 6). REG. 12-6-1994.

- 1,865,584. MOTORCRAFT. INT. CL. 8. (U.S. CLS. 23 AND 44). REG. 12-6-1994.
- 1,865,674. WATT (STYLIZED). INT. CL. 9. (U.S. CLS. 21 AND 32). REG. 12-6-1994.
- 1,865,693. CONSENSUS. INT. CL. 10. (U.S. CL. 44). REG. 12-6-1994.
- 1,865,757. CHIME. INT. CL. 16. (U.S. CL. 38). REG. 12-6-1994.
- 1,865,817. PERMAFRAME. INT. CL. 20. (U.S. CL. 32). REG. 12-6-1994.
- 1,865,830. MOTORCRAFT. INT. CL. 24. (U.S. CLS. 42 AND 50). REG. 12-6-1994.
- 1,865,864. MORET ULTRA. INT. CL. 25. (U.S. CL. 39). REG. 12-6-1994.
- 1,865,889. BELLA ROSSA. INT. CLS. 29 AND 30. (U.S. CL. 46). REG. 12-6-1994.
- 1,866,028. MISCELLANEOUS DESIGN. INT. CL. 41. (U.S. CL. 107). REG. 12-6-1994.
- 1,866,201. MISCELLANEOUS DESIGN. INT. CL. 6. (U.S. CL. 14). REG. 12-6-1994.
- 1,866,506. GELITE. INT. CL. 29. (U.S. CL. 46). REG. 12-6-1994.
- 1,866,654. RESICOAT. INT. CL. 2. (U.S. CL. 16). REG. 12-13-1994.
- 1,866,667. DIAMOND-POWER. INT. CL. 3. (U.S. CL. 51). REG. 12-13-1994.
- 1,866,730. W WEIAND (STYLIZED). INT. CL. 7. (U.S. CLS. 19 AND 23). REG. 12-13-1994.
- 1,866,752. CORONA AND DESIGN. INT. CLS. 8 AND 21. (U.S. CLS. 2, 13 AND 23). REG. 12-13-1994.
- 1,866,779. CALIFORNIA AMPLIFIER. INT. CL. 9. (U.S. CL. 21). REG. 12-13-1994.
- 1,866,803. FEMFAT. INT. CL. 9. (U.S. CL. 38). REG. 12-13-1994.
- 1,866,816. INSTA-SET. INT. CL. 9. (U.S. CL. 26). REG. 12-13-1994.
- 1,866,819. NIKON. INT. CLS. 9, 18, 21, 25 AND 28. (U.S. CLS. 2, 3, 22, 26, 39 AND 41). REG. 12-13-1994.
- 1,866,894. AQUASAVAR. INT. CL. 11. (U.S. CL. 13). REG. 12-13-1994.
- 1,866,910. THUNDERBIRD. INT. CL. 12. (U.S. CL. 19). REG. 12-13-1994.
- 1,866,970. MOTORCRAFT. INT. CL. 16. (U.S. CLS. 2, 22, 23, 37, 38 AND 50). REG. 12-13-1994.
- 1,867,031. TERMIX. INT. CL. 21. (U.S. CL. 29). REG. 12-13-1994.
- 1,867,042. PRECONSTRAINT. INT. CL. 24. (U.S. CL. 42). REG. 12-13-1994.
- 1,867,044. LEONARD. INT. CL. 25. (U.S. CL. 39). REG. 12-13-1994.
- 1,867,109. MISCELLANEOUS DESIGN. INT. CL. 29. (U.S. CL. 46). REG. 12-13-1994.
- 1,867,206. SUNSPECTRUM. INT. CLS. 37 AND 42. (U.S. CLS. 100 AND 103). REG. 12-13-1994.
- 1,867,304. MISCELLANEOUS DESIGN. INT. CL. 42. (U.S. CLS. 100, 101 AND 103). REG. 12-13-1994.
- 1,867,472. TOP FIT. INT. CL. 9. (U.S. CL. 39). REG. 12-13-1994.
- 1,867,549. POWERPASS. INT. CL. 9. (U.S. CLS. 21 AND 26). REG. 12-13-1994.
- 1,867,676. SURF HERO. INT. CL. 25. (U.S. CLS. 22 AND 39). REG. 12-13-1994.
- 1,867,677. SURF HERO AND DESIGN. INT. CL. 25. (U.S. CLS. 22 AND 39). REG. 12-13-1994.
- 1,867,713. SHOOT CASE. INT. CL. 28. (U.S. CL. 22). REG. 12-13-1994.
- 1,867,734. NUTRI CLASSICS. INT. CL. 30. (U.S. CL. 46). REG. 12-13-1994.
- 1,867,822. HIDDEN JUNGLE. INT. CL. 41. (U.S. CLS. 100 AND 107). REG. 12-13-1994.
- 1,867,841. CAR CRAZY. INT. CL. 42. (U.S. CL. 100). REG. 12-13-1994.
- 1,867,992. WEIAND. INT. CL. 7. (U.S. CL. 23). REG. 12-20-1994.
- 1,868,015. AMERICAN GARDENER. INT. CL. 8. (U.S. CL. 23). REG. 12-20-1994.
- 1,868,106. H HARGER LIGHTNING PROTECTION, INC. AND DESIGN. INT. CL. 9. (U.S. CLS. 21 AND 26). REG. 12-20-1994.
- 1,868,219. BUGS IN A BOX. INT. CL. 16. (U.S. CL. 38). REG. 12-20-1994.
- 1,868,251. FORD. INT. CL. 16. (U.S. CLS. 2, 5, 22, 23, 29, 37, 38 AND 50). REG. 12-20-1994.
- 1,868,263. QUICK STUDY (STYLIZED). INT. CL. 16. (U.S. CL. 38). REG. 12-20-1994.
- 1,868,308. SYSTEM PLATON. INT. CL. 19. (U.S. CL. 12). REG. 12-20-1994.
- 1,868,322. KLIP-IT (STYLIZED). INT. CL. 20. (U.S. CL. 23). REG. 12-20-1994.
- 1,868,326. RESCUBE (STYLIZED). INT. CL. 20. (U.S. CL. 2). REG. 12-20-1994.
- 1,868,372. CABORCA. INT. CL. 25. (U.S. CL. 39). REG. 12-20-1994.
- 1,868,462. FORD. INT. CL. 28. (U.S. CLS. 22 AND 50). REG. 12-20-1994.
- 1,868,499. MICHAEL'S FROZEN CUSTARD. INT. CL. 30. (U.S. CL. 46). REG. 12-20-1994.
- 1,869,108. PREMIUM PLAN. INT. CL. 36. (U.S. CL. 102). REG. 12-20-1994.
- 1,869,117. ORIENT LINES. INT. CL. 39. (U.S. CLS. 105 AND 107). REG. 12-20-1994.
- 1,869,135. DICE. INT. CL. 1. (U.S. CL. 6). REG. 12-27-1994.
- 1,869,152. GREAT LAKES DBS. INT. CL. 1. (U.S. CL. 6). REG. 12-27-1994.
- 1,869,203. ALUSPRAY. INT. CL. 5. (U.S. CL. 18). REG. 12-27-1994.
- 1,869,409. CHOICELINK. INT. CL. 9. (U.S. CL. 38). REG. 12-27-1994.
- 1,869,498. THE OXFORD ANALYTICA DAILY BRIEF. INT. CLS. 16 AND 35. (U.S. CLS. 38 AND 101). REG. 12-27-1994.
- 1,869,561. MORNAP JR.. INT. CL. 16. (U.S. CL. 37). REG. 12-27-1994.
- 1,869,879. CARS AND DESIGN. INT. CLS. 35, 36 AND 37. (U.S. CLS. 101, 102 AND 103). REG. 12-27-1994.
- 1,870,004. IMUAL. INT. CL. 39. (U.S. CLS. 100 AND 105). REG. 12-27-1994.
- 1,870,197. COMPLYNET. INT. CL. 42. (U.S. CLS. 100 AND 101). REG. 12-27-1994.
- 1,870,246. REGENT PACIFIC MANAGEMENT EUROPE. INT. CLS. 35 AND 36. (U.S. CLS. 101 AND 102). REG. 12-27-1994.
- 1,870,502. FMFL. INT. CL. 16. (U.S. CL. 38). REG. 12-27-1994.
- 1,870,607. BUILT FOR LIFE. INT. CL. 25. (U.S. CL. 39). REG. 12-27-1994.
- 1,870,707. SHREDDIES. INT. CL. 30. (U.S. CL. 46). REG. 12-27-1994.
- 1,871,088. FORCHECK. INT. CL. 9. (U.S. CL. 38). REG. 1-3-1995.
- 1,871,115. SALEWA. INT. CLS. 9, 25 AND 28. (U.S. CLS. 22, 26 AND 39). REG. 1-3-1995.
- 1,871,174. FLOWCHECKER. INT. CL. 9. (U.S. CL. 26). REG. 1-3-1995.
- 1,871,179. UNTANGLER. INT. CLS. 10 AND 21. (U.S. CLS. 23, 40 AND 44). REG. 1-3-1995.
- 1,871,212. CMC AND DESIGN. INT. CL. 12. (U.S. CLS. 19, 21, 23, 31, 35 AND 44). REG. 1-3-1995.
- 1,871,234. MRC. INT. CL. 12. (U.S. CL. 44). REG. 1-3-1995.
- 1,871,245. BTC. INT. CL. 12. (U.S. CL. 44). REG. 1-3-1995.
- 1,871,388. ATLANTIC COAST CONFERENCE. INT. CL. 25. (U.S. CL. 39). REG. 1-3-1995.
- 1,871,475. MISCELLANEOUS DESIGN. INT. CL. 30. (U.S. CL. 46). REG. 1-3-1995.
- 1,871,476. MISCELLANEOUS DESIGN. INT. CL. 30. (U.S. CL. 46). REG. 1-3-1995.
- 1,871,780. CHRO-MOR. INT. CL. 1. (U.S. CL. 6). REG. 1-3-1995.
- 1,871,877. MATRIX. INT. CL. 10. (U.S. CL. 44). REG. 1-3-1995.
- 1,871,948. BOUTIQUE EUROPA. INT. CL. 25. (U.S. CL. 39). REG. 1-3-1995.
- 1,872,181. POLYTAC. INT. CL. 4. (U.S. CL. 15). REG. 1-10-1995.
- 1,872,182. ECLIPSE. INT. CL. 4. (U.S. CL. 15). REG. 1-10-1995.
- 1,872,183. INJEX. INT. CL. 4. (U.S. CL. 15). REG. 1-10-1995.
- 1,872,393. SPLIT STREAM. INT. CL. 11. (U.S. CL. 34). REG. 1-10-1995.
- 1,872,597. SB AND DESIGN. INT. CLS. 25 AND 41. (U.S. CLS. 39 AND 107). REG. 1-10-1995.
- 1,873,213. "THE LABELING ANSWER". INT. CL. 9. (U.S. CL. 38). REG. 1-10-1995.
- 1,873,225. INPUT. INT. CL. 10. (U.S. CL. 44). REG. 1-10-1995.
- 1,873,408. HOTEL ACCESS. INT. CL. 39. (U.S. CL. 105). REG. 1-10-1995.
- 1,873,486. BS (STYLIZED). INT. CL. 1. (U.S. CL. 6). REG. 1-17-1995.
- 1,873,797. COLORS. INT. CL. 16. (U.S. CL. 38). REG. 1-17-1995.

- 1,873,894. WARM & NATURAL AND DESIGN. INT. CL. 22. (U.S. CLS. 7 AND 50). REG. 1-17-1995.
- 1,874,079. WONDER AND DESIGN. INT. CL. 30. (U.S. CL. 46). REG. 1-17-1995.
- 1,874,465. VERSA-BUFF. INT. CL. 3. (U.S. CLS. 4 AND 52). REG. 1-17-1995.
- 1,874,730. FOOTIE WOOTSIES. INT. CL. 25. (U.S. CL. 39). REG. 1-17-1995.
- 1,875,133. OCTAT. INT. CL. 9. (U.S. CLS. 21 AND 26). REG. 1-24-1995.
- 1,875,290. SPILLSKID. INT. CL. 20. (U.S. CL. 2). REG. 1-24-1995.
- 1,875,340. ASCOT AND DESIGN. INT. CL. 25. (U.S. CL. 39). REG. 1-24-1995.
- 1,875,436. MISCELLANEOUS DESIGN. INT. CL. 30. (U.S. CL. 46). REG. 1-24-1995.
- 1,875,725. LURPAK. U.S. CL. A. REG. 1-24-1995.
- 1,875,864. SAMSONITE. INT. CL. 9. (U.S. CLS. 2 AND 26). REG. 1-24-1995.
- 1,875,981. ECOPILE. INT. CL. 24. (U.S. CL. 42). REG. 1-24-1995.
- 1,876,085. GROUP STRATEGIC EDGE. INT. CL. 36. (U.S. CL. 102). REG. 1-24-1995.
- 1,877,019. LYRIC (STYLIZED). INT. CL. 42. (U.S. CLS. 101 AND 103). REG. 1-31-1995.
- 1,877,515. ALLIANCE. INT. CL. 10. (U.S. CL. 44). REG. 2-7-1995.
- 1,878,203. SQUEEEEEK NO MORE AND DESIGN. INT. CL. 6. (U.S. CLS. 13 AND 14). REG. 2-7-1995.
- 1,878,458. RIBBON MAGIC. INT. CL. 26 ONLY. (U.S. CL. 37). REG. 2-14-1995.
- 1,878,470. CALIFORNIA AMPLIFIER. INT. CL. 9. (U.S. CL. 26). REG. 2-14-1995.
- 1,878,978. WARNER NORCROSS & JUDD LLP. INT. CL. 42. (U.S. CLS. 100 AND 101). REG. 2-14-1995.
- 1,879,462. KICK. INT. CL. 3. (U.S. CL. 52). REG. 2-21-1995.
- 1,880,373. HYDROFLOW. INT. CL. 7. (U.S. CL. 23). REG. 2-28-1995.
- 1,880,765. ZAPATA. INT. CLS. 29 AND 30. (U.S. CL. 46). REG. 2-28-1995.
- 1,883,740. MTR AND DESIGN. INT. CL. 29. (U.S. CL. 46). REG. 3-14-1995.
- 1,886,083. THE PLAYERS CHAMPIONSHIP AND DESIGN. INT. CL. 21. (U.S. CL. 2). REG. 3-28-1995.
- 1,886,797. SUPER NOZZLE. INT. CL. 21. (U.S. CLS. 13 AND 23). REG. 3-28-1995.
- 1,887,025. GPS AND DESIGN. INT. CL. 9. (U.S. CLS. 21, 26 AND 36). REG. 4-4-1995.
- 1,887,497. MISCELLANEOUS DESIGN. INT. CL. 39. (U.S. CL. 105). REG. 4-4-1995.
- 1,888,855. COMMITTED TO PERSONAL SERVICE. INT. CL. 36. (U.S. CL. 102). REG. 4-11-1995.
- 1,888,856. STURDY. INT. CL. 36. (U.S. CL. 102). REG. 4-11-1995.
- 1,889,402. SUPERPRETZEL DINOSAUR SOFT PRETZELS AND DESIGN. INT. CL. 30. (U.S. CL. 46). REG. 4-11-1995.
- 1,891,023. WOMAN'S MISSIONARY UNION. INT. CL. 16. (U.S. CL. 38). REG. 4-25-1995.
- 1,891,166. FREEZE. INT. CL. 25. (U.S. CLS. 22 AND 39). REG. 4-25-1995.
- 1,891,223. ELK-FIRE. INT. CL. 28. (U.S. CLS. 6 AND 22). REG. 4-25-1995.
- 1,891,316. CORPORATE ELECTION SERVICES. INT. CLS. 35 AND 42. (U.S. CLS. 100, 101 AND 102). REG. 4-25-1995.
- 1,891,600. CORTICURE. INT. CL. 3. (U.S. CL. 51). REG. 4-25-1995.
- 1,891,814. SUPRE SWEETS. INT. CL. 34. (U.S. CL. 17). REG. 4-25-1995.
- 1,892,956. KK KLENK AND DESIGN. INT. CL. 8. (U.S. CLS. 23, 28 AND 44). REG. 5-9-1995.
- 1,893,483. BUSHY RIDGE. INT. CLS. 24 AND 28. (U.S. CLS. 22 AND 42). REG. 5-9-1995.
- 1,893,810. TWIN CITIES BUSINESS MONTHLY. INT. CL. 16. (U.S. CL. 38). REG. 5-9-1995.
- 1,894,201. TREASURY OF LITERATURE. INT. CL. 28. (U.S. CLS. 22 AND 38). REG. 5-16-1995.
- 1,895,124. KATYDID DESIGNS FANCY FLORALS. INT. CL. 20. (U.S. CL. 32). REG. 5-23-1995.
- 1,895,917. DUTY. INT. CL. 8. (U.S. CL. 23). REG. 5-30-1995.
- 1,896,026. FMF FIELDS & MADISON AND DESIGN. INT. CL. 9. (U.S. CL. 26). REG. 5-30-1995.
- 1,896,459. GENERAL BANK. INT. CL. 36. (U.S. CL. 102). REG. 5-30-1995.
- 1,897,506. MISCELLANEOUS DESIGN. INT. CL. 16. (U.S. CLS. 37 AND 38). REG. 6-6-1995.
- 1,897,641. POUR-A-QUICHE. INT. CL. 29. (U.S. CL. 46). REG. 6-6-1995.
- 1,897,862. BEEF 'O'BRADY'S. INT. CL. 42. (U.S. CL. 100). REG. 6-6-1995.
- 1,898,091. TIG PRODUCTIONS AND DESIGN. INT. CL. 16. (U.S. CLS. 2, 5, 22, 23, 29, 37, 38 AND 50). REG. 6-6-1995.
- 1,899,473. CROCKETT & RENALDE. INT. CLS. 6 AND 18. (U.S. CLS. 1, 2, 3, 12, 13, 14, 22, 23, 25, 41 AND 50). REG. 6-13-1995.
- 1,900,334. DUMOSTAR. INT. CL. 6. (U.S. CL. 14). REG. 6-20-1995.
- 1,901,296. MGD LIGHT. INT. CL. 32. (U.S. CL. 48). REG. 6-20-1995.
- 1,902,732. SHERLOCK HOLMES. INT. CL. 18. (U.S. CL. 3). REG. 7-4-1995.
- 1,903,148. SPALON MONTAGE. INT. CL. 42. (U.S. CLS. 101 AND 107). REG. 7-4-1995.
- 1,904,690. CORRPAK. INT. CL. 41. (U.S. CL. 107). REG. 7-11-1995.
- 1,905,106. HARVEST RIDGE. INT. CL. 30. (U.S. CL. 46). REG. 7-11-1995.
- 1,905,366. DESIGN ARCHITECT. INT. CL. 9. (U.S. CL. 38). REG. 7-18-1995.
- 1,905,598. MISCELLANEOUS DESIGN. INT. CL. 16. (U.S. CLS. 2 AND 37). REG. 7-18-1995.
- 1,905,797. FLAVOR ISLANDS. INT. CL. 30. (U.S. CL. 46). REG. 7-18-1995.
- 1,907,712. THE AESTHETIC SURGERY CENTER AND DESIGN. INT. CL. 42. (U.S. CL. 100). REG. 7-25-1995.
- 1,909,812. THE ACAPPELLA COMPANY AND DESIGN. INT. CL. 9. (U.S. CL. 36). REG. 8-8-1995.
- 1,910,957. PHYTO-ZYME. INT. CL. 1. (U.S. CL. 10). REG. 8-15-1995.
- 1,911,001. MC 501. INT. CL. 3. (U.S. CL. 52). REG. 8-15-1995.
- 1,911,323. MISCELLANEOUS DESIGN. INT. CL. 36 ONLY. (U.S. CL. 102). REG. 8-15-1995.
- 1,911,324. HEALTHWORDS FOR WOMEN. INT. CL. 16. (U.S. CL. 38). REG. 8-15-1995.
- 1,911,788. MODERNISTIC. INT. CL. 37. (U.S. CL. 103). REG. 8-15-1995.
- 1,911,926. OAKLEY SMITH NAPRAPATHIC METHOD. INT. CL. 42. (U.S. CL. 100). REG. 8-15-1995.
- 1,912,013. CWP AND DESIGN. INT. CL. 42. (U.S. CL. 100). REG. 8-15-1995.
- 1,912,775. TOOLS FOR SUCCESS. INT. CL. 41. (U.S. CLS. 100, 101 AND 107). REG. 8-15-1995.
- 1,913,140. HOTPLOT. INT. CL. 9. (U.S. CL. 38). REG. 8-22-1995.
- 1,913,480. MISCELLANEOUS DESIGN. INT. CL. 28. (U.S. CL. 50). REG. 8-22-1995.
- 1,913,642. MILLER GENUINE DRAFT DE ETIQUETA NEGRA. INT. CL. 32. (U.S. CL. 48). REG. 8-22-1995.
- 1,914,233. SHOWCASE SUPREME AND DESIGN. INT. CL. 29. (U.S. CL. 46). REG. 8-22-1995.
- 1,914,328. SELF-LOCK. INT. CL. 15. (U.S. CL. 36). REG. 8-22-1995.
- 1,915,949. BIOSTAR. INT. CL. 5. (U.S. CL. 18). REG. 9-5-1995.
- 1,918,385. Q6. INT. CL. 38. (U.S. CLS. 100, 101 AND 104). REG. 9-12-1995.
- 1,920,036. BRAWNY LAD (STYLIZED). INT. CL. 30. (U.S. CL. 46). REG. 9-19-1995.
- 1,920,433. THE FEAST. INT. CL. 42. (U.S. CLS. 100 AND 101). REG. 9-19-1995.
- 1,920,446. CECIL WHITTAKER'S PIZZERIA. INT. CL. 42. (U.S. CL. 100). REG. 9-19-1995.
- 1,922,107. VENTURA CHINA (STYLIZED). INT. CL. 21. (U.S. CLS. 2, 30 AND 33). REG. 9-26-1995.
- 1,923,317. MISCELLANEOUS DESIGN. INT. CL. 7. (U.S. CLS. 13, 19, 21, 23, 31, 34 AND 35). REG. 10-3-1995.
- 1,923,371. QMR. INT. CL. 9. (U.S. CLS. 21, 23, 26, 36 AND 38). REG. 10-3-1995.
- 1,924,636. 3 PHASE. INT. CL. 19. (U.S. CLS. 1, 12, 33 AND 50). REG. 10-3-1995.
- 1,924,773. CHESHIRE. INT. CL. 31. (U.S. CLS. 1 AND 46). REG. 10-3-1995.
- 1,925,224. TOPLIST. INT. CL. 9. (U.S. CLS. 21, 23, 26, 36 AND 38). REG. 10-10-1995.
- 1,925,316. ECON AIR. INT. CL. 11. (U.S. CLS. 13, 21, 23, 31 AND 34). REG. 10-10-1995.

- 1,926,770. PORTMANN'S. INT. CL. 30. (U.S. CL. 46). REG. 10-10-1995.
- 1,928,124. DISPATCH. INT. CL. 5. (U.S. CLS. 6, 18, 44, 46, 51 AND 52). REG. 10-17-1995.
- 1,929,545. CHEMISTRY CONNECTION AND DESIGN. INT. CL. 41. (U.S. CL. 107). REG. 10-24-1995.
- 1,930,048. MISCELLANEOUS DESIGN. INT. CL. 25. (U.S. CLS. 22 AND 39). REG. 10-24-1995.
- 1,930,369. CABALLERO DE LA CEPA. INT. CL. 33. (U.S. CLS. 46 AND 47). REG. 10-31-1995.
- 1,931,153. CHEMISTRY CONNECTION. INT. CL. 41. (U.S. CL. 107). REG. 10-31-1995.
- 1,931,188. PETROCOM. INT. CL. 38. (U.S. CLS. 100, 101 AND 104). REG. 10-31-1995.
- 1,931,451. DER KUSS AND DESIGN. INT. CL. 33. (U.S. CLS. 47 AND 49). REG. 10-31-1995.
- 1,934,495. AMERICAN HEALTH LABORATORIES. INT. CL. 42. (U.S. CLS. 100 AND 101). REG. 11-7-1995.
- 1,935,311. MEDIA. INT. CL. 9. (U.S. CLS. 21, 23, 26, 36 AND 38). REG. 11-14-1995.
- 1,937,004. BENVAL. INT. CL. 9. (U.S. CLS. 21, 23, 26, 36 AND 38). REG. 11-21-1995.
- 1,937,166. DEERFIELD. INT. CL. 9. (U.S. CLS. 21, 23, 26, 36 AND 38). REG. 11-21-1995.
- 1,937,921. ULTIMATE BEAR LURE. INT. CL. 28. (U.S. CLS. 6 AND 22). REG. 11-28-1995.
- 1,938,076. CARIBBEAN COIN. INT. CL. 36. (U.S. CLS. 100, 101 AND 102). REG. 11-28-1995.
- 1,938,782. SAFE BLOCK. INT. CL. 20. (U.S. CLS. 2, 13, 22, 25, 32 AND 50). REG. 11-28-1995.
- 1,939,377. 70M. INT. CL. 7. (U.S. CLS. 13, 19, 21, 23, 31, 34 AND 35). REG. 12-5-1995.
- 1,941,416. SHOP FOX AND DESIGN. INT. CL. 7. (U.S. CLS. 13, 19, 21, 23, 31, 34 AND 35). REG. 12-12-1995.
- 1,942,243. MISCELLANEOUS DESIGN. INT. CL. 41. (U.S. CL. 107). REG. 12-19-1995.

\* \* \* \* \*

# TRADEMARK REGISTRATIONS CANCELED

The designation "U.S. Cl." appearing in this section refers to the U.S. class in effect prior to Sep. 1, 1973 rather than the international class which applies to applications filed on or after that date. For adoption of international classification see notice in the OFFICIAL GAZETTE of Jun. 26, 1973 (911 O.G. TM 210).

## SECTION 7(D)

1,103,976.	JARLSBERG AND DESIGN. INT. CL. 29. REG. 10-10-1978.	406,586.	POIRETTE (STYLIZED). U.S. CL. 39. REG. 4-11-1944.
1,114,961.	JARLSBERG (STYLIZED). INT. CL. 29. REG. 3-13-1979.	768,057.	GLASSROOT (STYLIZED). INT. CL. 1. REG. 4-14-1964.
1,294,878.	REAL-TRIEVE. INT. CL. 35. REG. 9-11-1984.	768,071.	MR. TURF'S. U.S. CLS. 6 AND 10. REG. 4-14-1964.
1,383,021.	GYP-GRIP. INT. CL. 6. REG. 2-18-1986.	768,072.	BOROCHLOR. U.S. CL. 6. REG. 4-14-1964.
1,859,213.	JARLSBERG LITE JARLSBERG CHEESE AND DESIGN. INT. CL. 29. REG. 10-18-1994.	768,077.	SULFAMEX. U.S. CL. 6. REG. 4-14-1964.
2,153,281.	JARLSBERG AND DESIGN. INT. CLS. 29 AND 30. REG. 4-28-1998.	768,087.	FAR-GO AND DESIGN. U.S. CL. 12. REG. 4-14-1964.
2,163,117.	JARLSBERG AND DESIGN. INT. CL. 29. REG. 6-9-1998.	768,090.	DOUBLE DURABILITY. U.S. CL. 13. REG. 4-14-1964.
2,167,270.	BANCSTAR PRISM. INT. CL. 9. REG. 6-23-1998.	768,100.	PARATYFOL. U.S. CL. 18. REG. 4-14-1964.
2,233,817.	PREFERRED DATA BDS BROADCAST DATA SYSTEMS AND DESIGN. INT. CL. 35. REG. 3-23-1999.	768,105.	AMPLI-VOX. U.S. CL. 21. REG. 4-14-1964.
2,240,101.	ADVANCED INFORMATION RESOURCES. INT. CLS. 9 AND 36. REG. 4-20-1999.	768,112.	RCL AND DESIGN. U.S. CL. 21. REG. 4-14-1964.
2,498,262.	ALADDIN TUNER. INT. CL. 9. REG. 10-16-2001.	768,121.	CATALINA. U.S. CL. 21. REG. 4-14-1964.
2,753,212.	SOYQUICK. INT. CL. 29. REG. 8-19-2003.	768,122.	MAGNEFIX. U.S. CL. 21. REG. 4-14-1964.
2,767,435.	CROSS LANDER. INT. CL. 12. REG. 9-23-2003.	768,141.	SHUR-LINE AND DESIGN. U.S. CL. 22. REG. 4-14-1964.
2,791,148.	PULSE HEALTHCARE STAFFING AND DESIGN. INT. CL. 35. REG. 12-9-2003.	768,149.	OXFORD. U.S. CL. 22. REG. 4-14-1964.
2,879,672.	SAGE. INT. CL. 16. REG. 8-31-2004.	768,152.	MISCELLANEOUS DESIGN. U.S. CL. 23. REG. 4-14-1964.

## SECTION 8

182,257.	MISCELLANEOUS DESIGN. U.S. CL. 13. REG. 4-8-1924.	768,176.	S AND DESIGN. U.S. CL. 26. REG. 4-14-1964.
182,258.	MISCELLANEOUS DESIGN. U.S. CL. 13. REG. 4-8-1924.	768,177.	STELLA. U.S. CL. 27. REG. 4-14-1964.
182,259.	MISCELLANEOUS DESIGN. U.S. CL. 13. REG. 4-8-1924.	768,215.	STEDMAN. U.S. CL. 39. REG. 4-14-1964.
182,260.	MISCELLANEOUS DESIGN. U.S. CL. 13. REG. 4-8-1924.	768,224.	TUF-DUK. U.S. CL. 39. REG. 4-14-1964.
182,261.	MISCELLANEOUS DESIGN. U.S. CL. 13. REG. 4-8-1924.	768,225.	USS (STYLIZED). U.S. CL. 39. REG. 4-14-1964.
182,262.	MISCELLANEOUS DESIGN. U.S. CL. 13. REG. 4-8-1924.	768,229.	NATALIE GREEN. U.S. CL. 39. REG. 4-14-1964.
182,263.	MISCELLANEOUS DESIGN. U.S. CL. 13. REG. 4-8-1924.	768,236.	BAN-ROL. U.S. CL. 40. REG. 4-14-1964.
182,311.	MILL ON THE FLOSS. U.S. CL. 46. REG. 4-8-1924.	768,237.	PLASTI-LIP (STYLIZED). U.S. CL. 40. REG. 4-14-1964.
182,358.	GOLD STANDARD (STYLIZED). U.S. CL. 46. REG. 4-8-1924.	768,240.	COFFEETONE. U.S. CL. 46. REG. 4-14-1964.
182,438.	FENWAY. U.S. CL. 39. REG. 4-8-1924.	768,244.	GLORI-FRIED (STYLIZED). U.S. CL. 46. REG. 4-14-1964.
182,445.	JOHN C. ROBERTS AND DESIGN. U.S. CL. 39. REG. 4-8-1924.	768,245.	BRANDED BY QUALITY MACK BROS AND DESIGN. U.S. CL. 46. REG. 4-14-1964.
182,468.	LIDGERWOOD. U.S. CL. 23. REG. 4-8-1924.	768,246.	SALADA. U.S. CL. 46. REG. 4-14-1964.
182,475.	MAPLE GROVE (STYLIZED). U.S. CL. 46. REG. 4-8-1924.	768,256.	ARLINGTON. U.S. CL. 46. REG. 4-14-1964.
406,533.	CHEWRITE DENTURE POWDER AND DESIGN. U.S. CL. 6. REG. 4-11-1944.	768,263.	CAPUCINE (STYLIZED). U.S. CL. 49. REG. 4-14-1964.
406,543.	HI-BOND. U.S. CL. 6. REG. 4-11-1944.	768,264.	BLACKHEATH. U.S. CL. 49. REG. 4-14-1964.
406,569.	TA-POFF AND DESIGN. U.S. CL. 6. REG. 4-11-1944.	768,291.	DIRCO. U.S. CL. 103. REG. 4-14-1964.
		768,298.	GALLAHER'S RICH DARK HONEYDEW. U.S. CL. 17. REG. 4-14-1964.
		768,315.	SUN STICK (STYLIZED). U.S. CL. 51. REG. 4-14-1964.
		1,232,361.	SUNDAE CRUNCH. INT. CL. 30. REG. 3-22-1983.
		1,234,840.	PSI AND DESIGN. INT. CLS. 35, 39 AND 42. REG. 4-12-1983.
		1,273,234.	EXYLITE. INT. CL. 1. REG. 4-10-1984.
		1,273,237.	FERMWAY (STYLIZED). INT. CL. 1. REG. 4-10-1984.
		1,273,239.	PDQ 15 (STYLIZED). INT. CL. 1. REG. 4-10-1984.
		1,273,241.	SODASTREAM. INT. CLS. 1, 6, 7, 32 AND 37. REG. 4-10-1984.
		1,273,244.	FEDERAL BENTONITE. INT. CL. 1. REG. 4-10-1984.

- 1,273,253. CIRCUITPREP. INT. CL. 1. REG. 4-10-1984.  
1,273,261. FOX VALLEY MARKING SYSTEMS. INT. CL. 2. REG. 4-10-1984.  
1,273,262. FOX VALLEY SYSTEMS. INT. CL. 2. REG. 4-10-1984.  
1,273,267. COMPASSION. INT. CL. 3. REG. 4-10-1984.  
1,273,270. PREMIERE. INT. CL. 3. REG. 4-10-1984.  
1,273,273. WET-SHINE. INT. CL. 3. REG. 4-10-1984.  
1,273,276. BATHE BEANS AND DESIGN. INT. CL. 3. REG. 4-10-1984.  
1,273,277. SERCO NO SPOT (STYLIZED). INT. CL. 3. REG. 4-10-1984.  
1,273,282. COM-PAT. INT. CL. 3. REG. 4-10-1984.  
1,273,283. KEROWICK AND DESIGN. INT. CL. 4. REG. 4-10-1984.  
1,273,285. NEOCHEM (STYLIZED). INT. CL. 4. REG. 4-10-1984.  
1,273,286. MATCH LIGHT AND DESIGN. INT. CL. 4. REG. 4-10-1984.  
1,273,287. SUPEREX. INT. CL. 5. REG. 4-10-1984.  
1,273,288. ISOTEX 70 (STYLIZED). INT. CL. 5. REG. 4-10-1984.  
1,273,297. BACTIMOS. INT. CL. 5. REG. 4-10-1984.  
1,273,302. LIQUID PRED. INT. CL. 5. REG. 4-10-1984.  
1,273,303. MAGNA FORCE. INT. CL. 5. REG. 4-10-1984.  
1,273,304. SPEDEC. INT. CLS. 6, 7 AND 17. REG. 4-10-1984.  
1,273,305. RIGID "X". INT. CL. 6. REG. 4-10-1984.  
1,273,310. OBLIQUE WALL. INT. CL. 6. REG. 4-10-1984.  
1,273,313. ALCAN AND DESIGN. INT. CL. 6. REG. 4-10-1984.  
1,273,314. NEWPORT FASTENER. INT. CL. 6. REG. 4-10-1984.  
1,273,317. SLUDGE MONSTER AND DESIGN. INT. CL. 7. REG. 4-10-1984.  
1,273,329. KERO PUMP AND DESIGN. INT. CL. 7. REG. 4-10-1984.  
1,273,334. BELMANITE. INT. CL. 7. REG. 4-10-1984.  
1,273,335. BELMANITE II. INT. CL. 7. REG. 4-10-1984.  
1,273,336. VARI-BAR. INT. CL. 7. REG. 4-10-1984.  
1,273,338. THERMASHIELD. INT. CL. 7. REG. 4-10-1984.  
1,273,339. POLYTEC. INT. CL. 7. REG. 4-10-1984.  
1,273,340. ATROMESH. INT. CL. 7. REG. 4-10-1984.  
1,273,341. ATRONIP. INT. CL. 7. REG. 4-10-1984.  
1,273,342. VIBRA-COTE. INT. CL. 7. REG. 4-10-1984.  
1,273,343. CHROME-FLEX. INT. CL. 7. REG. 4-10-1984.  
1,273,345. FLEXIBOS. INT. CL. 7. REG. 4-10-1984.  
1,273,346. DUROLL. INT. CL. 7. REG. 4-10-1984.  
1,273,355. MANILA FOLDER. INT. CL. 8. REG. 4-10-1984.  
1,273,356. YORKVILLE. INT. CL. 8. REG. 4-10-1984.  
1,273,361. DELTA. INT. CL. 9. REG. 4-10-1984.  
1,273,362. SPECTRUM. INT. CL. 9. REG. 4-10-1984.  
1,273,368. CI COOPER INDUSTRIES AND DESIGN. INT. CL. 9. REG. 4-10-1984.  
1,273,374. AT AND DESIGN. INT. CL. 9. REG. 4-10-1984.  
1,273,375. ELECTRO-LOOP. INT. CL. 9. REG. 4-10-1984.  
1,273,383. B AND DESIGN. INT. CL. 9. REG. 4-10-1984.  
1,273,384. FIBERPORT (STYLIZED). INT. CL. 9. REG. 4-10-1984.  
1,273,387. SSD. INT. CL. 9. REG. 4-10-1984.  
1,273,389. PARTGARD (STYLIZED). INT. CL. 9. REG. 4-10-1984.  
1,273,394. MISCELLANEOUS DESIGN. INT. CL. 9. REG. 4-10-1984.  
1,273,406. AMBER. INT. CL. 9. REG. 4-10-1984.  
1,273,407. ALL AROUNDS. INT. CL. 9. REG. 4-10-1984.  
1,273,410. STRAIGHT-WIRE. INT. CL. 10. REG. 4-10-1984.  
1,273,411. DIGITRON. INT. CL. 10. REG. 4-10-1984.  
1,273,412. PLC '75. INT. CL. 10. REG. 4-10-1984.  
1,273,413. SCOPEMASTER. INT. CL. 10. REG. 4-10-1984.  
1,273,417. CBM. INT. CL. 11. REG. 4-10-1984.  
1,273,418. HURRY HOT. INT. CL. 11. REG. 4-10-1984.  
1,273,420. COLDBUSTER AND DESIGN. INT. CL. 11. REG. 4-10-1984.  
1,273,423. "HANK JR.". INT. CL. 11. REG. 4-10-1984.  
1,273,431. GEP. INT. CL. 12. REG. 4-10-1984.  
1,273,432. TRISUN. INT. CL. 12. REG. 4-10-1984.  
1,273,435. STARLINE. INT. CLS. 12 AND 37. REG. 4-10-1984.  
1,273,448. WEBSTER WILCOX. INT. CL. 14. REG. 4-10-1984.  
1,273,449. LINDEN. INT. CL. 15. REG. 4-10-1984.  
1,273,457. NATIONAL SCHOOL STUDIOS INC. (STYLIZED). INT. CL. 16. REG. 4-10-1984.  
1,273,458. SAMSONITE. INT. CL. 16. REG. 4-10-1984.  
1,273,470. SLAB-PAK (STYLIZED). INT. CL. 16. REG. 4-10-1984.  
1,273,473. MISCELLANEOUS DESIGN. INT. CL. 16. REG. 4-10-1984.  
1,273,474. SERVICE AND DESIGN. INT. CL. 16. REG. 4-10-1984.  
1,273,481. TENN-TOM. INT. CL. 16. REG. 4-10-1984.  
1,273,493. SAND & SEA. INT. CL. 16. REG. 4-10-1984.  
1,273,494. E-Z-TRACK. INT. CL. 16. REG. 4-10-1984.  
1,273,502. FOOD PACKAGING FROM THE FOOD CITY. INT. CL. 17. REG. 4-10-1984.  
1,273,506. CP (STYLIZED). INT. CLS. 18 AND 25. REG. 4-10-1984.  
1,273,508. DELSEY (STYLIZED). INT. CL. 18. REG. 4-10-1984.  
1,273,509. LOCKER LOOT. INT. CL. 18. REG. 4-10-1984.  
1,273,513. OMEGA (STYLIZED). INT. CL. 18. REG. 4-10-1984.  
1,273,514. TREK SAF AND DESIGN. INT. CL. 18. REG. 4-10-1984.  
1,273,518. MISCHIEF MAKERS. INT. CL. 18. REG. 4-10-1984.  
1,273,520. STYROCRETE. INT. CL. 19. REG. 4-10-1984.  
1,273,528. EXTRUDA-FORM. INT. CL. 19. REG. 4-10-1984.  
1,273,545. ELITE. INT. CL. 20. REG. 4-10-1984.  
1,273,550. CASTLEGARD. INT. CL. 20. REG. 4-10-1984.  
1,273,551. ETERNAGARD. INT. CL. 20. REG. 4-10-1984.  
1,273,552. SEMIGARD. INT. CL. 20. REG. 4-10-1984.  
1,273,553. PRESTIGE. INT. CL. 20. REG. 4-10-1984.  
1,273,554. OMNIGARD. INT. CL. 20. REG. 4-10-1984.  
1,273,555. PROTECTAGARD. INT. CL. 20. REG. 4-10-1984.  
1,273,559. GLAMOUR PEDIC. INT. CL. 20. REG. 4-10-1984.  
1,273,564. MKS AND DESIGN. INT. CL. 20. REG. 4-10-1984.  
1,273,567. NOCTURNE (STYLIZED). INT. CL. 20. REG. 4-10-1984.  
1,273,575. MISCELLANEOUS DESIGN. INT. CLS. 21 AND 42. REG. 4-10-1984.  
1,273,581. THE REBEL. INT. CL. 21. REG. 4-10-1984.  
1,273,583. MISCELLANEOUS DESIGN. INT. CL. 21. REG. 4-10-1984.  
1,273,585. HANG-UPS. INT. CL. 22. REG. 4-10-1984.  
1,273,591. SOCK-IT-AWAY. INT. CL. 24. REG. 4-10-1984.  
1,273,593. LA SEIGNEURIE. INT. CL. 24. REG. 4-10-1984.  
1,273,596. FUMI-SLEEVE. INT. CL. 24. REG. 4-10-1984.  
1,273,598. COTTON-COOLER. INT. CL. 25. REG. 4-10-1984.  
1,273,601. NATURAL TOUCH AND DESIGN. INT. CL. 25. REG. 4-10-1984.  
1,273,606. TENNY. INT. CL. 25. REG. 4-10-1984.  
1,273,610. JAC DALE. INT. CL. 25. REG. 4-10-1984.  
1,273,612. LADY GARLAND. INT. CL. 25. REG. 4-10-1984.  
1,273,614. ASICS TIGER (STYLIZED). INT. CL. 25. REG. 4-10-1984.  
1,273,620. SUPERBLUE. INT. CL. 25. REG. 4-10-1984.  
1,273,621. ERMENEGILDO ZEGNA AND DESIGN. INT. CL. 25. REG. 4-10-1984.  
1,273,624. LITTLE PAPPAGALLO. INT. CL. 25. REG. 4-10-1984.  
1,273,625. YOUNG PAPPAGALLO. INT. CL. 25. REG. 4-10-1984.  
1,273,637. SOLER SYSTEM AND DESIGN. INT. CL. 25. REG. 4-10-1984.  
1,273,644. MARK SCOT. INT. CL. 25. REG. 4-10-1984.  
1,273,645. TOWN DALES. INT. CL. 25. REG. 4-10-1984.  
1,273,647. PURITAN AND DESIGN. INT. CL. 25. REG. 4-10-1984.  
1,273,656. DONBERRY & KEATS (STYLIZED). INT. CL. 25. REG. 4-10-1984.  
1,273,657. SAMUEL JASON. INT. CL. 25. REG. 4-10-1984.  
1,273,658. M.I. COLLECTIBLES. INT. CL. 25. REG. 4-10-1984.  
1,273,661. ODOR GUARD. INT. CL. 25. REG. 4-10-1984.  
1,273,669. CRAZY LACES. INT. CL. 26. REG. 4-10-1984.  
1,273,676. POLYMAT. INT. CL. 27. REG. 4-10-1984.  
1,273,685. 4030. INT. CL. 28. REG. 4-10-1984.  
1,273,686. ADVANCED DUNGEONS & DRAGONS. INT. CL. 28. REG. 4-10-1984.



- 1,273,691. LE HARVE. INT. CL. 28. REG. 4-10-1984.  
 1,273,704. PIERCE DIP'N CHIK'N AND DESIGN. INT. CL. 29. REG. 4-10-1984.  
 1,273,705. LITTLE DRUMMERS. INT. CL. 29. REG. 4-10-1984.  
 1,273,706. BETTER BUY AND DESIGN. INT. CL. 29. REG. 4-10-1984.  
 1,273,707. CHIK'N DIP'N. INT. CL. 29. REG. 4-10-1984.  
 1,273,711. GOLD 'N LITE. INT. CL. 29. REG. 4-10-1984.  
 1,273,712. BLUE LABEL AND DESIGN. INT. CL. 29. REG. 4-10-1984.  
 1,273,715. CONTESSA AND DESIGN. INT. CL. 29. REG. 4-10-1984.  
 1,273,720. YARA. INT. CL. 29. REG. 4-10-1984.  
 1,273,723. ANTONIO GIUFFRIDA AND DESIGN. INT. CL. 29. REG. 4-10-1984.  
 1,273,724. MAURICE. INT. CL. 29. REG. 4-10-1984.  
 1,273,728. BARBE-CUTIES. INT. CL. 29. REG. 4-10-1984.  
 1,273,733. LOVE ME TENDER. INT. CL. 29. REG. 4-10-1984.  
 1,273,734. MISCELLANEOUS DESIGN. INT. CL. 29. REG. 4-10-1984.  
 1,273,741. DUPACO AND DESIGN. INT. CL. 29. REG. 4-10-1984.  
 1,273,744. SHIOCTON. INT. CL. 29. REG. 4-10-1984.  
 1,273,747. MISCELLANEOUS DESIGN. INT. CL. 29. REG. 4-10-1984.  
 1,273,753. BOIN AND DESIGN. INT. CL. 30. REG. 4-10-1984.  
 1,273,759. REAL STUFF. INT. CL. 30. REG. 4-10-1984.  
 1,273,761. CARRIACOU. INT. CL. 30. REG. 4-10-1984.  
 1,273,767. MUD PIE (STYLIZED). INT. CL. 30. REG. 4-10-1984.  
 1,273,770. CHILI DOG SPLIT. INT. CL. 30. REG. 4-10-1984.  
 1,273,774. YARNELL. INT. CL. 30. REG. 4-10-1984.  
 1,273,776. NATURES GIFT OF GOODNESS. INT. CL. 30. REG. 4-10-1984.  
 1,273,780. CASCADE INN. INT. CL. 30. REG. 4-10-1984.  
 1,273,786. BOND BOND AND DESIGN. INT. CL. 30. REG. 4-10-1984.  
 1,273,791. HAUTE CANINE THE NATURAL GOURMET DOG SNACK AND DESIGN. INT. CL. 31. REG. 4-10-1984.  
 1,273,794. JUBILEE GYP AND DESIGN. INT. CL. 31. REG. 4-10-1984.  
 1,273,795. DOGGIE DONUTS. INT. CL. 31. REG. 4-10-1984.  
 1,273,802. TOPMARK AND DESIGN. INT. CL. 32. REG. 4-10-1984.  
 1,273,804. WAY UP. INT. CL. 32. REG. 4-10-1984.  
 1,273,806. VITA-MAID. INT. CL. 32. REG. 4-10-1984.  
 1,273,809. MISCELLANEOUS DESIGN. INT. CL. 33. REG. 4-10-1984.  
 1,273,811. BOGGS. INT. CL. 33. REG. 4-10-1984.  
 1,273,821. THE LYNX LONGLIGHT AND DESIGN. INT. CL. 34. REG. 4-10-1984.  
 1,273,823. BARTLETT. INT. CL. 34. REG. 4-10-1984.  
 1,273,826. COMPUCON. INT. CLS. 35 AND 42. REG. 4-10-1984.  
 1,273,832. ADVENTURE AND DESIGN. INT. CL. 35. REG. 4-10-1984.  
 1,273,835. THE DOLL MASTERS. INT. CLS. 35 AND 41. REG. 4-10-1984.  
 1,273,837. CUTLERY WORLD. INT. CL. 35. REG. 4-10-1984.  
 1,273,840. CUTLERY WORLD AND DESIGN. INT. CLS. 35 AND 42. REG. 4-10-1984.  
 1,273,842. DENTACOM. INT. CL. 36. REG. 4-10-1984.  
 1,273,844. QUAYSIDE. INT. CL. 36. REG. 4-10-1984.  
 1,273,847. CAFES ON THE PARK. INT. CLS. 36 AND 37. REG. 4-10-1984.  
 1,273,848. CAFES ON THE PARK AND DESIGN. INT. CLS. 36 AND 37. REG. 4-10-1984.  
 1,273,849. FINANCIAL PATHFINDER. INT. CL. 36. REG. 4-10-1984.  
 1,273,850. A LIVING BEQUEST, YOUR GIFT TODAY IS REMEMBERED TOMORROW. INT. CL. 36. REG. 4-10-1984.  
 1,273,854. TIME FINANCE ADJUSTERS AND DESIGN. INT. CL. 36. REG. 4-10-1984.  
 1,273,855. FLEXI-BELL. INT. CL. 36. REG. 4-10-1984.  
 1,273,862. MISCELLANEOUS DESIGN. INT. CL. 36. REG. 4-10-1984.  
 1,273,863. NA (STYLIZED). INT. CL. 36. REG. 4-10-1984.  
 1,273,864. FARM & RANCH PROTECTION PAC AND DESIGN. INT. CL. 36. REG. 4-10-1984.  
 1,273,865. SUNPLAN 2. INT. CL. 36. REG. 4-10-1984.  
 1,273,866. MISCELLANEOUS DESIGN. INT. CL. 37. REG. 4-10-1984.  
 1,273,871. DECISION DATA. INT. CL. 37. REG. 4-10-1984.  
 1,273,873. MISCELLANEOUS DESIGN. INT. CL. 37. REG. 4-10-1984.  
 1,273,880. CHEMLAWN GUARANTEES. INT. CL. 37. REG. 4-10-1984.  
 1,273,885. CDC AND DESIGN. INT. CL. 38. REG. 4-10-1984.  
 1,273,889. UNITED SPORTS ASSOCIATES USA (STYLIZED). INT. CL. 39. REG. 4-10-1984.  
 1,273,895. SYSTEM 2. INT. CL. 40. REG. 4-10-1984.  
 1,273,899. THE PHOTO SYSTEM AND DESIGN. INT. CL. 40. REG. 4-10-1984.  
 1,273,900. THE PHOTOTRON SYSTEM. INT. CL. 40. REG. 4-10-1984.  
 1,273,901. THE PHOTOTRON SYSTEM AND DESIGN. INT. CL. 40. REG. 4-10-1984.  
 1,273,902. GUY'S FOTO. INT. CL. 40. REG. 4-10-1984.  
 1,273,906. COLORTYME AND DESIGN. INT. CL. 41. REG. 4-10-1984.  
 1,273,916. AMERICAN INTERCULTURAL STUDENT EXCHANGE AND DESIGN. INT. CL. 41. REG. 4-10-1984.  
 1,273,926. NADA DEALER CANDIDATE ACADEMY AND DESIGN. INT. CL. 41. REG. 4-10-1984.  
 1,273,940. MISCELLANEOUS DESIGN. INT. CL. 42. REG. 4-10-1984.  
 1,273,941. MISCELLANEOUS DESIGN. INT. CL. 42. REG. 4-10-1984.  
 1,273,946. X AND DESIGN. INT. CL. 42. REG. 4-10-1984.  
 1,273,956. THE ART STORE AND DESIGN. INT. CL. 42. REG. 4-10-1984.  
 1,273,958. DEVONSHIRE. INT. CL. 42. REG. 4-10-1984.  
 1,273,961. THE FRIENDLY WIZARD. INT. CL. 42. REG. 4-10-1984.  
 1,273,965. LETCO. INT. CL. 42. REG. 4-10-1984.  
 1,273,966. AFAR AND DESIGN. INT. CL. 42. REG. 4-10-1984.  
 1,273,974. THE PAMPERED CHEF THE PAMPERED CHEF AND DESIGN. INT. CL. 42. REG. 4-10-1984.  
 1,273,975. CASCADE REHABILITATION COUNSELING. INT. CL. 42. REG. 4-10-1984.  
 1,273,983. THE COMPUTER PATCH. INT. CL. 42. REG. 4-10-1984.  
 1,273,995. MISCELLANEOUS DESIGN. INT. CL. 42. REG. 4-10-1984.  
 1,789,678. SHORESH. INT. CL. 39. REG. 8-24-1993.  
 1,797,865. RTC. INT. CL. 20. REG. 10-12-1993.  
 1,814,559. MOBILE CHIROPRACTIC OF FLORIDA HEALTH CHIROPRACTIC AND DESIGN. INT. CL. 42. REG. 12-28-1993.  
 1,830,056. NUTRIOX. INT. CL. 1. REG. 4-12-1994.  
 1,830,062. PHOSPHOLIPID SV. INT. CL. 1. REG. 4-12-1994.  
 1,830,075. J SHINE. INT. CL. 1. REG. 4-12-1994.  
 1,830,081. PRO-DEC. INT. CL. 2. REG. 4-12-1994.  
 1,830,083. HIDUCT. INT. CL. 2. REG. 4-12-1994.  
 1,830,085. MIDGET. INT. CL. 2. REG. 4-12-1994.  
 1,830,088. FRAGRANCE FOUNTAIN AND DESIGN. INT. CL. 3. REG. 4-12-1994.  
 1,830,090. MISCELLANEOUS DESIGN. INT. CLS. 3 AND 5. REG. 4-12-1994.  
 1,830,094. NUGGET. INT. CL. 3. REG. 4-12-1994.  
 1,830,097. EARTHLY ESSENTIALS. INT. CLS. 3 AND 21. REG. 4-12-1994.  
 1,830,104. MISCELLANEOUS DESIGN. INT. CL. 4. REG. 4-12-1994.  
 1,830,106. LOCTITE (STYLIZED). INT. CL. 4. REG. 4-12-1994.  
 1,830,118. SYMONS' SUPER MIX. INT. CL. 5. REG. 4-12-1994.  
 1,830,122. M AND DESIGN. INT. CL. 5. REG. 4-12-1994.  
 1,830,131. NEW BODY (STYLIZED). INT. CL. 5. REG. 4-12-1994.

- 1,830,135. SCORES AND DESIGN. INT. CLS. 6, 41 AND 42. REG. 4-12-1994.
- 1,830,139. MISCELLANEOUS DESIGN. INT. CLS. 6, 14, 16, 20, 21, 25 AND 41. REG. 4-12-1994.
- 1,830,141. LIFT AND TURN. INT. CL. 6. REG. 4-12-1994.
- 1,830,150. SKINNY DIPPER. INT. CL. 7. REG. 4-12-1994.
- 1,830,151. KSI AND DESIGN. INT. CLS. 7, 9, 11, 37 AND 42. REG. 4-12-1994.
- 1,830,154. GIL MARINE. INT. CL. 7. REG. 4-12-1994.
- 1,830,161. SUPER 86. INT. CL. 7. REG. 4-12-1994.
- 1,830,165. AQUA-IMAGE. INT. CL. 7. REG. 4-12-1994.
- 1,830,174. SK (STYLIZED). INT. CL. 9. REG. 4-12-1994.
- 1,830,184. TRANSMISSION COMMAND MODULE. INT. CL. 9. REG. 4-12-1994.
- 1,830,185. SPATIALIST. INT. CL. 9. REG. 4-12-1994.
- 1,830,186. IMAGE TECH. INT. CL. 9. REG. 4-12-1994.
- 1,830,192. PREPARED. INT. CLS. 9 AND 16. REG. 4-12-1994.
- 1,830,195. HORIZONS TECHNOLOGY, INC.. INT. CL. 9. REG. 4-12-1994.
- 1,830,197. FIRE ATTACKER. INT. CL. 9. REG. 4-12-1994.
- 1,830,223. Z-LOK. INT. CL. 9. REG. 4-12-1994.
- 1,830,224. HOLSTEIN DESIGN AND DESIGN. INT. CL. 9. REG. 4-12-1994.
- 1,830,230. POWERTRONIX. INT. CL. 9. REG. 4-12-1994.
- 1,830,238. SCHUKRA. INT. CL. 10. REG. 4-12-1994.
- 1,830,249. MICRO ACCESS FOR THE TWENTY-FIRST CENTURY. INT. CL. 10. REG. 4-12-1994.
- 1,830,273. FABBRI AND DESIGN. INT. CL. 12. REG. 4-12-1994.
- 1,830,274. KEI HIN AND DESIGN. INT. CL. 12. REG. 4-12-1994.
- 1,830,276. K AND DESIGN. INT. CL. 12. REG. 4-12-1994.
- 1,830,277. ROADFLIGHT. INT. CL. 12. REG. 4-12-1994.
- 1,830,280. AEROBRAKE. INT. CL. 12. REG. 4-12-1994.
- 1,830,287. MISCELLANEOUS DESIGN. INT. CL. 14. REG. 4-12-1994.
- 1,830,288. DE LILLO AND DESIGN. INT. CL. 14. REG. 4-12-1994.
- 1,830,293. SAVIOUR. INT. CL. 14. REG. 4-12-1994.
- 1,830,301. ECOJET (STYLIZED). INT. CL. 16. REG. 4-12-1994.
- 1,830,305. M L S A AND DESIGN. INT. CL. 16. REG. 4-12-1994.
- 1,830,309. CROSS STITCH! MAGAZINE. INT. CL. 16. REG. 4-12-1994.
- 1,830,312. KEY MAIL YOUR KEY TO THE WORLD AND DESIGN. INT. CLS. 16, 38 AND 39. REG. 4-12-1994.
- 1,830,327. THE HARCOURT PRESS AND DESIGN. INT. CL. 16. REG. 4-12-1994.
- 1,830,330. ARMED FORCES JOURNAL INTERNATIONAL. INT. CL. 16. REG. 4-12-1994.
- 1,830,333. AD LAW. INT. CL. 16. REG. 4-12-1994.
- 1,830,351. SALT CORNER. INT. CLS. 16 AND 35. REG. 4-12-1994.
- 1,830,354. TECHNITIPS. INT. CL. 16. REG. 4-12-1994.
- 1,830,356. MISCELLANEOUS DESIGN. INT. CL. 16. REG. 4-12-1994.
- 1,830,361. ESTIMEASURE (STYLIZED). INT. CL. 16. REG. 4-12-1994.
- 1,830,362. COGO BEAR AND DESIGN. INT. CL. 16. REG. 4-12-1994.
- 1,830,364. THIS SIDE OF 60. INT. CL. 16. REG. 4-12-1994.
- 1,830,372. METAFLEX. INT. CL. 17. REG. 4-12-1994.
- 1,830,373. EVERTITE (STYLIZED). INT. CL. 17. REG. 4-12-1994.
- 1,830,383. BAGMATE. INT. CL. 21. REG. 4-12-1994.
- 1,830,384. POLAA AND DESIGN. INT. CL. 21. REG. 4-12-1994.
- 1,830,399. TASMANWOOL. INT. CL. 24. REG. 4-12-1994.
- 1,830,410. MOEBIUS. INT. CL. 25. REG. 4-12-1994.
- 1,830,411. ECOSPORT AND DESIGN. INT. CL. 25. REG. 4-12-1994.
- 1,830,418. JUST FOR WRAPS (STYLIZED). INT. CL. 25. REG. 4-12-1994.
- 1,830,422. REALLUSIONS. INT. CLS. 26 AND 40. REG. 4-12-1994.
- 1,830,423. WEAR-DATED FREEDOM AND DESIGN. INT. CL. 27. REG. 4-12-1994.
- 1,830,424. POWER PUCK AND DESIGN. INT. CL. 28. REG. 4-12-1994.
- 1,830,425. THE POWER BALL. INT. CL. 28. REG. 4-12-1994.
- 1,830,426. FIRSTPLAY. INT. CL. 28. REG. 4-12-1994.
- 1,830,427. MOEBIUS. INT. CL. 28. REG. 4-12-1994.
- 1,830,429. NIGHT CRAWLER LINKS. INT. CL. 28. REG. 4-12-1994.
- 1,830,430. EARTHWORMS AND DESIGN. INT. CL. 28. REG. 4-12-1994.
- 1,830,431. BALLET FUN CLASS. INT. CL. 28. REG. 4-12-1994.
- 1,830,432. BRIDAL PARTY. INT. CL. 28. REG. 4-12-1994.
- 1,830,433. CYBERDROME (STYLIZED). INT. CL. 28. REG. 4-12-1994.
- 1,830,450. THE NUTTY BAVARIAN NUTS AND DESIGN. INT. CLS. 29 AND 30. REG. 4-12-1994.
- 1,830,454. COMO. INT. CL. 29. REG. 4-12-1994.
- 1,830,456. ATLANTIC PEARL BRAND AND DESIGN. INT. CL. 29. REG. 4-12-1994.
- 1,830,469. KOSHI HIKARI USA IMPERIAL QUALITY RICE AND DESIGN. INT. CL. 30. REG. 4-12-1994.
- 1,830,475. DENALI MT. MCKINLEY AND DESIGN. INT. CL. 30. REG. 4-12-1994.
- 1,830,479. MISCELLANEOUS DESIGN. INT. CL. 30. REG. 4-12-1994.
- 1,830,485. ULTRA GEL. INT. CL. 30. REG. 4-12-1994.
- 1,830,493. PIMA'S CHOICE. INT. CL. 31. REG. 4-12-1994.
- 1,830,497. FLORA TEC FT-2000 WHERE QUALITY BEGINS AND DESIGN. INT. CL. 31. REG. 4-12-1994.
- 1,830,498. PETALGRAM. INT. CL. 31. REG. 4-12-1994.
- 1,830,509. CALIFORNIA SOURCE AND DESIGN. INT. CL. 32. REG. 4-12-1994.
- 1,830,520. MONTEREY CREST. INT. CL. 33. REG. 4-12-1994.
- 1,830,525. ARI. INT. CLS. 35, 38 AND 42. REG. 4-12-1994.
- 1,830,529. UNIVERSAL DATABASE BY GLADSON & ASSOCIATES AND DESIGN. INT. CL. 35. REG. 4-12-1994.
- 1,830,539. COMDISCO. INT. CL. 35. REG. 4-12-1994.
- 1,830,542. LARK OF AMERICA AND DESIGN. INT. CLS. 35 AND 42. REG. 4-12-1994.
- 1,830,558. INSTAPAY AND DESIGN. INT. CL. 35. REG. 4-12-1994.
- 1,830,572. PAEG/L. INT. CL. 36. REG. 4-12-1994.
- 1,830,573. MISCELLANEOUS DESIGN. INT. CL. 36. REG. 4-12-1994.
- 1,830,581. EXPECT. INT. CL. 36. REG. 4-12-1994.
- 1,830,599. CCI AND DESIGN. INT. CL. 37. REG. 4-12-1994.
- 1,830,602. SKYSTAR PLUS. INT. CL. 38. REG. 4-12-1994.
- 1,830,606. PVS. INT. CL. 38. REG. 4-12-1994.
- 1,830,607. COMLINK. INT. CL. 38. REG. 4-12-1994.
- 1,830,608. CIRCULO DE LLAMADAS. INT. CL. 38. REG. 4-12-1994.
- 1,830,612. SAIMA AND DESIGN. INT. CL. 39. REG. 4-12-1994.
- 1,830,614. BUSINESS ONE. INT. CL. 39. REG. 4-12-1994.
- 1,830,616. GENTLE MOVERS AND DESIGN. INT. CL. 39. REG. 4-12-1994.
- 1,830,624. CHROMA COPY AND DESIGN. INT. CL. 40. REG. 4-12-1994.
- 1,830,630. SOMERTON SPRINGS. INT. CLS. 41 AND 42. REG. 4-12-1994.
- 1,830,634. HIGH TRUST LEADERSHIP/MANAGEMENT. INT. CL. 41. REG. 4-12-1994.
- 1,830,636. JUMBO PICTURES INC. AND DESIGN. INT. CL. 41. REG. 4-12-1994.
- 1,830,637. GOOD DESIGN AND DESIGN. INT. CL. 41. REG. 4-12-1994.
- 1,830,641. SYNCHRONICITY AND DESIGN. INT. CL. 41. REG. 4-12-1994.
- 1,830,643. PPS AND DESIGN. INT. CL. 41. REG. 4-12-1994.
- 1,830,648. CASTLE MUSIC PICTURES AND DESIGN. INT. CL. 41. REG. 4-12-1994.
- 1,830,652. CTSC. INT. CL. 41. REG. 4-12-1994.
- 1,830,655. CAPITAL JAZZ. INT. CL. 41. REG. 4-12-1994.
- 1,830,661. THE CHOCOLATE CHIP COOKIE FACTORY. INT. CL. 41. REG. 4-12-1994.
- 1,830,668. PARADORES DE TURISMO AND DESIGN. INT. CL. 42. REG. 4-12-1994.

- 1,830,671. PERDIDO BEACH RESORT AND DESIGN. INT. CL. 42. REG. 4-12-1994.
- 1,830,688. COMDISCO. INT. CL. 42. REG. 4-12-1994.
- 1,830,698. SIMPEX WHOLESALE FLORIST FLORAL EXPRESS AND DESIGN. INT. CL. 42. REG. 4-12-1994.
- 1,830,710. MEGA MAC. INT. CL. 42. REG. 4-12-1994.
- 1,830,711. PCI. INT. CL. 42. REG. 4-12-1994.
- 1,830,719. MHN. INT. CL. 42. REG. 4-12-1994.
- 1,830,728. DUOMO (STYLIZED). INT. CL. 42. REG. 4-12-1994.
- 1,830,730. PAWSITIVELY PETS AND DESIGN. INT. CL. 42. REG. 4-12-1994.
- 1,830,738. SUGOI AND DESIGN. INT. CLS. 25 AND 28. REG. 4-12-1994.
- 1,830,753. NANODYNE. INT. CL. 1. REG. 4-12-1994.
- 1,830,755. VITASPA. INT. CL. 3. REG. 4-12-1994.
- 1,830,763. ADVERA. INT. CL. 5. REG. 4-12-1994.
- 1,830,764. GAUCHO AND DESIGN. INT. CL. 5. REG. 4-12-1994.
- 1,830,768. HELI-NUT (STYLIZED). INT. CL. 6. REG. 4-12-1994.
- 1,830,770. TWIN PASTEL. INT. CL. 8. REG. 4-12-1994.
- 1,830,778. SIGMASTAT. INT. CL. 9. REG. 4-12-1994.
- 1,830,781. THE POWER TO SUCCEED. INT. CL. 9. REG. 4-12-1994.
- 1,830,787. ULTRA-VAC. INT. CL. 10. REG. 4-12-1994.
- 1,830,800. ECOPALLET AND DESIGN. INT. CL. 16. REG. 4-12-1994.
- 1,830,803. MOTHER IN THE MAKING. INT. CL. 16. REG. 4-12-1994.
- 1,830,812. AUTOLUX. INT. CL. 17. REG. 4-12-1994.
- 1,830,813. COBBLELOCK. INT. CL. 19. REG. 4-12-1994.
- 1,830,822. SAS SUPERMOCS. INT. CL. 25. REG. 4-12-1994.
- 1,830,825. E.Z. GEAR. INT. CL. 25. REG. 4-12-1994.
- 1,830,849. WISCONSIN HOMESTEAD. INT. CL. 29. REG. 4-12-1994.
- 1,830,853. TR'S GREAT AMERICAN AND DESIGN. INT. CL. 30. REG. 4-12-1994.
- 1,830,872. PEAKS. INT. CL. 32. REG. 4-12-1994.
- 1,830,884. CORE AND GATEWAY. INT. CL. 36. REG. 4-12-1994.
- 1,830,885. QUORUM CAPITAL MANAGEMENT LIMITED. INT. CL. 36. REG. 4-12-1994.
- 1,830,888. LOUVER-TO-LOUVER. INT. CL. 36. REG. 4-12-1994.
- 1,830,892. AMERICAN PHONECARD AND DESIGN. INT. CL. 38. REG. 4-12-1994.
- 1,830,897. THE SHOT DOCTOR. INT. CL. 41. REG. 4-12-1994.
- 1,830,898. EARTHSTATION. INT. CL. 41. REG. 4-12-1994.
- 1,830,902. AUTOMATION USA. INT. CL. 42. REG. 4-12-1994.
- 1,830,905. TRI-ELECTRIC SUPPLY COMPANY. INT. CL. 42. REG. 4-12-1994.
- 1,830,908. ORTLIEB. INT. CLS. 12 AND 18. REG. 4-12-1994.
- 1,830,919. GALLET (STYLIZED). INT. CL. 9. REG. 4-12-1994.
- 1,830,926. BERN CHRONOMETER WORKS. INT. CL. 14. REG. 4-12-1994.
- 1,830,928. MIDRANGE COMPUTING. INT. CL. 16. REG. 4-12-1994.
- 1,830,935. ONE FAMILY'S FINANCES. INT. CL. 16. REG. 4-12-1994.
- 1,830,939. US MIX. INT. CL. 19. REG. 4-12-1994.
- 1,830,943. MISCELLANEOUS DESIGN. INT. CL. 28. REG. 4-12-1994.
- 1,830,945. BEER AT ITS BEST!. INT. CL. 32. REG. 4-12-1994.
- 1,835,921. PROFILES. INT. CLS. 21 AND 26 ONLY. REG. 5-10-1994.
- 1,864,543. KID DESK AND DESIGN. INT. CL. 16 ONLY. REG. 11-29-1994.
- 2,034,184. STORYOPOLIS. INT. CL. 25 ONLY. REG. 1-28-1997.
- 2,045,402. A AND DESIGN. INT. CLS. 16, 28 AND 41 ONLY. REG. 3-18-1997.
- 2,069,638. HARD ROCK HOTEL. INT. CLS. 15, 18, 20 AND 28. REG. 6-10-1997.
- 2,080,332. AQUADECK. INT. CL. 2. REG. 7-15-1997.
- 2,100,753. I KNOW. INT. CL. 28. REG. 9-30-1997.
- 2,114,020. MISCELLANEOUS DESIGN. INT. CL. 35. REG. 11-18-1997.
- 2,115,952. U.S. DIAMOND EXCHANGE AND DESIGN. INT. CL. 36. REG. 11-25-1997.
- 2,119,600. LYONDELL. INT. CLS. 1 AND 4. REG. 12-9-1997.
- 2,122,608. MAGIC. INT. CLS. 16 AND 28. REG. 12-23-1997.
- 2,138,092. SELBY COMFORT FLEX. INT. CL. 25. REG. 2-24-1998.
- 2,143,551. GOTTA GO. INT. CL. 18. REG. 3-10-1998.
- 2,146,932. THE BUILDER'S CHOICE. INT. CLS. 6, 19 AND 20 ONLY. REG. 3-31-1998.
- 2,149,921. COMME DES GARCONS NOIR (STYLIZED). INT. CLS. 18 AND 25. REG. 4-14-1998.
- 2,149,923. PIONER. INT. CL. 12. REG. 4-14-1998.
- 2,149,924. BIOPUR (STYLIZED). INT. CL. 11. REG. 4-14-1998.
- 2,149,926. COFFEESMART. INT. CLS. 21, 30 AND 42. REG. 4-14-1998.
- 2,149,929. THE BIG POPPER. INT. CL. 30. REG. 4-14-1998.
- 2,149,931. JEUNIQUE THE ONE DAY DIET. INT. CL. 5. REG. 4-14-1998.
- 2,149,933. HETTICH INTERNATIONAL AND DESIGN. INT. CLS. 16 AND 21. REG. 4-14-1998.
- 2,149,935. RACEMATE. INT. CL. 9. REG. 4-14-1998.
- 2,149,936. BICYCLE CLUB CASINO. INT. CL. 41. REG. 4-14-1998.
- 2,149,939. MUSIC CITY AND DESIGN. INT. CL. 9. REG. 4-14-1998.
- 2,149,940. PCNET DIRECT. INT. CL. 9. REG. 4-14-1998.
- 2,149,941. MISCELLANEOUS DESIGN. INT. CL. 16. REG. 4-14-1998.
- 2,149,942. GECAP (STYLIZED). INT. CLS. 9, 16, 35, 41 AND 42. REG. 4-14-1998.
- 2,149,945. THE SABRE GROUP. INT. CL. 16. REG. 4-14-1998.
- 2,149,947. CANBAC. INT. CL. 9. REG. 4-14-1998.
- 2,149,948. INTERACTIVE SHOPPER. INT. CL. 9. REG. 4-14-1998.
- 2,149,949. AUDAPAD (STYLIZED). INT. CLS. 35 AND 36. REG. 4-14-1998.
- 2,149,950. A ANDRE GROUP AND DESIGN. INT. CLS. 1, 3, 7, 23, 29, 30, 31, 36, 39 AND 42. REG. 4-14-1998.
- 2,149,951. CARNEROS ALAMBIC DISTILLERY AND DESIGN. INT. CL. 33. REG. 4-14-1998.
- 2,149,954. NURISTOR. INT. CL. 5. REG. 4-14-1998.
- 2,149,955. MACTOR. INT. CL. 5. REG. 4-14-1998.
- 2,149,957. LOUIS XIV. INT. CL. 33. REG. 4-14-1998.
- 2,149,958. THERAPISTS UNLIMITED. INT. CL. 35. REG. 4-14-1998.
- 2,149,959. NORFLEX. INT. CL. 6. REG. 4-14-1998.
- 2,149,961. QUALITY FOR LIFE. INT. CLS. 9, 18, 25 AND 34. REG. 4-14-1998.
- 2,149,965. THE D'ARCY LANE INSTITUTE & SPA AND DESIGN. INT. CLS. 16 AND 41. REG. 4-14-1998.
- 2,149,966. BUZZ AND DESIGN. INT. CLS. 40 AND 41. REG. 4-14-1998.
- 2,149,967. GLOBEO. INT. CLS. 9, 16, 36, 38 AND 42. REG. 4-14-1998.
- 2,149,968. MARCHE MOVENPICK AND DESIGN. INT. CLS. 29, 30 AND 42. REG. 4-14-1998.
- 2,149,970. PARKABIKE AND DESIGN. INT. CL. 6. REG. 4-14-1998.
- 2,149,971. PEMATECH. INT. CL. 7. REG. 4-14-1998.
- 2,149,972. THE AMERICAN INSTITUTE OF WINE & FOOD. INT. CL. 41. REG. 4-14-1998.
- 2,149,973. NO NO NO. INT. CL. 25. REG. 4-14-1998.
- 2,149,974. UTV. INT. CLS. 38 AND 41. REG. 4-14-1998.
- 2,149,977. RATEVIEW. INT. CL. 35. REG. 4-14-1998.
- 2,149,978. PRACTICAL! SOLUTIONS AND DESIGN. INT. CL. 41. REG. 4-14-1998.
- 2,149,979. RED HOT PEPPER FOAM. INT. CL. 1. REG. 4-14-1998.
- 2,149,980. THE INTERNET EXPERIENCE. INT. CL. 35. REG. 4-14-1998.
- 2,149,982. CANTARELLI C AND DESIGN. INT. CLS. 3 AND 18. REG. 4-14-1998.
- 2,149,984. E-Z INVOICE. INT. CL. 9. REG. 4-14-1998.
- 2,149,994. FIRST INVESTMENT (STYLIZED). INT. CL. 36. REG. 4-14-1998.

- 2,149,995. DIAMON-KOTE. INT. CL. 40. REG. 4-14-1998.  
 2,149,996. LAREDO STEAKHOUSE & SALOON. INT. CL. 42. REG. 4-14-1998.  
 2,149,998. MISCELLANEOUS DESIGN. INT. CL. 32. REG. 4-14-1998.  
 2,150,001. GOLD SNOW. INT. CLS. 32 AND 33. REG. 4-14-1998.  
 2,150,002. FUNKY FLASH. INT. CL. 34. REG. 4-14-1998.  
 2,150,009. UNICEM AND DESIGN. INT. CL. 19. REG. 4-14-1998.  
 2,150,011. VELVETOUCH. INT. CL. 2. REG. 4-14-1998.  
 2,150,014. MISCELLANEOUS DESIGN. INT. CL. 41. REG. 4-14-1998.  
 2,150,015. ISOLOGIC. INT. CL. 9. REG. 4-14-1998.  
 2,150,016. REFLEX. INT. CL. 12. REG. 4-14-1998.  
 2,150,017. WING GOLF AND DESIGN. INT. CL. 28. REG. 4-14-1998.  
 2,150,019. F/X SPECIAL EFFECTS AND DESIGN. INT. CL. 3. REG. 4-14-1998.  
 2,150,022. LIENS D'OR. INT. CL. 14. REG. 4-14-1998.  
 2,150,023. NANOSFERA. INT. CL. 1. REG. 4-14-1998.  
 2,150,028. AGUSTA SKYHORSE. INT. CL. 12. REG. 4-14-1998.  
 2,150,030. SHAMROCK GENETICS. INT. CLS. 5, 31 AND 42. REG. 4-14-1998.  
 2,150,031. CLEANNET. INT. CL. 1. REG. 4-14-1998.  
 2,150,034. A7. INT. CLS. 8, 18, 25 AND 28. REG. 4-14-1998.  
 2,150,037. WATERLOO MAPLE AND DESIGN. INT. CL. 9. REG. 4-14-1998.  
 2,150,038. TISCO AND DESIGN. INT. CLS. 7 AND 12. REG. 4-14-1998.  
 2,150,039. PARK CITY SKI AREA 2002!. INT. CL. 41. REG. 4-14-1998.  
 2,150,042. INTERNET IN A MALL. INT. CL. 35. REG. 4-14-1998.  
 2,150,044. LIFE ON THE INTERNET. INT. CL. 41. REG. 4-14-1998.  
 2,150,047. NMGAS AND DESIGN. INT. CLS. 36, 39 AND 41. REG. 4-14-1998.  
 2,150,049. CANADA WAX AND DESIGN. INT. CL. 3. REG. 4-14-1998.  
 2,150,050. MEGGA. INT. CL. 7. REG. 4-14-1998.  
 2,150,051. MORE THAN GOLD AND DESIGN. INT. CL. 42. REG. 4-14-1998.  
 2,150,052. INTERNET WITHOUT LIMITS. INT. CL. 42. REG. 4-14-1998.  
 2,150,053. GLOBAL MEDNET. INT. CL. 42. REG. 4-14-1998.  
 2,150,056. INNOVATIVE SOLUTIONS FOR INFORMATION TECHNOLOGY. INT. CL. 42. REG. 4-14-1998.  
 2,150,057. HBR. INT. CL. 7. REG. 4-14-1998.  
 2,150,059. CAVS AND DESIGN. INT. CLS. 25 AND 41. REG. 4-14-1998.  
 2,150,060. STRATEGY MAXIMIZER. INT. CL. 9. REG. 4-14-1998.  
 2,150,062. I-NET AND DESIGN. INT. CLS. 9 AND 42. REG. 4-14-1998.  
 2,150,065. NON-STOP LOGISTICS. INT. CL. 35. REG. 4-14-1998.  
 2,150,067. FULFILL A CHILD'S DREAM RENT AND RESCUE A TOY TOY RESCUE AND DESIGN. INT. CL. 28. REG. 4-14-1998.  
 2,150,069. ESKIMO. INT. CL. 12. REG. 4-14-1998.  
 2,150,072. TIMANTTI AND DESIGN. INT. CL. 20. REG. 4-14-1998.  
 2,150,073. HYALIP. INT. CL. 5. REG. 4-14-1998.  
 2,150,074. MISCELLANEOUS DESIGN. INT. CL. 9. REG. 4-14-1998.  
 2,150,076. CALIFORNIA GIFT SHOW AND DESIGN. INT. CL. 35. REG. 4-14-1998.  
 2,150,080. LHS (STYLIZED). INT. CLS. 9, 38 AND 42. REG. 4-14-1998.  
 2,150,083. INTELLEQUEST. INT. CL. 9. REG. 4-14-1998.  
 2,150,084. XTRAS AND DESIGN. INT. CLS. 6, 9 AND 20. REG. 4-14-1998.  
 2,150,085. DENVER BUFFALO COMPANY. INT. CL. 42. REG. 4-14-1998.  
 2,150,086. NIGHT ENCOUNTERS. INT. CL. 38. REG. 4-14-1998.  
 2,150,088. THOMAS REGISTER ON THE INTERNET. INT. CL. 35. REG. 4-14-1998.  
 2,150,090. SANTA'S SECRETS. INT. CL. 14. REG. 4-14-1998.  
 2,150,091. THE LONG DISTANCE COMPANY BUILT AROUND YOUR BUSINESS. INT. CL. 38. REG. 4-14-1998.  
 2,150,092. SKICROSS. INT. CL. 41. REG. 4-14-1998.  
 2,150,093. HALLOWEEN HAVOC. INT. CL. 25. REG. 4-14-1998.  
 2,150,099. SQUARE TEK AND DESIGN. INT. CL. 28. REG. 4-14-1998.  
 2,150,100. SQUARE TEK 90 AND DESIGN. INT. CL. 28. REG. 4-14-1998.  
 2,150,101. TELECHIPPER. INT. CL. 9. REG. 4-14-1998.  
 2,150,102. RED BARON PASTRY POUCHES. INT. CL. 30. REG. 4-14-1998.  
 2,150,105. STARGAZERS AND DESIGN. INT. CL. 42. REG. 4-14-1998.  
 2,150,110. COSATEC. INT. CL. 35. REG. 4-14-1998.  
 2,150,111. TOTAL MEDICAL COMPLIANCE. INT. CL. 42. REG. 4-14-1998.  
 2,150,114. AVEGLUCAN. INT. CL. 1. REG. 4-14-1998.  
 2,150,116. CYMBOLIC SCIENCES. INT. CL. 9. REG. 4-14-1998.  
 2,150,117. TONFERIN. INT. CL. 5. REG. 4-14-1998.  
 2,150,121. VIRTUAL FOOT. INT. CL. 9. REG. 4-14-1998.  
 2,150,122. CARROT TECHNOLOGIES AND DESIGN. INT. CLS. 35, 37 AND 42. REG. 4-14-1998.  
 2,150,123. SECA. INT. CLS. 7 AND 12. REG. 4-14-1998.  
 2,150,124. SCALE. INT. CLS. 7 AND 12. REG. 4-14-1998.  
 2,150,126. TWIN PAQ. INT. CL. 9. REG. 4-14-1998.  
 2,150,127. ALL LIFT (STYLIZED). INT. CL. 3. REG. 4-14-1998.  
 2,150,130. HAMMER. INT. CLS. 28 AND 35. REG. 4-14-1998.  
 2,150,132. BEACH LINGO. INT. CL. 25. REG. 4-14-1998.  
 2,150,133. SOUND AND DESIGN. INT. CL. 9. REG. 4-14-1998.  
 2,150,134. TODAY'S SELECTION. INT. CL. 29. REG. 4-14-1998.  
 2,150,135. FIRE SOUND AND DESIGN. INT. CL. 9. REG. 4-14-1998.  
 2,150,136. CHICKEN BUN-PATTIES AND DESIGN. INT. CL. 29. REG. 4-14-1998.  
 2,150,137. ATMAN ENTERTAINMENT. INT. CL. 41. REG. 4-14-1998.  
 2,150,139. AQUATRAK SYSTEMS AND DESIGN. INT. CL. 42. REG. 4-14-1998.  
 2,150,140. TEACH ME STUFF. INT. CLS. 9 AND 16. REG. 4-14-1998.  
 2,150,147. MASTER AND DESIGN. INT. CL. 7. REG. 4-14-1998.  
 2,150,150. HEARTBREAK RECORDS (STYLIZED). INT. CL. 9. REG. 4-14-1998.  
 2,150,151. ISN'T THAT A GRAND IDEA?. INT. CL. 42. REG. 4-14-1998.  
 2,150,153. INTRABUILDER. INT. CL. 9. REG. 4-14-1998.  
 2,150,154. A+ 400 (STYLIZED). INT. CL. 9. REG. 4-14-1998.  
 2,150,155. CIRCORED. INT. CL. 6. REG. 4-14-1998.  
 2,150,156. THE WOODWORKING SHOWS AND DESIGN. INT. CLS. 35 AND 41. REG. 4-14-1998.  
 2,150,157. MISCELLANEOUS DESIGN. INT. CL. 38. REG. 4-14-1998.  
 2,150,159. NORTHERN WHITE. INT. CLS. 29, 30 AND 32. REG. 4-14-1998.  
 2,150,162. THE GREEN CULTURE. INT. CL. 35. REG. 4-14-1998.  
 2,150,165. CREMA RICA. INT. CL. 30. REG. 4-14-1998.  
 2,150,166. ROCKET GLOVE. INT. CLS. 9, 15 AND 25. REG. 4-14-1998.  
 2,150,167. BACK IN TIME. INT. CLS. 38 AND 42. REG. 4-14-1998.  
 2,150,169. MAGCORP (STYLIZED). INT. CL. 6. REG. 4-14-1998.  
 2,150,170. ACT CANOE (STYLIZED). INT. CL. 9. REG. 4-14-1998.  
 2,150,172. GIGAMASK. INT. CL. 9. REG. 4-14-1998.  
 2,150,173. R RACOM INFORMATION TECHNOLOGIES AND DESIGN. INT. CL. 40. REG. 4-14-1998.

- 2,150,175. PERSONAL AACCESS AND DESIGN. INT. CLS. 9 AND 42. REG. 4-14-1998.
- 2,150,177. ARTSWEB. INT. CL. 9. REG. 4-14-1998.
- 2,150,178. A AND DESIGN. INT. CL. 25. REG. 4-14-1998.
- 2,150,179. STRANGE CAT. INT. CL. 25. REG. 4-14-1998.
- 2,150,182. IMAGETEL. INT. CL. 9. REG. 4-14-1998.
- 2,150,185. VISA REWARDS PERSONALIZED AND DESIGN. INT. CL. 35. REG. 4-14-1998.
- 2,150,189. RIVERMEN AND DESIGN. INT. CL. 25. REG. 4-14-1998.
- 2,150,191. 'CAUSE YOU CAN'T GO NAKED ALL THE TIME. INT. CL. 42. REG. 4-14-1998.
- 2,150,192. DATACLEAR EF GOLD. INT. CL. 9. REG. 4-14-1998.
- 2,150,193. POWERS ROMANIAN PSYCHIC CONNECTION NETWORK. INT. CL. 41. REG. 4-14-1998.
- 2,150,195. LONG ISLAND PRIMARY MEDICAL CARE AFFILIATED WITH WINTHROP-SOUTH NAS-SAU UNIVERSITY HEALTH SYSTEM, INC. AND DESIGN. INT. CL. 42. REG. 4-14-1998.
- 2,150,198. A AND DESIGN. INT. CLS. 35 AND 40. REG. 4-14-1998.
- 2,150,200. LISTENING PROJECT. INT. CL. 42. REG. 4-14-1998.
- 2,150,201. HEALTHBEAT. INT. CL. 41. REG. 4-14-1998.
- 2,150,202. SHENANDOAH BREWING COMPANY SCB ESTABLISHED 1994 ALEXANDRIA, VA AND DESIGN. INT. CL. 32. REG. 4-14-1998.
- 2,150,203. NATIONAL VETERINARY WEEK AND DESIGN. INT. CL. 41. REG. 4-14-1998.
- 2,150,205. GET AHEAD IN STYLE. INT. CL. 41. REG. 4-14-1998.
- 2,150,207. CALOI AUTHENTIC SINCE 1898 USA BRAZIL AND DESIGN. INT. CL. 12. REG. 4-14-1998.
- 2,150,209. ESTATE PLANNING SYSTEM AND DESIGN. INT. CL. 9. REG. 4-14-1998.
- 2,150,210. PANDA. INT. CL. 9. REG. 4-14-1998.
- 2,150,211. THE RECORD NO ONE DELIVERS MORE CHOICES. INT. CLS. 16, 35, 38 AND 42. REG. 4-14-1998.
- 2,150,212. VALIO MADE IN FINLAND AND DESIGN. INT. CL. 29. REG. 4-14-1998.
- 2,150,215. FIRSTLINK. INT. CLS. 38 AND 42. REG. 4-14-1998.
- 2,150,217. ISM (STYLIZED). INT. CL. 25. REG. 4-14-1998.
- 2,150,218. COLANA. INT. CL. 25. REG. 4-14-1998.
- 2,150,219. REALITYMODEL. INT. CL. 42. REG. 4-14-1998.
- 2,150,220. THE DIFFERENCE IS REALITY. INT. CL. 42. REG. 4-14-1998.
- 2,150,222. APS EZBID. INT. CL. 9. REG. 4-14-1998.
- 2,150,224. EXCEEDING CUSTOMER EXPECTATIONS! OMNICARE SERVICENET AND DESIGN. INT. CL. 42. REG. 4-14-1998.
- 2,150,227. REALSEARCH. INT. CL. 36. REG. 4-14-1998.
- 2,150,228. STEAKS2GO CHAR-GRILLED DELIVERY AND DESIGN. INT. CL. 39. REG. 4-14-1998.
- 2,150,230. LOGITRAK. INT. CL. 9. REG. 4-14-1998.
- 2,150,231. IN LINE. INT. CLS. 1 AND 4. REG. 4-14-1998.
- 2,150,238. THE LAST WORD IN ECHO CONTROL. INT. CL. 9. REG. 4-14-1998.
- 2,150,240. MISCELLANEOUS DESIGN. INT. CL. 9. REG. 4-14-1998.
- 2,150,245. 748. INT. CLS. 7, 12 AND 25. REG. 4-14-1998.
- 2,150,249. DELTA PLAN AND DESIGN. INT. CL. 16. REG. 4-14-1998.
- 2,150,251. NOUVEAU TECHNOLOGIES. INT. CL. 42. REG. 4-14-1998.
- 2,150,252. HOMECENTRAL. INT. CL. 36. REG. 4-14-1998.
- 2,150,254. BEROMUN. INT. CL. 5. REG. 4-14-1998.
- 2,150,255. LAW OF THE C.I.S. THE BOTTOM LINE. INT. CL. 16. REG. 4-14-1998.
- 2,150,256. SHOUTS & MURMURS AND DESIGN. INT. CL. 16. REG. 4-14-1998.
- 2,150,257. COMMENT AND DESIGN. INT. CL. 16. REG. 4-14-1998.
- 2,150,259. COMCOR, INC. AND DESIGN. INT. CL. 42. REG. 4-14-1998.
- 2,150,264. E.J. OVENS. INT. CL. 11. REG. 4-14-1998.
- 2,150,266. NEW TECHNOLOGY FOR A NEW WAY OF DOING BUSINESS. INT. CLS. 9, 35 AND 36. REG. 4-14-1998.
- 2,150,267. THE ORIGINAL SPICE OF NEW ORLEANS. INT. CL. 30. REG. 4-14-1998.
- 2,150,268. ENDO'S HIGH PERFORMANCE DOG RUNNING SHOES AND DESIGN. INT. CL. 18. REG. 4-14-1998.
- 2,150,271. ALUMALITE. INT. CL. 19. REG. 4-14-1998.
- 2,150,272. MIRACLE FLIGHTS FOR KIDS UNDER THE WING OF THE ANGEL PLANES AND DESIGN. INT. CL. 42. REG. 4-14-1998.
- 2,150,276. MISCELLANEOUS DESIGN. INT. CL. 9. REG. 4-14-1998.
- 2,150,277. MACHINEXPERT. INT. CL. 9. REG. 4-14-1998.
- 2,150,280. BIG BANG TECHNOLOGY. INT. CL. 9. REG. 4-14-1998.
- 2,150,281. FOREMOST. INT. CL. 15. REG. 4-14-1998.
- 2,150,282. VMWAY, INC. AND DESIGN. INT. CL. 35. REG. 4-14-1998.
- 2,150,285. WORLDBUSINESS (STYLIZED). INT. CL. 16. REG. 4-14-1998.
- 2,150,288. PEACHTREE DESSERTS ATLANTA, GEORGIA AND DESIGN. INT. CL. 30. REG. 4-14-1998.
- 2,150,290. NEWSGATE. INT. CL. 9. REG. 4-14-1998.
- 2,150,295. TREADCO INC. AND DESIGN. INT. CLS. 35 AND 37. REG. 4-14-1998.
- 2,150,300. TRI-CELL. INT. CL. 6. REG. 4-14-1998.
- 2,150,301. PAISLEY PARK AND DESIGN. INT. CL. 9. REG. 4-14-1998.
- 2,150,302. MISCELLANEOUS DESIGN. INT. CL. 29. REG. 4-14-1998.
- 2,150,303. THE OFFICIAL BOARD WEAR OF COOL. INT. CL. 25. REG. 4-14-1998.
- 2,150,304. PAUL BUNYAN. INT. CL. 25. REG. 4-14-1998.
- 2,150,308. SUNSTAR (STYLIZED). INT. CLS. 5, 10 AND 21. REG. 4-14-1998.
- 2,150,310. MODUS. INT. CL. 20. REG. 4-14-1998.
- 2,150,315. MODULAN. INT. CL. 9. REG. 4-14-1998.
- 2,150,318. INTERACTIVE ENTERT INMENT LIMITED AND DESIGN. INT. CLS. 41 AND 42. REG. 4-14-1998.
- 2,150,321. BLACK ARMOR. INT. CLS. 12 AND 27. REG. 4-14-1998.
- 2,150,323. EPSILON AND DESIGN. INT. CLS. 35 AND 42. REG. 4-14-1998.
- 2,150,324. MAXI. INT. CL. 7. REG. 4-14-1998.
- 2,150,326. THE FOODSERVICE DISTRIBUTOR. INT. CL. 16. REG. 4-14-1998.
- 2,150,328. FERBY. INT. CL. 3. REG. 4-14-1998.
- 2,150,329. DAILY ROCKET. INT. CL. 41. REG. 4-14-1998.
- 2,150,330. CITY MEAT. INT. CLS. 29 AND 35. REG. 4-14-1998.
- 2,150,331. PROJECT DRIVE AND DESIGN. INT. CL. 35. REG. 4-14-1998.
- 2,150,338. KITCHEN VALUE (STYLIZED). INT. CL. 29. REG. 4-14-1998.
- 2,150,341. MEMBERSHIPMASTER. INT. CL. 9. REG. 4-14-1998.
- 2,150,343. MARIACHI USA FESTIVAL. INT. CLS. 14, 16, 20, 25 AND 41. REG. 4-14-1998.
- 2,150,344. WESTRENDS. INT. CLS. 16, 35, 41 AND 42. REG. 4-14-1998.
- 2,150,345. TRANSMILLENNIUM. INT. CL. 16. REG. 4-14-1998.
- 2,150,347. RECAP PLUS. INT. CLS. 16, 35, 36 AND 42. REG. 4-14-1998.
- 2,150,348. PEKING DUCK HOUSE AND DESIGN. INT. CL. 42. REG. 4-14-1998.
- 2,150,350. BIZTRAVELER. INT. CL. 42. REG. 4-14-1998.
- 2,150,355. PROTECHS. INT. CL. 19. REG. 4-14-1998.
- 2,150,356. CD PHONETEC PREPAID CALLING CARDS AND DESIGN. INT. CL. 16. REG. 4-14-1998.
- 2,150,357. ACTIGEL. INT. CL. 5. REG. 4-14-1998.
- 2,150,360. VEGA DEL REY REPUBLICA DOMINICANA BIEN HECHO A MANO AND DESIGN. INT. CL. 34. REG. 4-14-1998.
- 2,150,361. SMARTLEAF. INT. CL. 1. REG. 4-14-1998.

- 2,150,362. NO B.S. GUIDE. INT. CL. 16. REG. 4-14-1998.
- 2,150,363. STEALS AND DEALS. INT. CL. 35. REG. 4-14-1998.
- 2,150,364. VISIONARY MANAGEMENT SERVICES. INT. CL. 42. REG. 4-14-1998.
- 2,150,365. FARMER'S INTERNET COFFEE SHOP. INT. CL. 9. REG. 4-14-1998.
- 2,150,367. HEARTLAND FARMS. INT. CL. 30. REG. 4-14-1998.
- 2,150,369. FIT SURE "HEALTH PLANS FOR FITNESS EQUIPMENT". INT. CL. 36. REG. 4-14-1998.
- 2,150,372. TOM PETERS FAST FORWARD. INT. CL. 16. REG. 4-14-1998.
- 2,150,373. CARIBBEAN BREATHABILITEA. INT. CLS. 5 AND 30. REG. 4-14-1998.
- 2,150,375. N'AMERIX. INT. CL. 39. REG. 4-14-1998.
- 2,150,376. FOCUS AND DESIGN. INT. CLS. 9 AND 17. REG. 4-14-1998.
- 2,150,377. BUN BLASTER. INT. CL. 28. REG. 4-14-1998.
- 2,150,380. POLYGRESSIV. INT. CL. 9. REG. 4-14-1998.
- 2,150,390. INTERNETPRESS. INT. CL. 35. REG. 4-14-1998.
- 2,150,393. TAP TEASER. INT. CL. 21. REG. 4-14-1998.
- 2,150,394. NEW YORK NOW. INT. CL. 42. REG. 4-14-1998.
- 2,150,395. NEW YORK NOW. INT. CL. 35. REG. 4-14-1998.
- 2,150,403. EL ANTARQUI AND DESIGN. INT. CL. 5. REG. 4-14-1998.
- 2,150,404. JUFFEL. INT. CL. 30. REG. 4-14-1998.
- 2,150,405. TOTAL VIEW 360 AND DESIGN. INT. CL. 36. REG. 4-14-1998.
- 2,150,409. PACIFIC RUNNER (STYLIZED). INT. CL. 25. REG. 4-14-1998.
- 2,150,410. MOBILEREACH USA. INT. CL. 38. REG. 4-14-1998.
- 2,150,411. A3D. INT. CL. 42. REG. 4-14-1998.
- 2,150,413. PRO MAG PM LIMITED AND DESIGN. INT. CL. 9. REG. 4-14-1998.
- 2,150,414. SINTEESIS AND DESIGN. INT. CL. 25. REG. 4-14-1998.
- 2,150,415. TINTORETTO AND DESIGN. INT. CL. 25. REG. 4-14-1998.
- 2,150,417. PURES NIC AND DESIGN. INT. CL. 9. REG. 4-14-1998.
- 2,150,418. NSIC (STYLIZED). INT. CL. 42. REG. 4-14-1998.
- 2,150,419. CYBERSORT. INT. CL. 9. REG. 4-14-1998.
- 2,150,421. MOLSON RED JACK AND DESIGN. INT. CL. 32. REG. 4-14-1998.
- 2,150,422. HOSPITALITY EXPRESS. INT. CLS. 24 AND 40. REG. 4-14-1998.
- 2,150,423. PRODERMA. INT. CL. 5. REG. 4-14-1998.
- 2,150,424. S (STYLIZED). INT. CL. 9. REG. 4-14-1998.
- 2,150,425. 1ST MORTGAGE AMERICA 1ST FIRST MORTGAGE AMERICA FIRST AND DESIGN. INT. CL. 36. REG. 4-14-1998.
- 2,150,428. MIXIL. INT. CL. 1. REG. 4-14-1998.
- 2,150,429. MISCELLANEOUS DESIGN. INT. CL. 35. REG. 4-14-1998.
- 2,150,430. HIJK. INT. CL. 42. REG. 4-14-1998.
- 2,150,435. GLOBALAND. INT. CL. 35. REG. 4-14-1998.
- 2,150,437. A HOUSEWORKS HOME AND DESIGN. INT. CLS. 37 AND 42. REG. 4-14-1998.
- 2,150,438. PFN. INT. CL. 36. REG. 4-14-1998.
- 2,150,439. CLAYBAKERS HOLIDAY HEARTH SINGLES (STYLIZED). INT. CL. 21. REG. 4-14-1998.
- 2,150,440. SNOW CENTRAL. INT. CL. 41. REG. 4-14-1998.
- 2,150,446. EAB MONEY CARD. INT. CL. 36. REG. 4-14-1998.
- 2,150,453. POCARI SWEAT STEVIA AND DESIGN. INT. CL. 32. REG. 4-14-1998.
- 2,150,454. BIOSYS IPM INTEGRATED PEST MANAGEMENT MONITORING CARDS AND DESIGN. INT. CL. 5. REG. 4-14-1998.
- 2,150,455. TCI.NET. INT. CL. 42. REG. 4-14-1998.
- 2,150,458. FAST APP. INT. CL. 36. REG. 4-14-1998.
- 2,150,460. LUGGAGE FOR LITERATURE. INT. CL. 16. REG. 4-14-1998.
- 2,150,463. ...FOR DUMMIES BESTSELLING BOOK SERIES FROM IDG AND DESIGN. INT. CL. 21. REG. 4-14-1998.
- 2,150,464. MONEY TALK. INT. CL. 36. REG. 4-14-1998.
- 2,150,466. THE COFFEE CAFE. INT. CL. 11. REG. 4-14-1998.
- 2,150,469. CARUS. INT. CL. 36. REG. 4-14-1998.
- 2,150,470. AUTOMANUAL. INT. CL. 9. REG. 4-14-1998.
- 2,150,472. MATRIX ANALYTICAL. INT. CL. 42. REG. 4-14-1998.
- 2,150,473. COST TO SERVE AND DESIGN. INT. CL. 35. REG. 4-14-1998.
- 2,150,474. WORLD QUILT & TEXTILE. INT. CL. 35. REG. 4-14-1998.
- 2,150,475. TEDDY BEDD. INT. CL. 20. REG. 4-14-1998.
- 2,150,476. WEDDING GALLERY. INT. CL. 42. REG. 4-14-1998.
- 2,150,477. VANTIVE ENTERPRISE. INT. CL. 9. REG. 4-14-1998.
- 2,150,478. LA REINA DE CANARIAS. INT. CL. 34. REG. 4-14-1998.
- 2,150,481. ACE BEAUTY COMPANY SINCE 1939 AND DESIGN. INT. CLS. 35 AND 41. REG. 4-14-1998.
- 2,150,484. ULTRAGINSENG. INT. CL. 5. REG. 4-14-1998.
- 2,150,486. THE FLOODED SWAMP COMPANY AND DESIGN. INT. CL. 16. REG. 4-14-1998.
- 2,150,489. WE OPEN THE LINES OF COMMUNICATION!. INT. CL. 42. REG. 4-14-1998.
- 2,150,490. AMEND DRUG & CHEMICAL CO., INC. IRVINGTON, N.J. AND DESIGN. INT. CL. 1. REG. 4-14-1998.
- 2,150,491. MISCELLANEOUS DESIGN. INT. CLS. 39 AND 42. REG. 4-14-1998.
- 2,150,493. WHERE THE STARS TRADE LIKE JUNK BONDS. INT. CL. 41. REG. 4-14-1998.
- 2,150,495. CLEAN COUNT. INT. CL. 9. REG. 4-14-1998.
- 2,150,496. MISCELLANEOUS DESIGN. INT. CLS. 9 AND 42. REG. 4-14-1998.
- 2,150,499. ELECTRONIC HOLLYWOOD. INT. CL. 42. REG. 4-14-1998.
- 2,150,501. C AND DESIGN. INT. CL. 37. REG. 4-14-1998.
- 2,150,502. GOTEAM.COM. INT. CL. 35. REG. 4-14-1998.
- 2,150,503. PATHWAYS TO YOUR FUTURE. INT. CL. 36. REG. 4-14-1998.
- 2,150,505. I/A INTELLIGENT AUTOMATION AND DESIGN. INT. CL. 9. REG. 4-14-1998.
- 2,150,506. FOODWORKS. INT. CL. 42. REG. 4-14-1998.
- 2,150,507. MANDA. INT. CL. 9. REG. 4-14-1998.
- 2,150,508. ENVY AND DESIGN. INT. CLS. 16 AND 28. REG. 4-14-1998.
- 2,150,509. ZAP (STYLIZED). INT. CL. 9. REG. 4-14-1998.
- 2,150,510. EIGHTEEN CARROT. INT. CL. 35. REG. 4-14-1998.
- 2,150,511. LUBE CONNECT AND DESIGN. INT. CL. 37. REG. 4-14-1998.
- 2,150,513. MISCELLANEOUS DESIGN. INT. CL. 42. REG. 4-14-1998.
- 2,150,514. ALECO. INT. CL. 20. REG. 4-14-1998.
- 2,150,516. SWEET CONCEPTS. INT. CL. 30. REG. 4-14-1998.
- 2,150,520. MISCELLANEOUS DESIGN. INT. CL. 35. REG. 4-14-1998.
- 2,150,521. UNBEATABLE EATABLES AND DESIGN. INT. CL. 42. REG. 4-14-1998.
- 2,150,524. MISCELLANEOUS DESIGN. INT. CL. 9. REG. 4-14-1998.
- 2,150,525. KRUGANS AND DESIGN. INT. CL. 25. REG. 4-14-1998.
- 2,150,528. THE ANTIQUE QUILT SOURCE AND DESIGN. INT. CL. 24. REG. 4-14-1998.
- 2,150,530. MISCELLANEOUS DESIGN. INT. CL. 25. REG. 4-14-1998.
- 2,150,534. FREE SPIRIT PUBLISHING SELF-HELP FOR KIDS (STYLIZED). INT. CL. 16. REG. 4-14-1998.
- 2,150,536. CENTRAL DATA TECHNOLOGIES, INC.. INT. CLS. 35 AND 36. REG. 4-14-1998.
- 2,150,537. ITF INTERNATIONAL TURNTABLIST FEDERATION AND DESIGN. INT. CL. 41. REG. 4-14-1998.
- 2,150,540. WORLD WIDE CLASSIFIED AND DESIGN. INT. CL. 35. REG. 4-14-1998.
- 2,150,543. CIGAR TORCH. INT. CL. 34. REG. 4-14-1998.
- 2,150,544. SHOP & SKI. INT. CL. 35. REG. 4-14-1998.

- 2,150,545. PERSONNEL PLUS AND DESIGN. INT. CL. 35. REG. 4-14-1998.
- 2,150,546. LIFIBER. INT. CL. 5. REG. 4-14-1998.
- 2,150,556. THE N.Y. BIG BAND AND DESIGN. INT. CL. 41. REG. 4-14-1998.
- 2,150,558. BACK TO THE 1940'S (STYLIZED). INT. CL. 41. REG. 4-14-1998.
- 2,150,559. WEB HEALTH NETWORK AND DESIGN. INT. CL. 42. REG. 4-14-1998.
- 2,150,561. IMZ AND DESIGN. INT. CL. 12. REG. 4-14-1998.
- 2,150,562. REDWOOD COMMUNICATIONS AND DESIGN. INT. CLS. 36 AND 41. REG. 4-14-1998.
- 2,150,563. VITALITY NOW! (STYLIZED). INT. CL. 41. REG. 4-14-1998.
- 2,150,564. METHODS BAY. INT. CL. 9. REG. 4-14-1998.
- 2,150,567. SPINFREE. INT. CL. 42. REG. 4-14-1998.
- 2,150,568. FIBERGAIN. INT. CL. 9. REG. 4-14-1998.
- 2,150,569. WRU AND DESIGN. INT. CLS. 24 AND 25. REG. 4-14-1998.
- 2,150,571. DELIZIOSO FETTINE DI POMODORI PELATI AND DESIGN. INT. CL. 29. REG. 4-14-1998.
- 2,150,572. BB AND DESIGN. INT. CLS. 12 AND 28. REG. 4-14-1998.
- 2,150,573. CAMPUS ADDRESS. INT. CL. 35. REG. 4-14-1998.
- 2,150,574. CAMBRIDGE CROSSING. INT. CL. 33. REG. 4-14-1998.
- 2,150,575. ERGO. INT. CL. 9. REG. 4-14-1998.
- 2,150,582. MASTERFIT AND DESIGN. INT. CL. 6. REG. 4-14-1998.
- 2,150,583. S SNAP SOFTWARE AND DESIGN. INT. CL. 9. REG. 4-14-1998.
- 2,150,585. ORTHOSAVE AND DESIGN. INT. CL. 42. REG. 4-14-1998.
- 2,150,586. PAINT BOX AND DESIGN. INT. CL. 25. REG. 4-14-1998.
- 2,150,587. MISCELLANEOUS DESIGN. INT. CL. 25. REG. 4-14-1998.
- 2,150,593. B AND DESIGN. INT. CL. 14. REG. 4-14-1998.
- 2,150,594. SNIZ & FONDUE. INT. CL. 41. REG. 4-14-1998.
- 2,150,596. HANK-SWAGE. INT. CL. 6. REG. 4-14-1998.
- 2,150,599. COLD TURKEY. INT. CL. 28. REG. 4-14-1998.
- 2,150,600. SUCCESSGUIDE. INT. CL. 16. REG. 4-14-1998.
- 2,150,602. DIGIDYNE. INT. CL. 9. REG. 4-14-1998.
- 2,150,605. DA YING AND DESIGN. INT. CL. 29. REG. 4-14-1998.
- 2,150,607. DRAIN. INT. CL. 9. REG. 4-14-1998.
- 2,150,609. SOBRINCA AND DESIGN. INT. CLS. 12 AND 20. REG. 4-14-1998.
- 2,150,610. NO MORE GRATED KNUCKLES. INT. CL. 29. REG. 4-14-1998.
- 2,150,615. MISCELLANEOUS DESIGN. INT. CL. 14. REG. 4-14-1998.
- 2,150,617. MCI PREPAID CALLING CARD AND DESIGN. INT. CL. 9. REG. 4-14-1998.
- 2,150,619. MISCELLANEOUS DESIGN. INT. CL. 42. REG. 4-14-1998.
- 2,150,620. SILK. INT. CL. 41. REG. 4-14-1998.
- 2,150,624. ZAK BABY COMPANY. INT. CL. 21. REG. 4-14-1998.
- 2,150,627. DIAL-A-TANK. INT. CL. 9. REG. 4-14-1998.
- 2,150,628. H (STYLIZED). INT. CL. 6. REG. 4-14-1998.
- 2,150,629. ZAK BABY COMPANY. INT. CL. 20. REG. 4-14-1998.
- 2,150,631. DURAGREEN. INT. CL. 16. REG. 4-14-1998.
- 2,150,632. A DIFFERENT KIND OF MUTUAL INSURANCE COMPANY. INT. CL. 36. REG. 4-14-1998.
- 2,150,634. NECK SHADE. INT. CL. 25. REG. 4-14-1998.
- 2,150,636. SCANCENTRAL. INT. CL. 39. REG. 4-14-1998.
- 2,150,637. JOHN ALDEN HEALTH AND DESIGN. INT. CL. 42. REG. 4-14-1998.
- 2,150,638. THE VINYL VALET INC. AT YOUR SERVICE AND DESIGN. INT. CL. 35. REG. 4-14-1998.
- 2,150,639. IMMUNE UMBRELLA. INT. CL. 5. REG. 4-14-1998.
- 2,150,640. FINEZZA. INT. CL. 30. REG. 4-14-1998.
- 2,150,644. ICONOCAST. INT. CL. 35. REG. 4-14-1998.
- 2,150,645. BARNYARD EXPRESS A MOBILE EDUCATIONAL FARM CENTER AND DESIGN. INT. CL. 41. REG. 4-14-1998.
- 2,150,648. SMOCKERS. INT. CL. 25. REG. 4-14-1998.
- 2,150,649. D L F AND DESIGN. INT. CL. 42. REG. 4-14-1998.
- 2,150,652. POLITEMPS AND DESIGN. INT. CL. 35. REG. 4-14-1998.
- 2,150,654. CHELSEA COMPUTER CONSULTANTS. INT. CL. 35. REG. 4-14-1998.
- 2,150,656. MCGIX THE INFORMATION EXCHANGE (STYLIZED). INT. CL. 42. REG. 4-14-1998.
- 2,150,657. PRESERVINO. INT. CL. 21. REG. 4-14-1998.
- 2,150,658. EVERYTHING2000. INT. CL. 42. REG. 4-14-1998.
- 2,150,659. 4-BITS FINANCIAL SECURITY FOR A LIFETIME AND DESIGN. INT. CL. 41. REG. 4-14-1998.
- 2,150,660. THE TIME BEINGS. INT. CL. 41. REG. 4-14-1998.
- 2,150,661. WE'LL HELP YOU LIVE YOUR BEST WITH CONFIDENCE. INT. CL. 5. REG. 4-14-1998.
- 2,150,662. SELECT SOURCE. INT. CL. 17. REG. 4-14-1998.
- 2,150,665. CREATIVELY BRIDGING SCIENCE WITH SPIRIT. INT. CL. 5. REG. 4-14-1998.
- 2,150,668. C & S. INT. CL. 14. REG. 4-14-1998.
- 2,150,669. BECKTRONIX TV - VCR - STEREO - PROJECTION TV SERVICE AND DESIGN. INT. CL. 37. REG. 4-14-1998.
- 2,150,671. DOO DAH DAY!. INT. CL. 41. REG. 4-14-1998.
- 2,150,677. ERICE'. INT. CL. 25. REG. 4-14-1998.
- 2,150,681. LEG SHAPER PROFIL JAMBES SWISSCARE POUR GIVENCHY AND DESIGN. INT. CL. 3. REG. 4-14-1998.
- 2,150,684. PROAMICS. INT. CLS. 9, 16 AND 42. REG. 4-14-1998.
- 2,150,685. W (STYLIZED). INT. CL. 25. REG. 4-14-1998.
- 2,150,687. MERONA. INT. CL. 14. REG. 4-14-1998.
- 2,150,690. CAL-CLEAN. INT. CL. 9. REG. 4-14-1998.
- 2,150,692. ARTISTIC NOISE. INT. CL. 9. REG. 4-14-1998.
- 2,150,693. LA INMEJORABLE AND DESIGN. INT. CL. 34. REG. 4-14-1998.
- 2,150,694. LITTLE PIPER. INT. CL. 21. REG. 4-14-1998.
- 2,150,695. CANTABELL. INT. CL. 21. REG. 4-14-1998.
- 2,150,697. BUGOFF. INT. CL. 25. REG. 4-14-1998.
- 2,150,701. MAELSTROM. INT. CL. 9. REG. 4-14-1998.
- 2,150,703. WHATASIZE IT!. INT. CL. 42. REG. 4-14-1998.
- 2,150,704. SHARPER SHADES AND DESIGN. INT. CL. 9. REG. 4-14-1998.
- 2,150,707. EXOTIC TROPICALS. INT. CL. 31. REG. 4-14-1998.
- 2,150,709. FASHION INFLUENCES. INT. CLS. 25 AND 35. REG. 4-14-1998.
- 2,150,710. JUNGLE ADVENTURES GREATER ORLANDO-CHRISTMAS FLORIDA AND DESIGN. INT. CL. 41. REG. 4-14-1998.
- 2,150,712. BROADWAY BURGER. INT. CL. 42. REG. 4-14-1998.
- 2,150,713. JEAN NATE (STYLIZED). INT. CL. 9. REG. 4-14-1998.
- 2,150,714. KING ZACK AND DESIGN. INT. CL. 16. REG. 4-14-1998.
- 2,150,715. INFOCENTER. INT. CL. 9. REG. 4-14-1998.
- 2,150,716. VOODOO. INT. CL. 12. REG. 4-14-1998.
- 2,150,718. FRED. INT. CL. 11. REG. 4-14-1998.
- 2,150,719. RELATIONSHIPS TO SAVOR. INT. CL. 42. REG. 4-14-1998.
- 2,150,720. MILES FROM EARTH. INT. CL. 20. REG. 4-14-1998.
- 2,150,726. ECOSLAT FROM SUSTAINED-YIELD FORESTS AND DESIGN. INT. CL. 20. REG. 4-14-1998.
- 2,150,728. FACTOR DESIGN. INT. CLS. 35 AND 42. REG. 4-14-1998.
- 2,150,730. UNI SCALE. INT. CL. 9. REG. 4-14-1998.
- 2,150,731. DECOFOR. INT. CL. 6. REG. 4-14-1998.
- 2,150,732. ERICE' AND DESIGN. INT. CL. 25. REG. 4-14-1998.
- 2,150,735. VELVET DESIGNS AND DESIGN. INT. CL. 16. REG. 4-14-1998.
- 2,150,736. MISCELLANEOUS DESIGN. INT. CL. 41. REG. 4-14-1998.

- 2,150,737. MERCHANT 2000. INT. CL. 42. REG. 4-14-1998.  
 2,150,738. UNIMAR AND DESIGN. INT. CL. 11. REG. 4-14-1998.  
 2,150,741. ALFRESCO. INT. CL. 12. REG. 4-14-1998.  
 2,150,743. BLUECURVE AND DESIGN. INT. CL. 9. REG. 4-14-1998.  
 2,150,744. JP AND DESIGN. INT. CLS. 9 AND 16. REG. 4-14-1998.  
 2,150,752. ELEGANT TOUCH. INT. CL. 19. REG. 4-14-1998.  
 2,150,753. DELTA DRY. INT. CL. 9. REG. 4-14-1998.  
 2,150,755. ILSI. INT. CLS. 16, 36 AND 41. REG. 4-14-1998.  
 2,150,760. BLUE QUALITY CENTERS. INT. CLS. 36 AND 42. REG. 4-14-1998.  
 2,150,761. STOGIES AND DESIGN. INT. CL. 35. REG. 4-14-1998.  
 2,150,762. THE MARYLAND. INT. CL. 36. REG. 4-14-1998.  
 2,150,763. @BIGGER NET AND DESIGN. INT. CL. 9. REG. 4-14-1998.  
 2,150,767. POWERCUBE. INT. CL. 9. REG. 4-14-1998.  
 2,150,772. WINDOWS IN THE GLASS CEILING. INT. CL. 41. REG. 4-14-1998.  
 2,150,775. SMARTWARE. INT. CL. 9. REG. 4-14-1998.  
 2,150,777. LEWTAN TECHNOLOGIES. INT. CL. 9. REG. 4-14-1998.  
 2,150,779. CATCH THE SPIRIT!. INT. CL. 39. REG. 4-14-1998.  
 2,150,780. LOS RIELEROS DEL NORTE. INT. CL. 41. REG. 4-14-1998.  
 2,150,782. G177 UNISTEEL. INT. CL. 12. REG. 4-14-1998.  
 2,150,790. ECOSCOPE. INT. CL. 9. REG. 4-14-1998.  
 2,150,791. WE FIX IT RIGHT THE FIRST TIME!. INT. CL. 37. REG. 4-14-1998.  
 2,150,792. VXPPO. INT. CL. 9. REG. 4-14-1998.  
 2,150,793. PC82C437VX+. INT. CL. 9. REG. 4-14-1998.  
 2,150,794. PC82C438VX+. INT. CL. 9. REG. 4-14-1998.  
 2,150,795. PC82C371USB. INT. CL. 9. REG. 4-14-1998.  
 2,150,796. GUN HILL ROAD. INT. CL. 41. REG. 4-14-1998.  
 2,150,801. MUNCH BREAK. INT. CL. 42. REG. 4-14-1998.  
 2,150,804. CARAVAN MFG. CO., INC. AND DESIGN. INT. CL. 12. REG. 4-14-1998.  
 2,150,805. CARAVAN MFG. CO., INC. CONFORMAL AND DESIGN. INT. CL. 20. REG. 4-14-1998.  
 2,150,806. DNTV. INT. CL. 9. REG. 4-14-1998.  
 2,150,810. VALET PIZZA. INT. CL. 42. REG. 4-14-1998.  
 2,150,811. 4-IN-1 (STYLIZED). INT. CL. 12. REG. 4-14-1998.  
 2,150,813. COMFORT WEDGE. INT. CL. 12. REG. 4-14-1998.  
 2,150,815. AI EXPRESS YOUR EXPRESSWAY INTO AIG AND DESIGN. INT. CL. 35. REG. 4-14-1998.  
 2,150,819. ALAIN AFFLELOU. INT. CL. 9. REG. 4-14-1998.  
 2,150,820. OCEANSIDE. INT. CL. 19. REG. 4-14-1998.  
 2,150,821. DCTV. INT. CL. 9. REG. 4-14-1998.  
 2,150,824. CYBERHODES. INT. CL. 42. REG. 4-14-1998.  
 2,150,825. HOME BUYING CHOICES. INT. CL. 16. REG. 4-14-1998.  
 2,150,826. TECH NOW AND DESIGN. INT. CLS. 35, 41 AND 42. REG. 4-14-1998.  
 2,150,827. CORPORATE EVENT SERVICES AND DESIGN. INT. CL. 42. REG. 4-14-1998.  
 2,150,830. MICROBOND. INT. CL. 9. REG. 4-14-1998.  
 2,150,833. SOUTHERN INSURANCE MANAGEMENT ASSOCIATES. INT. CL. 36. REG. 4-14-1998.  
 2,150,837. CROSSTIE. INT. CL. 9. REG. 4-14-1998.  
 2,150,839. MOTORWORLD. INT. CLS. 35 AND 41. REG. 4-14-1998.  
 2,150,840. INTERCELLULAR, L.C.. INT. CL. 38. REG. 4-14-1998.  
 2,150,841. DMC. INT. CL. 9. REG. 4-14-1998.  
 2,150,842. SRVNET. INT. CL. 42. REG. 4-14-1998.  
 2,150,844. NUTEST (STYLIZED). INT. CL. 5. REG. 4-14-1998.  
 2,150,849. FAMILY MEMORIES ALBUM. INT. CL. 9. REG. 4-14-1998.  
 2,150,850. MISCELLANEOUS DESIGN. INT. CL. 42. REG. 4-14-1998.  
 2,150,851. PURIFY-HERBAL. INT. CL. 5. REG. 4-14-1998.  
 2,150,852. QUINTESSENCE. INT. CL. 9. REG. 4-14-1998.  
 2,150,853. CSSM. INT. CL. 35. REG. 4-14-1998.  
 2,150,856. SSM. INT. CL. 35. REG. 4-14-1998.  
 2,150,860. MESA/VISTA. INT. CL. 9. REG. 4-14-1998.  
 2,150,866. PARFUMS D' EXCEPTION AND DESIGN. INT. CL. 4. REG. 4-14-1998.  
 2,150,867. SKYRON ALTERNATIVE RECRUITMENT STRATEGIES. INT. CL. 35. REG. 4-14-1998.  
 2,150,871. CHUCKLE VALLEY FRIENDS. INT. CL. 28. REG. 4-14-1998.  
 2,150,873. NAVIGATOR. INT. CL. 7. REG. 4-14-1998.  
 2,150,875. BIG BOB'S CO-OP. INT. CL. 35. REG. 4-14-1998.  
 2,150,877. MISCELLANEOUS DESIGN. INT. CL. 28. REG. 4-14-1998.  
 2,150,878. MISCELLANEOUS DESIGN. INT. CL. 41. REG. 4-14-1998.  
 2,150,881. ALOHA DISCOUNT GUIDE. INT. CL. 16. REG. 4-14-1998.  
 2,150,882. VOICES OF WELLNESS. INT. CL. 16. REG. 4-14-1998.  
 2,150,883. WHEY TO GO. INT. CL. 25. REG. 4-14-1998.  
 2,150,886. MASTERPACK. INT. CLS. 9 AND 35. REG. 4-14-1998.  
 2,150,887. MASTERPACK INTERNATIONAL. INT. CLS. 9 AND 35. REG. 4-14-1998.  
 2,150,888. ENERGY CURRENT. INT. CL. 16. REG. 4-14-1998.  
 2,150,892. VIP SUITE. INT. CL. 9. REG. 4-14-1998.  
 2,150,894. PICK PAY AND DESIGN. INT. CL. 35. REG. 4-14-1998.  
 2,150,895. FOR P.D.'S SAKE AND DESIGN. INT. CLS. 36 AND 42. REG. 4-14-1998.  
 2,150,899. INTEHGRO. INT. CL. 42. REG. 4-14-1998.  
 2,150,900. ENVIRO-MOLD. INT. CL. 20. REG. 4-14-1998.  
 2,150,903. QVC EXPLORER. INT. CL. 35. REG. 4-14-1998.  
 2,150,904. COURBE EXPRESS. INT. CL. 3. REG. 4-14-1998.  
 2,150,906. PROFACOR. INT. CL. 5. REG. 4-14-1998.  
 2,150,907. THE PICKLE COTTAGE PICKLES FROM THE HEARTLAND AND DESIGN. INT. CL. 29. REG. 4-14-1998.  
 2,150,909. MISCELLANEOUS DESIGN. INT. CL. 39. REG. 4-14-1998.  
 2,150,910. CHAPLAINCARE. INT. CL. 42. REG. 4-14-1998.  
 2,150,911. WEBRECALL. INT. CL. 9. REG. 4-14-1998.  
 2,150,912. BOA CORP. INT. CL. 35. REG. 4-14-1998.  
 2,150,913. PBS SCIENCE. INT. CL. 42. REG. 4-14-1998.  
 2,150,915. TRIPLE PLAY TOFFEE. INT. CL. 30. REG. 4-14-1998.  
 2,150,917. MARAVONDA AND DESIGN. INT. CL. 30. REG. 4-14-1998.  
 2,150,921. WEE PEATS. INT. CL. 35. REG. 4-14-1998.  
 2,150,925. BRAIN ALERT. INT. CL. 5. REG. 4-14-1998.  
 2,150,926. HARMONY FIELD. INT. CL. 5. REG. 4-14-1998.  
 2,150,930. HYDRO-BLANKET AND DESIGN. INT. CL. 31. REG. 4-14-1998.  
 2,150,931. IMPORTED EAST AFRICA AND DESIGN. INT. CL. 32. REG. 4-14-1998.  
 2,150,932. IDN. INT. CL. 30. REG. 4-14-1998.  
 2,150,933. RECREATING MARRIAGE. INT. CL. 41. REG. 4-14-1998.  
 2,150,934. BEST OF EUROPE AND DESIGN. INT. CL. 30. REG. 4-14-1998.  
 2,150,938. BREAKTHROUGH ORGANIZATIONAL IMPROVEMENT. INT. CL. 35. REG. 4-14-1998.  
 2,150,939. KY'S GIANT. INT. CL. 35. REG. 4-14-1998.  
 2,150,941. BEHAVIORAL HEALTHCARE SOLUTIONS. INT. CL. 42. REG. 4-14-1998.  
 2,150,942. HUMAN AFFAIRS INTERNATIONAL. INT. CL. 42. REG. 4-14-1998.  
 2,150,943. HUMAN AFFAIRS INTL (STYLIZED). INT. CL. 42. REG. 4-14-1998.  
 2,150,946. ISADORA DOLPHIN EYE PILLOW AND DESIGN. INT. CL. 20. REG. 4-14-1998.  
 2,150,947. 1-2-3 GROW WITH ME. INT. CL. 28. REG. 4-14-1998.  
 2,150,955. NEXAMINER AND DESIGN. INT. CL. 16. REG. 4-14-1998.  
 2,150,958. MISCELLANEOUS DESIGN. INT. CL. 41. REG. 4-14-1998.  
 2,150,962. COMFORT PLUS STYLE. INT. CL. 35. REG. 4-14-1998.  
 2,150,969. DRAMATICALLY DIFFERENT.... INT. CL. 6. REG. 4-14-1998.



- 2,150,970. MAMA KIN AND DESIGN. INT. CL. 25. REG. 4-14-1998.
- 2,150,971. WHEN THE SAME OLD THING JUST DOESN'T GET IT. INT. CL. 30. REG. 4-14-1998.
- 2,150,972. MAMA KIN. INT. CL. 25. REG. 4-14-1998.
- 2,150,975. BRIELLE GALLERIES. INT. CL. 35. REG. 4-14-1998.
- 2,150,976. FLAME OPAL. INT. CL. 33. REG. 4-14-1998.
- 2,150,977. WINTERBOY. INT. CL. 41. REG. 4-14-1998.
- 2,150,979. WEE BUNKS. INT. CL. 18. REG. 4-14-1998.
- 2,150,984. PRO-BODIES. INT. CL. 42. REG. 4-14-1998.
- 2,150,985. SONGMEADOW. INT. CL. 33. REG. 4-14-1998.
- 2,150,986. INDUSTRIAL OVERLOAD. INT. CL. 35. REG. 4-14-1998.
- 2,150,988. MAIN STREET MAGAZINE THE BEST IN LONGMONT AREA LIVING. INT. CL. 16. REG. 4-14-1998.
- 2,150,989. THE FOOLISH GOURMET AND DESIGN. INT. CL. 30. REG. 4-14-1998.
- 2,150,991. DESIGNED FOR VISIO AND DESIGN. U.S. CL. A. REG. 4-14-1998.
- 2,150,995. IMPERIAL TREASURES BY JOAN RIVERS. INT. CL. 21. REG. 4-14-1998.
- 2,150,996. B BAFFO (STYLIZED). INT. CL. 25. REG. 4-14-1998.
- 2,150,998. MINI GUARD. INT. CL. 20. REG. 4-14-1998.
- 2,151,003. VISXCHANGE. INT. CL. 16. REG. 4-14-1998.
- 2,151,004. POORE SIMON'S. INT. CL. 35. REG. 4-14-1998.
- 2,151,005. SKATES ALIVE!. INT. CL. 28. REG. 4-14-1998.
- 2,151,006. YOZEUM. INT. CL. 41. REG. 4-14-1998.
- 2,151,007. STRATEGIC POWER MANAGEMENT. INT. CL. 9. REG. 4-14-1998.
- 2,151,008. WALLY AND DESIGN. INT. CL. 40. REG. 4-14-1998.
- 2,151,010. PRIMARY COLORS. INT. CL. 35. REG. 4-14-1998.
- 2,151,012. WORLD HOPPER. INT. CL. 41. REG. 4-14-1998.
- 2,151,013. LEN JUS. INT. CL. 3. REG. 4-14-1998.
- 2,151,015. TIMED RELEASE. INT. CL. 16. REG. 4-14-1998.
- 2,151,016. SILICON PLANET. INT. CL. 36. REG. 4-14-1998.
- 2,151,018. BACKYARD AND DESIGN. INT. CL. 28. REG. 4-14-1998.
- 2,151,019. OFFICE COMFORT INDEX (STYLIZED). INT. CL. 16. REG. 4-14-1998.
- 2,151,028. EXTRA MONEY (STYLIZED). INT. CL. 16. REG. 4-14-1998.
- 2,151,029. DOUBLE TAKE. INT. CL. 28. REG. 4-14-1998.
- 2,151,030. CRAW-GO. INT. CL. 28. REG. 4-14-1998.
- 2,151,032. THE UNFAIR ADVANTAGE. INT. CL. 35. REG. 4-14-1998.
- 2,151,035. ABOVE AND BEYOND. INT. CL. 3. REG. 4-14-1998.
- 2,151,036. SUNSIBILITY. INT. CL. 3. REG. 4-14-1998.
- 2,151,040. ART OF WAX. INT. CL. 4. REG. 4-14-1998.
- 2,151,041. MISCELLANEOUS DESIGN. INT. CL. 35. REG. 4-14-1998.
- 2,151,042. SHARE A SMILE. INT. CL. 28. REG. 4-14-1998.
- 2,151,043. MARK VII. INT. CL. 28. REG. 4-14-1998.
- 2,151,050. HARD ROCK HOTEL. INT. CLS. 8, 14, 20, 21 AND 26. REG. 4-14-1998.
- 2,151,051. SE QUALITY WITHOUT QUESTION AND DESIGN. INT. CL. 39. REG. 4-14-1998.
- 2,151,052. S E AND DESIGN. INT. CL. 39. REG. 4-14-1998.
- 2,151,055. ISADORA DOLPHIN. INT. CL. 20. REG. 4-14-1998.
- 2,151,056. CORPORATE EVENT! SERVICES AND DESIGN. INT. CL. 42. REG. 4-14-1998.
- 2,151,057. URBAN YOGA. INT. CLS. 25 AND 41. REG. 4-14-1998.
- 2,151,058. CNA WEATHER GUARD. INT. CL. 36. REG. 4-14-1998.
- 2,151,062. THE GRIZZLY AND DESIGN. INT. CLS. 6, 16 AND 21. REG. 4-14-1998.
- 2,151,064. TAZZA (STYLIZED). INT. CLS. 11 AND 30. REG. 4-14-1998.
- 2,151,065. PCS ONE (STYLIZED). INT. CL. 9. REG. 4-14-1998.
- 2,151,067. KINGDOM. INT. CL. 28. REG. 4-14-1998.
- 2,151,068. DIGITAL DELI. INT. CLS. 38 AND 41. REG. 4-14-1998.
- 2,151,071. PERSONALONE (STYLIZED). INT. CL. 38. REG. 4-14-1998.
- 2,151,072. THREE BRIDGES. INT. CL. 42. REG. 4-14-1998.
- 2,151,073. TAC SHOES SO AFFORDABLY COMFORTABLE, YOU MAY NEVER TAKE THEM OFF.. INT. CL. 42. REG. 4-14-1998.
- 2,151,074. UNIVERSAL SHOWDOWN. INT. CL. 25. REG. 4-14-1998.
- 2,151,075. S & C (STYLIZED). INT. CL. 9. REG. 4-14-1998.
- 2,151,076. PHARMASOFT AND DESIGN. INT. CLS. 9, 16, 37 AND 42. REG. 4-14-1998.
- 2,151,077. GOAT'S BREATH. INT. CL. 32. REG. 4-14-1998.
- 2,151,080. PIERRE BERNARD AND DESIGN. INT. CL. 14. REG. 4-14-1998.
- 2,151,081. MISCELLANEOUS DESIGN. INT. CL. 25. REG. 4-14-1998.
- 2,151,083. THE 21ST CENTURY TRADE SHOW. INT. CL. 41. REG. 4-14-1998.
- 2,151,084. INTREPID. INT. CL. 30. REG. 4-14-1998.
- 2,151,085. MISCELLANEOUS DESIGN. INT. CL. 28. REG. 4-14-1998.
- 2,151,088. CHANGE THE GAME. INT. CLS. 18 AND 28. REG. 4-14-1998.
- 2,151,089. TRUE GRACE. INT. CL. 36. REG. 4-14-1998.
- 2,151,090. OPTIMA TRUE GRACE. INT. CL. 36. REG. 4-14-1998.
- 2,151,091. TROLL. INT. CL. 11. REG. 4-14-1998.
- 2,151,095. JEUNI-LEEN. INT. CL. 3. REG. 4-14-1998.
- 2,151,096. MOTIONSETS. INT. CL. 9. REG. 4-14-1998.
- 2,151,099. SAN PATRIGNANO AND DESIGN. INT. CLS. 6, 19, 20, 21, 24, 27 AND 37. REG. 4-14-1998.
- 2,151,101. AIR SPECIALTIES EXPRESS. INT. CL. 16. REG. 4-14-1998.
- 2,151,102. BELIEVE. AND DESIGN. INT. CL. 5. REG. 4-14-1998.
- 2,151,104. MENTIS. INT. CL. 25. REG. 4-14-1998.
- 2,151,106. PRETTY CHOICES. INT. CL. 28. REG. 4-14-1998.
- 2,151,107. SPORTS FISHING. INT. CL. 28. REG. 4-14-1998.
- 2,151,109. WINITALL. INT. CL. 25. REG. 4-14-1998.
- 2,151,112. BAGEL BUDDY. INT. CL. 11. REG. 4-14-1998.
- 2,151,113. GOOD-BYE BALL. INT. CL. 28. REG. 4-14-1998.
- 2,151,115. MISCELLANEOUS DESIGN. INT. CL. 25. REG. 4-14-1998.
- 2,151,116. COBALT. INT. CLS. 9 AND 12. REG. 4-14-1998.
- 2,151,118. CAFE GLOCKENSPIEL. INT. CLS. 21 AND 30. REG. 4-14-1998.
- 2,151,119. JAVA CUP AND DESIGN. INT. CL. 42. REG. 4-14-1998.
- 2,151,121. V9. U.S. CL. B. REG. 4-14-1998.
- 2,151,122. V7. U.S. CL. B. REG. 4-14-1998.
- 2,151,124. BAYLOR UNIVERSITY DEPARTMENT OF ENVIRONMENTAL STUDIES ON SITE WASTE WATER CERTIFIED PRODUCT AND DESIGN. U.S. CL. A. REG. 4-14-1998.
- 2,151,125. MISCELLANEOUS DESIGN. INT. CL. 38. REG. 4-14-1998.
- 2,151,132. SPEXX. INT. CL. 7. REG. 4-14-1998.
- 2,151,134. MISCELLANEOUS DESIGN. INT. CLS. 39 AND 42. REG. 4-14-1998.
- 2,151,136. BITZ DOG TRAINING TREATS AND DESIGN. INT. CL. 31. REG. 4-14-1998.
- 2,151,138. THE MORE YOU LIVE, THE LESS YOU DIE.. INT. CL. 25. REG. 4-14-1998.
- 2,151,139. CAFE GLOCKENSPIEL (STYLIZED). INT. CLS. 21 AND 30. REG. 4-14-1998.
- 2,151,142. GRAN SAMAN. INT. CL. 30. REG. 4-14-1998.
- 2,151,143. MENTAL FITNESS. INT. CL. 16. REG. 4-14-1998.
- 2,151,144. MR AND DESIGN. INT. CL. 41. REG. 4-14-1998.
- 2,151,145. EXECUTIVE GOLD. INT. CL. 28. REG. 4-14-1998.
- 2,151,146. PLANET XTREME. INT. CL. 25. REG. 4-14-1998.
- 2,151,148. LAKER ICE CANADIAN LAGER BEER AND DESIGN. INT. CL. 32. REG. 4-14-1998.
- 2,151,149. DR. JIM'S GREAT PETS!. INT. CL. 9. REG. 4-14-1998.
- 2,151,153. AUTHENTIC FINANCE. INT. CL. 36. REG. 4-14-1998.
- 2,151,154. CARGILL PORK AND DESIGN. INT. CL. 42. REG. 4-14-1998.

- 2,151,155. LI'L FRIENDS OF KELLY. INT. CL. 28. REG. 4-14-1998.
- 2,151,156. NIAGARA. INT. CL. 19. REG. 4-14-1998.
- 2,151,157. CARGILL PORK AND DESIGN. INT. CL. 42. REG. 4-14-1998.
- 2,151,158. PLASMATRON. INT. CL. 9. REG. 4-14-1998.
- 2,151,164. SWINGING PRETTY. INT. CL. 28. REG. 4-14-1998.
- 2,151,167. OXFORD GARDEN. INT. CL. 8. REG. 4-14-1998.
- 2,151,169. NEO FRUIT. INT. CL. 1. REG. 4-14-1998.
- 2,151,172. FILEXEC AND DESIGN. INT. CL. 16. REG. 4-14-1998.
- 2,151,173. SANDTRAY - WORLDPLAY. INT. CL. 42. REG. 4-14-1998.
- 2,151,174. VINCENZA COLLECTION. INT. CL. 41. REG. 4-14-1998.
- 2,151,178. STOCK POT AND DESIGN. INT. CL. 29. REG. 4-14-1998.
- 2,151,179. STOCK POT AND DESIGN. INT. CL. 30. REG. 4-14-1998.
- 2,151,181. DAILY GRAINS. INT. CL. 30. REG. 4-14-1998.
- 2,151,182. FRESCO ESPRESSO AND DESIGN. INT. CL. 42. REG. 4-14-1998.
- 2,151,186. LAKHAN. INT. CL. 25. REG. 4-14-1998.
- 2,151,189. HEARTHSTONE CLASSICS AND DESIGN. INT. CL. 29. REG. 4-14-1998.
- 2,151,190. COMCAST ROADSIDE CONNECT. INT. CL. 38. REG. 4-14-1998.
- 2,151,191. BUTTONS. INT. CL. 28. REG. 4-14-1998.
- 2,151,193. GINKOGIN. INT. CL. 5. REG. 4-14-1998.
- 2,151,197. DAS. INT. CLS. 9 AND 42. REG. 4-14-1998.
- 2,151,198. INFOQUERY. INT. CL. 9. REG. 4-14-1998.
- 2,151,199. ISENHOUR. INT. CLS. 19 AND 42. REG. 4-14-1998.
- 2,151,200. TWO BRATS PRODUCTIONS. INT. CL. 41. REG. 4-14-1998.
- 2,151,202. AUDACITY DESIGNS. INT. CL. 11. REG. 4-14-1998.
- 2,151,204. STOP-SHED. INT. CL. 5. REG. 4-14-1998.
- 2,151,207. CHASE TOYS. INT. CL. 28. REG. 4-14-1998.
- 2,151,208. U.S. PAPCHECK. INT. CL. 42. REG. 4-14-1998.
- 2,151,210. CLUSTERSTORE. INT. CL. 9. REG. 4-14-1998.
- 2,151,211. MISCELLANEOUS DESIGN. INT. CL. 9. REG. 4-14-1998.
- 2,151,213. EL REY CARENERO SUPERIOR AND DESIGN. INT. CL. 30. REG. 4-14-1998.
- 2,151,214. KAGSSIBUN AND DESIGN. INT. CL. 18. REG. 4-14-1998.
- 2,151,219. FIT & HEALTHY LIFESTYLES. INT. CL. 16. REG. 4-14-1998.
- 2,151,220. MISCELLANEOUS DESIGN. INT. CL. 42. REG. 4-14-1998.
- 2,151,222. HEXGRID. INT. CL. 16. REG. 4-14-1998.
- 2,151,224. MISCELLANEOUS DESIGN. INT. CL. 32. REG. 4-14-1998.
- 2,151,225. TEAMREPAIR. INT. CL. 9. REG. 4-14-1998.
- 2,151,229. ZEFTRON. INT. CL. 12. REG. 4-14-1998.
- 2,151,230. MISCELLANEOUS DESIGN. INT. CL. 41. REG. 4-14-1998.
- 2,151,232. SOFT PAL. INT. CL. 28. REG. 4-14-1998.
- 2,151,236. DISK-TO-LAN. INT. CL. 9. REG. 4-14-1998.
- 2,151,237. SFN-P (STYLIZED). INT. CL. 40. REG. 4-14-1998.
- 2,151,238. FUN ON THE GO. INT. CL. 28. REG. 4-14-1998.
- 2,151,241. DEM. INT. CL. 36. REG. 4-14-1998.
- 2,151,242. NEUROM. INT. CL. 9. REG. 4-14-1998.
- 2,151,243. RECEPTIONS RM & MEETINGS AND DESIGN. INT. CL. 16. REG. 4-14-1998.
- 2,151,244. BIKER ROAD. INT. CL. 25. REG. 4-14-1998.
- 2,151,245. THE PERFUME SHOP. INT. CL. 3. REG. 4-14-1998.
- 2,151,246. OFFICE COMPANION. INT. CL. 18. REG. 4-14-1998.
- 2,151,248. GREEN HUNTER BEETLEBORG. INT. CL. 16. REG. 4-14-1998.
- 2,151,252. SLIMMONS. INT. CL. 30. REG. 4-14-1998.
- 2,151,255. RUGRATS. INT. CL. 27. REG. 4-14-1998.
- 2,151,257. ABLEPICK. INT. CL. 9. REG. 4-14-1998.
- 2,151,258. CORZO. INT. CL. 11. REG. 4-14-1998.
- 2,151,259. EVOLUTION, NOT REVOLUTION. INT. CL. 18. REG. 4-14-1998.
- 2,151,260. EVOLUTION, NOT REVOLUTION. INT. CL. 25. REG. 4-14-1998.
- 2,151,261. EVOLUTION, NOT REVOLUTION. INT. CL. 26. REG. 4-14-1998.
- 2,151,262. EVOLUTION, NOT REVOLUTION. INT. CL. 14. REG. 4-14-1998.
- 2,151,266. VIDDI. INT. CL. 9. REG. 4-14-1998.
- 2,151,271. APPSYNC. INT. CL. 9. REG. 4-14-1998.
- 2,151,272. ROAD RULES. INT. CL. 6. REG. 4-14-1998.
- 2,151,274. MISCELLANEOUS DESIGN. INT. CL. 16. REG. 4-14-1998.
- 2,151,275. VGATE. INT. CL. 9. REG. 4-14-1998.
- 2,151,276. TOWERDUCK. INT. CL. 11. REG. 4-14-1998.
- 2,151,278. BSB SPEED BEARINGS (STYLIZED). INT. CL. 4. REG. 4-14-1998.
- 2,151,280. HOME BASICS. INT. CLS. 7, 9 AND 11. REG. 4-14-1998.
- 2,151,281. IMAGE MAX 2000. INT. CL. 2. REG. 4-14-1998.
- 2,151,282. XYLIDENT. INT. CL. 30. REG. 4-14-1998.
- 2,151,283. TC12 AND DESIGN. INT. CLS. 38 AND 41. REG. 4-14-1998.
- 2,151,284. WINSTON STEVENS. INT. CL. 25. REG. 4-14-1998.
- 2,151,285. QUARTET. INT. CL. 9. REG. 4-14-1998.
- 2,151,289. DREAM WALKER. INT. CLS. 18 AND 25. REG. 4-14-1998.
- 2,151,290. NET EARNINGS. INT. CLS. 35, 36, 38 AND 42. REG. 4-14-1998.
- 2,151,291. GLEN RIDGE. INT. CL. 29. REG. 4-14-1998.
- 2,151,292. PUSH BUTTON BANKING. INT. CL. 36. REG. 4-14-1998.
- 2,151,294. 7 STEERS. INT. CL. 42. REG. 4-14-1998.
- 2,151,296. ON THE EDGE AND IN CONTROL. INT. CL. 41. REG. 4-14-1998.
- 2,151,297. Y + ONE. INT. CL. 25. REG. 4-14-1998.
- 2,151,298. BROKEN HEART. INT. CL. 41. REG. 4-14-1998.
- 2,151,299. TCG U.S.A.. INT. CL. 38. REG. 4-14-1998.
- 2,151,300. HANDMADE PIZZA STIX AND DESIGN. INT. CL. 30. REG. 4-14-1998.
- 2,151,301. TRACK. INT. CL. 9. REG. 4-14-1998.
- 2,151,303. GRAN ESPRIT. INT. CL. 12. REG. 4-14-1998.
- 2,151,306. L'ILE SUPREME. INT. CL. 33. REG. 4-14-1998.
- 2,151,307. SCIUS. INT. CL. 9. REG. 4-14-1998.
- 2,151,308. CBEX. INT. CLS. 35 AND 36. REG. 4-14-1998.
- 2,151,310. FSO FOOD SERVICE OUTLET. INT. CL. 35. REG. 4-14-1998.
- 2,151,311. HOME ROAST. INT. CL. 29. REG. 4-14-1998.
- 2,151,316. MISCELLANEOUS DESIGN. INT. CL. 29. REG. 4-14-1998.
- 2,151,318. GT SECURE. INT. CL. 9. REG. 4-14-1998.
- 2,151,319. SIGNICADE. INT. CL. 20. REG. 4-14-1998.
- 2,151,321. PURE GENIUS. INT. CL. 32. REG. 4-14-1998.
- 2,151,323. MISCELLANEOUS DESIGN. INT. CL. 28. REG. 4-14-1998.
- 2,151,324. TRAVEL SMART KIDS. INT. CL. 18. REG. 4-14-1998.
- 2,151,325. DALLYO AND DESIGN. INT. CL. 25. REG. 4-14-1998.
- 2,151,326. SYNERZYME. INT. CL. 5. REG. 4-14-1998.
- 2,151,327. WE MAKE YOU LOOK YOUR BEST. INT. CL. 7. REG. 4-14-1998.
- 2,151,328. XCEL FEDERAL CREDIT UNION AND DESIGN. INT. CL. 36. REG. 4-14-1998.
- 2,151,332. THUNDER. INT. CL. 16. REG. 4-14-1998.
- 2,151,334. GET IT ALL. INT. CL. 30. REG. 4-14-1998.
- 2,151,336. PRO TOUCH. INT. CL. 9. REG. 4-14-1998.
- 2,151,337. INSERTTECH. INT. CL. 28. REG. 4-14-1998.
- 2,151,338. MISCELLANEOUS DESIGN. INT. CL. 38. REG. 4-14-1998.
- 2,151,339. S (STYLIZED). INT. CL. 28. REG. 4-14-1998.
- 2,151,340. BITTER BITE. INT. CL. 5. REG. 4-14-1998.
- 2,151,341. PASTOS. INT. CL. 30. REG. 4-14-1998.
- 2,151,345. GENTLE BIN. INT. CL. 6. REG. 4-14-1998.
- 2,151,353. READER'S REMEDY AND DESIGN. INT. CL. 16. REG. 4-14-1998.
- 2,151,354. FINANCIAL SUPERMARKET. INT. CL. 36. REG. 4-14-1998.
- 2,151,355. SEMCO SELECT95. INT. CL. 9. REG. 4-14-1998.
- 2,151,357. BLUE MESA. INT. CL. 14. REG. 4-14-1998.

- 2,151,358. MISCELLANEOUS DESIGN. INT. CL. 3. REG. 4-14-1998.
- 2,151,360. SUNFROG AMPHIBIOUS WEAR. INT. CL. 25. REG. 4-14-1998.
- 2,151,361. THE UNPUNCHABLES. INT. CL. 24. REG. 4-14-1998.
- 2,151,362. WILD ORCHARD. INT. CL. 32. REG. 4-14-1998.
- 2,151,363. CAFE HERPE (STYLIZED). INT. CL. 42. REG. 4-14-1998.
- 2,151,369. KENSINGTON & JAMES RIDING CLUB AND DESIGN. INT. CL. 19. REG. 4-14-1998.
- 2,151,370. MELEXIS. INT. CL. 9. REG. 4-14-1998.
- 2,151,371. SHOCKWAVE SW (STYLIZED). INT. CL. 25. REG. 4-14-1998.
- 2,151,372. EMPLOYEE PERFORMANCE SOLUTIONS. INT. CL. 35. REG. 4-14-1998.
- 2,151,374. COX COBRA. INT. CL. 9. REG. 4-14-1998.
- 2,151,375. URGENCY IN ANY EMERGENCY. GUARANTEED. INT. CL. 42. REG. 4-14-1998.
- 2,151,376. CLEARLY COASTERS. INT. CL. 21. REG. 4-14-1998.
- 2,151,379. THE GREEN COURT. INT. CLS. 25 AND 28. REG. 4-14-1998.
- 2,151,384. USPC AND DESIGN. INT. CL. 28. REG. 4-14-1998.
- 2,151,386. NOW THERE'S A BETTER WAY.. INT. CL. 38. REG. 4-14-1998.
- 2,151,387. VELVET IMARI. INT. CL. 3. REG. 4-14-1998.
- 2,151,389. DOODLERS. INT. CL. 28. REG. 4-14-1998.
- 2,151,390. EYE LIGHTS. INT. CL. 3. REG. 4-14-1998.
- 2,151,391. INTEGRION. INT. CL. 36. REG. 4-14-1998.
- 2,151,392. GULF COAST GATEWAY. INT. CL. 42. REG. 4-14-1998.
- 2,151,393. HEALTHVIEW FOR DIABETES. INT. CL. 9. REG. 4-14-1998.
- 2,151,394. EASY PAK. INT. CL. 39. REG. 4-14-1998.
- 2,151,395. MEGA CHARGER. INT. CL. 9. REG. 4-14-1998.
- 2,151,396. SUNDOWNER. INT. CL. 11. REG. 4-14-1998.
- 2,151,397. TRAUMACATH. INT. CL. 10. REG. 4-14-1998.
- 2,151,399. WHIP! AND DESIGN. INT. CL. 9. REG. 4-14-1998.
- 2,151,400. ELECTRONIC TALKING PHONE BOOK. INT. CL. 42. REG. 4-14-1998.
- 2,151,401. AIRSTAR PAGING AND DESIGN. INT. CL. 38. REG. 4-14-1998.
- 2,151,402. SMARTLABS. INT. CL. 28. REG. 4-14-1998.
- 2,151,404. TIGER TUFF. INT. CL. 16. REG. 4-14-1998.
- 2,151,405. ANTILLA CIGARS. INT. CL. 34. REG. 4-14-1998.
- 2,151,406. BATH AND DESIGN. INT. CL. 24. REG. 4-14-1998.
- 2,151,407. EPICUREAN HAUTE TO GO. INT. CL. 29. REG. 4-14-1998.
- 2,151,408. EPICUREAN HAUTE TO GO. INT. CL. 30. REG. 4-14-1998.
- 2,151,409. STOCKER 400. INT. CL. 28. REG. 4-14-1998.
- 2,151,410. EXPO-ERA. INT. CL. 25. REG. 4-14-1998.
- 2,151,411. WE WASHINGTON ENTERTAINING AND DESIGN. INT. CL. 16. REG. 4-14-1998.
- 2,151,413. SPR KNOWLEDGEPLAN. INT. CL. 9. REG. 4-14-1998.
- 2,151,414. ACCUPAK. INT. CL. 7. REG. 4-14-1998.
- 2,151,417. ANASTASIA. INT. CL. 24. REG. 4-14-1998.
- 2,151,418. ANASTASIA. INT. CL. 26. REG. 4-14-1998.
- 2,151,419. RIO GRANDE. INT. CL. 28. REG. 4-14-1998.
- 2,151,423. QAPRO. INT. CL. 35. REG. 4-14-1998.
- 2,151,425. PERSONAL FOCUS. INT. CLS. 25 AND 42. REG. 4-14-1998.
- 2,151,427. ROYAL QUEST. INT. CL. 28. REG. 4-14-1998.
- 2,151,430. PACIFIC BELL BUSINESS ONE NUMBER CARD. INT. CL. 36. REG. 4-14-1998.
- 2,151,432. PACIFIC BELL ONE NUMBER CALLING CARD. INT. CL. 36. REG. 4-14-1998.
- 2,151,435. EVERGREEN. INT. CL. 23. REG. 4-14-1998.
- 2,151,436. LICENSED LIFESTYLES. INT. CL. 9. REG. 4-14-1998.
- 2,151,437. LICENSED LIFESTYLES. INT. CL. 26. REG. 4-14-1998.
- 2,151,438. WOMAN THING MUSIC. INT. CL. 41. REG. 4-14-1998.
- 2,151,441. MISCELLANEOUS DESIGN. INT. CL. 14. REG. 4-14-1998.
- 2,151,443. STICKJOY AND DESIGN. INT. CL. 35. REG. 4-14-1998.
- 2,151,446. BLAKE STREET BOMBERS. INT. CL. 32. REG. 4-14-1998.
- 2,151,448. NEW ENGLAND BLIZZARD AND DESIGN. INT. CLS. 16, 25 AND 41. REG. 4-14-1998.
- 2,151,450. MISCELLANEOUS DESIGN. INT. CL. 21. REG. 4-14-1998.
- 2,151,451. ODDVILLE, MTV. INT. CL. 41. REG. 4-14-1998.
- 2,151,456. NABISCO AND DESIGN. INT. CL. 30. REG. 4-14-1998.
- 2,151,457. HOT KISS (STYLIZED). INT. CL. 25. REG. 4-14-1998.
- 2,151,458. SITES ALIVE. INT. CL. 16. REG. 4-14-1998.
- 2,151,459. APPLE CREEK. INT. CL. 27. REG. 4-14-1998.
- 2,151,460. FOLLOW YOUR OWN LEAD. INT. CL. 36. REG. 4-14-1998.
- 2,151,461. LOFTY IDEAS. INT. CL. 35. REG. 4-14-1998.
- 2,151,463. SMARTFORART. INT. CL. 16. REG. 4-14-1998.
- 2,151,464. DREXELINK. INT. CL. 42. REG. 4-14-1998.
- 2,151,465. GENUINE GORTON'S CRUNCH!. INT. CL. 29. REG. 4-14-1998.
- 2,151,466. NATURAL GAS, ELECTRICITY AND ENDLESS POSSIBILITIES. INT. CLS. 35, 36, 37, 39 AND 42. REG. 4-14-1998.
- 2,151,468. THE FAIRIES OF COTTINGLY GLEN. INT. CL. 28. REG. 4-14-1998.
- 2,151,469. SQUISHERS. INT. CL. 8. REG. 4-14-1998.
- 2,151,470. READER'S DIGEST SMART SERIES. INT. CL. 16. REG. 4-14-1998.
- 2,151,472. RESCUE ZORDS. INT. CL. 28. REG. 4-14-1998.
- 2,151,473. LIGHTNING FIRE TAMER. INT. CL. 28. REG. 4-14-1998.
- 2,151,475. SPACESHIP SALAD. INT. CL. 29. REG. 4-14-1998.
- 2,151,476. MARTIAN MUFFIN. INT. CL. 30. REG. 4-14-1998.
- 2,151,477. SLICE. INT. CL. 30. REG. 4-14-1998.
- 2,151,478. FRUITWISE. INT. CL. 32. REG. 4-14-1998.
- 2,151,479. CHECKTHRU. INT. CL. 36. REG. 4-14-1998.
- 2,151,481. MISCELLANEOUS DESIGN. INT. CL. 38. REG. 4-14-1998.
- 2,151,482. MISCELLANEOUS DESIGN. INT. CL. 38. REG. 4-14-1998.
- 2,151,483. QUIK SHADE. INT. CL. 22. REG. 4-14-1998.
- 2,151,484. DAYDREAMERS. INT. CL. 16. REG. 4-14-1998.
- 2,151,485. WAFERCEL. INT. CL. 21. REG. 4-14-1998.
- 2,151,486. ARM CENTER. INT. CL. 42. REG. 4-14-1998.
- 2,151,488. LEARNING WITH LEATHER. INT. CL. 28. REG. 4-14-1998.
- 2,151,489. MICROCHIMP. INT. CL. 28. REG. 4-14-1998.
- 2,151,492. SAFETOUCH. INT. CL. 8. REG. 4-14-1998.
- 2,151,494. AQUACHOICE. INT. CL. 32. REG. 4-14-1998.
- 2,151,495. YEAR 2000. INT. CL. 20. REG. 4-14-1998.
- 2,151,496. FOSTER-FLYNT AND DESIGN. INT. CL. 33. REG. 4-14-1998.
- 2,151,497. J-FILL AND DESIGN. INT. CL. 21. REG. 4-14-1998.
- 2,151,498. MARIKA S.P.. INT. CL. 25. REG. 4-14-1998.
- 2,151,499. THE SYRINGE PEOPLE. INT. CLS. 3, 5 AND 10. REG. 4-14-1998.
- 2,151,503. MICHIGAN INDUSTRIAL EXPO. INT. CL. 35. REG. 4-14-1998.
- 2,151,504. BOTANICAL TECHNOLOGIES. INT. CL. 42. REG. 4-14-1998.
- 2,151,505. MISCELLANEOUS DESIGN. INT. CL. 25. REG. 4-14-1998.
- 2,151,506. MISCELLANEOUS DESIGN. INT. CL. 25. REG. 4-14-1998.
- 2,151,507. MISCELLANEOUS DESIGN. INT. CL. 25. REG. 4-14-1998.
- 2,151,509. MONTREUX JAZZ CAFE (STYLIZED). INT. CLS. 32 AND 33. REG. 4-14-1998.
- 2,151,510. MISCELLANEOUS DESIGN. INT. CL. 14. REG. 4-14-1998.
- 2,151,511. REAL DARTS. INT. CL. 28. REG. 4-14-1998.
- 2,151,513. ROSSITER SYSTEM. INT. CL. 41. REG. 4-14-1998.
- 2,151,514. INTERNETSOURCE. INT. CL. 42. REG. 4-14-1998.
- 2,151,515. THE BUSINESS INTERNETWORK. INT. CL. 42. REG. 4-14-1998.

- 2,151,517. DAIRYLIKE. INT. CL. 30. REG. 4-14-1998.  
 2,151,518. QUIKDRY. INT. CL. 19. REG. 4-14-1998.  
 2,151,519. SUPERGRAPHICS THE BUS WRAP COMPANY.  
 INT. CL. 40. REG. 4-14-1998.  
 2,151,520. FLOODSTAT!. INT. CL. 9. REG. 4-14-1998.  
 2,151,521. FLOODSTAT!. INT. CL. 36. REG. 4-14-1998.  
 2,151,522. VET.NET. INT. CL. 42. REG. 4-14-1998.  
 2,151,525. PARENTING NEW ENGLAND. INT. CL. 16. REG.  
 4-14-1998.  
 2,151,526. MUSIC BUSINESS INTERNET GUIDE. INT. CL.  
 41. REG. 4-14-1998.  
 2,151,528. THE QUADRUPED. INT. CL. 41. REG. 4-14-1998.  
 2,151,529. GREECE IN PRINT. INT. CL. 41. REG. 4-14-1998.  
 2,151,530. BUTTERLIKE. INT. CL. 29. REG. 4-14-1998.  
 2,151,531. SAUTE' BUTTER. INT. CL. 29. REG. 4-14-1998.  
 2,151,533. SHOOTERS ON TAP. INT. CL. 33. REG. 4-14-1998.  
 2,151,534. SEXUAL HEALTH THE MAGAZINE FOR SEX-  
 UAL WELL BEING AND DESIGN. INT. CL. 16.  
 REG. 4-14-1998.  
 2,151,535. DECORATOR SHOWHOUSE. INT. CL. 16. REG.  
 4-14-1998.  
 2,151,536. HEALTHY RECIPE. INT. CL. 29. REG. 4-14-1998.  
 2,151,537. MILLER BRACKET. INT. CL. 12. REG. 4-14-1998.  
 2,151,538. MISCELLANEOUS DESIGN. INT. CL. 29. REG. 4-  
 14-1998.  
 2,151,539. D ONLY DIAMONDS AND DESIGN. INT. CL. 35.  
 REG. 4-14-1998.  
 2,151,540. CAR TOURS AND DESIGN. INT. CL. 9. REG. 4-  
 14-1998.  
 2,151,543. COLORADO BICYCLE CLASSIC. INT. CL. 41.  
 REG. 4-14-1998.  
 2,193,836. EAT AT ED DEBEVIC'S GOOD FOOD\*FRESH  
 SERVICE AND DESIGN. INT. CL. 29 ONLY.  
 REG. 10-6-1998.  
 2,194,790. PIPER. INT. CL. 5 ONLY. REG. 10-13-1998.
- 2,201,753. EVITA PERONI AND DESIGN. INT. CL. 25  
 ONLY. REG. 11-3-1998.  
 2,208,031. INNOTEST. INT. CL. 9 ONLY. REG. 12-8-1998.  
 2,219,531. ICG AND DESIGN. INT. CL. 17 ONLY. REG. 1-19-  
 1999.  
 2,226,961. UTSCH. INT. CLS. 2 AND 11 ONLY. REG. 3-2-  
 1999.  
 2,246,354. VALUCAR. INT. CL. 39 ONLY. REG. 5-18-1999.  
 2,264,776. ULTIMUS. INT. CL. 35 ONLY. REG. 7-27-1999.

---

**SECTION 18**

- 846,746. GLOBETROTTER. U.S. CL. 41. REG. 3-26-1968.  
 1,019,645. CHILD WORLD. INT. CL. 42. REG. 9-2-1975.  
 1,450,764. ACE (STYLIZED). INT. CL. 16. REG. 8-4-1987.  
 1,504,036. RENAISSANCE. INT. CL. 25. REG. 9-13-1988.  
 2,144,713. ONE PARTNER. FULL ACCOUNTABILITY..  
 INT. CL. 42. REG. 3-17-1998.  
 2,234,603. MEAL SOLUTIONS. INT. CL. 30. REG. 3-23-1999.  
 2,357,721. J&P JEWELS AND PASHMINAS PARIS (STY-  
 LIZED). INT. CL. 25. REG. 6-13-2000.  
 2,501,078. JOMANDI. INT. CL. 41. REG. 10-23-2001.  
 2,551,037. NEWEST. INT. CLS. 18 AND 20. REG. 3-19-2002.  
 2,568,513. TOOTH & GUM TONIC. INT. CL. 5. REG. 5-7-  
 2002.  
 2,635,052. ROSS AND DESIGN. INT. CL. 30. REG. 10-15-  
 2002.  
 2,700,034. CYCLIS PHARMACEUTICALS. INT. CL. 42. REG.  
 3-25-2003.  
 2,749,491. ROSS AND DESIGN. INT. CL. 30. REG. 8-12-2003.

\* \* \* \* \*

# TRADEMARK REGISTRATIONS AMENDED, CORRECTED, ETC.

The designation "U.S. Cl." appearing in this section refers to the U.S. class in effect prior to Sep. 1, 1973 rather than the international class which applies to applications filed on or after that date. For adoption of international classification see notice in the OFFICIAL GAZETTE of Jun. 26, 1973 (911 O.G. TM 210).

Any change to the registration will be indicated at the bottom of each entry under ELEMENTS AMENDED, CORRECTED OR RESTRICTED. With the exception of changes to the goods and services, additions to the registration will appear in asterisks and deletions of the registration will appear in brackets. Elements which are only changed will be listed with no punctuation. As to the goods/services statement, amendments to the goods/services will appear in asterisks and deletions will appear in brackets. In addition if any change to the goods/services occurs, the element "Goods/Services" will be listed under ELEMENTS AMENDED, CORRECTED OR RESTRICTED.

1,950,849. REG. 1-23-1996. PERSONAL MARKETING COMPANY, INC., THE (TEXAS CORPORATION) 11843 WEST 83RD TERRACE, SHAWNEE MISSION, KS, 66214, SN 74-611,674. FILED 12-16-1994. PRINCIPAL REGISTER.

## RAPIDCARD

INT. CL. 35/U.S. CLS. 100, 101 AND 102

FOR MARKETING SERVICES, NAMELY PREPARATION AND DISTRIBUTION, ON BEHALF OF SELLERS OF PRODUCTS AND/OR SERVICES, OF CUSTOM PRINTED POST CARDS BEARING THE NAME, ADDRESS, AND/OR LIKENESS OF THE SELLER TOGETHER WITH A MARKETING MESSAGE TO STIMULATE NEW, REPEAT, OR FOLLOW-UP SALES.

FIRST USE 5-0-1994; IN COMMERCE 5-0-1994.

ELEMENTS AMENDED  
MARK

2,166,970. REG. 6-23-1998. BENTLEY SYSTEMS, INCORPORATED (DELAWARE CORPORATION) 690 PENNSYLVANIA DRIVE, EXTON, PA, 19341, SN 75-194,285. FILED 11-6-1996. PRINCIPAL REGISTER.



INT. CL. 41/U.S. CLS. 100, 101 AND 107

FOR EDUCATIONAL SERVICES, NAMELY, CONDUCTING TECHNICAL TRAINING SEMINARS IN THE FIELD OF ENGINEERING AND ARCHITECTURAL DESIGN SOFTWARE.

FIRST USE 10-13-1994; IN COMMERCE 10-13-1994.

INT. CL. 42/U.S. CLS. 100 AND 101

FOR ENGINEERING SERVICES AND ARCHITECTURAL DESIGN SERVICES.

FIRST USE 10-13-1994; IN COMMERCE 10-13-1994.

ELEMENTS AMENDED  
MARK

2,192,214. REG. 9-29-1998. ODEGARD, INC. (NEW YORK CORPORATION) 200 LEXINGTON AVENUE, SUITE 1206, NEW YORK, NY, 10016, SN 75-334,789. FILED 8-1-1997. PRINCIPAL REGISTER.

## YOUNGTSE

INT. CL. 27/U.S. CLS. 19, 20, 37, 42 AND 50  
FOR CARPETS.

FIRST USE 6-17-1989; IN COMMERCE 6-17-1989.

ELEMENTS AMENDED  
MARK

2,395,888. REG. 10-17-2000. ORION BUS INDUSTRIES, A DIVISION OF WESTERN STAR TRUCKS INC. (BRITISH COLUMBIA CORPORATION) 350 HAZELHURST ROAD, MISSISSAUGA, ONTARIO, CANADA, L5J 4T8, SN 75-852,807. FILED 11-18-1999. PRINCIPAL REGISTER.



INT. CL. 12/U.S. CLS. 19, 21, 23, 31, 35 AND 44  
FOR BUSES AND STRUCTURAL PARTS THEREOF.

FIRST USE 8-1-1999; IN COMMERCE 9-1-1999.

ELEMENTS CORRECTED  
OWNER NAME

2,638,973. REG. 10-22-2002. MARCEGAGLIA S.P.A. (ITALY CORPORATION) VIA BRESCIANI, 16, I-46040 GAZOLDO DEGLI IPPOLITI (MN), ITALY., SN 76-290,531. FILED 7-27-2001. PRINCIPAL REGISTER.

## MARCEGAGLIA

PRIORITY CLAIMED UNDER SEC. 44(D) ON ITALY APPLICATION NO. TO2001C2123, FILED 6-21-2001, REG. NO. 00853344, DATED 10-30-2001, EXPIRES 6-21-2011.

INT. CL. 6/U.S. CLS. 2, 12, 13, 14, 23, 25 AND 50

FOR COMMON METALS AND THEIR ALLOYS, INCLUDING STEEL, IN THE FORM OF SHEETS, RODS, BARS, BILLETS; METAL BUILDING MATERIALS, NAMELY, BEAMS, POLES, POSTS; TRANSPORTABLE BUILDINGS OF METAL; COMMON METALS FOR FURTHER MANUFACTURE INTO RAILWAY TRACKS; NON-ELECTRIC CABLES AND SINGLE-STRAND AND MULTI-STRAND WIRES; METAL LOCKS AND SMALL ITEMS OF METAL HARDWARE, NAMELY, NUTS, WASHERS, BOLTS, BRACKETS; STEEL PIPES AND TUBES OF ALUMINUM; BUILDING PANELS MADE OF METAL; BANDS AND SHEETS AND PLATES OF METAL FOR FURTHER MANUFACTURE; DRAW PIECES AND SHAPES OF METAL, NAMELY EXTRUDED CHANNEL MEMBERS, TUBES, BEAMS; ROOFING MADE OF METAL; SCAFFOLDING MADE OF METAL; METAL STRUCTURES, NAMELY STORAGE SHEDS AND SMALL BUILDINGS; METAL ROAD BARRIERS; FENCES OF METAL; METAL SAFES; GOODS OF COMMON METAL NOT INCLUDED IN OTHER CLASSES, NAMELY BRACKETS, HINGES; METAL ORES.

FIRST USE ; IN COMMERCE .  
INT. CL. 37/U.S. CLS. 100, 103 AND 106

FOR CONSTRUCTION SERVICES, NAMELY, PLANNING, LAYOUT, AND CUSTOM CONSTRUCTION OF STEELWORKS PLANTS AND FACTORIES AND FACTORIES FOR ENERGY PRODUCTION; PAINTING CONTRACTOR SERVICES.

FIRST USE ; IN COMMERCE .  
INT. CL. 39/U.S. CLS. 100 AND 105

FOR DELIVERY OF STEELWORKS PRODUCTS VIA NAMELY, TRUCK, RAIL, SHIP; TRAVEL AGENCY SERVICES, NAMELY, MAKING RESERVATIONS AND BOOKINGS FOR TRANSPORTATION.

FIRST USE ; IN COMMERCE .  
INT. CL. 42/U.S. CLS. 100 AND 101

FOR SERVICES IN THE FIELD OF STEEL AND OF ITS APPLICATIONS, NAMELY, ENGINEERING SPECIFICATION CONSULTING, TECHNICAL DESIGN CONSULTING; SERVICES FOR THE PROTECTION OF THE ENVIRONMENT, NAMELY, ENVIRONMENTAL ENGINEERING; ENVIRONMENTAL RESEARCH, ANALYSIS, AND CONSULTATION; ZOOTECNICAL BREEDING, NAMELY, ANIMAL BREEDING.

FIRST USE ; IN COMMERCE .

ELEMENTS CORRECTED  
OWNER ADDRESS  
FOREIGN REG. DATE  
FOREIGN REG. EXPIRATION DATE

2,678,598. REG. 1-21-2003. OPNET TECHNOLOGIES, INC. (DELAWARE CORPORATION) 3400 INTERNATIONAL DRIVE, N.W., WASHINGTON, DC, 20008, SN 75-911,937. FILED 2-7-2000. PRINCIPAL REGISTER.

## OPNET TECHNOLOGIES, INC.

OWNER OF U.S. REG. NOS. 1,571,693, 2,209,632 AND OTHERS.

NO CLAIM IS MADE TO THE EXCLUSIVE RIGHT TO USE "TECHNOLOGIES, INC.", APART FROM THE MARK AS SHOWN.

INT. CL. 9/U.S. CLS. 21, 23, 26, 36 AND 38

FOR COMPUTER PROGRAMS FOR COMPUTER NETWORK MODELING AND SIMULATION AND PROGRAM MANUALS SOLD AS A UNIT THEREWITH.

FIRST USE 2-1-2000; IN COMMERCE 2-2-2000.  
INT. CL. 41/U.S. CLS. 100, 101 AND 107

FOR PROVIDING EDUCATIONAL SEMINARS, TRAINING COURSES AND CUSTOMIZED TRAINING SESSIONS IN THE FIELD OF COMPUTER NETWORK MODELING AND [ STIMULATION ] \* SIMULATION \*.

FIRST USE 2-1-2000; IN COMMERCE 2-2-2000.  
INT. CL. 42/U.S. CLS. 100 AND 101

FOR COMPUTER CONSULTING SERVICES, NAMELY CONSULTING IN THE FIELD OF COMPUTER NETWORK MODELING AND [ STIMULATION ] \* SIMULATION \*.

FIRST USE 2-1-2000; IN COMMERCE 2-2-2000.

ELEMENTS CORRECTED  
GOODS/SERVICES  
OWNER NAME

2,703,441. REG. 4-8-2003. FEDERATION INTERNATIONALE DE SOCIETES D'AVIRON (SWITZERLAND FEDERATION) AVENUE DE COUR 135, 1007 LAUSANNE, SWITZERLAND., SN 75-883,981. FILED 12-30-1999. PRINCIPAL REGISTER.



PRIORITY CLAIMED UNDER SEC. 44(D) ON SWITZERLAND APPLICATION NO. 08469/1999, FILED 9-21-1999, REG. NO. 482203, DATED 9-21-1999.

NO CLAIM IS MADE TO THE EXCLUSIVE RIGHT TO USE "WORLD ROWING", APART FROM THE MARK AS SHOWN.

INT. CL. 9/U.S. CLS. 21, 23, 26, 36 AND 38

FOR NAVIGATIONAL EQUIPMENT, NAMELY, BUOYS AND BEACON LIGHTS; SIGNAL BELLS; PHOTOGRAPHIC EQUIPMENT, NAMELY, PHOTOGRAPHIC PROJECTORS, PHOTOGRAPHIC SLIDE TRANSPARENCIES, PHOTOGRAPHIC CAMERAS, PHOTOGRAPHIC FLASH BULBS TO DETERMINE THE FINISH OF A ROWING RACE; UNEXPOSED PHOTOGRAPHIC AND CINEMAGRAPHIC FILM; BINOCULARS; WEIGHING VEHICLES; LIFE RAFTS, LIFE NETS, LIFE BUOYS, LIFE JACKETS, LIFE BELTS; PROTECTIVE CLOTHING, NAMELY HELMETS, HATS, GLOVES AND GOGGLES; TEACHING EQUIPMENT USED IN THE TEACHING AND TRAINING OF ROWING, NAMELY, STROKE COUNTERS, STROKE TIMERS, MEGAPHONES, PITCH METERS, SCULLING SPAN METERS AND AUDIO VISUAL TEACHING AIDES, NAMELY, PRERECORDED VIDEO RECORDINGS, CD-ROMS, CDS, AUDIO DISKS AND AUDIO TAPES ALL FEATURING TEACHING AND INSTRUCTIONAL MATERIALS AND DATA ON THE SUBJECT OF ROWING AND SPORTS IN GENERAL; TELEVISION CAMERAS, VIDEO CAMERAS, DIGITAL CAMERAS, WEBCAMS, VIDEO RECORDINGS, VIDEO TAPES, VIDEO DISKS, VIDEO CASSETTES, VIDEO CARTRIDGES, AUDIO CARTRIDGES, CDS, CD-ROMS, CDIS, DISKS, TAPES, AUDIO TAPES, ALL FEATURING ENTERTAINMENT AND INFORMATION CONCERNING THE SPORT OF ROWING, ROWING COMPETITIONS, SPORTSMEN AND SPORTSWOMEN; AUDIO CASSETTE PLAYERS AND RECORDERS FOR USE IN BEARING VIDEO OR SOUND RECORDINGS FOR THE TRANSMISSION OR REPRODUCTION OF SOUND OR IMAGES VIA TELEVISION AND THE GLOBAL COMPUTER NETWORK; LOUDSPEAKERS; INTERNALLY AMPLIFIED SPEAKER SYSTEMS FOR USE IN BOATS; SPEAKERS AND MICROPHONES; BLANK MAGNETIC DATA CARRIERS AND BLANK COMPACT DISKS; PRE-RECORDED MAGNETIC DATA CARRIERS AND PRE-RECORDED VIDEO CASSETTES IN THE FIELD OF ROWING; AUTOMATIC VENDING MACHINES; CASH REGISTERS; CALCULATORS; DATA PROCESSORS AND COMPUTERS; FIRE EXTINGUISHERS; ELECTRONIC PUBLICATIONS, NAMELY BOOKS, JOURNALS, MAGAZINES, NEWSPAPERS, NEWSPAPER AND PAMPHLETS FOR DISTRIBUTION TO THE TELEVISION AND RADIO MEDIA, BROCHURES, HANDBOOKS, CATALOGS, GUIDELINES AND INSTRUCTIONAL MANUALS, COMMEMORATIVE GAMES AND PROGRAMS, EVENT PROGRAMS, MAPS, PLANS, CHARTS AND STATISTICAL BOOKS, ALL RE-

CORDED ON CD-ROM IN THE FIELD OF ROWING; COMPUTER SOFTWARE FOR USE IN ACCESSING THE GLOBAL COMPUTER NETWORK; ELECTRONIC ROWING MACHINES; ELECTRONIC BUZZERS; ARCHING AND SIGNALING BUOYS; ELECTRIC MEASURING DEVICES AND MEASURING INSTRUMENTS, NAMELY WIND METERS, INSTRUMENTS TO MEASURE THE TIMING OF A ROWING RACE USED IN CONNECTION WITH THE CONDUCT OF ROWING REGATTAS AND OTHER SPORTING EVENTS; ANEMOMETERS, CHRONOMETERS; COMPUTERS USED TO MEASURE THE TIME OF A ROWING RACE; SPEEDOMETERS, WATER SPEED SENSORS AND WATER LEVEL INDICATORS, RATING METERS USED TO MEASURE STROKES TAKEN IN ROWING; PEDOMETERS; SAFETY PRODUCTS, NAMELY REFLECTIVE DISKS TO BE WORN ON THE BODY; AND MARINE COMPASSES; MOUSE PADS; PARLOR TYPE COMPUTER GAME PROGRAMS; VIDEO OUTPUT GAME MACHINES FOR USE WITH TELEVISIONS; ERGOMETERS FOR SPORTS TRAINING EQUIPMENT.

FIRST USE ; IN COMMERCE .

INT. CL. 16/U.S. CLS. 2, 5, 22, 23, 29, 37, 38 AND 50

FOR PAPER, CARDBOARD AND GOODS MADE FROM THESE MATERIALS, NAMELY PAPER BAGS, PAPER CONTAINERS, WRITING PAPER, LOOSE LEAF NOTEBOOKS, LOOSE LEAF BINDERS, BINDER NOTEBOOKS, NOTEBOOKS, SPIRAL BOUND NOTEBOOKS, WIRE BOUND NOTEBOOKS, PORTFOLIO NOTEBOOKS, ACTIVITY BOOKS, STATISTICAL BOOKS AND WORD NOTEBOOKS, PADS OF PAPER, MEMO PADS, REPORT PAPER, LABELS, PAPER TAPE AND CARDS USED IN DATA PROCESSING, SCRATCH CARDS, ENTERTAINMENT CARDS, GIFT TAGS, GIFT VOUCHERS, ENVELOPES, PAPER NAPKINS AND SERVIETTES; FLAGS OF PAPER AND FLAGS OF LAMINATED PAPER THAT ARE FOR USE IN CONNECTION WITH OR FOR THE PROMOTION OF ROWING; BOOKS, JOURNALS, MAGAZINES, NEWSPAPERS, NEWSPAPER AND PAMPHLETS FOR DISTRIBUTION TO THE TELEVISION AND RADIO MEDIA, BROCHURES, HANDBOOKS, CATALOGS, GUIDELINES AND INSTRUCTION MANUALS, COMMEMORATIVE GAME PROGRAMS, EVENT PROGRAMS, MAPS, PLANS, CHARTS, STATISTICAL BOOKS, POSTERS, POSTCARDS AND PRINTS IN THE FIELD OF ROWING; BOOK BINDING MATERIALS, NAMELY BOOK BINDING CLEF, TAPE OR WIRE; UNMOUNTED AND MOUNTED PHOTOGRAPHS; CARDBOARD; STATIONARY; ADHESIVES FOR STATIONARY OR HOUSEHOLD PURPOSES; ARTISTS' MATERIALS, NAMELY ARTISTS' PENCILS, PASTELS OR BRUSHES; PAINT BRUSHES; TYPEWRITERS; OFFICE SUPPLIES, NAMELY WRITING INSTRUMENTS INCLUDING PENS, BALL PENS, FELT PENS, NIB PENS, PENCILS AND MECHANICAL PENCILS AND INKS; BOOK BANDS; BOXES; PEN CASES; PENCIL BOXES; PENCIL CASES; PEN STANDS; PENCIL STANDS; PEN, PENCIL, PEN AND PENCIL TRAYS; TRANSFER BOXES; TRANSFER CASES; MAGNETIC CLIPS; ENVELOPES; RUBBER ERASERS; FILES; FOLDERS; CARD HOLDERS; MEMO HOLDERS; LOOSE LEAF; DESK MATS, LETTER PAPERS, BLOTTERS, MENUS; PHOTO STANDS; PHOTOGRAPH HOLDERS; LETTER RACKS; LETTER RESTS; OFFICE RULERS; STICKERS; TAPES; TRANSFERS AND DECALS; INSTRUCTIONAL AND TEACHING MANUALS IN THE FIELD OF ROWING; HANDBOOKS AND GUIDELINES IN THE FIELD OF ROWING; PLASTIC BUBBLE WRAP FOR USE IN PACKAGING; PLAYING CARDS; PRINTING BLOCKS; COMMEMORATIVE ROWING STAMPS; PAPER ADVERTISING SIGNS AND BANNERS FOR USE IN CONNECTION WITH OR FOR THE PROMOTION FOR THE SPORT OF ROWING; PLAYING CARDS.

FIRST USE ; IN COMMERCE .

INT. CL. 18/U.S. CLS. 1, 2, 3, 22 AND 41

FOR ARTICLES MADE OF LEATHER AND/OR IMITATION LEATHER NAMELY, LUGGAGE, BOOT BAGS, BEACH BAGS, TOTE BAGS, TOOL BAGS SOLD EMPTY, VALISES, KNAPSACKS, SATCHELS, GARMENT BAGS, BACKPACKS, DUFFEL BAGS, [ HOLD-AILS ] \* HOLD-ALLS \* AND HAND BAGS; CASES, NAMELY VANITY CASES, SUITCASES, PILOT CASES, BRIEFCASES, ATTACHE CASES, PASSPORT CASES AND KEY CASES; WALLETS AND PURSES, CREDIT CARD HOLDERS, BUSINESS CARD HOLDERS; BELTS; ANIMAL SKINS; HIDES; TRUNKS AND TRAVELING BAGS; UMBRELLAS, PARASOLS AND WALKING STICKS; WHIPS, HARNESS AND SADDLERY; AND ALL PURPOSE ATHLETIC BAGS.

FIRST USE ; IN COMMERCE .

INT. CL. 25/U.S. CLS. 22 AND 39

FOR CLOTHING USED IN THE SPORT OF ROWING NAMELY, THERMAL SHIRTS, THERMAL TIGHTS, TRAINER TIGHTS, SPORTS SHORTS, TEAR-AWAY PANTS, VESTS AND SWEATSHIRTS; FOOTWEAR, HEADWEAR; ROWING SUITS; UNITARDS; ROWING TOPS, PANTS AND SUITS MADE OF SWEAT ABSORBENT MATERIAL; DRIVING GLOVES.

FIRST USE ; IN COMMERCE .

INT. CL. 28/U.S. CLS. 22, 23, 38 AND 50

FOR GAMES AND PLAYTHINGS NAMELY, BALLS FOR PLAYING GOLF, CRICKET, FIELD HOCKEY, RACQUET BALL, RUGBY, SOCCER, SQUASH AND TENNIS; GAMES, TOYS AND PLAYTHINGS, NAMELY, ELECTRONIC GAMES, NAMELY, ARCADE-TYPE ELECTRONIC EDUCATION VIDEO GAMES, ELECTRONIC EDUCATIONAL GAME MACHINES FOR CHILDREN, ELECTRONIC GAME EQUIPMENT WITH A WATCH FUNCTION, HAND HELD UNIT FOR PLAYING ELECTRONIC GAMES, DOLLS AND DOLLS' CLOTHING AND ACCESSORIES FOR DOLLS INCLUDING DOLLS' HOUSES AND DOLLS' FURNITURE, TEDDY BEARS, TOY ACTION FIGURES, TOY VEHICLES, SCALE MODEL VEHICLES, SOFT TOYS, BALLOONS, TOY MONEY BOXES, TOY BICYCLES, ANIMAL AND/OR VEHICLE TRACKS AND RACING SETS, ELECTRONIC HAND HELD GAMES UNITS, HAND HELD UNIT FOR PLAYING COMPUTER GAMES, CARD GAMES, DICE GAMES, BOARD GAMES, PARLOR GAMES, ACTION TYPE TARGET GAMES; ARCADE GAME MACHINES, JIGSAW AND MANIPULATIVE PUZZLES, COMMEMORATIVE BOARD GAMES; TOY, NAMELY, BATTERY POWERED COMPUTER GAME WHICH FEATURES SOUND EFFECTS; GYMNASIAC AND SPORTING TRAINING EQUIPMENT FOR USE IN RELATION TO ROWING TRAINING, NAMELY EXERCISE TREADMILLS, STATIONARY EXERCISE BICYCLES, ROWING MACHINES, WATER ROWING MACHINES, WEIGHT LIFTING MACHINES; DECORATIONS FOR CHRISTMAS TREES; AIR RESISTANCE OR WATER RESISTANCE ROWING MACHINES; ERGOMETERS SOLD AS A UNIT WITH AIR RESISTANCE OR WATER RESISTANCE ROWING MACHINES; FOOT STRAPS FOR USE IN ROWING, GLOVES FOR GAMES AND ROWING; GYMNASIAC, BODY TRAINING AND BODY BUILDING APPARATUS FOR USE IN RELATION TO ROWING; SHINGUARDS AND SPORTING BAGS AND CONTAINERS ADAPTED FOR CARRYING SPORTS ARTICLES, PARTICULARLY ROWING EQUIPMENT; SPORTS EQUIPMENT AND SPORTING GOODS, NAMELY ROWING MACHINES.

FIRST USE ; IN COMMERCE .

INT. CL. 35/U.S. CLS. 100, 101 AND 102

FOR ELECTRONIC RETAILING SERVICES VIA COMPUTER AND/OR INTERACTIVE COMMUNICATIONS TECHNOLOGIES IN THE FIELDS OF SPORTS RELATED EQUIPMENT, CLOTHING, GAMES AND PLAYTHINGS, MEMORABILIA AND GENERAL MERCHANDISE; PROVIDING FACILITIES FOR BUSINESS MEETINGS.

FIRST USE ; IN COMMERCE .

INT. CL. 38/U.S. CLS. 100, 101 AND 104

FOR TELECOMMUNICATION SERVICES NAMELY RADIO, TELEVISION TRANSMISSION SERVICES; TRANSMISSION OF MESSAGES AND DATA VIA AN ON-LINE GLOBAL COMPUTER NETWORK; RADIO AND TELEVISION BROADCASTING SERVICES VIA AN ON-LINE GLOBAL COMPUTER NETWORK AND/OR AN INTER COMPUTER COMMUNICATIONS NETWORKS AND ON-LINE PAY-PER-VIEW TELEVISION TRANSMISSIONS SERVICES AND INTERACTIVE SUBSCRIPTION BROADCAST SERVICES; BROADCASTING OF SPORTS AND SPORTING EVENTS VIA AN ON-LINE COMPUTER NETWORK.

FIRST USE ; IN COMMERCE .

INT. CL. 41/U.S. CLS. 100, 101 AND 107

FOR – EDUCATIONAL SERVICES, NAMELY PROVIDING CLASSES, TRAINING SEMINARS, SYMPOSIUMS, WORKSHOPS, EXHIBITIONS IN RELATION TO THE SPORT OF ROWING; PUBLICATION OF TRAINING GUIDELINES, HANDBOOKS AND MANUALS, IN THE FIELD OF THE SPORT OF ROWING; PRODUCTION OF VIDEOS AND CDS IN THE FIELD OF THE SPORT OF ROWING; CONDUCTING CLASSES, SEMINARS, CONFERENCES AND WORKSHOPS IN THE FIELD OF ROWING; TRAINING SPORTS REFEREES AND LINESMAN; ENTERTAINMENT SERVICES, NAMELY, PLANNING AND CONDUCTING ROWING COMPETITIONS AND ROWING EVENTS; ORGANIZING COMMUNITY EVENTS FEATURING A VARIETY OF ACTIVITIES, NAMELY SPORTING EVENTS, EXHIBITIONS, GAMES AND SHOWS RELATED TO ROWING; PROVIDING INFORMATION IN THE FIELDS OF SPORTING, ENTERTAINMENT AND EDUCATION IN THE FIELD OF ROWING VIA AN ON-LINE COMPUTER DATABASE OR THE GLOBAL COMPUTER NETWORK; ORGANIZATION OF ROWING REGATTAS; PROVIDING INFORMATION RELATING TO THE AFORESAID; PROVIDING INFORMATION IN THE FIELDS OF SPORTING, ENTERTAINMENT AND EDUCATION, NAMELY IN THE FIELD OF ROWING, VIA AN ON-LINE COMPUTER DATABASE OR THE GLOBAL COMPUTER NETWORK; RADIO AND TELEVISION PROGRAMMING SERVICES VIA AN ONLINE GLOBAL COMPUTER NETWORK AND/OR INTER COMPUTER COMMUNICATIONS NETWORK; PROVIDING ON-LINE ENTERTAINMENT IN THE NATURE OF INTERACTIVE SPORTING GAMES VIA GLOBAL COMPUTER NETWORK; PROVIDING FACILITIES FOR BUSINESS TO ENTERTAIN CLIENTS IN THE NATURE OF SPORTS FACILITIES.

FIRST USE ; IN COMMERCE .

INT. CL. 42/U.S. CLS. 100 AND 101

FOR COMPUTER SERVICES, NAMELY PROVIDING ON-LINE BOOKS, JOURNALS, MAGAZINES, NEWSPAPERS, NEWSPAPER AND PAMPHLETS FOR DISTRIBUTION TO THE TELEVISION AND RADIO MEDIA, BROCHURES, HAND BOOKS, CATALOGS, GUIDELINES, INSTRUCTIONAL MANUALS, COMMEMORATIVE GAMES PROGRAMS, EVENTS PROGRAMS, MAPS, PLANS, CHARTS AND STATISTICAL BOOKS IN THE FIELD OF ROWING; RESTAURANT SERVICES; PROVIDING TEMPORARY HOUSING ACCOMMODATIONS; MEDICAL SERVICES; VETERINARY SERVICES; LEGAL SERVICES; SCIENTIFIC AND INDUSTRIAL RESEARCH; COMPUTER PROGRAMMING FOR OTHERS; PROVISION OF HOTEL SERVICES; TRAVEL AGENCY SERVICES FOR BOOKING ACCOMMODATION, RENTAL OF ROOMS, PROVIDING FACILITIES FOR BUSINESS TO ENTERTAIN CLIENTS IN THE NATURE OF PROVIDING BANQUET AND SOCIAL FUNCTION FACILITIES FOR SPECIAL OCCASIONS; PROVISION OF MEDICAL ADVICE AND ASSISTANCE ALL RELATING TO OR FOR THE PROMOTION OF SPORTS, NAMELY ROWING; PROVISION OF INFORMATION BY MEANS OF COMPUTER DATABASES IN RELATION TO ADVICE ON SURGERIES IN THE FIELD OF ROWING INJURIES.

FIRST USE ; IN COMMERCE .

ELEMENTS AMENDED  
GOODS/SERVICES

2,705,785. REG. 4-15-2003. FEDERATION INTERNATIONALE DE SOCIETES D'AVIRON (SWITZERLAND FEDERATION) AVENUE DE COUR 135, 1007 LAUSANNE, SWITZERLAND., SN 75-883,984. FILED 12-30-1999. PRINCIPAL REGISTER.

## FISA WORLD ROWING CHAMPIONSHIPS

PRIORITY CLAIMED UNDER SEC. 44(D) ON SWITZERLAND APPLICATION NO. 08467/1999, FILED 9-21-1999, REG. NO. 482123, DATED 2-28-2001.

NO CLAIM IS MADE TO THE EXCLUSIVE RIGHT TO USE "WORLD ROWING CHAMPIONSHIPS", APART FROM THE MARK AS SHOWN.

INT. CL. 9/U.S. CLS. 21, 23, 26, 36 AND 38

FOR NAVIGATIONAL EQUIPMENT, NAMELY, BUOYS AND BEACON LIGHTS; SIGNAL BELLS; PHOTOGRAPHIC EQUIPMENT, NAMELY, PHOTOGRAPHIC PROJECTORS, PHOTOGRAPHIC SLIDE TRANSPARENCIES, PHOTOGRAPHIC CAMERAS, PHOTOGRAPHIC FLASH BULBS TO DETERMINE THE FINISH OF A ROWING RACE; UNEXPOSED PHOTOGRAPHIC AND CINEMAGRAPHIC FILM; BINOCULARS; WEIGHING VEHICLES; LIFE RAFTS, LIFE NETS, LIFE BUOYS, LIFE JACKETS, LIFE BELTS; PROTECTIVE CLOTHING, NAMELY HELMETS, HATS, GLOVES AND GOGGLES; TEACHING EQUIPMENT USED IN THE TEACHING AND TRAINING OF ROWING, NAMELY, STROKE COUNTERS, STROKE TIMERS, MEGAPHONES, PITCH METERS, SCULLING SPAN METERS AND AUDIO VISUAL TEACHING AIDES, NAMELY, PRERECORDED VIDEO RECORDINGS, CD-ROMS, CDS, AUDIO DISKS AND AUDIO TAPES ALL FEATURING TEACHING AND INSTRUCTIONAL MATERIALS AND DATA ON THE SUBJECT OF ROWING AND SPORTS IN GENERAL; TELEVISION CAMERAS, VIDEO CAMERAS, DIGITAL CAMERAS, WEBCAMS, VIDEO RECORDINGS, VIDEO TAPES, VIDEO DISKS, VIDEO CASSETTES, VIDEO CARTRIDGES, AUDIO CARTRIDGES, CDS, CD-ROMS, CDS, DISKS, TAPES, AUDIO TAPES, ALL FEATURING ENTERTAINMENT AND INFORMATION CONCERNING THE SPORT OF ROWING, ROWING COMPETITIONS, SPORTSMEN AND SPORTSWOMEN; AUDIO CASSETTE PLAYERS AND RECORDERS FOR USE IN BEARING VIDEO OR SOUND RECORDINGS FOR THE TRANSMISSION OR REPRODUCTION OF SOUND OR IMAGES VIA TELEVISION AND THE GLOBAL COMPUTER NETWORK; LOUDSPEAKERS; INTERNALLY AMPLIFIED SPEAKER SYSTEMS FOR USE IN BOATS; SPEAKERS AND MICROPHONES; BLANK MAGNETIC DATA CARRIERS AND BLANK COMPACT DISKS; PRE-RECORDED MAGNETIC DATA CARRIERS AND PRE-RECORDED VIDEO CASSETTES IN THE FIELD OF ROWING; AUTOMATIC VENDING MACHINES; CASH REGISTERS; CALCULATORS; DATA PROCESSORS AND COMPUTERS; FIRE EXTINGUISHERS; ELECTRONIC PUBLICATIONS, NAMELY BOOKS, JOURNALS, MAGAZINES, NEWSPAPERS, NEWSPAPER AND PAMPHLETS FOR DISTRIBUTION TO THE TELEVISION AND RADIO MEDIA, BROCHURES, HANDBOOKS, CATALOGS, GUIDELINES AND INSTRUCTIONAL MANUALS, COMMEMORATIVE GAMES AND PROGRAMS, EVENT PROGRAMS, MAPS, PLANS, CHARTS AND STATISTICAL BOOKS, ALL RECORDED ON CD-ROM IN THE FIELD OF ROWING; COMPUTER SOFTWARE FOR USE IN ACCESSING THE GLOBAL COMPUTER NETWORK; ELECTRONIC ROWING MACHINES; ELECTRONIC BUZZERS; ARCHING AND SIGNALING BUOYS; ELECTRIC MEASURING DEVICES AND MEASURING INSTRUMENTS, NAMELY WIND METERS, INSTRUMENTS TO MEASURE THE TIMING OF A ROWING RACE USED IN CONNECTION WITH THE CONDUCT OF ROWING REGATTAS AND



OTHER SPORTING EVENTS; ANEMOMETERS, CHRONOMETERS; COMPUTERS USED TO MEASURE THE TIME OF A ROWING RACE; SPEEDOMETERS, WATER SPEED SENSORS AND WATER LEVEL INDICATORS, RATING METERS USED TO MEASURE STROKES TAKEN IN ROWING; PEDOMETERS; SAFETY PRODUCTS, NAMELY REFLECTIVE DISKS TO BE WORN ON THE BODY; AND MARINE COMPASSES; MOUSE PADS; PARLOR TYPE COMPUTER GAME PROGRAMS; VIDEO OUTPUT GAME MACHINES FOR USE WITH TELEVISIONS; ERGOMETERS FOR SPORTS TRAINING EQUIPMENT.

FIRST USE ; IN COMMERCE .

INT. CL. 16/U.S. CLS. 2, 5, 22, 23, 29, 37, 38 AND 50

FOR PAPER, CARDBOARD AND GOODS MADE FROM THESE MATERIALS, NAMELY PAPER BAGS, PAPER CONTAINERS, WRITING PAPER, LOOSE LEAF NOTEBOOKS, LOOSE LEAF BINDERS, BINDER NOTEBOOKS, NOTEBOOKS, SPIRAL BOUND NOTEBOOKS, WIRE BOUND NOTEBOOKS, PORTFOLIO NOTEBOOKS, ACTIVITY BOOKS, STATISTICAL BOOKS AND WORD NOTEBOOKS, PADS OF PAPER, MEMO PADS, REPORT PAPER, LABELS, PAPER TAPE AND CARDS USED IN DATA PROCESSING, SCRATCH CARDS, ENTERTAINMENT CARDS, GIFT TAGS, GIFT VOUCHERS, ENVELOPES, PAPER NAPKINS AND SERVIETTES; FLAGS OF PAPER AND FLAGS OF LAMINATED PAPER THAT ARE FOR USE IN CONNECTION WITH OR FOR THE PROMOTION OF ROWING; BOOKS, JOURNALS, MAGAZINES, NEWSPAPERS, NEWSPAPER AND PAMPHLETS FOR DISTRIBUTION TO THE TELEVISION AND RADIO MEDIA, BROCHURES, HANDBOOKS, CATALOGS, GUIDELINES AND INSTRUCTION MANUALS, COMMEMORATIVE GAME PROGRAMS, EVENT PROGRAMS, MAPS, PLANS, CHARTS, STATISTICAL BOOKS, POSTERS, POSTCARDS AND PRINTS IN THE FIELD OF ROWING; BOOK BINDING MATERIALS, NAMELY BOOK BINDING CLEF, TAPE OR WIRE; UNMOUNTED AND MOUNTED PHOTOGRAPHS; CARDBOARD; STATIONARY; ADHESIVES FOR STATIONARY OR HOUSEHOLD PURPOSES; ARTISTS' MATERIALS, NAMELY ARTISTS' PENCILS, PASTELS OR BRUSHES; PAINT BRUSHES; TYPEWRITERS; OFFICE SUPPLIES, NAMELY WRITING INSTRUMENTS INCLUDING PENS, BALL PENS, FELT PENS, NIB PENS, PENCILS AND MECHANICAL PENCILS AND INKS; BOOK BANDS; BOXES; PEN CASES; PENCIL BOXES; PENCIL CASES; PEN STANDS; PENCIL STANDS; PEN, PENCIL, PEN AND PENCIL TRAYS; TRANSFER BOXES; TRANSFER CASES; MAGNETIC CLIPS; ENVELOPES; RUBBER ERASERS; FILES; FOLDERS; CARD HOLDERS; MEMO HOLDERS; LOOSE LEAF; DESK MATS, LETTER PAPERS, BLOTTERS, MENUS; PHOTO STANDS; PHOTOGRAPH HOLDERS; LETTER RACKS; LETTER RESTS; OFFICE RULERS; STICKERS; TAPES; TRANSFERS AND DECALS; INSTRUCTIONAL AND TEACHING MANUALS IN THE FIELD OF ROWING; HANDBOOKS AND GUIDELINES IN THE FIELD OF ROWING; PLASTIC BUBBLE WRAP FOR USE IN PACKAGING; PLAYING CARDS; PRINTING BLOCKS; COMMEMORATIVE ROWING STAMPS; PAPER ADVERTISING SIGNS AND BANNERS FOR USE IN CONNECTION WITH OR FOR THE PROMOTION FOR THE SPORT OF ROWING; PLAYING CARDS.

FIRST USE ; IN COMMERCE .

INT. CL. 18/U.S. CLS. 1, 2, 3, 22 AND 41

FOR ARTICLES MADE OF LEATHER AND/OR IMITATION LEATHER NAMELY, LUGGAGE, BOOT BAGS, BEACH BAGS, TOTE BAGS, TOOL BAGS SOLD EMPTY, VALISES, KNAPSACKS, SATCHELS, GARMENT BAGS, BACKPACKS, DUFFEL BAGS, [ HOLD-AILS ] \* HOLD-ALLS \* AND HAND BAGS; CASES, NAMELY VANITY CASES, SUITCASES, PILOT CASES, BRIEFCASES, ATTACHE CASES, PASSPORT CASES AND KEY CASES; WALLETS AND PURSES, CREDIT CARD HOLDERS, BUSINESS CARD HOLDERS; BELTS; ANIMAL SKINS; HIDES; TRUNKS AND TRAVELING BAGS; UMBRELLAS, PARASOLS AND WALKING STICKS; WHIPS, HARNESS AND SADDLERY; AND ALL PURPOSE ATHLETIC BAGS.

FIRST USE ; IN COMMERCE .

INT. CL. 25/U.S. CLS. 22 AND 39

FOR CLOTHING USED IN THE SPORT OF ROWING NAMELY, THERMAL SHIRTS, THERMAL TIGHTS, TRAINER TIGHTS, SPORTS SHORTS, TEAR-AWAY PANTS, VESTS AND SWEATSHIRTS; FOOTWEAR, HEADWEAR; ROWING SUITS; UNITARDS; ROWING TOPS, PANTS AND SUITS MADE OF SWEAT ABSORBENT MATERIAL; DRIVING GLOVES.

FIRST USE ; IN COMMERCE .

INT. CL. 28/U.S. CLS. 22, 23, 38 AND 50

FOR GAMES AND PLAYTHINGS NAMELY, BALLS FOR PLAYING GOLF, CRICKET, FIELD HOCKEY, RACQUET BALL, RUGBY, SOCCER, SQUASH AND TENNIS; GAMES, TOYS AND PLAYTHINGS, NAMELY, ELECTRONIC GAMES, NAMELY, ARCADE-TYPE ELECTRONIC EDUCATION VIDEO GAMES, ELECTRONIC EDUCATIONAL GAME MACHINES FOR CHILDREN, ELECTRONIC GAME EQUIPMENT WITH A WATCH FUNCTION, HAND HELD UNIT FOR PLAYING ELECTRONIC GAMES, DOLLS AND DOLLS' CLOTHING AND ACCESSORIES FOR DOLLS INCLUDING DOLLS' HOUSES AND DOLLS' FURNITURE, TEDDY BEARS, TOY ACTION FIGURES, TOY VEHICLES, SCALE MODEL VEHICLES, SOFT TOYS, BALLOONS, TOY MONEY BOXES, TOY BICYCLES, ANIMAL AND/OR VEHICLE TRACKS AND RACING SETS, ELECTRONIC HAND HELD GAMES UNITS, HAND HELD UNIT FOR PLAYING COMPUTER GAMES, CARD GAMES, DICE GAMES, BOARD GAMES, PARLOR GAMES, ACTION TYPE TARGET GAMES; ARCADE GAME MACHINES, JIGSAW AND MANIPULATIVE PUZZLES, COMMEMORATIVE BOARD GAMES; TOY, NAMELY, BATTERY POWERED COMPUTER GAME WHICH FEATURES SOUND EFFECTS; GYMNASIAC AND SPORTING TRAINING EQUIPMENT FOR USE IN RELATION TO ROWING TRAINING, NAMELY EXERCISE TREADMILLS, STATIONARY EXERCISE BICYCLES, ROWING MACHINES, WATER ROWING MACHINES, WEIGHT LIFTING MACHINES; DECORATIONS FOR CHRISTMAS TREES; AIR RESISTANCE OR WATER RESISTANCE ROWING MACHINES; ERGOMETERS SOLD AS A UNIT WITH AIR RESISTANCE OR WATER RESISTANCE ROWING MACHINES; FOOT STRAPS FOR USE IN ROWING, GLOVES FOR GAMES AND ROWING; GYMNASIAC, BODY TRAINING AND BODY BUILDING APPARATUS FOR USE IN RELATION TO ROWING; SHINGUARDS AND SPORTING BAGS AND CONTAINERS ADAPTED FOR CARRYING SPORTS ARTICLES, PARTICULARLY ROWING EQUIPMENT; SPORTS EQUIPMENT AND SPORTING GOODS, NAMELY ROWING MACHINES.

FIRST USE ; IN COMMERCE .

INT. CL. 35/U.S. CLS. 100, 101 AND 102

FOR ELECTRONIC RETAILING SERVICES VIA COMPUTER AND/OR INTERACTIVE COMMUNICATIONS TECHNOLOGIES IN THE FIELDS OF SPORTS RELATED EQUIPMENT, CLOTHING, GAMES AND PLAYTHINGS, MEMORABILIA AND GENERAL MERCHANDISE; PROVIDING FACILITIES FOR BUSINESS MEETINGS.

FIRST USE ; IN COMMERCE .

INT. CL. 38/U.S. CLS. 100, 101 AND 104

FOR TELECOMMUNICATION SERVICES NAMELY RADIO, TELEVISION TRANSMISSION SERVICES; TRANSMISSION OF MESSAGES AND DATA VIA AN ON-LINE GLOBAL COMPUTER NETWORK; RADIO AND TELEVISION BROADCASTING SERVICES VIA AN ON-LINE GLOBAL COMPUTER NETWORK AND/OR AN INTER COMPUTER COMMUNICATIONS NETWORKS AND ON-LINE PAY-PER-VIEW TELEVISION TRANSMISSIONS SERVICES AND INTERACTIVE SUBSCRIPTION BROADCAST SERVICES; BROADCASTING OF SPORTS AND SPORTING EVENTS VIA AN ONLINE COMPUTER NETWORK.

FIRST USE ; IN COMMERCE .

INT. CL. 41/U.S. CLS. 100, 101 AND 107

FOR EDUCATIONAL SERVICES, NAMELY PROVIDING CLASSES, TRAINING SEMINARS, SYMPOSIUMS, WORKSHOPS, EXHIBITIONS IN RELATION TO THE SPORT OF ROWING; PUBLICATION OF TRAINING GUIDELINES, HANDBOOKS AND MANUALS, IN THE FIELD OF THE SPORT OF ROWING; PRODUCTION OF VIDEOS AND CDS IN THE FIELD OF THE SPORT OF ROWING; CONDUCTING CLASSES, SEMINARS, CONFERENCES AND WORKSHOPS IN THE FIELD OF ROWING; TRAINING SPORTS REFEREES AND LINESMAN; ENTERTAINMENT SERVICES, NAMELY, PLANNING AND CONDUCTING ROWING COMPETITIONS AND ROWING EVENTS; ORGANIZING COMMUNITY EVENTS FEATURING A VARIETY OF ACTIVITIES, NAMELY SPORTING EVENTS, EXHIBITIONS, GAMES AND SHOWS RELATED TO ROWING; PROVIDING INFORMATION IN THE FIELDS OF SPORTING, ENTERTAINMENT AND EDUCATION IN THE FIELD OF ROWING VIA AN ON-LINE COMPUTER DATABASE OR THE GLOBAL COMPUTER NETWORK; ORGANIZATION OF ROWING REGATTAS; PROVIDING INFORMATION RELATING TO THE AFORESAID; PROVIDING INFORMATION IN THE FIELDS OF SPORTING, ENTERTAINMENT AND EDUCATION, NAMELY IN THE FIELD OF ROWING, VIA AN ON-LINE COMPUTER DATABASE OR THE GLOBAL COMPUTER NETWORK; RADIO AND TELEVISION PROGRAMMING SERVICES VIA AN ONLINE GLOBAL COMPUTER NETWORK AND/OR INTER COMPUTER COMMUNICATIONS NETWORK; PROVIDING ON-LINE ENTERTAINMENT IN THE NATURE OF INTERACTIVE SPORTING GAMES VIA GLOBAL COMPUTER NETWORK; PROVIDING FACILITIES FOR BUSINESS TO ENTERTAIN CLIENTS IN THE NATURE OF SPORTS FACILITIES.

FIRST USE ; IN COMMERCE .

INT. CL. 42/U.S. CLS. 100 AND 101

FOR COMPUTER SERVICES, NAMELY PROVIDING ON-LINE BOOKS, JOURNALS, MAGAZINES, NEWSPAPERS, NEWSPAPER AND PAMPHLETS FOR DISTRIBUTION TO THE TELEVISION AND RADIO MEDIA, BROCHURES, HAND BOOKS, CATALOGS, GUIDELINES, INSTRUCTIONAL MANUALS, COMMEMORATIVE GAMES PROGRAMS, EVENTS PROGRAMS, MAPS, PLANS, CHARTS AND STATISTICAL BOOKS IN THE FIELD OF ROWING; RESTAURANT SERVICES; PROVIDING TEMPORARY HOUSING ACCOMMODATIONS; MEDICAL SERVICES; VETERINARY SERVICES; LEGAL SERVICES; SCIENTIFIC AND INDUSTRIAL RESEARCH; COMPUTER PROGRAMMING FOR OTHERS; PROVISION OF HOTEL SERVICES; TRAVEL AGENCY SERVICES FOR BOOKING ACCOMMODATION, RENTAL OF ROOMS, PROVIDING FACILITIES FOR BUSINESS TO ENTERTAIN CLIENTS IN THE NATURE OF PROVIDING BANQUET AND SOCIAL FUNCTION FACILITIES FOR SPECIAL OCCASIONS; PROVISION OF MEDICAL ADVICE AND ASSISTANCE ALL RELATING TO OR FOR THE PROMOTION OF SPORTS, NAMELY ROWING; PROVISION OF INFORMATION BY MEANS OF COMPUTER DATABASES IN RELATION TO ADVICE ON SURGERIES IN THE FIELD OF ROWING INJURIES.

FIRST USE ; IN COMMERCE .

ELEMENTS AMENDED  
GOODS/SERVICES

2,705,786. REG. 4-15-2003. FEDERATION INTERNATIONALE DE SOCIETES D'AVIRON (SWITZERLAND FEDERATION) AVENUE DE COUR 135, 1007 LAUSANNE, SWITZERLAND., SN 75-883,987. FILED 12-30-1999. PRINCIPAL REGISTER.



PRIORITY CLAIMED UNDER SEC. 44(D) ON SWITZERLAND APPLICATION NO. 08468/1999, FILED 9-21-1999, REG. NO. 482202, DATED 9-21-1999.

NO CLAIM IS MADE TO THE EXCLUSIVE RIGHT TO USE "ROWING", APART FROM THE MARK AS SHOWN.

INT. CL. 9/U.S. CLS. 21, 23, 26, 36 AND 38

FOR NAVIGATIONAL EQUIPMENT, NAMELY, BUOYS AND BEACON LIGHTS; SIGNAL BELLS; PHOTOGRAPHIC EQUIPMENT, NAMELY, PHOTOGRAPHIC PROJECTORS, PHOTOGRAPHIC SLIDE TRANSPARENCIES, PHOTOGRAPHIC CAMERAS, PHOTOGRAPHIC FLASH BULBS TO DETERMINE THE FINISH OF A ROWING RACE; UNEXPOSED PHOTOGRAPHIC AND CINEMAGRAPHIC FILM; BINOCULARS; WEIGHING VEHICLES; LIFE RAFTS, LIFE NETS, LIFE BUOYS, LIFE JACKETS, LIFE BELTS; PROTECTIVE CLOTHING, NAMELY HELMETS, HATS, GLOVES AND GOGGLES; TEACHING EQUIPMENT USED IN THE TEACHING AND TRAINING OF ROWING, NAMELY, STROKE COUNTERS, STROKE TIMERS, MEGAPHONES, PITCH METERS, SCULLING SPAN METERS AND AUDIO VISUAL TEACHING AIDES, NAMELY, PRERECORDED VIDEO RECORDINGS, CD-ROMS, CDS, AUDIO DISKS AND AUDIO TAPES ALL FEATURING TEACHING AND INSTRUCTIONAL MATERIALS AND DATA ON THE SUBJECT OF ROWING AND SPORTS IN GENERAL; TELEVISION CAMERAS, VIDEO CAMERAS, DIGITAL CAMERAS, WEBCAMS, VIDEO RECORDINGS, VIDEO TAPES, VIDEO DISKS, VIDEO CASSETTES, VIDEO CARTRIDGES, AUDIO CARTRIDGES, CDS, CD-ROMS, CDIS, DISKS, TAPES, AUDIO TAPES, ALL FEATURING ENTERTAINMENT AND INFORMATION CONCERNING THE SPORT OF ROWING, ROWING COMPETITIONS, SPORTSMEN AND SPORTSWOMEN; AUDIO CASSETTE PLAYERS AND RECORDERS FOR USE IN BEARING VIDEO OR SOUND RECORDINGS FOR THE TRANSMISSION OR REPRODUCTION OF SOUND OR IMAGES VIA TELEVISION AND THE GLOBAL COMPUTER NETWORK; LOUDSPEAKERS; INTERNALLY AMPLIFIED SPEAKER SYSTEMS FOR USE IN BOATS; SPEAKERS AND MICROPHONES; BLANK MAGNETIC DATA CARRIERS AND BLANK COMPACT DISKS; PRE-RECORDED MAGNETIC DATA CARRIERS AND PRE-RECORDED VIDEO CASSETTES IN THE FIELD OF ROWING; AUTOMATIC VENDING MACHINES; CASH REGISTERS; CALCULATORS; DATA PROCESSORS AND COMPUTERS; FIRE EXTINGUISHERS; ELECTRONIC PUBLICATIONS, NAMELY BOOKS, JOURNALS, MAGAZINES, NEWSPAPERS, NEWSPAPER AND PAMPHLETS FOR DISTRIBUTION TO THE TELEVISION AND RADIO MEDIA, BROCHURES, HANDBOOKS, CATALOGS, GUIDELINES AND INSTRUCTIONAL MANUALS, COMMEMORATIVE GAMES AND PROGRAMS, EVENT PROGRAMS, MAPS, PLANS, CHARTS AND STATISTICAL BOOKS, ALL RECORDED ON CD-ROM IN THE FIELD OF ROWING; COMPUTER SOFTWARE FOR USE IN ACCESSING THE GLOBAL COMPUTER NETWORK; ELECTRONIC ROWING MACHINES; ELECTRONIC BUZZERS; ARCHING AND SIGNALING BUOYS; ELECTRIC MEASURING DEVICES AND MEASURING INSTRUMENTS, NAMELY

WIND METERS, INSTRUMENTS TO MEASURE THE TIMING OF A ROWING RACE USED IN CONNECTION WITH THE CONDUCT OF ROWING REGATTAS AND OTHER SPORTING EVENTS; ANEMOMETERS, CHRONOMETERS; COMPUTERS USED TO MEASURE THE TIME OF A ROWING RACE; SPEEDOMETERS, WATER SPEED SENSORS AND WATER LEVEL INDICATORS, RATING METERS USED TO MEASURE STROKES TAKEN IN ROWING; PEDOMETERS; SAFETY PRODUCTS, NAMELY REFLECTIVE DISKS TO BE WORN ON THE BODY; AND MARINE COMPASSES; MOUSE PADS; PARLOR TYPE COMPUTER GAME PROGRAMS; VIDEO OUTPUT GAME MACHINES FOR USE WITH TELEVISIONS; ERGOMETERS FOR SPORTS TRAINING EQUIPMENT.

FIRST USE ; IN COMMERCE .

INT. CL. 16/U.S. CLS. 2, 5, 22, 23, 29, 37, 38 AND 50

FOR PAPER, CARDBOARD AND GOODS MADE FROM THESE MATERIALS, NAMELY PAPER BAGS, PAPER CONTAINERS, WRITING PAPER, LOOSE LEAF NOTEBOOKS, LOOSE LEAF BINDERS, BINDER NOTEBOOKS, NOTEBOOKS, SPIRAL BOUND NOTEBOOKS, WIRE BOUND NOTEBOOKS, PORTFOLIO NOTEBOOKS, ACTIVITY BOOKS, STATISTICAL BOOKS AND WORD NOTEBOOKS, PADS OF PAPER, MEMO PADS, REPORT PAPER, LABELS, PAPER TAPE AND CARDS USED IN DATA PROCESSING, SCRATCH CARDS, ENTERTAINMENT CARDS, GIFT TAGS, GIFT VOUCHERS, ENVELOPES, PAPER NAPKINS AND SERVIETTES; FLAGS OF PAPER AND FLAGS OF LAMINATED PAPER THAT ARE FOR USE IN CONNECTION WITH OR FOR THE PROMOTION OF ROWING; BOOKS, JOURNALS, MAGAZINES, NEWSPAPERS, NEWSPAPER AND PAMPHLETS FOR DISTRIBUTION TO THE TELEVISION AND RADIO MEDIA, BROCHURES, HANDBOOKS, CATALOGS, GUIDELINES AND INSTRUCTION MANUALS, COMMEMORATIVE GAMES PROGRAMS, EVENT PROGRAMS, MAPS, PLANS, CHARTS, STATISTICAL BOOKS, POSTERS, POSTCARDS AND PRINTS IN THE FIELD OF ROWING; BOOK BINDING MATERIALS, NAMELY BOOK BINDING CLEF, TAPE OR WIRE; UNMOUNTED AND MOUNTED PHOTOGRAPHS; CARDBOARD; STATIONARY; ADHESIVES FOR STATIONARY OR HOUSEHOLD PURPOSES; ARTISTS' MATERIALS, NAMELY ARTISTS' PENCILS, PASTELS OR BRUSHES; PAINT BRUSHES; TYPEWRITERS; OFFICE SUPPLIES, NAMELY WRITING INSTRUMENTS INCLUDING PENS, BALL PENS, FELT PENS, NIB PENS, PENCILS AND MECHANICAL PENCILS AND INKS; BOOK BANDS; BOXES; PEN CASES; PENCIL BOXES; PENCIL CASES; PEN STANDS; PENCIL STANDS; PEN, PENCIL, PEN AND PENCIL TRAYS; TRANSFER BOXES; TRANSFER CASES; MAGNETIC CLIPS; ENVELOPES; RUBBER ERASERS; FILES; FOLDERS; CARD HOLDERS; MEMO HOLDERS; LOOSE LEAF; DESK MATS, LETTER PAPERS, BLOTTERS, MENUS; PHOTO STANDS; PHOTOGRAPH HOLDERS; LETTER RACKS; LETTER RESTS; OFFICE RULERS; STICKERS; TAPES; TRANSFERS AND DECALS; INSTRUCTIONAL AND TEACHING MANUALS IN THE FIELD OF ROWING; HANDBOOKS AND GUIDELINES IN THE FIELD OF ROWING; PLASTIC BUBBLE WRAP FOR USE IN PACKAGING; PLAYING CARDS; PRINTING BLOCKS; COMMEMORATIVE ROWING STAMPS; PAPER ADVERTISING SIGNS AND BANNERS FOR USE IN CONNECTION WITH OR FOR THE PROMOTION OF THE SPORT OF ROWING; PLAYING CARDS .

FIRST USE ; IN COMMERCE .

INT. CL. 18/U.S. CLS. 1, 2, 3, 22 AND 41

FOR ARTICLES MADE OF LEATHER AND/OR IMITATION LEATHER NAMELY, LUGGAGE, BOOT BAGS, BEACH BAGS, TOTE BAGS, TOOL BAGS SOLD EMPTY, VALISES, KNAPSACKS, SATCHELS, GARMENT BAGS, BACKPACKS, DUFFEL BAGS, [ HOLD-AILS ] \* HOLD-ALLS \* AND HAND BAGS; CASES, NAMELY VANITY CASES, SUITCASES, PILOT CASES, BRIEFCASES, ATACHE CASES, PASSPORT CASES AND KEY CASES; WALLETS AND PURSES, CREDIT CARD HOLDERS, BUSINESS CARD HOLDERS; BELTS; ANIMAL SKINS; HIDES; TRUNKS AND TRAVELING BAGS; UMBRELLAS, PARASOLS AND WALKING STICKS; WHIPS, HARNESS AND SADDLERY; AND ALL PURPOSE ATHLETIC BAGS.

FIRST USE ; IN COMMERCE .

INT. CL. 25/U.S. CLS. 22 AND 39

FOR CLOTHING USED IN THE SPORT OF ROWING NAMELY, THERMAL SHIRTS, THERMAL TIGHTS, TRAINER TIGHTS, SPORTS SHORTS, TEAR-AWAY PANTS, VESTS AND SWEATSHIRTS; FOOTWEAR, HEADWEAR; ROWING SUITS; UNITARDS; ROWING TOPS, PANTS AND SUITS MADE OF SWEAT ABSORBENT MATERIAL; DRIVING GLOVES.

FIRST USE ; IN COMMERCE .

INT. CL. 28/U.S. CLS. 22, 23, 38 AND 50

FOR GAMES AND PLAYTHINGS NAMELY, BALLS FOR PLAYING GOLF, CRICKET, FIELD HOCKEY, RACQUET BALL, RUGBY, SOCCER, SQUASH AND TENNIS; GAMES, TOYS AND PLAYTHINGS, NAMELY, ELECTRONIC GAMES, NAMELY, ARCADE-TYPE ELECTRONIC EDUCATION VIDEO GAMES, ELECTRONIC EDUCATIONAL GAME MACHINES FOR CHILDREN, ELECTRONIC GAME EQUIPMENT WITH A WATCH FUNCTION, HAND HELD UNIT FOR PLAYING ELECTRONIC GAMES, DOLLS AND DOLLS' CLOTHING AND ACCESSORIES FOR DOLLS INCLUDING DOLLS' HOUSES AND DOLLS' FURNITURE, TEDDY BEARS, TOY ACTION FIGURES, TOY VEHICLES, SCALE MODEL VEHICLES, SOFT TOYS, BALLOONS, TOY MONEY BOXES, TOY BICYCLES, ANIMAL AND/OR VEHICLE TRACKS AND RACING SETS, ELECTRONIC HAND HELD GAMES UNITS, HAND HELD UNIT FOR PLAYING COMPUTER GAMES, CARD GAMES, DICE GAMES, BOARD GAMES, PARLOR GAMES, ACTION TYPE TARGET GAMES; ARCADE GAME MACHINES, JIGSAW AND MANIPULATIVE PUZZLES, COMMEMORATIVE BOARD GAMES; TOY, NAMELY, BATTERY POWERED COMPUTER GAME WHICH FEATURES SOUND EFFECTS; GYMNASIAC AND SPORTING TRAINING EQUIPMENT FOR USE IN RELATION TO ROWING TRAINING, NAMELY EXERCISE TREADMILLS, STATIONARY EXERCISE BICYCLES, ROWING MACHINES, WATER ROWING MACHINES, WEIGHT LIFTING MACHINES; DECORATIONS FOR CHRISTMAS TREES; AIR RESISTANCE OR WATER RESISTANCE ROWING MACHINES; AND ERGOMETERS SOLD AS A UNIT WITH AIR RESISTANCE OR WATER RESISTANCE ROWING MACHINES; FOOT STRAPS FOR USE IN ROWING, GLOVES FOR GAMES AND ROWING; GYMNASIAC, BODY TRAINING AND BODY BUILDING APPARATUS FOR USE IN RELATION TO ROWING; SHINGUARD AND SPORTING BAGS AND CONTAINERS ADAPTED FOR CARRYING SPORTS ARTICLES, PARTICULARLY ROWING EQUIPMENT; SPORTS EQUIPMENT AND SPORTING GOODS, NAMELY ROWING MACHINES.

FIRST USE ; IN COMMERCE .

INT. CL. 35/U.S. CLS. 100, 101 AND 102

FOR ELECTRONIC RETAILING SERVICES VIA COMPUTER AND/OR INTERACTIVE COMMUNICATIONS TECHNOLOGIES IN THE FIELDS OF SPORTS RELATED EQUIPMENT, CLOTHING, GAMES AND PLAYTHINGS, MEMORABILIA AND GENERAL MERCHANDISE; PROVIDING FACILITIES FOR BUSINESS MEETINGS.

FIRST USE ; IN COMMERCE .

INT. CL. 38/U.S. CLS. 100, 101 AND 104

FOR TELECOMMUNICATION SERVICES NAMELY RADIO, TELEVISION TRANSMISSION SERVICES; TRANSMISSION OF MESSAGES AND DATA VIA AN ON-LINE GLOBAL COMPUTER NETWORK; RADIO AND TELEVISION BROADCASTING SERVICES VIA AN ON-LINE GLOBAL COMPUTER NETWORK AND/OR AN INTER COMPUTER COMMUNICATIONS NETWORKS AND ON-LINE PAY-PER-VIEW TELEVISION TRANSMISSIONS SERVICES AND INTERACTIVE SUBSCRIPTION BROADCAST SERVICES; BROADCASTING OF SPORTS AND SPORTING EVENTS VIA AN ON-LINE COMPUTER NETWORK.

FIRST USE ; IN COMMERCE .

INT. CL. 41/U.S. CLS. 100, 101 AND 107

FOR EDUCATIONAL SERVICES, NAMELY PROVIDING CLASSES, TRAINING SEMINARS, SYMPOSIUMS, WORKSHOPS, EXHIBITIONS IN RELATION TO THE SPORT OF ROWING; PUBLICATION OF TRAINING GUIDELINES, HANDBOOKS AND MANUALS, IN THE FIELD OF THE SPORT OF ROWING; PRODUCTION OF VIDEOS AND CDS IN THE FIELD OF THE SPORT OF ROWING; CONDUCTING CLASSES, SEMINARS CONFERENCES AND WORKSHOPS IN THE FIELD OF ROWING; TRAINING SPORTS REFEREES AND LINESMAN; ENTERTAINMENT SERVICES, NAMELY, PLANNING AND CONDUCTING ROWING COMPETITIONS AND ROWING EVENTS; ORGANIZING COMMUNITY EVENTS FEATURING A VARIETY OF ACTIVITIES, NAMELY SPORTING EVENTS, EXHIBITIONS, GAMES AND SHOWS RELATED TO ROWING; PROVIDING INFORMATION IN THE FIELDS OF SPORTING, ENTERTAINMENT AND EDUCATION IN THE FIELD OF ROWING VIA AN ON-LINE COMPUTER DATABASE OR THE GLOBAL COMPUTER NETWORK; ORGANIZATION OF ROWING REGATTAS; PROVIDING INFORMATION RELATING TO THE AFORESAID; PROVIDING INFORMATION IN THE FIELDS OF SPORTING, ENTERTAINMENT AND EDUCATION, NAMELY IN THE FIELD OF ROWING, VIA AN ON-LINE COMPUTER DATABASE OR THE GLOBAL COMPUTER NETWORK; RADIO AND TELEVISION PROGRAMMING SERVICES VIA AN ON-LINE GLOBAL COMPUTER NETWORK AND/OR INTER COMPUTER COMMUNICATIONS NETWORK; PROVIDING ON-LINE ENTERTAINMENT IN THE NATURE OF INTERACTIVE SPORTING GAMES VIA GLOBAL COMPUTER NETWORK; PROVIDING FACILITIES FOR BUSINESS TO ENTERTAIN CLIENTS IN THE NATURE OF SPORTS FACILITIES.

FIRST USE ; IN COMMERCE .

INT. CL. 42/U.S. CLS. 100 AND 101

FOR COMPUTER SERVICES, NAMELY PROVIDING ON-LINE BOOKS, JOURNALS, MAGAZINES, NEWSPAPERS, NEWSPAPER AND PAMPHLETS FOR DISTRIBUTION TO THE TELEVISION AND RADIO MEDIA, BROCHURES, HAND BOOKS, CATALOGS, GUIDELINES, INSTRUCTIONAL MANUALS, COMMEMORATIVE GAMES PROGRAMS, EVENTS PROGRAMS, MAPS, PLANS, CHARTS AND STATISTICAL BOOKS IN THE FIELD OF ROWING; RESTAURANT SERVICES; PROVIDING TEMPORARY HOUSING ACCOMMODATIONS; MEDICAL SERVICES; VETERINARY SERVICES; LEGAL SERVICES; SCIENTIFIC AND INDUSTRIAL RESEARCH; COMPUTER PROGRAMMING FOR OTHERS; PROVISION OF HOTEL SERVICES; TRAVEL AGENCY SERVICES FOR BOOKING ACCOMMODATION, RENTAL OF ROOMS, PROVIDING FACILITIES FOR BUSINESS TO ENTERTAIN CLIENTS IN THE NATURE OF PROVIDING BANQUET AND SOCIAL FUNCTION FACILITIES FOR SPECIAL OCCASIONS; PROVISION OF MEDICAL ADVICE AND ASSISTANCE ALL RELATING TO OR FOR THE PROMOTION OF SPORTS, NAMELY ROWING; PROVISION OF INFORMATION BY MEANS OF COMPUTER DATABASES IN RELATION TO ADVISE SURGERIES IN THE FIELD OF ROWING INJURIES.

FIRST USE ; IN COMMERCE .

ELEMENTS AMENDED  
GOODS/SERVICES

2,733,495. REG. 7-1-2003. DCI CHEESE COMPANY, INC. (WISCONSIN CORPORATION) 119 SOUTH MAIN STREET, MAYVILLE, WI, 53050, SN 78-118,719. FILED 4-1-2002. PRINCIPAL REGISTER.



INT. CL. 29/U.S. CL. 46  
FOR CHEESE.  
FIRST USE 5-24-2002; IN COMMERCE 5-24-2002.

ELEMENTS CORRECTED  
OWNER NAME

2,734,940. REG. 7-8-2003. COLLECTORS UNIVERSE, INC. (DELAWARE CORPORATION) POST OFFICE BOX 6280, NEWPORT BEACH, CA, 92658, SN 78-161,918. FILED 9-9-2002. PRINCIPAL REGISTER.

## HISTORY IN YOUR HANDS

OWNER OF U.S. REG. NO. 1,705,403.  
INT. CL. 35/U.S. CLS. 100, 101 AND 102

FOR RETAIL STORE SERVICES, ELECTRONIC RETAILING SERVICES VIA COMPUTER, AND RETAILING SERVICES VIA TELEPHONE, ALL IN THE FIELD OF GENERAL MEMORABILIA.

FIRST USE 10-0-1987; IN COMMERCE 10-0-1987.

ELEMENTS AMENDED  
CITIZENSHIP

2,789,926. REG. 12-2-2003. GOSPO CENTRIC (CALIFORNIA CORPORATION) 421 EAST BEACH STREET, INGLEWOOD, CA, 90302, SN 75-983,111. FILED P.R. 3-6-2000; AM. S.R. 7-11-2003. SUPPLEMENTAL REGISTER.

## THE S.O.P. CHORALE

NO CLAIM IS MADE TO THE EXCLUSIVE RIGHT TO USE "CHORALE", APART FROM THE MARK AS SHOWN.  
INT. CL. 9/U.S. CLS. 21, 23, 26, 36 AND 38

FOR PRE-RECORDED COMPACT DISCS [ AND AUDIOCASSETTES ] FEATURING MUSIC.  
FIRST USE 11-0-2000; IN COMMERCE 11-0-2000.

ELEMENTS CORRECTED  
GOODS/SERVICES

2,797,729. REG. 12-23-2003. C&H DISTRIBUTORS, LLC (DELAWARE LTD LIAB CO) 770 SOUTH 70TH STREET, MILWAUKEE, WI, 53214, SN 78-203,033. FILED 1-14-2003. PRINCIPAL REGISTER.



INT. CL. 35/U.S. CLS. 100, 101 AND 102

FOR MAIL ORDER CATALOG SERVICES AND ELECTRONIC CATALOG SERVICES FEATURING GOODS AND SUPPLIES FOR INDUSTRIAL, WAREHOUSE, OFFICE, AND COMMERCIAL USES, NAMELY CABINETS AND LOCKERS, SHELVING AND RACKS, MATERIAL STORAGE CONTAINERS, SHOP BENCHES, DESKS, STOOLS, AND EQUIPMENT, TOOL AND MAINTENANCE CARTS, TOOL CHESTS, UTILITY CARTS, PLATFORM TRUCKS, SCOOTERS, BICYCLES, AND PERSONNEL CARRIERS, PALLET TRUCKS, CONVEYOR SYSTEMS, HOISTS, CRANES, DRUM TRUCKS, PERSONAL SAFETY PRODUCTS, PACKAGING AND SHIPPING PRODUCTS, DOCK EQUIPMENT, JANITORIAL AND MAINTENANCE PRODUCTS, AND OFFICE AND BUSINESS FURNITURE.

FIRST USE 1-1-2003; IN COMMERCE 1-1-2003.

ELEMENTS CORRECTED  
ENTITY

2,798,209. REG. 12-23-2003. SYSMEX CORPORATION (JAPAN COMPANY) 1-5-1, WAKINOHAMA-KAIGANDORI, CHUO-KU, KOBE, JAPAN, SN 76-080,894. FILED 6-30-2000. PRINCIPAL REGISTER.

**LAFIA**

INT. CL. 9/U.S. CLS. 21, 23, 26, 36 AND 38

FOR \*COMPUTER SOFTWARE RECORDED ON CD-ROMS FOR FILING AND PROCESSING IMAGE DATA IN THE FIELD OF MEDICAL ANALYSIS OF CELLS;\* COMPUTER SYSTEMS CONSISTING OF SERVERS, TERMINALS, COMPUTER SOFTWARE, MICROSCOPES AND CHARGE COUPLED DEVICE CAMERAS USED FOR FILING AND PROCESSING IMAGES DATA IN THE FIELD OF BLOOD CELL ANALYSIS.

FIRST USE 3-1-1997; IN COMMERCE 10-28-1999.

ELEMENTS CORRECTED  
GOODS/SERVICES

2,823,606. REG. 3-16-2004. FRIESLAND BRANDS B.V. (NETHERLANDS PRIVATE LIMITED COMPANY) BLANKENSTEIN 142, MEPPEL, NETHERLANDS, 7943 PE, SN 75-579,499. FILED 10-29-1998. PRINCIPAL REGISTER.

**EXTRAN**

INT. CL. 30/U.S. CL. 46

FOR FOODSTUFFS, NAMELY CEREAL AND MUESLI BARS BASED ON FLOUR - SOLD ONLY TO THE GENERAL PUBLIC.

FIRST USE 0-0-1987; IN COMMERCE 7-9-1999.

INT. CL. 32/U.S. CLS. 45, 46 AND 48

FOR NON-ALCOHOLIC DRINKS, NAMELY ENERGY DRINKS; AND POWDERS FOR THE PREPARATION OF ENERGY DRINKS - SOLD ONLY TO THE GENERAL PUBLIC.

FIRST USE 0-0-1987; IN COMMERCE 7-9-1999.

ELEMENTS CORRECTED  
OWNER NAME  
OWNER ADDRESS

2,824,708. REG. 3-23-2004. GLENRIDGE PUBLISHING, LLC (COLORADO LTD LIAB CO) 7009 SOUTH POTOMAC STREET SUITE 200, ENGLEWOOD, CO, 80112, SN 76-495,018. FILED 3-6-2003. PRINCIPAL REGISTER.

**ATLANTA HOMES**

OWNER OF U.S. REG. NO. 1,830,930.  
SEC. 2(F).

INT. CL. 16/U.S. CLS. 2, 5, 22, 23, 29, 37, 38 AND 50

FOR MAGAZINE PUBLISHED PERIODICALLY FOR READING BY THE GENERAL PUBLIC CONTAINING BOTH SYNDICATED AND NON-SYNDICATED MAGAZINE ARTICLES REGARDING GARDENS, HOME DECOR, ARCHITECTURE, INTERIOR DESIGN, ENTERTAINMENT, PEOPLE AND EVENTS.

FIRST USE 11-0-1991; IN COMMERCE 11-0-1991.

ELEMENTS CORRECTED  
OWNER NAME

2,838,513. REG. 5-4-2004. THOMSON MULTIMEDIA (FRANCE CORPORATION) 46 QUAI ALPHONSE LE GALLO, BOULOGNE-BILLANCOURT, FRANCE, 92100, SN 78-184,313. FILED 11-12-2002. PRINCIPAL REGISTER.

**DM-R**  
digital media **RECORDER**

PRIORITY CLAIMED UNDER SEC. 44(D) ON FRANCE APPLICATION NO. 023165664, FILED 5-24-2002, REG. NO. 023165664, DATED 5-24-2002, EXPIRES 5-24-2012.

NO CLAIM IS MADE TO THE EXCLUSIVE RIGHT TO USE "DIGITAL MEDIA RECORDER", APART FROM THE MARK AS SHOWN.

INT. CL. 9/U.S. CLS. 21, 23, 26, 36 AND 38

FOR TELEVISIONS; TELEVISION SETS WITH DIGITAL AUDIO-VIDEO DISC PLAYERS INTEGRATED; TELEVISIONS WITH VIDEO RECORDERS INTEGRATED; VIDEO CASSETTE RECORDERS AND VIDEO DISC RECORDERS; DIGITAL AUDIO DISC PLAYERS AND RECORDERS; PROGRAMMABLE DIGITAL VIDEO DISC PLAYERS AND RECORDERS; PORTABLE COMPACT DISC PLAYERS; CAMCORDERS; PORTABLE CAMCORDERS WITH VIDEO RECORDER INTEGRATED; PROJECTION TELEVISIONS; AUDIO AMPLIFIERS; HIGH FIDELITY MICRO-MINI SYSTEMS COMPRISED OF STEREO TUNERS, STEREO RECEIVERS, STEREO SPEAKERS, CD PLAYERS AND RECORDERS, CASSETTE PLAYERS AND RECORDERS; REMOTE CONTROLS FOR ALL THE AFORESAID GOODS; REMOTE CONTROLS WITH VOICE RECOGNITION FOR ALL THE AFORESAID GOODS; TELEVISION SCREENS, NAMELY, PLASMA SCREENS, LCD SCREENS, FLAT PANEL DISPLAY SCREENS, VIDEO MONITORS; RADIOS; HEADPHONES; WIRELESS HEADPHONES; MICROPHONES; VIDEO TRANSMITTERS; AUDIO SPEAKERS; ANTENNAS; AUDIO-VIDEO RECEIVERS; BLANK VIDEOTAPES; BLANK VIDEO CASSETTES; BLANK MAGNETIC DATA CARRIERS; BLANK ACOUSTIC DISCS; BLANK AUDIO-VIDEO COMPACT DISCS.

FIRST USE ; IN COMMERCE .  
INT. CL. 38/U.S. CLS. 100, 101 AND 104

FOR CABLE RADIO TRANSMISSION, CABLE TELEVISION TRANSMISSION, DIGITAL TRANSMISSION OF VOICE, DATA, IMAGES, SIGNALS, AND MESSAGES VIA SATELLITE, CABLE, AND ANTENNA.

FIRST USE ; IN COMMERCE .

ELEMENTS CORRECTED  
MARK

2,846,585. REG. 5-25-2004. DRAPER HOLDING COMPANY, INC. (SOUTH DAKOTA CORPORATION) PO BOX 158, DRAPER, SD, 57531, SN 78-160,893. FILED 9-5-2002. PRINCIPAL REGISTER.

## YOUR LAND. YOUR COMMUNITY. YOUR BANK.

INT. CL. 36/U.S. CLS. 100, 101 AND 102

FOR [ LOAN FINANCING SERVICES, MORTGAGE AND HOME EQUITY LOAN SERVICES, AUTOMATED TELLER MACHINE SERVICES, DEBIT CARD SERVICES AND HOME BANKING SERVICES, NAMELY, BANKING SERVICES ACCESSED VIA A PERSONAL COMPUTER AND A GLOBAL COMPUTER NETWORK CONNECTION; INSURANCE AGENCY SERVICES; AND, MORTGAGE BANKING AND LENDING SERVICES ] \* BANKING AND FINANCIAL SERVICES, NAMELY, CHECKING AND SAVINGS ACCOUNT SERVICES, CERTIFICATE OF DEPOSIT ACCOUNT SERVICES, INDIVIDUAL RETIREMENT ACCOUNT SERVICES, CREDIT CARD SERVICES, AND DIRECT DEPOSIT SERVICES \*.

FIRST USE 1-1-2003; IN COMMERCE 1-1-2003.

ELEMENTS CORRECTED  
GOODS/SERVICES

2,855,523. REG. 6-22-2004. IDENTIFICATION, INC. (WYOMING CORPORATION) SUITE B7, #200 463 JOHNNY MERCER BLVD., SAVANNAH, GA, 31410, SN 76-386,398. FILED 3-22-2002. PRINCIPAL REGISTER.

## IDENTIFICATION

INT. CL. 35/U.S. CLS. 100, 101 AND 102

FOR MAINTAINING A COMPUTERIZED NETWORK AND DATABASE REGISTRY OF FINGERPRINTS, DNA SAMPLES, HANDWRITING SAMPLES, HANDWRITING SAMPLES, POLYGRAPH RESULTS FOR IDENTIFICATION PURPOSES.

FIRST USE 8-22-2001; IN COMMERCE 8-22-2001.

ELEMENTS CORRECTED  
OWNER NAME

2,858,661. REG. 6-29-2004. CENDANT PUBLISHING, INC. (DELAWARE CORPORATION) 10750 WEST CHARLESTON BOULEVARD, LAS VEGAS, NV, 89135, SN 76-495,087. FILED 3-6-2003. PRINCIPAL REGISTER.

**BUYERS ADVANTAGE**

OWNER OF U.S. REG. NOS. 1,531,245, 1,614,237 AND 2,484,963.

INT. CL. 36/U.S. CLS. 100, 101 AND 102

FOR PROVIDING TO CONSUMERS A COMPREHENSIVE PACKAGE WHICH ENTITLES THEM TO EXTENDED WARRANTIES, FULL AND PARTIAL PURCHASE PRICE REIMBURSEMENT, REIMBURSEMENT FOR POST-PURCHASE PRICE REDUCTIONS, AND REIMBURSEMENT FOR PRODUCT REPAIR AND REPLACEMENT, IN CONNECTION WITH A WIDE RANGE OF CONSUMER MERCHANDISE; AND, COMPUTER ON-LINE SERVICES, PROVIDED BY MEANS OF A GLOBAL COMPUTER NETWORK, NAMELY, ARRANGING FOR CONSUMERS TO RECEIVE EXTENDED WARRANTIES, FULL AND PARTIAL PRICE REIMBURSEMENT, REIMBURSEMENT FOR POST-PURCHASE PRICE REDUCTIONS, AND REIMBURSEMENT FOR PRODUCT REPAIR AND REPLACEMENT IN CONNECTION WITH THEIR PURCHASE OF A WIDE RANGE OF CONSUMER MERCHANDISE.

FIRST USE 2-0-2003; IN COMMERCE 2-0-2003.

ELEMENTS CORRECTED  
MARK

2,882,854. REG. 9-7-2004. RAYS CO., LTD. (JAPAN CORPORATION) 3-18, NAGATA-NISHI 5-CHOME, HIGASHI-OSAKA-CITY, OSAKA, JAPAN, 577-0016, SN 78-093,776. FILED 11-16-2001. PRINCIPAL REGISTER.

**gram  
LIGHTS**

INT. CL. 7/U.S. CLS. 13, 19, 21, 23, 31, 34 AND 35

FOR ENGINE OR MOTOR MUFFLERS.

FIRST USE 10-0-2001; IN COMMERCE 10-0-2001.

INT. CL. 12/U.S. CLS. 19, 21, 23, 31, 35 AND 44

FOR HUB CAPS; WHEEL HUBS FOR LAND VEHICLES; RIMS FOR [ VEHICLES ] \* VEHICLE \* WHEELS; STEERING WHEELS FOR VEHICLES; VEHICLE BUMPERS; AND VEHICLE WHEELS.  
FIRST USE 10-0-2001; IN COMMERCE 10-0-2001.

ELEMENTS CORRECTED  
GOODS/SERVICES

2,883,593. REG. 9-14-2004. GOTTWALD PORT TECHNOLOGY GMBH (FED REP GERMANY LTD LIAB JT ST CO) FORSTSTR. 16, 40597 DÜSSELDORF, FED REP GERMANY., SN 76-433,516. FILED 7-22-2002. PRINCIPAL REGISTER.



OWNER OF FED REP GERMANY REG. NO. 30018044, DATED 11-15-2000, EXPIRES 3-31-2010.

NO CLAIM IS MADE TO THE EXCLUSIVE RIGHT TO USE "PORT TECHNOLOGY", APART FROM THE MARK AS SHOWN.

THE MARK CONSISTS OF THE WORDS "PORT TECHNOLOGY" WITH AN ARBITRARY DESIGN.

INT. CL. 7/U.S. CLS. 13, 19, 21, 23, 31, 34 AND 35

FOR MACHINES, MECHANICAL APPARATUS AND MECHANICAL DEVICES IN THE FIELDS OF HANDLING AND LIFTING EQUIPMENT AND VEHICULAR TECHNOLOGY, MOBILE CRANES, NAMELY, TELESCOPIC CRANES, LATTICE MAST CRANES, DOCK CRANES AND RAILWAY CRANES, GANTRY CRANES; COLUMN JIB CRANES, ORDER PICKERS FOR COMMISSIONING CONTAINERS, IN PARTICULAR, SEAFREIGHT CONTAINERS, TRANSPOSITION BRIDGES, NAMELY MACHINES FOR TRANSPOSITIONING BRIDGE CRANES BETWEEN THE ELEVATED TRACK OF THE BRIDGE CRANE AND A MAINTENANCE AREA, CRANES FOR LIFTING AND MOVING LONG OBJECTS, CONTAINER HANDLING DEVICES, NAMELY, MACHINES FOR LOADING AND UNLOADING CONTAINERS.

FIRST USE 6-0-1999; IN COMMERCE 6-0-1999.

INT. CL. 9/U.S. CLS. 21, 23, 26, 36 AND 38

FOR ELECTRICAL AND ELECTRONIC APPARATUS, DEVICES AND INSTRUMENTS FOR THE OPEN-LOOP AND CLOSED-LOOP CONTROL OF HANDLING AND LIFTING MACHINES AND DEVICES, NAMELY, PROCESS COMPUTERS, DATA TRANSMISSION UNITS, NAMELY, REMOTE CONTROLS.

FIRST USE 6-0-1999; IN COMMERCE 6-0-1999.

INT. CL. 12/U.S. CLS. 19, 21, 23, 31, 35 AND 44

FOR DRIVERLESS TRANSPORTATION VEHICLES, NAMELY, AUTOMATED GUIDED VEHICLES IN THE NATURE OF WHEEL-DRIVEN TRUCKS FOR CONTAINERS HAVING AN AUTOMATIC ELECTRICAL AND ELECTRONIC CONTROL SYSTEM FOR DRIVING AND STEERING THE TRUCK WITHOUT A DRIVER.

FIRST USE 6-0-1999; IN COMMERCE 6-0-1999.

INT. CL. 37/U.S. CLS. 100, 103 AND 106

FOR FITTING, REPAIR, MAINTENANCE OF APPARATUS AND THE FIELDS OF EQUIPMENT AND MOBILE CRANES, CRANES, LATTICE AND PREVENTIVE MACHINES, MECHANICAL DEVICES IN HANDLING AND LIFTING VEHICULAR TECHNOLOGY, NAMELY, TELESCOPIC MAST CRANES, DOCK CRANES AND RAILWAY CRANES, GANTRY CRANES; COLUMN JIB CRANES, ORDER PICKERS FOR COMMISSIONING GOODS, TRANSPOSITION BRIDGES, NAMELY DEVICES FOR TRANSPOSITIONING BRIDGE CRANES BETWEEN MAINTENANCE AREA, CRANES FOR LIFTING LONG OBJECTS, CONTAINER HANDLING DEVICES, NAMELY, DEVICES FOR LOADING AND UNLOADING CONTAINERS.

FIRST USE 6-0-1999; IN COMMERCE 6-0-1999.

INT. CL. 42/U.S. CLS. 100 AND 101

FOR PROJECT-DESIGN, TECHNICAL ENGINEERING AND TECHNICAL PRODUCT DEVELOPMENT OF DEVICES, SYSTEMS AND FACILITIES IN THE FIELDS OF VEHICULAR TECHNOLOGY AND LIFTING AND HANDLING EQUIPMENT, IN PARTICULAR OF HANDLING SYSTEMS FOR PORTS; SERVICES OF AN ENGINEER, CONTROL TECHNICIAN, SYSTEM TECHNICIAN, NAMELY PROVIDING TECHNICAL CONSULTATION AND ELABORATION OF TECHNICAL EXPERT OPINIONS IN THE FIELDS OF VEHICULAR TECHNOLOGY AND LIFTING AND HANDLING EQUIPMENT, IN PARTICULAR OF HANDLING SYSTEMS FOR PORTS; MATERIALS TESTING, COMPUTER SOFTWARE DEVELOPMENT OF DATA PROCESSING PROGRAMS, IN PARTICULAR OF LOGISTICS AND CONTROL SOFTWARE IN THE FIELD OF HANDLING SYSTEMS FOR PORTS.

FIRST USE 6-0-1999; IN COMMERCE 6-0-1999.

ELEMENTS CORRECTED  
\*OWNER NAME\*

2,893,748. REG. 10-12-2004. GOODLIFE (M) SDN BHD (MALAYSIA CORPORATION) 10 JALAN APOLLO U5/190, BANDAR PINGGIRAN SUBANG, SEKSYEN 1, SUBANG 2, 40150 SHAH ALAM, SELANGOR DARUL EHSAN, MALAYSIA., SN 76-401,484. FILED 4-29-2002. PRINCIPAL REGISTER.



INT. CL. 4/U.S. CLS. 1, 6 AND 15

FOR LUBRICATING OILS FOR INDUSTRIAL AND HOUSEHOLD USE.

FIRST USE 4-26-2004; IN COMMERCE 4-26-2004.

ELEMENTS CORRECTED  
OWNER ADDRESS

2,894,053. REG. 10-19-2004. BETTINA LIANO PTY LTD. (AUSTRALIA COMPANY) 471 CHAPEL STREET, SOUTH YARRA, 3131, VIC, AUSTRALIA., SN 76-076,731. FILED 6-26-2000. PRINCIPAL REGISTER.

## BETTINA LIANO

OWNER OF AUSTRALIA REG. NO. 716147, DATED 8-29-1996, EXPIRES 8-29-2006.

THE NAME BETTINA LIANO IDENTIFIES A LIVING INDIVIDUAL WHOSE CONSENT IS OF RECORD.

INT. CL. 25/U.S. CLS. 22 AND 39

FOR CLOTHING, NAMELY, JACKETS, SHIRTS, PANTS, T-SHIRTS, SUITS,[DRESSED] \* DRESSES \*, SKIRTS; SHOES AND BELTS; KNITWEAR, NAMELY CAMISOLES, CARDIGANS, SWEATERS AND T-SHIRTS. FIRST USE 0-0-1985; IN COMMERCE 8-26-1999.

ELEMENTS CORRECTED  
GOODS/SERVICES

FOR CLOTHING, NAMELY DUSTERS, JUMPERS, PINAFORES, PLAYSUITS, PULLOVERS, SHIRTS, SMOCKS, CARDIGANS, SWEAT PANTS, SWEAT SHIRTS, APRONS, KNIT SHIRTS, SWEATERS, SOCKS; SLEEPWEAR, NAMELY BED JACKETS, NIGHTGOWNS, NIGHT SHIRTS, AND PAJAMAS; LOUNGEWEAR, NAMELY ROBES, BATHROBES, CAFTANS, DRESSING GOWNS, HOUSECOATS, KIMONOS, LINGERIE, MUU MUUS, NEGLIGEEES, AND PEIGNOIRS; SCARVES; HEADWEAR. FIRST USE ; IN COMMERCE .

ELEMENTS CORRECTED  
OWNER ADDRESS

2,897,581. REG. 10-26-2004. NATIONAL PAINTBALL SUPPLY, INC. (DELAWARE CORPORATION) 570 MANTUA BOULEVARD, SEWELL, NJ, 08080, SN 76-117,758. FILED 8-28-2000. PRINCIPAL REGISTER.

2,899,792. REG. 11-2-2004. HERMES INTERNATIONAL (FRANCE CORPORATION) 24, RUE DU FAUBOURG SAINT-HONORE, PARIS, FRANCE, 75008, SN 78-304,936. FILED 9-24-2003. PRINCIPAL REGISTER.

**PAINTBALLHUT.COM**

**OMNIBUS**

INT. CL. 35/U.S. CLS. 100, 101 AND 102 FOR ON-LINE RETAIL SERVICES FEATURING PAINTBALL GUNS, ACCESSORIES AND SUPPLIES. FIRST USE 7-26-2004; IN COMMERCE 7-26-2004.

PRIORITY CLAIMED UNDER SEC. 44(D) ON FRANCE APPLICATION NO. 03.3.218.972, FILED 4-4-2003, REG. NO. 033218972, DATED 4-4-2003, EXPIRES 4-4-2013. INT. CL. 18/U.S. CLS. 1, 2, 3, 22 AND 41 FOR \* GOODS OF \* LEATHER AND IMITATION LEATHER, NAMELY HANDBAGS, TRAVELING BAGS, RUCKSACKS, PURSES IN LEATHER, BUSINESS CARD CASES, WALLET, KEY CASES IN LEATHER, SUIT-CASES, BRIEFCASES, AND TRUNKS \* AND LUGGAGE\*. FIRST USE ; IN COMMERCE .

ELEMENTS CORRECTED  
CITIZENSHIP

ELEMENTS CORRECTED  
GOODS/SERVICES

2,898,670. REG. 11-2-2004. ZANOTTO SA (SWITZERLAND CORPORATION) WENGISTRASSE 7, CH-8004 ZURICH, SWITZERLAND., SN 76-466,357. FILED 11-1-2002. PRINCIPAL REGISTER.

2,903,849. REG. 11-16-2004. HELMS II, CARL R. (UNITED STATES INDIVIDUAL) 1421 N.W. 150TH ST, EDMOND, OK, 73013, SN 78-166,274. FILED 9-20-2002. PRINCIPAL REGISTER.

**NIVES ZANOTTO**

**21ST CENTURY HOME HEALTH AGENCY**

PRIORITY CLAIMED UNDER SEC. 44(D) ON SWITZERLAND APPLICATION NO. 05126/2002, FILED 6-7-2002, REG. NO. 502860, DATED 9-4-2002, EXPIRES 9-4-2012. INT. CL. 24/U.S. CLS. 42 AND 50 FOR TEXTILE GOODS, NAMELY, HAND TOWELS, NAPKINS, HANDKERCHIEFS, CURTAINS, AND UP-HOLSTERED FABRICS; TAPESTRY; BED LINENS, HOUSEHOLD LINENS, BATH AND TABLE LINENS. FIRST USE ; IN COMMERCE . INT. CL. 25/U.S. CLS. 22 AND 39

NO CLAIM IS MADE TO THE EXCLUSIVE RIGHT TO USE "HOME HEALTH AGENCY", APART FROM THE MARK AS SHOWN. INT. CL. 44/U.S. CLS. 100 AND 101 FOR HOME HEALTH CARE. FIRST USE 9-0-1997; IN COMMERCE 9-0-1997.

ELEMENTS CORRECTED  
OWNER NAME

\* \* \* \* \*



# INDEX OF REGISTRANTS

MARCH 1, 2005

(Registered; Renewed; Canceled; Amended, Corrected, etc.; New Certificates; 12c Publications.)

The designation "U.S. Cl." appearing in this section refers to the U.S. class in effect prior to Sep. 1, 1973 rather than the international class which applies to applications filed on or after that date. For adoption of international classification see notice in the OFFICIAL GAZETTE of Jun. 26, 1973 (911 O.G. TM 210).

A HOUSEWORKS HOME LLC, EAST FARMINGDALE, NY:  
2,150,437, CANC. MULTIPLE CLASS, INT. CLS. 37 AND 42.

A PEEK IN THE POD, LLC, NEW YORK, NY:  
2,928,627, PUB. 12-7-2004. INT. CL. 44.

A. AND C. PARODI PARTNERSHIP, THE, DOWNEY, CA:  
2,150,403, CANC. INT. CL. 5.

A. DAIGGER AND COMPANY, INC., VERNON HILLS, IL:  
2,929,681, INT. CL. 28.

A.J. VAN DEN HUL B.V., 8167 LH OENE, NETHERLANDS:  
1,317,778. REN. 1-21-05. INT. CL. 9.

A.M. IMAGINATION LIMITED, TORTOLA, BR.VIRGIN ISLANDS:  
2,929,259, INT. CL. 38.  
2,929,260, INT. CL. 39.

A.T.R. JEWELRY, INC., NEW YORK, NY:  
2,151,510, CANC. INT. CL. 14.

A-1 INDUSTRIAL LAWN CARE, INC., DALLAS, TX:  
2,151,504, CANC. INT. CL. 42.

AAF-MCQUAY INC., LOUISVILLE, KY:  
782,838. REN. 1-21-05. U.S. CL. 31 (INT. CL. 11).

ABBE SCHMIDT, INC., MAUMEE, OH TO FIRE ATTACKER, INC., PETERSBURG, MI:  
1,830,197, CANC. INT. CL. 9.

ABBOTT GMBH & CO. KG, WIESBADEN, FED REP GERMANY:  
1,862,212. REN. 1-21-05. INT. CL. 5.

ABBOTT LABORATORIES, ABBOTT PARK, IL:  
1,830,763, CANC. INT. CL. 5.

ABILITYONE CORPORATION, BOLINGBROOK, IL, ROLYAN MANUFACTURING CO. INC., MENOMONEE FALLS, WI:  
1,306,595. REN. 1-18-05. INT. CL. 10.

ABN AMRO MORTGAGE GROUP, INC., ANN ARBOR, MI:  
2,928,485, PUB. 3-23-2004. INT. CL. 36.

AC, INC., JACKSON, AL, TELEDYNE INDUSTRIES, INC., HUNTSVILLE, AL, DBA TELEDYNE BROWN ENGINEERING DIVISION:  
1,893,483. REN. 1-18-05. MULTIPLE CLASS, INT. CLS. 24 AND 28.

ACADEMY, LTD., KATY, TX:  
2,929,133, INT. CL. 28.

ACAPPELLA COMPANY, INC., THE, PARIS, TN:  
1,909,812. REN. 1-18-05. INT. CL. 9.

ACCESS CINCINNATI DAYTON, INC., CINCINNATI, OH:  
2,150,600, CANC. INT. CL. 16.

ACCESS DEVELOPMENT CORPORATION, SALT LAKE CITY, UT, GOLF ACCESS, INC., SALT LAKE CITY, UT:  
1,873,408. REN. 1-19-05. INT. CL. 39.

ACE BEAUTY COMPANY, INC., LARGO, FL:  
2,150,481, CANC. MULTIPLE CLASS, INT. CLS. 35 AND 41.

ACE CASH EXPRESS, INC., IRVING, TX:  
2,929,489, INT. CL. 36.

ACE MOTORCYCLE CORPORATION, NEW YORK, NY:  
2,929,085, MULTIPLE CLASS, INT. CLS. 12 AND 14.

ACE NOVELTY COMPANY, INC., BELLEVUE, WA:  
1,450,764, CANC. INT. CL. 16.

ACE RENT-A-CAR, INC., DES PLAINES, IL:  
2,929,767, INT. CL. 39.

ACTIMETRICS, INC., EVANSTON, IL:  
2,928,887, PUB. 12-7-2004. INT. CL. 9.

AD-IN KIDS, INC., NEW YORK, NY:  
2,151,113, CANC. INT. CL. 28.

ADHERENT TECHNOLOGIES, INC., ALBUQUERQUE, NM:  
2,929,124, MULTIPLE CLASS, INT. CLS. 9, 12 AND 42.

ADLER & ASSOCIATES, INC., CINCINNATI, OH:  
2,929,451, INT. CL. 9.

ADRIAN HAMERS, INCORPORATED, LARCHMONT, NY:  
1,308,885. REN. 1-21-05. INT. CL. 14.

ADVANCE MAGAZINE PUBLISHERS INC., NEW YORK, NY:  
1,897,506. REN. 1-21-05. INT. CL. 16.  
2,150,256, CANC. INT. CL. 16.  
2,150,257, CANC. INT. CL. 16.

ADVANCE SLEEP PRODUCTS:  
1,273,567, CANC. INT. CL. 20.

ADVANCED INSTRUMENT DEVELOPMENT INCORPORATED, MELROSE PARK, IL:  
1,307,717. REN. 1-18-05. INT. CL. 9.

ADVANCED STENT TECHNOLOGIES, INC., PLEASANTON, CA:  
2,929,371, INT. CL. 10.

ADVANCED TELECOMMUNICATION NETWORK, INC., CHERRY HILL, NJ:  
2,150,091, CANC. INT. CL. 38.

ADVANSTAR COMMUNICATIONS, INC., DULUTH, MN:  
2,150,203, CANC. INT. CL. 41.

AEGIS TECHNICAL SOLUTIONS, INC., JACKSONVILLE, FL:  
2,150,852, CANC. INT. CL. 9.

AERIS ENTERPRISES, INC, RENO, NV:  
2,929,389, INT. CL. 9.

AETNA INC., BLUE BELL, PA:  
2,929,705, INT. CL. 42.

AETNA U.S. HEALTHCARE INC., BLUE BELL, PA:  
2,151,208, CANC. INT. CL. 42.

AFASSCO, INC., CARSON CITY, NV:  
1,714,976. REN. 1-18-05. INT. CL. 5.

AFFINITY TECHNOLOGY GROUP, INC., COLUMBIA, SC:  
2,151,354, CANC. INT. CL. 36.

AFFLELOU, ALAIN, 75008 PARIS, FRANCE:  
2,150,819, CANC. INT. CL. 9.

AGC, INC., CLEVELAND, OH:  
2,929,294, INT. CL. 16.

AGENCOURT BIOSCIENCE CORPORATION, BEVERLY, MA:  
2,929,404, INT. CL. 1.

AGRIDATA RESOURCES, INC., MILWAUKEE, WI TO ARI NETWORK SERVICES, INC., MILWAUKEE, WI:  
1,830,525, CANC. MULTIPLE CLASS, INT. CLS. 35, 38 AND 42.

AGUSTA S.P.A., 21017 SAMARATE (VARESE), ITALY:  
2,150,028, CANC. INT. CL. 12.

AGXPLORE INTERNATIONAL, LLC, PARMA, MO:  
2,928,998, PUB. 12-7-2004. INT. CL. 1.  
2,928,999, PUB. 12-7-2004. INT. CL. 3.

AHA AMERICAN HOMEOWNERS ASSOCIATION, STAMFORD, CT:  
2,150,252, CANC. INT. CL. 36.

AIR BALTIC CORPORATION, SIA, RIGA DISTRICT LV-1053, LATVIA:  
2,150,909, CANC. INT. CL. 39.

- AIR STAR PAGING, LOS ANGELES, CA:  
2,151,401, CANC. INT. CL. 38.
- AIREY-THOMPSON CO., LOS ANGELES, CA:  
1,273,374, CANC. INT. CL. 9.
- AKZO NOBEL COATINGS INTERNATIONAL B. V., VELPERWEG 76, 6824 BM, NETHERLANDS, AKZO COATINGS INTERNATIONAL B. V., ARNHEM, NETHERLANDS:  
1,866,654, REN. 1-21-05, INT. CL. 2.
- ALADDIN SYSTEMS, INC., WATSONVILLE, CA:  
2,498,262, CANC. INT. CL. 9.
- ALADI, AZUKA FRANKIE, SUMMERVILLE, SC:  
2,929,776, INT. CL. 12.
- ALASKA AIR GROUP, INC., SEATTLE, WA:  
2,151,394, CANC. INT. CL. 39.
- ALBA-WALDENSIAN, INC., VALDESE, NC:  
1,273,598, CANC. INT. CL. 25.
- ALBION LABORATORIES, INC., CLEARFIELD, UT:  
1,830,122, CANC. INT. CL. 5.
- ALCAN ALUMINUM LIMITED, MONTREAL, QUEBEC, CANADA:  
1,273,313, CANC. INT. CL. 6.
- ALDEN SHOE COMPANY, MIDDLEBOROUGH, MA:  
1,001,082, REN. 1-18-05, INT. CL. 25.
- ALDI INC., BATAVIA, IL:  
1,273,780, CANC. INT. CL. 30.  
2,929,135, INT. CL. 21.  
2,929,169, INT. CL. 30.  
2,929,341, INT. CL. 4.
- ALDRICH, JOHN F., CAMARILLO, CA:  
2,928,884, PUB. 12-7-2004, INT. CL. 16.
- ALECO FURNITURE MFG INC., VERNON, CA:  
2,150,514, CANC. INT. CL. 20.
- ALIMENTATION COUCHE-TARD INC., LAVAL, QUEBEC, CANADA:  
2,929,173, MULTIPLE CLASS, INT. CLS. 21 AND 32.  
2,929,174, MULTIPLE CLASS, INT. CLS. 21 AND 32.
- ALL IN THE CARDS, INC., BROOKLYN, NY:  
2,928,905, PUB. 12-7-2004, INT. CL. 16.
- ALL KITCHENS, INC., BOISE, ID:  
2,150,338, CANC. INT. CL. 29.
- ALL NET MEDIA, INC., COLUMBIA, SC:  
2,150,502, CANC. INT. CL. 35.
- ALL-STATE INTERNATIONAL, INC., CRANFORD, NJ:  
1,337,887, REN. 1-21-05, INT. CL. 16.
- ALLERGAN, INC., IRVINE, CA:  
1,830,356, CANC. INT. CL. 16.
- ALLIANCE TELECOMMUNICATIONS CORPORATION, DALLAS, TX:  
1,273,826, CANC. MULTIPLE CLASS, INT. CLS. 35 AND 42.
- ALLIANT FOODSERVICE, INC., DEERFIELD, IL:  
2,150,330, CANC. MULTIPLE CLASS, INT. CLS. 29 AND 35.
- ALLIED BUILDING PRODUCTS CORPORATION, EAST RUTHERFORD, NJ:  
2,929,455, INT. CL. 19.
- ALLIED MANAGEMENT, INC., LIVINGSTON, NJ:  
2,929,171, INT. CL. 33.
- ALLIED MARKETING GROUP, INC., DALLAS, TX:  
2,929,136, INT. CL. 9.
- ALLIED PRODUCTS CORPORATION, CHICAGO, IL:  
2,151,327, CANC. INT. CL. 7.
- ALLISON, ERIC, CITRUS HEIGHTS, CA:  
2,791,148, CANC. INT. CL. 35.
- ALLTEMPWARE, INC., PIGEON, MI:  
2,929,319, INT. CL. 21.
- ALPINE ENGINEERED PRODUCTS, INC., POMPANO BEACH, FL:  
2,150,147, CANC. INT. CL. 7.
- ALPS ELECTRIC CO., LTD., OTA-KU, TOKYO, 145-8501, JAPAN:  
2,929,158, INT. CL. 9.
- ALRA LABORATORIES, INC., GURNEE, IL:  
2,150,198, CANC. MULTIPLE CLASS, INT. CLS. 35 AND 40.
- ALSPAUGH, SARAH P., CINCINNATI, OH:  
2,929,482, INT. CL. 36.
- ALTABET, JORDAN A., SAN DIEGO, CA:  
2,929,564, INT. CL. 25.
- ALUNG TECHNOLOGIES, INC., PITTSBURGH, PA:  
2,929,699, INT. CL. 10.
- AM-WEST MANAGEMENT, LTD., COLORADO SPRINGS, CO:  
2,150,839, CANC. MULTIPLE CLASS, INT. CLS. 35 AND 41.
- AMARLITE ARCHITECTURAL PRODUCTS, INC., ATLANTA, GA:  
1,273,310, CANC. INT. CL. 6.
- AMBAC CONNECT INC., AUSTIN, TX:  
2,150,222, CANC. INT. CL. 9.
- AMBER SOFTWARE LIMITED, RAMSEY, ISLE OF MAN, UNITED KINGDOM:  
1,273,406, CANC. INT. CL. 9.
- AMERACE CORPORATION, NEW YORK, NY:  
768,090, CANC. U.S. CL. 13.
- AMERICAN AIRLINES, INC., DALLAS/FORT WORTH AIRPORT, TX:  
2,149,945, CANC. INT. CL. 16.
- AMERICAN AIRLINES, INC., FORT WORTH, TX:  
2,150,175, CANC. MULTIPLE CLASS, INT. CLS. 9 AND 42.
- AMERICAN BASKETBALL LEAGUE, INC., PALO ALTO, CA:  
2,151,448, CANC. MULTIPLE CLASS, INT. CLS. 16, 25 AND 41.
- AMERICAN BUYERS, INC., NORTH LITTLE ROCK, AR:  
2,150,704, CANC. INT. CL. 9.
- AMERICAN CHEMICAL SOCIETY; THE, WASHINGTON, DC:  
1,312,587, REN. 1-18-05, INT. CL. 35.
- AMERICAN COMMUNITY MUTUAL INSURANCE COMPANY, LIVONIA, MI:  
2,929,680, INT. CL. 36.
- AMERICAN CONSULTING & TRAINING, INC., MILL VALLEY, CA:  
2,150,170, CANC. INT. CL. 9.
- AMERICAN DAIRY QUEEN CORPORATION, EDINA, MN:  
978,236, REN. 1-18-05, U.S. CL. 46 (INT. CLS. 1, 5, 29, 30, 31 AND 32).
- AMERICAN DAIRY QUEEN CORPORATION, MINNEAPOLIS, MN:  
1,273,770, CANC. INT. CL. 30.
- AMERICAN EXPRESS CENTURION BANK, MIDVALE, UT:  
2,151,089, CANC. INT. CL. 36.  
2,151,090, CANC. INT. CL. 36.
- AMERICAN EXPRESS COMPANY, NEW YORK, NY:  
2,929,805, INT. CL. 36.
- AMERICAN EXPRESS FINANCIAL CORPORATION, MINNEAPOLIS, MN:  
2,150,266, CANC. MULTIPLE CLASS, INT. CLS. 9, 35 AND 36.
- AMERICAN FARM PRODUCTS, INC., YPSILANTI, MI:  
2,928,625, PUB. 12-7-2004, INT. CL. 5.
- AMERICAN FEDERATION FOR AGING RESEARCH (AFAR), INC., NEW YORK, NY:  
1,273,966, CANC. INT. CL. 42.
- AMERICAN FERRET ASSOC., INC., FREDERICK, MD:  
2,150,850, CANC. INT. CL. 42.
- AMERICAN HEALTH & NUTRITION INC., ANN ARBOR, MI:  
2,753,212, CANC. INT. CL. 29.
- AMERICAN INSTITUTE OF WINE & FOOD, THE, SAN FRANCISCO, CA:  
2,149,972, CANC. INT. CL. 41.
- AMERICAN INTERCULTURAL STUDENT EXCHANGE, LA JOLLA, CA:  
1,273,916, CANC. INT. CL. 41.
- AMERICAN INTERNATIONAL GROUP, INC., NEW YORK, NY:  
2,150,815, CANC. INT. CL. 35.
- AMERICAN MULTI-CINEMA, INC., KANSAS CITY, MO:  
2,929,619, INT. CL. 35.

- AMERICAN NATIONAL STANDARDS INSTITUTE, INC., NEW YORK, NY:  
2,150,853, CANC. INT. CL. 35.  
2,150,856, CANC. INT. CL. 35.
- AMERICAN PAYROLL INSTITUTE, NEW YORK, NY:  
2,929,778, INT. CL. 41.
- AMERICAN SPORTING GOODS CORPORATION, IRVINE, CA:  
2,929,608, INT. CL. 41.
- AMERICAN TECHNOLOGY & DEVELOPMENT CORP., LAKELAND, FL, DBA AT&D:  
1,830,280, CANC. INT. CL. 12.
- AMERICAN US BABY CORP., WILMINGTON, DE:  
2,928,487, PUB. 12-7-2004. INT. CL. 10.
- AMERICATEL CORPORATION, MIAMI, FL:  
2,929,262, INT. CL. 38.
- AMES DEPARTMENT STORES, INC., ROCKY HILL, CT:  
1,830,730, CANC. INT. CL. 42.  
1,830,825, CANC. INT. CL. 25.
- AMHERST SECURITIES GROUP, L.P., HOUSTON, TX:  
2,929,016, PUB. 12-7-2004. INT. CL. 36.
- AMI GROUP CONSULTING, LLC, SANTA MONICA, CA:  
2,929,800, INT. CL. 33.
- AMISH PANTRY, LLC, FORT WAYNE, IN:  
2,150,367, CANC. INT. CL. 30.
- AMPACET CORP., TARRYTOWN, NY:  
2,929,693, MULTIPLE CLASS, INT. CLS. 35, 40 AND 42.
- ANACON FOODS COMPANY, MINNEAPOLIS, MN, A. SAHADI & CO., INC., ENGLEWOOD CLIFFS, NJ, DBA FLAVOR TREE FOODS CO.:  
1,318,451, REN. 1-19-05. INT. CL. 30.
- ANDERSON, KENT, BISMARCK, ND:  
2,150,067, CANC. INT. CL. 28.
- ANDRE & CIE. S.A., CH-1002 LAUSANNE, SWITZERLAND:  
2,149,950, CANC. MULTIPLE CLASS, INT. CLS. 1, 3, 7, 23, 29, 30, 31, 36, 39 AND 42.
- ANDREW D. THOMSON & CO. LIMITED, GLASGOW, SCOTLAND:  
768,264, CANC. U.S. CL. 49.
- ANDRX LABS, LLC, DAVIE, FL:  
2,929,566, INT. CL. 5.
- ANIMATION CONTENT, LLC., EAST GRANBY, CT:  
2,929,659, INT. CL. 35.
- ANSELL HEALTHCARE PRODUCTS, LLC, RED BANK, NJ, DBA ANSELL HEALTHCARE:  
2,929,611, INT. CL. 10.
- APFELROTH, STEPHEN, NORWALK, CT:  
1,934,495, REN. 1-19-05. INT. CL. 42.
- APPLIANCE CORP. OF AMERICA, GREAT NECK, NY, DBA WELBILT:  
2,150,466, CANC. INT. CL. 11.
- APPLIANZ TECHNOLOGIES, INC., WICHITA, KS:  
2,929,385, MULTIPLE CLASS, INT. CLS. 9 AND 42.
- APPLIED ENGINEERED SURFACES INC., ELYRIA, OH:  
2,929,700, INT. CL. 6.
- APPLIED FORMAL METHODS INSTITUTE INC., 8003 ZURICH, SWITZERLAND:  
2,929,052, MULTIPLE CLASS, INT. CLS. 9, 16, 41 AND 42.
- APPRIZE, INC., EDINA, MN:  
2,929,747, MULTIPLE CLASS, INT. CLS. 36 AND 37.
- APPROVED AERONAUTICS, L.L.C., SAN DIEGO, CA:  
2,929,553, INT. CL. 11.
- APPROVED PERFORMANCE TOOLING, INC., TROY, MI:  
998,398, REN. 1-21-05. INT. CL. 7.
- APPS OF BOONE, INC., BOONE, NC:  
2,929,396, INT. CL. 35.
- AQFTM, INC., CAREY, NC:  
2,929,502, INT. CL. 30.
- AQUAPENN SPRING WATER COMPANY, INC., THE, STATE COLLEGE, PA:  
2,149,998, CANC. INT. CL. 32.
- AQUINO, ALEXIS R., COLMA, CA, DBA ACE BEAT ENTERTAINMENT:  
2,150,537, CANC. INT. CL. 41.
- ARAMARK CORPORATION, PHILADELPHIA, PA:  
2,929,004, PUB. 12-7-2004. INT. CL. 43.  
2,929,248, MULTIPLE CLASS, INT. CLS. 30 AND 43.
- ARBORGUARD, INC., AVONDALE ESTATES, GA:  
2,929,734, INT. CL. 44.
- ARCHER DANIELS MIDLAND COMPANY, DECATUR, IL:  
2,151,517, CANC. INT. CL. 30.
- ARCURI, ANTHONY, HILTON HEAD ISLAND, SC:  
2,929,863, INT. CL. 30.
- ARDIENTE FOODS INCORPORATED, LONG BEACH, CA:  
2,151,300, CANC. INT. CL. 30.
- ARK-LES CORPORATION, STOUGHTON, MA:  
2,929,354, INT. CL. 9.
- ARLINGTON CANDY CO., INC., WOBURN, MA:  
768,256, CANC. U.S. CL. 46.
- ARMAMENT SYSTEMS AND PROCEDURES, INC., APPLETON, WI:  
1,895,917, REN. 1-19-05. INT. CL. 8.
- ARMED FORCES JOURNAL INTERNATIONAL, INC., HILTON HEAD, SC TO ARMED FORCES JOURNAL INTERNATIONAL, INC., MCLEAN, VA:  
1,830,330, CANC. INT. CL. 16.
- ARNELL GROUP LTD., NEW YORK, NY:  
2,150,411, CANC. INT. CL. 42.
- AROMA FRESH, LLC, COLUMBUS, OH:  
2,929,572, INT. CL. 11.  
2,929,885, INT. CL. 11.
- ARQULE INC., WOBURN, MA:  
2,929,150, INT. CL. 9.
- ART ADVANCED RESEARCH TECHNOLOGIES INC./ART RECHERCHES ET TECHNOLOGIES AVANCEES INC., SAINT-LAURENT, QUEBEC, CANADA:  
2,928,474, PUB. 8-17-2004. INT. CL. 10.
- ARTGLO COMPANY, THE, COLUMBUS, OH:  
2,929,582, MULTIPLE CLASS, INT. CLS. 40 AND 42.
- ARTIN INDUSTRIAL CO. LTD., SAN POKONG, KOWLOON, HONG KONG, HONG KONG:  
2,929,873, INT. CL. 28.
- ASCENT TECHNOLOGY, INC., CAMBRIDGE, MA:  
2,929,847, INT. CL. 9.  
2,929,848, INT. CL. 9.  
2,929,849, INT. CL. 9.  
2,929,851, INT. CL. 9.  
2,929,856, INT. CL. 9.
- ASCOT (S&F) INTERNATIONAL LTD., HACKBRIDGE SURREY SM6 7AH, ENGLAND:  
1,875,340, REN. 1-18-05. INT. CL. 25.
- ASD SOFTWARE, INC., PLANO, TX, DBA AGAVE SOFTWARE DESIGN:  
2,150,496, CANC. MULTIPLE CLASS, INT. CLS. 9 AND 42.
- ASHEVILLE TOURISTS BASEBALL, INC., ASHEVILLE, NC:  
2,045,402, CANC. MULTIPLE CLASS, INT. CLS. 16, 28 AND 41.
- ASHLAR-STONE, INC., MISSISSAUGA, ONTARIO, CANADA:  
2,928,917, PUB. 12-7-2004. INT. CL. 35.
- ASICS CORPORATION, TERADA-CHO, SUMA-KU, KOBE CITY, HYOGO PR, JAPAN:  
1,273,614, CANC. INT. CL. 25.
- ASML MASKTOOLS B.V., NL O5500 AH VELDHOVEL, NETHERLANDS:  
2,928,646, PUB. 12-7-2004. MULTIPLE CLASS, INT. CLS. 9, 41 AND 42.
- ASQ TECHNOLOGY, INC., SAN CLEMENTE, CA, ASQ BOATS, INC., TUSTIN, CA:  
1,309,042, REN. 1-15-05. INT. CL. 21.
- ASSOCIACION MUNDIAL DE MEXICANOS EN EL EXTERIOR, BEVERLY HILLS, CA:  
2,928,849, PUB. 12-7-2004. INT. CL. 35.
- ASSOCIATED CITRUS PACKERS, INC., YUMA, AZ:  
1,830,493, CANC. INT. CL. 31.
- ASSOCIATED MATERIALS, INC., CUYAHOGA FALLS, OH, DBA ALSIDE:  
2,929,845, MULTIPLE CLASS, INT. CLS. 35 AND 40.
- ASTER NUT PRODUCTS, INC., NEWARK, NJ:  
1,273,734, CANC. INT. CL. 29.
- ASTILEAN, AUREL A., EAST HAMPTON, NY:  
2,929,057, INT. CL. 41.
- ASTRAZENECA AB, SODERTALJE, SWEDEN:  
2,929,634, INT. CL. 16.

- AT&T CORP., NEW YORK, NY:  
2,929,627, INT. CL. 38.
- ATI, INCORPORATED, FOND DU LAC, WI:  
2,150,230, CANC. INT. CL. 9.
- ATLANTIC COAST CONFERENCE, GREENSBORO, NC:  
1,871,388, REN. 1-18-05, INT. CL. 25.
- ATLANTIC RICHFIELD COMPANY, LOS ANGELES, CA:  
2,151,419, CANC. INT. CL. 28.
- ATM OUTSOURCES, INC., OKLAHOMA CITY, OK:  
2,928,486, PUB. 12-7-2004, INT. CL. 35.
- ATOMIC AUSTRIA GMBH, A-5541 ALTENMARKT, AUSTRIA:  
2,928,658, PUB. 7-20-2004, MULTIPLE CLASS, INT. CLS. 18, 25 AND 28.
- ATOP TECHNOLOGIES, INC., HSINCHU, TAIWAN:  
2,151,257, CANC. INT. CL. 9.
- AUDATEX AG, 8038 ZURICH, SWITZERLAND:  
2,149,949, CANC. MULTIPLE CLASS, INT. CLS. 35 AND 36.
- AUSPEX GROUP, L.P., COS COB, CT:  
2,929,351, INT. CL. 36.  
2,929,352, INT. CL. 36.  
2,929,353, INT. CL. 36.
- AUSPICE, INC., FRAMINGHAM, MA:  
2,929,629, INT. CL. 9.
- AUSTRAL VON ROLL ISOLA, INC., DOUGLASVILLE, GA:  
2,929,210, INT. CL. 9.
- AUTO EUROPE, LLC, PORTLAND, ME:  
2,928,456, PUB. 12-7-2004, MULTIPLE CLASS, INT. CLS. 16, 36, 39 AND 42.
- AUTODESK, INC., SAN RAFAEL, CA:  
2,151,399, CANC. INT. CL. 9.
- AUTOMATION KOLN, 5000 KOLN 60, FED REP GERMANY:  
1,830,902, CANC. INT. CL. 42.
- AUTOMOTIVE COMPONENTS LIMITED, MELBOURNE, 3000, VIC, AUSTRALIA:  
2,929,300, INT. CL. 27.
- AVAX INTERNATIONAL IP HOLDINGS, INC., OVERLAND PARK, MO FROM AVAX TECHNOLOGIES, INC., KANSAS CITY, MO:  
2,929,049, INT. CL. 5.
- AVAYA INC., BASKING RIDGE, NJ:  
2,929,557, MULTIPLE CLASS, INT. CLS. 41 AND 42.
- AVCOM AVIONICS AND INSTRUMENTS, INC., MIAMI, FL:  
2,928,948, PUB. 12-7-2004, INT. CL. 37.
- AVENIDA AMERICA, INC., DULUTH, GA:  
2,929,089, MULTIPLE CLASS, INT. CLS. 35 AND 42.
- AVENTIS HOLDINGS, INC., GREENVILLE, DE:  
2,929,091, MULTIPLE CLASS, INT. CLS. 38 AND 42.
- AVIATION LABORATORIES, INC., HOUSTON, TX:  
1,869,135, REN. 1-19-05, INT. CL. 1.
- AVIATION ROAD DEVELOPMENT CORP., QUEENSBURY, NY:  
2,151,294, CANC. INT. CL. 42.
- AVID TECHNOLOGY, INC., TEWSKBURY, MA:  
2,928,925, PUB. 12-7-2004, INT. CL. 9.
- AVON PRODUCTS, INC., NEW YORK, NY:  
2,151,387, CANC. INT. CL. 3.
- AWESOME KIDS, LLC, WHEATON, IL:  
2,929,721, INT. CL. 41.
- AZTECA FOODS, INC., CHICAGO, IL:  
2,929,753, INT. CL. 30.
- B & F SYSTEM, INC., THE, DALLAS, TX:  
1,273,356, CANC. INT. CL. 8.
- B.V. CHEMISCHE FABRIEK TRIADE, 2675 AD HONSELERSDIJK, NETHERLANDS:  
1,865,511, REN. 1-19-05, INT. CL. 2.
- BAB SPORTS SA, SIERRE, SWITZERLAND:  
2,929,510, MULTIPLE CLASS, INT. CLS. 9 AND 25.
- BACA, ENRIQUE, ALPHARETTA, GA:  
2,929,691, INT. CL. 36.
- BACHMANN INDUSTRIES, INC., PHILADELPHIA, PA:  
2,929,228, INT. CL. 9.
- BAJA PEAK PROPERTIES, INC., SANTA MONICA, CA:  
2,150,429, CANC. INT. CL. 35.
- BAJC, MIKE, MISSION VIEJO, CA:  
2,929,695, INT. CL. 40.
- BAKED BEADS, INC., WAITSFIELD, VT:  
2,929,032, PUB. 12-7-2004, INT. CL. 14.
- BALTIMORE AIRCOIL COMPANY, INC., JESSUP, MD:  
1,830,888, CANC. INT. CL. 36.
- BANCO DE LA NACION ARGENTINA, BUENOS AIRES, ARGENTINA:  
1,294,900, REN. 1-18-05, INT. CL. 36.
- BANK OF AMERICA CORPORATION, CHARLOTTE, NC, NATIONS BANK CORPORATION, CHARLOTTE, NC, AKA NATIONS BANK MILITARY BANKING:  
1,873,797, REN. 1-18-05, INT. CL. 16.
- BANK OF NEW YORK, THE, NEW YORK, NY:  
2,151,259, CANC. INT. CL. 18.  
2,151,260, CANC. INT. CL. 25.  
2,151,261, CANC. INT. CL. 26.  
2,151,262, CANC. INT. CL. 14.
- BANK OF NOVA SCOTIA, THE, TORONTO 1, ONTARIO, CANADA:  
1,003,026, REN. 1-19-05, INT. CL. 36.
- BANK, MORT, BISMARCK, ND:  
2,151,475, CANC. INT. CL. 29.  
2,151,476, CANC. INT. CL. 30.
- BANKAMERICA CORPORATION, CHARLOTTE, NC:  
1,830,581, CANC. INT. CL. 36.
- BARBARA JOSEPH CORPORATION, NEW YORK, NY, DBA URBAN YOGA CENTER:  
2,151,057, CANC. MULTIPLE CLASS, INT. CLS. 25 AND 41.
- BARCharts, INC., BOCA RATON, FL:  
1,868,263, REN. 1-18-05, INT. CL. 16.
- BARDAHL MANUFACTURING CORPORATION, SEATTLE, WA:  
2,929,792, INT. CL. 1.
- BARLEAN'S ORGANIC OILS, LLC, FERNDALE, WA:  
2,929,665, INT. CL. 5.
- BARON DE LEY, S.A., 31587 MENDAVIA (NAVARRA), SPAIN:  
2,929,313, INT. CL. 29.
- BARON'S HIGH CHAPARRAL, STANWOOD, WA:  
2,150,136, CANC. INT. CL. 29.
- BARSAN GLOBAL LOJISTIK ANONIM SIRKETI, ISTANBUL, TURKEY:  
2,928,687, PUB. 12-7-2004, INT. CL. 35.
- BARSKY, JANICE L., LAMY, NM:  
2,150,105, CANC. INT. CL. 42.
- BARTON, BRAD, R., STILLWATER, OK:  
2,928,752, PUB. 12-7-2004, INT. CL. 43.
- BASELL TECHNOLOGY COMPANY B.V., 2132 MS HOOFDORP, NETHERLANDS:  
2,929,117, MULTIPLE CLASS, INT. CLS. 1, 17 AND 42.  
2,929,132, MULTIPLE CLASS, INT. CLS. 1, 17 AND 42.
- BASF CORPORATION, MOUNT OLIVE, NJ:  
1,830,083, CANC. INT. CL. 2.
- BASF DRUCKSYSTEME GMBH, STUTTGART, FED REP GERMANY, BASF FARBEN + FASERN AKTIENGESELLSCHAFT, HAMBURG 30, FED REP GERMANY:  
1,300,063, REN. 1-21-05, INT. CL. 2.
- BASS PRO TRADEMARKS, L.L.C., SPRINGFIELD, MO:  
2,929,833, INT. CL. 35.
- BATTAGLIA, JOSEPH A., CHAPPAQUA, NY:  
2,150,556, CANC. INT. CL. 41.
- BATTERY SOLUTIONS, INC., LUBBOCK, TX:  
2,929,638, INT. CL. 9.
- BAUCHEL HOLDINGS PTY LTD, GYMPIE QUEENSLAND 4570, AUSTRALIA:  
2,150,404, CANC. INT. CL. 30.
- BAY STATE MILLING COMPANY, QUINCY, MA:  
2,151,084, CANC. INT. CL. 30.
- BAYER AKTIENGESELLSCHAFT, 5090 LEVERKUSEN-BAYERWERK, FED REP GERMANY:  
1,830,764, CANC. INT. CL. 5.
- BAYERISCHE HYPO-UND VEREINSBANK AG, MUNICH, FED REP GERMANY:  
2,928,651, PUB. 5-18-2004, MULTIPLE CLASS, INT. CLS. 16, 35 AND 36.

- BAYLOR UNIVERSITY, WACO, TX:  
2,151,124, CANC. U.S. CL. A.
- BC INTERNATIONAL COSMETIC & IMAGE SERVICES, INC., ORLANDO, FL, BC INTERNATIONAL COSMETIC & IMAGE SERVICES, INC., ORLANDO, FL:  
1,891,600, REN. 1-18-05. INT. CL. 3.
- BC SPORTS, INC., PORTLAND, OR:  
2,928,815, PUB. 12-7-2004. INT. CL. 28.
- BDH TWO, INC., WILMINGTON, DE TO BFC INVESTMENTS, L.P., WILMINGTON, DE:  
1,830,479, CANC. INT. CL. 30.
- BEAN COLLECTION COFFEE, INC., SEATTLE, WA:  
2,150,165, CANC. INT. CL. 30.
- BEAUMAN, REBECCA L., COLUMBIA, MD:  
2,929,716, INT. CL. 35.
- BEAUTE CREATEURS (SOCIETE ANONYME), PARIS, FRANCE:  
2,928,751, PUB. 12-7-2004. INT. CL. 3.
- BEAUTY HOLDING COMPANY, INC., HAMILTON, BERMUDA:  
2,928,859, PUB. 12-7-2004. INT. CL. 3.
- BEAUTY WITHOUT CRUELTY (SOUTH PACIFIC) LIMITED, MANUREWA, AUCKLAND, NEW ZEALAND:  
1,273,267, CANC. INT. CL. 3.
- BECKER & MAYERL, LTD., BELLEVUE, WA:  
2,151,402, CANC. INT. CL. 28.
- BECKTRONIX, STATEN ISLAND, NY:  
2,150,669, CANC. INT. CL. 37.
- BECTON, DICKINSON AND COMPANY, PARAMUS, NJ:  
768,224, CANC. U.S. CL. 39.
- BEEFAMERICA OPERATING COMPANY, INC., DUBUQUE, IA:  
1,273,741, CANC. INT. CL. 29.
- BEIJING AMSSY ELECTRONIC SCIENCE & TECHNOLOGY CO., LTD., BEIJING, CHINA:  
2,928,681, PUB. 12-7-2004. INT. CL. 10.
- BEIJING SUNSHINE SUREN-CRAFT LEATHER MAKING CO., LTD., BEIJING, CHINA:  
2,928,796, PUB. 12-7-2004. MULTIPLE CLASS, INT. CLS. 18 AND 25.
- BEL-ART PRODUCTS, PEQUANNOCK, NJ:  
1,273,375, CANC. INT. CL. 9.
- BELK STORES SERVICES, INC., CHARLOTTE, NC:  
2,150,697, CANC. INT. CL. 25.
- BELL FEDERAL SAVINGS & LOAN ASSOCIATION, CHICAGO, IL:  
1,273,855, CANC. INT. CL. 36.
- BELL GARDENS BICYCLE CLUB, THE, BELL GARDENS, CA:  
2,149,936, CANC. INT. CL. 41.
- BELL HELICOPTER TEXTRON INC., FORT WORTH, TX:  
2,928,806, PUB. 12-7-2004. INT. CL. 12.
- BELLRICA TRADING CONCEPTS, N.V., WILLEMSTAD, CURACAO, NETHERLD ANTILLES:  
1,273,506, CANC. MULTIPLE CLASS, INT. CLS. 18 AND 25.
- BELLSOUTH INTELLECTUAL PROPERTY CORPORATION, WILMINGTON, DE:  
2,929,789, INT. CL. 38.
- BELOIT CORPORATION, BELOIT, WI:  
1,273,334, CANC. INT. CL. 7.  
1,273,335, CANC. INT. CL. 7.  
1,273,338, CANC. INT. CL. 7.  
1,273,339, CANC. INT. CL. 7.  
1,273,342, CANC. INT. CL. 7.  
1,273,343, CANC. INT. CL. 7.  
1,273,345, CANC. INT. CL. 7.  
1,273,346, CANC. INT. CL. 7.
- BELSER, SCOTT, SAN FRANCISCO, CA:  
2,151,290, CANC. MULTIPLE CLASS, INT. CLS. 35, 36, 38 AND 42.
- BENCIVENGO, MICHAEL L., JR., NORTH BRANFORD, CT:  
2,151,425, CANC. MULTIPLE CLASS, INT. CLS. 25 AND 42.
- BENDER, SANDRA G., CLEVELAND HEIGHTS, OH:  
2,150,933, CANC. INT. CL. 41.
- BENINGER, AILEEN, TORONTO, ONTARIO, CANADA:  
2,149,973, CANC. INT. CL. 25.
- BENTLEY LINGERIE, INC., JERSEY CITY, NJ:  
1,832,285, REN. 1-21-05. INT. CL. 25.
- BENTLEY SYSTEMS, INCORPORATED, EXTON, PA:  
2,166,970, AM. MULTIPLE CLASS, INT. CLS. 41 AND 42.
- BERG TECHNOLOGY INC., RENO, NV:  
1,310,878, REN. 1-18-05. INT. CL. 9.
- BERGEN DISTRIBUTING, L.C., AMES, IA:  
2,150,925, CANC. INT. CL. 5.  
2,150,926, CANC. INT. CL. 5.
- BERGEN RECORD CORPORATION, HACKENSACK, NJ:  
2,150,211, CANC. MULTIPLE CLASS, INT. CLS. 16, 35, 38 AND 42.
- BERKELEY MEDEVICES, INC.:  
1,273,413, CANC. INT. CL. 10.
- BERN CHRONOMETER WORKS, INC., TORONTO, ONTARIO, M5C 2C5, CANADA:  
1,830,926, CANC. INT. CL. 14.
- BERTUCCI, MICHAEL, GURNEE, IL:  
2,929,664, INT. CL. 14.
- BERU AG, 71636 LUDWIGSBURG, FED REP GERMANY:  
2,928,488, PUB. 12-7-2004. MULTIPLE CLASS, INT. CLS. 7 AND 12.
- BERWICK DELAWARE, INC., WILMINGTON, DE, RIBBON MAGIC, INC., CHASKA, MN:  
1,878,458, REN. 1-21-05. INT. CL. 26.
- BETTER SOUND ALL AROUND CORPORATION, SEATTLE, WA:  
2,151,540, CANC. INT. CL. 9.
- BETTINA LIANO PTY LTD., VIC, AUSTRALIA:  
2,894,053, COR. INT. CL. 25.
- BEVERLY HILLS PASHMINAS LLC, BEVERLY HILLS, CA:  
2,357,721, CANC. INT. CL. 25.
- BEXAR MANUFACTURING & TRADING COMPANY, INC., SAN ANTONIO, TX:  
2,150,648, CANC. INT. CL. 25.
- BFS RETAIL & COMMERCIAL OPERATIONS, LLC, CARMEL, IN:  
2,928,544, PUB. 12-7-2004. INT. CL. 37.
- BI-LO, INC., MAULDIN, SC:  
2,151,536, CANC. INT. CL. 29.
- BIC CORPORATION, MILFORD, CT:  
1,830,770, CANC. INT. CL. 8.
- BICICLETAS CALOI S.A., SAO PAULO-SP, BRAZIL:  
2,150,207, CANC. INT. CL. 12.
- BIG BOB'S NEW & USED CARPET OF AMERICA, INC., OLATHE, KS:  
2,150,875, CANC. INT. CL. 35.
- BIG DOG HOLDINGS, INC., SANTA BARBARA, CA:  
1,854,353, REN. 1-18-05. INT. CL. 42.
- BIO-BOTANICA, INC., HAUPPAUGE, NY:  
2,929,483, INT. CL. 5.
- BIO-LAB, INC., DECATUR, GA:  
2,151,276, CANC. INT. CL. 11.
- BIOENVELOP AGRO INC., LAVAL, QUEBEC, CANADA:  
2,929,220, INT. CL. 1.
- BIOFERM, INC., WHEELING, IL:  
1,273,237, CANC. INT. CL. 1.
- BIOMED COMM, INC., SEATTLE, WA:  
2,150,665, CANC. INT. CL. 5.
- BIOMERIEUX, MARCY - L'ETOILE, FRANCE:  
2,928,784, PUB. 12-7-2004. MULTIPLE CLASS, INT. CLS. 1 AND 9.
- BIOMET, INC., WARSAW, IN:  
1,877,515, REN. 1-21-05. INT. CL. 10.  
2,929,597, INT. CL. 10.
- BIOPHILE CORPORATION, LTD., PATUMWAN, BANGKOK 10330, THAILAND:  
2,929,397, MULTIPLE CLASS, INT. CLS. 3 AND 5.
- BIOPORT CORPORATION, LANSING, MI:  
2,928,539, PUB. 12-7-2004. INT. CL. 5.  
2,928,540, PUB. 12-7-2004. INT. CL. 5.
- BIOSCULPTOR CORPORATION, HIALEAH, FL, MARAMED PRECISION CORPORATION, CORAL GABLES, FL:  
1,863,100, REN. 1-21-05. INT. CL. 9.
- BIOSYS, INC., COLUMBIA, MD:  
2,150,454, CANC. INT. CL. 5.

- BIOTHERM, MONACO, MONACO:  
2,929,446, INT. CL. 3.
- BIRAMBEAU, S.A., 75012 PARIS, FRANCE:  
2,928,457, PUB. 12-7-2004. MULTIPLE CLASS, INT. CLS. 8 AND 21.
- BIRCHFIELD INTERNET PLC, CARDIFF, UNITED KINGDOM:  
2,929,128, MULTIPLE CLASS, INT. CLS. 9, 41 AND 42.
- BIRD-X, INC., CHICAGO, IL:  
2,928,966, PUB. 12-7-2004. INT. CL. 5.
- BIRKO ORTHOPAEDIE GMBH, 53545 LINZ, FED REP GERMANY:  
2,929,183, MULTIPLE CLASS, INT. CLS. 10 AND 25.  
2,929,184, MULTIPLE CLASS, INT. CLS. 10 AND 25.
- BISON MANUFACTURING, LLC, ELKHART, IN:  
2,928,968, PUB. 12-7-2004. INT. CL. 12.
- BITEC INC., NORRILTON, AR, B.P.S. BITUMINOUS PROTECTION SYSTEMS, LIMITED, ZUG 2, SWITZERLAND:  
1,310,062, REN. 1-18-05. INT. CL. 19.
- BIZTRAVEL.COM, INC., NEW YORK, NY:  
2,150,350, CANC. INT. CL. 42.
- BLACK AND DECKER CORPORATION, THE, TOWSON, MD:  
2,928,914, PUB. 12-7-2004. INT. CL. 7.
- BLACK DIAMOND EQUIPMENT, LTD., SALT LAKE CITY, UT, GREAT PACIFIC IRON WORKS, VENTURA, CA:  
997,453, REN. 1-19-05. U.S. CL. 13 (INT. CL. 28).
- BLACK MAX DOWNHOLE TOOLS LTD., NISKU, ALBERTA, CANADA:  
2,929,108, MULTIPLE CLASS, INT. CLS. 7 AND 37.
- BLACKALL ASSOCIATES, PROVIDENCE, RI AND DYNAMIC GROUP, THE, GREAT FALLS, VA:  
2,150,593, CANC. INT. CL. 14.
- BLAZE RESTORATION, INC., MOLINE, IL:  
2,928,893, PUB. 12-7-2004. INT. CL. 37.
- BLENDEX COMPANY, LOUISVILLE, KY:  
1,905,598, REN. 1-21-05. INT. CL. 16.
- BLES, THOMAS G., TEMPE, AZ:  
2,929,435, MULTIPLE CLASS, INT. CLS. 12 AND 44.
- BLUE CROSS AND BLUE SHIELD ASSOCIATION, CHICAGO, IL:  
2,150,760, CANC. MULTIPLE CLASS, INT. CLS. 36 AND 42.
- BLUE RIDGE FARMS ILLINOIS, INC., CHICAGO, IL:  
2,150,516, CANC. INT. CL. 30.
- BLUECURVE, INC., OAKLAND, CA:  
2,150,743, CANC. INT. CL. 9.
- BLUELINK CORPORATION, F/K/A ABP DISTRIBUTION INC., ATLANTA, GA:  
1,383,021, CANC. INT. CL. 6.
- BLUERIDGE SOLUTIONS, LC, PHOENIX, AZ:  
2,928,558, PUB. 12-7-2004. INT. CL. 42.
- BOARD OF CERTIFICATION OF GENEALOGISTS, WAYNE, PA:  
1,831,728, REN. 1-21-05. U.S. CL. B.
- BOARD OF REGENTS OF THE UNIVERSITY SYSTEM OF GEORGIA, ATLANTA, GA:  
2,928,559, PUB. 12-7-2004. INT. CL. 9.
- BOARD OF REGENTS, THE UNIVERSITY OF TEXAS SYSTEM, AUSTIN, TX:  
1,911,323, REN. 1-18-05. INT. CL. 36.
- BOB ROSS, INC., CHANTILLY, VA:  
2,928,514, PUB. 12-7-2004. MULTIPLE CLASS, INT. CLS. 9 AND 41.
- BOC GROUP, INC., THE, MONTVALE, NJ:  
406,543, CANC. U.S. CL. 6.
- BOEHRINGER INGELHEIM KG, 6507 INGELHEIM AM RHEIN, FED REP GERMANY:  
2,150,254, CANC. INT. CL. 5.
- BOHLIN INSTRUMENTS LIMITED, CIRENCESTER, GLOUCESTER, GREAT BRITAIN:  
2,929,261, INT. CL. 9.
- BOIN, S.A., BRETENOUX, FRANCE:  
1,273,753, CANC. INT. CL. 30.
- BOMBARDIER RECREATIONAL PRODUCTS INC., VALCOURT, QUEBEC:  
1,313,012, REN. 1-18-05. INT. CL. 4.
- BOMBARDIER RECREATIONAL PRODUCTS INC., VALCOURT JOE 2L0, CANADA:  
2,929,732, INT. CL. 12.
- BONNE BELL, INC., LAKEWOOD, OH:  
2,929,652, INT. CL. 3.
- BOOTS COMPANY USA HOLDINGS INC., THE, WILMINGTON, DE:  
2,929,889, INT. CL. 3.  
2,929,893, INT. CL. 3.
- BORAL BRICKS, INC., ATLANTA, GA:  
2,151,199, CANC. MULTIPLE CLASS, INT. CLS. 19 AND 42.
- BORDEN, INC., COLUMBUS, OH:  
1,273,806, CANC. INT. CL. 32.
- BORLAND INTERNATIONAL, INC., SCOTTS VALLEY, CA:  
2,150,153, CANC. INT. CL. 9.
- BOSCACCI, PAUL JON, COLUMBIA, SC:  
2,150,714, CANC. INT. CL. 16.
- BOTANICUS, INC., GAITHERSBURG, MD:  
1,273,276, CANC. INT. CL. 3.
- BOTAS CABORCA, S.A. DE C.V., LEON, GTO, MEXICO:  
1,868,372, REN. 1-18-05. INT. CL. 25.
- BOULDIN & LAWSON, INC., MCMINNVILLE, TN:  
2,150,324, CANC. INT. CL. 7.
- BOUMAN, MARIE C., WILMINGTON, DE:  
1,895,124, REN. 1-21-05. INT. CL. 20.
- BOUTINOT LIMITED, GATLEY, CHESHIRE, UNITED KINGDOM:  
2,929,360, INT. CL. 33.
- BOX, LTD., NEW YORK, NY:  
2,929,615, INT. CL. 9.
- BOY'S FARMERS MARKET, INC., THE, DELRAY BEACH, FL:  
2,929,162, MULTIPLE CLASS, INT. CLS. 36 AND 42.
- BOZZALLA & LESNA S.P.A., 13863 COGGIOLA, BIELLA, ITALY:  
1,830,399, CANC. INT. CL. 24.
- BRADY WORLDWIDE, INC., MILWAUKEE, WI, TEMPBADGE SECURITY SYSTEMS, INC., RAMSEY, NJ:  
1,308,743, REN. 1-20-05. INT. CL. 9.
- BRAINTAINMENT RESOURCES, INC., LAGUNA BEACH, CA:  
2,150,775, CANC. INT. CL. 9.
- BRAINY BABY COMPANY, LLC, THE, ALPHARETTA, GA:  
2,929,561, INT. CL. 9.
- BRAND EXPERIENCE LLC, THE, MIAMI BEACH, FL:  
2,928,664, PUB. 12-7-2004. INT. CL. 25.
- BRANDESS-KALT-AETNA GROUP, INC., VERNON HILLS, IL:  
2,929,821, INT. CL. 9.
- BRASILCONNECTS, NEW YORK, NY:  
2,929,346, INT. CL. 35.
- BRAUNER, HOWARD, MANALAPAN, NJ:  
2,929,244, INT. CL. 3.
- BRAVO CORPORATION, SANTA ANA, CA:  
2,151,278, CANC. INT. CL. 4.
- BREAKER, RICHARD, GOLDEN, CO:  
2,928,973, PUB. 12-7-2004. INT. CL. 28.
- BREAST IMAGING AND BIOPSY SPECIALISTS, LLC, RUMSON, NJ:  
2,929,021, PUB. 12-7-2004. INT. CL. 44.
- BREWSTER DAIRY, INC., BREWSTER, OH:  
2,929,221, INT. CL. 29.  
2,929,222, INT. CL. 29.
- BRIAREUS CORPORATION, LOS ANGELES, CA:  
1,273,383, CANC. INT. CL. 9.
- BRIDGEVIEW VINEYARDS, INC., CAVE JUNCTION, OR:  
2,928,511, PUB. 12-7-2004. INT. CL. 33.
- BRIGADE QUARTERMASTERS LTD., MARIETTA, GA, DBA BRIGADE QUARTERMASTERS:  
1,273,514, CANC. INT. CL. 18.
- BRIGHT ENTERPRISES, INC., NEW YORK, NY:  
2,151,296, CANC. INT. CL. 41.
- BRIGHT SOLUTIONS, INC., TROY, MI:  
1,873,486, REN. 1-21-05. INT. CL. 1.
- BRINE, INC., MILFORD, MA:  
2,929,829, INT. CL. 28.

- BRINKER RESTAURANT CORPORATION, DALLAS, TX:  
2,150,571, CANC. INT. CL. 29.
- BRITAX CHILD SAFETY INC., CHARLOTTE, NC:  
2,929,587, INT. CL. 12.
- BROMAN, TERESA E., CLAYTON, WA, DBA FRESCO ESPRESSO:  
2,151,182, CANC. INT. CL. 42.
- BRONER GLOVE COMPANY, AUBURN HILLS, MI:  
2,929,503, INT. CL. 25.
- BRONX PIZZA, INC., SAN DIEGO, CA:  
2,928,972, PUB. 12-7-2004. INT. CL. 43.
- BROWN INVESTMENT PARTNERSHIP, LTD., KANSAS CITY, MO:  
2,929,316, INT. CL. 36.
- BROWN, REBECCA A., VIRGINIA BEACH, VA:  
2,928,550, PUB. 12-7-2004. INT. CL. 7.
- BROWN, SMITH, WALLACE, LIBRACH & GORDON, PARTNERSHIP, THE, ST. LOUIS, MO TO BROWN SMITH WALLACE, L.L.C., ST. LOUIS, MO:  
1,830,661, CANC. INT. CL. 41.
- BROWN, STEVE, HESPERIA, CA:  
2,929,790, INT. CL. 21.
- BRT, INC., WILMINGTON, DE:  
780,344, REN. 1-18-05. U.S. CL. 37 (INT. CL. 16).  
780,345, REN. 1-18-05. U.S. CL. 37 (INT. CL. 16).
- BRUNING PAINT COMPANY, SARASOTA, FL:  
2,080,332, CANC. INT. CL. 2.
- BRUNETTE, BLAKE R., ROCHESTER, MN:  
2,929,596, INT. CL. 24.
- BRUNSWICK CORPORATION, LAKE FOREST, IL:  
2,928,832, PUB. 12-7-2004. INT. CL. 9.
- BRYCE-N-TOYS, INC., CORNELIUS, NC:  
2,929,348, INT. CL. 28.
- BTI AMERICAS, INC., NORTHBROOK, IL:  
2,151,134, CANC. MULTIPLE CLASS, INT. CLS. 39 AND 42.
- BUBB, PATRICIA, PHILADELPHIA, PA:  
2,929,302, INT. CL. 16.
- BUC INTERNATIONAL CORPORATION, FORT LAUDERDALE, FL:  
2,929,430, INT. CL. 42.
- BUCHANAN STREET PARTNERS, INC., NEWPORT BEACH, CA:  
2,929,780, INT. CL. 36.
- BUCKMAN LABORATORIES INTERNATIONAL, INC., MEMPHIS, TN:  
2,929,279, INT. CL. 1.
- BUILDING ONLINE AMERICA CORPORATION, MANASSAS, VA:  
2,150,912, CANC. INT. CL. 35.
- BULGARI S.P.A., ROME, ITALY, PARTECIPAZIONI BULGARI S.P.A., 00187 ROME, ITALY:  
1,848,461, REN. 1-19-05. INT. CL. 3.
- BULKLEY VALLEY MILK LTD., BRITISH COLUMBIA, CANADA:  
2,150,159, CANC. MULTIPLE CLASS, INT. CLS. 29, 30 AND 32.
- BURHAM SERVICES, INC., WILMINGTON, DE:  
2,929,423, INT. CL. 11.
- BURLWOOD GROUP, INC., BURBANK, CA:  
2,929,712, INT. CL. 30.
- BUSBY GROUP, INC., BLUE SPRINGS, MO:  
1,830,898, CANC. INT. CL. 41.
- BUSCH ENTERTAINMENT CORPORATION, ST. LOUIS, MO:  
1,938,076, REN. 1-19-05. INT. CL. 36.
- BUSINESS BANK OF NEVADA, LAS VEGAS, NV:  
2,929,110, INT. CL. 36.
- BUTCHER COMPANY, THE, MARLBOROUGH, MA:  
2,149,978, CANC. INT. CL. 41.
- BUTLER CORPORATION, THE, LUDLOW, MA:  
1,361,739, REN. 1-21-05. INT. CL. 12.
- C & S PRODUCTS CO., INC., FORT DODGE, IA:  
2,928,864, PUB. 12-7-2004. INT. CL. 31.
- C SQUARED TV LLC, SHERMAN OAKS, CA:  
2,929,297, INT. CL. 16.
- C. H. GUENTHER & SON, INC., SAN ANTONIO, TX, DBA PIONEER FLOUR MILLS:  
986,541, REN. 1-19-05. U.S. CL. 46 (INT. CL. 30).
- C.A. SUCESSORA DE JOSE PUIG & CO., CARACAS, VENEZUELA:  
2,929,577, INT. CL. 30.
- C.B. FLEET COMPANY, INCORPORATED, LYNCHBURG, VA:  
2,929,498, INT. CL. 5.  
2,929,499, INT. CL. 5.
- C.B. FLEET INVESTMENT CORPORATION, WILMINGTON, DE:  
2,928,632, PUB. 12-7-2004. INT. CL. 10.
- C&H DISTRIBUTORS, LLC, MILWAUKEE, WI:  
2,797,729, COR. INT. CL. 35.
- CACHE, INC., NEW YORK, NY:  
1,351,848, REN. 1-19-05. MULTIPLE CLASS, INT. CLS. 25 AND 42.
- CAFE PACIFIC, INC., DALLAS, TX:  
1,332,600, REN. 1-21-05. INT. CL. 42.
- CAFRAMO LIMITED, WIARTON, ONTARIO N0H 2T0, CANADA:  
1,808,913, REN. 1-18-05. MULTIPLE CLASS, INT. CLS. 9 AND 11.
- CALERO, JORGE CABRERA, 38710 BRENA ALTA, SPAIN:  
2,150,693, CANC. INT. CL. 34.
- CALIFORNIA ALMOND GROWERS EXCHANGE, SACRAMENTO, CA:  
1,273,747, CANC. INT. CL. 29.
- CALIFORNIA AMPLIFIER, INC., OXNARD, CA:  
1,866,779, REN. 1-19-05. INT. CL. 9.  
1,878,470, REN. 1-21-05. INT. CL. 9.
- CALIFORNIA DESIGN STUDIO INC., WESTLAKE VILLAGE, CA:  
2,151,369, CANC. INT. CL. 19.
- CALLAHAN, E.J., POMONA, CA, DBA E.J. OVENS COMPANY:  
2,150,264, CANC. INT. CL. 11.
- CALLAWAY GOLF COMPANY, CARLSBAD, CA:  
1,310,230, REN. 1-18-05. INT. CL. 28.  
2,929,040, PUB. 12-7-2004. INT. CL. 28.
- CALTECH INDUSTRIES, INC., MIDLAND, MI, DOW CHEMICAL COMPANY, THE, MIDLAND, MI:  
1,372,046, REN. 1-18-05. MULTIPLE CLASS, INT. CLS. 3 AND 5.
- CALTECH INDUSTRIES, INC., MIDLAND, MI:  
1,928,124, REN. 1-18-05. INT. CL. 5.
- CALVARY CHAPEL OF MODESTO, INC., MODESTO, CA:  
2,928,569, PUB. 12-7-2004. INT. CL. 41.
- CAMBRIDGE SCIENTIFIC ABSTRACTS, BETHESDA, MD, DISCLOSURE PARTNERS, BETHESDA, MD:  
1,247,660, REN. 1-18-05. INT. CL. 16.
- CANADA/EAGLEBROOK, INC. DU CANADA, CONCORD, ONTARIO, L4K 4P3, CANADA:  
2,928,571, PUB. 12-7-2004. INT. CL. 1.
- CANADIAN BACK INSTITUTE LIMITED, TORONTO, ONTARIO, CANADA:  
2,149,947, CANC. INT. CL. 9.
- CANDLE CORPORATION OF AMERICA, DESPLAINES, IL:  
1,830,104, CANC. INT. CL. 4.
- CANON SYSTEMS GLOBALIZATION, INC., SANTA CLARA, CA:  
2,150,435, CANC. INT. CL. 35.
- CANTARELLI & C. S.P.A., 52040 RIGUTINO (AREZZO), ITALY:  
2,149,982, CANC. MULTIPLE CLASS, INT. CLS. 3 AND 18.
- CANTRELL, BRAD, D., ALAMOGORDO, NM:  
2,929,795, INT. CL. 3.
- CAP GEMINI AMERICA, INC., NEW YORK, NY:  
2,150,345, CANC. INT. CL. 16.
- CAPITAL JAZZ INC., LARGO, MD:  
1,830,655, CANC. INT. CL. 41.
- CAPO, INC., ORMOND BEACH, FL:  
2,929,719, INT. CL. 9.  
2,929,743, INT. CL. 9.
- CAPTIVE PLASTICS, INC., PISCATAWAY, NJ:  
1,273,575, CANC. MULTIPLE CLASS, INT. CLS. 21 AND

42.  
CAPTIVE-AIRE SYSTEMS, INC., YOUNGSVILLE, NC:  
2,928,499, PUB. 7-20-2004. INT. CL. 11.
- CARADON LIMITED, TORONTO, ONTARIO, M5H 3Y4,  
CANADA, DBA CARADON LITE PRODUCTS:  
2,150,084, CANC. MULTIPLE CLASS, INT. CLS. 6, 9 AND  
20.
- CARAVAN MFG. CO., INC., LONG BEACH, CA:  
2,150,804, CANC. INT. CL. 12.  
2,150,805, CANC. INT. CL. 20.
- CARDONE INDUSTRIES, INC., PHILADELPHIA, PA:  
2,928,599, PUB. 12-7-2004. MULTIPLE CLASS, INT. CLS.  
7, 9 AND 12.
- CARE-TECH LABORATORIES, INC., ST. LOUIS, MO:  
2,929,060, INT. CL. 5.
- CAREERSTAFF UNLIMITED, INC., HOUSTON, TX:  
2,149,958, CANC. INT. CL. 35.
- CAREMARK INTERNATIONAL INC., NORTHBROOK, IL:  
2,929,827, INT. CL. 35.
- CARGILL, INCORPORATED, WAYZATA, MN:  
1,310,297, REN. 1-19-05. INT. CL. 29.  
2,151,154, CANC. INT. CL. 42.  
2,151,157, CANC. INT. CL. 42.
- CARLSON MARKETING GROUP, INC., MINNEAPOLIS,  
MN:  
2,151,372, CANC. INT. CL. 35.
- CARMEDA AB, 113 47 STOCKHOLM, SWEDEN:  
2,929,226, INT. CL. 10.
- CARNELL, BRIAN, CLAYTON, NC:  
2,928,704, PUB. 12-7-2004. MULTIPLE CLASS, INT. CLS.  
25 AND 28.
- CARNES COMPANY, INC., MILWAUKEE, WI:  
2,151,101, CANC. INT. CL. 16.
- CARR BUYING OFFICE, INC., NEW YORK, NY:  
1,273,657, CANC. INT. CL. 25.  
1,273,658, CANC. INT. CL. 25.
- CARROLL COMPANY, GARLAND, TX, SOUTHERN CHEMICAL  
PRODUCTS COMPANY, MACON, GA, DBA  
SOHEMCO:  
1,353,561, REN. 1-18-05. MULTIPLE CLASS, INT. CLS. 3  
AND 5.
- CARSONITE INTERNATIONAL CORPORATION, EARLY  
BRANCH, SC:  
1,306,823, REN. 1-18-05. INT. CL. 9.
- CARTAGENA, JOSE MANUEL, WOODBRIDGE, VA:  
2,929,610, MULTIPLE CLASS, INT. CLS. 25 AND 35.
- CARTOON NETWORK LP, LLLP, THE, ATLANTA, GA:  
2,929,653, INT. CL. 28.
- CARVEL CORPORATION, YONKERS, NY:  
1,232,361, CANC. INT. CL. 30.
- CASCADE REHABILITATION COUNSELING, INC., VAN-  
COUVER, WA:  
1,273,975, CANC. INT. CL. 42.
- CASCADE RESTORATION & CONSTRUCTION, INC.,  
BRIER, WA:  
2,928,661, PUB. 7-20-2004. INT. CL. 9.
- CASINO DATA SYSTEMS, LAS VEGAS, NV:  
2,929,125, INT. CL. 9.  
2,929,152, INT. CL. 9.  
2,929,159, INT. CL. 9.
- CASKET SHELLS, INC., EYNON, PA:  
1,273,550, CANC. INT. CL. 20.  
1,273,551, CANC. INT. CL. 20.  
1,273,552, CANC. INT. CL. 20.  
1,273,553, CANC. INT. CL. 20.  
1,273,554, CANC. INT. CL. 20.  
1,273,555, CANC. INT. CL. 20.
- CAST LIGHTING LLC, HAWTHORNE, NJ:  
2,929,198, INT. CL. 11.
- CASTILLO, JUAN DEL, POTOMAC, MD:  
2,929,431, INT. CL. 12.
- CASTLE, RICHARD A., OLYMPIA, WA, HANDI-WARES  
CORPORATION, SEATTLE, WA:  
1,868,322, REN. 1-20-05. INT. CL. 20.
- CATALYST, INC., NEW YORK, NY:  
2,929,603, MULTIPLE CLASS, INT. CLS. 16 AND 35.
- CATHAY BANK, LOS ANGELES, CA:  
1,848,717, REN. 1-19-05. INT. CL. 36.  
1,850,042, REN. 1-19-05. INT. CL. 36.  
1,896,459, REN. 1-19-05. INT. CL. 36.
- CATTLELOGOS BRAND MANAGEMENT SYSTEMS LLC,  
PHILADELPHIA, PA:  
2,928,747, PUB. 12-7-2004. INT. CL. 35.
- CBEX, INC., SEATTLE, WA:  
2,151,308, CANC. MULTIPLE CLASS, INT. CLS. 35 AND  
36.
- CBJ ENTERPRISES, INC., IRVINE, CA, DBA MEMORY  
MEDIA PRODUCTS:  
1,273,362, CANC. INT. CL. 9.
- CBS BROADCASTING INC., NEW YORK, NY:  
2,928,976, PUB. 12-7-2004. INT. CL. 41.
- CDC PARTNERS, LLC, IRVINE, CA:  
2,929,824, INT. CL. 35.
- CDV SOFTWARE ENTERTAINMENT AG, KARLSRUHE,  
FED REP GERMANY:  
2,928,461, PUB. 12-7-2004. MULTIPLE CLASS, INT. CLS.  
9, 16, 28, 35, 38, 41 AND 42.
- CECIL WHITTAKER'S INC., CHESTERFIELD, MO:  
1,912,013, REN. 1-18-05. INT. CL. 42.
- CECIL WHITTAKER'S, INC., CHESTERFIELD, MO:  
1,920,446, REN. 1-18-05. INT. CL. 42.
- CEDAR KNOLL VINEYARDS, INC., SAN ANTONIO, TX:  
2,929,641, INT. CL. 41.
- CELION NETWORKS INC., RICHARDSON, TX:  
2,929,239, INT. CL. 9.
- CELLO-FOIL PRODUCTS, INC., BATTLE CREEK, MI:  
1,273,502, CANC. INT. CL. 17.
- CELLULAR ONE GROUP, DALLAS, TX:  
2,151,071, CANC. INT. CL. 38.
- CENDANT PUBLISHING, INC., LAS VEGAS, NV:  
2,858,661, COR. INT. CL. 36.
- CENTRAL DATA TECHNOLOGIES, INC., BALTIMORE,  
MD:  
2,150,536, CANC. MULTIPLE CLASS, INT. CLS. 35 AND  
36.
- CENTRAL DISTRIBUTORS, INC., LEWISTON, ME:  
2,150,657, CANC. INT. CL. 21.
- CENTRAL MILLS, INC., NEW YORK, NY:  
1,891,166, REN. 1-21-05. INT. CL. 25.
- CENTRAL NEWSPAPERS, INC., INDIANAPOLIS, IN:  
2,150,825, CANC. INT. CL. 16.
- CENTURY PRODUCTS COMPANY, MACEDONIA, OH:  
2,150,811, CANC. INT. CL. 12.
- CERAL WEST, LLC, HARLOWTON, MT:  
1,875,436, REN. 1-18-05. INT. CL. 30.
- CEREAL WEST, LLC, HARLOWTON, MT:  
1,871,475, REN. 1-18-05. INT. CL. 30.  
1,871,476, REN. 1-18-05. INT. CL. 30.
- CERES, LLC, SOUTH SAN FRANCISCO, CA:  
2,150,866, CANC. INT. CL. 4.  
2,151,040, CANC. INT. CL. 4.
- CEWAL, INC., LOS ANGELES, CA:  
2,929,636, INT. CL. 1.
- CGS ASSOCIATES, L.P., ATLANTA, GA:  
2,150,076, CANC. INT. CL. 35.
- CHADBOURNE & PARKE LLP, NEW YORK, NY:  
2,150,255, CANC. INT. CL. 16.
- CHAMP CONCEPTS, INC., ASHBURNHAM, MA:  
2,928,997, PUB. 12-7-2004. INT. CL. 41.
- CHAMPLAIN CABLE CORPORATION, COLCHESTER, VT:  
2,150,192, CANC. INT. CL. 9.
- CHAPMAN COMPANY, THE, BALTIMORE, MD:  
2,151,241, CANC. INT. CL. 36.
- CHARLES GROUP MARKETING CORPORATION, THE,  
LAKE TAHOE, NV:  
2,150,559, CANC. INT. CL. 42.
- CHARLOTTE DESIGN GROUP, INC., CONCORD, NC:  
2,929,589, INT. CL. 25.
- CHASE CORPORATION, BRIDGEWATER, MA:  
1,314,605, REN. 1-19-05. INT. CL. 17.
- CHASE TOYS, INC., VENTURA, CA:  
2,151,207, CANC. INT. CL. 28.
- CHATEAU JEWELRY CORP., FOREST HILLS, NY:  
2,150,615, CANC. INT. CL. 14.



- CHAUMET INTERNATIONAL S.A., 75001 PARIS, FRANCE:  
2,150,022, CANC. INT. CL. 14.
- CHEATWOOD, HARRY, T., STILLWATER, OK:  
2,928,812, PUB. 12-7-2004. INT. CL. 11.
- CHEFWORKS INC., PALOS VERDES ESTATES, CA:  
2,929,349, MULTIPLE CLASS, INT. CLS. 8 AND 21.
- CHEIFTAIN MARKETING, LTD., POOLE, UNITED KING-  
DOM:  
2,929,661, INT. CL. 21.
- CHELSEA COMPUTER CONSULTANTS INCORPORATED,  
NEW YORK, NY:  
2,150,654, CANC. INT. CL. 35.
- CHELSEA HOUSE PUBLISHERS LLC, LANGHORNE, PA:  
2,929,875, INT. CL. 16.
- CHELSEA INDUSTRIES, INC., PEABODY, MA, DBA WEB-  
STER INDUSTRIES:  
2,929,028, PUB. 12-7-2004. INT. CL. 16.
- CHEM FREE LAWNS, INC., ORONO, MN:  
2,928,607, PUB. 12-7-2004. INT. CL. 5.
- CHEMGENEX THERAPEUTICS, INC., MENLO PARK, CA  
FROM BROWN, DENNIS M., FREMONT, CA:  
2,929,532, INT. CL. 42.
- CHEMLAWN CORPORATION, COLUMBUS, OH TO CHEM-  
LAWN CORPORATION, ST. PAUL, MN:  
1,273,880, CANC. INT. CL. 37.
- CHEMOFORMA AG, 4302 AUGST, SWITZERLAND:  
2,929,140, INT. CL. 5.
- CHERRY BEKAERT & HOLLAND, L.L.P., RICHMOND, VA:  
2,929,308, INT. CL. 9.
- CHICAGO ATHENAEUM, THE, CHICAGO, IL:  
1,830,637, CANC. INT. CL. 41.
- CHICAGO NATIONAL COLLEGE OF NAPRAPATHY, CHI-  
CAGO, IL:  
1,911,926, REN. 1-21-05. INT. CL. 42.
- CHIH SHYANG CORPORATION, NEW YORK, NY:  
2,150,348, CANC. INT. CL. 42.
- CHIME, INC., WALLINGFORD, CT, CONNECTICUT HOS-  
PITAL RESEARCH & EDUCATION FOUNDATION, INC.,  
THE, WALLINGFORD, CT:  
1,865,757, REN. 1-21-05. INT. CL. 16.
- CHIP PC ISRAEL LTD, TIART-CARMEL, ISRAEL:  
2,929,540, INT. CL. 9.
- CHIPPEWA VALLEY CONVENTION & VISITORS BUREAU,  
INC., EAU CLAIRE, WI:  
2,928,931, PUB. 12-7-2004. INT. CL. 35.
- CHIRI ENTERPRISE INC., ROXBORO, CANADA:  
2,928,800, PUB. 12-7-2004. INT. CL. 2.
- CHITEC CHEMICAL CO., LTD., TAIPEI HSIEN, TAIWAN:  
2,929,258, INT. CL. 1.
- CHOCOLATES EL REY, C.A., CARACAS, VENEZUELA:  
2,151,142, CANC. INT. CL. 30.  
2,151,213, CANC. INT. CL. 30.
- CHOCTAW RACING SERVICES L.L.C., DURANT, OK:  
2,928,797, PUB. 12-7-2004. INT. CL. 41.
- CHOICE HOTELS INTERNATIONAL, INC., SILVER  
SPRING, MD:  
1,869,409, REN. 1-18-05. INT. CL. 9.
- CHONGQING YUQUAN INDUSTRIAL (GROUP) CO., LTD.,  
WANZHOU DISTRICT, CHONGQING, CHINA:  
2,928,818, PUB. 12-7-2004. INT. CL. 29.
- CHRISTENSEN, CARMA, BOISE, ID:  
1,830,485, CANC. INT. CL. 30.
- CHRISTIAN ART GIFTS, INC, LOMBARD, IL:  
2,929,689, INT. CL. 16.
- CHROMA COPY FRANCHISING OF AMERICA, INC., NEW  
YORK, NY, DBA CHROMA COPY:  
1,830,624, CANC. INT. CL. 40.
- CHRYSLER CORPORATION, HIGHLAND PARK, MI:  
1,273,474, CANC. INT. CL. 16.
- CHU, VICTOR W., TORRANCE, CA:  
2,928,934, PUB. 12-7-2004. INT. CL. 9.
- CHUBB CORPORATION, THE, WARREN, NJ:  
2,929,185, INT. CL. 36.
- CHUMBLEY, JAMES F., EDMONDS, WA:  
1,873,894, REN. 1-18-05. INT. CL. 22.
- CHYCOGO AND COMPANY, LTD., CHICAGO, IL:  
1,830,362, CANC. INT. CL. 16.
- CINETIC AUTOMATION CORPORATION, FARMINGTON  
HILLS, MI:  
2,929,605, MULTIPLE CLASS, INT. CLS. 7 AND 9.
- CIRCLE Y SADDLES, INC., YOAKUM, TX:  
2,928,789, PUB. 12-7-2004. INT. CL. 18.
- CIRCUIT CENTER, INC., DAYTON, OH:  
1,830,599, CANC. INT. CL. 37.
- CIS INTERNET LTD, ESSEX, UNITED KINGDOM, TA  
FACEPARTY.COM:  
2,928,667, PUB. 7-20-2004. INT. CL. 38.
- CISCO-LINKSYS LLC, SAN JOSE, CA:  
2,929,342, INT. CL. 9.
- CITA TABACOS DE CANARIAS, S.A., 38009 SANTA CRUZ  
DE TENERIFE, SPAIN:  
2,150,478, CANC. INT. CL. 34.
- CITY OF COLLEGE PARK, COLLEGE PARK, MD:  
2,150,361, CANC. INT. CL. 1.
- CITY OF SANTA ROSA, SANTA ROSA, CA:  
2,928,493, PUB. 12-7-2004. INT. CL. 41.
- CITY PUBLIC SERVICE, SAN ANTONIO, TX:  
2,150,014, CANC. INT. CL. 41.
- CJLF, INC., LOS ANGELES, CA:  
2,929,030, PUB. 12-7-2004. INT. CL. 25.
- CLABROOK FARM, INC., CHRISTMAS, FL:  
2,150,710, CANC. INT. CL. 41.
- CLARK BOILER AND MANUFACTURING, INC., LAKE-  
LAND, FL:  
1,273,417, CANC. INT. CL. 11.
- CLARKE CHECKS, INC., SAN ANTONIO, TX:  
1,273,493, CANC. INT. CL. 16.
- CLEANLOOK CHEMICAL CORP., OPA LOCKA, FL:  
2,928,579, PUB. 12-7-2004. INT. CL. 3.
- CLICKDATA. COM, INC., GOLDEN, CO, MARKETING  
SOLUTIONS, LTD., DENVER, CO:  
1,925,224, REN. 1-21-05. INT. CL. 9.
- CLIMACREAM INC., LAS VEGAS, NV:  
2,929,322, INT. CL. 3.
- CLIO DESIGNS INCORPORATED, WATERTOWN, MA:  
2,929,701, INT. CL. 8.
- CLOVER CORPORATION, NEW YORK, NY:  
2,151,174, CANC. INT. CL. 41.
- CLUETT PEABODY RESOURCES CORPORATION, NEW  
YORK, NY, CLUETT, PEABODY & CO., INC., NEW  
YORK, NY:  
1,307,135, REN. 1-21-05. INT. CL. 25.
- CLUETT, PEABODY & CO., INC., TROY, NY:  
182,438, CANC. U.S. CL. 39.
- CMJ/USA, AMBRIDGE, PA TO SHORESH/USA, INC., JACK-  
SONVILLE, FL:  
1,789,678, CANC. INT. CL. 39.
- CMP MEDIA LLC, MANHASSET, NY:  
2,928,693, PUB. 12-7-2004. MULTIPLE CLASS, INT. CLS.  
16 AND 41.  
2,929,365, INT. CL. 35.
- CNA FINANCIAL CORPORATION, CHICAGO, IL:  
1,273,832, CANC. INT. CL. 35.  
2,151,058, CANC. INT. CL. 36.
- COCA-COLA COMPANY; THE, ATLANTA, GA:  
1,311,116, REN. 1-19-05. INT. CL. 20.
- CODEMESH, INC., CARLISLE, MA:  
2,929,736, INT. CL. 9.
- COFFEY, JEFF, AUSTIN, TX:  
2,150,607, CANC. INT. CL. 9.
- COLBERT PACKAGING CORPORATION, LAKE FOREST,  
IL:  
2,929,295, INT. CL. 16.
- COLDGON PRODUCTS INTERNATIONAL, INC., SUPER-  
IOR, WI:  
2,928,686, PUB. 12-7-2004. INT. CL. 27.
- COLE & PARKS, LLC, PITTSFORD, NY FROM TODAY'S  
COOKIE, LLC, PITTSFORD, NY:  
2,929,625, INT. CL. 30.
- COLGATE-PALMOLIVE COMPANY, NEW YORK, NY,  
COLGATE-PALMOLIVE-PEET COMPANY, JERSEY  
CITY, NJ:  
410,626, REN. 1-19-05. U.S. CL. 4 (INT. CL. 3).

- COLGATE-PALMOLIVE COMPANY, NEW YORK, NY:  
2,151,358, CANC. INT. CL. 3.  
2,929,001, PUB. 12-7-2004. INT. CL. 3.
- COLLECTORS UNIVERSE, SANTA ANA, CA:  
2,929,606, INT. CL. 42.
- COLLECTORS UNIVERSE, INC., NEWPORT BEACH, CA:  
2,734,940, AM. INT. CL. 35.
- COLLISION CENTERS INTERNATIONAL, INC., CLAREMORE, OK:  
1,869,879, REN. 1-19-05. MULTIPLE CLASS, INT. CLS. 35, 36 AND 37.
- COLON, ALBERT, VOORBURG, NETHERLANDS:  
2,928,792, PUB. 12-7-2004. INT. CL. 41.
- COLONIAL PARKING, INC., WASHINGTON, DC:  
2,929,267, INT. CL. 35.
- COLOR FAST INDUSTRIES INC., COLTON, CA:  
2,929,534, INT. CL. 1.
- COLORFUL HARVEST LLC, MINNETONKA, MN:  
2,929,850, INT. CL. 31.
- COLORTYME, INC., ATHENS, TX:  
1,273,906, CANC. INT. CL. 41.
- COLUMBIA/HCA HEALTHCARE CORPORATION, NASHVILLE, TN:  
2,151,375, CANC. INT. CL. 42.
- COMCAST CORPORATION, WAYNE, PA:  
2,151,190, CANC. INT. CL. 38.
- COMCOR, INC., COLORADO SPRINGS, CO:  
2,150,259, CANC. INT. CL. 42.
- COMDATA NETWORK, INC., BRENTWOOD, TN:  
2,929,328, INT. CL. 9.
- COMDISCO, INC., ROSEMONT, IL:  
1,830,539, CANC. INT. CL. 35.  
1,830,688, CANC. INT. CL. 42.
- COMLINK, INC., ROCKLEDGE, FL:  
1,830,607, CANC. INT. CL. 38.
- COMME DES GARCONS CO., LTD., MINATO-KU, TOKYO, 107, JAPAN:  
2,149,921, CANC. MULTIPLE CLASS, INT. CLS. 18 AND 25.
- COMMERCIAL STEEL TREATING CORPORATION, MADISON HEIGHTS, MI:  
2,151,237, CANC. INT. CL. 40.
- COMMISSION FOR THE LAS VEGAS CENTENNIAL, LAS VEGAS, NV:  
2,928,596, PUB. 12-7-2004. INT. CL. 6.  
2,928,597, PUB. 12-7-2004. INT. CL. 25.
- COMMONWEALTH TOY & NOVELTY CO., INC., NEW YORK, NY:  
1,273,691, CANC. INT. CL. 28.
- COMMSCOPE PROPERTIES, LLC, SPARKS, NV:  
2,929,129, INT. CL. 35.
- COMPAQ TRADEMARK B.V., 1187 XR AMSTELVEEN, NETHERLANDS:  
2,150,126, CANC. INT. CL. 9.
- COMPUTER HEALTH NETWORK, INC., SCHAMBURG, IL AND COMPUTER HEALTH NETWORK, INC., HOFFMAN ESTATES, IL:  
2,929,585, MULTIPLE CLASS, INT. CLS. 9, 35, 36, 41, 42 AND 44.
- COMPUTER KNOW HOW, INC., JACKSONVILLE, FL:  
2,928,690, PUB. 12-7-2004. INT. CL. 42.
- COMPUTER SCIENCES CORPORATION, EL SEGUNDO, CA:  
2,929,867, INT. CL. 42.
- COMPUTER TRAINING & SUPPORT CORPORATION, LIVONIA, MI:  
1,830,652, CANC. INT. CL. 41.
- COMPUTERLOGIC, INC., MACON, GA:  
2,928,960, PUB. 12-7-2004. INT. CL. 9.
- COMPUWARE CORPORATION, FARMINGTON HILLS, MI:  
2,150,790, CANC. INT. CL. 9.
- CONAGRA, INC., OMAHA, NE:  
2,150,114, CANC. INT. CL. 1.  
2,151,181, CANC. INT. CL. 30.
- CONFECTIONATELY YOURS, INC., TORONTO, ONTARIO, CANADA:  
1,867,734, REN. 1-19-05. INT. CL. 30.
- CONNAUGHT TECHNOLOGY CORPORATION, GREENVILLE, DE:  
2,929,536, INT. CL. 5.
- CONNECT THE THOUGHTS, INC., GRANADA HILLS, CA:  
2,928,626, PUB. 12-7-2004. INT. CL. 16.
- CONNECTICUT GENERAL LIFE INSURANCE COMPANY, BLOOMFIELD, CT:  
1,273,842, CANC. INT. CL. 36.
- CONOCOPHILLIPS COMPANY, HOUSTON, TX:  
1,872,181, REN. 1-18-05. INT. CL. 4.  
1,872,182, REN. 1-18-05. INT. CL. 4.  
1,872,183, REN. 1-18-05. INT. CL. 4.
- CONSERVATION FOR CENTRAL OREGON, BEND, OR, DBA THE RECYCLING TEAM:  
2,929,271, INT. CL. 41.
- CONSOLIDATED COTTON GIN CO., INC., LUBBOCK, TX:  
1,830,161, CANC. INT. CL. 7.
- CONSOLIDATED FIBERGLASS PRODUCTS COMPANY, BAKERSFIELD, CA:  
1,318,150, REN. 1-21-05. INT. CL. 19.
- CONSOLIDATED PROPERTY HOLDINGS, LAS VEGAS, NV, CONSOLIDATED STORES CORPORATION, COLUMBUS, OH:  
1,868,015, REN. 1-19-05. INT. CL. 8.
- CONSULAB EDUCATECH INC., STE-FOY, QUEBEC, CANADA, H.O.P. CONSULAB INC., BEAUPORT, QUEBEC 5, CANADA:  
997,497, REN. 1-21-05. U.S. CL. 21 (INT. CLS. 9 AND 11).
- CONTEMPORARY CONCIERGE, LLC, ORLANDO, FL:  
2,929,390, INT. CL. 45.
- CONTINENTAL AMERICAN CORPORATION, WICHITA, KS, PIONEER BALLOON COMPANY:  
1,273,239, CANC. INT. CL. 1.
- CONTROL DATA CORPORATION, MINNEAPOLIS, MN:  
1,273,885, CANC. INT. CL. 38.
- COOPER INDUSTRIES, INC., HOUSTON, TX:  
1,273,368, CANC. INT. CL. 9.
- COOPER LABORATORIES, INC., PALO ALTO, CA:  
768,315, CANC. U.S. CL. 51.
- COORS GLOBAL PROPERTIES, INC., LAKEWOOD, CO:  
2,151,446, CANC. INT. CL. 32.
- COPELAND CORPORATION, SIDNEY, OH:  
2,928,974, PUB. 12-7-2004. INT. CL. 9.
- COPPER KETTLE CANDY, INC., RIALTO, CA:  
2,928,497, PUB. 12-7-2004. INT. CL. 30.
- COPPER RIVER DELTA SMOKERY, CORDOVA, AK:  
2,151,538, CANC. INT. CL. 29.
- CORBI, DEBRA ANN, PEACHTREE CITY, GA:  
2,928,787, PUB. 12-7-2004. INT. CL. 30.
- CORIMAX, INC., TALLAHASSEE, FL:  
2,928,684, PUB. 10-19-2004. INT. CL. 16.
- CORNERSTONE INDUSTRIES, INC., ATLANTA, GA:  
2,151,146, CANC. INT. CL. 25.
- CORNERSTONE PROMOTION, INC., NEW YORK, NY:  
2,929,309, INT. CL. 9.
- CORNING INCORPORATED, CORNING, NY:  
2,150,568, CANC. INT. CL. 9.
- CORPORATE ELECTION SERVICES, INC., PITTSBURGH, PA:  
1,891,316, REN. 1-18-05. MULTIPLE CLASS, INT. CLS. 35 AND 42.
- CORPORATE EVENT SERVICES, INC., NAPERVILLE, IL:  
2,150,827, CANC. INT. CL. 42.
- CORPORATE EVENT SERVICES, INC., CHICAGO, IL:  
2,151,056, CANC. INT. CL. 42.
- CORPORATE EXECUTIVE BOARD COMPANY, THE, WASHINGTON, DC:  
2,929,151, INT. CL. 16.
- CORRAN INDUSTRIES, INC., BRIDGEWATER, NJ:  
1,273,873, CANC. INT. CL. 37.
- CORVU CORPORATION, EDINA, MN:  
2,929,024, PUB. 12-7-2004. INT. CL. 9.
- CORVUS SYSTEMS INC., VIENNA, VA:  
1,273,940, CANC. INT. CL. 42.  
1,273,941, CANC. INT. CL. 42.
- COSATEC AG, ZURICH, SWITZERLAND:  
2,150,110, CANC. INT. CL. 35.

COSENTINO, RALPH, NORTH OLMSTED, OH:  
2,929,765, INT. CL. 16.

COSMERICA LABORATORIES INCORPORATED, FORT LAUDERDALE, FL:  
2,151,340, CANC. INT. CL. 5.

COTTON, GARY A., FINDLAY, OH:  
2,928,649, PUB. 9-21-2004. MULTIPLE CLASS, INT. CLS. 25, 31 AND 44.

COULTON ASSOCIATES, INC., GRAPELINE, TX:  
2,150,989, CANC. INT. CL. 30.

COUNCIL OF STATE GOVERNMENTS - WEST, THE, SAN FRANCISCO, CA:  
2,150,344, CANC. MULTIPLE CLASS, INT. CLS. 16, 35, 41 AND 42.

COUNTY SEAT STORES, INC., EDEN PRAIRIE, MN:  
1,273,509, CANC. INT. CL. 18.

COURTAULDS TEXTILES (HOLDINGS) LIMITED, SLOUGH, BERKSHIRE, GREAT BRITAIN:  
1,837,934, REN. 1-18-05. INT. CL. 25.

COVENEY, TIM, ATLANTA, GA:  
2,929,066, INT. CL. 41.

COX ACQUISITION CORP., BEVERLY, MA:  
2,151,374, CANC. INT. CL. 9.

CPC INTERNATIONAL INC., ENGLEWOOD CLIFFS, NJ:  
2,150,302, CANC. INT. CL. 29.

CRA FOUNDATION, PROVO, UT:  
2,928,641, PUB. 12-7-2004. INT. CL. 16.

CRAFT HOUSE CORPORATION, TOLEDO, OH:  
2,928,615, PUB. 12-7-2004. INT. CL. 28.

CRANIUM INC., SEATTLE, WA:  
2,929,888, INT. CL. 28.

CRANIUM, INC., SEATTLE, WA:  
2,929,886, INT. CL. 28.

CRAUFORD WINE COMPANY LLC, ST. HELENA, CA:  
2,929,013, PUB. 12-7-2004. INT. CL. 33.

CRAWSPACE DOCTOR, INC., SPRINGVILLE, IN:  
2,928,985, PUB. 12-7-2004. INT. CL. 37.

CRAY RESEARCH, INC., CHIPPEWA FALLS, WI:  
1,273,387, CANC. INT. CL. 9.

CRAZY PET, LLC, AZUSA, CA:  
2,928,572, PUB. 12-7-2004. INT. CL. 16.

CRE TECHNOLOGIES, INC., NASHVILLE, TN:  
2,928,821, PUB. 12-7-2004. MULTIPLE CLASS, INT. CLS. 35 AND 42.

CREATIVE HEALTHCARE SERVICES, INC., WILLIAMS ISLAND, FL:  
2,150,111, CANC. INT. CL. 42.

CREATIVE INDUSTRIES, INC., EL CAJON, CA:  
2,928,918, PUB. 12-7-2004. INT. CL. 7.

CREATIVE THINKING, INC., WABASH, IN TO HOBBIE, ERNIE P., WILMINGTON, NC:  
1,830,897, CANC. INT. CL. 41.

CREDIT SUISSE FIRST BOSTON LLC, NEW YORK, NY:  
2,928,950, PUB. 12-7-2004. INT. CL. 36.

CREGAN, BRIAN LESLIE, BERRARA, NEW SOUTH WALES, AUSTRALIA AND CREGAN, THOMAS JOSEPH, SWANHAVEN, NEW SOUTH WALES, AUSTRALIA AND CREGAN, MYRA INA, SWANHAVEN, NEW SOUTH WALES, AUSTRALIA:  
2,928,682, PUB. 9-7-2004. MULTIPLE CLASS, INT. CLS. 18, 25 AND 28.

CRESCENT, INC., NIOTA, TN:  
2,929,376, INT. CL. 25.  
2,929,378, INT. CL. 25.

CRL GROUP, LLC, LOS ANGELES, CA:  
2,929,250, INT. CL. 25.

CROCE, PASQUALE W., JR., VILLANOVA, PA:  
2,151,505, CANC. INT. CL. 25.  
2,151,506, CANC. INT. CL. 25.  
2,151,507, CANC. INT. CL. 25.

CROP MATE COMPANY, PITTSFIELD, IL, DBA THE HOWE COMPANY:  
1,860,604, REN. 1-21-05. INT. CL. 1.

CROWN CASTLE INTERNATIONAL CORP., HOUSTON, TX:  
2,928,758, PUB. 12-7-2004. MULTIPLE CLASS, INT. CLS. 36, 37 AND 38.

CRS HOLDINGS, INC., WILMINGTON, DE:  
1,309,644, REN. 1-18-05. INT. CL. 6.

CRYSTAL-DYNAMICS (ANTILLES) N.V., CURACAO, NETHERLD ANTILLES:  
2,151,115, CANC. INT. CL. 25.

CSC BRANDS LP, CAMDEN, NJ, JOSEPH CAMPBELL COMPANY, CAMDEN, NJ:  
47,154, REN. 1-21-05. U.S. CL. 46 (INT. CL. 29).

CUBE COMPUTER CORPORATION, HAWTHORNE, NY:  
2,150,767, CANC. INT. CL. 9.

CUC PUBLISHING, INC., AURORA, CO:  
2,150,405, CANC. INT. CL. 36.

CUCINA ANTICA FOODS CORPORATION, BRIARCLIFF MANOR, NY:  
2,929,046, PUB. 12-7-2004. INT. CL. 30.

CUDAHY TANNING COMPANY, INC., CUDAHY, WI:  
2,929,298, INT. CL. 35.

CULLEN EGAN DELL LIMITED (ACN 000 300 176), SYDNEY NEW SOUTH WALES 2000, AUSTRALIA:  
2,150,060, CANC. INT. CL. 9.

CULLIGAN INTERNATIONAL COMPANY, NORTH-BROOK, IL:  
782,574, REN. 1-19-05. U.S. CL. 52 (INT. CL. 3).  
2,928,674, PUB. 12-7-2004. INT. CL. 11.

CUP EXPRESS PARIS, INC., POTTSTOWN, PA:  
2,928,604, PUB. 12-7-2004. INT. CL. 30.

CUREF HOLDING BV, ROTTERDAM, NETHERLANDS:  
2,928,685, PUB. 12-7-2004. INT. CL. 6.

CURRENT COMMUNICATIONS SERVICES, LLC, GERMANTOWN, MD:  
2,929,688, MULTIPLE CLASS, INT. CLS. 9 AND 38.

CURTICE-BURNS FOODS, INC., ROCHESTER, NY:  
1,273,712, CANC. INT. CL. 29.

CUSTOM FOOT, INC., THE, WESTPORT, CT:  
2,150,121, CANC. INT. CL. 9.

CUTLERY WORLD OF AMERICA, INC., CHATTANOOGA, TN:  
1,273,837, CANC. INT. CL. 35.  
1,273,840, CANC. MULTIPLE CLASS, INT. CLS. 35 AND 42.

CYBERLINK CORP., SHINDIAN CITY, TAIPEI, TAIWAN:  
2,929,718, INT. CL. 9.

CYCLIS PHARMACEUTICALS, INC., NORWOOD, MA:  
2,700,034, CANC. INT. CL. 42.

CYMBOLIC SCIENCES INTERNATIONAL, INC., LAGUNA HILLS, CA:  
2,150,116, CANC. INT. CL. 9.

CYNTHIA L. KEMPER, DENVER, CO:  
2,928,481, PUB. 12-7-2004. MULTIPLE CLASS, INT. CLS. 35 AND 41.

CYTEC TECHNOLOGY CORP., WILMINGTON, DE:  
794,244, REN. 1-21-05. U.S. CL. 1 (INT. CL. 1).

D. R. HORTON LOS ANGELES HOLDING COMPANY, INC., ARLINGTON, TX:  
2,929,563, MULTIPLE CLASS, INT. CLS. 36 AND 37.

D.O.C. OPTICS CORPORATION, SOUTHFIELD, MI:  
1,896,026, REN. 1-18-05. INT. CL. 9.

D.P.P. MIRABILIA S.R.L., 96 - 00187 ROMA, ITALY:  
1,830,287, CANC. INT. CL. 14.

D.R. HORTON LOS ANGELES HOLDING COMPANY, INC., ARLINGTON, TX:  
2,929,562, MULTIPLE CLASS, INT. CLS. 36 AND 37.

D-BALL MANUFACTURING, FREMONT, CA:  
2,928,814, PUB. 12-7-2004. INT. CL. 28.

D'ARCY LANE INCORPORATED O/A THE D'ARCY LANE INSTITUTE, LONDON, ONTARIO, CANADA:  
2,149,965, CANC. MULTIPLE CLASS, INT. CLS. 16 AND 41.

DAEWOO INTERNATIONAL CORPORATION, JOONG-GU, SEOUL, REPUBLIC OF KOREA:  
2,929,237, INT. CL. 9.

DAILY ROCKET COMPANY, THE, SEATTLE, WA:  
2,150,329, CANC. INT. CL. 41.

DAKCS SOFTWARE SYSTEMS, OGDEN, UT:  
2,929,645, INT. CL. 9.

DAKOTA WORLDWIDE CORPORATION, BLOOMINGTON, MN:  
2,151,222, CANC. INT. CL. 16.

- DALE SEYMOUR PUBLICATIONS, INC., MENLO PARK, CA:  
1,830,361, CANC. INT. CL. 16.
- DAMON CREATIONS, INC., NEW YORK, NY:  
1,273,656, CANC. INT. CL. 25.
- DAN CARTER, INC., MAYVILLE, WI:  
2,733,495, COR. INT. CL. 29.
- DANA CORPORATION, TOLEDO, OH:  
2,929,543, INT. CL. 7.
- DATA FLOW SYSTEMS, INC., MELBOURNE, FL:  
2,928,836, PUB. 12-7-2004. INT. CL. 9.
- DATAACULT, INC., ATLANTA, GA:  
2,928,505, PUB. 12-7-2004. INT. CL. 35.
- DATALEX LIMITED, DUBLIN, IRELAND:  
2,929,121, MULTIPLE CLASS, INT. CLS. 9, 16, 35, 41 AND 42.
- DATAMETRICS CORPORATION, WOODLAND HILLS, CA:  
2,150,841, CANC. INT. CL. 9.
- DATESTONE ASSOCIATES, NEW HOPE, PA, DBA GAME-GIRLS:  
2,929,223, INT. CL. 28.
- DAVENPORT UNIVERSITY, GRAND RAPIDS, MI:  
2,928,573, PUB. 12-7-2004. INT. CL. 41.  
2,928,574, PUB. 12-7-2004. MULTIPLE CLASS, INT. CLS. 25 AND 41.
- DAVID N. DEUTSCH & COMPANY LLC, NEW YORK, NY:  
2,151,153, CANC. INT. CL. 36.
- DAVIS MOUNTAINS ORGANIC BEEF, L.L.C., DALLAS, TX:  
2,929,391, INT. CL. 29.  
2,929,392, INT. CL. 29.  
2,929,393, INT. CL. 29.
- DAVIS, DAYLE M., AKRON, OH:  
2,929,599, INT. CL. 24.
- DAYCO PRODUCTS, INC., DAYTON, OH:  
1,273,585, CANC. INT. CL. 22.
- DAYTON HUDSON CORPORATION, MINNEAPOLIS, MN:  
2,150,801, CANC. INT. CL. 42.
- DDS MARKETING, INC., FORT LAUDERDALE, FL:  
2,150,393, CANC. INT. CL. 21.
- DE DOMENICO, GISELA SCHUBACH, OAKLAND, CA:  
2,151,173, CANC. INT. CL. 42.
- DE NOVO, INC., PIKESVILLE, MD:  
2,150,883, CANC. INT. CL. 25.
- DE-LUXE TIME LIMITED, KWAI CHUNG, N.T., HONG KONG:  
2,151,080, CANC. INT. CL. 14.
- DEBEVIC'S LLC, CHICAGO, IL:  
2,193,836, CANC. INT. CL. 29.
- DEBUS, STEVEN S., TORONTO, ONTARIO, CANADA:  
2,928,829, PUB. 12-7-2004. INT. CL. 25.
- DECISION DATA INC.:  
1,273,871, CANC. INT. CL. 37.
- DECOSPAN N.V., MENEN, BELGIUM:  
2,928,551, PUB. 12-7-2004. INT. CL. 19.
- DEER STAGS, INC., NEW YORK, NY:  
2,929,684, INT. CL. 25.
- DEGAN, ROY E. III, GERMANTOWN, TN:  
2,928,673, PUB. 12-7-2004. INT. CL. 35.
- DEGUSSA AKTIENGESELLSCHAFT, FRANKFURT/MAIN, FED REP GERMANY:  
2,150,428, CANC. INT. CL. 1.
- DEICHMANN+CO LTD, TSUEN WAN, HONG KONG:  
2,201,753, CANC. INT. CL. 25.
- DELICATO VINEYARDS, MANTECA, CA, DBA MONTEREY CREST:  
1,830,520, CANC. INT. CL. 33.
- DENTSPLY INTERNATIONAL INC., YORK, PA:  
2,928,963, PUB. 12-7-2004. INT. CL. 3.
- DENVER BUFFALO COMPANY, DENVER, CO:  
2,150,085, CANC. INT. CL. 42.
- DENVER PUBLISHING COMPANY, THE, DENVER, CO, DBA ROCKY MOUNTAIN NEWS:  
2,150,440, CANC. INT. CL. 41.
- DERIVADOS DE LECHE LA ESMERALDA, S.A. DE C.V., GUANAJUATO, MEXICO:  
2,929,073, INT. CL. 29.
- DEVINE MARKETING GROUP, INC., LOS ANGELES, CA:  
2,150,156, CANC. MULTIPLE CLASS, INT. CLS. 35 AND 41.
- DEVONSHIRE RARE COIN GALLERIES, INC., BOSTON, MA:  
1,273,958, CANC. INT. CL. 42.
- DG PERFORMANCE SPECIALTIES, INC., ANAHEIM, CA:  
2,929,670, INT. CL. 12.
- DIAGEO IRELAND, DUBLIN 8, IRELAND, ARTHUR GUINNESS, SON & CO., LTD., LONDON, ENGLAND:  
321,014, REN. 1-21-05. U.S. CL. 48 (INT. CL. 32).
- DIAGEO NORTH AMERICA, INC., STAMFORD, CT FROM GUINNESS UDV NORTH AMERICA, INC., STAMFORD, CT:  
2,929,546, INT. CL. 33.
- DIALAMERICA MARKETING, INC., MAHWAH, NJ:  
2,928,959, PUB. 12-7-2004. INT. CL. 35.
- DIALOGUEDIRECT LTD., OXFORD, UNITED KINGDOM:  
2,929,671, INT. CL. 36.
- DICK BLICK HOLDINGS, INC., HIGHLAND PARK, IL:  
1,273,956, CANC. INT. CL. 42.
- DICK IDOL VENTURES, LLC, LEXINGTON, NC:  
2,929,280, MULTIPLE CLASS, INT. CLS. 11, 16, 20, 24, 27 AND 31.
- DICKINSON RETAILING CO., DENVER, CO:  
2,150,191, CANC. INT. CL. 42.
- DIGIBUG EXPRESS, INC., WALTHAM, MA:  
2,929,467, INT. CL. 40.
- DIGITAL FICTION INC., MONTREAL, QUEBEC, CANADA:  
2,929,296, INT. CL. 9.
- DIGITAL MATRIX CORPORATION, HEMPSTEAD, NY:  
2,928,475, PUB. 12-7-2004. INT. CL. 7.
- DILLARD'S, INC., LITTLE ROCK, AR:  
2,929,409, INT. CL. 25.
- DILLSTAR PRODUCTIONS, INC., RANCHO CUCUMONGA, CA:  
2,928,871, PUB. 12-7-2004. INT. CL. 41.
- DIMENSION ONE SPAS, INC, VISTA, CA:  
2,928,592, PUB. 12-7-2004. INT. CL. 11.
- DIRECT BENEFITS, INC., ST. PAUL, MN:  
2,928,899, PUB. 12-7-2004. INT. CL. 36.
- DISNEY ENTERPRISES, INC., BURBANK, CA:  
2,151,012, CANC. INT. CL. 41.  
2,929,163, INT. CL. 9.  
2,929,164, INT. CL. 28.  
2,929,630, MULTIPLE CLASS, INT. CLS. 36 AND 43.
- DISTILLEERDERIJ EN LIKEURSTOKERIJ HERMAN JANSSEN B.V., SCHIEDAM, NETHERLANDS:  
768,263, CANC. U.S. CL. 49.
- DISTILLERIE DE VUE BELLE, S.A., REUNION ISLAND, FRANCE:  
2,151,306, CANC. INT. CL. 33.
- DIVERSITECH EQUIPMENT & SALES LTD./LES EQUIPMENTS ET VENTES DIVERSITECH LTEE., MONTREAL, QUEBEC, CANADA:  
2,150,718, CANC. INT. CL. 11.
- DIVINE LIGHT FELLOWSHIP, INC., LITCHFIELD, CT:  
2,150,649, CANC. INT. CL. 42.
- DOLBY LABORATORIES LICENSING CORPORATION, SAN FRANCISCO, CA:  
2,929,205, MULTIPLE CLASS, INT. CLS. 9 AND 42.
- DOMESTIC SEED & SUPPLY, INC., MADISON, SD:  
1,337,038, REN. 1-21-05. INT. CL. 31.
- DOMINION BLUELINE INC., ST-JEAN-SUR-RICHELIEU, QUEBEC, CANADA:  
2,149,984, CANC. INT. CL. 9.
- DON MIGUEL MEXICAN FOODS, INC., ANAHEIM, CA:  
2,928,660, PUB. 7-20-2004. INT. CL. 30.
- DOOR CONTROLS INTERNATIONAL, DEXTER, MI:  
1,310,769, REN. 1-21-05. INT. CL. 6.
- DOREX INTERNATIONAL CORP, PAOLI, PA:  
2,150,844, CANC. INT. CL. 5.
- DOW AGROSCIENCES LLC, INDIANAPOLIS, IN, DOW CHEMICAL COMPANY; THE, MIDLAND, MI:  
1,308,606, REN. 1-21-05. INT. CL. 5.
- DOWBRANDS L.P., INDIANAPOLIS, IN:  
2,149,941, CANC. INT. CL. 16.
- DOWDEN HEALTH MEDIA, INC., MONTVALE, NJ, DOWDEN PUBLISHING COMPANY, INC., MONTVALE, NJ:  
1,911,324, REN. 1-19-05. INT. CL. 16.

- DOX ELECTRONICS, INC., ROCHESTER, NY:  
2,928,979, PUB. 12-7-2004. INT. CL. 42.
- DPI CO., LTD., GYOUNGGI-DO, 430-030, REPUBLIC OF KOREA:  
2,929,429, INT. CL. 2.
- DRAKE OFFICE OVERLOAD INC., BUFFALO, NY:  
2,150,986, CANC. INT. CL. 35.
- DRANTEZ TECHNOLOGIES, INC., EDISON, NJ, DBA DRANETZ-BMI:  
2,929,419, INT. CL. 9.
- DRAPER HOLDING COMPANY, INC., DRAPER, SD:  
2,846,585, COR. INT. CL. 36.
- DRAPER KNITTING COMPANY, INC., CANTON, MA:  
1,875,981. REN. 1-18-05. INT. CL. 24.
- DREAMGEAR LLC, TORRANCE, CA:  
2,929,418, INT. CL. 9.
- DREIMAN, MARGARET, VINCENNES, IN:  
2,151,298, CANC. INT. CL. 41.
- DRESSER, INC., ADDISON, TX, RING-O VALVE CORPORATION, OYSTER BAY, NY:  
1,860,710. REN. 1-18-05. MULTIPLE CLASS, INT. CLS. 9 AND 11.
- DREXEL HERITAGE FURNISHINGS INC., DREXEL, NC:  
2,151,464, CANC. INT. CL. 42.
- DREYER'S GRAND ICE CREAM, INC., OAKLAND, CA:  
1,273,767, CANC. INT. CL. 30.
- DRIVE INC., BOULDER, CO:  
2,151,543, CANC. INT. CL. 41.
- DRUM, TOM, POMPANO BEACH, FL:  
2,928,894, PUB. 12-7-2004. INT. CL. 28.
- DRUNK'N LEMUR, INC., FREDERICKSBURG, VA:  
2,929,788, INT. CL. 41.
- DUCATI MOTOR S.P.A., 23100 SONDRIO, ITALY:  
2,150,245, CANC. MULTIPLE CLASS, INT. CLS. 7, 12 AND 25.
- DUNCAN, DONALD F., TUCSON, AZ:  
2,151,006, CANC. INT. CL. 41.
- DUNLOP MAXFLI SPORTS CORPORATION, GREENVILLE, SC:  
2,151,337, CANC. INT. CL. 28.
- DUNN, GREGORY, WINDSOR, CT:  
2,151,443, CANC. INT. CL. 35.
- DUOMO PHOTOGRAPHY, INC., NEW YORK, NY:  
1,830,728, CANC. INT. CL. 42.
- DUPHAR B.V., CP WEESP, NETHERLANDS:  
1,273,297, CANC. INT. CL. 5.
- DURABLE WOOD PRODUCTS USA, INC., MIAMI LAKES, FL:  
2,929,815, INT. CL. 19.
- DUROCHER, BRYAN JAMES, CORAL GABLES, FL AND TRACY STEVENS, ROCHESTER, NY:  
2,929,583, INT. CL. 9.
- DUTCH PIPE LTD., NASSAU, NP, BAHAMAS:  
2,929,643, INT. CL. 20.
- DW FOOD CENTERS, INC., GRAND RAPIDS, MI:  
2,928,447, PUB. 12-7-2004. INT. CL. 42.
- DWYER, DEBORAH R., URBANA, OH, DBA HUMAN SYSTEMS DEVELOPMENT:  
2,928,588, PUB. 12-7-2004. INT. CL. 35.
- DYER, RICHARD A., LONG BEACH, CA:  
2,151,067, CANC. INT. CL. 28.
- DYNO NOBEL LTD., MISSISSAUGA, ONTARIO, CANADA:  
2,149,923, CANC. INT. CL. 12.
- E. B. MALONE CORPORATION, LAKE WALES, FL:  
1,273,559, CANC. INT. CL. 20.
- E. C. DITTRICH AND CO., INC., DETROIT, MI:  
2,928,619, PUB. 12-7-2004. INT. CL. 41.
- E. GLENN GLASSMAN, D.D.S., P.C., ST. LOUIS, MO, DBA ORTHOCARE SYSTEMS:  
2,928,644, PUB. 12-7-2004. INT. CL. 44.
- E.R. SQUIBB & SONS, L.L.C., PRINCETON, NJ:  
2,929,549, INT. CL. 5.
- E.S. ORIGINALS, INC., NEW YORK, NY:  
2,929,421, INT. CL. 25.
- E.T. BROWNE DRUG CO., INC., ENGLEWOOD CLIFFS, NJ:  
2,929,586, MULTIPLE CLASS, INT. CLS. 3 AND 5.
- E-MAIL PUBLISHING, INC., BOULDER, CO:  
2,151,041, CANC. INT. CL. 35.
- EAGLE EYE DISTRIBUTING, INC., IDAHO FALLS, ID:  
2,928,891, PUB. 12-7-2004. INT. CL. 31.
- EAGLE RESEARCH GROUP, INC., THE, DENVER, CO:  
2,150,583, CANC. INT. CL. 9.
- EAGLE ROCK ART GUILD, INC., IDAHO FALLS, ID:  
2,928,629, PUB. 12-7-2004. INT. CL. 41.
- EAGLE TELEPROGRAMS, INC., NEW YORK, NY:  
1,830,892, CANC. INT. CL. 38.
- EARCRAFT, INC., TOPSHAM, ME:  
2,929,361, INT. CL. 9.
- EARNEST MACHINE PRODUCTS COMPANY, CLEVELAND, OH:  
786,360. REN. 1-19-05. U.S. CL. 23 (INT. CL. 7).
- EASCO HAND TOOLS, INC., SIMSBURY, CT:  
2,928,469, PUB. 7-20-2004. INT. CL. 8.
- EAST COAST SHOWS, INC., STUART, FL:  
2,928,656, PUB. 12-7-2004. INT. CL. 35.
- EAST WEST MARKETING INC., TIPP CITY, OH:  
2,151,332, CANC. INT. CL. 16.
- EASTMAN KODAK COMPANY, ROCHESTER, NY:  
1,830,165, CANC. INT. CL. 7.
- EATON AEROQUIP INC., CLEVELAND, OH:  
2,929,735, INT. CL. 17.
- EATON CORPORATION, CLEVELAND, OH:  
2,929,799, INT. CL. 41.
- EBERT, KENNETH R, RANCHO CUCAMONGA, CA, DBA EBERT ENT.:  
2,928,897, PUB. 12-7-2004. INT. CL. 28.
- ECOLAB INC., ST. PAUL, MN:  
2,929,644, INT. CL. 3.
- ECOLOGICAL PALLETS, LIMITED, TUCSON, AZ:  
1,830,800, CANC. INT. CL. 16.
- ECON AIR, INC., RALEIGH, NC:  
1,925,316. REN. 1-21-05. INT. CL. 11.
- ECONUGENICS, INC., CORTE MADERA, CA:  
2,150,639, CANC. INT. CL. 5.
- ECOSPORT, INC., BROOMFIELD, CO, DBA ECOSPORT:  
1,830,411, CANC. INT. CL. 25.
- EDFUND, RANCHO CORDOVA, CA:  
2,928,835, PUB. 12-7-2004. INT. CL. 35.
- EDMUND F. KRIMEN, SAN FRANCISCO, CA, DBA PHOTOBIRD.COM:  
2,928,830, PUB. 12-7-2004. INT. CL. 42.
- EDULENCE CORPORATION, FAIRFIELD, NJ:  
2,929,667, INT. CL. 41.
- EDWARDS FINE FOODS, INC., NORCROSS, GA:  
2,150,288, CANC. INT. CL. 30.
- EGOSUM, INC., NEW YORK, NY:  
2,929,009, PUB. 12-7-2004. INT. CL. 42.
- EHRHART, CURTIS, ROY, ANCHORAGE, AK:  
2,929,650, INT. CL. 35.
- EICHELBERGER PERFORMING ARTS CENTER, HANOVER, PA:  
2,928,504, PUB. 12-7-2004. INT. CL. 41.
- EISAI COMPANY LIMITED, BUNKYO-KU, TOKYO, JAPAN:  
2,149,954, CANC. INT. CL. 5.  
2,149,955, CANC. INT. CL. 5.
- EK SUCCESS, LTD., CLIFTON, NJ:  
2,929,241, INT. CL. 16.
- EKA CHEMICALS AB, STOCKHOLM, SWEDEN, EKA NOBEL AB, 80 BOHUS, SWEDEN:  
1,804,979. REN. 1-15-05. MULTIPLE CLASS, INT. CLS. 7 AND 37.
- EL REY INDUSTRIES, INC., ONTARIO, CA:  
1,273,412, CANC. INT. CL. 10.
- ELANSTYL DIFFUSION LTEE., MONTREAL, QUEBEC, CANADA:  
1,273,610, CANC. INT. CL. 25.
- ELASTIC CORPORATION OF AMERICA, INC., COLUMBIANA, AL:  
2,929,717, INT. CL. 26.
- ELECTRICAL INSTRUMENT SERVICES, INC., MT. VERNON, NY:  
768,176, CANC. U.S. CL. 26.
- ELEGANT USA, LLC, TOTOWA, NJ:  
2,929,613, INT. CL. 12.

- ELENCO ELECTRONICS, INC., WHEELING, IL:  
2,150,419, CANC. INT. CL. 9.
- ELEVATION BED LLC, WILMINGTON, DE, CRAFTMATIC/  
CONTOUR ORGANIZATION, INC., BENSLEM, PA:  
1,324,599. REN. 1-21-05. INT. CL. 20.
- ELEVEN HUNDRED SPRINGS, INC., DALLAS, TX:  
2,151,321, CANC. INT. CL. 32.
- ELITE GROUP INC., MONTREAL, QUEBEC, CANADA:  
2,929,709, INT. CL. 9.
- ELITEGROUP COMPUTER SYSTEMS CO., LTD., TAIPEI,  
TAIWAN:  
2,929,558, MULTIPLE CLASS, INT. CLS. 9, 35 AND 42.
- ELIXIR JUICE BAR, LLC, NEW YORK, NY:  
2,928,450, PUB. 12-7-2004. INT. CL. 42.
- ELIZABETH CHARLES CORPORATION, EDINA, MN, ELI-  
ZABETH CHARLES CORPORATION, EDINA, MN:  
1,903,148. REN. 1-19-05. INT. CL. 42.
- ELKHAN CORP., EL MONTE, CA:  
2,151,186, CANC. INT. CL. 25.
- ELLEN & CO., INC., GARDENA, CA:  
2,150,602, CANC. INT. CL. 9.
- ELLEN KATHERINE WEEREN, FAIRFAX, VA:  
2,928,848, PUB. 12-7-2004. INT. CL. 16.
- ELMER'S INVESTMENTS, INC., WILMINGTON, DE:  
2,151,469, CANC. INT. CL. 8.
- EMACHINES, INC., IRVINE, CA:  
2,929,077, INT. CL. 9.
- EMCO INDUSTRIES, INC., OCEANSIDE, CA:  
1,879,462. REN. 1-18-05. INT. CL. 3.
- EMERGENETICS, LLC, CASTLE ROCK, CO:  
2,929,200, MULTIPLE CLASS, INT. CLS. 41 AND 42.
- EMHART INC., NEWARK, DE:  
1,830,768, CANC. INT. CL. 6.
- EMMIS PUBLISHING, L.P., INDIANAPOLIS, IN:  
2,928,909, PUB. 12-7-2004. INT. CL. 16.
- EMPAK FOODS, INC., MILWAUKEE, WI:  
2,929,731, INT. CL. 29.
- EMPLOYEES' RETIREMENT SYSTEM OF ALABAMA, THE,  
MONTGOMERY, AL AND TEACHER'S RETIREMENT  
SYSTEM OF ALABAMA, THE, MONTGOMERY, AL,  
SUNBELT GOLF CORPORATION, BIRMINGHAM, AL:  
1,866,028. REN. 1-19-05. INT. CL. 41.
- EMULGEN LABORATORIES, INC., DES PLAINES, IL:  
2,928,610, PUB. 12-7-2004. INT. CL. 3.
- ENDEMANN, INGO, D-41466 NEUSS, FED REP GERMANY:  
2,929,113, MULTIPLE CLASS, INT. CLS. 9, 16, 35, 38, 41  
AND 42.
- ENERGYSOLUTIONS, HOUSTON, TX:  
2,928,763, PUB. 7-20-2004. INT. CL. 9.
- ENGINEERING CENTER STEYR GMBH & CO. KG, ST.  
VALENTIN, AUSTRIA:  
1,866,803. REN. 1-19-05. INT. CL. 9.
- ENNS, WALTER G., WINNIPEG, MB, CANADA:  
1,830,118, CANC. INT. CL. 5.
- ENOLOGICA VASON S.R.L., 37020 SAN PIETRO IN CAR-  
IANO (VR), ITALY:  
2,928,777, PUB. 12-7-2004. INT. CL. 1.
- ENRICH CORPORATION, THE, OREM, UT:  
2,150,546, CANC. INT. CL. 5.
- ENRON CORP., HOUSTON, TX:  
2,151,466, CANC. MULTIPLE CLASS, INT. CLS. 35, 36, 37,  
39 AND 42.
- ENSAR CORPORATION, WHEELING, IL:  
1,276,708. REN. 1-21-05. MULTIPLE CLASS, INT. CLS. 6,  
8, 17, 20 AND 21.
- ENSERCH ENERGY SERVICES, INC., HOUSTON, TX:  
2,150,888, CANC. INT. CL. 16.
- ENTENMANN'S PRODUCTDS, INC., LOMBARD, IL,  
KRAFT GENERAL FOODS, INC., NORTHFIELD, IL:  
1,864,843. REN. 1-19-05. INT. CL. 30.
- ENTERPRISE NETWORKING SYSTEMS, INC., REDWOOD  
CITY, CA:  
2,144,713, CANC. INT. CL. 42.
- ENVIRON-METAL, INC., SWEET HOME, OR:  
2,929,029, PUB. 12-7-2004. MULTIPLE CLASS, INT. CLS.  
6, 13 AND 28.
- ENVIRONMENTAL LIGHTING CONCEPTS, INC., TAMPA,  
FL:  
2,929,044, PUB. 12-7-2004. INT. CL. 11.  
2,929,045, PUB. 12-7-2004. INT. CL. 11.
- ENVIROTECH SERVICES, INC., GREELEY, CO:  
2,929,869, INT. CL. 1.
- ENVY, CARDIFF, CA:  
2,150,508, CANC. MULTIPLE CLASS, INT. CLS. 16 AND  
28.
- EPICENTER INTERACTIVE, INC., MALIBU, CA:  
2,150,701, CANC. INT. CL. 9.
- EPSILON DATA MANAGEMENT, INC., BURLINGTON,  
MA:  
2,150,323, CANC. MULTIPLE CLASS, INT. CLS. 35 AND  
42.
- EQUIFLOR CORPORATION, MIAMI, FL TO AGRIVEST  
INTERNATIONAL, INC., OCALA, FL:  
1,830,497, CANC. INT. CL. 31.
- ERESMAS INTERACTICA INC., MADRIS, SPAIN:  
2,929,061, INT. CL. 35.
- ERICH UTSCHE AG, D-57080 SIEGEN, FED REP GERMANY:  
2,226,961, CANC. MULTIPLE CLASS, INT. CLS. 2 AND  
11.
- ERIE BRUSH & MANUFACTURING CORP, CHICAGO, IL,  
ERIE BRUSH CO., INC., CHICAGO, IL:  
1,886,797. REN. 1-19-05. INT. CL. 21.
- ERMENEGILDO ZEGNA CORPORATION, NEW YORK,  
NY:  
1,273,621, CANC. INT. CL. 25.
- ERN ENTERPRISES, INC., PALATINE, IL:  
2,929,822, INT. CL. 21.
- ERW ENTERPRISES, INC., VIRGINIA BEACH, VA:  
2,150,369, CANC. INT. CL. 36.
- ESSENS BRANDS, L.L.C., KENT, WA:  
2,929,273, INT. CL. 30.
- ESSEX ENTERTAINMENT, INC., ENGLEWOOD CLIFFS,  
NJ:  
2,150,524, CANC. INT. CL. 9.
- ESTABLECIMIENTOS FELIX GASULL, S.A., REUS, SPAIN:  
2,929,682, INT. CL. 29.
- ETIENNE AIGNER, INC., NEW YORK, NY:  
2,149,961, CANC. MULTIPLE CLASS, INT. CLS. 9, 18, 25  
AND 34.
- ETRAFFIC SOLUTIONS, INC., VICTORIA, BRITISH CO-  
LUMBIA, CANADA:  
2,928,675, PUB. 12-7-2004. MULTIPLE CLASS, INT. CLS.  
41 AND 42.
- EUGENE & ASSOCIATES, LOS ANGELES, CA:  
2,929,425, INT. CL. 43.
- EUROPEAN AMERICAN BANK, UNIONDALE, NY:  
2,150,446, CANC. INT. CL. 36.
- EUROPEAN CIGARETTE IMPORTS, INC., RANDOLPH, NJ:  
2,929,531, INT. CL. 34.
- EVERHARD PRODUCTS, INC., CANTON, OH:  
1,892,956. REN. 1-19-05. INT. CL. 8.
- EX-SPEED-ITE SERVICE, INC., SILVER SPRING, MD:  
986,186. REN. 1-18-05. U.S. CL. 101 (INT. CL. 35).
- EXECUTIVE LAW GROUP, INC., NEWPORT BEACH, CA:  
2,929,168, MULTIPLE CLASS, INT. CLS. 9, 16, 41 AND 42.
- EXECUTIVE LEADERSHIP GROUP, INC., LAKEWOOD,  
CO:  
2,928,623, PUB. 12-7-2004. INT. CL. 35.
- EXERFUN, INC., MARIETTA, GA:  
1,310,286. REN. 1-18-05. INT. CL. 28.
- EXHAUST TECH, DIVN OF DYNAFLEX, CITY OF COM-  
MERCE, CA:  
2,928,962, PUB. 12-7-2004. INT. CL. 7.
- EXHIBITOR PUBLICATIONS, INC., ROCHESTER, MN:  
2,928,874, PUB. 12-7-2004. INT. CL. 41.
- EXIDE ELECTRONICS CORPORATION, RALEIGH, NC:  
2,151,007, CANC. INT. CL. 9.
- EXPECTATIONS, LLC, PUYALLUP, WA:  
2,929,607, INT. CL. 28.
- EYE OJO CORP., EL CENTRO, CA:  
2,929,097, INT. CL. 9.
- EYGN LIMITED, NASSAU, BAHAMAS:  
2,928,470, PUB. 12-7-2004. MULTIPLE CLASS, INT. CLS.  
35 AND 36.

FAB INDUSTRIES, INC., NEW YORK, NY:  
1,840,587. REN. 1-19-05. INT. CL. 24.

FABRICTECH 2000, LLC, NEWARK, NJ:  
2,929,217. INT. CL. 24.

FACTOR DESIGN, INC., LOS GATOS, CA:  
2,150,728. CANC. MULTIPLE CLASS, INT. CLS. 35 AND 42.

FALL, KEVIN ROLAND, SAN DIEGO, CA:  
2,929,537. INT. CL. 42.

FAMILY SPORTS CONCEPTS, INC., TAMPA, FL, MELLODY, JAMES, VALRICO, FL:  
1,897,862. REN. 1-21-05. INT. CL. 42.

FAMILY TIME CAPSULES, LLC, AMELIA ISLAND, FL:  
2,929,323. MULTIPLE CLASS, INT. CLS. 9, 35 AND 41.

FARAGHER FAMILY FARM, NEWPORT, KY, DBA OUR FAMILY FARM:  
2,929,155. INT. CL. 30.  
2,929,156. INT. CL. 30.

FARES, INC., ALEXANDRIA, VA, TA SIMPLY FISH:  
2,928,545. PUB. 12-7-2004. INT. CL. 43.

FARLAN ENTERTAINMENT, PORT LOUIS, MAURITIUS:  
2,929,773. MULTIPLE CLASS, INT. CLS. 9 AND 41.

FEDERAL EXPRESS CORPORATION, MEMPHIS, TN:  
2,929,575. MULTIPLE CLASS, INT. CLS. 25, 41 AND 43.  
2,929,883. INT. CL. 39.

FEDERAL HOME LOAN MORTGAGE CORPORATION, MCLEAN, VA, TA FREDDIE MAC:  
1,304,074. REN. 1-19-05. INT. CL. 35.

FEDERAL SIGNAL CORPORATION, OAK BROOK, IL, FEDERAL ELECTRIC COMPANY, INC., CHICAGO, IL:  
412,286. REN. 1-19-05. U.S. CL. 21 (INT. CLS. 9 AND 11).

FEDERATION INTERNATIONALE DE SOCIETES D'AVIRON, 1007 LAUSANNE, SWITZERLAND:  
2,703,441. AM. MULTIPLE CLASS, INT. CLS. 9, 16, 18, 25, 28, 35, 38, 41 AND 42.  
2,705,785. AM. MULTIPLE CLASS, INT. CLS. 9, 16, 18, 25, 28, 35, 38, 41 AND 42.

FEDERATION INTERNATIONALE DE SOCIETES D'AVIRON, 1007 LAUSANNE, SWITZERLAND:  
2,705,786. AM. MULTIPLE CLASS, INT. CLS. 9, 16, 18, 25, 28, 35, 38, 41 AND 42.

FELTERS COMPANY, THE, ROEBUCK, SC:  
2,929,674. INT. CL. 24.

FERN A. SOKOLOFF-SOLOMON AND SAMUEL A. SOLOMON PARTNERSHIP, THE, LONG BEACH, CA:  
2,150,694. CANC. INT. CL. 21.  
2,150,695. CANC. INT. CL. 21.

FERRARO, JOSEPH, MELROSE, MA:  
2,151,074. CANC. INT. CL. 25.

FIBERSPAR, INC., WEST WAREHAM, MA:  
2,150,016. CANC. INT. CL. 12.

FIDELITY INFORMATION SERVICES, INC., LITTLE ROCK, AR:  
2,240,101. CANC. MULTIPLE CLASS, INT. CLS. 9 AND 36.

FIDIA S.P.A., I-35031 ABANO TERME, ITALY:  
2,150,073. CANC. INT. CL. 5.

FIGGIE INTERNATIONAL INC., WILLOUGHBY, OH:  
768,172. CANC. U.S. CL. 26.

FILA U.S.A., INC., HUNT VALLEY, MD:  
2,151,088. CANC. MULTIPLE CLASS, INT. CLS. 18 AND 28.

FINCA FLICHTMAN S.A., BUENOS AIRES, ARGENTINA:  
1,930,369. REN. 1-21-05. INT. CL. 33.

FINETRE CORPORATION, HERNDON, VA FROM FINANCIAL PLANNING RESOURCES, INC., MARIETTA, GA:  
2,929,059. INT. CL. 36.

FINK & COMPANY, INC., HOPE, AR:  
2,150,631. CANC. INT. CL. 16.

FIRESTONE POLYMERS, LLC, AKRON, OH:  
781,889. REN. 1-18-05. U.S. CL. 1 (INT. CL. 1).

FIRST FAMILY OF TRAVEL HOLDING, INC., MANHATTAN BEACH, CA, FIRST FAMILY OF TRAVEL SPECIALISTS, LTD., OAK BROOK, IL:  
1,305,349. REN. 1-21-05. INT. CL. 39.

FIRST NATIONAL BANK OF ANCHORAGE, THE, ANCHORAGE, AK:  
2,149,994. CANC. INT. CL. 36.

FIRST NIAGARA FINANCIAL GROUP, INC., LOCKPORT, NY:  
2,929,357. INT. CL. 36.

FIRSTLINK COMMUNICATIONS INC., PORTLAND, OR:  
2,150,215. CANC. MULTIPLE CLASS, INT. CLS. 38 AND 42.

FISKARS BRANDS, INC., MADISON, WI:  
2,151,167. CANC. INT. CL. 8.

FITCH INVESTORS SERVICE, L.P., NEW YORK, NY:  
2,151,121. CANC. U.S. CL. B.  
2,151,122. CANC. U.S. CL. B.

FLAWLESS RECORDS, INC., NEW YORK, NY:  
2,929,081. INT. CL. 25.  
2,929,082. INT. CL. 25.

FLEISCHMANN, JUANA SOFIA, BUENOS AIRES, ARGENTINA:  
2,150,023. CANC. INT. CL. 1.

FLEMING ENTERPRISES, CARLSBAD, CA TO IIR PUBLICATIONS, INC., CARLSBAD, CA, DBA MIDRAGE COMPUTING:  
1,830,928. CANC. INT. CL. 16.

FLETCHER, LESLIE R., BENSALEM, PA:  
2,929,749. INT. CL. 41.

FLEXI-MAT CORPORATION, CHICAGO, IL:  
2,150,475. CANC. INT. CL. 20.

FLEXURA N.V., B-8792 DESSELGEM, BELGIUM:  
2,928,582. PUB. 12-7-2004. MULTIPLE CLASS, INT. CLS. 19 AND 35.

FLICK, KENNETH E., DOUGLASVILLE, GA:  
2,151,116. CANC. MULTIPLE CLASS, INT. CLS. 9 AND 12.

FLIP CHIP TECHNOLOGIES, LLC, PHOENIX, AZ:  
2,929,612. INT. CL. 9.

FLOETRY, PHILADELPHIA, PA:  
2,929,252. MULTIPLE CLASS, INT. CLS. 9 AND 41.

FLOORGRAPHICS, INC., PRINCETON, NJ:  
2,929,118. INT. CL. 16.

FLORIDA SILICA SAND COMPANY, DANIA, FL:  
2,929,474. INT. CL. 19.

FLUENT DESIGN, INC., LONG ISLAND CITY, NY:  
2,928,576. PUB. 12-7-2004. INT. CL. 37.

FMR CORP., BOSTON, MA:  
2,929,535. INT. CL. 36.  
2,929,668. INT. CL. 36.  
2,929,830. INT. CL. 36.  
2,929,852. INT. CL. 36.  
2,929,853. INT. CL. 36.  
2,929,854. INT. CL. 36.

FOLCIK, KRISTINA MARIE, EAST HAMPTON, CT:  
2,929,825. INT. CL. 28.

FOLKMAR, JAN, CH-7050, AROSA, SWITZERLAND:  
1,830,384. CANC. INT. CL. 21.

FONDATION DU FESTIVAL DE JAZZ DE MONTREUX, TERRITET-MONTREUX, SWITZERLAND:  
2,151,509. CANC. MULTIPLE CLASS, INT. CLS. 32 AND 33.

FONG, PETER SUI LUN, MONTEREY PARK, CA:  
2,929,083. INT. CL. 28.

FONTAINE INDUSTRIES, INC., BIRMINGHAM, AL, FONTAINE TRUCK EQUIPMENT COMPANY, BIRMINGHAM, AL:  
1,307,939. REN. 1-18-05. INT. CL. 12.

FOOD NETWORK INC., CHATHAM, NJ:  
2,929,770. INT. CL. 16.

FOOD-KRAFT, INC., ST. LOUIS, MO:  
1,306,278. REN. 1-18-05. INT. CL. 32.

FOODWORKS, VERNON HILLS, IL:  
2,150,506. CANC. INT. CL. 42.

FOOT LEVELERS, INC., ROANOKE, VA:  
2,928,546. PUB. 12-7-2004. INT. CL. 10.

FOOT LOCKER RETAIL, INC., NEW YORK, NY:  
1,273,645. CANC. INT. CL. 25.

FOOT LOCKER RETAIL, INC., NEW YORK, NY, KINNEY SHOE CORPORATION, NEW YORK, NY:  
1,839,747. REN. 1-19-05. INT. CL. 42.  
1,864,412. REN. 1-19-05. INT. CL. 42.

- FORD MOTOR COMPANY, DEARBORN, MI:  
1,865,584. REN. 1-18-05. INT. CL. 8.  
1,865,830. REN. 1-18-05. INT. CL. 24.  
1,866,910. REN. 1-21-05. INT. CL. 12.  
1,866,970. REN. 1-21-05. INT. CL. 16.  
1,868,251. REN. 1-21-05. INT. CL. 16.  
1,868,462. REN. 1-21-05. INT. CL. 28.  
2,151,043. CANC. INT. CL. 28.
- FOREIGN AUTO SALVAGE, INC., COVINGTON, KY:  
2,929,343. INT. CL. 35.
- FOREST LABORATORIES, INC., NEW YORK, NY:  
2,929,594. INT. CL. 5.
- FORSHEE, JOHN, YPSILANTI, MI, DBA BARNYARD EXPRESS:  
2,150,645. CANC. INT. CL. 41.
- FORT JAMES OPERATING COMPANY, ATLANTA, GA,  
FORT HOWARD CORPORATION, GREEN BAY, WI:  
1,869,561. REN. 1-15-05. INT. CL. 16.
- FORT JAMES OPERATING COMPANY, ATLANTA, GA:  
2,929,823. INT. CL. 16.
- FORTRON INTERNATIONAL INC., HAMILTON, ONTARIO,  
CANADA TO VICEROY RUBBER & PLASTICS LIMITED,  
TORONTO ONTARIO, CANADA:  
1,830,424. CANC. INT. CL. 28.
- FORTROSS CAPITAL MANAGEMENT, LLC, SANTA MONICA,  
CA:  
2,929,462. INT. CL. 36.
- FORTUN FOODS, INC., REDMOND, WA:  
2,151,178. CANC. INT. CL. 29.  
2,151,179. CANC. INT. CL. 30.
- FORTUNE PRODUCTS, INC., LAKE STEVENS, WA:  
2,929,468. INT. CL. 11.
- FOUR STAR INTERNATIONAL TRADING COMPANY,  
TAIPEI, TAIWAN:  
2,929,212. MULTIPLE CLASS, INT. CLS. 16, 20, 21 AND  
28.
- FOX FACTORY, INC., WATSONVILLE, CA:  
2,929,593. INT. CL. 12.
- FOX VALLEY MARKING SYSTEMS, INC., CARY, IL:  
1,273,262. CANC. INT. CL. 2.
- FOX VALLEY SYSTEMS, INC.:  
1,273,261. CANC. INT. CL. 2.
- FOXBORO COMPANY, THE, FOXBOROUGH, MA:  
2,150,505. CANC. INT. CL. 9.
- FRANCE TELECOM, 75015 PARIS, FRANCE:  
2,149,967. CANC. MULTIPLE CLASS, INT. CLS. 9, 16, 36,  
38 AND 42.
- FRANK A. LOGOLUSO FARMS, INC., MADERA, CA:  
2,928,575. PUB. 12-7-2004. INT. CL. 31.
- FRANK LYNN & ASSOCIATES, INC., CHICAGO, IL:  
2,150,473. CANC. INT. CL. 35.
- FRANK RIEMAN MUSIC, INC., DES MOINES, IA:  
2,150,281. CANC. INT. CL. 15.
- FRANKE, INC., HARTFIELD, PA:  
1,862,264. REN. 1-21-05. INT. CL. 7.
- FRANKLIN INTERNATIONAL, INC., COLUMBUS, OH:  
1,830,373. CANC. INT. CL. 17.
- FRANZUS COMPANY INC., BEACON FALLS, CT:  
2,151,324. CANC. INT. CL. 18.
- FRED MEYER, INC., PORTLAND, OR:  
2,151,357. CANC. INT. CL. 14.
- FRED W. ALBRECHT GROCERY COMPANY, THE, AKRON,  
OH:  
2,151,310. CANC. INT. CL. 35.
- FREDA CORPORATION, PHILADELPHIA, PA:  
1,273,723. CANC. INT. CL. 29.  
1,273,728. CANC. INT. CL. 29.
- FREE MOTION FITNESS, INC., COLORADO SPRINGS, CO:  
2,929,820. INT. CL. 28.
- FREE SPIRIT PUBLISHING INC., MINNEAPOLIS, MN:  
2,150,534. CANC. INT. CL. 16.
- FREUND CORPORATION, TOKYO, JAPAN:  
1,308,621. REN. 1-20-05. INT. CL. 7.
- FRIED, JASON, DEERFIELD, IL:  
2,150,567. CANC. INT. CL. 42.
- FRIENDLY ICE CREAM CORPORATION, WILBRAHAM,  
MA:  
1,273,961. CANC. INT. CL. 42.
- FRISCH'S RESTAURANTS, INC., CINCINNATI, OH:  
1,920,036. REN. 1-18-05. INT. CL. 30.
- FRITO-LAY NORTH AMERICA, INC., PLANO, TX:  
2,929,369. INT. CL. 30.
- FROG DESIGN, INC., SUNNYVALE, CA, HAUG; ANDREAS,  
ALTENSTEIG 1, FED REP GERMANY:  
1,312,760. REN. 1-19-05. INT. CL. 42.
- FROMARTHARIE, INC., WARREN, NJ:  
2,929,814. INT. CL. 29.
- FRONTIER FASHION, INC., EL MONTE, CA:  
2,928,637. PUB. 12-7-2004. INT. CL. 9.
- FULLMARK PTE. LTD., JURONG TOWN, SINGAPORE:  
1,830,301. CANC. INT. CL. 16.
- FULTON-DEKALB HOSPITAL AUTHORITY, THE, ATLANTA,  
GA:  
1,837,187. REN. 1-18-05. INT. CL. 42.
- FX NETWORKS, LLC, LOS ANGELES, CA:  
2,928,879. PUB. 12-7-2004. INT. CL. 41.
- G & R FOODS, INC., REEDSBURG, WI:  
2,929,359. INT. CL. 29.
- G.K. EMPLOYMENT ANALYSTS, INC., BETHEL PARK, PA  
AND KONTOS, GEORGE, BETHEL PARK, PA:  
2,150,545. CANC. INT. CL. 35.
- GALE BANKS ENGINEERING, AZUSA, CA:  
1,830,184. CANC. INT. CL. 9.
- GALLAGHER, CAROL A., PIEDMONT, CA:  
2,150,772. CANC. INT. CL. 41.
- GALLAHER LIMITED, LONDON, ENGLAND:  
768,298. CANC. U.S. CL. 17.
- GALLET S.A., 01400 CHATILLON SUR CHALARONNE,  
FRANCE:  
1,830,919. CANC. INT. CL. 9.
- GAMBRO LUNDIA AB, LUND, SWEDEN:  
2,929,725. INT. CL. 10.
- GAME TRACKER, INC., THE, FLUSHING, MI:  
2,929,192. MULTIPLE CLASS, INT. CLS. 11, 21 AND 30.
- GAMES FOR ALL REASONS, LLC, ARLINGTON, MA:  
2,929,722. INT. CL. 28.
- GANNETT CO., INC., ARLINGTON, VA:  
2,151,392. CANC. INT. CL. 42.
- GANTTHEAD.COM, INC., FAIRFAX, VA:  
2,929,126. INT. CL. 42.
- GAP (APPAREL), LLC, SAN FRANCISCO, CA:  
1,273,620. CANC. INT. CL. 25.
- GARAGETEK, INC., PORT WASHINGTON, NY:  
2,928,584. PUB. 12-7-2004. MULTIPLE CLASS, INT. CLS.  
37 AND 42.
- GARDNER TECHNOLOGIES, INC., NAPA, CA:  
2,928,838. PUB. 12-7-2004. MULTIPLE CLASS, INT. CLS.  
20 AND 21.
- GARLAND CORPORATION, BROCKTON, MA:  
1,273,612. CANC. INT. CL. 25.
- GARRETT, CALVERT K., BELLEVUE, WA, DBA MICROBOND  
SOFTWARE:  
2,150,830. CANC. INT. CL. 9.
- GARTMORE INVESTMENT MANAGEMENT PLC, LONDON,  
EC3M 4PH, ENGLAND:  
2,928,502. PUB. 12-7-2004. MULTIPLE CLASS, INT. CLS.  
35 AND 36.
- GATES CORPORATION, THE, DENVER, CO:  
1,282,478. REN. 1-21-05. INT. CL. 17.
- GB 500, INC., NAPLES, FL:  
2,929,552. INT. CL. 37.
- GECAP GESELLSCHAFT FUR TECHNISCHE INFORMATION  
MBH, D-82008 UNTERHACHING, FED REP GERMANY:  
2,149,942. CANC. MULTIPLE CLASS, INT. CLS. 9, 16, 35,  
41 AND 42.
- GEERLINGS & WADE, INC., CANTON, MA:  
2,929,471. INT. CL. 33.
- GELMART INDUSTRIES, INC., NEW YORK, NY:  
2,928,746. PUB. 12-7-2004. INT. CL. 25.
- GEN-X SPORTS SARL, CHATEL ST. DENIS, SWITZERLAND:  
2,929,892. INT. CL. 18.
- GENCORP INC., FAIRLAWN, OH:  
2,151,459. CANC. INT. CL. 27.



GENERAL AMERICAN LIFE INSURANCE COMPANY, ST. LOUIS, MO:  
2,150,632, CANC. INT. CL. 36.

GENERAL BUISNESS CORP., RICHMOND, UT:  
2,928,880, PUB. 12-7-2004. INT. CL. 37.

GENERAL CONTAINER CO. OF MICHIGAN, INC., HILLSDALE, MI TO DENALI FLAVORS, LLC, HILLSDALE, MI:  
1,830,475, CANC. INT. CL. 30.

GENERAL ELECTRIC CAPITAL CORPORATION, NORWALK, CT:  
2,929,559, INT. CL. 9.

GENERAL MILLS, INC., MINNEAPOLIS, MN:  
2,928,982, PUB. 12-7-2004. INT. CL. 30.

GENERAL RE CORPORATION, STAMFORD, CT:  
2,928,570, PUB. 12-7-2004. MULTIPLE CLASS, INT. CLS. 9 AND 16.

GENERAL WIG MANUFACTURERS, INC., MIAMI LAKES, FL:  
2,929,104, INT. CL. 26.

GENICA CORPORATION, OCEANSIDE, CA:  
2,929,395, INT. CL. 9.

GENLIME GROUP, L.P., WAYNE, PA:  
2,151,156, CANC. INT. CL. 19.

GENSTAR STONE PRODUCTS COMPANY, FRANKLIN PARK, IL:  
768,087, CANC. U.S. CL. 12.

GENTLE TRUCKING, INC., BOSTON, MA:  
1,830,616, CANC. INT. CL. 39.

GEO. A. HORMEL & COMPANY, AUSTIN, TX:  
1,273,711, CANC. INT. CL. 29.

GEORGE LITTLE MANAGEMENT, LLC, WHITE PLAINS, NY:  
2,929,488, INT. CL. 35.

GEORGIA PUBLIC TELECOMMUNICATIONS COMMISSION, ATLANTA, GA, DBA GEORGIA PUBLIC TELEVISION:  
2,150,044, CANC. INT. CL. 41.

GEORGIANO, JOSEPH, HICKSVILLE, NY AND MATH, IRWIN, GREENVALE, NY:  
2,929,157, INT. CL. 9.

GEOWORKS, ALAMEDA, CA:  
2,151,125, CANC. INT. CL. 38.

GEPTEK, INC., MADISON, NJ:  
2,928,483, PUB. 12-7-2004. MULTIPLE CLASS, INT. CLS. 35 AND 40.

GERALD J. BROOCK, M.D., INC., WILLIAMSBURG, VA:  
2,150,585, CANC. INT. CL. 42.

GES EXPOSITION SERVICES, INC., LAS VEGAS, NV, GREYHOUND EXPOSITION SERVICES, INC., PHOENIX, AZ:  
1,309,650, REN. 1-18-05. MULTIPLE CLASS, INT. CLS. 7, 9, 11 AND 20.

GETSMART.COM, INC., SAN FRANCISCO, CA:  
2,929,887, INT. CL. 35.

GEXA CORPORATION, HOUSTON, TX:  
2,928,862, PUB. 12-7-2004. MULTIPLE CLASS, INT. CLS. 35 AND 36.

GF HEALTH PRODUCTS INC., ATLANTA, GA:  
1,871,234, REN. 1-18-05. INT. CL. 12.

GF HEALTH PRODUCTS, INC., ATLANTA, GA:  
1,871,245, REN. 1-21-05. INT. CL. 12.

GILFORD INSTRUMENT LABORATORIES, INC., OBERLIN, OH:  
768,166, CANC. U.S. CL. 26.

GLADSON & ASSOCIATES, INC., LISLE, IL:  
1,830,529, CANC. INT. CL. 35.

GLANCY, CHERYL L., ELLETTSVILLE, IN:  
2,150,513, CANC. INT. CL. 42.

GLENDRIDGE PUBLISHING, LLC, ENGLEWOOD, CO:  
2,824,708, COR. INT. CL. 16.

GLENN COMPUTER CORPORATION, SOUTHFIELD, MI:  
2,928,591, PUB. 12-7-2004. INT. CL. 36.

GLI INTERNATIONAL, INC., MILWAUKEE, WI:  
2,150,690, CANC. INT. CL. 9.

GLOBAL MEDNET, INC., COPPELL, TX:  
2,150,053, CANC. INT. CL. 42.

GLOBAL SPORTS CONSULTANTS, LLC, FAR HILLS, NJ, DBA JET SET SPORTS:  
2,928,671, PUB. 12-7-2004. INT. CL. 25.

GLOBALCENTER, INC., SUNNYVALE, CA:  
2,151,338, CANC. INT. CL. 38.

GLOBALWARE SOLUTIONS MASSACHUSETTS, INC., HAVERHILL, MA FROM ZBR PUBLICATIONS, INC., HAVERHILL, MA:  
2,929,094, MULTIPLE CLASS, INT. CLS. 35 AND 39.

GLOVIS CO. LTD., SEOUL, REPUBLIC OF KOREA:  
2,929,370, INT. CL. 39.

GMAC MORTGAGE CORPORATION, HORSHAM, PA:  
2,928,628, PUB. 12-7-2004. INT. CL. 36.  
2,928,640, PUB. 12-7-2004. INT. CL. 36.  
2,928,647, PUB. 12-7-2004. INT. CL. 36.  
2,928,648, PUB. 12-7-2004. INT. CL. 36.

GMB, INC., KING, NC:  
1,021,649, REN. 1-21-05. INT. CL. 34.

GOEMANS, ROBERT, TUCSON, AZ:  
1,830,351, CANC. MULTIPLE CLASS, INT. CLS. 16 AND 35.

GOLDEN SELECT FOODS COMPANY, CITY OF COMMERCE, CA:  
1,866,506, REN. 1-19-05. INT. CL. 29.

GOLDEN TEMPLE OF OREGON, INC., EUGENE, OR:  
2,929,368, INT. CL. 3.

GOLDSTEIN, EDDIE, SUPERIOR, CO AND HOROWITZ, ELLEN, SUPERIOR, CO:  
1,830,224, CANC. INT. CL. 9.

GOMI USA, LLC, ALEXANDRIA, VA:  
2,929,755, INT. CL. 25.

GOODLIFE (M) SDN BHD, 40150 SHAH ALAM, SELANGOR DARUL EHSAN, MALAYSIA:  
2,893,748, COR. INT. CL. 4.

GOODYEAR TIRE & RUBBER COMPANY, THE, AKRON, OH:  
782,088, REN. 1-21-05. U.S. CL. 35 (INT. CL. 12).  
987,374, REN. 1-18-05. U.S. CL. 35 (INT. CL. 17).  
1,848,561, REN. 1-18-05. INT. CL. 12.  
2,150,782, CANC. INT. CL. 12.

GOOSE DADDY LLC, PORTLAND, OR:  
2,929,541, INT. CL. 16.  
2,929,542, INT. CL. 16.

GORDINI U.S.A. INC., ESSEX JUNCTION, VT:  
2,929,358, INT. CL. 25.

GORDON FOOD SERVICE, INC., GRAND RAPIDS, MI:  
2,151,189, CANC. INT. CL. 29.

GORDON, JOHN B., GRANGER, IN:  
2,929,114, INT. CL. 11.

GORSTEW LIMITED, KINGSTON 5, JAMAICA:  
2,929,808, MULTIPLE CLASS, INT. CLS. 39 AND 43.

GOSPO CENTRIC, INGLEWOOD, CA:  
2,789,926, COR. INT. CL. 9.

GOTTWALD HOLDCO 6 (SECHS) GMBH, DUSSELDORF, FED REP GERMANY:  
2,883,593, COR. MULTIPLE CLASS, INT. CLS. 7, 9, 12, 37 AND 42.

GOVERN, STANLEY, POINT PLEASANT, NJ:  
2,929,363, INT. CL. 25.

GOWAN COMPANY, YUMA, AZ:  
784,237, REN. 1-21-05. U.S. CL. 6 (INT. CL. 1).

GRAF, ALICELEE, CARLISLE, PA:  
2,150,528, CANC. INT. CL. 24.

GRAND CHAVIN PRODUCT S.A.R.L., F-39220 LES ROUSSES, FRANCE:  
2,150,130, CANC. MULTIPLE CLASS, INT. CLS. 28 AND 35.

GRAND COURT LIFESTYLES, INC., BOCA RATON, FL:  
2,150,151, CANC. INT. CL. 42.

GRANDE CHEESE COMPANY, BROWNSVILLE, WI:  
1,273,715, CANC. INT. CL. 29.

GRANT ENGINEERING PRODUCTS COMPANY, INC., LOS ANGELES, CA:  
1,273,431, CANC. INT. CL. 12.

GREAT AMERICAN INSURANCE CO., CINCINNATI, OH:  
2,929,401, INT. CL. 9.  
2,929,433, INT. CL. 9.

- GREAT CONCEPTS, LLC, PLANTATION, FL:  
2,929,764, INT. CL. 43.
- GREATER ILLINOIS TITLE COMPANY, CHICAGO, IL:  
2,150,227, CANC. INT. CL. 36.
- GREATER PARK CITY COMPANY, PARK CITY, UT:  
2,150,039, CANC. INT. CL. 41.
- GREEN COURT, INC., THE, WILMINGTON, NC:  
2,151,379, CANC. MULTIPLE CLASS, INT. CLS. 25 AND 28.
- GREENBLATT, JOEL, NEW YORK, NY, DBA GOTHAM CAPITAL:  
2,929,076, INT. CL. 36.
- GREENHEART FARMS, INC., ARROYO GRANDE, CA AND GREENHEART FARMS - YUMA, ARROYO GRANDE, CA:  
1,867,304, REN. 1-21-05, INT. CL. 42.
- GREER STOP NUT, INC., NASHVILLE, TN, MICRODOT INC., DARIEN, CT:  
1,309,636, REN. 1-21-05, INT. CL. 6.
- GREINER BIO-ONE GMBH, FRICKENHAUSEN, FED REP GERMANY, C. A. GREINER & SOHNE GMBH & CO. KG, NUERTINGEN, FED REP GERMANY:  
1,308,671, REN. 1-21-05, INT. CL. 9.
- GRIDLINE AB, 17141 SOLNA, SWEDEN:  
2,929,111, INT. CL. 9.
- GRIEGO, ARTHUR G., MESA, AZ:  
2,150,634, CANC. INT. CL. 25.
- GROUPE IMAGE BUZZ INC./BUZZ IMAGE GROUP INC., MONTREAL, PROVINCE OF QUEBEC, CANADA:  
2,149,966, CANC. MULTIPLE CLASS, INT. CLS. 40 AND 41.
- GROVER MUSICAL PRODUCTS, INC., CLEVELAND, OH:  
1,914,328, REN. 1-21-05, INT. CL. 15.
- GT SOFTWARE, INC., ATLANTA, GA:  
2,928,937, PUB. 12-7-2004, INT. CL. 9.  
2,928,939, PUB. 12-7-2004, INT. CL. 9.
- GTE SPACENET CORPORATION, MCLEAN, VA TO SPACE-NET INC., MCLEAN, VA:  
1,830,602, CANC. INT. CL. 38.
- GUANGDONG TAKSTAR ELECTRONIC CO., LTD., CHAOYANG, GUANGDONG PROVINCE, CHINA:  
2,928,494, PUB. 12-7-2004, INT. CL. 9.
- GUERRA, RENE HECTOR GARZA, SAN PEDRO GARZA GARCIA, NUEVO LEON, MEXICO:  
2,929,618, MULTIPLE CLASS, INT. CLS. 35, 36 AND 39.
- GUERRILLA NEWS NETWORK, INC., NEW YORK, NY:  
2,929,103, INT. CL. 41.
- GUILFORD MILLS, INC., GREENSBORO, NC:  
2,151,361, CANC. INT. CL. 24.
- GULF & WESTERN MANUFACTURING COMPANY, SOUTHFIELD, MI:  
768,152, CANC. U.S. CL. 23.
- GULF BEACH HOTEL, INC., ORANGE BEACH, AL:  
1,830,671, CANC. INT. CL. 42.
- GUM TECH INTERNATIONAL, INC., PHOENIX, AZ:  
2,151,282, CANC. INT. CL. 30.
- GUNSLINGER RECORDS, INC., PHOENIX, AZ:  
2,150,796, CANC. INT. CL. 41.
- GYRR, INC., ANAHEIM, CA:  
2,150,806, CANC. INT. CL. 9.  
2,150,821, CANC. INT. CL. 9.
- H. A. JONES CHEVROLET-BUICK-OLDSMOBILE, INC., CYNTHIANA, KY, DBA JONES AUTO GROUP:  
2,150,939, CANC. INT. CL. 35.
- H. BOLLMANN MANUFACTURERS LIMITED, WEST SUSSEX RH15 9NF, ENGLAND:  
2,150,315, CANC. INT. CL. 9.
- H. KOHNSTAMM & CO., INC., NEW YORK, NY:  
768,072, CANC. U.S. CL. 6.
- H.D. LEE COMPANY, INC., THE, WILMINGTON, DE:  
2,929,556, MULTIPLE CLASS, INT. CLS. 18 AND 25.
- H-TECH, INC., WILMINGTON, DE:  
1,938,782, REN. 1-18-05, INT. CL. 20.
- HAESSLY, JENNIFER A., MUKWONAGO, WI:  
2,150,476, CANC. INT. CL. 42.
- HAIR FRANCE CORP., PALM DESERT, CA:  
1,365,043, REN. 1-21-05, INT. CL. 3.
- HALKE, ROBERT, BLACKWOOD, NJ:  
2,929,099, INT. CL. 8.
- HALL, DICKLER, LAWLER, KENT & FRIEDMAN, NEW YORK, NY TO HALL DICKLER KENT FRIEDMAN & WOOD LLP, NEW YORK, NY:  
1,830,333, CANC. INT. CL. 16.
- HALLIBURTON ENERGY SERVICES, INC., CARROLLTON, TX:  
2,929,036, PUB. 12-7-2004, INT. CL. 7.
- HALLMARK LICENSING, INC., KANSAS CITY, MO:  
2,929,640, INT. CL. 20.  
2,929,791, INT. CL. 16.
- HALSTON LLC, NEW YORK, NY, HALSTON ENTERPRISES, INC., NEW YORK, NY:  
1,002,073, REN. 1-21-05, MULTIPLE CLASS, INT. CLS. 25 AND 42.
- HAMAMATSU PHOTONICS K.K., SHIZUOKA, JAPAN:  
2,929,548, INT. CL. 9.
- HANDY & HARMAN, RYE, NY:  
2,929,445, INT. CL. 6.
- HANNIGAN, FRANK, KIRKLAND, WA:  
2,151,441, CANC. INT. CL. 14.
- HANOVER COLLEGE, HANOVER, IN:  
2,929,714, INT. CL. 41.
- HANS GROHE GMBH & CO., KG, 7622 SCHILTACH, FED REP GERMANY TO HANS GROHE AG, DEX-FED REP, FED REP GERMANY:  
1,830,372, CANC. INT. CL. 17.
- HANSEN, DARYL G., KANEOHE, HI:  
2,150,881, CANC. INT. CL. 16.
- HARBOR SALES COMPANY, TROY, MI:  
2,928,964, PUB. 12-7-2004, INT. CL. 12.
- HARCOURT BRACE & COMPANY, ORLANDO, FL TO HARCOURT, INC., ORLANDO, FL:  
1,830,327, CANC. INT. CL. 16.
- HARCOURT, INC., ORLANDO, FL, HARCOURT BRACE & COMPANY, ORLANDO, FL:  
1,894,201, REN. 1-21-05, INT. CL. 28.
- HARD ROCK CAFE LICENSING CORPORATION, BEVERLY HILLS, CA:  
2,069,638, CANC. MULTIPLE CLASS, INT. CLS. 15, 18, 20 AND 28.
- HARD ROCK CAFE LICENSING CORPORATION, ORLANDO, FL:  
2,151,050, CANC. MULTIPLE CLASS, INT. CLS. 8, 14, 20, 21 AND 26.
- HARGER LIGHTNING PROTECTION, INC., GRAYSLAKE, IL:  
1,868,106, REN. 1-21-05, INT. CL. 9.
- HARKRIDER, KENT, CARTHAGE, TX:  
2,929,306, INT. CL. 28.
- HARMAN INTERNATIONAL INDUSTRIES, INCORPORATED, NORTHRIDGE, CA:  
2,929,086, INT. CL. 37.  
2,929,639, INT. CL. 9.
- HARRIS PUBLICATIONS, INC., NEW YORK, NY:  
1,252,920, REN. 1-19-05, INT. CL. 16.
- HARTZELL FAN, INC., PIQUA, OH:  
788,168, REN. 1-21-05, U.S. CL. 34 (INT. CL. 11).
- HARVE BENARD, LTD., CLIFTON, NJ:  
1,309,117, REN. 1-15-05, INT. CL. 25.
- HASBRO, INC., PAWTUCKET, RI, MILTON BRADLEY COMPANY, SPRINGFIELD, MA:  
1,009,552, REN. 1-21-05, INT. CL. 28.
- HASBRO, INC., PAWTUCKET, RI, KUSAN, INC., NASHVILLE, TN:  
1,009,985, REN. 1-21-05, INT. CL. 28.
- HASBRO, INC., PAWTUCKET, RI:  
2,150,599, CANC. INT. CL. 28.
- HATCH, INC., WINSTON-SALEM, NC:  
1,864,543, CANC. INT. CL. 16.
- HATCO CORPORATION, MILWAUKEE, WI:  
2,151,112, CANC. INT. CL. 11.
- HAUPT, THOMAS M., LINDENHURST, NY:  
2,929,364, INT. CL. 21.
- HAUSSERMANN STAUDEN + GEHOLZE GBR, MOGLINGEN, FED REP GERMANY:  
2,929,550, INT. CL. 31.

- HAY, IAN M., ATLANTA, GA:  
2,928,676, PUB. 12-7-2004. INT. CL. 41.
- HAYES MEDICAL, INC., EL DORADO HILLS, CA, U. S. MEDICAL PRODUCTS, INC., AUSTIN, TX:  
1,865,693. REN. 1-18-05. INT. CL. 10.
- HAYES, THOMAS, SAN JOSE, CA:  
2,151,016, CANC. INT. CL. 36.
- HAYGEMAN, ISOBE, JOHNSON, KRACKE, LTD., CARLSBAD, CA:  
2,150,430, CANC. INT. CL. 42.
- HAYNES INTERNATIONAL, INC., KOKOMO, IN, UNION CARBIDE AND CARBON CORPORATION, NEW YORK, NY:  
605,011. REN. 1-21-05. U.S. CL. 13 (INT. CL. 6).
- HAZEMEYER B.V., HENGELO, NETHERLANDS:  
768,122, CANC. U.S. CL. 21.
- HEAD SPORT AG, A-6921 KENNELBACH, AUSTRIA:  
2,928,477, PUB. 12-7-2004. INT. CL. 9.
- HEALTH INTERNATIONAL CORPORATION, INDIAN SHORES, FL:  
2,929,402, INT. CL. 41.
- HEALTH MANAGEMENT SOFTWARE, INC., ROSWELL, GA:  
2,151,393, CANC. INT. CL. 9.
- HEALTHCARE FINANCIAL MANAGEMENT ASSOCIATION, WESTCHESTER, IL:  
1,861,542. REN. 1-21-05. INT. CL. 42.  
1,861,549. REN. 1-21-05. U.S. CL. 200.
- HEALTHCARE WORKS, LOS ANGELES, CA:  
1,830,192, CANC. MULTIPLE CLASS, INT. CLS. 9 AND 16.
- HEALTHY INSPIRATIONS MANAGEMENT, INC., WAKEFIELD, RI:  
2,929,590, INT. CL. 41.
- HEARST COMMUNICATIONS, INC., NEW YORK, NY:  
2,929,100, INT. CL. 9.
- HEARST MAGAZINES PROPERTY, INC., GREENWICH, CT:  
188,718. REN. 1-21-05. U.S. CL. 38 (INT. CLS. 9, 16 AND 28).
- HEARST MAGAZINES PROPERTY, INC., GREENWICH, CT, TRIANGLE PUBLICATIONS, INC., PHILADELPHIA, PA:  
411,294. REN. 1-19-05. U.S. CL. 38 (INT. CL. 16).
- HEARTECH PRECISION, INC., ELK GROVE VILLAGE, IL:  
2,928,711, PUB. 12-7-2004. INT. CL. 7.
- HEARTHSONG, INC., ROHNERT PARK, CA:  
2,151,323, CANC. INT. CL. 28.
- HEARTS ON FIRE COMPANY LLP, BOSTON, MA:  
2,929,816, INT. CL. 14.  
2,929,817, INT. CL. 14.
- HEAVEN HILL DISTILLERIES, INC, BARDSTOWN, KY:  
2,929,882, INT. CL. 41.
- HEB GROCERY COMPANY, LP, SAN ANTONIO, TX:  
2,929,649, INT. CL. 29.
- HEKMAN FURNITURE COMPANY, GRAND RAPIDS, MI:  
1,323,300. REN. 1-15-05. INT. CL. 20.
- HELEN OF TROY LIMITED, BRIDGETOWN, BARBADOS:  
2,928,713, PUB. 12-7-2004. INT. CL. 11.  
2,929,332, INT. CL. 3.  
2,929,333, INT. CL. 3.  
2,929,334, INT. CL. 3.
- HELENA HOLDING COMPANY, WILMINGTON, DE:  
2,929,018, PUB. 12-7-2004. INT. CL. 1.
- HELENE CURTIS, INC., WILMINGTON, DE:  
2,929,253, MULTIPLE CLASS, INT. CLS. 25 AND 26.  
2,929,738, INT. CL. 20.
- HELLENIC LITERATURE SOCIETY, INC., RIVER VALE, NJ:  
2,151,529, CANC. INT. CL. 41.
- HELM INSTRUMENT COMPANY, INC., MAUMEE, OH:  
1,273,389, CANC. INT. CL. 9.
- HELMS, CARL R., EDMOND, OK:  
2,903,849, COR. INT. CL. 44.
- HENKEL CORPORATION, GULPH MILLS, PA:  
1,830,106, CANC. INT. CL. 4.  
1,837,891. REN. 1-18-05. INT. CL. 17.
- HENRY COMPANY, HUNTINGTON PARK, CA:  
2,151,518, CANC. INT. CL. 19.
- HENRY FILTERS, INC., BOWLING GREEN, OH:  
1,273,423, CANC. INT. CL. 11.
- HERAEUS KULZER GMBH & CO. KG, D-63450 HANAU, FED REP GERMANY:  
2,929,056, INT. CL. 5.
- HERB'S SEAFOOD, INC., MT. HOLLY, NJ:  
2,929,327, INT. CL. 29.
- HERBAL MAGIC, INC., FOREST KNOLLS, CA:  
2,150,851, CANC. INT. CL. 5.
- HERBALANIMALS, INC., BETHESDA, MD:  
2,150,946, CANC. INT. CL. 20.  
2,151,055, CANC. INT. CL. 20.
- HERBERT H. MOSER, STAMFORD, CT:  
2,151,515, CANC. INT. CL. 42.
- HERITAGE BRANDS, LLC, JERSEY CITY, NJ:  
2,928,971, PUB. 12-7-2004. INT. CL. 16.
- HERMES INTERNATIONAL, PARIS, FRANCE:  
2,899,792, COR. INT. CL. 18.
- HERRE, SUSAN, M., WASHINGTON, DC:  
2,929,783, INT. CL. 39.
- HERSHEY CHOCOLATE & CONFECTIONERY CORPORATION, WHEAT RIDGE, CO, LIFE SAVERS, INC., NEW YORK, NY:  
1,001,109. REN. 1-21-05. INT. CL. 30.
- HESTER INDUSTRIES, INC., MOOREFIELD, WV:  
1,273,705, CANC. INT. CL. 29.  
1,273,707, CANC. INT. CL. 29.
- HETTICH MARKETING-UND VERTRIEBS GMBH & CO. KG PAUL HETTICH GMBH & CO. LTD, 4983 KIRCHLENGERN, FED REP GERMANY:  
2,149,933, CANC. MULTIPLE CLASS, INT. CLS. 16 AND 21.
- HEUBLEIN, INC., HARTFORD, CT:  
1,273,811, CANC. INT. CL. 33.
- HEYER-SCHULTE NEUROCARE, L.P., PLEASANT PRAIRIE, WI:  
2,151,397, CANC. INT. CL. 10.
- HI FIBRE TEXTILES LTD., BURNABY, BRITISH COLUMBIA, CANADA:  
1,830,738, CANC. MULTIPLE CLASS, INT. CLS. 25 AND 28.
- HI-LIFE PACKING COMPANY, GLEN ELLYN, IL:  
1,273,795, CANC. INT. CL. 31.
- HI-TECH GOLF, INC., ARLINGTON, VA:  
1,830,425, CANC. INT. CL. 28.
- HIBISCUS GROUP, INC., THE, COLUMBUS, OH:  
2,150,439, CANC. INT. CL. 21.
- HICKORY PARK FURNITURE GALLERIES, INC., HICKORY, NC:  
2,929,774, INT. CL. 35.
- HICKS JASON F, DENVER, CO:  
2,928,701, PUB. 12-7-2004. INT. CL. 39.
- HIGH FREQUENCY ECONOMICS, LTD., VALHALLA, NY:  
1,856,719. REN. 1-21-05. MULTIPLE CLASS, INT. CLS. 16 AND 36.
- HIGHLAND GROUP INDUSTRIES L.P., SOLON, OH:  
2,150,321, CANC. MULTIPLE CLASS, INT. CLS. 12 AND 27.
- HIGHLIGHT INDUSTRIES, INC., WYOMING, MI:  
2,929,706, INT. CL. 7.
- HILEC, LLC., ARCADE, NY, BRAND-REX COMPANY, WILLIAMANTIC, CT:  
1,308,975. REN. 1-21-05. INT. CL. 17.
- HILMOE, MARY JANE, SPRINGFIELD, IL:  
2,149,929, CANC. INT. CL. 30.
- HILTON HOSPITALITY, INC., BEVERLY HILLS, CA:  
2,928,886, PUB. 12-7-2004. INT. CL. 39.
- HMR ACQUISITION COMPANY, INC., SOUTH BEND, IN, HACIENDA MEXICAN RESTAURANTS, INC., MISHAWAKA, IN:  
1,331,341. REN. 1-18-05. INT. CL. 42.
- HMS SALES AND MARKETING, INC., JACKSONVILLE, FL:  
1,830,558, CANC. INT. CL. 35.
- HOFFERBER, SCOTT, BILLINGS, MT:  
2,151,325, CANC. INT. CL. 25.

- HOLIDAY FAIR, INC., NEW YORK, NY:  
1,273,518, CANC. INT. CL. 18.
- HOLLAND ADVERTISING, INC., NEW YORK, NY:  
2,151,032, CANC. INT. CL. 35.
- HOLLANDER, JAMES, PLAINFIELD, NH:  
2,929,362, INT. CL. 12.
- HOLLY PRATT, CINCINNATI, OH:  
2,928,847, PUB. 12-7-2004, INT. CL. 41.
- HOLT, DARRYL SHANNON, GRAND RAPIDS, MI:  
2,150,692, CANC. INT. CL. 9.
- HOLYBEARS, INC., HOUSTON, TX:  
2,929,601, INT. CL. 28.
- HOMEDICS, INC., COMMERCE TOWNSHIP, MI:  
2,929,724, INT. CL. 9.
- HOMELAND HOUSEWARES, LLC, LOS ANGELES, CA:  
2,929,383, INT. CL. 7.
- HOME2OFFICE COMPUTING SOLUTIONS, INC., SAN DIEGO, CA:  
2,928,616, PUB. 12-7-2004, INT. CL. 42.
- HONDO COMMUNICATIONS INC., BROOMFIELD, CO:  
2,928,929, PUB. 12-7-2004, INT. CL. 35.
- HONEYWELL INTERNATIONAL INC., MORRISTOWN, NJ:  
2,929,565, INT. CL. 9.
- HONEYWELL SAFETY MANAGEMENT SYSTEMS B.V., AS'S HERIOGENBOSEN, NETHERLANDS, PEPPERL + FUCHS SYSTEMS B.V., 5223 AZ 'S-HERTOGENBOSCH, NETHERLANDS:  
1,923,371, REN. 1-19-05, INT. CL. 9.
- HOOT, JEFFREY S, BRYCEVILLE, FL:  
2,151,528, CANC. INT. CL. 41.
- HOP KEE INC., CHICAGO, IL, DBA ORIENTAL DELICACIES INC.:  
2,929,033, PUB. 12-7-2004, INT. CL. 30.
- HORIZONS TECHNOLOGY, INC., SAN DIEGO, CA:  
1,830,195, CANC. INT. CL. 9.
- HOT KISS, INC., LOS ANGELES, CA:  
2,151,457, CANC. INT. CL. 25.
- HOUSE FOODS AMERICA CORPORATION, GARDEN GROVE, CA:  
2,929,373, INT. CL. 29.
- HOWARD, MALCOLM B., SCOTTSDALE, AZ:  
2,929,533, INT. CL. 32.
- HOWZE, BENJAMIN G. II, WALNUT, CA:  
2,150,685, CANC. INT. CL. 25.
- HP INTELLECTUAL CORP., WILMINGTON, DE:  
1,835,921, REN. 1-18-05, MULTIPLE CLASS, INT. CLS. 3, 9 AND 11.  
1,835,921, CANC. MULTIPLE CLASS, INT. CLS. 21 AND 26.
- HSI SERVICE CORP., NEWARK, DE:  
2,928,881, PUB. 12-7-2004, INT. CL. 35.
- HSING TECH ENTERPRISE CO., LTD., TAIPEI, TAIWAN:  
2,150,792, CANC. INT. CL. 9.  
2,150,793, CANC. INT. CL. 9.  
2,150,794, CANC. INT. CL. 9.  
2,150,795, CANC. INT. CL. 9.
- HSU & FUNG, INC., SAN JOSE, CA:  
2,150,619, CANC. INT. CL. 42.
- HSX HOLDINGS, INC., NEW YORK, NY:  
2,150,493, CANC. INT. CL. 41.
- HUBBARD FEEDS INC., MANKATO, MN, ALLIED MILLS, INC., CHICAGO, IL:  
317,588, REN. 1-18-05, U.S. CL. 46 (INT. CL. 31).
- HUBBARD FEEDS INC., MANKATO, MN, HUBBARD MILLING COMPANY, MANKATO, MN:  
1,864,871, REN. 1-18-05, INT. CL. 31.
- HUCK INTERNATIONAL, INC., TUCSON, AZ:  
2,150,628, CANC. INT. CL. 6.
- HUDSON ICS, SAN LEANDRO, CA:  
2,150,726, CANC. INT. CL. 20.
- HUDSON STANDARD CORPORATION, NEWARK, NJ:  
1,273,418, CANC. INT. CL. 11.
- HUMAN AFFAIRS INTERNATIONAL, INC., SANDY, UT:  
2,150,941, CANC. INT. CL. 42.  
2,150,942, CANC. INT. CL. 42.  
2,150,943, CANC. INT. CL. 42.
- HUNTSMAN ADVANCED MATERIALS AMERICAS INC., AUBURN HILLS, MI:  
2,929,010, PUB. 12-7-2004, INT. CL. 1.
- HUSKY INJECTION MOLDING SYSTEMS LTD., BOLTON, ONTARIO, CANADA:  
2,929,101, INT. CL. 35.
- HYDRA-ELECTRIC COMPANY, BURBANK, CA, CRYOGENIC DISTRIBUTORS, INC., SAN GABRIEL, CA:  
1,007,079, REN. 1-18-05, U.S. CL. 23 (INT. CL. 7).
- HYDROFLOW INCORPORATED, PERRYSBURG, OH:  
1,880,373, REN. 1-18-05, INT. CL. 7.
- HYPER QUALITY, SEATTLE, WA:  
2,929,779, INT. CL. 35.
- HYPER QUALITY, LLC., SEATTLE, WA:  
2,929,781, INT. CL. 35.
- HYPERFLITE, INC., ATLANTA, GA:  
2,929,211, INT. CL. 28.
- I.C.E.D. MANAGEMENT, INC., WILMINGTON, DE, MARLEIGH CORPORATION, LONGVIEW, TX:  
1,848,435, REN. 1-19-05, INT. CL. 42.
- I.C.E.D. MANAGEMENT, INC., WILMINGTON, DE:  
2,929,139, MULTIPLE CLASS, INT. CLS. 35 AND 39.
- I.F. ANDERSON FARMS, INC., LONOKE, AR:  
2,928,813, PUB. 12-7-2004, INT. CL. 31.
- I-NET, INC., BETHESDA, MD:  
2,150,062, CANC. MULTIPLE CLASS, INT. CLS. 9 AND 42.
- I-TRAX HEALTH MANAGEMENT SOLUTIONS, INC., PHILADELPHIA, PA FROM ISUMMIT PARTNERS INC., NEW YORK, NY:  
2,929,088, MULTIPLE CLASS, INT. CLS. 41 AND 44.
- ICBC BROADCAST HOLDINGS, INC., NEW YORK, NY:  
2,928,650, PUB. 12-7-2004, INT. CL. 41.
- ICIM CORPORATION, NEW ALBANY, IN, DBA PLANET TELECOM:  
2,928,753, PUB. 12-7-2004, INT. CL. 35.
- ICS DELOITTE, CHADDS FORD, PA, DBA DELOITTE & TOUCHE CONSULTING GROUP/ICS:  
2,150,219, CANC. INT. CL. 42.  
2,150,220, CANC. INT. CL. 42.
- ID ANALYTICS, INC., SAN DIEGO, CA:  
2,928,750, PUB. 12-7-2004, INT. CL. 45.
- ID SOFTWARE, INC., MESQUITE, TX:  
2,928,605, PUB. 12-7-2004, INT. CL. 9.
- IDA CASON CALLAWAY FOUNDATION, PINE MOUNTAIN, GA:  
2,929,229, INT. CL. 41.
- IDEAL SCANNERS & SYSTEMS, INC., ROCKVILLE, MD:  
2,150,636, CANC. INT. CL. 39.
- IDEALOGY, INC., BOULDER, CO:  
2,150,210, CANC. INT. CL. 9.
- IENTRY, INC., LEXINGTON, KY:  
2,928,705, PUB. 12-7-2004, INT. CL. 35.
- IGNITASITE INC., DALLAS, TX:  
2,929,876, INT. CL. 42.
- IGT, RENO, NV:  
2,929,105, INT. CL. 9.  
2,929,131, INT. CL. 9.  
2,929,204, INT. CL. 9.
- ILLICOM, CHATOU CEDEX, FRANCE:  
2,929,832, INT. CL. 9.
- ILLINOIS TOOL WORKS INC., GLENVIEW, IL:  
2,928,745, PUB. 12-7-2004, INT. CL. 2.
- ILMA S.R.L. INDUSTRIA LAVORAZIONI MECCANICHE AUTOACCESSORI, CAZZAGO SAN MARTINO (BRESCIA), ITALY TO FABBRI S.R.L., BORNATIO CAZZAGO SAN MARTINO ( BRESCIA), ITALY:  
1,830,273, CANC. INT. CL. 12.
- IMAGE PROJECTIONS, L.L.C., INDIANAPOLIS, IN:  
2,151,281, CANC. INT. CL. 2.
- IMAGE TECHNOLOGY INTERNATIONAL, INC., BRADBURY, CA:  
1,830,186, CANC. INT. CL. 9.
- IMAGETEL INTERNATIONAL, INC., LOUISVILLE, KY:  
2,150,182, CANC. INT. CL. 9.
- IMAGINATION PRESS LLC, LOS ANGELES, CA:  
2,034,184, CANC. INT. CL. 25.

IMAGININGS 3, INC., NILES, IL:  
2,928,732, PUB. 12-7-2004. INT. CL. 30.

IMCO REALTY SERVICES, SANTA ROSA, CA:  
1,273,863, CANC. INT. CL. 36.

IN THE DOUGH, LLC, CALLAWAY, NE:  
2,929,466, INT. CL. 43.

INCHWORM INC., BOSTON, MA:  
2,929,144, INT. CL. 25.  
2,929,149, INT. CL. 25.

INDEPENDENT BANK CORPORATION, IONIA, MI:  
2,150,458, CANC. INT. CL. 36.

INDEPENDENT HEALTH ASSOCIATION, INC., BUFFALO, NY:  
2,929,407, INT. CL. 44.

INDOPCO, INC., BRIDGEWATER, NJ, DBA NATIONAL STARCH AND CHEMICAL COMPANY:  
2,929,692, INT. CL. 30.

INDUSTRIA DE ALIMENTOS DOS EN UNO S.A., SANTIAGO, CHILE:  
2,929,227, INT. CL. 30.

INDUSTRIAL COATINGS GROUP, INC., KINGSPORT, TN:  
2,219,531, CANC. INT. CL. 17.

INDUSTRIAL FARMACEUTICA CANTABRIA, S.A., 28043 MADRID, SPAIN:  
2,150,423, CANC. INT. CL. 5.

INDUSTRIAS Y CONFECCIONES, S.A. - INDUYCO, MADRID 28045, SPAIN:  
2,150,414, CANC. INT. CL. 25.  
2,150,415, CANC. INT. CL. 25.

INDY FESTIVALS, INC., INDIANAPOLIS, IN, DBA 500 FESTIVAL ASSOCIATES:  
2,928,811, PUB. 12-7-2004. INT. CL. 41.

INDYMAC BANK, F.S.B., PASADENA, CA:  
2,929,399, INT. CL. 36.  
2,929,405, INT. CL. 36.

INEOS CHLOR LIMITED, RUNCORN, CHESHIRE, WA7 4JE, UNITED KINGDOM:  
2,928,712, PUB. 12-7-2004. INT. CL. 1.

INFINEON TECHNOLOGIES AG, MUNICH, FED REP GERMANY:  
1,875,133, REN. 1-19-05. INT. CL. 9.

INFINICOM INTERNATIONAL CORPORATION, CHATHAM, NJ:  
2,150,377, CANC. INT. CL. 28.

INFINITY BROADCASTING CORPORATION, NEW YORK, NY:  
2,928,906, PUB. 12-7-2004. INT. CL. 38.

INFLEXION, INC., NEWTON, MA:  
2,929,428, INT. CL. 9.

INFOLOOK INC., SECAUCUS, NJ:  
2,151,514, CANC. INT. CL. 42.

INFOPERIPHERALS, INC., CAMPBELL, CA:  
2,150,715, CANC. INT. CL. 9.

INFOR GLAObAL SOLUTIONS (RHODE ISLAND), INC., ALPHARETTA, GA:  
2,150,154, CANC. INT. CL. 9.

INGENJORSFIRMAN N A SANDBERGS INDUSTRIKONSTRUKTIONER AB, HASSLEHOLM, SWEDEN:  
1,273,317, CANC. INT. CL. 7.

INGERSOLL-RAND COMPANY, WOODCLIFF LAKE, NJ:  
1,851,875, REN. 1-18-05. INT. CL. 7.

INNOCORP, LLC, VERONA, WI:  
2,929,784, MULTIPLE CLASS, INT. CLS. 12 AND 41.

INNOGENETICS N.V., B-9052 GENT, BELGIUM:  
2,208,031, CANC. INT. CL. 9.

INNOVATIONS - SUCCESSFUL SALON SERVICES, INC., CHATSWORTH, CA:  
2,929,115, INT. CL. 3.

INNOVATIVE CONCEPTS INC., MCLEAN, VA:  
2,928,638, PUB. 12-7-2004. INT. CL. 9.

INOLEX INVESTMENT CORPORATION, WILMINGTON, DE:  
2,929,574, INT. CL. 1.

INSIGHTFUL CORPORATION, SEATTLE, WA:  
2,929,571, INT. CL. 9.

INSL - X PRODUCTS CORPORATION, STONY POINT, NY:  
1,830,081, CANC. INT. CL. 2.

INSTA-FOAM PRODUCTS, INC., JOLIET, IL:  
2,151,414, CANC. INT. CL. 7.

INSTINET, LLC, NEW YORK, NY:  
2,929,708, INT. CL. 36.

INTEGRAMED AMERICA, INC., PURCHASE, NY:  
2,928,748, PUB. 12-7-2004. INT. CL. 44.

INTEGRATED PEST MANAGEMENT TECHNOLOGIES, INC., HONOLULU, HI:  
2,929,310, INT. CL. 5.

INTEGRION FINANCIAL NETWORK, L.L.C., PHILADELPHIA, PA:  
2,151,391, CANC. INT. CL. 36.

INTEGRITY MEDIA, INC., MOBILE, AL:  
2,929,547, INT. CL. 41.

INTEGRITY SYSTEMS, INC., LEESBURG, VA:  
2,928,801, PUB. 12-7-2004. INT. CL. 37.

INTELSTAF HEALTHCARE MANAGEMENT, L.P., DALLAS, TX:  
2,929,846, INT. CL. 35.

INTELLECTUAL PROPERTY RESEARCH, INCORPORATED, ARLINGTON, VA:  
2,929,723, MULTIPLE CLASS, INT. CLS. 35 AND 42.

INTELLIQUEST, INC., AUSTIN, TX:  
2,150,083, CANC. INT. CL. 9.

INTELLITECH CORPORATION, NEW YORK, NY:  
2,150,052, CANC. INT. CL. 42.

INTER-STATE FOTO FINISHING, INC., SEDALIA, MO:  
1,273,902, CANC. INT. CL. 40.

INTERACTIVE ENTERTAINMENT LIMITED, MEMPHIS, TN:  
2,150,318, CANC. MULTIPLE CLASS, INT. CLS. 41 AND 42.

INTERAMERICANA HEALTHCARE GROUP, LAS VEGAS, NV:  
2,150,899, CANC. INT. CL. 42.

INTERCELLULAR, L.C., WINTER HAVEN, FL:  
2,150,840, CANC. INT. CL. 38.

INTERCO INCORPORATED, ST. LOUIS, MO:  
182,445, CANC. U.S. CL. 39.

INTERDYNAMICS, INC., BROOKLYN, NY:  
2,929,481, INT. CL. 1.

INTERFACE GROUP - NEVADA, INC., LAS VEGAS, NV:  
2,149,980, CANC. INT. CL. 35.

INTERGRAPH CORPORATION, HUNTSVILLE, AL:  
1,762,527, REN. 1-19-05. INT. CL. 9.

INTERHEALTH NUTRACEUTICALS, BENICIA, CA:  
2,929,146, MULTIPLE CLASS, INT. CLS. 1 AND 5.

INTERNATIONAL ASSOCIATION FOR ORTHODONTICS, MILWAUKEE, WI:  
2,929,008, PUB. 12-7-2004. INT. CL. 35.

INTERNATIONAL BUSINESS MACHINES CORPORATION, ARMONK, NY:  
2,928,455, PUB. 12-7-2004. MULTIPLE CLASS, INT. CLS. 9, 16, 37 AND 42.

INTERNATIONAL COMPUTERS LIMITED, PUTNEY, LONDON SW15 1SW, ENGLAND:  
2,149,948, CANC. INT. CL. 9.

INTERNATIONAL DATA GROUP, INC., HOBOKEN, NJ:  
2,150,463, CANC. INT. CL. 21.

INTERNATIONAL HEALTH AWARENESS CENTER, INC., KALAMAZOO, MI:  
2,150,659, CANC. INT. CL. 41.

INTERNATIONAL HOBBYCRAFT CO., INC., NORTH-BROOK, IL:  
2,928,677, PUB. 12-7-2004. MULTIPLE CLASS, INT. CLS. 7 AND 12.

INTERNATIONAL INFORMATION SYSTEMS SECURITY CERTIFICATION CONSORTIUM, INC., FRAMINGHAM, MA:  
2,929,366, U.S. CL. B.

INTERNATIONAL LIFE SCIENCES INSTITUTE, WASHINGTON, DC:  
2,150,755, CANC. MULTIPLE CLASS, INT. CLS. 16, 36 AND 41.

INTERNATIONAL PAPER COMPANY, STAMFORD, CT:  
2,151,450, CANC. INT. CL. 21.  
2,929,567, INT. CL. 16.  
2,929,598, INT. CL. 35.

- INTERNATIONAL SOCIETY FOR VASCULAR SURGERY, MOUNT ROYAL, NJ:  
2,929,457, INT. CL. 35.
- INTERNATIONAL SWAPS AND DERIVATIVES ASSOCIATION, INC., NEW YORK, NY:  
2,929,877, INT. CL. 41.
- INTERNATIONAL TRUCK INTELLECTUAL PROPERTY COMPANY, LLC, WARRENVILLE, IL:  
2,928,691, PUB. 12-7-2004, INT. CL. 35.
- INTERNATIONAL TRUCK INTELLECTUAL PROPERTY COMPANY, LLC., WARRENVILLE, IL:  
2,928,703, PUB. 12-7-2004, INT. CL. 35.
- INTERNET IN A MALL, INC., LOS ANGELES, CA:  
2,150,042, CANC. INT. CL. 35.
- INTERNET TRUCKSTOP LLC, NEW PLYMOUTH, ID:  
2,928,977, PUB. 12-7-2004, INT. CL. 36.
- INTERSTATE BAKERIES CORPORATION, KANSAS CITY, MO, CONTINENTAL BAKING COMPANY, ST. LOUIS, MO:  
1,845,798, REN. 1-19-05, INT. CL. 30.  
1,874,079, REN. 1-19-05, INT. CL. 30.
- INTERSTATE BAKERIES CORPORATION, KANSAS CITY, MO, INTERSTATE BRANDS COMPANY - LICENSING CO., KANSAS CITY, MO:  
1,905,106, REN. 1-19-05, INT. CL. 30.
- INTERTRADE AVENUE INC., WHITBY, ONTARIO, CANADA:  
2,928,662, PUB. 12-7-2004, INT. CL. 11.
- INTERVET, INC., MILLSBORO, DE:  
2,929,130, INT. CL. 5.
- INTERVISUAL BOOKS, INC., DAVID A. CARTER, AND SIMON & SCHUSTER, INC., JOINT VENTURE, THE, SANTA MONICA, CA:  
1,868,219, REN. 1-18-05, INT. CL. 16.
- INTRINSYC SOFTWARE, INC., VANCOUVER BC, CANADA:  
2,928,463, PUB. 12-7-2004, INT. CL. 42.
- INVENSYS BUILDING SYSTEMS, INC., LOVES PARK, IL, BARBER-COLMAN COMPANY, LOVES PARK, IL:  
1,866,816, REN. 1-18-05, INT. CL. 9.
- INVENSYS SYSTEMS, INC., FOXBORO, MA:  
1,312,283, REN. 1-21-05, INT. CL. 16.
- INVIRO MEDICAL DEVICES LTD., BRIDGETOWN, BARBADOS:  
2,929,507, INT. CL. 10.
- INVISIBLE FENCE, INC, GARRETT, IN, INVISIBLE FENCE COMPANY, INC., BERWYN, PA:  
1,865,194, REN. 1-18-05, INT. CL. 9.
- INVIVO RESEARCH INC., ORLANDO, FL:  
2,928,742, PUB. 12-7-2004, INT. CL. 10.
- IPIYA, INC., SOUTH PASADENA, CA:  
2,928,888, PUB. 12-7-2004, INT. CL. 36.
- IPSG, P.C., SAN JOSE, CA:  
2,929,023, PUB. 12-7-2004, INT. CL. 42.
- IPSOGEN, MARSEILLE, FRANCE:  
2,928,680, PUB. 12-7-2004, INT. CL. 5.
- IRONCLAD PERFORMANCE WEAR CORP., LOS ANGELES, CA:  
2,929,284, INT. CL. 9.
- IRVINE COMPANY, THE, NEWPORT BEACH, CA:  
2,929,614, INT. CL. 36.
- IRWIN TOY LIMITED, TORONTO, ONTARIO M6K 1X6, CANADA:  
1,830,943, CANC. INT. CL. 28.
- ISAKSON/BARNHART RETIREMENT DEVELOPMENT CO., LLC, NORCROSS, GA:  
2,929,647, MULTIPLE CLASS, INT. CLS. 36, 43 AND 44.
- ISBELL, CHRIS, ENGLAND, AR:  
1,830,469, CANC. INT. CL. 30.
- ISI BRANDS INC., GRAND RAPIDS, MI:  
2,150,373, CANC. MULTIPLE CLASS, INT. CLS. 5 AND 30.
- ISOLA A/S, N-3945 EIDANGER, NORWAY:  
1,868,308, REN. 1-19-05, INT. CL. 19.
- IT&E GLOBAL, INC., PALO ALTO, CA:  
2,929,107, MULTIPLE CLASS, INT. CLS. 9 AND 35.
- ITT INDUSTRIES, INC., WHITE PLAINS, NY, ITT CORPORATION, NEW YORK, NY:  
1,939,377, REN. 1-19-05, INT. CL. 7.
- IVERY, LISA MARIE, SILVER SPRING, MD:  
2,928,949, PUB. 12-7-2004, INT. CL. 25.
- IZUMI, GEORGE, TORRANCE, CA:  
2,928,738, PUB. 12-7-2004, INT. CL. 35.
- J & L FOOTWEAR, INC., COMMERCE, CA:  
2,150,409, CANC. INT. CL. 25.
- J. B. & ASSOCIATES INC., PARK CITY, UT:  
2,150,668, CANC. INT. CL. 14.
- J. CREW INTERNATIONAL, INC., WILMINGTON, DE:  
2,929,166, INT. CL. 25.
- J. FELIU DE LA PENYA, S.A., 08420 CANOVELLES (BARCELONA), SPAIN:  
2,151,091, CANC. INT. CL. 11.
- J.C. PENNEY COMPANY, INC., PLANO, TX:  
2,150,709, CANC. MULTIPLE CLASS, INT. CLS. 25 AND 35.
- J.R. SIMPLOT COMPANY, BOISE, NV FROM ECO SOIL SYSTEMS, INC, SAN DIEGO, CA:  
2,929,193, INT. CL. 1.
- J.R. SIMPLOT COMPANY, BOISE, ID FROM ECO SOIL SYSTEMS, INC., SAN DIEGO, CA:  
2,929,194, INT. CL. 1.
- J&J SNACK FOODS CORPORATION, PENNSAUKEN, NJ:  
1,889,402, REN. 1-21-05, INT. CL. 30.
- JACK ECKERD CORPORATION:  
1,273,895, CANC. INT. CL. 40.
- JACKALL, INC., MANO OTSU, SHIGA, JAPAN:  
2,928,733, PUB. 12-7-2004, INT. CL. 28.
- JACKSON RANCHERIA BAND OF MIWUK INDIANS, JACKSON, CA, DBA JACKSON RANCHERIA:  
2,928,517, PUB. 12-7-2004, MULTIPLE CLASS, INT. CLS. 41 AND 43.
- JACQUES MORET INC., NEW YORK, NY:  
1,865,864, REN. 1-18-05, INT. CL. 25.
- JAFFE ASSOCIATES LLC, BETHESDA, MD:  
2,929,573, MULTIPLE CLASS, INT. CLS. 35 AND 42.
- JAGENBERG AKTIENGESELLSCHAFT, DUSSELDORF 1, FED REP GERMANY:  
1,273,336, CANC. INT. CL. 7.
- JAMES HALSTEAD LIMITED, WHITEFIELD, MANCHESTER, ENGLAND:  
1,273,676, CANC. INT. CL. 27.
- JAMES MILLS GROWERS SERVICE COMPANY, HAMILTON CITY, CA:  
182,311, CANC. U.S. CL. 46.
- JAMES PHILLIPS COMPANY, PLYMOUTH, MN:  
406,569, CANC. U.S. CL. 6.
- JANAL, L.L.C., SIOUX FALLS, SD:  
2,151,119, CANC. INT. CL. 42.
- JANDEL CORPORATION, SAN RAFAEL, CA:  
1,830,778, CANC. INT. CL. 9.
- JANSON, MICHAEL, GREENVILLE, NH:  
2,150,563, CANC. INT. CL. 41.
- JANTZEN INC., PORTLAND, OR:  
1,273,601, CANC. INT. CL. 25.
- JASON FOUNDATION FOR EDUCATION, NEEDHAM HEIGHTS, MA:  
2,929,230, MULTIPLE CLASS, INT. CLS. 9 AND 16.
- JASON NATURAL PRODUCTS, INC., CULVER CITY, CA:  
997,679, REN. 1-21-05, MULTIPLE CLASS, U.S. CLS. 51 (INT. CLS. 3 AND 5) AND 52 (INT. CLS. 3 AND 5).
- JASPER PRODUCTIONS, INC., SADDLE RIVER, NJ:  
2,928,490, PUB. 12-7-2004, INT. CL. 41.
- JAVELIN ENTERPRISES, INC., LAUDERHILL, FL:  
2,928,472, PUB. 12-7-2004, INT. CL. 36.
- JDLA, LLC, KNOXVILLE, TN:  
2,929,292, MULTIPLE CLASS, INT. CLS. 35 AND 40.
- JEN CHAN INTERNATIONAL INC., CHINO, CA:  
2,151,172, CANC. INT. CL. 16.
- JEUNIQUE INTERNATIONAL, INC., CITY OF INDUSTRY, CA:  
2,149,931, CANC. INT. CL. 5.  
2,151,095, CANC. INT. CL. 3.

- JIANGSU KANION PHARMACEUTICAL CO., LTD., JIANGSU, CHINA:  
2,928,716, PUB. 12-7-2004. INT. CL. 5.
- JIMLAR CORPORATION, GREAT NECK, NY:  
1,870,607. REN. 1-21-05. INT. CL. 25.
- JOAN'S COMPANY, FENNVILLE, MI:  
2,150,140, CANC. MULTIPLE CLASS, INT. CLS. 9 AND 16.
- JOBST INSTITUTE, INC., TOLEDO, OH:  
1,273,282, CANC. INT. CL. 3.
- JOHANN FROESCHEIS LYRA-BLEISTIFT-FABRIK GMBH & CO., 90449 NURNBERG, FED REP GERMANY:  
2,150,328, CANC. INT. CL. 3.
- JOHN ALDEN LIFE INSURANCE COMPANY, MIAMI, FL:  
2,150,637, CANC. INT. CL. 42.
- JOHN MICHAELS, INC., VERONA, WI, DBA MICHAEL'S FROZEN CUSTARD:  
1,868,499. REN. 1-19-05. INT. CL. 30.
- JOHN WAGNER ASSOCIATES, INC., CONCORD, CA:  
1,005,226. REN. 1-18-05. INT. CL. 6.
- JOHNSON & JOHNSON, NEW BRUNSWICK, NJ:  
1,273,410, CANC. INT. CL. 10.
- JOMAR INTERNATIONAL, LTD., MADISON HEIGHTS, MI:  
2,150,969, CANC. INT. CL. 6.
- JONES, CELIA K., FORT WORTH, TX AND ELBERT, REBECCA B., FORT WORTH, TX, DBA WHAT A GREAT IDEA!  
2,151,376, CANC. INT. CL. 21.
- JONES, ROBERT CHRISTIAN, WASHINGTON, DC:  
2,150,652, CANC. INT. CL. 35.
- JONES, THOMAS, W., II, EAST POINT, GA AND STEVENS, DIANA JONES, EAST POINT, GA AND FULLER-RUFFIN, ANDREA, EAST POINT, GA:  
2,501,078, CANC. INT. CL. 41.
- JUMBO PICTURES, INC., NEW YORK, NY:  
1,830,636, CANC. INT. CL. 41.
- JUST FOR WRAPS, INC., LOS ANGELES, CA:  
1,830,418, CANC. INT. CL. 25.
- JUSTIN PRODUCTS, INC., NEW YORK, NY:  
1,830,431, CANC. INT. CL. 28.  
1,830,432, CANC. INT. CL. 28.
- JWI LTD., KANATA, ONTARIO, CANADA:  
1,273,340, CANC. INT. CL. 7.  
1,273,341, CANC. INT. CL. 7.
- K & M INTERNATIONAL, INC., TWINSBURG, OH:  
2,929,434, INT. CL. 28.
- K & S ENTERPRISES, NASHUA, NH:  
2,928,896, PUB. 12-7-2004. INT. CL. 43.
- K & S HAWAIIAN CREATIONS, INCORPORATED, HONOLULU, HI, DBA HONOLULU COOKIE COMPANY:  
2,928,642, PUB. 12-7-2004. INT. CL. 30.
- KABUSHIKI KAISHA DAIEI OMC, CHUO-KU, TOKYO, JAPAN:  
2,150,491, CANC. MULTIPLE CLASS, INT. CLS. 39 AND 42.
- KABUSHIKI KAISHA KEIHINSEIKI SEISAKUSHO, SHINJUKU-KU, TOKYO, JAPAN TO LEOJOM CORPORATION, SHINJUKU-KU TOKYO, JAPAN:  
1,830,274, CANC. INT. CL. 12.
- KABUSHIKI KAISHA KEIHINSEIKI SEISAKUSHO, SHINJUKU-KU, TOKYO, JAPAN TO KEIHIN CORPORATION, TOKYO, JAPAN:  
1,830,276, CANC. INT. CL. 12.
- KABUSHIKI KAISHA KENWOOD, SHIBUYA-KU, TOKYO, 150, JAPAN, TA KENWOOD CORPORATION:  
2,929,147, INT. CL. 9.  
2,929,148, INT. CL. 9.
- KABUSHIKI KAISHA SEGA ENTERPRISES, TOKYO 144, JAPAN, DBA SEGA ENTERPRISES, LTD.:  
2,151,107, CANC. INT. CL. 28.
- KABUSHIKI KAISHA SOFT 99 CORPORATION, CHUO-KU, OSAKA, JAPAN:  
2,929,092, MULTIPLE CLASS, INT. CLS. 3 AND 21.
- KAIRE INTERNATIONAL, INC., LONGMONT, CO:  
2,151,326, CANC. INT. CL. 5.
- KALBAUGH, EDWIN PORTER, BEAUMONT, TX:  
2,150,150, CANC. INT. CL. 9.
- KANESA CO., LTD., AOMORI-SHI, AOMORI-KEN, JAPAN:  
2,929,314, INT. CL. 29.
- KANOKLA TELEPHONE ASSOCIATION, CALDWELL, KS:  
2,928,927, PUB. 12-7-2004. INT. CL. 38.
- KANOTECH INFORMATION SYSTEMS, LTD., EDMONTON, ALBERTA T5L 4S8, CANADA:  
1,830,185, CANC. INT. CL. 9.
- KAO KABUSHIKI KAISHA, TOKYO, JAPAN, TA KAO CORPORATION:  
2,929,802, INT. CL. 3.
- KASA-DJUKIC, VLADIMIR, NEW YORK, NY:  
2,151,463, CANC. INT. CL. 16.
- KASHI COMPANY, LA JOLLA, CA:  
2,928,938, PUB. 12-7-2004. INT. CL. 30.
- KATZ, STEVEN L., POTOMAC, MD:  
2,929,686, INT. CL. 35.
- KBRESEARCH LLC, SCOTTSDALE, AZ:  
2,929,496, INT. CL. 5.
- KEFFER CAPITAL MANAGEMENT, INC., NEW YORK, NY TO FORUM FINANCIAL GROUP, LIMITED LIABILITY COMPANY, PORTLAND, ME:  
1,830,884, CANC. INT. CL. 36.
- KELLER, THOMAS QUINN, COLORADO SPRINGS, CO:  
2,929,744, INT. CL. 14.
- KELLOGG COMPANY, BATTLE CREEK, MI:  
768,246, CANC. U.S. CL. 46.
- KELLY FOODS CORPORATION, BERLIN, MD:  
2,929,116, INT. CL. 31.
- KEMIRA GROWHOW OY, 00180 HELSINKI, FINLAND:  
2,928,489, PUB. 12-7-2004. MULTIPLE CLASS, INT. CLS. 9, 42 AND 44.
- KENNAMETAL TC INC., MONROVIA, CA:  
776,137. REN. 1-18-05. U.S. CL. 23 (INT. CL. 7).
- KENNEDY, PATRICK J., SR., SAN ANTONIO, TX, RIVER HOTEL COMPANY, SAN ANTONIO, TX:  
1,311,568. REN. 1-19-05. INT. CL. 42.
- KENNETH GORDON/IAG, INC., NEW ORLEANS, LA:  
2,150,677, CANC. INT. CL. 25.  
2,150,732, CANC. INT. CL. 25.
- KENNY STARR ENTERPRISES, INC., PLEASANT VIEW, TN:  
2,149,939, CANC. INT. CL. 9.
- KENT SCIENTIFIC CORPORATION, LITCHFIELD, CT:  
2,150,276, CANC. INT. CL. 9.
- KENYA BREWERIES LIMITED, NAIROBI, KENYA:  
2,150,931, CANC. INT. CL. 32.
- KESSLER ENTERPRISE, INC., THE, ORLANDO, FL:  
2,928,512, PUB. 12-7-2004. MULTIPLE CLASS, INT. CLS. 35 AND 43.
- KEY ENTERPRISES LLC, MINNEAPOLIS, MN, MSP PUBLICATIONS, L.P., MINNEAPOLIS, MN, DBA MSP COMMUNICATIONS:  
1,893,810. REN. 1-18-05. INT. CL. 16.
- KEY MAIL N.V., WILLEMSTAD, NETHERLD ANTILLES:  
1,830,312, CANC. MULTIPLE CLASS, INT. CLS. 16, 38 AND 39.
- KEY SEAFOOD IMPORTS, INC., PERTH AMBOY, NJ:  
2,929,872, INT. CL. 29.
- KEYCORP, CLEVELAND, OH:  
2,929,673, INT. CL. 36.
- KEYSTONE CONSOLIDATED INDUSTRIES, DALLAS, TX:  
182,257, CANC. U.S. CL. 13.
- KEYSTONE CONSOLIDATED INDUSTRIES, INC., DALLAS, TX:  
182,258, CANC. U.S. CL. 13.
- KEYSTONE CONSOLIDATED INDUSTRIES, INC., PEORIA, IL:  
182,259, CANC. U.S. CL. 13.
- KEYSTONE CONSOLIDATED INDUSTRIES, INC., DALLAS, TX:  
182,260, CANC. U.S. CL. 13.
- KEYSTONE CONSOLIDATED INDUSTRIES, INC., PEORIA, IL:  
182,261, CANC. U.S. CL. 13.
- KEYSTONE CONSOLIDATED INDUSTRIES, INC., DALLAS, TX:  
182,262, CANC. U.S. CL. 13.  
182,263, CANC. U.S. CL. 13.

- KF-DELAWARE, INC., WILMINGTON, DE:  
1,296,281. REN. 1-21-05. INT. CL. 20.
- KHQ, INCORPORATED, SPOKANE, WA:  
1,918,385. REN. 1-20-05. INT. CL. 38.
- KID'S CREATIONS, L.L.C., SPRINGHILL, KS:  
2,929,477. INT. CL. 28.
- KIM, MYUNG BO, LA HABRA, CA:  
2,928,543. PUB. 12-7-2004. INT. CL. 25.
- KINETIC TECHNOLOGIES, LLC, LEXINGTON, KY:  
2,929,475. INT. CL. 5.
- KINGSDOWN, INC., MEBANE, NC:  
2,928,861. PUB. 12-7-2004. INT. CL. 20.
- KINSFORD PRODUCTS COMPANY, THE, OAKLAND, CA:  
1,273,286. CANC. INT. CL. 4.
- KIRKMAN LABORATORIES, INC., LAKE OSWEGO, OR:  
1,000,478. REN. 1-15-05. INT. CL. 5.
- KITCHEN FRESH FOODS, INC., HICKSVILLE, NY:  
2,150,934. CANC. INT. CL. 30.
- KIWANIS CLUB OF LITTLE HAVANA, INC., MIAMI, FL:  
2,928,593. PUB. 12-7-2004. INT. CL. 41.
- KIWI BRANDS INC., DOUGLASSVILLE, PA:  
1,273,661. CANC. INT. CL. 25.  
1,273,669. CANC. INT. CL. 26.
- KKMC, LLC, PLEASANTON, CA:  
2,143,551. CANC. INT. CL. 18.
- KKT GROUP SERVICES INC., CHICAGO, IL:  
1,851,609. REN. 1-18-05. MULTIPLE CLASS, INT. CLS. 30 AND 42.
- KLEIN, STANLEY J., LOS ALTOS, CA:  
2,929,394. INT. CL. 21.
- KLIER BROTHER ALLIANCE, ENCINO, CA:  
2,151,104. CANC. INT. CL. 25.
- KLIMAN, DEBORAH S., CHADDS FORD, PA, DBA CHILD AND FAMILY STUDY TEAM:  
2,929,203. MULTIPLE CLASS, INT. CLS. 41 AND 42.
- KNAPP, PEGGY F., QUARTZSITE, AZ AND KNAPP, MILTON L., QUARTZSITE, AZ:  
2,150,877. CANC. INT. CL. 28.
- KNF NEUBERGER GMBH, 79112 FREIBURG, FED REP GERMANY:  
2,928,473. PUB. 7-13-2004. INT. CL. 7.
- KNIGHT, DAVID MC, SOUTHAMPTON, NY:  
2,928,689. PUB. 12-7-2004. INT. CL. 36.
- KNIPP, GREGORY, D/DONALD, LEE'S SUMMIT, MO AND KNIPP, ELIZABETH, D/DELACY, LEE'S SUMMIT, MO:  
2,929,818. INT. CL. 25.
- KNIRPS INTERNATIONAL GMBH, SOLINGEN, FED REP GERMANY:  
846,746. CANC. U.S. CL. 41.
- KNOWLTON, PAUL ENRIQUE, DECATUR, GA:  
2,879,672. CANC. INT. CL. 16.
- KNUD NIELSEN COMPANY, INC., EVERGREEN, AL:  
1,273,794. CANC. INT. CL. 31.
- KNUD SIMONSEN INDUSTRIES LIMITED, REXDALE, ONTARIO M9W 5N6, CANADA:  
1,830,151. CANC. MULTIPLE CLASS, INT. CLS. 7, 9, 11, 37 AND 42.
- KO, JAY Y, SAN MARINO, CA:  
2,929,041. PUB. 12-7-2004. INT. CL. 25.
- KOCH DEVELOPMENT CORPORATION, SANTA CLAUSE, IN:  
1,322,620. REN. 1-18-05. INT. CL. 41.
- KOCHISS, KERRY DAVID, KAUFMAN, TX:  
2,929,264. INT. CL. 35.
- KOHLER CO., MINNEAPOLIS, MN:  
2,929,702. MULTIPLE CLASS, INT. CLS. 6, 20 AND 21.
- KOLACHE FACTORY, INC., THE, HOUSTON, TX:  
2,150,971. CANC. INT. CL. 30.
- KOMFORT KARRIER, INC., TURLOCK, CA:  
1,273,591. CANC. INT. CL. 24.
- KONA BREWING CO., INC., KAILEU-KONA, HI:  
2,929,726. INT. CL. 32.
- KONAMI CORPORATION, TOKYO, JAPAN:  
2,928,513. PUB. 7-20-2004. INT. CL. 9.
- KONAMI CORPORATION, CHIYODA-KU, TOKYO, JAPAN:  
2,929,175. INT. CL. 28.
- KONAMI CORPORATION, MINATO-KU, TOKYO, JAPAN:  
2,929,214. INT. CL. 28.
- KONAMI CORPORATION, TOKYO, JAPAN:  
2,929,733. INT. CL. 28.
- KONAMI GAMING, INC., LAS VEGAS, NV:  
2,929,803. INT. CL. 9.  
2,929,804. INT. CL. 9.
- KONINKLIJKE PTT NEDERLAND N.V., 9726 GRONINGEN, NETHERLANDS:  
2,150,101. CANC. INT. CL. 9.
- KOOS, INC., KENOSHA, WI:  
768,071. CANC. MULTIPLE CLASS, U.S. CLS. 6 AND 10.
- KORN, MICHELLE, NEW YORK, NY:  
2,929,069. MULTIPLE CLASS, INT. CLS. 3, 18 AND 25.
- KPMG PEAT MARWICK LLP, NEW YORK, NY:  
2,150,285. CANC. INT. CL. 16.
- KRAFT FOODS HOLDINGS, INC., NORTHFIELD, IL, KRAFT GENERAL FOODS, INC., NORTHFIELD, IL:  
1,870,707. REN. 1-19-05. INT. CL. 30.
- KRAFT FOODS HOLDINGS, INC., NORTHFIELD, IL:  
2,928,958. PUB. 12-7-2004. INT. CL. 30.
- KRAFT FOODS NORTH AMERICA, INC., NORTHFIELD, IL:  
1,866,752. REN. 1-19-05. MULTIPLE CLASS, INT. CLS. 8 AND 21.
- KRAFT FOODS, INC., NORTHFIELD, IL:  
2,151,118. CANC. MULTIPLE CLASS, INT. CLS. 21 AND 30.  
2,151,139. CANC. MULTIPLE CLASS, INT. CLS. 21 AND 30.
- KRATOCHVIL, GARY, SAN ANTONIO, TX, DBA EXOTIC TROPICALS:  
2,150,707. CANC. INT. CL. 31.
- KREG CORPORATION, ATLANTA, GA:  
2,928,819. PUB. 12-7-2004. MULTIPLE CLASS, INT. CLS. 9, 35 AND 42.  
2,928,820. PUB. 12-7-2004. MULTIPLE CLASS, INT. CLS. 9, 35 AND 42.
- KRIS JAMSA SOFTWARE, INC., LAS VEGAS, NV:  
2,150,744. CANC. MULTIPLE CLASS, INT. CLS. 9 AND 16.
- KRNICH, TOMISLAV, LOS GATOS, CA:  
2,150,390. CANC. INT. CL. 35.
- KRUGANS KIMONOS LTDA.-ME, LEBLON, RIO DE JANEIRO, RJ, BRAZIL:  
2,150,525. CANC. INT. CL. 25.
- KRYOGENIFEX, INC., MIAMI, FL:  
2,928,564. PUB. 12-7-2004. INT. CL. 11.
- KS GREEN, ALISO VIEJO, CA:  
2,150,162. CANC. INT. CL. 35.
- KSC INDUSTRIES, INCORPORATED, SAN DIEGO, CA:  
2,929,602. INT. CL. 9.
- KUDOS PHARMACEUTICALS LIMITED, CAMBRIDGE CB4 0WG, UNITED KINGDOM:  
2,929,255. INT. CL. 5.
- KULMBACHER BRAUEREI AKTIEN-GESELLSCHAFT, 95326 KULMBACH, FED REP GERMANY, ERSTE KULMBACHER ACTIEN-EXPORTBIER-BRAUEREI, KULMBACHER, BAYERN, FED REP GERMANY:  
599,753. REN. 1-15-05. U.S. CL. 48 (INT. CL. 32).
- KUMBHO & CO., INC.:  
1,273,432. CANC. INT. CL. 12.
- KWIK SHOP, INC., HUTCHINSON, KS:  
2,929,785. INT. CL. 35.
- L & K COFFEE COMPANY, L.L.C., NUNICA, MI:  
2,928,865. PUB. 12-7-2004. INT. CL. 30.
- L. COFFEY, LTD., MINNEAPOLIS, MN:  
1,273,791. CANC. INT. CL. 31.
- L.A. AUDIO VIDEO, INC., LOS ANGELES, CA:  
2,929,538. INT. CL. 20.
- L.C. INDUSTRIES, LLC, CHICAGO, IL:  
2,929,651. INT. CL. 18.
- L.D.C. GROUP, INC., AKRON, OH:  
2,151,539. CANC. INT. CL. 35.
- L.E. & L, INC., LAS VEGAS, NV, DBA LABTRADE:  
2,115,952. CANC. INT. CL. 36.
- L.P.I. CONSUMER PRODUCTS, INC., POMPANO BEACH, FL:  
2,928,870. PUB. 12-7-2004. INT. CL. 8.



- L.S.I., INC. - NEW GLARUS, MINONG, WI:  
1,830,849, CANC. INT. CL. 29.
- L'OREAL, PARIS CEDEX 08, FRANCE:  
1,273,270, CANC. INT. CL. 3.
- L'OREAL, 75008 PARIS, FRANCE:  
2,150,904, CANC. INT. CL. 3.
- LA CIENEGA ASSOCIATES, HAYWARD, CA:  
1,273,847, CANC. MULTIPLE CLASS, INT. CLS. 36 AND 37.
- LA CIENEGA ASSOCIATES, BLOOMFIELD HILLS, CA:  
1,273,848, CANC. MULTIPLE CLASS, INT. CLS. 36 AND 37.
- LA MAISON DU CHOCOLAT, NANTERRE, FRANCE:  
2,928,665, PUB. 12-7-2004. INT. CL. 30.
- LA SEIGNEURIE, S.A., BOBIGNY, FRANCE:  
1,273,593, CANC. INT. CL. 24.
- LAB SAFETY SUPPLY, INC., JANESVILLE, WI:  
1,871,174, REN. 1-19-05. INT. CL. 9.  
1,875,290, REN. 1-19-05. INT. CL. 20.
- LABORATOIRES DE BIOLOGIE VEGETALE YVES ROCHER, 56200 LA GACILLY, FRANCE:  
2,929,170, INT. CL. 3.
- LABORATOIRES M.A.I. (MISS ANTILLES INTERNATIONAL), SAINT SOUPPLETS, FRANCE:  
2,929,231, INT. CL. 3.  
2,929,232, INT. CL. 3.
- LABORATORIOS BIAGRO S.A., BUENOS AIRES, ARGENTINA:  
2,928,654, PUB. 12-7-2004. INT. CL. 1.
- LACOUNT, VIRGINIA, WAYNESBURG, PA, DBA VIROLAC INDUSTRIES:  
1,862,129, REN. 1-21-05. INT. CL. 42.
- LACROSSE FOUNDATION, INC., THE, HOMEWOOD, BALTIMORE, MD, DBA THE LACROSSE INTERNATIONAL:  
1,273,995, CANC. INT. CL. 42.
- LADIES-IN-WADING, INC., OMAHA, NE:  
1,306,442, REN. 1-21-05. INT. CL. 41.
- LAHARCO INC., PORTLAND, OR, DBA LACEY-HARMER SUPPLY & MFG. CO.:  
2,929,276, INT. CL. 9.
- LAIRD, DOUGLAS, KELOWNA, BRITISH COLUMBIA V1Y 7V8, CANADA, DBA RACEMATE:  
2,149,935, CANC. INT. CL. 9.
- LAKE FOREST GRADUATE SCHOOL OF MANAGEMENT, LAKE FOREST, IL:  
2,928,609, PUB. 12-7-2004. INT. CL. 41.
- LAKEPORT BREWING CORPORATION, HAMILTON, ONTARIO L8L 4H2, CANADA:  
2,151,148, CANC. INT. CL. 32.
- LAKESHORE CENTRE HOLDINGS LLC, CHICAGO, IL:  
2,929,400, INT. CL. 41.
- LAKOCY, JACQUELINE M., SAUSALITO, CA:  
2,151,360, CANC. INT. CL. 25.
- LAMINATORS INCORPORATED, HATFIELD, PA:  
2,150,271, CANC. INT. CL. 19.
- LAMPLIGHT FARMS, INC., MENOMONEE FALLS, WI:  
1,273,821, CANC. INT. CL. 34.
- LANDERMAN, HELEN A., ALBANY, CA:  
2,151,202, CANC. INT. CL. 11.
- LANGE LABORATORIES, INC., HAYWARD, CA:  
1,830,090, CANC. MULTIPLE CLASS, INT. CLS. 3 AND 5.
- LANGLEY, FRED R., KNOXVILLE, TN:  
2,929,741, INT. CL. 36.
- LANTRONIX, INC., IRVINE, CA FROM LIGHTWAVE COMMUNICATIONS, INC., MILFORD, CT:  
2,928,452, PUB. 12-7-2004. INT. CL. 9.
- LAPORTE, ALBERT, F-32100 BERAUT, FRANCE:  
1,864,140, REN. 1-19-05. INT. CL. 3.
- LARGE HORSE INTERNATIONAL (GROUP) CO., LTD., WANCHAI, HONG KONG:  
2,929,344, INT. CL. 11.
- LAS VEGAS FESTIVAL FOOD CORP., NEW YORK, NY:  
2,150,712, CANC. INT. CL. 42.
- LATELTIN AG, CH-8045 ZURICH, SWITZERLAND:  
2,150,001, CANC. MULTIPLE CLASS, INT. CLS. 32 AND 33.
- LATINA MEDIA VENTURES LLC, NEW YORK, NY:  
2,929,347, INT. CL. 16.
- LAWRENCE, STEVEN ROBERT, NEWCASTLE, ONTARIO, CANADA:  
2,928,854, PUB. 12-7-2004. INT. CL. 37.
- LAYERS, INC., RALEIGH, NC:  
2,928,636, PUB. 12-7-2004. INT. CL. 25.
- LAZERSON, JEFF, LEGUNA NIGUEL, CA:  
2,929,620, INT. CL. 36.
- LAZIO, LAWRENCE G., EUREKA, CA:  
2,929,007, PUB. 12-7-2004. INT. CL. 29.
- LEADERS IN EDUCATION, INC., HOUSTON, TX:  
2,928,717, PUB. 12-7-2004. INT. CL. 41.
- LEADING EDGE MARKETING INC., NASSAU, BAHAMAS:  
2,929,748, INT. CL. 9.
- LEBANON CHEMICAL CORPORATION, LEBANON, PA:  
768,162, CANC. U.S. CL. 23.
- LEE KWAN TEA TRADE LIMITED, QUARRY BAY, HONG KONG:  
2,929,127, INT. CL. 30.
- LEFT FIELD NYC, INC., BROOKLYN, NY:  
2,929,592, INT. CL. 25.
- LEGEND FILMS, INC., LA JOLLA, CA:  
2,929,710, INT. CL. 9.
- LEICA LITHOGRAPHY SYSTEMS LIMITED, CAMBRIDGE CBI 3QH, ENGLAND:  
2,150,172, CANC. INT. CL. 9.
- LEN-JUS, LTD., MASON CITY, IA:  
2,151,013, CANC. INT. CL. 3.
- LENDCO, INC., CORAL GABLES, FL:  
2,928,816, PUB. 12-7-2004. INT. CL. 36.
- LEO ELEKTRONENMIKROSKOPIE GMBH, FED REP GERMANY:  
2,929,413, INT. CL. 9.
- LEO ELEKTRONENMIKROSKOPIE GMBH, 73447 OBERKOCHEN, FED REP GERMANY:  
2,929,414, INT. CL. 9.
- LEONARD FASHION, 75008 PARIS, FRANCE, LEONARD FASHION, 75008 PARIS, FRANCE:  
1,867,044, REN. 1-21-05. INT. CL. 25.
- LEPORE, TRACEY, WEST ORANGE, NJ:  
2,928,898, PUB. 12-7-2004. INT. CL. 41.
- LERNER MEDICAL DEVICES, INC., LOS ANGELES, CA:  
2,928,878, PUB. 12-7-2004. INT. CL. 10.
- LESHNER FINANCIAL INC., CINCINNATI, OH:  
1,273,862, CANC. INT. CL. 36.
- LESLIE LAWRENCE AND NANCY URBSCHAT PARTNERSHIP, THE, SPRINGFIELD, MA, DBA THE SUPER MARKET:  
1,830,803, CANC. INT. CL. 16.
- LETCO, INC., PHOENIX, AZ:  
1,273,965, CANC. INT. CL. 42.
- LEVITZ FURNITURE CORPORATION, BOCA RATON, FL:  
2,151,461, CANC. INT. CL. 35.
- LEVY, JAIME, NEW YORK, NY:  
2,150,499, CANC. INT. CL. 42.
- LEWIS, DOUGLAS J, ST. LOUIS, MO:  
2,929,811, INT. CL. 25.
- LEWTAN TECHNOLOGIES, INC., WALTHAM, MA:  
2,150,777, CANC. INT. CL. 9.
- LEXINGTON LICENSING, LTD., GRAPEVINE, TX, LEXINGTON APARTMENTS & MOTOR INNS, IRVING, TX:  
1,309,495, REN. 1-21-05. INT. CL. 42.
- LG ELECTRONICS INC., SEOUL, REPUBLIC OF KOREA:  
2,928,663, PUB. 12-7-2004. INT. CL. 11.  
2,929,268, INT. CL. 9.
- LHS COMMUNICATIONS SYSTEMS INC., ATLANTA, GA:  
2,150,080, CANC. MULTIPLE CLASS, INT. CLS. 9, 38 AND 42.
- LI GANG MING, WANCHAI, HONG KONG:  
2,150,530, CANC. INT. CL. 25.
- LIBERTYVILLE SADDLE SHOP, INC., LIBERTYVILLE, IL:  
1,899,473, REN. 1-19-05. MULTIPLE CLASS, INT. CLS. 6 AND 18.
- LIDGERWOOD MANUFACTURING COMPANY, SUPERIOR, WI:  
182,468, CANC. U.S. CL. 23.
- LIFE AUTOMOTIVE PRODUCTS, INC., CORDOVA, TN:  
2,929,485, INT. CL. 1.

- LIFEMASTER SUPPORTED SELFCARE, INC., IRVINE, CA:  
2,929,051, INT. CL. 42.
- LIFEMASTERS SUPPORTED SELFCARE, INC., IRVINE, CA:  
2,929,517, MULTIPLE CLASS, INT. CLS. 16, 35, 38, 39, 41 AND 42.
- LIFESTYLE GROUP GMBH, MUNICH, FED REP GERMANY:  
2,928,702, PUB. 12-7-2004. INT. CL. 14.
- LIFESTYLES CUSTOM HOMES & REMODELING, LLC, OVERLAND PARK, KS:  
2,928,975, PUB. 12-7-2004. INT. CL. 37.
- LIFETIME PRODUCTS, INC., CLEARFIELD, UT:  
1,867,713. REN. 1-19-05. INT. CL. 28.
- LIFETOUCH INC., BLOOMINGTON, MN:  
1,273,457, CANC. INT. CL. 16.
- LIFETOUCH INC., EDEN PRAIRIE, MN:  
2,929,172, MULTIPLE CLASS, INT. CLS. 35 AND 42.
- LIFEWAY CHRISTIAN RESOURCES OF THE SOUTHERN BAPTIST, NASHVILLE, TN:  
2,929,464, INT. CL. 41.
- LIGHTWAVE COMMUNICATIONS, INC.:  
*See— LANTRONIX, INC..*
- LIGHTWAVE SYSTEMS, INC., CARPINTERIA, CA:  
2,929,109, INT. CL. 9.
- LIM, TERRY KIA NGEE, SINGAPORE 629936, SINGAPORE:  
2,928,678, PUB. 12-7-2004. INT. CL. 28.
- LIMESTONE PRODUCTS CORPORATION, SPARTA, NJ TO CEMEX FINANCE, INC., BREA, CA:  
1,830,813, CANC. INT. CL. 19.
- LINCOLN-WAY COMMUNITY HIGH SCHOOL DISTRICT 210, NEW LENOX, IL:  
2,151,230, CANC. INT. CL. 41.
- LINSEY FOODS LTD., MARKHAM, ONTARIO L3R 0J3, CANADA:  
2,234,603, CANC. INT. CL. 30.
- LINTEC KABUSHIKI KAISHA, ITABASHI-KU, TOKYO, JAPAN, TA LINTEC CORPORATION:  
2,929,513, INT. CL. 17.
- LIQUID PLANET, INC., CLEVELAND, OH:  
2,929,039, PUB. 12-7-2004. MULTIPLE CLASS, INT. CLS. 32 AND 43.
- LISCO, INC., TAMPA, FL:  
2,151,145, CANC. INT. CL. 28.
- LITE-ON IT CORPORATION, TAIPEI, TAIWAN:  
2,929,707, INT. CL. 9.
- LITEL INSTRUMENTS, SAN DIEGO, CA:  
2,929,439, INT. CL. 9.
- LITTLE KIDS, INC., PROVIDENCE, RI:  
2,151,018, CANC. INT. CL. 28.  
2,928,901, PUB. 12-7-2004. INT. CL. 28.
- LIVE LINK, INC., HOLLAND, PA:  
2,150,086, CANC. INT. CL. 38.
- LMT-FETTE, CLEVELAND, OH:  
2,928,940, PUB. 12-7-2004. INT. CL. 8.
- LOADED BOARDS, INC., BEVERLY HILLS, CA:  
2,929,715, INT. CL. 28.
- LOCHER, JOHN, MERCER ISLAND, WA:  
2,150,658, CANC. INT. CL. 42.
- LOGIC SHOP, INC., ATLANTA, GA:  
2,150,511, CANC. INT. CL. 37.
- LOGIXML, INC., MCLEAN, VA:  
2,929,337, INT. CL. 9.
- LOH, CAROLYN, OCEAN CITY, MD, DBA BIG FUN TOY CO. AND KOTIS, CLARE C., OCEAN CITY, MD, DBA BIG FUN TOY CO.:  
1,830,430, CANC. INT. CL. 28.
- LONE STAR MEDICAL PRODUCTS, INC., HOUSTON, TX:  
2,928,779, PUB. 12-7-2004. INT. CL. 10.  
2,928,780, PUB. 12-7-2004. INT. CL. 10.  
2,928,781, PUB. 12-7-2004. INT. CL. 10.
- LONG ISLAND PRIMARY MEDICAL CARE, P.C., MINEOLA, NY:  
2,150,195, CANC. INT. CL. 42.
- LOS RIELEROS DEL NORTE, INC., DEXTER, NM:  
2,150,780, CANC. INT. CL. 41.
- LOUIS P. CIMINELLI CONSTRUCTION CO., INC., BUFFALO, NY:  
2,150,501, CANC. INT. CL. 37.
- LOVE OF QUILTING, INC., WINTERSSET, IA:  
2,928,957, PUB. 12-7-2004. INT. CL. 16.
- LOVE, GLENN H., CONCORD, NC:  
2,929,440, INT. CL. 35.
- LOVETT, JAY A., NEW SMYRNA BEACH, FL:  
2,929,763, INT. CL. 36.
- LOWERY, JOHN D., MIDLAND, TX:  
2,150,356, CANC. INT. CL. 16.
- LOWRANCE ELECTRONICS, INC., TULSA, OK:  
1,887,025. REN. 1-19-05. INT. CL. 9.
- LPG GREETINGS, INC., GURNEE, IL:  
2,929,870, INT. CL. 16.
- LUBRIZOL CORPORATION, THE, WICKLIFFE, OH:  
2,150,331, CANC. INT. CL. 35.
- LUCAS, MAKEEBA J. LAKE RIDGE, VA AND LUCAS, ADERO R, LAKE RIDGE, VA:  
2,928,725, PUB. 12-7-2004. MULTIPLE CLASS, INT. CLS. 16 AND 35.
- LUCASFILM ENTERTAINMENT COMPANY LTD., NICASIO, CA:  
1,308,002. REN. 1-21-05. MULTIPLE CLASS, INT. CLS. 16 AND 28.
- LUCIANO, STEVE, LOS ANGELES, CA AND LEO, NICK, LOS ANGELES, CA AND ROSSI, PAUL, LOS ANGELES, CA:  
2,929,443, INT. CL. 25.
- LUDWIG, ALLEN C., SAN ANTONIO, TX:  
2,150,355, CANC. INT. CL. 19.
- LUIGI, GIANCARLO, AGUADILLA, PUERTO RICO:  
2,929,384, INT. CL. 10.
- LUKENS, WILLIAM W., MERRITT ISLAND, FL FROM LUKENS, WILLIAM W., ROCKLEDGE, FL:  
2,929,067, MULTIPLE CLASS, INT. CLS. 9, 16, 25, 35 AND 41.
- LUNA INTERNATIONAL USA INC, HAUPPAUGE, NY:  
1,874,730. REN. 1-19-05. INT. CL. 25.
- LUND INDUSTRIES, INC., ANOKA, MN:  
2,929,330, INT. CL. 12.
- LUNSFORD, BRIAN J., WOODSTOCK, GA:  
2,928,635, PUB. 12-7-2004. INT. CL. 35.
- LURGI AKTIENGESELLSCHAFT, 60295 FRANKFURT, FED REP GERMANY:  
2,150,155, CANC. INT. CL. 6.
- LUTRON ELECTRONICS CO., INC., COOPERSBURG, PA:  
1,306,846. REN. 1-21-05. INT. CL. 9.
- LUXTON ENTERPRISES, INC., WHITE PLAINS, NY:  
2,928,825, PUB. 12-7-2004. INT. CL. 35.
- LUXURY APPAREL GROUP, L.L.C., BRISTOL, TN:  
2,928,679, PUB. 12-7-2004. INT. CL. 25.
- LYKOS CORP., SPOKANE, WA:  
1,334,204. REN. 1-21-05. INT. CL. 12.
- LYONDELL CHEMICAL COMPANY, HOUSTON, TX:  
2,119,600, CANC. MULTIPLE CLASS, INT. CLS. 1 AND 4.
- LYRIC HI-FI, INC., NEW YORK, NY:  
1,877,019. REN. 1-19-05. INT. CL. 42.
- M & A TECHNOLOGY, INC., DALLAS, TX:  
2,150,507, CANC. INT. CL. 9.
- M J MUNDY LIMITED, CHRISTCHURCH, NEW ZEALAND, TA WILLOW CREEK VINEYARDS:  
2,929,554, INT. CL. 33.
- M. LEE SMITH PUBLISHERS, BRENTWOOD, TN:  
2,928,795, PUB. 12-7-2004. MULTIPLE CLASS, INT. CLS. 16, 35 AND 41.
- M. R. CORKUM ENTERPRISES, INC., SALISBURY, MA:  
2,929,472, INT. CL. 28.
- M.L.W. CUSTOM CYCLE, INC., VERSAILLES, OH:  
2,151,537, CANC. INT. CL. 12.
- M.S.H. ASSOCIATION, FABER, VA TO SYNCHRONICITY FOUNDATION, INC., NELLYSFORD, VA:  
1,830,641, CANC. INT. CL. 41.
- M/A-COM, INC., LOWELL, MA:  
2,929,304, INT. CL. 9.
- MACHINEXPERT, LLC, KNOXVILLE, TN:  
2,150,277, CANC. INT. CL. 9.

MACHINING TECHNOLOGIES, INC., HEBRON, MD:  
2,929,216, INT. CL. 7.

MACK BROS. LTD., GOSHEN, NY:  
768,245, CANC. U.S. CL. 46.

MACLIN & ASSOCIATES, LOUISVILLE, KY:  
2,929,493, INT. CL. 21.

MADICO, INC., WOBURN, MA:  
1,830,812, CANC. INT. CL. 17.

MAFFUCCI, ROBERT, HARTFORD, CT:  
2,150,810, CANC. INT. CL. 42.

MAGLIFICIO PRESTIGE S.P.A., CARPI (MODENA), ITALY:  
2,150,996, CANC. INT. CL. 25.

MAGLIO BROS., INC., PHILADELPHIA, PA:  
1,840,667, REN. 1-18-05, INT. CL. 29.

MAGNESIA PRODUCTS, INC., THE, DAYTON, OH:  
406,533, CANC. U.S. CL. 6.

MAGNESIUM CORPORATION OF AMERICA, SALT LAKE CITY, UT:  
2,150,169, CANC. INT. CL. 6.

MAGNOLIA HI-FI, INC., KENT, WA:  
2,929,750, INT. CL. 35.  
2,929,751, INT. CL. 35.

MAGUIRE, THOMAS J., NEWTOWN, CT:  
2,928,630, PUB. 12-7-2004, INT. CL. 14.

MAHARISHI AYUR-VED PRODUCTS INTERNATIONAL, INC., COLORADO SPRINGS, CO:  
2,929,062, INT. CL. 5.

MAIN STREET MEDIA GROUP, INC., LONGMONT, CO:  
2,150,988, CANC. INT. CL. 16.

MAJOR LEAGUE BASEBALL PLAYERS ASSOCIATION, NEW YORK, NY:  
2,929,068, MULTIPLE CLASS, INT. CLS. 9 AND 28.

MAK TECHNOLOGIES, CAMBRIDGE, MA:  
2,150,627, CANC. INT. CL. 9.

MALLO, THOMAS P., MESA, AZ:  
2,929,191, INT. CL. 37.

MALONEY, RICHARD W., NAPLES, FL:  
1,907,712, REN. 1-19-05, INT. CL. 42.

MAMBI CHEESE COMPANY, MIAMI, FL:  
1,273,720, CANC. INT. CL. 29.

MANCUSO, DAVID M., NEW HOPE, PA AND MANCUSO, PETER J., NEW HOPE, PA:  
2,150,474, CANC. INT. CL. 35.

MANDESE, TIM, BRANDON, FL AND JACKSON, JOHN, TEMPLE TERRACE, FL:  
2,929,687, INT. CL. 28.

MANNINGTON CARPETS, INC., CALHOUN, GA:  
2,929,480, INT. CL. 27.

MANUFACTURES D'OUTILS DUMONT S.A., 2924 MONTIGNEZ, SWITZERLAND:  
1,900,334, REN. 1-19-05, INT. CL. 6.

MAPLE GROVE, INC., ST. JOHNSBURY, VT:  
182,475, CANC. U.S. CL. 46.

MAPLES INDUSTRIES, INC., SCOTTSBORO, AL:  
2,929,742, INT. CL. 27.

MARC ANTHONY VENTURE CORPORATION, CONCORD, CANADA:  
2,928,700, PUB. 12-7-2004, INT. CL. 3.

MARCEGAGLIA S.P.A., I-46040 GAZOLDO DEGLI IPPOLITI (MN), ITALY:  
2,638,973, COR. MULTIPLE CLASS, INT. CLS. 6, 37, 39 AND 42.

MARGARET H. MAGERKO, A U.S. CITIZEN, AS TRUSTEE OF THE NWL CO., FARMINGTON, PA:  
2,151,144, CANC. INT. CL. 41.

MARJAN CORPORATION, THE, WAUWATOSA, WI:  
1,830,573, CANC. INT. CL. 36.

MARK CASHMORE WINES PTY. LIMITED, NEW SOUTH WALES 2071, AUSTRALIA:  
2,150,976, CANC. INT. CL. 33.

MARKET APPROACH CONSULTING SERVICES, L.P., LORENA, TX:  
2,929,654, INT. CL. 36.  
2,929,655, INT. CL. 35.

MARKIR ONE, INC., NEW MILFORD, NJ:  
2,928,766, PUB. 12-7-2004, INT. CL. 41.

MARKS, NEAL, TRENTON, GA:  
2,929,796, INT. CL. 25.

MARLBORO FOOTWORKS, LTD., NEWTON, MA:  
1,863,777, REN. 1-21-05, INT. CL. 25.

MARS, INCORPORATED, MCLEAN, VA:  
2,929,179, INT. CL. 30.  
2,929,318, INT. CL. 3.

MARSH SUPERMARKETS, INC., YORKTOWN, IN:  
1,273,946, CANC. INT. CL. 42.

MARSHALL MANAGEMENT COMPANY, LAS VEGAS, NV:  
2,151,244, CANC. INT. CL. 25.

MARTIN OPERATING PARTNERSHIP L.P., KILGORE, TX, CENTER PLAINS INDUSTRIES, INC., AMARILLO, TX:  
1,310,623, REN. 1-19-05, INT. CL. 1.

MARTINEZ, ZARELA, NEW YORK, NY:  
2,929,071, INT. CL. 30.

MARVEL CHARACTERS, INC., CALABASAS, CA:  
2,151,484, CANC. INT. CL. 16.

MARY KAY INC., DALLAS, TX:  
2,929,134, MULTIPLE CLASS, INT. CLS. 16, 25 AND 41.

MARYLAND CASUALTY COMPANY, BALTIMORE, MD:  
2,150,762, CANC. INT. CL. 36.

MASTERCRAFT INDUSTRIES, INC., NEWBURGH, NY:  
2,150,873, CANC. INT. CL. 7.

MASTERPACK INTERNATIONAL, INC., ATLANTA, GA:  
2,150,886, CANC. MULTIPLE CLASS, INT. CLS. 9 AND 35.  
2,150,887, CANC. MULTIPLE CLASS, INT. CLS. 9 AND 35.

MASTIC INC., LONDON, ONTARIO, CANADA:  
1,273,528, CANC. INT. CL. 19.

MATCHMAKERS INTERNATIONAL LIMITED, BRADFORD, UNITED KINGDOM:  
2,928,823, PUB. 12-7-2004, INT. CL. 18.

MATHERNE, BERNARD A., SR., BRANDON, MS:  
2,929,456, INT. CL. 12.

MATRIX ANALYTICAL, INC., HOPKINTON, MA:  
2,150,472, CANC. INT. CL. 42.

MATSON NAVIGATION COMPANY, INC., OAKLAND, CA:  
1,870,004, REN. 1-18-05, INT. CL. 39.

MATTEL, INC., EL SEGUNDO, CA:  
2,151,042, CANC. INT. CL. 28.  
2,151,106, CANC. INT. CL. 28.  
2,151,155, CANC. INT. CL. 28.  
2,151,164, CANC. INT. CL. 28.  
2,151,232, CANC. INT. CL. 28.  
2,151,238, CANC. INT. CL. 28.  
2,151,339, CANC. INT. CL. 28.  
2,929,053, MULTIPLE CLASS, INT. CLS. 20 AND 21.  
2,929,576, INT. CL. 28.

MATTHEW HEADLEY HOLDINGS LLC, KANSAS CITY, MO:  
771,219, REN. 1-20-05, U.S. CL. 46 (INT. CLS. 29 AND 30).

MAUNA LOA MACADAMIA NUT CORPORATION, IRVINE, CA:  
1,840,053, REN. 1-18-05, INT. CL. 30.

MAURER + WIRTZ GMBH & CO. KG, D-52224 STOLBERG, FED REP GERMANY:  
2,928,459, PUB. 10-9-2001, INT. CL. 3.

MAURER SOHNE GMBH & CO. KG, 80807 MUNICH, FED REP GERMANY:  
2,928,498, PUB. 12-7-2004, INT. CL. 28.

MAURICE CORPORATION, PORTSMOUTH, NH, DBA POORE SIMON'S:  
2,151,004, CANC. INT. CL. 35.

MAX ROHR, INC., WILMINGTON, DE, CONSOLIDATED CIGAR CORPORATION, FT. LAUDERDALE, FL:  
1,891,814, REN. 1-19-05, INT. CL. 34.

MAXIMUM COMPUTER TECHNOLOGIES, INC., KENNESAW, GA:  
2,150,837, CANC. INT. CL. 9.

MAXWAX INC., NEW YORK, NY:  
2,929,844, MULTIPLE CLASS, INT. CLS. 3 AND 44.

MAY DEPARTMENT STORES INTERNATIONAL, INC., ST. LOUIS, MO:  
2,929,831, INT. CL. 16.

MAYOR'S JEWELER'S, INC., SUNRISE, FL:  
2,929,450, INT. CL. 14.

MAYTAG CORPORATION, NEWTON, IA:  
2,929,525, MULTIPLE CLASS, INT. CLS. 7 AND 11.

- MAZZONE, THOMAS, COWLESVILLE, NY:  
2,929,186, INT. CL. 42.
- MBL COMMUNICATIONS, INC., NEW YORK, NY:  
2,151,143, CANC. INT. CL. 16.
- MCCARTER THEATRE COMPANY, INC., PRINCETON, NJ:  
2,150,177, CANC. INT. CL. 9.
- MCCORMICK & SCHMICK RESTAURANT CORP., PORTLAND, OR:  
1,328,806, REN. 1-18-05, INT. CL. 30.
- MCDEVITT, DAVID P., IRVING, TX:  
2,928,988, PUB. 12-7-2004, INT. CL. 28.
- MCDONALD'S CORPORATION, OAK BROOK, IL:  
1,830,710, CANC. INT. CL. 42.
- MCDONALD'S CORPORATION, OAK BROOK, IL, BOSTON CHICKEN, INC., NAPERVILLE, IL:  
1,865,024, REN. 1-21-05, INT. CL. 42.
- MCGREGOR II LLC, DENVER, CO, MCGREGOR CORPORATION, NEW YORK, NY:  
1,861,890, REN. 1-21-05, INT. CL. 25.
- MCGUFFEY'S RESTAURANTS, INC., ASHEVILLE, NC:  
1,865,066, REN. 1-21-05, INT. CL. 42.
- MCI COMMUNICATIONS CORPORATION, WASHINGTON, DC:  
1,830,608, CANC. INT. CL. 38.  
2,150,617, CANC. INT. CL. 9.
- MCKESSON CORPORATION, SAN FRANCISCO, CA:  
2,928,776, PUB. 12-7-2004, MULTIPLE CLASS, INT. CLS. 3, 5, 9 AND 10.
- MCKINLAY, BRUCE A., RIDGETOWN, ONTARIO, N0P 2C0, CANADA:  
2,150,050, CANC. INT. CL. 7.
- MCLOUGHLIN, DENNIS MICHAEL, CARPINTERIA, CA, DBA EXCELLENCE, THE INSTITUTE FOR HIGH TRUST LEADERSHIP & TEACHING, AND HIGH TRUST MANAGEMENT:  
1,830,634, CANC. INT. CL. 41.
- MEAD-HATCHER, INC., BUFFALO, NY:  
2,151,019, CANC. INT. CL. 16.
- MEASUREMENT SPECIALTIES, INC., FAIRFIELD, NJ:  
2,929,195, INT. CL. 9.
- MEDCALLBACKS, INC., FULLERTON, CA:  
2,929,080, MULTIPLE CLASS, INT. CLS. 9 AND 42.
- MEDIARY GROUP, INC., CHICAGO, IL:  
2,928,990, PUB. 12-7-2004, INT. CL. 35.
- MEDICAL DEVICE TECHNOLOGIES, INC., GAINESVILLE, FL:  
1,830,787, CANC. INT. CL. 10.
- MEDICAL FLIGHT TEAM, INC., THE, LAS VEGAS, NV:  
2,150,272, CANC. INT. CL. 42.
- MEDICAL MUTUAL OF OHIO, CLEVELAND, OH:  
2,928,991, PUB. 12-7-2004, INT. CL. 44.
- MEDIMMUNE ONCOLOGY, INC., GAITHERSBURG, MD, U.S. BIOSCIENCE, INC., WEST CONSHOHOCKEN, PA:  
1,865,146, REN. 1-18-05, INT. CL. 5.
- MEDTRONIC AVE, INC., SANTA ROSA, CA, C.R. BARD, INC., MURRAY HILL, NJ:  
1,873,225, REN. 1-18-05, INT. CL. 10.
- MEDTRONIC, INC., MINNEAPOLIS, MN:  
1,871,877, REN. 1-18-05, INT. CL. 10.
- MEERAE TECH., INC., BUK-KU, KWANGJU, REPUBLIC OF KOREA:  
2,928,466, PUB. 4-13-2004, INT. CL. 9.
- MEGUIARS, INC., IRVINE, CA:  
1,867,841, REN. 1-18-05, INT. CL. 42.
- MEISSNER FILTRATION PRODUCTS, INC., CAMARILLO, CA:  
2,928,478, PUB. 12-7-2004, INT. CL. 11.
- MEJERIFORENINGEN DANISH DAIRY BOARD, DK-8000 ARHUS C, DENMARK, DANSKE MEJERIERS FAELLESORGANISATION (DANISH DAIRY BOARD), DK-8000 ARHUS C, DENMARK:  
1,875,725, REN. 1-19-05, U.S. CL. A.
- MELON BANK, N.A., PITTSBURGH, PA:  
2,928,462, PUB. 12-7-2004, INT. CL. 9.
- MELTON CLASSICS INCORPORATED, LAWRENCEVILLE, GA:  
2,928,601, PUB. 12-7-2004, INT. CL. 19.
- MEMPHIS LEGAL SECRETARIES ASSOCIATION, MEMPHIS, TN:  
1,830,305, CANC. INT. CL. 16.
- MEN'S HAIR NOW, LTD., FOREST HILLS, NY:  
1,830,719, CANC. INT. CL. 42.
- MENASHA CORPORATION, NEENAH, WI:  
2,928,768, PUB. 12-7-2004, INT. CL. 16.
- MENTOR GRAPHICS CORPORATION, WILSONVILLE, OR:  
1,905,366, REN. 1-21-05, INT. CL. 9.  
1,913,140, REN. 1-21-05, INT. CL. 9.
- MERCANTILE BANKSHARES CORPORATION, BALTIMORE, MD:  
2,150,503, CANC. INT. CL. 36.
- MERCEDES-BENZ AKTIENGESELLSCHAFT, 70327 STUTTGART, FED REP GERMANY:  
2,150,123, CANC. MULTIPLE CLASS, INT. CLS. 7 AND 12.  
2,150,124, CANC. MULTIPLE CLASS, INT. CLS. 7 AND 12.
- MERCK-MEDCO MANAGED CARE, L.L.C., MONTVALE, NJ:  
2,151,015, CANC. INT. CL. 16.
- MERCURY GROUP LLC, THE, WILTON, CT:  
2,929,331, INT. CL. 32.
- MEREDITH CORPORATION, DES MOINES, IA, REED PROPERTIES INC., WILMINGTON, DE:  
1,819,872, REN. 1-18-05, INT. CL. 16.
- MEREDITH CORPORATION, DES MOINES, IA:  
2,151,535, CANC. INT. CL. 16.  
2,928,885, PUB. 12-7-2004, INT. CL. 41.
- MERETEC CORPORATION, EAST CHICAGO, IN:  
2,929,160, INT. CL. 40.
- MERIDIAN HEALTH SYSTEM, INC., NEPTUNE, NJ:  
2,929,422, INT. CL. 44.
- MERONA INDUSTRIES, INC., ATLANTA, GA:  
2,150,687, CANC. INT. CL. 14.
- MERRILL LYNCH & CO., INC., NEW YORK, NY:  
1,273,849, CANC. INT. CL. 36.  
2,929,495, INT. CL. 36.
- MERRILL, JOSEPH, HOLLYWOOD, FL AND MERRILL, CHRISTEL, HOLLYWOOD, FL:  
2,928,996, PUB. 12-7-2004, INT. CL. 9.
- MESA SYSTEMS GUILD, INC., WARWICK, RI:  
2,150,860, CANC. INT. CL. 9.
- METALTECH, INC., HIALEAH, FL:  
2,150,310, CANC. INT. CL. 20.
- METHODS BAY, INC., GARDNERVILLE, NV:  
2,150,564, CANC. INT. CL. 9.
- METRIS DIRECT, INC., MINNETONKA, MN:  
2,929,224, INT. CL. 36.
- METRO SPIRE L.L.C., NEW YORK, NY:  
2,928,760, PUB. 5-18-2004, INT. CL. 36.
- MFP FRANCHISE SYSTEMS, INC., ATLANTA, GA, DBA MY FRIEND'S PLACE:  
2,928,633, PUB. 12-7-2004, INT. CL. 43.
- MG OVERSEAS LTD, KOWLOON, HONG KONG:  
2,929,871, INT. CL. 25.
- MHO, LLC, TAMPA, FL:  
2,928,645, PUB. 12-7-2004, INT. CL. 37.
- MI DRILLING FLUIDS COMPANY, HOUSTON, TX:  
1,273,244, CANC. INT. CL. 1.
- MIAMI COMPUTER SUPPLY CORPORATION, DAYTON, OH:  
2,114,020, CANC. INT. CL. 35.
- MIAMI DOLPHINS LTD., DAVIE, FL:  
1,864,650, REN. 1-19-05, MULTIPLE CLASS, INT. CLS. 16 AND 25.
- MICHAEL EDWARDS COMMUNICATIONS, INC., CHICAGO, IL:  
2,929,479, INT. CL. 35.
- MICHELIN NORTH AMERICA, INC., GREENVILLE, SC:  
2,929,178, INT. CL. 12.
- MICHIGAN HEALTH MAINTENANCE ORGANIZATION PLANS, INC., DETROIT, MI, DBA OMNICARE HEALTH PLAN:  
2,150,224, CANC. INT. CL. 42.

- MICHIGAN INDUSTRIAL EXPOSITION, L.L.C., DETROIT, MI:  
2,151,503, CANC. INT. CL. 35.
- MICHIGAN TUBE SWAGERS & FABRICATORS, INC., TEMPERANCE, MI:  
2,150,011, CANC. INT. CL. 2.
- MICROSOFT CORPORATION, REDMOND, WA:  
1,864,262, REN. 1-21-05. INT. CL. 16.
- MICROSYSTEMS DEVELOPMENT, SAN JOSE, CA:  
2,928,943, PUB. 12-7-2004. INT. CL. 12.
- MID-AMERICA CONSULTING GROUP, INC., BEACHWOOD, OH:  
2,150,656, CANC. INT. CL. 42.
- MID-TOWN RECREATION, INC., HOLCOMB, MO:  
2,929,666, INT. CL. 30.
- MIDWAY GAMES INC., CHICAGO, IL:  
2,151,427, CANC. INT. CL. 28.
- MIELE, PATRICK A., WILLISTON PARK, NY, DBA TR'S GREAT AMERICAN:  
1,830,853, CANC. INT. CL. 30.
- MIFAB LIMITED, TORONTO, ONTARIO, CANADA:  
2,929,269, INT. CL. 11.
- MIGUEL TORRES, S.A., 08720-VILAFRANCA DEL PEÑEDES (BARCELONA), SPAIN:  
2,929,180, INT. CL. 33.
- MIKRATOM LTD., 37120 NOKIA, FINLAND:  
2,929,504, INT. CL. 9.
- MILES INC., ELKHART, IN TO BAYER CORPORATION, ELKHART, IN:  
1,830,354, CANC. INT. CL. 16.
- MILES LABORATORIES, INC., ELKHART, IN:  
768,100, CANC. U.S. CL. 18.
- MILES, LAURIE S., IPSWICH, MA:  
2,150,720, CANC. INT. CL. 20.
- MILLER PRODUCTS COMPANY, MILWAUKEE, WI:  
1,901,296, REN. 1-21-05. INT. CL. 32.  
1,912,775, REN. 1-21-05. INT. CL. 41.  
1,913,642, REN. 1-21-05. INT. CL. 32.
- MILLER, STEVEN, PROVO, UT:  
2,928,782, PUB. 12-7-2004. INT. CL. 25.
- MILLER, WILLIAM Z. III, CHARLOTTE, NC:  
2,929,662, INT. CL. 41.
- MILTON BRADLEY COMPANY, SPRINGFIELD, MA:  
768,149, CANC. U.S. CL. 22.
- MILUS, THOMAS BAKER, PLEASANTON, CA:  
2,928,807, PUB. 12-7-2004. INT. CL. 41.
- MINDWORKS PROFESSIONAL EDUCATION GROUP, INC., SCOTTSDALE, AZ:  
2,150,878, CANC. INT. CL. 41.
- MINIGRIP, INC., ORANGEBURG, NY:  
768,237, CANC. U.S. CL. 40.
- MINNESOTA LAWYERS MUTUAL INSURANCE COMPANY, MINNEAPOLIS, MN:  
2,929,206, MULTIPLE CLASS, INT. CLS. 35, 36, 41 AND 42.
- MINOLTA CORPORATION, RAMSEY, NJ:  
2,150,280, CANC. INT. CL. 9.
- MITANI USA INC., NEW YORK, NY:  
2,929,461, INT. CL. 9.
- MITCHELL, KENNETH G. JR, HULL, MA:  
2,150,671, CANC. INT. CL. 41.
- MIX, DEANN, NEWPORT BEACH, CA:  
2,928,956, PUB. 12-7-2004. MULTIPLE CLASS, INT. CLS. 3 AND 44.
- MKS PRODUCTS INC., LAVAL, PROVINCE OF QUEBEC, CANADA:  
1,273,564, CANC. INT. CL. 20.
- MOAB BIT & TOOL CO., INC., MOAB, UT:  
2,928,831, PUB. 12-7-2004. INT. CL. 7.
- MOBILE CHIROPRACTIC OF FLORIDA, MIAMI, FL:  
1,814,559, CANC. INT. CL. 42.
- MODERNISTIC CARPET CLEANING CO., TROY, MI, AKA MODERNISTIC CLEANING SERVICES:  
1,911,788, REN. 1-21-05. INT. CL. 37.
- MOHAWK PAPER MILLS, INC., COHOES, NY, INTERNATIONAL PAPER COMPANY, NEW YORK, NY:  
787,571, REN. 1-15-05. U.S. CL. 37 (INT. CL. 16).
- MOLD BUSTERS, GROVE, OK:  
2,929,604, INT. CL. 37.
- MOLINIER S.A., VEAUCHE, FRANCE:  
1,273,287, CANC. INT. CL. 5.
- MOLSON BREWERIES, TORONTO, ONTARIO, CANADA:  
2,150,421, CANC. INT. CL. 32.
- MONA INDUSTRIES, INC., PATERSON, NJ:  
1,830,062, CANC. INT. CL. 1.
- MONARK GOLF SUPPLY, INC., WALNUT, CA:  
2,929,864, INT. CL. 28.
- MONOFLO INTERNATIONAL, INC., MCLEAN, VA:  
1,273,581, CANC. INT. CL. 21.
- MONOGRAM INTERNATIONAL, INC., LARGO, FL:  
2,928,501, PUB. 7-8-2003. INT. CL. 16.
- MONSANTO COMPANY, ST. LOUIS, MO TO MONSANTO COMPANY, ST. LOUIS, MO:  
1,830,423, CANC. INT. CL. 27.
- MONTI & ASSOCIATES, INC., BONITA SPRINGS, FL:  
2,928,794, PUB. 12-7-2004. INT. CL. 41.
- MOORE BUSINESS FORMS, INC., GRAND ISLAND, NY:  
1,273,473, CANC. INT. CL. 16.  
2,151,404, CANC. INT. CL. 16.
- MORARI SPECIALTIES, INC., MIAMI, FL:  
2,928,995, PUB. 12-7-2004. INT. CL. 31.
- MOTOR VEHICLE REPAIR CORPORATION, GAITHERSBURG, MD, TA AUTO WORLD:  
2,150,791, CANC. INT. CL. 37.
- MOTOROLA, INC., SCHAUMBURG, IL, MOTOROLA, INC., CHICAGO, IL:  
614,157, REN. 1-19-05. U.S. CL. 7 (INT. CL. 9).
- MOUNT OF OLIVES TREASURES, LLC, NEW YORK, NY:  
2,928,860, PUB. 12-7-2004. INT. CL. 30.
- MOUNT VERNON BUSINESS SYSTEMS INC, ALEXANDRIA, VA:  
2,929,072, INT. CL. 9.
- MOUNTAIN MANNA EXOTIC JELLIES, MARBLE, NC:  
2,928,907, PUB. 12-7-2004. INT. CL. 29.
- MOVENPICK HOLDING, 8002 ZURICH, SWITZERLAND:  
2,149,968, CANC. MULTIPLE CLASS, INT. CLS. 29, 30 AND 42.
- MOVIE GALLERY ASSET MANAGEMENT, INC., WILMINGTON, DE:  
2,929,469, INT. CL. 41.
- MOVING MENTOR, INC., AMHERST, MA:  
2,929,285, MULTIPLE CLASS, INT. CLS. 9, 16 AND 35.
- MOWER, TERRENCE KELLY, GRAPEVINE, TX:  
2,929,524, INT. CL. 9.
- MOXIE MOMS LLC, BOULDER, CO:  
2,928,840, PUB. 12-7-2004. MULTIPLE CLASS, INT. CLS. 35, 41 AND 45.
- MPL ASSOCIATES, LTD., PHOENIX, AZ:  
2,151,109, CANC. INT. CL. 25.
- MQSOFTWARE, INC., MINNEAPOLIS, MN:  
2,929,417, INT. CL. 9.
- MR. BAR-B-Q-, INC., OLD BETHPAGE, NY:  
1,273,329, CANC. INT. CL. 7.
- MR. BAR-B-Q, INC., OLD BETHPAGE, NY:  
1,273,283, CANC. INT. CL. 4.
- MRS. BATEMAN'S BAKERY L.C., RIGBY, ID:  
2,151,531, CANC. INT. CL. 29.
- MRS. BATEMANS BAKERY L.C., RIGBY, ID:  
2,151,530, CANC. INT. CL. 29.
- MTR GAMING GROUP, INC., CHESTER, WV:  
2,928,951, PUB. 12-7-2004. INT. CL. 43.  
2,928,952, PUB. 12-7-2004. INT. CL. 43.
- MTR IMPORTS, INC., DARIEN, IL:  
1,883,740, REN. 1-18-05. INT. CL. 29.
- MUELHENS GMBH & CO. KG, 50828 KÖLN, FED REP GERMANY:  
2,929,449, INT. CL. 3.
- MULTI SERVICE CORPORATION, OVERLAND PARK, KS:  
2,150,167, CANC. MULTIPLE CLASS, INT. CLS. 38 AND 42.
- MULTICLIP COMPANY LIMITED, ADDLESTONE, SURREY KT15 2AR, UNITED KINGDOM:  
1,861,610, REN. 1-21-05. MULTIPLE CLASS, INT. CLS. 6 AND 8.

- MULTIFOODS BRANDS, INC., MINNETONKA, MN, INTERNATIONAL MULTIFOODS CORPORATION, MINNEAPOLIS, MN:  
1,020,031. REN. 1-18-05. INT. CL. 30.
- MULTIMEDIA GAMES, INC., AUSTIN, TX:  
2,929,288, INT. CL. 9.  
2,929,289, INT. CL. 9.  
2,929,290, INT. CL. 9.  
2,929,291, INT. CL. 9.
- MULTIQUIP, INC., CARSON, CA:  
2,929,497, INT. CL. 11.
- MULTITECH INDUSTRIES, LTD., COLDWATER, MI:  
2,150,572, CANC. MULTIPLE CLASS, INT. CLS. 12 AND 28.
- MUNCHMEYER-STELLA B.V., MAASTRICHT, NETHERLANDS:  
768,177, CANC. U.S. CL. 27.
- MUNRO & COMPANY, INC., HOT SPRINGS, AR:  
2,929,436, INT. CL. 25.
- MURAD, HOWARD, MARINA DEL REY, CA:  
2,151,035, CANC. INT. CL. 3.  
2,151,036, CANC. INT. CL. 3.
- MURDICK'S FAMOUS FUDGE, CHARLEVOIX, MI, C. GOULD MURDICK, CHARLEVOIX, MI:  
784,110. REN. 1-18-05. U.S. CL. 46 (INT. CL. 30).
- MURO PHARMACEUTICAL, INC., TEWKSBURY, MA:  
1,273,302, CANC. INT. CL. 5.
- MUSIC BUSINESS REFERENCE, INC., NEW ROCHELLE, NY:  
2,151,526, CANC. INT. CL. 41.
- MUSIC PICTURES, NEW YORK, NY TO CASTLE COMMUNICATIONS PLC, CHESSINGTON, SURREY, ENGLAND:  
1,830,648, CANC. INT. CL. 41.
- MUSSELMAN, LUTHER K., BRIDGEPORT, CT:  
2,150,090, CANC. INT. CL. 14.
- MWH AMERICAS, INC., BROOMFIELD, CO:  
2,929,437, MULTIPLE CLASS, INT. CLS. 35 AND 36.
- MYERS, SUSAN MARIE, PHOENIX, AZ, DBA CHUCKLE VALLEY FRIENDS:  
2,150,871, CANC. INT. CL. 28.
- M2K, INC., HOUSTON, TX:  
2,150,737, CANC. INT. CL. 42.
- N.V. BEKAERT S.A., B-8550, ZWEEGEM, BELGIUM:  
2,150,731, CANC. INT. CL. 6.
- N.V. ORGANON, OSS, NETHERLANDS:  
2,928,710, PUB. 12-7-2004. MULTIPLE CLASS, INT. CLS. 41 AND 44.
- N'AMERIX LOGISTIX, INC., WATERLOO, ONTARIO N2J 2L5, CANADA:  
2,150,375, CANC. INT. CL. 39.
- NABISCO BRANDS COMPANY, CHICAGO, IL:  
2,151,456, CANC. INT. CL. 30.
- NAN YANG FABRIC CO., LTD., PETCHABURI PROVINCE 76140, THAILAND:  
2,929,891, INT. CL. 25.
- NANDO'S INTERNATIONAL LIMITED, DUBLIN, IRELAND, UNITED KINGDOM:  
2,929,473, INT. CL. 43.  
2,929,487, INT. CL. 43.
- NANO-TEX, LLC, GREENSBORO, NC FROM NANO-TEX, INC., GREENSBORO, NC:  
2,929,208, INT. CL. 25.
- NANODYNE INCORPORATED, NEW BRUNSWICK, NJ:  
1,830,753, CANC. INT. CL. 1.
- NANOSCALE MATERIALS, INC., MANHATTAN, KS:  
2,929,246, MULTIPLE CLASS, INT. CLS. 1 AND 6.
- NANOSPECTRA BIOSCIENCES, INC., HOUSTON, TX:  
2,928,935, PUB. 12-7-2004. INT. CL. 1.
- NASSAU INTERNATIONAL, INC., MORRISVILLE, PA:  
2,150,376, CANC. MULTIPLE CLASS, INT. CLS. 9 AND 17.
- NATIONAL AUTOMOBILE DEALERS ASSOCIATION, MCLEAN, VA:  
1,273,926, CANC. INT. CL. 41.
- NATIONAL BANKERS TRUST CORP, MEMPHIS, TN:  
2,929,819, INT. CL. 36.
- NATIONAL BUSINESS TRAVEL ASSOCIATION, INC., ALEXANDRIA, VA:  
2,928,552, PUB. 12-7-2004. MULTIPLE CLASS, INT. CLS. 35 AND 41.  
2,928,553, PUB. 12-7-2004. MULTIPLE CLASS, INT. CLS. 35 AND 41.  
2,928,554, PUB. 12-7-2004. MULTIPLE CLASS, INT. CLS. 35 AND 41.
- NATIONAL CATTLEMEN'S BEEF ASSOCIATION, CENTENNIAL, CO AND CATTLEMEN'S BEEF PROMOTION AND RESEARCH BOARD, CENTENNIAL, CO:  
2,928,993, PUB. 12-7-2004. INT. CL. 35.
- NATIONAL CITY CORPORATION, CLEVELAND, OH:  
2,151,460, CANC. INT. CL. 36.
- NATIONAL CORSET SUPPLY HOUSE, LOS ANGELES, CA:  
2,928,464, PUB. 9-21-2004. INT. CL. 3.
- NATIONAL FARMERS UNION PROPERTY AND CASUALTY COMPANY, DENVER, CO:  
1,273,864, CANC. INT. CL. 36.
- NATIONAL FEDERATION OF STATE HIGH SCHOOL ASSOCIATIONS, INDIANAPOLIS, IN:  
1,320,238. REN. 1-21-05. INT. CL. 42.
- NATIONAL FLOOD INFORMATION SERVICES, INC., ARLINGTON, TX:  
2,151,520, CANC. INT. CL. 9.  
2,151,521, CANC. INT. CL. 36.
- NATIONAL FOOTBALL LEAGUE, NEW YORK, NY, AMERICAN FOOTBALL LEAGUE, DALLAS, TX:  
771,279. REN. 1-21-05. U.S. CL. 101 (INT. CL. 35).
- NATIONAL INFORMATION SOLUTIONS COOPERATIVE, INC., ST. PETERS, MO:  
2,928,568, PUB. 12-7-2004. MULTIPLE CLASS, INT. CLS. 9, 35, 41 AND 42.
- NATIONAL JUNIOR BASKETBALL LEAGUE, SANTA ANA, CA:  
1,858,072. REN. 1-21-05. U.S. CL. 200.
- NATIONAL PAINTBALL SUPPLY, INC., SEWELL, NJ:  
2,897,581, COR. INT. CL. 35.
- NATIONAL PICTURE & FRAME CO., GREENWOOD, MS:  
2,150,900, CANC. INT. CL. 20.
- NATIONAL PROCESSING COMPANY, LOUISVILLE, KY:  
2,151,479, CANC. INT. CL. 36.
- NATIONAL SERVICE INDUSTRIES, INC., ATLANTA, GA:  
768,225, CANC. U.S. CL. 39.
- NATIONAL SOLARCRETE, INC., HUNTLEY, IL:  
2,929,321, INT. CL. 19.
- NATIONAL STARCH AND CHEMICAL INVESTMENT HOLDING CORPORATION, NEW CASTLE, DE:  
2,929,835, INT. CL. 5.
- NATIONAL STORAGE INDUSTRY CONSORTIUM, SAN DIEGO, CA:  
2,150,418, CANC. INT. CL. 42.
- NATIONAL TELEWIRE CORPORATION, MAPLEWOOD, NJ:  
1,304,142. REN. 1-18-05. INT. CL. 38.
- NATIONAL TOBACCO COMPANY, L.P., LOUISVILLE, KY, LOEW'S THEATRES, INC., NEW YORK, NY:  
1,358,381. REN. 1-19-05. INT. CL. 34.
- NATIONAL TOUR ASSOCIATION, INC., LEXINGTON, KY:  
2,928,922, PUB. 12-7-2004. INT. CL. 35.
- NATIONAL TRANSPORTATION SOFTWARE, INC., AMHERST, NY:  
2,149,977, CANC. INT. CL. 35.
- NATIONAL VALEDICTORIAN SOCIETY, LOUVIERS, CO:  
2,929,188, INT. CL. 9.
- NATURAL ALTERNATIVES INTERNATIONAL, INC., SAN MARCOS, CA:  
2,928,916, PUB. 12-7-2004. INT. CL. 5.
- NATURAL CREATIONS, CORP., WHITMORE LAKE, MI:  
2,928,527, PUB. 12-7-2004. INT. CL. 11.
- NATURAL HAZARDS DISCLOSURE, LLC, LOS ANGELES, CA:  
2,929,286, INT. CL. 16.
- NATURAL ORGANICS INC., FARMINGDALE, NY:  
1,273,303, CANC. INT. CL. 5.

- NATURAL SUPPLEMENT ASSOCIATION, INCORPORATED, GOLDEN, CO, DBA EXPERIMENTAL AND APPLIED SCIENCES, INC.:  
2,929,031, PUB. 12-7-2004. INT. CL. 30.
- NATURAL WELLNESS CENTERS OF AMERICA, ANAHEIM, CA, DBA ULTRA-PET PRODUCTS AND BRANNEN, ROGER, ANAHEIM, CA:  
2,928,754, PUB. 12-7-2004. INT. CL. 5.
- NATURES HEALTH SUPPLY, INC., SANTA BARBARA, CA:  
2,929,838, INT. CL. 5.
- NB HOLDINGS CORPORATION, CHARLOTTE, NC:  
2,151,292, CANC. INT. CL. 36.
- NBAC CORPORATION, WASHINGTON GROVE, MD:  
2,150,249, CANC. INT. CL. 16.
- NCL CORPORATION LTD., MIAMI, FL, OCEANAIR AG, 1820 MONTREUX 2, SWITZERLAND:  
1,869,117, REN. 1-21-05. INT. CL. 39.
- NDCHEALTH CORPORATION, ATLANTA, CA FROM NDCHEALTH CORPORATION, ATLANTA, GA:  
2,929,270, INT. CL. 42.
- NEEDLECRAFT SHOP, INC., THE, BIG SANDY, TX TO NEEDLECRAFT SHOP, THE, L.L.C., BIG SANDY, TX:  
1,830,309, CANC. INT. CL. 16.
- NEILL CORPORATION, HAMMOND, LA:  
2,928,598, PUB. 12-7-2004. INT. CL. 35.
- NEOCHEM CORPORATION, BELLAIRE, TX:  
1,273,285, CANC. INT. CL. 4.
- NEOZYME INTERNATIONAL INC, NEWPORT BEACH, CA:  
1,911,001, REN. 1-21-05. INT. CL. 3.
- NEOZYME INTERNATIONAL, INC., NEWPORT BEACH, CA:  
1,910,957, REN. 1-21-05. INT. CL. 1.
- NESCO/AMERICAN HARVEST CORP., TWO RIVERS, WI:  
1,313,319, REN. 1-18-05. INT. CL. 11.
- NETFRAME SYSTEMS, INC., MILPITAS, CA:  
2,151,210, CANC. INT. CL. 9.
- NETSPOKE, INC., WOBURN, MA:  
2,928,561, PUB. 12-7-2004. INT. CL. 38.
- NETWORK OF INDIAN PROFESSIONALS OF NORTH AMERICA, INC., WILIMINGTON, DE:  
2,928,583, PUB. 12-7-2004. INT. CL. 41.
- NEUBERGER BERMAN MANAGEMENT INC., NEW YORK, NY:  
2,929,676, INT. CL. 36.  
2,929,677, INT. CL. 36.
- NEW BOND BREAD CO., INC., PHILADELPHIA, PA:  
1,273,786, CANC. INT. CL. 30.
- NEW HOLLAND NORTH AMERICA, INC., NEW HOLLAND, PA, SPERRY CORPORATION, NEW HOLLAND, PA:  
1,282,208, REN. 1-18-05. INT. CL. 9.
- NEW PERSPECTIVE SOFTWARE, INC., FLAGSTAFF, AZ:  
2,150,341, CANC. INT. CL. 9.
- NEW PIPER AIRCRAFT, INC., THE, VERO BEACH, FL:  
2,194,790, CANC. INT. CL. 5.
- NEWLINK GENETICS CORPORATION, AMES, IA:  
2,929,514, INT. CL. 5.
- NEWPORT FASTENER COMPANY, INC., COSTA MESA, CA:  
1,273,314, CANC. INT. CL. 6.
- NEXIDIA, INC., ATLANTA, GA:  
2,928,803, PUB. 7-20-2004. INT. CL. 9.  
2,928,804, PUB. 7-20-2004. MULTIPLE CLASS, INT. CLS. 9 AND 42.
- NEXTEL COMMUNICATIONS, INC., MCLEAN, VA:  
2,150,955, CANC. INT. CL. 16.
- NIAGARA MOHAWK POWER CORPORATION, SYRACUSE, NY:  
2,150,047, CANC. MULTIPLE CLASS, INT. CLS. 36, 39 AND 41.
- NICE ENTERPRISE CO., LTD., CHIA YI, TAIWAN:  
2,929,632, INT. CL. 3.
- NIECO EQUIPMENT CORPORATION, WINDSOR, CA:  
1,301,451, REN. 1-19-05. INT. CL. 11.
- NIKON CORPORATION, CHIYODA-KU, TOKYO, JAPAN:  
1,866,819, REN. 1-15-05. MULTIPLE CLASS, INT. CLS. 9, 18, 21, 25 AND 28.
- NINE WEST DEVELOPMENT CORPORATION, STAMFORD, CT:  
2,138,092, CANC. INT. CL. 25.
- NON-STOP LOGISTICS CORPORATION, SAN FRANCISCO, CA:  
2,150,065, CANC. INT. CL. 35.
- NORSK HYDRO A.S, 0240 OSLO 2, NORWAY:  
1,830,056, CANC. INT. CL. 1.
- NORSKE MEIERIER (NORWEGIAN DAIRIES ASSOCIATION), VATERLAND, N-0134 OSLO, NORWAY TO TINE BA, 0133, OSLO, NORWAY:  
1,859,213, CANC. INT. CL. 29.
- NORSKE MEIERIERS SALGSSENTRAL (NORWEGIAN DAIRIES SALES ASSOCIATION), OSLO 1, NORWAY TO TINE BA, 0133, OSLO, NORWAY:  
1,103,976, CANC. INT. CL. 29.
- NORTH AMERICAN GREEN, INC., EVANSVILLE, IN:  
1,924,636, REN. 1-21-05. INT. CL. 19.
- NORTH AMERICAN RAILWAY SERVICES, INC., SHREVEPORT, LA:  
1,309,357, REN. 1-18-05. INT. CL. 37.
- NORTH FORK BANCORPORATION, INC., MELVILLE, NY, AKA NORTH FORK BANK:  
2,928,720, PUB. 12-7-2004. INT. CL. 36.
- NORTHEAST BANK FSB, AUBURN, ME:  
2,929,786, INT. CL. 36.
- NORTHEAST MOBILE SHREDDING, LLC, HORSEHEADS, NY:  
2,928,594, PUB. 12-7-2004. MULTIPLE CLASS, INT. CLS. 37 AND 40.
- NORTHWEST PUBLICATIONS INC., DULUTH, MN:  
2,929,403, INT. CL. 16.
- NOVEAU TECHNOLOGIES, INC., TEQUESTA, FL:  
2,150,251, CANC. INT. CL. 42.
- NOVILLE ESSENTIAL OILS CO., INC., SOUTH HACKENSACK, NJ:  
2,151,169, CANC. INT. CL. 1.
- NOWLAND, C. MARTIN, BRATTLEBORO, VT:  
2,150,139, CANC. INT. CL. 42.
- NTN CORPORATION, OSAKA, JAPAN:  
2,929,675, INT. CL. 7.
- NU SKIN INTERNATIONAL, INC., PROVO, UT:  
2,150,932, CANC. INT. CL. 30.
- NUEDGE SYSTEMS, LLC, WAUKESHA, WI:  
2,928,981, PUB. 12-7-2004. MULTIPLE CLASS, INT. CLS. 9 AND 35.
- NUTRICIA DRINKS TRADEMARKS B.V., 2712 PJ ZOETERMEER, NETHERLANDS:  
2,823,606, COR. MULTIPLE CLASS, INT. CLS. 30 AND 32.
- NUTTY BAVARIAN, INC., THE, ALTAMONTE SPRINGS, FL TO TNB, INC., LAKE MARY, FL:  
1,830,450, CANC. MULTIPLE CLASS, INT. CLS. 29 AND 30.
- NYCOMED PHARMA AS, N-0301 OSLO 3, NORWAY:  
2,150,117, CANC. INT. CL. 5.
- NYNEX CORPORATION, NEW YORK, NY:  
2,150,410, CANC. INT. CL. 38.
- O'BERRY ENTERPRISES, INC., CRYSTAL LAKE, IL:  
1,878,203, REN. 1-21-05. INT. CL. 6.
- O'HORA, JAMES, MINNEAPOLIS, MN:  
2,150,917, CANC. INT. CL. 30.
- OAK STREET MORTGAGE, LLC, CARMEL, IN FROM CRESLEIGH FINANCIAL SERVICES, LLC, CARMEL, IN:  
2,929,595, INT. CL. 36.
- OBERFRANKISCHE GLAS- UND SPIELZEUG KG FRITZ REMPEL COMPANY, INH. R. REMPEL, D-96465 NEUSTADT B. COBURG, FED REP GERMANY:  
1,913,480, REN. 1-19-05. INT. CL. 28.
- OCEAN BEAUTY ALASKA, INC., SEATTLE, WA:  
182,358, CANC. U.S. CL. 46.
- OCEAN CHALLENGE, INC., BOSTON, MA:  
2,151,458, CANC. INT. CL. 16.
- OCEAN GARDEN PRODUCTS, INC., SAN DIEGO, CA:  
1,867,109, REN. 1-19-05. INT. CL. 29.
- OCHSNER INTERNATIONAL, INC., WHEELING, IL:  
1,862,438, REN. 1-18-05. MULTIPLE CLASS, INT. CLS. 12 AND 25.

- OCINOMLED, LTD, NEW YORK, NY:  
2,928,614, PUB. 12-7-2004. INT. CL. 43.
- OCULAR SCIENCES, INC., CONCORD, CA, O.S.I. CORPORATION, SOUTH SAN FRANCISCO, CA:  
1,865,193. REN. 1-18-05. INT. CL. 9.
- ODEGARD, INC., NEW YORK, NY:  
2,192,214, AM. INT. CL. 27.
- OFFENBACHER, DOUG, SANTA ROSA, CA:  
2,929,189, INT. CL. 35.
- OHIO ART COMPANY; THE, BRYAN, OH:  
1,309,900. REN. 1-21-05. MULTIPLE CLASS, INT. CLS. 15, 16, 21 AND 28.
- OHIO ASSOCIATED ENTERPRISES, INC., PAINESVILLE, OH:  
1,830,154, CANC. INT. CL. 7.
- OKUMA AMERICA CORPORATION, CHARLOTTE, NC:  
2,929,119, INT. CL. 37.
- OLD MOTHER HUBBARD DOG FOOD CO, INC., LOWELL, MA:  
2,151,136, CANC. INT. CL. 31.
- OLDCASTLE PRECAST, INC., AUBURN, WA:  
2,928,802, PUB. 12-7-2004. INT. CL. 19.
- OLIN CORPORATION, NORWALK, CT:  
1,006,175. REN. 1-21-05. INT. CL. 1.
- OLLIEVANA LICENSING GROUP, LLC, SANTA BARBARA, CA:  
2,928,728, PUB. 12-7-2004. INT. CL. 25.
- OLYMPIA ENTERTAINMENT, INC., DETROIT, MI:  
2,928,471, PUB. 7-29-2003. MULTIPLE CLASS, INT. CLS. 25 AND 41.
- OLYMPUS OPTICAL CO., LTD., TOKYO, JAPAN:  
2,929,201, INT. CL. 9.
- OMEGA ENGINEERING, INC., STAMFORD, CT:  
1,302,422. REN. 1-21-05. INT. CL. 9.  
1,302,423. REN. 1-21-05. INT. CL. 9.
- OMEGA FASHIONS LTD., NEW YORK, NY:  
1,273,513, CANC. INT. CL. 18.
- OMI INTERNATIONAL CORPORATION, WARREN, MI:  
768,077, CANC. U.S. CL. 6.  
1,273,234, CANC. INT. CL. 1.  
1,273,253, CANC. INT. CL. 1.
- OMNI STUDIO, INC., BOISE, ID:  
2,150,958, CANC. INT. CL. 41.
- OMNITRITION INTERNATIONAL, INC., CARROLLTON, TX:  
2,150,906, CANC. INT. CL. 5.
- ONE CALL HOME MANAGEMENT SERVICE, LLC., NISSWA, MN:  
2,928,790, PUB. 12-7-2004. INT. CL. 35.
- ONE WORLD NETWORKS INTEGRATED TECHNOLOGIES, INC., LOS ANGELES, CA:  
2,928,817, PUB. 12-7-2004. INT. CL. 3.
- ONEIDA LTD., ONEIDA, NY:  
1,273,448, CANC. INT. CL. 14.
- ONEMORLD MARKETING, INC., OVERLAND PARK, KS:  
2,928,634, PUB. 12-7-2004. INT. CL. 36.
- ONSALE, INC., MOUNTAIN VIEW, CA:  
2,150,363, CANC. INT. CL. 35.
- OPNET TECHNOLOGIES, INC., WASHINGTON, DC TO MIL 3, INC., WASHINGTON, DC:  
2,678,598, COR. MULTIPLE CLASS, INT. CLS. 9, 41 AND 42.
- OPTIBRAND LTD., LLC, FORT COLLINS, CO:  
2,929,213, INT. CL. 42.
- OPTIMUM LIFESTYLE, INC., MILL VALLEY, CA:  
1,830,131, CANC. INT. CL. 5.
- OPTISCHE WERKE G. RODENSTOCK, D-8000 MUNCHEN, FED REP GERMANY:  
2,150,380, CANC. INT. CL. 9.  
2,150,575, CANC. INT. CL. 9.
- OPTIVE RESEARCH, INC., AUSTIN, TX:  
2,929,338, MULTIPLE CLASS, INT. CLS. 9 AND 42.
- OR MUSIC LLC, NEW YORK, NY:  
2,929,521, MULTIPLE CLASS, INT. CLS. 9 AND 25.
- ORCHARD COUNTRREE MARKET, INC., LA CRESCENT, MN:  
2,929,860, INT. CL. 35.
- ORCHID BIOSCIENCES, INC., PRINCETON, NJ:  
2,929,219, INT. CL. 42.
- ORION BUS INDUSTRIES, A DIVISION OF WESTERN STAR TRUCKS INC., MISSISSAUGA, ONTARIO, CANADA:  
2,395,888, COR. INT. CL. 12.
- ORLANDO/ORANGE COUNTY CONVENTION & VISITORS BUREAU, INC., ORLANDO, FL:  
2,929,486, INT. CL. 35.
- ORTHO-KINETICS, INC., WAUKESHA, WI:  
1,830,542, CANC. MULTIPLE CLASS, INT. CLS. 35 AND 42.
- ORTLIEB, HARTMUT, 8500 NURNBERG 80, FED REP GERMANY:  
1,830,908, CANC. MULTIPLE CLASS, INT. CLS. 12 AND 18.
- OTC CONNECTION, INC., SUFFERN, NY, DBA FOOT-WORLD USA:  
2,928,492, PUB. 12-7-2004. MULTIPLE CLASS, INT. CLS. 3 AND 10.
- OTEVAN S.A., MONTEVIDEO, URUGUAY:  
2,928,643, PUB. 12-7-2004. INT. CL. 14.
- OTICON A/S, 2900 HELLERUP, DENMARK:  
2,928,683, PUB. 12-7-2004. INT. CL. 10.
- OTSUKA PHARMACEUTICAL CO., LTD., CHIYODA-KU, TOKYO, JAPAN:  
2,150,453, CANC. INT. CL. 32.
- OUTDOOR LIFE NETWORK, L.L.C., STAMFORD, CT:  
2,929,448, INT. CL. 41.
- OUTLAST TECHNOLOGIES, INC., BOULDER, CO:  
2,929,812, INT. CL. 22.  
2,929,813, INT. CL. 23.
- OVERBREAK, L.L.C., SUN VALLEY, CA:  
2,928,528, PUB. 12-7-2004. INT. CL. 35.
- OX-GEN, INC., BOISE, ID:  
2,928,577, PUB. 12-7-2004. INT. CL. 10.  
2,928,578, PUB. 12-7-2004. INT. CL. 10.
- OXFORD ANALYTICA LTD., OXFORD, GREAT BRITAIN:  
1,869,498. REN. 1-19-05. MULTIPLE CLASS, INT. CLS. 16 AND 35.
- P. ROTOLA-PUKKILA OY, 61800 KAUAJOKI, FINLAND:  
2,150,072, CANC. INT. CL. 20.
- P.J. KIDS, LLC, PRINCETON, NJ:  
2,929,153, INT. CL. 20.
- P.M. DESIGN, LLC, LOVELAND, CO:  
2,150,135, CANC. INT. CL. 9.
- PABST BREWING COMPANY, MILL VALLEY, CA:  
1,830,872, CANC. INT. CL. 32.
- PABU SERVICES, INC., WILMINGTON, DE, GREAT LAKES CHEMICAL CORPORATION, WEST LAFAYETTE, IN:  
1,869,152. REN. 1-19-05. INT. CL. 1.
- PACE FINANCIAL NETWORK, WASHINGTON, DC:  
2,150,438, CANC. INT. CL. 36.
- PACESETTER GROUP, INC., THE, PRINCETON, NJ:  
2,150,938, CANC. INT. CL. 35.
- PACIFIC BIODIESEL, INC., KAHULUI, HI:  
2,928,877, PUB. 12-7-2004. INT. CL. 4.
- PACIFIC HANDY CUTTER, INC., COSTA MESA, CA:  
2,150,543, CANC. INT. CL. 34.
- PACIFIC LIFECARE CORPORATION, SANTA ROSA, CA:  
2,151,072, CANC. INT. CL. 42.
- PACIFIC SAFETY PRODUCTS INC., KELOWNA BRITISH COLUMBIA, CANADA:  
2,929,679, INT. CL. 9.
- PACIFIC TELESIS GROUP, SAN FRANCISCO, CA:  
2,151,430, CANC. INT. CL. 36.  
2,151,432, CANC. INT. CL. 36.
- PAGEMART, INC., DALLAS, TX:  
2,150,157, CANC. INT. CL. 38.
- PAINT BOX, INC., SEATTLE, WA:  
2,150,586, CANC. INT. CL. 25.  
2,150,587, CANC. INT. CL. 25.
- PAISLEY PARK ENTERPRISES, CHANHASSEN, MN:  
2,150,301, CANC. INT. CL. 9.
- PALM BEACH WELLNESS CENTER, INC., WEST PALM BEACH, FL:  
2,150,882, CANC. INT. CL. 16.



- PALMERO SALES CO., INC., STRATFORD, CT:  
1,273,288, CANC. INT. CL. 5.
- PALMSOURCE, INC., SUNNYVALE, CA:  
2,929,669, INT. CL. 37.
- PAMPERED CHEF, THE, RIVER FOREST, IL:  
1,273,974, CANC. INT. CL. 42.
- PAPER MAGIC GROUP, INC., THE, WILMINGTON, DE:  
2,151,389, CANC. INT. CL. 28.  
2,929,048, INT. CL. 21.
- PAPER-PAK PRODUCTS, INC., LA VERNE, CA:  
2,150,661, CANC. INT. CL. 5.
- PAR-WAY GROUP, ST. CLAIR, MO:  
2,150,753, CANC. INT. CL. 9.
- PARADORES DE TURISMO DE ESPANA, S.A., 28001 MADRID, SPAIN:  
1,830,668, CANC. INT. CL. 42.
- PARAMOUNT INDUSTRIAL COMPANIES, INC., NORFOLK, VA:  
2,150,422, CANC. MULTIPLE CLASS, INT. CLS. 24 AND 40.
- PARAMOUNT PARKS INC., CHARLOTTE, NC:  
2,151,062, CANC. MULTIPLE CLASS, INT. CLS. 6, 16 AND 21.
- PARAMOUNT PICTURES CORPORATION, LOS ANGELES, CA:  
2,151,468, CANC. INT. CL. 28.
- PARFUMS GIVENCHY, 92300 LEVALLOIS PERRET, FRANCE:  
2,150,681, CANC. INT. CL. 3.
- PARFUMS MIRO INTL INC., QUEBEC, CANADA TO PARFUMS MIRO CANADA INC., BROSSARD, QUEBEC, CANADA:  
1,830,088, CANC. INT. CL. 3.
- PARFUMS VAN CLEEF & ARPELS S. A., NEUILLY SUR SEINE, FRANCE:  
2,929,063, INT. CL. 3.
- PARK-A-BIKE FRANCHISE S A (PROPRIETARY) LIMITED, SOMERSET WEST, SOUTH AFRICA:  
2,149,970, CANC. INT. CL. 6.
- PARKDALE MILLS, INCORPORATED, LOWELL, NC:  
2,151,435, CANC. INT. CL. 23.
- PARKINSON'S DISEASE SUPPORT NETWORK OKI, CINCINNATI, OH:  
2,150,895, CANC. MULTIPLE CLASS, INT. CLS. 36 AND 42.
- PARSLEY FAMILY ESTATE, INC., NAPA, CA:  
2,929,145, INT. CL. 33.
- PASSLER, SANDRA, K, LAS CRUCES, NM AND PASSLER, KENNETH, T., LAS CRUCES, NM:  
2,929,782, INT. CL. 30.
- PASTIFICIO AZIENDA AGRARIA LATINI S.R.L., OSIMO (ANCONA), ITALY:  
2,928,612, PUB. 12-7-2004. INT. CL. 30.
- PAT ALLEN ASSOCIATES, INC., GOLDENS BRIDGE, NY:  
2,929,003, PUB. 12-7-2004. INT. CL. 35.
- PATH, ROBERT, NORWOOD, NJ:  
2,928,883, PUB. 12-7-2004. INT. CL. 25.
- PATTON, DOROTHIEA HUNDLEY, CHICAGO, IL:  
1,331,757, REN. 1-19-05. INT. CL. 9.
- PAUL MUELLER COMPANY, SPRINGFIELD, MO:  
2,928,788, PUB. 12-7-2004. INT. CL. 11.
- PAULIG OY, 00980 HELSINKI, FINLAND:  
2,151,064, CANC. MULTIPLE CLASS, INT. CLS. 11 AND 30.
- PAWLING CORPORATION, WASSAIC, NY, PAWLING RUBBER CORPORATION, PAWLING, NY:  
999,170, REN. 1-21-05. U.S. CL. 12 (INT. CL. 19).
- PAWS, INCORPORATED, ALBANY, IN:  
2,929,374, INT. CL. 9.  
2,929,375, INT. CL. 9.
- PAYLESS SHOESOURCE WORLDWIDE, INC., TOPEKA, KS:  
2,150,962, CANC. INT. CL. 35.
- PC CONNECTION, INC., MERRIMACK, NH:  
2,928,969, PUB. 12-7-2004. MULTIPLE CLASS, INT. CLS. 16 AND 35.
- PCI REMOTE SENSING CORP., ARLINGTON, VA:  
1,830,711, CANC. INT. CL. 42.
- PCNET, INC., SHELTON, CT:  
2,149,940, CANC. INT. CL. 9.
- PCS HEALTH SYSTEMS, INC., SCOTTSDALE, AZ:  
2,150,347, CANC. MULTIPLE CLASS, INT. CLS. 16, 35, 36 AND 42.
- PEDRANTI, DERRICK J., RANCHO MIRAGE, CA:  
2,151,219, CANC. INT. CL. 16.  
2,151,274, CANC. INT. CL. 16.
- PELCO, INC., LAKE CHARLES, LA:  
2,151,496, CANC. INT. CL. 33.
- PEMATECH GMBH, D-78315 RADOLFZELL, FED REP GERMANY:  
2,149,971, CANC. INT. CL. 7.
- PENTON PUBLISHING, INC., CLEVELAND, OH:  
2,150,326, CANC. INT. CL. 16.
- PEORIA CHIEFS COMMUNITY BASEBALL CLUB, PEORIA, IL:  
2,928,688, PUB. 7-20-2004. INT. CL. 25.
- PEP BOYS MANNY, MOE & JACK OF CALIFORNIA, THE, PHILADELPHIA, PA:  
2,929,441, MULTIPLE CLASS, INT. CLS. 36 AND 37.  
2,929,442, MULTIPLE CLASS, INT. CLS. 36 AND 37.
- PEPCOM INC., BOYNTON BEACH, FL:  
2,928,611, PUB. 12-7-2004. INT. CL. 35.
- PEPSICO, INC., PURCHASE, NY:  
2,150,640, CANC. INT. CL. 30.  
2,151,477, CANC. INT. CL. 30.
- PERE JEANTY, LLC, YOUNTVILLE, CA:  
2,928,844, PUB. 12-7-2004. INT. CL. 29.
- PERMA-POWER ELECTRONICS, INC., CHICAGO, IL:  
768,105, CANC. U.S. CL. 21.
- PERMAFRAME, INC., FORT LAUDERDALE, FL:  
1,865,817, REN. 1-18-05. INT. CL. 20.
- PEROXSYS LTD., WEST BLOOMFIELD, MI:  
2,929,672, INT. CL. 5.
- PERPETUAL STORAGE INC., SANDY, UT:  
1,234,840, CANC. MULTIPLE CLASS, INT. CLS. 35, 39 AND 42.
- PERSONAL MARKETING COMPANY, INC., THE, SHAWNEE MISSION, KS:  
1,950,849, AM. INT. CL. 35.
- PERU INVESTMENTS GROUP, INC., MANCHESTER CENTER, VT:  
2,151,008, CANC. INT. CL. 40.
- PERVASIVE SOFTWARE INC., AUSTIN, TX:  
2,928,856, PUB. 12-7-2004. INT. CL. 9.
- PESTCON SYSTEMS, INC.:  
1,273,596, CANC. INT. CL. 24.
- PETER L. CARNEY & JAMES CONWAY PARTNERSHIP, THE, SALT LAKE CITY, UT:  
2,150,268, CANC. INT. CL. 18.
- PETER STORM COMPANY, BELMONT, CA:  
2,929,555, INT. CL. 14.
- PETERS, ALAN S., SOMERVILLE, MA, DBA ALAN WINTERSPRING:  
2,150,977, CANC. INT. CL. 41.
- PETIT BATEAU VALTON S.A., TROYES, FRANCE:  
1,273,606, CANC. INT. CL. 25.
- PETROCOM, L.L.C., HARAHAH, LA:  
1,931,188, REN. 1-21-05. INT. CL. 38.
- PEWAG, INC., BURR RIDGE, IL:  
2,929,484, INT. CL. 12.
- PGA TOUR, INC., PONTE VEDRA BEACH, FL:  
1,886,083, REN. 1-21-05. INT. CL. 21.
- PHARMASOFT AKTIEBOLAG, UPPSALA, SWEDEN:  
2,151,076, CANC. MULTIPLE CLASS, INT. CLS. 9, 16, 37 AND 42.
- PHEASANT MALL RESTAURANT GROUP, INC., BOSTON, MA, 279, INC., BOSTON, MA:  
1,361,176, REN. 1-19-05. INT. CL. 42.
- PHILIP MORRIS INCORPORATED, RICHMOND, VA:  
2,151,438, CANC. INT. CL. 41.
- PHOENIX LIFE INSURANCE COMPANY, HARTFORD, CT:  
1,876,085, REN. 1-19-05. INT. CL. 36.

- PHOENIX SATELLITE TELEVISION TRADEMARK LIMITED, ROAD TOWN, TORTOLA, BR.VIRGIN ISLANDS FROM BINJI OVERSEAS LIMITED, TORTOLA, BR.VIRGIN ISLANDS:  
2,929,106, INT. CL. 38.
- PHOTOTRON CORPORATION, SAN BERNARDINO, CA:  
1,273,899, CANC. INT. CL. 40.  
1,273,900, CANC. INT. CL. 40.  
1,273,901, CANC. INT. CL. 40.
- PHYSICIANS WORLD COMMUNICATIONS GROUP, SE-CAUCUS, NJ:  
1,830,643, CANC. INT. CL. 41.
- PIAGGIO & C. S.P.A., PONTEDERA, ITALY:  
2,928,453, PUB. 7-13-2004. MULTIPLE CLASS, INT. CLS. 29, 30, 32, 33, 35 AND 42.
- PICCADILLY RESTAURANTS, LLC, BATON ROUGE, LA:  
2,928,770, PUB. 7-20-2004. INT. CL. 43.
- PICK PAY BETRIEBS AG, 8152 GLATTBRUGG, SWITZERLAND:  
2,150,894, CANC. INT. CL. 35.
- PICKENS AGENCY, INC., THE, ALPHARETTA, GA:  
1,273,850, CANC. INT. CL. 36.
- PIGGY TOES, A CHILDREN'S SHOE BOUTIQUE, LLC, CHICAGO, IL:  
2,928,769, PUB. 7-20-2004. INT. CL. 35.
- PIKE, LEWIS JEFFREY, FOREST PARK, GA:  
2,929,683, INT. CL. 41.
- PILGRIM'S PRIDE CORPORATION OF WEST VIRGINIA, INC., PITTSBURG, TX:  
1,273,704, CANC. INT. CL. 29.
- PIZZA HUT, INC., DALLAS, TX, PIZZA HUT, INC., WICHITA, KS:  
1,865,062, REN. 1-18-05. INT. CL. 42.  
1,865,063, REN. 1-18-05. INT. CL. 42.  
1,865,064, REN. 1-18-05. INT. CL. 42.
- PLA, INC., PROVIDENCE, RI:  
1,273,449, CANC. INT. CL. 15.
- PLANET MARKETING INC., NEW YORK, NY:  
2,151,495, CANC. INT. CL. 20.
- PLANET ZOO, LLC, EUGENE, OR:  
2,928,827, PUB. 12-7-2004. INT. CL. 16.
- PLASTICADE PRODUCTS CORPORATION, ROLLING MEADOWS, IL:  
2,151,319, CANC. INT. CL. 20.
- PLASTRONICS SOCKET CO., INC., IRVING, TX:  
1,303,524, REN. 1-19-05. INT. CL. 9.
- PLATFORM COMPUTING CORPORATION, MARKHAM, ONTARIO, CANADA:  
2,928,467, PUB. 12-7-2004. INT. CL. 9.
- PLATINUM FILMS LIMITED, BUCKS, UNITED KINGDOM:  
2,928,755, PUB. 12-7-2004. MULTIPLE CLASS, INT. CLS. 9, 16, 21, 24, 25, 28, 29, 30, 32 AND 41.
- PLATINUM TECHNOLOGY, INC., OAKBROOK TERRACE, IL:  
2,151,198, CANC. INT. CL. 9.
- PLAY CAFE, LLC, SALEM, MA:  
2,929,501, MULTIPLE CLASS, INT. CLS. 41 AND 43.
- PLAYWORLD SYSTEMS, INC., LEWISBURG, PA:  
1,830,426, CANC. INT. CL. 28.
- PLEXUS GROUP, SANTA MONICA, CA TO PLEXUS GROUP, INC, LOS ANGELES, CA:  
1,830,572, CANC. INT. CL. 36.
- PLOGHOFT, PHILIP R., ATHENS, OH:  
2,928,945, PUB. 12-7-2004. INT. CL. 30.
- PLUSNETMARKETING, INC., WILMINGTON, DE:  
2,929,588, MULTIPLE CLASS, INT. CLS. 6 AND 35.
- PMC SERVICE CORP., MOUNT SINAI, NY:  
2,929,356, INT. CL. 35.
- POIRETTE CORSETS, INC., NEW YORK, NY:  
406,586, CANC. U.S. CL. 39.
- POLA CHEMICAL INDUSTRIES, INC., SHIZUOKA-KEN, JAPAN:  
2,150,127, CANC. INT. CL. 3.
- POLLOCK, WILLIAM, SAN FRANCISCO, CA:  
2,150,362, CANC. INT. CL. 16.
- POLOMATE CORPORATION, NEW YORK, NY:  
2,151,410, CANC. INT. CL. 25.
- POLYSOFT CONSULTING, 1202 GENEVA, SWITZERLAND:  
2,150,015, CANC. INT. CL. 9.
- PONCE, PAMELA D., VACAVILLE, CA:  
2,150,921, CANC. INT. CL. 35.
- PONTES, EDWARD JR., BROOKLINE, MA:  
2,929,202, INT. CL. 35.
- POP COVER, INC., ST. PAUL, MN:  
2,929,138, INT. CL. 22.
- POPE AND YOUNG CLUB, CHATFIELD, MN:  
1,305,560, REN. 1-19-05. U.S. CL. 200.
- POPKIN, JEFF, NEEDHAM, MA:  
2,928,589, PUB. 12-7-2004. INT. CL. 41.
- PORCH PLAYERS, INC., MATTAWAN, MI:  
2,929,637, INT. CL. 20.
- PORT OF GRAYS HARBOR, AVERDEEN, WA:  
1,887,497, REN. 1-21-05. INT. CL. 39.
- PORTER ATHLETIC EQUIPMENT COMPANY, BROADVIEW, IL:  
1,851,468, REN. 1-18-05. INT. CL. 16.  
1,852,390, REN. 1-18-05. INT. CL. 16.
- POSTIE'S BEVERAGES, INCORPORATED, MCADOO, PA, DBA POSTIE'S SOFT DRINKS:  
1,273,804, CANC. INT. CL. 32.
- POWER PLUG INC., LATHAM, NY:  
2,929,578, INT. CL. 9.
- POWER, JOHN C., THE SEA RANCH, CA:  
2,929,834, INT. CL. 30.
- POWERCERV TECHNOLOGIES CORPORATION, TAMPA, FL:  
2,151,271, CANC. INT. CL. 9.
- POWERS ROMANIAN PSYCHIC CONNECTION NETWORK, INC., VIRGINIA BEACH, VA:  
2,150,193, CANC. INT. CL. 41.
- POWERTRONIX CORPORATION, FOSTER CITY, CA:  
1,830,230, CANC. INT. CL. 9.
- POWERWARE CORPORATION, RALEIGH, NC, EXIDE ELECTONICS CORPORATION, RALEIGH, NC:  
1,867,549, REN. 1-19-05. INT. CL. 9.
- PPG INDUSTRIES, INC., PITTSBURGH, PA:  
768,057, CANC. U.S. CL. 1.
- PRAIRIE BANK AND TRUST COMPANY, BRIDGEVIEW, IL:  
2,929,035, PUB. 12-7-2004. INT. CL. 36.
- PREMIUM GIFTS ACQUISITION, LLC, BRIELLE, NJ:  
2,150,975, CANC. INT. CL. 35.
- PREMIUM NUTRITIONAL PRODUCTS, INC., LENEXA, KS:  
2,929,187, INT. CL. 31.
- PREMIX-MARBLETITE MANUFACTURING CO., MIAMI, FL:  
1,273,520, CANC. INT. CL. 19.
- PRESCENDO CONSULTING LP, HOUSTON, TX:  
2,928,926, PUB. 12-7-2004. INT. CL. 36.
- PRESSPART GMBH & CO.KG, MARSBERG, FED REP GERMANY:  
2,928,500, PUB. 12-7-2004. INT. CL. 6.
- PRIMARY COLORS, L.L.C., PRAIRIE VILLAGE, KS:  
2,151,010, CANC. INT. CL. 35.
- PRIMECO PERSONAL COMMUNICATIONS, L.P., WESTLAKE, TX:  
2,151,481, CANC. INT. CL. 38.  
2,151,482, CANC. INT. CL. 38.
- PRIMOS TRADING COMPANY, LLC ON BEHALF OF BODEGAS LA CERCA, MONROE TOWNSHIP, NJ:  
2,928,657, PUB. 12-7-2004. INT. CL. 33.
- PRO FOOTBALL, INC., ASHBURN, VA:  
1,861,766, REN. 1-21-05. MULTIPLE CLASS, INT. CLS. 16 AND 25.
- PRO SHOPS AT SOMERTON SPRINGS GOLF, LTD., THE, FEASTERVILLE, PA:  
1,830,630, CANC. MULTIPLE CLASS, INT. CLS. 41 AND 42.
- PRO-ACT MICROBIAL, INC., PORTSMOUTH, RI:  
2,928,912, PUB. 12-7-2004. INT. CL. 1.
- PRO-BODIES INC., CHAMPLAIN, NY:  
2,150,984, CANC. INT. CL. 42.
- PRO-LINER, INC., EVANSDALE, IA:  
2,928,858, PUB. 9-21-2004. INT. CL. 2.

- PROAMICS CORPORATION, LINCOLNSHIRE, IL:  
2,150,684, CANC. MULTIPLE CLASS, INT. CLS. 9, 16 AND 42.
- PROCAPS ENCAPSULATION INC., QUEBEC, CANADA:  
2,929,233, INT. CL. 28.  
2,929,234, INT. CL. 28.  
2,929,235, INT. CL. 28.  
2,929,236, INT. CL. 28.
- PROCTER & GAMBLE COMPANY, THE, CINCINNATI, OH:  
1,823,856, REN. 1-18-05, INT. CL. 29.  
2,151,334, CANC. INT. CL. 30.  
2,929,628, INT. CL. 3.
- PRODIGY SERVICES CORPORATION, WHITE PLAINS, NY:  
2,150,464, CANC. INT. CL. 36.
- PROFORMA INTERIORS LTD., BURNABY, BRITISH COLUMBIA V5J 4M3, CANADA:  
2,928,458, PUB. 12-7-2004, MULTIPLE CLASS, INT. CLS. 6 AND 20.
- PROGRESSIVE VETERINARY SOFTWARE, INC., AGOURA HILLS, CA:  
2,151,522, CANC. INT. CL. 42.
- PROMAG PM LIMITED, BATON ROUGE, LA:  
2,150,413, CANC. INT. CL. 9.
- PROTEON, INC., WESTBOROUGH, MA:  
2,151,318, CANC. INT. CL. 9.
- PROTEXT, INC., BETHESDA, MD:  
1,868,326, REN. 1-19-05, INT. CL. 20.
- PROVIDA LIFE SCIENCES, INC., LOS ANGELES, CA:  
2,929,305, MULTIPLE CLASS, INT. CLS. 9, 16 AND 35.
- PROVIDENCE HARDWARE COMPANY, THE, PROVIDENCE, RI:  
2,928,538, PUB. 12-7-2004, INT. CL. 6.
- PROVIGO CORP., SANTA ROSA, IL:  
1,273,706, CANC. INT. CL. 29.
- PUBLIC BROADCASTING SERVICE, ALEXANDRIA, VA:  
2,150,913, CANC. INT. CL. 42.  
2,929,122, INT. CL. 9.  
2,929,123, INT. CL. 9.
- PUBLIC RADIO INTERNATIONAL, INC., MINNEAPOLIS, MN:  
1,942,243, REN. 1-19-05, INT. CL. 41.
- PURE PLEASURE MUSIC GMBH, 20537 HAMBURG, FED REP GERMANY:  
2,928,953, PUB. 12-7-2004, MULTIPLE CLASS, INT. CLS. 9 AND 35.
- PUREOLOGY RESEARCH, LLC, IRVINE, CA:  
2,928,869, PUB. 12-7-2004, INT. CL. 3.
- PURESONIC ELECTRIC MFG. CO., LTD., TAOYUAN HSIEN, TAIWAN:  
2,150,417, CANC. INT. CL. 9.
- PURPLE PIN DESIGNS LIMITED, KWUN TONG, HONG KONG:  
2,929,238, INT. CL. 25.
- QUAD/GRAPHICS, INC., SUSSEX, WI:  
2,151,486, CANC. INT. CL. 42.
- QUAKER OATS COMPANY, THE, CHICAGO, IL, AMERICAN CEREAL COMPANY, THE, AKRON, OH:  
26,253, REN. 1-19-05, U.S. CL. 46 (INT. CL. 30).
- QUALI TECH, INC., CHASKA, MN:  
1,905,797, REN. 1-18-05, INT. CL. 30.
- QUALITY JUICE & BEVERAGE CORPORATION, TROY, MI:  
2,151,362, CANC. INT. CL. 32.
- QUALITY STEEL FOUNDRIES LTD., NISKU, ALBERTA T9E 7W7, CANADA:  
1,866,201, REN. 1-21-05, INT. CL. 6.
- QUANTM LIMITED, MELBOURNE, AUSTRALIA:  
2,928,698, PUB. 12-7-2004, MULTIPLE CLASS, INT. CLS. 37 AND 42.
- QUAST; MARTIN E., CHASKA, MN:  
768,141, CANC. U.S. CL. 22.
- QUAYSIDE ASSOCIATES, LTD., MIAMI, FL:  
1,273,844, CANC. INT. CL. 36.
- QUESTAR ENERGY SERVICES, INC., SALT LAKE CITY, UT:  
2,928,448, PUB. 12-7-2004, INT. CL. 37.
- QUICK SERVICE TEXTILES, INC., CHICAGO, IL:  
768,236, CANC. U.S. CL. 40.
- QUICKIE DESIGNS INC., FRESNO, CA:  
2,150,300, CANC. INT. CL. 6.
- QUIKSILVER, INC., HUNTINGTON BEACH, CA, RAISIN COMPANY, INC., THE, SAN JUAN CAPISTRANO, CA:  
1,860,943, REN. 1-21-05, MULTIPLE CLASS, INT. CLS. 18 AND 25.
- QUILES, MICHELLE D., JERSEY CITY, NJ:  
2,929,569, INT. CL. 44.
- QUORUM CAPITAL MANAGEMENT LIMITED, LONDON, ENGLAND:  
1,830,885, CANC. INT. CL. 36.
- QVC, INC., WEST CHESTER, PA:  
2,150,903, CANC. INT. CL. 35.  
2,929,843, INT. CL. 25.
- R & E ASSOCIATES, LLC, FRAMINGHAM, MA:  
2,151,492, CANC. INT. CL. 8.
- R.C.T., INC., BONNIE, IL:  
1,866,894, REN. 1-21-05, INT. CL. 11.
- R&J PASTA SNACKS, INC., WILMINGTON, DE:  
2,151,341, CANC. INT. CL. 30.
- RACHETER, DEBRA K., NORFORK, AR:  
2,928,936, PUB. 12-7-2004, INT. CL. 18.
- RACOM CORPORATION, METAIRIE, LA:  
2,150,173, CANC. INT. CL. 40.
- RADWARE LTD., TEL AVIV, ISRAEL:  
2,929,842, INT. CL. 9.
- RAINBOW PLAY SYSTEMS, INC., BROOKINGS, SD:  
2,928,621, PUB. 12-7-2004, INT. CL. 28.
- RAINDANCE COMMUNICATIONS, INC., LOUISVILLE, CO:  
2,929,757, INT. CL. 42.
- RAINING ROSE, INC., CEDAR RAPIDS, IA:  
2,928,900, PUB. 12-7-2004, INT. CL. 3.
- RAJ MANUFACTURING, INC., TUSTIN, CA:  
2,150,132, CANC. INT. CL. 25.
- RALEY'S TM, INC., WEST SACRAMENTO, CA:  
2,929,470, INT. CL. 35.
- RALLY MANUFACTURING, INC., MIAMI, FL:  
2,929,326, INT. CL. 11.
- RAMADA EXPRESS, INC., LAUGHLIN, NV:  
2,150,558, CANC. INT. CL. 41.
- RAMPERSAD, KENNETH, WELLINGTON, FL:  
2,149,979, CANC. INT. CL. 1.
- RAPISTAN SYSTEMS ADVERTISING CORP., GRAND RAPIDS, MI:  
2,928,595, PUB. 12-7-2004, INT. CL. 9.
- RATH, WAYNE, MANLIUS, NY AND RATH, JEAN DUFFY, MANLIUS, NY:  
2,929,879, INT. CL. 41.  
2,929,880, INT. CL. 41.
- RAYNES, BARBARA J., RENTON, WA:  
2,929,858, INT. CL. 25.
- RAYS CO., LTD., OSAKA, JAPAN:  
2,882,854, COR. MULTIPLE CLASS, INT. CLS. 7 AND 12.
- RAZOR & TIE DIRECT, L.L.C., NEW YORK, NY:  
2,929,837, MULTIPLE CLASS, INT. CLS. 35 AND 41.
- RCS LOGISTICS, INC., SPRINGFIELD GARDENS, NY:  
2,929,522, MULTIPLE CLASS, INT. CLS. 35 AND 39.
- READER'S DIGEST ASSOCIATION, INC., THE, PLEASANTVILLE, NY:  
2,151,470, CANC. INT. CL. 16.
- REAL DARTS INTERNATIONAL, INC., SATHARINES, ONTARIO, CANADA:  
2,151,511, CANC. INT. CL. 28.
- REAL ENTERTAINMENT GROUP, PHILADELPHIA, PA:  
2,929,245, MULTIPLE CLASS, INT. CLS. 41 AND 43.
- REAL LIVING, INC., COLUMBUS, OH:  
2,929,600, INT. CL. 36.
- REAL MEASURE CORPORATION, BOULDER, CO:  
2,929,624, MULTIPLE CLASS, INT. CLS. 9, 16 AND 42.
- REALESTATECAREERS.COM, L.L.C., DALLAS, TX:  
2,929,015, PUB. 12-7-2004, INT. CL. 35.
- RECKITT & COLMAN (OVERSEAS) LIMITED, WINDSOR, BERKSHIRE, ENGLAND:  
1,830,094, CANC. INT. CL. 3.
- RECTOR AND VISITORS OF THE UNIVERSITY OF VIRGINIA, THE, CHARLOTTESVILLE, VA:  
2,150,059, CANC. MULTIPLE CLASS, INT. CLS. 25 AND

41.  
 RED LINE SYNTHETIC OIL CORP., BENICIA, CA, NATIONAL PRODUCT GROUP, INC., TULSA, OK:  
 1,331,577. REN. 1-21-05. INT. CL. 4.  
 RED STEER GLOVE COMPANY, SALEM, OR:  
 2,929,277. INT. CL. 9.  
 REDCOM LABORATORIES, INC., FAIRPORT, NY:  
 1,273,394. CANC. INT. CL. 9.  
 REDDING, SAMUEL F., LINCOLN, IL:  
 2,929,544. MULTIPLE CLASS, INT. CLS. 16, 35 AND 41.  
 REDTAIL PRODUCTS, INC., HOUSTON, TX:  
 2,150,231. CANC. MULTIPLE CLASS, INT. CLS. 1 AND 4.  
 REDWOOD COMMUNICATIONS, LLC, VENICE, CA:  
 2,150,562. CANC. MULTIPLE CLASS, INT. CLS. 36 AND 41.  
 REECE COACHING, SAN RAFAEL, CA:  
 2,929,387. INT. CL. 41.  
 REED ELSEVIER PROPERTIES INC., WILMINGTON, DE:  
 1,330,832. REN. 1-21-05. INT. CL. 16.  
 REEMAY, INC., OLD HICKORY, TN:  
 2,929,283. INT. CL. 17.  
 REESE FINER FOODS, INC., DAYTON, OH:  
 1,273,724. CANC. INT. CL. 29.  
 REFLEX CORPORATION OF AMERICA INC., GARDNERVILLE, NV:  
 2,929,411. INT. CL. 25.  
 REGAL INDUSTRIES, INC., PHILADELPHIA, PA, REGAL INDUSTRIES, INC., PHILADELPHIA, PA:  
 1,771,348. REN. 1-21-05. INT. CL. 14.  
 REGENT PACIFIC MANAGEMENT CORPORATION, SAN FRANCISCO, CA:  
 1,870,246. REN. 1-15-05. MULTIPLE CLASS, INT. CLS. 35 AND 36.  
 REGENTS OF THE UNIVERSITY OF MINNESOTA, MINNEAPOLIS, MN:  
 2,929,000. PUB. 12-7-2004. INT. CL. 41.  
 2,929,002. PUB. 12-7-2004. INT. CL. 42.  
 REGIONAL ECONOMIC MODELS, INC., AMHERST, MA:  
 2,929,752. INT. CL. 9.  
 REID, PERRI A., ALPHARETTA, GA:  
 2,929,840. INT. CL. 3.  
 RELATIONSHIP MARKETING, INC., DES MOINES, IA:  
 2,150,365. CANC. INT. CL. 9.  
 RELATIONSHIPS TO SAVOR, INC., SEATTLE, WA:  
 2,150,719. CANC. INT. CL. 42.  
 RELIANCE COMMUNICATIONS, INC., NEW YORK, NY:  
 2,928,617. PUB. 12-7-2004. INT. CL. 38.  
 RELIANCE ORTHODONTIC PRODUCTS, INC., ITASCA, IL:  
 2,928,600. PUB. 12-7-2004. INT. CL. 5.  
 RELIANT ENERGY, INC., HOUSTON, TX:  
 2,929,141. INT. CL. 35.  
 2,929,142. INT. CL. 28.  
 REMY AMERIQUE, INC., NEW YORK, NY:  
 2,149,951. CANC. INT. CL. 33.  
 RENA ENTERPRISES, INC., SINKING SPRING, PA:  
 2,929,307. INT. CL. 25.  
 RENAISSANCE CIGAR COMPANY, INC., THE, MIAMI, FL:  
 2,150,360. CANC. INT. CL. 34.  
 RENAISSANCE, INC., BROOKLYN, NY:  
 1,504,036. CANC. INT. CL. 25.  
 RENATURE SKIN CARE INC., NEW YORK, NY:  
 2,928,875. PUB. 12-7-2004. INT. CL. 3.  
 RENEGADE TOBACCO INC., MOCKSVILLE, NC:  
 2,929,424. INT. CL. 34.  
 REPUBLIC ROLLER CORPORATION, THREE RIVERS, MI:  
 1,830,150. CANC. INT. CL. 7.  
 RETAIL BRAND ALLIANCE, INC., ENFIELD, CT:  
 2,929,663. INT. CL. 3.  
 REVLO CONSUMER PRODUCTS CORPORATION, NEW YORK, NY:  
 2,150,713. CANC. INT. CL. 9.  
 REYNOLDS METALS COMPANY, RICHMOND, VA:  
 2,928,908. PUB. 12-7-2004. INT. CL. 21.  
 RHEA-FX, SAN DIMAS, CA:  
 1,830,433. CANC. INT. CL. 28.  
 RHEOGENE HOLDINGS, INC., WILMINGTON, DE:  
 2,929,545. INT. CL. 5.  
 RHODE ISLAND QUALITY PARTNERS, PROVIDENCE, RI:  
 2,928,666. PUB. 12-7-2004. MULTIPLE CLASS, INT. CLS. 16 AND 35.  
 RHODES COLLEGE, MEMPHIS, TN:  
 2,150,824. CANC. INT. CL. 42.  
 RHODIA INC, CRANBURY, NJ, MIRANOL CHEMICAL COMPANY, INC., SOUTH BRUNSWICK (DAYTON), NJ:  
 1,310,618. REN. 1-20-05. INT. CL. 1.  
 RHODIA INC., CRANBURY, NJ, RHONE-POULENC INC., MONMOUTH JUNCTION, NJ:  
 1,929,545. REN. 1-21-05. INT. CL. 41.  
 RHODIA INC., CRANBURY, NJ:  
 1,931,153. REN. 1-21-05. INT. CL. 41.  
 RICE FOOD MARKETS, INC., HOUSTON, TX:  
 2,151,407. CANC. INT. CL. 29.  
 2,151,408. CANC. INT. CL. 30.  
 RICHARD SIMMONS, A U.S. CITIZEN, AS THE TRUSTEE OF THE RICHARD SIMMONS LIVING TRUST, LOS ANGELES, CA:  
 2,151,252. CANC. INT. CL. 30.  
 RICHARD SIMMONS, A U.S. CITIZEN, AS TRUSTEE OF THE RICHARD SIMMONS LIVING TRUST, LOS ANGELES, CA:  
 2,151,289. CANC. MULTIPLE CLASS, INT. CLS. 18 AND 25.  
 RICHARDE, DAVID, MARQUETTE, MI:  
 2,150,092. CANC. INT. CL. 41.  
 RICHARDSON, MELVIN A., ROANOKE, VA AND RICHARDSON, MARY C., ROANOKE, VA:  
 2,929,240. INT. CL. 41.  
 RICHELIEU ET CIE (EXPORTERS) LIMITED, STELLENBOSCH, SOUTH AFRICA:  
 2,149,957. CANC. INT. CL. 33.  
 RIDLEY BLOCK OPERATIONS, INC., MANKATO, MN:  
 2,929,416. INT. CL. 5.  
 2,929,841. INT. CL. 5.  
 RIGHT PLACE MEDIA, LLC, LEXINGTON, KY:  
 2,928,495. PUB. 12-7-2004. INT. CL. 35.  
 RINGLING MULTIMEDIA CORPORATION, SARASOTA, FL:  
 2,150,240. CANC. INT. CL. 9.  
 RISE LEARNING SOLUTIONS, INC., CINCINNATI, OH FROM RESOURCES AND INSTRUCTION FOR STAFF EXCELLENCE, INC., CINCINNATI, OH:  
 2,929,095. MULTIPLE CLASS, INT. CLS. 9, 16 AND 41.  
 RITTAL GMBH & CO. KG, D-35745 HERBORN, FED REP GERMANY:  
 1,864,541. REN. 1-18-05. MULTIPLE CLASS, INT. CLS. 9, 11 AND 20.  
 RIVERMEN, INC., PEORIA, IL:  
 2,150,189. CANC. INT. CL. 25.  
 RIVIANA FOODS INC., HOUSTON, TX:  
 2,929,855. INT. CL. 30.  
 RMK, INCORPORATED, NEW YORK, NY:  
 2,928,872. PUB. 12-7-2004. INT. CL. 30.  
 ROADFLIGHT, INC., PRINCETON, NJ:  
 1,830,277. CANC. INT. CL. 12.  
 ROBBINS, ANTHONY J., SAN DIEGO, CA:  
 1,830,781. CANC. INT. CL. 9.  
 ROBERT E. OLDS, SAVANNAH, GA:  
 2,855,523. COR. INT. CL. 35.  
 ROCKET SCIENCE, LTD., WINTER PARK, FL:  
 2,150,166. CANC. MULTIPLE CLASS, INT. CLS. 9, 15 AND 25.  
 ROCKLEA SPINNING MILLS PTY. LTD., ABBOTSFORD, VICTORIA, AUSTRALIA:  
 2,150,218. CANC. INT. CL. 25.  
 RODRIGUEZ, RODRI J., STUDIO CITY, CA, DBA MARIACHI USA:  
 2,150,343. CANC. MULTIPLE CLASS, INT. CLS. 14, 16, 20, 25 AND 41.  
 ROLAND, GARY, WINDERMERE, FL:  
 2,928,987. PUB. 12-7-2004. INT. CL. 41.  
 ROMAN SYSTEMS, LTD., HICKORY, NC:  
 2,149,996. CANC. INT. CL. 42.  
 ROMANCE FOODS, L.L.C., AUSTIN, TX:  
 2,929,775. INT. CL. 30.

ROMAR INNOVATIONS, INC., TEMECULA, CA, DBA  
AQUA ULTRAVIOLET:  
2,929,623, INT. CL. 11.

ROPER STARCH WORLDWIDE, NEW YORK, NY, ROPER  
ORGANIZATION, INC., THE, NEW YORK, NY:  
1,000,152, REN. 1-21-05, INT. CL. 42.

ROSE ART INDUSTRIES, INC., LIVINGSTON, NJ:  
2,151,245, CANC. INT. CL. 3.

ROSENBERG, JOAN RIVERS, BEVERLY HILLS, CA:  
2,150,995, CANC. INT. CL. 21.

ROSEVINE ENTERPRISES, ATLANTA, GA:  
2,929,406, INT. CL. 40.

ROSS GRAYSON BELL, LOS ANGELES, CA:  
2,150,137, CANC. INT. CL. 41.

ROSSITER & ASSOCIATES, INC., LITTLE ROCK, AR:  
2,151,513, CANC. INT. CL. 41.

ROTISSER-EEZE BAR-BE-QUE SYSTEMS, LLC, WEST AL-  
LIS, WI:  
2,929,797, INT. CL. 11.

ROUSH BAKERY PRODUCTS CO., INC., CEDAR RAPIDS,  
IA:  
1,273,776, CANC. INT. CL. 30.

ROWE, SHARON L., SOUTHLAKE, TX:  
2,929,866, INT. CL. 16.

ROYAL INSTITUTION OF CHARTERED SURVEYORS,  
THE, LONDON, UNITED KINGDOM:  
2,928,694, PUB. 12-7-2004, MULTIPLE CLASS, INT. CLS.  
35, 36, 37, 41 AND 42.  
2,928,695, PUB. 12-7-2004, MULTIPLE CLASS, INT. CLS.  
35, 36, 37, 41 AND 42.

RTC INDUSTRIES, INC., CHICAGO, IL:  
1,797,865, CANC. INT. CL. 20.

RUBBERMAID INCORPORATED, FREEPORT, IL:  
2,929,787, INT. CL. 21.

RUGER CHEMICAL CO., INC., IRVINGTON, NJ:  
2,150,490, CANC. INT. CL. 1.

RURAL SOUTHERN VOICE FOR PEACE, BURNSVILLE,  
NC:  
2,150,200, CANC. INT. CL. 42.

RUTHER, HUBERT, SEEVETAL, FED REP GERMANY:  
1,281,658, REN. 1-19-05, INT. CL. 28.

RYKOFF-SEXTON, INC., LOS ANGELES, CA:  
1,273,277, CANC. INT. CL. 3.

S & C KABUSHIKI KAISHA, AIKOH-GUN, KANAGAWA-  
KEN, JAPAN:  
2,151,075, CANC. INT. CL. 9.

S & R PRODUCTS, LLC, FOUNTAIN VALLEY, CA, DBA  
SUMMIT SPORTSWEAR:  
2,929,646, INT. CL. 25.

S SMITH & SON PTY LTD, ANGASTON, SOUTH AUSTRA-  
LIA, AUSTRALIA:  
2,150,574, CANC. INT. CL. 33.

S. C. JOHNSON & SON, INC., RACINE, WI:  
2,151,497, CANC. INT. CL. 21.  
2,929,890, INT. CL. 4.

S&F PRODUCTS, PLACENTIA, CA:  
2,928,805, PUB. 12-7-2004, INT. CL. 16.

S&M NUTEC, LLC, NORTH KANSAS CITY, MO:  
2,929,345, INT. CL. 24.

S/R INDUSTRIES, INC., HUNTINGTON BEACH, CA:  
1,369,214, REN. 1-21-05, INT. CL. 28.

SABAN ENTERTAINMENT, INC., LOS ANGELES, CA:  
2,151,248, CANC. INT. CL. 16.  
2,151,472, CANC. INT. CL. 28.  
2,151,473, CANC. INT. CL. 28.

SABATE, BRIAN, HONOLULU, HI:  
2,928,892, PUB. 12-7-2004, INT. CL. 25.

SABERI, MEHRDAD, SAN FRANCISCO, CA:  
2,150,122, CANC. MULTIPLE CLASS, INT. CLS. 35, 37  
AND 42.

SACHS LAWLOR COMPANY, DENVER, CO:  
2,150,752, CANC. INT. CL. 19.

SAFE-T PRODUCTS, INC., LOMBARD, IL:  
2,928,783, PUB. 12-7-2004, MULTIPLE CLASS, INT. CLS. 9  
AND 16.

SAFEWAY STORES, INCORPORATED, OAKLAND, CA:  
768,240, CANC. U.S. CL. 46.

SAGE TECHNOLOGY, INC., SMYRNA, GA:  
2,151,242, CANC. INT. CL. 9.

SAIMA AVANDERO S.P.A., 20139 MILANO, ITALY:  
1,830,612, CANC. INT. CL. 39.

SAJA FOOD PRODUCTS COMPANY, UNION SPRINGS, AL:  
2,151,316, CANC. INT. CL. 29.

SAKURA FINETEK, U.S.A., INC., TORRANCE, CA:  
2,929,777, MULTIPLE CLASS, INT. CLS. 9 AND 10.

SALDINGER, ERIC J., DANVILLE, CA:  
2,150,849, CANC. INT. CL. 9.

SALEM COMMUNICATIONS HOLDING CORPORATION,  
CAMARILLO, CA:  
2,929,515, INT. CL. 41.

SALEWA SPORTGERATE GMBH, D-8011 ASCHEIM, FED  
REP GERMANY:  
1,871,115, REN. 1-21-05, MULTIPLE CLASS, INT. CLS. 9,  
25 AND 28.

SALMANS, SUSANN E., WICHITA, KS:  
2,929,551, INT. CL. 20.

SAMSONITE CORPORATION, DENVER, CO:  
1,273,458, CANC. INT. CL. 16.  
1,875,864, REN. 1-21-05, INT. CL. 9.

SAMSONITE FURNITURE CO.:  
1,273,545, CANC. INT. CL. 20.

SAMSUNG ELECTRO-MECHANICS CO., LTD., KYUNGKI-  
DO, REPUBLIC OF KOREA:  
2,929,746, INT. CL. 9.

SAMSUNG ELECTRONICS CO., LTD., SUWON-CITY,  
KYUNGKI-DO, REPUBLIC OF KOREA:  
2,928,731, PUB. 12-7-2004, INT. CL. 9.

SAMSUNG ELECTRONICS CO., LTD., SUWON-SI,  
GYEONGGI-DO, LAO PEOPLES DEM REP:  
2,929,519, MULTIPLE CLASS, INT. CLS. 7, 9 AND 11.

SAMSUNG ELECTRONICS CO., LTD., SUWON-SI,  
GYEONGGI-DO, REPUBLIC OF KOREA:  
2,929,523, MULTIPLE CLASS, INT. CLS. 7, 9 AND 11.

SAN ANTONIO METROPOLITAN MINISTRY, INC., SAN  
ANTONIO, TX:  
2,929,458, INT. CL. 35.

SAN ANTONIO SHOE, INC., SAN ANTONIO, TX:  
1,830,822, CANC. INT. CL. 25.

SAN PATRIGNANO S.C.A.R.L., 47040 CORIANO RIMINI,  
ITALY:  
2,151,099, CANC. MULTIPLE CLASS, INT. CLS. 6, 19, 20,  
21, 24, 27 AND 37.

SANDRA JORDAN COLLECTION, LLC, HEALDSBURG,  
CA:  
2,929,090, INT. CL. 18.

SANDY'S VENETIAN GARDEN, L.L.C., NOKOMIS, FL:  
2,929,257, INT. CL. 30.

SANITARIOS AZTECA, S.A., 64000, MONTERREY, N.L.,  
MEXICO:  
2,151,258, CANC. INT. CL. 11.

SANKYO COMPANY LIMITED, TOKYO, JAPAN:  
2,928,799, PUB. 12-7-2004, INT. CL. 5.

SANTARUS, INC., SAN DIEGO, CA:  
2,929,881, INT. CL. 5.

SANTUCCI BROTHERS, INC., PHILADELPHIA, PA:  
2,929,426, INT. CL. 43.  
2,929,427, INT. CL. 43.

SANYO NORTH AMERICA CORPORATION, CHATS-  
WORTH, CA:  
2,929,859, INT. CL. 7.

SARA LEE CORPORATION, WINSTON-SALEM, NC:  
1,833,894, REN. 1-21-05, INT. CL. 25.  
2,929,560, INT. CL. 25.

SARA LEE FOODS, INC., CINCINNATI, OH:  
2,150,134, CANC. INT. CL. 29.  
2,151,311, CANC. INT. CL. 29.

SARCOS INVESTMENTS LC, SALT LAKE CITY, UT:  
2,929,064, MULTIPLE CLASS, INT. CLS. 7 AND 9.

SARLEY MEDIA CORP., LOS ANGELES, CA:  
2,928,743, PUB. 12-7-2004, INT. CL. 35.

SASOL GERMANY GMBH, 20537 HAMBURG, FED REP  
GERMANY:  
2,928,724, PUB. 12-7-2004, INT. CL. 1.

SASSABY, INC., CARDIFF, CA:  
2,151,390, CANC. INT. CL. 3.

- SAUL ZAENTZ COMPANY, THE, BERKELEY, CA, DBA TOLKIEN ENTERPRISES:  
2,929,516, INT. CL. 8.
- SAVA KRANJ, SI-64000 KRANJ, SLOVENIA:  
2,150,069, CANC. INT. CL. 12.
- SAVE-A-LOT FOOD STORES, LTD., EARTH CITY, MO, MORAN FOODS, INC., ST. LOUIS, MO:  
1,924,773. REN. 1-21-05. INT. CL. 31.  
1,926,770. REN. 1-21-05. INT. CL. 30.
- SAVIN DIAMOND CORPORATION, NEW YORK, NY:  
2,928,778, PUB. 12-7-2004. INT. CL. 35.
- SAVIOUR WATCHES INTERNATIONAL, INC., KISSIMMEE, FL:  
1,830,293, CANC. INT. CL. 14.
- SAWGRASS SYSTEMS, INC., MT. PLEASANT, SC:  
2,929,197, INT. CL. 2.
- SAWYER BROWN, INC., FRANKLIN, TN, SAWYER BROWN, NASHVILLE, TN:  
1,334,770. REN. 1-21-05. INT. CL. 41.
- SAWYER BROWN, INC., FRANKLIN, TN:  
1,872,597. REN. 1-21-05. MULTIPLE CLASS, INT. CLS. 25 AND 41.
- SCHAFFER SYSTEMS INC., ADAIR, IA:  
2,929,377, INT. CL. 19.
- SCHECHTER, BERNARD, NORTHAMPTON, MA:  
2,568,513, CANC. INT. CL. 5.
- SCHEMALOGIC, INC., REDMOND, WA:  
2,929,019, PUB. 12-7-2004. INT. CL. 9.
- SCHERER, KATHRYN, TEANECK, NJ:  
2,150,179, CANC. INT. CL. 25.
- SCHLUMBERGER WEIN-UND SEKTKELLEREI GMBH, VIENNA, AUSTRIA, KREUTZER, HELGA, A-1100 VIENNA, AUSTRIA:  
1,931,451. REN. 1-21-05. INT. CL. 33.
- SCHNEIDER & KOCH & CO. DATENSYSYSTEME GMBH, 76275 ETTLINGEN, FED REP GERMANY:  
1,830,174, CANC. INT. CL. 9.
- SCHOBER, SCOTT, N. METUCHEN, NJ:  
2,929,568, INT. CL. 9.
- SCHOKO-DRAGEE GMBH, RHEDE, D-46414, FED REP GERMANY:  
2,928,480, PUB. 12-7-2004. MULTIPLE CLASS, INT. CLS. 5, 29 AND 30.
- SCHOLASTIC INC., NEW YORK, NY:  
2,928,556, PUB. 7-20-2004. INT. CL. 16.
- SCHOOL FOR RHYTHMICAL MASSAGE, THE, PHILMONT, NY:  
2,150,736, CANC. INT. CL. 41.
- SCHOTT INTERNATIONAL, INC., AKRON, OH:  
2,929,762, INT. CL. 22.
- SCHROTH, MARY LOUISE, PITTSBURGH, PA, DBA WORLDWIDE TRANSLATIONS:  
2,150,489, CANC. INT. CL. 42.
- SCHUKRA-GERATEBAU ING. WILHELM SCHUSTER GSELLSCHAF T.M.B.H., A-4030 LINZ, AUSTRIA TO SCHUKRA-GERATEBAU GMBH, LEONDING, AUSTRIA:  
1,830,238, CANC. INT. CL. 10.
- SCHULTENOVER, JAMES D., WELLS, ME AND JACOBS, LARRY, WELLS, ME:  
2,928,902, PUB. 12-7-2004. INT. CL. 16.
- SCHUTT GRANDE FORGE, 67114 ESCHAU, FRANCE:  
2,928,655, PUB. 12-7-2004. INT. CL. 6.
- SCHWAN'S IP LLC, MARSHALL, MN:  
2,929,266, MULTIPLE CLASS, INT. CLS. 29, 30 AND 32.
- SCHWAN'S SALES ENTERPRISES, INC., MARSHALL, MN:  
2,150,102, CANC. INT. CL. 30.
- SCHWANS IP, LLC, MARSHALL, MN, FLOWERS FAMILY BAKERIES, INC., WILMINGTON, DE:  
1,897,641. REN. 1-19-05. INT. CL. 29.
- SCIENTECH, LLC, IDAHO FALLS, ID:  
2,150,842, CANC. INT. CL. 42.
- SCIENTIFIC-ATLANTA, INC., LAWRENCEVILLE, GA:  
2,929,570, INT. CL. 9.
- SCIQUEST, INC., MORRISVILLE, NC:  
2,929,161, INT. CL. 35.
- SCIUS CORPORATION, REDMOND, WA:  
2,151,307, CANC. INT. CL. 9.
- SCORES HOLDING COMPANY INC., NEW YORK, NY:  
1,830,135, CANC. MULTIPLE CLASS, INT. CLS. 6, 41 AND 42.
- SCORPION FASTENERS, INC., EAST WINDSOR, CT:  
2,928,846, PUB. 12-7-2004. MULTIPLE CLASS, INT. CLS. 7 AND 8.
- SCOTSMAN GROUP INC., VERNON HILLS, IL:  
2,929,460, INT. CL. 11.
- SCREENLIFE, LLC, SEATTLE, WA:  
2,929,826, MULTIPLE CLASS, INT. CLS. 9 AND 28.
- SCRIPPS BASEBALL GROUP, INC., AUGUSTA, GA:  
2,150,178, CANC. INT. CL. 25.
- SEA-RICH SEAFOODS, INC., NEW BEDFORD, MA TO AMERICAN GEM SEAFOODS, KIRKLAND, WA:  
1,830,456, CANC. INT. CL. 29.
- SEALED AIR CORPORATION (US), SADDLE BROOK, NJ:  
2,928,761, PUB. 12-7-2004. MULTIPLE CLASS, INT. CLS. 16 AND 17.  
2,929,713, INT. CL. 1.
- SEALED UNIT PARTS CO., INC., ALLENWOOD, NJ:  
2,928,954, PUB. 12-7-2004. INT. CL. 7.
- SEALSOURCE, LLC, OREM, UT:  
2,929,617, INT. CL. 2.
- SEARS, PH.D., BARRY D., DANVERS, MA:  
2,929,836, INT. CL. 16.
- SEBASTIAN INTERNATIONAL, INC., WOODLAND HILLS, CA:  
2,150,019, CANC. INT. CL. 3.
- SEBASTIAN; JOHN F., NEWTON SQUARE, PA:  
768,291, CANC. U.S. CL. 103.
- SEBASTIANI VINEYARDS INC., SONOMA, CA:  
2,928,730, PUB. 12-7-2004. MULTIPLE CLASS, INT. CLS. 29, 30 AND 33.
- SEBONAC NECK HOLDINGS LLC, MELVILLE, NY:  
2,928,590, PUB. 12-7-2004. INT. CL. 41.
- SECA CORPORATION, COLUMBIA, MD:  
2,150,730, CANC. INT. CL. 9.
- SECURITY ARMORED EXPRESS, INC., HELENA, MT:  
2,929,005, PUB. 12-7-2004. INT. CL. 9.
- SECURITY FINANCIAL LIFE INSURANCE COMPANY, LINCOLN, NE:  
2,929,247, INT. CL. 36.
- SEGBRECHT, LINDA, OVERLAND PARK, KS AND BECICKA, CHRIS, OVERLAND PARK, KS:  
2,929,660, INT. CL. 41.
- SEGEL, ALAN J., BRYN MAWR, PA:  
2,929,420, INT. CL. 35.
- SEGUE SOFTWARE, INC., LEXINGTON, MA:  
2,928,915, PUB. 12-7-2004. INT. CL. 42.
- SEMCO INCORPORATED, COLOMBIA, MO:  
2,151,355, CANC. INT. CL. 9.
- SENCO PRODUCTS, INC., CINCINNATI, OH:  
2,150,582, CANC. INT. CL. 6.
- SENNHEISER ELECTRONIC CORPORATION, OLD LYME, CT, SENNHEISER ELECTRONIC CORPORATION, NEW YORK, NY:  
1,308,693. REN. 1-19-05. INT. CL. 9.
- SENS CORPORATION, IRVINE, CA:  
2,929,828, INT. CL. 9.
- SEOUL HANDBAG MANUFACTURERS COOPERATIVE, SEOUL, REPUBLIC OF KOREA:  
2,151,214, CANC. INT. CL. 18.
- SEQUOIA BARK SALES, ORANGE COVE, CA:  
2,928,889, PUB. 12-7-2004. INT. CL. 1.
- SERVICEMASTER INDUSTRIES INC., DOWNERS GROVE, IL, WADE, WENGER SERVICEMASTER CO., CHICAGO, IL:  
782,584. REN. 1-18-05. U.S. CL. 103 (INT. CL. 37).
- SEXUAL HEALTH MAGAZINE, INC., NEW YORK, NY:  
2,151,534, CANC. INT. CL. 16.
- SEYMOUR, JUDY A., PHOENIX, AZ, DBA WE MAKE IT PERSONAL:  
1,862,109. REN. 1-21-05. INT. CL. 42.
- SFS STADLER AG, ALTSTATTEN (ST. GALL), SWITZERLAND:  
1,273,304, CANC. MULTIPLE CLASS, INT. CLS. 6, 7 AND 17.

- SHAMROCK SWINE GENETICS, INC., SHEDDEN, ONTARIO, CANADA:  
2,150,030, CANC. MULTIPLE CLASS, INT. CLS. 5, 31 AND 42.
- SHANGHAI DAYING MEAT & BIRDS JOINT COMPANY, SHANGHAI 201712, CHINA:  
2,150,605, CANC. INT. CL. 29.
- SHARON REDD INC, ROWLETT, TX:  
2,928,842, PUB. 12-7-2004. INT. CL. 44.
- SHARPER IMAGE CORPORATION, SAN FRANCISCO, CA:  
2,928,740, PUB. 12-7-2004. MULTIPLE CLASS, INT. CLS. 16 AND 35.
- SHARTEX INTERNATIONAL TRADING CO., LTD., SHANGHAI, CHINA:  
2,928,809, PUB. 12-7-2004. INT. CL. 25.
- SHELL ARTISTREE LLC, FAIRFAX, VA:  
2,929,339, MULTIPLE CLASS, INT. CLS. 16 AND 35.
- SHELL TRADEMARK MANAGEMENT B.V., THE HAGUE, NETHERLANDS:  
2,928,744, PUB. 12-7-2004. INT. CL. 4.
- SHENANDOAH BREWING COMPANY, ALEXANDRIA, VA:  
2,150,202, CANC. INT. CL. 32.
- SHERLOCK HOLMES LTD., MIAMI, FL:  
1,902,732. REN. 1-19-05. INT. CL. 18.
- SHERPA SOFTWARE GROUP, INC., BRIDGEVILLE, PA:  
2,929,798, INT. CL. 9.
- SHERWIN-WILLIAMS COMPANY, THE, CLEVELAND, OH:  
2,151,081, CANC. INT. CL. 25.
- SHERWOOD SERVICES AG, SCHAFFHAUSEN, SWITZERLAND:  
1,307,895. REN. 1-19-05. INT. CL. 10.
- SHERWOOD-DROLET CORPORATION LTD., SHERBROOKE, PROVINCE OF QUEBEC, CANADA:  
1,273,685, CANC. INT. CL. 28.
- SHIOCTON KRAUT COMPANY, INC., SHIOCTON, WI:  
1,273,744, CANC. INT. CL. 29.
- SHIPP, PATRICK, TOLEDO, OH:  
2,929,772, INT. CL. 6.
- SHIPYARD BREWING COMPANY, LLC, PORTLAND, ME:  
2,928,980, PUB. 12-7-2004. INT. CL. 32.
- SHISEIDO COMPANY, LTD., TOKYO, JAPAN:  
2,929,756, INT. CL. 3.
- SHOCKWAVE CREATIONS INC., LOS ANGELES, CA:  
2,151,371, CANC. INT. CL. 25.
- SHOE MAKER S.R.L., BARLETTA (BA), ITALY:  
2,928,613, PUB. 12-7-2004. INT. CL. 25.
- SHORTER, DEANDRE BERNARD, WATER'S EDGE DRIVE, GA:  
2,929,584, INT. CL. 25.
- SHOUP MANUFACTURING COMPANY, KANKAKEE, IL:  
2,151,345, CANC. INT. CL. 6.
- SHOWCASE MANAGEMENT, INC., HATFIELD, PA:  
2,928,767, PUB. 12-7-2004. MULTIPLE CLASS, INT. CLS. 35 AND 36.
- SHOYEIDO CORPORATION, BOULDER, CO:  
1,866,667. REN. 1-18-05. INT. CL. 3.
- SHRINKSAFE SYSTEMS LLC, LINCOLN UNIVERSITY, PA:  
2,929,729, INT. CL. 17.
- SHRIRAM FOODS, HILLSBORO, OR:  
2,928,851, PUB. 12-7-2004. INT. CL. 30.
- SICOR INC., IRVINE, CA:  
2,928,833, PUB. 12-7-2004. INT. CL. 5.
- SIEBE NORTH, INC., CHARLESTON, SC:  
1,273,407, CANC. INT. CL. 9.
- SIEMENS A.G., MUNICH 2, FED REP GERMANY:  
1,273,411, CANC. INT. CL. 10.
- SIEMENS POWER CORPORATION, MILWAUKEE, WI:  
2,150,057, CANC. INT. CL. 7.
- SIERRA HOLDINGS, LLC, GREENSBORO, NC:  
2,929,167, MULTIPLE CLASS, INT. CLS. 35 AND 37.
- SIGMA DELTA PI, NATIONAL COLLEGIATE HISPANIC HONOR SOCIETY, CHARLESTON, SC:  
2,928,757, PUB. 12-7-2004. U.S. CL. 200.
- SIGNAL INDUSTRIES, INC., BOSTON, MA:  
2,150,998, CANC. INT. CL. 20.
- SILBERSTEIN, IVY, NEW YORK, NY:  
2,928,762, PUB. 12-7-2004. INT. CL. 41.
- SILHOUET-TONE LTD., MONTREAL, QUEBEC, CANADA:  
2,928,668, PUB. 12-7-2004. INT. CL. 8.
- SILICON MAGIC CORPORATION, CUPERTINO, CA:  
2,150,424, CANC. INT. CL. 9.
- SILVER PINES VINEYARD LLC, SANTA ROSA, CA:  
2,929,865, INT. CL. 33.
- SILVEROFFICE, INC., SAN FRANCISCO, CA:  
2,929,703, INT. CL. 42.
- SIMMONS OUTDOOR CORPORATION, IRVINE, CA, SIMMONS OUTDOOR CORPORATION, IRVINE, CA:  
1,852,889. REN. 1-18-05. INT. CL. 9.
- SIMMONS OUTDOOR CORPORATION, IRVINE, CA:  
1,937,166. REN. 1-20-05. INT. CL. 9.
- SIMMONS, JOHN M., HEMLOCK, MI AND SIMMONS, TOM M., HEMLOCK, MI AND SIMMONS, JACK (NMI), HEMLOCK, MI:  
2,150,495, CANC. INT. CL. 9.
- SIMPEX INTERNATIONAL TRADING, INC., ELK RIDGE, MD:  
1,830,698, CANC. INT. CL. 42.
- SIMPLE WISHES, INC., LA QUINTA, CA:  
2,929,737, INT. CL. 28.
- SIMPLOT PROCESSOR, INC., BOISE, ID:  
768,244, CANC. U.S. CL. 46.
- SIMPSON PRINT LIMITED, TYNE & WEAR, UNITED KINGDOM:  
2,928,810, PUB. 12-7-2004. INT. CL. 16.
- SIMUCAD, INC., SANTA CLARA, CA:  
2,928,933, PUB. 12-7-2004. INT. CL. 9.
- SIPLAST, INC., ARKADDELPHIA, AR:  
2,929,631, INT. CL. 19.
- SIROIS, MICHAEL A., DOVER, NH, DBA ON TARGET TECHNOLOGIES, LLC:  
2,928,765, PUB. 12-7-2004. INT. CL. 13.
- SISTERS OF THE SEA, JACKSONVILLE BEACH, FL:  
2,929,476, MULTIPLE CLASS, INT. CLS. 25 AND 41.
- SJS FOOD IMPORTERS, INC., BEDFORD PARK, NY:  
2,151,291, CANC. INT. CL. 29.
- SK ENTERPRISES, INC., NEWBURGH, NY:  
2,929,079, MULTIPLE CLASS, INT. CLS. 7 AND 8.
- SKELETAL KINETICS, LLC, CUPERTINO, CA:  
2,929,312, MULTIPLE CLASS, INT. CLS. 5 AND 10.
- SKILA, INC., MAHWAH, NJ:  
2,150,290, CANC. INT. CL. 9.
- SKIPPACK CREEK CORPORATION, WILMINGTON, DE, PPC ACQUISITION CO. (RENAMED PACKERLAND PACKING COMPANY, INC.), GREEN BAY, WI:  
1,914,233. REN. 1-18-05. INT. CL. 29.
- SKONECKI, DEBRA, TOLEDO, OH, DBA THE ROYAL ROSE:  
1,830,498, CANC. INT. CL. 31.
- SKYRON, INC., NEW YORK, NY:  
2,150,867, CANC. INT. CL. 35.
- SK8MAFIA, SAN DIEGO, CA:  
2,929,806, INT. CL. 25.
- SLAUGHTER, CARECE H., CARROLLTON, TX:  
2,928,911, PUB. 12-7-2004. INT. CL. 35.
- SMART DOCUMENT SOLUTIONS, LLC, ALPHARETTA, GA:  
2,928,863, PUB. 12-7-2004. INT. CL. 9.
- SMITH ANDERSON ENTERPRISES INC., HUNTINGTON PARK, CA:  
2,150,985, CANC. INT. CL. 33.
- SMITH, GAYLE, JACKSONVILLE, FL, DBA THE FLOODED SWAMP COMPANY:  
2,150,486, CANC. INT. CL. 16.
- SMITH, KEELY, PALM SPRINGS, CA:  
2,929,176, INT. CL. 41.
- SMITHBURG, INC., KEY WEST, FL:  
2,928,857, PUB. 12-7-2004. MULTIPLE CLASS, INT. CLS. 25 AND 43.
- SMITHKLINE BEECHAM CORPORATION, PHILADELPHIA, PA:  
2,151,363, CANC. INT. CL. 42.  
2,929,043, PUB. 12-7-2004. INT. CL. 21.
- SMITHKLINE BEECHAM P.L.C., BRENTFORD, MIDDLESEX, UNITED KINGDOM:  
2,928,773, PUB. 7-20-2004. INT. CL. 5.

- SNIDER, MARIE, NORTH NEWTON, KS:  
1,830,364, CANC. INT. CL. 16.
- SNOWDEN PENCER, INC., TUCKER, GA:  
2,928,947, PUB. 12-7-2004. INT. CL. 10.
- SNR TECHNOLOGIES GROUP, LLC, NEWBERRY, FL:  
2,928,786, PUB. 12-7-2004. INT. CL. 38.
- SNYDER, DOUGLAS D., BERGHOLZ, OH:  
2,929,165, INT. CL. 9.
- SOBRINCA - BRINQUEDOS E UTILIDADES PARA CRIANCA, LDA., 4535 LOUROSA, PORTUGAL:  
2,150,609, CANC. MULTIPLE CLASS, INT. CLS. 12 AND 20.
- SOCIALTECH, INC., SAN MATEO, CA:  
2,929,868, INT. CL. 45.
- SOCIETE DELSEY, BOBIGNY, FRANCE:  
1,273,508, CANC. INT. CL. 18.
- SOCIETE DES PRODUITS NESTLE S.A., 1800 VEVEY, SWITZERLAND:  
2,928,855, PUB. 12-7-2004. INT. CL. 5.
- SODASTREAM LIMITED, WOODSTON, PETERBOROUGH, UNITED KINGDOM:  
1,273,241, CANC. MULTIPLE CLASS, INT. CLS. 1, 6, 7, 32 AND 37.
- SODEXHO OPERATIONS, LLC, GAITHERSBURG, MD:  
2,928,727, PUB. 12-7-2004. INT. CL. 9.
- SOFA CONNECTION, INC., MADISON, TN:  
2,929,704, INT. CL. 35.
- SOFTBANK EXPOSITION AND CONFERENCE CO., L.P., FOSTER CITY, CA:  
2,151,083, CANC. INT. CL. 41.
- SOFTWARE PRODUCTIVITY RESEARCH, LLC, MARLBOROUGH, MA:  
2,151,413, CANC. INT. CL. 9.
- SOFTWARE SERVICES CORPORATION, ANN ARBOR, MI:  
2,150,056, CANC. INT. CL. 42.
- SOLAGRAN PTY LTD, MELBOURNE VICTORIA, AUSTRALIA:  
2,929,055, MULTIPLE CLASS, INT. CLS. 3 AND 5.
- SOLEMATES LLC, WASHINGTON, DC:  
2,928,639, PUB. 12-7-2004. INT. CL. 35.
- SOLID FLUE CHIMNEY SYSTEMS, INC., GRAND RAPIDS, MI, AMERICAN CHIMNEY LINING SYSTEMS, INC., BYRON CENTER, MI:  
1,308,034, REN. 1-18-05. INT. CL. 19.
- SOLOMON, KAREN, SEBASTOPOL, CA:  
2,929,459, INT. CL. 41.
- SOMMERS, J. F., BRYAN COUNTY, GA, DBA EL CHEAPO FUEL STOP:  
1,273,866, CANC. INT. CL. 37.
- SONG, CHON SIN, RONKONKOMA, NY:  
2,151,297, CANC. INT. CL. 25.
- SONY KABUSHIKI KAISHA, TOKYO, JAPAN, TA SONY CORPORATION:  
2,151,158, CANC. INT. CL. 9.  
2,151,285, CANC. INT. CL. 9.
- SONY KABUSHIKI KAISHA, TOKYO 141, JAPAN, TA SONY CORPORATION:  
2,929,093, INT. CL. 9.
- SONY KABUSHIKI KAISHA, TOKYO, JAPAN, TA SONY CORPORATION:  
2,929,177, INT. CL. 9.
- SORANNO, RICHARD S., LAS VEGAS, NV:  
2,928,930, PUB. 12-7-2004. INT. CL. 41.
- SOURCE MEDIA, INC., NEW YORK, NY, AKA AB HOLDING INC., NRS SYSTEMS, INC., LAKEVILLE, CT:  
1,870,197, REN. 1-19-05. INT. CL. 42.
- SOUTHCO, INC., CONCORDVILLE, PA:  
1,830,141, CANC. INT. CL. 6.
- SOUTHEASTERN FREIGHT LINES, INC., COLUMBIA, SC:  
2,151,051, CANC. INT. CL. 39.  
2,151,052, CANC. INT. CL. 39.
- SOUTHERN COMFORT PROPERTIES, INC., SAN RAFAEL, CA:  
2,151,533, CANC. INT. CL. 33.
- SOUTHERN GRAIN, UVALDE, TX:  
2,929,254, INT. CL. 31.
- SOUTHLAND NATIONAL INSURANCE CORPORATION, TUSCALOOSA, AL:  
2,150,833, CANC. INT. CL. 36.
- SOUTHTRUST CORPORATION, BIRMINGHAM, AL:  
1,307,405, REN. 1-18-05. INT. CL. 36.
- SOUTHWEST RESEARCH INSTITUTE, SAN ANTONIO, TX:  
2,929,324, INT. CL. 9.  
2,929,325, INT. CL. 9.
- SOUTHWESTERN VERMONT HEALTH CARE, BENNINGTON, VT:  
2,929,242, INT. CL. 44.  
2,929,243, INT. CL. 16.
- SPACE NEEDLE CORPORATION, SEATTLE, WA:  
1,273,583, CANC. INT. CL. 21.
- SPAFIT, LLC, DALLAS, TX:  
2,928,764, PUB. 12-7-2004. INT. CL. 35.
- SPARTA INDUSTRIES, INC., SPARTA, NC:  
1,273,823, CANC. INT. CL. 34.
- SPATIAL DATA ANALYTICS CORPORATION, MCLEAN, VA:  
2,928,606, PUB. 12-7-2004. INT. CL. 42.
- SPECIALTY POLYMER COATINGS, INC., LANGLEY, BRITISH COLUMBIA, CANADA:  
2,928,496, PUB. 12-7-2004. MULTIPLE CLASS, INT. CLS. 16, 25, 28 AND 37.
- SPECTRA-PHYSICS LASERS, INC., MOUNTAIN VIEW, CA:  
1,830,223, CANC. INT. CL. 9.
- SPECTRONICS CORPORATION, WESTBURY, NY:  
768,175, CANC. U.S. CL. 26.
- SPECTRUM DIAMON-KOTE INC., SALT LAKE CITY, UT:  
2,149,995, CANC. INT. CL. 40.
- SPEED MEASUREMENT LABORATORIES, INC., FORT WORTH, TX:  
2,928,737, PUB. 12-7-2004. U.S. CL. A.
- SPEEDWARE CORPORATION INC., RICHMOND HILL, ONTARIO, CANADA:  
1,935,311, REN. 1-21-05. INT. CL. 9.
- SPENCER AIRCRAFT INDUSTRIES, INC., SEATTLE, WA:  
1,273,420, CANC. INT. CL. 11.
- SPICE OF NEW ORLEANS, INC., THE, METAIRIE, LA:  
2,150,267, CANC. INT. CL. 30.
- SPIEGEL CATALOG HOLDINGS CORPORATION, NEW YORK, NY:  
1,840,600, REN. 1-21-05. INT. CL. 25.  
1,871,948, REN. 1-21-05. INT. CL. 25.
- SPIELO MANUFACTURING INCORPORATED, MONCTON, NEW BRUNSWICK, CANADA:  
2,929,730, INT. CL. 9.
- SPIKE'S HOLDING, LLC, INDIANAPOLIS, IN:  
2,929,412, INT. CL. 25.
- SPIN MASTER LTD, TORONTO, ONTARIO M5V 1B6, CANADA:  
2,929,315, INT. CL. 28.
- SPINAL CONCEPTS, INC., AUSTIN, TX:  
2,929,096, INT. CL. 10.
- SPINTEK FILTRATION, INC., LOSE ANGELES, CA:  
1,854,025, REN. 1-18-05. INT. CL. 7.
- SPIRIT RENT-A-CAR, INC., FORT LAUDERDALE, FL:  
2,150,779, CANC. INT. CL. 39.
- SPORTS OUTREACH AMERICA, PASADENA, CA:  
2,150,051, CANC. INT. CL. 42.
- SPRAYING SYSTEM CO., WHEATON, IL:  
781,948, REN. 1-19-05. U.S. CL. 13 (INT. CL. 6).
- SPRING MEADOW NURSERY, INC., GRAND HAVEN, MI:  
2,929,020, PUB. 12-7-2004. INT. CL. 31.
- SPRINT COMMUNICATIONS COMPANY L.P., OVERLAND PARK, KS:  
2,929,591, INT. CL. 38.
- SQUARE FOREST, INC., BOCA RATON, FL:  
2,928,555, PUB. 7-20-2004. INT. CL. 16.
- SQUARE TECHNOLOGY, L.L.C., CHESTNUT HILL, MA:  
2,150,099, CANC. INT. CL. 28.  
2,150,100, CANC. INT. CL. 28.
- SR HOLDINGS INC., LEXINGTON, MA:  
1,819,293, REN. 1-18-05. INT. CL. 42.
- ST TRAINING & SIMULATION PTE LTD, SINGAPORE:  
2,928,659, PUB. 9-14-2004. MULTIPLE CLASS, INT. CLS. 9, 41 AND 42.



STABAR ENTERPRISES, INC., AVON, CT:  
2,151,204, CANC. INT. CL. 5.

STACKED STYLE, INC., LOS ANGELES, CA:  
2,928,903, PUB. 12-7-2004. INT. CL. 3.

STANDEX INTERNATIONAL CORPORATION, SALEM,  
NH, GENERAL SLICING MACHINE CO., INC., WALDEN,  
NY:  
604,422. REN. 1-20-05. U.S. CL. 21 (INT. CL. 7).

STANLEY SMITH SECURITY, INC., SAN ANTONIO, TX,  
DBA INITIAL SECURITY:  
2,928,923, PUB. 12-7-2004. INT. CL. 45.

STARCHILD, ADAM, LONGWOOD, FL:  
2,150,304, CANC. INT. CL. 25.

STARFISH SOFTWARE, INC., SCOTTS VALLEY, CA:  
2,150,074, CANC. INT. CL. 9.

STARKES, RAYMOND H, III, LANHAM, MD:  
2,150,425, CANC. INT. CL. 36.

STARLINE VAN COMPANY, INC., AIBION, IN:  
1,273,435, CANC. MULTIPLE CLASS, INT. CLS. 12 AND  
37.

STARNUMBER, INC., WASHINGTON, DC:  
2,928,910, PUB. 12-7-2004. INT. CL. 38.

STARWATCHER GRAPHICS, INC., RESEDA, CA:  
1,830,410, CANC. INT. CL. 25.  
1,830,427, CANC. INT. CL. 28.

STAT RADIOLOGY MEDICAL CORPORATION, LA JOLLA,  
CA:  
2,929,633, INT. CL. 44.

STATACORP, L.P., COLLEGE STATION, TX:  
1,371,080. REN. 1-21-05. INT. CL. 9.

STATE OF IDAHO, BOISE, ID:  
2,929,465, INT. CL. 14.

STATION CASINOS, INC., LAS VEGAS, NV, DBA PALACE  
STATION HOTEL & CASINO:  
1,920,433. REN. 1-21-05. INT. CL. 42.

STAUFFER COMMUNICATIONS, INC., TOPEKA, KS:  
1,273,983, CANC. INT. CL. 42.

STAUFFER, DENNIS A., PLYMOUTH, MN:  
2,928,984, PUB. 12-7-2004. INT. CL. 41.

STEDMAN CORPORATION, ASHEBORO, NC:  
768,215, CANC. U.S. CL. 39.

STEMCELL TECHNOLOGIES INC., VANCOUVER BRITISH  
COLUMBIA, CANADA:  
2,928,756, PUB. 12-7-2004. INT. CL. 1.

STEPHAN CO., THE, FORT LAUDERDALE, FL:  
2,929,771, INT. CL. 3.

STEPHEN BURLINGHAM, INC., PRINCETON, NJ:  
2,929,529, INT. CL. 3.

STEPP FOUNDATION, INC., GOLDEN, CO:  
2,929,580, INT. CL. 35.

STETHOSCOPE HOLSTER, INC., PINELLAS PARK, IL:  
2,929,367, INT. CL. 10.

STEVE SPANGLER, INC., ENGLEWOOD, CO:  
2,928,946, PUB. 12-7-2004. INT. CL. 17.

STILES, DAVID L., WHEELING, WV:  
2,151,005, CANC. INT. CL. 28.

STILLMAN, DAVID A., MINNETONKA, MN:  
2,151,197, CANC. MULTIPLE CLASS, INT. CLS. 9 AND  
42.

STIMPERT, BARRY, BUCKLIN, KS:  
2,150,907, CANC. INT. CL. 29.

STOCK BUILDING SUPPLY HOLDINGS, INC., RALEIGH,  
NC:  
2,146,932, CANC. MULTIPLE CLASS, INT. CLS. 6, 19  
AND 20.

STOGIES, L.L.C., GLEN ALLEN, VA:  
2,150,761, CANC. INT. CL. 35.

STOLLE MILK BIOLOGICS, INC., CINCINNATI, OH:  
2,929,087, INT. CL. 32.

STORACTIVE, INC., MARINA DEL REY, CA:  
2,928,772, PUB. 12-7-2004. MULTIPLE CLASS, INT. CLS. 9  
AND 42.

STRATFORD VENTURES, LITHIA SPRINGS, GA:  
2,929,340, INT. CL. 5.

STRAYER-VOIGT INC, GRAND PRAIRIE, TX:  
2,929,027, PUB. 12-7-2004. INT. CL. 13.

STREETWISE MAPS INC., SARASOTA, FL:  
2,928,735, PUB. 12-7-2004. INT. CL. 35.

STRICKLAND, ROY T., JR., GOLDSBORO, NC:  
2,100,753, CANC. INT. CL. 28.

STRIKE KING LURE COMPANY, COLLIERVILLE, TN:  
1,830,429, CANC. INT. CL. 28.

STRUCTURED DATA SYSTEMS PTY LTD, MELBOURNE,  
VICTORIA, AUSTRALIA FROM TABCORP ASSETS PTY  
LIMITED, MELBOURNE, VICTORIA, AUSTRALIA:  
2,929,895, MULTIPLE CLASS, INT. CLS. 36 AND 41.

STURDY SAVINGS BANK, CAPE MAY COURT HOUSE, NJ:  
1,888,855. REN. 1-19-05. INT. CL. 36.  
1,888,856. REN. 1-19-05. INT. CL. 36.

STYLE TREND STUDIOS, INC., DELRAY BEACH, FL:  
2,929,381, INT. CL. 21.  
2,929,382, INT. CL. 21.

SULLIVAN REALTY LLC, PEPPER PIKE, OH:  
2,929,740, INT. CL. 36.

SUMITOMO CHEMICAL COMPANY, LTD., CHUO-KU,  
TOKYO 104-8260, JAPAN:  
783,475. REN. 1-18-05. U.S. CL. 6 (INT. CLS. 1, 2, 3, 4 AND  
5).

SUN LIFE OF ASSURANCE COMPANY OF CANADA,  
WELLESLEY HILLS, MA, DBA SUN LIFE OF CANADA  
AND SUN LIFE OF ASSURANCE COMPANY OF CANA-  
DA, TORONTO, CANADA, DBA SUN LIFE OF CANADA:  
1,273,865, CANC. INT. CL. 36.

SUN MICROSYSTEMS, INC., SANTA CLARA, CA:  
1,867,206. REN. 1-18-05. MULTIPLE CLASS, INT. CLS. 37  
AND 42.

SUNBEAM CORPORATION, OAK BROOK, IL:  
768,174, CANC. U.S. CL. 26.

SUNDOWNER, INC., LAUREL, MD:  
2,151,396, CANC. INT. CL. 11.

SUNKIST GROWERS, INC., SHERMAN OAKS, CA:  
1,372,857. REN. 1-18-05. INT. CL. 29.

SUNSHINE HEALTH GROUP, INC., ORLANDO, FL:  
2,150,357, CANC. INT. CL. 5.

SUNSTAR INC., OSAKA-FU, JAPAN:  
2,150,308, CANC. MULTIPLE CLASS, INT. CLS. 5, 10  
AND 21.

SUPER LAWN TRUCK, INC., BONAIRE, GA:  
2,928,523, PUB. 12-7-2004. INT. CL. 12.

SUPERGRAPHICS, INC., SUNNYVALE, CA:  
2,151,519, CANC. INT. CL. 40.

SUPERIOR CONSULTING SERVICES, INC., TAVARES, FL:  
2,928,465, PUB. 12-7-2004. INT. CL. 42.

SUPERTEK INTERNATIONAL PRODUITS TELE INC., ST-  
LAURENT, QUEBEC, CANADA:  
2,150,049, CANC. INT. CL. 3.

SUPERVALU HOLDINGS, INC., EDEN PRAIRIE, MN:  
2,929,026, PUB. 12-7-2004. INT. CL. 9.

SUPPORTSOFT, INC., REDWOOD CITY, CA FROM PIN-  
CUS, MARK J., SAN FRANCISCO, CA:  
2,929,050, INT. CL. 9.

SURE-FIT TRUCK RACKS, CARSON CITY, NV:  
2,929,372, INT. CL. 12.

SUTTER HOME WINERY, INC., ST. HELENA, CA:  
2,928,736, PUB. 12-7-2004. INT. CL. 33.

SUZUKA FUJI XEROX KABUSHIKI KAISHA, SUZUKA-  
SHI, MIE, JAPAN, DBA SUZUKA FUJI XEROX CO., LTD.:  
2,929,054, MULTIPLE CLASS, INT. CLS. 1, 16 AND 40.

SVENGALI MERCHANDISING INCORPORATED, NEW  
YORK, NY:  
2,150,970, CANC. INT. CL. 25.  
2,150,972, CANC. INT. CL. 25.

SWAN ENTERPRISES, INC., RENO, NV:  
2,929,511, INT. CL. 25.

SWEDISH MATCH NORTH EUROPE AB, STOCKHOLM,  
SWEDEN:  
2,928,482, PUB. 12-7-2004. INT. CL. 34.

SWEET WATERS CAFE INC., ANN ARBOR, MI:  
2,928,890, PUB. 12-7-2004. INT. CL. 43.

SHOWA CO, HIMEJI-SHI, HYOGO-KEN, JAPAN, SHOWA  
KAKO CO., LTD., HYOGO-KEN, JAPAN:  
1,867,472. REN. 1-21-05. INT. CL. 9.

SYBRON CHEMICAL HOLDINGS INC., WILMINGTON,  
DE:  
1,830,075, CANC. INT. CL. 1.

- SYLVAN LEARNING, INC., BALTIMORE, MD:  
2,929,120, INT. CL. 9.
- SYNGENCE, L.L.C., DALLAS, TX:  
2,928,560, PUB. 12-7-2004. INT. CL. 9.
- SYNGENTA PARTICIPATIONS AG, BASEL, SWITZERLAND:  
2,929,579, INT. CL. 31.  
2,929,739, INT. CL. 5.
- SYNIVERSE TECHNOLOGIES, INC., TAMPA, FL:  
1,830,606, CANC. INT. CL. 38.
- SYNTRION GMBH, CALW, FED REP GERMANY:  
2,929,181, INT. CL. 5.
- SYRACUSE UNIVERSITY, SYRACUSE, NY:  
2,929,720, INT. CL. 25.
- SYSMEX CORPORATION, CHUO-KU, KOBE, JAPAN:  
2,798,209, COR. INT. CL. 9.
- SYSTEMES NORBEC INC., BOUCHERVILLE, QUEBEC, CANADA:  
2,149,959, CANC. INT. CL. 6.
- T. R. FASTENINGS LIMITED, UCKFIELD, EAST SUSSEX TN22 1QW, ENGLAND:  
2,150,596, CANC. INT. CL. 6.
- T.D. SALES & MARKETING, INC., COOPER CITY, FL TO EARTHLY ESSENTIALS, INC., COOPER CITY, FL:  
1,830,097, CANC. MULTIPLE CLASS, INT. CLS. 3 AND 21.
- T.L. ASHFORD & ASSOCIATES, INC., COVINGTON, KY:  
1,873,213, REN. 1-18-05. INT. CL. 9.
- T.L.C., INC., ST. LOUIS, MO, DBA THE SIGNATURE BEER COMPANY:  
2,151,077, CANC. INT. CL. 32.
- TABCORP ASSETS PTY LIMITED:  
*See—STRUCTURED DATA SYSTEMS PTY LTD.*
- TAC HOLDINGS, INC., FT. WORTH, TX:  
2,151,436, CANC. INT. CL. 9.  
2,151,437, CANC. INT. CL. 26.  
2,151,488, CANC. INT. CL. 28.
- TADE PAYS DU LEVANT S.A.R.L., OLLIOULES, FRANCE:  
2,928,709, PUB. 12-7-2004. INT. CL. 3.
- TAGA HOLDINGS INC., WINNIPEG, MANITOBA, CANADA, DBA FORT GARRY PHARMACY:  
2,928,518, PUB. 12-7-2004. INT. CL. 35.
- TALBOT MARKETING GROUP, INC., NEW YORK, NY:  
2,150,460, CANC. INT. CL. 16.
- TAM, WILLIAM, CHICAGO, IL:  
2,928,587, PUB. 12-7-2004. INT. CL. 43.
- TAMBRANDS INC., CINCINNATI, OH:  
2,929,690, INT. CL. 5.
- TANGENT 4 INC., KITCHENER, ONTARIO, CANADA:  
1,830,383, CANC. INT. CL. 21.
- TANGLER-WRANGLER, INC., CHICAGO, IL, PLASTISONICS, INCORPORATED, CHICAGO, IL:  
1,871,179, REN. 1-21-05. MULTIPLE CLASS, INT. CLS. 10 AND 21.
- TANGO PUBLISHING, INC., NEW YORK, NY:  
2,929,478, INT. CL. 16.
- TANTALUS INTERACTIVE PTY LTD., SOUTH MELBOURNE, VICTORIA, AUSTRALIA:  
2,928,707, PUB. 12-7-2004. MULTIPLE CLASS, INT. CLS. 9, 16 AND 28.
- TANYO CO. LTD., RICHMOND, BRITISH COLUMBIA V6X 3P3, CANADA:  
2,151,085, CANC. INT. CL. 28.
- TARA DISTRIBUTION GROUP, L.L.C., MARION, OH:  
2,928,837, PUB. 12-7-2004. INT. CL. 1.
- TARAKARREN CORP., INGLEWOOD, CA:  
1,273,761, CANC. INT. CL. 30.
- TARQUINE, HENRY E., FORT LAUDERDALE, FL:  
2,929,801, INT. CL. 16.
- TATA SONS LIMITED, MUMBAI 400 001, INDIA:  
2,929,070, MULTIPLE CLASS, INT. CLS. 6, 9, 16 AND 30.
- TATHO MATERIALS, INC., TAMPA, FL:  
2,928,771, PUB. 12-7-2004. INT. CL. 3.
- TAU KAPPA EPSILON FRATERNITY, INDIANAPOLIS, IN:  
2,928,798, PUB. 7-20-2004. MULTIPLE CLASS, INT. CLS. 14 AND 25.
- TAUW MILIEU B.V., 7400 AL DEVENTER, NETHERLANDS:  
2,149,924, CANC. INT. CL. 11.
- TAYLOR FOAM, INC.:  
1,273,470, CANC. INT. CL. 16.
- TAYLOR TOPPER, INC., MILLBRAE, CA, DBA TAYLOR-MADE AND DBA REALLUSIONS:  
1,830,422, CANC. MULTIPLE CLASS, INT. CLS. 26 AND 40.
- TAYLOR; STEWART A., KINGSPORT, TN:  
1,273,355, CANC. INT. CL. 8.
- TAYLOR, GARY W., PAHRUMP, NV, DBA WORLD WIDE CLASSIFIED:  
2,150,540, CANC. INT. CL. 35.
- TBC CORPORATION, MEMPHIS, TN:  
2,151,303, CANC. INT. CL. 12.
- TCH CANADA INC., OGDEN, UT:  
2,928,672, PUB. 12-7-2004. MULTIPLE CLASS, INT. CLS. 35, 36, 38 AND 39.
- TCHONG, MICHAEL, SAN FRANCISCO, CA:  
2,150,644, CANC. INT. CL. 35.
- TCI ENTERPRISES LLC, NEW YORK, NY:  
2,929,754, MULTIPLE CLASS, INT. CLS. 16 AND 41.
- TDS ACQUISITION COMPANY, CORVALLIS, OR:  
2,929,047, INT. CL. 9.
- TEAMSOFT, INC., MONTREAL, CANADA:  
2,151,225, CANC. INT. CL. 9.
- TECH NOW, INC., SAN ANTONIO, TX:  
2,150,826, CANC. MULTIPLE CLASS, INT. CLS. 35, 41 AND 42.
- TECHNICAL ASSOCIATION OF THE PULP AND PAPER INDUSTRY, INC., NORCROSS, GA:  
1,904,690, REN. 1-21-05. INT. CL. 41.
- TECHNICOTE, INC., MIAMISBURG, OH:  
1,315,243, REN. 1-19-05. INT. CL. 1.
- TECHNOLOGY & PATENT RESEARCH INTERNATIONAL, INC., SAN DIEGO, CA:  
2,928,509, PUB. 12-7-2004. INT. CL. 42.  
2,928,510, PUB. 12-7-2004. INT. CL. 16.
- TECHNOLOGY PROFESSIONALS, INC., BRIDGEWATER, NJ:  
2,929,491, INT. CL. 35.
- TECHPRESS, INC., PARADISE VALLEY, AZ:  
2,928,839, PUB. 12-7-2004. INT. CL. 41.
- TECOM SERVICES AG, OB. GERLAFINGEN, SWITZERLAND:  
2,929,199, INT. CL. 34.
- TED GREEN, INC., NEW YORK, NY:  
768,229, CANC. U.S. CL. 39.
- TEENAGE RESEARCH UNLIMITED, INC., NORTHBROOK, IL:  
2,928,932, PUB. 12-7-2004. INT. CL. 35.
- TELE-COMMUNICATIONS, INC., DENVER, CO:  
2,150,455, CANC. INT. CL. 42.  
2,151,283, CANC. MULTIPLE CLASS, INT. CLS. 38 AND 41.  
2,151,386, CANC. INT. CL. 38.
- TELECOMMUNICATIONS RESEARCH LABORATORIES, EDMONTON, ALBERTA, CANADA:  
2,928,822, PUB. 12-7-2004. INT. CL. 42.
- TELEGRAPH PUBLISHING COMPANY, HUDSON, NH:  
2,151,525, CANC. INT. CL. 16.
- TELEPORT COMMUNICATIONS GROUP INC., STATEN ISLAND, NY:  
2,151,299, CANC. INT. CL. 38.
- TELEVISION FOOD NETWORK, G.P., NEW YORK, NY:  
2,929,656, INT. CL. 43.
- TELLABS OPERATIONS, INC., LISLE, IL:  
2,150,238, CANC. INT. CL. 9.
- TELULAR CORPORATION, BUFFALO GROVE, IL:  
2,151,065, CANC. INT. CL. 9.
- TEMPO, INC., ATLANTA, GA:  
2,150,520, CANC. INT. CL. 35.
- TENNESSEE EDUCATION LOTTERY CORPORATION, NASHVILLE, TN:  
2,929,500, INT. CL. 41.
- TERAGREN LLC, BAINBRIDGE ISLAND, WA:  
2,928,714, PUB. 12-7-2004. INT. CL. 19.  
2,928,715, PUB. 12-7-2004. INT. CL. 19.

- TERMIX MANUFACTURING, INC., HOUSTON, TX, TER-  
MIX MANUFACTURING, INC., HOUSTON, TX:  
1,867,031. REN. 1-21-05. INT. CL. 21.
- TEXAVIA INTERNATIONAL, INC., DALLAS, TX:  
2,151,494. CANC. INT. CL. 32.
- TFL LEDERTECHNIK GMBH, 79576 WEIL AM RHEIN, FED  
REP GERMANY:  
2,928,567. PUB. 12-7-2004. MULTIPLE CLASS, INT. CLS. 1  
AND 2.
- TGGH, INCORPORATED, SAN JOSE, CA:  
2,150,763. CANC. INT. CL. 9.
- THE AMYOTROPHIC LATERAL SCLEROSIS ASSOCIA-  
TION, CALABASAS HILLS, CA:  
2,928,516. PUB. 12-7-2004. INT. CL. 36.
- THE BATTER'S BOX ACADEMY, INC., REYNOLDSBURG,  
OH:  
2,928,868. PUB. 12-7-2004. INT. CL. 41.
- THE BEAR STEARNS COMPANIES INC., NEW YORK, NY:  
2,928,624. PUB. 12-7-2004. INT. CL. 36.
- THE BURLINGTON NORTHERN AND SANTA FE RAIL-  
WAY COMPANY, FORT WORTH, TX:  
2,929,616. INT. CL. 39.
- THE CARTOON NETWORK LP, LLLP, ATLANTA, GA:  
2,929,444. INT. CL. 21.
- THE CHILLBILLIES, LLC, KNOXVILLE, TN:  
2,928,719. PUB. 12-7-2004. INT. CL. 41.
- THE COLEMAN COMPANY, INC., WICHITA, KS:  
2,928,895. PUB. 12-7-2004. INT. CL. 22.
- THE DINEX GROUP, LLC, NEW YORK, NY:  
2,928,718. PUB. 12-7-2004. INT. CL. 43.
- THE DYCKMAN HOUSE RESTAURANT, INC., WASHING-  
TON HEIGHTS, NY:  
2,928,541. PUB. 12-7-2004. MULTIPLE CLASS, INT. CLS.  
41 AND 43.
- THE EPISCOPAL CHURCH, NEW YORK, NY:  
2,928,522. PUB. 12-7-2004. INT. CL. 41.
- THE EVENT MANAGEMENT GROUP, INC., PALM DE-  
SERT, CA:  
2,928,581. PUB. 12-7-2004. INT. CL. 43.
- THE FEDERATED GROUP, INC., ARLINGTON HEIGHTS,  
IL:  
2,928,845. PUB. 12-7-2004. INT. CL. 29.
- THE GUTTER GUYS, INC., EGG HARBOR, NJ:  
2,928,542. PUB. 12-7-2004. INT. CL. 37.
- THE HEALING STORE, LLC, MARLTON, NJ:  
2,928,739. PUB. 12-7-2004. INT. CL. 5.
- THE INTERNATIONAL ASSOCIATION OF LIONS CLUBS,  
OAK BROOK, IL:  
2,928,507. PUB. 12-7-2004. INT. CL. 16.
- THE KROGER CO. OF MICHIGAN, LIVONIA, MI:  
2,928,775. PUB. 12-7-2004. INT. CL. 35.
- THE MAIDS INTERNATIONAL, INC., OMAHA, NE:  
2,928,853. PUB. 12-7-2004. INT. CL. 37.
- THE MCGRAW-HILL COMPANIES, INC., NEW YORK, NY:  
2,928,726. PUB. 12-7-2004. INT. CL. 36.
- THE MEMORIAL HOSPITAL, PAWTUCKET, RI:  
2,928,537. PUB. 12-7-2004. INT. CL. 9.
- THE MONSTER CORP., CHICAGO, IL:  
2,929,303. INT. CL. 11.
- THE NAVIGATORS, COLORADO SPRINGS, CO:  
2,928,722. PUB. 12-7-2004. INT. CL. 25.
- THE ORUP COMPANY, INC., LOS GATOS, CA, DBA REP-  
CAL RESEARCH LABS:  
2,928,876. PUB. 12-7-2004. INT. CL. 5.
- THE PARADE COMPANY, DETROIT, MI:  
2,928,828. PUB. 12-7-2004. INT. CL. 41.
- THE PILLSBURY COMPANY, MINNEAPOLIS, MN:  
2,928,699. PUB. 12-7-2004. INT. CL. 41.
- THE PNC FINANCIAL SERVICES GROUP, INC., PITTS-  
BURGH, PA, PNC FINANCIAL CORP, PITTSBURGH, PA:  
1,869,108. REN. 1-18-05. INT. CL. 36.
- THE READER'S DIGEST ASSOCIATION, INC., PLEASANT-  
VILLE, NY:  
2,929,038. PUB. 12-7-2004. INT. CL. 16.
- THE RODALE INSTITUTE, KUTZTOWN, PA:  
2,928,562. PUB. 12-7-2004. MULTIPLE CLASS, INT. CLS.  
25, 35 AND 41.
- 2,928,563. PUB. 12-7-2004. INT. CL. 16.
- THE S & W AGENCY, INC., NEW YORK, NY:  
2,929,275. INT. CL. 36.
- THE SANSIN CORPORATION, STRATHROY, ONTARIO,  
CANADA:  
2,928,484. PUB. 12-7-2004. INT. CL. 35.
- THE SANTA CRUZ COFFEE ROASTING COMPANY, WAT-  
SONVILLE, CA:  
2,928,994. PUB. 12-7-2004. INT. CL. 30.
- THE SCOLAR COMPANY, OVERLAND PARK, KS:  
2,928,536. PUB. 12-7-2004. INT. CL. 31.
- THE SEBRANEK GROUP, INC., BURLINGTON, WI:  
2,929,317. MULTIPLE CLASS, INT. CLS. 9, 16 AND 41.
- THE SOUP MARKET, LTD., MILWAUKEE, WI:  
2,928,697. PUB. 12-7-2004. INT. CL. 29.
- THE SPECTRANETICS CORPORATION, COLORADO  
SPRINGS, CO:  
2,928,706. PUB. 12-7-2004. INT. CL. 10.
- THE ST. PAUL TRAVELERS COMPANIES, INC., SAINT  
PAUL, MN:  
2,928,721. PUB. 9-21-2004. INT. CL. 36.
- THE TRANZONIC COMPANIES, HIGHLAND HEIGHTS,  
OH:  
2,928,618. PUB. 12-7-2004. INT. CL. 5.
- THE TRIPLE-I CORPORATION, OVERLAND PARK, KS:  
2,929,810. INT. CL. 35.
- THE TRUSTEES OF THE KENT A. RASMUSSEN AND  
CELIE E. RAMSAY REVOCABLE TRUST, A CALIFOR-  
NIA TRUST, THE TRUSTEES COMPRISING KENT A.  
RASMUSSEN, A U.S. CITIZEN, AND CELIE E. RAMSAY,  
A U.S. CITIZEN., ST. HELENA, CA:  
2,928,978. PUB. 12-7-2004. INT. CL. 33.
- THE TUSCAN OVEN, INC., TAMPA, FL:  
2,928,692. PUB. 12-7-2004. INT. CL. 30.
- THE UNIMAX CORPORATION, NEW YORK, NY:  
2,928,531. PUB. 12-7-2004. INT. CL. 6.
- THE UNIVERSITY OF CHICAGO, CHICAGO, IL:  
2,928,515. PUB. 12-7-2004. INT. CL. 9.
- THE VANDERBILT UNIVERSITY, NASHVILLE, TN:  
2,928,843. PUB. 12-7-2004. MULTIPLE CLASS, INT. CLS.  
41 AND 44.
- THE WINE ANGEL, INC., NEW YORK, NY:  
2,928,749. PUB. 12-7-2004. INT. CL. 33.
- THE WOODLANDS COMMERCIAL PROPERTIES COM-  
PANY L.P., THE WOODLANDS, TX:  
2,928,723. PUB. 12-7-2004. INT. CL. 41.
- THERIAULT; FLORENCE, ANNAPOLIS, MD, DBA THER-  
IAULT'S:  
1,273,835. CANC. MULTIPLE CLASS, INT. CLS. 35 AND  
41.
- THERMO BIOSTAR INC., LOUISVILLE, CO, BIOSTAR,  
INC., BOULDER, CO:  
1,915,949. REN. 1-18-05. INT. CL. 5.
- THIELEN MARKETING INC., BUFFALO, MN:  
2,928,774. PUB. 12-7-2004. INT. CL. 22.
- THIELEN MARKETING, INC., BUFFALO, MN:  
2,928,669. PUB. 12-7-2004. INT. CL. 12.
- THOM BROWN OF BOSTON, INC., HANOVER, MA:  
2,928,970. PUB. 12-7-2004. INT. CL. 25.
- 2,929,037. PUB. 12-7-2004. MULTIPLE CLASS, INT. CLS.  
25 AND 35.
- THOMAS GRAPHICS, INC., AUSTIN, TX:  
2,928,834. PUB. 12-7-2004. MULTIPLE CLASS, INT. CLS.  
35 AND 40.
- THOMAS LOWE VENTURES, INC., CASSPOLIS, MI:  
2,151,395. CANC. INT. CL. 9.
- THOMAS LOWE VENTURES, INC., SOUTH BEND, IN:  
2,151,409. CANC. INT. CL. 28.
- THOMAS PUBLISHING COMPANY, NEW YORK, NY:  
2,150,088. CANC. INT. CL. 35.
- THOMAS, GEORGE R, LONDON, ONTARIO, CANADA:  
2,928,852. PUB. 12-7-2004. INT. CL. 41.
- THOMMEN MEDICAL AG, CH-4437 WALDENBURG, SWIT-  
ZERLAND:  
2,929,272. INT. CL. 10.
- THOMPSON HOSPITALITY CORPORATION, HERNDON,  
VA:  
2,928,850. PUB. 12-7-2004. INT. CL. 43.

- THOMPSON MEDICAL COMPANY, INC., WEST PALM BEACH, FL:  
2,151,193, CANC. INT. CL. 5.
- THOMPSON, DAWN, PAWTUCKET, RI:  
2,928,506, PUB. 12-7-2004. INT. CL. 28.
- THOMPSON, KELSEN D., TAHOE CITY, CA:  
2,928,608, PUB. 12-7-2004. INT. CL. 25.
- THOMSON LICENSING CORPORATION, WILMINGTON, DE:  
2,150,209, CANC. INT. CL. 9.
- THOMSON MULTIMEDIA, BOULOGNE-BILLANCOURT, FRANCE:  
2,838,513, COR. MULTIPLE CLASS, INT. CLS. 9 AND 38.
- THOMSON, E. CHIP, AUSTIN, TX:  
2,929,794, INT. CL. 35.
- THQ WIRELESS INC., CALABASAS HILLS, CA:  
2,928,548, PUB. 12-7-2004. INT. CL. 41.
- THREE CREEK VINEYARD, LLC, SARATOGA, CA:  
2,929,299, INT. CL. 33.
- THUNDER DYNAMICS INC., TAMPA, FL:  
2,928,785, PUB. 12-7-2004. INT. CL. 9.
- TIB THE INDEPENDENT BANKERSBANK, IRVING, TX:  
2,928,653, PUB. 12-7-2004. INT. CL. 41.
- TIDWELL, COLTEN, PROVO, UT:  
2,928,696, PUB. 12-7-2004. INT. CL. 25.
- TIG PRODUCTIONS, INC., BURBANK, CA:  
1,898,091, REN. 1-19-05. INT. CL. 16.
- TIGER ELECTRONICS, INC., VERNON HILLS, IL:  
2,151,489, CANC. INT. CL. 28.
- TIME ADJUSTERS CONFERENCE, INC., DAYTONA BEACH, FL:  
1,273,854, CANC. INT. CL. 36.
- TIME FOR GOOD FOOD INC., ALEXANDRIA, VA:  
2,928,535, PUB. 12-7-2004. INT. CL. 30.
- TIME INC., NEW YORK, NY:  
1,830,935, CANC. INT. CL. 16.  
2,151,028, CANC. INT. CL. 16.  
2,929,017, PUB. 12-7-2004. INT. CL. 16.
- TIME WARNER CABLE INC., STAMFORD, CT:  
1,862,837, REN. 1-21-05. INT. CL. 41.
- TIMEWARE INCORPORATED, TWINSBURG, OH:  
2,928,729, PUB. 12-7-2004. INT. CL. 9.
- TIMKEN COMPANY, THE, CANTON, OH:  
2,151,132, CANC. INT. CL. 7.
- TINE BA, 0133, OSLO, NORWAY:  
1,114,961, CANC. INT. CL. 29.  
2,153,281, CANC. MULTIPLE CLASS, INT. CLS. 29 AND 30.  
2,163,117, CANC. INT. CL. 29.
- TISSAGE ET ENDUCTION SERGE FERRARI S.A., SAINT JEAN DE SOUDAIN, FRANCE:  
1,867,042, REN. 1-21-05. INT. CL. 24.
- TLSI INCORPORATED, HUNTINGTON, NY:  
2,928,529, PUB. 12-7-2004. MULTIPLE CLASS, INT. CLS. 9 AND 42.
- TMC MORTGAGE CORPORATION, PLANO, TX:  
2,928,867, PUB. 12-7-2004. INT. CL. 36.
- TMT RESEARCH DEVELOPMENT, INC., SMITH RIVER, CA:  
1,306,373, REN. 1-18-05. MULTIPLE CLASS, INT. CLS. 37 AND 40.
- TOHKUTSU AMERICA CORP., ENGLEWOOD CLIFFS, NJ:  
2,151,073, CANC. INT. CL. 42.
- TOKO KABUSHIKI KAISHA, TOKYO, JAPAN, DBA TOKO, INC.:  
768,112, CANC. U.S. CL. 21.
- TOLEDO TACKLE USA, INC., MANY, LA:  
2,151,029, CANC. INT. CL. 28.  
2,151,030, CANC. INT. CL. 28.
- TOM CHAMBERS LIMITED, WEST YORKSHIRE, HX5 0BJ, UNITED KINGDOM:  
2,928,508, PUB. 12-7-2004. MULTIPLE CLASS, INT. CLS. 6, 22 AND 28.
- TOMMY ARMOUR GOLF COMPANY, MORTON GROVE, IL:  
1,273,644, CANC. INT. CL. 25.
- TONE BROTHERS, INC., DES MOINES, IA:  
1,273,759, CANC. INT. CL. 30.
- TONE BROTHERS, INC., ANKENY, IA:  
2,929,878, INT. CL. 30.
- TOPCO HOLDINGS, INC., SKOKIE, IL:  
2,929,642, INT. CL. 30.
- TOUCAN TELL IT PRODUCTIONS, NEW YORK, NY:  
2,929,074, INT. CL. 9.
- TOUCH YO SELF RECORDS, L.L.C., LAKEWOOD, CA:  
2,929,447, MULTIPLE CLASS, INT. CLS. 9 AND 41.
- TOUCHSTONE ACCENT LIGHTING, LONG LAKE, MN:  
2,929,265, INT. CL. 11.
- TOVAR, JOAO VASCO CASSIO, MC-9800 MONACO, MONACO:  
2,928,476, PUB. 9-14-2004. INT. CL. 25.
- TOWERS, PERRIN, FORSTER & CROSBY, INC., PHILADELPHIA, PA:  
1,937,004, REN. 1-21-05. INT. CL. 9.
- TOWN OF ADDISON, TEXAS, ADDISON, TX:  
1,861,139, REN. 1-21-05. INT. CL. 35.
- TOY BIZ, INC., NEW YORK, NY:  
2,150,947, CANC. INT. CL. 28.
- TOYOTA JIDOSHA KABUSHIKI KAISHA (TOYOTA MOTOR CORPORATION), TOYOTA-SHI, AICHI-KEN, JAPAN:  
1,340,066, REN. 1-20-05. INT. CL. 7.
- TPG COMMUNICATIONS, INC., PALO ALTO, CA:  
2,150,372, CANC. INT. CL. 16.
- TRACKER MARINE, L.L.C., SPRINGFIELD, MO:  
2,928,841, PUB. 12-7-2004. INT. CL. 12.
- TRADALL S.A., MEYRIN 12, SWITZERLAND:  
1,273,809, CANC. INT. CL. 33.
- TRADE DIMENSIONS INTERNATIONAL, INC., WILTON, CT:  
2,928,524, PUB. 12-7-2004. MULTIPLE CLASS, INT. CLS. 9 AND 16.
- TRADECO INTERNATIONAL CORPORATION, ADDISON, IL:  
1,922,107, REN. 1-19-05. INT. CL. 21.
- TRADEMARK MANAGEMENT COMPANY, BOISE, ID, ESCALON PACKERS, INC., ESCALON, CA:  
1,865,889, REN. 1-19-05. MULTIPLE CLASS, INT. CLS. 29 AND 30.
- TRANSITCENTER, INC., NEW YORK, NY:  
2,929,355, INT. CL. 9.
- TRANSOMA MEDICAL, INC., ST. PAUL, MN:  
2,929,379, INT. CL. 9.  
2,929,380, INT. CL. 10.
- TRANSPACIFIC FOODS, INC, IRVINE, CA:  
2,929,698, INT. CL. 29.
- TRANSWITCH CORPORATION, SHELTON, CT:  
2,150,133, CANC. INT. CL. 9.
- TRANSWORLD MAGAZINE CORPORATION, OCEANSIDE, CA:  
2,929,694, INT. CL. 36.
- TRAPPE PACKING CORP., TRAPPE, MD:  
1,273,802, CANC. INT. CL. 32.
- TRAVELGIRL INC., CHAMBLEE, GA:  
2,929,769, INT. CL. 41.
- TRAVIS BODY & TRAILER, INC., HOUSTON, TX:  
1,871,212, REN. 1-19-05. INT. CL. 12.
- TREADCO, INC., FORT SMITH, AR:  
2,150,295, CANC. MULTIPLE CLASS, INT. CLS. 35 AND 37.
- TREE OF CONCERN INTERNATIONAL FOUNDATION, INC., PHILADELPHIA, PA:  
2,928,534, PUB. 12-7-2004. INT. CL. 43.
- TREE OF LIFE, INC., ST. AUGUSTINE, FL, GOURMET FOODS, INC., ST. PAUL, MN:  
1,281,793, REN. 1-21-05. INT. CL. 30.
- TREE OF LIFE, INC., ST. AUGUSTINE, FL:  
1,880,765, REN. 1-18-05. MULTIPLE CLASS, INT. CLS. 29 AND 30.
- TREEBONES RESORT LLC, LONG BEACH, CA:  
2,929,207, INT. CL. 42.
- TREK BICYCLE CORPORATION, WATERLOO, WI:  
2,150,741, CANC. INT. CL. 12.
- TRI VALLEY GROWERS, SAN FRANCISCO, CA:  
1,830,454, CANC. INT. CL. 29.

- TRI-ELECTRIC SUPPLY COMPANY, SAN ANTONIO, TX  
TO DXP ENTERPRISES, INC., HOUSTON, TX:  
1,830,905, CANC. INT. CL. 42.
- TRIAD FINANCIAL, INC., HUNTINGTON BEACH, CA:  
2,928,479, PUB. 12-7-2004. INT. CL. 36.
- TRIANGLE PACIFIC CORP., DALLAS, TX:  
2,150,820, CANC. INT. CL. 19.
- TRIARCO INDUSTRIES, INC., WAYNE, NJ:  
2,929,112, INT. CL. 5.
- TRIAUD, FRANCOISE, 33250 PAUILLAC, FRANCE:  
2,929,711, INT. CL. 33.
- TRIPLE L DISTRIBUTING CO., INC., CARSON, CA:  
1,830,509, CANC. INT. CL. 32.
- TROPICAL MUSIC EXPORT ENTERPRISES, INC., MIAMI, FL:  
2,928,530, PUB. 12-7-2004. INT. CL. 9.
- TROPICANA PRODUCTS, INC., BRADENTON, FL:  
2,151,478, CANC. INT. CL. 32.
- TROUW NUTRITION USA, LLC, HIGHLAND, IL, NUTRI-BASICS, HIGHLAND, IL:  
1,871,780, REN. 1-15-05. INT. CL. 1.
- TRU-PART MANUFACTURING CORPORATION, ST. PAUL, MN:  
2,150,038, CANC. MULTIPLE CLASS, INT. CLS. 7 AND 12.
- TRUCK ACCESSORIES GROUP, INC., ELKHART, IN:  
1,001,017, REN. 1-19-05. INT. CL. 12.
- TRUCKLOAD MANAGEMENT, INC., DENVER, CO, DBA TMI:  
2,928,533, PUB. 12-7-2004. MULTIPLE CLASS, INT. CLS. 9 AND 40.
- TRUE TEMPER SPORTS, INC., MEMPHIS, TN:  
2,928,924, PUB. 12-7-2004. INT. CL. 28.
- TRUTH HARDWARE CORPORATION, OWATONNA, MN:  
2,929,453, INT. CL. 7.  
2,929,454, INT. CL. 7.
- TSP COMPANIES, INC., DULUTH, GA:  
2,150,911, CANC. INT. CL. 9.
- TSR HOBBIES, INC., LAKE GENEVA, WI TO TSR, INC., LAKE GENEVA, WI:  
1,273,686, CANC. INT. CL. 28.
- TSUMURA INTERNATIONAL INC., CHASKA, MN, DBA FMG AND FRAGRANCE MARKETING GROUP TO BELAE BRANDS, INC., PHOENIX, DE:  
1,830,755, CANC. INT. CL. 3.
- TTC INC., JACKSON, NJ, TA TRAVELER'S CHANNEL:  
2,928,824, PUB. 12-7-2004. INT. CL. 35.
- TUI AG, HANNOVER, FED REP GERMANY:  
2,928,468, PUB. 4-20-2004. MULTIPLE CLASS, INT. CLS. 16, 39, 41 AND 42.
- TULIP BOUTIQUE, INC., CALABASAS, CA:  
2,928,491, PUB. 5-27-2003. INT. CL. 3.
- TULLY'S COFFEE CORPORATION, SEATTLE, WA:  
2,928,741, PUB. 12-7-2004. INT. CL. 43.
- TURNING TECHNOLOGIES, LLC, YOUNGSTOWN, OH:  
2,929,281, MULTIPLE CLASS, INT. CLS. 9 AND 42.  
2,929,282, MULTIPLE CLASS, INT. CLS. 9 AND 42.
- TUTUNARU, CATALIN, OLD ORCHARD BEACH, ME:  
2,767,435, CANC. INT. CL. 12.
- TV ONE, LLC, SILVER SPRING, MD:  
2,929,758, INT. CL. 21.  
2,929,759, INT. CL. 25.
- TVN ENTERTAINMENT CORPORATION, BURBANK, CA:  
2,151,068, CANC. MULTIPLE CLASS, INT. CLS. 38 AND 41.
- TWECO PRODUCTS, INC., CHESTERFIELD, MO:  
1,006,539, REN. 1-18-05. MULTIPLE CLASS, U.S. CLS. 6 (INT. CL. 1) AND 34 (INT. CLS. 7 AND 9).
- TWENTIETH CENTURY FOX FILM CORPORATION, LOS ANGELES, CA:  
2,151,417, CANC. INT. CL. 24.  
2,151,418, CANC. INT. CL. 26.  
2,929,621, INT. CL. 11.
- TWO BRATS PRODUCTIONS, INC., CHARLOTTE, NC:  
2,151,200, CANC. INT. CL. 41.
- TWO PONDS, LLC, BEAVERDAM, VA:  
2,929,530, INT. CL. 33.
- TXDC, L.P., IRVING, TX:  
2,929,410, INT. CL. 14.
- TYBUR, WILLIAM P., TEMPE, AZ, DBA JOHNSON & MAXWELL PROMOTIONAL SERVICES AND TYBUR, SHEILA M., TEMPE, AZ, DBA JOHNSON & MAXWELL PROMOTIONAL SERVICES:  
1,870,502, REN. 1-19-05. INT. CL. 16.
- TYCO ELECTRONICS LOGISTICS AG, CH 9323 STEINACH/SG, SWITZERLAND:  
2,929,137, INT. CL. 9.
- TYCO HEALTHCARE GROUP LP, NORWALK, CT:  
2,929,301, INT. CL. 10.
- TYCO HEALTHCARE RETAIL SERVICES AG, SCHAFFHAUSEN, SWITZERLAND:  
2,929,678, INT. CL. 5.
- TYLER ENTERPRISES, INC., PALM SPRINGS, CA:  
2,150,813, CANC. INT. CL. 12.
- U.S. DIVERS CO., INC., SANTA ANA, CA:  
2,151,211, CANC. INT. CL. 9.
- U.S. NOW CORP., NEW YORK, NY:  
2,150,394, CANC. INT. CL. 42.  
2,150,395, CANC. INT. CL. 35.
- U.S. SALT, INC., BURNSVILLE, MN:  
1,307,590, REN. 1-21-05. INT. CL. 1.  
1,307,591, REN. 1-21-05. INT. CL. 1.
- U.S. TRAFFIC CORPORATION, SANTA FE SPRINGS, CA:  
1,304,827, REN. 1-18-05. INT. CL. 9.
- UARCO INCORPORATED, BARRINGTON, IL:  
1,273,494, CANC. INT. CL. 16.
- UBERMAN, DONNA, WASHINGTON, DC:  
2,151,243, CANC. INT. CL. 16.  
2,151,411, CANC. INT. CL. 16.
- UHS OF DELAWARE, INC., KING OF PRUSSIA, PA:  
2,928,557, PUB. 12-7-2004. INT. CL. 44.  
2,929,432, INT. CL. 44.
- UICI, INC., OKLAHOMA CITY, OK:  
2,929,215, INT. CL. 36.
- ULTIMATE OUTDOOR SOLUTIONS, INC., RANGER, GA:  
2,929,697, INT. CL. 1.
- ULTIMUS, INC., CART, NC:  
2,264,776, CANC. INT. CL. 35.
- ULTRADENT PRODUCTS, INC., SOUTH JORDAN, UT:  
1,830,249, CANC. INT. CL. 10.
- ULTRADENT PRODUCTS, INC., SO. JORDAN, UT:  
2,151,499, CANC. MULTIPLE CLASS, INT. CLS. 3, 5 AND 10.
- ULTRATERA CORPORATION, HSIN-CHU, TAIWAN:  
2,928,451, PUB. 12-7-2004. INT. CL. 9.
- ULTRAVIT ENTERPRISES, INC., PASADENA, CA:  
2,150,484, CANC. INT. CL. 5.
- UMBRA INC., BUFFALO, NY:  
2,929,335, INT. CL. 24.
- UNBEATABLE EATABLES, INC., MAITLAND, FL:  
2,150,521, CANC. INT. CL. 42.
- UNDEAD PRODUCTIONS INC., PITTSBURGH, PA:  
2,929,807, INT. CL. 41.
- UNDER SEA INDUSTRIES, INC., RANCHO DOMINQUEZ, CA, AKA SCUBAPRO:  
1,273,361, CANC. INT. CL. 9.
- UNICEM S.P.A., 15033 CASALE MONFERRATO, ALESSANDRIA, ITALY:  
2,150,009, CANC. INT. CL. 19.
- UNIFORCE SERVICES, INC., WOODBURY, NY:  
2,150,205, CANC. INT. CL. 41.
- UNIGEN PHARMACEUTICALS, INC., LACEY, WA:  
2,929,760, INT. CL. 1.  
2,929,761, INT. CL. 1.
- UNILEVER N.V., 3000 DK ROTTERDAM, NETHERLANDS:  
2,151,465, CANC. INT. CL. 29.
- UNION BIOMETRICA, INC., SOMERVILLE, MA:  
2,929,256, INT. CL. 9.
- UNIPEN, INC., ARLINGTON HEIGHTS, IL:  
2,551,037, CANC. MULTIPLE CLASS, INT. CLS. 18 AND 20.
- UNIQUE INDUSTRIES, INC., PHILADELPHIA, PA:  
2,929,494, INT. CL. 28.
- UNIQUELY ME, INC., ROCKVILLE CENTRE, NY:  
2,929,508, MULTIPLE CLASS, INT. CLS. 25 AND 41.

- UNISEN, INC., IRVINE, CA, DBA STAR TRAC:  
2,929,249, INT. CL. 28.
- UNISOURCE WORLDWIDE, INC., NORCROSS, GA:  
2,150,662, CANC. INT. CL. 17.
- UNISPHERE MEDIA, L.L.C., CHATHAM, NJ:  
2,928,942, PUB. 12-7-2004. INT. CL. 41.
- UNISYS CORPORATION, BLUE BELL, PA:  
2,928,547, PUB. 12-7-2004. INT. CL. 42.
- UNITED AIR LINES, INC., CHICAGO, IL:  
1,830,614, CANC. INT. CL. 39.
- UNITED FEATURE SYNDICATE, INC., NEW YORK, NY:  
1,930,048, REN. 1-21-05. INT. CL. 25.
- UNITED HEALTHCARE CORPORATION, MINNEAPOLIS, MN:  
2,150,469, CANC. INT. CL. 36.
- UNITED SERVICE ORGANIZATIONS, INC., WASHINGTON, DC:  
2,929,766, MULTIPLE CLASS, INT. CLS. 14, 16, 25 AND 36.
- UNITED SPORTS ASSOCIATES, INC., COS COB, CT:  
1,273,889, CANC. INT. CL. 39.
- UNITED STATES DISTILLED PRODUCTS COMPANY, PRINCETON, MN:  
2,929,490, INT. CL. 33.  
2,929,505, INT. CL. 33.
- UNITED STATES PLAYING CARD COMPANY, THE, CINCINNATI, OH:  
2,151,384, CANC. INT. CL. 28.
- UNITED STATES SHOE CORPORATION, THE, CINCINNATI, OH:  
1,273,624, CANC. INT. CL. 25.  
1,273,625, CANC. INT. CL. 25.  
1,273,637, CANC. INT. CL. 25.
- UNITED STEEL PRODUCTS COMPANY, MONTGOMERY, MN:  
2,929,329, MULTIPLE CLASS, INT. CLS. 6 AND 9.
- UNITED TELEVISION, INC., BEVERLY HILLS, CA:  
2,149,974, CANC. MULTIPLE CLASS, INT. CLS. 38 AND 41.
- UNITED WAY OF NORTHEAST FLORIDA, JACKSONVILLE, FL:  
2,928,586, PUB. 12-7-2004. INT. CL. 36.
- UNIVERSAL INTERACTIVE, INC., LOS ANGELES, CA:  
2,928,955, PUB. 12-7-2004. INT. CL. 16.
- UNIVERSAL MARKETING ASSOCIATES INC., ATLANTA, GA:  
2,150,915, CANC. INT. CL. 30.
- UNIVERSAL MARKETING INC., NEW ROCHELLE, NY:  
2,150,738, CANC. INT. CL. 11.
- UNIVERSAL TRAILER HOLDINGS CORP., GREENWICH, CT:  
2,928,986, PUB. 12-7-2004. INT. CL. 12.  
2,929,014, PUB. 12-7-2004. INT. CL. 12.
- UNIVERSITEIT LEIDEN, LEIDEN, NETHERLANDS:  
1,871,088, REN. 1-21-05. INT. CL. 9.
- UNIVERSITY OF THE FAMILY, INC., LITTLETON, CO:  
2,928,585, PUB. 12-7-2004. INT. CL. 41.
- UNIVEX LICENSING GROUP, INC., NEW CANAAN, CT:  
1,019,645, CANC. INT. CL. 42.
- UNOVA INDUSTRIAL AUTOMATION SYSTEMS, INC., WARREN, MI, CINCINNATI MILACRON INC., CINCINNATI, OH:  
1,864,186, REN. 1-21-05. INT. CL. 7.
- UPPER ROOM, THE, NASHVILLE, TN:  
2,929,509, INT. CL. 25.
- UPSTATE GROUP, INC., CHARLOTTESVILLE, VA:  
2,928,566, PUB. 12-7-2004. INT. CL. 1.
- UPSTREAM SOLUTIONS, LLC, MINNEAPOLIS, MN:  
2,928,919, PUB. 12-7-2004. INT. CL. 42.  
2,928,920, PUB. 12-7-2004. INT. CL. 42.
- UPTON PYNE ESTATES, LLC, BERNARDSVILLE, NJ:  
2,929,408, INT. CL. 36.
- URAL AMERICA, INC., PRESTON, WA:  
2,150,561, CANC. INT. CL. 12.
- URSCHEL LABORATORIES INCORPORATED, VALPARAISO, IN:  
1,923,317, REN. 1-19-05. INT. CL. 7.
- US AIRWAYS, INC., ARLINGTON, VA:  
2,928,989, PUB. 12-7-2004. INT. CL. 39.
- US MIX PRODUCTS CO., DENVER, CO:  
1,830,939, CANC. INT. CL. 19.
- USA GIFT, INC., MIAMI, FL:  
2,150,735, CANC. INT. CL. 16.
- USA METRO, INC., NORTH BRUNSWICK, NJ:  
2,929,182, INT. CL. 4.
- USFILTER CORPORATION, BURLINGTON, MA:  
2,929,078, INT. CL. 11.
- USG INTERIORS, INC.:  
1,273,305, CANC. INT. CL. 6.
- USIGHT, LLC, OREM, UT:  
2,928,525, PUB. 12-7-2004. INT. CL. 42.
- V&S VIN & SPRIT AKTIEBOLAG, SE-117 97 STOCKHOLM, SWEDEN:  
2,929,287, INT. CL. 33.
- V-CORP TECHNOLOGIES, INC., CARLSBAD, CA:  
2,928,961, PUB. 12-7-2004. INT. CL. 9.
- VALA, JOHN D., PLYMOUTH, MI:  
2,151,266, CANC. INT. CL. 9.
- VALDES CIGARS, INC., MIAMI, FL:  
2,151,405, CANC. INT. CL. 34.
- VALERA PHARMACEUTICALS, INC., CRANBURY, NJ:  
2,929,415, INT. CL. 5.
- VALIO LTD, 00370 HELSINKI, FINLAND:  
2,150,212, CANC. INT. CL. 29.
- VALUCAR, LLC, COLORADO SPRINGS, CO:  
2,246,354, CANC. INT. CL. 39.
- VALUE CITY OF MICHIGAN, INC., WESTLAND, MI:  
2,929,518, MULTIPLE CLASS, INT. CLS. 11, 20 AND 22.  
2,929,520, INT. CL. 31.
- VAN DYKE SUPPLY COMPANY, INC., WOONSOCKET, SD, FORMERLY VDS, INC.:  
1,326,518, REN. 1-19-05. INT. CL. 2.
- VANGUARD GROUP, INC., THE, MALVERN, PA:  
2,928,734, PUB. 12-7-2004. INT. CL. 36.
- VANITY FAIR, INC., WILMINGTON, DE:  
2,929,034, PUB. 12-7-2004. INT. CL. 25.
- VANMOOR, ARTHUR, BOCA RATON, FL:  
2,929,657, INT. CL. 5.
- VANS, INC., ORANGE, CA:  
2,151,138, CANC. INT. CL. 25.
- VANTIVE CORPORATION, THE, SANTA CLARA, CA:  
2,150,477, CANC. INT. CL. 9.
- VARIFLEX, INC., MOORPARK, CA:  
2,151,483, CANC. INT. CL. 22.
- VAUGHAN & BUSHNELL MFG. CO., HEBRON, IL:  
787,418, REN. 1-21-05. U.S. CL. 13 (INT. CL. 6).
- VAZIRANI, MINAL, ANAHEIM HILLS, CA:  
2,929,075, MULTIPLE CLASS, INT. CLS. 35 AND 41.
- VENTURCOM, INC., WALTHAM, MA:  
2,928,620, PUB. 12-7-2004. INT. CL. 9.
- VENTURE STORES, INC., O'FALLON, MO:  
2,151,284, CANC. INT. CL. 25.
- VERATEX, INC., PANAMA CITY, CA:  
2,928,941, PUB. 12-7-2004. INT. CL. 24.
- VERIFONE, INC., REDWOOD CITY, CA:  
2,151,275, CANC. INT. CL. 9.
- VERIZON COMMUNICATIONS INC., NEW YORK, NY:  
2,928,708, PUB. 12-7-2004. INT. CL. 38.
- VERMILLION CONSULTING, INC., GRAYSLAKE, IL:  
2,928,759, PUB. 12-7-2004. INT. CL. 16.
- VERSACARE, INC., CORONA, CA:  
2,150,910, CANC. INT. CL. 42.
- VERTEX CHEMICAL CORPORATION, ST. LOUIS, MO:  
2,928,873, PUB. 12-7-2004. INT. CL. 1.
- VETOQUINOL S.A., 70204 LURE CEDEX, FRANCE:  
1,869,203, REN. 1-19-05. INT. CL. 5.
- VETRAL INCORPORATED, DALLAS, TX:  
2,151,149, CANC. INT. CL. 9.

- VIACOM INTERNATIONAL INC., NEW YORK, NY:  
 2,150,594, CANC. INT. CL. 41.  
 2,151,255, CANC. INT. CL. 27.  
 2,151,272, CANC. INT. CL. 6.  
 2,151,451, CANC. INT. CL. 41.  
 2,928,826, PUB. 12-7-2004. INT. CL. 9.  
 2,929,696, INT. CL. 18.  
 2,929,793, INT. CL. 25.
- VICEISZA, FIORELLA L. G., ATLANTA, GA:  
 2,929,209, INT. CL. 28.
- VICTORY PACKAGING, INC., HOUSTON, TX:  
 2,929,539, MULTIPLE CLASS, INT. CLS. 6, 16, 17, 20, 22 AND 35.
- VIDEOMEDIA, INC., SAN JOSE, CA:  
 2,150,892, CANC. INT. CL. 9.
- VIEGA N.A., INC., BEDFORD, MA:  
 2,928,580, PUB. 12-7-2004. INT. CL. 11.
- VIEWPOINT DATALABS INTERNATIONAL, INC., OREM, UT:  
 2,151,096, CANC. INT. CL. 9.
- VIGANO ACCESSORI S.P.A., INVERIGO (CO), ITALY:  
 2,928,521, PUB. 12-7-2004. INT. CL. 25.
- VIKING ENGINEERING & DEVELOPMENT, INCORPORATED, FRIDLEY, MN:  
 2,928,565, PUB. 12-7-2004. INT. CL. 7.
- VILLAGER OF STORM LAKE, INC., STORM LAKE, IA:  
 2,928,983, PUB. 12-7-2004. INT. CL. 43.
- VILLANOVA UNIVERSITY IN THE STATE OF PENNSYLVANIA, VILLANOVA, PA, AKA VILLANOVA UNIVERSITY:  
 1,830,139, CANC. MULTIPLE CLASS, INT. CLS. 6, 14, 16, 20, 21, 25 AND 41.
- VINSON SUPPLY COMPANY, TULSA, OK:  
 2,151,220, CANC. INT. CL. 42.
- VINYL VALET INC., THE, TEMPE, AZ:  
 2,150,638, CANC. INT. CL. 35.
- VIRBAC AH, INC., FORT WORTH, TX:  
 1,307,619, REN. 1-18-05. INT. CL. 5.
- VIRGINIA BREAST CANCER FOUNDATION, RICHMOND, VA:  
 2,929,626, INT. CL. 16.
- VISA INTERNATIONAL SERVICE ASSOCIATION, FOSTER CITY, CA, VISA, U.S.A. INC., SAN MATEO, CA:  
 1,834,025, REN. 1-21-05. INT. CL. 36.
- VISA INTERNATIONAL SERVICE ASSOCIATION, FOSTER CITY, CA:  
 2,150,185, CANC. INT. CL. 35.
- VISIO CORPORATION, SEATTLE, WA:  
 2,150,991, CANC. U.S. CL. A.
- VISIONARY MANAGEMENT SERVICES, INC., MONTGOMERY, AL:  
 2,150,364, CANC. INT. CL. 42.
- VISTA DMS, INC., SAN DIEGO, CA:  
 1,294,878, CANC. INT. CL. 35.
- VISX, INCORPORATED, SANTA CLARA, CA:  
 2,151,003, CANC. INT. CL. 16.
- VITALWORKS INC., RIDGEFIELD, CT:  
 2,928,532, PUB. 12-7-2004. INT. CL. 9.
- VITO, ROBERT, BERWYN, PA:  
 2,929,512, MULTIPLE CLASS, INT. CLS. 16 AND 21.
- VIVENDI UNIVERSAL INTERACTIVE PUBLISHING INTERNATIONAL, MEUDON LA FORET, FRANCE:  
 2,928,652, PUB. 5-4-2004. MULTIPLE CLASS, INT. CLS. 9, 16, 28, 38, 41 AND 42.
- VMDIRECT LLC, LAS VEGAS, NV:  
 2,928,670, PUB. 12-7-2004. INT. CL. 38.
- VMWAY, INC., STAMFORD, CT:  
 2,150,282, CANC. INT. CL. 35.
- VNU BUSINESS MEDIA, INC., NEW YORK, NY:  
 2,233,817, CANC. INT. CL. 35.
- VOLOROSSO S.R.L., BOLOGNA, ITALY:  
 2,928,519, PUB. 12-7-2004. INT. CL. 33.
- VON DUPRIN LLC, INDIANAPOLIS, IN:  
 1,309,631, REN. 1-18-05. INT. CL. 6.
- VOODOO CYCLES, INC., MILPITAS, CA:  
 2,150,716, CANC. INT. CL. 12.
- VORTECHNICS, INC., SCARBOROUGH, ME:  
 2,929,839, INT. CL. 11.
- VTV: VARSITY TELEVISION, INC., AUSTIN, TX:  
 2,928,526, PUB. 7-20-2004. INT. CL. 38.
- VUKOTICH, DENISE M., 4636 NOAH OVERLOOK WEST, GA:  
 2,928,967, PUB. 12-7-2004. INT. CL. 44.
- W. L. SNOOK & ASSOCIATES, INC., WEST CHESTER, PA, DBA THE TRAFFIC SAFETY STORE:  
 2,929,874, INT. CL. 19.
- W. R. RAYSON COMPANY, INC., BURGAW, NC:  
 2,929,506, INT. CL. 5.
- W. W. GRAINGER, INC., LAKE FOREST, IL:  
 1,874,465, REN. 1-19-05. INT. CL. 3.
- W.C. BRADLEY/ ZEBCO HOLDINGS, INC., TULSA, OK:  
 1,861,035, REN. 1-21-05. INT. CL. 28.
- W.L. GORE & ASSOCIATES, INC., NEWARK, DE:  
 2,150,031, CANC. INT. CL. 1.
- WAL-MART STORES, INC., BENTONVILLE, AR:  
 2,151,246, CANC. INT. CL. 18.
- WAL-MART STORES, INC., BENTONVILLE, AR:  
 2,929,154, INT. CL. 16.
- WAL-MART STORES, INC., BENTONVILLE, AR:  
 2,929,311, INT. CL. 25.
- WALLACE, DONALD, PORTLAND, OR:  
 2,929,263, MULTIPLE CLASS, INT. CLS. 9, 41 AND 42.
- WALTER G. LEGGE COMPANY, INC., NEW YORK, NY:  
 1,273,273, CANC. INT. CL. 3.
- WANG, FENGYING, BALTIMORE, MD:  
 2,929,526, INT. CL. 25.
- WARNACO INC., NEW YORK, NY:  
 1,273,647, CANC. INT. CL. 25.
- WARNACO U.S., INC., BRIDGEPORT, CT:  
 2,928,449, PUB. 12-7-2004. INT. CL. 25.
- WARNER NORCROSS & JUDD LLP, GRAND RAPIDS, MI:  
 1,878,978, REN. 1-21-05. INT. CL. 42.
- WARNER, JAN L., COLUMBIA, SC:  
 2,928,921, PUB. 12-7-2004. INT. CL. 42.
- WARRI INTERNATIONAL, INC., NEW YORK, NY:  
 2,929,218, MULTIPLE CLASS, INT. CLS. 18, 20, 24 AND 25.
- WASHING EQUIPMENT TECHNOLOGIES, INC., WEBSTER, NY:  
 2,929,658, INT. CL. 7.
- WASHINGTON MUTUAL, INC., SEATTLE, WA:  
 2,929,894, MULTIPLE CLASS, INT. CLS. 36 AND 42.
- WATCH ALL, INC., WEYMOUTH, MA:  
 1,862,010, REN. 1-19-05. INT. CL. 37.
- WATER JUNCTION, INC., THE, SPRING BRANCH, TX:  
 2,151,224, CANC. INT. CL. 32.
- WATERFRONT HOTEL LLC, THE, NEWPORT BEACH, CA, WATERFRONT, INC., THE, NEWPORT BEACH, CA:  
 1,867,676, REN. 1-21-05. INT. CL. 25.  
 1,867,677, REN. 1-19-05. INT. CL. 25.
- WATERLOO MAPLE INC., WATERLOO, ONTARIO, N2L 5J2, CANADA:  
 2,150,037, CANC. INT. CL. 9.
- WATKINS, INC., WINONA, MN:  
 2,929,745, MULTIPLE CLASS, INT. CLS. 16, 24 AND 41.
- WCI COMMUNITIES, INC., BONITA SPRINGS, FL:  
 2,928,622, PUB. 12-7-2004. INT. CL. 37.
- WEATHERFORD/LAMB, INC., HOUSTON, TX:  
 2,928,904, PUB. 12-7-2004. INT. CL. 7.
- WEAVER, AIMEE, HERMITAGE, TN:  
 2,928,965, PUB. 12-7-2004. INT. CL. 41.
- WEBTONE TECHNOLOGIES, INC., ATLANTA, GA:  
 2,167,270, CANC. INT. CL. 9.
- WEEKEND EXERCISE COMPANY, INC., THE, SAN DIEGO, CA:  
 2,151,498, CANC. INT. CL. 25.
- WEIAND AUTOMOTIVE INDUSTRIES, LOS ANGELES, CA:  
 1,866,730, REN. 1-21-05. INT. CL. 7.  
 1,867,992, REN. 1-21-05. INT. CL. 7.
- WELLS LAMONT CORPORATION, NILES, IL, WELLS LAMONT CORPORATION, CHICAGO, IL:  
 779,958, REN. 1-19-05. U.S. CL. 39 (INT. CL. 25).
- WELLS LAMONT CORPORATION, NILES, IL:  
 2,929,388, INT. CL. 21.

- WELLSPARK GROUP LIMITED PARTNERSHIP, NEWTON, MA:  
2,150,544, CANC. INT. CL. 35.
- WELSH RUGBY UNION LIMITED, THE, CARDIFF, CF10 1GE WALES, UNITED KINGDOM:  
2,150,569, CANC. MULTIPLE CLASS, INT. CLS. 24 AND 25.
- WEST, GREG, ATLANTA, GA:  
2,929,042, PUB. 12-7-2004. INT. CL. 16.
- WESTELL TECHNOLOGIES, INC., AURORA, IL:  
2,929,058, INT. CL. 9.
- WESTERN SIZZLIN CORPORATION, ROANOKE, VA:  
1,364,725, REN. 1-21-05. INT. CL. 29.
- WESTMAN, DYAN RIPPLE, MINNEAPOLIS, MN, DBA BUGS EAR:  
2,150,979, CANC. INT. CL. 18.
- WEYERHAEUSER COMPANY, TACOMA, WA:  
1,273,481, CANC. INT. CL. 16.
- WEYERHAEUSER COMPANY, FEDERAL WAY, WA:  
2,928,882, PUB. 12-7-2004. INT. CL. 16.
- WHAT'S WITH THAT MUSIC COMPANY, VILLA PARK, IL:  
2,150,660, CANC. INT. CL. 41.
- WHATABURGER, INC., CORPUS CHRISTI, TX:  
2,150,703, CANC. INT. CL. 42.
- WHIRLPOOL PROPERTIES, INC., ST. JOSEPH, MI:  
2,929,768, INT. CL. 11.
- WHISTLIN' DIXIE CORPORATION, WINCHESTER, VA:  
1,273,733, CANC. INT. CL. 29.
- WHITE CASTLE MANAGEMENT CO., COLUMBUS, OH:  
2,929,398, INT. CL. 43.
- WHITE DIRECTORY PUBLISHERS, INC., BUFFALO, NY:  
2,151,400, CANC. INT. CL. 42.
- WHITE STORES, INC., WICHITA FALLS, TX:  
768,121, CANC. U.S. CL. 21.
- WHITE, RANDOLPH, L, PUNTA GORDA, FL:  
2,929,622, INT. CL. 20.
- WHITE, STEPHEN A., SOMERS POINT, NJ:  
2,929,438, INT. CL. 25.
- WIATER, KEITH, FORT LAUDERDALE, FL:  
2,928,928, PUB. 12-7-2004. INT. CL. 39.
- WIDGERY, WILLIAM TROY, DENVER, CO:  
2,929,528, INT. CL. 32.
- WILD GOOSE HOLDING CO., INC., WILMINGTON, DE:  
1,309,445, REN. 1-18-05. INT. CL. 42.
- WILDCOUNTRY, INC., FT. PAYNE, AL:  
1,299,918, REN. 1-18-05. INT. CL. 41.  
1,300,962, REN. 1-18-05. INT. CL. 41.
- WILDLIFE RESEARCH CENTER, INC., ANOKA, MN:  
1,891,223, REN. 1-19-05. INT. CL. 28.  
1,937,921, REN. 1-19-05. INT. CL. 28.
- WILLIAM DETTMAN ENTERPRISES, INC., CYPRESS, CA:  
2,929,274, MULTIPLE CLASS, INT. CLS. 9, 18, 25 AND 35.
- WILLIAM GRANT & SONS, INC., EDISON, NJ:  
2,929,293, INT. CL. 33.
- WILLIAM O. DE LILLO AND ROBERT F. CLARK PARTNERSHIP, THE, PARADISE VALLEY, AZ:  
1,830,288, CANC. INT. CL. 14.
- WILLIAMS-SONOMA, INC., SAN FRANCISCO, CA:  
2,151,406, CANC. INT. CL. 24.
- WILLIAMSON, NATHANIEL, VALLEJO, CA:  
2,929,350, INT. CL. 16.
- WILLIS, DERRICK E., CHICAGO, IL:  
2,150,573, CANC. INT. CL. 35.
- WILSON AUDIO SPECIALTIES, INC., PROVO, UT:  
1,865,674, REN. 1-21-05. INT. CL. 9.
- WINDBRELLA PRODUCTS CORP, BOYNTON BEACH, FL:  
2,929,527, INT. CL. 18.
- WINDMERE CORPORATION, MIAMI LAKES, FL:  
2,151,280, CANC. MULTIPLE CLASS, INT. CLS. 7, 9 AND 11.  
2,151,336, CANC. INT. CL. 9.
- WINDOW ROCK ENTERPRISES, INC., YORBA LINDA, CA:  
2,929,452, INT. CL. 5.
- WING GOLF, WICHITA, KS:  
2,150,017, CANC. INT. CL. 28.
- WINGET CYC INDUSTRIAL LIMITED, KWAI CHUNG, N.T., HONG KONG:  
2,929,225, INT. CL. 26.
- WINNER INTERNATIONAL ROYALTY LLC, SHARON, PA:  
2,929,862, INT. CL. 9.
- WINTERCO DISCOUNT SKIWEAR INC., CALGARY, ALBERTA T2K 5X3, CANADA:  
2,150,303, CANC. INT. CL. 25.
- WIRE BELT COMPANY OF AMERICA, LONDONDERRY, NH:  
2,928,602, PUB. 12-7-2004. INT. CL. 7.  
2,928,603, PUB. 12-7-2004. INT. CL. 7.
- WIRELESSDEVELOPER, INC., EAST LANSING, MI:  
2,929,386, INT. CL. 35.
- WISE FOODS INVESTMENTS, INC., SPARTANBURG, SC:  
2,929,463, INT. CL. 29.
- WISE, DANIEL, NEW YORK, NY:  
2,929,581, INT. CL. 9.
- WISEMAN, ORLY, STATEN ISLAND, NY:  
2,929,336, INT. CL. 41.
- WIZARDS OF THE COAST, INC., RENTON, WA:  
2,122,608, CANC. MULTIPLE CLASS, INT. CLS. 16 AND 28.
- WJB MANAGEMENT, INC., PANAMA CITY BEACH, FL:  
2,150,228, CANC. INT. CL. 39.
- WKI HOLDING COMPANY, INC., RESTON, VA:  
2,929,025, PUB. 12-7-2004. INT. CL. 21.
- WLVI INC., DORCESTER, MA, GANNETT CO., INC., ARLINGTON, VA:  
1,840,922, REN. 1-19-05. INT. CL. 38.
- WOLD WRESTLING ENTERTAINMENT, INC., STAMFORD, CT:  
1,860,719, REN. 1-21-05. INT. CL. 9.
- WOLF, GEORGE T., III, LANCASTER, PA:  
2,929,685, INT. CL. 35.
- WOMAN'S MISSIONARY UNION, BIRMINGHAM, AL:  
1,891,023, REN. 1-21-05. INT. CL. 16.
- WONDERLIC, INC., LIBERTYVILLE, IL:  
2,929,861, INT. CL. 16.
- WOOD RECYCLING, INC., WOBURN, MA:  
2,150,930, CANC. INT. CL. 31.
- WOODS, DESMOND L., HOUSTON, TX:  
2,150,217, CANC. INT. CL. 25.
- WOODSMALL, ROGER L., COSTA MESA, CA:  
2,150,470, CANC. INT. CL. 9.
- WOODSTOCK BREWING COMPANY INC., KINGSTON, NY, DBA WOODSTOCK BREWING COMPANY:  
1,830,945, CANC. INT. CL. 32.
- WOODSTOCK INTERNATIONAL, INC., BELLINGHAM, WA:  
1,941,416, REN. 1-18-05. INT. CL. 7.
- WORK FORCE, INC., STOUGHTON, MA:  
2,928,503, PUB. 9-21-2004. INT. CL. 25.
- WORLD ACCESS, INC., RICHMOND, VA:  
2,929,190, MULTIPLE CLASS, INT. CLS. 35, 36, 39 AND 42.  
2,929,196, MULTIPLE CLASS, INT. CLS. 35, 36, 39 AND 42.
- WORLD CHAMPIONSHIP WRESTLING, INC., ATLANTA, GA:  
2,150,093, CANC. INT. CL. 25.
- WORLD EMBLEM INTERNATIONAL, INC., MIAMI, FL:  
2,929,022, PUB. 12-7-2004. INT. CL. 16.
- WORLD MEDIA COMMUNICATIONS, INC., SKANEATELES, NY:  
2,150,201, CANC. INT. CL. 41.
- WORLD TANG SOO DO ASSOCIATION, PHILADELPHIA, PA:  
1,327,588, REN. 1-18-05. U.S. CL. 200.  
1,341,743, REN. 1-18-05. U.S. CL. 200.
- WORLD TRIATHLON CORPORATION, TARPON SPRINGS, FL:  
2,929,884, INT. CL. 41.
- WORLD WRESTLING ENTERTAINMENT, INC., STAMFORD, CT:  
2,928,793, PUB. 12-7-2004. INT. CL. 41.
- WORLD WRESTLING ENTERTAINMENT, INC., STAMFORD, CT:  
2,928,460, PUB. 12-7-2004. MULTIPLE CLASS, INT. CLS. 9, 16, 28 AND 41.



WORMTRAP, INC., DAYTON, OH:  
 2,151,102, CANC. INT. CL. 5.  
 WP PRODUCTIONS, INC., RAY CITY, GA:  
 2,929,251, INT. CL. 25.  
 WRIGHT COATING COMPANY, INC, KALAMAZOO, MI:  
 2,929,492, INT. CL. 40.  
 WUDTIK INDUSTRIES LLC, NEW YORK MILLS, MN:  
 2,929,857, INT. CL. 9.  
 WYATT COMPANY, THE, WASHINGTON, DC:  
 2,151,301, CANC. INT. CL. 9.  
 WYETH, MADISON, NJ:  
 1,005,211, REN. 1-19-05, INT. CL. 5.  
 X-FAB GMBH, HAARBERGERSTRASSE 61, D99097, FED  
 REP GERMANY:  
 2,151,370, CANC. INT. CL. 9.  
 XCEL FEDERAL CREDIT UNION, NEW YORK, NY:  
 2,151,328, CANC. INT. CL. 36.  
 XEL HERBACEUTICALS, INC., SALT LAKE CITY, UT:  
 2,929,065, INT. CL. 5.  
 XOMED SURGICAL PRODUCTS, INC., JACKSONVILLE,  
 FL:  
 2,151,485, CANC. INT. CL. 21.  
 XOTHERMIC, INC., APOPKA, FL:  
 1,872,393, REN. 1-19-05, INT. CL. 11.  
 XPEDiate CONSULTING, LLC, CORTE MADERA, CA:  
 2,929,006, PUB. 12-7-2004, INT. CL. 9.  
 XPOINT TECHNOLOGIES, INC., BOCA RATON, FL:  
 2,151,236, CANC. INT. CL. 9.  
 XPRESSBET INCORPORATED, WASHINGTON, PA:  
 2,929,320, INT. CL. 36.  
 XTZ INDUSTRIES, INC., EDMONDS, WA:  
 2,929,143, INT. CL. 32.  
 XXCAL, INC., LOS ANGELES, CA:  
 2,151,423, CANC. INT. CL. 35.  
 YAMAHA HATSUDOKI KABUSHIKI KAISHA, SHIZUOKA-  
 KEN, JAPAN:  
 2,929,809, INT. CL. 12.  
 YANG, ROGER, CITY OF INDUSTRY, CA:  
 2,929,011, PUB. 12-7-2004, INT. CL. 18.  
 2,929,012, PUB. 12-7-2004, INT. CL. 18.  
 YARNELL ICE CREAM CO., INC., SEARCY, AR:  
 1,273,774, CANC. INT. CL. 30.  
 YKK CORPORATION, CHIYODA-KU, TOKYO, JAPAN:  
 2,928,520, PUB. 9-14-2004, INT. CL. 26.  
 YOUBILL.COM, INC., JENKINTOWN, PA:  
 2,929,098, INT. CL. 35.  
 YOUNG CHAMPIONS RECREATION PROGRAMS, INC.,  
 SANTA ANA, CA:  
 2,929,278, MULTIPLE CLASS, INT. CLS. 18, 25 AND 28.  
 YOUR HATS DESIRE, INC., MANLIUS, NY, DBA NEW  
 DIMENSIONS:  
 2,928,913, PUB. 12-7-2004, INT. CL. 21.  
 YSI INCORPORATED, YELLOW SPRINGS, OH:  
 781,359, REN. 1-21-05, U.S. CL. 26 (INT. CL. 9).  
 YUANG JIA FU INDUSTRIAL CORP., CHANGHUA CITY,  
 TAIWAN:  
 2,928,808, PUB. 12-7-2004, INT. CL. 6.  
 YUNNAN BAIYAO GROUP COMPANY LIMITED, KUNM-  
 ING, YUNNAN, CHINA:  
 2,929,102, INT. CL. 5.  
 YWHC, INC., WILMINGTON, DE:  
 1,273,384, CANC. INT. CL. 9.  
 ZACHMEIER MANUFACTURING, INC., MANDAN, ND:  
 2,928,631, PUB. 12-7-2004, INT. CL. 12.  
 ZAK DESIGNS, INC., SPOKANE, WA:  
 2,150,624, CANC. INT. CL. 21.  
 2,150,629, CANC. INT. CL. 20.  
 ZANOTTO SA, 6300 ZUG, SWITZERLAND:  
 2,898,670, COR. MULTIPLE CLASS, INT. CLS. 24 AND  
 25.  
 ZAP, INC., VIRGINIA BEACH, VA:  
 2,150,509, CANC. INT. CL. 9.  
 ZARECK, MARK A., AURORA, CO, DBA ZARECK INDUS-  
 TRIES:  
 2,151,353, CANC. INT. CL. 16.  
 ZAZ CORPORATION, BOULDER, CO:  
 2,929,648, INT. CL. 42.  
 ZBL, INC., FORT BRAGG, CA:  
 2,928,866, PUB. 12-7-2004, INT. CL. 40.  
 ZEFTRON, INC., MONTGOMERY, IL:  
 2,151,229, CANC. INT. CL. 12.  
 ZERO DEGREE MANUFACTURING AG, 6302 ZUG, SWIT-  
 ZERLAND:  
 2,150,034, CANC. MULTIPLE CLASS, INT. CLS. 8, 18, 25  
 AND 28.  
 ZESTO HOLDINGS INC., KELOWNA, BRITISH COLUMBIA  
 VIW 4J2, CANADA:  
 2,150,610, CANC. INT. CL. 29.  
 ZHOU, TAO, HANGZHOU, ZHEJIANG, CHINA:  
 2,929,084, INT. CL. 28.  
 ZNOMICS, INC., OREGON CITY, OR:  
 2,929,635, INT. CL. 42.  
 ZOO YORK, LLC, SOUTH RIVER, NJ:  
 2,929,609, INT. CL. 25.  
 ZOOLOGICAL SOCIETY OF SAN DIEGO, INC., SAN  
 DIEGO, CA:  
 1,867,822, REN. 1-21-05, INT. CL. 41.  
 ZUCCHERO, VINCENT W., VENTURA, CA:  
 2,928,549, PUB. 7-20-2004, INT. CL. 11.  
 ZUIDINGA, THERESIA PETRONELLA, 1017 WV AMSTER-  
 DAM, NETHERLANDS AND EHRlich, JOHANNA STE-  
 PHANIE, 1017 WV AMSTERDAM, NETHERLANDS AND  
 JANSSEN, ALOYSIUS WILHELMUS HENDRIKUS, 1017  
 WV AMSTERDAM, NETHERLANDS:  
 2,150,002, CANC. INT. CL. 34.  
 ZYNOLYTE PRODUCTS COMPANY, CARSON, CA TO THE  
 GLIDDEN COMPANY, CLEVELAND, OH:  
 1,830,085, CANC. INT. CL. 2.  
 1-888 NEVER PAINT, SAN DIEGO, CA:  
 2,928,944, PUB. 12-7-2004, INT. CL. 37.  
 18 KARAT INTERNATIONAL PRODUCT SOURCING INC.,  
 MAPLE RIDGE, B.C., CANADA:  
 2,150,510, CANC. INT. CL. 35.  
 1914 HOLDING COMPANY, KANSAS CITY, MO:  
 1,311,614, REN. 1-18-05, INT. CL. 42.  
 2000717 ONTARIO LIMITED, BROCKVILLE, ONTARIO,  
 CANADA:  
 2,929,727, INT. CL. 9.  
 2,929,728, MULTIPLE CLASS, INT. CLS. 9, 10 AND 18.  
 21ST CENTURY HEALTHCARE MANAGEMENT, INC.,  
 WOODRIDGE, IL:  
 2,928,791, PUB. 12-7-2004, INT. CL. 36.  
 3398889 CANADA INC., BROSSARD, QUEBEC, CANADA:  
 2,928,454, PUB. 10-1-2002, MULTIPLE CLASS, INT. CLS.  
 41 AND 42.  
 5 ALIVE, LLC, ATLANTA, GA:  
 2,150,620, CANC. INT. CL. 41.  
 579732 B.C. LTD., SCOTCHCREEK, BRITISH COLUMBIA,  
 CANADA, DBA ROSS CHOCOLATES:  
 2,635,052, CANC. INT. CL. 30.  
 2,749,491, CANC. INT. CL. 30.  
 618 MAIN CLOTHING CORP., UNION CITY, NJ:  
 2,928,992, PUB. 12-7-2004, INT. CL. 35.  
 9-1-1 FOR KIDS, INC., CARPENTERIA, CA:  
 2,151,191, CANC. INT. CL. 28.  
 951300 ONTARIO INC., MISSISSAUGA, ONTARIO L5R 2Z6,  
 CANADA:  
 2,149,926, CANC. MULTIPLE CLASS, INT. CLS. 21, 30  
 AND 42.