

MARKS PUBLISHED FOR OPPOSITION

The following marks are published in compliance with section 12(a) of the Trademark Act of 1946. Applications for the registration of marks in more than one class have been filed as provided in section 30 of said act as amended by Public Law 772, 87th Congress, approved Oct. 9, 1962, 76 Stat. 769. Opposition under section 13 may be filed within thirty days of the date of this publication. See rules 2.101 to 2.105.

A separate fee of two hundred dollars for opposing each mark in each class must accompany the opposition.

SECTION 1.— INTERNATIONAL CLASSIFICATION

The short titles associated below with the international class numbers are terms designed merely for quick identification and are not an official part of the international classification. The full names of international classes are given in section 6.1 of the trademark rules of practice.

The designation "U.S. Cl." appearing in this section refers to the U.S. class in effect prior to Sep. 1, 1973 rather than the international class which applies to applications filed on or after that date. For adoption of international classification see notice in the OFFICIAL GAZETTE of Jun. 26, 1973 (911 O.G. TM 210).

Application in more than one class

SN 75-834,331. DIAVIK DIAMOND MINES INC., YELLOW-KNIFE, CANADA, FILED 10-29-1999.

SN 75-936,124. KABUSHIKI KAISHA SONY COMPUTER ENTERTAINMENT, TA SONY COMPUTER ENTERTAINMENT INC., MINATO-KU, TOKYO 107-0052, JAPAN, FILED 3-6-2000.

**DIAVIK DIAMOND MINES
INC.**

PS.COM

OWNER OF CANADA REG. NO. TMA599570, DATED 1-15-2004, EXPIRES 1-15-2019.

NO CLAIM IS MADE TO THE EXCLUSIVE RIGHT TO USE "DIAMOND MINES INC.", APART FROM THE MARK AS SHOWN.

OWNER OF JAPAN REG. NO. 4598550, DATED 8-23-2002, EXPIRES 8-23-2012.

CLASS 14—JEWELRY

FOR DIAMONDS (U.S. CLS. 2, 27, 28 AND 50).

CLASS 35—ADVERTISING AND BUSINESS

FOR WHOLESALE STORE AND DISTRIBUTORSHIP SERVICES FEATURING DIAMONDS (U.S. CLS. 100, 101 AND 102).

CLASS 37—CONSTRUCTION AND REPAIR

FOR MINING OF DIAMONDS, NAMELY MINING EXTRACTION (U.S. CLS. 100, 103 AND 106).

CLASS 40—MATERIAL TREATMENT

FOR DIAMOND PROCESSING, NAMELY LASER ENGRAVING OF DIAMONDS AND GEMSTONES FOR OTHERS; CUTTING AND POLISHING DIAMONDS FOR OTHERS; DIAMOND REFINING AND DEEP DIAMOND BOILING PROCESSING SERVICES, NAMELY, EXPOSING DIAMONDS TO SOLVENTS, CONCENTRATED CAUSTICS AND ACIDS UNDER HIGH TEMPERATURE AND PRESSURES (U.S. CLS. 100, 103 AND 106).

CLASS 42—SCIENTIFIC, COMPUTER AND LEGAL SERVICES

FOR MINING OF DIAMONDS, NAMELY MINING AND MINERAL EXPLORATION SERVICES (U.S. CLS. 100 AND 101).
DANIEL CAPSHAW, EXAMINING ATTORNEY

CLASS 9—ELECTRICAL AND SCIENTIFIC APPARATUS

FOR ABACUSES; ACID HYDROMETERS; ACTINOMETERS; ADDING MACHINES; AEROMETERS; AIR TANKS FOR USE IN SCUBA DIVING; ALTIMETERS; AMMETERS; ANEMOMETERS; ANTENNAS; ARM RESTS FOR USE WITH COMPUTERS; AUTOMATIC TELEPHONE DIALERS; AUTOMATIC VALVES; BAR CODE READERS; BAROMETERS; BATTERIES FOR VEHICLES; BATTERIES; BATTERY CHARGERS; BINOCULARS; BLANK MAGNETIC COMPUTER TAPES; CALCULATORS; CAMERA CASES; CAMERA FILTERS; CAMERA TRIPODS; CAPACITORS; CASH REGISTERS; CATHODE RAY TUBES; CHRONOGRAPHS FOR USE AS SPECIALIZED TIME RECORDING APPARATUS; CIRCUIT BOARDS; CIRCUIT BREAKERS; CLINOMETER; COAXIAL CABLES; COLOR SEPARATION FILM; COMMUTATORS; COMPUTER BUFFERS; COMPUTER CABLES; COMPUTER CARRYING CASES; COMPUTER CHIPS; COMPUTER COLOR PRINTER USING HEAT SENSITIVE DRY PRINTING PROCESS; COMPUTER DISC DRIVES; COMPUTER FAX MODEM CARDS; COMPUTER GAME CARTRIDGES; COMPUTER GAME CASSETTES; COMPUTER GAME DISCS; COMPUTER GAME EQUIPMENT CONTAINING MEMORY DEVICES NAMELY, DISCS; COMPUTER GAME JOYSTICKS; COMPUTER GAME PROGRAMS; COMPUTER GAME SOFTWARE; COMPUTER GAME TAPES; COMPUTER HARDWARE; COMPUTER INTERFACE BOARDS; COMPUTER KEYBOARDS; COMPUTER MEMORIES; COMPUTER MONITORS; COMPUTER MOUSE; COMPUTER OPERATING PROGRAMS; COMPUTER OPERATING SYSTEMS; COMPUTER PERIPHERALS; COMPUTER PRINTERS; COMPUTER TERMINALS; COMPUTER UTILITY PROGRAMS; COMPUTERS AND INSTRUCTIONAL MANUALS SOLD AS A UNIT; COMPUTERS; CONDENSERS; CONVERTERS; COVERS FOR ELECTRIC OUTLETS; COVERS FOR TELEPHONE RECEIVERS NOT MADE OF PAPER; CRUISE CONTROLS FOR MOTOR VEHICLES; CYCLOTRONS; DAISY WHEEL PRINTERS; DATA PROCESSORS; DECOMPRESSION CHAMBERS; DEMAGNETIZERS FOR MAGNETIC

TAPES; DICTATION MACHINES; DIGITAL AUDIO TAPE PLAYERS; DOG WHISTLES; DOSIMETERS; DOT MATRIX PRINTERS; DYNAMOMETERS; EAR PLUGS NOT FOR MEDICAL PURPOSES; ELECTRIC FENCES; ELECTRIC OUTLET COVERS; ELECTRIC SWITCH PLATES; ELECTRICAL POWER EXTENSION CORDS; ELECTRONIC ANIMAL CONFINEMENT SYSTEMS; ELECTRONIC APPARATUS FOR TESTING THE STERILITY OF PHARMACEUTICALS AND INJECTABLE SOLUTIONS; ELECTRONIC APPARATUS FOR TESTING THE STERILITY OF MEDICAL EQUIPMENT; ELECTRONIC EFFECT PEDALS FOR USE WITH SOUND AMPLIFIERS; ELECTRONIC NOTICE BOARDS; ELECTRONIC PERSONAL ORGANIZER; ELECTRONIC SAFES; EMERGENCY WARNING LIGHTS; ENCODERS; EPIDIASCOPES; EVENT RECORDERS; FACSIMILE MACHINES; FAX MACHINES; FIBER OPTIC CABLES; FIBER OPTIC LIGHT AND IMAGE CONDUITS; FIBER OPTICS; FILTERS FOR RESPIRATORY MASKS; FIRE ALARMS; FIRE SPRINKLERS; FIRE TRUCKS; FUEL PUMPS FOR SERVICE STATIONS; FUSES FOR AUTOMOBILES; GALVANOMETERS; GAMBLING MACHINES; GAMING EQUIPMENT, NAMELY, SLOT MACHINES WITH OR WITHOUT VIDEO OUTPUT; GAMING MACHINES; GAS CHROMATOGRAPHY APPARATUS; GAS MASKS; GAS METERS; GASOMETERS; HEADPHONES; HIGHWAY SAFETY CONES; HOLDERS FOR COMPACT DISCS; HUBS FOR TIMING DIALS; HYDROMETERS; HYGROMETERS; IMPACT PRINTERS; INSULATED ELECTRICAL CONNECTORS; INTEGRATED CIRCUITS; INTERACTIVE MULTIMEDIA COMPUTER GAME PROGRAM; INTERACTIVE VIDEO GAME PROGRAMS; INTERACTIVE VIDEO GAMES OF VIRTUAL REALITY COMPRISED OF COMPUTER HARDWARE AND SOFTWARE; INVERTERS; JACKETS FOR COMPUTER DISKS; JACKETS FOR VIDEO CASSETTES; JOYSTICKS FOR VIDEO GAMES; JUMPER CABLES; KALEIDOSCOPIES; LASER POINTERS; LASER PRINTERS; LASER SCANNERS FOR INDUSTRIAL INSPECTION; LASERS FOR MEASURING PURPOSES; LASERS NOT FOR MEDICAL USE; LETTER SCALES; LIGHT EMITTING DIODE DISPLAYS; LIGHT EMITTING DIODES; LIGHTING BALLASTS; LIGHTNING RODS; LOUDSPEAKER CABINETS; LOUDSPEAKERS; MACHINES FOR PLAYING GAMES OF CHANCE; MAGNETIC CODED CARD READERS; MAGNETIC CODED CARDS; MAGNIFYING GLASSES; MARINE DEPTH FINDERS; MARKER BUOYS; MEASURING CUPS; MEASURING SPOONS; MEGAPHONES; METAL DETECTORS; METRONOMES; MICRO-PROCESSORS; MICROCOMPUTERS; MICROFICHE; MICROMETERS; MICROPHONES; MICROSCOPES; MICROWAVE OVENS FOR LABORATORY USE; MINICOMPUTERS; MODEMS; MOTION PICTURE CAMERAS; MULTIPLEXERS; MUSICAL SOUND RECORDINGS; MUSICAL VIDEO RECORDINGS; NAVIGATIONAL BUOYS; NEON SIGNS; ODOMETERS; OHMMETERS; OXYGEN MASKS NOT FOR MEDICAL USE; PARKING METERS; PARTICLE ACCELERATORS; PEDOMETERS; PERISCOPES; PERSONAL SECURITY ALARMS; PHONOGRAPH NEEDLES; PHONOGRAPH RECORD PLAYERS; PHONOGRAPHS; PHOTOCOPYING MACHINES; PLUMB BOBS; PLUMB LEVELS; PLUMB LINES; POCKET CALIPERS FOR MEASURING; POLYGRAPH MACHINES; POWER LINE CONDITIONERS; PRESSURE GAUGES; PRESSURE INDICATING PLUGS FOR VALVES; PRINTED CIRCUITS; PRISMS FOR SCIENTIFIC PURPOSES; PROJECTION SCREENS; PROTRACTORS; PYROMETERS; RADAR DETECTORS; RADAR; RADIO CONTROLLED MINIATURE AERIAL TARGETS; RADIO PAGERS; RADIO TELEPHONES; RADIOS FOR VEHICLES; RADIOS INCORPORATING CLOCKS; RADIOS; RADON DETECTORS; REGULATORS FOR USE IN SCUBA DIVING; REMOTE CURSOR CONTROLS FOR COMPUTERS; RESPIRATORS OTHER THAN FOR ARTIFICIAL RESPIRATION; RESPIRATORY MASK FILTERS; RHEOSTATS; RING BUOYS FOR USE IN WATER RESCUE; SALINOMETERS; SATELLITE PROCESSORS; SATELLITES FOR SCIENTIFIC PURPOSES; SATELLITES; SCALES; SEMICONDUCTOR DEVICES; SEMICONDUCTORS; SEXTANTS; SIGNAL BELLS; SIGNAL PROCESSORS; SIGNAL WHISTLES; SIGNALING BUOYS; SILICON CHIPS; SILICON WAFERS; SIRENS FOR VEHICLES; SIRENS; SLIDE PROJECTORS; SLIDE RULES; SLOT MACHINES; SMOKE DETECTORS; SOLENOID VALVES; SONAR; SPECTACLES; SPEEDOMETERS FOR VEHICLES; SPEEDOMETERS; STEREO AMPLIFIERS; STEREO RECEIVERS; STEREO TUNERS; SUPERCOMPUTERS; SUPERMINI COMPUTERS; SURVEYING

CHAINS; SURVEYORS' LEVELS; TACHOMETERS; TELEPHONE ANSWERING MACHINES; TELEPHONE APPARATUS, NAMELY INTERCOMS; TELEPHONE EQUIPMENT, NAMELY, CALLER IDENTIFICATION BOXES; TELEPHONES; TELEPROMPTERS; TELESCOPES; TELESCOPIC GUN SIGHTS; TELESCOPIC LENS SIGHTS; TELEVISION ANTENNAS; TELEVISION SETS; THEODOLITES; THERMOMETERS NOT FOR MEDICAL USE; THERMOSTATS; TICKET CANCELING MACHINES; TIMING DIALS; TIMING SENSORS; TIRE BALANCING MACHINES FOR LAND VEHICLES; TIRE BALANCING UNITS FOR LAND VEHICLES; TRANSCIEVERS; TRANSPONDERS; TRIPODS FOR CAMERAS; TYPEFACE FONTS RECORDED ON MAGNETIC MEDIA; VEHICLE WHEEL ALIGNMENT MACHINES; VENDING MACHINES; VIDEO CAMERAS; VIDEO CASSETTE RECORDERS; VIDEO GAME CARTRIDGES; VIDEO GAME DISCS; VIDEO GAME INTERACTIVE CONTROL FLOOR PADS OR MATS; VIDEO GAME INTERACTIVE REMOTE CONTROL UNITS; VIDEO GAME JOYSTICKS; VIDEO GAME MACHINES FOR USE WITH TELEVISIONS; VIDEO GAME SOFTWARE; VIDEO GAME TAPE CASSETTES; VIDEO MONITORS; VIDEO TAPE RECORDERS; VIRTUAL REALITY GAME SOFTWARE; VOLTAGE SURGE PROTECTORS; VOLTAGE SURGE SUPPRESSORS; VOLTMETERS; VOTING MACHINES; WALKIE-TALKIES; WARNING TRIANGLES TO INDICATE VEHICLE BREAKDOWNS; WATER METERS; WELDING ELECTRODES; WORD PROCESSORS; X-Y PLOTTERS; X-RAY PHOTOGRAPHS, OTHER THAN FOR MEDICAL PURPOSES (U.S. CLS. 21, 23, 26, 36 AND 38).

CLASS 16—PAPER GOODS AND PRINTED MATTER

FOR ACCOUNT BOOKS; ACCOUNTING FORMS; ADDRESS BOOKS; ADDRESS LABELS; AGENDAS; ALMANACS; ANIMATION CELLS; ANNIVERSARY BOOKS; ANNOUNCEMENT CARDS; ANT VIVARIA; APPLIQUES IN THE FORM OF DECALS; APPOINTMENT BOOKS; ARCHITECTURAL MODELS; ARCHITECTURAL PLANS AND SPECIFICATIONS; ARCHIVAL STORAGE PAGES; ART ETCHINGS; ART PADS; ART PAPER; ART PICTURES; ART PRINTS; ARTISTS' BRUSHES; ATLASES; AUTOGRAPH BOOKS; BABY BOOKS; BAGS FOR MICROWAVE COOKING; BALL POINT PENS; BANK CHECKS; BIBLES; BINDERS; BLACKBOARDS; BLANK NOTE CARDS; BLUEPRINTS; BOND PAPER; BOOK COVERS; BOOK HOLDERS; BOOKKEEPING BOOKS; BOOKKEEPING FORMS; BOOKMARKS; BULLETIN BOARDS; BUMPER STICKERS; BUSINESS CARDS; BUSINESS FORMS; BUSINESS RECORD BOOKS; CALENDAR DESK PADS; CALENDARS; CANVAS FOR PAINTING; CARBON PAPER; CARDS BEARING UNIVERSAL GREETINGS; CARICATURES; CARTOON PRINTS; CARTOON STRIPS; CASH RECEIPT BOOKS; CHALK ERASERS; CHARCOAL PENCILS; CHECK BOOKS; CHECKBOOK AND PASSBOOK WALLETS; CHECKBOOK COVERS; CHECKBOOK HOLDERS; CHILDREN'S ACTIVITY BOOKS; CHILDREN'S BOOKS; CHRISTMAS CARDS; COLLAGES; COLOR PRINTS; COLORING BOOKS; COMIC BOOKS; COMIC STRIPS; COMIC FEATURES; COMMEMORATIVE STAMP SHEETS; COMPOSITION BOOKS; COMPUTER GAME INSTRUCTION MANUALS; COMPUTER PAPER; CONSTRUCTION PAPER; COOK BOOKS; COPY BOOKS; COPY PAPER; COPY; COPYHOLDERS; CORRECTING PENCILS FOR TYPE; COUPON BOOKS; COUPONS; CRAFT PAPER; CROSSWORD PUZZLES; DAILY PLANNERS; DATA BOOKS; DATE BOOKS; DESK CALENDARS; DIARIES; DICTATION BOOKS; DICTIONARIES; DRAWING BOARDS; DRAWING BRUSHES; DRAWING PAPER; DRAWING PENCILS; EMBROIDERY DESIGN PATTERNS; ENGAGEMENT BOOKS; ENVELOPES; ERASER DUSTING BRUSHES; ERASERS; ETCHINGS; EXERCISE BOOKS; EXPENSE BOOKS; FELT PENS; FELT TIP MARKERS; FLASH CARDS; GAZETTEERS; GIFT CARDS; GRAPHIC ART REPRODUCTIONS; GRAPHIC NOVELS; GREETING CARDS; GUEST BOOKS; HIGHLIGHTING MARKERS; HIGHLIGHTING PENS; HOUSE ORGANS; HYMN BOOKS; INDEX BOOKS; INDEX CARDS; INSTRUCTION SHEETS; LAW DIGESTS; LAW REPORTS; LEDGER BOOKS; LITHOGRAPHIC PRINTS; LITHOGRAPHS; LOG BOOKS; LOOSE LEAF BINDERS; LOOSE LEAF PAPER; LUMINOUS PAPER; MAPS; MARKERS; MARKING PENS; MECHANICAL PENCIL SHARPENERS; MECHANICAL PENCILS; MEDICAL

IDENTIFICATION CARDS; MEMORANDUM BOOKS; MOTIVATIONAL CARDS; MUSICAL GREETING CARDS; NEGOTIABLE INSTRUMENT FORMS; NEWS BULLETINS; NEWSPAPER CARTOONS; NEWSPAPER COMIC STRIPS; NEWSPAPERS FOR GENERAL CIRCULATION; NOTE BOOKS; NOTE CARDS; NOTE PADS; NOTE PAPER; NOTEBOOK PAPER; NOVELS; OCCASION CARDS; ORDER FORMS; PAINT BRUSHES; PAINTING PALETTES; PAINTINGS; PALETTES FOR PAINTING; PAPER BADGES; PAPER ENVELOPES FOR PACKAGING; PAPER IDENTIFICATION TAGS; PAPER TAGS; PATTERNS FOR MAKING CLOTHES; PENCILS; PHOTOGRAPHIC PRINTS; PICTORIAL PRINTS; PICTURE BOOKS; PICTURE POSTCARDS; PLACE CARDS; POSTCARDS; PRAYER BOOKS; PRICE TAGS; PRICE TICKETS; PRINTED AWARDS; PRINTED EMBLEMS; PRINTED FORMS; PRINTED INVITATIONS; PRINTED MUSIC BOOKS; PRINTED PATTERNS; PRINTED PLANS; PRINTED RECIPES SOLD AS A COMPONENT OF FOOD PACKAGING; PRINTED SEMINAR NOTES; PRINTED SURVEY ANSWER SHEETS; RECEIPT BOOKS; RECIPE BOOKS; RECORD CARDS; RELIGIOUS BOOKS; RELIGIOUS CIRCULAR LETTERS; REPORTERS' NOTE BOOKS; ROMANCE NOVELS; SCORE BOOKS; SCORE CARDS; SCORE CHARTS; SCORE PADS; SCORE SHEETS; SCRAPBOOK ALBUMS; SCRAPBOOKS; SCRATCH PADS; SHEET MUSIC; SHIPPING LABELS; SKETCH BOOKS; SOCIAL NOTE CARDS; SONG BOOKS; SPORTS TRADING CARDS; STATIONERY WRITING PAPER AND ENVELOPES; STATIONERY; STORIES IN ILLUSTRATED FORM; STUDY GUIDES; TALKING CHILDREN'S BOOKS; TELEPHONE DIRECTORIES; TELEPHONE INDEXES; TELEPHONE NUMBER BOOKS; TRAVEL BOOKS; TYPEWRITER PAPER; VOUCHER BOOKS; WALL CALENDARS; WALL COVERING SAMPLE BOOKS; WALLPAPER SAMPLE BOOK; WIRE-BOUND BOOKS; WRITING PAPER (U.S. CLS. 2, 5, 22, 23, 29, 37, 38 AND 50).

CLASS 35—ADVERTISING AND BUSINESS

FOR ADVERTISING SERVICES, NAMELY, PROVIDING ADVERTISING SPACE IN A PERIODICAL; AGENCIES FOR THE SALE OF ADVERTISING TIME AND SPACE; ATTORNEY REFERRALS; BUSINESS MANAGEMENT; BUSINESS MANAGEMENT OF HOTELS FOR OTHERS; BUSINESS MANAGEMENT PLANNING; BUSINESS MANAGEMENT SUPERVISION; BUSINESS MANAGEMENT; COMMERCIAL AND INDUSTRIAL MANAGEMENT ASSISTANCE; COOPERATIVE ADVERTISING AND MARKETING; DEVELOPING PROMOTIONAL CAMPAIGNS FOR BUSINESS; DIRECT MAIL ADVERTISING; DISSEMINATION OF ADVERTISING FOR OTHERS VIA AN ON-LINE ELECTRONIC COMMUNICATIONS NETWORK; DISSEMINATION OF ADVERTISING MATTER; DOCTOR REFERRALS; ELECTRONIC BILLBOARD ADVERTISING; FOREIGN TRADE INFORMATION AND CONSULTATION; HOSPITAL MANAGEMENT; HOTEL MANAGEMENT FOR OTHERS; LAWYER REFERRALS; MEDICAL REFERRALS; PHYSICIAN REFERRALS; PLACING ADVERTISEMENTS FOR OTHERS; PREPARING ADVERTISEMENTS FOR OTHERS; PREPARING AUDIO-VISUAL PRESENTATIONS FOR USE IN ADVERTISING; PRODUCING AUDIO OR VIDEO INFORMATIONALS; PRODUCTION AND DISTRIBUTION OF RADIO AND TELEVISION COMMERCIALS; PRODUCT DEMONSTRATION; PRODUCTION OF TELEVISION COMMERCIALS; PROMOTING SPORTS COMPETITIONS AND/OR EVENTS OF OTHERS; PROMOTING THE CONCERTS OF OTHERS; PROMOTING THE GOODS AND SERVICES OF OTHERS BY PREPARING AND PLACING ADVERTISEMENTS IN AN ELECTRONIC MAGAZINE ACCESSED THROUGH A GLOBAL COMPUTER NETWORK; PROMOTING THE GOODS AND SERVICES OF OTHERS THROUGH THE DISTRIBUTION OF DISCOUNT CARDS; PROMOTING THE SALE OF CREDIT CARD ACCOUNTS THROUGH THE ADMINISTRATION OF INCENTIVE AWARD PROGRAMS; PROMOTING THE SALE OF GOODS AND SERVICES OF OTHERS BY AWARDED PURCHASE POINTS FOR CREDIT CARD USE; PROMOTING THE SALE OF GOODS AND SERVICES OF OTHERS THROUGH THE DISTRIBUTION OF PRINTED MATERIAL AND PROMOTIONAL CONTESTS; PROVIDING TELEVISION ADVERTISING FOR OTHERS; MODELING FOR ADVERTISING OR SALES PROMOTION; PUBLIC OPINION POLLING FOR ADVERTISING PUR-

POSES; PUBLIC RELATIONS; PUBLICITY AGENTS; REFERRALS FOR GENERAL BUILDING CONTRACTORS; RENTAL OF ADVERTISING SPACE; TELEVISION ADVERTISING AGENCIES; THEATRICAL MANAGEMENT; TRAVEL MANAGEMENT; SHOP WINDOW DRESSING (U.S. CLS. 100, 101 AND 102).

CLASS 41—EDUCATION AND ENTERTAINMENT

FOR ENTERTAINMENT SERVICES, NAMELY, PROVIDING AN ON-LINE COMPUTER GAME; PROVIDING A COMPUTER GAME THAT MAY BE ACCESSED NETWORK-WIDE BY NETWORK USERS (U.S. CLS. 100, 101 AND 107).

PRISCILLA MILTON, EXAMINING ATTORNEY

SN 76-087,622. B. I. SOLUTION PROVIDERS, INC., NORCROSS, GA. FILED 7-12-2000.



NO CLAIM IS MADE TO THE EXCLUSIVE RIGHT TO USE "INTELLIGENT BUSINESS SOLUTIONS", APART FROM THE MARK AS SHOWN.

THE STIPPLING SHOWN IS A FEATURE OF THE MARK AND IS NOT INTENDED TO INDICATE COLOR.

CLASS 35—ADVERTISING AND BUSINESS

FOR DISTRIBUTORSHIP IN THE FIELD OF COMPUTER SOFTWARE WHICH PROVIDES ACCESS TO, AND ANALYSIS OF, CORPORATE DATA, ENABLING COMPREHENSIVE DATA REPORTING AND TREND ANALYSIS OF KEY PERFORMANCE INDICATORS (U.S. CLS. 100, 101 AND 102).

FIRST USE 6-30-2000; IN COMMERCE 6-30-2000.

CLASS 41—EDUCATION AND ENTERTAINMENT

FOR COMPUTER EDUCATION TRAINING SERVICES (U.S. CLS. 100, 101 AND 107).

FIRST USE 6-30-2000; IN COMMERCE 6-30-2000.

CLASS 42—SCIENTIFIC, COMPUTER AND LEGAL SERVICES

FOR INSTALLATION OF COMPUTER SOFTWARE SYSTEMS WHICH PROVIDE ACCESS TO, AND ANALYSIS OF, CORPORATE DATA, ENABLING COMPREHENSIVE DATA REPORTING AND TREND ANALYSIS OF KEY PERFORMANCE INDICATOR (U.S. CLS. 100 AND 101).

FIRST USE 6-30-2000; IN COMMERCE 6-30-2000.
CYNTHIA SLOAN, EXAMINING ATTORNEY

SN 76-103,890. GEOMETRIE CONCERN VERWALTUNGS- UND BETEILIGUNGSGESELLSCHAFT MBH, D-97232 GIEBELSTADT, FED REP GERMANY, FILED 8-4-2000.

Psi-m

PRIORITY CLAIMED UNDER SEC. 44(D) ON ERPN CMNTY TM OFC APPLICATION NO. 1,660,661, FILED 5-17-2000, REG. NO. 1660661, DATED 9-3-2001, EXPIRES 5-17-2010.

CLASS 9—ELECTRICAL AND SCIENTIFIC APPARATUS

FOR SCIENTIFIC, ELECTRIC, CINEMATOGRAPHIC, WEIGHING, SIGNALING, LIFE-SAVING AND TEACHING APPARATUS AND INSTRUMENTS, NAMELY PHOTOGRAPHIC AND CINEMATOGRAPHIC CAMERAS; DEVICES FOR GRAVIMETRIC EXPLORATION, NAMELY GRAVIMETRIC MEASURING SYSTEMS COMPRISING SENSORS, MONITORS, PRINTERS, MODEMS, PDA, MOBILE PHONES, TRANSMITTERS, DISKETTE-, CD-ROM- AND DVD-DRIVES, LAN, WAN, WORK STATIONS, PCS, SERVERS, GATEWAYS, INTERFACES; ANALOG TO DIGITAL CONVERTERS FOR SEISMIC EXPLORATION; APPARATUS FOR RECORDING, TRANSMISSION OR REPRODUCTION OF SOUND OR IMAGES, NAMELY AUDIO CASSETTE RECORDERS, VIDEO CASSETTE RECORDERS, MICROPHONES, GEOPHONES; DIGITAL AUDIO TAPE RECORDERS; DIGITAL CAMERAS; DIGITAL PHONES AND DIGITAL VIDEO RECORDERS; PRE-RECORDED MAGNETIC, OPTIC AND MAGNETO-OPTIC DATA CARRIERS FEATURING MUSIC, DATABASES IN THE FIELD OF GEOLOGY, GEODESY, AND GEOPHYSICS, GEODETIC, GEOLOGICAL, GEOPHYSICAL AND SURVEILLANCE DATA; BLANK MAGNETIC DATA CARRIERS FOR RECORDING OF MUSIC; COMPUTER PROGRAMS FOR USE IN RECORDING, COLLECTING, STORING, GOVERNING, ANALYZING, PROCESSING, RECALLING, PRINTING, DISTRIBUTING AND EXCHANGING DATA IN THE FIELD OF GEOLOGY, GEODESY AND GEOPHYSICS; COMPUTER MEDIA CONTAINING DATABASES FEATURING GEODETIC, GEOLOGICAL, GEOPHYSICAL AND SURVEILLANCE DATA; AUTOMATIC VENDING MACHINES; CASH REGISTERS, CALCULATORS; FIRE EXTINGUISHERS (U.S. CLS. 21, 23, 26, 36 AND 38).

CLASS 12—VEHICLES

FOR CARS, TRUCKS, ALL TERRAIN CRAWLER TYPE VEHICLES, BICYCLES, MOTORCYCLES, AIRPLANES, HELICOPTERS AND BOATS (U.S. CLS. 19, 21, 23, 31, 35 AND 44).

CLASS 35—ADVERTISING AND BUSINESS

FOR ADVERTISING AGENCIES (U.S. CLS. 100, 101 AND 102).

CLASS 36—INSURANCE AND FINANCIAL

FOR FINANCIAL SERVICES, NAMELY INVESTOR RELATIONSHIP MANAGEMENT, PROVIDING FINANCIAL INFORMATION BY ELECTRONIC MEANS, FINANCIAL SERVICES IN THE NATURE OF AN INVESTMENT SECURITY AND SECURITY SERVICES, NAMELY GUARANTEEING LOANS; FINANCIAL INFORMATION PROCESSING; FINANCIAL RESEARCH; FINANCIAL ANALYSIS AND CONSULTATION; INVESTMENT BROKERAGE; INSURANCE ADMINISTRATION; INSURANCE AGENCIES; INSURANCE BROKERAGE; REAL ESTATE APPRAISAL; REAL ESTATE BROKERAGE (U.S. CLS. 100, 101 AND 102).

CLASS 40—MATERIAL TREATMENT

FOR WATER TREATMENT, WASTE TREATMENT AND METAL TREATMENT (U.S. CLS. 100, 103 AND 106).

CLASS 42—SCIENTIFIC, COMPUTER AND LEGAL SERVICES

FOR EXPLOITATION OF INTELLECTUAL PROPERTY RIGHTS, NAMELY LICENSING OF PATENT AND TRADEMARKS; INTELLECTUAL PROPERTY CONSULTATION (U.S. CLS. 100 AND 101).
CYNTHIA SLOAN, EXAMINING ATTORNEY

SN 76-113,333. ITALFRESCO LIMITED, LONDON, ENGLAND, FILED 8-18-2000.

ITALFRESCO

PRIORITY CLAIMED UNDER SEC. 44(D) ON ERPN CMNTY TM OFC APPLICATION NO. 001815570, FILED 8-8-2000, REG. NO. 001815570, DATED 9-24-2001, EXPIRES 8-8-2010.

CLASS 29—MEATS AND PROCESSED FOODS

FOR (BASED ON INTENT TO USE) (BASED ON 44(E)) SALAMI; SAUSAGES; DRY CURED HAMS; COOKED HAMS; SMOKED HAMS; TOMATO PUREE; MEAT; MEAT PRODUCTS, NAMELY, BEEF RIBS, FLANK STEAK, LAMB CHOPS; MEAT EXTRACTS; GAME; GAME PRODUCTS, NAMELY, VENISON, DUCK BREASTS; POULTRY; POULTRY PRODUCTS, NAMELY, CHICKEN BREASTS, CHICKEN WINGS, CHICKEN SLICES; FROZEN, PREPARED OR PACKAGED CHICKEN ENTREES, NAMELY, ENTREES CONSISTING PRIMARILY OF PREPARED CHICKEN; FISH; FISH PRODUCTS, NAMELY, CAVIAR, AND FISH FILLETS; FROZEN, PREPARED OR PACKAGED SEAFOOD PAELLA, NAMELY, AN ENTREE COMPOSED PRIMARILY OF SEAFOOD AND ALSO CONTAINING RICE; FROZEN, PREPARED OR PACKAGED FISH ENTREES, NAMELY, ENTREES CONSISTING PRIMARILY OF PREPARED FISH; CHEESE; CHEESE PRODUCTS, NAMELY, CREAM CHEESE, COTTAGE CHEESE; DAIRY PRODUCTS, NAMELY, CREAM, BUTTER; DAIRY SPREADS, NAMELY, CHEESE SPREADS AND LOW FAT SPREADS CONSISTING PRIMARILY OF BUTTERMILK AND VEGETABLE OILS; MILK PRODUCTS, NAMELY, MILK, CHOCOLATE MILK, MILK AND CREAM MIXTURE ALSO KNOWN AS HALF AND HALF, AND SKIM MILK; PRESERVED, DRIED AND COOKED FRUITS AND VEGETABLES; FRUIT AND VEGETABLE PRODUCTS, NAMELY, VEGETABLE SOUP MIXES, FRUIT RINDS, CANDIED FRUIT; FROZEN, PREPARED OR PACKAGED VEGETABLE PAELLA, NAMELY, AN ENTREE CONSISTING PRIMARILY OF VEGETABLES AND ALSO CONTAINING RICE; FROZEN, PREPARED OR PACKAGED VEGETARIAN MEALS, NAMELY, ENTREES CONSISTING PRIMARILY OF PREPARED VEGETABLES; JELLIES; JAMS; FRUIT SAUCES; EDIBLE OILS AND FATS; ENTREES AND SNACK FOODS, ALL CONSISTING PRIMARILY OF MEAT AND/OR VEGETABLES FOR HUMAN CONSUMPTION, ALL BEING FROZEN, PREPARED OR PACKAGED; POTATO PRODUCTS, NAMELY, BAKED POTATOES WITH TOPPING, AND FRENCH FRIES (U.S. CL. 46).

CLASS 30—STAPLE FOODS

FOR (BASED ON INTENT TO USE) (BASED ON 44(E)) FRESH PASTA; PASTA SAUCE; PASTA, NAMELY, MACARONI, SPAGHETTI, TAGLIATELLE, LASAGNA, RAVIOLI, PENNE, CANNELLONI, VERMICELLI, FETTUCCINI; PASTA ENTREES, NAMELY, MEALS CONSISTING PRIMARILY OF PREPARED PASTA, PASTA-BASED SNACK FOODS, EGG PASTA, EGG PASTA WITH HAM, EGG PASTA WITH SPINACH AND RICOTTA, ALL BEING FROZEN, PREPARED OR PACKAGED; POLENTA; PROCESSED MAIZE; PROCESSED MAIZE PRODUCTS, NAMELY, MAIZE MEAL, MAIZE FLOUR, MAIZE-BASED SNACK FOODS, AND MAIZE STICKS; GNOCCHI (BASED ON 44(E)); RISOTTO; RISOTTO ENTREES, NAMELY, MEALS CONSISTING PRIMARILY OF RISOTTO, ALL BEING FROZEN, PREPARED OR PACKAGED; PROCESSED CEREALS; CEREAL PRODUCTS, NAMELY, READY-TO-EAT CEREAL DERIVED FOOD BARS, CEREAL BASED SNACK FOODS; RICE; RICE PRODUCTS, NAMELY, RICE BALLS; RICE-BASED ENTREES, NAMELY, MEALS CONSISTING PRIMARILY OF RICE, RICE-BASED SNACK FOODS, ALL BEING FROZEN, PREPARED OR PACKAGED; VINEGAR, SAUCES, SPICES; CONDIMENTS, NAMELY, KETCHUP, MAYONNAISE, AND SEASONINGS; FLOUR; FLOUR PRODUCTS, NAMELY FLOUR-BASED SNACK FOODS, ALL BEING FROZEN, PREPARED OR PACKAGED; BREAD; PASTRIES; PASTRY AND BREAD PRODUCTS, NAMELY DOUGHNUTS, CROISSANTS, BREAD CRUMBS; FLAVORED ICES; CONFECTIONERY, NAMELY, FROZEN CONFECTIONS AND CONFECTIONERY CHIPS FOR BAKING; CONFECTIONERY BARS, NAMELY, CHOCOLATE-BASED READY-TO-EAT FOOD BARS; SUGAR-BASED AND SUGAR-SUBSTITUTE BASED PRODUCTS, NAMELY, CANDY, CANDY CAKE DECORATIONS, AND CANDY MINTS; SALT, PEPPER, MUSTARD, BAKING POWDER, YEAST, HONEY, AND TREACLE; COFFEE; TEA; COCOA; SUBSTITUTES FOR COFFEE, TEA AND COCOA; NON-ALCOHOLIC COFFEE, TEA AND COCOA BASED BEVERAGES; MILK SHAKES; FRUIT AND VEGETABLE EXTRACTS FOR FLAVORING FOODS; POTATO DUMPLINGS; POTATO DUMPLINGS WITH SPINACH AND TOMATO (U.S. CL. 46).

DANIELLE MATTESSICH, EXAMINING ATTORNEY

SN 76-213,098. CENTER PARCS EUROPE N.V., ROTTERDAM, NETHERLANDS, FILED 2-20-2001.

CENTER PARCS

OWNER OF BENELUX REG. NO. 618993, DATED 12-15-1997, EXPIRES 12-15-2007.

NO CLAIM IS MADE TO THE EXCLUSIVE RIGHT TO USE "PARCS", APART FROM THE MARK AS SHOWN. THE ENGLISH TRANSLATION OF "PARCS" IS "PARKS".

CLASS 39—TRANSPORTATION AND STORAGE

FOR TOURIST AGENCY SERVICES; TRAVEL AGENCY SERVICES, NAMELY, MAKING RESERVATIONS AND BOOKINGS FOR TRANSPORTATION; ARRANGING TRAVEL TOURS (U.S. CLS. 100 AND 105).

CLASS 41—EDUCATION AND ENTERTAINMENT

FOR RECREATIONAL CAMPS, DISCOTHEQUE SERVICES, PROVIDING GOLF, TENNIS, SWIMMING, SCUBA, SKIING, BOATING, HORSEBACK RIDING AND BIKING FACILITIES; PROVIDING FACILITIES FOR RECREATION ACTIVITIES; PROVIDING INSTRUCTION IN GOLF, TENNIS, SCUBA, SNORKELING, SAILING, WINDSURFING, AEROBICS AND SWIMMING; SPORTS CAMPS; AMUSEMENT PARKS (U.S. CLS. 100, 101 AND 107).

CLASS 42—SCIENTIFIC, COMPUTER AND LEGAL SERVICES

FOR HEALTH SPA SERVICES, HEALTH RESORTS, PROVIDING CAMPGROUND FACILITIES, TOURIST HOMES, RESORT AND LODGING SERVICES, HOTEL SERVICES, BOARDING HOUSE SERVICES, RESTAURANT SERVICES, CHILD CARE SERVICES, HOTEL CONCIERGE SERVICES (U.S. CLS. 100 AND 101).

RONALD MCMORROW, EXAMINING ATTORNEY

SN 76-141,296. KALE, JAMES, WINNIPEG, MANITOBA, CANADA, FILED 10-5-2000.

THE GUESS WHO

PRIORITY CLAIMED UNDER SEC. 44(D) ON CANADA APPLICATION NO. 826,324, FILED 10-17-1996, REG. NO. TMA491747, DATED 3-20-1998, EXPIRES 3-20-2013.

CLASS 6—METAL GOODS

FOR METAL KEYCHAINS (U.S. CLS. 2, 12, 13, 14, 23, 25 AND 50).

CLASS 9—ELECTRICAL AND SCIENTIFIC APPARATUS

FOR SUNGLASSES, COMPACT DISC HOLDERS, PRE-RECORDED MUSIC VIDEOS (U.S. CLS. 21, 23, 26, 36 AND 38).

CLASS 25—CLOTHING

FOR T-SHIRTS, JACKETS, CAPS, SWEAT SHIRTS, BANDANAS (U.S. CLS. 22 AND 39).

HENRY S. ZAK, EXAMINING ATTORNEY

SN 76-227,129. AUSTRALIAN EXPORT RESOURCES PTY LTD., MAITLAND, AUSTRALIA, FILED 3-20-2001.

FRESH FACES**CLASS 3—COSMETICS AND CLEANING PREPARATIONS**

FOR AFTERSHAVE LOTIONS; SOAP, NON-MEDICATED BATH SALTS, BATH GEL, BATH FOAMS, BATH OIL; BEAUTY MASKS; COSMETICS; LOTIONS FOR CELLULITE REDUCTION; COTTON STICKS FOR COSMETIC PURPOSES; COTTON WOOL FOR COSMETIC PURPOSES; DEODORANTS FOR PERSONAL USE; ESSENTIAL OILS FOR PERSONAL USE; EAU DE COLOGNE; EYEBROW COSMETICS; EYEBROW PENCILS; FALSE EYELASHES; FALSE NAILS; HAIR COLOURANTS; HAIR SPRAY; HAIR LOTIONS; HAIR DYES; HAIR WAVING PREPARATIONS; INCENSE; ROUGE; LIPSTICKS; MAKE-UP; MAKE-UP REMOVING PREPARATIONS; LOTIONS FOR COSMETIC PURPOSES; NAIL POLISH; NAIL VARNISH; ESSENTIAL OILS FOR USE IN MANUFACTURING OF SCENTED PRODUCTS; COSMETIC PENCILS; NON-MEDICINAL MOUTH WASHES; PETROLEUM JELLY FOR COSMETIC PURPOSES; PERFUMES; POTPOURRIS; SHAVING SOAP; SHAVING PREPARATIONS; COSMETIC TISSUES PRE-MOISTENED WITH LOTIONS; TOILET WATER; TALCUM POWDER FOR COSMETIC USE; CREAM FOR WHITENING THE SKIN; SUN-TANNING PREPARATIONS (U.S. CLS. 1, 4, 6, 50, 51 AND 52).

CLASS 9—ELECTRICAL AND SCIENTIFIC APPARATUS

FOR COMPUTER HARDWARE; COMPUTER SOFTWARE FOR WORD PROCESSING AND COMPUTER GRAPHICS; COMPUTER PROGRAMS FOR WORD PROCESSING AND COMPUTER GRAPHICS; NOTEBOOK COMPUTERS; DATA PROCESSORS; CALCULATORS; CAMCORDERS; VIDEO RECORDERS; VIDEO CAMERAS; DIGITAL CAMERAS; 35 MM CAMERAS AND DISPOSABLE CAMERAS; COMPACT DISC PLAYERS; RADIOS; RECORD PLAYERS; DICTATING MACHINES; SPECTACLES; SPECTACLE FRAMES; EYEGLASSES; SPECTACLE CASES; SPECTACLE CHAINS; SUNGLASSES (U.S. CLS. 21, 23, 26, 36 AND 38).

CLASS 16—PAPER GOODS AND PRINTED MATTER

FOR PHOTOGRAPHS; POSTCARDS; POSTERS; PORTRAITS; PRINTED MATTER IN THIS CLASS, NAMELY, MAGAZINES, MANUALS, NEWSLETTERS, NEWSPAPERS, BOOKLETS, AND PAMPHLETS RELATING TO COSMETICS, COMPUTER HARDWARE AND SOFTWARE, CAMERAS, EYEGLASSES, REAL ESTATE, BUSINESS CONSULTATION, INSURANCE, FINANCIAL CONSULTATION AND ACCOUNTING; TIMETABLES, CALENDARS, TICKETS, FORMS, COMIC BOOKS; PENS; PEN CASES; PAPERWEIGHTS; PENCILS; INKWELLS; STATIONERY FOLDERS AND BOOK COVERS; PLAYING CARDS; PAPER TOWELS (U.S. CLS. 2, 5, 22, 23, 29, 37, 38 AND 50).

CLASS 35—ADVERTISING AND BUSINESS

FOR ACCOUNTING SERVICES; ADVERTISING AGENCIES; RENTAL OF ADVERTISING SPACE; BUSINESS AND ACCOUNTING AUDITING SERVICES; PROFESSIONAL BUSINESS CONSULTATION SERVICES; BUSINESS MANAGEMENT CONSULTATION SERVICES; ORGANIZING EXHIBITIONS AND TRADE SHOWS FOR COMMERCIAL AND ADVERTISING PURPOSES IN THE FIELD OF COSMETICS, COMPUTER HARDWARE AND SOFTWARE, CAMERAS, REAL ESTATE, FINANCIAL CONSULTATION, INSURANCE, AND ACCOUNTING; PERSONNEL MANAGEMENT CONSULTATION; PERSONNEL RECRUITMENT SERVICES; PUBLIC RELATIONS SERVICES; PUBLICITY AGENT; TAX PREPARATION; SECRETARIAL SERVICES; MODELLING AGENCIES; MODELLING FOR ADVERTISING OR SALES PROMOTION (U.S. CLS. 100, 101 AND 102).

CLASS 36—INSURANCE AND FINANCIAL

FOR REAL ESTATE APPRAISAL; RENTING OF APARTMENTS; RENT COLLECTION AGENCIES; RENTING RESIDENTIAL AND COMMERCIAL PROPERTY; REAL ESTATE AGENCIES; REAL ESTATE MANAGEMENT; LEASING OF REAL ESTATE; INSURANCE CONSULTATION; INSURANCE BROKERAGE; FINANCIAL ANALYSIS AND CONSULTATION (U.S. CLS. 100, 101 AND 102).

CLASS 42—SCIENTIFIC, COMPUTER AND LEGAL SERVICES

FOR PROVIDING TEMPORARY HOUSING ACCOMMODATIONS; ARBITRATION SERVICES; BEAUTY SALONS; MANICURING; MASSAGE; CAFES; CAFETERIAS; CATERING; RESTAURANTS; CHAPERONING; DATING SERVICES; COCKTAIL LOUNGE SERVICES; RECOVERY OF COMPUTER DATA; COMPUTER HARDWARE CONSULTATION, COMPUTER PROGRAMMING FOR OTHERS; MAINTENANCE OF COMPUTER SOFTWARE; UPDATING OF COMPUTER SOFTWARE FOR OTHERS; COMPUTER SOFTWARE DESIGN FOR OTHERS; COMPUTER SYSTEMS ANALYSIS; COMPUTER RENTAL; DETECTIVE AGENCIES; SECURITY GUARD SER-

VICES; COSMETIC RESEARCH; INDUSTRIAL DESIGN; GRAPHIC ARTS DESIGNING; PROVIDING FASHION INFORMATION; FLOWER ARRANGING; LANDSCAPE GARDENING; HORTICULTURAL SERVICES; PHYSICAL THERAPY; PORTRAIT PHOTOGRAPHY; WEDDING PHOTOGRAPHY; PHOTOGRAPHY FOR SCHOOLS; PHOTOGRAPHY FOR THE FASHION INDUSTRY; NEWS REPORTERS SERVICES; MISSING PERSONS INVESTIGATIONS; LITHOGRAPHIC AND OFFSET PRINTING SERVICES; SILKSCREEN PRINTING; RETIREMENT HOMES; VOCATIONAL GUIDANCE (U.S. CLS. 100 AND 101).

JEFFERY COWARD, EXAMINING ATTORNEY

SN 76-245,420. JVP CONSULTING (UK) LIMITED, LONDON, UNITED KINGDOM, FILED S.R. 4-23-2001; AM. P.R. 3-21-2002.

JERUSALEM VENTURE PARTNERS

PRIORITY CLAIMED UNDER SEC. 44(D) ON UNITED KINGDOM APPLICATION NO. 2252123, FILED 11-9-2000, REG. NO. 2252123, DATED 7-6-2001, EXPIRES 11-9-2010.

NO CLAIM IS MADE TO THE EXCLUSIVE RIGHT TO USE VENTURE PARTNERS, APART FROM THE MARK AS SHOWN.

SEC. 2(F).

CLASS 35—ADVERTISING AND BUSINESS

FOR ADVERTISING AGENCY SERVICES, CO-OPERATIVE ADVERTISING AND MARKETING SERVICES, BUSINESS MARKETING CONSULTATION SERVICES, PREPARATION OF CUSTOM ADVERTISEMENT AND CUSTOM PROMOTIONAL PRODUCTS FOR OTHERS, PREPARING PROMOTIONAL AND MERCHANDISING MATERIAL FOR OTHERS; PROMOTING THE GOODS AND SERVICES OF OTHERS THROUGH THE DISTRIBUTION OF PRINTED MATERIAL AND PROMOTIONAL CONTESTS; PREPARATION OF MARKETING STRATEGY FOR OTHERS (U.S. CLS. 100, 101 AND 102). FIRST USE 6-19-1997; IN COMMERCE 6-19-1997.

CLASS 36—INSURANCE AND FINANCIAL

FOR VENTURE CAPITAL SERVICES, NAMELY, PROVIDING FINANCING TO EMERGING START-UP COMPANIES (U.S. CLS. 100, 101 AND 102).

FIRST USE 6-19-1997; IN COMMERCE 6-19-1997.

KATHERINE STOIDES, EXAMINING ATTORNEY

SN 76-285,152. TAG COMPANY (UK) LIMITED, WEST DREYTON, MIDDLESEX, UNITED KINGDOM, FILED 7-13-2001.

MARY I. SPARROW, EXAMINING ATTORNEY

THE TAG COMPANY

CLASS 9—ELECTRICAL AND SCIENTIFIC APPARATUS

FOR PACKAGE LABELS CONTAINING ELECTRONIC, ELECTROMAGNETIC AND ACCOUSTOMAGNETIC SECURITY DEVICES; ELECTRONIC TAGGING APPARATUS AND DEVICES, NAMELY ELECTRONIC TAGS AND LABELS FOR PREVENTING LOSS OR THEFT OF RETAIL MERCHANDISE, FOR PROVIDING RETAIL SECURITY, FOR PREVENTING VENDOR FRAUD AND FOR USE IN SURVEILLANCE OF ELECTRONIC ARTICLES, AND DEVICES AND APPARATUS USED TO ATTACH, SECURE, ACTIVATE, DEACTIVATE AND REMOVE ELECTRONIC, ELECTROMAGNETIC AND ACCOUSTOMAGNETIC LABELS ON AND FROM PACKAGES, GOODS AND WARES (U.S. CLS. 21, 23, 26, 36 AND 38).

CLASS 42—SCIENTIFIC, COMPUTER AND LEGAL SERVICES

FOR ADVISORY AND CONSULTANCY SERVICES RELATING TO THE PROTECTION OF PERSONAL EFFECTS, MULTIMEDIA PRODUCTS AND PACKAGING; ADVISORY AND CONSULTANCY SERVICES RELATING TO THE DESIGN AND MANUFACTURE OF ELECTRONIC TAGGING APPARATUS FOR USE IN RELATION TO THE PROTECTION OF PERSONAL EFFECTS, MULTIMEDIA PRODUCTS AND PACKAGING (U.S. CLS. 100 AND 101).

KAREN BRACEY, EXAMINING ATTORNEY

SN 76-287,851. SONY MUSIC ENTERTAINMENT, INC., NEW YORK, NY. FILED 7-18-2001.

EBRIDGE

CLASS 9—ELECTRICAL AND SCIENTIFIC APPARATUS

FOR OPTICAL DISCS AND SOFTWARE USED TO LINK END USERS TO A GLOBAL COMPUTER NETWORK AND MONITOR, COLLECT, COMPILE AND PROCESS THE END USERS ACTIVITIES ON THE GLOBAL COMPUTER NETWORK AND PROVIDE CONTENT, INFORMATION AND BI-DIRECTIONAL COMMUNICATIONS TO END USERS (U.S. CLS. 21, 23, 26, 36 AND 38).

CLASS 35—ADVERTISING AND BUSINESS

FOR BUSINESS CONSULTING SERVICES (U.S. CLS. 100, 101 AND 102).

CLASS 38—COMMUNICATION

FOR STREAMING OF AUDIO AND VISUAL BASED INFORMATION OVER A GLOBAL COMPUTER NETWORK (U.S. CLS. 100, 101 AND 104).

CLASS 42—SCIENTIFIC, COMPUTER AND LEGAL SERVICES

FOR PROVIDING AND MAINTAINING A SERVER FOR USE BY CONTENT PROVIDERS WHICH MONITORS, COMPILES INFORMATION ON, AND ASSISTS END USERS; PROVISION OF CONTENT ON OPTICAL DISCS AND GLOBAL COMPUTER NETWORKS AND LINKING OPTICAL DISCS TO GLOBAL COMPUTER NETWORKS (U.S. CLS. 100 AND 101).

SN 76-300,157. BROADCOM CORPORATION, IRVINE, CA. FILED 8-14-2001.

Connecting
everything

CLASS 9—ELECTRICAL AND SCIENTIFIC APPARATUS

FOR COMPUTER HARDWARE, INTEGRATED CIRCUITS AND SOFTWARE FOR CONTROLLING AND USING INTEGRATED CIRCUITS (U.S. CLS. 21, 23, 26, 36 AND 38).

FIRST USE 3-13-2002; IN COMMERCE 3-13-2002.

CLASS 42—SCIENTIFIC, COMPUTER AND LEGAL SERVICES

FOR DESIGN FOR OTHERS OF COMPUTERS, INTEGRATED CIRCUITS, COMMUNICATIONS HARDWARE AND SOFTWARE, AND NETWORKS (U.S. CLS. 100 AND 101).

FIRST USE 3-14-2002; IN COMMERCE 3-14-2002.

JIM RINGLE, EXAMINING ATTORNEY

SN 76-345,407. ZESPRI GROUP LIMITED, NEWTON, AUCKLAND, NEW ZEALAND, FILED 12-5-2001.

ZESPRI

OWNER OF NEW ZEALAND REG. NO. 246561, DATED 12-20-1996, EXPIRES 7-26-2006.

OWNER OF NEW ZEALAND REG. NO. 246459, DATED 11-7-1996, EXPIRES 7-26-2006.

OWNER OF NEW ZEALAND REG. NO. 246458, DATED 3-24-1997, EXPIRES 10-26-2006.

CLASS 29—MEATS AND PROCESSED FOODS

FOR PRESERVED, DRIED, AND COOKED FRUITS (U.S. CL. 46).

CLASS 30—STAPLE FOODS

FOR CONFECTIONERIES, NAMELY, CANDY, CANDIED FRUITS, AND FROZEN CONFECTIONS; AND ICE CREAM (U.S. CL. 46).

CLASS 31—NATURAL AGRICULTURAL PRODUCTS

FOR NON-ALCOHOLIC DRINKS, NAMELY, FRUIT JUICES AND KIWI-FRUIT BEVERAGES (U.S. CLS. 1 AND 46).

DAWN FELDMAN, EXAMINING ATTORNEY

SN 76-362,456. AMS N.V., 1076 EE AMSTERDAM, NETHERLANDS, FILED 1-24-2002.



PRIORITY CLAIMED UNDER SEC. 44(D) ON ERPN CMNTY TM OFC APPLICATION NO. 002506384, FILED 12-17-2001, REG. NO. 002506384, DATED 12-18-2003, EXPIRES 12-17-2011.

CLASS 9—ELECTRICAL AND SCIENTIFIC APPARATUS

FOR COMPUTERIZED SONAR OPERATOR TRAINING UNITS FOR USE IN NAVAL TRAINING; COMPUTERIZED PERISCOPE SIMULATORS FOR USE IN NAVAL TRAINING; COMPUTERIZED RADAR AND ELECTRONIC WARFARE TRAINING UNITS FOR USE IN NAVAL TRAINING; COMPUTERIZED SHIP'S BRIDGE SIMULATORS FOR USE IN NAVAL TRAINING; COMPUTERIZED TACTICAL TRAINING UNITS FOR USE IN NAVAL TRAINING; COMPUTERIZED TEAM TRAINING UNITS AND COMPUTERIZED FULL MISSION SIMULATORS FOR USE IN NAVAL TRAINING; COMPUTERIZED ON BOARD TRAINING UNITS FOR USE IN NAVAL TRAINING; COMPUTERIZED MACHINERY CONTROL ROOM AND SHIP TRAINING UNITS FOR USE IN NAVAL TRAINING; COMPUTERIZED MAINTAINER TRAINING UNITS FOR USE IN NAVAL TRAINING, SHIP TO SHORE INTEGRATIONS AND NAVAL TESTING FACILITIES; COMPUTERIZED AIR DEFENSE SIMULATORS FOR USE IN LAND WARFARE TRAINING; COMPUTERIZED GUNNERY TRAINING SIMULATORS FOR USE IN LAND WARFARE TRAINING; COMPUTERIZED AIR NAVIGATION TRAINING UNITS FOR USE IN AVIATION TRAINING; COMPUTERIZED ANTI-SUBMARINE WARFARE TRAINING UNITS FOR USE IN ANTI-SUBMARINE WARFARE TRAINING; COMPUTERIZED AIRBORNE EARLY WARNING UNITS FOR USE IN CONNECTION WITH AIR DEFENSE SYSTEMS; SONAR AND SONOBOUY; COMPUTERIZED AVIONICS SYSTEMS TRAINING UNITS FOR USE IN AVIATION TRAINING; COMPUTERIZED ELECTRONIC WARFARE TRAINING UNITS FOR USE IN MILITARY TRAINING; COMPUTERIZED BATTLEFIELD COMMAND AND CONTROL UNITS FOR USE IN LAND WARFARE OPERATIONS; COMPUTERIZED WEAPONS FIRE CONTROL SYSTEMS FOR USE IN LAND WARFARE OPERATIONS; COMPUTERIZED UNITS FOR ANALYZING BATTLEFIELD METEOROLOGICAL CONDITIONS; COMPUTERIZED UNITS FOR PLOTTING MILITARY AIRCRAFT STRATEGIES; COMPUTERIZED AIR DEFENSE COMMAND UNITS FOR USE IN AIR DEFENSE OPERATIONS; COMPUTERIZED NAVAL COMMAND AND CONTROL UNITS FOR USE IN NAVAL OPERATIONS; COMPUTERIZED UNDERWATER COMMAND AND CONTROL UNITS FOR USE IN NAVAL OPERATIONS; COMPUTERIZED NAVAL DECOY UNITS FOR USE IN NAVAL OPERATIONS; COMPUTERIZED NAVAL GUN FIRE PREDICTOR UNITS FOR USE IN NAVAL OPERATIONS; DIGITAL INTEGRATED COMMUNICATIONS CONTROL UNITS; LONG RANGE AIR DEFENSE RADARS; MEDIUM RANGE AIR DEFENSE RADARS; NAVAL SURVEILLANCE RADARS; RADAR WEAPONS FIRE CONTROL UNITS FOR USE IN NAVAL OPERATIONS; LAND BASED TRACKING RADARS; RADAR AND SATELLITE BASED MARITIME SURVEILLANCE UNITS; COMPUTERIZED VESSEL TRAFFIC MANAGEMENT UNITS; COMPUTERIZED AIRBORNE SURVEILLANCE UNITS; COMPUTERIZED OPTRONIC WEAPONS FIRE CONTROL UNITS FOR USE IN NAVAL OPERATIONS; NAVAL MULTI-FUNCTION RADARS; COMPUTERIZED BATTLEFIELD SURVEILLANCE UNITS FOR USE IN MILITARY OPERATIONS; RADAR COMMAND AND CONTROL UNITS FOR USE IN MILITARY OPERATIONS; COMPUTERIZED NAVAL INTERROGATOR UNITS FOR USE IN NAVAL OPERATIONS; COMPUTERIZED AIR TRAFFIC CONTROL TRAINING UNITS; PRIMARY AIR TRAFFIC CONTROL RADARS; COMPUTERIZED AIRSPACE AND FLOW MANAGEMENT UNIT

FOR USE IN AIR TRAFFIC CONTROL; COMPUTERIZED CENTRAL AIR TRAFFIC CONTROL AND MANAGEMENT UNITS; ELECTRONIC AUTOMATIC DEPENDENT SURVEILLANCE UNITS; COMPUTERIZED UNITS FOR MONITORING AND ANALYZING METEOROLOGICAL CONDITIONS; SECONDARY AIR TRAFFIC CONTROL RADARS; TRANSPORTABLE AIR TRAFFIC CONTROL RADARS; COMPUTERIZED METEOROLOGICAL FORECASTING UNITS; COMPUTERIZED UNITS FOR STRATEGIC AND TACTICAL PLANNING OF MILITARY COUNTERMEASURES; COMPUTERIZED AVIONICS CONTROL UNITS FOR USE IN AVIATION; COMPUTERS; COMPUTER HARDWARE; COMPUTERIZED COMMUNICATIONS UNITS FOR USE IN MILITARY COMMUNICATIONS; TELEPHONES; MOBILE CELLULAR TELEPHONES; MOBILE RADIOS; COMPUTERIZED COMMUNICATIONS NETWORK FAILURE DETECTION UNITS; PARTS AND FITTINGS FOR ALL THE AFORESAID GOODS; UNMANNED AND ELECTRONICALLY GUIDED AERIAL TARGETS; UNMANNED REMOTE-CONTROLLED POWERED AIRCRAFT FOR USE AS MILITARY TARGETS; TELESCOPIC SIGHTS FOR FIREARMS; OPTICAL SIGHTS FOR FIREARMS; RADARS; ELECTRONIC UNDERWATER COMMUNICATIONS UNITS FOR MILITARY USE; TELESCOPIC SIGHTS FOR AERONAUTICAL, NAVAL AND TERRESTRIAL WEAPONS; TELESCOPIC ARTILLERY SIGHTS; OPTICAL SIGHTS FOR AERONAUTICAL, NAVAL AND TERRESTRIAL WEAPONS; OPTICAL ARTILLERY SIGHTS; AND COMPUTERIZED TARGET SEEKING UNITS FOR USE IN MILITARY OPERATIONS; DIGITAL INTEGRATED COMMUNICATIONS CONTROL SYSTEMS FOR USE IN MILITARY OPERATIONS; RESCUE SIGNALING FLARES FOR MILITARY USE (U.S. CLS. 21, 23, 26, 36 AND 38).

CLASS 13—FIREARMS

FOR ACTUATORS FOR USE IN WEAPON EJECTING AND LOADING INSTALLATIONS; ACTUATORS FOR USE WITH WEAPONS; AIR-TO-AIR MISSILES; AIR LAUNCHED ANTI-SHIP MISSILES; AIR LAUNCHED ANTI-ARMOR MISSILES; AIR-TO-SURFACES MISSILES; AIR GUNS; AIR LAUNCHERS FOR LAUNCHING GRENADES AND ROCKETS; AMMONIUM NITRATE EXPLOSIVES; AMMUNITION; ANTI-SUBMARINE TORPEDOES FITTED WITH WARHEADS; ANTI-TANK MINES; APPARATUS FOR LAUNCHING WEAPONS, NAMELY, GRENADE LAUNCHERS, ROCKET LAUNCHERS AND MISSILE LAUNCHERS; APPARATUS FOR USE IN THE FIRING, GUIDANCE AND STABILIZATION OF MISSILES, NAMELY, MISSILE LAUNCHERS; ARMOR-PIERCING INCENDIARY PROJECTILES; ARMOR-PIERCING INCENDIARY PROJECTILES FOR USE BY AIRCRAFT; ARMOR-PIERCING PROJECTILES; ARMOR-PIERCING PROJECTILES FOR USE BY AIRCRAFT; ARTILLERY GUNS; ARTILLERY PIECES; BALLISTIC MISSILES; BALLISTIC WEAPONS; BOMBS; BOMB DETONATORS; BULLETS; CARTRIDGES FOR BULLETS AND ARTILLERY SHELLS; WEAPONS FOR USE IN ELECTRONIC WARFARE, NAMELY CARTRIDGES CONTAINING NON-CHEMICAL REFLECTIVE MATERIALS FOR RADAR AND RADIO SIGNAL BLOCKING; CONTAINERS FOR LAUNCHING AND STORING WEAPONS, NAMELY, STORAGE CASES FOR ROCKETS AND MISSILES WHICH MAY BE CONVERTED INTO ROCKET AND MISSILE LAUNCHERS; CONVENTIONAL AIR DELIVERED WEAPONS NAMELY, BOMBS AND MISSILES; CRUISE MISSILES; DETONATING PLUGS; DETONATING RELAYS FOR USE WITH DETONATING CORD, WITH DETONATORS, WITH EXPLOSIVES AND WITH PRIMERS; DETONATORS; DISTRESS ROCKETS; DYNAMITE; ELECTRONIC DETONATORS; EXPLOSIVE DEVICES, NAMELY, GRENADES, MINES AND BOMBS; EXPLOSIVE DEVICES FOR MINEFIELD BREACHING AND MINEFIELD CLEARANCE; EXPLOSIVE POWDERS; EXPLOSIVES; EXPLOSIVES IN THE FORM OF LIQUIDS AND POWDERS; MAGAZINES FOR FIREARMS, NAMELY, FEEDERS FOR FEEDING PAINT BULLETS; FIREARM SIGHTS, EXCLUDING TELESCOPIC AND OPTICAL SIGHTS; FIREARM STANDS; FIREARMS; FIRE LANYARDS FOR EXPLOSIVES; FIRE PLATFORMS BEING MECHANIZED MOBILE UNITS FOR CARRYING AND FIRING HEAVY WEAPONS IN THE NATURE OF ARTILLERY AND MISSILES; FIRE CONTROL SYSTEMS FOR USE WITH WEAPONS; FUSES

FOR EXPLOSIVES; GUIDED ANTI-TANK MINES; GUIDED BOMBS; GUIDED MISSILES; GUIDED MORTAR BOMBS; GUIDED PROJECTILES; GUIDED ROCKETS; GUNS; GUN ILLUMINATING GRENADES AND PROJECTILES; HELICOPTER-LAUNCHED ANTI-SHIP GUIDED WEAPONS; INFRARED DEFENSE ROCKET WARHEADS; INFRARED MISSILES FOR INFRARED CLOSE DEFENSE; LANCE ROCKETS; LAND-BASED AIR DEFENSE MISSILE SYSTEMS PRIMARILY COMPRISED OF MISSILES AND MISSILE LAUNCHERS; LAUNCHERS FOR MISSILES; LAUNCHERS FOR PROJECTILES AND ROCKETS; MILITARY PYROTECHNICS, NAMELY, POWDERS WHICH BURN COLOR FLAMES FOR MILITARY PYROTECHNICAL PURPOSES; MINES; MORTARS; MOTORIZED MILITARY VEHICLES FOR THE LAUNCHING OF PROJECTILES, NAMELY, MOTORIZED MILITARY VEHICLES FOR LAUNCHING ROCKETS AND MISSILES; MOTORIZED WEAPONS, NAMELY, TANKS AND MOTORIZED ARTILLERY PIECES; MULTI-MUNITION STAND-OFF BOMBS; MUNITIONS; NAVAL AIR DEFENSE MISSILE SYSTEMS PRIMARILY COMPRISED OF MISSILES AND MISSILE LAUNCHERS; NAVAL ANTI-SHIP MISSILE SYSTEMS PRIMARILY COMPRISED OF MISSILES AND MISSILE LAUNCHERS; NAVAL ANTI-SUBMARINE TORPEDO CARRIERS BEING MOBILE CARRIERS FOR TRANSPORTING AND LOADING TORPEDOS DURING FIRING OPERATIONS; NOISE-SUPPRESSORS FOR GUNS; GUIDED MISSILE COMPONENTS, NAMELY, OPTOELECTRONIC APPARATUS FOR MISSILE DRIVING; PNEUMATIC CATAPULTS FOR FIRING MISSILES; PRIMERS FOR EXPLOSIVES; PRIMERS FOR PYROTECHNIC DEVICES; PYROTECHNIC AMMUNITIONS; MISSILE COMPONENTS, NAMELY, PYROTECHNIC THRUST GENERATORS FOR STEERING AIRBORNE WEAPONS; RADAR JAMMING PROJECTILES COMPRISING CONTAINERS OF RADAR ABSORBING AND REFLECTING MATERIALS; RADAR JAMMING WARHEADS; ROCKET LAUNCHERS; ROCKET MORTARS; ROCKET-PROPELLED BALLISTIC MISSILES; ROCKETS BEING MUNITIONS; ARTILLERY SHELLS; SIGHTS FOR AERONAUTICAL, NAVAL AND TERRESTRIAL WEAPONS, EXCLUDING TELESCOPIC AND OPTICAL SIGHTS; ARTILLERY SIGHTS, EXCLUDING TELESCOPIC AND OPTICAL SIGHTS; SIGNAL ROCKETS; SILENCERS FOR FIREARMS; SMOKE MISSILES FOR ARMORED VEHICLES AND TANKS; PROJECTILES FOR ROCKETS; SMOKE PROJECTILES FOR TORPEDO TUBE ARTILLERY; SURFACE-TO-SURFACE ANTI-ARMOR MISSILE SYSTEMS; TANKS; TEAR-GAS PERSONAL ATTACK DEFENSE WEAPONS; TEAR-GAS WEAPONS; TORPEDO TUBE ARTILLERY; AND TRUNNIONS FOR HEAVY WEAPONS (U.S. CLS. 2 AND 9).

CLASS 37—CONSTRUCTION AND REPAIR

FOR INSTALLATION AND REPAIR OF NAVAL TRAINING SYSTEMS, SONAR OPERATOR TRAINERS, PERISCOPE SIMULATORS, RADAR AND ELECTRONIC WARFARE TRAINERS, SHIP'S BRIDGE SIMULATORS, TACTICAL TRAINERS, TEAM TRAINERS AND FULL MISSION SIMULATORS, ON BOARD TRAINERS, MACHINERY CONTROL ROOM AND SHIP TRAINERS, MAINTAINER TRAINERS, SHORE INTEGRATION AND TEST FACILITIES, LAND TRAINING SYSTEMS, AIR DEFENSE SIMULATORS, GUNNERY TRAINING SIMULATORS, AIR TRAINING SYSTEMS, AIR NAVIGATION TRAINERS, ANTI-SUBMARINE WARFARE, AIRBORNE EARLY WARNING, SONAR AND SONOBOUY, OPERATOR TRAINERS, AVIONICS SYSTEMS TRAINERS, ELECTRONIC WARFARE, POWER INDUSTRY TRAINING SYSTEMS, SYNTHETIC ENVIRONMENTS, BATTLEFIELD COMMAND AND CONTROL SYSTEMS, FIRE CONTROL SYSTEMS, BATTLEFIELD METEOROLOGICAL SYSTEMS, AIR SYSTEMS, DATA LINKS, STRATEGIC MILITARY AIRCRAFT SYSTEMS, AIR DEFENSE COMMAND, CONTROL AND INFORMATION SYSTEMS, NAVAL COMMAND AND CONTROL SYSTEMS, UNDERWATER COMMAND AND CONTROL SYSTEMS, NAVAL DECOY SYSTEMS, NAVAL GUN FIRE PREDICTORS, DIGITAL INTEGRATED COMMUNICATIONS CONTROL SYSTEMS, DIGITIZATION, LONG RANGE AIR DEFENSE RADARS, MEDIUM RANGE AIR DEFENSE RADARS, NAVAL SURVEILLANCE RADARS, NAVAL RADAR FIRE CONTROL SYSTEMS, LAND BASED TRACKING RADARS, MARITIME SURVEILLANCE SYSTEMS, VESSEL TRAFFIC

MANAGEMENT SYSTEMS, AIRBORNE SURVEILLANCE SYSTEMS, NAVAL OPTRONIC FIRE CONTROL SYSTEMS, NAVAL MULTI-FUNCTION RADARS, BATTLEFIELD SURVEILLANCE SYSTEMS, RADAR COMMAND AND CONTROL, NAVAL INTERROGATOR, AIR TRAFFIC CONTROL TRAINING SYSTEMS, PRIMARY AIR TRAFFIC CONTROL RADARS, AIRSPACE AND FLOW MANAGEMENT SYSTEMS, AIR TRAFFIC CONTROL AND MANAGEMENT CENTERS, AUTOMATIC DEPENDENT SURVEILLANCE SYSTEMS, DATA PROCESSING SYSTEMS, METEOROLOGICAL SYSTEMS, SECONDARY AIR TRAFFIC CONTROL RADARS, TRANSPORTABLE AIR TRAFFIC CONTROL RADARS, METEOROLOGICAL FORECAST INSTALLATIONS, INTEGRATED APPARATUS AND INSTALLATIONS, ALL FOR NAVAL AND AIR DEFENSE, SURFACE AND UNDERWATER COMBAT AND FOR AIR AND MARITIME TRAFFIC CONTROL, APPARATUS AND INSTRUMENTS, ALL FOR ELECTRO-OPTICS, ELECTRONIC COUNTERMEASURES AND FOR AVIONICS, CIVIL AND MILITARY SUPPORT APPARATUS AND INSTALLATIONS, NAVIGATION APPARATUS AND INSTRUMENTS, COMPUTERS, HARDWARE, SOFTWARE, MICROELECTRONICS, SIGNAL, IMAGE AND DATA PROCESSING APPARATUS AND INSTRUMENTS, ELECTRO-OPTICAL SENSORS, RADAR APPARATUS AND INSTALLATIONS, APPARATUS AND INSTALLATIONS, ALL FOR COMMAND AND CONTROL, INFORMATICS AND TELECOMMUNICATIONS, AND FOR COMMUNICATION AND SUPERVISION, COMPUTERIZED COMMUNICATION NETWORKS, TELEPHONES, MOBILE CELLULAR TELEPHONES, MOBILE RADIOS, APPARATUS AND INSTALLATIONS FOR GROUND-AIR, GROUND COMMUNICATION, NETWORK FAILURE DETECTION, GAME AUTOMATION, AND FOR SECURITY AND ACCESS CONTROL, ELECTRO-ACOUSTICS APPARATUS AND INSTRUMENTS, APPARATUS, INSTRUMENTS, INSTALLATIONS AND EQUIPMENT, BEING ELECTRONIC OR ELECTRICAL; AND APPARATUS AND EQUIPMENT FOR THE RECORDING AND TRANSMISSION OF SOUND, VOICE, DATA AND IMAGES; INSTALLATION AND REPAIR OF ACTUATORS FOR USE IN WEAPON EJECTING AND LOADING INSTALLATIONS, ACTUATORS FOR USE WITH WEAPONS, AERIAL TARGETS, AIR-TO-AIR MISSILES, AIR LAUNCHED ANTI-SHIP MISSILES, AIR LAUNCHED ANTI-ARMOR MISSILES, AIR-TO-SURFACES MISSILES, AIR GUNS, AIR LAUNCHERS, AMMONIUM NITRATE EXPLOSIVES, AMMUNITION, ANTI-SUBMARINE TORPEDOES FITTED WITH WARHEADS, ANTI-TANK MINES, APPARATUS FOR LAUNCHING WEAPONS, APPARATUS FOR USE IN THE FIRING, GUIDANCE AND STABILIZATION OF MISSILES, ARMAMENTS, ARMAMENTS INSTALLATIONS, ARMOR-PIERCING INCENDIARY PROJECTILES, ARMOR-PIERCING INCENDIARY PROJECTILES FOR USE BY AIRCRAFT, ARMOR-PIERCING PROJECTILES, ARMOR-PIERCING PROJECTILES FOR USE BY AIRCRAFT, ARTILLERY, ARTILLERY GUNS, ARTILLERY PIECES, BALLISTIC MISSILES, BALLISTIC WEAPONS, BOMBS, BOMB TECHNOLOGY, BULLETS, CARTRIDGES, CARTRIDGES CONTAINING REFLECTIVE MATERIALS FOR RADAR AND RADIO BLOCKING, CARTRIDGES FOR CARRYING MATERIALS TO BE DEPLOYED IN DECOY, IN DEFENSE AND IN WEAPON INSTALLATIONS, CONTAINERS FOR LAUNCHING AND STORING WEAPONS, CONVENTIONAL AIR DELIVERED WEAPONS, CRUISE MISSILES, DECOY APPARATUS AND INSTALLATIONS, DEFENSE APPARATUS AND INSTALLATIONS, DETONATING PLUGS, DETONATING RELAYS FOR USE WITH DETONATING CORD, WITH DETONATORS, WITH EXPLOSIVES AND WITH PRIMERS, DETONATORS, DISTRESS ROCKETS, DYNAMITE, ELECTRONIC DETONATORS, DIGITAL INTEGRATED COMMUNICATIONS CONTROL SYSTEMS, EXPLOSIVE DEVICES, EXPLOSIVE DEVICES FOR MINEFIELD BREACHING AND MINEFIELD CLEARANCE EXPLOSIVE POWERS, PRODUCTS AND SUBSTANCES, EXPLOSIVES, EXPLOSIVES IN THE FORM OF LIQUIDS AND POWDERS, FEEDERS FOR FEEDING PAINT BULLETS, FIREARM SIGHTS, FIREARM STANDS, FIREARMS, FIRE LANYARDS FOR EXPLOSIVES, FIRE PLATFORMS, FIRE CONTROL SYSTEMS, FLARES, FUSES FOR EXPLOSIVES, GUIDED ANTI-TANK MINES, GUIDED BOMBS, GUIDED FLYING MACHINES FOR MILITARY USE, GUIDED MISSILES, GUIDED MORTAR BOMBS, GUIDED PROJECTILES, GUIDED ROCKETS, GUIDED WEAPONS, GUNS, GUN ILLUMINATING GRENADES

AND PROJECTILES, HELICOPTER-LAUNCHED ANTI-SHIP GUIDED WEAPONS, INFRARED DEFENSE ROCKET WARHEADS, INFRARED MISSILES FOR INFRARED CLOSE DEFENSE, LANCE ROCKETS, LAND-BASED AIR DEFENSE MISSILE SYSTEMS, LAUNCHERS FOR MISSILES, LAUNCHERS FOR PROJECTILES AND ROCKETS, METEORS, MILITARY PYROTECHNICS, MINES, MISSILES, MORTARS, MOTORIZED MILITARY VEHICLES FOR THE LAUNCHING OF PROJECTILES, MOTORIZED WEAPONS, MULTI-MUNITION STAND-OFF BOMBS, MUNITION DISPENSERS, MUNITIONS, NAVAL AIR DEFENSE MISSILE SYSTEMS, NAVAL ANTI-SHIP MISSILE SYSTEMS, NAVAL ANTI-SUBMARINE TORPEDO CARRIER SYSTEMS, NAVAL GUN FIRE PREDICTORS, NOISE SUPPRESSORS FOR GUNS, OPTOELECTRONIC APPARATUS FOR MISSILE DRIVING, PNEUMATIC CATAPULTS FOR FIRING MISSILES, PRIMERS FOR EXPLOSIVES, PRIMERS FOR PYROTECHNIC DEVICES, PROPELLANT SUBSTANCES, PROJECTILES, PYROPHORIC SUBSTANCES, PYROTECHNIC AMMUNITIONS, APPARATUS, ARTICLES AND DEVICES, PYROTECHNIC THRUST GENERATORS FOR STEERING AIRBORNE WEAPONS, RADAR JAMMING PROJECTILES COMPRISING CONTAINERS OF RADAR ABSORBING AND REFLECTING MATERIALS, RADAR JAMMING WARHEADS, RADARS, ROCKET LAUNCHERS, ROCKET MORTARS, ROCKET-PROPELLED BALLISTIC MISSILES, ROCKETS, SEEKER TECHNOLOGY, SELF-PROPELLED WEAPONS, SHELLS, SIGHT DEVICES FOR AERONAUTICAL, NAVAL AND TERRESTRIAL WEAPON USE, SIGHTING DEVICES FOR ARTILLERY AND FIREARMS, SIGNAL ROCKETS, SIGNALING FLARES, SILENCERS FOR FIREARMS, SMOKE MISSILES FOR ARMORED VEHICLES AND TANKS, SMOKE PROJECTILES FOR ROCKETS, SMOKE PROJECTILES FOR TORPEDO TUBE ARTILLERY, SURFACE-TO-SURFACE ANTI-ARMOR MISSILE SYSTEMS, TANKS, TEAR-GAS PERSONAL ATTACK DEFENSE WEAPONS, TEAR-GAS WEAPONS, TORPEDO TUBE ARTILLERY, TRUNNIONS FOR HEAVY WEAPONS, UNDERWATER COMMAND AND CONTROL SYSTEMS, UNDERWATER COMMUNICATIONS SYSTEMS, UNMANNED REMOTE-CONTROLLED POWERED AIRCRAFT FOR USE AS MILITARY TARGETS, WEAPON SYSTEMS, WEAPONS, WEAPONS FOR LAUNCHING MISSILES AND PROJECTILES, AND WEAPON APPARATUS AND INSTALLATIONS (U.S. CLS. 100, 103 AND 106).

CLASS 41—EDUCATION AND ENTERTAINMENT

FOR TRAINING AND TEACHING SERVICES, NAMELY, TRAINING AND TEACHING SERVICES RELATING TO NAVAL TRAINING SYSTEMS, SONAR OPERATORS, PERISCOPE SIMULATORS, RADAR AND ELECTRONIC WARFARE TRAINERS, SHIP'S BRIDGE SIMULATORS, TACTICAL TRAINERS, TEAM TRAINERS AND FULL MISSION SIMULATORS, ON BOARD TRAINERS, MACHINERY CONTROL ROOM AND SHIP TRAINERS, MAINTAINER TRAINERS AND SHORE INTEGRATION AND TEST FACILITIES; TRAINING AND TEACHING SERVICES RELATING TO LAND TRAINING SYSTEMS; MILITARY COMMAND AND STAFF TRAINING; COMBINED ARMS TACTICAL TRAINING; TRAINING AND TEACHING SERVICES RELATING TO DRIVER TRAINING SIMULATORS; TRAINING AND TEACHING SERVICES RELATING TO THE OPERATION OF AIR TRAINING SYSTEMS; AIR DEFENSE TRAINING; TRAINING AND TEACHING SERVICES RELATING TO THE DESIGN AND PRODUCTION OF SYSTEMS RELATING TO NAVAL, LAND, AIR AND CIVIL WARFARE; TRAINING AND TEACHING SERVICES RELATING TO THE DESIGN AND PRODUCTION OF SYSTEMS FOR AIRPORTS, AIR AND MARITIME TRAFFIC CONTROL, MOBILE AND RADIO COMMUNICATIONS SYSTEMS; TRAINING AND TEACHING SERVICES RELATING TO INFORMATION SYSTEMS FOR NETWORKS; TRAINING AND TEACHING SERVICES RELATING TO SUPERVISORY AND SECURITY SYSTEMS; TRAINING AND TEACHING SERVICES RELATING TO INTEGRATED SYSTEMS FOR ENVIRONMENTAL PROTECTION AND MANAGEMENT SYSTEMS, COMPUTER AIDED DESIGN SYSTEMS AND COMPUTER AIDED MANAGEMENT SYSTEMS; TRAINING AND TEACHING SERVICES FOR OPERATORS IN SUBMARINE AND SURFACE VESSEL MACHINERY AND SHIP CONTROL ROOMS;

TRAINING AND TEACHING SERVICES RELATING TO EQUIPMENT DRILLS; TRAINING AND TEACHING SERVICES RELATING TO MILITARY OPERATIONAL PROCEDURES; TRAINING AND TEACHING SERVICES RELATING TO DRIVING SKILLS; TRAINING AND TEACHING SERVICES RELATING TO AIR NAVIGATION, ANTI-SUBMARINE WARFARE, AIRBORNE EARLY WARNING SYSTEMS, SONAR AND SONOBUOY OPERATORS, AVIONICS SYSTEMS AND AIR DEFENSE; TRAINING AND TEACHING SERVICES RELATING TO POWER GENERATING SYSTEMS; AND TRAINING AND TEACHING SERVICES RELATING TO TRANSPORTATION SYSTEMS (U.S. CLS. 100, 101 AND 107).

CLASS 42—SCIENTIFIC, COMPUTER AND LEGAL SERVICES

FOR RESEARCH, DESIGN AND TECHNICAL CONSULTATION SERVICES RELATING TO NAVAL TRAINING SYSTEMS, SONAR OPERATOR TRAINERS, PERISCOPE SIMULATORS, RADAR AND ELECTRONIC WARFARE TRAINERS, SHIP'S BRIDGE SIMULATORS, TACTICAL TRAINERS, TEAM TRAINERS AND FULL MISSION SIMULATORS, ON BOARD TRAINERS, MACHINERY CONTROL ROOM AND SHIP TRAINERS, MAINTAINER TRAINERS, SHORE INTEGRATION AND TEST FACILITIES, LAND TRAINING SYSTEMS, AIR DEFENSE SIMULATORS, GUNNERY TRAINING SIMULATORS, AIR TRAINING SYSTEMS, AIR NAVIGATION TRAINERS, ANTI-SUBMARINE WARFARE, AIRBORNE EARLY WARNING, SONAR AND SONOBUOY, OPERATOR TRAINERS, AVIONICS SYSTEMS TRAINERS, ELECTRONIC WARFARE, POWER INDUSTRY TRAINING SYSTEMS, SYNTHETIC ENVIRONMENTS, BATTLEFIELD COMMAND AND CONTROL SYSTEMS, FIRE CONTROL SYSTEMS, BATTLEFIELD METEOROLOGICAL SYSTEMS, AIR SYSTEMS, DATA LINKS, STRATEGIC MILITARY AIRCRAFT SYSTEMS, AIR DEFENSE COMMAND, CONTROL AND INFORMATION SYSTEMS, NAVAL COMMAND AND CONTROL SYSTEMS, UNDERWATER COMMAND AND CONTROL SYSTEMS, NAVAL DECOY SYSTEMS, NAVAL GUN FIRE PREDICTORS, DIGITAL INTEGRATED COMMUNICATIONS CONTROL SYSTEMS, DIGITIZATION, LONG RANGE AIR DEFENSE RADARS, MEDIUM RANGE AIR DEFENSE RADARS, NAVAL SURVEILLANCE RADARS, NAVAL RADAR FIRE CONTROL SYSTEMS, LAND BASED TRACKING RADARS, MARITIME SURVEILLANCE SYSTEMS, VESSEL TRAFFIC MANAGEMENT SYSTEMS, AIRBORNE SURVEILLANCE SYSTEMS, NAVAL OPTRONIC FIRE CONTROL SYSTEMS, NAVAL MULTI-FUNCTION RADARS, BATTLEFIELD SURVEILLANCE SYSTEMS, RADAR COMMAND AND CONTROL, NAVAL INTERROGATOR, AIR TRAFFIC CONTROL TRAINING SYSTEMS, PRIMARY AIR TRAFFIC CONTROL RADARS, AIRSPACE AND FLOW MANAGEMENT SYSTEMS, AIR TRAFFIC CONTROL AND MANAGEMENT CENTERS, AUTOMATIC DEPENDENT SURVEILLANCE SYSTEMS, DATA PROCESSING SYSTEMS, SECONDARY AIR TRAFFIC SYSTEMS, CONTROL RADARS, TRANSPORTABLE AIR TRAFFIC CONTROL RADARS, METEOROLOGICAL FORECAST INSTALLATIONS, INTEGRATED APPARATUS AND INSTALLATIONS, ALL FOR NAVAL AND AIR DEFENSE, SURFACE AND UNDERWATER COMBAT AND FOR AIR AND MARITIME TRAFFIC CONTROL, APPARATUS AND INSTRUMENTS, ALL FOR ELECTRO-OPTICS, ELECTRONIC COUNTERMEASURES AND FOR AVIONICS, CIVIL AND MILITARY SUPPORT APPARATUS AND INSTALLATIONS, NAVIGATION APPARATUS AND INSTRUMENTS, COMPUTERS, HARDWARE, SOFTWARE, MICROELECTRONICS, SIGNAL, IMAGE AND DATA PROCESSING APPARATUS AND INSTRUMENTS, ELECTRO-OPTICAL SENSORS, RADAR APPARATUS AND INSTALLATIONS, APPARATUS AND INSTALLATIONS, ALL FOR COMMAND AND CONTROL, INFORMATICS AND TELECOMMUNICATIONS, AND FOR COMMUNICATION AND SUPERVISION, COMPUTERIZED COMMUNICATION NETWORKS, TELEPHONES, MOBILE CELLULAR TELEPHONES, MOBILE RADIOS, AND APPARATUS AND INSTALLATIONS FOR GROUND-AIR, GROUND COMMUNICATION, NETWORK FAILURE DETECTION, GAME AUTOMATION, AND FOR SECURITY AND ACCESS CONTROL, ELECTRO-ACOUSTICS APPARATUS AND INSTRUMENTS, APPARATUS, INSTRUMENTS, INSTALLATIONS AND EQUIPMENT, BEING ELECTRONIC OR ELECTRICAL;

AND APPARATUS AND EQUIPMENT FOR THE RECORDING AND TRANSMISSION OF SOUND, VOICE, DATA AND IMAGES; RESEARCH, DESIGN AND TECHNICAL CONSULTATION SERVICES RELATING TO ACTUATORS FOR USE IN WEAPON EJECTING AND LOADING INSTALLATIONS, ACTUATORS FOR USE WITH WEAPONS, AERIAL TARGETS, AIR-TO-AIR MISSILES, AIR LAUNCHED ANTI-SHIP MISSILES, AIR LAUNCHED ANTI-ARMOR MISSILES, AIR-TO-SURFACES MISSILES, AIR GUNS, AIR LAUNCHERS, AMMONIUM NITRATE EXPLOSIVES, AMMUNITION, ANTI-SUBMARINE TORPEDOES FITTED WITH WARHEADS, ANTI-TANK MINES, APPARATUS FOR LAUNCHING WEAPONS, APPARATUS FOR USE IN THE FIRING, GUIDANCE AND STABILIZATION OF MISSILES, ARMAMENTS, ARMAMENTS INSTALLATIONS, ARMOR-PIERCING INCENDIARY PROJECTILES, ARMOR-PIERCING INCENDIARY PROJECTILES FOR USE BY AIRCRAFT, ARMOR-PIERCING PROJECTILES, ARMOR-PIERCING PROJECTILES FOR USE BY AIRCRAFT, ARTILLERY, ARTILLERY GUNS, ARTILLERY PIECES, BALLISTIC MISSILES, BALLISTIC WEAPONS, BOMBS, BOMB TECHNOLOGY, BULLETS, CARTRIDGES, CARTRIDGES CONTAINING REFLECTIVE MATERIALS FOR RADAR AND RADIO BLOCKING, CARTRIDGES FOR CARRYING MATERIALS TO BE DEPLOYED IN DECOY, IN DEFENSE AND IN WEAPON INSTALLATIONS, CONTAINERS FOR LAUNCHING AND STORING WEAPONS, CONVENTIONAL AIR DELIVERED WEAPONS, CRUISE MISSILES, DECOY APPARATUS AND INSTALLATIONS, DEFENSE APPARATUS AND INSTALLATIONS, DETONATING PLUGS, DETONATING RELAYS FOR USE WITH DETONATING CORD, WITH DETONATORS, WITH EXPLOSIVES AND WITH PRIMERS, DETONATORS, DISTRESS ROCKETS, DYNAMITE, ELECTRONIC DETONATORS, DIGITAL INTEGRATED COMMUNICATIONS CONTROL SYSTEMS, EXPLOSIVE DEVICES, EXPLOSIVE DEVICES FOR MINEFIELD BREACHING AND MINEFIELD CLEARANCE, EXPLOSIVE POWERS, PRODUCTS AND SUBSTANCES, EXPLOSIVES, EXPLOSIVES IN THE FORM OF LIQUIDS AND POWDERS, FEEDERS FOR FEEDING PAINT BULLETS, FIREARM SIGHTS, FIREARM STANDS, FIREARMS, FIRE LANYARDS FOR EXPLOSIVES, FIRE PLATFORMS, FIRE CONTROL SYSTEMS, FLARES, FUSES FOR EXPLOSIVES, GUIDED ANTI-TANK MINES, GUIDED BOMBS, GUIDED FLYING MACHINES FOR MILITARY USE, GUIDED MISSILES, GUIDED MORTAR BOMBS, GUIDED PROJECTILES, GUIDED ROCKETS, GUIDED WEAPONS, GUNS, GUN ILLUMINATING GRENADES, AND PROJECTILES, HELICOPTER-LAUNCHED ANTI-SHIP GUIDED WEAPONS, INFRARED DEFENSE ROCKET WARHEADS, INFRARED MISSILES FOR INFRARED CLOSE DEFENSE, LANCE ROCKETS, LAND-BASED AIR DEFENSE MISSILE SYSTEMS, LAUNCHERS FOR MISSILES, LAUNCHERS FOR PROJECTILES AND ROCKETS, METEORS, MILITARY PYROTECHNICS, MINES, MISSILES, MORTARS, MOTORIZED MILITARY VEHICLES FOR THE LAUNCHING OF PROJECTILES, MOTORIZED WEAPONS, MULTI-MUNITION STAND-OFF BOMBS, MUNITION DISPENSERS, MUNITIONS, NAVAL AIR DEFENSE MISSILE SYSTEMS, NAVAL ANTI-SHIP MISSILE SYSTEMS, NAVAL ANTI-SUBMARINE TORPEDO CARRIER SYSTEMS, NAVAL GUN FIRE PREDICTORS, NOISE-SUPPRESSORS FOR GUNS, OPTOELECTRONIC APPARATUS FOR MISSILE DRIVING, PNEUMATIC CATAPULTS FOR FIRING MISSILES, PRIMERS FOR EXPLOSIVES, PRIMERS FOR PYROTECHNIC DEVICES, PROPELLANT SUBSTANCES, PROJECTILES, PYROPHORIC SUBSTANCES, PYROTECHNIC AMMUNITIONS, APPARATUS, ARTICLES AND DEVICES, PYROTECHNIC THRUST GENERATORS FOR STEERING AIRBORNE WEAPONS, RADAR JAMMING PROJECTILES COMPRISING CONTAINERS OF RADAR ABSORBING AND REFLECTING MATERIALS, RADAR JAMMING WARHEADS, RADARS, ROCKET LAUNCHERS, ROCKET MORTARS, ROCKET PROPELLED BALLISTIC MISSILES, ROCKETS, SEEKER TECHNOLOGY, SELF-PROPELLED WEAPONS, SHELLS, SIGHT DEVICES FOR AERONAUTICAL, NAVAL AND TERRESTRIAL WEAPON USE, SIGHTING DEVICES FOR ARTILLERY AND FIREARMS, SIGNAL ROCKETS, SIGNALING FLARES, SILENCERS FOR FIREARMS, SMOKE MISSILES FOR ARMORED VEHICLES AND TANKS, SMOKE PROJECTILES FOR ROCKETS, SMOKE PROJECTILES FOR TORPEDO TUBE ARTILLERY, SURFACE-TO-SURFACE ANTI-ARMOR MISSILE SYSTEMS, TANKS, TEAR-GAS

PERSONAL ATTACK DEFENSE WEAPONS, TEAR-GAS WEAPONS, TORPEDO TUBE ARTILLERY, TRUNNIONS FOR HEAVY WEAPONS, UNDERWATER COMMAND AND CONTROL SYSTEMS, UNDERWATER COMMUNICATIONS SYSTEMS, UNMANNED REMOTE-CONTROLLED POWERED AIRCRAFT FOR USE AS MILITARY TARGETS, WEAPON SYSTEMS, WEAPONS, WEAPONS FOR LAUNCHING MISSILES AND PROJECTILES, WEAPON APPARATUS AND INSTALLATIONS, AND RELATING TO THE AUTOMATION OF THE DISTRIBUTION SERVICES; TESTING AND CALIBRATION OF NAVAL TRAINING SYSTEMS, SONAR OPERATOR TRAINERS, PERISCOPE SIMULATORS, RADAR AND ELECTRONIC WARFARE TRAINERS, SHIP'S BRIDGE SIMULATORS, TACTICAL TRAINERS, TEAM TRAINERS AND FULL MISSION SIMULATORS, ON BOARD TRAINERS, MACHINERY CONTROL ROOM AND SHIP TRAINERS, MAINTAINER TRAINERS, SHORE INTEGRATION AND TEST FACILITIES, LAND TRAINING SYSTEMS, AIR DEFENSE SIMULATORS, GUNNERY TRAINING SIMULATORS, AIR TRAINING SYSTEMS, AIR NAVIGATION TRAINERS, ANTI-SUBMARINE WARFARE, AIRBORNE EARLY WARNING, SONAR AND SONOBOUY, OPERATOR TRAINERS, AVIONICS SYSTEMS TRAINERS, ELECTRONIC WARFARE, POWER INDUSTRY TRAINING SYSTEMS, SYNTHETIC ENVIRONMENTS, BATTLEFIELD COMMAND AND CONTROL SYSTEMS, FIRE CONTROL SYSTEMS, BATTLEFIELD METEOROLOGICAL SYSTEMS, AIR SYSTEMS, DATA LINKS, STRATEGIC MILITARY AIRCRAFT SYSTEMS, AIR DEFENSE COMMAND, CONTROL AND INFORMATION SYSTEMS, NAVAL COMMAND AND CONTROL SYSTEMS, UNDERWATER COMMAND AND CONTROL SYSTEMS, NAVAL DECOY SYSTEMS, NAVAL GUN FIRE PREDICTORS, DIGITAL INTEGRATED COMMUNICATIONS CONTROL SYSTEMS, DIGITIZATION, LONG RANGE AIR DEFENSE RADARS, MEDIUM RANGE AIR DEFENSE RADARS, NAVAL SURVEILLANCE RADARS, NAVAL RADAR FIRE CONTROL SYSTEMS, LAND BASED TRACKING RADARS, MARITIME SURVEILLANCE SYSTEMS, VESSEL TRAFFIC MANAGEMENT SYSTEMS, AIRBORNE SURVEILLANCE SYSTEMS, NAVAL OPTRONIC FIRE CONTROL SYSTEMS, NAVAL MULTI-FUNCTION RADARS, BATTLEFIELD SURVEILLANCE SYSTEMS, RADAR COMMAND AND CONTROL, NAVAL INTERROGATOR, AIR TRAFFIC CONTROL TRAINING SYSTEMS, PRIMARY AIR TRAFFIC CONTROL RADARS, AIRSPACE AND FLOW MANAGEMENT SYSTEMS, AIR TRAFFIC CONTROL AND MANAGEMENT CENTERS, AUTOMATIC DEPENDENT SURVEILLANCE SYSTEMS, DATA PROCESSING SYSTEMS, METEOROLOGICAL SYSTEMS, SECONDARY AIR TRAFFIC CONTROL RADARS, TRANSPORTABLE AIR TRAFFIC CONTROL RADARS, METEOROLOGICAL FORECAST INSTALLATIONS, INTEGRATED APPARATUS AND INSTALLATIONS, ALL FOR NAVAL AND AIR DEFENSE, SURFACE AND UNDERWATER COMBAT AND FOR AIR AND MARITIME TRAFFIC CONTROL, APPARATUS AND INSTRUMENTS, ALL FOR ELECTRO-OPTICS, ELECTRONIC COUNTERMEASURES AND FOR AVIONICS, CIVIL AND MILITARY SUPPORT APPARATUS AND INSTALLATIONS, NAVIGATION APPARATUS AND INSTRUMENTS, COMPUTERS, HARDWARE, SOFTWARE, MICROELECTRONICS, SIGNAL, IMAGE AND DATA PROCESSING APPARATUS AND INSTRUMENTS, ELECTRO-OPTICAL SENSORS, RADAR APPARATUS AND INSTALLATIONS, APPARATUS AND INSTALLATIONS, ALL FOR COMMAND AND CONTROL, INFORMATICS AND TELECOMMUNICATIONS, AND FOR COMMUNICATION AND SUPERVISION, COMPUTERIZED COMMUNICATION NETWORKS, TELEPHONES, MOBILE CELLULAR TELEPHONES, MOBILE RADIOS, APPARATUS AND INSTALLATIONS, ALL FOR GROUND-AIR, GROUND COMMUNICATION, NETWORK FAILURE DETECTION, GAME AUTOMATION, AND FOR SECURITY AND ACCESS CONTROL, ELECTRO-ACOUSTICS APPARATUS AND INSTRUMENTS, APPARATUS, INSTRUMENTS, INSTALLATIONS AND EQUIPMENT, BEING ELECTRONIC OR ELECTRICAL, AND APPARATUS AND EQUIPMENT FOR THE RECORDING AND TRANSMISSION OF SOUND, VOICE, DATA AND IMAGES; TESTING AND CALIBRATION OF ACTUATORS FOR USE IN WEAPON EJECTING AND LOADING INSTALLATIONS, ACTUATORS FOR USE WITH WEAPONS, AERIAL TARGETS, AIR-TO-AIR MISSILES, AIR LAUNCHED ANTI-ARMOR

MISSILES, AIR-TO-SURFACES MISSILES, AIR GUNS, AIR LAUNCHERS, AMMONIUM NITRATE EXPLOSIVES, AMMUNITION, ANTI-SUBMARINE TORPEDOES FITTED WITH WARHEADS, ANTI-TANK MINES, APPARATUS FOR LAUNCHING WEAPONS, APPARATUS FOR USE IN THE FIRING, GUIDANCE AND STABILIZATION OF MISSILES, ARMAMENTS, ARMAMENTS INSTALLATIONS, ARMOR-PIERCING INCENDIARY PROJECTILES, ARMOR-PIERCING INCENDIARY PROJECTILES FOR USE BY AIRCRAFT, ARMOR-PIERCING PROJECTILES, ARMOR-PIERCING PROJECTILES FOR USE BY AIRCRAFT, ARTILLERY, ARTILLERY GUNS, ARTILLERY PIECES, BALLISTIC MISSILES, BALLISTIC WEAPONS, BOMBS, BOMB TECHNOLOGY, BULLETS, CARTRIDGES, CARTRIDGES CONTAINING REFLECTIVE MATERIALS FOR RADAR AND RADIO BLOCKING, CARTRIDGES FOR CARRYING MATERIALS TO BE DEPLOYED IN DECOY, IN DEFENSE AND IN WEAPON INSTALLATIONS, CONTAINERS FOR LAUNCHING AND STORING WEAPONS, CONVENTIONAL AIR DELIVERED WEAPONS, CRUISE MISSILES, DECOY APPARATUS AND INSTALLATIONS, DEFENSE APPARATUS AND INSTALLATIONS, DETONATING PLUGS, DETONATING RELAYS FOR USE WITH DETONATING CORD, WITH DETONATORS, WITH EXPLOSIVES AND WITH PRIMERS, DETONATORS, DISTRESS ROCKETS, DYNAMITE, ELECTRONIC DETONATORS, DIGITAL INTEGRATED COMMUNICATIONS CONTROL SYSTEMS, EXPLOSIVE DEVICES, EXPLOSIVE DEVICES FOR MINEFIELD BREACHING AND MINEFIELD CLEARANCE EXPLOSIVE POWERS, PRODUCTS AND SUBSTANCES, EXPLOSIVES, EXPLOSIVES IN THE FORM OF LIQUIDS AND POWDERS, FEEDERS FOR FEEDING PAINT BULLETS, FIREARM SIGHTS, FIREARM STANDS, FIREARMS, FIRE LANYARDS FOR EXPLOSIVES, FIRE PLATFORMS, FIRE CONTROL SYSTEMS, FLARES, FUSES FOR EXPLOSIVES, GUIDED ANTI-TANK MINES, GUIDED BOMBS, GUIDED FLYING MACHINES FOR MILITARY USE, GUIDED MISSILES, GUIDED MORTAR BOMBS, GUIDED PROJECTILES, GUIDED ROCKETS, GUIDED WEAPONS, GUNS, GUN ILLUMINATING GRENADES AND PROJECTILES, HELICOPTER-LAUNCHED ANTI-SHIP GUIDED WEAPONS, INFRARED DEFENSE ROCKET WARHEADS, INFRARED MISSILES FOR INFRARED CLOSE DEFENSE, LANCE ROCKETS, LAND-BASED AIR DEFENSE MISSILE SYSTEMS, LAUNCHERS FOR MISSILES, LAUNCHERS FOR PROJECTILES AND ROCKETS, METEORS, MILITARY PYROTECHNICS, MINES, MISSILES, MORTARS, MOTORIZED MILITARY VEHICLES FOR THE LAUNCHING OF PROJECTILES, MOTORIZED WEAPONS, MULTI-MUNITION STAND-OFF BOMBS, MUNITION DISPENSERS, MUNITIONS, NAVAL AIR DEFENSE MISSILE SYSTEMS, NAVAL ANTI-SHIP MISSILE SYSTEMS, NAVAL ANTI-SUBMARINE TORPEDO CARRIER SYSTEMS, NAVAL GUN FIRE PREDICTORS, NOISE SUPPRESSORS FOR GUNS, OPTOELECTRONIC APPARATUS FOR MISSILE DRIVING, PNEUMATIC CATAPULTS FOR FIRING MISSILES, PRIMERS FOR EXPLOSIVES, PRIMERS FOR PYROTECHNIC DEVICES, PROPELLANT SUBSTANCES, PROJECTILES, PYROPHORIC SUBSTANCES, PYROTECHNIC AMMUNITIONS, APPARATUS, ARTICLES AND DEVICES, PYROTECHNIC THRUST GENERATORS FOR STEERING AIRBORNE WEAPONS, RADAR JAMMING PROJECTILES COMPRISING CONTAINERS OF RADAR ABSORBING AND REFLECTING MATERIALS, RADAR JAMMING WARHEADS, RADARS, ROCKET LAUNCHERS, ROCKET MORTARS, ROCKET-PROPELLED BALLISTIC MISSILES, ROCKETS, SEEKER TECHNOLOGY, SELF-PROPELLED WEAPONS, SHELLS, SIGHT DEVICES FOR AERONAUTICAL, NAVAL AND TERRESTRIAL WEAPON USE, SIGHTING DEVICES FOR ARTILLERY AND FIREARMS, SIGNAL ROCKETS, SIGNALING FLARES, SILENCERS FOR FIREARMS, SMOKE MISSILES FOR ARMORED VEHICLES AND TANKS, SMOKE PROJECTILES FOR ROCKETS, SMOKE PROJECTILES FOR TORPEDO TUBE ARTILLERY, SURFACE-TO-SURFACE ANTI-ARMOR MISSILE SYSTEMS, TANKS, TEAR-GAS PERSONAL ATTACK DEFENSE WEAPONS, TEAR-GAS WEAPONS, TORPEDO TUBE ARTILLERY, TRUNNIONS FOR HEAVY WEAPONS, UNDERWATER COMMAND AND CONTROL SYSTEMS, UNDERWATER COMMUNICATIONS SYSTEMS, UNMANNED REMOTE-CONTROLLED POWERED AIRCRAFT FOR USE AS MILITARY TARGETS, WEAPON SYSTEMS, WEAPONS, WEAPONS FOR LAUNCHING MISSILES AND PROJEC-

TILES, AND WEAPON APPARATUS AND INSTALLATIONS; INSTALLATION AND REPAIR OF SOFTWARE (U.S. CLS. 100 AND 101).

ANGELA M. MICHELI, EXAMINING ATTORNEY

SN 76-362,930. DRESSER-RAND COMPANY, OLEAN, NY. FILED 1-25-2002.

D-R

OWNER OF U.S. REG. NOS. 532,689 AND 1,536,088.

CLASS 2—PAINTS

FOR CORROSION INHIBITING, PAINT-TYPE, POLYMER AND METALLIC-CERAMIC COATINGS TO PREVENT CORROSION, EROSION, AND FOULING OF COMPRESSOR VALVES, TURBOMACHINERY, AIR-FOILS, AND STEAM TURBINES (U.S. CLS. 6, 11 AND 16).

CLASS 7—MACHINERY

FOR TURBOMACHINERY, NAMELY, CENTRIFUGAL COMPRESSORS, AXIAL COMPRESSORS, PROCESS RECIPROCATING COMPRESSORS, SEPARABLE RECIPROCATING COMPRESSORS, GAS TURBINES, STEAM TURBINES, PIPELINE BOOSTERS, AND POWER RECOVERY EXPANDERS, ALL FOR USE IN OIL AND GAS PRODUCTION, LIQUEFIED NATURAL GAS PRODUCTION, AMMONIA AND ETHYLENE PRODUCTION, FUEL AND CHEMICAL REFINING, AND POWER GENERATION (U.S. CLS. 13, 19, 21, 23, 31, 34 AND 35).

CLASS 9—ELECTRICAL AND SCIENTIFIC APPARATUS

FOR CONTROL SYSTEMS FOR TURBOMACHINERY, NAMELY, COMPUTER SOFTWARE FOR REMOTE MONITORING OF GAS TURBINES, STEAM TURBINES, POWER RECOVERY EXPANDERS, MOTOR DRIVEN COMPRESSORS AND GENERATORS, CENTRIFUGAL COMPRESSORS, AXIAL COMPRESSORS, PROCESS RECIPROCATING COMPRESSORS, SEPARABLE RECIPROCATING COMPRESSORS, AND PIPELINE BOOSTERS (U.S. CLS. 21, 23, 26, 36 AND 38).

CLASS 37—CONSTRUCTION AND REPAIR

FOR REPAIR AND RECONDITIONING OF TURBOMACHINERY, NAMELY, CENTRIFUGAL COMPRESSORS, AXIAL COMPRESSORS, PROCESS RECIPROCATING COMPRESSORS, SEPARABLE RECIPROCATING COMPRESSORS, GAS TURBINES, STEAM TURBINES, PIPELINE BOOSTERS, AND POWER RECOVERY EXPANDERS (U.S. CLS. 100, 103 AND 106).

CLASS 41—EDUCATION AND ENTERTAINMENT

FOR TRAINING SERVICES, NAMELY, PROVIDING CLASSES, WORKSHOPS AND SEMINARS, REGARDING THE SAFE OPERATION OF TURBOMACHINERY, NAMELY, CENTRIFUGAL COMPRESSORS, AXIAL COMPRESSORS, PROCESS RECIPROCATING COMPRESSORS, SEPARABLE RECIPROCATING COMPRESSORS, GAS TURBINES, STEAM TURBINES, PIPELINE BOOSTERS, AND POWER RECOVERY EXPANDERS (U.S. CLS. 100, 101 AND 107).

CLASS 42—SCIENTIFIC, COMPUTER AND LEGAL SERVICES

FOR TECHNICAL SUPPORT SERVICES, NAMELY, MONITORING AND TROUBLESHOOTING TURBOMACHINERY, NAMELY, CENTRIFUGAL COMPRESSORS, AXIAL COMPRESSORS, PROCESS RECIPROCATING COMPRESSORS, SEPARABLE RECIPROCATING COMPRESSORS, GAS TURBINES, STEAM TURBINES, PIPELINE BOOSTERS, AND POWER RECOVERY EXPANDERS (U.S. CLS. 100 AND 101).

GLENN CLARK, EXAMINING ATTORNEY

CLASS 41—EDUCATION AND ENTERTAINMENT

FOR TRAINING SERVICES, NAMELY, PROVIDING CLASSES, WORKSHOPS AND SEMINARS, REGARDING THE SAFE OPERATION OF TURBOMACHINERY; NAMELY, CENTRIFUGAL COMPRESSORS, AXIAL COMPRESSORS, PROCESS RECIPROCATING COMPRESSORS, SEPARABLE RECIPROCATING COMPRESSORS, GAS TURBINES, STEAM TURBINES, PIPELINE BOOSTERS, AND POWER RECOVERY EXPANDERS (U.S. CLS. 100, 101 AND 107).

CLASS 42—SCIENTIFIC, COMPUTER AND LEGAL SERVICES

FOR TECHNICAL SUPPORT SERVICES, NAMELY, MONITORING AND TROUBLESHOOTING TURBOMACHINERY, NAMELY, CENTRIFUGAL COMPRESSORS, AXIAL COMPRESSORS, PROCESS RECIPROCATING COMPRESSORS, SEPARABLE RECIPROCATING COMPRESSORS, GAS TURBINES, STEAM TURBINES, PIPELINE BOOSTERS, AND POWER RECOVERY EXPANDERS (U.S. CLS. 100 AND 101).

GLENN CLARK, EXAMINING ATTORNEY

SN 76-363,946. DRESSER-RAND COMPANY, OLEAN, NY. FILED 1-25-2002.

D-R COMPANY

OWNER OF U.S. REG. NOS. 1,532,689 AND 1,536,088.
NO CLAIM IS MADE TO THE EXCLUSIVE RIGHT TO USE COMPANY, APART FROM THE MARK AS SHOWN.

CLASS 2—PAINTS

FOR CORROSION INHIBITING, PAIN-TYPE, POLYMER AND METALLIC-CERAMIC COATINGS TO PREVENT CORROSION, EROSION, AND FOULING OF COMPRESSOR VALVES, TURBOMACHINERY, AIRFOILS, AND STEAM TURBINES (U.S. CLS. 6, 11 AND 16).

CLASS 7—MACHINERY

FOR TURBOMACHINERY, NAMELY, CENTRIFUGAL COMPRESSORS, AXIAL COMPRESSORS, PROCESS RECIPROCATING COMPRESSORS, SEPARABLE RECIPROCATING COMPRESSORS, GAS TURBINES, STEAM TURBINES, PIPELINE BOOSTERS, AND POWER RECOVERY EXPANDERS, ALL FOR USE IN OIL AND GAS PRODUCTION, LIQUEFIED NATURAL GAS PRODUCTION, AMMONIA AND ETHYLENE PRODUCTION, FUEL AND CHEMICAL REFINING, AND POWER GENERATION (U.S. CLS. 13, 19, 21, 23, 31, 34 AND 35).

CLASS 9—ELECTRICAL AND SCIENTIFIC APPARATUS

FOR CONTROL SYSTEMS FOR TURBOMACHINERY, NAMELY, COMPUTER SOFTWARE FOR REMOTE MONITORING OF GAS TURBINES, STEAM TURBINES, POWER RECOVERY EXPANDERS, MOTOR DRIVEN COMPRESSORS AND GENERATORS, CENTRIFUGAL COMPRESSORS, AXIAL COMPRESSORS, PROCESS RECIPROCATING COMPRESSORS, SEPARABLE RECIPROCATING COMPRESSORS, AND PIPELINE BOOSTERS (U.S. CLS. 21, 23, 26, 36 AND 38).

CLASS 37—CONSTRUCTION AND REPAIR

FOR REPAIR AND RECONDITIONING OF TURBOMACHINERY, NAMELY, CENTRIFUGAL COMPRESSORS, AXIAL COMPRESSORS, PROCESS RECIPROCATING COMPRESSORS, SEPARABLE RECIPROCATING COMPRESSORS, GAS TURBINES, STEAM TURBINES, PIPELINE BOOSTERS, AND POWER RECOVERY EXPANDERS (U.S. CLS. 100, 103 AND 106).

SN 76-402,129. SONY MUSIC ENTERTAINMENT INC., NEW YORK, NY. FILED 5-1-2002.

BE*TWEEN**CLASS 9—ELECTRICAL AND SCIENTIFIC APPARATUS**

FOR MUSICAL SOUND RECORDINGS; MUSICAL VIDEO RECORDINGS; DOWNLOADABLE MUSICAL SOUND RECORDINGS; PRERECORDED VIDEO TAPES ON A WIDE VARIETY OF SUBJECTS; MOTION PICTURE FILMS ON A WIDE VARIETY OF SUBJECTS (U.S. CLS. 21, 23, 26, 36 AND 38).

CLASS 16—PAPER GOODS AND PRINTED MATTER

FOR SERIES OF CHILDREN'S BOOKS; MERCHANDISE, NAMELY, POSTCARDS, STICKERS, POSTERS, GIFT-WRAPPING, NOTE PADS, NOTE CARDS, STATIONERY, PHOTO ALBUMS, ADDRESS BOOKS, CALENDARS, PERSONAL PLANNERS, BOOK COVERS, BOOK ENDS, BOOK MARKS, LOOSE LEAF BINDERS, BLANK CARDS, GIFT CARDS, GREETING CARDS (U.S. CLS. 2, 5, 22, 23, 29, 37, 38 AND 50).

CLASS 25—CLOTHING

FOR CLOTHING, NAMELY, T-SHIRTS, SWEATSHIRTS, AND HEADWEAR; MERCHANDISE, NAMELY HEAD BANDS AND SCARVES (U.S. CLS. 22 AND 39).

CLASS 41—EDUCATION AND ENTERTAINMENT

FOR ENTERTAINMENT SERVICES, NAMELY LIVE PERFORMANCES BY A MUSICAL GROUP; INTERNET BASED SERVICES, NAMELY, PRODUCING AND PROVIDING A WEBSITE THAT FEATURES INFORMATION IN THE FIELDS OF EDUCATION AND ENTERTAINMENT; ENTERTAINMENT IN THE NATURE OF ONGOING TELEVISION PROGRAMS FOR CHILDREN (U.S. CLS. 100, 101 AND 107).

JAMES GRIFFIN, EXAMINING ATTORNEY

SN 76-419,308. DGT RESEARCH LTD., ELLEL, LANCASTER L12 0QL, UNITED KINGDOM, FILED 6-10-2002.

SN 76-448,110. JR. MOTORSPORTS, L.L.C., MOORESVILLE, NC. FILED 9-9-2002.

DGT

CLASS 9—ELECTRICAL AND SCIENTIFIC APPARATUS

FOR APPARATUS AND INSTRUMENTS, NAMELY PROBES FOR MONITORING AND DETECTING CHEMICALS AND THEIR COMPOUNDS IN THE ENVIRONMENT; COMPUTER HARDWARE AND SOFTWARE FOR RECORDING, STORING, ANALYZING AND REPORTING THE MONITORING AND DETECTION OF CHEMICALS AND THEIR COMPOUNDS; ALL OF THE FOREGOING BEING GOODS DIRECTED TOWARDS OR FOR USE IN OR BY RESEARCH LABORATORIES; WATER AND SOIL TESTING LABORATORIES AND REGULATORY AGENCIES (U.S. CLS. 21, 23, 26, 36 AND 38).

CLASS 42—SCIENTIFIC, COMPUTER AND LEGAL SERVICES

FOR MONITORING AND DETECTION OF CHEMICALS AND THEIR COMPOUNDS IN THE ENVIRONMENT; ADVISORY AND CONSULTANCY SERVICES RELATED THERETO; ALL OF THE FOREGOING BEING SERVICES DIRECTED TOWARDS OR FOR USE IN OR BY RESEARCH LABORATORIES, WATER AND SOIL TESTING LABORATORIES AND REGULATORY AGENCIES (U.S. CLS. 100 AND 101).

KATHERINE STOIDES, EXAMINING ATTORNEY

SN 76-431,082. FOR CHILDREN WORLDWIDE, INC., DBA PROJECT KIDS WORLDWIDE, NEW YORK, NY. FILED 7-16-2002.

PROJECT KIDS WORLDWIDE

NO CLAIM IS MADE TO THE EXCLUSIVE RIGHT TO USE KIDS WORLDWIDE, APART FROM THE MARK AS SHOWN.

CLASS 36—INSURANCE AND FINANCIAL

FOR CHARITABLE FUNDRAISING AND PHILANTHROPIC SERVICES CONCERNING MONETARY DONATIONS (U.S. CLS. 100, 101 AND 102).

FIRST USE 3-15-2002; IN COMMERCE 3-15-2002.

CLASS 44—MEDICAL, BEAUTY AND AGRICULTURAL SERVICES

FOR PHILANTHROPIC SERVICES CONCERNING IN KIND DONATIONS OF MEDICAL AND HEALTH CARE SERVICES AND SUPPLIES; CHARITABLE AND PHILANTHROPIC SERVICES, NAMELY PROVIDING PREVENTIVE, DIAGNOSTIC, MEDICAL TREATMENT INCLUDING CORRECTIVE HEART SURGERY, AND MEDICAL TREATMENT, INCLUDING CORRECTIVE HEART SURGERY, AND HEALTH CARE SERVICES AND SUPPLIES TO DISADVANTAGED CHILDREN WITH CONGENITAL HEART DEFECTS (U.S. CLS. 100 AND 101).

FIRST USE 3-15-2002; IN COMMERCE 3-15-2002.
ESTHER BELENKER, EXAMINING ATTORNEY

DIRTY MO' POSSE

CLASS 6—METAL GOODS

FOR METAL GOODS, NAMELY, KEY RINGS, KEY CHAINS, KEY CLIPS, COLLECTOR TINS SOLD EMPTY, DECORATIVE TINS SOLD EMPTY, METAL LICENSE PLATES, HOLIDAY ORNAMENTS, METAL KEY FOBS, AND METAL BASEBALL HOLDERS (U.S. CLS. 2, 12, 13, 14, 23, 25 AND 50).

CLASS 8—HAND TOOLS

FOR POCKET KNIVES (U.S. CLS. 23, 28 AND 44).

CLASS 9—ELECTRICAL AND SCIENTIFIC APPARATUS

FOR AUDIO, VIDEO, COMPUTER AND LASER DISCS FEATURING SPORTS AND MUSIC; PRE-RECORDED AUDIO AND VIDEO CASSETTES, PRE-RECORDED AUDIO AND VIDEO TAPES, PRE-RECORDED COMPACT DISCS, AND PRE-RECORDED COMPUTER DISCS FEATURING SPORTS AND MUSIC; COMPUTER ACCESSORIES, NAMELY, COMPUTER MICE, COMPUTER MOUSE PADS, COMPUTER DISC CASES, COMPUTER CARRYING CASES, AND KEYBOARD WRIST PADS FOR COMPUTER USERS; COMPUTER SOFTWARE FOR STORING, RECEIVING, RETRIEVING, DISPLAYING, ANALYZING AND PROCESSING INFORMATION, DATA, STATISTICS AND TRIVIA RELATING TO SPORTS AND MUSIC; COMPUTER SOFTWARE FOR USE AS A SCREEN SAVER FEATURING SPORTS AND MUSIC; VIDEO GAME COMPUTER SOFTWARE; VIDEO GAME CARTRIDGES; VIDEO GAME MACHINES FOR USE WITH A TELEVISION; RADIOS; TELEPHONES; WALKIE-TALKIES; BINOCULARS; SUNGLASSES; EYEGLASS CASES; DECORATIVE MAGNETS; CELLULAR TELEPHONE CARRYING CASES (U.S. CLS. 21, 23, 26, 36 AND 38).

CLASS 11—ENVIRONMENTAL CONTROL APPARATUS

FOR FLASHLIGHTS (U.S. CLS. 13, 21, 23, 31 AND 34).

CLASS 12—VEHICLES

FOR VISOR COVERS FOR CAR WINDSHIELD VISORS, AUTOMOBILE WINDSHIELD SUNSHADES, AND AUTOMOBILE SPLASH GUARDS; LICENSE PLATE HOLDERS; LICENSE PLATE FRAMES (U.S. CLS. 19, 21, 23, 31, 35 AND 44).

CLASS 14—JEWELRY

FOR BELT BUCKLES, MONEY CLIPS AND HAT PINS OF PRECIOUS METAL; WATCHES, CLOCKS AND WALL CLOCKS; JEWELRY; LAPEL PINS; CHARMS; PENDANTS; EARRINGS; RINGS BEING JEWELRY; TIE FASTENERS; TIE CLASPS; NECKLACES; WATCH BANDS (U.S. CLS. 2, 27, 28 AND 50).

CLASS 16—PAPER GOODS AND PRINTED MATTER

FOR PAPER GOODS AND PRINTED MATERIAL, NAMELY, BROCHURES, MAGAZINES, NEWSLETTERS, PAMPHLETS, SOUVENIR PROGRAMS, STATISTICAL RECORD SHEETS, AND BOOKS FEATURING SPORTS AND MUSIC; TRADING CARDS; COMMEMORATIVE STAMPS SHEETS; POSTCARDS; NOTE CARDS; POSTERS; STICKERS; BUMPER STICKERS; DECALS; STATIC DECALS; STATIC CLINGS MADE OF PAPER; CALENDARS; PAPER PLACE MATS; PAPER PENNANTS; PAPER BANNERS; UNMOUNTED AND MOUNTED PHOTOGRAPHS; ART PRINTS; PHOTOGRAPHIC PRINTS; LITHOGRAPHIC PRINTS; MEMO PADS; NOTE PADS; PENS; PENCILS; BINDERS; FOLDERS; BOOK COVERS; STATIONERY AND STATIONERY TYPE PORTFOLIOS (U.S. CLS. 2, 5, 22, 23, 29, 37, 38 AND 50).

CLASS 18—LEATHER GOODS

FOR LUGGAGE, ATHLETIC BAGS, SHOE BAGS FOR TRAVEL, OVERNIGHT BAGS, BACKPACKS, FANNY PACKS, WAIST PACKS, DUFFEL BAGS, TOTE BAGS, BOOK BAGS, ALL PURPOSE SPORTS BAGS, GYM BAGS, GARMENT BAGS FOR TRAVEL, HANDBAGS, PURSES, TOILETRY CASES SOLD EMPTY, COSMETIC CASES SOLD EMPTY, TRUNKS, BRIEFCASES, ATTACHE CASES, SUITCASES, KNAPSACKS, BUSINESS CARD CASES, KEY CASES, BILLFOLDS, WALLETS, LUGGAGE TAGS, AND UMBRELLAS (U.S. CLS. 1, 2, 3, 22 AND 41).

CLASS 20—FURNITURE AND ARTICLES NOT OTHERWISE CLASSIFIED

FOR NON-METAL KEY RINGS, NON-METAL KEY CHAINS, NON-METAL NOVELTY LICENSE PLATES, PLAQUES, SEAT CUSHIONS, DIECAST DISPLAYS FEATURING SPORTS AND MUSIC SCENES; FOLDING CHAIRS AND CARRYING CASES; PICTURE FRAMES; PLASTIC PENNANTS AND PLASTIC BANNERS; KEY FOBS, NOT OF METAL; CUSHIONS; CHAIRS; FIGURINES AND SCULPTURES MADE OF PLASTIC; FIGURINES AND SCULPTURES MADE OF ACRYLIC; DISPLAYS MADE OF PLASTIC FEATURING SPORTS AND MUSIC SCENES; DISPLAYS MADE OF ACRYLIC FEATURING SPORTS AND MUSIC SCENES (U.S. CLS. 2, 13, 22, 25, 32 AND 50).

CLASS 21—HOUSEWARES AND GLASS

FOR HOUSEWARES AND GLASS, NAMELY, SHOT GLASSES; PLATES, DRINKING GLASSES, CUPS, MUGS AND DRINKING STEINS; BOTTLE OPENERS; RUBBER, PLASTIC OR FOAM INSULATING FOOD CONTAINERS, PORTABLE COOLERS AND INSULATING BEVERAGE HOLDERS; WATER BOTTLES SOLD EMPTY; TRASH CANS; WASTEBASKETS; LUNCH BOXES; NON-METAL DECORATIVE BOXES; FIGURINES AND SCULPTURES MADE OF CHINA, PORCELAIN, EARTHENWARE, GLASS, CRYSTAL, TERRA COTTA AND CERAMIC; DISPLAYS MADE OF CHINA, PORCELAIN, EARTHENWARE, GLASS, CRYSTAL, TERRA COTTA AND CERAMIC FEATURING SPORTS AND MUSIC SCENES; COASTERS NOT MADE OF PAPER OR CLOTH; WIND CHIMES; BASEBALL HOLDERS (U.S. CLS. 2, 13, 23, 29, 30, 33, 40 AND 50).

CLASS 24—FABRICS

FOR AFGHANS, TABLECLOTHS NOT MADE OF PAPER, SHEETS, PILLOWCASES, TOWELS, FABRIC FLAGS, PENNANTS AND BANNERS NOT MADE OF PAPER OR PLASTIC (U.S. CLS. 42 AND 50).

CLASS 25—CLOTHING

FOR CLOTHING, NAMELY, SWEATSHIRTS, SWEAT PANTS, SWEAT SUITS, WARM-UP SUITS, SHIRTS, SPORT SHIRTS, GOLF SHIRTS, T-SHIRTS, TANK TOPS, SWEATERS, DRESSES, SKIRTS, JERSEYS, LONG PANTS, SPORT SHORTS, SHORTS, BATHING SUITS, PANTS, JACKETS, COATS, HATS, CAPS, BANDANAS, VISORS, LANYARDS, BELTS, SUSPENDERS, HEAD BANDS, WRIST BANDS, SOCKS, HOSIERY, FOOTWEAR, GLOVES, SCARVES, NECKTIES, RAINCOATS, PONCHOS, PAJAMAS, NIGHT SHIRTS, NIGHT GOWNS AND ROBES; MASQUERADE COSTUMES, NAMELY, REPLICA DRIVER SUITS, REPLICA DRIVER HELMETS AND BASEBALL UNIFORMS; INFANT WEAR; AND CLOTH BABY BIBS NOT OF PAPER (U.S. CLS. 22 AND 39).

CLASS 26—FANCY GOODS

FOR FANCY GOODS, NAMELY, ORNAMENTAL CLOTH PATCHES FOR CLOTHING; HAT PINS; LAPEL PINS AND NOVELTY PINS NOT OF PRECIOUS METAL; BELT BUCKLES NOT OF PRECIOUS METAL; ORNAMENTAL NOVELTY BUTTONS; BUTTONS FOR CLOTHING (U.S. CLS. 37, 39, 40, 42 AND 50).

CLASS 28—TOYS AND SPORTING GOODS

FOR TOYS AND SPORTING GOODS, NAMELY, MINIATURE AUTOMOBILES, AUTOMOBILE HOODS, AIRPLANES, TRUCKS, BOATS, MOTORCYCLES AND ALL-TERRAIN VEHICLES; RADIO-CONTROLLED TOY CARS, AIRPLANES, TRUCKS, BOATS, MOTORCYCLES AND ALL-TERRAIN VEHICLES; TOY MODEL AUTOMOBILES, AIRPLANES, TRUCKS, BOATS, MOTORCYCLES AND ALL-TERRAIN VEHICLES; AUTOMOBILE, AIRPLANE, TRUCK, BOAT, MOTORCYCLE, AND ALL-TERRAIN VEHICLE TOY BANKS; TOY SLOT TRACK CARS AND TRUCKS; TOY PEDAL STOCK CARS AND TRUCKS; SPORTS BALLS, NAMELY, BASEBALLS, BASKETBALLS, FOOTBALLS, BEACH BALLS, TENNIS BALLS, VOLLEYBALLS, SOCCER BALLS AND GOLF BALLS; GOLF BAGS; BASEBALL TABLE TOP GAMES; SPORTS BOARD GAMES; DOLLS; STUFFED TOYS; STUFFED TOY ANIMALS; STUFFED TOY CARS AND TRUCKS; TOY ACTION FIGURES; CHRISTMAS TREE ORNAMENTS; BALLOONS; BASEBALL BATS; MINIATURE BASEBALL BATS; INFLATABLE BASEBALL BATS; REPLICA BATTING HELMETS; MINIATURE BATTING HELMETS; MINIATURE RACING HELMETS; AND YO-YOS; STAND ALONE AND HAND-HELD VIDEO GAME MACHINES; PLAYING CARDS (U.S. CLS. 22, 23, 38 AND 50).

CLASS 41—EDUCATION AND ENTERTAINMENT

FOR ENTERTAINMENT SERVICES IN THE NATURE OF PARTICIPATING IN PROFESSIONAL AUTOMOBILE RACES AND AUTO RACING EXHIBITIONS; ENTERTAINMENT SERVICES IN THE NATURE OF BASEBALL GAMES AND RELATED EXHIBITIONS; ENTERTAINMENT SERVICES IN THE NATURE OF LIVE MUSICAL CONCERTS; ENTERTAINMENT, NAMELY, LIVE PERFORMANCES BY A MUSICAL BAND; ENTERTAINMENT IN THE NATURE OF VISUAL AND AUDIO PERFORMANCES, AND MUSICAL, VARIETY, NEWS AND COMEDY SHOWS (U.S. CLS. 100, 101 AND 107).

ANN LINNEHAN, EXAMINING ATTORNEY

SN 76-457,345. DREAMWORKS ANIMATION L.L.C., GLENDALE, CA. FILED 10-10-2002.

THE WANDERER

CLASS 9—ELECTRICAL AND SCIENTIFIC APPARATUS

FOR MOUSE PADS (COMPUTER PERIPHERAL), HOLDERS FOR COMPACT DISCS, COMPUTER GAME CARTRIDGES, COMPUTER GAME CASSETTES, AND COMPUTER GAME TAPES; VIDEO GAME CARTRIDGES, VIDEO GAME CASSETTES, PRERECORDED AUDIO CASSETTES, PRERECORDED VIDEO CASSETTES, PRERECORDED AUDIO TAPES, PRERECORDED VIDEO TAPES, PRERECORDED DISCS FEATURING MUSIC AND MOTION PICTURE SOUND TRACKS; CD ROM AND DVD PROGRAMS FEATURING MUSIC AND MOTION PICTURE SOUND TRACKS; PRERECORDED COMPUTER SOFTWARE PROGRAMS FEATURING MUSIC AND MOTION PICTURE SOUND TRACKS; INTERACTIVE MULTIMEDIA SOFTWARE PROGRAMS FOR ENTERTAINMENT; INTERACTIVE MULTI-MEDIA SOFTWARE FOR PLAYING GAMES; MAGNETS AND SUNGLASSES (U.S. CLS. 21, 23, 26, 36 AND 38).

CLASS 16—PAPER GOODS AND PRINTED MATTER

FOR PAPER PARTY DECORATIONS; PAPER PARTY SUPPLIES; NAMELY, PAPER PARTY HATS, PAPER NAPKINS; PAPER PLACE MATS, GIFTWRAPPING PAPER AND GIFT WRAPPING RIBBONS, PAPER GIFT WRAP BOWS, PAPER TABLE CLOTHS AND PAPER PARTY BAGS; CHILDREN'S ACTIVITY BOOKS, CHILDREN'S STORYBOOKS, COMIC BOOKS, COLORING BOOKS, BOOK MARKS, LOOSE LEAF BINDERS, STATIONERY-TYPE PORTFOLIOS, SPIRAL BOUND NOTEBOOKS, NOTE PADS OR WRITING PADS, DIARIES, DAILY PLANNERS, CALENDARS, SCRAPBOOK ALBUMS, SKETCHBOOK ALBUMS, PHOTOGRAPH ALBUMS, STICKER ALBUMS, STICKERS, DECALS, STAMP PADS OR INKING PADS, RUBBER STAMPS, HEAT APPLIED APPLIQUES MADE OF PAPER, TEMPORARY TATTOOS, SLATEBOARDS, PENCILS, PENS, PENCIL ERASERS, DECORATIVE PENCIL-TOP ORNAMENTS, PEN CASES AND PENCIL CASES, PEN BOXES AND PENCIL BOXES, PENCIL SHARPENERS, CHALK, MARKERS, POSTERS, POSTCARDS, TRADING CARDS, GREETING CARDS, PENNANTS MADE OF PAPER, PAINTING SETS FOR CHILDREN; ARTS AND CRAFTS PAINT KITS; STUDY KITS, CONSISTING OF PENCIL ERASERS, DRAWING RULERS, PENCIL SHARPENERS AND PENCIL CASE; STATIONERY PACKS CONSISTING OF WRITING PAPER, ENVELOPES, MARKERS, AND STENCILS; AND ACTIVITY KITS CONSISTING OF STICKERS AND STAMPS (U.S. CLS. 2, 5, 22, 23, 29, 37, 38 AND 50).

CLASS 25—CLOTHING

FOR SHIRTS AND TOPS, DRESSES, SKIRTS, PANTS, TROUSERS, JEANS, SHORTS, ROMPERS, OVERALLS, SWEATSHIRTS AND SWEAT PANTS, SWEATSUITS, GLOVES, SUSPENDERS, TIES, COATS AND JACKET, HOSIERY, SHOES, BOOTS, SLIPPERS, PAJAMAS, ROBES, SLEEPSHIRTS, SLEEPWEAR, UNDERWEAR, HALLOWEEN COSTUMES (U.S. CLS. 22 AND 39).

CLASS 28—TOYS AND SPORTING GOODS

FOR ACTION FIGURES AND ACCESSORIES THEREFOR, BATHTUB TOYS, KITES, TOY BUILDING BLOCKS, BOARD GAMES, COSTUME MASKS, HANDHELD UNIT FOR PLAYING ELECTRONIC GAMES, DIE CAST MINIATURE TOY VEHICLES, DOLLS, DOLL ACCESSORIES, DOLL CLOTHING, BEAN BAG DOLLS, BENDABLE PLAY FIGURES, FLYING DISKS, INFLATABLE VINYL PLAY FIGURES, JIGSAW PUZZLES, MARBLES, PLUSH TOYS, PUPPETS, RIDE-ON TOYS, SKATEBOARDS, BALLOONS, ROLLERSKATES, TOY BANKS, WATER SQUIRTING TOYS, STUFFED TOYS, TOY VEHICLES, CHRISTMAS TREE ORNAMENTS; PLAYING CARDS; PINBALL MACHINES AND MODEL CRAFT KITS OF TOY FIGURES (U.S. CLS. 22, 23, 38 AND 50).

SAMUEL E. SHARPER JR., EXAMINING ATTORNEY

SN 76-464,543. RHODIA, 92100 BOULOGNE-BILLANCOURT, FRANCE, FILED 10-28-2002.

CHALLENGING BOUNDARIES

PRIORITY CLAIMED UNDER SEC. 44(D) ON FRANCE APPLICATION NO. 023162380, FILED 4-30-2002, REG. NO. 023162380, DATED 4-30-2002, EXPIRES 4-30-2012.

CLASS 1—CHEMICALS

FOR CHEMICALS FOR USE IN THE MANUFACTURE OF HORTICULTURE AND FORESTRY PRODUCTS, AGROCHEMICAL PRODUCTS, FIBERS, POLYMERS, FOOD PRODUCTS, ANIMAL NUTRITION PRODUCTS, VETERINARY PRODUCTS, COSMETIC PRODUCTS, PAINT, BUILDING MATERIALS, SILICONES, PAPER, TEXTILES, DETERGENTS AND PNEUMATIC PRODUCTS; CHEMICALS FOR USE IN THE TREATMENT OF WATER; CHEMICALS FOR USE IN THE MANUFACTURE OF ELECTRONIC PRODUCTS, PHOTOGRAPHY PRODUCTS AND CATALYSTS; CHEMICALS FOR USE IN THE DEPOLLUTING OF VEHICLES, NAMELY, FUEL INJECTION CLEANER CHEMICAL ADDITIVES AND RARE EARTH OXIDES; CHEMICALS FOR USE IN THE MANUFACTURE OF BIOTECHNOLOGY PRODUCTS; UNPROCESSED ARTIFICIAL RESINS FOR USE IN THE MANUFACTURE OF PAPER, PAINTS, BUILDING MATERIALS AND SILICONES; UNPROCESSED ENGINEERING PLASTICS FOR USE IN THE MANUFACTURE OF A WIDE VARIETY OF GOODS, POLYMERS BEADS FOR USE IN THE MANUFACTURE OF A WIDE VARIETY OF GOODS; UNPROCESSED PLASTIC MANURE; FIRE EXTINGUISHING COMPOSITIONS; TEMPERING AND SOLDERING FLUX; CHEMICAL SUBSTANCES FOR USE IN THE MANUFACTURE OF FOODSTUFFS; TANNING SUBSTANCES, NAMELY, OXYGENATED SOLVENT; PLANT GROW REGULATORS FOR AGRICULTURAL AND/OR DOMESTIC USE; POLYMER AGENTS NOT INCLUDING A PESTICIDE FOR COATING AND PROTECTING AGRICULTURAL SEEDS; CHEMICALS USED IN THE MANUFACTURE OF PHARMACEUTICALS; SOIL FERTILIZERS FOR DOMESTIC AND AGRICULTURAL USE; UNPROCESSED CELLULOSE ACETATE FOR USE IN A WIDE VARIETY OF FIELDS; CHEMICALS USED IN THE MANUFACTURE OF COMPUTER CHIPS, CAPACITORS FOR AUTOMOBILE AND DESKTOP COMPUTERS, LIGHT BULBS, CATALYTIC CONVERTERS FOR GASOLINE AND DIESEL ENGINES, AND PRODUCTS USED IN POLISHING ELECTRONIC COMPONENTS WHICH ARE USED FOR COMPUTER MEMORIES, ELECTRONIC CHIPS AND HARD DISKS; CHEMICALS USED IN THE MANUFACTURE OF COLORATION PRODUCTS, COLORANTS, MAGNETS, LUMINESCENCE PRODUCTS AND BATTERIES; PHOSPHATES FOR USE IN THE MANUFACTURE OF A WIDE VARIETY OF GOODS, LACTIC FERMENTATION EXTRACTS FOR USE IN MILK AND MEAT FERMENTATION PROCESSES; FERMENTATION EXTRACTS; CHEMICAL DUST ABSORBING, WETTING AND BIND-

ING COMPOSITIONS FOR USE IN THE FILTER INDUSTRY AND CHEMICAL ADDITIVES FOR FUEL TREATMENT (U.S. CLS. 1, 5, 6, 10, 26 AND 46).

CLASS 2—PAINTS

FOR INTERIOR, EXTERIOR AND HOUSE PAINTS; PAINT FOR ARTISTS; PAINT FOR INDUSTRIAL USE, NAMELY, FOR INDUSTRIAL EQUIPMENT AND MACHINERY AND MANUFACTURED ARTICLES AND PARTS; PAINT THICKENERS AND THINNERS; VARNISHES FOR WOOD AND WOOD PRODUCTS; LACQUERS IN THE NATURE OF A COATING; THINNERS AND THICKENERS FOR LACQUERS; WOOD PRESERVATIVES AND RUST PREVENTATIVE COATINGS; OILS FOR THE PRESERVATION OF WOOD AND FOR THE PREVENTION OF RUST; COLORANTS FOR USE IN THE MANUFACTURE OF PAINTS, FOOD, BEVERAGES AND COSMETICS; NATURAL RESINS FOR USE IN THE MANUFACTURE OF ADHESIVES AND ENGINEERING PLASTICS; METALS IN FOIL AND POWDER FORM FOR PAINTERS, DECORATORS, PRINTERS AND ARTISTS (U.S. CLS. 6, 11 AND 16).

CLASS 3—COSMETICS AND CLEANING PREPARATIONS

FOR LAUNDRY BLEACH AND LAUNDRY DETERGENT; GENERAL PURPOSE CLEANING, POLISHING AND ABRASIVE LIQUIDS AND POWDERS AND DEGREASING PREPARATIONS FOR HOUSEHOLD USE; SOAPS, NAMELY, DEODORANT SOAPS, DETERGENT SOAPS, SHAVING SOAPS, SKIN SOAPS, TOILET SOAPS, AND LIQUID SOAPS FOR SKIN AND TOILET; PERFUME; ESSENTIAL OILS FOR USE IN FOOD FLAVORINGS; ESSENTIAL OILS FOR PERSONAL USE; ESSENTIAL OILS FOR USE IN THE MANUFACTURE OF SCENTED PRODUCTS; ESSENTIAL OILS FOR USE IN THE MANUFACTURE OF CHEMICAL PRODUCTS; DENTIFRICE; COSMETICS, NAMELY, BODY CREAMS, COLD CREAMS, EYE CREAMS, HAIR REMOVING CREAMS, HAND CREAMS, NIGHT CREAMS, SKIN CLEANSING CREAMS, VANISHING CREAMS, BODY LOTIONS, FACIAL LOTIONS, HAIR LOTIONS, HAIR-WAVING LOTIONS, SKIN LOTIONS, BABY OIL, BATH OIL, BODY OIL, MASSAGE OIL, BABY POWDER, BATH POWDER, BODY POWDER, FACE POWDER, NON-MEDICATED FOOT POWDER, TALCUM POWDER, TALCUM GELS, HAIR GELS, SHOWER GELS, BATH GELS AND NON-MEDICATED BATH SALTS (U.S. CLS. 1, 4, 6, 50, 51 AND 52).

CLASS 4—LUBRICANTS AND FUELS

FOR ALL PURPOSE LUBRICANTS; INDUSTRIAL LUBRICANTS AND AUTOMOTIVE LUBRICANTS; DUST ABSORBING COMPOSITIONS FOR USE ON UNPAVED ROADS; DUST ABSORBING, WETTING AND BINDING COMPOSITIONS FOR USE IN THE FILTER INDUSTRY; GASOLINE AND DIESEL FUELS FOR MOTOR VEHICLES, SHIPS AND AIRCRAFT; INDUSTRIAL OILS; INDUSTRIAL GREASES FOR GENERAL INDUSTRIAL USE; FUEL FOR MOTOR VEHICLES; LIGHT MOTOR OILS; HEAVY MOTOR OILS; CANDLES; DIESEL FUEL; GASOLINE; LIGHTER FLUID; WICKS FOR OIL LAMPS; INDUSTRIAL WAXES; LEATHER PRESERVATIVE SHOE OIL; LEATHER PRESERVATIVE

CLASS 5—PHARMACEUTICALS

FOR PHARMACEUTICAL PREPARATIONS FOR THE TREATMENT OF PAIN; VETERINARY VACCINES FOR HORSES; FEMININE HYGIENE CLEANSING TOWELLETTES FOR MEDICAL AND PERSONAL HYGIENE PURPOSES; FOOD FOR MEDICALLY RESTRICTED DIETS; BABY FOOD; MEDICAL PLASTERS, SURGICAL DRESSINGS AND WOUND DRESSINGS; FILLINGS FOR TEETH; MEDICINAL PREPARATION FILLINGS FOR STENTS; DISINFECTANTS FOR MEDICAL INSTRUMENTS; RODENTICIDES; FUNGICIDES AND WEED KILLERS FOR AGRICULTURAL USE; PHARMACEUTICAL PREPARATIONS, NAMELY FOR THE TREATMENT OF CIRCULATORY, CARDIOVASCULAR, RESPIRATORY, ASTHMATIC, ALLERGY, BLOOD INFECTION, CENTRAL NERVOUS SYSTEM, OPHTHALMOLOGICAL, HORMONAL DISEASES AND DISORDERS; VETERINARY PHARMACEUTICAL PREPARATIONS FOR DOMESTIC ANIMALS AND CATTLE FOR THE TREATMENT OF CANCER THROUGH GENE AND CELL THERAPY (U.S. CLS. 6, 18, 44, 46, 51 AND 52).

CLASS 9—ELECTRICAL AND SCIENTIFIC APPARATUS

FOR DATA PROCESSING EQUIPMENT AND COMPUTER HARDWARE; PROTECTIVE CLOTHING, NAMELY, CLOTHING FOR SCREENING AGAINST HEAT, CHEMICAL RISKS, RADIATION AND FIRE; CALIBRATED GLASSWARE; PROTECTIVE CLOTHING, NAMELY GLOVES USED FOR PROTECTION FROM AN ACCIDENT; DUST PROOF MASKS; GASMASKS; PROTECTIVE WELDING MASKS; CERTAIN ELECTROTHERMIC TOOLS AND APPARATUS, NAMELY, ELECTRIC SOLDERING IRONS AND ELECTRIC FLAT IRONS; PROTRACTORS; ELECTRIC PUNCH CARD OFFICE MACHINES (U.S. CLS. 21, 23, 26, 36 AND 38).

CLASS 17—RUBBER GOODS

FOR ASBESTOS FABRIC FOR USE IN CABLE INSULATION; ASBESTOS FOR USE IN THE MANUFACTURE OF BRAKE LININGS; ASBESTOS PACKING FOR VALVES AND PISTONS; ASBESTOS SAFETY SCREENS FOR FIREMEN; LATEX FOR USE IN THE MANUFACTURE OF FOAM RUBBER, RUBBER GLOVES, INSULATING MATERIALS; MICA FOR USE IN THE MANUFACTURE OF INSULATING MATERIALS; RUBBER FOR INDUSTRIAL USE IN THE MANUFACTURE OF A WIDE VARIETY OF GOODS; RUBBER IN BARS FOR USE IN THE MANUFACTURE OF A WIDE VARIETY OF GOODS, RUBBER SEALANT FOR CAULKING AND ADHESIVE PURPOSES; GUTTA PERCHA, XANTHAM GUM, GUAR AND GUAR DERIVATIVES FOR USE IN THE MANUFACTURE OF A WIDE VARIETY OF GOODS; EXTRUDED PLASTIC IN GRANULAR FORM FOR GENERAL INDUSTRIAL USE FOR TRANSFORMATION BY MOLDING AND EXTRUSION; PLASTIC IN BARS, BLOCKS, PELLETS, RODS, SHEETS AND TUBES FOR GENERAL INDUSTRIAL USE; PACKING, STOPPING AND INSULATING MATERIALS, NAMELY, INSULATING PLASTER, WATER-PROOF PACKINGS, CAULKING MATERIALS, INSULATING TAPE AND BAND; FLEXIBLE PIPES NOT OF METAL; FILTERING MATERIALS IN THE NATURE OF MINERAL WOOL FOR USE IN THE MANUFACTURE OF FILTER MEDIA; SEMI-PROCESSED CELLULOSE ACETATE FOR USE IN CIGARETTE FILTERS, TEXTILE FIBRES; INSULATING TILES FOR COVERING EXISTING FLOORS (U.S. CLS. 1, 5, 12, 13, 35 AND 50).

CLASS 22—CORDAGE AND FIBERS

FOR ROPES, STRING; COMMERCIAL FISHING NETS, COMMERCIAL NETS; CAMOUFLAGE NETS FOR VISUAL AND RADAR USES; TENTS; SAILS; AWNINGS; CARBON OR GLASS FIBERS FOR TEXTILE USE; WADDING FOR PADDING, STUFFING AND FILTERING; RAW FIBROUS TEXTILE MATERIALS CONTAINING FIBERS, NAMELY, ACRYLIC FIBERS, COCONUT FIBERS, POLYESTER STUFFING FIBERS, RAFFIA FIBERS, RAMIE FIBERS, SISAL FIBERS, SYNTHETIC FIBERS, TEXTILE FIBERS AND YARN FIBERS (U.S. CLS. 1, 2, 7, 19, 22, 42 AND 50).

CLASS 23—YARNS AND THREADS

FOR YARNS AND THREADS FOR TEXTILE USE; SYNTHETIC THREADS AND YARDS FOR TEXTILE USE; POLYAMIDE YARNS AND THREADS; POLYESTER YARNS AND THREADS; ARTIFICIAL YARNS AND THREADS (U.S. CL. 43).

CLASS 24—FABRICS

FOR TEXTILES AND TEXTILE GOODS, NAMELY, FABRICS FOR THE MANUFACTURE OF A WIDE VARIETY OF GOODS; BED BLANKETS; TEXTILES USED AS LINING FOR CLOTHING; TEXTILE LININGS FOR GARMENTS; TEXTILE PLACE MATS; TEXTILE NAPKINS; PRINTED TEXTILE LABELS; TAPESTRIES OF TEXTILE; TEXTILE WALL HANGINGS; TEXTILES FABRICS FOR USE IN THE MANUFACTURE OF CLOTHING, FABRICS, CURTAINS, SHOES, LININGS FOR SHOES, FURNITURE, BED SPREADS AND TABLE CLOTHS NOT OF PAPER; FABRIC CURTAINS, NET CURTAINS (U.S. CLS. 42 AND 50).

CLASS 25—CLOTHING

FOR CLOTHING, NAMELY, SHIRTS, SHORT SLEEVE SHIRTS, SUITS, DRESSES, SKIRTS SHORTS, PAJAMAS, TROUSERS, TEE-SHIRTS, PULLOVERS, PARKAS, COATS, JACKETS, DRESSING GOWNS, GYM SUITS, JOGGING SUITS, PLAY SUITS, SKI SUITS, SNOW SUITS, SWEATSUITS, WARM UP SUITS, SWIMSUITS, GOLF SHIRTS, KNIT SHIRTS, POLO SHIRTS, SPORTS-HIRTS, SWEAT SHIRTS, FOUL WEATHER GEAR, LINGERIE, UNDERWEAR, HOSIERY, UNDERGARMENTS, BRAS, SLIPS, STOCKINGS, SOCKS, TIGHTS, PANTY-HOSE, BODY SHAPERS, BODY SUITS, CORSETS, BUSINESS SUITS, UNIFORMS, VESTS, OVERALLS, WAISTCOATS, CARDIGANS, GLOVES, FOOTWEAR AND HEADWEAR (U.S. CLS. 22 AND 39).

CLASS 27—FLOOR COVERINGS

FOR CARPETS; RUGS; MATS AND MATTING, NAMELY, DOORMATS OF TEXTILE, FLOOR MATS FOR VEHICLES AND ANTI-STATIC RUBBER MATS; LINOLEUM FOR USE ON FLOORS; HARD SURFACE COVERING FOR FLOORS; NON-TEXTILE TAPESTRY-STYLE WALL HANGINGS; FITTED CARPETS (U.S. CLS. 19, 20, 37, 42 AND 50).

CLASS 30—STAPLE FOODS

FOR YEASTS; VANILLIN EXTRACTS USED AS FLAVORING (U.S. CL. 46).

CLASS 34—SMOKERS' ARTICLES

FOR TOBACCO; MATCHES; ASHTRAYS NOT OF PRECIOUS METAL; FILTER TIPS FOR CIGARETTES, CIGARS AND PIPES; FILTER TIPPED CIGARETTES; CIGARS AND SMOKING PIPES; CIGARETTE ROLLING PAPERS; CIGARETTE LIGHTERS NOT FOR LAND VEHICLES OR OF PRECIOUS METAL; CIGARETTES CONTAINING TOBACCO SUBSTITUTES NOT FOR MEDICAL PURPOSES (U.S. CLS. 2, 8, 9 AND 17).

CLASS 35—ADVERTISING AND BUSINESS

FOR DISSEMINATION OF ADVERTISING MATTER; PREPARING ADVERTISEMENTS FOR OTHERS, NAMELY, UPDATING OF ADVERTISING DOCUMENTS; ADVERTISING CONSULTANCY TO INDUSTRIAL AND COMMERCIAL FIRMS REGARDING BUSINESS MANAGEMENT; ADVERTISING CONSULTANCY TO COMMERCIAL INFORMATION AGENCIES; BUSINESS CONSULTATION; CONDUCTING MARKET-ING STUDIES AND MARKET RESEARCH; DATA PROCESSING SERVICES; BUSINESS CONSULTATION, NAMELY, CONTRACTING FOR OPERATIONS OF ELECTRONIC COMMERCE; BUSINESS CONSULTATION REGARDING COMMERCIAL NEGOTIATIONS AND TRANSACTIONS ON BEHALF OF THIRD PARTIES; BUSINESS MARKETING CONSULTING SERVICES REGARDING ONLINE PURCHASE AND SALES OFFERS, BUSINESS CONSULTATION SERVICES, NAMELY, TECHNICAL CONSULTATION AND ADVICE IN THE FIELD OF ONLINE RETAIL SERVICES (U.S. CLS. 100, 101 AND 102).

CLASS 36—INSURANCE AND FINANCIAL

FOR PROVIDING FINANCIAL INFORMATION TO EMPLOYEES AND RETIRED EMPLOYEE CORPORATE SHAREHOLDERS, IN PARTICULAR, FINANCIAL INFORMATION WITHIN THE FRAMEWORK OF REGULATIONS CONCERNING LISTED COMPANIES (U.S. CLS. 100, 101 AND 102).

CLASS 37—CONSTRUCTION AND REPAIR

FOR INFORMATION AND ADVISORY SERVICES RELATING TO CONSTRUCTION OF WATER PURIFICATION STATIONS; LEATHER CLEANING AND REPAIR; ELECTRIC APPLIANCE INSTALLATION AND REPAIR; WAREHOUSE CONSTRUCTION AND REPAIR; BUILDING SEALING; INSTALLATION, MAINTENANCE AND REPAIR OF COMPUTER HARDWARE (U.S. CLS. 100, 103 AND 106).

CLASS 38—COMMUNICATION

FOR ELECTRONIC TRANSMISSION OF DATA AND DOCUMENTS VIA COMPUTER TERMINALS; TELECOMMUNICATION BY TELEGRAMS, TELEPHONE AND FAX; RADIO BROADCASTING; COMPUTER AIDED TRANSMISSION OF DATA, MESSAGES AND IMAGES NOTABLY FOR THE GLOBAL COMPUTER NETWORK, SUCH AS INTERNET OR FOR RESTRICTED ACCESS NETWORK, SUCH AS INTRANET; ELECTRONIC TRANSMISSION OF DATA FROM DATABASES; ELECTRONIC MAIL; TRANSMISSION OF INFORMATION AND DATA BY ELECTRONIC MAIL; SATELLITE TRANSMISSION OF DATA, SOUND AND IMAGES; PROVIDING MULTIPLE-USER ACCESS TO DATABASES AND SERVERS OF DATABASES (U.S. CLS. 100, 101 AND 104).

CLASS 39—TRANSPORTATION AND STORAGE

FOR PUBLIC UTILITY SERVICES IN THE NATURE OF TRANSPORT, DELIVERY AND STORAGE OF ELECTRICITY, STEAM, NATURAL GAS, COAL, FUEL OIL AND OTHER FUELS (U.S. CLS. 100 AND 105).

CLASS 40—MATERIAL TREATMENT

FOR WASTE TREATMENT, NAMELY, TREATMENT OF MANURE; WATER TREATMENT SERVICES, NAMELY, REMOVAL OF BACTERIA, VIRUSES, SUSPENDED SOLIDS AND ANY OTHER CHEMICALS, PHARMACEUTICALS AND BIOLOGICAL COMPOUNDS FROM WATER; WATER TREATMENT SERVICES, NAMELY, PURIFICATION, EXTRACTION, CONCENTRATION, FILTRATION AND RECYCLING EFFLUENT TREATMENT; BACTERIA REMOVAL TREATMENT OF FOOD; RECYCLING OF MATERIALS, NAMELY, COLLECTION AND OPTIMIZATION OF CATALYSTS; RECYCLING OF INDUSTRIAL WASTES; PROVIDING WASTE MATERIAL TREATMENT INFORMATION; PA-

PER TREATING; WASTE TREATMENT OF CHEMICAL PRODUCTS; ENVIRONMENTAL REMEDIATION SERVICES, NAMELY, POLLUTED SOILS, AND GROUND WATER TREATMENT SERVICES; COLLECTION AND RECYCLING OF CATALYSTS; TEXTILE TREATMENT SERVICES OF TEXTILE FIBERS AND YARNS, NAMELY, TRANSFORMATION AND TEXTURATION; BACTERIA REMOVAL TREATMENT OF FOOD AND DRINKS; FABRICS WATERPROOFING AND FIRE-PROOFING; PARTS MOLDING PROCESSING AND TREATMENT OF ENGINEERING PLASTICS, NAMELY, MOLDING, TRANSFORMATION AND EXTRUSION; PRODUCTION OF GAS, OIL AND ENERGY (U.S. CLS. 100, 103 AND 106).

CLASS 41—EDUCATION AND ENTERTAINMENT

FOR EDUCATIONAL SERVICES, NAMELY, CONDUCTING CLASSES AND SEMINARS IN THE FIELD OF ELECTRONIC COMMERCE; TRAINING SERVICES IN THE FIELD OF CONSCIOUSNESS-RAISING AND BUSINESS MANAGEMENT AND TRAINING IN THE USE AND OPERATION OF THE INTERNET COMPUTER NETWORKS; EDUCATIONAL SERVICES, NAMELY, ORGANIZING AND CONDUCTING LECTURES, SYMPOSIUMS, CONFERENCES, SEMINARS, FORUMS, EXHIBITIONS, SHOWS AND FAIRS FOR EDUCATIONAL PURPOSES IN THE FIELD OF ELECTRONIC AND COMPUTER COMMUNICATION PROCESS; DEVELOPMENT AND DISSEMINATION OF EDUCATIONAL MATERIALS OF OTHERS IN THE FIELD OF COMPUTER INTRANET AND THE INTERNET; PUBLICATION OF BOOKS, BROCHURES AND MAGAZINES IN MULTIMEDIA FORMATS (U.S. CLS. 100, 101 AND 107).

CLASS 42—SCIENTIFIC, COMPUTER AND LEGAL SERVICES

FOR COMPUTER SERVICES, NAMELY, PROVIDING SEARCH ENGINES FOR OBTAINING DATA AND INFORMATION ON A GLOBAL COMPUTER NETWORK; TECHNICAL CONSULTATION AND ADVICE IN THE FIELD OF DESIGNING WEB SITES ON COMPUTER NETWORKS TO MAKE DATA AVAILABLE ONLINE; TECHNOLOGY CONSULTATION AND ADVICE IN THE FIELD OF ONLINE RETAIL SERVICES; ONLINE DATABASE DEVELOPMENT SERVICES; COMPUTER SOFTWARE DESIGN FOR OTHERS AND UPDATING OF COMPUTER SOFTWARE FOR OTHERS, ALL FOR USE IN TELEMATIC, TELEPROCESSING AND MULTIMEDIA SYSTEMS; LEGAL RESEARCH UTILIZING LEGAL AND COMMERCIAL DATABASES ONLINE; DEVELOPMENT OF COMPUTER HARDWARE SYSTEMS FOR USE IN ONLINE RETAIL TRANSACTIONS ON INTRANET COMPUTER NETWORKS AND THE INTERNET; ENGINEERING SERVICES AND RESEARCH; TECHNICAL STUDIES IN THE FIELD OF ENGINEERING; TECHNICAL RESEARCH, CONSULTATION AND ADVICE IN THE FIELDS OF CONSTRUCTION, SAFETY, BUILDING, SECURITY, CORROSION, AUTOMATION, ELECTRICITY, INSTRUMENTATION, CIVIL ENGINEERING, MAINTENANCE, ONLINE SERVICES AND MODELING ELECTRICITY; COMPUTER PROGRAMMING FOR OTHERS; SCIENTIFIC RESEARCH AND CHEMICAL INDUSTRY SCIENTIFIC RESEARCH (U.S. CLS. 100 AND 101).

FRED MANDIR, EXAMINING ATTORNEY

SN 76-467,578. ALLIED MOTION TECHNOLOGIES, INC., LITTLETON, CO. FILED 11-15-2002.

ALLIED MOTION

NO CLAIM IS MADE TO THE EXCLUSIVE RIGHT TO USE "MOTION", APART FROM THE MARK AS SHOWN.

CLASS 7—MACHINERY

FOR MOTORS, NAMELY, BRUSH AND BRUSHLESS DC AND AC MOTORS (U.S. CLS. 13, 19, 21, 23, 31, 34 AND 35).

CLASS 9—ELECTRICAL AND SCIENTIFIC APPARATUS

FOR ELECTRICAL ENCODERS, CONTROLLERS AND AMPLIFIERS; ELECTRO-MAGNETIC PRODUCTS, NAMELY DRIVE ELECTRONICS AND ELECTRONIC CONTROLS FOR ELECTRIC MOTORS; SINE/COSINE ENCODERS AND DIGITAL ELECTRONIC ENCODERS (U.S. CLS. 21, 23, 26, 36 AND 38).

CLASS 42—SCIENTIFIC, COMPUTER AND LEGAL SERVICES

FOR RESEARCH, DESIGN AND APPLICATION SERVICES AND TECHNICAL RESEARCH FOR OTHERS IN THE FIELD OF ELECTRO-MAGNETIC MOTION CONTROL. DESIGN OF DRIVE ELECTRONICS, CONTROLLERS AND AMPLIFIERS (U.S. CLS. 100 AND 101).

DAVID H. STINE, EXAMINING ATTORNEY

SN 76-470,031. CUTCOST.COM LIMITED, BLOOMSBURY LONDON WC1H 0QA, UNITED KINGDOM, FILED 11-25-2002.

cutcost.com

OWNER OF ERPN CMNTY TM OFC REG. NO. 002721470, DATED 5-24-2002, EXPIRES 5-24-2012.

NO CLAIM IS MADE TO THE EXCLUSIVE RIGHT TO USE "CUT COST.COM", APART FROM THE MARK AS SHOWN.

CLASS 16—PAPER GOODS AND PRINTED MATTER

FOR PUBLICATIONS AND PRINTED MATTER, NAMELY, INFORMATIONAL BROCHURES, CATALOGS AND PRINTED LISTS FEATURING OFFICE REQUISITES (U.S. CLS. 2, 5, 22, 23, 29, 37, 38 AND 50).

CLASS 35—ADVERTISING AND BUSINESS

FOR ON-LINE SERVICES, NAMELY, ORDERING AND INVENTORY MONITORING OF OFFICE REQUISITES FOR OTHERS; AND ARRANGING FOR THE DELIVERY OF OFFICE REQUISITES FOR OTHERS (U.S. CLS. 100, 101 AND 102).

MARTHA FROMM, EXAMINING ATTORNEY

SN 76-476,411. TRIVIUM, 75004 PARIS, FRANCE, FILED 12-17-2002.

SEE-K

PRIORITY CLAIMED UNDER SEC. 44(D) ON FRANCE APPLICATION NO. 023169537, FILED 6-17-2002, REG. NO. 023169537, DATED 6-17-2002, EXPIRES 6-17-2012.

THE STIPPLING IS A FEATURE OF THE MARK AND IS NOT MEANT TO INDICATE COLOR.

SN 76-478,472. BUDDHIST COMPASSION RELIEF TZU-CHI FOUNDATION, HUALIEN COUNTY, TAIWAN, FILED 12-17-2002.

CLASS 9—ELECTRICAL AND SCIENTIFIC APPARATUS

FOR APPARATUS FOR THE RECORDING, TRANSMISSION AND REPRODUCTION OF DATA, NAMELY TAPE PLAYERS AND RECORDERS, TELEPHONES, SCANNERS; SOFTWARE AUTOMATING THE BACKUP OF COMPUTER DATA; BACK UP DRIVES FOR COMPUTERS; MAGNETIC RECORDING MEDIA, NAMELY BLANK MAGNETIC COMPUTER TAPES, BLANK MAGNETIC DATA CARRIERS, BLANK MAGNETO-OPTIC DATA CARRIERS; CALCULATORS; COMPUTER HARDWARE; COMPUTERS; SOFTWARE FOR USE IN ACCESSING A DATABASE MANAGEMENT SYSTEM; SOFTWARE, NAMELY A DATABASE MANAGEMENT SYSTEM COMPRISED OF COMPUTER SOFTWARE FOR USE IN DATA ANALYSIS APPLICATIONS IN THE FIELDS OF BUSINESS, SCIENCE, TECHNOLOGY, COMMERCE, EDUCATION AND PERSONAL COMPUTING (U.S. CLS. 21, 23, 26, 36 AND 38).

CLASS 38—COMMUNICATION

FOR TELECOMMUNICATIONS SERVICES, NAMELY PROVIDING TELECOMMUNICATION CONNECTIONS TO AREA NETWORKS AND A GLOBAL COMPUTER NETWORK; PROVIDING MULTI-USER ACCESS TO A GLOBAL COMPUTER INFORMATION NETWORK; TELECOMMUNICATION SERVICES, NAMELY, LOCAL, LONG DISTANCE AND INTERNATIONAL TRANSMISSION OF VOICE, DATA, GRAPHICS BY MEANS OF TELEPHONE, TELEGRAPHIC, CABLE, SATELLITE TRANSMISSIONS, AREA NETWORKS AND GLOBAL COMPUTER NETWORKS; ELECTRONIC TRANSMISSION OF DATA AND DOCUMENTS VIA COMPUTER TERMINALS; ELECTRONIC TRANSMISSION OF DATA, ELECTRONIC DOCUMENTS, DATABASES, GRAPHICS AUDIO AND AUDIOVISUAL INFORMATION ACCESSIBLE BY ACCESS CODE BY COMPUTER AND TELECOMMUNICATION NETWORKS, INCLUDING THE INTERNET; ELECTRONIC MAIL SERVICE; ELECTRONIC BROADCAST OF DATA THROUGH WORLD WIDE COMMUNICATION NETWORKS, INCLUDING THE INTERNET (U.S. CLS. 100, 101 AND 104).

CLASS 40—MATERIAL TREATMENT

FOR DOCUMENT DATA TRANSFER AND PHYSICAL CONVERSION SERVICES FROM ONE MEDIA TO ANOTHER (U.S. CLS. 100, 103 AND 106).

CLASS 42—SCIENTIFIC, COMPUTER AND LEGAL SERVICES

FOR RESEARCH AND DEVELOPMENT OF NEW PRODUCTS FOR THIRD PARTIES; TECHNICAL RESEARCH FOR OTHERS IN THE FIELDS OF CREATION, MANAGEMENT, UPDATE OR USE OF DATABASES; TECHNICAL RESEARCH FOR OTHERS IN THE FIELDS OF CREATION, MANAGEMENT, UPDATE OR USE OF SOFTWARE FOR ANALYSIS OF TEXTUAL DIGITAL INFORMATION OBTAINED ONLINE OR OFFLINE, STRUCTURED IN A DATABASE OR NOT; COMPUTER PROGRAMMING FOR OTHERS; SOFTWARE DESIGN FOR OTHERS; CONSULTING AND ASSISTANCE SERVICES IN THE FIELD OF DESIGN, SELECTION, DEVELOPMENT, IMPLEMENTATION AND USE OF COMPUTER HARDWARE AND SOFTWARE SYSTEMS FOR OTHERS; PROVIDING AN ON-LINE COMPUTER DATABASE IN THE FIELD OF ANALYSIS OF TEXTUAL DIGITAL INFORMATION OBTAINED ONLINE OR OFFLINE, STRUCTURED IN A DATABASE OR NOT (U.S. CLS. 100 AND 101).

LESLEY LAMOTHE, EXAMINING ATTORNEY

THE ENGLISH TRANSLATION OF "TAI-AI" IS "GREAT LOVE".

CLASS 36—INSURANCE AND FINANCIAL

FOR CHARITABLE FUND RAISING SERVICES IN THE NATURE OF GLOBAL MISSION CHARITY, COLLECTIONS AND ARRANGING OF FUNDS FOR OVERSEAS AID PROJECTS (U.S. CLS. 100, 101 AND 102).

CLASS 41—EDUCATION AND ENTERTAINMENT

FOR ENTERTAINMENT SERVICES, NAMELY, PROVIDING A WEB SITE FEATURING MUSICAL PERFORMANCES, MUSICAL VIDEOS, RELATED FILM CLIPS, PHOTOGRAPHS, AND OTHER MULTIMEDIA MATERIALS; ENTERTAINMENT SERVICES, NAMELY PROVIDING PRERECORDED MUSIC, INFORMATION IN THE FIELD OF MUSIC, COMMENTARY AND ARTICLES ABOUT MUSIC, ALL ONLINE VIA A GLOBAL COMPUTER NETWORK; CHARITABLE SERVICES, NAMELY, PROVIDING BOOKS AND TOYS TO NEEDY CHILDREN FOR DISASTER RELIEF (U.S. CLS. 100, 101 AND 107).

CLASS 44—MEDICAL, BEAUTY AND AGRICULTURAL SERVICES

FOR NURSING HOMES; MEDICAL SERVICES; HOSPITAL SERVICES AND PROVIDING MEDICAL INFORMATION REGARDING BONE MARROW DATA CENTERS AND USE THEREOF FOR MEDICAL PURPOSES AND INTERNATIONAL RELIEF (U.S. CLS. 100 AND 101).

ROBERT LORENZO, EXAMINING ATTORNEY

SN 76-487,413. WANG, TERRY SHILIANG, NORTH VANCOUVER, BRITISH COLUMBIA, CANADA, FILED 2-3-2003.

SAVE ON CARTRIDGE PLUS

PRIORITY CLAIMED UNDER SEC. 44(D) ON CANADA APPLICATION NO. 1148857, FILED 8-2-2002, REG. NO. TMA600452, DATED 1-23-2004, EXPIRES 1-23-2019.

NO CLAIM IS MADE TO THE EXCLUSIVE RIGHT TO USE "CARTRIDGE", APART FROM THE MARK AS SHOWN.

CLASS 2—PAINTS

FOR INK JET AND LASER JET CARTRIDGES (U.S. CLS. 6, 11 AND 16).

CLASS 35—ADVERTISING AND BUSINESS

FOR RETAIL STORE SERVICES FEATURING NEW INK JET AND LASER JET CARTRIDGES AND COMPUTER PAPER; NEW AND USED COMPUTERS, PRINTERS, COPIERS AND PARTS FOR COMPUTERS, PRINTERS AND COPIERS (U.S. CLS. 100, 101 AND 102).

CLASS 37—CONSTRUCTION AND REPAIR

FOR REFILLING INK JET CARTRIDGES; RE-MANUFACTURING LASER JET CARTRIDGES; REPAIRING PRINTERS, COPIERS AND COMPUTERS (U.S. CLS. 100, 103 AND 106).

FIRST USE 3-1-2001; IN COMMERCE 1-20-2003.
KAREN K. BUSH, EXAMINING ATTORNEY

SN 76-489,415. Q.E.P. CO., INC., BOCA RATON, FL. FILED 2-12-2003.

WOODSOLUTIONS**CLASS 8—HAND TOOLS**

FOR HAND TOOLS, NAMELY HAND SAWS, SCISSORS, CHISELS, BLADES, SANDING BLOCKS AND WOOD KNIVES FOR INSTALLING, SHAPING, CUTTING, POLISHING, SANDING, REFINISHING AND REPAIRING WOOD FLOORS, CEILINGS AND WALLS, AND HAND TOOL PROJECT KITS, NAMELY, PROJECT KITS AND PACKAGES CONTAINING AN ASSORTMENT OF PRODUCTS FOR INSTALLING, SHAPING, CUTTING, POLISHING, SANDING, REFINISHING AND REPAIRING WOOD FLOORS, CEILINGS AND WALLS, NAMELY TOOLS, CLEANING MATERIALS, WOOD STRIPS, WOOD TILES, CAULKS AND GROUTS, ADHESIVES, HARDWARE AND WRITTEN INSTRUCTIONS, THE FOREGOING SOLD AS A UNIT (U.S. CLS. 23, 28 AND 44).

CLASS 17—RUBBER GOODS

FOR ADHESIVES, NAMELY, CAULK AND GROUT FOR INSTALLING, REFINISHING AND REPAIRING WOOD FLOORS, CEILINGS AND WALLS (U.S. CLS. 1, 5, 12, 13, 35 AND 50).

CLASS 19—NON-METALLIC BUILDING MATERIALS

FOR WOOD FLOORING, CEILING AND WALL PRODUCTS, NAMELY, WOOD STRIPS AND WOOD TILES (U.S. CLS. 1, 12, 33 AND 50).

CLASS 21—HOUSEWARES AND GLASS

FOR CLEANING MATERIALS FOR WOOD FLOORS, CEILINGS AND WALLS, NAMELY, CLEANING TOWELS AND RAGS, CLEANING TOWELS AND RAGS TREATED WITH CLEANING SOLUTIONS, BRUSHES, BROOMS AND MOPS (U.S. CLS. 2, 13, 23, 29, 30, 33, 40 AND 50).

BRIAN NEVILLE, EXAMINING ATTORNEY

SN 76-491,076. ISRAEL AIRCRAFT INDUSTRIES LTD., LOD 701000, ISRAEL, FILED 2-13-2003.

MALAT

PRIORITY CLAIMED UNDER SEC. 44(D) ON ISRAEL APPLICATION NO. 158848, FILED 8-15-2002, REG. NO. 158848, DATED 7-4-2004, EXPIRES 8-15-2009.

PRIORITY CLAIMED UNDER SEC. 44(D) ON ISRAEL APPLICATION NO. 158847, FILED 8-15-2002, REG. NO. 158847, DATED 7-4-2004, EXPIRES 8-15-2009.

PRIORITY CLAIMED UNDER SEC. 44(D) ON ISRAEL APPLICATION NO. 158846, FILED 8-15-2002, REG. NO. 158846, DATED 7-4-2004, EXPIRES 8-15-2009.

CLASS 9—ELECTRICAL AND SCIENTIFIC APPARATUS

FOR UNMANNED AERIAL VEHICLE (UAV) COMPONENTS, NAMELY, SENSORS, DOWNSIZED, PORTABLE, PASSIVE AND ACTIVE REMOTE GROUND CONTROL TERMINALS; DATA LINKS COMPRISED OF GROUND CONTROL TERMINALS AND AIRBORNE DATA TERMINALS THAT ALLOW THE UAV TO BE CONTROLLED BY THE GROUND OPERATORS AND FURTHER ALLOW DATA TO BE TRANSMITTED FROM THE UAV TO THE GROUND OPERATORS; AND TRAINING SIMULATORS, NAMELY, ONE SYSTEM INTEGRATING SOFTWARE INTERFACE AND HARDWARE COMPONENTS TO SIMULATE UAV (U.S. CLS. 21, 23, 26, 36 AND 38).

FIRST USE 9-1-1989; IN COMMERCE 9-1-1989.

CLASS 12—VEHICLES

FOR UNMANNED AERIAL VEHICLES (UAV); UAV SYSTEMS COMPOSED OF UAVS AND COMPONENT PARTS, NAMELY, SENSORS, DOWNSIZED, PORTABLE, PASSIVE AND ACTIVE REMOTE GROUND CONTROL TERMINALS, DATA LINKS COMPRISED OF GROUND CONTROL TERMINALS AND AIRBORNE DATA TERMINALS THAT ALLOW THE UAV TO BE CONTROLLED BY THE GROUND OPERATORS AND FURTHER ALLOW DATA TO BE TRANSMITTED FROM THE UAV TO THE GROUND OPERATORS (U.S. CLS. 19, 21, 23, 31, 35 AND 44).

FIRST USE 9-1-1989; IN COMMERCE 9-1-1989.

CLASS 37—CONSTRUCTION AND REPAIR

FOR REPAIR, MAINTENANCE AND SERVICING OF UNMANNED AERIAL VEHICLES (UAV) COMPONENTS, NAMELY, FLIGHT CONTROLLING PARTS, SENSORS, DOWNSIZED, PORTABLE, PASSIVE AND ACTIVE REMOTE GROUND CONTROL TERMINALS; DATA LINKS COMPRISED OF GROUND CONTROL TERMINALS AND AIRBORNE DATA TERMINALS THAT ALLOW THE UAV TO BE CONTROLLED BY THE GROUND OPERATORS AND FURTHER ALLOW DATA TO BE TRANSMITTED FROM THE UAV TO THE GROUND OPERATORS; AND TRAINING SIMULATORS, NAMELY, ONE SYSTEM INTEGRATING SOFTWARE INTERFACE AND HARDWARE COMPONENTS TO SIMULATE UAV FLIGHT (U.S. CLS. 100, 103 AND 106).

FIRST USE 9-1-1989; IN COMMERCE 9-1-1989.
DAWN FELDMAN, EXAMINING ATTORNEY

SN 76-511,390. HNF FOODSERVICE, INC., NAPA, CA. FILED 5-5-2003.



SEC. 2(F).

CLASS 29—MEATS AND PROCESSED FOODS

FOR OLIVE OIL, FLAVORED OLIVE OIL, CANOLA OIL, SAFFLOWER OIL, AND OIL BLENDS (U.S. CL. 46).
FIRST USE 1-1-1997; IN COMMERCE 1-1-1997.

CLASS 30—STAPLE FOODS

FOR VINEGAR (U.S. CL. 46).
FIRST USE 1-1-1997; IN COMMERCE 1-1-1997.
STEVEN R. FINE, EXAMINING ATTORNEY

SN 76-511,391. HNF FOODSERVICE, INC., NAPA, CA. FILED 5-5-2003.

SN 76-512,987. AUTOMATED DOCUMENT EXCHANGE SERVICES INC., CHICAGO, IL. FILED 5-9-2003.



CLASS 29—MEATS AND PROCESSED FOODS

FOR OLIVE OIL, FLAVORED OLIVE OIL, CANOLA OIL, SAFFLOWER OIL, AND OIL BLENDS (U.S. CL. 46).
FIRST USE 1-1-1997; IN COMMERCE 1-1-1997.

CLASS 30—STAPLE FOODS

FOR VINEGAR (U.S. CL. 46).
FIRST USE 1-1-1997; IN COMMERCE 1-1-1997.
STEVEN R. FINE, EXAMINING ATTORNEY

SN 76-511,405. ENZO BIOCHEM, INC., NEW YORK, NY.
FILED 5-2-2003.

CHIP IN A WELL

CLASS 1—CHEMICALS

FOR SYSTEM, NAMELY, NUCLEIC ACID, PROTEIN OR POLYSACCHARIDE ARRAYS LOCATED IN ONE OR MORE DEPRESSIONS OR INDENTATION FOR QUANTIFICATION OF THE BINDING OF INDIVIDUAL COMPONENTS FROM A COMPLEX MIXTURE, FOR SCIENTIFIC OR RESEARCH USE (U.S. CLS. 1, 5, 6, 10, 26 AND 46).
FIRST USE 4-29-2003; IN COMMERCE 4-29-2003.

CLASS 5—PHARMACEUTICALS

FOR SYSTEM, NAMELY, NUCLEIC ACID, PROTEIN OR POLYSACCHARIDE ARRAYS LOCATED IN ONE OR MORE DEPRESSIONS OR INDENTATION FOR QUANTIFICATION OF THE BINDING OF INDIVIDUAL COMPONENTS FROM A COMPLEX MIXTURE, FOR CLINICAL AND MEDICAL USE (U.S. CLS. 6, 18, 44, 46, 51 AND 52).
FIRST USE 4-29-2003; IN COMMERCE 4-29-2003.
DOMINICK J. SALEMI, EXAMINING ATTORNEY



CLASS 9—ELECTRICAL AND SCIENTIFIC APPARATUS

FOR ON-LINE, DOWNLOADABLE COMPUTER SOFTWARE TO CONVERT DATA INTO DIGITAL FORMAT, AND UPLOAD ELECTRONIC FILES, FOR ONLINE WAREHOUSING, INDEXING AND DISTRIBUTION IN THE FIELD OF CHEMICALS, PHARMACEUTICALS, TRANSPORTATION, HEALTHCARE AND MANUFACTURING (U.S. CLS. 21, 23, 26, 36 AND 38).
FIRST USE 9-0-2002; IN COMMERCE 9-0-2002.

CLASS 35—ADVERTISING AND BUSINESS

FOR COMMERCIAL AND INDUSTRIAL RECORDS MANAGEMENT ASSISTANCE FOR UPDATING, WAREHOUSING AND DISTRIBUTING DIGITAL DATA VIA A GLOBAL COMPUTER NETWORK IN THE FIELD OF CHEMICALS, PHARMACEUTICALS, TRANSPORTATION, HEALTHCARE AND MANUFACTURING (U.S. CLS. 100, 101 AND 102).
FIRST USE 9-0-2002; IN COMMERCE 9-0-2002.

CLASS 42—SCIENTIFIC, COMPUTER AND LEGAL SERVICES

FOR PROVIDING TEMPORARY USE OF ON-LINE, NON-DOWNLOADABLE SOFTWARE FOR WAREHOUSING, INDEXING, AND DISTRIBUTION OF DIGITAL DATA IN THE FIELD OF CHEMICALS, PHARMACEUTICALS, TRANSPORTATION, HEALTHCARE AND MANUFACTURING (U.S. CLS. 100 AND 101).
FIRST USE 9-0-2002; IN COMMERCE 9-0-2002.
MICHAEL WEBSTER, EXAMINING ATTORNEY

SN 76-513,221. FNF INTELLECTUAL PROPERTY HOLDINGS, INC., JACKSONVILLE, FL. FILED 5-9-2003.

FIDELITY NATIONAL INFORMATION SOLUTIONS

NO CLAIM IS MADE TO THE EXCLUSIVE RIGHT TO USE INFORMATION SOLUTIONS, APART FROM THE MARK AS SHOWN,
SEC. 2(F) AS TO "NATIONAL".

CLASS 35—ADVERTISING AND BUSINESS

FOR REAL ESTATE SERVICES, NAMELY, PROPERTY TAX REPORTING SERVICES, DELINQUENCY DATA PROCESSING SERVICES, PUBLIC RECORDS DATA SERVICES, AGENT PRODUCTIVITY SERVICES, BUSINESS OFFICE MANAGEMENT SERVICES AND TRANSACTIONS TRACKING, MONITORING AND MANAGEMENT SERVICES; ALL OF THE AFOREMENTIONED PROVIDED PERSONALLY AND/OR VIA TELEPHONE, CABLE, MAIL, COMPUTER APPLICATION SOFTWARE, THE GLOBAL COMPUTER NETWORK AND/OR OTHER SIMILAR MEANS OF COMMUNICATION (U.S. CLS. 100, 101 AND 102).
FIRST USE 7-31-2001; IN COMMERCE 7-31-2001.

CLASS 36—INSURANCE AND FINANCIAL

FOR REAL ESTATE SERVICES, NAMELY, CREDIT REPORTING SERVICES, EVALUATION AND APPRAISAL SERVICES, PROPERTY RISK INFORMATION SERVICES, REAL ESTATE SERVICES IN THE NATURE OF AN ONLINE SEARCHABLE DATABASE OF PROPERTY LISTINGS; ALL OF THE AFOREMENTIONED PROVIDED PERSONALLY AND/OR VIA TELEPHONE, CABLE, MAIL, COMPUTER APPLICATION SOFTWARE, THE GLOBAL COMPUTER NETWORK AND/OR OTHER SIMILAR MEANS OF COMMUNICATION; TAX DISBURSEMENT PROCESSING SERVICES (U.S. CLS. 100, 101 AND 102).

FIRST USE 7-31-2001; IN COMMERCE 7-31-2001.

CLASS 40—MATERIAL TREATMENT

FOR PRINTING SERVICES (U.S. CLS. 100, 103 AND 106).

FIRST USE 7-31-2001; IN COMMERCE 7-31-2001.

CLASS 42—SCIENTIFIC, COMPUTER AND LEGAL SERVICES

FOR LITIGATION SUPPORT SERVICES; AND APPLICATION SERVICE PROVIDER SERVICES, NAMELY DEVELOPING AND PROVIDING COMPUTER SOFTWARE PROGRAMS AND HOSTING SUCH SOFTWARE PROGRAMS ONLINE FOR OTHERS IN THE REAL ESTATE INDUSTRY; FLOOD, ENVIRONMENTAL AND NATURAL HAZARD COMPLIANCE AND DISCLOSURE SERVICES (U.S. CLS. 100 AND 101).

FIRST USE 7-31-2001; IN COMMERCE 7-31-2001.

TRICIA THOMPSON, EXAMINING ATTORNEY

SN 76-514,314. FINMECCANICA S.P.A., I-00195 ROMA, ITALY, FILED 5-15-2003.

 **oto melara**

PRIORITY CLAIMED UNDER SEC. 44(D) ON ITALY APPLICATION NO. RM2003C00133, FILED 3-10-2003, REG. NO. 00895346, DATED 6-5-2003, EXPIRES 3-10-2013.

OTO MELARA DOES NOT IDENTIFY A PARTICULAR LIVING INDIVIDUAL.

CLASS 7—MACHINERY

FOR TURBOGENERATORS; HYDRAULIC TURBINES; POWER MACHINES AND IMPLEMENTS FOR SHIPS AND AIRCRAFTS, NAMELY, AIRCRAFT AND SHIP ENGINES; POWER TRANSMISSION GEARS AND BELTS FOR SHIPS AND AIRCRAFTS; MACHINE ELEMENTS, NAMELY, FANS FOR MACHINE ENGINES, INTERNAL COMBUSTION ENGINES FOR MACHINE OPERATION AND REPLACEMENT PARTS THEREFOR, MACHINE OPERATED PLATFORMS CAPABLE OF ELEVATION ABOVE GROUND LEVEL AND USED FOR STORAGE, HOODS, POWER TRANSMISSION GEARS AND BELTS FOR MACHINES; BRAKING DEVICES FOR MACHINES, NAMELY, BRAKE LININGS AND DISCS; ELECTRIC GENERATORS AND ELECTRIC MOTORS FOR MACHINES; INDUSTRIAL ROBOTS (U.S. CLS. 13, 19, 21, 23, 31, 34 AND 35).

CLASS 9—ELECTRICAL AND SCIENTIFIC APPARATUS

FOR RADAR; RADAR DETECTORS; SAFETY EQUIPMENT, NAMELY, ELECTROMECHANICAL AND ELECTRONIC SIGNAL LIGHTS; SWITCH CONTROL BOXES; SAFETY EQUIPMENT, NAMELY, COLORED LIGHT SIGNALS; RADAR AND LABORATORY ROBOTS FOR REMOTE MAINTENANCE OPERATIONS; HIGH DEXTERITY LABORATORY ROBOTS FOR APPLICATIONS IN THE NUCLEAR, AIRSPACE, CIVIL DEFENSE, MARINE AND REMOTE OR HAZARDOUS ENVIRONMENT SECTORS AND FOR USE IN THE TRANSFER AND INSPECTING OF REMOTE CONTROLLED MOBILE PLATFORMS; SATELLITES, COMPUTER DATABASE MANAGEMENT AND MODELING SOFTWARE IN THE FIELD OF MILITARY DEFENSE AND MEASUREMENT; RADARS FOR EARTH OBSERVATION, ANALOGUE, DIGITAL AND OPTOELECTRONIC SYSTEMS FOR FIRE CONTROL, AIRBORNE SYSTEMS AND OF LIGHT AND MEDIUM ANTI-AIRCRAFT GUNS FOR BARREL OR TURRET MOUNTING CONSISTING OF AIMING OPTICS, LASER RANGE FINDERS, CONTROL ELECTRONICS, DRIVE SERVOS, AND NIGHT SIGHT SYSTEMS, NAMELY, OPTOELECTRONIC FIRE CONTROL SYSTEMS FOR BATTLE TANKS CONSISTING OF AIMING OPTICS, LASER RANGE FINDERS AND DIGITAL COMPUTERS; AUTOMATION SYSTEMS FOR FIELD ARTILLERY, CONSISTING OF COMMAND CONTROL AND COMMUNICATION APPARATUS FOR OPERATION AT GROUP AND BATTERY LEVEL; INFRARED NIGHT VISION APPARATUS FOR OBSERVATION AT NIGHT OR IN LIMITED VISIBILITY CONDITIONS SUCH AS SMOKE, DUST, OR CAMOUFLAGE ARTILLERY FIRE CONTROL SYSTEMS FOR LOCAL CONTROL OF GUNS AND ANTI-AIRCRAFT, COMPRISING OPTICAL SIGHTS, DATA INTRODUCTION PANELS, ON-BOARD COMPUTERS AND RADAR STATIONS; COMPUTER SIMULATORS FOR USE IN AIRCRAFT, NAVAL, AND TRAINING SIMULATION; COMPUTERS TO COMPUTE MORTAR-FIRING DATA AND PRINTER-RECORDERS USED WITH SUCH COMPUTERS; ELECTRO-OPTIC MICROSENSORS FOR MILITARY USE IN AIDING NAVIGATION, OBSERVATION, AND AIMING FOR AIRBORNE SURVEILLANCE, AIRBORNE ENVIRONMENTAL SENSING AND MONITORING; PANORAMIC PERISCOPE LASER SIGHTS FOR TANKS; BALLISTIC DIGITAL MICROPROCESSORS FOR FIRE CONTROLS; GUNNER, COMMANDER AND LOADER CONTROL PANELS FOR CONTROLLING TANK ATTITUDE, CROSS WIND PRESENCE, POWDER AND TEMPERATURE-SENSITIVITY; THERMAL SIGHTING UNITS WITH LASER RANGE-FINDERS FOR BATTLEFIELD OBSERVATION; THERMAL CAMERAS FOR GENERAL OBSERVATION AS WELL AS BATTLEFIELD, AIRBORNE AND SHIPBOARD OBSERVATION AND AIMING; AIR TRAFFIC CONTROL SYSTEMS FOR CIVIL AND MILITARY PURPOSES, NAMELY, SHORT, MEDIUM AND LONG RANGE PRIMARY RADARS; SECONDARY RADARS; RADAR DATA EXTRACTORS; RADIO TELEPHONES FOR GROUND-AIR-GROUND RADIO COMMUNICATIONS; THREE-DIMENSIONAL RADARS FOR AIR SURVEILLANCE; COAST AND LOW ALTITUDE SURVEILLANCE RADARS; RADARS FOR AUTOMATIC FIRE CONTROL; TERRESTRIAL SURFACE-AIR MISSILE RADARS FOR POINT DEFENSE AND FOR BATTLE POINT; AIR-AIR MISSILE RADARS, AIR DEFENSE RADAR FOR INTERCEPTION, ANALYSIS AND JAMMING OF RADAR SIGNALS; LASERS AND RADARS FOR SIGHTING AND TRACKING; LASERS FOR SEARCHING AND TRACKING NAVAL RADARS (U.S. CLS. 21, 23, 26, 36 AND 38).

CLASS 12—VEHICLES

FOR AIRPLANES; HELICOPTERS; UNMANNED REMOTE-CONTROLLED POWERED AIRCRAFT FOR USE AS MILITARY TARGETS (U.S. CLS. 19, 21, 23, 31, 35 AND 44).

CLASS 13—FIREARMS

FOR TANKS; ACTUATORS FOR USE IN WEAPON EJECTING INSTALLATIONS; ACTUATORS FOR USE IN WEAPON LOADING INSTALLATIONS; ACTUATORS FOR USE IN WEAPONS, AERIAL TARGETS, AND AIR LAUNCHERS; AMMUNITION; AMMUNITION FOR FIREARMS; AMMUNITION FOR GUNS; ANTI-SUBMARINE TORPEDOES FITTED WITH WARHEADS; ANTI-TANK MINES; INITIATORS FOR FIRING WEAPONS, NAMELY, FUSES; ROCKET LAUNCHERS; ABOVE WATER AND SUB WATER TORPEDO TUBES; RADAR-GUIDED MISSILES; ARTILLERY GUNS, NAMELY, CANNONS; BAGS FOR CARRYING FIREARMS; BAGS FOR STORING FIREARMS; BALLISTIC MISSILES; BALLISTIC WEAPONS; BANDOLIERS FOR WEAPONS; BARRELS FOR GUNS; BARRELS FOR CANNONS; BENGAL LIGHTS; BOMBS; BREECHES OF FIREARMS; BULLETS; BULLETS FOR USE WITH RIFLES; CANNON CARRIAGES; CANNON TUBES; AUTOMATIC CARBINES; CARRYING CASES ADAPTED FOR FIREARMS; APPARATUS FOR FILLING CARTRIDGE BELTS; CARTRIDGE LOADING FILLERS; CRUISE MISSILES; WEAPON DECOY APPARATUS, NAMELY, DECOY SHIPS, DECOY AIRPLANES, DECOY MISSILES, DECOY WEAPON INSTALLATIONS; DETONATING CAPS OTHER THAN TOYS; DETONATING FUSES FOR EXPLOSIVES; DETONATOR PARTS, NAMELY, DETONATOR PLUGS; DETONATING RELAYS FOR USE WITH DETONATING CORD; DETONATING RELAYS FOR USE WITH DETONATORS; DETONATING RELAYS FOR USE WITH EXPLOSIVES; DETONATING RELAYS FOR USE WITH PRIMERS; DETONATORS; ELECTRONIC DETONATORS; DISTRESS ROCKETS, NAMELY, SIGNAL ROCKETS; SIGHTS, NAMELY, OPEN SIGHTS FOR USE ON FIREARMS EXCLUDING NON-OPTICAL OR NON TELESCOPIC; FIREARM STANDS; FIREARMS; AMMUNITION FOR FIREARMS; WEAPONS FIRING PLATFORMS; FLAMETHROWERS; FOG SIGNALS EXPLOSIVES; FUSES FOR EXPLOSIVES; GUIDED ANTI-TANK LAND MINES; GUIDED BOMBS; GUIDED MISSILES; GUIDED MORTAR BOMBS; GUIDED PROJECTILES; ILLUMINATING GRENADES; ILLUMINATING PROJECTILES; LANCE ROCKETS; LAUNCHERS FOR AMMUNITION; LAUNCHERS FOR MISSILES; LAUNCHERS FOR PROJECTILES; LAUNCHERS FOR ROCKETS; LEAD SHOT FOR USE WITH RESPECT TO AMMUNITION FOR FIREARMS; LOADED CARTRIDGE FOR MAGAZINES FOR FIREARMS; MACHINE GUNS; MILITARY FIREWORKS; EXPLOSIVE MINES; MISSILES; MORTARS AS FIREARMS; MUNITIONS DISPENSERS; MUNITIONS; MUZZLES FOR GUNS; OPTOELECTRONIC SWITCHING FOR MISSILE DRIVING; AMMUNITION PELLETS; STARTER PISTOLS; PLACEMENT MACHINE GUNS; PNEUMATIC CATALYSTS FOR FIRING MISSILES; PRIMERS FOR EXPLOSIVES; PRIMERS FOR PYROTECHNIC DEVICES; PRIMINGS AS FUSES; RADAR JAMMING PROJECTILES COMPRISING CONTAINERS OF RADAR ABSORBING MATERIALS; RADAR JAMMING PROJECTILES COMPRISING CONTAINERS OF RADAR REFLECTING MATERIALS; RADAR JAMMING WARHEADS; ROCKET MORTARS; ROCKET-PROPELLED BALLISTIC MISSILES; SIGNAL ROCKETS; PROJECTILE ROCKETS; NON-OPTICAL OR NON-TELESCOPIC SIGHTS FOR WEAPON USES; NAVAL WEAPON USE; TERRESTRIAL WEAPON USE; NON-OPTICAL OR NON-TELESCOPIC SIGHTS FOR ARTILLERY GUNS AND RIFLES; SILENCERS FOR FIREARMS; SMOKE DETONATORS; SMOKE MISSILES FOR ARMORED VEHICLES; SMOKE MISSILES FOR TANKS; SMOKE PROJECTILES FOR ROCKETS; SMOKE PROJECTILES FOR TORPEDO TUBE ARTILLERY; TANKS AMMUNITIONS; TORPEDO TUBE ARTILLERY; TRUNNIONS FOR HEAVY WEAPONS TUMBLERS; GUN MOUNTS AND GUN TURRETS (U.S. CLS. 2 AND 9).

CLASS 16—PAPER GOODS AND PRINTED MATTER

FOR BLANK OR PARTIALLY PRINTED PAPER LABELS; BLANK PAPER COMPUTER TAPES FOR RECORDING PROGRAMS; BROCHURES, CATALOGS, BOOKS, AND MANUALS CONCERNING MILITARY AND DEFENSE MATTERS; CARTOON PRINTS AND STRIPS; PLASTIC OR PAPER BAGS, ENVELOPES, AND POUCHES FOR MERCHANDISE PACKAGES; POSTERS (U.S. CLS. 2, 5, 22, 23, 29, 37, 38 AND 50).

CLASS 35—ADVERTISING AND BUSINESS

FOR CUSTOMER CONSULTATION SERVICES REGARDING INFORMATION TECHNOLOGY AND TRANSPORTATION IN THE FIELD OF AERONAUTICS, SPACE AND DEFENSE; BUSINESS OUTSOURCING CONSULTATION SERVICES FOR OTHERS IN THE FIELDS OF AUTOMATION, INFORMATION AND COMMUNICATION TECHNOLOGY, AND E-COMMERCE; MANAGEMENT OF ON-LINE TELECOMMUNICATIONS AND INFORMATION AND ASSISTANCE SERVICES, NAMELY, THOSE SPECIFICALLY ADDRESSED TO THE USERS OF CALL CENTERS (U.S. CLS. 100, 101 AND 102).

CLASS 37—CONSTRUCTION AND REPAIR

FOR CONSTRUCTION, MAINTENANCE AND REPAIR SERVICES OF WEAPONS, OF LAND, NAVAL, AND AIRBORNE VEHICLES, AND OF ELECTRICAL AND TELECOMMUNICATIONS SYSTEMS (U.S. CLS. 100, 103 AND 106).

CLASS 38—COMMUNICATION

FOR PROVIDING TELECOMMUNICATIONS CONNECTIONS TO A GLOBAL COMPUTER NETWORK; TELECOMMUNICATIONS CONSULTATION; TELECOMMUNICATIONS ROUTING AND JUNCTION SERVICES; TELECOMMUNICATIONS SERVICES, NAMELY, PROVIDING FIBER OPTIC NETWORK SERVICES; TELECOMMUNICATIONS SERVICES, NAMELY, INTERCEPTING AND PREVENTING UNSOLICITED CALLS FROM TELEMARETERS; SATELLITE TRANSMISSION; TELECOMMUNICATION SERVICES, NAMELY, LOCAL AND LONG DISTANCE TRANSMISSION OF VOICE, DATA, GRAPHICS BY MEANS OF TELEPHONE, TELEGRAPHIC, CABLE, AND SATELLITE TRANSMISSIONS; TELECOMMUNICATIONS, NAMELY, SERVICES FOR THE MULTI-USER ACCESS TO GLOBAL COMPUTER NETWORKS FOR THE COLLECTION, TRANSFER AND SPREADING OF INFORMATION, NEWS AND DATA, AND INTERACTION WITH USERS; RENTAL OF MULTIPLE USER ACCESS TO A GLOBAL COMPUTER INFORMATION NETWORK FOR THE TRANSFER AND SPREADING OF A WIDE RANGE OF INFORMATION; ELECTRONIC MAIL SERVICES; PROVIDING ACCESS TO DATA BANKS (U.S. CLS. 100, 101 AND 104).

CLASS 41—EDUCATION AND ENTERTAINMENT

FOR COMPUTER EDUCATION TRAINING; EDUCATION SERVICES IN THE NATURE OF COURSES AND SEMINARS IN THE FIELD OF SPACE, AERONAUTICS, DEFENSE, TRANSPORTATION, ENERGY AND INFORMATION TECHNOLOGY (U.S. CLS. 100, 101 AND 107).

CLASS 42—SCIENTIFIC, COMPUTER AND LEGAL SERVICES

FOR SCIENTIFIC RESEARCH; DESIGN AND MAINTENANCE OF COMPUTER SOFTWARE, COMPUTER CONSULTATION PROVIDED IN PERSON AND THROUGH A GLOBAL COMPUTER NETWORK; COMPUTER PROGRAMMING, NAMELY, CREATING DATA BANKS FOR OTHERS; ENGINEERING SERVICES; TECHNICAL CONSULTATION AND RESEARCH IN THE FIELD OF SPACE, AERONAUTICS, DEFENSE, TRANSPORTATION, ENERGY AND INFORMATION TECHNOLOGY (U.S. CLS. 100 AND 101).

BRENDAN MCCAULEY, EXAMINING ATTORNEY

SN 76-516.002. MIGHTY FINE, LOS ANGELES, CA. FILED 5-23-2003.



CLASS 16—PAPER GOODS AND PRINTED MATTER

FOR PAPER GOODS, NAMELY, STATIONERY, NOTE CARDS, POSTCARDS, JOURNAL DIARIES, WRAPPING PAPER, GREETING CARDS, PICTURE BOOKS, GIFT BOOKS, GUEST BOOKS, BOOKS IN THE FIELD OF LIFE ISSUES THAT PERTAIN TO CONTEMPORARY YOUNG WOMEN, COOKING BOOKS, BOOKS ABOUT COCKTAIL DRINKS, POSTERS, FOLDERS, PAPER BAGS, GIFT BOXES, STICKERS, BINDERS, AND PENCIL BOXES (U.S. CLS. 2, 5, 22, 23, 29, 37, 38 AND 50).
FIRST USE 5-15-1999; IN COMMERCE 5-15-1999.

CLASS 18—LEATHER GOODS

FOR HANDBAGS, NAMELY DUFFLE BAGS, TOTE BAGS, PURSES, COIN PURSES SOLD EMPTY, WALLETS, AND MESSENGER AND COURIER BAGS, AND BACKPACKS (U.S. CLS. 1, 2, 3, 22 AND 41).
FIRST USE 1-5-1999; IN COMMERCE 3-24-1999.

CLASS 25—CLOTHING

FOR CLOTHING, NAMELY TOPS, SWEATERS, PANTS, SKIRTS, DRESSES, JACKETS, HOSIERY, SOCKS, FOOTWEAR, HEADWEAR, NAMELY, HATS, CAPS AND VISORS, SCARVES, GLOVES, MITTENS, UNDERWEAR, SLEEPWEAR, ACTIVE WEAR, NAMELY JOGGING SUITS, SWEATSHIRTS, AND SWEAT PANTS (U.S. CLS. 22 AND 39).
FIRST USE 1-5-1999; IN COMMERCE 3-4-1999.
TONJA GASKINS, EXAMINING ATTORNEY

SN 76-516.306. GLITTER CREEK, INC., CINCINNATI, OH. FILED 5-22-2003.

GLITTER CREEK

CLASS 16—PAPER GOODS AND PRINTED MATTER

FOR SERIES OF FICTION AND NON-FICTION BOOKS ON A VARIETY OF TOPICS (U.S. CLS. 2, 5, 22, 23, 29, 37, 38 AND 50).

CLASS 28—TOYS AND SPORTING GOODS

FOR STUFFED TOYS (U.S. CLS. 22, 23, 38 AND 50).
SONYA STEPHENS, EXAMINING ATTORNEY

SN 76-521.728. A. P. TOLDO HOLDING CORPORATION, WINDSOR, ONTARIO, CANADA, FILED 6-10-2003.

PETER ANTHONY DESIGNS

NO CLAIM IS MADE TO THE EXCLUSIVE RIGHT TO USE DESIGNS, APART FROM THE MARK AS SHOWN.

THE NAME(S), PORTRAIT(S), AND/OR SIGNATURE(S) SHOWN IN THE MARK IDENTIFIES ANTHONY PETER TOLDO, WHOSE CONSENT(S) TO REGISTER IS SUBMITTED.

CLASS 20—FURNITURE AND ARTICLES NOT OTHERWISE CLASSIFIED

FOR COMMERCIAL FURNITURE (U.S. CLS. 2, 13, 22, 25, 32 AND 50).

CLASS 40—MATERIAL TREATMENT

FOR MANUFACTURE OF FURNITURE TO THE ORDER AND SPECIFICATION OF OTHERS; CUSTOM MANUFACTURER OF FURNITURE (U.S. CLS. 100, 103 AND 106).

CLASS 42—SCIENTIFIC, COMPUTER AND LEGAL SERVICES

FOR INTERIOR DECORATING AND INTERIOR DECORATION CONSULTATION; DESIGN OF COMMERCIAL FURNITURE (U.S. CLS. 100 AND 101).
APRIL L. RADEMACHER, EXAMINING ATTORNEY

SN 76-523.098. HIGH-SCAN-ARTIKELSICHERUNGS-GMBH, D-41469 NEUSS, FED REP GERMANY, FILED 6-13-2003.



PRIORITY CLAIMED UNDER SEC. 44(D) ON FED REP GERMANY APPLICATION NO. 2978179, FILED 12-16-2002.

OWNER OF ERPN CMNTY TM OFC REG. NO. 002978179, DATED 5-25-2004, EXPIRES 12-16-2012.

THE MARK IS LINED FOR THE COLORS RED AND GRAY. THE FIRST H AND S ARE LINED FOR THE COLOR RED, AND THE OTHER LETTERS ARE LINED FOR THE COLOR GRAY.

CLASS 8—HAND TOOLS

FOR MANUALLY OPERATED OPENER FOR TAGS AND LABELS (U.S. CLS. 23, 28 AND 44).

CLASS 9—ELECTRICAL AND SCIENTIFIC APPARATUS

FOR ELECTRONIC SECURITY DEVICE USED TO SECURE ARTICLES FROM THEFT ATTACHED TO TAGS AND LABELS; ELECTRONIC SECURITY DETECTOR USED TO DETECT SECURITY DEVICES ATTACHED TO TAGS AND LABELS; ELECTRONIC SECURITY MONITOR CONTAINING ACOUSTIC ALARMS AND ELECTRONIC SPEAKING DEVICES USED TO ALERT THE THEFT OF ARTICLES WHICH CONTAIN ELECTRONIC SECURITY DEVICES (U.S. CLS. 21, 23, 26, 36 AND 38).

TARAH HARDY, EXAMINING ATTORNEY

SN 76-523,337. QWK.NET, LLC, BOISE, ID. FILED 5-11-2004.

QWK.NET

CLASS 38—COMMUNICATION

FOR PROVIDING MULTIPLE USER DIAL-UP AND DEDICATED ACCESS TO THE INTERNET (U.S. CLS. 100, 101 AND 104).

FIRST USE 4-1-1998; IN COMMERCE 4-1-1998.

CLASS 42—SCIENTIFIC, COMPUTER AND LEGAL SERVICES

FOR HOSTING OF DIGITAL CONTENT ON THE INTERNET; HOSTING THE WEB SITES OF OTHERS ON A COMPUTER SERVER FOR A GLOBAL COMPUTER NETWORK; COMPUTER SERVICES, NAMELY, CREATING AND MAINTAINING WEB SITES FOR OTHERS; COMPUTER SERVICES, NAMELY, DESIGNING AND IMPLEMENTING WEB SITES FOR OTHERS; COMPUTER SERVICES, NAMELY, MANAGING WEB SITES FOR OTHERS; WEB SITE FORWARDING SERVICES; COMPUTER PROGRAMMING FOR OTHERS; CONSULTING SERVICES IN THE FIELD OF WEB SITE DESIGN, HOSTING, AND MANAGEMENT (U.S. CLS. 100 AND 101).

FIRST USE 4-1-1998; IN COMMERCE 4-1-1998.
HENRY S. ZAK, EXAMINING ATTORNEY

SN 76-524,111. MID ATLANTIC MEDICAL SERVICES, INC., ROCKVILLE, MD. FILED 6-13-2003.

MAMSI

OWNER OF U.S. REG. NOS. 2,462,891, 2,553,564 AND 2,553,634.

CLASS 16—PAPER GOODS AND PRINTED MATTER

FOR NEWSLETTERS CONCERNING MEDICAL INFORMATION, HEALTH MAINTENANCE, PREVENTATIVE HEALTH CARE, AND INSURANCE SERVICES (U.S. CLS. 2, 5, 22, 23, 29, 37, 38 AND 50).

FIRST USE 8-27-1999; IN COMMERCE 8-27-1999.

CLASS 36—INSURANCE AND FINANCIAL

FOR INSURANCE SERVICES, NAMELY UNDERWRITING, CLAIMS PROCESSING, AND CLAIMS ADMINISTRATION IN THE FIELDS OF LIFE, HEALTH, DENTAL, VISION, PRESCRIPTION DRUG, ACCIDENT, EXCESS RISK/STOP LOSS, AND DISABILITY; ORGANIZATION AND ADMINISTRATION OF HEALTH INSURANCE PLANS; ORGANIZATION AND ADMINISTRATION OF HEALTH INSURANCE PLANS FOR OTHERS; RECOVERY SERVICES, NAMELY RECOVERY OF MONEY IMPROPERLY PAID BY AN INSURANCE COMPANY; CHARITABLE SERVICES, NAMELY, PROVIDING FINANCIAL ASSISTANCE TO FAMILIES WITH CHILDREN HAVING HEALTH CARE NEEDS NOT COVERED BY COMMERCIAL HEALTH INSURANCE (U.S. CLS. 100, 101 AND 102).

FIRST USE 8-27-1999; IN COMMERCE 8-27-1999.

CLASS 44—MEDICAL, BEAUTY AND AGRICULTURAL SERVICES

FOR CREATING AND PROVIDING CLINICAL GUIDELINES AND HEALTH MAINTENANCE GUIDELINES (U.S. CLS. 100 AND 101).

FIRST USE 8-27-1999; IN COMMERCE 8-27-1999.
SUELLEN HICKEY, EXAMINING ATTORNEY

SN 76-524,113. MID ATLANTIC MEDICAL SERVICES, INC., ROCKVILLE, MD. FILED 6-13-2003.

MAMSI

OWNER OF U.S. REG. NOS. 2,462,891, 2,553,564 AND 2,553,634.

CLASS 16—PAPER GOODS AND PRINTED MATTER

FOR NEWSLETTERS CONCERNING MEDICAL INFORMATION, HEALTH MAINTENANCE, PREVENTATIVE HEALTH CARE, AND INSURANCE SERVICES (U.S. CLS. 2, 5, 22, 23, 29, 37, 38 AND 50).

FIRST USE 8-27-1999; IN COMMERCE 8-27-1999.

CLASS 36—INSURANCE AND FINANCIAL

FOR INSURANCE SERVICES, NAMELY UNDERWRITING, CLAIMS PROCESSING, AND CLAIMS ADMINISTRATION IN THE FIELDS OF LIFE, HEALTH, DENTAL, VISION, PRESCRIPTION DRUG, ACCIDENT, EXCESS RISK/STOP LOSS, AND DISABILITY; ORGANIZATION AND ADMINISTRATION OF HEALTH INSURANCE PLANS; ORGANIZATION AND ADMINISTRATION OF HEALTH INSURANCE PLANS FOR OTHERS; RECOVERY SERVICES, NAMELY RECOVERY OF MONEY IMPROPERLY PAID BY AN INSURANCE COMPANY; CHARITABLE SERVICES, NAMELY, PROVIDING FINANCIAL ASSISTANCE TO FAMILIES WITH CHILDREN HAVING HEALTH CARE NEEDS NOT COVERED BY COMMERCIAL HEALTH INSURANCE (U.S. CLS. 100, 101 AND 102).

FIRST USE 8-27-1999; IN COMMERCE 8-27-1999.

CLASS 44—MEDICAL, BEAUTY AND AGRICULTURAL SERVICES

FOR MANAGED HEALTH CARE SERVICES; MENTAL HEALTH AND PSYCHIATRIC SERVICES; CREATING AND PROVIDING CLINICAL GUIDELINES AND HEALTH MAINTENANCE GUIDELINES (U.S. CLS. 100 AND 101).

FIRST USE 8-27-1999; IN COMMERCE 8-27-1999.
SUELLEN HICKEY, EXAMINING ATTORNEY

SN 76-527,351. FIFE, INC., BOSTON, MA. FILED 6-30-2003.

GENERAL INVESTMENT & DEVELOPMENT

NO CLAIM IS MADE TO THE EXCLUSIVE RIGHT TO USE INVESTMENT DEVELOPMENT, APART FROM THE MARK AS SHOWN.

SEC. 2(F).

CLASS 36—INSURANCE AND FINANCIAL

FOR FINANCIAL SERVICES, NAMELY INVESTMENT MANAGEMENT; COMMERCIAL AND RESIDENTIAL REAL ESTATE SERVICES, NAMELY MANAGEMENT OF APARTMENT HOUSING UNITS, LEASING AND RENTAL OF APARTMENTS, LEASING OF OFFICE SPACE, LEASING OF REAL PROPERTY, REAL ESTATE INVESTMENT, AND REAL ESTATE MANAGEMENT (U.S. CLS. 100, 101 AND 102).

FIRST USE 0-0-1960; IN COMMERCE 0-0-1960.

CLASS 37—CONSTRUCTION AND REPAIR

FOR BUILDING CONSTRUCTION AND DEVELOPMENT SERVICES, NAMELY REAL ESTATE DEVELOPMENT AND BUILDING REPAIR AND MAINTENANCE SERVICES (U.S. CLS. 100, 103 AND 106).

FIRST USE 0-0-1960; IN COMMERCE 0-0-1960.

CLASS 43—HOTEL AND RESTAURANT SERVICES

FOR PROVISION OF TEMPORARY HOUSING ACCOMMODATIONS (U.S. CLS. 100 AND 101).

FIRST USE 0-0-1960; IN COMMERCE 0-0-1960.
BRIAN NEVILLE, EXAMINING ATTORNEY

SN 76-528,102. ICEBREAKER NEW ZEALAND LIMITED, WELLINGTON, NEW ZEALAND, FILED 7-7-2003.

ICEBREAKER

PRIORITY CLAIMED UNDER SEC. 44(D) ON NEW ZEALAND APPLICATION NO. 679541, FILED 5-23-2003, REG. NO. 679541, DATED 12-8-2003, EXPIRES 12-8-2013.

PRIORITY CLAIMED UNDER SEC. 44(D) ON NEW ZEALAND APPLICATION NO. 679542, FILED 5-23-2003, REG. NO. 679542, DATED 11-11-2004, EXPIRES 11-11-2011.

CLASS 9—ELECTRICAL AND SCIENTIFIC APPARATUS

FOR DIVESUITS (U.S. CLS. 21, 23, 26, 36 AND 38).

CLASS 24—FABRICS

FOR FABRIC FOR USE IN THE MANUFACTURE OF CLOTHING, FOOTWEAR AND HEADWEAR (U.S. CLS. 42 AND 50).

MICHAEL ENGEL, EXAMINING ATTORNEY

SN 76-528,565. KABUSHIKIKAISHA MATSUI SEISAKUSHO, CHUO-KU, OSAKA, JAPAN, FILED 7-9-2003.

plas-mini

THE MARK CONSISTS OF STANDARD CHARACTERS WITHOUT CLAIM TO ANY PARTICULAR FONT, STYLE, SIZE, OR COLOR.

PRIORITY CLAIMED UNDER SEC. 44(D) ON JAPAN APPLICATION NO. 2003-000993, FILED 1-9-2003.

CLASS 7—MACHINERY

FOR CARGO HANDLING MACHINES; CARGO HANDLING APPARATUS, NAMELY, PNEUMATIC CONVEYORS AND SCREW CONVEYORS; CHEMICAL MACHINES; NAMELY, MIXERS, SCRUBBERS, GRANULATORS, AND CRUSHERS; PLASTIC PROCESSING MACHINES, NAMELY, PLASTIC MOLDS (U.S. CLS. 13, 19, 21, 23, 31, 34 AND 35).

CLASS 9—ELECTRICAL AND SCIENTIFIC APPARATUS

FOR PHYSICAL AND CHEMICAL APPARATUS AND INSTRUMENTS, NAMELY, HYGROSTATS AND THERMOSTATS (U.S. CLS. 21, 23, 26, 36 AND 38).

CLASS 11—ENVIRONMENTAL CONTROL APPARATUS

FOR FURNACE BOILERS; FEED HOT WATER HEATERS; DRYING APPARATUS, NAMELY, HEAT AIR VENTILATION DRYERS; REFRIGERATING MACHINES AND EQUIPMENT, NAMELY, REFRIGERATORS AND WALK-IN COOLERS; HEAT EXCHANGERS; INDUSTRIAL DRYERS FOR CHEMICALS (U.S. CLS. 13, 21, 23, 31 AND 34).

KEVON CHISOLM, EXAMINING ATTORNEY

SN 76-528,699. LEONI KABEL GMBH & CO. KG, DE-90402 NURNBERG, FED REP GERMANY, FILED 7-11-2003.

ParaLink

PRIORITY CLAIMED UNDER SEC. 44(D) ON FED REP GERMANY APPLICATION NO. 30301634.5/0, FILED 1-16-2003, REG. NO. 30301634, DATED 4-10-2003, EXPIRES 1-17-2013.

CLASS 9—ELECTRICAL AND SCIENTIFIC APPARATUS

FOR ELECTRIC CABLES, WIRES, PIPES, FLEX AND SPUN YARNS, NAMELY FLATTENED BRAIDS, STRANDED AND THREADED CABLES IN ROSES FOR ELECTRICAL PURPOSES, CIRCUIT BOARDS, NAMELY SUPPORT PLATES, CABLE HARNESSSES (U.S. CLS. 21, 23, 26, 36 AND 38).

CLASS 17—RUBBER GOODS

FOR ELECTRICAL INSULATION AND PROTECTIVE MATERIAL, NAMELY ELECTRICAL INSULATING TAPE, RUBBER TUBE CONDUCTORS (U.S. CLS. 1, 5, 12, 13, 35 AND 50).

MICHAEL ENGEL, EXAMINING ATTORNEY

SN 76-530,120. DIATECH DENTAL, INC., CHARLESTON, SC, FILED 7-15-2003.

HYGIENIST CHOICE

NO CLAIM IS MADE TO THE EXCLUSIVE RIGHT TO USE "HYGIENIST", APART FROM THE MARK AS SHOWN.

CLASS 5—PHARMACEUTICALS

FOR DENTAL PREVENTATIVE CARE PRODUCTS, NAMELY, PROPHY PASTE TO PREVENT CAVITIES; DENTAL PREVENTATIVE CARE PREPARATIONS, NAMELY, FLUORIDE GEL; COTTON ROLLS FOR DENTAL PURPOSES; AND MEDICATED DENTAL FLOSS (U.S. CLS. 6, 18, 44, 46, 51 AND 52).

FIRST USE 8-0-1999; IN COMMERCE 8-0-1999.

CLASS 10—MEDICAL APPARATUS

FOR DENTAL PREVENTATIVE CARE PRODUCTS, NAMELY, DISPOSABLE MIRRORS; DENTAL INSTRUMENTS, NAMELY, PROPHY ANGLES AND TONGUE CLEANERS; EAR LOOP MASKS FOR USE BY DENTAL PERSONNEL; AND STERILIZATION POUCHES FOR STERILIZING DENTAL INSTRUMENTS (U.S. CLS. 26, 39 AND 44).

FIRST USE 8-0-1999; IN COMMERCE 8-0-1999.

CLASS 21—HOUSEWARES AND GLASS

FOR MANUAL TOOTHBRUSHES; DENTAL FLOSS; INTERDENTAL BRUSHES; DISPOSABLE MANUAL TOOTHBRUSHES (U.S. CLS. 2, 13, 23, 29, 30, 33, 40 AND 50).

FIRST USE 8-0-1999; IN COMMERCE 8-0-1999.

SOPHIA S. KIM, EXAMINING ATTORNEY

SN 76-533,816. ARCHER-DANIELS-MIDLAND COMPANY, DECATUR, IL. FILED 7-29-2003.

NOVALIPID**CLASS 5—PHARMACEUTICALS**

FOR EDIBLE OILS USED AS CARRIER INJECTABLE RECIPIENTS IN PHARMACEUTICAL PRODUCTS AND REFINED OILS USED AS AN ENERGY SOURCE IN PHARMACEUTICAL PRODUCTS (U.S. CLS. 6, 18, 44, 46, 51 AND 52).

CLASS 29—MEATS AND PROCESSED FOODS

FOR REFINED OILS FOR USE IN THE MANUFACTURE OF FOOD PRODUCTS, NAMELY, ZERO AND REDUCED FAT OILS IN THE NATURE OF COOKING OIL, VEGETABLE OIL, SOYBEAN OIL, CORN OIL, CANOLA OIL, SUNFLOWER OIL, PALM OIL, KERNEL OIL, COCONUT OIL, SALAD OIL AND EDIBLE OILS (U.S. CL. 46).

STANLEY I. OSBORNE, EXAMINING ATTORNEY

SN 76-535,733. ACTIFI, INC., PLYMOUTH, MN. FILED 8-11-2003.

ACTIFI**CLASS 9—ELECTRICAL AND SCIENTIFIC APPARATUS**

FOR COMPUTER SOFTWARE USED TO SPECIFY METHODS, DEFINE RULES, AND CONSTRUCT CUSTOMIZED COMPUTER PROGRAMS, IN THE FIELD OF WORKFLOW AUTOMATION; SOFTWARE FOR INTEGRATING OTHER COMPUTER SYSTEMS AND SOFTWARE PACKAGES; SOFTWARE FOR DEVELOPING METHODS TO AUTOMATE PROCESS, PRACTICES AND PROCEDURES, IN THE FIELD OF TOOLS FOR PROFESSIONALS TO MANAGE AND PROCESS CLIENT FINANCIAL INFORMATION. (U.S. CLS. 21, 23, 26, 36 AND 38).

CLASS 35—ADVERTISING AND BUSINESS

FOR COMPUTERIZED DATABASE MANAGEMENT (U.S. CLS. 100, 101 AND 102).

CLASS 42—SCIENTIFIC, COMPUTER AND LEGAL SERVICES

FOR APPLICATION SERVICE PROVIDER (ASP) FEATURING SOFTWARE FOR WORKFLOW AUTOMATION; ASP FEATURING SOFTWARE FOR INTEGRATING VARIOUS COMPUTER SYSTEMS AND SOFTWARE PACKAGES; ASP FEATURING SOFTWARE FOR MANAGING AND PROCESSING CLIENT FINANCIAL INFORMATION; COMPUTER SERVICES, NAMELY, COMPUTER SOFTWARE CONSULTATION, COMPUTER SYSTEMS INTEGRATION, DATABASE MANAGEMENT AND SOFTWARE DESIGN FOR OTHERS (U.S. CLS. 100 AND 101).

APRIL L. RADEMACHER, EXAMINING ATTORNEY

SN 76-536,227. DYANSYS, INC., BURLINGAME, CA. FILED 7-31-2003.

ANSISCOPE**CLASS 9—ELECTRICAL AND SCIENTIFIC APPARATUS**

FOR COMPUTER MONITORS, COMPUTER HARDWARE, COMPUTER PERIPHERALS, AND COMPUTER SOFTWARE FOR ANALYZING AND DISPLAYING DATA OBTAINED VIA A MEDICAL ELECTRODE, RELATING TO THE AUTONOMIC NERVOUS SYSTEM, ALL SOLD AS A UNIT (U.S. CLS. 21, 23, 26, 36 AND 38).

CLASS 10—MEDICAL APPARATUS

FOR MEDICAL DEVICES, NAMELY, MEDICAL ELECTRODES AND ATTACHED MONITOR FOR MONITORING AND ASSESSING THE REACTIVITY OF THE AUTONOMIC NERVOUS SYSTEM (U.S. CLS. 26, 39 AND 44).

STEVEN R. FOSTER, EXAMINING ATTORNEY

SN 76-536,228. DYANSYS, INC., BURLINGAME, CA. FILED 7-31-2003.

ANSIRISK**CLASS 9—ELECTRICAL AND SCIENTIFIC APPARATUS**

FOR COMPUTER MONITORS, COMPUTER HARDWARE, COMPUTER PERIPHERALS, AND COMPUTER SOFTWARE FOR ANALYZING AND DISPLAYING DATA OBTAINED VIA A MEDICAL ELECTRODE, RELATING TO THE AUTONOMIC NERVOUS SYSTEM, ALL SOLD AS A UNIT (U.S. CLS. 21, 23, 26, 36 AND 38).

CLASS 10—MEDICAL APPARATUS

FOR MEDICAL DEVICES, NAMELY, MEDICAL ELECTRODES AND ATTACHED MONITOR FOR MONITORING AND ASSESSING THE REACTIVITY OF THE AUTONOMIC NERVOUS SYSTEM (U.S. CLS. 26, 39 AND 44).

STEVEN R. FOSTER, EXAMINING ATTORNEY

SN 76-536,234. DYANSYS, INC., BURLINGAME, CA. FILED
7-31-2003.

ANSINDEX

CLASS 9—ELECTRICAL AND SCIENTIFIC APPARATUS

FOR COMPUTER MONITORS, COMPUTER HARDWARE, COMPUTER PERIPHERALS, AND COMPUTER SOFTWARE FOR ANALYZING AND DISPLAYING DATA OBTAINED VIA A MEDICAL ELECTRODE, RELATING TO THE AUTONOMIC NERVOUS SYSTEM, ALL SOLD AS A UNIT (U.S. CLS. 21, 23, 26, 36 AND 38).

CLASS 10—MEDICAL APPARATUS

FOR MEDICAL DEVICES, NAMELY, MEDICAL ELECTRODES AND ATTACHED MONITOR FOR MONITORING AND ASSESSING THE REACTIVITY OF THE AUTONOMIC NERVOUS SYSTEM (U.S. CLS. 26, 39 AND 44).

STEVEN R. FOSTER, EXAMINING ATTORNEY

SN 76-536,235. DYANSYS, INC., BURLINGAME, CA. FILED
7-31-2003.

ANSIGRAM

CLASS 9—ELECTRICAL AND SCIENTIFIC APPARATUS

FOR COMPUTER MONITORS, COMPUTER HARDWARE, COMPUTER PERIPHERALS, AND COMPUTER SOFTWARE FOR ANALYZING AND DISPLAYING DATA OBTAINED VIA A MEDICAL ELECTRODE, RELATING TO THE AUTONOMIC NERVOUS SYSTEM, ALL SOLD AS A UNIT (U.S. CLS. 21, 23, 26, 36 AND 38).

CLASS 10—MEDICAL APPARATUS

FOR MEDICAL DEVICES, NAMELY, MEDICAL ELECTRODES AND ATTACHED MONITOR FOR MONITORING AND ASSESSING THE REACTIVITY OF THE AUTONOMIC NERVOUS SYSTEM (U.S. CLS. 26, 39 AND 44).

STEVEN R. FOSTER, EXAMINING ATTORNEY

SN 76-536,622. TRUST CO., LTD., SANBU-GUN, CHIBA 289-1605, JAPAN, FILED 8-12-2003.



OWNER OF U.S. REG. NOS. 2,133,939 AND 2,382,247.

CLASS 7—MACHINERY

FOR TURBOCHARGER PARTS, NAMELY, HOUSINGS AND HOODS; TIMING BELTS; EXHAUST SYSTEMS FOR LAND VEHICLE ENGINES, COMPRISED OF EXHAUST PIPES, MUFFLERS, TAILPIPES AND MOUNTING HARDWARE; LAND VEHICLE ENGINE PARTS, NAMELY, OIL CATCH TANKS, OIL CAPS, OIL PANS, OIL PUMPS, GREASE RINGS, OIL FILTERS, GASKETS, CAM SHAFTS, CAM SPROCKETS, CRANK SHAFTS, ELECTRONIC SENSOR ADAPTORS SOLD AS A UNIT WITH EXHAUST SYSTEM, VALVE SPRINGS, EXHAUST PIPES, VALVES, ELBOWS, PISTONS, FANS, FLANGES, FAN BELTS, HOSES, HEAD BOLTS, RADIATOR CAPS, RADIATOR HOSES, FUEL PRESSURE REGULATORS, AIR FILTERS, COUPLING JOINTS, SILENCERS, ELECTRONIC MODULES FOR CONTROLLING FUEL INJECTORS, SPARK PLUG WIRES, ENGINE IGNITERS, AND CONNECTING RODS (U.S. CLS. 13, 19, 21, 23, 31, 34 AND 35).

FIRST USE 11-15-1993; IN COMMERCE 11-15-1993.

CLASS 9—ELECTRICAL AND SCIENTIFIC APPARATUS

FOR COMPUTER PROGRAMS FOR ENGINE CONTROL, COMPUTERS FOR ENGINE CONTROL, ELECTRONIC SWITCHES FOR MODULATING SETTING OF BOOST CONTROLLERS, GLOVES FOR PROTECTION AGAINST ACCIDENTS, AND STRAPS FOR RADIOTELEPHONY SETS (U.S. CLS. 21, 23, 26, 36 AND 38).

FIRST USE 6-30-1988; IN COMMERCE 6-30-1988.

CLASS 12—VEHICLES

FOR LAND VEHICLE PARTS, NAMELY, BUMPERS, SIDE SKIRTS, SPOILERS, WING SPOILERS, OIL CATCH TANKS, SECURITY HARNESES OF VEHICLE SEAT, SEAT BELTS, SHIFT LEVER KNOBS, SHOULDER PADS FOR SECURITY HARNESS OF VEHICLE SEATS, AND STEERING STABILIZERS; STRUCTURAL REINFORCEMENT PARTS FOR LAND VEHICLES, NAMELY, TENSION BARS, TENSION GAUGES AND TENSION FRAMES; AND SUSPENSION COMPONENTS FOR LAND VEHICLES, NAMELY, SHOCK ABSORBERS, COIL AND LEAF SPRINGS, TORSION BARS, AND METAL MOUNTINGS THEREFOR SOLD AS A UNIT WITH THE SUSPENSION COMPONENTS (U.S. CLS. 19, 21, 23, 31, 35 AND 44).

FIRST USE 11-15-1993; IN COMMERCE 11-15-1993.

CLASS 14—JEWELRY

FOR CLOCKS, AND WATCHES (U.S. CLS. 2, 27, 28 AND 50).

FIRST USE 12-17-2000; IN COMMERCE 12-17-2000.

CLASS 16—PAPER GOODS AND PRINTED MATTER

FOR CALENDARS, PENS, STICKERS, AND WRITING PADS (U.S. CLS. 2, 5, 22, 23, 29, 37, 38 AND 50).

FIRST USE 11-15-1993; IN COMMERCE 11-15-1993.

CLASS 20—FURNITURE AND ARTICLES NOT OTHERWISE CLASSIFIED

FOR NON-METAL KEY HOLDER (U.S. CLS. 2, 13, 22, 25, 32 AND 50).

FIRST USE 4-30-1998; IN COMMERCE 4-30-1998.

CLASS 25—CLOTHING

FOR CLOTHING NAMELY, APRONS, GLOVES, CAPS, JUMPERS, JACKETS, LIVERIES, NAMELY, UNIFORMS, MOTORIST'S CLOTHING, NAMELY, OVERALLS, PARKAS, POLO SHIRTS, SHIRTS, SHOES, SWEATERS AND T-SHIRTS (U.S. CLS. 22 AND 39).

FIRST USE 12-5-2000; IN COMMERCE 12-5-2000.

CLASS 28—TOYS AND SPORTING GOODS

FOR TOY SCALE MODEL VEHICLES (U.S. CLS. 22, 23, 38 AND 50).

FIRST USE 6-1-2003; IN COMMERCE 6-1-2003.

ELIZABETH J. WINTER, EXAMINING ATTORNEY

CLASS 42—SCIENTIFIC, COMPUTER AND LEGAL SERVICES

FOR DEVELOPMENT OF WAFER SOLAR CELLS AND MODULES TO THE SPECIFIC ORDER OF THIRD PARTIES; PROVIDING TEMPORARY USE OF ON-LINE NON-DOWNLOADABLE SOFTWARE FOR DETERMINING OPTIMIZED USE OF ELECTRIC ENERGY PRODUCED BY SOLAR CELLS AND SOLAR MODULES (U.S. CLS. 100 AND 101).

TARAH HARDY, EXAMINING ATTORNEY

SN 76-539,058. RWE SCHOTT SOLAR GMBH, D-63755 ALZENAU, FED REP GERMANY, FILED 8-19-2003.

SN 76-540,837. ELASTOGRAN GMBH, LEMFOERDE, FED REP GERMANY, FILED 8-15-2003.

RSS

ELASTOCLEAR

PRIORITY CLAIMED UNDER SEC. 44(D) ON FED REP GERMANY APPLICATION NO. 30310455.4, FILED 2-25-2003, REG. NO. 30310455, DATED 7-3-2003, EXPIRES 2-28-2013.

CLASS 6—METAL GOODS

FOR RACKS MADE OF STEEL AND ALUMINUM FOR SOLAR POWER SYSTEMS; WATER PUMPING INSTALLATIONS, NAMELY, METAL WATER PIPES (U.S. CLS. 2, 12, 13, 14, 23, 25 AND 50).

CLASS 7—MACHINERY

FOR ELECTRIC GENERATORS EMPLOYING SOLAR CELLS, AND MODULES AND COMPONENTS THEREOF; WATER PUMPING INSTALLATIONS IN THE NATURE OF WATER PUMPS FOR CIRCULATING WATER IN SOLAR POWER SYSTEMS, AND VALVES FOR WATER PUMPS (U.S. CLS. 13, 19, 21, 23, 31, 34 AND 35).

CLASS 9—ELECTRICAL AND SCIENTIFIC APPARATUS

FOR WAFERS FOR SOLAR CELLS AND SOLAR MODULES; ELECTRONIC AND ELECTROTECHNICAL COMPONENTS FOR SOLAR POWER SYSTEMS, NAMELY SOLAR CELLS, SOLAR MODULES, CHARGE REGULATORS, BATTERIES; HOME SOLAR SYSTEMS COMPRISING SOLAR CELLS AND BATTERIES; STORAGE BATTERIES, INVERTERS, ELECTRICAL AND ELECTRONIC CIRCUITS, MACHINES FOR ENERGY DISTRIBUTION, NAMELY ELECTRIC CONTROL GEAR FOR CURRENT AND WATER SUPPLY BASED ON PHOTO-VOLTAIC COMPONENTS OR COMBINATIONS WITH OTHER REGENERATIVE CONVENTIONAL ENERGY CARRIERS; MOBILE, NON-SYSTEM CONNECTED ELECTRIC SMALL-TYPE POWER STATIONS WHICH ARE CONTAINER MOUNTED CONSISTING OF A SOLAR POWER GENERATOR AND STORAGE BATTERY; COMPUTER SOFTWARE USED FOR DETERMINING THE OPTIMIZED USE OF ELECTRIC ENERGY PRODUCED BY SOLAR CELLS AND SOLAR MODULES (U.S. CLS. 21, 23, 26, 36 AND 38).

CLASS 20—FURNITURE AND ARTICLES NOT OTHERWISE CLASSIFIED

FOR PLASTIC RACKS FOR SOLAR POWER SYSTEMS (U.S. CLS. 2, 13, 22, 25, 32 AND 50).

CLASS 1—CHEMICALS

FOR CHEMICALS USED IN INDUSTRY, NAMELY, POLYURETHANE FOR USE IN SEALANTS AND COATINGS BY THE AUTOMOBILE AND FURNITURE INDUSTRIES (U.S. CLS. 1, 5, 6, 10, 26 AND 46).

CLASS 17—RUBBER GOODS

FOR THERMAL OR ACOUSTIC INSULATING MATERIALS MADE FROM UNPROCESSED PLASTICS IN THE FORM OF GRANULES, POWDERS, LIQUIDS OR PASTES (U.S. CLS. 1, 5, 12, 13, 35 AND 50).

PAUL F. GAST, EXAMINING ATTORNEY

SN 76-547,044. BEALL, KAREN A., HILTON HEAD ISLAND, SC. FILED 9-25-2003.

PET ROX**CLASS 14—JEWELRY**

FOR PET JEWELRY (U.S. CLS. 2, 27, 28 AND 50).
FIRST USE 7-10-2003; IN COMMERCE 7-10-2003.

CLASS 18—LEATHER GOODS

FOR PET CLOTHING AND COLLARS (U.S. CLS. 1, 2, 3, 22 AND 41).
FIRST USE 7-10-2003; IN COMMERCE 7-10-2003.
KEVON CHISOLM, EXAMINING ATTORNEY

SN 76-547,066. MAD PEPPER FARMS, INC., SAN JOSE, CA.
FILED 9-25-2003.



THE COLOR(S) THE COMMON COLORS OF GREEN, RED, WHITE, PURPLE, YELLOW, GRAY, IS/ARE CLAIMED AS A FEATURE OF THE MARK.

THE COLOR GREEN APPEARS ON THE HUMAN-LIKE CHILI PEPPER, STEM, CELERY STICK AND OLIVES. THE COLOR RED APPEARS ON THE RIGHT AND LEFT HAND, FEET, TONGUE, "MP" BELT, STRIPED STRAW, AND OLIVES. THE COLOR WHITE APPEARS ON THE EYES, TEETH AND STRIPED STRAW. THE COLORS YELLOW, PURPLE AND GRAY APPEARS ON THE "MP" BELT. THE COLOR YELLOW APPEARS ON THE CELERY STICK. THE COLOR BLACK APPEARS INSIDE THE MOUTH, ON THE EYES AND ARROW.

STRONG HUMAN LIKE CHILE PEPPER WITH A CRAZY FACIAL LOOK, WEARING A HEAD BAND WITH ATTACHED STRAW, CELERY AND ARROW WITH OLIVES, AND A "MP" INITIAL BELT, AS HIS RIGHT FINGER IS POINTED UPWARD AND HIS LEFT HAND IS GIVING THE OK SIGN. THE COLOR GREEN APPEARS ON THE HUMAN-LIKE CHILI PEPPER, STEM, CELERY STICK AND OLIVES. THE COLOR RED APPEARS ON THE RIGHT AND LEFT HAND, FEET, TONGUE, "MP" BELT, STRIPED STRAW, AND OLIVES. THE COLOR WHITE APPEARS ON THE EYES, TEETH AND STRIPED STRAW. THE COLORS YELLOW, PURPLE AND GRAY APPEARS ON THE "MP" BELT. THE COLOR YELLOW APPEARS ON THE CELERY STICK. THE COLOR BLACK APPEARS INSIDE THE MOUTH, ON THE EYES AND ARROW.

CLASS 30—STAPLE FOODS

FOR MARINADE SAUCE SPICE CONCENTRATE USED AS A CONDIMENT FOR FOODS (U.S. CL. 46).
FIRST USE 7-29-2003; IN COMMERCE 7-29-2003.

CLASS 32—LIGHT BEVERAGES

FOR NON-ALCOHOLIC BLOODY MARY COCKTAIL MIXES COMPRISED OF MARINADE SAUCE SPICE CONCENTRATE (U.S. CLS. 45, 46 AND 48).
FIRST USE 7-29-2003; IN COMMERCE 7-29-2003.
DAVID TAYLOR, EXAMINING ATTORNEY

SN 76-547,940. S.H. ROWAT ENTERPRISES LTD., PRE-SCOTT, ONTARIO, CANADA, FILED 9-29-2003.

COMMON GOALS

PRIORITY CLAIMED UNDER SEC. 44(D) ON CANADA APPLICATION NO. 1,188,430, FILED 9-5-2003, REG. NO. TMA622,764, DATED 10-19-2004, EXPIRES 10-19-2019.

CLASS 9—ELECTRICAL AND SCIENTIFIC APPARATUS

FOR COMPUTER SOFTWARE FOR CLIENT RELATIONSHIP MANAGEMENT, SALES FORCE AUTOMATION AND ACCOUNTING (U.S. CLS. 21, 23, 26, 36 AND 38).

CLASS 41—EDUCATION AND ENTERTAINMENT

FOR COMPUTER SOFTWARE TRAINING SERVICES REGARDING SOFTWARE FOR CLIENT RELATIONSHIP MANAGEMENT, SALES FORCE AUTOMATION AND ACCOUNTING (U.S. CLS. 100, 101 AND 107).

CLASS 42—SCIENTIFIC, COMPUTER AND LEGAL SERVICES

FOR COMPUTER SOFTWARE CONSULTING SERVICES REGARDING CLIENT RELATIONSHIP MANAGEMENT, SALES FORCE AUTOMATION AND ACCOUNTING; TECHNICAL SUPPORT, NAMELY, PROVIDING BACK-UP COMPUTER PROGRAMS AND FACILITIES (U.S. CLS. 100 AND 101).

WILLIAM P. SHANAHAN, EXAMINING ATTORNEY

SN 76-549,880. SOMMERS, GLADYS, EAST BRUNSWICK, NJ. FILED 10-8-2003.



NO CLAIM IS MADE TO THE EXCLUSIVE RIGHT TO USE "PUZZLE PREZZENTS", APART FROM THE MARK AS SHOWN.

THE COLOR RED APPEARS IN THE WORD PUZZLE AND THE REST OF THE MARK IS BLACK. THESE ARE THE ONLY COLORS CLAIMED IN THE DRAWING.

CLASS 9—ELECTRICAL AND SCIENTIFIC APPARATUS

FOR MOUSE PADS AND DECORATIVE MAGNETS (U.S. CLS. 21, 23, 26, 36 AND 38).
FIRST USE 1-14-2004; IN COMMERCE 1-14-2004.

CLASS 16—PAPER GOODS AND PRINTED MATTER

FOR NOTE PADS, PENCILS, AND PENS (U.S. CLS. 2, 5, 22, 23, 29, 37, 38 AND 50).
FIRST USE 1-14-2004; IN COMMERCE 1-14-2004.

CLASS 18—LEATHER GOODS

FOR TOTE BAGS (U.S. CLS. 1, 2, 3, 22 AND 41).
FIRST USE 1-14-2004; IN COMMERCE 1-14-2004.

CLASS 21—HOUSEWARES AND GLASS

FOR MUGS (U.S. CLS. 2, 13, 23, 29, 30, 33, 40 AND 50).
FIRST USE 1-14-2004; IN COMMERCE 1-14-2004.

CLASS 25—CLOTHING

FOR T-SHIRTS AND HATS (U.S. CLS. 22 AND 39).
FIRST USE 1-14-2004; IN COMMERCE 1-14-2004.

CLASS 35—ADVERTISING AND BUSINESS

FOR ONLINE ORDERING SERVICES FEATURING MOUSE PAD, DECORATIVE MAGNETS, NOTE PADS, PENCILS, PENS, TOTE BAGS, MUGS, T-SHIRTS, AND HATS (U.S. CLS. 100, 101 AND 102).

FIRST USE 1-14-2004; IN COMMERCE 1-14-2004.
ELLEN B. AWRICH, EXAMINING ATTORNEY

SN 76-551,210. BUSINESS APPLICATIONS LTD., RANCHO SANTA FE, CA. FILED 9-22-2003.

BIZyCity

THE MARK CONSISTS OF STANDARD CHARACTERS WITHOUT CLAIM TO ANY PARTICULAR FONT, STYLE, SIZE, OR COLOR.

CLASS 38—COMMUNICATION

FOR COMMUNICATION BY ELECTRONIC COMPUTER TERMINALS; COMMUNICATION SERVICES, NAMELY, ELECTRONIC TRANSMISSION OF DATA AND DOCUMENTS AMONG USERS OF COMPUTERS; DATA COMMUNICATION BY ELECTRONIC EMAIL; DELIVERY OF MESSAGES BY ELECTRONIC TRANSMISSION; ELECTRONIC MAIL SERVICES; ELECTRONIC MESSAGE SENDING; ELECTRONIC MESSAGE TRANSMISSION; ELECTRONIC MESSAGE SYSTEM, NAMELY, THE RECORDING AND SUBSEQUENT TRANSMISSION OF VOICE MESSAGES BY TELEPHONE; ELECTRONIC STORE-AND-FORWARD MESSAGING; ELECTRONIC TRANSMISSION OF MESSAGES AND DATA; E-MAIL FORWARDING SERVICES; PROVIDING E-MAIL SERVICES (U.S. CLS. 100, 101 AND 104).

FIRST USE 7-13-2003; IN COMMERCE 9-8-2003.

CLASS 42—SCIENTIFIC, COMPUTER AND LEGAL SERVICES

FOR COMPUTER SERVICES, NAMELY, CREATING AND MAINTAINING WEB SITE FOR OTHERS; CREATING AND MAINTAINING WEB STOREFRONTS; COMPUTER SERVICES, NAMELY, REDIRECTING ELECTRONIC MAIL TO CHANGED PERSONAL ELECTRONIC ADDRESS (U.S. CLS. 100 AND 101).

FIRST USE 7-13-2003; IN COMMERCE 9-8-2003.
MARK SPARACINO, EXAMINING ATTORNEY

SN 76-553,124. BAR B QUE SPECIALTIES, INC., GRAFTON, NE. FILED 10-2-2003.

**THE AUTHORITY IN BAR B
QUE!**

NO CLAIM IS MADE TO THE EXCLUSIVE RIGHT TO USE BARBECUE, APART FROM THE MARK AS SHOWN.

CLASS 4—LUBRICANTS AND FUELS

FOR CHARCOAL BRIQUETTES, LUMP CHARCOAL AND CORN COB PIECES FOR USE IN GRILLING (U.S. CLS. 1, 6 AND 15).

CLASS 30—STAPLE FOODS

FOR SEASONINGS, SAUCES, BARBECUE SAUCES AND SPICES (U.S. CL. 46).
KEVON CHISOLM, EXAMINING ATTORNEY

SN 76-553,741. GENNUM CORPORATION, BURLINGTON, ONTARIO L7R 3Y3, CANADA, FILED 10-6-2003.



PRIORITY CLAIMED UNDER SEC. 44(D) ON CANADA APPLICATION NO. 1186950, FILED 8-8-2003.

CLASS 10—MEDICAL APPARATUS

FOR HEARING INSTRUMENTS, NAMELY, HEARING AIDS AND PARTS THEREFOR (U.S. CLS. 26, 39 AND 44).

CLASS 42—SCIENTIFIC, COMPUTER AND LEGAL SERVICES

FOR DESIGN AND DEVELOPMENT OF INTEGRATED CIRCUITS AND COMPONENTS AND HIGH-FIDELITY DIGITAL TECHNOLOGY, ALL FOR HEARING AIDS (U.S. CLS. 100 AND 101).

NICHOLAS ALTREE, EXAMINING ATTORNEY

SN 76-554,849. HUNT, CARRIE L., FLORENCE, MT. FILED 10-14-2003.

**WIND RIVER KARELIAN
BEAR DOGS**

NO CLAIM IS MADE TO THE EXCLUSIVE RIGHT TO USE "KARELIAN BEAR DOGS", APART FROM THE MARK AS SHOWN.

CLASS 41—EDUCATION AND ENTERTAINMENT

FOR TRAINING OF KARELIAN BEAR DOGS TO BE USED BY OTHERS IN CONNECTION WITH GUIDING BEARS AND PROTECTING THEM BY REDUCING CONFLICTS BETWEEN HUMANS AND BEARS (U.S. CLS. 100, 101 AND 107).

CLASS 42—SCIENTIFIC, COMPUTER AND LEGAL SERVICES

FOR TESTING, ANALYSIS AND EVALUATION OF KARELIAN BEAR DOGS TO BE USED BY OTHERS IN CONNECTION WITH GUIDING BEARS AND PROTECTING THEM BY REDUCING CONFLICTS BETWEEN HUMANS AND BEARS (U.S. CLS. 100 AND 101).

CLASS 44—MEDICAL, BEAUTY AND AGRICULTURAL SERVICES

FOR BREEDING OF KARELIAN BEAR DOGS (U.S. CLS. 100 AND 101).
LAURA KOVAISKY, EXAMINING ATTORNEY

SN 76-557,674. JOYSOUL CORPORATION, LISBON, ND.
FILED 10-23-2003.

GOD IS FOR EVERY DAY**CLASS 9—ELECTRICAL AND SCIENTIFIC APPARATUS**

FOR PRE-RECORDED AUDIO AND VIDEO CASSETTES AND CD'S FEATURING RELIGIOUSLY ORIENTED STORIES AND SONGS (U.S. CLS. 21, 23, 26, 36 AND 38).

CLASS 16—PAPER GOODS AND PRINTED MATTER

FOR CHILDREN'S ACTIVITY BOOKS, CHILDREN'S BOOKS, SHEET MUSIC AND BOOKS CONTAINING MUSIC (U.S. CLS. 2, 5, 22, 23, 29, 37, 38 AND 50).
JENNIFER CHICOSKI, EXAMINING ATTORNEY

SN 76-557,690. NATIONAL ASSOCIATION OF MUSIC MERCHANTS, INC., CARLSBAD, CA. FILED 11-5-2003.

BELIEVE IN MUSIC

THE MARK CONSISTS OF STANDARD CHARACTERS WITHOUT CLAIM TO ANY PARTICULAR FONT, STYLE, SIZE, OR COLOR.

CLASS 16—PAPER GOODS AND PRINTED MATTER

FOR (BASED ON INTENT TO USE) PENS AND PRINTED EDUCATIONAL AND INFORMATIONAL MATERIALS FOR THE MUSIC PRODUCTS INDUSTRY, NAMELY, BOOKS, MANUALS, JOURNALS, PAMPHLETS, AND BULLETINS PROMOTING THE PHYSICAL, PSYCHOLOGICAL AND SOCIAL BENEFITS OF MAKING MUSIC (U.S. CLS. 2, 5, 22, 23, 29, 37, 38 AND 50).

CLASS 25—CLOTHING

FOR (BASED ON INTENT TO USE) CLOTHING AND HEADGEAR, NAMELY, HATS AND CAPS, BANDANNAS, T-SHIRTS, SWEATSHIRTS, SHIRTS AND JACKETS (U.S. CLS. 22 AND 39).

CLASS 35—ADVERTISING AND BUSINESS

FOR (BASED ON USE IN COMMERCE) ARRANGING AND CONDUCTING TRADE SHOW EXHIBITIONS AND CONVENTIONS IN THE FIELD OF THE MUSIC PRODUCTS INDUSTRY, IN ORDER TO FURTHER THE INTERESTS OF MUSIC MANUFACTURERS AND DISTRIBUTORS (U.S. CLS. 100, 101 AND 102).
FIRST USE 9-1-2003; IN COMMERCE 9-1-2003.

CLASS 41—EDUCATION AND ENTERTAINMENT

FOR (BASED ON INTENT TO USE) EDUCATIONAL SERVICES, NAMELY, CONDUCTING WORKSHOPS AND SEMINARS CONCERNING SALES STRATEGIES AND MARKETING TECHNIQUES FOR THE MUSIC PRODUCTS INDUSTRY AND DISTRIBUTING EDUCATIONAL MATERIALS IN CONNECTION THEREWITH (U.S. CLS. 100, 101 AND 107).
DAVID H. STINE, EXAMINING ATTORNEY

SN 76-559,551. ROSENCRANTZ, LYNN, LAS VEGAS, NV.
FILED 10-27-2003.



THE NAME "LYNNIMER" IDENTIFIES A LIVING INDIVIDUAL WHOSE CONSENT IS OF RECORD.

THE MARK CONSISTS OF A SILHOUETTE OF A LITTLE GIRL WITH A HEART, AND A JUMP ROPE ALONG WITH THE WORDS LYNNIMER AN INNER CHILD.

CLASS 16—PAPER GOODS AND PRINTED MATTER

FOR SERIES OF CHILDREN'S BOOKS, JOURNALS FEATURING ACTIVITY PAGES ADDRESSING A PERSON'S DAILY FEELINGS WITH THEIR INNER CHILD, CALENDAR, PRINTED FLASHCARDS FEATURING AFFIRMATION STATEMENTS WITH FLASHCARD HOLDER AND PEN, GREETING CARDS, STATIONERY SETS COMPRISING OF STATIONERY, ENVELOPES AND PEN, BOXED GREETING CARDS, BOOKMARK, PAPER GIFT BAGS WITH JUMP ROPE HANDLES, LETTERHEAD STATIONERY (U.S. CLS. 2, 5, 22, 23, 29, 37, 38 AND 50).
FIRST USE 2-3-2000; IN COMMERCE 9-23-2003.

CLASS 20—FURNITURE AND ARTICLES NOT OTHERWISE CLASSIFIED

FOR FABRIC PILLOW (U.S. CLS. 2, 13, 22, 25, 32 AND 50).
FIRST USE 2-3-2000; IN COMMERCE 9-23-2003.

CLASS 28—TOYS AND SPORTING GOODS

FOR FABRIC DOLL (U.S. CLS. 22, 23, 38 AND 50).
FIRST USE 2-3-2000; IN COMMERCE 9-23-2003.
KATHERINE STOIDES, EXAMINING ATTORNEY

SN 76-561,803. BOLLEA, BROOKE, BELLAIRE, FL. FILED 11-24-2003.

BROOKE HOGAN

THE MARK CONSISTS OF STANDARD CHARACTERS WITHOUT CLAIM TO ANY PARTICULAR FONT, STYLE, SIZE, OR COLOR.

CLASS 3—COSMETICS AND CLEANING PREPARATIONS

FOR HAIR SHAMPOO; HAIR CONDITIONER; HAIR MOUSSE; HAIR CREAM RINSE, SKIN CLEANSING CREAM; FACIAL, HAND, AND BODY CREAM, HAIR LOTION, BODY LOTION, AND SKIN LOTION AND SKIN MOISTURIZER; SCALP CONDITIONER; BUBBLE BATH; BATH OIL; BATH POWDER, NAIL POLISH; NAIL HARDENER; FACIAL SCRUB; FACIAL MASK; TALCUM POWDER; PERFUME; COLOGNE; AFTERSHAVE LOTION; SHAVING CREAM AND SHAVING FOAM; DEODORANT SOAP AND SKIN SOAP; LIQUID SOAP FOR HANDS, FACE, AND BODY; EYE SHADOW, BLUSH, FOUNDATION, ROUGE, FACE POWDER, MASCARA, LIP LINER, EYELINER, COVER STICK, EYEBROW PENCILS, AND LIPSTICK (U.S. CLS. 1, 4, 6, 50, 51 AND 52).

CLASS 9—ELECTRICAL AND SCIENTIFIC APPARATUS

FOR EYEGLASSES, SUNGLASS AND EYEGLASS CASES, CORDS FOR EYEGLASSES AND SUNGLASSES, COMPUTER GAMES; VIDEO GAMES; GAME SOFTWARE; CD ROM ENCODED VIDEO GAME SOFTWARE; DVD ROM ENCODED VIDEO GAME SOFTWARE; MEMORY CARDS FOR VIDEO GAME; PRE-RECORDED SOUND AND VIDEO RECORDINGS NAMELY, CDS, DVDS, AUDIO AND VIDEO TAPES AND CASSETTES, PHONOGRAPH AND DIGITAL FILES FEATURING MUSICAL AND DRAMATIC PERFORMANCES (U.S. CLS. 21, 23, 26, 36 AND 38).

CLASS 14—JEWELRY

FOR JEWELRY, WATCHES, AND CLOCKS, EARRINGS AND EAR CLIPS, CHARMS; ORNAMENTAL PINS; BRACELETS; MEDALS, RINGS, NECKLACES; CUFF LINKS; PENDANTS; BELT BUCKLES OF PRECIOUS METAL (U.S. CLS. 2, 27, 28 AND 50).

CLASS 16—PAPER GOODS AND PRINTED MATTER

FOR BLANK JOURNALS, NOTEPADS, BOOK COVERS, ACTIVITY AND COLORING BOOKS, RUBBER STAMPS, PENS, PENCILS, CASES FOR PENS OR PENCILS, ERASERS, DRAFTING, DRAWING AND UNGRADUATED RULERS, IRON ON TRANSFERS, TEMPORARY TATTOOS, MARKERS, PAPER PARTY DECORATIONS, POSTERS, STICKERS, MOUNTED AND UNMOUNTED PHOTOGRAPHS, BOOKS ON THE TOPIC OF MUSIC, STYLE, ENTERTAINMENT AND FASHION, FAN MAGAZINES AND MAGAZINES ON THE TOPIC OF MUSIC, STYLE, ENTERTAINMENT AND FASHION, COMIC BOOKS, TRADING CARDS, GREETING CARDS, POST CARDS, FOLDERS, NOTEBOOKS, BINDERS, GIFT WRAP, STATIONERY, CALENDARS, DIARIES, SCRAPBOOK ALBUMS, ADDRESS BOOKS, PAINT, CLAY, BEADS OR STRING ART ARTS AND CRAFT KITS, PAINTING SETS, AUTOGRAPH BOOKS, DECALS, PRINTED IRON ON TRANSFERS (U.S. CLS. 2, 5, 22, 23, 29, 37, 38 AND 50).

CLASS 18—LEATHER GOODS

FOR PURSES, BACKPACKS, FANNY PACKS, DAY-PACKS, HANDBAGS, SPORTS BAGS, COSMETIC AND HAIR ACCESSORY POUCHES SOLD EMPTY, AND WALLETS (U.S. CLS. 1, 2, 3, 22 AND 41).

CLASS 25—CLOTHING

FOR CLOTHING NAMELY, APPAREL, NAMELY, SHIRTS, BLOUSES, T-SHIRTS, PANTS, SHORTS, OVERALLS, SHORTALLS, CREEPERS, SWEATSHIRTS, SWEATPANTS, JOGGING SUITS, JACKETS, COATS, SKIRTS, DRESSES, JUMPSUITS, JUMPERS, TOPS, SWEATERS, VESTS, MITTENS, GLOVES, RAINCOATS, UNDERWEAR, NIGHT GOWNS, PAJAMAS, ROBES, BOXER SHORTS, UNDERSHIRTS, SPORTS BRAS; LINGERIE, NECKTIES, SWIM WEAR, BATHING SUITS, BEACH WEAR, BEACH COVER UPS; GLOVES, SCARVES, BANDANAS, HEADBANDS, HATS, CAPS, SUSPENDERS, BELTS; TIGHTS, LEOTARDS, SOCKS, LEGGINGS, BOOTIES AND FOOTWEAR (U.S. CLS. 22 AND 39).

CLASS 26—FANCY GOODS

FOR HAIR ORNAMENTS AND ACCESSORY KITS CONTAINING HAIR ORNAMENTS; HAIR CLIPS, SCRUNCHIES, ORNAMENTAL NOVELTY PINS AND ORNAMENTAL NOVELTY BUTTONS (U.S. CLS. 37, 39, 40, 42 AND 50).

CLASS 28—TOYS AND SPORTING GOODS

FOR TOYS, NAMELY, DOLLS, DOLL ACCESSORIES, STUFFED ANIMALS, BASKETBALLS, SPORTS BALLS, BOARD GAMES, JIGSAW PUZZLES, CHRISTMAS TREE ORNAMENTS, TOY TELEPHONES, TOY RADIOS, TOY MICROPHONES, YO-YOS, TOY SCOOTERS, DOLL PLAY SETS, TOY SLIDE VIEWERS; EDUCATIONAL TOYS, NAMELY, ACTIVITY KITS UTILIZING INTERCHANGEABLE DESIGN STICKERS, MANIPULATIVE PUZZLES, PLAYING CARDS (U.S. CLS. 22, 23, 38 AND 50).

CLASS 41—EDUCATION AND ENTERTAINMENT

FOR ENTERTAINMENT SERVICES NAMELY, LIVE PERFORMANCES AND PERSONAL APPEARANCES BY AN ENTERTAINER; LIVE VISUAL AND AUDIO PERFORMANCES BY AN ENTERTAINER IN THE FIELD OF MUSICAL, THEATRICAL AND DRAMATIC ARTS; PROVIDING A WEBSITE FEATURING MUSICAL AND THEATRICAL PERFORMANCES, VIDEOS OF SAME, RELATED FILM CLIPS AND OTHER MULTI-MEDIA MATERIALS (U.S. CLS. 100, 101 AND 107).

JAMES GRIFFIN, EXAMINING ATTORNEY

SN 76-562,183. KOHL'S ILLINOIS, INC., AURORA, IL. FILED 11-13-2003.

STUDENT LOUNGE

THE MARK CONSISTS OF STANDARD CHARACTERS WITHOUT CLAIM TO ANY PARTICULAR FONT, STYLE, SIZE, OR COLOR.

NO CLAIM IS MADE TO THE EXCLUSIVE RIGHT TO USE STUDENT, APART FROM THE MARK AS SHOWN.

CLASS 6—METAL GOODS

FOR METAL SHOWER CURTAIN RINGS (U.S. CLS. 2, 12, 13, 14, 23, 25 AND 50).

CLASS 9—ELECTRICAL AND SCIENTIFIC APPARATUS

FOR BATHROOM SCALES; COMPUTER STANDS, ESPECIALLY DESIGNED FOR HOLDING A COMPUTER, PRINTER AND ACCESSORIES; CD HOLDERS; VENDING MACHINES, NAMELY, COIN OPERATED GUMBALL MACHINES (U.S. CLS. 21, 23, 26, 36 AND 38).

CLASS 20—FURNITURE AND ARTICLES NOT OTHERWISE CLASSIFIED

FOR FLOOR CUSHIONS; FOOT STOOLS; HAMPERS MADE OF FABRIC; NON-METAL SHOWER CURTAIN RINGS, PLANT STANDS, BOOKCASES, FOLDING CHAIRS, HANGING ORGANIZERS DESIGNED TO HOLD APPAREL COMPRISED OF HANGING PLASTIC STORAGE CONTAINERS, PICTURE FRAMES, FURNITURE, NAMELY, TELEVISION STANDS, UNDERBED STORAGE BOXES MADE OF PLASTIC AND/OR FABRIC, DECORATIVE PLASTIC WALL SIGNS; PILLOWS, DECORATIVE PILLOWS AND BODY PILLOWS; BED RESTS, NAMELY, HEAD AND BODY PILLOWS TO BE USED IN BED (U.S. CLS. 2, 13, 22, 25, 32 AND 50).

CLASS 21—HOUSEWARES AND GLASS

FOR WASTE BASKETS MADE OF FABRIC; SHOWER CADDIES; TABLETOP IRON BOARDS; PLASTIC WATER BOTTLES SOLD EMPTY; WASTE BASKETS MADE OF METAL (U.S. CLS. 2, 13, 23, 29, 30, 33, 40 AND 50).

CLASS 24—FABRICS

FOR BED SHEETS; BLANKET THROWS; COMFORTERS, MATTRESS PADS; SHOWER CURTAINS; TOWELS, NAMELY, BATH TOWELS (U.S. CLS. 42 AND 50).

CLASS 27—FLOOR COVERINGS

FOR RUGS (U.S. CLS. 19, 20, 37, 42 AND 50).
JAMES GRIFFIN, EXAMINING ATTORNEY

SN 76-562,251. THE NOURISHING TREE, L.L.C., MAPLEWOOD, NJ. FILED 11-28-2003.

THE NOURISHING TREE

THE MARK CONSISTS OF STANDARD CHARACTERS WITHOUT CLAIM TO ANY PARTICULAR FONT, STYLE, SIZE, OR COLOR.

CLASS 16—PAPER GOODS AND PRINTED MATTER

FOR COOKBOOKS, CATALOGS, BROCHURES, AND PRINTED RECIPE CARDS FEATURING SPECIALTY FOOD ITEMS (U.S. CLS. 2, 5, 22, 23, 29, 37, 38 AND 50).

CLASS 29—MEATS AND PROCESSED FOODS

FOR SPECIALTY FOOD ITEMS, NAMELY, PRESERVED, DRIED, AND COOKED FRUITS AND VEGETABLES; CANNED TOMATOES; JELLIES; JAMS; EDIBLE OILS; PEANUT BUTTER; APPLESAUCE; CRANBERRY SAUCE; PROCESSED EDIBLE NUTS AND PROCESSED EDIBLE SEEDS; AND PROCESSED JARRED GARLIC FOR USE AS A VEGETABLE (U.S. CL. 46).

CLASS 30—STAPLE FOODS

FOR TEAS; FLOURS; DRIED HERBS AND SPICE MIXES; SPICES; MUSTARDS; VINEGARS; MARINADES; SALSA; SAUCES; SALAD DRESSING; DRY PASTA; PROCESSED EDIBLE GRAINS AND GRAIN MIXES; RICE AND RICE MIXES; COUSCOUS; CRACKERS; MIXES FOR MAKING BREAD; BAKERY GOODS; PANCAKES; WAFFLES; BREAD CRUMBS; JARRED MINCED OR CRUSHED GARLIC; JARRED POWDERED GARLIC FOR USE AS A SEASONING; AND CONDIMENTS, NAMELY, MAYONNAISE, KETCHUP, FRUIT AND VEGETABLE RELISHES AND CHUTNEYS (U.S. CL. 46).

CLASS 31—NATURAL AGRICULTURAL PRODUCTS

FOR FRESH, UNPROCESSED EDIBLE NUTS AND SEEDS; AND JARRED FRESH GARLIC (U.S. CLS. 1 AND 46).

CLASS 35—ADVERTISING AND BUSINESS

FOR SHOP AT HOME PARTY SERVICES IN THE FIELD OF SPECIALTY FOOD ITEMS AND PRINTED MATERIALS, NAMELY, COOKBOOKS AND PRINTED RECIPE CARDS, FOR THE PURPOSE OF ASSISTING IN HEALTHFUL EATING; PROVIDING BUSINESS CONSULTATION SERVICES IN THE ESTABLISHMENT AND OPERATION OF INDEPENDENT BUSINESSES SPECIALIZING IN THE SALE OF SPECIALTY FOOD ITEMS AND PRINTED MATERIALS, NAMELY, COOKBOOKS AND PRINTED RECIPE CARDS, FOR THE PURPOSE OF ASSISTING IN HEALTHFUL EATING; ELECTRONIC CATALOG ORDERING SERVICES FEATURING SPECIALTY FOOD ITEMS; MAIL ORDER CATALOG ORDERING SERVICES FEATURING SPECIALTY FOOD ITEMS, AND CATALOG ORDERING SERVICES PROVIDED BY INDEPENDENT SALES REPRESENTATIVES FEATURING SPECIALTY FOOD ITEMS (U.S. CLS. 100, 101 AND 102).

BARBARA A. LOUGHRAN, EXAMINING ATTORNEY

SN 76-562,331. AMERICAN HEART ASSOCIATION, INC., DALLAS, TX. FILED 12-1-2003.

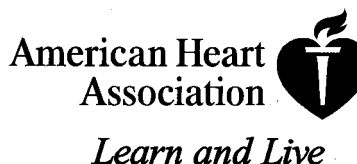

OWNER OF U.S. REG. NOS. 1,091,140, 2,072,127 AND OTHERS.
SEC. 2(F) AS TO "AMERICAN HEART ASSOCIATION".

CLASS 9—ELECTRICAL AND SCIENTIFIC APPARATUS

FOR EDUCATIONAL COMPUTER SOFTWARE FEATURING INSTRUCTION IN THE FIELD OF CARDIOVASCULAR HEALTH, FITNESS, NUTRITION, AND/OR PREVENTION OR REDUCTION OF CARDIOVASCULAR DISEASE AND STROKE (U.S. CLS. 21, 23, 26, 36 AND 38).

CLASS 16—PAPER GOODS AND PRINTED MATTER

FOR PRINTED PAMPHLETS, BROCHURES, MANUALS, BOOKS, COOKBOOKS, BOOKLETS, LEAFLETS, FLYERS, WALLET CARDS, POSTERS, INFORMATIONAL SHEETS AND NEWSLETTERS, RESEARCH MONOGRAPHS, JOURNAL REPRINTS, CHARTS, DIAGRAMS, POSTERS, ADHESIVE BACKED STICKERS, AND KITS COMPRISING ONE OR MORE OF THE FOREGOING MATERIALS, ALL RELATING TO THE PROMOTION OF CARDIOVASCULAR HEALTH, FITNESS AND NUTRITION, AND/OR THE PREVENTION OR REDUCTION OF CARDIOVASCULAR DISEASE AND STROKE (U.S. CLS. 2, 5, 22, 23, 29, 37, 38 AND 50).

CLASS 35—ADVERTISING AND BUSINESS

FOR ASSOCIATION SERVICES, NAMELY, PROMOTING CARDIOVASCULAR HEALTH, FITNESS AND NUTRITION AND/OR THE PREVENTION OR REDUCTION OF CARDIOVASCULAR DISEASE AND STROKE; PROMOTING PUBLIC AWARENESS OF THE NEED FOR COMMUNITY EDUCATION IN THE FIELD OF CARDIOVASCULAR HEALTH, FITNESS AND NUTRITION AND/OR PREVENTION OR REDUCTION OF CARDIOVASCULAR DISEASE AND STROKE; PROMOTING RESEARCH IN THE FIELD OF CARDIOVASCULAR HEALTH, FITNESS AND NUTRITION AND/OR PREVENTION OR REDUCTION OF CARDIOVASCULAR DISEASE AND STROKE (U.S. CLS. 100, 101 AND 102).

CLASS 36—INSURANCE AND FINANCIAL

FOR CHARITABLE FUND-RAISING SERVICES FOR PROMOTING RESEARCH, EDUCATION AND OTHER ACTIVITIES RELATING TO CARDIOVASCULAR HEALTH, FITNESS AND NUTRITION, AND OR THE PREVENTION OR REDUCTION OF CARDIOVASCULAR DISEASE AND STROKE; PROMOTING MEMORIAL DONATIONS TO CARDIOVASCULAR CHARITY (U.S. CLS. 100, 101 AND 102).

CLASS 41—EDUCATION AND ENTERTAINMENT

FOR EDUCATIONAL SERVICES, NAMELY, CONDUCTING SEMINARS, COURSES, CONFERENCES AND SCIENTIFIC SESSION MEETINGS, LECTURES AND WORKSHOPS, PRODUCING RADIO AND TELEVISION ADVERTISEMENTS RELATING TO CARDIOVASCULAR HEALTH, FITNESS AND NUTRITION, AND/OR PREVENTION OR REDUCTION OF CARDIOVASCULAR DISEASE AND STROKE (U.S. CLS. 100, 101 AND 107).

KELLY BOULTON, EXAMINING ATTORNEY

SN 76-562,525. ORBSEAL LLC, RICHMOND, MO. FILED 11-19-2003.

OPAAS

THE MARK CONSISTS OF STANDARD CHARACTERS WITHOUT CLAIM TO ANY PARTICULAR FONT, STYLE, SIZE, OR COLOR.

CLASS 1—CHEMICALS

FOR ADHESIVES FOR USE IN THE AUTOMOTIVE INDUSTRY AND DURING AUTOMOBILE ASSEMBLY; AUTOMATED OR ROBOTICALLY APPLIED ADHESIVES FOR USE IN THE AUTOMOTIVE INDUSTRY AND DURING AUTOMOBILE ASSEMBLY (U.S. CLS. 1, 5, 6, 10, 26 AND 46).

CLASS 7—MACHINERY

FOR AUTOMATED OR ROBOTIC EQUIPMENT FOR APPLYING ADHESIVES, COATINGS, SEALANTS AND SOUND ABATEMENT MATERIALS FOR USE IN THE AUTOMOTIVE INDUSTRY AND DURING AUTOMOBILE ASSEMBLY, NAMELY, INDUSTRIAL ROBOTS (U.S. CLS. 13, 19, 21, 23, 31, 34 AND 35).

ROBERT LORENZO, EXAMINING ATTORNEY

SN 76-562,661. MEDIAVAST, INC., NEW YORK, NY. FILED 12-2-2003.

FILMMAGIC

THE MARK CONSISTS OF STANDARD CHARACTERS WITHOUT CLAIM TO ANY PARTICULAR FONT, STYLE, SIZE, OR COLOR.

CLASS 38—COMMUNICATION

FOR ELECTRONIC DELIVERY OF IMAGES, PHOTOGRAPHS, ART, GRAPHIC IMAGES AND GRAPHIC DESIGNS, CLIP ART, NEWS IMAGES, ILLUSTRATIONS, DIGITAL ANIMATION, VIDEO CLIPS, FILM FOOTAGE, AND AUDIO DATA VIA A GLOBAL COMPUTER NETWORK AND OTHER COMPUTER NETWORKS (U.S. CLS. 100, 101 AND 104).

FIRST USE 8-29-2002; IN COMMERCE 8-29-2002.

CLASS 41—EDUCATION AND ENTERTAINMENT

FOR PHOTOGRAPHY SERVICES; NEWS PRESS AGENCY SERVICES, NAMELY, GATHERING AND DISSEMINATION OF PHOTOGRAPHS AND IMAGES RELATED TO CELEBRITIES, FASHION, AND ENTERTAINMENT NEWS TO OTHER MEDIA (U.S. CLS. 100, 101 AND 107).

FIRST USE 8-29-2002; IN COMMERCE 8-29-2002.

CLASS 42—SCIENTIFIC, COMPUTER AND LEGAL SERVICES

FOR STOCK PHOTOGRAPHY SERVICES, NAMELY, LICENSING OF INTELLECTUAL PROPERTY REPRODUCTION RIGHTS TO PHOTOGRAPHS AND IMAGES RELATED TO CELEBRITIES, FASHION, AND ENTERTAINMENT NEWS, CELEBRITY PORTRAITS, ART, GRAPHIC IMAGES AND GRAPHIC DESIGNS, CLIP ART, ILLUSTRATIONS, VIDEO CLIPS, FILM FOOTAGE, AND AUDIOVISUAL DATA (U.S. CLS. 100 AND 101).

FIRST USE 8-29-2002; IN COMMERCE 8-29-2002.
ESTHER A. BORSUK, EXAMINING ATTORNEY

SN 76-562,662. MEDIAVAST, INC., NEW YORK, NY. FILED 12-2-2003.

WIREIMAGESTOCK

THE MARK CONSISTS OF STANDARD CHARACTERS WITHOUT CLAIM TO ANY PARTICULAR FONT, STYLE, SIZE, OR COLOR.

CLASS 38—COMMUNICATION

FOR ELECTRONIC DELIVERY OF IMAGES, PHOTOGRAPHS, ART, GRAPHIC IMAGES AND GRAPHIC DESIGNS, CLIP ART, NEWS IMAGES, ILLUSTRATIONS, DIGITAL ANIMATION, VIDEO CLIPS, FILM FOOTAGE, AND AUDIO DATA VIA A GLOBAL COMPUTER NETWORK AND OTHER COMPUTER NETWORKS (U.S. CLS. 100, 101 AND 104).

FIRST USE 6-30-2003; IN COMMERCE 6-30-2003.

CLASS 41—EDUCATION AND ENTERTAINMENT

FOR PHOTOGRAPHY SERVICES; NEWS PRESS AGENCY SERVICES, NAMELY GATHERING AND DISSEMINATION OF PHOTOGRAPHS AND IMAGES TO OTHER MEDIA (U.S. CLS. 100, 101 AND 107).

FIRST USE 6-30-2003; IN COMMERCE 6-30-2003.

CLASS 42—SCIENTIFIC, COMPUTER AND LEGAL SERVICES

FOR STOCK PHOTOGRAPHY SERVICES, NAMELY, LICENSING OF INTELLECTUAL PROPERTY REPRODUCTION RIGHTS TO PHOTOGRAPHS, ART, GRAPHIC IMAGES AND GRAPHIC DESIGNS, CLIP ART, ILLUSTRATIONS, VIDEO CLIPS, FILM FOOTAGE, AND AUDIOVISUAL DATA (U.S. CLS. 100 AND 101).

FIRST USE 6-30-2003; IN COMMERCE 6-30-2003.

ESTHER A. BORSUK, EXAMINING ATTORNEY

SN 76-562,676. MEDIAVAST, INC., NEW YORK, NY. FILED 12-2-2003.

MEDIAVAST

THE MARK CONSISTS OF STANDARD CHARACTERS WITHOUT CLAIM TO ANY PARTICULAR FONT, STYLE, SIZE, OR COLOR.

CLASS 35—ADVERTISING AND BUSINESS

FOR AGENCY SERVICES, NAMELY A TALENT AGENCY THAT REPRESENTS AND PROMOTES PHOTOGRAPHERS - PROMOTING THE SERVICES OF PHOTOGRAPHERS IN THE MEDIA, NAMELY VIA THE INTERNET AND PRINT; PROVIDING BUSINESS MANAGEMENT AND BUSINESS CONSULTATION SERVICES FOR PHOTOGRAPHERS; AND SERVING AS PUBLICITY AGENTS FOR PHOTOGRAPHERS (U.S. CLS. 100, 101 AND 102).

FIRST USE 3-1-2001; IN COMMERCE 3-1-2001.

CLASS 38—COMMUNICATION

FOR ELECTRONIC DELIVERY OF IMAGES, PHOTOGRAPHS, ART, GRAPHIC IMAGES AND GRAPHIC DESIGNS, CLIP ART, NEWS IMAGES, ILLUSTRATIONS, DIGITAL ANIMATION, VIDEO CLIPS, FILM FOOTAGE, AND AUDIO DATA VIA A GLOBAL COMPUTER NETWORK AND OTHER COMPUTER NETWORKS (U.S. CLS. 100, 101 AND 104).

FIRST USE 3-1-2001; IN COMMERCE 3-1-2001.

CLASS 41—EDUCATION AND ENTERTAINMENT

FOR PHOTOGRAPHY SERVICES; NEWS PRESS AGENCY SERVICES, NAMELY, GATHERING AND DISSEMINATION OF PHOTOGRAPHS AND IMAGES RELATED TO CELEBRITY, ENTERTAINMENT, FASHION, SPORTS, AND NEWS TO OTHER MEDIA (U.S. CLS. 100, 101 AND 107).

FIRST USE 3-1-2001; IN COMMERCE 3-1-2001.

CLASS 42—SCIENTIFIC, COMPUTER AND LEGAL SERVICES

FOR STOCK PHOTOGRAPHY SERVICES, NAMELY, LICENSING OF INTELLECTUAL PROPERTY REPRODUCTION RIGHTS TO PHOTOGRAPHS AND IMAGES RELATED TO ENTERTAINMENT, FASHION, SPORTS, AND NEWS, CELEBRITY PORTRAITS, ART, GRAPHIC IMAGES AND GRAPHIC DESIGNS, CLIP ART, ILLUSTRATIONS, VIDEO CLIPS, FILM FOOTAGE, AND AUDIOVISUAL DATA (U.S. CLS. 100 AND 101).

FIRST USE 3-1-2001; IN COMMERCE 3-1-2001.

ESTHER A. BORSUK, EXAMINING ATTORNEY

SN 76-562,685. MEDIAVAST, INC., NEW YORK, NY. FILED 12-2-2003.

WIREIMAGE

THE MARK CONSISTS OF STANDARD CHARACTERS WITHOUT CLAIM TO ANY PARTICULAR FONT, STYLE, SIZE, OR COLOR.

CLASS 38—COMMUNICATION

FOR ELECTRONIC DELIVERY OF IMAGES, PHOTOGRAPHS, ART, GRAPHIC IMAGES AND GRAPHIC DESIGNS, CLIP ART, NEWS IMAGES, ILLUSTRATIONS, DIGITAL ANIMATION, VIDEO CLIPS, FILM FOOTAGE, AND AUDIO DATA VIA A GLOBAL COMPUTER NETWORK AND OTHER COMPUTER NETWORKS (U.S. CLS. 100, 101 AND 104).

FIRST USE 1-1-2001; IN COMMERCE 1-1-2001.

CLASS 41—EDUCATION AND ENTERTAINMENT

FOR PHOTOGRAPHY SERVICES; NEWS PRESS AGENCY SERVICES, NAMELY, GATHERING AND DISSEMINATION OF PHOTOGRAPHS AND IMAGES RELATED TO CELEBRITIES, ENTERTAINMENT, FASHION, SPORTS, AND NEWS TO OTHER MEDIA (U.S. CLS. 100, 101 AND 107).

FIRST USE 1-1-2001; IN COMMERCE 1-1-2001.

CLASS 42—SCIENTIFIC, COMPUTER AND LEGAL SERVICES

FOR STOCK PHOTOGRAPHY SERVICES, NAMELY, LICENSING OF INTELLECTUAL PROPERTY REPRODUCTION RIGHTS TO PHOTOGRAPHS AND IMAGES RELATED TO CELEBRITIES, ENTERTAINMENT, FASHION, SPORTS, AND NEWS, CELEBRITY PORTRAITS, ART, GRAPHIC IMAGES AND GRAPHIC DESIGNS, CLIP ART, ILLUSTRATIONS, VIDEO CLIPS, FILM FOOTAGE, AND AUDIOVISUAL DATA (U.S. CLS. 100 AND 101).

FIRST USE 1-1-2001; IN COMMERCE 1-1-2001.

ESTHER A. BORSUK, EXAMINING ATTORNEY

SN 76-562,688. MEDIAVAST, INC., NEW YORK, NY. FILED 12-2-2003.

CONTOUR PHOTOS

THE MARK CONSISTS OF STANDARD CHARACTERS WITHOUT CLAIM TO ANY PARTICULAR FONT, STYLE, SIZE, OR COLOR.

NO CLAIM IS MADE TO THE EXCLUSIVE RIGHT TO USE PHOTOS, APART FROM THE MARK AS SHOWN.

CLASS 38—COMMUNICATION

FOR ELECTRONIC DELIVERY OF IMAGES, PHOTOGRAPHS, ART, GRAPHIC IMAGES AND GRAPHIC DESIGNS, CLIP ART, NEWS IMAGES, ILLUSTRATIONS, DIGITAL ANIMATION, VIDEO CLIPS, FILM FOOTAGE, AND AUDIO DATA VIA A GLOBAL COMPUTER NETWORK AND OTHER COMPUTER NETWORKS (U.S. CLS. 100, 101 AND 104).

FIRST USE 5-19-2003; IN COMMERCE 5-19-2003.

CLASS 41—EDUCATION AND ENTERTAINMENT

FOR PHOTOGRAPHY SERVICES; NEWS PRESS AGENCY SERVICES, NAMELY, GATHERING AND DISSEMINATION OF CELEBRITY PORTRAITS AND PHOTOGRAPHS RELATED TO FASHION AND ENTERTAINMENT TO OTHER MEDIA (U.S. CLS. 100, 101 AND 107).

FIRST USE 5-19-2003; IN COMMERCE 5-19-2003.

CLASS 42—SCIENTIFIC, COMPUTER AND LEGAL SERVICES

FOR STOCK PHOTOGRAPHY SERVICES, NAMELY, LICENSING OF INTELLECTUAL PROPERTY REPRODUCTION RIGHTS TO CELEBRITY PORTRAITS AND PHOTOGRAPHS RELATED TO FASHION AND ENTERTAINMENT (U.S. CLS. 100 AND 101).

FIRST USE 5-19-2003; IN COMMERCE 5-19-2003.
ESTHER A. BORSUK, EXAMINING ATTORNEY

SN 76-563,657. SSM HEALTH CARE OF OKLAHOMA, INC., OKLAHOMA CITY, OK. FILED 11-24-2003.

BONE & JOINT HOSPITAL

THE MARK CONSISTS OF STANDARD CHARACTERS WITHOUT CLAIM TO ANY PARTICULAR FONT, STYLE, SIZE, OR COLOR.

NO CLAIM IS MADE TO THE EXCLUSIVE RIGHT TO USE "HOSPITAL", APART FROM THE MARK AS SHOWN. SEC. 2(F).

CLASS 41—EDUCATION AND ENTERTAINMENT

FOR EDUCATIONAL SERVICES, NAMELY LECTURES AND SEMINARS RELATED TO HEALTH CARE, AND THE DISSEMINATION OF PRINTED MATERIALS IN CONNECTION THEREWITH (U.S. CLS. 100, 101 AND 107).

FIRST USE 1-1-1939; IN COMMERCE 1-1-1939.

CLASS 44—MEDICAL, BEAUTY AND AGRICULTURAL SERVICES

FOR HEALTHCARE AND HOSPITAL CARE SERVICES (U.S. CLS. 100 AND 101).

FIRST USE 1-1-1939; IN COMMERCE 1-1-1939.
KATHY DE JONGE, EXAMINING ATTORNEY

SN 76-563,715. ADVANTA CORP., SPRING HOUSE, PA. FILED 11-24-2003.



OWNER OF U.S. REG. NOS. 1,484,579, 2,732,354 AND OTHERS.

NO CLAIM IS MADE TO THE EXCLUSIVE RIGHT TO USE "MOBILE", APART FROM THE MARK AS SHOWN.

CLASS 35—ADVERTISING AND BUSINESS

FOR ON-LINE AND WIRELESS CREDIT CARD REGISTRATION SERVICES (U.S. CLS. 100, 101 AND 102).

FIRST USE 9-0-2001; IN COMMERCE 9-0-2001.

CLASS 36—INSURANCE AND FINANCIAL

FOR ON-LINE BANKING SERVICES; ON-LINE CREDIT CARD SERVICES; ON-LINE ELECTRONIC CREDIT CARD TRANSACTIONS; ON-LINE CREDIT CARD TRANSACTION PROCESSING SERVICES; WIRELESS BANKING SERVICES; WIRELESS CREDIT CARD SERVICES; WIRELESS ELECTRONIC CREDIT CARD TRANSACTIONS; WIRELESS CREDIT CARD TRANSACTION PROCESSING SERVICES (U.S. CLS. 100, 101 AND 102).

FIRST USE 9-0-2001; IN COMMERCE 9-0-2001.

MICHAEL WEBSTER, EXAMINING ATTORNEY

SN 76-563,716. ADVANTA CORP., SPRING HOUSE, PA. FILED 11-24-2003.

MOBILE ADVANTA

OWNER OF U.S. REG. NOS. 1,484,579, 2,732,354 AND OTHERS.

NO CLAIM IS MADE TO THE EXCLUSIVE RIGHT TO USE "MOBILE", APART FROM THE MARK AS SHOWN.

CLASS 35—ADVERTISING AND BUSINESS

FOR ON-LINE AND WIRELESS CREDIT CARD REGISTRATION SERVICES (U.S. CLS. 100, 101 AND 102).

FIRST USE 9-0-2001; IN COMMERCE 9-0-2001.

CLASS 36—INSURANCE AND FINANCIAL

FOR ON-LINE BANKING SERVICES; ON-LINE CREDIT CARD SERVICES; ON-LINE ELECTRONIC CREDIT CARD TRANSACTIONS; ON-LINE CREDIT CARD TRANSACTION PROCESSING SERVICES; WIRELESS BANKING SERVICES; WIRELESS CREDIT CARD SERVICES; WIRELESS ELECTRONIC CREDIT CARD TRANSACTIONS; WIRELESS CREDIT CARD TRANSACTION PROCESSING SERVICES (U.S. CLS. 100, 101 AND 102).

FIRST USE 9-0-2001; IN COMMERCE 9-0-2001.
MICHAEL WEBSTER, EXAMINING ATTORNEY

SN 76-564,073. SPORTS & LEISURE TECHNOLOGY CORP.,
YONKERS, NY. FILED 12-8-2003.

WALKING SHOP

THE MARK CONSISTS OF STANDARD CHARACTERS WITHOUT CLAIM TO ANY PARTICULAR FONT, STYLE, SIZE, OR COLOR.

NO CLAIM IS MADE TO THE EXCLUSIVE RIGHT TO USE SHOP, APART FROM THE MARK AS SHOWN.

CLASS 9—ELECTRICAL AND SCIENTIFIC APPARATUS

FOR REFLECTIVE SAFETY VESTS, ARMBANDS, ANKLE BANDS AND SHOE BANDS TO BE WORN ON THE BODY, FLASHING SAFETY LIGHTS AND PEDOMETERS (U.S. CLS. 21, 23, 26, 36 AND 38).

CLASS 28—TOYS AND SPORTING GOODS

FOR EXERCISE ACCESSORIES, NAMELY, ADJUSTABLE ANKLE WEIGHTS, TORSO WEIGHTS, WEIGHTED BELTS, EXERCISE BELT WITH RESISTANT TUBING AND O RING WEIGHTS (U.S. CLS. 22, 23, 38 AND 50).

BARBARA BROWN, EXAMINING ATTORNEY

SN 76-564,736. KNOWLEDGE & MERCHANDISING, INC.
LIMITED, CHESHAM, BUCKINGHAMSHIRE HP5 2PX,
UNITED KINGDOM, FILED 12-11-2003.

KING OF SHAVERS

THE MARK CONSISTS OF STANDARD CHARACTERS WITHOUT CLAIM TO ANY PARTICULAR FONT, STYLE, SIZE, OR COLOR.

OWNER OF U.S. REG. NO. 2,173,312.

CLASS 3—COSMETICS AND CLEANING PREPARATIONS

FOR TOILETRIES, NAMELY, PERSONAL DEODORANTS, BODY CREAM, AND TOOTH GEL; BODY DEODORANT, SHOWER GEL; SKIN CLEANSERS; BODY WASH, FACIAL CLEANSER, FACIAL SCRUB, FACIAL WASH; ANTI-BACTERIAL AND MEDICATED FACE, HAND AND SKIN SOAPS; NON-MEDICATED SKIN CARE PREPARATIONS; BODY MIST SPRAY, SPOT REMOVAL STICKS; SKIN MOISTURIZERS; BODY LOTION, BODY MOISTURIZER, FACIAL MOISTURIZER; SHAVING GEL; SHAVING PREPARATIONS; SHAVING OIL, SHAVING FOAM, SHAVING SPRITZ, SHAVING SOAP, SHAVING STONES; AFTER-SHAVE PREPARATIONS; AFTER-SHAVE GEL, AFTER-SHAVE BALM; HAIR REMOVAL PREPARATIONS AND CREAMS, DEPILATORY PREPARATIONS, DEPILATORY WAX; HAIR CARE PREPARATIONS; SHAMPOO, CONDITIONER, HAIR GEL, HAIR SPRITZ, AND HAIRSPRAY; PERFUMERY; EAU DE TOILETTE; ESSENTIAL OILS FOR PERSONAL USE; COSMETICS; DENTIFRICES (U.S. CLS. 1, 4, 6, 50, 51 AND 52).

CLASS 8—HAND TOOLS

FOR CUTTING AND EDGED TOOLS AND IMPLEMENTS, ALL BEING HAND OPERATED, NAMELY, RAZORS; SAFETY RAZORS; ELECTRIC SHAVERS; DRY SHAVERS; BLADES FOR RAZORS; RAZOR BLADE DISPENSERS; CASES FOR RAZORS AND FOR DRY SHAVERS; SCISSORS; PARTS AND FITTINGS FOR THE AFORESAID GOODS (U.S. CLS. 23, 28 AND 44).

RAUL CORDOVA, EXAMINING ATTORNEY

SN 76-565,323. STANDARD MOTOR PRODUCTS, INC.,
LEWISVILLE, TX. FILED 12-15-2003.

GENUINE AIR

THE MARK CONSISTS OF STANDARD CHARACTERS WITHOUT CLAIM TO ANY PARTICULAR FONT, STYLE, SIZE, OR COLOR.

SEC. 2(F).

CLASS 7—MACHINERY

FOR REPLACEMENT PARTS FOR AUTOMOTIVE AIR CONDITIONERS, NAMELY, COMPRESSORS (U.S. CLS. 13, 19, 21, 23, 31, 34 AND 35).

FIRST USE 2-1-1993; IN COMMERCE 2-1-1993.

CLASS 9—ELECTRICAL AND SCIENTIFIC APPARATUS

FOR REPLACEMENT PARTS FOR AUTOMOTIVE HEATING APPARATUS, NAMELY, SWITCHES AND RELAYS, AND REPLACEMENT PARTS FOR AUTOMOTIVE AIR CONDITIONERS, NAMELY, ELECTRIC SWITCHES AND RELAYS (U.S. CLS. 21, 23, 26, 36 AND 38).

FIRST USE 2-1-1993; IN COMMERCE 2-1-1993.

CLASS 11—ENVIRONMENTAL CONTROL APPARATUS

FOR REPLACEMENT PARTS FOR AUTOMOTIVE AIR CONDITIONERS, NAMELY, MOTORS, VALVES, FANS, FAN CLUTCHES, AND DRYERS (U.S. CLS. 13, 21, 23, 31 AND 34).

FIRST USE 2-1-1993; IN COMMERCE 2-1-1993.

CLASS 17—RUBBER GOODS

FOR CONNECTING HOSES FOR VEHICLE HEATING AND VEHICLE AIR CONDITIONING APPARATUS (U.S. CLS. 1, 5, 12, 13, 35 AND 50).

FIRST USE 2-1-1993; IN COMMERCE 2-1-1993.
NORA BUCHANAN WILL, EXAMINING ATTORNEY

SN 76-566,273. APOTHECARY PRODUCTS, INC., BURNSVILLE, MN. FILED 12-11-2003.

SN 76-565,340. EDEN FOODS, INC., CLINTON, MI. FILED 12-16-2003.



OWNER OF U.S. REG. NO. 1,711,940.
NO CLAIM IS MADE TO THE EXCLUSIVE RIGHT TO USE DOUBLE CERTIFIED ORGANICALLY GROWN, APART FROM THE MARK AS SHOWN.

CLASS 29—MEATS AND PROCESSED FOODS

FOR ROASTED ALMONDS (U.S. CL. 46).

CLASS 30—STAPLE FOODS

FOR PROCESSED UNPOPPED POPCORN (U.S. CL. 46).
PAUL F. GAST, EXAMINING ATTORNEY

SN 76-565,346. KRONOTEX FUSSBODEN GMBH & CO. KG, HEILIGENGRABE, FED REP GERMANY, FILED 12-16-2003.

LOFT-CLIC

THE MARK CONSISTS OF STANDARD CHARACTERS WITHOUT CLAIM TO ANY PARTICULAR FONT, STYLE, SIZE, OR COLOR.

CLASS 17—RUBBER GOODS

FOR LAMINATE FOIL CONSISTING PRIMARILY OF PLASTIC WITH OR WITHOUT A METAL LAYER FOR APPLICATION TO A SUBSTRATE (U.S. CLS. 1, 5, 12, 13, 35 AND 50).

CLASS 19—NON-METALLIC BUILDING MATERIALS

FOR NON-METAL BUILDING MATERIALS, NAMELY, PLATES, LEDGES, BARS AND PANELS FOR BUILDING PURPOSES; DERIVED TIMBER PRODUCTS, NAMELY, GLUED PRESS PLATES CONSISTING COMPLETELY OR MAINLY OF WOOD, CHIP BOARDS AND FIBER PLATES FOR BUILDING PURPOSES, PARQUET IN BOARDING AND PARQUET BLOCKS FOR FLOORING; HIGH-PRESSURE LAMINATE FLOORING (U.S. CLS. 1, 12, 33 AND 50).

ANN LINNEHAN, EXAMINING ATTORNEY

FLENTS

THE MARK CONSISTS OF STANDARD CHARACTERS WITHOUT CLAIM TO ANY PARTICULAR FONT, STYLE, SIZE, OR COLOR.

OWNER OF U.S. REG. NOS. 230,234, 854,228 AND 2,350,614.

CLASS 3—COSMETICS AND CLEANING PREPARATIONS

FOR NON-MEDICATED SKIN CARE PRODUCTS, NAMELY, CREAMS, LOTIONS, AND MOISTURIZERS. (U.S. CLS. 1, 4, 6, 50, 51 AND 52).

CLASS 5—PHARMACEUTICALS

FOR MEDICAL ADHESIVE TAPE, BANDAGES, FIRST AID KITS, FIRST AID KITS FOR SNAKE BITES AND TICK REMOVAL, LICE TREATMENT SHAMPOO, LICE CONTROL SPRAY; DENTAL PREPARATIONS, NAMELY, PLAQUE IDENTIFYING TABLETS; ORTHODONTIC WAX; MEDICATED DIAGNOSTIC PH TEST STRIPS FOR DIABETICS; COTTON ALCOHOL SWABS FOR DIABETIC PURPOSES; PRE-MOISTENED SANITIZING WIPES FOR TOILET SEATS; DOUCHE KITS COMPRISED OF WATER BOTTLE, CLAMP, HOSE, BOTTLE ADAPTOR, AND PIPES. (U.S. CLS. 6, 18, 44, 46, 51 AND 52).

CLASS 8—HAND TOOLS

FOR TWEEZERS; NOSE AND EAR HAIR TRIMMERS; NAIL CLIPPERS, NAIL FILES; PET HAIR CLIPPERS; PLASTIC TWEEZERS FOR FLEA AND TICK REMOVAL. (U.S. CLS. 23, 28 AND 44).

CLASS 9—ELECTRICAL AND SCIENTIFIC APPARATUS

FOR FIRE BLANKETS, NAMELY, RESCUE BLANKETS. (U.S. CLS. 21, 23, 26, 36 AND 38).

CLASS 10—MEDICAL APPARATUS

FOR FOOT CARE PRODUCTS, NAMELY, INSOLES, TOE CAPS, PADS, PATCHES, SPLINTS, HEAL CUPS, BUNION SHIELDS, BUNION SLEEVES; THERMAL COLD AND HOT PACKS FOR FIRST AID AND THERAPEUTIC PURPOSES; DENTAL CARE PRODUCTS, NAMELY, DENTAL MIRRORS, IRRIGATING SYRINGES, PLASTIC TONGUE CLEANERS; DIABETIC CARE PRODUCTS, NAMELY, SYRINGE MAGNIFIERS, SPECIMEN CONTAINERS, SYRINGE CARRYING CASES, ALCOHOL APPLICATOR BOTTLES, LANCETS, SYRINGE SAFETY HOLDERS, SYRINGE GUARDS; FIRST AID SUPPLIES AND HEALTH CARE PRODUCTS, NAMELY, EYEWASH CUPS, IRRIGATING EYEWASH BOTTLES, EYE DROPPERS, FINGER GUARDS, FINGER SPLINTS, FINGER SLEEVES, FINGER COTS, THERMOMETERS FOR MEDICAL PURPOSES, EYE PATCHES FOR MEDICAL USE, SEIZURE STICKS FOR USE IN RESTRAINING SEIZURE VICTIMS, TOURNIQUETS; SURGICAL INSTRUMENTS, NAMELY, EXTRACTORS, SURGICAL SCISSORS, SURGICAL TAPE REMOVERS; EYE DROPPER GUIDES, TONGUE DEPRESSORS; STEAM INHALERS FOR THERAPEUTIC USE SOLD EMPTY, EXTERNAL NASAL DILATORS, SPLINTER REMOVAL KITS COMPRISED OF TWEEZERS AND MAGNIFYING GLASS; ORTHOPEDIC PRODUCTS, NAMELY, ARM SLINGS, BANDAGE CLIPS; OTOSCOPES; FILTRATION MASKS FOR MEDICAL USE; PERSONAL CARE PRODUCTS, NAMELY, TOILET SEAT COVERS, TOILET SEAT WIPES, ENEMA KITS COMPRISED OF WATER BOTTLE, CLAMP, HOSE, BOTTLE ADAPTOR AND PIPES; PORTABLE URINALS FOR MEDICAL PURPOSES; RECTAL SYRINGES, MEDICAL ICE PACKS IN THE NATURE OF ICE BAGS, EAR SYRINGES, ENEMA BOTTLES SOLD EMPTY, VAGINAL APPLICATORS, SPECIMEN CUPS, AND BEDPANS; LICE AND LICE EGGS DETECTION KITS COMPRISED OF LICE COMB, CLEANING BRUSH, TWEEZERS, AND MAGNIFYING GLASS; SPECIMEN BOTTLES FOR PET CARE; TABLET CUTTERS FOR PET MEDICATIONS (U.S. CLS. 26, 39 AND 44).

CLASS 21—HOUSEWARES AND GLASS

FOR PET CARE PRODUCTS, NAMELY, BRUSHES AND FLEA AND TICK COMBS; DENTAL CARE PRODUCTS, NAMELY, TOOTHBRUSHES AND TOOTHBRUSH COVERS, TOOTHPICKS, DENTAL FLOSS, TOOTHPASTE TUBE WINDERS (U.S. CLS. 2, 13, 23, 29, 30, 33, 40 AND 50).

CLASS 25—CLOTHING

FOR TRAVEL WRISTBANDS AND HEADACHE HEADBANDS. (U.S. CLS. 22 AND 39).
STEVEN BERK, EXAMINING ATTORNEY

SN 76-566,973. OLD MOTHER HUBBARD, INC., LOWELL, MA. FILED 12-12-2003.

SPIRIT

CLASS 5—PHARMACEUTICALS

FOR VITAMINS FOR DOGS AND CATS, DIETARY SUPPLEMENTS FOR DOGS AND CATS, AND NUTRACEUTICALS FOR USE AS DIETARY SUPPLEMENTS FOR DOGS AND CATS (U.S. CLS. 6, 18, 44, 46, 51 AND 52).

CLASS 31—NATURAL AGRICULTURAL PRODUCTS

FOR PET FOOD FOR DOGS AND CATS AND EDIBLE PET TREATS FOR DOGS AND CATS (U.S. CLS. 1 AND 46).

SUSAN LESLIE DUBOIS, EXAMINING ATTORNEY

SN 76-567,764. THE LAST TWIST, INC., CONSHOHOCKEN, PA. FILED 12-30-2003.

CHUBBY CHECKER'S

THE MARK CONSISTS OF STANDARD CHARACTERS WITHOUT CLAIM TO ANY PARTICULAR FONT, STYLE, SIZE, OR COLOR.

OWNER OF U.S. REG. NO. 2,823,034.

THE NAME CHUBBY CHECKER IDENTIFIES A LIVING INDIVIDUAL WHOSE CONSENT IS OF RECORD.

CLASS 29—MEATS AND PROCESSED FOODS

FOR (BASED ON USE IN COMMERCE) JERKY; (BASED ON INTENT TO USE) HOT DOGS, STEAKS, LAMB CHOPS, PORK CHOPS, VEAL CHOPS, HAMBURGERS, CHICKEN (U.S. CL. 46).

FIRST USE 0-0-1994; IN COMMERCE 0-0-1994.

CLASS 30—STAPLE FOODS

FOR (BASED ON USE IN COMMERCE) POPPED OR PROCESSED POPCORN; (BASED ON INTENT TO USE) CANDY, CHOCOLATE (U.S. CL. 46).

FIRST USE 0-0-1994; IN COMMERCE 0-0-1994.

CLASS 32—LIGHT BEVERAGES

FOR (BASED ON INTENT TO USE) SPRING WATER (U.S. CLS. 45, 46 AND 48).

BRENDAN REGAN, EXAMINING ATTORNEY

SN 76-567,767. THE LAST TWIST, INC., CONSHOHOCKEN, PA. FILED 12-30-2003.



OWNER OF U.S. REG. NO. 2,823,034.

THE NAME CHUBBY CHECKER IDENTIFIES A LIVING INDIVIDUAL WHOSE CONSENT IS OF RECORD.

CLASS 29—MEATS AND PROCESSED FOODS

FOR (BASED ON USE IN COMMERCE) JERKY; (BASED ON INTENT TO USE) HOT DOGS, STEAKS, LAMB CHOPS, PORK CHOPS, VEAL CHOPS, HAMBURGERS, CHICKEN (U.S. CL. 46).

FIRST USE 0-0-1994; IN COMMERCE 0-0-1994.

CLASS 30—STAPLE FOODS

FOR (BASED ON USE IN COMMERCE) POPPED OR PROCESSED POPCORN; (BASED ON INTENT TO USE) CANDY, CHOCOLATE (U.S. CL. 46).

FIRST USE 0-0-1994; IN COMMERCE 0-0-1994.

CLASS 32—LIGHT BEVERAGES

FOR (BASED ON INTENT TO USE) SPRING WATER (U.S. CLS. 45, 46 AND 48).

BRENDAN REGAN, EXAMINING ATTORNEY

SN 76-567,785. THE LAST TWIST, INC., CONSHOHOCKEN, PA. FILED 12-30-2003.



OWNER OF U.S. REG. NO. 2,823,034.
NO CLAIM IS MADE TO THE EXCLUSIVE RIGHT TO USE "SNACKS" AND "FOOD PRODUCTS", APART FROM THE MARK AS SHOWN.

CLASS 29—MEATS AND PROCESSED FOODS

FOR JERKY; HOT DOGS, STEAKS, LAMB CHOPS, PORK CHOPS, VEAL CHOPS, HAMBURGER, CHICKEN (U.S. CL. 46).

CLASS 30—STAPLE FOODS

FOR POPPED OR PROCESSED POPCORN, CANDY, CHOCOLATE (U.S. CL. 46).

CLASS 32—LIGHT BEVERAGES

FOR SPRING WATER (U.S. CLS. 45, 46 AND 48).
BRENDAN REGAN, EXAMINING ATTORNEY

SN 76-567,786. THE ERNEST EVANS CORPORATION, CONSHOHOCKEN, PA. FILED 12-30-2003.

THE ORIGINAL MASTER OF THE DANCE HALL BEAT

THE MARK CONSISTS OF STANDARD CHARACTERS WITHOUT CLAIM TO ANY PARTICULAR FONT, STYLE, SIZE, OR COLOR.

CLASS 9—ELECTRICAL AND SCIENTIFIC APPARATUS

FOR MUSICAL SOUND RECORDINGS; PRE-RECORDED CD'S FEATURING MUSIC (U.S. CLS. 21, 23, 26, 36 AND 38).

CLASS 24—FABRICS

FOR BED LINENS, PILLOW CASES, BED SHEETS, AND TOWELS (U.S. CLS. 42 AND 50).

CLASS 25—CLOTHING

FOR CLOTHING, NAMELY, ANORAKS, APRONS, ASCOTS, BABY BUNTINGS, HEADBANDS, SWEATBANDS, WRISTBANDS, HATS, CAPS, BATHING SUITS, BATHING TRUNKS, BATHROBES, BEACHWEAR, BELTS, BLAZERS, BLOOMERS, BLOUSES, BODYSUITS, FOOTWEAR, BOTTOMS, BRAS, UNDERWEAR, CAMISOLES, COATS, CHAPS, CHEMISES, DRESSES, DRESSING GOWNS, EVENING GOWNS, FOUL WEATHER GEAR, FOUNDATION GARMENTS, JACKETS, GLOVES, GOLF SHIRTS, GOWNS, HATS, HEADWEAR, JOGGING SUITS, JUMP SUITS, LAYETTES, LEGGINGS, LINGERIE, LOUNGE WEAR, MITTENS, MUFFLERS, NECK TIES, NECKWEAR, NIGHTGOWNS, OVERALLS, PAJAMAS, PANTS, PANT SUITS, PANTYHOSE, POLO SHIRTS, VESTS, ROBES, ROMPERS, SCARVES, SARONGS, SHIRTS, SKIRTS, SHOES, SHORT SETS, BOXER SHORTS, GYM SHORTS, SWEAT SHORTS, SKIWEAR, SLACKS, SLEEPWEAR, SNOW PANTS, SNOWSUITS, SOCKS, SPORT COATS, STOCKINGS, STOLETS, SUIT COATS, GYM SUITS, SWEAT SUITS, SUN VISORS, SUSPENDERS, SWEATERS, SWEATSHIRTS, SWEATPANTS, SWEAT SUITS, SWEAT SOCKS, SWIMWEAR, SWIMSUITS, T-SHIRTS, TANK TOPS, TAP PANTS, TEDDIES, TENNIS WEAR, THERMAL UNDERWEAR, TIGHTS, TOPCOATS, TOPS, TROUSERS, TURTLENECKS, TUXEDOS, UNDERGARMENTS, UNDERPANTS, UNDERSHIRTS, UNDERWEAR, WARM-UP SUITS, WIND RESISTANT JACKETS; FOOTWEAR; SPORT FOOTWEAR (U.S. CLS. 22 AND 39).

CLASS 41—EDUCATION AND ENTERTAINMENT

FOR ENTERTAINMENT SERVICES, NAMELY PRODUCTION OF MUSICAL RECORDINGS, OF MUSICAL PERFORMANCES, AND OF OTHER PRESENTATIONS FEATURING MUSICAL PERFORMANCES RENDERED BY A SINGER; ENTERTAINMENT SERVICES, NAMELY PROVIDING INFORMATION RELATING TO MUSICAL PERFORMANCES, TO CHUBBY CHECKER, AND TO HIS MUSIC VIA A GLOBAL COMPUTER NETWORK; ENTERTAINMENT SERVICES, NAMELY PROVIDING LIVE MUSICAL PERFORMANCES, DIRECTION AND PRODUCTION OF PERSONAL MUSICAL PERFORMANCES OF OTHERS; ENTERTAINMENT SERVICES, NAMELY, TOURING PRODUCTIONS FEATURING LIVE MUSICAL PERFORMANCES BY MULTIPLE ARTISTS (U.S. CLS. 100, 101 AND 107).

BRENDAN REGAN, EXAMINING ATTORNEY

SN 76-567,976. WHOLE FOODS MARKET IP, L.P., AUSTIN, TX. FILED 1-2-2004.



OWNER OF U.S. REG. NO. 2,864,719.

CLASS 29—MEATS AND PROCESSED FOODS

FOR EGGS, BUTTER; MEATS; FISH; SEAFOOD; POULTRY; DAIRY PRODUCTS, EXCLUDING ICE CREAM, ICE MILK AND FROZEN YOGURT; LUNCHEON MEATS; PROCESSED MEAT, NAMELY BACON, BEEF, BOLOGNA, CHICKEN, HAM, PORK, SALAMI SAUSAGE, SAUSAGE LINKS, AND TURKEY (U.S. CL. 46).

CLASS 30—STAPLE FOODS

FOR BREAD, BAKERY PRODUCTS, BAKERY DESERTS, AND ROLLS (U.S. CL. 46).
MICHAEL KEATING, EXAMINING ATTORNEY

SN 76-567,977. WHOLE FOODS MARKET IP, L.P., AUSTIN, TX. FILED 1-2-2004.

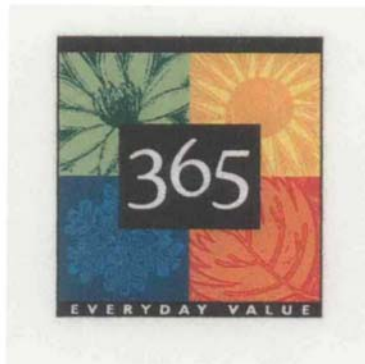

OWNER OF U.S. REG. NO. 2,864,719.
THE COLORS CLAIMED GREEN, YELLOW, BLUE, AND ORANGE.

APPLICANT CLAIMS THE COLORS OF EACH OF THE FOUR SQUARES DEPICTING THE FOUR SEASONS, NAMELY GREEN (TOP LEFT), YELLOW (TOP RIGHT), BLUE (BOTTOM LEFT), AND ORANGE (BOTTOM RIGHT).

CLASS 29—MEATS AND PROCESSED FOODS

FOR EGGS, BUTTER; MEATS; FISH; SEAFOOD; POULTRY; DAIRY PRODUCTS, EXCLUDING ICE CREAM, ICE MILK AND FROZEN YOGURT; LUNCHEON MEATS; PROCESSED MEAT, NAMELY BACON, BEEF, BOLOGNA, CHICKEN, HAM, PORK, SALAMI SAUSAGE, SAUSAGE LINKS, AND TURKEY (U.S. CL. 46).

CLASS 30—STAPLE FOODS

FOR BREAD, BAKERY PRODUCTS, BAKERY DESERTS, AND ROLLS (U.S. CL. 46).
MICHAEL KEATING, EXAMINING ATTORNEY

SN 76-568,241. INTRIVAH, INC., ALTOONA, PA. FILED 12-22-2003.



CLASS 41—EDUCATION AND ENTERTAINMENT

FOR HEALTH CLUB SERVICES, NAMELY, PROVIDING INSTRUCTION AND EQUIPMENT IN THE FIELD OF PHYSICAL EXERCISE AND FITNESS (U.S. CLS. 100, 101 AND 107).

CLASS 44—MEDICAL, BEAUTY AND AGRICULTURAL SERVICES

FOR NUTRITION COUNSELING SERVICES AND PHYSICAL REHABILITATION SERVICES (U.S. CLS. 100 AND 101).
REBECCA SMITH, EXAMINING ATTORNEY

SN 76-568,342. XEROX CORPORATION, STAMFORD, CT. FILED 1-6-2004.

MADE FOR EACH OTHER

THE MARK CONSISTS OF STANDARD CHARACTERS WITHOUT CLAIM TO ANY PARTICULAR FONT, STYLE, SIZE, OR COLOR.

OWNER OF U.S. REG. NO. 1,924,595.

CLASS 2—PAINTS

FOR SOLID INK FOR COMPUTER PRINTERS AND LASER PRINTERS; TONER (U.S. CLS. 6, 11 AND 16).
FIRST USE 4-1-1993; IN COMMERCE 4-1-1993.

CLASS 9—ELECTRICAL AND SCIENTIFIC APPARATUS

FOR PARTS NAMELY FUSERS, FUSER WEBS, FEEDERS, FINISHERS, AND DISK DRIVES, ALL FOR LASER PRINTERS, SOLID INK PRINTERS, PHOTOCOPIERS, AND MULTIFUNCTIONAL DEVICES COMPOSED OF PHOTOCOPIER, PRINTER, OPTICAL CHARACTER RECOGNITION (OCR) SCANNER, FACSIMILE MACHINE (U.S. CLS. 21, 23, 26, 36 AND 38).
FIRST USE 4-1-1993; IN COMMERCE 4-1-1993.

CLASS 16—PAPER GOODS AND PRINTED MATTER

FOR PAPER AND PAPER PRODUCTS, NAMELY COPIER PAPER, PRINTER PAPER, CARD STOCK PAPER NAMELY PAPERBOARD, FOLDERS, LABELS, INDEX DIVIDERS, NOTEBOOK DIVIDERS, CARBONLESS PAPER FOR FORMS AND INVOICES, STAPLES (U.S. CLS. 2, 5, 22, 23, 29, 37, 38 AND 50).
FIRST USE 4-1-1993; IN COMMERCE 4-1-1993.
FRED MANDIR, EXAMINING ATTORNEY

SN 76-569,658. THE WHITE HOUSE COMMISSION ON THE NATIONAL MOMENT OF REMEMBRANCE, WASHINGTON, DC. FILED 1-14-2004.

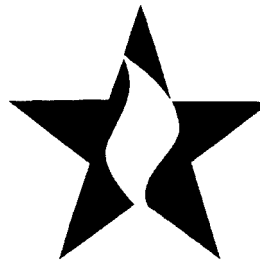

SN 76-569,308. MARTIN, GAIL, SHARON, MA. FILED 12-29-2003.

CLASS 14—JEWELRY

FOR LAPEL PINS (U.S. CLS. 2, 27, 28 AND 50).
FIRST USE 5-0-2000; IN COMMERCE 5-0-2000.

CLASS 16—PAPER GOODS AND PRINTED MATTER

FOR STICKERS; POSTERS; PRINTED CERTIFICATES; PAPER DOOR KNOB HANGERS; CALENDARS; AND PAPER BANNERS (U.S. CLS. 2, 5, 22, 23, 29, 37, 38 AND 50).
FIRST USE 5-0-2001; IN COMMERCE 5-0-2001.

**CLASS 25—CLOTHING**

FOR SHIRTS; HATS; TIES; AND SCARVES (U.S. CLS. 22 AND 39).
FIRST USE 5-0-2001; IN COMMERCE 5-0-2001.

CLASS 26—FANCY GOODS

FOR ORNAMENTAL NOVELTY BUTTONS (U.S. CLS. 37, 39, 40, 42 AND 50).
FIRST USE 5-0-2001; IN COMMERCE 5-0-2001.

CLASS 28—TOYS AND SPORTING GOODS

FOR FLYING DISCS (U.S. CLS. 22, 23, 38 AND 50).
FIRST USE 1-0-2001; IN COMMERCE 1-0-2001.

CLASS 25—CLOTHING

FOR TANK TOPS, HATS, SPORTS JERSEYS, SWEAT PANTS AND SWEAT SHIRTS (U.S. CLS. 22 AND 39).
FIRST USE 10-16-2003; IN COMMERCE 10-16-2003.

CLASS 44—MEDICAL, BEAUTY AND AGRICULTURAL SERVICES

FOR MASSAGE SERVICES (U.S. CLS. 100 AND 101).
FIRST USE 10-16-2003; IN COMMERCE 10-16-2003.
KIMBERLY PERRY, EXAMINING ATTORNEY

CLASS 35—ADVERTISING AND BUSINESS

FOR PROMOTING PUBLIC AWARENESS OF THE RELEVANCE AND LEGACY OF MEMORIAL DAY; PROMOTING PUBLIC AWARENESS OF THE NEED TO HONOR AND SUPPORT THE MEN AND WOMEN WHO DIED WHILE IN SERVICE TO THEIR COUNTRY, VETERANS OF THE ARMED SERVICES, AND THOSE WHO CONTINUE TO SERVE; PROMOTING AWARENESS IN CHILDREN ABOUT PATRIOTISM AND THE AMERICAN SPIRIT (U.S. CLS. 100, 101 AND 102).
FIRST USE 5-0-2000; IN COMMERCE 5-0-2000.
JOHN LINCOSKI, EXAMINING ATTORNEY

SN 76-570,415. NATIONAL ORGANIZATION OF THE NEW APOSTOLIC CHURCH OF NORTH AMERICA, CHICAGO, IL. FILED 1-9-2004.

SN 76-571,648. DOVER MOTORSPORTS, INC., WILMINGTON, DE. FILED 1-23-2004.

NEW APOSTOLIC CHURCH

NO CLAIM IS MADE TO THE EXCLUSIVE RIGHT TO USE "APOSTOLIC CHURCH", APART FROM THE MARK AS SHOWN.
SEC. 2(F).

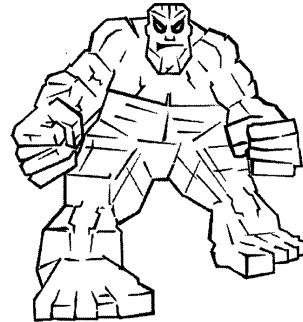

CLASS 16—PAPER GOODS AND PRINTED MATTER

FOR RELIGIOUS PERIODICALS AND PUBLICATIONS; NAMELY, MAGAZINES AND INFORMATION FOLDERS (U.S. CLS. 2, 5, 22, 23, 29, 37, 38 AND 50).
FIRST USE 4-26-1936; IN COMMERCE 4-26-1936.

CLASS 45—PERSONAL SERVICES

FOR RELIGIOUS SERVICES, NAMELY, PROVIDING BAPTISMS, WEDDINGS, FUNERALS, RELIGIOUS COUNSELING AND MINISTERIAL SERVICES (U.S. CLS. 100 AND 101).
FIRST USE 3-31-1918; IN COMMERCE 3-31-1918.
EUGENIA MARTIN, EXAMINING ATTORNEY

CLASS 9—ELECTRICAL AND SCIENTIFIC APPARATUS

FOR DECORATIVE MAGNETS AND SUNGLASSES (U.S. CLS. 21, 23, 26, 36 AND 38).

CLASS 21—HOUSEWARES AND GLASS

FOR BEVERAGEWARE (U.S. CLS. 2, 13, 23, 29, 30, 33, 40 AND 50).

CLASS 28—TOYS AND SPORTING GOODS

FOR HAND HELD EQUIPMENT FOR PLAYING VIDEO GAMES AND ACTION FIGURES (U.S. CLS. 22, 23, 38 AND 50).
SHARI SHEFFIELD, EXAMINING ATTORNEY

SN 76-570,531. MATRIX ASSET MANAGEMENT LLC, DENVER, CO. FILED 12-4-2003.

REOSOURCE

CLASS 35—ADVERTISING AND BUSINESS

FOR PROVIDING AN ON-LINE WEBSITE AT WHICH USERS CAN SUBMIT OFFERS AND ACCEPTANCES FOR REAL ESTATE TRANSACTIONS (U.S. CLS. 100, 101 AND 102).
FIRST USE 8-0-2003; IN COMMERCE 8-0-2003.

CLASS 36—INSURANCE AND FINANCIAL

FOR PROVIDING AN ON-LINE DATABASE THAT FEATURES INFORMATION REGARDING REAL ESTATE AND REAL ESTATE AGENTS (U.S. CLS. 100, 101 AND 102).
FIRST USE 8-0-2003; IN COMMERCE 8-0-2003.
SCOTT BALDWIN, EXAMINING ATTORNEY

SN 76-571,660. CYBERCORP HOLDINGS, INC., AUSTIN, TX. FILED 1-23-2004.

CYBERTRADER LIVE

THE MARK CONSISTS OF STANDARD CHARACTERS WITHOUT CLAIM TO ANY PARTICULAR FONT, STYLE, SIZE, OR COLOR.

OWNER OF U.S. REG. NOS. 2,569,834, 2,788,187 AND OTHERS.

NO CLAIM IS MADE TO THE EXCLUSIVE RIGHT TO USE "LIVE", APART FROM THE MARK AS SHOWN.
SEC. 2(F) CYBERTRADER.

CLASS 9—ELECTRICAL AND SCIENTIFIC APPARATUS

FOR DOWNLOADABLE SOFTWARE FOR REAL-TIME FINANCIAL MARKET ANALYSIS IN THE FIELD OF SECURITIES, OPTIONS, AND COMMODITIES; DOWNLOADABLE SOFTWARE FOR PROVIDING CHAT ROOMS FOR TRANSMISSION OF DATA, TEXT, AND VOICE MESSAGES IN THE FIELD OF FINANCIAL MARKET ANALYSIS AND INVESTMENT STRATEGY (U.S. CLS. 21, 23, 26, 36 AND 38).
FIRST USE 12-9-2003; IN COMMERCE 12-9-2003.

CLASS 36—INSURANCE AND FINANCIAL

FOR PROVIDING INFORMATION IN THE FIELD OF FINANCIAL MARKET ANALYSIS AND INVESTMENT STRATEGY (U.S. CLS. 100, 101 AND 102).
FIRST USE 12-10-2003; IN COMMERCE 12-10-2003.

CLASS 38—COMMUNICATION

FOR PROVIDING ON-LINE CHAT ROOMS FOR TRANSMISSION OF MESSAGES, INCLUDING VOICE, TEXT, AND IMAGES, AMONG COMPUTER USERS CONCERNING FINANCIAL SECURITIES, COMMODITIES, AND OPTIONS, THE FINANCIAL SECURITIES MARKET, REAL-TIME MARKET ANALYSIS, TECHNICAL AND FUNDAMENTAL ANALYSIS, AND TRADING OF FINANCIAL SECURITIES, COMMODITIES, AND OPTIONS (U.S. CLS. 100, 101 AND 104).

FIRST USE 12-10-2003; IN COMMERCE 12-10-2003.

CLASS 41—EDUCATION AND ENTERTAINMENT

FOR EDUCATIONAL SERVICES, NAMELY, ONLINE INTERACTIVE TRAINING IN THE FIELD OF FINANCIAL SECURITIES, COMMODITIES, AND OPTIONS, THE FINANCIAL SECURITIES MARKET, REAL-TIME MARKET ANALYSIS, TECHNICAL AND FUNDAMENTAL ANALYSIS, AND TRADING OF FINANCIAL SECURITIES, COMMODITIES, AND OPTIONS (U.S. CLS. 100, 101 AND 107).

FIRST USE 1-6-2004; IN COMMERCE 1-6-2004.
TRACY FLETCHER, EXAMINING ATTORNEY

SN 76-572,894. JUSTINIAN, LLC, CHICAGO, IL. FILED 1-30-2004.



THE COLOR GRAY IS NOT A PART OF THE MARK AND APPLICANT IS NOT CLAIMING COLOR.

CLASS 9—ELECTRICAL AND SCIENTIFIC APPARATUS

FOR SOFTWARE FOR CREATING, DISPLAYING, PRINTING, PUBLISHING, AND EDITING BUSINESS AND PROFESSIONAL FORMS, BOOKS, AND OTHER DOCUMENTATION, NAMELY GRAPHS, CHARTS, CHECKLISTS AND MANUALS (U.S. CLS. 21, 23, 26, 36 AND 38).

CLASS 16—PAPER GOODS AND PRINTED MATTER

FOR BUSINESS AND PROFESSIONAL FORMS, BOOKS RELATING TO BUSINESS AND PROFESSIONALS, AND OTHER DOCUMENTATION, NAMELY GRAPHS, CHARTS, CHECKLISTS AND MANUALS FOR USE BY BUSINESSES AND PROFESSIONALS (U.S. CLS. 2, 5, 22, 23, 29, 37, 38 AND 50).

DAVID TAYLOR, EXAMINING ATTORNEY

SN 76-571,675. INDEX GIFT IMPORTS LTD., CALGARY, ALBERTA, T2E 6T4, CANADA, FILED 1-23-2004.

SN 76-573,158. MATTSO, JEFF, MELVILLE, NY. FILED 1-26-2004.

STONEWITWORDS

THE MARK CONSISTS OF STANDARD CHARACTERS WITHOUT CLAIM TO ANY PARTICULAR FONT, STYLE, SIZE, OR COLOR.

CLASS 20—FURNITURE AND ARTICLES NOT OTHERWISE CLASSIFIED

FOR DECORATIVE PLAQUES MADE OF STONE (U.S. CLS. 2, 13, 22, 25, 32 AND 50).

CLASS 21—HOUSEWARES AND GLASS

FOR COASTERS NOT MADE OF PAPER OR LINEN (U.S. CLS. 2, 13, 23, 29, 30, 33, 40 AND 50).
TRACY FLETCHER, EXAMINING ATTORNEY

ZEN TRICKSTERS

THE MARK CONSISTS OF STANDARD CHARACTERS WITHOUT CLAIM TO ANY PARTICULAR FONT, STYLE, SIZE, OR COLOR.

CLASS 9—ELECTRICAL AND SCIENTIFIC APPARATUS

FOR MUSICAL SOUND RECORDINGS (U.S. CLS. 21, 23, 26, 36 AND 38).
FIRST USE 6-8-1989; IN COMMERCE 6-8-1989.

CLASS 41—EDUCATION AND ENTERTAINMENT

FOR ENTERTAINMENT SERVICES, NAMELY, LIVE MUSICAL PERFORMANCES BY A VOCAL AND INSTRUMENTAL GROUP (U.S. CLS. 100, 101 AND 107).
FIRST USE 6-8-1989; IN COMMERCE 6-8-1989.
STEVEN R. FOSTER, EXAMINING ATTORNEY

SN 76-573,432. EMPIRE VISION CENTER, INC., SYRACUSE, NY. FILED 2-2-2004.

**Empire
Vision Centers**
Focused on You

OWNER OF U.S. REG. NOS. 1,496,303 AND 1,867,340.
NO CLAIM IS MADE TO THE EXCLUSIVE RIGHT TO USE "VISION CENTERS", APART FROM THE MARK AS SHOWN.

THE STIPPLING IS FOR SHADING PURPOSES.

CLASS 35—ADVERTISING AND BUSINESS

FOR RETAIL STORE SERVICES FEATURING EYEGLASSES AND CONTACT LENSES (U.S. CLS. 100, 101 AND 102).

FIRST USE 10-26-2003; IN COMMERCE 10-26-2003. THE MARK WAS FIRST USED IN COMMERCE IN A DIFFERENT FORM OTHER THAN THAT SOUGHT TO BE REGISTERED ON 03/01/1978..

CLASS 44—MEDICAL, BEAUTY AND AGRICULTURAL SERVICES

FOR OPTICIAN SERVICES (U.S. CLS. 100 AND 101).
FIRST USE 10-26-2003; IN COMMERCE 10-26-2003. THE MARK WAS FIRST USED IN COMMERCE IN A DIFFERENT FORM OTHER THAN THAT SOUGHT TO BE REGISTERED ON 03/01/1978..

ROBERT COGGINS, EXAMINING ATTORNEY

SN 76-573,613. ZUKO, LLC, CLEVELAND, OH. FILED 1-30-2004.

FACIALIZER

THE MARK CONSISTS OF STANDARD CHARACTERS WITHOUT CLAIM TO ANY PARTICULAR FONT, STYLE, SIZE, OR COLOR.

CLASS 3—COSMETICS AND CLEANING PREPARATIONS

FOR NON-MEDICATED CLEANSERS FOR THE FACE AND SKIN (U.S. CLS. 1, 4, 6, 50, 51 AND 52).

CLASS 8—HAND TOOLS

FOR FACIAL IMPLEMENT, NAMELY, A BATTERY-POWERED, HAND-HELD FACIAL BUFFER FOR USE IN COSMETIC CLEANSING AND CONDITIONING, AND REPLACEMENT BUFFER PADS THEREFORE (U.S. CLS. 23, 28 AND 44).

CLASS 10—MEDICAL APPARATUS

FOR FACIAL MASSAGE APPARATUS (U.S. CLS. 26, 39 AND 44).

CLASS 21—HOUSEWARES AND GLASS

FOR FACIAL SCRUBBING PUFFS, BRUSHES AND SPONGES (U.S. CLS. 2, 13, 23, 29, 30, 33, 40 AND 50).
BARBARA A. LOUGHRAN, EXAMINING ATTORNEY

SN 76-575,072. FIRST ACT, INC., NEWTON, MA. FILED 2-11-2004.

BORGLUND

CLASS 9—ELECTRICAL AND SCIENTIFIC APPARATUS

FOR COMPUTER SOFTWARE FOR LEARNING ABOUT MUSIC AND THE PLAYING OF MUSICAL INSTRUMENTS; PRERECORDED AUDIO CASSETTES, VIDEO CASSETTES AND DVD'S FEATURING INSTRUCTION IN MUSIC AND THE PLAYING OF MUSICAL INSTRUMENTS; SOUND AMPLIFIERS; MICROPHONES (U.S. CLS. 21, 23, 26, 36 AND 38).

CLASS 15—MUSICAL INSTRUMENTS

FOR FULL LINE OF MUSICAL INSTRUMENTS AND COMPONENT PARTS THEREFORE; ELECTRONIC TUNERS FOR MUSICAL INSTRUMENTS; CARRYING CASES FOR MUSICAL INSTRUMENTS; SHEET MUSIC STANDS (U.S. CLS. 2, 21 AND 36).

CLASS 16—PAPER GOODS AND PRINTED MATTER

FOR BOOKS AND PAMPHLETS FEATURING INSTRUCTION IN MUSIC AND THE PLAYING OF MUSICAL INSTRUMENTS (U.S. CLS. 2, 5, 22, 23, 29, 37, 38 AND 50).

CLASS 28—TOYS AND SPORTING GOODS

FOR TOY MUSICAL INSTRUMENTS; A FULL LINE OF TOYS (U.S. CLS. 22, 23, 38 AND 50).
WENDY GOODMAN, EXAMINING ATTORNEY

SN 76-575,779. THE CURE SERVICE GROUP, INC., SEATTLE, WA. FILED 2-17-2004.

DRIQUEST

THE MARK CONSISTS OF STANDARD CHARACTERS WITHOUT CLAIM TO ANY PARTICULAR FONT, STYLE, SIZE, OR COLOR.

CLASS 37—CONSTRUCTION AND REPAIR

FOR RESTORATION SERVICES, NAMELY RESTORATIVE DRYING SERVICES IN THE FIELD OF WATER DAMAGE REMEDIATION IN COMMERCIAL AND RESIDENTIAL BUILDINGS (U.S. CLS. 100, 103 AND 106).
FIRST USE 3-1-2004; IN COMMERCE 3-1-2004.

CLASS 41—EDUCATION AND ENTERTAINMENT

FOR EDUCATIONAL SERVICES, NAMELY PROVIDING CLASSES, SEMINARS, AND WORKSHOPS IN THE FIELD OF RESTORATIVE SERVICES (U.S. CLS. 100, 101 AND 107).

FIRST USE 3-1-2004; IN COMMERCE 3-1-2004.
ROBERT COGGINS, EXAMINING ATTORNEY

SN 76-576,352. VECTOR PRODUCTS, INC., FT. LAUDERDALE, FL. FILED 2-19-2004.



OWNER OF U.S. REG. NO. 2,553,753.

CLASS 9—ELECTRICAL AND SCIENTIFIC APPARATUS

FOR BATTERY JUMP STARTERS, AUTOMOBILE AND MARINE BATTERY CHARGERS, POWER CONVERTERS, POWER INVERTORS AND PORTABLE POWER SUPPLIES (U.S. CLS. 21, 23, 26, 36 AND 38).

CLASS 11—ENVIRONMENTAL CONTROL APPARATUS

FOR SPOTLIGHTS, AND THERMOELECTRIC COOLER FOR FOOD AND BEVERAGES (U.S. CLS. 13, 21, 23, 31 AND 34).

KELLY BOULTON, EXAMINING ATTORNEY

SN 76-576,225. TRUSTEES OF THE UNIVERSITY OF PENNSYLVANIA, PHILADELPHIA, PA. FILED 2-13-2004.



**Wharton School
Publishing**

NO CLAIM IS MADE TO THE EXCLUSIVE RIGHT TO USE SCHOOL PUBLISHING, APART FROM THE MARK AS SHOWN.

CLASS 9—ELECTRICAL AND SCIENTIFIC APPARATUS

FOR BOOKS, MAGAZINES, JOURNALS AND ARTICLES RECORDED ON COMPUTER MEDIA IN THE FIELDS OF BUSINESS, MANAGEMENT, LEADERSHIP, PERSONAL FINANCE, SMALL BUSINESS, SALES AND MARKETING, ECONOMICS, ACCOUNTING, FINANCE, GEOPOLITICS, REAL ESTATE FINANCE, AND PENSIONS AND RETIREMENT PLANNING; PRERECORDED AUDIOTAPES, VIDEOTAPES, DVDS, CDS AND CD-ROMS ON A VARIETY OF TOPICS, NAMELY, BUSINESS, MANAGEMENT, LEADERSHIP, PERSONAL FINANCE, SMALL BUSINESS, SALES AND MARKETING, ECONOMICS, ACCOUNTING, FINANCE, GEOPOLITICS, REAL ESTATE FINANCE, AND PENSIONS AND RETIREMENT PLANNING; COMPUTER SOFTWARE USED FOR TEACHING AND EDUCATING STUDENTS AND THE PUBLIC AND DELIVERING CONTENT CONCERNING BUSINESS MANAGEMENT (U.S. CLS. 21, 23, 26, 36 AND 38).

CLASS 16—PAPER GOODS AND PRINTED MATTER

FOR BOOKS, MAGAZINES AND JOURNALS IN THE FIELD OF BUSINESS, MANAGEMENT, LEADERSHIP, PERSONAL FINANCE, SMALL BUSINESS, SALES AND MARKETING, ECONOMICS, ACCOUNTING, FINANCE, GEOPOLITICS, REAL ESTATE FINANCE, AND PENSIONS AND RETIREMENT PLANNING (U.S. CLS. 2, 5, 22, 23, 29, 37, 38 AND 50).

KEVON CHISOLM, EXAMINING ATTORNEY

SN 76-576,483. PHILADELPHIA SPORTS MEDIA, L.P., PHILADELPHIA, PA. FILED 2-20-2004.

COMCAST SPORTSNET

THE MARK CONSISTS OF STANDARD CHARACTERS WITHOUT CLAIM TO ANY PARTICULAR FONT, STYLE, SIZE, OR COLOR.

NO CLAIM IS MADE TO THE EXCLUSIVE RIGHT TO USE "SPORTSNET", APART FROM THE MARK AS SHOWN.

CLASS 25—CLOTHING

FOR CLOTHING, NAMELY, GOLF SHIRTS, T-SHIRTS, SWEATSHIRTS, SWEATPANTS AND HATS (U.S. CLS. 22 AND 39).

FIRST USE 7-0-1997; IN COMMERCE 7-0-1997.

CLASS 38—COMMUNICATION

FOR TELEVISION BROADCASTING SERVICES (U.S. CLS. 100, 101 AND 104).

FIRST USE 7-0-1997; IN COMMERCE 7-0-1997.

CLASS 41—EDUCATION AND ENTERTAINMENT

FOR ENTERTAINMENT SERVICES, NAMELY, PRODUCTION OF A SERIES OF SPORTS-RELATED TELEVISION PROGRAMS (U.S. CLS. 100, 101 AND 107).

FIRST USE 7-0-1997; IN COMMERCE 7-0-1997.

ALICE SUE CARRUTHERS, EXAMINING ATTORNEY

SN 76-576,484. PHILADELPHIA SPORTS MEDIA, L.P., PHILADELPHIA, PA. FILED 2-20-2004.

SN 76-577,454. IPG TECHNOLOGIES INC., COLUMBIA, SC. FILED 2-5-2004.



UGLY TAPE

NO CLAIM IS MADE TO THE EXCLUSIVE RIGHT TO USE "SPORTSNET", APART FROM THE MARK AS SHOWN.

THE MARK CONSISTS OF STANDARD CHARACTERS WITHOUT CLAIM TO ANY PARTICULAR FONT, STYLE, SIZE, OR COLOR.

NO CLAIM IS MADE TO THE EXCLUSIVE RIGHT TO USE "TAPE", APART FROM THE MARK AS SHOWN.

CLASS 25—CLOTHING

FOR CLOTHING, NAMELY, GOLF SHIRTS, T-SHIRTS, SWEATSHIRTS, SWEATPANTS AND HATS (U.S. CLS. 22 AND 39).

FIRST USE 1-0-2000; IN COMMERCE 1-0-2000.

CLASS 16—PAPER GOODS AND PRINTED MATTER

FOR NATURAL RUBBER ADHESIVE CARTON SEALING TAPE FOR HOUSEHOLD PURPOSES (U.S. CLS. 2, 5, 22, 23, 29, 37, 38 AND 50).

CLASS 38—COMMUNICATION

FOR TELEVISION BROADCASTING SERVICES (U.S. CLS. 100, 101 AND 104).

FIRST USE 1-0-2000; IN COMMERCE 1-0-2000.

CLASS 17—RUBBER GOODS

FOR NATURAL RUBBER ADHESIVE CARTON SEALING TAPE FOR INDUSTRIAL PURPOSES (U.S. CLS. 1, 5, 12, 13, 35 AND 50).

MITCHELL FRONT, EXAMINING ATTORNEY

CLASS 41—EDUCATION AND ENTERTAINMENT

FOR ENTERTAINMENT SERVICES, NAMELY, PRODUCTION OF A SERIES OF SPORTS-RELATED TELEVISION PROGRAMS (U.S. CLS. 100, 101 AND 107).

FIRST USE 1-0-2000; IN COMMERCE 1-0-2000.

ALICE SUE CARRUTHERS, EXAMINING ATTORNEY

SN 76-578,168. KONE CORPORATION, 00330 HELSINKI, FINLAND, FILED 2-27-2004.

SN 76-577,452. IPG TECHNOLOGIES INC., COLUMBIA, SC. FILED 2-5-2004.

KONE DIMENSION

MAILAWAY UGLY TAPE

THE MARK CONSISTS OF STANDARD CHARACTERS WITHOUT CLAIM TO ANY PARTICULAR FONT, STYLE, SIZE, OR COLOR.

OWNER OF U.S. REG. NOS. 1,105,492, 1,402,933 AND 1,572,871.

THE MARK CONSISTS OF STANDARD CHARACTERS WITHOUT CLAIM TO ANY PARTICULAR FONT, STYLE, SIZE, OR COLOR.

OWNER OF U.S. REG. NO. 1,072,237.

NO CLAIM IS MADE TO THE EXCLUSIVE RIGHT TO USE "TAPE", APART FROM THE MARK AS SHOWN.

CLASS 7—MACHINERY

FOR LIFTING AND TRANSPORTING EQUIPMENT, NAMELY ELEVATORS, ESCALATORS AND MOVING WALKWAYS AND COMPONENTS AND PARTS THEREFOR (U.S. CLS. 13, 19, 21, 23, 31, 34 AND 35).

CLASS 16—PAPER GOODS AND PRINTED MATTER

FOR NATURAL RUBBER ADHESIVE CARTON SEALING TAPE FOR HOUSEHOLD PURPOSES (U.S. CLS. 2, 5, 22, 23, 29, 37, 38 AND 50).

CLASS 37—CONSTRUCTION AND REPAIR

FOR INSTALLATION, MAINTENANCE, REPAIR AND MODERNIZATION, NAMELY REPLACEMENT OF OUT-MODED COMPONENTS, OF LIFTING AND TRANSPORTING EQUIPMENT, NAMELY ELEVATORS, ESCALATORS AND MOVING WALKWAYS AND COMPONENTS THEREFOR (U.S. CLS. 100, 103 AND 106).

TERESA M. RUPP, EXAMINING ATTORNEY

CLASS 17—RUBBER GOODS

FOR NATURAL RUBBER ADHESIVE CARTON SEALING TAPE FOR INDUSTRIAL PURPOSES (U.S. CLS. 1, 5, 12, 13, 35 AND 50).

MITCHELL FRONT, EXAMINING ATTORNEY

SN 76-578,912. LAURICE EL BADRY RAHME LTD., DBA LAURICE & CO., NEW YORK, NY. FILED 3-3-2004.



Bond no. 9
NEW YORK

OWNER OF U.S. REG. NO. 2,742,675.
NO CLAIM IS MADE TO THE EXCLUSIVE RIGHT TO USE NEW YORK, APART FROM THE MARK AS SHOWN.

CLASS 3—COSMETICS AND CLEANING PREPARATIONS

FOR COSMETICS, NAMELY, SKIN CARE PRODUCTS, NAMELY, NON-MEDICATED SKIN CARE PREPARATIONS, COSMETIC PREPARATIONS FOR SKIN RENEWAL, NON-MEDICATED SKIN SERUM, SKIN CLARIFIERS, SKIN CLEANSERS, SKIN CONDITIONERS, SKIN CREAM, SKIN EMOLLIENTS, SKIN LOTIONS, SKIN MASKS, SKIN MOISTURIZERS, SKIN TONERS; IIPSTICKS AND MAKEUP (U.S. CLS. 1, 4, 6, 50, 51 AND 52).

CLASS 35—ADVERTISING AND BUSINESS

FOR RETAIL STORE SERVICES FEATURING PERFUMES AND COSMETICS (U.S. CLS. 100, 101 AND 102).
FIRST USE 10-7-2002; IN COMMERCE 10-7-2002.
ROBERT LORENZO, EXAMINING ATTORNEY

SN 76-579,360. BUILT NY, INC., NEW YORK, NY. FILED 3-4-2004.

BUILT NY

THE MARK CONSISTS OF STANDARD CHARACTERS WITHOUT CLAIM TO ANY PARTICULAR FONT, STYLE, SIZE, OR COLOR.

NO CLAIM IS MADE TO THE EXCLUSIVE RIGHT TO USE "NY", APART FROM THE MARK AS SHOWN.

CLASS 18—LEATHER GOODS

FOR TOTE BAGS; SHOULDER BAGS; TRAVEL BAGS; CLUTCH BAGS; AND CARRY-ON BAGS (U.S. CLS. 1, 2, 3, 22 AND 41).
FIRST USE 4-0-2002; IN COMMERCE 4-0-2002.

CLASS 21—HOUSEWARES AND GLASS

FOR WINE BOTTLE CRADLES; THERMALLY INSULATED TOTE BAGS AND CONTAINERS FOR FOOD AND BEVERAGE; THERMALLY INSULATED WRAP FOR CANS TO KEEP CONTENTS COLD OR HOT; CONTAINERS NOT OF PRECIOUS METAL FOR HOUSEHOLD OR KITCHEN USE (U.S. CLS. 2, 13, 23, 29, 30, 33, 40 AND 50).
FIRST USE 4-0-2002; IN COMMERCE 4-0-2002.
CHRISIE B. KING, EXAMINING ATTORNEY

SN 76-579,882. KONE CORPORATION, 00330 HELSINKI, FINLAND, FILED 3-8-2004.



KONE

OWNER OF U.S. REG. NOS. 1,105,492 AND 1,572,871.

CLASS 7—MACHINERY

FOR LIFTING AND TRANSPORTING EQUIPMENT, NAMELY ELEVATORS, ESCALATORS AND MOVING WALKWAYS AND PARTS AND FITTINGS THEREFOR (U.S. CLS. 13, 19, 21, 23, 31, 34 AND 35).
FIRST USE 1-7-2000; IN COMMERCE 1-8-2000.

CLASS 9—ELECTRICAL AND SCIENTIFIC APPARATUS

FOR ELECTRONIC MEASURING AND CONTROL SYSTEMS FOR ELEVATORS, ESCALATORS AND MOVING WALKWAYS, NAMELY— CONTROLS FOR DIRECT OR INDIRECT OPERATION OF ELEVATORS, ESCALATORS AND MOVING WALKWAYS AND FOR REGULATING OR INFLUENCING TRAVELING SPEED, ACCELERATION OR DECELERATION; ELEVATOR GROUP CONTROLS; ELEVATOR CONTROLS TAKING ACCOUNT OF CALLS GIVEN TO THE ELEVATOR SYSTEM; ELEVATOR CONTROLS TO SUIT TRAFFIC CONDITIONS; ELECTRONIC CONTROLS FOR MEASURING ELEVATOR TRAFFIC; ELECTRONIC CONTROLS FOR DETERMINING WEIGHT LOADS OF ELEVATORS, ESCALATORS AND MOVING WALKWAYS; ELEVATORS, ESCALATORS AND MOVING WALKWAY CONDITION INDICATORS; ELEVATOR POSITION INDICATORS; AND PARTS AND ACCESSORIES OF THE MEASURING AND CONTROL SYSTEMS (U.S. CLS. 21, 23, 26, 36 AND 38).
FIRST USE 1-7-2000; IN COMMERCE 10-15-2002.

CLASS 37—CONSTRUCTION AND REPAIR

FOR INSTALLATION, MAINTENANCE, REPAIR AND MODERNIZATION OF LIFTING AND TRANSPORTING EQUIPMENT, NAMELY ELEVATORS, ESCALATORS AND MOVING WALKWAYS AND OF COMPONENTS AND FITTINGS OF SUCH EQUIPMENT (U.S. CLS. 100, 103 AND 106).
FIRST USE 1-7-2000; IN COMMERCE 12-13-2000.
JERI J. FICKES, EXAMINING ATTORNEY

SN 76-580,125. FIRST ACT, INC., NEWTON, MA. FILED 3-10-2004.

DESIGNED BY MUSICIANS FOR MUSICIANS

CLASS 9—ELECTRICAL AND SCIENTIFIC APPARATUS

FOR COMPUTER SOFTWARE FOR LEARNING ABOUT MUSIC AND THE PLAYING OF MUSICAL INSTRUMENTS; PRERECORDED AUDIO CASSETTES, VIDEO CASSETTES AND DVD'S FEATURING INSTRUCTION IN MUSIC AND THE PLAYING OF MUSICAL INSTRUMENTS; SOUND AMPLIFIERS; MICROPHONES (U.S. CLS. 21, 23, 26, 36 AND 38).

CLASS 15—MUSICAL INSTRUMENTS

FOR FULL LINE OF MUSICAL INSTRUMENTS AND COMPONENT PARTS THEREFORE; ELECTRONIC TUNERS FOR MUSICAL INSTRUMENTS; CARRYING CASES FOR MUSICAL INSTRUMENTS; SHEET MUSIC STANDS (U.S. CLS. 2, 21 AND 36).

CLASS 16—PAPER GOODS AND PRINTED MATTER

FOR BOOKS AND PAMPHLETS FEATURING INSTRUCTION IN MUSIC AND THE PLAYING OF MUSICAL INSTRUMENTS (U.S. CLS. 2, 5, 22, 23, 29, 37, 38 AND 50).

CLASS 28—TOYS AND SPORTING GOODS

FOR TOY MUSICAL INSTRUMENTS; A FULL LINE OF TOYS (U.S. CLS. 22, 23, 38 AND 50).
WENDY GOODMAN, EXAMINING ATTORNEY

SN 76-580,888. FLAVOR BURST CO., L.L.P., DANVILLE, IN.
FILED 3-15-2004.

CRUNCHICREME**CLASS 11—ENVIRONMENTAL CONTROL APPARATUS**

FOR DISPENSING EQUIPMENT, NAMELY, SOFT-SERVE FREEZERS FOR THE PRODUCTION OF FROZEN CONFECTIONS AND BEVERAGES (U.S. CLS. 13, 21, 23, 31 AND 34).

CLASS 30—STAPLE FOODS

FOR FLAVORING ADDITIVES FOR NON-NUTRITIONAL PURPOSES FOR FROZEN CONFECTIONS AND BEVERAGES (U.S. CL. 46).
ALICE BENMAMAN, EXAMINING ATTORNEY

SN 76-582,638. DALLAS COWBOYS FOOTBALL CLUB, LTD.,
IRVING, TX. FILED 3-24-2004.

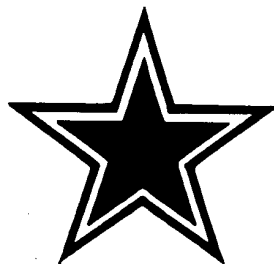

OWNER OF U.S. REG. NOS. 1,087,850, 2,656,022 AND OTHERS.

CLASS 35—ADVERTISING AND BUSINESS

FOR ONLINE RETAIL STORE SERVICES FEATURING A WIDE VARIETY OF GENERAL MERCHANDISE PRODUCTS; PROMOTING PUBLIC AWARENESS AS TO THE NEED FOR COMMUNITY INVOLVEMENT IN CHARITIES AND CHARITABLE FUNDRAISING BY HOSTING AND SPONSORING CHARITY EVENTS; ADVERTISING SERVICES, NAMELY, PROMOTING THE GOODS AND SERVICES OF OTHERS VIA A WEB SITE ON THE INTERNET (U.S. CLS. 100, 101 AND 102).
FIRST USE 0-0-1975; IN COMMERCE 0-0-1975.

CLASS 36—INSURANCE AND FINANCIAL

FOR CHARITABLE FUNDRAISING SERVICES; REAL ESTATE INVESTMENT, REAL ESTATE MORTGAGE BROKERAGE AND REAL ESTATE BROKERAGE SERVICES (U.S. CLS. 100, 101 AND 102).
FIRST USE 0-0-1975; IN COMMERCE 0-0-1975.

CLASS 38—COMMUNICATION

FOR PROVIDING MULTIPLE-USER ACCESS TO INTERACTIVE COMPUTER DATABASES IN THE FIELDS OF ATHLETICS AND ATHLETIC COMPETITIONS; PROVIDING COMPUTER BULLETIN BOARDS AND REAL-TIME CHAT ROOMS FOR TRANSMISSION OF MESSAGES AMONG COMPUTER USERS IN THE FIELD OF ATHLETICS AND ATHLETIC COMPETITIONS (U.S. CLS. 100, 101 AND 104).
FIRST USE 0-0-1975; IN COMMERCE 0-0-1975.

CLASS 41—EDUCATION AND ENTERTAINMENT

FOR EDUCATIONAL AND ENTERTAINMENT SERVICES, NAMELY, PROVIDING PROFESSIONAL FOOTBALL GAMES AND EXHIBITIONS; PROVIDING SPORTS AND ENTERTAINMENT INFORMATION VIA A GLOBAL COMPUTER NETWORK OR A COMMERCIAL ONLINE SERVICE; FAN CLUBS; ORGANIZATION OF SPORTS AND SPORTS EVENTS; ENTERTAINMENT SERVICES PROVIDED DURING INTERVALS AT SPORTING EVENTS, NAMELY, THEATRICAL, MUSICAL AND MULTIMEDIA PERFORMANCES; ARRANGING AND ORGANIZING OF ATHLETIC COMPETITIONS, PHYSICAL EDUCATIONAL INSTRUCTION AND TRAINING, PRODUCTION OF RADIO AND TELEVISION PROGRAMS; GOLF CLUB SERVICES; PROVIDING ENTERTAINMENT IN THE NATURE OF GOLF TOURNAMENTS; SPORTS CAMPS; PROVIDING FACILITIES FOR SPORTS EXHIBITIONS; PROVIDING FACILITIES FOR RECREATIONAL ACTIVITIES; PROVIDING SPORTS INFORMATION VIA A WEB SITE ON THE INTERNET (U.S. CLS. 100, 101 AND 107).
FIRST USE 0-0-1975; IN COMMERCE 0-0-1975.
PAUL F. GAST, EXAMINING ATTORNEY

SN 76-582,654. FILTRAN AFTERMARKET PRODUCTS, DES
PLAINES, IL. FILED 3-23-2004.

BRYCO

THE MARK CONSISTS OF STANDARD CHARACTERS WITHOUT CLAIM TO ANY PARTICULAR FONT, STYLE, SIZE, OR COLOR.

OWNER OF U.S. REG. NO. 2,275,289.

CLASS 7—MACHINERY

FOR LAND VEHICLE ENGINE TIMING COMPONENTS, NAMELY, CAM SPROCKETS, CHAINS, SIDE GUIDES, TENSIONERS, INNER CRANK SPROCKETS, TENSION GUIDES, BALANCE SHAFT GUIDES, BALANCE SHAFT SPROCKETS, BALANCE SHAFT CHAINS, OUTER CRANK SPROCKETS, WATER PUMP GASKETS, OIL SEALS, GASKETS AND GUIDE RAILS (U.S. CLS. 13, 19, 21, 23, 31, 34 AND 35).

CLASS 12—VEHICLES

FOR LAND VEHICLE AUTOMATIC TRANSMISSION REBUILD KITS SOLD AS A UNIT; LAND VEHICLE AUTOMATIC TRANSMISSION PARTS, NAMELY, BANDS, BUSHINGS, CHAINS, CLUTCH PLATES, FILTERS, FLYWHEELS, FLEX PLATES, GASKETS, O-RINGS, PUMP RINGS, SPRAGS, SPRINGS, DIAPHRAGM SPRINGS, THRUST WASHERS, PUMP SEALS; STANDARD CLUTCH ASSEMBLIES FOR LAND VEHICLES, NAMELY, CLUTCH DISCS, RELEASE BEARINGS, FACINGS, AND CLUTCH COVERS (U.S. CLS. 19, 21, 23, 31, 35 AND 44).

JASON TURNER, EXAMINING ATTORNEY

SN 76-584,249. AURORA TRAILERS HOLDINGS LLC, NEW YORK, NY. FILED 3-31-2004.

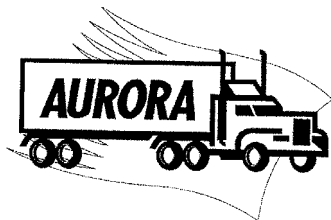
**CLASS 35—ADVERTISING AND BUSINESS**

FOR DISTRIBUTORSHIPS IN THE FIELD OF TRAILER PARTS AND ACCESSORIES; ONLINE RETAIL ORDERING SERVICES AND ONLINE WHOLESALE ORDERING SERVICES, ALL IN THE FIELD OF TRAILER PARTS AND ACCESSORIES; DEALERSHIPS IN THE FIELD OF TRAILERS AND TRAILER PARTS AND ACCESSORIES (U.S. CLS. 100, 101 AND 102).

FIRST USE 10-1-2003; IN COMMERCE 10-1-2003.

CLASS 39—TRANSPORTATION AND STORAGE

FOR LEASING AND RENTAL OF TRAILERS (U.S. CLS. 100 AND 105).

FIRST USE 10-1-2003; IN COMMERCE 10-1-2003.

AMOS T. MATTHEWS, JR., EXAMINING ATTORNEY

SN 76-584,323. GALBRAITH, PAUL, MARAZION, CORNWALL, TR17 0QD, UNITED KINGDOM, FILED 4-1-2004.

PAUL GALBRAITH

THE MARK CONSISTS OF STANDARD CHARACTERS WITHOUT CLAIM TO ANY PARTICULAR FONT, STYLE, SIZE, OR COLOR.

PRIORITY CLAIMED UNDER SEC. 44(D) ON UNITED KINGDOM APPLICATION NO. 2354562, FILED 1-28-2004, REG. NO. 2354562, DATED 1-28-2004, EXPIRES 1-28-2014.

CLASS 9—ELECTRICAL AND SCIENTIFIC APPARATUS

FOR AUDIO CASSETTES FEATURING MUSIC; AUDIO DIGITAL TAPES FEATURING MUSIC; AUDIO DISCS FEATURING MUSIC; COMPACT DISCS FEATURING MUSIC; DVDS FEATURING MUSIC; PHONOGRAPH RECORDS FEATURING MUSIC (U.S. CLS. 21, 23, 26, 36 AND 38).

CLASS 16—PAPER GOODS AND PRINTED MATTER

FOR BOOKS ABOUT MUSIC; BROCHURES ABOUT MUSIC; CALENDARS; MUSIC MAGAZINES; POSTERS (U.S. CLS. 2, 5, 22, 23, 29, 37, 38 AND 50).

CLASS 41—EDUCATION AND ENTERTAINMENT

FOR CONCERT BOOKING; ENTERTAINMENT, NAMELY, LIVE MUSIC CONCERTS; MUSIC COMPOSITION AND TRANSCRIPTION FOR OTHERS (U.S. CLS. 100, 101 AND 107).

ANDREA K. NADELMAN, EXAMINING ATTORNEY

SN 76-584,526. GIDDY UP, L.L.C., ANN ARBOR, MI. FILED 3-30-2004.

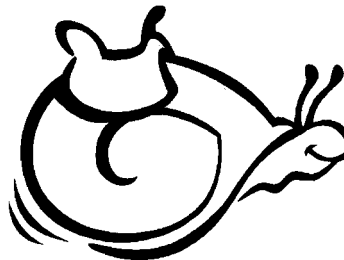

THE MARK CONSISTS OF A SNAIL WITH A SADDLE.

CLASS 16—PAPER GOODS AND PRINTED MATTER

FOR BOOK MARKS, CHILDREN'S GAME, COLORING AND ACTIVITY BOOKS, CHILDREN'S STICKERS, WRITING IMPLEMENTS, CRAYONS, MARKERS, STATIONERY, AND STATIONERY CONTAINING INVISIBLE INKS WHICH ARE ACTIVATED UPON USE OF SPECIAL COLOR CHANGING MARKERS, AS WELL AS ACTIVITY KITS CONSISTING OF STATIONERY SHEETS, MARKERS, RUBBER STAMPS AND STICKERS (U.S. CLS. 2, 5, 22, 23, 29, 37, 38 AND 50).

FIRST USE 9-23-2002; IN COMMERCE 9-23-2002.

CLASS 28—TOYS AND SPORTING GOODS

FOR TOYS CONSISTING OF WORD GAMES, COLORING GAMES, MAZES, MATCHING GAMES, CONNECT THE DOT GAMES AND PUZZLES (U.S. CLS. 22, 23, 38 AND 50).

FIRST USE 9-23-2002; IN COMMERCE 9-23-2002.

LESLEY LAMOTHE, EXAMINING ATTORNEY

SN 76-585,381. SAFE SKIES LLC., BROOKLYN, NY. FILED 4-2-2004.



CLASS 6—METAL GOODS

FOR METAL LOCKS (U.S. CLS. 2, 12, 13, 14, 23, 25 AND 50).

CLASS 35—ADVERTISING AND BUSINESS

FOR DISTRIBUTORSHIPS IN THE FIELD OF METAL LOCKS THAT HAVE APPROVAL OF AUTHORITIES RESPONSIBLE FOR AIRLINE LUGGAGE SCREENING, THE LOCKS HAVING MASTER KEYS THAT ARE HELD BY THE AIRLINE LUGGAGE SCREENER (U.S. CLS. 100, 101 AND 102).

LAURA KOVAISKY, EXAMINING ATTORNEY

SN 76-585,493. CRYSTAL MOUNTAIN PRODUCTIONS LTD., CLEVELAND, OH. FILED 4-5-2004.



CLASS 38—COMMUNICATION

FOR RADIO BROADCASTING (U.S. CLS. 100, 101 AND 104).

CLASS 41—EDUCATION AND ENTERTAINMENT

FOR RADIO ENTERTAINMENT PRODUCTION (U.S. CLS. 100, 101 AND 107).

CHRISTOPHER ADKINS, EXAMINING ATTORNEY

SN 76-586,497. CARNEGIE MELLON UNIVERSITY, PITTSBURGH, PA. FILED 4-12-2004.

CARNEGIE MELLON CYLAB CONFIDENCE FOR A NETWORKED WORLD

THE MARK CONSISTS OF STANDARD CHARACTERS WITHOUT CLAIM TO ANY PARTICULAR FONT, STYLE, SIZE, OR COLOR.

CLASS 35—ADVERTISING AND BUSINESS

FOR CONSULTATION AND RESEARCH FOR OTHERS IN THE FIELDS OF PUBLIC POLICY, AND BUSINESS MANAGEMENT (U.S. CLS. 100, 101 AND 102). FIRST USE 10-0-2003; IN COMMERCE 1-9-2004.

CLASS 41—EDUCATION AND ENTERTAINMENT

FOR EDUCATIONAL SERVICES, NAMELY, DEVELOPING, ARRANGING FOR AND PROVIDING COURSES OF INSTRUCTION, TRAINING, SEMINARS, WORKSHOPS, AND CONFERENCES IN THE FIELDS OF INFORMATION TECHNOLOGY, PUBLIC POLICY, AND MANAGEMENT (U.S. CLS. 100, 101 AND 107). FIRST USE 10-0-2003; IN COMMERCE 1-9-2004.

CLASS 42—SCIENTIFIC, COMPUTER AND LEGAL SERVICES

FOR DESIGN AND DEVELOPMENT OF COMPUTER PROGRAMS FOR INFORMATION TECHNOLOGY SECURITY SYSTEMS; MONITORING OF INFORMATION TECHNOLOGY SECURITY SYSTEMS FOR OTHERS FOR TECHNICAL PURPOSES; CONSULTATION AND RESEARCH FOR OTHERS IN THE FIELDS OF INFORMATION TECHNOLOGY AND COMPUTER PROJECT MANAGEMENT (U.S. CLS. 100 AND 101). FIRST USE 10-0-2003; IN COMMERCE 1-9-2004.

CLASS 45—PERSONAL SERVICES

FOR MONITORING OF INFORMATION TECHNOLOGY SECURITY SYSTEMS FOR OTHERS FOR SECURITY PURPOSES (U.S. CLS. 100 AND 101). FIRST USE 10-0-2003; IN COMMERCE 1-9-2004. KARANENDRA S. CHHINA, EXAMINING ATTORNEY

SN 76-587,398. ALL AROUND AUDIO, LLC, LANSING, MI. FILED 4-20-2004.

ALL AROUND AUDIO

THE MARK CONSISTS OF STANDARD CHARACTERS WITHOUT CLAIM TO ANY PARTICULAR FONT, STYLE, SIZE, OR COLOR.

NO CLAIM IS MADE TO THE EXCLUSIVE RIGHT TO USE "AUDIO", APART FROM THE MARK AS SHOWN.

CLASS 15—MUSICAL INSTRUMENTS

FOR PERCUSSION ACCESSORIES, NAMELY, CYMBAL AND DRUM STANDS. (U.S. CLS. 2, 21 AND 36).

CLASS 41—EDUCATION AND ENTERTAINMENT

FOR ENTERTAINMENT SERVICES, NAMELY, MUSIC PRODUCTION SERVICES AND THE PRODUCTION AND PROVIDING OF LIVE PERFORMANCES AS PART OF A MUSICAL GROUP (U.S. CLS. 100, 101 AND 107).

AMY HELLA, EXAMINING ATTORNEY

SN 76-587,400. FLAVOR SYSTEMS INTERNATIONAL, INC., CINCINNATI, OH. FILED 4-19-2004.

SN 76-590,320. NAMCO LTD., TOKYO, JAPAN, FILED 5-3-2004.

SOYPLEX

THE MARK CONSISTS OF STANDARD CHARACTERS WITHOUT CLAIM TO ANY PARTICULAR FONT, STYLE, SIZE, OR COLOR.

CLASS 5—PHARMACEUTICALS

FOR NUTRITIONAL SUPPLEMENT IN THE NATURE OF HIGH-PROTEIN FLAVOR-MASKED SOY POWDER (U.S. CLS. 6, 18, 44, 46, 51 AND 52).
FIRST USE 8-15-2003; IN COMMERCE 8-15-2003.

CLASS 29—MEATS AND PROCESSED FOODS

FOR SOY MILK POWDER (U.S. CL. 46).
FIRST USE 8-15-2003; IN COMMERCE 8-15-2003.
MARK RADEMACHER, EXAMINING ATTORNEY

SN 76-587,799. D.K. SHIFFLET & ASSOCIATES, LTD., FALLS CHURCH, VA. FILED 4-19-2004.

GEST

THE MARK CONSISTS OF STANDARD CHARACTERS WITHOUT CLAIM TO ANY PARTICULAR FONT, STYLE, SIZE, OR COLOR.

CLASS 35—ADVERTISING AND BUSINESS

FOR CONDUCTING CUSTOMER SATISFACTION, BUSINESS AND MARKET RESEARCH SURVEYS, ONLINE, IN THE HOTEL, TRAVEL AND HOSPITALITY INDUSTRIES; PREPARING BUSINESS REPORTS IN THE FIELDS OF RESORT HOTELS AND HOSPITALITY AND IN THE FIELD OF TRAVEL (U.S. CLS. 100, 101 AND 102).

CLASS 39—TRANSPORTATION AND STORAGE

FOR PROVIDING INFORMATION IN THE FIELD OF TRAVEL (U.S. CLS. 100 AND 105).

CLASS 43—HOTEL AND RESTAURANT SERVICES

FOR PROVIDING INFORMATION IN THE FIELDS OF RESORT HOTELS AND HOSPITALITY (U.S. CLS. 100 AND 101).
PAUL F. GAST, EXAMINING ATTORNEY

MAXIMUM TUNE

THE MARK CONSISTS OF STANDARD CHARACTERS WITHOUT CLAIM TO ANY PARTICULAR FONT, STYLE, SIZE, OR COLOR.

NO CLAIM IS MADE TO THE EXCLUSIVE RIGHT TO USE "TUNE", APART FROM THE MARK AS SHOWN.

CLASS 9—ELECTRICAL AND SCIENTIFIC APPARATUS

FOR VIDEO GAME CARTRIDGES, COMPUTER GAME PROGRAMS (U.S. CLS. 21, 23, 26, 36 AND 38).

CLASS 28—TOYS AND SPORTING GOODS

FOR COIN-OPERATED AMUSEMENT GAME MACHINES (U.S. CLS. 22, 23, 38 AND 50).
HOWARD SMIGA, EXAMINING ATTORNEY

SN 76-590,340. WORLD OF JEANS & TOPS, INC., IRVINE, CA. FILED 5-3-2004.

BLENDOUT

THE MARK CONSISTS OF STANDARD CHARACTERS WITHOUT CLAIM TO ANY PARTICULAR FONT, STYLE, SIZE, OR COLOR.

CLASS 25—CLOTHING

FOR MEN'S AND BOY'S WEARING APPAREL, NAMELY, T-SHIRTS, SWEATSHIRTS, TANK TOPS, WOVEN SHIRTS, SWEATERS, CARDIGANS, VESTS, JACKETS, PANTS, SWEATPANTS, JEANS, SHORTS, HATS, CAPS, COATS, PAJAMAS, SOCKS, UNDERWEAR, SWIM WEAR, AND TRUNKS; AND WOMEN'S AND GIRLS WEARING APPAREL, NAMELY, T-SHIRTS, SWEATSHIRTS, TANK TOPS, WOVEN SHIRTS, SWEATERS, CARDIGANS, VESTS, JACKETS, PANTS, SWEATPANTS, JEANS, SHORTS, HATS, CAPS, COATS, PAJAMAS, SOCK, UNDERWEAR, PANTYHOSE, TEDDIES, BRAS, SKIRTS, DRESSES, BLOUSES, SWIM WEAR, AND BIKINIS (U.S. CLS. 22 AND 39).

CLASS 35—ADVERTISING AND BUSINESS

FOR RETAIL STORE SERVICES FEATURING MEN'S, BOY'S, WOMEN'S, AND GIRL'S WEARING APPAREL (U.S. CLS. 100, 101 AND 102).
RONALD MCMORROW, EXAMINING ATTORNEY

SN 76-590,597. ZINC MATRIX POWER, INC., SANTA BARBARA, CA. FILED 5-3-2004.

SN 76-592,462. JADE PRODUCTIONS, LLC, WILMINGTON, DE. FILED 5-17-2004.

ZINC MATRIX POWER

NO CLAIM IS MADE TO THE EXCLUSIVE RIGHT TO USE "ZINC" AND "POWER", APART FROM THE MARK AS SHOWN.

CLASS 1—CHEMICALS

FOR UNEXPOSED CAMERA FILM (U.S. CLS. 1, 5, 6, 10, 26 AND 46).

CLASS 9—ELECTRICAL AND SCIENTIFIC APPARATUS

FOR BATTERIES (U.S. CLS. 21, 23, 26, 36 AND 38).
RON FAIRBANKS, EXAMINING ATTORNEY

SN 76-590,984. SCHLIAPNIK, JAIME, SAN DIEGO, CA. FILED 5-7-2004.

EULA

THE MARK CONSISTS OF STANDARD CHARACTERS WITHOUT CLAIM TO ANY PARTICULAR FONT, STYLE, SIZE, OR COLOR.

CLASS 16—PAPER GOODS AND PRINTED MATTER

FOR PRINTED MATTER; NAMELY, DECALS, CALENDARS, POSTERS, NEWSPAPERS, AND MAGAZINES, NAMELY, GENERAL FEATURE, SPORTS, AND TRAVEL (U.S. CLS. 2, 5, 22, 23, 29, 37, 38 AND 50).

CLASS 25—CLOTHING

FOR CLOTHING NAMELY, T-SHIRTS, SHIRTS, TANK TOPS, SHORTS, PANTS, SWEAT SHIRTS, HATS, CAPS, VISORS, SWIM TRUNKS, RAIN WEAR CLOTHING, SHOES, SANDALS AND BELTS (U.S. CLS. 22 AND 39).
KARANENDRA S. CHHINA, EXAMINING ATTORNEY

FIT☆DINA

CLASS 25—CLOTHING

FOR CLOTHING, NAMELY T-SHIRTS (U.S. CLS. 22 AND 39).
FIRST USE 6-0-2002; IN COMMERCE 6-0-2002.

CLASS 41—EDUCATION AND ENTERTAINMENT

FOR ENTERTAINMENT SERVICES NAMELY, PROVIDING INFORMATION ONLINE REGARDING FITNESS COMPETITION (U.S. CLS. 100, 101 AND 107).
FIRST USE 8-0-2000; IN COMMERCE 8-0-2000.
THEODORE MCBRIDE, EXAMINING ATTORNEY

SN 76-592,618. SEVADA DESIGN INC., DBA ETHOS DESIGN, GLENDALE, CA. FILED 5-17-2004.



NO CLAIM IS MADE TO THE EXCLUSIVE RIGHT TO USE "LOUNGE", APART FROM THE MARK AS SHOWN.

CLASS 35—ADVERTISING AND BUSINESS

FOR FURNITURE RETAIL STORE SERVICES; SECOND HAND FURNITURE RESALE DEALERSHIP SERVICES; GENERAL CONSUMER MERCHANDISE RETAIL STORE SERVICES (U.S. CLS. 100, 101 AND 102).

CLASS 37—CONSTRUCTION AND REPAIR

FOR CONTRACT FURNITURE SERVICES, NAMELY, CUSTOM INSTALLATION OF FURNITURE (U.S. CLS. 100, 103 AND 106).

CLASS 40—MATERIAL TREATMENT

FOR CONTRACT FURNITURE SERVICES, NAMELY, CUSTOM FABRICATION OF FURNITURE (U.S. CLS. 100, 103 AND 106).
KARANENDRA S. CHHINA, EXAMINING ATTORNEY

SN 76-592,623. SEVADA DESIGN INC., DBA ETHOS DESIGN, GLENDALE, CA. FILED 5-17-2004.

LOUNGE 22

THE MARK CONSISTS OF STANDARD CHARACTERS WITHOUT CLAIM TO ANY PARTICULAR FONT, STYLE, SIZE, OR COLOR.

NO CLAIM IS MADE TO THE EXCLUSIVE RIGHT TO USE "LOUNGE", APART FROM THE MARK AS SHOWN.

CLASS 35—ADVERTISING AND BUSINESS

FOR FURNITURE RETAIL STORE SERVICES; SECOND HAND FURNITURE RESALE DEALERSHIP SERVICES; GENERAL CONSUMER MERCHANDISE RETAIL STORE SERVICES (U.S. CLS. 100, 101 AND 102).

CLASS 37—CONSTRUCTION AND REPAIR

FOR CONTRACT FURNITURE SERVICES, NAMELY, CUSTOM INSTALLATION OF FURNITURE (U.S. CLS. 100, 103 AND 106).

CLASS 40—MATERIAL TREATMENT

FOR CONTRACT FURNITURE SERVICES, NAMELY, CUSTOM FABRICATION OF FURNITURE (U.S. CLS. 100, 103 AND 106).

KARANENDRA S. CHHINA, EXAMINING ATTORNEY

SN 76-593,291. TOLK HOME & ESTATE PROPERTY MANAGEMENT, LLC, FAIRFIELD, CT. FILED 5-20-2004.

THE EYES WHEN YOU'RE AWAY, THE HANDS WHEN YOU'RE HOME

THE MARK CONSISTS OF STANDARD CHARACTERS WITHOUT CLAIM TO ANY PARTICULAR FONT, STYLE, SIZE, OR COLOR.

CLASS 35—ADVERTISING AND BUSINESS

FOR RECORDS MANAGEMENT SERVICES, NAMELY, DOCUMENT INDEXING AND RECORD-KEEPING FOR OTHERS IN CONNECTION WITH RESIDENTIAL PROPERTIES; BOOKKEEPING SERVICES; BUSINESS MANAGEMENT SERVICES, NAMELY STAFF SUPERVISION SERVICES FOR OTHERS; VENDOR CONTRACT MANAGEMENT AND APPOINTMENT SCHEDULING FOR OTHERS; PROVIDING REFERRALS TO HOMEOWNERS IN THE FIELD OF HOME REPAIR AND RENOVATION (U.S. CLS. 100, 101 AND 102).

FIRST USE 11-0-2003; IN COMMERCE 11-0-2003.

CLASS 37—CONSTRUCTION AND REPAIR

FOR HOME MAINTENANCE SERVICES, NAMELY, PREVENTIVE MAINTENANCE, CLEANING, RENOVATION AND CONSTRUCTION PROJECT SUPERVISION FOR OTHERS; HOME INSPECTION IN THE COURSE OF BUILDING CONSTRUCTION; AND HOME REPAIR SERVICES (U.S. CLS. 100, 103 AND 106).

FIRST USE 11-0-2003; IN COMMERCE 11-0-2003.

CLASS 45—PERSONAL SERVICES

FOR HOUSE SITTING SERVICES, NAMELY, MAIL COLLECTION, HOUSE KEY SAFEKEEPING, ACCEPTING DELIVERIES FOR HOMEOWNERS; RUNNING ERRANDS FOR HOMEOWNERS; SECURITY INSPECTION SERVICES FOR OTHERS (U.S. CLS. 100 AND 101).

FIRST USE 11-0-2003; IN COMMERCE 11-0-2003.

AMY GEARIN, EXAMINING ATTORNEY

SN 76-593,895. ENICS AG, CH-5300 TURGI, SWITZERLAND, FILED 5-25-2004.

ENICS

THE MARK CONSISTS OF STANDARD CHARACTERS WITHOUT CLAIM TO ANY PARTICULAR FONT, STYLE, SIZE, OR COLOR.

CLASS 9—ELECTRICAL AND SCIENTIFIC APPARATUS

FOR POWER SUPPLIES AND ELECTRICAL COMPONENTS, ELECTRONIC CONTROL AND REGULATING EQUIPMENT, AND SENSOR ELECTRONICS, NAMELY TRANSFORMERS, TIMERS, CONTROLLERS, RELAY MODULES, SURGE PROTECTORS, AND POWER DISTRIBUTION MODULES, FOR SECURITY, ELEVATORS, LIGHTING, RAILWAY, METERING, ENERGY BUILDING, ACCESS CONTROL, HOME AUTOMATION, LIFE SAFETY AND HIGH TO LOW VOLTAGE INDUSTRIAL PRODUCT SECTORS (U.S. CLS. 21, 23, 26, 36 AND 38).

CLASS 42—SCIENTIFIC, COMPUTER AND LEGAL SERVICES

FOR DESIGN OF POWER SUPPLIES, ELECTRICAL COMPONENTS, ELECTRONIC CONTROL AND REGULATING EQUIPMENT, AND SENSOR ELECTRONICS, NAMELY TRANSFORMERS, TIMERS, CONTROLLERS, RELAY MODULES, SURGE PROTECTORS, AND POWER DISTRIBUTION MODULES, FOR SECURITY, ELEVATORS, LIGHTING, RAILWAY, METERING, ENERGY BUILDING, ACCESS CONTROL, HOME AUTOMATION, LIFE SAFETY AND HIGH TO LOW VOLTAGE INDUSTRIAL PRODUCT SECTORS (U.S. CLS. 100 AND 101).

ANN E. SAPPENFIELD, EXAMINING ATTORNEY

SN 76-594,962. MILLER INDUSTRIES TOWING EQUIPMENT, INC., OOLTEWAH, TN. FILED 6-1-2004.

MIDNIGHT EXPRESS

THE MARK CONSISTS OF STANDARD CHARACTERS WITHOUT CLAIM TO ANY PARTICULAR FONT, STYLE, SIZE, OR COLOR.

OWNER OF U.S. REG. NO. 2,412,784.

CLASS 7—MACHINERY

FOR HOISTS, BOOMS, LIFTS, AND WINCHES USED IN THE RECOVERY AND TOWING OF DISABLED VEHICLES (U.S. CLS. 13, 19, 21, 23, 31, 34 AND 35).
FIRST USE 1-12-1998; IN COMMERCE 1-12-1998.

CLASS 12—VEHICLES

FOR WRECKER BODIES AND BEDS, AND TRUCK MOUNTED COMPONENTS SOLD THEREWITH, NAMELY HOISTS, BOOMS, LIFTS, AND WINCHES USED IN THE RECOVERY AND TOWING OF DISABLED VEHICLES (U.S. CLS. 19, 21, 23, 31, 35 AND 44).
FIRST USE 1-12-1998; IN COMMERCE 1-12-1998.
JASON LOTT, EXAMINING ATTORNEY

SN 76-595,270. HERR HOLDINGS, INC., WILMINGTON, DE.
FILED 6-3-2004.



OWNER OF U.S. REG. NOS. 1,078,501, 2,855,674 AND OTHERS.

CLASS 29—MEATS AND PROCESSED FOODS

FOR SNACK FOODS, NAMELY, POTATO CHIPS PACKAGED IN VARIETY PACKS; SNACK FOOD DIPS, NAMELY, CHEESE DIPS, NACHO DIPS, SOUR CREAM AND ONION DIPS, GREEN ONION DIPS, GUACAMOLE DIPS, HONEY MUSTARD DIPS, SMOKY BACON-FLAVORED DIPS, AND OTHER CREAM AND DAIRY DIPS; SOY CRISPS; BANANA CHIPS; POTATO STICKS; CHEESE STICKS; AND ONION RINGS (U.S. CL. 46).
FIRST USE 1-1-1980; IN COMMERCE 1-1-1980.

CLASS 30—STAPLE FOODS

FOR VARIETY PACKS CONTAINING TORTILLA CHIPS, PRETZELS, CHEESE CURLS, AND POPCORN; SNACK FOODS, NAMELY, TORTILLA AND NACHO CHIPS PACKAGED SINGLY AND IN VARIETY PACKS; CRACKERS; SALSA; PEANUT BUTTER NUGGETS; AND COTTON CANDY (U.S. CL. 46).
FIRST USE 1-1-1980; IN COMMERCE 1-1-1980.
ALICE SUE CARRUTHERS, EXAMINING ATTORNEY

SN 76-595,705. AXIOM WORLDWIDE, INC., TAMPA, FL.
FILED 6-4-2004.

AXIOM WORLDWIDE

THE MARK CONSISTS OF STANDARD CHARACTERS WITHOUT CLAIM TO ANY PARTICULAR FONT, STYLE, SIZE, OR COLOR.

NO CLAIM IS MADE TO THE EXCLUSIVE RIGHT TO USE "WORLDWIDE", APART FROM THE MARK AS SHOWN.

CLASS 10—MEDICAL APPARATUS

FOR MEDICAL DEVICES AND SYSTEMS, NAMELY NON-SURGICAL DIAGNOSTIC AND TREATMENT DEVICES AND SYSTEMS INCLUDING SPINAL DECOMPRESSION UNITS, BONE DENSITOMETERS AND NON-SURGICAL LASER THERAPY SYSTEMS (U.S. CLS. 26, 39 AND 44).
FIRST USE 1-0-2001; IN COMMERCE 1-0-2001.

CLASS 35—ADVERTISING AND BUSINESS

FOR WHOLESALE DISTRIBUTORSHIP OF MEDICAL, NON-SURGICAL DIAGNOSTIC AND TREATMENT DEVICES AND SYSTEMS (U.S. CLS. 100, 101 AND 102).
FIRST USE 1-0-2001; IN COMMERCE 1-0-2001.

CLASS 40—MATERIAL TREATMENT

FOR CUSTOM MANUFACTURING OF MEDICAL, NON-SURGICAL DIAGNOSTIC AND TREATMENT DEVICES AND SYSTEMS TO THE ORDER AND SPECIFICATION OF OTHERS (U.S. CLS. 100, 103 AND 106).
FIRST USE 1-0-2001; IN COMMERCE 1-0-2001.
MIDGE BUTLER, EXAMINING ATTORNEY

SN 76-596,639. IMAGEM INC., PHILADELPHIA, PA. FILED
6-9-2004.

VERIGEM

THE MARK CONSISTS OF STANDARD CHARACTERS WITHOUT CLAIM TO ANY PARTICULAR FONT, STYLE, SIZE, OR COLOR.

CLASS 36—INSURANCE AND FINANCIAL

FOR PREPARING APPRAISALS OF GEMS AND GEOLOGICAL SPECIMENS, AND ASSOCIATED REPORTS AND CERTIFICATES (U.S. CLS. 100, 101 AND 102).

CLASS 42—SCIENTIFIC, COMPUTER AND LEGAL SERVICES

FOR GEMOLOGICAL SERVICES, NAMELY MEASURING PHYSICAL CHARACTERISTICS OF GEMSTONES FOR OTHERS, CREATING AND MAINTAINING A DATABASE OF INFORMATION FROM THE MEASURED PHYSICAL CHARACTERISTICS, AND IDENTIFYING GEMSTONES FOR OTHERS BY COMPARING ACTUAL MEASURED PHYSICAL CHARACTERISTICS OF THE GEMSTONES TO INFORMATION IN THE DATABASE (U.S. CLS. 100 AND 101).
WANDA KAY PRICE, EXAMINING ATTORNEY

SN 76-596,676. KOHL'S ILLINOIS, INC., AURORA, IL. FILED
6-10-2004.

STUDENT LOUNGE

THE MARK CONSISTS OF STANDARD CHARACTERS WITHOUT CLAIM TO ANY PARTICULAR FONT, STYLE, SIZE, OR COLOR.

NO CLAIM IS MADE TO THE EXCLUSIVE RIGHT TO USE STUDENT, APART FROM THE MARK AS SHOWN.

CLASS 11—ENVIRONMENTAL CONTROL APPARATUS

FOR LAMPS, DECORATIVE LAMPS (U.S. CLS. 13, 21, 23, 31 AND 34).

CLASS 14—JEWELRY

FOR ALARM CLOCKS (U.S. CLS. 2, 27, 28 AND 50).

CLASS 16—PAPER GOODS AND PRINTED MATTER

FOR PHOTO ALBUMS, LAP DESKS WITH DRINK HOLDERS, MEMO BOARDS WITH MARKERS, STICKERS IN THE NATURE OF DECORATIVE GLOW STARS (U.S. CLS. 2, 5, 22, 23, 29, 37, 38 AND 50).

CLASS 22—CORDAGE AND FIBERS

FOR CLOTH LAUNDRY BAGS (U.S. CLS. 1, 2, 7, 19, 22, 42 AND 50).
JAMES GRIFFIN, EXAMINING ATTORNEY

SN 76-596,707. NAISMITH MEMORIAL BASKETBALL HALL OF FAME, INC., SPRINGFIELD, MA. FILED 6-9-2004.

HOOPHALL

OWNER OF U.S. REG. NO. 2,754,997.

CLASS 25—CLOTHING

FOR CLOTHING NAMELY, SHIRTS, JACKETS, PANTS, SHORTS, HATS, COATS, SOCKS AND SHOES (U.S. CLS. 22 AND 39).

CLASS 28—TOYS AND SPORTING GOODS

FOR TOY ACTION FIGURES, AND ACCESSORIES THEREFOR INCLUDING, CLOTHING FOR ACTION FIGURES, COLLECTABLE TOY FIGURES CARD GAMES, CHILDREN'S MULTIPLE ACTIVITY TOYS AND SPORT BALLS (U.S. CLS. 22, 23, 38 AND 50).
STANLEY I. OSBORNE, EXAMINING ATTORNEY

SN 76-596,766. STITZER, KIMBERLEY, KEYPORT, WA. FILED 6-14-2004.

DRAW YOUR WORLD

THE MARK CONSISTS OF STANDARD CHARACTERS WITHOUT CLAIM TO ANY PARTICULAR FONT, STYLE, SIZE, OR COLOR.

CLASS 35—ADVERTISING AND BUSINESS

FOR ON-LINE RETAIL STORE SERVICES FEATURING EDUCATIONAL BOOKS AND SOFTWARE AND RELATED EDUCATIONAL MATERIALS (U.S. CLS. 100, 101 AND 102).
FIRST USE 6-8-2004; IN COMMERCE 6-8-2004.

CLASS 41—EDUCATION AND ENTERTAINMENT

FOR EDUCATIONAL SERVICES, NAMELY, PROVIDING COURSES OF INSTRUCTION AT THE PRIMARY AND SECONDARY LEVELS AND DISTRIBUTION OF COURSE MATERIALS AND TEACHER'S MANUALS IN CONNECTION THEREWITH (U.S. CLS. 100, 101 AND 107).
FIRST USE 6-8-2004; IN COMMERCE 6-8-2004.
CURTIS FRENCH, EXAMINING ATTORNEY

SN 76-596,799. AMERICAN NEWLAND COMMUNITIES, LP, LA JOLLA, CA. FILED 6-14-2004.

AT THE HEART OF GREAT LIVING

THE MARK CONSISTS OF STANDARD CHARACTERS WITHOUT CLAIM TO ANY PARTICULAR FONT, STYLE, SIZE, OR COLOR.

CLASS 36—INSURANCE AND FINANCIAL

FOR REAL ESTATE SERVICES, NAMELY, REAL ESTATE AGENCIES, REAL ESTATE MANAGEMENT, REAL ESTATE LISTING, REAL ESTATE SYNDICATION, REAL ESTATE, HOTEL, AND RESORT BROKERAGE AND LEASING SERVICES; REAL ESTATE INVESTMENT, NAMELY, FINANCIAL INVESTMENT IN REAL ESTATE, RESORTS, AND PLANNED COMMUNITIES; COMMERCIAL REAL ESTATE ACQUISITION, NAMELY, COMMERCIAL REAL ESTATE BROKERAGE SERVICES; ONLINE INFORMATION SERVICES IN THE FIELD OF REAL ESTATE; PROVIDING WEBSITES AND INTRANETS IN THE FIELD OF REAL ESTATE (U.S. CLS. 100, 101 AND 102).

CLASS 37—CONSTRUCTION AND REPAIR

FOR REAL ESTATE SITE SELECTION; REAL ESTATE DEVELOPMENT; LAND DEVELOPMENT SERVICES, NAMELY, PLANNING, LAYING OUT, AND MANAGEMENT OF RESIDENTIAL AND/OR COMMERCIAL DEVELOPMENTS AND GOLF COURSES; CONSTRUCTION SERVICES, NAMELY, PLANNING, LAYING OUT, AND CUSTOM CONSTRUCTION OF RESIDENTIAL AND/OR COMMERCIAL DEVELOPMENTS, AND GOLF COURSES; CONSTRUCTION SUPERVISION; CONSTRUCTION PLANNING; ONLINE INFORMATION SERVICES IN THE FIELDS OF REAL ESTATE DEVELOPMENT, PLANNED COMMUNITIES, RESIDENTIAL AND COMMERCIAL DEVELOPMENTS, AND GOLF COURSES (U.S. CLS. 100, 103 AND 106).

CLASS 38—COMMUNICATION

FOR TELECOMMUNICATIONS SERVICES, NAMELY, PROVIDING MULTIPLE USER ACCESS TO COMPUTER NETWORKS, THE INTERNET, AND INTRANETS; EMAIL SERVICES; PROVIDING BROADBAND CONNECTIONS TO COMPUTER NETWORKS, THE INTERNET, AND INTRANETS; BROADCASTING AND DELIVERY OF COMMUNITY NEWS INFORMATION AND OF AUDIO, VIDEO, AND/OR MULTIMEDIA CONTENT BY MEANS OF ELECTRONIC COMMUNICATIONS NETWORKS OR COMPUTER NETWORKS; ELECTRONIC TRANSMISSION OF DATA, IMAGES, AND DOCUMENTS VIA THE INTERNET, COMPUTER NETWORKS, AND INTRANETS; GLOBAL COMPUTER NETWORK BROADCASTING SERVICES; ELECTRONIC TRANSMISSION OF VIDEO AND VOICE DATA, STREAMING MEDIA AND MUSIC (U.S. CLS. 100, 101 AND 104).
INGRID C. EULIN, EXAMINING ATTORNEY

SN 76-596,874. O.C. SEACRETS, INC., OCEAN CITY, MD.
FILED 6-10-2004.

SN 76-597,397. SPOETZL BREWERY, INC., SAN ANTONIO,
TX. FILED 6-15-2004.

SEACRETS

THE MARK CONSISTS OF STANDARD CHARACTERS
WITHOUT CLAIM TO ANY PARTICULAR FONT, STYLE,
SIZE, OR COLOR.

OWNER OF U.S. REG. NO. 2,102,604 AND OTHERS.

CLASS 11—ENVIRONMENTAL CONTROL AP- PARATUS

FOR FLASHLIGHTS (U.S. CLS. 13, 21, 23, 31 AND 34).
FIRST USE 6-0-1988; IN COMMERCE 6-0-1988.

CLASS 14—JEWELRY

FOR JEWELRY PINS FOR USE ON HATS (U.S. CLS. 2,
27, 28 AND 50).
FIRST USE 5-0-2000; IN COMMERCE 5-0-2000.

CLASS 16—PAPER GOODS AND PRINTED MATTER

FOR POSTCARDS AND BUMPER STICKERS (U.S.
CLS. 2, 5, 22, 23, 29, 37, 38 AND 50).
FIRST USE 6-0-1988; IN COMMERCE 6-0-1988.
ROBERT LORENZO, EXAMINING ATTORNEY

SN 76-597,175. MORRISON PARTNERS, LLC, CHERRY
HILL, NJ. FILED 6-14-2004.



CLASS 21—HOUSEWARES AND GLASS

FOR COFFEE CUPS AND DRINK CUPS (U.S. CLS. 2,
13, 23, 29, 30, 33, 40 AND 50).
FIRST USE 7-8-2004; IN COMMERCE 7-8-2004.

CLASS 25—CLOTHING

FOR SHIRTS, JACKETS, PANTS, VESTS, PULLOVERS,
HOODS, AND HEADGEAR, NAMELY, HATS AND CAPS
(U.S. CLS. 22 AND 39).
FIRST USE 7-8-2004; IN COMMERCE 7-8-2004.
CHERYL CLAYTON, EXAMINING ATTORNEY

BACK HOME AGAIN

THE MARK CONSISTS OF STANDARD CHARACTERS
WITHOUT CLAIM TO ANY PARTICULAR FONT, STYLE,
SIZE, OR COLOR.

CLASS 32—LIGHT BEVERAGES

FOR BEER (U.S. CLS. 45, 46 AND 48).

CLASS 41—EDUCATION AND ENTERTAIN- MENT

FOR CONDUCTING ENTERTAINMENT EXHIBI-
TIONS FEATURING BEER, MUSIC, DANCING AND
FOOD (U.S. CLS. 100, 101 AND 107).
GWEN STOKOLS, EXAMINING ATTORNEY

SN 76-597,430. ASHBROOK CORPORATION, HOUSTON, TX.
FILED 6-16-2004.

COPLASTIX

THE MARK CONSISTS OF STANDARD CHARACTERS
WITHOUT CLAIM TO ANY PARTICULAR FONT, STYLE,
SIZE, OR COLOR.

CLASS 17—RUBBER GOODS

FOR NON-TEXTILE SHEETS, BLOCKS AND RODS,
ALL MADE WHOLLY OR PRINCIPALLY OF PLASTICS
AND FOR USE IN THE MANUFACTURE OF PEN-
STOCKS, SLUICE GATES, VALVES, OR OF ARTICLES,
APPARATUS, EQUIPMENT OR INSTALLATIONS FOR
THE CONTROL OR TREATMENT OF EFFLUENT, SEW-
AGE, WATER, CHEMICALS AND THE LIKE (U.S. CLS.
1, 5, 12, 13, 35 AND 50).
FIRST USE 0-0-1977; IN COMMERCE 0-0-1977.

CLASS 19—NON-METALLIC BUILDING MA- TERIALS

FOR PENSTOCKS, SLUICE GATES, AND VALVES,
ALL MADE WHOLLY OR PRINCIPALLY OF PLASTICS
MATERIAL (U.S. CLS. 1, 12, 33 AND 50).
FIRST USE 0-0-1977; IN COMMERCE 0-0-1977.
DOMINIC J. FERRAIUOLO, EXAMINING ATTORNEY

SN 76-597,515. BETTEN, JORDAN, DBA LOST ART, BOZ-
RAH, CT. FILED 6-14-2004.

LOST ART

THE MARK CONSISTS OF STANDARD CHARACTERS
WITHOUT CLAIM TO ANY PARTICULAR FONT, STYLE,
SIZE, OR COLOR.

OWNER OF U.S. REG. NO. 2,195,618.

CLASS 18—LEATHER GOODS

FOR ACCESSORIES MADE OF LEATHER AND ANI-
MAL SKINS NAMELY, HANDBAGS, LUGGAGE AND
KNAPSACKS (U.S. CLS. 1, 2, 3, 22 AND 41).

FIRST USE 1-19-1997; IN COMMERCE 5-30-1997.

CLASS 25—CLOTHING

FOR CLOTHING MADE OF LEATHER AND ANIMAL
SKINS, NAMELY PANTS, SHIRTS, VESTS, JACKETS,
AND HATS (U.S. CLS. 22 AND 39).

FIRST USE 1-19-1997; IN COMMERCE 5-30-1997.

KHANH LE, EXAMINING ATTORNEY

SN 76-597,541. YOUNG-WONG, KAYCEE, OAK PARK, CA.
FILED 6-14-2004.

MOMRACER

THE MARK CONSISTS OF STANDARD CHARACTERS
WITHOUT CLAIM TO ANY PARTICULAR FONT, STYLE,
SIZE, OR COLOR.

CLASS 25—CLOTHING

FOR CLOTHING, NAMELY, CASUAL FOOTWEAR,
DRESS SHOES, SANDALS, BOOTS, ATHLETIC SHOES,
APRONS, BANDANNAS, HEADBANDS, SWEATBANDS,
WRISTBANDS, BATHING SUITS AND TRUNKS,
BEACHWEAR, SWIMWEAR, BEACH AND BATHING
COVERUPS, BIKINIS, BELTS, SHORTS, BLAZERS,
BLOUSES, COATS, PANTS, PLAY SUITS, POLO SHIRTS,
PULLOVERS, SHIRTS, SKIRTS, SLACKS, SWEATPANTS,
SWEATSHIRTS, SWEATSHORTS, SWEATERS, T-
SHIRTS, TANK TOPS, WETSUITS, JACKETS, JEANS,
SUITS AND JOGGING SUITS, SWEAT SUITS, BODY-
SUITS, LEOTARDS, LEG WARMERS, TROUSERS,
SPORT COATS, KNIT SHIRTS, VESTS, JUMPSUITS,
SLEEPWEAR, NIGHTGOWNS, ROBES, PAJAMAS,
NIGHTSHIRTS, DRESSES, BEANIES, CAPS, HEAD
WRAPS, HATS, RAINCOATS, PARKAS, PONCHOS, TIES,
SUSPENDERS, CLOTH BIBS, GLOVES, MITTENS, KNIT
HATS AND CAPS, SCARVES, EAR MUFFS AND UN-
DERWEAR (U.S. CLS. 22 AND 39).

CLASS 35—ADVERTISING AND BUSINESS

FOR ON-LINE RETAIL STORE SERVICES FEATUR-
ING TOTE BAGS, COSMETIC BAGS, SPORT BAGS,
BACKPACKS, PURSES, UMBRELLAS, SPORTS CHAIRS,
PLASTIC WATER BOTTLES, INSULATED BEVERAGE
CUPS, PORTABLE FOOD AND BEVERAGE COOLERS,
TOWELS, BLANKETS, BUMPER STICKERS, PERSONAL
ORGANIZERS, DESK ORGANIZERS, JOURNALS, PENS,
STATIONERY, GREETING CARDS, CALENDARS, KEY
CHAINS MADE OF METAL OR PLASTIC, WHISTLES,
CELL PHONE COVERS, SPORT WATCHES, LICENSE
PLATE FRAMES, COSMETICS AND VARIOUS SKIN
PREPARATIONS (U.S. CLS. 100, 101 AND 102).

CHERYL CLAYTON, EXAMINING ATTORNEY

SN 76-597,542. MORRISON PARTNERS, LLC, CHERRY
HILL, NJ. FILED 6-14-2004.



NO CLAIM IS MADE TO THE EXCLUSIVE RIGHT TO
USE "CAPE COD" AND "HARWICH PORT", APART FROM
THE MARK AS SHOWN.

WHALE'S TAIL OUT OF WATER WITHIN TWO CIRCLES
AND THE WORDS THE POOR WHALE CAPE COD HAR-
WICH PORT

CLASS 21—HOUSEWARES AND GLASS

FOR COFFEE CUPS AND DRINK CUPS (U.S. CLS. 2,
13, 23, 29, 30, 33, 40 AND 50).

FIRST USE 7-8-2004; IN COMMERCE 7-8-2004.

CLASS 25—CLOTHING

FOR SHIRTS, JACKETS, PANTS, VESTS, PULLOVERS,
HOODS, AND HEADGEAR, NAMELY, HATS AND CAPS
(U.S. CLS. 22 AND 39).

FIRST USE 7-8-2004; IN COMMERCE 7-8-2004.

CHERYL CLAYTON, EXAMINING ATTORNEY

SN 76-597,543. MORRISON PARTNERS, LLC, CHERRY HILL, NJ. FILED 6-14-2004.



CLASS 21—HOUSEWARES AND GLASS

FOR COFFEE CUPS AND DRINK CUPS (U.S. CLS. 2, 13, 23, 29, 30, 33, 40 AND 50).
FIRST USE 7-8-2004; IN COMMERCE 7-8-2004.

CLASS 25—CLOTHING

FOR SHIRTS, JACKETS, PANTS, VESTS, PULLOVERS, HOODS, AND HEADGEAR, NAMELY HATS AND CAPS (U.S. CLS. 22 AND 39).
FIRST USE 7-8-2004; IN COMMERCE 7-8-2004.
CHERYL CLAYTON, EXAMINING ATTORNEY

SN 76-597,761. 101 COMMUNICATIONS LLC, CHATSWORTH, CA. FILED 6-17-2004.

Recharger

CLASS 9—ELECTRICAL AND SCIENTIFIC APPARATUS

FOR DOWNLOADABLE ELECTRONIC PUBLICATIONS, NAMELY, MAGAZINES, NEWSLETTERS, REPORTS, BULLETINS, AND COMMUNIQUES RELATING TO THE OFFICE PRODUCTS RECYCLING INDUSTRY (U.S. CLS. 21, 23, 26, 36 AND 38).
FIRST USE 12-0-1997; IN COMMERCE 12-0-1997.

CLASS 16—PAPER GOODS AND PRINTED MATTER

FOR PRINTED PUBLICATIONS, NAMELY, MAGAZINES RELATING TO THE OFFICE PRODUCTS RECYCLING INDUSTRY (U.S. CLS. 2, 5, 22, 23, 29, 37, 38 AND 50).
FIRST USE 12-0-1989; IN COMMERCE 12-0-1989.
MARK T. MULLEN, EXAMINING ATTORNEY

SN 76-597,762. 101 COMMUNICATIONS LLC, CHATSWORTH, CA. FILED 6-17-2004.

RECHARGER

THE MARK CONSISTS OF STANDARD CHARACTERS WITHOUT CLAIM TO ANY PARTICULAR FONT, STYLE, SIZE, OR COLOR.

CLASS 9—ELECTRICAL AND SCIENTIFIC APPARATUS

FOR DOWNLOADABLE ELECTRONIC PUBLICATIONS, NAMELY, MAGAZINES, NEWSLETTERS, REPORTS, BULLETINS, AND COMMUNIQUES RELATING TO THE OFFICE PRODUCTS RECYCLING INDUSTRY (U.S. CLS. 21, 23, 26, 36 AND 38).
FIRST USE 12-0-1997; IN COMMERCE 12-0-1997.

CLASS 16—PAPER GOODS AND PRINTED MATTER

FOR PRINTED PUBLICATIONS, NAMELY, MAGAZINES RELATING TO THE OFFICE PRODUCTS RECYCLING INDUSTRY (U.S. CLS. 2, 5, 22, 23, 29, 37, 38 AND 50).
FIRST USE 12-0-1989; IN COMMERCE 12-0-1989.
HOWARD SMIGA, EXAMINING ATTORNEY

SN 76-598,136. EDUCATION THROUGH MUSIC, INC., NEW YORK, NY. FILED 6-18-2004.



CLASS 16—PAPER GOODS AND PRINTED MATTER

FOR PUBLICATIONS AND PRINTED MATERIALS, NAMELY, BOOKS, NEWSLETTERS, PRINTED TEACHING MATERIALS, WORKBOOKS, INSTRUCTION MANUALS, TEACHERS' MANUALS, COLORING BOOKS, ACTIVITY BOOKS, SONG BOOKS AND PRINTED CURRICULUM IN THE FIELD OF MUSIC AND EDUCATION FOR CHILDREN (U.S. CLS. 2, 5, 22, 23, 29, 37, 38 AND 50).
FIRST USE 10-0-2000; IN COMMERCE 10-0-2000.

CLASS 36—INSURANCE AND FINANCIAL

FOR CHARITABLE FUND RAISING SERVICES, NAMELY, RAISING FUNDS FOR THE DEVELOPMENT AND DISSEMINATION OF PROGRAMS AND ACADEMIC CURRICULUM INTEGRATED WITH MUSIC AND OTHER FINE ARTS FOR THE PURPOSE OF STIMULATING AND ENHANCING ACADEMIC PERFORMANCE IN CHILDREN (U.S. CLS. 100, 101 AND 102).
FIRST USE 10-0-2000; IN COMMERCE 10-0-2000.

CLASS 41—EDUCATION AND ENTERTAINMENT

FOR EDUCATIONAL SERVICES, NAMELY, THE DEVELOPMENT AND DISSEMINATION OF PROGRAMS AND ACADEMIC CURRICULUM INTEGRATED WITH MUSIC AND OTHER FINE ARTS FOR THE PURPOSE OF STIMULATING AND ENHANCING ACADEMIC PERFORMANCE IN CHILDREN (U.S. CLS. 100, 101 AND 107).

FIRST USE 10-0-2000; IN COMMERCE 10-0-2000.
CIMMERIAN COLEMAN, EXAMINING ATTORNEY

SN 76-598,159. CLOCKWORK ENTERTAINMENT, LLC, ZEPHYR COVE, NV. FILED 6-18-2004.



THE MARK CONSISTS OF STANDARD CHARACTERS WITHOUT CLAIM TO ANY PARTICULAR FONT, STYLE, SIZE, OR COLOR.

CLASS 9—ELECTRICAL AND SCIENTIFIC APPARATUS

FOR MUSICAL SOUND RECORDINGS AND MUSICAL VIDEO RECORDINGS; AND PRERECORDED AUDIO TAPES, COMPACT DISCS, PRERECORDED VIDEO TAPES, AND DVDS, ALL FEATURING MUSIC (U.S. CLS. 21, 23, 26, 36 AND 38).

CLASS 41—EDUCATION AND ENTERTAINMENT

FOR ENTERTAINMENT SERVICES IN THE NATURE OF LIVE PERFORMANCES BY A MUSICAL GROUP (U.S. CLS. 100, 101 AND 107).

KAREN K. BUSH, EXAMINING ATTORNEY

SN 76-598,311. NEALE, B.R., DALLAS, TX. FILED 6-21-2004.



NO CLAIM IS MADE TO THE EXCLUSIVE RIGHT TO USE "RACING TEAM", APART FROM THE MARK AS SHOWN.

CLASS 12—VEHICLES

FOR AUTOMOBILES (U.S. CLS. 19, 21, 23, 31, 35 AND 44).
FIRST USE 0-0-1992; IN COMMERCE 0-0-1992.

CLASS 16—PAPER GOODS AND PRINTED MATTER

FOR POSTERS (U.S. CLS. 2, 5, 22, 23, 29, 37, 38 AND 50).
FIRST USE 0-0-1965; IN COMMERCE 0-0-1965.

CLASS 25—CLOTHING

FOR SHIRTS, JACKETS AND CAPS (U.S. CLS. 22 AND 39).
FIRST USE 0-0-1965; IN COMMERCE 0-0-1965.

CLASS 28—TOYS AND SPORTING GOODS

FOR TOY MODEL CARS (U.S. CLS. 22, 23, 38 AND 50).
FIRST USE 0-0-1992; IN COMMERCE 0-0-1992.
GEOFFREY FOSDICK, EXAMINING ATTORNEY

SN 76-598,312. SEUNG-YEUP RHEE, DONALD, PARAMOUNT, CA. FILED 6-21-2004.

SOCK POPITS

THE MARK CONSISTS OF STANDARD CHARACTERS WITHOUT CLAIM TO ANY PARTICULAR FONT, STYLE, SIZE, OR COLOR.

CLASS 25—CLOTHING

FOR CLOTHING, NAMELY STOCKINGS, SOCKS AND HOSIERY (U.S. CLS. 22 AND 39).

CLASS 26—FANCY GOODS

FOR ORNAMENTS FOR STOCKINGS NOT MADE OF PRECIOUS METAL (U.S. CLS. 37, 39, 40, 42 AND 50).
GEOFFREY FOSDICK, EXAMINING ATTORNEY

SN 76-599,662. ADVANTAGE GOLD, INC., SOUTHAMPTON, PA. FILED 6-29-2004.

ADVANTAGE GOLD

THE MARK CONSISTS OF STANDARD CHARACTERS WITHOUT CLAIM TO ANY PARTICULAR FONT, STYLE, SIZE, OR COLOR.

CLASS 36—INSURANCE AND FINANCIAL

FOR REAL ESTATE BROKERAGE SERVICES, REAL ESTATE LISTING AND MANAGEMENT SERVICES, MORTGAGE BROKERAGE SERVICES (U.S. CLS. 100, 101 AND 102).

CLASS 42—SCIENTIFIC, COMPUTER AND LEGAL SERVICES

FOR REAL ESTATE CLOSING SERVICES (U.S. CLS. 100 AND 101).
CAROL SPILS, EXAMINING ATTORNEY

CLASS 37—CONSTRUCTION AND REPAIR

FOR REPAIR AND MAINTENANCE SERVICES FOR VEHICLES (U.S. CLS. 100, 103 AND 106).
FIRST USE 9-0-2001; IN COMMERCE 9-0-2001.
KEVON CHISOLM, EXAMINING ATTORNEY

SN 76-599,717. H.J. BAKER & BRO., INC., WESTPORT, CT.
FILED 6-29-2004.



SN 76-604,591. CIRCLE A FENCES, INC., MARIETTA, GA.
FILED 7-27-2004.

CIRCLE A FENCES

NO CLAIM IS MADE TO THE EXCLUSIVE RIGHT TO USE "FENCES", APART FROM THE MARK AS SHOWN. SEC. 2(F).

CLASS 5—PHARMACEUTICALS

FOR LIVESTOCK AND POULTRY FEED SUPPLEMENT (U.S. CLS. 6, 18, 44, 46, 51 AND 52).
FIRST USE 9-29-1992; IN COMMERCE 9-29-1992.

CLASS 35—ADVERTISING AND BUSINESS

FOR IMPORT-EXPORT AGENCY SERVICES; DISTRIBUTORSHIP SERVICES IN THE FIELD OF LIVESTOCK AND POULTRY FEED SUPPLEMENT AND MATERIALS USED IN THE MANUFACTURE OF FERTILIZERS (U.S. CLS. 100, 101 AND 102).
FIRST USE 9-29-1992; IN COMMERCE 9-29-1992.

CLASS 39—TRANSPORTATION AND STORAGE

FOR TRANSPORTATION BY TRUCK, BOAT AND RAIL OF LIVESTOCK AND POULTRY FEED SUPPLEMENTS AND MATERIALS USED IN THE MANUFACTURE OF FERTILIZERS (U.S. CLS. 100 AND 105).
FIRST USE 9-29-1992; IN COMMERCE 9-29-1992.
CAROL SPILS, EXAMINING ATTORNEY

SN 76-599,782. MORAN CHEVROLET, INC., CLINTON TOWNSHIP, MI. FILED 6-25-2004.

WE TREAT YOU LIKE FAMILY**CLASS 35—ADVERTISING AND BUSINESS**

FOR AUTOMOBILE AND TRUCK DEALERSHIP SERVICES (U.S. CLS. 100, 101 AND 102).
FIRST USE 9-0-2001; IN COMMERCE 9-0-2001.

CLASS 36—INSURANCE AND FINANCIAL

FOR FINANCING AND EXTENDED WARRANTY SERVICES FOR VEHICLES (U.S. CLS. 100, 101 AND 102).
FIRST USE 9-0-2001; IN COMMERCE 9-0-2001.

CLASS 6—METAL GOODS

FOR METAL FENCES; METAL FENCING MATERIALS, NAMELY METAL FENCE PANELS, POSTS, STAYS AND RAILINGS; METAL GATES; ORNAMENTAL METAL, NAMELY STEEL AND ALUMINUM POSTS, PICKETS, RAILS AND PANELS; METAL PRIVACY FENCING; METAL TENNIS COURT FENCING; METAL DOG PEN AND RUN FENCING; METAL FARM FENCING; METAL RESIDENTIAL FENCING; METAL COMMERCIAL FENCING; METAL FENCE INSTALLATION MATERIALS, NAMELY, STAYS, POSTS, PICKETS, RAILS AND PANELS; CHAIN LINK FENCING; RAZOR RIBBON FENCING; GALVANIZED FENCING; CUSTOM METAL GATES; AND CUSTOM METAL FENCING (U.S. CLS. 2, 12, 13, 14, 23, 25 AND 50).
FIRST USE 0-0-1968; IN COMMERCE 0-0-1968.

CLASS 19—NON-METALLIC BUILDING MATERIALS

FOR NON-METAL FENCES; NON-METAL FENCING MATERIALS, NAMELY NON-METAL FENCE PANELS, POSTS, STAYS AND RAILINGS; NON-METAL GATES; NON-METAL PRIVACY FENCING; NON-METAL TENNIS COURT FENCING; NON-METAL DOG PEN AND RUN FENCING; NON-METAL FARM FENCING; NON-METAL RESIDENTIAL FENCING; NON-METAL COMMERCIAL FENCING; NON-METAL FENCE INSTALLATION MATERIALS, NAMELY STAYS, POSTS, PICKETS, RAILS AND PANELS; WOOD FENCING; PVC FENCING; CEDAR FENCING, CUSTOM NON-METAL GATES; AND CUSTOM NON-METAL FENCING (U.S. CLS. 1, 12, 33 AND 50).
FIRST USE 0-0-1968; IN COMMERCE 0-0-1968.

CLASS 37—CONSTRUCTION AND REPAIR

FOR INSTALLATION, REPAIR, CUSTOMIZATION, AND CONSTRUCTION SERVICES FOR FENCES, GATES, ORNAMENTAL METAL, PRIVACY FENCING, TENNIS COURT FENCING, DOG PEN AND RUN FENCING, FARM FENCING, RESIDENTIAL FENCING, COMMERCIAL FENCING, ELECTRIC FENCE SYSTEMS, WOOD FENCING, PVC FENCING, CHAIN LINK FENCING, RAZOR RIBBON FENCING, CEDAR FENCING, AND GALVANIZED FENCING (U.S. CLS. 100, 103 AND 106).
FIRST USE 0-0-1968; IN COMMERCE 0-0-1968.
ERNEST SHOSHO, EXAMINING ATTORNEY

SN 76-607,183. STARBUCKS U.S. BRANDS, LLC, MINDEN, NV. FILED 8-16-2004.

STARBUCKS

THE MARK CONSISTS OF STANDARD CHARACTERS WITHOUT CLAIM TO ANY PARTICULAR FONT, STYLE, SIZE, OR COLOR.

OWNER OF U.S. REG. NOS. 2,035,005, 2,325,182 AND OTHERS.

CLASS 9—ELECTRICAL AND SCIENTIFIC APPARATUS

FOR COMPUTER SOFTWARE FOR USE IN AUTHORIZING, DOWNLOADING, TRANSMITTING, RECEIVING, EDITING, EXTRACTING, ENCODING, DECODING, PLAYING, STORING AND ORGANIZING AUDIO DATA; AUDIO RECORDINGS FEATURING CLASSICAL, JAZZ, CONTEMPORARY, POP, SEASONAL, R AND B, SOUL, WORLD, ZYDECO, REGGAE, ROCK, FOLK AND SHOW TUNES MUSIC; DIGITAL AUDIO PLAYERS; DOWNLOADABLE MUSIC VIA A GLOBAL COMPUTER NETWORK AND WIRELESS DEVICES (U.S. CLS. 21, 23, 26, 36 AND 38).

CLASS 38—COMMUNICATION

FOR COMMUNICATION SERVICES, NAMELY, TRANSMITTING STREAMED AND DOWNLOADABLE AUDIO AND VIDEO ENTERTAINMENT PROGRAMMING VIA COMPUTER, SATELLITE AND COMMUNICATIONS NETWORKS; AUDIO ENTERTAINMENT BROADCASTING AND TRANSMISSION; SUBSCRIPTION AUDIO AND VIDEO ENTERTAINMENT BROADCASTING AND TRANSMISSION VIA COMPUTER, SATELLITE AND COMMUNICATIONS NETWORKS; ELECTRONIC AND DIGITAL TRANSMISSION OF VOICE, DATA, INFORMATION, IMAGES, SIGNALS AND MESSAGES; PROVIDING ON-LINE CHAT ROOMS, BULLETIN BOARDS AND COMMUNITY FORUMS FOR THE TRANSMISSION OF MESSAGES AMONG COMPUTER USERS CONCERNING ENTERTAINMENT, MUSIC, CONCERTS, VIDEOS, RADIO, TELEVISION, FILM, NEWS, SPORTS, GAMES AND CULTURAL EVENTS; DELIVERY OF MESSAGES BY ELECTRONIC TRANSMISSION; PROVISION OF CONNECTIVITY SERVICES AND ACCESS TO ELECTRONIC COMMUNICATIONS NETWORKS, FOR TRANSMISSION OR RECEPTION OF AUDIO, VIDEO OR MULTIMEDIA CONTENT (U.S. CLS. 100, 101 AND 104).

CLASS 41—EDUCATION AND ENTERTAINMENT

FOR PROVIDING ACCESS TO AN INTERACTIVE COMPUTER DATABASE FEATURING A COMPREHENSIVE DIGEST OF MUSICAL RECORDINGS; PROVIDING DATABASES AND DIRECTORIES IN THE FIELDS OF MUSIC, VIDEO, RADIO, TELEVISION, NEWS, SPORTS, GAMES, CULTURAL EVENTS, ENTERTAINMENT, AND ARTS AND LEISURE VIA COMMUNICATIONS NETWORKS; PROVIDING INFORMATION, AUDIO, VIDEO, GRAPHICS, TEXT AND OTHER MULTIMEDIA CONTENT IN THE FIELDS OF MUSIC, VIDEO, RADIO, TELEVISION, NEWS, SPORTS, GAMES, CULTURAL EVENTS, ENTERTAINMENT, AND ARTS AND LEISURE VIA COMMUNICATIONS NETWORKS; MUSIC PUBLISHING SERVICES; PUBLISHING OF TEXT, GRAPHIC, AUDIO AND VIDEO WORKS VIA COMMUNICATIONS NETWORKS; PROVIDING IN STORE AND ON-LINE FACILITIES TO ENABLE USERS TO PROGRAM AUDIO, VIDEO, TEXT AND OTHER MULTIMEDIA CONTENT, INCLUDING MUSIC, CONCERTS, VIDEOS, RADIO, TELEVISION, NEWS, SPORTS, GAMES, CULTURAL EVENTS AND ENTERTAINMENT-RELATED PROGRAMS; PRODUCTION AND DISTRIBUTION OF RADIO PROGRAMS; MUSIC PRODUCTION SERVICES; ENTERTAINMENT SERVICES, NAMELY PROVIDING REVIEWS OF MUSIC AND COMMENTARY AND ARTICLES ABOUT MUSIC (U.S. CLS. 100, 101 AND 107).

BARBARA RUTLAND, EXAMINING ATTORNEY

SN 76-621,630. ALDI INC., BATAVIA, IL. FILED 11-19-2004.

LA MAS RICA

THE MARK CONSISTS OF STANDARD CHARACTERS WITHOUT CLAIM TO ANY PARTICULAR FONT, STYLE, SIZE, OR COLOR.

THE ENGLISH TRANSLATION OF THE SPANISH WORDING "LA MAS RICA" IS "THE MOST RICH".

CLASS 29—MEATS AND PROCESSED FOODS

FOR CHEESE, MEAT (U.S. CL. 46).

CLASS 32—LIGHT BEVERAGES

FOR FRUIT JUICES (U.S. CLS. 45, 46 AND 48).
GRETTA YAO, EXAMINING ATTORNEY

SN 76-976,418. WORLDWIDE RESTAURANT CONCEPTS, INC., SHERMAN OAKS, CA. FILED 8-15-2001.



CLASS 6—METAL GOODS

FOR METAL KEY CHAINS (U.S. CLS. 2, 12, 13, 14, 23, 25 AND 50).
FIRST USE 9-0-2003; IN COMMERCE 9-0-2003.

CLASS 16—PAPER GOODS AND PRINTED MATTER

FOR PAPER GOODS, NAMELY STATIONERY, WRITING PAPER, PENS (U.S. CLS. 2, 5, 22, 23, 29, 37, 38 AND 50).

FIRST USE 9-0-2001; IN COMMERCE 9-0-2001.

CLASS 25—CLOTHING

FOR CLOTHING, NAMELY T-SHIRTS, POLO SHIRTS, HEADWEAR, NAMELY HATS (U.S. CLS. 22 AND 39).

FIRST USE 9-0-2003; IN COMMERCE 9-0-2003.

CLASS 35—ADVERTISING AND BUSINESS

FOR TECHNICAL ASSISTANCE IN THE ESTABLISHMENT AND/OR OPERATION OF RESTAURANTS FOR OTHERS (U.S. CLS. 100, 101 AND 102).

FIRST USE 12-13-2002; IN COMMERCE 12-13-2002.

MARTHA FROMM, EXAMINING ATTORNEY

SN 76-977,237. THX LTD., SAN RAFAEL, CA. FILED 10-31-2003.

THX

OWNER OF U.S. REG. NOS. 1,419,801 AND 2,552,064.

CLASS 9—ELECTRICAL AND SCIENTIFIC APPARATUS

FOR HOME LOUDSPEAKER SYSTEMS COMPRISING MAIN LOUDSPEAKERS, SURROUND LOUDSPEAKERS, CENTER LOUDSPEAKERS, SUBWOOFERS, SOUND AMPLIFIERS AND CROSSOVERS; TELEVISIONS; SOUND AMPLIFIERS; RECEIVERS; STEREO SPEAKERS; DVD PLAYERS; CD PLAYERS; AUDIO AND VIDEO INTERCONNECTS; SPEAKER CABLES; EQUALIZERS; PROJECTION SCREENS; VIDEO SCALARS; THEATER PROJECTION EQUIPMENT, NAMELY FILM PROJECTORS AND DIGITAL PROJECTORS; AUTOMOBILE STEREOs; COMPUTER SOFTWARE AND HARDWARE FOR AUDIO AND AUDIOVISUAL RECORDING, DISPLAY, AND PLAYBACK; VIDEO GAME DISCS; AND DVDS FEATURING AUDIOVISUAL WORKS (U.S. CLS. 21, 23, 26, 36 AND 38).
FIRST USE 11-0-1990; IN COMMERCE 11-0-1990.

CLASS 41—EDUCATION AND ENTERTAINMENT

FOR EDUCATIONAL SERVICES, NAMELY PROVIDING TRAINING IN THE FIELD OF HOME THEATER SALES AND INSTALLATION (U.S. CLS. 100, 101 AND 107).
FIRST USE 4-0-1991; IN COMMERCE 4-0-1991.

CLASS 42—SCIENTIFIC, COMPUTER AND LEGAL SERVICES

FOR TESTING OF THE GOODS AND SERVICES OF OTHERS FOR THE PURPOSES OF CERTIFICATION IN THE FIELDS OF THEATER LOUDSPEAKER SYSTEMS; HOME LOUDSPEAKER SYSTEMS; ELECTRONIC EQUIPMENT FOR AUDIO AND AUDIOVISUAL RECORDING, DISPLAY, AND PLAYBACK; COMPUTER SOFTWARE AND HARDWARE FOR AUDIO AND AUDIOVISUAL RECORDING, DISPLAY, AND PLAYBACK; VIDEOGAMES AND DVDS; AND CONSULTATION SERVICES THEREFOR (U.S. CLS. 100 AND 101).
FIRST USE 11-0-1990; IN COMMERCE 11-0-1990.
LINDA E. BLOHM, EXAMINING ATTORNEY

SN 76-977,242. THX LTD., SAN RAFAEL, CA. FILED 10-31-2003.

THX

OWNER OF U.S. REG. NOS. 1,419,801 AND 2,552,064.

CLASS 9—ELECTRICAL AND SCIENTIFIC APPARATUS

FOR THEATER LOUDSPEAKER SYSTEMS COMPRISING MAIN LOUDSPEAKERS, SURROUND LOUDSPEAKERS, CENTER LOUDSPEAKERS, SUBWOOFERS, SOUND AMPLIFIERS AND CROSSOVERS; HOME LOUDSPEAKERS SYSTEMS COMPRISING MAIN LOUDSPEAKERS, SURROUND LOUDSPEAKERS, CENTER LOUDSPEAKERS, SUBWOOFERS, SOUND AMPLIFIERS AND CROSSOVERS; TELEVISIONS; SOUND AMPLIFIERS; RECEIVERS; STEREO SPEAKERS; DVD PLAYERS; CD PLAYERS; AUDIO AND VIDEO INTERCONNECTS; SPEAKER CABLES; EQUALIZERS; PROJECTION SCREENS; NETWORK CONTROLLERS; THEATER PROJECTION EQUIPMENT, NAMELY FILM PROJECTORS AND DIGITAL PROJECTORS; AUTOMOBILE STEREOs; COMPUTER SOFTWARE AND HARDWARE FOR AUDIO AND AUDIOVISUAL RECORDING, DISPLAY, AND PLAYBACK; VIDEO GAME DISCS; DVDS FEATURING AUDIOVISUAL WORKS (U.S. CLS. 21, 23, 26, 36 AND 38).
FIRST USE 5-0-1983; IN COMMERCE 5-0-1983.

CLASS 41—EDUCATION AND ENTERTAINMENT

FOR EDUCATIONAL SERVICES, NAMELY PROVIDING TRAINING IN THE FIELD OF HOME THEATER SALES AND INSTALLATION (U.S. CLS. 100, 101 AND 107).
FIRST USE 4-0-1991; IN COMMERCE 4-0-1991.

CLASS 42—SCIENTIFIC, COMPUTER AND LEGAL SERVICES

FOR TESTING OF THE GOODS AND SERVICES OF OTHERS FOR THE PURPOSES OF CERTIFICATION IN THE FIELDS OF THEATER LOUDSPEAKER SYSTEMS, HOME LOUDSPEAKER SYSTEMS, ELECTRONIC EQUIPMENT FOR AUDIO AND AUDIOVISUAL RECORDING, DISPLAY, AND PLAYBACK, COMPUTER SOFTWARE AND HARDWARE FOR AUDIO AND AUDIOVISUAL RECORDING, DISPLAY, AND PLAYBACK, VIDEO GAMES AND DVD'S, AND CONSULTATION SERVICES THEREFOR (U.S. CLS. 100 AND 101).
FIRST USE 5-0-1983; IN COMMERCE 5-0-1983.
LINDA E. BLOHM, EXAMINING ATTORNEY

SN 78-067,410. ALLIED MATERIAL CORPORATION, TOKYO, JAPAN, FILED 6-5-2001.



PRIORITY CLAIMED UNDER SEC. 44(D) ON JAPAN APPLICATION NO. 2000-139577, FILED 12-26-2000, REG. NO. 4547057, DATED 3-1-2002, EXPIRES 3-1-2012.

CLASS 1—CHEMICALS

FOR CUBIC BORON NITRIDE IN THE FORM OF GRANULES AND PARTICLES FOR USE IN MAKING GRINDING TOOLS, POLISHING TOOLS, CUTTING TOOLS AND TOOLS FOR WEAR-RESISTANT APPLICATIONS; TUNGSTEN CARBIDES IN THE FORM OF POWDER FOR USE IN MAKING DIAMOND TOOLS AND CEMENTED CARBIDE TOOLS; OTHER CHEMICALS, NAMELY, TITANIUM CARBIDE POWDER AND TITANIUM CARBONITRIDE POWDER FOR USE IN MAKING GRINDING TOOLS; TUNGSTEN CARBIDE COBALT MIXED POWDER, VANADIUM CARBIDE POWDER, AND CHROME CARBIDE POWDER FOR USE IN MAKING CEMENTED CARBIDE TOOLS; AMMONIUM PARATUNGSTATE POWDER AND TUNGSTEN OXIDE POWDER FOR USE IN MAKING CEMENTED CARBIDE TOOLS, DIAMOND TOOLS, HEAVY METALS, CU-W ALLOYS, AND W-NI ALLOYS, AND MAKING AUXILIARY LIQUID FOR POLISHING (U.S. CLS. 1, 5, 6, 10, 26 AND 46).

CLASS 6—METAL GOODS

FOR METAL FITTINGS, NAMELY, NUTS, BOLTS, WASHERS AND ROPE JOINT METAL FITTING FOR SEMICONDUCTORS; METAL WIRE NETS (U.S. CLS. 2, 12, 13, 14, 23, 25 AND 50).

CLASS 7—MACHINERY

FOR COPY MACHINE PARTS, NAMELY, DISCHARGE WIRE (U.S. CLS. 13, 19, 21, 23, 31, 34 AND 35).

CLASS 9—ELECTRICAL AND SCIENTIFIC APPARATUS

FOR MEASURING APPARATUS AND INSTRUMENTS, NAMELY, METAL AND NON-METAL FLATNESS TESTERS; METAL AND NON-METAL SURFACE ROUGHNESS TESTERS, METAL AND NON-METAL HARDNESS TESTERS; ELECTRICAL RESISTANCE WIRES; ELECTRODES FOR USE IN DISCHARGE LAMPS FOR STEPPERS, ELECTRODES FOR USE IN STEP AND REPEAT PHOTOLITHOGRAPHIC SYSTEMS WITH DEMAGNIFICATION FOR SEMICONDUCTORS, ELECTRODES FOR USE IN DISCHARGE LAMPS FOR PROJECTORS, ELECTRODES FOR USE IN PLUGS FOR AUTOMOBILES, ELECTRODES FOR USE IN STROBES FOR CAMERAS, ELECTRODES FOR WIRE CUTTERS, ANODE PLATES FOR USE IN MEDICAL X-RAY MACHINES, ELECTRODES BOATS FOR INDUSTRIAL EVAPORATING APPARATUS, ELECTRICAL COMMUNICATION APPARATUS, NAMELY, PORTABLE TELEPHONES AND PARTS THEREFOR, WIRELESS COMMUNICATION APPARATUS AND PARTS THEREFOR, NAMELY RADIO COMMUNICATION MACHINES AND PARTS THEREFOR, AMPLIFIERS AT THE BASE STATION FOR THE PORTABLE TELEPHONE; SEMICONDUCTORS AND PARTS THEREFOR; MICROWAVE OVEN PARTS, NAMELY, ELECTRODE PARTS FOR CATHODE, ELECTRON TUBE PARTS, NAMELY, CATHODE AND CAP FOR ELECTRON GUN, SEMICONDUCTOR PARTS, NAMELY, HEAT SINKS, SEMICONDUCTOR TESTING APPARATUS PARTS, NAMELY, PROBES (U.S. CLS. 21, 23, 26, 36 AND 38).

CLASS 11—ENVIRONMENTAL CONTROL APPARATUS

FOR PARTS FOR AIR PURIFYING APPARATUS, NAMELY, ION GENERATING WIRE (U.S. CLS. 13, 21, 23, 31 AND 34).

CLASS 40—MATERIAL TREATMENT

FOR FORGING OF METAL GOODS TO THE ORDER AND SPECIFICATION OF OTHERS; MANUFACTURE OF JEWELS AND THEIR RAW ORES AND IMITATIONS OF JEWELS, RUBBERS, CERAMICS, STONES, CONCRETE, AND PLASTIC MATERIALS (NOT FOR BUILDING); AMMONIUM PARATUNGSTATE POWDER, TUNGSTEN TRIOXIDE POWDER TO THE ORDER AND/OR SPECIFICATION OF OTHERS; ELECTROPLATING, MILL WORKING; ANNEALING; MOLTEN PLATING (U.S. CLS. 100, 103 AND 106).

GINA HAYES, EXAMINING ATTORNEY

SN 78-071,604. COMPLEWARE CORPORATION, IOWA CITY, IA. FILED 6-28-2001.

CLINDATALINK**CLASS 9—ELECTRICAL AND SCIENTIFIC APPARATUS**

FOR CLINICAL RESEARCH SOFTWARE FOR MEDICAL PURPOSES, NAMELY, FOR USE FOR COLLECTION, ENTRY, ANALYSIS, MANAGEMENT, ORGANIZATION AND VALIDATION OF DATA, INCLUDING PHYSIOLOGICAL DATA AND CLINICAL TRIAL DESIGN AND MONITORING (U.S. CLS. 21, 23, 26, 36 AND 38).

CLASS 42—SCIENTIFIC, COMPUTER AND LEGAL SERVICES

FOR COMPUTER CONSULTATION IN THE FIELD OF DATA COLLECTION, DATA ENTRY, DATA ANALYSIS, DATA MANAGEMENT, DATA ORGANIZATION AND DATA VALIDATION FOR CLINICAL TRIAL DESIGN AND MONITORING; DATA CONVERSION OF COMPUTER PROGRAM DATA FOR USE IN CLINICAL TRIAL DESIGN AND MONITORING (U.S. CLS. 100 AND 101).

REBECCA SMITH, EXAMINING ATTORNEY

SN 78-079,290. KURARAY CO., LTD., OKAYAMA PREFECTURE, JAPAN, FILED 8-15-2001.

PARCASSIO

PRIORITY CLAIMED UNDER SEC. 44(D) ON JAPAN APPLICATION NO. 2001-074305, FILED 8-15-2001, REG. NO. 4566880, DATED 5-10-2002, EXPIRES 5-10-2012.

CLASS 12—VEHICLES

FOR VESSELS, NAMELY, SHIPS, BOATS AND COMPONENT PARTS; AIRCRAFT, NAMELY, AIRPLANES AND COMPONENT PARTS; RAILWAY ROLLING STOCK, NAMELY, TRAINS AND COMPONENT PARTS; AUTOMOBILES AND STRUCTURAL PARTS THEREFOR; TWO-WHEELED MOTOR VEHICLES, NAMELY, MOTORCYCLES AND COMPONENT PARTS; BICYCLES AND THEIR PARTS AND FITTINGS; BABY CARRIAGES; WHEELCHAIRS; RICKSHAWS; WHEELBARROWS; CARTS, NAMELY, HANDEARTS; HORSE DRAWN CARRIAGES; BICYCLE TRAILERS; ROPEWAYS FOR CARGO OR FREIGHT HANDLING; AC AND DC MOTORS FOR LAND VEHICLES; ADHESIVE RUBBER PATCHES FOR REPAIRING TUBES OR TIRES; ANTI-THEFT ALARMS FOR VEHICLES; PARACHUTES; SHOPPING CARTS; AND VEHICLE SEAT COVERS OF TEXTILE (U.S. CLS. 19, 21, 23, 31, 35 AND 44).

CLASS 18—LEATHER GOODS

FOR LEATHER CLOTH SOLD IN BULK; IMITATION LEATHER SOLD IN BULK; BAGS, NAMELY, FOLDING BRIEFCASES, SHOULDER BAGS, GLADSTONE BAGS, BRIEFCASES, SUITCASES, CARRY-ON BAGS, TRUNKS, HANDBAGS, BOSTON BAGS, SCHOOLCHILDREN'S BACKPACKS, RUCKSACKS, ATTACHE CASES, TOTE BAGS, TRAVELING BAGS, SHOPPING BAGS, SATCHELS, SCHOOL BAGS, SCHOOL SATCHELS, BACKPACKS, KNAPSACKS, AND SPORTS BAGS; POUCHES, NAMELY, JAPANESE CHARM BAGS IN THE NATURE OF OMAMORI-IRE, CARD CASES, PURSES, KEY CASES, WALLET, JAPANESE UTILITY POUCHES IN THE NATURE OF SHINGEN-BUKURO, PASS CASES, AND NAME CASES; PURSE CLASPS; VANITY CASES, SOLD EMPTY; UMBRELLAS AND THEIR PARTS, NAMELY, HANDLES AND COVERS; WALKING STICKS; CANES; HANDLES OF CANES AND WALKING STICKS; SADDLERY; CLOTHING FOR DOMESTIC ANIMALS (U.S. CLS. 1, 2, 3, 22 AND 41).

CLASS 20—FURNITURE AND ARTICLES NOT OTHERWISE CLASSIFIED

FOR FURNITURE; VALVES OF PLASTIC BEING OTHER THAN MACHINE PARTS; NAILS, WEDGES, NUTS, SCREWS, TACKS, BOLTS, RIVETS AND CASTERS ALL NOT OF METAL; LOCKS, NON-ELECTRIC, NOT OF METAL; INDUSTRIAL PACKAGING CONTAINERS OF WOOD, BAMBOO AND PLASTICS; LOADING PALLET NOT OF METAL; BEEHIVE BOXES AND HONEYCOMBS; CUSHIONS; ZABUTON, NAMELY, JAPANESE FLOOR CUSHIONS; PILLOWS; MATTRESSES; PORTABLE BEDS FOR HOUSEHOLD PETS; DOG KENNELS; HAND-HELD FLAT FANS; PICTURE FRAMES; STEP LADDERS AND LADDERS BOTH NOT OF METAL; TOOL BOXES NOT OF METAL; EMBROIDERY FRAMES AND HOOPS; STAKES FOR PLANTS OR TREES; SUDARE, NAMELY, WINDOW BLINDS OF REED, RATTAN AND BAMBOO; DRINKING STRAWS; SLEEPING BAGS FOR CAMPING; HAND-HELD FOLDING FANS; BEAD CURTAINS FOR DECORATION; TOWEL DISPENSERS NOT OF METAL; TSUITATE, NAMELY, ORIENTAL SINGLE PANEL STANDING PARTITIONS; NAMEPLATES AND DOOR NAMEPLATES BOTH NOT OF METAL; FLAG POLES; HAIRDRESSER'S CHAIRS; BYOUBU, NAMELY, ORIENTAL FOLDING PARTITION SCREENS; BENCHES; HAT HOOKS NOT OF METAL; PLASTIC TRAYS; MANNEQUINS; UPRIGHT SIGNBOARDS OF WOOD OR PLASTIC; LETTER BOXES OF PLASTIC; INFANT CRADLES; INFANT WALKERS; BARBERS' CHAIRS; PLASTER SCULPTURES; PLASTIC SCULPTURES; WOODEN SCULPTURES; FUTONS; UNSTUFFED FUTONS; AND WINDOW BLINDS OF TEXTILE; BALLOONS FOR USE IN ADVERTISING BY OTHERS (U.S. CLS. 2, 13, 22, 25, 32 AND 50).

CLASS 24—FABRICS

FOR WOVEN FABRICS COMPOSED OF VISCOSE RAYON, CUPRAMMONIUM RAYON, ACETATE, POLY-MIX, NYLON, POLYAMINO-ACID, POLYESTER, POLY-ETHYLENE, POLYURETHANE, POLYPROPYLENE, POLYOLEFIN, POLYVINYL, VINYLON, POLYCHLAL, AND/OR ACRYLIC; KNITTED FABRICS COMPOSED OF VISCOSE RAYON, CUPRAMMONIUM RAYON, ACETATE, POLY-MIX, NYLON, POLYAMINO-ACID, POLYESTER, POLYETHYLENE, POLYURETHANE, POLYPROPYLENE, POLYOLEFIN, POLYVINYL, VINYLON, POLYCHLAL, AND/OR ACRYLIC; FELT CLOTH; NON-WOVEN TEXTILE FABRICS COMPOSED OF VISCOSE RAYON, CUPRAMMONIUM RAYON, ACETATE, POLY-MIX, NYLON, POLYAMINO-ACID, POLYESTER, POLYETHYLENE, POLYURETHANE, POLYPROPYLENE, POLYOLEFIN, POLYVINYL, VINYLON, POLYCHLAL, AND/OR ACRYLIC; GUMMED WATERPROOF CLOTH, NAMELY, CLOTH PROCESSED WITH GUM FOR WATERPROOFING; VINYL COATED CLOTH, NAMELY, CLOTH COATED WITH VINYL; RUBBERIZED CLOTH, NAMELY, CLOTH PROCESSED WITH RUBBER; LEATHER CLOTH, NAMELY, CLOTH PROCESSED WITH LEATHER AND SYNTHETIC LEATHER; FILTER CLOTH, NAMELY, CLOTH FOR FILTERING LIQUID AND/OR POWDER; PERSONAL ARTICLES OF WOVEN, KNITTED AND NON-WOVEN TEXTILES, NOT

FOR WEAR, NAMELY, TOWELS, HANDKERCHIEFS, JAPANESE CEREMONIAL WRAPPING CLOTH AND JAPANESE GENERAL WRAPPING CLOTH; TABLE NAPKINS OF TEXTILE; DISH CLOTHS; MOSQUITO NETS; BED SHEETS; QUILTS; FUTON AND QUILT COVERS; PILLOWCASES; BED BLANKETS; WALL HANGINGS OF TEXTILE; CURTAINS; SHOWER CURTAINS; TABLE CLOTHS NOT OF PAPER; DRAPERIES; TOILET SEAT COVERS OF TEXTILE; SHROUDS; KYOKATABIRA KIMONO, NAMELY, JAPANESE CLOTH FOR DRESSING A CORPSE FOR FUNERAL PURPOSES; KUROSHIRO-MAKU, NAMELY, JAPANESE CLOTH SCREENS WITH BLACK-AND-WHITE STRIPES FOR UNHAPPY EVENT PURPOSES; KOHAKU-MAKU, NAMELY, JAPANESE CLOTH SCREENS WITH RED-AND-WHITE STRIPES FOR HAPPY EVENT PURPOSES; LABELS OF CLOTH; BILLIARD CLOTH; CLOTH BANNERS; AND CLOTH FLAGS (U.S. CLS. 42 AND 50).

CLASS 25—CLOTHING

FOR CLOTHING, NAMELY, OUTERWEAR, NAMELY, DRESSES, CHILDREN'S WEARS, NAMELY, JUMPSUITS AND PANTS, LIVERIES, JACKETS, JOGGING PANTS, SWEAT PANTS, SUITS, SKIRTS, SKI JACKETS, SKI PANTS, TROUSERS, SMOCKS, FORMALWEAR, NAMELY, TUXEDOS, TUXEDO SHIRTS, CUMMERBUNDS, BOW TIES, VESTS, GOWNS AND TIES FOR CLOTHING, COATS, MANTLES, RAINWEAR, SNOW PANTS, SWEATERS, CARDIGANS, VESTS AND WAISTCOATS, SHIRTS, BLOUSES, NIGHTGOWNS, NEGLIGENCE, NIGHTWEAR, NAMELY, NIGHT GOWNS AND NIGHT SHIRTS, PAJAMAS, ROBES, UNDERWEAR, SWIMWEAR, SWIMMING CAPS, JAPANESE TRADITIONAL CLOTHING, NAMELY, JAPANESE KIMONOS, JAPANESE SHROUDS FOR DRESSING A CORPSE FOR FUNERAL IN THE NATURE OF KYOKATABIRA KIMONO, APRONS FOR WEAR, COLLAR PROTECTORS FOR WEAR, SHAWLS, SCARVES, GLOVES AND MITTENS, NECKERCHIEFS, WARMTH-KEEPING SUPPORTERS, MUFFLERS, EAR MUFFS, HEADGEAR, NAMELY, CAPS, HATS AND VISORS; GARTERS; SOCKS; STOCKINGS; SUSPENDERS; WAISTBANDS; BELTS FOR CLOTHING; FOOTWEAR; MASQUERADE COSTUMES; SPECIAL SPORTSWEAR, NAMELY, SHORTS, SHIRTS, ANORAKS, WIND AND RAIN RESISTANT JACKETS, SKI SUITS, JACKETS, VESTS, SPORTS TEAM UNIFORMS, HOSIERY AND STOCKINGS, WRISTBANDS, AND GYMNASIIC WEAR, NAMELY, TIGHTS AND PULLOVERS, ALL FOR SPORTS; SPECIAL SPORTS FOOTWEAR, NAMELY, GOLF SHOES, SOCCER SHOES, SKI BOOTS, GYMNASIIC SHOES, TENNIS SHOES, CLIMBING BOOTS, BASKETBALL SNEAKERS, VOLLEYBALL SHOES, HANDBALL SHOES, BOWLING SHOES, BOXING SHOES, HOCKEY SHOES, BASEBALL SHOES, RUGBY SHOES, FOOTWEAR FOR TRACK AND FIELD ATHLETICS, AND HORSE-RIDING BOOTS (U.S. CLS. 22 AND 39).

CLASS 28—TOYS AND SPORTING GOODS

FOR GAME MACHINES, NAMELY, BOARD GAMES; GO GAMES; JAPANESE CHESS GAMES CALLED SHOGI; JAPANESE BACKGAMMON GAMES CALLED SUGOROKU; DICE; DICE CUPS; DIAMOND GAMES; CHESS GAMES; CHECKERS AND CHECKER SETS; DOMINOES; MAH-JONG GAMES; BILLIARD EQUIPMENT, NAMELY, BILLIARD CUES, BILLIARD BALLS, BILLIARD MARKERS, AND BILLIARD TABLES; TOYS, NAMELY, STUFFED TOYS; DOLLS; TOYS FOR DOMESTIC PETS; SPORT EQUIPMENT, NAMELY, GLOVES FOR SPORTS, BALLS FOR SPORTS, PROTECTIVE PADDING FOR SPORTING, PROTECTIVE AND/OR SAFETY HELMETS, GOLF BAGS, AND RACKET CASES FOR SPORTS; WAX FOR SKIS; FISHING TACKLE; BALLOONS FOR USE IN ADVERTISING BY OTHERS; SNOW SLEIGHS AND SLEDS FOR RECREATIONAL USE (U.S. CLS. 22, 23, 38 AND 50).

ALICIA COLLINS, EXAMINING ATTORNEY

SN 78-111,648. HERBASIN (SHENYANG) CO., LTD., SHENYANG, CHINA, FILED 2-28-2002.



THE MARK CONSISTS OF AN OUTER SEMI-CIRCLE WITH A PARTIAL INNER SEMI-CIRCLE ENCLOSING A SPLIT PARTIALLY-COLORED LEAF WHICH EXTENDS FROM THE LETTER "B" IN THE STYLIZED WORD HERBASIN. THREE CHINESE CHARACTERS ARE IMMEDIATELY BELOW THE STYLIZED WORD HERBASIN. THE SEMI-CIRCLES ARE SMEARED!

THE NON-LATIN CHARACTERS IN THE MARK TRANSLITERATE TO DE SHENG TANG AND THIS MEANS GERMANY LIFE SHOP IN ENGLISH.

CLASS 5—PHARMACEUTICALS

FOR HERBAL SUPPLEMENTS; HERB EXTRACT AND HERB EXTRACT GRANULES FOR USE IN NUTRITIONAL SUPPLEMENTS (U.S. CLS. 6, 18, 44, 46, 51 AND 52).

CLASS 30—STAPLE FOODS

FOR PROCESSED HERBS; PROCESSED BULK HERBS (U.S. CL. 46).

CLASS 31—NATURAL AGRICULTURAL PRODUCTS

FOR RAW HERBS; UNPROCESSED HERBS; FRESH HERBS (U.S. CLS. 1 AND 46).
ESTHER A. BORSUK, EXAMINING ATTORNEY

SN 78-127,838. INCOMPASS SOLUTIONS, INC., NEW YORK, NY. FILED 5-10-2002.

INCOMPASS

CLASS 35—ADVERTISING AND BUSINESS

FOR BUSINESS CONSULTATION SERVICES IN THE FIELD OF RACETRACKS; COMPUTERIZED DATABASE MANAGEMENT FOR RACETRACKS; PREPARING BUSINESS REPORTS FOR RACETRACKS (U.S. CLS. 100, 101 AND 102).

CLASS 42—SCIENTIFIC, COMPUTER AND LEGAL SERVICES

FOR DEVELOPMENT OF TECHNOLOGY SOLUTIONS FOR OTHERS IN THE NATURE OF COMPUTER SOFTWARE DEVELOPMENT; TECHNICAL SUPPORT SERVICES FOR OTHERS IN THE FIELD OF RACETRACKS IN THE NATURE OF TROUBLESHOOTING OF COMPUTER HARDWARE AND SOFTWARE PROBLEMS, AND PROVIDING BACK-UP COMPUTER PROGRAMS AND FACILITIES; DEVELOPMENT OF PARAMETER DRIVE SOFTWARE APPLICATIONS FOR OTHERS (U.S. CLS. 100 AND 101).

ANN E. SAPPENFIELD, EXAMINING ATTORNEY

SN 78-133,366. PURDY, CORINNE, NEW YORK, NY. FILED 6-5-2002.

PURDY GIRL

CLASS 25—CLOTHING

FOR WOMEN'S CLOTHING NAMELY, PANTS, SHIRTS, SKIRTS (U.S. CLS. 22 AND 39).

CLASS 35—ADVERTISING AND BUSINESS

FOR RETAIL STORE SERVICES FEATURING WOMEN'S CLOTHING (U.S. CLS. 100, 101 AND 102).
STANLEY I. OSBORNE, EXAMINING ATTORNEY

SN 78-142,060. FORUM BIOSCIENCE HOLDINGS LIMITED, REDHILL SURREY, UNITED KINGDOM, FILED 7-8-2002.

HYDROACTIVE

OWNER OF UNITED KINGDOM REG. NO. 2304787, DATED 7-9-2002, EXPIRES 7-9-2012.

CLASS 1—CHEMICALS

FOR ELECTROCHEMICALLY TREATED WATER FOR INDUSTRIAL USE (U.S. CLS. 1, 5, 6, 10, 26 AND 46).

CLASS 11—ENVIRONMENTAL CONTROL APPARATUS

FOR WATER TREATMENT APPARATUS, NAMELY, MACHINES USED FOR THE PRODUCTION OF ELECTROCHEMICALLY TREATED WATER, COMPRISING WATER SOFTENERS, CATALYST RESERVOIR, ANOLYTE AND CATALIGHT RESERVOIRS AND ANY OTHER NECESSARY ANCILLARY EQUIPMENT (U.S. CLS. 13, 21, 23, 31 AND 34).

CLASS 40—MATERIAL TREATMENT

FOR TREATMENT OF WATER (U.S. CLS. 100, 103 AND 106).
WILLIAM P. SHANAHAN, EXAMINING ATTORNEY

SN 78-142,133. EPPENDORF AG, HAMBURG, FED REP GERMANY, FILED 7-9-2002.

EPPENDORF PHYSIOCARE CONCEPT

PRIORITY CLAIMED UNDER SEC. 44(D) ON SPAIN APPLICATION NO. 002737674, FILED 6-17-2002, REG. NO. 002737674, DATED 3-17-2004, EXPIRES 6-17-2012.

OWNER OF U.S. REG. NOS. 1,345,690, 1,404,655 AND 2,014,139.

CLASS 1—CHEMICALS

FOR CHEMICALS USED IN INDUSTRY AND SCIENCES, NAMELY LABORATORY REAGENTS (U.S. CLS. 1, 5, 6, 10, 26 AND 46).

CLASS 9—ELECTRICAL AND SCIENTIFIC APPARATUS

FOR PHYSICO-CHEMICAL, BIOCHEMICAL, OPTICAL AND ELECTRONIC ANALYSIS APPARATUS AND EQUIPMENT, NAMELY PHOTOMETERS, FLAME PHOTOMETERS, ANALYSERS USING ION-SENSITIVE OPERATION TECHNOLOGY; LABORATORY APPARATUS AND EQUIPMENT FOR THE DOSAGE DISPENSING, TRANSFERRING, TEMPERATURE EQUALIZATION, AGITATING, MIXING, DILUTING, CONCENTRATING AND SEPARATING OF LIQUIDS, NAMELY SAMPLE REAGENT DOSAGE DISPENSERS, MECHANICAL, ELECTRONIC AND AUTOMATIC PIPETTES, DISPENSERS FOR LABORATORY USE, BOTTLE DISPENSERS FOR LABORATORY USE, AUXILIARY PIPETTE AND DISPENSING DEVICES AND MULTI-FUNCTION DOSAGE DISPENSERS FOR LABORATORY USE, SAMPLE AND REAGENT TEMPERATURE EQUALIZING APPARATUS, LABORATORY CENTRIFUGES, CONCENTRATORS, VACUUM CONCENTRATORS, CENTRIFUGAL CONCENTRATORS, ROTORS AND ACCESSORIES FOR LABORATORY CENTRIFUGES AND VACUUM CONCENTRATORS, THERMOMIXERS, MICROTITRE PLATES AND ACCESSORIES, NAMELY CLOSING COVERS, FILMS AND FOILS, CAPS, CAP STRIPS, SEALS, SEALING MATS AND CLOSURES, SAMPLE TAKING APPARATUS, NAMELY MECHANICALLY OR OPTICALLY CONTROLLED CANNULAE; APPARATUS FOR PROCESSING CELLS OR LIQUIDS CONTAINING CELLS, NAMELY ELECTROPORATORS, MICRO-INJECTORS AND MICRO-MANIPULATORS; MICRO-DISTILLERS; DNA AMPLIFICATION APPARATUS, NAMELY THERMOCYCLERS; BURETTES FOR DISPENSING; DISPOSABLE LABORATORY ARTICLES, NAMELY PLASTIC VESSELS, SAMPLE STORAGE VESSELS, REACTION VESSELS, PIPETTE TIPS, NAMELY CONDUCTIVE, SYRINGE-TYPE PARTS FOR PIPETTE DEVICES; TIPS, NAMELY FILTER TIPS AND DISPENSER TIPS; TUBES, NAMELY TUBES FOR POLYMERASE CHAIN REACTION AND MICRO-CENTRIFUGES; MICRO-INJECTION AND MICRO-MANIPULATING CAPILLARIES, PIPETTE TIPS AND TIP BOXES; LABORATORY APPARATUS FOR SAMPLE DISTRIBUTION, CLASSIFYING AND IDENTIFICATION, NAMELY CONTROLLED VOLUME PUMPS; LABORATORY RACKS AND HOLDERS FOR SAMPLE STORAGE VESSELS, REACTION VESSELS AND PIPETTE TIPS; PUMPS FOR LABORATORY USE; THERMOSTATS, LABORATORY INCUBATORS; APPARATUS FOR THE RECORDING, PROCESSING, STORAGE AND OUTPUT OF DATA, NAMELY COMPUTER APPLICATION PROGRAMS RECORDED ON MAGNETIC DISCS, RAMS, PROMS, EEPROMS AND FLOPPY DISCS FOR ALL FIELDS OF ANALYTICAL CHEMISTRY IN CLINICAL CHEMICAL LABORATORIES FOR USE IN INFORMATION PROCESSING AND CONTROL OF ANALYSIS APPARATUS; COMPUTER SOFTWARE FOR PROCESSING OF LABORATORY APPARATUS, ALL FOR LABORATORY USE (U.S. CLS. 21, 23, 26, 36 AND 38).

CLASS 40—MATERIAL TREATMENT

FOR CUSTOM MANUFACTURE OF SCIENTIFIC APPARATUS AND INSTRUMENTS, NAMELY PHOTOMETERS, FLAME PHOTOMETERS, ANALYSERS USING ION-SENSITIVE, ELECTROCHEMICAL OR SEPARATION COLUMN-SPECIFIC OPERATION TECHNOLOGY AND CAPILLARY DISTILLATION APPARATUS; CUSTOM MANUFACTURE OF LABORATORY APPARATUS, NAMELY, LABORATORY APPARATUS AND EQUIPMENT FOR THE DOSAGE DISPENSING, TRANSFERRING, TEMPERATURE EQUALIZATION, AGITATING, MIXING, DILUTING, CONCENTRATING AND SEPARATING OF LIQUIDS, NAMELY, SAMPLE REAGENT DOSAGE DISPENSERS, MECHANICAL, ELECTRONIC AND AUTOMATIC PIPETTES, DISPENSERS, BOTTLE DISPENSERS, AUXILIARY PIPETTE AND DISPENSING DEVICES AND MULTI-FUNCTION DOSAGE DISPENSERS, SAMPLE AND REAGENT TEMPERATURE EQUALIZING APPARATUS, LABORATORY CENTRIFUGES, CONCENTRATORS, VACUUM CONCENTRATORS, CENTRIFUGAL CONCENTRATORS, ROTORS AND ACCESSORIES FOR LABORATORY CENTRIFUGES AND VACUUM CONCENTRATORS, THERMOMIXERS, MICROTITRE PLATES AND ACCESSORIES, AND SAMPLE TAKING APPARATUS, NAMELY, MECHANICALLY OR OPTICALLY CONTROLLED CANNULAE; CUSTOM MANUFACTURE OF APPARATUS FOR PROCESSING CELLS OR LIQUIDS CONTAINING CELLS, NAMELY, ELECTROPORATORS, MICRO-INJECTORS AND MICRO-MANIPULATORS; CUSTOM MANUFACTURE OF MICRO-DISTILLERS; CUSTOM MANUFACTURE OF DNA AMPLIFICATION APPARATUS, NAMELY, THERMOCYCLERS; CUSTOM MANUFACTURE OF CLEANSING KITS FOR NUCLEIC ACIDS, VESSELS AND BURETTES, APPARATUS FOR SAMPLE DISTRIBUTION, CLASSIFYING AND IDENTIFICATION, PUMPS, THERMOSTATS AND INCUBATORS; CUSTOM MANUFACTURE OF DISPOSABLE LABORATORY ARTICLES, NAMELY PLASTIC VESSELS, SAMPLE STORAGE VESSELS, REACTION VESSELS, AND PIPETTE TIPS, INCLUDING CONDUCTIVE, SYRINGE-TYPE PARTS FOR PIPETTE DEVICES; CUSTOM MANUFACTURE OF TIPS, INCLUDING FILTER TIPS AND DISPENSER TIPS; CUSTOM MANUFACTURE OF TUBES, INCLUDING TUBES FOR PCR AND MICRO-CENTRIFUGES; CUSTOM MANUFACTURE OF MICRO-INJECTION AND MICRO-MANIPULATING CAPILLARIES; CUSTOM MANUFACTURE PIPETTE TIPS AND TIP BOXES; CUSTOM MANUFACTURE OF RACKS AND HOLDERS FOR SAMPLE STORAGE VESSELS, REACTION VESSELS AND PIPETTE TIPS; AND CUSTOM MANUFACTURE OF DATA PROCESSING APPARATUS FOR THE RECORDING, PROCESSING, STORAGE AND OUTPUT OF DATA, NAMELY, DATA PROCESSORS (U.S. CLS. 100, 103 AND 106).

CLASS 42—SCIENTIFIC, COMPUTER AND LEGAL SERVICES

FOR CONSULTANCY WITH REGARD TO THE EQUIPPING AND ORGANIZATION OF MEDICAL, CHEMICAL, BIOLOGICAL AND PHARMACEUTICAL LABORATORIES; COMPUTER APPLICATION PROGRAM AND SOFTWARE DESIGN AND DEVELOPMENT FOR OTHERS (U.S. CLS. 100 AND 101).

KATHY DE JONGE, EXAMINING ATTORNEY

SN 78-147,473. SPENCER, SABINA ANNE, EAST MOLESEY, SURREY, UNITED KINGDOM, FILED 7-25-2002.



OWNER OF UNITED KINGDOM REG. NO. 2270218, DATED 5-16-2001, EXPIRES 5-16-2011.

CLASS 9—ELECTRICAL AND SCIENTIFIC APPARATUS

FOR COMPUTER GAME SOFTWARE, COMPUTER GAME DISCS, VIDEO GAME SOFTWARE AND VIDEO GAME DISCS (U.S. CLS. 21, 23, 26, 36 AND 38).

CLASS 16—PAPER GOODS AND PRINTED MATTER

FOR STATIONERY, NOTE PAPER, CHILDREN'S ACTIVITY BOOKS, ART PAPER, AND CARDBOARD BOXES (U.S. CLS. 2, 5, 22, 23, 29, 37, 38 AND 50).

CLASS 28—TOYS AND SPORTING GOODS

FOR PLUSH TOYS; PLASTIC TOYS, NAMELY, DOLLS, TOY ACTION FIGURES AND TOY ACTION VEHICLES; PAPER DOLLS; AND HAND HELD UNITS FOR PLAYING ELECTRONIC GAMES (U.S. CLS. 22, 23, 38 AND 50).
PATRICIA EVANKO, EXAMINING ATTORNEY

SN 78-148,103. THE LAST BEST BEEF LLC, LAS VEGAS, NV, FILED 7-26-2002.

THE LAST BEST PLACE

OWNER OF U.S. REG. NOS. 1,845,246 AND 1,879,361.

CLASS 14—JEWELRY

FOR NECKLACES; EARRINGS; ORNAMENTAL PINS; PINS BEING JEWELRY; BRACELETS; WATCHES (U.S. CLS. 2, 27, 28 AND 50).

CLASS 24—FABRICS

FOR BLANKETS, NAMELY BED BLANKETS, BLANKET THROWS, AFGHANS; BED PADS, BED SHEETS; BED LINEN; BED SPREADS; COMFORTERS; PILLOW CASES; PILLOW COVERS; TABLE LINEN; TOWELS; BATH LINEN; CURTAINS; HANDKERCHIEFS; HOUSEHOLD LINEN; MATTRESS COVERS; MATTRESS PADS; QUILTS; SHOWER CURTAINS (U.S. CLS. 42 AND 50).

CLASS 25—CLOTHING

FOR CLOTHING, NAMELY SHIRTS, BLOUSES, PANTS, SWEATERS, SKIRTS, JACKETS, COATS, PAJAMAS, ROBES, HATS, BELTS, SHOES, BOOTS, SLIPPERS, TIES, TOPS, BOTTOMS, WRAPS, JERSEYS, SOCKS, CARDIGANS, UNDERWEAR, STOCKINGS, SLIPS, AND SHORTS (U.S. CLS. 22 AND 39).
MARIA-VICTORIA SUAREZ, EXAMINING ATTORNEY

SN 78-148,267. AERO PRODUCTS INTERNATIONAL, INC., WAUCONDA, IL, FILED 7-29-2002.

AERO SPORTS

OWNER OF U.S. REG. NO. 1,755,357.
NO CLAIM IS MADE TO THE EXCLUSIVE RIGHT TO USE "SPORTS", APART FROM THE MARK AS SHOWN.

CLASS 20—FURNITURE AND ARTICLES NOT OTHERWISE CLASSIFIED

FOR SLEEPING BAGS (U.S. CLS. 2, 13, 22, 25, 32 AND 50).

CLASS 28—TOYS AND SPORTING GOODS

FOR INFLATABLE MATTRESSES FOR RECREATIONAL USE AND INFLATABLE WATER SKI TOWABLES (U.S. CLS. 22, 23, 38 AND 50).
MARIA-VICTORIA SUAREZ, EXAMINING ATTORNEY

SN 78-151,797. WELLNESS RESOURCES, INC., ST. LOUIS PARK, MN, FILED 8-7-2002.

WELLNESS RESOURCES

OWNER OF U.S. REG. NO. 2,132,232.
NO CLAIM IS MADE TO THE EXCLUSIVE RIGHT TO USE "WELLNESS", APART FROM THE MARK AS SHOWN.

CLASS 5—PHARMACEUTICALS

FOR VITAMINS AND MINERAL SUPPLEMENTS (U.S. CLS. 6, 18, 44, 46, 51 AND 52).
FIRST USE 8-1-1995; IN COMMERCE 8-8-1995.

CLASS 16—PAPER GOODS AND PRINTED MATTER

FOR PRINTED INSTRUCTIONAL MATERIALS RELATING TO HEALTH AND NUTRITION (U.S. CLS. 2, 5, 22, 23, 29, 37, 38 AND 50).
FIRST USE 8-1-1995; IN COMMERCE 8-1-1995.

CLASS 41—EDUCATION AND ENTERTAINMENT

FOR EDUCATIONAL SERVICES, NAMELY, PROVIDING COURSES, SEMINARS AND WORKSHOPS REGARDING HEALTH AND NUTRITION (U.S. CLS. 100, 101 AND 107).
FIRST USE 8-1-1995; IN COMMERCE 8-8-1995.

CLASS 44—MEDICAL, BEAUTY AND AGRICULTURAL SERVICES

FOR HEALTH AND NUTRITION COUNSELING SERVICES (U.S. CLS. 100 AND 101).
FIRST USE 8-1-1995; IN COMMERCE 8-8-1995.

NORA BUCHANAN WILL, EXAMINING ATTORNEY

SN 78-163,860. SARTORIUS AG, GOETTINGEN, FED REP GERMANY, FILED 9-13-2002.

SN 78-156,530. CAMLIN, LTD., MARINA DEL REY, CA. FILED 8-21-2002.

CAMELLIA

CAMELLIA IS THE COMMON ENGLISH NAME FOR THE SHRUB OR SMALL TREE.



CLASS 2—PAINTS

FOR COLORING AND ART MATERIALS FOR ARTISTS, NAMELY OIL, ACRYLIC AND WATERCOLOR PAINTS, CRAFT PAINTS (U.S. CLS. 6, 11 AND 16).

CLASS 9—ELECTRICAL AND SCIENTIFIC APPARATUS

FOR MULTIMEDIA SOFTWARE RECORDED ON CD-ROM IN THE AREA OF CHILDREN'S ART CURRICULUM AND PROJECTS; DOWNLOADABLE CHILDREN'S EDUCATIONAL SOFTWARE; CHILDREN'S EDUCATIONAL SOFTWARE (U.S. CLS. 21, 23, 26, 36 AND 38).

CLASS 16—PAPER GOODS AND PRINTED MATTER

FOR PAINT BRUSHES, PASTELS AND OIL PASTELS, DRAWING INKS, PLASTIC AND WAX CRAYONS, COLORING, WATERCOLOR AND DRAWING PENCILS, COLORING PENS AND MARKERS, ERASERS, PENCIL SHARPENERS, FOUNTAIN, BALL POINT AND ROLLER BALL PENS AND MECHANICAL PENCILS, MECHANICAL PENCIL LEADS, GLUE FOR STATIONERY OR HOUSEHOLD USE (U.S. CLS. 2, 5, 22, 23, 29, 37, 38 AND 50).

THEODORE MCBRIDE, EXAMINING ATTORNEY

SN 78-161,560. WORKPLACE SYSTEMS, INC., LONDONDERRY, NH. FILED 9-6-2002.

THE RESULT IS QUALITY

CLASS 20—FURNITURE AND ARTICLES NOT OTHERWISE CLASSIFIED

FOR METAL FURNITURE, NAMELY, DESKS, CHAIRS, TABLES, FILE CABINETS, STORAGE CABINETS, MOBILE CARTS, AND WORK BENCHES (U.S. CLS. 2, 13, 22, 25, 32 AND 50).

CLASS 37—CONSTRUCTION AND REPAIR

FOR INSTALLATION OF METAL FURNITURE; CONSULTING SERVICES IN THE FIELD OF ASSEMBLY AND INSTALLATION OF FURNITURE (U.S. CLS. 100, 103 AND 106).

CLASS 42—SCIENTIFIC, COMPUTER AND LEGAL SERVICES

FOR FURNITURE DESIGN SERVICES; CONSULTING SERVICES IN THE FIELD OF THE DESIGN AND LAYOUT OF FURNITURE (U.S. CLS. 100 AND 101). JOHN GARTNER, EXAMINING ATTORNEY

PRIORITY CLAIMED UNDER SEC. 44(D) ON FED REP GERMANY APPLICATION NO. 30223146.3, FILED 5-8-2002, REG. NO. 30223146, DATED 6-13-2002, EXPIRES 6-13-2012.

PRIORITY CLAIMED UNDER SEC. 44(D) ON FED REP GERMANY APPLICATION NO. 30223146.3, FILED 5-8-2002, REG. NO. 30223146, DATED 6-13-2002, EXPIRES 6-13-2012.

PRIORITY CLAIMED UNDER SEC. 44(D) ON FED REP GERMANY APPLICATION NO. 30223146.3, FILED 5-8-2002, REG. NO. 30223146, DATED 6-13-2002, EXPIRES 6-13-2012.

NO CLAIM IS MADE TO THE EXCLUSIVE RIGHT TO USE "DENVER" AND "INSTRUMENT", APART FROM THE MARK AS SHOWN.

CLASS 9—ELECTRICAL AND SCIENTIFIC APPARATUS

FOR SCIENTIFIC AND LABORATORY APPARATUS, NAMELY, WEIGHING APPARATUS, NAMELY, SCALES OF ALL KINDS, EXCLUDING SCALES ASSOCIATED WITH MINERAL AND COAL OR CHEMICAL PROCESSING ASSOCIATED THEREWITH, INCLUDING ANALYSIS AND PRECISION BALANCES, POWER MEASURING CELLS, COUNT MEASURING COMPONENTS, TESTING WEIGHTS AND COMPONENTS THEREOF; COMPUTER PERIPHERAL APPARATUS, NAMELY, PRINTERS, DATA INPUT SOFTWARE, DISPLAY MONITORS, DATA TRANSMISSION AND CONTROL HARDWARE; LABORATORY EQUIPMENT FOR ELECTROCHEMICAL ANALYSIS FOR FIXING PH VALUES AND FOR ION SELECTIVE ANALYSIS, NAMELY, CONDUCTIVITY METERS, NAMELY, BENCHTOPS AND ELECTROCHEMISTRY METERS, CONDUCTIVITY CELLS AND ELECTRODES; LABORATORY EQUIPMENT FOR REALIZATION OF TITRATION, NAMELY, TITRATION APPARATUS FOR COULOMETRIC CONDUCTIVITY, ION AND PH TITRATION, TITRATION CONTROLLERS; LABORATORY EQUIPMENT FOR FIXING MATERIAL DAMP OF GRAVIMETRIC BASE, IN PARTICULAR BY USE OF RADIATION, NAMELY, MICROWAVE OVENS; AND LABORATORY PROCESS CONTROL SOFTWARE (U.S. CLS. 21, 23, 26, 36 AND 38).

CLASS 37—CONSTRUCTION AND REPAIR

FOR REPAIR AND MAINTENANCE OF ELECTRICAL PRODUCTS, PRECISION PRODUCTS, MECHANICAL EQUIPMENT, SCALES AND OTHER MEASURING INSTRUMENTS, ELECTRONIC PRECISION BALANCES, SCIENTIFIC APPARATUS AND INSTRUMENTS, AND LABORATORY APPARATUS (U.S. CLS. 100, 103 AND 106).

CLASS 42—SCIENTIFIC, COMPUTER AND LEGAL SERVICES

FOR CALIBRATION SERVICES; AND MATERIAL TESTING SERVICES (U.S. CLS. 100 AND 101). TINA L. SNAPP, EXAMINING ATTORNEY

SN 78-164,522. WELLNESS RESOURCES, INC., ST. LOUIS PARK, MN. FILED 9-16-2002.



OWNER OF U.S. REG. NO. 2,132,232.
NO CLAIM IS MADE TO THE EXCLUSIVE RIGHT TO USE "WELLNESS", APART FROM THE MARK AS SHOWN.

CLASS 16—PAPER GOODS AND PRINTED MATTER

FOR PRINTED INSTRUCTIONAL MATERIALS RELATING TO HEALTH AND NUTRITION (U.S. CLS. 2, 5, 22, 23, 29, 37, 38 AND 50).
FIRST USE 12-1-2000; IN COMMERCE 12-1-2000.

CLASS 41—EDUCATION AND ENTERTAINMENT

FOR EDUCATIONAL SERVICES, NAMELY, CONDUCTING CLASSES, SEMINARS, CONFERENCES AND WORKSHOPS IN THE FIELD OF HEALTH AND NUTRITION (U.S. CLS. 100, 101 AND 107).
FIRST USE 12-1-2000; IN COMMERCE 12-1-2000.

CLASS 44—MEDICAL, BEAUTY AND AGRICULTURAL SERVICES

FOR COUNSELING IN THE AREAS OF HEALTH AND NUTRITION (U.S. CLS. 100 AND 101).
FIRST USE 12-1-2000; IN COMMERCE 12-1-2000.
STEVEN BERK, EXAMINING ATTORNEY

SN 78-164,653. WOW! TECHNOLOGIES, INC., LAS VEGAS, NV. FILED 9-16-2002.

OWNER OF U.S. REG. NO. 2,881,345.
NO CLAIM IS MADE TO THE EXCLUSIVE RIGHT TO USE "CARD SERVICES", APART FROM THE MARK AS SHOWN.

THE COLOR(S) RED AND BLACK IS/ARE CLAIMED AS A FEATURE OF THE MARK.

THE WORDING "WOW!" APPEARS IN RED AND IS SHADOWED IN BLACK. THE WORDING "CARD SERVICES" APPEARS IN BLACK.

CLASS 36—INSURANCE AND FINANCIAL

FOR PRE-PAID PURCHASE CARD SERVICES NAMELY, PROCESSING ELECTRONIC PAYMENTS MADE THROUGH PREPAID CARDS; ELECTRONIC COMMERCE PAYMENT SERVICES, NAMELY, ESTABLISHING FUNDED ACCOUNTS USED TO PURCHASE GOODS AND SERVICES ON THE INTERNET; FINANCIAL SERVICES, NAMELY PROVIDING ON-LINE STORED VALUE ACCOUNTS IN AN ELECTRONIC ENVIRONMENT; ISSUING STORED VALUE CARDS (U.S. CLS. 100, 101 AND 102).

FIRST USE 1-1-1999; IN COMMERCE 1-1-1999.

CLASS 42—SCIENTIFIC, COMPUTER AND LEGAL SERVICES

FOR DATA AUTOMATION AND COLLECTION SERVICE USING PROPRIETARY SOFTWARE TO EVALUATE, ANALYZE AND COLLECT SERVICE DATA RELATING TO STORED VALUE, DEBIT, ELECTRONIC TRANSFER AND OTHER PAYMENT AND MULTIPLE USE CARDS FOR CONSUMER USE AND IN CONNECTION WITH THE GLOBAL COMPUTER NETWORK (U.S. CLS. 100 AND 101).

FIRST USE 1-1-1999; IN COMMERCE 1-1-1999.

APRIL L. RADEMACHER, EXAMINING ATTORNEY

SN 78-173,377. EXIQON A/S, VEDBAEK, DENMARK, FILED 10-11-2002.

GENOVIEV

OWNER OF DENMARK REG. NO. 200202858, DATED 8-14-2002, EXPIRES 8-14-2012.

CLASS 35—ADVERTISING AND BUSINESS

FOR INDUSTRIAL MANAGEMENT ASSISTANCE (U.S. CLS. 100, 101 AND 102).

CLASS 42—SCIENTIFIC, COMPUTER AND LEGAL SERVICES

FOR SCIENTIFIC RESEARCH; DESIGN OF COMPUTER SOFTWARE APPLICATIONS FOR OTHERS FOR RECORDING, ANALYZING, INTERPRETING, CALCULATING AND STORING SINGLE NUCLEOTIDE POLYMORPHISM, GENOTYPE, PHENOTYPE AND OTHER SCIENTIFIC DATA IN THE BIOTECHNOLOGY, GENOMIC, MOLECULAR BIOLOGY AND LIFE SCIENCES FIELDS; INDUSTRIAL DESIGN SERVICES; DESIGN AND DEVELOPMENT OF COMPUTER HARDWARE AND SOFTWARE FOR OTHERS; AND LEGAL SERVICES (U.S. CLS. 100 AND 101).

STEVEN R. FOSTER, EXAMINING ATTORNEY

SN 78-173,735. VICKERS, STEPHEN, TSING LUN TAU, NEW TERRITORIES, HONG KONG, FILED 10-11-2002.



PRIORITY CLAIMED UNDER SEC. 44(D) ON HONG KONG APPLICATION NO. 14975/2002, FILED 9-24-2002, REG. NO. 14975/2002, DATED 9-24-2002, EXPIRES 9-24-2012.

PRIORITY CLAIMED UNDER SEC. 44(D) ON HONG KONG APPLICATION NO. 14974/2002, FILED 9-24-2002, REG. NO. 14974/2002, DATED 9-24-2002, EXPIRES 9-24-2012.

NO CLAIM IS MADE TO THE EXCLUSIVE RIGHT TO USE "INTERNATIONAL RISK", "INTEGRITY", "INDEPENDENCE", AND "INSIGHT", APART FROM THE MARK AS SHOWN.

THE STIPPLING SHOWN IN THE DRAWING IS A FEATURE OF THE MARK TO INDICATE SHADING ONLY AND IS NOT INTENDED TO INDICATE COLOR.

CLASS 35—ADVERTISING AND BUSINESS

FOR BUSINESS INQUIRIES; BUSINESS INVESTIGATION SERVICES, BUSINESS RESEARCH, PROFESSIONAL BUSINESS CONSULTANCY, BUSINESS INFORMATION SERVICES, MARKETING RESEARCH, STUDIES, AND SURVEYS; BUSINESS INTELLIGENCE SERVICES, NAMELY, DUE DILIGENCE INVESTIGATIONS; BUSINESS INTELLIGENCE INVESTIGATIONS; POLITICAL RISK BUSINESS ASSESSMENTS AND COMPETITOR BUSINESS ASSESSMENTS (U.S. CLS. 100, 101 AND 102).

CLASS 45—PERSONAL SERVICES

FOR CORPORATE INVESTIGATION SERVICES, NAMELY, FRAUD INVESTIGATIONS, CONFLICT OF INTEREST INVESTIGATIONS, INSURANCE CLAIM INVESTIGATIONS, ARSON INVESTIGATIONS AND CYBER CRIME INVESTIGATIONS; SECURITY CONSULTANCY SERVICES; DETECTIVE AGENCIES SERVICES; INTELLECTUAL PROPERTY PROTECTION SERVICES, NAMELY, STRATEGIC MANAGEMENT OF INTELLECTUAL PROPERTY, RISK INVESTIGATIONS INTO INTELLECTUAL PROPERTY LOSSES, LICENSING DISPUTE INVESTIGATIONS, GREY MARKET AND PARALLEL TRADING INVESTIGATIONS; MISSING PERSONS INVESTIGATIONS; CORPORATE SECURITY SERVICES, NAMELY, PHYSICAL SECURITY AUDITS, THREAT ASSESSMENTS, INFORMATION TECHNOLOGY SECURITY AUDITS, EXECUTIVE PROTECTION PROGRAMS, TECHNICAL COUNTERMEASURE SECURITY PROGRAMS AND SECURITY CONTINGENCY PLANNING; FRAUD INVESTIGATION SERVICES (U.S. CLS. 100 AND 101).

PRISCILLA MILTON, EXAMINING ATTORNEY

SN 78-180,573, PBO GROUP APS, DK-8240 RISSKOV, DENMARK, FILED 10-31-2002.



OWNER OF ERPN CMNTY TM OFC REG. NO. 002649903, DATED 4-10-2002, EXPIRES 4-10-2012.

NO CLAIM IS MADE TO THE EXCLUSIVE RIGHT TO USE "GROUP", APART FROM THE MARK AS SHOWN.

CLASS 18—LEATHER GOODS

FOR ATTACHE CASES, BACKPACKS, BRIEFCASES, CREDIT CARD CASES, BUSINESS CARD CASES, GARMENT BAGS FOR TRAVEL, HANDBAGS, HAT BOXES FOR TRAVEL, KEY CASES, POCKET WALLETS, PURSES, UMBRELLAS, WALKING STICKS; ALL SUCH GOODS MADE OF LEATHER AND IMITATION OF LEATHER (U.S. CLS. 1, 2, 3, 22 AND 41).

CLASS 25—CLOTHING

FOR BELTS, BLAZERS, BLOUSES, COATS, DRESSES, EAR MUFFS, FROCKS, FUR STOLEES, GIRDLES, GLOVES, GOWNS, JACKETS, JERSEYS, JUMPERS, KNITWEAR, NAMELY, KNIT SHIRTS, KNIT SWEATERS, KNIT TOPS, KNIT SCARVES, KNIT SHAWLS, LEGGINGS, MITTENS, MUFFS, NECKTIES, OVERCOATS, INCLUDING OVERCOATS OF WOOL, FUR, LEATHER AND IMITATION OF LEATHER, PANTS, PARKAS, PULLOVERS, SCARVES, SHAWLS, SHIRTS, SHORTS, SKIRTS, SOCKS, SUITS, SWEATERS, TANK TOPS, T-SHIRTS, TROUSERS, VESTS, WAISTCOATS; FOOTWEAR AND HEADWEAR (U.S. CLS. 22 AND 39).

FRED MANDIR, EXAMINING ATTORNEY

SN 78-183,136, INDIA FIRST PUBLIC LIMITED COMPANY, LONDON, UNITED KINGDOM, FILED 11-8-2002.



PRIORITY CLAIMED UNDER SEC. 44(D) ON UNITED KINGDOM APPLICATION NO. 2305447, FILED 7-17-2002, REG. NO. 2305447, DATED 2-7-2003, EXPIRES 7-17-2012.

CLASS 5—PHARMACEUTICALS

FOR PHARMACEUTICAL PRODUCTS AND PREPARATIONS FOR USE IN THE TREATMENT OF ALLERGIES, ARTHRITIS, CANCER, DIABETES, DISEASES OF THE CENTRAL NERVOUS SYSTEM, INFLAMMATORY DISEASES, METABOLIC DISORDERS, VIRAL DISEASES, HEREDITARY DISEASES, HEART AND CIRCULATORY DISEASES, INFECTIOUS DISEASES, IMMUNOLOGICAL DISEASES, HEMATOLOGICAL DISEASES, SKIN DISEASES, METABOLIC DISEASES; VETERINARY PREPARATIONS, NAMELY, VETERINARY VACCINES FOR MAMMALS; SANITARY PREPARATIONS AND SUBSTANCES, NAMELY, ALL-PURPOSE DISINFECTANTS; DIETARY AND NUTRITIONAL SUPPLEMENTS; ADHESIVE BANDAGES; WOUND AND BURN MEDICAL AND SURGICAL DRESSINGS (U.S. CLS. 6, 18, 44, 46, 51 AND 52).

CLASS 25—CLOTHING

FOR CLOTHING, NAMELY, SHIRTS, T-SHIRTS, VESTS, PANTS, SHORTS, SOCKS, GLOVES, SCARVES, TIES, JACKETS, COATS, DRESSES, SKIRTS, BLOUSES, STOCKINGS, TIGHTS, LINGERIE, UNDERWEAR, BATHING SUITS, SWIM TRUNKS; FOOTWEAR; AND HEADGEAR, NAMELY, HATS, CAPS, AND VISORS (U.S. CLS. 22 AND 39).

CLASS 30—STAPLE FOODS

FOR PROCESSED CEREALS AND CEREAL PRODUCTS, NAMELY, BREAKFAST CEREALS; FLOUR AND FLOUR PRODUCTS, NAMELY, PASTAS; RICE AND RICE PRODUCTS, NAMELY, RICE CAKES; CAKES; PASTRY AND PASTRIES; COOKIES; BISCUITS; BAKERY PRODUCTS, NAMELY, DOUGHNUTS, COOKIES, PIES; BREAD AND BREAD PRODUCTS, NAMELY, ROLLS, BAGUETTES, AND BUNS; CHOCOLATE AND CHOCOLATE PRODUCTS, NAMELY CHOCOLATE BARS, CHOCOLATE CANDIES; CONFECTIONERY, NAMELY CANDIES; ICE CREAM AND FLAVORED ICES; SORBETS; FLAVORED MOUSSES, DESSERTS, NAMELY PREPARED CAKES, FRUIT PIES, AND PUDDINGS; COFFEE AND COFFEE SUBSTITUTES; TEA AND TEA SUBSTITUTES; SUGAR, HONEY, TREACLE; YEAST, BAKING POWDER; CONDIMENTS, NAMELY, MAYONNAISE, RELISHES; SAUCES; VINEGAR; SEASONINGS, SPICES AND SPICE MIXTURES, MUSTARDS, EXTRACTS OF HERBS AND SPICES USED AS FLAVORING, SALT AND SALT SUBSTITUTES; SALAD DRESSINGS; SNACKS, NAMELY, POPPED POPCORN, WHEAT-, RICE-, AND CORN-BASED SNACK FOODS; PREPARED MEALS CONSISTING PRIMARILY OF PASTA OR RICE (U.S. CL. 46).

CLASS 35—ADVERTISING AND BUSINESS

FOR BUSINESS ADVISORY SERVICES, BUSINESS MANAGEMENT ASSISTANCE, BUSINESS INFORMATION AND ADVISORY SERVICES RELATING TO BUSINESS MANAGEMENT AND BUSINESS OPERATION; BUSINESS APPRAISAL SERVICES; BUSINESS PLANNING SERVICES; BUSINESS INTRODUCTION SERVICES, NAMELY BUSINESS NETWORKING; ASSOCIATION SERVICES, NAMELY, PROMOTING THE INTERESTS OF EXPORT AGENCIES; BUSINESS CONSULTANCY SERVICES; EXPORT-IMPORT AGENCY SERVICES; PROVIDING COMMERCIAL INFORMATION IN THE FIELD OF IMPORT-EXPORT; MARKETING RESEARCH AND CONDUCTING MARKETING STUDIES; ECONOMIC ANALYSIS AND FORECASTING; ORGANIZATION AND CONDUCTING OF EXHIBITIONS FOR BUSINESS, COMMERCIAL OR ADVERTISING PURPOSES; ACCOUNTING; TAX CONSULTANCY AND ADVISORY SERVICES; SECRETARIAL SERVICES; RECRUITMENT AND PERSONNEL PLACEMENT SERVICES; INFORMATION, ADVISORY AND CONSULTANCY SERVICES RELATING TO ALL THE AFORESAID SERVICES (U.S. CLS. 100, 101 AND 102).

CLASS 36—INSURANCE AND FINANCIAL

FOR FINANCIAL SERVICES, NAMELY, INFORMATION, ADVISORY AND CONSULTANCY SERVICES RELATING TO FINANCIAL SPONSORSHIP, INVESTMENT, AND CHARITABLE FUND-RAISING; AGENCY SERVICES FOR ARRANGING INVESTMENT AND INVESTMENT INTRODUCTIONS (U.S. CLS. 100, 101 AND 102).

CLASS 41—EDUCATION AND ENTERTAINMENT

FOR EDUCATIONAL SERVICES, NAMELY, ARRANGING AND CONDUCTING CONFERENCES, SEMINARS AND WORKSHOPS TO PROMOTE, SUPPORT AND DEVELOP SPORTING AND CULTURAL ACTIVITIES BETWEEN INDIA AND THE UNITED STATES; ORGANIZING, MANAGING AND SPONSORING EXHIBITIONS, SHOWS AND EVENTS FOR CULTURAL, ENTERTAINMENT, SPORTING, RECREATIONAL, AND EDUCATIONAL PURPOSES, RELATING TO THE PROMOTION, SUPPORT AND DEVELOPMENT OF SPORTING AND CULTURAL ACTIVITIES BETWEEN INDIA AND THE UNITED STATES; PRODUCTION OF MOTION PICTURE FILMS, VIDEO TAPES, RADIO PROGRAMS, AND TELEVISION PROGRAMS; PUBLISHING SERVICES, NAMELY PUBLICATION OF NEWSLETTERS AND MAGAZINES TO PROMOTE, SUPPORT AND DEVELOP SPORTING AND CULTURAL ACTIVITIES BETWEEN INDIA AND THE UNITED STATES, INFORMATION, ADVISORY AND CONSULTANCY SERVICES RELATING TO ALL THE AFORESAID SERVICES (U.S. CLS. 100, 101 AND 107).

CYNTHIA SLOAN, EXAMINING ATTORNEY

SN 78-193,016. BELL/AGUSTA AEROSPACE COMPANY LLC, FORT WORTH, TX. FILED 12-10-2002.

**AN AVIATION COMPANY
BUILT FOR YOUR WORLD****CLASS 35—ADVERTISING AND BUSINESS**

FOR CUSTOMER SERVICE IN THE FIELD OF AVIATION; DISTRIBUTORSHIPS IN THE FIELD OF AVIATION AND AVIATION PARTS (U.S. CLS. 100, 101 AND 102).

FIRST USE 1-0-2000; IN COMMERCE 1-0-2000.

CLASS 36—INSURANCE AND FINANCIAL

FOR PROVIDING SERVICE PLANS AND EXTENDED WARRANTIES IN THE FIELD OF AVIATION (U.S. CLS. 100, 101 AND 102).

FIRST USE 1-0-2000; IN COMMERCE 1-0-2000.

CLASS 41—EDUCATION AND ENTERTAINMENT

FOR EDUCATIONAL AND TRAINING SERVICES IN THE FIELD OF PILOT AVIATION AND AVIATION MAINTENANCE (U.S. CLS. 100, 101 AND 107).

FIRST USE 1-0-2000; IN COMMERCE 1-0-2000.

CLASS 42—SCIENTIFIC, COMPUTER AND LEGAL SERVICES

FOR PROVIDING TECHNICAL PRODUCT SUPPORT IN THE FIELD OF AVIATION (U.S. CLS. 100 AND 101).

FIRST USE 1-0-2000; IN COMMERCE 1-0-2000.

GIANCARLO CASTRO, EXAMINING ATTORNEY

SN 78-195,907. ASOCIACION DE LA INDUSTRIA DE LA PIEL PARA EL COMERCIO EXTERIOR, BARCELONA, SPAIN, FILED 12-18-2002.



OWNER OF ERPN CMNTY TM OFC REG. NO. 002781813, DATED 1-29-2004, EXPIRES 7-18-2012.

NO CLAIM IS MADE TO THE EXCLUSIVE RIGHT TO USE "CURTIDORES ESPAÑOLES" AND "SPANISH TANNERS", APART FROM THE MARK AS SHOWN.

THE STIPLING IN THE DRAWING IS FOR SHADING PURPOSES ONLY.

THE ENGLISH TRANSLATION OF CURTIDORES ESPAÑOLES IS SPANISH TANNERS.

CLASS 18—LEATHER GOODS

FOR (BASED ON 44(E)) GOODS MADE OF LEATHER AND ANIMAL SKIN, NAMELY, TRUNKS AND TRAVELING BAGS, UMBRELLAS, PARASOLS, WALKING STICKS, PURSES, RUCKSACKS, SHOULDER BAGS, BOOK BAGS AND SCHOOL BOOK BAGS, HANDBAGS, SHOPPING BAGS, BEACH BAGS, SUITCASES, WALLET, BRIEFCASES, ATTACHE CASES, HARNESSES AND SADDLERY, VALISES, TRAVEL KITS CASES SOLD EMPTY, VANITY CASES SOLD EMPTY, KEY CASES, CREDIT-CARD CASES, BUSINESS-CARD CASES (U.S. CLS. 1, 2, 3, 22 AND 41).

CLASS 25—CLOTHING

FOR (BASED ON 44(E)) CLOTHING, NAMELY, FOOTWEAR AND HEADWEAR MADE OF LEATHER OR ANIMAL SKIN (U.S. CLS. 22 AND 39).

CLASS 35—ADVERTISING AND BUSINESS

FOR (BASED ON INTENT TO USE) INFORMATION, ADVISORY AND CONSULTANCY SERVICES RELATING TO THE IMPORT AND EXPORT, PROMOTION, AND SALE OF GOODS MADE OF LEATHER AND ANIMAL SKIN (U.S. CLS. 100, 101 AND 102).

DAVID ELTON, EXAMINING ATTORNEY

SN 78-197.131. LIZARRAN TABERNAS SELECTAS, S.L., VILANOVA Y LA GELTRU (BARCELONA), SPAIN, FILED 12-21-2002.



NO CLAIM IS MADE TO THE EXCLUSIVE RIGHT TO USE TABERNAS SELECTAS, APART FROM THE MARK AS SHOWN.

THE MARK CONSISTS IN PART OF THE FANCIFUL REPRESENTATION OF A HAND HOLDING FOOD.

THE ENGLISH TRANSLATION OF TABERNAS SELECTAS IS EXCELLENT TAVERN.

CLASS 16—PAPER GOODS AND PRINTED MATTER

FOR PAPER, NAMELY, WRITING PAPER, TYPING PAPER, NOTEBOOK PAPER, COPIER PAPER, NOTEPAD PAPER, WRAPPING PAPER, BONDED PAPER, COLORED PAPER, CARDBOARD; PHOTO ALBUMS, MOUNTED AND UNMOUNTED PHOTOGRAPHS; ART PRINTS, REPRODUCTION LITHOGRAPHIC PRINTS, PORTRAITS, ART DRAWINGS; BOOKS OF FICTION, NEWS, HUMOR, MUSIC AND SCIENTIFIC CONTENT; MAGAZINES AND MAIL ORDER CATALOGS FEATURING FICTION, NEWS, HUMOR, MUSIC AND SCIENTIFIC CONTENT, ALMANACS, AUTOMOTIVE BOOKS, PAPER OR PLASTIC BAGS FOR MERCHANDISE, BANK CHECKS, BUMPER STICKERS, BUSINESS CARD HOLDERS, BUSINESS CARDS, CALENDARS, CHECKBOOK COVERS, CHILDREN ACTIVITY BOOKS, COOKBOOKS, DECALS, DESK TOP HOLDERS FOR DESK ACCESSORIES, GIFT WRAPPING PAPER, GREETING CARDS, LETTER OPENERS, MARKERS, NOTE PAD HOLDERS, NOTE PADS, PAPER BANNERS, PAPER COASTERS, PAPER FLAGS, PAPER LUGGAGE TAGS, PAPER NAPKINS, PAPERWEIGHTS, PEN AND PENCIL HOLDERS, PENCILS, PENS, POCKET SECRETARIES, POSTCARDS, POSTERS, PRINTED LABELS, STATIONERY FOLDERS, TRADING AND COLLECTOR CARDS (U.S. CLS. 2, 5, 22, 23, 29, 37, 38 AND 50).

CLASS 33—WINES AND SPIRITS

FOR ALCOHOLIC BEVERAGES, NAMELY, BOURBON, WHISKEY, VODKA, GIN, TEQUILA, RUM, BRANDY, COGNAC; LIQUEURS; WINE, WINE COOLERS; CHAMPAGNE AND SPARKLING WINE (U.S. CLS. 47 AND 49).

CLASS 43—HOTEL AND RESTAURANT SERVICES

FOR SERVICES FOR PROVIDING FOOD AND DRINK, NAMELY, RESTAURANT, DELICATESSEN, SNACK BAR, BANQUET FACILITIES, CATERING, BAR, AND TAKE-OUT RESTAURANT SERVICES (U.S. CLS. 100 AND 101).

G. MAYERSCHOFF, EXAMINING ATTORNEY

SN 78-200.208. GREGG, HAROLD S., AUSTIN, TX. FILED 1-6-2003.



OWNER OF U.S. REG. NO. 2,656,611.
THE STIPPLING IS FOR SHADING PURPOSES ONLY.
THE COLOR(S) BLUE AND YELLOW IS/ARE CLAIMED AS A FEATURE OF THE MARK.

THE MARK CONSISTS OF THE WORDS "THEYELLOW-PAGES.COM" WITH THE ".COM" PORTION OF THE MARK OVER A GLOBE, WHICH FEATURES THE COLORS BLUE AND YELLOW, FOR THE OCEANS AND THE CONTINENTS, RESPECTIVELY.

CLASS 16—PAPER GOODS AND PRINTED MATTER

FOR CALENDARS, WALL CALENDARS (U.S. CLS. 2, 5, 22, 23, 29, 37, 38 AND 50).
FIRST USE 12-27-2002; IN COMMERCE 12-27-2002.

CLASS 18—LEATHER GOODS

FOR TOTE BAGS, BOOK BAGS, TRAVEL BAGS, BRIEFCASES, BACKPACKS (U.S. CLS. 1, 2, 3, 22 AND 41).

FIRST USE 12-27-2002; IN COMMERCE 12-27-2002.

CLASS 21—HOUSEWARES AND GLASS

FOR LUNCH BOXES, MUGS, DRINKING STEINS, COASTERS NOT OF PAPER AND NOT BEING TABLE LINEN (U.S. CLS. 2, 13, 23, 29, 30, 33, 40 AND 50).

FIRST USE 12-27-2002; IN COMMERCE 12-27-2002.

CLASS 25—CLOTHING

FOR PULLOVERS, VESTS, JACKETS, SWEATSHIRTS, T-SHIRTS, JERSEYS, GOLF SHIRTS, THONG UNDERWEAR, UNDERWEAR, BASEBALL CAPS, APRONS (U.S. CLS. 22 AND 39).

FIRST USE 12-27-2002; IN COMMERCE 12-27-2002.
KATHERINE STOIDES, EXAMINING ATTORNEY

SN 78-201,414. OBSCHESTVO S OGRANICHENNOY OTVETSTVENNOSTYU "VL ENTERPRISES", MOSCOW, RUSSIAN FED., FILED 1-8-2003.



PRIORITY CLAIMED UNDER SEC. 44(D) ON RUSSIAN FED. APPLICATION NO. 2002722548, FILED 10-14-2002, REG. NO. 242940, DATED 4-10-2003, EXPIRES 10-14-2012.

THE LINING SHOWN IN THE DRAWING IS A FEATURE OF THE MARK.

THE MARK CONSISTS OF THE CONFIGURATION OF A BOTTLE IN A STYLIZED DROP SHAPE WITH THE WORDS KAUFFMAN PRIVATE COLLECTION THEREON.

CLASS 3—COSMETICS AND CLEANING PREPARATIONS

FOR ESSENTIAL OILS FOR USE IN THE MANUFACTURE OF AROMATICS; ESSENTIAL OILS FOR BEVERAGE FLAVORINGS; SCENTED WATER, NAMELY, JAVELLE WATER, LAVENDER WATER; TOILET WATER; PERFUMES; PERFUMERY; SHAVING PREPARATIONS; HAIR LOTIONS; LOTIONS FOR COSMETIC PURPOSES; ESSENTIAL OILS FOR COSMETIC PURPOSES; ESSENTIAL OILS FOR PERFUMES AND SCENTS; ESSENTIAL OILS FOR COSMETIC PURPOSES; ESSENTIAL OILS FOR TOILET PURPOSES; ESSENTIAL OILS OF LEMON; ESSENTIAL OILS OF KEDARWOOD; BERGAMOT OIL; GAULTHERIA OIL; JASMINE OIL; LAVENDER OIL; ALMOND OIL; ROSE OIL; CLEANSING MILK FOR TOILET PURPOSES; ALMOND MILK FOR COSMETIC PURPOSES; ESSENTIAL OIL OF MUSK; EAU DE COLOGNE; MOUTH WASHES NOT FOR MEDICAL PURPOSES; COSMETICS; COSMETIC PREPARATIONS FOR SKIN CARE; DETERGENTS, NAMELY DETERGENT SOAP, DETERGENTS FOR AUTOMOBILES, DETERGENTS FOR MACHINE DISHWASHING, DETERGENTS PREPARED FROM PETROLEUM; DECOLORANT BLEACHING PREPARATIONS FOR COSMETIC PURPOSES; ESSENTIAL OIL OF TERPENES; SHAMPOOS; EXTRACTS OF FLOWERS; BADIAN ESSENCE; ESSENTIAL OIL OF MINT ESSENCE (U.S. CLS. 1, 4, 6, 50, 51 AND 52).

CLASS 32—LIGHT BEVERAGES

FOR NON-ALCOHOLIC APERITIFS; DRINKING WATER; NON-ALCOHOLIC COCKTAIL MIXES; PEANUT MILK-BASED BEVERAGES; ALMOND MILK-BASED BEVERAGES; LEMONADE; NON-ALCOHOLIC BEVERAGES, NAMELY, PUNCH, SPORTS DRINKS, SWEET CIDER; ISOTONIC DRINKS; WHEY BEVERAGES; NON-ALCOHOLIC FRUIT EXTRACTS USED IN THE PREPARATION OF BEVERAGES; FRUIT NECTARS; ORGEAT BEER; SARSAPARILLA; SOFT DRINKS; SYRUPS FOR LEMONADE; SYRUPS FOR MAKING SOFT DRINKS; TOMATO JUICE; APPLE JUICE; VEGETABLE JUICE; FRUIT JUICE; EXTRACTS OF HOPS FOR MAKING BEER; ESSENCES FOR USE IN MAKING BEVERAGES, NAMELY, SOFT DRINKS, NOT IN THE NATURE OF ESSENTIAL OILS (U.S. CLS. 45, 46 AND 48).

CLASS 33—WINES AND SPIRITS

FOR APERITIFS; ORAK; BRANDY; WINE; WHISKEY; GIN; VODKA; PREPARED ALCOHOLIC COCKTAILS; LIQUEURS; ALCOHOLIC BEVERAGES, NAMELY ALCOHOLIC COFFEE-BASED BEVERAGE; ALCOHOLIC TEA-BASED BEVERAGE; ALCOHOLIC PUNCH; CALVADOS; CHAMPAGNE; COGNAC; CURACAO; HERB LIQUEURS; OUZO; SCHNAPPS; TEQUILA; ALCOHOLIC BEVERAGES CONTAINING FRUIT; DISTILLED SPIRITS; MEAD; PEPPERMINT LIQUEURS; ALCOHOLIC BITTERS; RUM; SAKE; HARD CIDER; RICE ALCOHOL (U.S. CLS. 47 AND 49).

CAROLYN GRAY, EXAMINING ATTORNEY

SN 78-201,415. OBSCHESTVO S OGRANICHENNOY OTVETSTVENNOSTYU "VL ENTERPRISES", MOSCOW, RUSSIAN FED., FILED 1-9-2003.



PRIORITY CLAIMED UNDER SEC. 44(D) ON RUSSIAN FED. APPLICATION NO. 2002722547, FILED 10-14-2002, REG. NO. 241079, DATED 3-25-2003, EXPIRES 10-14-2012.

THE LINING SHOWN IN THE DRAWING IS A FEATURE OF THE MARK.

THE MARK CONSISTS OF THE CONFIGURATION OF A BOTTLE IN A STYLIZED ELONGATE SHAPE WITH THE WORDS KAUFFMAN COLLECTION THEREON.

CLASS 3—COSMETICS AND CLEANING PREPARATIONS

FOR ESSENTIAL OILS FOR USE IN THE MANUFACTURE OF AROMATICS; ESSENTIAL OILS FOR BEVERAGE FLAVORINGS; SCENTED WATER, NAMELY, JAVELLE WATER, LAVENDER WATER; TOILET WATER; PERFUMES; PERFUMERY; SHAVING PREPARATIONS; HAIR LOTIONS; LOTIONS FOR COSMETIC PURPOSES; ESSENTIAL OILS FOR COSMETIC PURPOSES; ESSENTIAL OILS FOR PERFUMES AND SCENTS; ESSENTIAL OILS FOR COSMETIC PURPOSES; ESSENTIAL OILS FOR TOILET PURPOSES; ESSENTIAL OILS OF LEMON; ESSENTIAL OILS OF KEDARWOOD; BERGAMOT OIL; GAULTHERIA OIL; JASMINE OIL; LAVENDER OIL; ALMOND OIL; ROSE OIL; CLEANSING MILK FOR TOILET PURPOSES; ALMOND MILK FOR COSMETIC PURPOSES; ESSENTIAL OIL OF MUSK; EAU DE COLOGNE; MOUTH WASHES NOT FOR MEDICAL PURPOSES; COSMETICS; COSMETIC PREPARATIONS FOR SKIN CARE; DETERGENTS, NAMELY DETERGENT SOAP, DETERGENTS FOR AUTOMOBILES, DETERGENTS FOR MACHINE DISHWASHING, DETERGENTS PREPARED FROM PETROLEUM; DECOLORANT BLEACHING PREPARATIONS FOR COSMETIC PURPOSES; ESSENTIAL OIL OF TERPENES; SHAMPOOS; EXTRACTS OF FLOWERS; BADIAN ESSENCE; ESSENTIAL OIL OF MINT ESSENCE (U.S. CLS. 1, 4, 6, 50, 51 AND 52).

CLASS 32—LIGHT BEVERAGES

FOR NON-ALCOHOLIC APERITIFS; DRINKING WATER; NON-ALCOHOLIC COCKTAIL MIXES; PEANUT MILK-BASED BEVERAGES; ALMOND MILK-BASED BEVERAGES; LEMONADE; NON-ALCOHOLIC BEVERAGES, NAMELY, PUNCH, SPORTS DRINKS, SWEET CIDER; ISOTONIC DRINKS; WHEY BEVERAGES; NON-ALCOHOLIC FRUIT EXTRACTS USED IN THE PREPARATION OF BEVERAGES; FRUIT NECTARS; ORGEAT BEER; SARSAPARILLA; SOFT DRINKS; SYRUPS FOR LEMONADE; SYRUPS FOR MAKING SOFT DRINKS; TOMATO JUICE; APPLE JUICE; VEGETABLE JUICE; FRUIT JUICE; EXTRACTS OF HOPS FOR MAKING BEER; ESSENCES FOR USE IN MAKING BEVERAGES, NAMELY, SOFT DRINKS, NOT IN THE NATURE OF ESSENTIAL OILS (U.S. CLS. 45, 46 AND 48).

CLASS 33—WINES AND SPIRITS

FOR APERITIFS; ORAK; BRANDY; WINE; WHISKEY; GIN; VODKA; PREPARED ALCOHOLIC COCKTAILS; LIQUEURS; ALCOHOLIC BEVERAGES, NAMELY ALCOHOLIC COFFEE-BASED BEVERAGE; ALCOHOLIC TEA-BASED BEVERAGE; ALCOHOLIC PUNCH; CALVADOS; CHAMPAGNE; COGNAC; CURACAO; HERB LIQUEURS; OUZO; SCHNAPPS; TEQUILA; ALCOHOLIC BEVERAGES CONTAINING FRUIT; DISTILLED SPIRITS; MEAD; PEPPERMINT LIQUEURS; ALCOHOLIC BITTERS; RUM; SAKE; HARD CIDER; RICE ALCOHOL (U.S. CLS. 47 AND 49).

CAROLYN GRAY, EXAMINING ATTORNEY

SN 78-204,299. SCHATZ, JÜRGEN, BERLIN, FED REP GERMANY, FILED 1-17-2003.

EUROVORTEX

OWNER OF FED REP GERMANY REG. NO. 39762421, DATED 3-30-1998, EXPIRES 12-31-2007.

CLASS 7—MACHINERY

FOR MACHINES FOR GENERATING AT LEAST ONE POTENTIAL VORTEX FOR PRODUCING USABLE ENERGY FROM PARALLEL FLOWS (U.S. CLS. 13, 19, 21, 23, 31, 34 AND 35).

CLASS 9—ELECTRICAL AND SCIENTIFIC APPARATUS

FOR FACTORY AND MACHINE AUTOMATION SOFTWARE FOR GENERATING AT LEAST ONE POTENTIAL VORTEX FOR PRODUCING USABLE ENERGY FROM PARALLEL FLOWS (U.S. CLS. 21, 23, 26, 36 AND 38).

CLASS 42—SCIENTIFIC, COMPUTER AND LEGAL SERVICES

FOR TECHNICAL ADVISORY SERVICES CONCERNING MACHINES AND FACTORIES FOR GENERATING AT LEAST ONE POTENTIAL VORTEX FOR PRODUCING USABLE ENERGY FROM PARALLEL FLOWS (U.S. CLS. 100 AND 101).

EDWARD NELSON, EXAMINING ATTORNEY

SN 78-206,938. DIA, MOHAMED, SAINT BRICE SOUS FORET, FRANCE, FILED 1-24-2003.

M.DiA



OWNER OF FRANCE REG. NO. 99814355, DATED 9-28-1999, EXPIRES 9-28-2009.

THE NON-LATIN CHARACTER(S) IN THE MARK TRANSLITERATES INTO BI SHENG, AND THIS MEANS PROMISE TO VICTORY IN ENGLISH.

CLASS 3—COSMETICS AND CLEANING PREPARATIONS

FOR PERFUMES, TOILET SOAPS, COSMETICS AND LOTIONS FOR COSMETIC USE (U.S. CLS. 1, 4, 6, 50, 51 AND 52).

CLASS 14—JEWELRY

FOR FANCY JEWELRY, NAMELY, NECKLACES, COLLARS, BRACELETS, BANGLES, RINGS, EARRINGS, BODY PIERCING JEWELRY, BROOCHES, KEY-RINGS AND KEY CHAINS MADE OF PRECIOUS METAL; HOROLOGICAL AND CHRONOMETRIC INSTRUMENTS, NAMELY, WATCHES, CLOCKS, ALARM CLOCKS, CHRONOMETERS (U.S. CLS. 2, 27, 28 AND 50).

CLASS 25—CLOTHING

FOR CLOTHING, NAMELY, BLOUSES, BOXER SHORTS, SHORTS, BELTS, SWEATERS, SOCKS, SHIRTS, SHIFTS, UNDERSHIRTS, NIGHTSHIRTS, NIGHT-DRESSES, UNDERWEAR, SWEAT-SHIRTS, GLOVES, PULLOVERS, DRESSES, VESTS, SKIRTS, SWIMSUITS, TROUSERS, OVERCOATS, PARKAS, T-SHIRTS; FOOTWEAR; HEADGEAR, NAMELY, HATS, BONNETS, BEREETS AND CAPS (U.S. CLS. 22 AND 39).

DOMINICK J. SALEMI, EXAMINING ATTORNEY

SN 78-211,843. INPRO CORPORATION, MUSKEGO, WI. FILED 2-6-2003.

INPRO 
IPC DOOR and WALL
PROTECTION SYSTEMS

NO CLAIM IS MADE TO THE EXCLUSIVE RIGHT TO USE "DOOR AND WALL PROTECTION SYSTEMS", APART FROM THE MARK AS SHOWN.

CLASS 6—METAL GOODS

FOR DOOR AND WALL PROTECTION PRODUCTS, NAMELY, METAL HANDRAILS, METAL GRAB BARS, METAL WALL GUARDS, METAL CORNER GUARDS, METAL CHAIR RAILS, METAL RUB RAILS, METAL DOOR KICK PLATES, METAL DOOR FRAME GUARDS, METAL DOOR EDGE PROTECTORS, METAL DOOR KNOB PROTECTORS (U.S. CLS. 2, 12, 13, 14, 23, 25 AND 50).

FIRST USE 1-1-1993; IN COMMERCE 1-1-1993.

CLASS 19—NON-METALLIC BUILDING MATERIALS

FOR DOOR AND WALL PROTECTION PRODUCTS, NAMELY, NON-METAL HANDRAILS, NON-METAL WALL GUARDS, NON-METAL CORNER GUARDS, NON-METAL CHAIR RAILS, NON-METAL RUB RAILS, NON-METAL DOOR KICK PLATES, NON-METAL DOOR FRAME GUARDS, NON-METAL DOOR EDGE PROTECTORS, NON-METAL DOOR KNOB PROTECTORS, VINYL AND RUBBER WALL BASES (U.S. CLS. 1, 12, 33 AND 50).

FIRST USE 1-1-1993; IN COMMERCE 1-1-1993.

CLASS 21—HOUSEWARES AND GLASS

FOR NON-METAL SHOWER GRAB BARS (U.S. CLS. 2, 13, 23, 29, 30, 33, 40 AND 50).

FIRST USE 1-1-1993; IN COMMERCE 1-1-1993.

CLASS 27—FLOOR COVERINGS

FOR VINYL WALL COVERINGS (U.S. CLS. 19, 20, 37, 42 AND 50).

FIRST USE 1-1-1993; IN COMMERCE 1-1-1993.
SCOTT BALDWIN, EXAMINING ATTORNEY

SN 78-211,864. INPRO CORPORATION, MUSKEGO, WI.
FILED 2-6-2003.

INPRO
CLICKEZE PRIVACY SYSTEMS

OWNER OF U.S. REG. NO. 872,437.

NO CLAIM IS MADE TO THE EXCLUSIVE RIGHT TO USE "PRIVACY SYSTEMS", APART FROM THE MARK AS SHOWN.

CLASS 6—METAL GOODS

FOR PRIVACY SYSTEMS COMPRISED OF METAL PRIVACY CURTAIN CEILING TRACKS, METAL TRACK CARRIERS, METAL STIFFENERS, METAL SPACERS, METAL CLIPS, METAL END CAPS, METAL SUPPORT BRACKETS, METAL TRACK PULLEY HOUSINGS, AND METAL CORD GUIDES (U.S. CLS. 2, 12, 13, 14, 23, 25 AND 50).

FIRST USE 6-1-2000; IN COMMERCE 6-1-2000.

CLASS 20—FURNITURE AND ARTICLES NOT OTHERWISE CLASSIFIED

FOR PRIVACY SYSTEMS COMPRISED OF WINDOW BLINDS AND WINDOW SHADES (U.S. CLS. 2, 13, 22, 25, 32 AND 50).

FIRST USE 6-1-2000; IN COMMERCE 6-1-2000.

CLASS 24—FABRICS

FOR PRIVACY SYSTEMS COMPRISED OF PRIVACY CURTAINS, SHOWER CURTAINS, DRAPERIES, FABRIC VALANCES, AND BEAD SPREADS (U.S. CLS. 42 AND 50).

FIRST USE 6-1-2000; IN COMMERCE 6-1-2000.
SCOTT BALDWIN, EXAMINING ATTORNEY

SN 78-212,064. S.B. STUDIOS, LLC, FT. LAUDERDALE, FL.
FILED 2-7-2003.

i-bella

CLASS 3—COSMETICS AND CLEANING PREPARATIONS

FOR SHAMPOO FOR HAIR; CONDITIONER FOR HAIR; STYLING PRODUCTS FOR HAIR, NAMELY, GELS, MOUSSE, POMADE, WAX, VOLUMIZER, AND ANTI-FRIZZ LOTIONS; FINISHING PRODUCTS FOR HAIR, NAMELY HAIR SPRAY; FACIAL CLEANSERS; BODY CLEANSERS, NAMELY, SHOWER GEL, SOAP, BATH SALTS, EXFOLIANTS; HAND LOTIONS; BODY LOTIONS; FRAGRANCES, NAMELY BODY SPRAYS AND PERFUME (U.S. CLS. 1, 4, 6, 50, 51 AND 52).

CLASS 9—ELECTRICAL AND SCIENTIFIC APPARATUS

FOR PRE-RECORDED COMPACT DISCS AND VIDEO-TAPES FEATURING EDUCATIONAL PRESENTATIONS SUCH AS COURSES, CLASSES, SEMINARS, WORKSHOPS, CONFERENCES, FORUMS, INSTITUTES IN THE FIELDS OF BEAUTY, SKIN CARE, COSMETICS AND HAIR CARE; PRE-RECORDED VIDEOTAPES, AUDIO CASSETTES AND COMPACT DISCS CONTAINING EDUCATIONAL COURSES, CLASSES, SEMINARS, WORKSHOPS, CONFERENCES, FORUMS, AND INSTITUTES IN THE FIELDS OF BEAUTY, SKIN CARE, COSMETICS AND HAIR CARE (U.S. CLS. 21, 23, 26, 36 AND 38).

CLASS 21—HOUSEWARES AND GLASS

FOR HAIR BRUSHES AND HAIR COMBS (U.S. CLS. 2, 13, 23, 29, 30, 33, 40 AND 50).

CLASS 41—EDUCATION AND ENTERTAINMENT

FOR EDUCATIONAL SERVICES, NAMELY PROVIDING COURSES, CLASSES, SEMINARS, WORKSHOPS, CONFERENCES, FORUMS, AND INSTITUTES IN THE FIELDS OF BEAUTY, SKIN CARE, COSMETICS AND HAIR CARE (U.S. CLS. 100, 101 AND 107).

ALICIA COLLINS, EXAMINING ATTORNEY

SN 78-217,032. AAAFORAY, INC., REHOBOTH, MA. FILED 2-20-2003.



CLASS 16—PAPER GOODS AND PRINTED MATTER

FOR GRAPHIC REPRODUCTIONS ON PAPER AND CANVAS (U.S. CLS. 2, 5, 22, 23, 29, 37, 38 AND 50).

CLASS 20—FURNITURE AND ARTICLES NOT OTHERWISE CLASSIFIED

FOR GRAPHIC REPRODUCTIONS ON BONE, IVORY, PLASTER, PLASTIC, WAX, WOOD (U.S. CLS. 2, 13, 22, 25, 32 AND 50).

CLASS 21—HOUSEWARES AND GLASS

FOR GRAPHIC REPRODUCTIONS ON CHINA, CRYSTAL, EARTHENWARE, GLASS, PORCELAIN, TERRA COTTA (U.S. CLS. 2, 13, 23, 29, 30, 33, 40 AND 50).
KIM SAITO, EXAMINING ATTORNEY

SN 78-218,904. PHILD CO., LTD., KYOTO CITY, KYOTO PREF., JAPAN, FILED 2-25-2003.



OWNER OF JAPAN REG. NO. 4359202, DATED 2-4-2000, EXPIRES 2-4-2010.

OWNER OF JAPAN REG. NO. 4356930, DATED 1-28-2000, EXPIRES 1-28-2010.

OWNER OF JAPAN REG. NO. 4402755, DATED 7-21-2000, EXPIRES 7-21-2010.

OWNER OF JAPAN REG. NO. 4402757, DATED 7-21-2000, EXPIRES 7-21-2010.

OWNER OF JAPAN REG. NO. 4402756, DATED 7-21-2000, EXPIRES 7-21-2010.

OWNER OF U.S. REG. NOS. 2,582,900 AND 2,610,185.

CLASS 3—COSMETICS AND CLEANING PREPARATIONS

FOR SOAPS; PERFUMERY, COSMETICS, HAIR LOTIONS; DENTIFRICES (U.S. CLS. 1, 4, 6, 50, 51 AND 52).

CLASS 24—FABRICS

FOR TEXTILES AND TEXTILE GOODS, NAMELY, TEXTILE PLACEMATS AND TEXTILE WALL HANGINGS (U.S. CLS. 42 AND 50).

CLASS 26—FANCY GOODS

FOR HAIR ORNAMENTS (U.S. CLS. 37, 39, 40, 42 AND 50).

CLASS 28—TOYS AND SPORTING GOODS

FOR GYMNASIUM AND SPORTING ARTICLES, NAMELY, GYMNASIUM EXERCISE MATS, VAULTING HORSES AND PARALLEL BARS (U.S. CLS. 22, 23, 38 AND 50).

CLASS 29—MEATS AND PROCESSED FOODS

FOR EGGS; MILK; MILK PRODUCTS, EXCLUDING, ICE CREAM, ICE MILK AND FROZEN YOGURT; EDIBLE OILS AND FATS; NON-ALCOHOLIC DRINKS, NAMELY, WHEY-FLAVORED BEVERAGES (U.S. CL. 46).

CLASS 30—STAPLE FOODS

FOR COFFEE, TEA, COCOA, SUGAR, RICE, BREAD, PASTRY, HONEY, YEAST, SALT, VINEGAR (U.S. CL. 46).

CLASS 32—LIGHT BEVERAGES

FOR BEER; MINERAL AND AERATED WATERS AND OTHER NON-ALCOHOLIC DRINKS, NAMELY, SOFT DRINKS; FRUIT DRINKS AND FRUIT JUICES (U.S. CLS. 45, 46 AND 48).

GLENN CLARK, EXAMINING ATTORNEY

SN 78-221,214. HONEYWELL INTERNATIONAL INC., MORRISTOWN, NJ. FILED 3-4-2003.

HOMETOWN SOLUTIONS

CLASS 36—INSURANCE AND FINANCIAL

FOR CHARITABLE AND PHILANTHROPIC SERVICES, NAMELY, PROVIDING EDUCATIONAL SCHOLARSHIPS (U.S. CLS. 100, 101 AND 102).

CLASS 37—CONSTRUCTION AND REPAIR

FOR CHARITABLE AND PHILANTHROPIC SERVICES, NAMELY, RENOVATING HOMES FOR LOW INCOME FAMILIES (U.S. CLS. 100, 103 AND 106).

CLASS 41—EDUCATION AND ENTERTAINMENT

FOR CHARITABLE AND PHILANTHROPIC SERVICES, NAMELY, PROVIDING ACADEMIC MENTORING OF SCHOOL AGE CHILDREN, PROVIDING TRAINING INFORMATION IN THE FIELD OF CHILD SAFETY, AND PROVIDING EDUCATIONAL SERVICES IN THE NATURE OF WORKSHOPS IN THE FIELDS OF SCIENCE AND MATHEMATICS (U.S. CLS. 100, 101 AND 107).

CLASS 42—SCIENTIFIC, COMPUTER AND LEGAL SERVICES

FOR CHARITABLE AND PHILANTHROPIC SERVICES, NAMELY PROVIDING COMPUTER EQUIPMENT TO SCHOOLS, REHABILITATION CENTERS AND TRAINING CENTERS (U.S. CLS. 100 AND 101).

CLASS 44—MEDICAL, BEAUTY AND AGRICULTURAL SERVICES

FOR CHARITABLE AND PHILANTHROPIC SERVICES, NAMELY, ORGANIZING MEDICAL CAMPS AND MEDICAL PERSONNEL TO PROVIDE MEDICAL SERVICES IN UNDERDEVELOPED COUNTRIES (U.S. CLS. 100 AND 101).

CLASS 45—PERSONAL SERVICES

FOR CHARITABLE AND PHILANTHROPIC SERVICES, NAMELY, PROVIDING CLOTHING TO NEEDY PERSONS (U.S. CLS. 100 AND 101).

LINDA E. BLOHM, EXAMINING ATTORNEY

SN 78-225,427. JENKINS, MARK, NEW YORK, NY. FILED 3-13-2003.

MARK JENKINS INTERNATIONAL FITNESS

NO CLAIM IS MADE TO THE EXCLUSIVE RIGHT TO USE "INTERNATIONAL FITNESS", APART FROM THE MARK AS SHOWN.

CLASS 9—ELECTRICAL AND SCIENTIFIC APPARATUS

FOR HELMETS FOR LIFE-SAVING APPARATUS, DIVING GLOVES, SWIM MASKS, SWIM GOGGLES, AND PRE-RECORDED VIDEO TAPES FEATURING FITNESS INSTRUCTION (U.S. CLS. 21, 23, 26, 36 AND 38).

CLASS 28—TOYS AND SPORTING GOODS

FOR WEIGHT LIFTING EQUIPMENT, NAMELY, WEIGHT LIFTING MACHINES, BELTS AND BENCHES; BARBELLS; EXERCISE, FITNESS AND GYMNASTIC EQUIPMENT, NAMELY, HOOPS; VOLLEY GAME PLAYING EQUIPMENT, NAMELY, NETS AND BALLS; RECREATIONAL LAWN GAMES, NAMELY, TENNIS; BADMINTON GAME PLAYING EQUIPMENT, NAMELY, BATS AND BALLS (U.S. CLS. 22, 23, 38 AND 50).

CLASS 41—EDUCATION AND ENTERTAINMENT

FOR EDUCATION, NAMELY, PROVIDING FITNESS TRAINING (U.S. CLS. 100, 101 AND 107).

JANICE L. MCMORROW, EXAMINING ATTORNEY

SN 78-227,016. ADMINISTRATORS OF THE TULANE EDUCATIONAL FUND, THE, NEW ORLEANS, LA. FILED 3-18-2003.

TULANE

OWNER OF U.S. REG. NOS. 1,915,719, 2,737,647 AND 2,743,096.

CLASS 6—METAL GOODS

FOR GIFT AND NOVELTIES MADE OF NON-PRECIOUS METAL, NAMELY, BOXES, KEY CHAINS AND RINGS, LICENSE PLATES, AND REPRESENTATIONAL SCULPTURES OF THE MARK (U.S. CLS. 2, 12, 13, 14, 23, 25 AND 50).

CLASS 12—VEHICLES

FOR GIFTS AND NOVELTIES MADE OF NON-PRECIOUS METAL, NAMELY, LICENSE PLATE FRAMES (U.S. CLS. 19, 21, 23, 31, 35 AND 44).

CLASS 20—FURNITURE AND ARTICLES NOT OTHERWISE CLASSIFIED

FOR GIFTS AND NOVELTIES MADE OF NON-PRECIOUS METAL, NAMELY, PICTURE FRAMES (U.S. CLS. 2, 13, 22, 25, 32 AND 50).

CLASS 21—HOUSEWARES AND GLASS

FOR GIFTS AND NOVELTIES MADE OF NON-PRECIOUS METAL, NAMELY, DRINKING STEINS (U.S. CLS. 2, 13, 23, 29, 30, 33, 40 AND 50).

MICHAEL TANNER, EXAMINING ATTORNEY

SN 78-227,105. THE ADMINISTRATORS OF THE TULANE EDUCATIONAL FUND, NEW ORLEANS, LA. FILED 3-18-2003.



OWNER OF U.S. REG. NOS. 1,915,719, 2,727,647 AND 2,743,096.

NO CLAIM IS MADE TO THE EXCLUSIVE RIGHT TO USE UNIVERSITY, APART FROM THE MARK AS SHOWN. THE MARK CONSISTS OF A SHIELD BEARING AN OVERLAPPING "T" AND "U".

CLASS 6—METAL GOODS

FOR GIFTS AND NOVELTIES MADE OF NON-PRECIOUS METAL, NAMELY, BOXES, KEY CHAINS AND RINGS, LICENSE PLATES, AND REPRESENTATIONAL SCULPTURES OF THE MARK (U.S. CLS. 2, 12, 13, 14, 23, 25 AND 50).

CLASS 12—VEHICLES

FOR GIFTS AND NOVELTIES MADE OF NON-PRECIOUS METAL, NAMELY, LICENSE PLATE FRAMES (U.S. CLS. 19, 21, 23, 31, 35 AND 44).

CLASS 20—FURNITURE AND ARTICLES NOT OTHERWISE CLASSIFIED

FOR GIFTS AND NOVELTIES MADE OF NON-PRECIOUS METAL, NAMELY PICTURE FRAMES (U.S. CLS. 2, 13, 22, 25, 32 AND 50).

CLASS 21—HOUSEWARES AND GLASS

FOR GIFTS AND NOVELTIES MADE OF NON-PRECIOUS METAL, NAMELY, DRINKING STEINS (U.S. CLS. 2, 13, 23, 29, 30, 33, 40 AND 50).

MICHAEL TANNER, EXAMINING ATTORNEY

SN 78-227,332. THE ADMINISTRATORS OF THE TULANE EDUCATIONAL FUND, NEW ORLEANS, LA. FILED 3-19-2003.

TULANE

OWNER OF U.S. REG. NOS. 1,915,719, 2,737,647 AND 2,743,096.

CLASS 16—PAPER GOODS AND PRINTED MATTER

FOR DESK TOP AND PERSONAL ORGANIZERS AND CHECKBOOK COVERS (U.S. CLS. 2, 5, 22, 23, 29, 37, 38 AND 50).

CLASS 18—LEATHER GOODS

FOR ATHLETIC BAGS, BACKPACKS, DUFFEL BAGS, TOTE BAGS, WALLETS, BILLFOLDS, COIN PURSE, LUGGAGE TAGS, AND ANIMAL COLLARS AND LEASHES (U.S. CLS. 1, 2, 3, 22 AND 41).

CLASS 22—CORDAGE AND FIBERS

FOR LANYARDS FOR HOLDING IDENTIFICATION, BADGES AND KEYS (U.S. CLS. 1, 2, 7, 19, 22, 42 AND 50).

MICHAEL TANNER, EXAMINING ATTORNEY

SN 78-227,481. THE ADMINISTRATORS OF THE TULANE EDUCATIONAL FUND, NEW ORLEANS, LA. FILED 3-19-2003.



OWNER OF U.S. REG. NOS. 1,915,719, 2,737,647 AND 2,743,096.

NO CLAIM IS MADE TO THE EXCLUSIVE RIGHT TO USE "UNIVERSITY", APART FROM THE MARK AS SHOWN.

THE MARK CONSISTS OF A SHIELD BEARING AND OVERLAPPING "T" AND "U" ADJACENT TO THE STYLIZED WORDS "TULANE" AND "UNIVERSITY".

CLASS 16—PAPER GOODS AND PRINTED MATTER

FOR DESK TOP AND PERSONAL ORGANIZERS AND CHECKBOOK COVERS (U.S. CLS. 2, 5, 22, 23, 29, 37, 38 AND 50).

CLASS 18—LEATHER GOODS

FOR ATHLETIC BAGS, BACKPACKS, DUFFEL BAGS, TOTE BAGS, WALLETS, BILLFOLDS, COIN PURSE, LUGGAGE TAGS, AND ANIMAL COLLARS AND LEASHES (U.S. CLS. 1, 2, 3, 22 AND 41).

CLASS 22—CORDAGE AND FIBERS

FOR LANYARDS FOR HOLDING IDENTIFICATION, BADGES, AND KEYS (U.S. CLS. 1, 2, 7, 19, 22, 42 AND 50).

MICHAEL TANNER, EXAMINING ATTORNEY

SN 78-229,532. EMERSON ELECTRIC CO., ST. LOUIS, MO. FILED 3-25-2003.

BUILD IT WITH COPPER

CLASS 6—METAL GOODS

FOR METAL CRIMP RINGS FOR USE IN JOINING COPPER PIPE. (U.S. CLS. 2, 12, 13, 14, 23, 25 AND 50).

CLASS 8—HAND TOOLS

FOR HAND TOOLS, NAMELY, HANDHELD CRIMPING TOOLS AND CRIMPING JAWS, PIPE AND TUBE CUTTERS, AND PARTS FOR ALL THE AFORESAID GOODS (U.S. CLS. 23, 28 AND 44).

STEVEN R. FOSTER, EXAMINING ATTORNEY

SN 78-236,994. MCI COMMUNICATIONS CORPORATION, WASHINGTON, DC. FILED 4-11-2003.



OWNER OF U.S. REG. NOS. 1,261,955, 2,104,145 AND OTHERS.

CLASS 9—ELECTRICAL AND SCIENTIFIC APPARATUS

FOR PRE-PAID, MAGNETICALLY ENCODED, TELEPHONE CALLING CARDS; MAGNETICALLY ENCODED CARDS USED TO ACCESS TELECOMMUNICATIONS SERVICES; COMPUTER SOFTWARE IN THE FIELDS OF TELECOMMUNICATIONS, DATA NETWORKING, COMPUTER TELEPHONY, E-COMMERCE, AND COMPUTER AND NETWORK SECURITY (U.S. CLS. 21, 23, 26, 36 AND 38).

CLASS 16—PAPER GOODS AND PRINTED MATTER

FOR NON-MAGNETICALLY ENCODED CARDS USED TO ACCESS TELECOMMUNICATIONS SERVICES; PRINTED MATERIALS, NAMELY, NEWSLETTERS, MAGAZINES AND NEWSPAPERS ALL ON THE SUBJECT OF TELECOMMUNICATIONS RELATED GOODS AND SERVICES (U.S. CLS. 2, 5, 22, 23, 29, 37, 38 AND 50).

CLASS 36—INSURANCE AND FINANCIAL

FOR TELEPHONE CALLING CARD SERVICES; TELECOMMUNICATIONS PREPAY AND POSTPAY CALLING CARD SERVICES OFFERED THROUGH NON-MAGNETICALLY ENCODED CARDS AND THROUGH MAGNETICALLY ENCODED PRE-PAID CARDS WITH STORED VALUE (U.S. CLS. 100, 101 AND 102).

CLASS 37—CONSTRUCTION AND REPAIR

FOR INSTALLATION, MAINTENANCE AND REPAIR OF COMPUTER HARDWARE, COMPUTER DATA NETWORKING HARDWARE AND TELECOMMUNICATIONS HARDWARE (U.S. CLS. 100, 103 AND 106).

CLASS 38—COMMUNICATION

FOR TELECOMMUNICATIONS SERVICES, NAMELY, THE ELECTRONIC TRANSMISSION OF VOICE, DATA AND INFORMATION; PROVIDING MULTI-USER ACCESS TO THE INTERNET, AND VIDEO AND AUDIO TELECONFERENCING VIA THE INTERNET, ASYNCHRONOUS TRANSFER MODE SERVICES, INTEGRATED SERVICE DIGITAL NETWORK SERVICES, INTERNET PROTOCOL COMMUNICATIONS SERVICES, VIRTUAL PRIVATE NETWORK SERVICES, AND PRIVATE LINE SERVICES; PROVIDING TELECOMMUNICATIONS GATEWAY SERVICES AND FRAME RELAY CONNECTIVITY SERVICES FOR DATA TRANSFER, PERSONAL COMMUNICATIONS SERVICES, ELECTRONIC DATA TRANSMISSION PACKET SERVICES; COMPUTER AIDED TRANSMISSION OF VOICE, DATA AND INFORMATION; SWITCHED VOICE, DATA, VIDEO AND MULTIMEDIA SERVICES; VOICE, VIDEO, DATA AND FACSIMILE TELEPHONY SERVICES; PROVIDING MULTI-USER TELECOMMUNICATIONS CONNECTIONS TO THE INTERNET; PROVIDING MULTIPLE-USER TELECOMMUNICATIONS CONNECTIONS TO COMPUTERIZED COMMUNICATIONS, DATA, AND WIRELESS NETWORKS; PROVIDING MULTI-USER ACCESS TO A WIRELESS COMMUNICATIONS NETWORK; PROVIDING MULTIPLE-USER ACCESS TO THE INTERNET AND OTHER COMPUTERIZED COMMUNICATIONS, DATA AND WIRELESS NETWORKS; PROVIDING ELECTRONIC MAIL SERVICES, FACSIMILE SERVICES AND TRANSMISSION AND STORAGE SERVICES FOR THE ELECTRONIC DATA OF OTHERS; TELECOMMUNICATIONS SERVICES, NAMELY, PROVIDING A GATEWAY FOR CONNECTING BETWEEN INDEPENDENT TELECOMMUNICATION AND COMPUTER NETWORKS FOR SHARING OF INTERNET TRAFFIC, VOICE MAIL SERVICES, TELEPHONE COMMUNICATION SERVICES; TELECOMMUNICATION SERVICES, NAMELY, PROVIDING TOLL FREE SERVICES AND CALL ROUTING SERVICES, MESSAGING CENTER SERVICES IN THE NATURE OF TELEPHONE VOICE MESSAGING SERVICES; VIDEO, AUDIO, AND DATA TELEPHONE CONFERENCE SERVICES, WIRELESS TELECOMMUNICATIONS SERVICES, NAMELY THE WIRELESS TRANSMISSION OF VOICE AND DATA; PROVIDING INFORMATION IN THE FIELDS OF TELECOMMUNICATIONS AND DATA TRANSMISSION FOR BUSINESSES; TELECOMMUNICATIONS CONSULTATION; TELECOMMUNICATION SERVICES, NAMELY, PROVIDING VOICE-OVER INTERNET PROTOCOL SERVICES (U.S. CLS. 100, 101 AND 104).

CLASS 42—SCIENTIFIC, COMPUTER AND LEGAL SERVICES

FOR PROVIDING DATA CENTER SERVICES, NAMELY, NETWORK MONITORING, COLOCATION SERVICES, NAMELY, THE PROVISION OF A SECURE ENVIRONMENTALLY-CONTROLLED FACILITY AND TECHNICAL MONITORING FOR THE TELECOMMUNICATIONS EQUIPMENT OF OTHERS; HOSTING OF DIGITAL CONTENT ON THE INTERNET; HOSTING THE WEB SITES OF OTHERS ON A COMPUTER SERVER FOR A GLOBAL COMPUTER NETWORK, DATA ENCRYPTION SERVICES; APPLICATION SERVICE PROVIDER, NAMELY, HOSTING COMPUTER SOFTWARE APPLICATIONS OF OTHERS; PROVIDING TEMPORARY USE OF NON-DOWNLOADABLE NETWORK AUDITING SOFTWARE IN THE FIELDS OF SECURE COMMUNICATIONS AND DATA NETWORKS;

COMPUTERIZED COMMUNICATION NETWORK DESIGN AND COMPUTER PROGRAMMING SERVICES IN THE FIELD OF TELECOMMUNICATIONS; DESIGN AND MAINTENANCE OF COMPUTERIZED COMMUNICATIONS AND DATA NETWORK SOFTWARE; DESIGN OF DATA NETWORKS FOR OTHERS; PROVIDING INFORMATION IN THE FIELDS OF COMPUTERIZED COMMUNICATION NETWORK SERVICES AND DATA CENTER SERVICES; CONSULTATION IN THE FIELDS OF COMPUTERIZED COMMUNICATION NETWORKS, AND DATA CENTER MANAGEMENT SERVICES (U.S. CLS. 100 AND 101).

CLASS 45—PERSONAL SERVICES

FOR COMPUTERIZED COMMUNICATION NETWORK SECURITY SERVICES; PROVIDING INFORMATION IN THE FIELDS OF INTERNET AND NETWORK SECURITY AND THE SECURE TRANSMISSION OF DATA AND INFORMATION; CONSULTING SERVICES IN THE FIELDS OF INTERNET AND NETWORK SECURITY SERVICES, INFORMATION SECURITY SERVICES, SECURE DATA AND INFORMATION TRANSMISSION SERVICES AND DATA ENCRYPTION AND DECRYPTION SERVICES; TELECOMMUNICATION SYSTEM DISASTER EMERGENCY RESPONSE AND RECOVERY SERVICES; AND CONSULTING SERVICES IN THE FIELD OF TELECOMMUNICATION SYSTEM DISASTER EMERGENCY RESPONSE AND RECOVERY; PROVIDING USER AUTHENTICATION SERVICES TO OTHERS IN THE FIELD OF VOICE AND DATA COMMUNICATION NETWORK SERVICES; MONITORING DATA NETWORKS FOR SECURITY PURPOSES, INCLUDING THE PROVISION OF FIREWALLS; CONSULTATION IN THE FIELD OF COMPUTERIZED COMMUNICATION NETWORK SECURITY (U.S. CLS. 100 AND 101).

FLORENTINA BLANDU, EXAMINING ATTORNEY

SN 78-237,442, CONVERSE TRADING LTD., LONDON, UNITED KINGDOM, FILED 4-14-2003.

TRUCCO**CLASS 25—CLOTHING**

FOR CLOTHING, NAMELY, EVENING DRESSES, JACKETS, SUITS, SKIRTS, SHIRTS, INCLUDING FORMAL SHIRTS, SPORT SHIRTS, POLO SHIRTS, TROUSERS, SMOCKS, FORMAL WEAR, COATS, OVERCOATS, TOPCOATS, MANTLES, RAINCOATS, SWEATERS, CARDIGANS, VESTS, WAISTCOATS, PANTS, CUFFS, COLLARS FOR CLOTHING, BLOUSES, NIGHTWEAR; FOOTWEAR; HEADGEAR, NAMELY, HATS AND CAPS (U.S. CLS. 22 AND 39).

CLASS 35—ADVERTISING AND BUSINESS

FOR RETAIL SERVICES OFFERED THROUGH RETAIL STORES AND OVER THE INTERNET FEATURING CLOTHING, FOOTWEAR AND HEADGEAR; BUSINESS MANAGEMENT SERVICES FOR COMMERCIAL AND INDUSTRIAL BUSINESS OPERATIONS; BUSINESS MANAGEMENT CONSULTATION; IMPORT AND EXPORT AGENCIES; FRANCHISING, NAMELY, OFFERING TECHNICAL ASSISTANCE IN THE ESTABLISHMENT AND OPERATION OF RETAIL CLOTHING, FOOTWEAR AND HEADGEAR STORES; ORGANIZING AND CONDUCTING TRADE SHOWS IN THE FIELD OF CLOTHING, FOOTWEAR AND HEADGEAR (U.S. CLS. 100, 101 AND 102).

VERNA BETH RIRIE, EXAMINING ATTORNEY

SN 78-238,943. NACIONALES, ELIJAH D., SAN PEDRO, CA.
FILED 4-17-2003.

THE GRID: DATA LOCATOR

CLASS 9—ELECTRICAL AND SCIENTIFIC APPARATUS

FOR EDUCATIONAL SOFTWARE FOR INSTRUCTION IN THE FIELDS OF MATH, SCIENCE, HISTORY, SOCIAL STUDIES, LANGUAGE ARTS, AND MUSIC (U.S. CLS. 21, 23, 26, 36 AND 38).

CLASS 16—PAPER GOODS AND PRINTED MATTER

FOR PRINTED INSTRUCTIONAL, EDUCATIONAL, AND TEACHING MATERIALS NAMELY POSTERS, ACTIVITY BOOKS, TEXTBOOKS, CHARTS, GRAPHS, TESTS, LESSON PLANS, FLASH CARDS, TEACHING MANUALS IN IN THE FIELDS OF MATH, SCIENCE, HISTORY, SOCIAL STUDIES, LANGUAGE ARTS, AND MUSIC (U.S. CLS. 2, 5, 22, 23, 29, 37, 38 AND 50).
PAM WILLIS, EXAMINING ATTORNEY

SN 78-239,583. GRUBB, LISA, SPARKILL, NY. FILED 4-18-2003.

HAPPY DOG

THE MARK CONSISTS OF STANDARD CHARACTERS WITHOUT CLAIM TO ANY PARTICULAR FONT, STYLE, SIZE, OR COLOR.

CLASS 16—PAPER GOODS AND PRINTED MATTER

FOR (BASED ON USE IN COMMERCE) BOOKS, NAMELY CHILDREN'S BOOKS; WRITING PAPER AND ENVELOPES, PAINT BRUSHES, PRINTED INSTRUCTIONAL TEACHING MATERIALS AND TEACHING MATERIALS, NAMELY CRAYONS, PENS, PENCILS, MARKS, ERASERS, PAPER LUNCHBAGS, CALENDARS, DRAWING PAPER, TABLES, MEMO PADS, GREETING CARDS, POSTERS, PAPER PORTFOLIOS, PAPER BANNERS, PEN HOLDERS, CHECKBOOKS AND CHECKBOOK COVERS, PAPER AND PLASTIC MERCHANDISE PACKAGING BAGS, ADDRESS BOOKS, DIARIES, BOOK MARKS, LITHOGRAPHS, ART ETCHINGS, ART MOUNTS, ART PADS, ART PAPER ART PICTURES, ART PRINTS, COLORED CRAFT AND ART SAND, GRAPHIC ART REPRODUCTIONS, PHOTOGRAPHIC OR ART MOUNTS, PRINTED ART REPRODUCTIONS, NOTEBOOKS, STICKERS, POSTERS, CALENDARS, PAINTINGS, STATIONERY (U.S. CLS. 2, 5, 22, 23, 29, 37, 38 AND 50).
FIRST USE 12-0-1998; IN COMMERCE 12-0-1998.

CLASS 25—CLOTHING

FOR (BASED ON INTENT TO USE) APPAREL, OUTERWEAR, BEACHWEAR, NAMELY SHIRTS; CLOTHING ACCESSORIES, NAMELY BELTS, TIES, SCARVES (U.S. CLS. 22 AND 39).

CLASS 28—TOYS AND SPORTING GOODS

FOR (BASED ON USE IN COMMERCE) PUZZLES, GAMES AND TOYS, NAMELY MANIPULATIVE GAMES, BOARD GAMES, TOY CARS, TOY TRAINS, DOLLS AND PLAYING CARDS (U.S. CLS. 22, 23, 38 AND 50).

FIRST USE 12-0-1998; IN COMMERCE 12-0-1998.

CLASS 41—EDUCATION AND ENTERTAINMENT

FOR (BASED ON INTENT TO USE) ENTERTAINMENT SERVICES IN THE NATURE OF ON-GOING ANIMATED TELEVISION PROGRAMS IN THE FIELD OF NEWS, COMEDY, VARIETY, ARTS AND CHILDREN'S PROGRAMMING (U.S. CLS. 100, 101 AND 107).
GEOFFREY FOSDICK, EXAMINING ATTORNEY

SN 78-239,954. DYNAL BIOTECH ASA, OSLO, NORWAY,
FILED 4-21-2003.

DYNASCREEN

PRIORITY CLAIMED UNDER SEC. 44(D) ON ERPNCMNTY TM OFC APPLICATION NO. 003047743, FILED 2-6-2003, REG. NO. 003047743, DATED 3-9-2004, EXPIRES 2-6-2013.

CLASS 1—CHEMICALS

FOR ANTIBODY SCREENING KITS CONSISTING OF STRIPS CONTAINING MULTIPLE RECOMBINANT DNA MOLECULES FOR USE IN LABORATORY ANALYSIS OF GENETIC STRUCTURES IN HUMANS FOR GENETICS, BIOCHEMISTRY, MOLECULAR BIOLOGY AND OTHER BIOSCIENCES; CHEMICAL AND BIOCHEMICAL REAGENTS, ANTIGENS ANTIGENS AND ANTIBODIES FOR USE IN LABORATORY ANALYSIS FOR GENETICS, BIOCHEMISTRY, MOLECULAR BIOLOGY AND OTHER BIOSCIENCES; CHEMICAL AND BIOCHEMICAL REAGENTS, ANTIGENS AND ANTIBODIES FOR USE IN BIOCHEMICAL ASSAY (U.S. CLS. 1, 5, 6, 10, 26 AND 46).

CLASS 5—PHARMACEUTICALS

FOR DIAGNOSTIC KITS CONSISTING OF STRIPS CONTAINING MULTIPLE RECOMBINANT DNA MOLECULES FOR USE IN LABORATORY ANALYSIS OF GENETIC STRUCTURES IN HUMANS FOR MEDICINE AND IMMUNOLOGY; CHEMICAL AND BIOCHEMICAL REAGENTS, ANTIGENS AND ANTIBODIES FOR USE IN LABORATORY ANALYSIS FOR MEDICAL AND IMMUNOLOGICAL USE (U.S. CLS. 6, 18, 44, 46, 51 AND 52).

DOMINICK J. SALEMI, EXAMINING ATTORNEY

SN 78-240,316. LISA FRANK, INC., TUCSON, AZ. FILED 4-21-2003.

KNOCKOFFS

CLASS 3—COSMETICS AND CLEANING PREPARATIONS

FOR COSMETIC ITEMS, NAMELY NAIL POLISH, NAIL CARE PREPARATIONS, LIP GLOSS, BODY GLITTER, LIPSTICK, FALSE FINGERNAILS, NAIL DECALS, NAIL GLITTER, NAIL ADHESIVES, EMERY BOARDS, MAKE-UP SETS CONSISTING OF LIPSTICKS, EYE SHADOW, LIP GLOSS, NAIL POLISH, BODY LOTION, HAIR CARE PREPARATIONS, HAIR STYLING PREPARATIONS, SHAMPOO, HAIR CONDITIONER, AND PERFUME (U.S. CLS. 1, 4, 6, 50, 51 AND 52).

CLASS 14—JEWELRY

FOR JEWELRY AND WATCHES (U.S. CLS. 2, 27, 28 AND 50).

CLASS 16—PAPER GOODS AND PRINTED MATTER

FOR PRINTED ITEMS, NAMELY, STATIONERY-TYPE PORTFOLIOS, NOTEBOOKS, FOLDERS, BINDERS, WRITING TABLETS, MEMO PADS, STATIONERY, STICKERS, STICKER BOOKS, ORGANIZERS FOR STATIONERY AND PERSONAL ORGANIZERS, CHILDREN'S ARTS AND CRAFTS KITS, CONSISTING OF GLITTER, SEQUINS, AND BUTTONS FOR DECORATING STATIONERY, JOURNALS, NAMELY PERSONAL JOURNALS, DIARIES, PAPER POSTCARDS TO COLOR, PAPER BOXES TO PAINT OR COLOR, PAPER POSTERS TO PAINT OR COLOR, PENCILS, PENS, ERASERS, PENCIL SHARPENERS, PAPER CLIPS, DIARIES, WORD OR MAZE PUZZLES ON PAPER, RUBBER STAMPS AND PADS, COLORING BOOKS, COLOR MARKERS, CHALK, STENCILS, PUZZLER ACTIVITY PADS, TRADING CARDS, ARTS AND CRAFTS PAINTING AND DRAWING KITS FOR CHILDREN, ACTIVITY SETS FOR CHILDREN CONSISTING OF TWO OR MORE OF PAPER POSTERS TO PAINT OR COLOR, PENCILS, PENS, ERASERS, PENCIL SHARPENERS, PAPER CLIPS, DIARIES, WORD OR MAZE PUZZLES ON PAPER, RUBBER STAMPS AND PADS, COLORING BOOKS, COLOR MARKERS, CHALK, STENCILS, PUZZLER ACTIVITY PADS, TRADING CARDS, SCRAPBOOKS, PAPER PARTY GOODS, NAMELY, HATS, PRINTED INVITATIONS, NAPKINS, TABLECLOTHS, PAPER PARTY DECORATIONS, PAPER GIFT WRAP, TEMPORARY BODY STICKERS, TEMPORARY TATTOOS, LUNCH BAGS (U.S. CLS. 2, 5, 22, 23, 29, 37, 38 AND 50).

CLASS 18—LEATHER GOODS

FOR BAGS, NAMELY BACKPACKS, HANDBAGS, PURSES, COIN PURSES, TOTE BAGS, SCHOOL BAGS, SCHOOL BOOK BAGS, BOOK BAGS, ALL-PURPOSE SPORT BAGS, DUFFEL BAGS, OVERNIGHT BAGS, AND ROLLING LUGGAGE; NOTIONS BOXES, NAMELY COSMETIC CASES, TOILETRY CASES, OR VANITY CASES, ALL SOLD EMPTY, COSMETIC BAGS SOLD EMPTY (U.S. CLS. 1, 2, 3, 22 AND 41).

CLASS 20—FURNITURE AND ARTICLES NOT OTHERWISE CLASSIFIED

FOR FURNITURE AND ROOM DECOR ITEMS, NAMELY, PICTURE FRAMES, BEANBAG CHAIRS, SMALL DRESSERS, HANGING MIRRORS, DECORATIVE BEAD CURTAINS, SLEEPING BAGS AND PILLOWS THEREFOR, FOLDING CHAIRS, FOLD-OUT SLEEPING CHAIRS AND SOFAS, DECORATIVE PILLOWS, BATH PILLOWS, NON-METAL KEY CHAINS, NON-METAL CLOSET HOOKS, NON-METAL PLANT HOOKS, TOY BOXES, PLASTIC TUBS, CURTAIN RODS, AND DECORATIVE ROD-ENDS FOR CURTAINS; MIRRORS, NAMELY HANGING MIRRORS, HAND-HELD MIRRORS, PERSONAL COMPACT MIRRORS; NOTIONS BOXES, NAMELY, JEWELRY BOXES NOT OF METAL, AND LEATHER JEWELRY AND ACCESSORY BOXES; FOAM OR PLASTIC TOE SEPARATORS (U.S. CLS. 2, 13, 22, 25, 32 AND 50).

CLASS 25—CLOTHING

FOR CLOTHING, NAMELY SKIRTS, PANTS, T-SHIRTS, TOPS, JACKETS, DRESSES, SWEATSHIRTS, SWEATPANTS, BLOUSES, COATS, SCARVES, JEANS, HEADGEAR, NAMELY HATS, HEADBANDS, HEAD-SCARVES, EAR MUFFS, STOCKING CAPS, FEATHER BOAS; AND FOOTWEAR, NAMELY SHOES, BOOTS, TENNIS SHOES, BEACH SHOES, SANDALS, THONGS, SLIDES, AND MULES (U.S. CLS. 22 AND 39).

CLASS 26—FANCY GOODS

FOR HAIR ACCESSORIES, NAMELY PONY TAIL HOLDERS, BARRETTES, HAIR CLIPS, SCRUNCHIES, DECORATIVE HAIR COMBS, AND HAIR ORNAMENTS (U.S. CLS. 37, 39, 40, 42 AND 50).

CLASS 28—TOYS AND SPORTING GOODS

FOR TOYS, GAMES, AND PLAYTHINGS, NAMELY DOLLS, DOLL CLOTHING, DOLL ACCESSORIES; ACTIVITY KITS FOR CHILDREN MAKING DOLLS, STUFFED ANIMALS, CANDLES, NON-METAL AND NON-LEATHER KEY-CHAINS, AND/OR SAND ART; BOARD GAMES, JUMP ROPE, PLAYING CARDS, FLYING DISCS, AND ACTIVITY KITS FOR PLAYING DRESS-UP (U.S. CLS. 22, 23, 38 AND 50).

ESTHER BELENKER, EXAMINING ATTORNEY

SN 78-242,465. COLLEN IP CONSULTING, LLC, OSSINING, NY. FILED 4-26-2003.

THE NOMINATOR

CLASS 35—ADVERTISING AND BUSINESS

FOR BUSINESS CONSULTATION SERVICES, NAMELY, BRAND EVALUATION AND CREATING TRADEMARKS FOR OTHERS (U.S. CLS. 100, 101 AND 102).

CLASS 42—SCIENTIFIC, COMPUTER AND LEGAL SERVICES

FOR LEGAL SERVICES; LEGAL CONSULTING SERVICES; CONSULTING AND PROVIDING REPORTS IN THE FIELD OF INTELLECTUAL PROPERTY LAW; LEGAL RESEARCH SERVICES, NAMELY, TRADEMARK AND COMPANY NAME RESEARCH SERVICES (U.S. CLS. 100 AND 101).

BRIAN BROWN, EXAMINING ATTORNEY

SN 78-244,686. R/M MANAGEMENT CO., INC., SCOTTS-DALE, AZ. FILED 5-1-2003.



NO CLAIM IS MADE TO THE EXCLUSIVE RIGHT TO USE THE REPRESENTATION OF THE CADUCEUS AND THE STAR OF LIFE, APART FROM THE MARK AS SHOWN.

CLASS 39—TRANSPORTATION AND STORAGE

FOR PROVIDING AMBULANCE TRANSPORTATION SERVICES, PROVIDING MEDICAL TRANSPORTATION SERVICES (U.S. CLS. 100 AND 105).
FIRST USE 5-31-1999; IN COMMERCE 5-31-1999.

CLASS 44—MEDICAL, BEAUTY AND AGRICULTURAL SERVICES

FOR EMERGENCY MEDICAL SERVICES (U.S. CLS. 100 AND 101).
FIRST USE 12-31-1948; IN COMMERCE 12-31-1948.
SUSAN HAYASH, EXAMINING ATTORNEY

SN 78-244,700. SLAGEL, BRIAN, WESTLAKE VILLAGE, CA. FILED 5-2-2003.

METAL BLADE RECORDS

NO CLAIM IS MADE TO THE EXCLUSIVE RIGHT TO USE "RECORDS", APART FROM THE MARK AS SHOWN.

CLASS 9—ELECTRICAL AND SCIENTIFIC APPARATUS

FOR DOWNLOADABLE ELECTRONIC PUBLICATIONS IN THE NATURE OF BROCHURES, MAGAZINES, NEWSLETTERS AND BOOKS IN THE FIELD OF ENTERTAINMENT, MUSIC AND LIFESTYLE; PRE-RECORDED COMPACT DISCS, LASER DISCS, CD ROMS, DVDS, DVD ROMS, VIDEO TAPES, AUDIO AND VIDEO CASSETTES, AND OTHER PRE-RECORDED OPTICAL, ELECTRONIC, AND MAGNETIC MEDIA FEATURING MUSIC AND PERFORMANCES BY MUSICIANS; AUDIO AND VISUAL RECORDINGS IN ALL ELECTRONIC AND MAGNETIC FORMS FEATURING MUSIC AND MUSICAL PERFORMANCES, AND ENTERTAINMENT IN THE NATURE OF INTERVIEWS AND FILMS FEATURING MUSICAL ARTISTS; DOWNLOADABLE MUSIC RECORDINGS AND DOWNLOADABLE VIDEO RECORDINGS FEATURING MUSIC AND MUSICAL PERFORMANCES; EYEWEAR, NAMELY, EYEGASSES AND SUNGLASSES AND CASES AND PARTS THEREFOR; PRE-PAID TELEPHONE CALLING CARDS, MAGNETICALLY ENCODED; COMPUTER GAME MACHINES FOR USE WITH TELEVISIONS, COMPUTER GAME EQUIPMENT CONTAINING MEMORY DEVICES, NAMELY DISCS (U.S. CLS. 21, 23, 26, 36 AND 38).

CLASS 41—EDUCATION AND ENTERTAINMENT

FOR ENTERTAINMENT SERVICES; PRESENTATION OF LIVE AND ON-LINE SHOW PERFORMANCES; PRESENTATION OF MUSICAL PERFORMANCES; PLANNING, ARRANGEMENT OF SHOWS FEATURING MUSICAL PERFORMANCES; MUSIC OR EDUCATIONAL TRAINING; PROVIDING NON-DOWNLOADABLE ELECTRONIC PUBLICATIONS IN THE NATURE OF INTERACTIVE WEB SITES, NEWSLETTERS, MAGAZINES IN THE FIELD OF MUSIC AND MUSICAL ENTERTAINMENT; SONG-WRITING, MUSIC COMPOSITION AND TRANSCRIPTION FOR OTHERS; AUDIO AND VIDEO RECORDING SERVICES, MUSIC PRODUCTION AND RECORD PRODUCTION; MOTION PICTURE SONG PRODUCTION (U.S. CLS. 100, 101 AND 107).
CATHERINE FAINT, EXAMINING ATTORNEY

SN 78-245,129. MORE CHI PRODUCTIONS, INC., NEW YORK, NY. FILED 5-2-2003.

TRAIN HARDER!

CLASS 25—CLOTHING

FOR CLOTHING ITEMS, NAMELY, VESTS, UNIFORMS, ROBES AND PANTS, JACKETS, SWEATERS, SWEAT SUITS, SHORTS, RUNNING PANTS, RUNNING SHORTS, RUNNING JACKETS, T-SHIRTS, SWEAT-SHIRTS, LONG SLEEVE SHIRTS, AND SHIRTS, TANK TOPS; AND HEADWEAR (U.S. CLS. 22 AND 39).

CLASS 41—EDUCATION AND ENTERTAINMENT

FOR CONSULTING SERVICES IN THE FIELD OF FILM PRODUCTION FOR MARTIAL ARTS MOTION PICTURES; ENTERTAINMENT SERVICES, NAMELY, PRODUCTION, SCREENWRITING, AND DISTRIBUTION OF MOTION PICTURES AND MOTION PICTURE FILMS FEATURING LIVE ACTION ENTERTAINMENT; PROVIDING A WEBSITE ON A GLOBAL COMPUTER NETWORK FEATURING ENTERTAINMENT INFORMATION ON MOTION PICTURE PRODUCTION AND DISTRIBUTION COMPANY AND MOTION PICTURES (U.S. CLS. 100, 101 AND 107).
SUELLEN HICKEY, EXAMINING ATTORNEY

SN 78-245,754. WETHEPEOPLE BIKE COMPANY GMBH, COLOGNE, FED REP GERMANY, FILED 5-5-2003.



NO CLAIM IS MADE TO THE EXCLUSIVE RIGHT TO USE BIKE COMPANY, APART FROM THE MARK AS SHOWN.

CLASS 9—ELECTRICAL AND SCIENTIFIC APPARATUS

FOR SAFETY GEAR FOR BIKERS, NAMELY BICYCLE HELMETS (U.S. CLS. 21, 23, 26, 36 AND 38). FIRST USE 0-0-1996; IN COMMERCE 6-0-1999.

CLASS 12—VEHICLES

FOR BICYCLES AND PARTS THEREOF, NAMELY BICYCLE FRAMES, FORKS, HANDLEBARS, RIMS FOR BICYCLE WHEELS, TIRES, HOSES FOR BICYCLE FRAMES, HUBS, SPOKES, PEDALS, CHAINS, SPROCKETS, BRAKES, SEATS, SADDLES, GRIPS; STRUCTURAL PARTS FOR BICYCLES, NAMELY VALVES, GEARS, BRAKE SHOES, RIM BANDS, AXLES, AXLE FIXATION NUTS, AXLE ADAPTERS, GEAR RIMS, BEARINGS, BALL-BEARINGS, WHEEL SPROCKETS, CHAIN GUARDS, STEMS, FOOTRESTS, PEGS, STEERING SETS, NAMELY HEAD SETS; BRAKE LINES, BRAKE LEVERS, SEAT POSTS, SEAT CLAMPS, SEAT STRUTS, AND SEAT BUTTS; BICYCLE FRAMES CONSISTING OF PLAQUES MADE OF METAL (U.S. CLS. 19, 21, 23, 31, 35 AND 44). FIRST USE 0-0-1996; IN COMMERCE 6-0-1999.

CLASS 25—CLOTHING

FOR CLOTHING, NAMELY BELTS, COATS, JACKETS, OVERALLS, PANTS, SOCKS, PULLOVERS, SHIRTS, SKIRTS, UNDERGARMENTS, STOCKINGS, SUITS, SWEAT ABSORBENT UNDERCLOTHES, SWEATERS, TIGHTS, TROUSERS, VESTS, WATERPROOF CLOTHING, NAMELY WATER PROOF JACKETS, WATER PROOF COATS AND WATERPROOF PANTS, GLOVES, HEADWEAR, FOOTWEAR, T-SHIRTS, SWEATSHIRTS, SHORTS, PANTS, CAPS, BICYCLING GLOVES (U.S. CLS. 22 AND 39). FIRST USE 0-0-1996; IN COMMERCE 6-0-1999.

CLASS 28—TOYS AND SPORTING GOODS

FOR ATHLETIC GEAR, NAMELY KNEEPADS, SHIN PADS, ELBOW PADS, AND BREASTPLATES IN THE NATURE OF CHEST PROTECTORS, ALL FOR USE IN BICYCLING; SCALE MODEL BICYCLES AND RELATED PARTS AND ACCESSORIES THEREOF SOLD AS A UNIT (U.S. CLS. 22, 23, 38 AND 50). FIRST USE 0-0-1996; IN COMMERCE 6-0-1999. SONYA STEPHENS, EXAMINING ATTORNEY

SN 78-246,276. SUÑÉ PAGÉS, JOSÉ ORIOL, BARCELONA, SPAIN, FILED 5-6-2003.



NO CLAIM IS MADE TO THE EXCLUSIVE RIGHT TO USE "MUSIC", APART FROM THE MARK AS SHOWN.

THE STIPPLING SHOWN IN THE DRAWING IS FOR SHADING PURPOSES ONLY AND IS NOT USED TO INDICATE COLOR.

CLASS 9—ELECTRICAL AND SCIENTIFIC APPARATUS

FOR (BASED ON USE IN COMMERCE) SOUND RECORDINGS, NAMELY, COMPACT DISCS AND DVDS FEATURING MUSIC; IMAGE RECORDINGS, NAMELY, DVDS FEATURING MUSICAL AND PICTURE VIDEOS; (BASED ON INTENT TO USE) SOUND RECORDINGS, NAMELY, PHONOGRAPH RECORDS, AUDIO CASSETTE TAPES, MAGNETIC TAPES, CD-ROMS AND INTERACTIVE MULTIMEDIA SOFTWARE FEATURING INSTRUMENTAL AND VOCAL MUSIC AS WELL AS SOUNDS; VIDEO RECORDINGS, PRE-RECORDED CD-ROMS AND INTERACTIVE MULTIMEDIA SOFTWARE FEATURING MUSICAL IMAGES, SOUNDS, MUSIC, DATA AND TEXT IN THE FIELD OF MUSIC (U.S. CLS. 21, 23, 26, 36 AND 38). FIRST USE 10-31-1997; IN COMMERCE 11-4-1998.

CLASS 41—EDUCATION AND ENTERTAINMENT

FOR (BASED ON USE IN COMMERCE) ENTERTAINMENT SERVICES IN THE NATURE OF PRODUCTION OF SOUND AND VIDEO RECORDINGS (U.S. CLS. 100, 101 AND 107). FIRST USE 10-31-1997; IN COMMERCE 11-4-1998. KAREN BRACEY, EXAMINING ATTORNEY

SN 78-250,362. NASSAU EQUIPMENT CO., INC., DBA NASSAU ASSET MANAGEMENT, ROSLYN HEIGHTS, NY. FILED 5-15-2003.

REPOPIPELINE

CLASS 35—ADVERTISING AND BUSINESS

FOR INDUSTRIAL ASSET MANAGEMENT SERVICES, NAMELY, AUCTIONING, LIQUIDATING AND REMARKETING INDUSTRIAL ASSETS OF OTHERS; BUSINESS APPRAISALS OF INDUSTRIAL ASSETS OF OTHERS; PROVIDING CUSTOMIZED DAILY EMAILS DISCLOSING PRE-MARKET AVAILABILITY OF PRE-DESIGNATED DESIRED ASSETS IN REAL TIME (U.S. CLS. 100, 101 AND 102).

CLASS 36—INSURANCE AND FINANCIAL

FOR DEBT RECOVERY AND COLLECTION; INDUSTRIAL ASSET REPOSSESSION (U.S. CLS. 100, 101 AND 102). KARANENDRA S. CHHINA, EXAMINING ATTORNEY

SN 78-250,374. NASSAU EQUIPMENT CO., INC., DBA NASSAU ASSET MANAGEMENT, ROSLYN HEIGHTS, NY. FILED 5-15-2003.

NASTRAC

CLASS 35—ADVERTISING AND BUSINESS

FOR INDUSTRIAL ASSET MANAGEMENT SERVICES, NAMELY, AUCTIONING, LIQUIDATING AND REMARKETING INDUSTRIAL ASSETS OF OTHERS; BUSINESS APPRAISALS OF INDUSTRIAL ASSETS OF OTHERS; ON-LINE ASSET-TRACKING SYSTEM IN REAL-TIME (U.S. CLS. 100, 101 AND 102).

CLASS 36—INSURANCE AND FINANCIAL

FOR DEBT RECOVERY AND COLLECTION; INDUSTRIAL ASSET REPOSSESSION (U.S. CLS. 100, 101 AND 102).

KARANENDRA S. CHHINA, EXAMINING ATTORNEY

SN 78-251,059. MARKETING RESULTS LTD., COLUMBUS, OH. FILED 5-16-2003.

**CLASS 8—HAND TOOLS**

FOR HAND TOOLS FOR USE IN A GARDEN, NAMELY, PRUNERS AND HAND OPERATED SHEARS (U.S. CLS. 23, 28 AND 44).

CLASS 9—ELECTRICAL AND SCIENTIFIC APPARATUS

FOR TAPE MEASURES (U.S. CLS. 21, 23, 26, 36 AND 38).

CLASS 11—ENVIRONMENTAL CONTROL APPARATUS

FOR FLASHLIGHTS (U.S. CLS. 13, 21, 23, 31 AND 34).

CLASS 12—VEHICLES

FOR CARTS FOR USE IN HOLDING BOTH GARDEN TOOLS AND GARDEN HOSES (U.S. CLS. 19, 21, 23, 31, 35 AND 44).

TONJA GASKINS, EXAMINING ATTORNEY

SN 78-251,997. AGRILECTRIC POWER, INC., LAKE CHARLES, LA. FILED 5-20-2003.

AGRILECTRIC

CLASS 1—CHEMICALS

FOR ASH MADE OF GREATER THAN 93% AMORPHOUS SILICA, NAMELY, RICE HULL ASH PACKAGED IN SACKS, RICE HULL ASH PACKAGED IN BOXES, AND RICE HULL ASH SHIPPED ON PALLETS, ALL FOR USE TO FILTER OILS, SOLVENTS, HEAVY METAL, NITRATES AND PHOSPHATES OUT OF LIQUID (U.S. CLS. 1, 5, 6, 10, 26 AND 46).

CLASS 17—RUBBER GOODS

FOR ASH MADE OF GREATER THAN 93% AMORPHOUS SILICA, NAMELY, RICE HULL ASH PACKAGED IN SACKS, RICE HULL ASH PACKAGED IN BOXES, AND RICE HULL ASH SHIPPED ON PALLETS, ALL FOR USE AS INSULATION IN STEEL MANUFACTURING (U.S. CLS. 1, 5, 12, 13, 35 AND 50).

CLASS 19—NON-METALLIC BUILDING MATERIALS

FOR ASH MADE OF GREATER THAN 93% AMORPHOUS SILICA, NAMELY, RICE HULL ASH PACKAGED IN SACKS, RICE HULL ASH PACKAGED IN BOXES, AND RICE HULL ASH SHIPPED ON PALLETS, ALL FOR USE AS AN ADDITIVE IN CEMENT (U.S. CLS. 1, 12, 33 AND 50).

GWEN STOKOLS, EXAMINING ATTORNEY

SN 78-252,293. THE STATE BAR OF CALIFORNIA, SAN FRANCISCO, CA. FILED 5-20-2003.



OWNER OF U.S. REG. NO. 2,597,601.
NO CLAIM IS MADE TO THE EXCLUSIVE RIGHT TO USE "JOURNAL", APART FROM THE MARK AS SHOWN.
SEC. 2(F) AS TO "CALIFORNIA REAL PROPERTY JOURNAL".

CLASS 16—PAPER GOODS AND PRINTED MATTER

FOR JOURNALS AND PRINTED EDUCATIONAL MATERIALS IN THE FIELD OF REAL PROPERTY LAW (U.S. CLS. 2, 5, 22, 23, 29, 37, 38 AND 50).
FIRST USE 0-0-1982; IN COMMERCE 0-0-1982.

CLASS 41—EDUCATION AND ENTERTAINMENT

FOR PROVIDING NON-DOWNLOADABLE ON-LINE JOURNALS IN THE FIELD OF REAL PROPERTY LAW (U.S. CLS. 100, 101 AND 107).
FIRST USE 0-0-1997; IN COMMERCE 0-0-1997.
REBECCA GILBERT, EXAMINING ATTORNEY

SN 78-252,804. WELEDA AG, ARLESHEIM, SWITZERLAND,
FILED 5-21-2003.

INFLUDORON

CLASS 3—COSMETICS AND CLEANING PREPARATIONS

FOR COSMETIC PREPARATIONS, NAMELY, BODY CARE PREPARATIONS, NAMELY, ARNICA MASSAGE OIL, CITRUS BODY OIL, CITRUS BODY LOTION, CITRUS LEG TONER, CITRUS FOOT CREAM, CITRUS DEODORANT, SAGE DEODORANT, AND UNSCENTED BODY LOTION; SKIN CARE PREPARATIONS; NAMELY, IRIS HAND AND BODY LOTION, IRIS CLEANSING LOTION, IRIS MOISTURIZING CREAM, IRIS NIGHT CREAM, IRIS FACE OIL, IRIS SKIN CARE PREPARATIONS; BABY CARE PREPARATIONS, NAMELY, CALENDULA BABY CREAM, NON-MEDICATED BABY CREAM, CALENDULA BABY OIL, CALENDULA BABY POWDER; BATH CARE PREPARATIONS, NAMELY, ROSEMARY BATH OIL, LAVENDER BATH OIL, PINE BATH OIL; NON-MEDICATED HERBAL PREPARATIONS, NAMELY, ARNICA OINTMENT, CALENDULA OINTMENT AND BALSAMICUM HEALING OINTMENT; AND ORAL CARE PREPARATIONS, NAMELY, LIP BALM; PERFUMERY, NAMELY, ARNICA ESSENCE, CALENDULA ESSENCE, AND OTHER HERBAL ESSENCES; ESSENTIAL OILS FOR PERSONAL USE, NAMELY, CITRONELLA OIL, EUCALYPTUS OIL, LAVENDER OIL, LEMON OIL, PINE OIL, AND ROSEMARY OIL; SOAPS, NAMELY, IRIS SOAP, CALENDULA BABY SOAP, AND ROSEMARY SOAP; ORAL CARE PREPARATIONS, NAMELY, PINK TOOTHPASTE, PLANT GEL TOOTHPASTE, NATURAL SALT TOOTHPASTE, CALENDULA TOOTHPASTE, AND MOUTHWASH CONCENTRATE; HAIR LOTIONS; AND DENTIFRICES. (U.S. CLS. 1, 4, 6, 50, 51 AND 52).

CLASS 5—PHARMACEUTICALS

FOR PHARMACEUTICAL AND SANITARY PREPARATIONS, NAMELY, MEDICATED ORAL CARE PREPARATIONS, NAMELY, PINK TOOTHPASTE, PLANT GEL TOOTHPASTE, NATURAL SALT TOOTHPASTE, CALENDULA TOOTHPASTE, AND MOUTHWASH CONCENTRATE; FRUIT SYRUPS FOR MEDICINAL PURPOSES, NAMELY, BIRCH SYRUP, BLACK CURRANT-LINGONBERRY SYRUP, BLACKTHORN SYRUP, ROSEHIP-BUFFALO BERRY SYRUP; MEDICATED CANDIES, NAMELY, BIRCH CANDIES, BLACKTHORN CANDIES, SAGE AND THYME COUGH CANDIES; HERBAL TEAS FOR MEDICINAL PURPOSES, NAMELY, LACTAGOGUE FOR NURSING MOTHERS, PINELLA - A BITTER, SONIO BEDTIME TEA, SYTRA TEA FOR COUGH, TRIPLEX, A CARMINATIVE, BREAKFAST MORNING BEVERAGE, CAMOMILE FLOWERS, BIRCH LEAVES, HORSETAIL HERB; HERBAL PRODUCTS FOR MEDICINAL PURPOSES, NAMELY, ARNICA OINTMENT FOR SPRAINS AND BRUISES, CALENDULA OINTMENT FOR SKIN IRRITATIONS, BALSAMICUM HEALING OINTMENT FOR ABRASIONS, CINNABAR COMPOUND FOR THERAPEUTIC USE, ECHINACEA COMPOUND FOR THERAPEUTIC USE, FERRUM PHOSPHATE TABLETS FOR THERAPEUTIC USE, INFLUDOM PELLETS FOR THERAPEUTIC USE, TOPICAL MEDICATED BURN GEL, MELISSENGEIST FOR THERAPEUTIC USE, AND SEDATIVE PILLS, NAMELY PHARMACEUTICAL PREPARATIONS FOR THE TREATMENT OF DERMATOLOGICAL, CARDIOVASCULAR, HEMATOLOGICAL, BONE, RESPIRATORY, CENTRAL NERVOUS SYSTEM, ENDOCRINOLOGICAL, CIRCULATORY, GASTROENTEROLOGICAL, HORMONAL AND DIABETIC DISORDERS, COUGHS, COLDS, INFLUENZA, HEADACHES, STOMACH AND DIGESTIVE DISORDERS, MUSCULAR AND/OR RHEUMATIC DISORDERS, INFLAMMATORY DISEASES, IMMUNE SYSTEM DISORDERS AND RELATED DISEASES, ALLERGIC REACTIONS, METABOLIC DISORDERS, ANTI-INFECTIVES, OCULAR DISORDERS, AND FOR USE IN ONCOLOGY; MEDICATED BABY CREAM, DIAGNOSTIC PREPARATIONS AND/OR REAGENTS FOR CLINICAL OR MEDICAL LABORATORY USE; NICOTINE FOR MEDICINAL PURPOSES IN LIQUID, PILL, TA-

BLET, CAPLET, POWDER OR TRANSDERMAL PATCH FORM; HORMONES; DIETETIC SUBSTANCES FOR MEDICAL PURPOSES, NAMELY, NUTRITIONAL, VITAMIN, HERBAL AND MINERAL SUPPLEMENTS AND PREPARATIONS, NUTRITIONAL DRINK MIX FOR USE AS A MEAL REPLACEMENT, NUTRITIONAL SUPPLEMENTS FOR USE AS A MEAL REPLACEMENT; FOOD AND BEVERAGES FOR BABIES, INFANTS AND INVALIDS, NAMELY, BABY FOOD, INFANT FORMULA, FOOD FOR ENTERAL ADMINISTRATION AND FOOD FOR MEDICALLY RESTRICTED DIETS AND MEAL REPLACEMENT AND DIETARY SUPPLEMENT DRINK MIXES. (U.S. CLS. 6, 18, 44, 46, 51 AND 52).

ANDREA SAUNDERS, EXAMINING ATTORNEY

SN 78-252,836. THE WAI LANA YOGA TRUST, A HAWAII TRUST COMPRISING SUNIL KHEMANEY AND WAI LAN BUTLER, BOTH U.S. CITIZENS, DBA GOLD MOON PRODUCTIONS, MALIBU, CA. FILED 5-21-2003.



CLASS 9—ELECTRICAL AND SCIENTIFIC APPARATUS

FOR PRERECORDED HOME VIDEO TAPES FEATURING YOGA EXERCISES; AND PRERECORDED AUDIO CASSETTES AND CDS FEATURING RELAXATION MUSIC (U.S. CLS. 21, 23, 26, 36 AND 38).

CLASS 25—CLOTHING

FOR MEN'S, WOMEN'S AND CHILDREN'S CLOTHING, NAMELY, BLOUSES, JACKETS, JUMP SUITS, COATS PANTS, PULLOVERS, SCARVES, SHIRTS, SWEAT SHIRTS, SWEAT PANTS, SWEAT JACKETS, T-SHIRTS, TOPS AND BOTTOMS (U.S. CLS. 22 AND 39).

CLASS 28—TOYS AND SPORTING GOODS

FOR YOGA PRODUCTS AND YOGA ACCESSORIES, NAMELY, YOGA MATS, YOGA STRAPS FOR CARRYING YOGA MATS AND STRETCHING, YOGA BAGS FITTED FOR CARRYING YOGA MATS, YOGA BAGS FITTED FOR CARRYING YOGA BRICKS, YOGA STRAPS, YOGA BALLS, YOGA TOTES FITTED TO CARRY YOGA MATS, YOGA BRICKS, YOGA BLOCKS, YOGA BLANKETS MADE ESPECIALLY AND SPECIFICALLY FOR YOGA AND FOR NO OTHER PURPOSE, YOGA BOLSTERS, YOGA ZAFUS, YOGA WEDGES, YOGA BALLS AND PHYSIO EXERCISE BALLS (U.S. CLS. 22, 23, 38 AND 50).

CLASS 35—ADVERTISING AND BUSINESS

FOR ONLINE RETAIL STORE SERVICES AND RETAIL STORE SERVICES FEATURING PRERECORDED HOME VIDEO TAPES IN THE FIELD OF YOGA, YOGA MATS, YOGA STRAPS, YOGA BAGS, YOGA TOTES, YOGA BRICKS, YOGA BLOCKS, YOGA BLANKETS, YOGA BOLSTERS, YOGA ZAFUS, YOGA WEDGES, YOGA BALLS (U.S. CLS. 100, 101 AND 102).

CLASS 41—EDUCATION AND ENTERTAINMENT

FOR EDUCATIONAL AND ENTERTAINMENT SERVICES, NAMELY, PRODUCTION OF RADIO PROGRAMS, TELEVISION PROGRAMS AND WEBCAST PROGRAMS; DISTRIBUTION OF RADIO PROGRAMS, TELEVISION PROGRAMS AND WEBCAST PROGRAMS FOR OTHERS; PROVIDING TELEVISION AND RADIO PROGRAMS IN THE FIELDS OF MUSIC, EXERCISE, FITNESS, HEALTH, NUTRITION, RELAXATION, HEALTHY LIVING, LIFESTYLES, NATURAL LIVING, DIET, NATURAL HEALING, AROMATHERAPY; EDUCATIONAL SERVICES, NAMELY, CONDUCTING CLASSES IN THE FIELDS OF MUSIC, EXERCISE, FITNESS, HEALTH, NUTRITION, RELAXATION, HEALTHY LIVING, LIFESTYLES, NATURAL LIVING, DIET, NATURAL HEALING (U.S. CLS. 100, 101 AND 107).

TANYA AMOS, EXAMINING ATTORNEY

SN 78-253,781. DAVANNI'S, INC., ST. LOUIS PARK, MN.
FILED 5-23-2003.



SN 78-253,095. DIEHL AVIONIK SYSTEME GMBH, D-88662
UBERLINGEN, FED REP GERMANY, FILED 5-22-2003.

SCALARE

THE MARK CONSISTS OF STANDARD CHARACTERS WITHOUT CLAIM TO ANY PARTICULAR FONT, STYLE, SIZE, OR COLOR.

OWNER OF FED REP GERMANY REG. NO. 30249875,
DATED 2-27-2003, EXPIRES 10-31-2012.

NO CLAIM IS MADE TO THE EXCLUSIVE RIGHT TO USE "CLASSIC PIZZA JOINT", APART FROM THE MARK AS SHOWN.

CLASS 30—STAPLE FOODS

FOR PIZZA, SANDWICHES, LASAGNA, PASTA, AND PASTA SALADS FOR CONSUMPTION ON OR OFF THE PREMISES (U.S. CL. 46).

FIRST USE 1-0-2003; IN COMMERCE 1-0-2003.

CLASS 43—HOTEL AND RESTAURANT SERVICES

FOR RESTAURANT SERVICES, NAMELY, RESTAURANTS FEATURING EAT IN, TAKE OUT AND DELIVERY SERVICES (U.S. CLS. 100 AND 101).

FIRST USE 1-0-2003; IN COMMERCE 1-0-2003.

NAAKWAMA ANKRAH, EXAMINING ATTORNEY

CLASS 9—ELECTRICAL AND SCIENTIFIC APPARATUS

FOR FLIGHT CONTROL COMPUTERS; FLIGHT NAVIGATION COMPUTERS SOFTWARE FOR FLIGHT CONTROL COMPUTERS AND FLIGHT NAVIGATION COMPUTERS; NAVIGATION APPARATUSES, NAMELY AIR DATA COMPUTERS, ACCELEROMETERS, GYROCOMPASSES, GYROSCOPES, INERTIAL REFERENCE MEASUREMENT COMPUTERS, AND NORTH FINDING GYROSCOPES; APPARATUS FOR REPRODUCING SOUND AND IMAGES, NAMELY CONTROL AND DISPLAY MONITORS AND DIGITAL MAP GENERATORS FOR GENERATING DIGITAL MAPS; DATA PROCESSING APPARATUSES, NAMELY ARMAMENT CONTROL COMPUTERS FOR DISPLAYING AND TARGETING ARMAMENTS, DATA PROCESSORS, AIRCRAFT AUTO PILOTS, BUS CONTROLLERS, CENTRAL MAINTENANCE AND DIAGNOSTIC COMPUTERS, ENGINE CONTROLLERS, FLIGHT CONTROLLERS, FLIGHT WARNING COMPUTERS, HEAD-UP DISPLAYS FOR DISPLAYING INFORMATION, FUEL MANAGEMENT COMPUTERS, PRIMARY AND SECONDARY FLIGHT CONTROL PROCESSORS, TACTICAL AWARENESS COMPUTERS, DIGITAL MAP GENERATING COMPUTERS, DOORS AND SLIDES MANAGEMENT COMPUTERS, AND TERRAIN FOLLOWING COMPUTERS (U.S. CLS. 21, 23, 26, 36 AND 38).

SN 78-255,435. CAMERON MACKINTOSH LIMITED, LONDON, UNITED KINGDOM, FILED 5-28-2003.

**CLASS 42—SCIENTIFIC, COMPUTER AND LEGAL SERVICES**

FOR ENGINEERING SERVICES (U.S. CLS. 100 AND 101).

LOURDES AYALA, EXAMINING ATTORNEY

OWNER OF ERPN CMNTY TM OFC REG. NO. 002146009,
DATED 1-23-2003, EXPIRES 3-14-2011.

THE STIPPLING IS A FEATURE OF THE MARK.

THE MARK INCLUDES THE WORDING "MY FAIR LADY" IN STYLIZED FORM.

CLASS 9—ELECTRICAL AND SCIENTIFIC APPARATUS

FOR PHONOGRAPH RECORDS FEATURING MUSIC AND THEATRICAL PRODUCTIONS AND PERFORMANCES, VIDEO CASSETTE TAPES FEATURING MUSIC AND THEATRICAL PRODUCTIONS AND PERFORMANCES, COMPACT DISCS FEATURING MUSIC AND THEATRICAL PRODUCTIONS AND PERFORMANCES, PRE-RECORDED AUDIO TAPES FEATURING MUSIC AND THEATRICAL PRODUCTIONS AND PERFORMANCES (U.S. CLS. 21, 23, 26, 36 AND 38).

CLASS 16—PAPER GOODS AND PRINTED MATTER

FOR PRINTED MATTER, NAMELY, BOOKS, POSTERS, PHOTOGRAPHS, STATIONERY, SCRIPTS, STUDY GUIDES, SHEET MUSIC BOOKS, CONDUCTORS SCORES, LYRIC BOOKS, AND SOUVENIR PROGRAMS AND BROCHURES; PACKAGING MATERIALS, NAMELY, CARDBOARD BOXES AND PAPER AND PLASTIC BAGS FOR WRAPPING AND PACKAGING; COASTERS MADE OF PAPER, SHEET MUSIC AND TISSUE PAPER, ALL THE AFORESAID PERTAINING TO THEATRICAL PRODUCTIONS AND PERFORMANCES (U.S. CLS. 2, 5, 22, 23, 29, 37, 38 AND 50).

CLASS 25—CLOTHING

FOR ARTICLES OF OUTER CLOTHING, NAMELY, T-SHIRTS, SWEATSHIRTS, COATS, JACKETS, WIND-RESISTANT JACKETS, MITTENS, GLOVES, SCARVES AND HATS, ALL THE AFORESAID PERTAINING TO THEATRICAL PRODUCTIONS AND PERFORMANCES (U.S. CLS. 22 AND 39).

CLASS 41—EDUCATION AND ENTERTAINMENT

FOR ENTERTAINMENT/SHOW BUSINESS SERVICES IN THE NATURE OF LIVE THEATRICAL PRODUCTIONS AND PERFORMANCES (U.S. CLS. 100, 101 AND 107).

MATTHEW PAPPAS, EXAMINING ATTORNEY

SN 78-258,318. 441 RECORDS CORPORATION, NEW YORK, NY. FILED 6-4-2003.

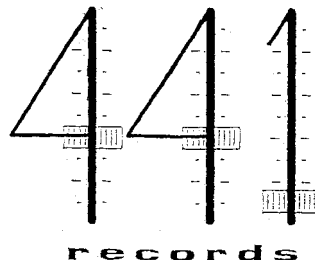

NO CLAIM IS MADE TO THE EXCLUSIVE RIGHT TO USE "RECORDS", APART FROM THE MARK AS SHOWN. THE LINING IS A FEATURE OF THE MARK AND DOES NOT INDICATE COLOR.

CLASS 9—ELECTRICAL AND SCIENTIFIC APPARATUS

FOR MUSICAL SOUND RECORDINGS (U.S. CLS. 21, 23, 26, 36 AND 38).
FIRST USE 6-24-2003; IN COMMERCE 6-26-2003.

CLASS 41—EDUCATION AND ENTERTAINMENT

FOR MUSIC PRODUCTION SERVICES FOR OTHERS (U.S. CLS. 100, 101 AND 107).
FIRST USE 5-16-2003; IN COMMERCE 5-16-2003.
DOMINIC J. FERRAIUOLO, EXAMINING ATTORNEY

SN 78-261,196. BATH SOLUTIONS, INC., ELK GROVE VILLAGE, IL. FILED 6-11-2003.

BATH SOLUTIONS

NO CLAIM IS MADE TO THE EXCLUSIVE RIGHT TO USE "BATH", APART FROM THE MARK AS SHOWN.

CLASS 20—FURNITURE AND ARTICLES NOT OTHERWISE CLASSIFIED

FOR HOOKS OF PLASTIC FOR BATH, SHOWER, SINK AND TOILET RELATED ITEMS; TOWEL RODS; AND SHOWER CURTAIN RODS (U.S. CLS. 2, 13, 22, 25, 32 AND 50).

CLASS 21—HOUSEWARES AND GLASS

FOR BATHROOM HARDWARE, NAMELY HOLDERS AND CONTAINERS, NAMELY SOAP DISHES, AND SHOWER CADDIES ALL BEING MADE OF PLASTIC, METAL OR COMBINATIONS THEREOF (U.S. CLS. 2, 13, 23, 29, 30, 33, 40 AND 50).
JAMES A. RAUEN, EXAMINING ATTORNEY

SN 78-257,111. FORSALEBYOWNER.COM CORP., NEW YORK, NY. FILED 6-2-2003.

NO COMMISSION, LOTS OF HELP**CLASS 16—PAPER GOODS AND PRINTED MATTER**

FOR MAGAZINES LISTING REAL ESTATE, HOMES AND LAND. (U.S. CLS. 2, 5, 22, 23, 29, 37, 38 AND 50).

CLASS 36—INSURANCE AND FINANCIAL

FOR PROVIDING ON LINE LISTINGS IN THE FIELD OF REAL ESTATE THROUGH A GLOBAL OPEN ACCESS NETWORK. (U.S. CLS. 100, 101 AND 102).
JILL C. ALT, EXAMINING ATTORNEY

SN 78-261,812. TELEFONOS DE MEXICO, S.A. DE C.V.,
MEXICO CITY, MEXICO, FILED 6-12-2003.



OWNER OF MEXICO REG. NO. 738269, DATED 2-28-2002,
EXPIRES 2-28-2012.

OWNER OF MEXICO REG. NO. 736863, DATED 2-28-2002,
EXPIRES 2-28-2012.

THE LINING IS A FEATURE OF THE MARK AND DOES
NOT INDICATE COLOR.

THE MARK CONSISTS OF THE WORD MULTIFON
WITH AN ARBITRARY DESIGN.

CLASS 9—ELECTRICAL AND SCIENTIFIC APPARATUS

FOR PRE-PAID TELEPHONE CARDS, MAGNETI-
CALLY ENCODED (U.S. CLS. 21, 23, 26, 36 AND 38).

CLASS 36—INSURANCE AND FINANCIAL

FOR TELEPHONE CALLING CARD SERVICES (U.S.
CLS. 100, 101 AND 102).

CAROLYN CATALDO, EXAMINING ATTORNEY

SN 78-262,129. COMPEER PARTNERS, LLC, DUBLIN, OH.
FILED 6-13-2003.

ATHLETE ZONE

NO CLAIM IS MADE TO THE EXCLUSIVE RIGHT TO
USE "ATHLETE", APART FROM THE MARK AS SHOWN.

CLASS 41—EDUCATION AND ENTERTAIN- MENT

FOR PROVIDING A WEB SITE FOR USE IN TRACK-
ING AN EXERCISE PROGRAM (U.S. CLS. 100, 101 AND
107).

CLASS 44—MEDICAL, BEAUTY AND AGRI- CULTURAL SERVICES

FOR PROVIDING A WEB SITE FOR USE IN TRACK-
ING A NUTRITIONAL REGIMEN (U.S. CLS. 100 AND
101).

RONALD MCMORROW, EXAMINING ATTORNEY

SN 78-263,473. GODINGER SILVER ART CO., LTD., NEW
YORK, NY. FILED 6-17-2003.

RICCI ANYTIME

OWNER OF U.S. REG. NO. 2,278,264.

CLASS 8—HAND TOOLS

FOR STAINLESS AND SILVERPLATED FLATWARE,
NAMESLY, SERVING SPOONS, SERVING FORKS, BUT-
TER SPREADERS/KNIVES, SUGAR SPOONS, CARVING
FORKS, CARVING KNIVES, SLOTTED SPOONS, CAKE
KNIVES, STEAK KNIVES, COFFEE SPOONS, LONG
DRINK/ICED TEA SPOONS, FISH FORKS, FISH KNI-
VES, CHEESE SLICERS, CHEESE KNIVES (U.S. CLS. 23,
28 AND 44).

CLASS 14—JEWELRY

FOR SILVERPLATED SERVING PIECES, NAMELY,
SOUP LADLES, GRAVY LADLES, CAKE SERVERS,
SALAD SERVING FORKS AND SPOONS, SERVING
TONGS FOR SALAD AND LASAGNA SERVERS (U.S.
CLS. 2, 27, 28 AND 50).

CLASS 21—HOUSEWARES AND GLASS

FOR STAINLESS SERVING PIECES, NAMELY, SOUP
LADLES, GRAVY LADLES, CAKE SERVERS, SALAD
SERVING FORKS AND SPOONS, SERVING TONGS FOR
SALAD AND LASAGNA SERVERS (U.S. CLS. 2, 13, 23,
29, 30, 33, 40 AND 50).

ROBERT C. CLARK JR., EXAMINING ATTORNEY

SN 78-268,527. AUNT PEARLIE'S FOOD PRODUCTS, INC.,
COLUMBUS, GA. FILED 6-30-2003.



NO CLAIM IS MADE TO THE EXCLUSIVE RIGHT TO
USE "READY TO BAKE", APART FROM THE MARK AS
SHOWN.

THE NAME(S), PORTRAIT(S), AND/OR SIGNATURE(S)
SHOWN IN THE MARK IDENTIFIES PEARLIE M. WRIGHT
, WHOSE CONSENT(S) TO REGISTER IS SUBMITTED.

THE MARK CONSISTS OF THE WORDS "AUNT PEAR-
LIE'S" IN AN ARCHED IMPRESSION OF A BANNER, WITH
STRAIGHT LINES IMINATING FROM THE TOP OF THE
BANNER. THE WORDS "READY TO BAKE" ARE UNDER
THE BANNER AND HAVE AN IMPRESSION OF A HEART
SHAPED ITEM OF PRODUCE ABOVE THEM.

CLASS 29—MEATS AND PROCESSED FOODS

FOR FROZEN PREPARED FOODS FEATURING
MEAT, FISH, POULTRY OR VEGETABLES (U.S. CL. 46).
FIRST USE 9-1-1995; IN COMMERCE 9-1-1995.

CLASS 30—STAPLE FOODS

FOR FROZEN PREPARED FOODS IN THE NATURE
OF SIDE DISHES CONSISTING PRIMARILY OF CORN-
BREAD DRESSING, PASTA OR RICE (U.S. CL. 46).

FIRST USE 9-1-1995; IN COMMERCE 9-1-1995.
CIMMERIAN COLEMAN, EXAMINING ATTORNEY

SN 78-268,581. AUNT PEARLIE'S FOOD PRODUCTS, INC.,
COLUMBUS, GA. FILED 6-30-2003.

IT TASTES HOMEMADE BECAUSE WE STILL MAKE IT THAT WAY

CLASS 29—MEATS AND PROCESSED FOODS

FOR FROZEN PREPARED FOODS FEATURING MEAT, FISH, POULTRY OR VEGETABLES (U.S. CL. 46).
FIRST USE 9-1-1995; IN COMMERCE 9-1-1995.

CLASS 30—STAPLE FOODS

FOR FROZEN PREPARED FOODS IN THE NATURE OF SIDE DISHES CONSISTING PRIMARILY OF CORN-BREAD DRESSING, PASTA OR RICE (U.S. CL. 46).
FIRST USE 7-1-1999; IN COMMERCE 7-1-1999.
CIMMERIAN COLEMAN, EXAMINING ATTORNEY

SN 78-269,922. BUMBLE AND BUMBLE LLC, NEW YORK,
NY. FILED 7-2-2003.

HAIR HEROES

NO CLAIM IS MADE TO THE EXCLUSIVE RIGHT TO USE "HAIR", APART FROM THE MARK AS SHOWN.

CLASS 3—COSMETICS AND CLEANING PREPARATIONS

FOR COSMETICS, FRAGRANCES FOR PERSONAL USE, NON-MEDICATED HAIR CARE PREPARATIONS, NON-MEDICATED SKIN CARE PREPARATIONS, SUN CARE PREPARATIONS, NAMELY SUN CARE LOTIONS (U.S. CLS. 1, 4, 6, 50, 51 AND 52).

CLASS 16—PAPER GOODS AND PRINTED MATTER

FOR PRINTED PUBLICATIONS, NAMELY, A SERIES OF NON-FICTION BOOKS AND PRINTED EDUCATIONAL MATERIALS RELATING TO HAIR CARE. (U.S. CLS. 2, 5, 22, 23, 29, 37, 38 AND 50).
GINA FINK, EXAMINING ATTORNEY

SN 78-272,016. ALLIANT TECHSYSTEMS INC., EDINA, MN.
FILED 7-9-2003.

RCBS

OWNER OF U.S. REG. NO. 820,178.

CLASS 7—MACHINERY

FOR INDUSTRIAL MACHINE PRESSES AND PRESS ACCESSORIES, NAMELY RELOADING PRESSES FOR USE IN MAKING BULLETS FOR WEAPONS AND FIREARMS AND DUST COVERS FOR AMMUNITION RELOADING PRESSES (U.S. CLS. 13, 19, 21, 23, 31, 34 AND 35).
FIRST USE 0-0-1943; IN COMMERCE 0-0-1943.

CLASS 8—HAND TOOLS

FOR HAND TOOLS, NAMELY HAND PRIMERS, PRIMER STRIPS, STRIP LOADERS, DIE LOCK-RING WRENCHES, HEX KEY WRENCH SETS FOR USE WITH AMMUNITION (U.S. CLS. 23, 28 AND 44).
FIRST USE 0-0-1943; IN COMMERCE 0-0-1943.

CLASS 13—FIREARMS

FOR LOADING TOOLS FOR WEAPONS AND FIREARMS, NAMELY RECAPPERS, LOADING BLOCKS AND SHELL LOADERS; CASES AND BOXES FOR AMMUNITION; AMMUNITION BOXES FOR USE WITH PISTOLS AND RIFLES; AMMUNITION BAGS; BULLET CASTING EQUIPMENT AND ACCESSORIES, NAMELY BULLET MOLDS AND STRUCTURAL PARTS THEREFORE; ACCESSORIES FOR PREPARING BULLET CASINGS, NAMELY GUN CLEANING CLOSER-CUPS; CLEANING IMPLEMENTS FOR FIREARMS, NAMELY, RODS, PULL-THROUGHS, CLOSER CUPS, SHELL EXTRACTORS, DECAPPERS, PRIMER BRUSHES, PRIMER TRAYS; GUN POWDER HANDLING ACCESSORIES, NAMELY POWDER FLASKS FOR FIREARMS; BULLET SHELL HOLDERS, NAMELY SHELL BELTS; BULLETS AND SHELL EXTRACTORS; BULLET MOLDS AND BULLET MOLD HANDLES; INGOT BULLET MOLDS; BULLET MOLDS IN THE FORM OF LEAD POTS FOR HOLDING MOLTEN METAL AND USE IN BULLET CASTING; TOOLS FOR LOADING WEAPONS, NAMELY CASE LOADING BLOCKS, PISTOL DECAPPING RODS, SHELL PLATES AND GUN POWDER CHECKERS; FIREARM PARTS, NAMELY CHUCK ASSEMBLIES (U.S. CLS. 2 AND 9).
FIRST USE 0-0-1943; IN COMMERCE 0-0-1943.

CLASS 21—HOUSEWARES AND GLASS

FOR POWDER FUNNELS (U.S. CLS. 2, 13, 23, 29, 30, 33, 40 AND 50).
FIRST USE 0-0-1943; IN COMMERCE 0-0-1943.
STEVEN BERK, EXAMINING ATTORNEY

SN 78-273,939. LAVA TRADING INC., NEW YORK, NY.
FILED 7-14-2003.

CLBK

CLASS 9—ELECTRICAL AND SCIENTIFIC APPARATUS

FOR COMPUTER SOFTWARE FOR CONDUCTING SECURITY TRADES OVER ELECTRONIC COMMUNICATIONS NETWORKS (U.S. CLS. 21, 23, 26, 36 AND 38).
FIRST USE 11-6-2000; IN COMMERCE 11-6-2000.

CLASS 36—INSURANCE AND FINANCIAL

FOR ELECTRONIC SECURITIES TRADING SERVICES (U.S. CLS. 100, 101 AND 102).
FIRST USE 11-6-2000; IN COMMERCE 11-6-2000.
TRACY WHITAKER-BOWN, EXAMINING ATTORNEY

SN 78-276,290. STAMPA ARTEFATOS DE COURO LTDA,
NOVO HAMBURGO/RS, BRAZIL, FILED 7-18-2003.

SN 78-278,821. INTRAGATE CORPORATION, CORAL
SPRINGS, FL. FILED 7-25-2003.



OWNER OF BRAZIL REG. NO. 820846015, DATED 6-5-2003, EXPIRES 6-5-2013.

OWNER OF BRAZIL REG. NO. 200007149, DATED 6-5-2003, EXPIRES 6-5-2013.

THE ENGLISH TRANSLATION OF THE MARK IS MOON LIGHT.

CLASS 18—LEATHER GOODS

FOR HANDBAGS AND WALLETS (U.S. CLS. 1, 2, 3, 22 AND 41).

CLASS 25—CLOTHING

FOR SHOES (U.S. CLS. 22 AND 39).
JENNIFER MARTIN, EXAMINING ATTORNEY



THE STIPPLING IS A FEATURE OF THE MARK.

CLASS 35—ADVERTISING AND BUSINESS

FOR MARKETING SERVICES, NAMELY, INDEPENDENT SALES REPRESENTATIVES IN THE NATURE OF MANUFACTURER SALES REPRESENTATIVES IN THE FIELD OF CONSUMER AND INDUSTRIAL PRODUCTS; BUSINESS MANAGEMENT SERVICES, NAMELY, PRODUCT DISTRIBUTION OPERATIONS MANAGEMENT SERVICES (U.S. CLS. 100, 101 AND 102).

CLASS 36—INSURANCE AND FINANCIAL

FOR TRADE FINANCE SERVICES IN THE NATURE OF ARRANGING INTERNATIONAL TRADE FINANCE, NAMELY, WORKING CAPITAL AND LONG-TERM LOANS (U.S. CLS. 100, 101 AND 102).
ALLISON HOLTZ, EXAMINING ATTORNEY

SN 78-278,127. AGRACEL, INC., EFFINGHAM, IL. FILED 7-24-2003.

AGRACEL

CLASS 36—INSURANCE AND FINANCIAL

FOR REAL PROPERTY MANAGEMENT; LEASING OF OFFICE SPACE, MANUFACTURING SPACE AND WAREHOUSE SPACE (U.S. CLS. 100, 101 AND 102).
FIRST USE 11-1-1986; IN COMMERCE 11-1-1986.

CLASS 37—CONSTRUCTION AND REPAIR

FOR CONSULTATION SERVICES IN THE FIELD OF REAL ESTATE DEVELOPMENT, SITE SELECTION AND BUILDING CONSTRUCTION (U.S. CLS. 100, 103 AND 106).
FIRST USE 11-1-1986; IN COMMERCE 11-1-1986.

CLASS 39—TRANSPORTATION AND STORAGE

FOR CONSULTATION IN THE FIELD OF WAREHOUSING SERVICES; WAREHOUSING SERVICES; PACKING ARTICLES FOR TRANSPORTATION (U.S. CLS. 100 AND 105).
FIRST USE 5-0-1995; IN COMMERCE 5-0-1995.
JOHN GARTNER, EXAMINING ATTORNEY

SN 78-279,004. WET CEMENT PRODUCTIONS, INC., EDINA, MN. FILED 7-25-2003.

AUTO-B-GOOD

CLASS 9—ELECTRICAL AND SCIENTIFIC APPARATUS

FOR VIDEOTAPES AND DVDS FEATURING CHILDREN'S CARTOONS, GAMES, STORIES, AND LESSONS (U.S. CLS. 21, 23, 26, 36 AND 38).

CLASS 16—PAPER GOODS AND PRINTED MATTER

FOR PRINTED CHILDREN'S MATERIALS NAMELY INSTRUCTIONAL BOOKS, EDUCATIONAL BOOKS, WORKBOOKS, COLORING AND ACTIVITY BOOKS, STORY BOOKS, PICTURE STORY BOOKS, STICKERS AND STICKER BOOKS, POSTERS, GAME BOOKS, AND TALKING BOOKS FEATURING CHILDREN'S CARTOONS, STORIES, AND LESSONS ALL IN THE FIELD OF CHARACTER TRAITS AND CHARACTER DEVELOPMENT (U.S. CLS. 2, 5, 22, 23, 29, 37, 38 AND 50).

CLASS 25—CLOTHING

FOR T-SHIRTS (U.S. CLS. 22 AND 39).

CLASS 28—TOYS AND SPORTING GOODS

FOR TOYS, GAMES AND PLAYTHINGS, NAMELY PLASTIC TOY AUTOMOBILES, PLUSH TOY AUTOMOBILES, METAL TOY AUTOMOBILES, PLASTIC CHARACTER TOYS, WOODEN CHARACTER TOYS, PLUSH CHARACTER TOYS AND METAL CHARACTER TOYS, AND HAND HELD ELECTRONIC GAMES FEATURING AUTOMOBILES (U.S. CLS. 22, 23, 38 AND 50).

ANDREA SAUNDERS, EXAMINING ATTORNEY

SN 78-280,748. LEVY-WAITZ, PATRICK, PARIS, FRANCE, FILED 7-30-2003.

EGOPRISM

OWNER OF FRANCE REG. NO. 023165681, DATED 5-24-2002, EXPIRES 5-24-2012.

CLASS 9—ELECTRICAL AND SCIENTIFIC APPARATUS

FOR MAGNETIC OR DIGITAL RECORDED DATA SOUND AND IMAGES CARRIERS RELATING TO HUMAN RESOURCES MANAGEMENT, PSYCHOLOGY CONSULTANCY AND GUIDANCE IN THE FIELD OF INDIVIDUAL SELF DEVELOPMENT AND EVOLUTION; COMPUTER SOFTWARE FOR USE IN PROVIDING INFORMATION AND PROFESSIONAL GUIDANCE IN THE FIELDS OF HUMAN RESOURCES, CAREER MANAGEMENT, PSYCHOLOGY, AND INDIVIDUAL SELF-DEVELOPMENT AND PERSONAL EVOLUTION; COMPUTERS AND THEIR PERIPHERALS; TELECOMMUNICATION APPARATUS, NAMELY, TELEPHONES, CELLULAR TELEPHONES AND WIRELESS HAND-HELD TELECOMMUNICATION TERMINALS (U.S. CLS. 21, 23, 26, 36 AND 38).

CLASS 16—PAPER GOODS AND PRINTED MATTER

FOR PRINTED MATTER, NAMELY, MAGAZINES, PERIODICALS, NEWSLETTERS, BOOKS, MANUALS, GUIDES, PLANNERS AND ORGANIZERS ON THE SUBJECT MATTER OF HUMAN RESOURCES, CAREER MANAGEMENT, PSYCHOLOGY AND INDIVIDUAL SELF DEVELOPMENT AND PERSONAL EVOLUTION (U.S. CLS. 2, 5, 22, 23, 29, 37, 38 AND 50).

CLASS 35—ADVERTISING AND BUSINESS

FOR BUSINESS MANAGEMENT; BUSINESS ADMINISTRATION; CONSULTANCY IN BUSINESS COMMUNICATION; CONSULTANCY IN HUMAN RESOURCES MANAGEMENT; CAREER MANAGEMENT; FRANCHISING SERVICES, NAMELY PROVIDING TECHNICAL ASSISTANCE IN THE ESTABLISHMENT OF COMPANIES DEDICATED TO HUMAN RESOURCES MANAGEMENT, PSYCHOLOGY CONSULTANCY, INDIVIDUAL SELF DEVELOPMENT AND PERSONAL EVOLUTION; BUSINESS CONSULTATION SERVICES WITH REGARD TO THE ESTABLISHMENT OF NEW COMPANIES; INFORMATION SERVICES ABOUT CONFERENCES AND EXHIBITIONS FOR COMMERCIAL PURPOSES; PROVIDING ONLINE COMPUTER DATABASES IN THE FIELD OF HUMAN RESOURCES MANAGEMENT; ADMINISTRATION OF CULTURAL AND EDUCATIONAL EXCHANGE PROGRAMS (U.S. CLS. 100, 101 AND 102).

CLASS 38—COMMUNICATION

FOR PROVIDING ACCESS TO INTERNET; BROADCASTING OF RADIO AND TELEVISION PROGRAMS; ELECTRONIC MAIL; PROVIDING INFORMATION IN THE FIELD OF TELECOMMUNICATIONS PERTAINING TO INTERNET RELATED ISSUES (U.S. CLS. 100, 101 AND 104).

CLASS 41—EDUCATION AND ENTERTAINMENT

FOR EDUCATIONAL SERVICES, NAMELY PROVIDING CONTINUING PROFESSIONAL EDUCATION COURSES IN THE FIELDS OF BUSINESS, HUMAN RESOURCES AND CAREER COUNSELING; TRAINING IN THE FIELDS OF BUSINESS MANAGEMENT, HUMAN RESOURCES, CAREER COUNSELING, PSYCHOLOGY, INDIVIDUAL SELF DEVELOPMENT AND PERSONAL EVOLUTION; SPORTING AND CULTURAL ACTIVITIES, NAMELY, ARRANGING AND CONDUCTING SPORTING EVENT COMPETITIONS AND TOURNAMENTS; HEALTH CLUB SERVICES, NAMELY, PROVIDING INSTRUCTION AND EQUIPMENT IN THE FIELD OF PHYSICAL EXERCISE; SPONSORING, DEVELOPING AND CARRYING OUT INTERNATIONAL STUDENT EXCHANGE PROGRAMS; ORGANIZATION OF CONCERTS; PROFESSIONAL TRAINING IN THE FIELDS OF BUSINESS MANAGEMENT, HUMAN RESOURCES, CAREER COUNSELING, PSYCHOLOGY CONSULTANCY, AND SELF DEVELOPMENT AND PERSONAL EVOLUTION; ARRANGING AND CONDUCTING EDUCATIONAL CONFERENCES, ORGANIZING COMMUNITY CULTURAL EVENTS, CONDUCTING CONFERENCES AND SEMINARS FOR CULTURAL AND EDUCATIONAL PURPOSES IN THE FIELDS OF BUSINESS, ARTS, SCIENCES AND TECHNOLOGY; PROVIDING SPORTS TRAINING SERVICES; PUBLICATION AND ONLINE PUBLICATION OF BOOKS; MOTION PICTURE FILM PRODUCTION; ORGANIZATION OF SHOWS FOR CULTURAL PURPOSES, NAMELY, CONCERTS, EXHIBITIONS CONCERNING ART AND EDUCATION, COMMUNITY CULTURAL SHOWS FOR CHARITABLE PURPOSES, AND FASHION SHOWS; PROVIDING ONLINE ELECTRONIC PUBLICATIONS, NAMELY MAGAZINES, PERIODICALS, NEWSLETTERS, BOOKS, MANUALS, GUIDES, PLANNERS AND ORGANIZERS IN THE FIELDS OF BUSINESS MANAGEMENT, HUMAN RESOURCES, CAREER MANAGEMENT, PSYCHOLOGY CONSULTANCY, SELF DEVELOPMENT AND PERSONAL EVOLUTION; ARRANGING AND CONDUCTING SEMINARS IN THE FIELDS OF BUSINESS, ECONOMICS AND POLITICS (U.S. CLS. 100, 101 AND 107).

CLASS 42—SCIENTIFIC, COMPUTER AND LEGAL SERVICES

FOR CREATING AND MAINTAINING WEB SITES FOR OTHERS; HOSTING WEB SITES FOR OTHERS; COMPUTER PROGRAMMING FOR OTHERS (U.S. CLS. 100 AND 101).

CLASS 44—MEDICAL, BEAUTY AND AGRICULTURAL SERVICES

FOR PSYCHOLOGY CONSULTANCY AND GUIDANCE IN THE FIELD OF INDIVIDUAL SELF DEVELOPMENT AND EVOLUTION; PROVIDING ONLINE COMPUTER DATABASES IN THE FIELD OF PSYCHOLOGY (U.S. CLS. 100 AND 101).

ELIZABETH HUGHITT, EXAMINING ATTORNEY

SN 78-281,141. COCO SPRING INTERNATIONAL BIO-TECH, INC., VANCOUVER, BC, CANADA, FILED 7-30-2003.

COCO SPRING

PRIORITY CLAIMED UNDER SEC. 44(D) ON CANADA APPLICATION NO. 1177901, FILED 5-22-2003, REG. NO. 622047, DATED 10-7-2004, EXPIRES 10-7-2019.

PRIORITY CLAIMED UNDER SEC. 44(D) ON CANADA APPLICATION NO. 1177901, FILED 5-22-2003, REG. NO. 622047, DATED 10-7-2004, EXPIRES 10-7-2019.

PRIORITY CLAIMED UNDER SEC. 44(D) ON CANADA APPLICATION NO. 1177901, FILED 5-22-2003, REG. NO. 622047, DATED 10-7-2004, EXPIRES 10-7-2019.

CLASS 5—PHARMACEUTICALS

FOR DIETARY SUPPLEMENTS (U.S. CLS. 6, 18, 44, 46, 51 AND 52).

CLASS 35—ADVERTISING AND BUSINESS

FOR RETAIL AND WHOLESALE SERVICES FEATURING DIETARY SUPPLEMENTS (U.S. CLS. 100, 101 AND 102).

CLASS 44—MEDICAL, BEAUTY AND AGRICULTURAL SERVICES

FOR HEALTH CARE SERVICES, NAMELY, CLINICS FOR THE PROMOTION OF HEALTH AND WELLNESS (U.S. CLS. 100 AND 101).

ALEXANDER L. POWERS, EXAMINING ATTORNEY

CLASS 16—PAPER GOODS AND PRINTED MATTER

FOR PAPER GOODS, NAMELY FICTION AND NON-FICTION BOOKS OF GENERAL INTEREST FOR TEENAGE GIRLS; PHOTOGRAPHS; STATIONERY; HOLIDAY AND GREETING CARDS, NOTE CARDS, SCORE PADS, PAPER COASTERS, TABLE COVERS OF PAPER, PLACE MATS OF PAPER, PRINTED INVITATIONS, MEMO PADS, WRITING AND NOTE PAPER, ADDRESS LABELS, ADDRESS BOOKS, SCRAPBOOKS, PERSONAL JOURNALS, BOOKMARKS, SCHOOL SUPPLIES, NAMELY, NOTEBOOKS, STUDENT PLANNERS, DATE BOOKS, BINDERS, POSTERS, CALENDARS, PICTURE BOOKS, NOTE PADS, RUBBER STAMPS; PRINTED INSTRUCTIONAL AND TEACHING MATERIAL, PAMPHLETS, NEWSLETTERS AND BROCHURES RELATING TO GIRLS FITNESS; STICKERS, DECALS, BUMPER STICKERS; PAPER PARTY KITS CONSISTING OF INVITATIONS, PAPER CUPS, PAPER PLATES, PAPER PARTY FAVORS FAVOR BAGS, TABLE COVERS, NAPKINS AND PLACE CARDS; PAPER PARTY DECORATIONS; PAPER BADGES, DIARIES, AGENDA BOOKS, STICKERS FOR FINGERNAILS, TRADING CARDS, POST CARDS, PHOTOGRAPH ALBUMS, GIFT WRAPPING PAPER, PAPER BOXES FOR STORAGE, AUTOGRAPH BOOKS, BOOK COVERS, SCRAPBOOKS, PAPER BANNERS, ACTIVITY BOOKS FOR TEENAGE GIRLS, MAGAZINES OF GENERAL INTEREST FOR TEEN GIRLS, TEMPORARY TATTOOS AND PAPER PATCHES FOR CLOTHING (U.S. CLS. 2, 5, 22, 23, 29, 37, 38 AND 50).

CLASS 25—CLOTHING

FOR SHIRTS, T-SHIRTS, TANK TOPS, PANTS, SHORTS, SWEAT PANTS, SWEAT SHIRTS, SWEAT SHORTS, SKIRTS, VESTS, SWEATERS, SCARVES, HOODIES, JACKETS, COATS, HATS, CAPS, HEADWEAR, UNDERWEAR, PANTIES, SOCKS, STOCKINGS, LEOTARDS, BATHING SUITS, SWIMSUITS, BEACH COVER-UPS, NIGHT SHIRTS, NIGHT GOWNS, PAJAMAS, BATHROBES, SHOES, BOOTS, SANDALS, SLIPPERS, BELTS, AND BANDANAS (U.S. CLS. 22 AND 39).

MIDGE BUTLER, EXAMINING ATTORNEY

SN 78-285,783. PRETTY TOUGH SPORTS, LLC, STUDIO CITY, CA. FILED 8-11-2003.

PRETTY TOUGH**CLASS 3—COSMETICS AND CLEANING PREPARATIONS**

FOR COSMETICS, NAMELY, HAIR GEL, SHOWER GEL, BATH GEL, SKIN SOAP, NON-MEDICATED BATH SALTS, PERFUME OILS, BATH OILS, SKIN CLEANSERS, FACIAL CLEANSERS, DEODORANTS, SHAMPOO, HAIR CONDITIONERS, BLUSH, BODY POWDER, FACE POWDER, EYE SHADOW, EYE EYELINER, COSMETIC PENCILS, EYE PENCILS, EYEBROW PENCILS, MASCARA, MAKEUP, EYE-MAKEUP REMOVER, SKIN CREAM, MOISTURIZING SKIN LOTION, LIPSTICK, NON-MEDICATED LIP BALM, LIP GLOSS, COLOGNE, NAIL POLISH, LIP CREAM, BRONZING POWDER AND LOTION, FACE GLITTER, BODY GLITTER, AND FACE PAINT, BATH POWDER, PERFUMERY, PRE-MOISTENED COSMETIC TOWELETTS, SUNSCREEN, SUNBLOCK, SCENTED BODY SPRAY, TOOTHPASTE, MOISTURIZING CRÈME FOR HANDS, FEET, FACE AND BODY, BODY BALMS, LIQUID TALC, PUMICE STONES FOR PERSONAL USE, EMERY BOARDS AND ESSENTIAL OILS FOR PERSONAL USE; COSMETIC KITS CONSISTING OF SHAMPOO, MOISTURIZING LOTION, HAIR CONDITIONER, SUNSCREEN, AND LIQUID TALC (U.S. CLS. 1, 4, 6, 50, 51 AND 52).

SN 78-290,146. DEAN, KURT, POHLHEIM-GRUNINGEN, FED REP GERMANY, FILED 8-21-2003.

RONCOCINI

PRIORITY CLAIMED UNDER SEC. 44(D) ON FED REP GERMANY APPLICATION NO. 30313210.8/2, FILED 3-17-2003, REG. NO. 30313210, DATED 7-24-2003, EXPIRES 3-31-2013.

CLASS 29—MEATS AND PROCESSED FOODS

FOR SALTED MEAT, MEAT FISH, POULTRY AND VENISON; PRESERVED MEAT, BEEF EXTRACTS; PREPARATIONS FOR THE PRODUCTION OF CONSOMME, NAMELY, WOODRUFF GRAVY, POULTRY GRAVY, MUSHROOM GRAVY, BEEF GRAVY; CONSOMME MIXES; MEAT JELLIES; SAUSAGES; SAUSAGE PRODUCTS, NAMELY, FRIED SAUSAGE IN A SPICY SAUCE, GRILLED SAUSAGE, FRIED SAUSAGE WITH HAM AND SPICY SMOKED SAUSAGE WITH GARLIC; MEAT PRODUCTS, NAMELY, CHICKEN, CAPON, PORK, BEEF, STEAKS, PORK CUTLETS AND CAPON CUTLETS, HONEY BEEF; HAM; TINNED FOOD, NAMELY, CANNED CAPON, CHICKEN, PORK, BEEF, STEAKS, PORK CUTLETS AND CAPON CUTLETS, HONEY BEEF, PORK HAM AIR-DRIED AND NATURALLY RIPENED, BEEF HAM AIR DRIED AND NATURALLY RIPENED; SOUPS; EDIBLE FAT; FAST FOOD, NAMELY, HONEY BEEF ROASTED, HONEY BEEF BURGER, HAMBURGER, HONEY HAM GRILLED, PORK STEAKS GROUND, POTATOES, FILLED MUSHROOMS, CHILI CON CARNE, MEATLOAF, MEAT CUT INTO STRIPS, POTATO FRITTERS, POTATO GRATIN, ESSENTIALLY MADE OF ANIMAL AND/OR VEGETABLE PROTEINS; FAST FOOD, NAMELY, PRE-CUT VEGETABLE SALAD (U.S. CL. 46).

CLASS 30—STAPLE FOODS

FOR FETTUCCINI WITH PESTO SAUCE, RAVIOLI IN TOMATO SAUCE, TORTELLONI IN CREAM SAUCE, TORTELLINI IN CREAM SAUCE, PIES, ESSENTIALLY MADE OF MEAT, EGGS, FLOUR, CREAM, MILK AND/OR VEGETABLE; SPICES, MIXED SPICES; SEASONINGS; MIXED SEASONINGS FOR FOOD; ROLLS; SANDWICHES; PASTA; BREAD, CAKES AND PASTRIES; SAUCES (U.S. CL. 46).

KEVON CHISOLM, EXAMINING ATTORNEY

SN 78-293,398. JAYSON SHANE JORGENSEN, PROVO, UT. FILED 8-28-2003.



NO CLAIM IS MADE TO THE EXCLUSIVE RIGHT TO USE "REAL ESTATE DATA EXCHANGE", APART FROM THE MARK AS SHOWN.

CLASS 9—ELECTRICAL AND SCIENTIFIC APPARATUS

FOR COMPUTER SOFTWARE AND DOWNLOADABLE COMPUTER SOFTWARE, FOR DOWNLOADING AND MANAGING REAL ESTATE LISTINGS (U.S. CLS. 21, 23, 26, 36 AND 38).

CLASS 36—INSURANCE AND FINANCIAL

FOR REAL ESTATE LISTING SERVICES (U.S. CLS. 100, 101 AND 102).
TRACY FLETCHER, EXAMINING ATTORNEY

SN 78-294,835. LINDEN CORPORATION, WILMINGTON, DE. FILED 9-2-2003.

**GET READY, GET SET,
BRUSH****CLASS 3—COSMETICS AND CLEANING PREPARATIONS**

FOR GENERAL PURPOSE CLEANING, POLISHING, SCOURING AND ABRASIVE LIQUIDS AND POWDERS; DRAIN AND SINK CLEANING LIQUIDS AND POWDERS; DISH AND LAUNDRY DETERGENTS; LIME-SCALE REMOVERS, RUST REMOVERS, DECALCIFYING AND DESCALING PREPARATIONS FOR HOUSEHOLD USE; SOAPS (U.S. CLS. 1, 4, 6, 50, 51 AND 52).

CLASS 5—PHARMACEUTICALS

FOR ALL PURPOSE DISINFECTANTS; FUNGICIDES FOR DOMESTIC USE; AIR FRESHENERS, PREPARATIONS OR SUBSTANCES HAVING SANITARY, DISINFECTING, AIR FRESHENING, AIR PURIFYING OR FUNGICIDAL PROPERTIES, NAMELY, FUNGICIDES FOR DOMESTIC USE, AIR DEODORIZERS, SANITIZERS FOR BATHROOMS AND TOILETS, AIR DEODORANTS (U.S. CLS. 6, 18, 44, 46, 51 AND 52).

CLASS 21—HOUSEWARES AND GLASS

FOR HOUSEHOLD OR KITCHEN UTENSILS AND CONTAINERS; COMBS AND SPONGES; BRUSHES EXCEPT PAINT BRUSHES; BROOMS; CARPET SWEEPERS; MOPS; SCRUBBING BRUSHES; ARTICLES FOR CLEANING PURPOSES; CLEANING RAGS, DUSTERS, CLOTHS FOR CLEANING; CLOTHS IMPREGNATED WITH A DETERGENT FOR CLEANING, POLISHING, SCOURING OR BLEACHING; STEELWOOL; POLISHING MATERIALS; POLISHING LEATHER (U.S. CLS. 2, 13, 23, 29, 30, 33, 40 AND 50).

CAROLYN GRAY, EXAMINING ATTORNEY

SN 78-295,997. DOCUCORP INTERNATIONAL, INC., DALLAS, TX. FILED 9-4-2003.

**CLASS 9—ELECTRICAL AND SCIENTIFIC APPARATUS**

FOR INTERACTIVE COMPUTER SOFTWARE FOR DOCUMENT CREATION, PRODUCTION, CONVERSION, RECORDING, INDEXING, ARCHIVING, PRINTING, DISPLAYING, PUBLISHING, TRANSMISSION, ENCRYPTION, MANAGEMENT, TYPOGRAPHY, AND DISTRIBUTION, ALL FOR HIGH VOLUME DOCUMENTS FOR BUSINESS USE (U.S. CLS. 21, 23, 26, 36 AND 38).

CLASS 35—ADVERTISING AND BUSINESS

FOR OUTSOURCING SERVICES FOR OTHERS IN THE FIELD OF DOCUMENT AUTOMATION, NAMELY FOR DOCUMENT CREATION, PRODUCTION, CONVERSION, RECORDING, INDEXING, ARCHIVING, PRINTING, DISPLAYING, VIEWING, PUBLISHING, TRANSMISSION, ENCRYPTION, MANAGEMENT, TYPOGRAPHY, AND DISTRIBUTION (U.S. CLS. 100, 101 AND 102).

CLASS 42—SCIENTIFIC, COMPUTER AND LEGAL SERVICES

FOR PROVIDING TEMPORARY USE OF ON-LINE NON-DOWNLOADABLE COMPUTER SOFTWARE FOR DOCUMENT AUTOMATION, ELECTRONIC PRESENTMENT OF INFORMATION, AND E-COMMERCE SOLUTIONS, NAMELY FOR DOCUMENT CREATION, PRODUCTION, CONVERSION, RECORDING, INDEXING, ARCHIVING, PRINTING, DISPLAYING, PUBLISHING, TRANSMISSION, ENCRYPTION, MANAGEMENT, TYPOGRAPHY, AND DISTRIBUTION, ALL FOR HIGH VOLUME DOCUMENTS FOR BUSINESS USE, VIA A GLOBAL COMPUTER INFORMATION NETWORK; DATA ENCRYPTION SERVICES; BUSINESS DOCUMENT AND FORM RETRIEVAL SERVICES PROVIDED VIA INTERNET (U.S. CLS. 100 AND 101).

JEFFERY COWARD, EXAMINING ATTORNEY

SN 78-298,729. PEAK PROFILE COMPANY, SALT LAKE CITY, UT. FILED 9-10-2003.

PEAK BUILDING PRODUCTS

NO CLAIM IS MADE TO THE EXCLUSIVE RIGHT TO USE "BUILDING PRODUCTS", APART FROM THE MARK AS SHOWN.

CLASS 6—METAL GOODS

FOR METAL BUILDING MATERIALS, NAMELY, WINDOW BUCKS, WINDOW SILLS, WINDOW FRAMES, WINDOW CASEMENTS, WINDOW WELLS, PANELING, AND FENCING (U.S. CLS. 2, 12, 13, 14, 23, 25 AND 50).

CLASS 19—NON-METALLIC BUILDING MATERIALS

FOR NON-METAL BUILDING MATERIALS, NAMELY, WINDOWS, WOOD AND PLASTIC MOLDINGS, DOOR ENTRIES, PANELING, FENCING, EXTRUDED BUILDING PRODUCTS, NAMELY, CURTAIN WALLS, WINDOW WALLS, WINDOW COVERINGS, WINDOW SILLS, WINDOW CASEMENTS, WINDOW GLASS, PLASTIC BUILDING PRODUCTS, NAMELY, DECKING AND PARTS AND COMPONENTS THEREOF, SIDING AND PARTS AND COMPONENTS THEREOF, AND DECK RAILS (U.S. CLS. 1, 12, 33 AND 50).

JEFF DEFORD, EXAMINING ATTORNEY

SN 78-303,667. TARKETT INC., FARNHAM, QUEBEC, FILED 9-22-2003.

STAND ON EXCELLENCE**CLASS 1—CHEMICALS**

FOR ADHESIVES FOR USE IN CONNECTION WITH THE INSTALLATION OF TILES, SOLID VINYL TILES AND OTHER FLOOR COVERINGS (U.S. CLS. 1, 5, 6, 10, 26 AND 46).

CLASS 3—COSMETICS AND CLEANING PREPARATIONS

FOR FLOOR PRODUCTS, NAMELY CLEANERS, WAXES AND POLISHES (U.S. CLS. 1, 4, 6, 50, 51 AND 52).

CLASS 19—NON-METALLIC BUILDING MATERIALS

FOR WOOD FLOORING (U.S. CLS. 1, 12, 33 AND 50).

CLASS 27—FLOOR COVERINGS

FOR FLOOR COVERINGS, NAMELY, VINYL FLOOR COVERINGS IN THE FORM OF TILES, PLANKS AND SHEETS (U.S. CLS. 19, 20, 37, 42 AND 50).

PAUL F. GAST, EXAMINING ATTORNEY

SN 78-306,591. ALEX C. FERGUSSON, INC., FRAZER, PA. FILED 9-29-2003.

**CLASS 1—CHEMICALS**

FOR DEGREASING PREPARATIONS FOR USE ON FOOD PROCESSING EQUIPMENT; WATER TREATMENT CHEMICALS FOR USE IN FOOD PROCESSING PLANTS (U.S. CLS. 1, 5, 6, 10, 26 AND 46).

CLASS 3—COSMETICS AND CLEANING PREPARATIONS

FOR CLEANERS FOR USE IN FOOD PROCESSING INDUSTRIES ON FLOORS, WALLS AND FOOD PROCESSING EQUIPMENT (U.S. CLS. 1, 4, 6, 50, 51 AND 52).

CLASS 11—ENVIRONMENTAL CONTROL APPARATUS

FOR WATER TREATMENT PRODUCTS, NAMELY CHEMICAL AND AQUEOUS-SOLUTION BASED STERILIZATION APPARATUS FOR USE PRINCIPALLY IN FOOD TREATMENT PLANTS (U.S. CLS. 13, 21, 23, 31 AND 34).

BRETT J. GOLDEN, EXAMINING ATTORNEY

SN 78-306,862. BLAVOD BLACK VODKA PLC, LONDON, UNITED KINGDOM, FILED 9-29-2003.

SN 78-307,082. LYRIA S.R.L., PRATO, ITALY, FILED 9-30-2003.



OWNER OF U.S. REG. NO. 2,795,524.

CLASS 33—WINES AND SPIRITS

FOR DISTILLED ALCOHOLIC BEVERAGES, NAMELY LIQUORS AND SPIRITS (U.S. CLS. 47 AND 49).

CLASS 35—ADVERTISING AND BUSINESS

FOR DISTRIBUTORSHIP SERVICES IN THE FIELD OF BEVERAGES (U.S. CLS. 100, 101 AND 102).
JEFFERY COWARD, EXAMINING ATTORNEY

SN 78-306,868. BLAVOD BLACK VODKA PLC, LONDON, UNITED KINGDOM, FILED 9-29-2003.



OWNER OF U.S. REG. NO. 2,795,524.
NO CLAIM IS MADE TO THE EXCLUSIVE RIGHT TO USE "VODKA RUM GIN", APART FROM THE MARK AS SHOWN.

CLASS 33—WINES AND SPIRITS

FOR DISTILLED ALCOHOLIC BEVERAGES, NAMELY LIQUORS AND SPIRITS (U.S. CLS. 47 AND 49).

CLASS 35—ADVERTISING AND BUSINESS

FOR DISTRIBUTORSHIP SERVICES IN THE FIELD OF BEVERAGES (U.S. CLS. 100, 101 AND 102).
JEFFERY COWARD, EXAMINING ATTORNEY

lyria

CLASS 22—CORDAGE AND FIBERS

FOR ROPES, STRING AND SAILS, PADDING AND STUFFING MATERIALS NOT OF RUBBER OR PLASTICS, RAW FIBROUS TEXTILE MATERIALS (U.S. CLS. 1, 2, 7, 19, 22, 42 AND 50).
FIRST USE 7-0-2003; IN COMMERCE 7-0-2003.

CLASS 23—YARNS AND THREADS

FOR YARNS AND THREADS FOR TEXTILE USE (U.S. CL. 43).
FIRST USE 7-0-2003; IN COMMERCE 7-0-2003.

CLASS 24—FABRICS

FOR TEXTILES AND TEXTILE GOODS NAMELY TAPESTRIES, TEXTILE FABRICS FOR THE MANUFACTURE OF CLOTHING, TEXTILE LININGS FOR GARMENTS, TEXTILE NAPKINS, TEXTILE PLACEMATS, TEXTILE WALL HANGINGS, BED COVERS AND TABLE COVERS NOT MADE OF PAPER (U.S. CLS. 42 AND 50).
FIRST USE 7-0-2003; IN COMMERCE 7-0-2003.

CLASS 25—CLOTHING

FOR CLOTHING NAMELY PANTS, SHIRTS, JACKETS, SHORTS; FOOTWEAR; HEADWEAR AND HEADGEAR NAMELY HATS AND CAPS (U.S. CLS. 22 AND 39).
FIRST USE 7-0-2003; IN COMMERCE 7-0-2003.
ROBERT LORENZO, EXAMINING ATTORNEY

SN 78-307,161. THE HAIN CELESTIAL GROUP, INC., MELVILLE, NY. FILED 9-30-2003.

CARB FIT

NO CLAIM IS MADE TO THE EXCLUSIVE RIGHT TO USE "CARB", APART FROM THE MARK AS SHOWN.

CLASS 29—MEATS AND PROCESSED FOODS

FOR NON DAIRY SOY BASED FOOD BEVERAGES, SOUPS, SOY BASED SNACK FOODS, FRUIT BASED SNACK FOODS, SOY BASED SNACK BARS AND FRUIT BASED SNACK BARS AND FROZEN ENTREES CONSISTING PRIMARILY OF MEAT, FISH, POULTRY OR VEGETABLES (U.S. CL. 46).

CLASS 30—STAPLE FOODS

FOR BREAKFAST CEREALS, SHAKES, FLOURS, CAKE MIXES, MUFFIN MIXES, BREAD MIXES, PANCAKE MIXES, WAFFLE MIXES, READY TO EAT PIE CRUSTS, COOKIES, FROZEN ENTREES CONSISTING PRIMARILY OF PASTA OR RICE, WHEAT BASED SNACK FOODS, RICE BASED SNACK FOODS, CEREAL BASED SNACK FOODS, CEREAL BASED SNACK BARS, WHEAT BASED SNACK BARS, RICE BASED SNACK BARS, PASTA AND RAVIOLI, AND SOY-BASED ICE CREAM (U.S. CL. 46).

CLASS 32—LIGHT BEVERAGES

FOR FRUIT JUICES (U.S. CLS. 45, 46 AND 48). CHRISTOPHER BUONGIORNO, EXAMINING ATTORNEY

SN 78-307,683. UNITED STATES POSTAL SERVICE, WASHINGTON, DC. FILED 9-30-2003.



THE MARK CONSISTS, IN PART, OF STYLIZED HUMAN LIPS.

CLASS 6—METAL GOODS

FOR METAL KEY CHAINS AND KEY RINGS (U.S. CLS. 2, 12, 13, 14, 23, 25 AND 50).

CLASS 14—JEWELRY

FOR JEWELRY AND PLASTIC BEADS FOR USE AS JEWELRY (U.S. CLS. 2, 27, 28 AND 50).

CLASS 18—LEATHER GOODS

FOR LEATHER KEY CHAINS, COSMETIC BAGS SOLD EMPTY, BAGS FOR WOMEN AND CHILDREN, NAMELY, BACKPACKS, MESSENGER BAGS, COIN PURSES, TOTE BAGS, SCHOOL BAGS, SCHOOL BOOK BAGS, PURSES, ALL-PURPOSE SPORTS BAGS, DUFFLE BAGS, AND OVERNIGHT LUGGAGE AND ROLLING LUGGAGE (U.S. CLS. 1, 2, 3, 22 AND 41).

CLASS 20—FURNITURE AND ARTICLES NOT OTHERWISE CLASSIFIED

FOR NON-METAL AND NON-LEATHER KEY CHAINS AND KEY RINGS, AND HAND-HELD, PERSONAL COMPACT AND FURNITURE MIRRORS (U.S. CLS. 2, 13, 22, 25, 32 AND 50).

CLASS 21—HOUSEWARES AND GLASS

FOR CUPS, MUGS, PLATES, WATER BOTTLES SOLD EMPTY, SPECIALTY HOLDERS FOR CARRYING WATER BOTTLES, LUNCH BOXES AND HAIR COMBS (U.S. CLS. 2, 13, 23, 29, 30, 33, 40 AND 50). JEFFERY COWARD, EXAMINING ATTORNEY

SN 78-308,082. GRAND ISLAND CARWASH, INC., GRAND ISLAND, NY. FILED 10-1-2003.

DR. HUGGS CAR WASH

NO CLAIM IS MADE TO THE EXCLUSIVE RIGHT TO USE "CAR WASH", APART FROM THE MARK AS SHOWN.

CLASS 35—ADVERTISING AND BUSINESS

FOR RETAIL STORE SERVICES FEATURING PROPANE GAS AND CAR WASH EQUIPMENT (U.S. CLS. 100, 101 AND 102).

CLASS 37—CONSTRUCTION AND REPAIR

FOR CAR WASHING SERVICES AND CAR DETAILING SERVICES (U.S. CLS. 100, 103 AND 106). BILL DAWE, EXAMINING ATTORNEY

SN 78-308,676. SPL ENTERPRISES, INCORPORATED, MCCORDSVILLE, IN. FILED 10-2-2003.



THE FOREIGN WORDING IN THE MARK TRANSLATES INTO ENGLISH AS BARTENDER.

CLASS 29—MEATS AND PROCESSED FOODS

FOR PRODUCTS USED IN THE COFFEE INDUSTRY, NAMELY, SOY MILK (U.S. CL. 46).

CLASS 30—STAPLE FOODS

FOR PRODUCTS USED IN THE COFFEE INDUSTRY, NAMELY, FLAVORING SYRUP, FRAPPE MIXES, TEAS, AND FINISHED BAKED GOODS. (U.S. CL. 46).

CLASS 32—LIGHT BEVERAGES

FOR PRODUCTS USED IN THE COFFEE INDUSTRY, NAMELY, FRUIT SMOOTHIES. (U.S. CLS. 45, 46 AND 48).

TINA L. SNAPP, EXAMINING ATTORNEY

SN 78-311,229. LISA LELEU STUDIOS, INC., DOYLESTOWN, PA. FILED 10-8-2003.

FRENCHY THE FROG

NO CLAIM IS MADE TO THE EXCLUSIVE RIGHT TO USE "FROG", APART FROM THE MARK AS SHOWN.

CLASS 16—PAPER GOODS AND PRINTED MATTER

FOR PUPPET SHOW OUTER BOOK COVERS; CHILDREN'S STORY BOOKLETS; CHILDREN'S STORY STARTER BOOKLETS; INTERACTIVE CHILDREN'S STORY BOOKS THAT INCLUDE COMBINATION OF PUPPET SHOW OUTER BOOK SHELLS, CHILDREN'S STORY BOOKLETS, AND A PUPPET TO PROVIDE AN INTERACTIVE READING EXPERIENCE; INTERACTIVE CHILDREN'S STORY STARTER BOOKS THAT INCLUDE COMBINATION OF PUPPET SHOW OUTER BOOK SHELLS, CHILDREN'S STORY STARTER BOOKLETS AND PUPPET TO PROVIDE AN INTERACTIVE CREATIVE WRITING EXPERIENCE AIDING CHILDREN IN THE CREATION OF THEIR OWN STORIES (U.S. CLS. 2, 5, 22, 23, 29, 37, 38 AND 50).
FIRST USE 7-12-2003; IN COMMERCE 7-12-2003.

CLASS 28—TOYS AND SPORTING GOODS

FOR PUPPETS (U.S. CLS. 22, 23, 38 AND 50).
FIRST USE 7-12-2003; IN COMMERCE 7-12-2003.
ANN E. SAPPENFIELD, EXAMINING ATTORNEY

SN 78-312,970. LONELY COW LIMITED, PAMELL, AUCKLAND, NEW ZEALAND, FILED 10-13-2003.

LONELY COW

PRIORITY CLAIMED UNDER SEC. 44(D) ON NEW ZEALAND APPLICATION NO. 677505, FILED 4-16-2003, REG. NO. 677505, DATED 10-16-2003, EXPIRES 4-16-2013.

PRIORITY CLAIMED UNDER SEC. 44(D) ON NEW ZEALAND APPLICATION NO. 677504, FILED 4-16-2003, REG. NO. 677504, DATED 10-16-2003, EXPIRES 4-16-2013.

CLASS 29—MEATS AND PROCESSED FOODS

FOR PROCESSED FRUITS AND VEGETABLES; PRESERVED, DRIED AND COOKED FRUITS AND VEGETABLES; DAIRY PRODUCTS, EXCLUDING ICE CREAM, ICE MILK, AND FROZEN YOGURT; JAMS; PRESERVES; MEAT, FISH, POULTRY AND GAME; CHEESE, BUTTER, YOGURT; DEHYDRATED CHEESE SNACK FOODS; JELLIES; EGGS; MILK; MILK PRODUCTS, NAMELY, MILK SHAKES, ICE MILK; MEAT EXTRACTS; FROZEN FRUITS AND VEGETABLES; SALADS, NAMELY, FRUIT SALADS AND GARDEN SALADS (U.S. CL. 46).

CLASS 30—STAPLE FOODS

FOR FLOUR AND PREPARATIONS MADE FROM CEREALS, NAMELY, CEREAL BASED SNACK FOOD, BREAD, PASTRY AND CONFECTIONERY IN THE NATURE OF FROZEN CONFECTIONS, CANDY, ICE CREAM, CHOCOLATE, CHOCOLATES; HONEY, TREATS; SAUCES; VINEGAR, CONDIMENTS, NAMELY, SPICES; SALT, MUSTARD, KETCHUP; COFFEE, TEA, COCOA, SUGAR, RICE; PASTA; CHUTNEY; SALADS, NAMELY, PASTA SALADS (U.S. CL. 46).

KIMBERLY PERRY, EXAMINING ATTORNEY

SN 78-314,140. LOCKHEED MARTIN CORPORATION, BETHESDA, MD. FILED 10-15-2003.

CHANGING THE CLOCK SPEED OF ROI**CLASS 35—ADVERTISING AND BUSINESS**

FOR COMPUTER HARDWARE AND SOFTWARE PROCUREMENT PURCHASING SERVICES FOR OTHERS, AND CONSULTING SERVICES IN CONNECTION THEREWITH (BASED ON 1A) (U.S. CLS. 100, 101 AND 102).

FIRST USE 8-0-2003; IN COMMERCE 8-0-2003.

CLASS 37—CONSTRUCTION AND REPAIR

FOR COMPUTER HARDWARE INSTALLATION AND MAINTENANCE SERVICES FOR OTHERS (BASED ON 1B) (U.S. CLS. 100, 103 AND 106).

CLASS 41—EDUCATION AND ENTERTAINMENT

FOR TRAINING SERVICES FOR OTHERS IN THE FIELD OF COMPUTER HARDWARE AND SOFTWARE, AND CONSULTING SERVICES IN CONNECTION THEREWITH (BASED ON 1B) (U.S. CLS. 100, 101 AND 107).

CLASS 42—SCIENTIFIC, COMPUTER AND LEGAL SERVICES

FOR COMPUTER HARDWARE DESIGN, CUSTOMIZATION, AND TESTING SERVICES FOR OTHERS (BASED ON 1A) (U.S. CLS. 100 AND 101).

FIRST USE 8-0-2003; IN COMMERCE 8-0-2003.

JENNIFER KRISP, EXAMINING ATTORNEY

SN 78-316,062. ITC FINANCIAL SERVICES, LLC, WEST POINT, GA. FILED 10-20-2003.

THE ONLY WAY**CLASS 9—ELECTRICAL AND SCIENTIFIC APPARATUS**

FOR MULTI-FUNCTIONAL MAGNETICALLY ENCODED ATM, DEBIT, STORED VALUE AND CREDIT CARDS (U.S. CLS. 21, 23, 26, 36 AND 38).

CLASS 36—INSURANCE AND FINANCIAL

FOR MULTI-FUNCTIONAL ATM, DEBIT STORED VALUE AND CREDIT CARD SERVICES; CONDUCTING FINANCIAL TRANSACTIONS VIA A COMPUTER NETWORK THAT CONNECTS TO OTHER NETWORKS FOR CONDUCTING FINANCIAL TRANSACTIONS, NAMELY, POINT OF SALE TRANSACTIONS AND MULTI-FUNCTIONAL ATM, DEBIT, STORED VALUE AND CREDIT CARD TRANSACTIONS; FINANCIAL SERVICES, NAMELY, ELECTRONIC PROCESSING AND TRANSMISSION OF BILL PAYMENT DATA, BILL PAYMENT SERVICES, AND CREDIT CARD, DEBIT CARD, ATM AND STORED VALUE CARD TRANSACTION PROCESSING SERVICES (U.S. CLS. 100, 101 AND 102).

ESTHER BELENKER, EXAMINING ATTORNEY

SN 78-316,602. DISNEY ENTERPRISES, INC., BURBANK, CA. FILED 10-21-2003.

OWNER OF AUSTRALIA REG. NO. 676667, DATED 10-30-1995, EXPIRES 10-30-2005.

WALT DISNEY WORLD

OWNER OF U.S. REG. NOS. 980,995, 1,189,727 AND 2,189,177.

THE NAME IN THE MARK DOES NOT IDENTIFY A PARTICULAR LIVING INDIVIDUAL.

CLASS 39—TRANSPORTATION AND STORAGE

FOR ARRANGING TRAVEL TOURS; AND TRAVEL AGENCY SERVICE, NAMELY, MAKING RESERVATIONS AND BOOKINGS FOR TRANSPORTATION (U.S. CLS. 100 AND 105).

CLASS 43—HOTEL AND RESTAURANT SERVICES

FOR TRAVEL AGENCY SERVICE, NAMELY, MAKING RESERVATIONS AND BOOKINGS FOR TEMPORARY LODGING AND FOR RESTAURANTS AND MEALS (U.S. CLS. 100 AND 101).

PAUL F. GAST, EXAMINING ATTORNEY

SN 78-316,806. HOFFMANN-LA ROCHE INC., NUTLEY, NJ. FILED 10-22-2003.



TAKE A BREATH

CLASS 16—PAPER GOODS AND PRINTED MATTER

FOR PRINTED MATERIALS, NAMELY NEWSLETTERS PROVIDING INFORMATION ABOUT ASTHMA CLINICAL TRIALS (U.S. CLS. 2, 5, 22, 23, 29, 37, 38 AND 50).

CLASS 42—SCIENTIFIC, COMPUTER AND LEGAL SERVICES

FOR PROVIDING INFORMATION ABOUT ASTHMA CLINICAL RESEARCH TRIALS, INCLUDING INFORMATION ABOUT PARTICIPATION OPPORTUNITIES IN ASTHMA CLINICAL RESEARCH STUDIES, VIA THE INTERNET (U.S. CLS. 100 AND 101).

ANDREA K. NADELMAN, EXAMINING ATTORNEY

SN 78-317,535. OPORTO PORTUGUESE STYLE CHICKEN PTY LIMITED, SYDNEY, NEW SOUTH WALES, AUSTRALIA, FILED 10-23-2003.



OWNER OF AUSTRALIA REG. NO. 676668, DATED 10-30-1995, EXPIRES 10-30-2005.

CLASS 29—MEATS AND PROCESSED FOODS

FOR (BASED ON 44(E)) MEAT; FISH; MEAT EXTRACTS; BEEF BURGERS, NAMELY HAMBURGERS; POULTRY, NAMELY UNCOOKED, MARINATED, PREPARED FOR COOKING, COOKED AND OTHER POULTRY; POULTRY, NAMELY PREPARED CHICKEN, CHICKEN BURGERS, CHICKEN SCHNITZEL AND CHICKEN SCHNITZEL BURGERS, CHILI CHICKEN; POULTRY AND VEGETABLES, NAMELY PRE-PACKAGED DINNERS CONSISTING OF CHICKEN WITH POTATOES, NAMELY FRENCH-FRIED POTATOES AND CHICKEN, VEGETABLES AND SALADS WITH DRESSING; SAUSAGES; FRUIT SALADS; VEGETABLE SALADS; JELLIES, NAMELY MEAT JELLIES AND FLAVORED JELLIES; COOKED, DRIED AND PRESERVED VEGETABLES; COOKED, DRIED AND PRESERVED VEGETABLES PREPARED WITH SAUCES AND DRESSINGS; CONDIMENTS, NAMELY PEPPER OIL AND MARINATED AND PROCESSED ONIONS (U.S. CL. 46).

CLASS 30—STAPLE FOODS

FOR (BASED ON 44(E)) GRAVIES; CONDIMENTS, NAMELY KETCHUP, RELISH; SAUCES, NAMELY CHILI SAUCE, HOT SAUCE, PIQUANTE SAUCE, TOMATO SAUCE, BARBEQUE SAUCE, LEMON AND HERB SAUCE; FRUIT JELLIES; (BASED ON INTENT TO USE) MUSTARD AND MAYONNAISE (U.S. CL. 46).

CLASS 43—HOTEL AND RESTAURANT SERVICES

FOR (BASED ON 44(E)) RESTAURANT SERVICES, NAMELY RESTAURANTS, CAFES AND SNACK BARS FEATURING DINE-IN AND TAKE-OUT SERVICES, HOME DELIVERY AND SELF-SERVICE (U.S. CLS. 100 AND 101).

ROBERT LORENZO, EXAMINING ATTORNEY

SN 78-317,689. B & W TEK, INC., NEWARK, DE. FILED 10-23-2003.

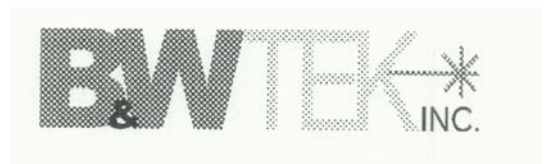

NO CLAIM IS MADE TO THE EXCLUSIVE RIGHT TO USE "INC.", APART FROM THE MARK AS SHOWN.

THE MARK IS COMPRISED OF APPLICANT'S NAME IN UNITARY FORM, "B&WTEKINC.," ATTACHED TO AN ASTERISK-LIKE DESIGN COMPONENT EXTENDING HORIZONTALLY TO THE RIGHT FROM THE "K" IN THE WORD "TEK."

CLASS 9—ELECTRICAL AND SCIENTIFIC APPARATUS

FOR OPTICAL SPECTROMETERS FOR NON-MEDICAL USE; LASERS FOR NON-MEDICAL USE; LIGHT SOURCES, NAMELY, DIODES, ELECTRIC DIODES, LASER DIODES, LIGHT DIODES, LIGHT EMITTING DIODES, SUPER-LUMINESCENT LASER DIODES, AND AMPLIFIED SPONTANEOUS EMISSION LASER DIODES; LIGHTING SYSTEMS COMPRISED OF LIGHT EMITTING DIODES AND CONVENTIONAL LAMPS; FIBER OPTICS; BIOMEDICAL INSTRUMENTS, NAMELY, DNA AND PROTEIN CHIP SCANNERS AND CYTOMETERS; OPTICAL SENSORS FOR BIOLOGICAL AND CHEMICAL SENSING, TEMPERATURE MEASUREMENT, AND STRAIN MEASUREMENT; AND ANALYTICAL APPARATUS, NAMELY, SENSING AND SIGNALING DEVICES FOR MEASUREMENT AND QUALITY CONTROL OF DISPLAY OF LIGHT EMITTING DIODES, OF MATERIALS PROCESSING, OF ENVIRONMENTAL MONITORING, AND OF GEMSTONE ANALYSIS (U.S. CLS. 21, 23, 26, 36 AND 38).
FIRST USE 1-1-1997; IN COMMERCE 1-1-1997.

CLASS 10—MEDICAL APPARATUS

FOR OPTICAL SPECTROMETERS FOR MEDICAL USE; LASERS FOR MEDICAL USE; SURGICAL LAMPS, MEDICAL EXAMINATION LAMPS; SURGICAL INSTRUMENTS, NAMELY, SURGICAL LASERS AND SCOPES; APPARATUS FOR CLINICAL DIAGNOSIS; AND ANALYTICAL APPARATUS FOR MEDICAL PURPOSES (U.S. CLS. 26, 39 AND 44).
FIRST USE 1-1-1997; IN COMMERCE 1-1-1997.
SUSAN STIGLITZ, EXAMINING ATTORNEY

SN 78-319,662. CROCE, PASQUALE W., JR., HAVERFORD, PA. FILED 10-28-2003.

PIRATE SOUL

NO CLAIM IS MADE TO THE EXCLUSIVE RIGHT TO USE PIRATE, APART FROM THE MARK AS SHOWN.

CLASS 9—ELECTRICAL AND SCIENTIFIC APPARATUS

FOR PRERECORDED VIDEO CASSETTES, CDS AND CD-ROMS, AND DVDS FEATURING PIRATE AND PIRATE HISTORY SUBJECT MATTER; DECORATIVE AND REFRIGERATOR MAGNETS; AND MOUSE PADS (U.S. CLS. 21, 23, 26, 36 AND 38).

CLASS 14—JEWELRY

FOR JEWELRY AND WATCHES; AND NOVELTY ORNAMENTAL PINS (U.S. CLS. 2, 27, 28 AND 50).

CLASS 16—PAPER GOODS AND PRINTED MATTER

FOR BOOKS AND BROCHURES FEATURING PIRATE AND PIRATE HISTORY SUBJECT MATTER; COUPONS; DECALS; GREETING CARDS; PAPER GIFT AND SHOPPING BAGS; PLASTIC SHOPPING BAGS; PAPERWEIGHTS; PENS; POSTCARDS; POSTERS; PRODUCT CATALOGS, STATIONERY; TICKETS; PAPER COASTERS; AND TREASURE MAPS (U.S. CLS. 2, 5, 22, 23, 29, 37, 38 AND 50).

CLASS 18—LEATHER GOODS

FOR TOTE BAGS AND LINEN SHOPPING BAGS (U.S. CLS. 1, 2, 3, 22 AND 41).

CLASS 20—FURNITURE AND ARTICLES NOT OTHERWISE CLASSIFIED

FOR PICTURE FRAMES AND KEY CHAINS NOT OF METAL OR LEATHER (U.S. CLS. 2, 13, 22, 25, 32 AND 50).

CLASS 21—HOUSEWARES AND GLASS

FOR BEVERAGeware; GLASSWARE; MUGS; AND PLASTIC COASTERS (U.S. CLS. 2, 13, 23, 29, 30, 33, 40 AND 50).

CLASS 24—FABRICS

FOR CLOTH FLAGS, TOWELS AND BEACH TOWELS (U.S. CLS. 42 AND 50).

CLASS 25—CLOTHING

FOR CLOTHING FOR MEN, WOMEN AND CHILDREN, NAMELY PANTS, SHORTS, SHIRTS, T-SHIRTS, SWEATSHIRTS, AND JACKETS; HATS AND BANDANAS; FOOTWEAR; AND MASQUERADE AND HALLOWEEN COSTUMES (U.S. CLS. 22 AND 39).

CLASS 26—FANCY GOODS

FOR NOVELTY ORNAMENTAL CLOTH PATCHES (U.S. CLS. 37, 39, 40, 42 AND 50).

CLASS 28—TOYS AND SPORTING GOODS

FOR TOYS, NAMELY, TOY SHIPS, DOLLS, ACTION FIGURES, TOY FIGURINES, STUFFED ANIMALS, TOY TREASURE CHESTS, AND GAMES AND PUZZLES (U.S. CLS. 22, 23, 38 AND 50).

CLASS 34—SMOKERS' ARTICLES

FOR ASHTRAYS AND CIGARETTE LIGHTERS, NOT OF PRECIOUS METAL (U.S. CLS. 2, 8, 9 AND 17).

CLASS 35—ADVERTISING AND BUSINESS

FOR RETAIL AND ON-LINE RETAIL STORE SERVICES IN THE AREAS OF APPAREL, GIFT ITEMS AND SOUVENIRS; ON-LINE RETAIL SERVICES FEATURING PIRATE-RELATED GOODS (U.S. CLS. 100, 101 AND 102).

CLASS 41—EDUCATION AND ENTERTAINMENT

FOR ENTERTAINMENT SERVICES, NAMELY, AN INTERACTIVE ATTRACTION AND SELF-GUIDED WALK-THROUGH TOUR FEATURING TOUCH SCREENS, AUDIO AND VISUAL DISPLAYS, INTERACTIVE EXHIBITS, PRESENTATIONS AND PROJECTIONS, ALL RELATING TO PIRATES AND PIRATE HISTORY; CONDUCTING ENTERTAINMENT AND EDUCATIONAL EXHIBITIONS FEATURING INTERACTIVE EXHIBITS, DISPLAYS, ARTIFACTS AND ACTIVITIES RELATING TO PIRATES AND PIRATE HISTORY; AND PROVIDING A WEBSITE FEATURING INFORMATION ABOUT PIRATES AND PIRATE HISTORY (U.S. CLS. 100, 101 AND 107).
RON FAIRBANKS, EXAMINING ATTORNEY

SN 78-320,914. DAN-DEE INTERNATIONAL, LTD., JERSEY CITY, NJ. FILED 10-30-2003.

CHRISTMAS COMING

NO CLAIM IS MADE TO THE EXCLUSIVE RIGHT TO USE "CHRISTMAS", APART FROM THE MARK AS SHOWN.

CLASS 26—FANCY GOODS

FOR ARTIFICIAL WREATHS. (U.S. CLS. 37, 39, 40, 42 AND 50).

CLASS 28—TOYS AND SPORTING GOODS

FOR TOY POLYRESIN FIGURINES, PLUSH TOYS AND DOLLS; SEASONAL DECORATIONS NAMELY CHRISTMAS STOCKINGS, ARTIFICIAL CHRISTMAS WREATHS AND GARLANDS AND CHRISTMAS TREE SKIRTS. (U.S. CLS. 22, 23, 38 AND 50).

STEVEN R. FOSTER, EXAMINING ATTORNEY

SN 78-323,346. TYRY, INC., ROCKLIN, CA. FILED 11-5-2003.

GOURMET RESERVES

THE MARK CONSISTS OF STANDARD CHARACTERS WITHOUT CLAIM TO ANY PARTICULAR FONT, STYLE, SIZE, OR COLOR.
SEC. 2(F).

CLASS 29—MEATS AND PROCESSED FOODS

FOR FREEZE-DRIED AND DEHYDRATED FOODS, NAMELY MEAT, POULTRY, SEAFOOD, VEGETABLES, FRUITS, EGGS, SOUPS, MILK, CHEESE AND BEANS; FREEZE-DRIED AND DEHYDRATED ENTREES AND SIDE DISHES COMPOSED PRIMARILY OF MEAT, POULTRY, SEAFOOD, OR VEGETABLES (U.S. CL. 46).
FIRST USE 3-1-1989; IN COMMERCE 3-1-1989.

CLASS 30—STAPLE FOODS

FOR FREEZE-DRIED AND DEHYDRATED FOODS, NAMELY BREAKFAST CEREAL, PASTA, RICE, PANCAKE MIX, GRANOLA-BASED AND CEREAL-BASED SNACK FOOD, MAPLE SYRUP, AND FRUIT COBBLER; FREEZE-DRIED AND DEHYDRATED ENTREES AND SIDE DISHES COMPOSED PRIMARILY OF PASTA OR RICE (U.S. CL. 46).
FIRST USE 3-1-1989; IN COMMERCE 3-1-1989.
STACY WAHLBERG, EXAMINING ATTORNEY

SN 78-323,560. ATELIER MARKGRAPH GMBH, FRANKFURT, FED REP GERMANY, FILED 11-5-2003.



THE MARK CONSISTS OF MULTIPLE AND OVERLAPPING RENDERINGS OF THE HANDWRITTEN WORD "MARKGRAPH".

CLASS 35—ADVERTISING AND BUSINESS

FOR ADVERTISING, NAMELY, SERVICE OF AN ADVERTISING AGENCY; REAL ESTATE MARKETING SERVICES, NAMELY, ON-LINE SERVICES FEATURING TOURS OF RESIDENTIAL AND COMMERCIAL REAL ESTATE; PRODUCTION OF TELEVISION COMMERCIALS; MANAGEMENT OF PERFORMING ARTISTS; PUBLICATION OF PUBLICITY TEXTS; DIRECT MARKETING ADVERTISING FOR OTHERS; CONDUCTING MARKETING STUDIES; PUBLIC OPINION POLLING; PRODUCT MERCHANDISING; PUBLIC RELATIONS; ARRANGING AND CONDUCTING TRADE SHOW EXHIBITIONS AND FAIRS FOR OTHERS IN THE FIELD OF PROJECT MANAGEMENT, ADVERTISING, PUBLIC RELATIONS, MARKETING, REAL ESTATE, COMPUTING AND INTERNET SERVICES, TELECOMMUNICATIONS AND FILM, PERFORMING ARTS AND SPORTS; DISSEMINATION OF ADVERTISING FOR OTHERS VIA THE INTERNET; PRODUCTION AND DISTRIBUTION OF RADIO AND TELEVISION COMMERCIALS; WINDOW DISPLAY ARRANGEMENT SERVICES; PROMOTING THE GOODS AND SERVICES OF OTHERS BY ARRANGING SPONSORS TO AFFILIATE THEIR GOODS AND SERVICES WITH SPORTS COMPETITIONS, SEASONAL EVENTS AND CULTURAL EVENTS; BUSINESS MANAGEMENT CONSULTATION; PROMOTING THE SALE OF GOODS AND SERVICES OF OTHERS THROUGH THE DISTRIBUTION OF PRINTED MATERIAL; CONTESTS AND INCENTIVE AWARD PROGRAMS TO PROMOTE THE SALE OF PRODUCTS AND SERVICES OF OTHERS; RENTAL OF ADVERTISING SPACE; PRODUCT DEMONSTRATION FOR ADVERTISING PURPOSES, GOODS AND SERVICE PRESENTATIONS; MODELING AGENCIES; BUSINESS SERVICES, NAMELY, FACILITIES MANAGEMENT OF TECHNICAL OPERATIONS (U.S. CLS. 100, 101 AND 102).

CLASS 41—EDUCATION AND ENTERTAINMENT

FOR ENTERTAINMENT, SPORTING AND CULTURAL ACTIVITIES, NAMELY, THE RUNNING OF DISCOTHEQUES, NIGHT CLUBS, AND AMUSEMENT PARKS; MODELING FOR ARTISTS; PUBLISHING OF BOOKS, MAGAZINES AND ELECTRONIC PUBLICATIONS; ORGANIZATION OF LIVE MUSICAL PERFORMANCES; MOTION PICTURE FILM PRODUCTION; MOVIE STUDIOS; PHOTOGRAPHY SERVICES; COMPOSITION OF MUSIC FOR OTHERS; ORGANIZING COMMUNITY SPORTING AND CULTURAL EVENTS; EDUCATIONAL SERVICES, NAMELY, CONDUCTING CLASSES, SEMINARS, CONFERENCES AND WORKSHOPS IN THE FIELD OF ADVERTISING, PUBLISHING AND BUILDING MANAGEMENT; PARTY PLANNING; PRODUCTION OF TELEVISION SHOWS; ENTERTAINMENT IN THE NATURE OF BEAUTY PAGEANTS; WRITING FILM SCRIPTS; RENTAL OF TAPE RECORDING EQUIPMENT, THEATRICAL LIGHTING DEVICES, CAMCORDERS, FILM PROJECTION DEVICES AND ACCESSORIES THEREFORE, MUSICAL INSTRUMENTS, RADIOS AND TELEVISION SETS, AND VIDEO CAMERAS; VIDEO FILM PRODUCTION (U.S. CLS. 100, 101 AND 107).

CLASS 42—SCIENTIFIC, COMPUTER AND LEGAL SERVICES

FOR DESIGNER SERVICES, NAMELY, CONSULTATION IN THE ORGANIZATION OF HOMEPAGE AND INTERNET SITES, DESIGN OF HOMEPAGES AND WEB PAGES; ARCHITECTURAL DESIGN; GRAPHIC DESIGN SERVICES; COMMERCIAL ART DESIGN; INDUSTRIAL DESIGN; INTERIOR DECORATING; PACKAGING DESIGN FOR OTHERS, PROVIDING CUSTOMIZED ONLINE WEB PAGES FEATURING USER-DEFINED INFORMATION, WHICH INCLUDES SEARCH ENGINES AND WEB LINKS TO OTHER WEB SITES; ORGANIZATION AND THE MAINTENANCE OF WEBSITES FOR THIRD PARTIES; COMPUTER SERVICES, NAMELY, DESIGNING AND IMPLEMENTING NETWORK WEB PAGES FOR OTHERS; COMPUTER SERVICE, NAMELY, ACTING AS AN APPLICATION SERVICE PROVIDER IN THE FIELD OF KNOWLEDGE MANAGEMENT TO HOST COMPUTER APPLICATION SOFTWARE FOR THE COLLECTION, EDITING, ORGANIZING, MODIFYING, BOOK MARKING, TRANSMISSION, STORAGE AND SHARING OF DATA AND INFORMATION, URBAN PLANNING, COMPUTER PROJECT MANAGEMENT SERVICES (U.S. CLS. 100 AND 101).

APRIL L. RADEMACHER, EXAMINING ATTORNEY

SN 78-326,130. OCTAGON, INC., NORWALK, CT. FILED 11-11-2003.

PASSION ENGAGEMENT RESULTS

THE MARK CONSISTS OF STANDARD CHARACTERS WITHOUT CLAIM TO ANY PARTICULAR FONT, STYLE, SIZE, OR COLOR.

CLASS 35—ADVERTISING AND BUSINESS

FOR MARKETING, ADVERTISING, PUBLIC RELATIONS, AND MARKETING CONSULTING AGENCY SERVICES, NAMELY, PROMOTING THE GOODS AND SERVICES OF OTHERS BY CREATING, DEVELOPING, AND STAGING MARKETING EVENTS, ENTERTAINMENT EVENTS, SPORTS COMPETITIONS AND SPORTING EVENTS, BY MANAGING MARKETING EVENTS, ENTERTAINMENT EVENTS, SPORTS COMPETITIONS AND SPORTING EVENTS, BY PROVIDING CUSTOMER ENTERTAINMENT AND HOSPITALITY SERVICES AT MARKETING EVENTS, ENTERTAINMENT EVENTS, SPORTS COMPETITIONS AND SPORTING EVENTS, BY GRAPHIC DESIGN AND PRINT PRODUCTION, AND BY SELECTING SPOKESPERSONS AND ENDORSERS; PROMOTING THE GOODS AND SERVICES OF OTHERS BY DEVELOPING AND IMPLEMENTING MARKETING PROGRAMS AND BY ARRANGING FOR SPONSORS TO AFFILIATE THEIR GOODS AND SERVICES WITH SPORTS COMPETITIONS, SPORTING EVENTS, AND ENTERTAINMENT EVENTS; DIRECT MARKETING AND ADVERTISING FOR OTHERS; PROMOTING SPORTS COMPETITIONS AND/OR EVENTS OF OTHERS; MANAGEMENT OF PROFESSIONAL ATHLETES AND ENTERTAINERS; PERSONAL MANAGEMENT SERVICES FOR ATHLETES AND ENTERTAINERS; AND SECURING SPONSORS FOR SPORTING AND ENTERTAINMENT EVENTS, ATHLETES, ENTERTAINERS, AND CELEBRITIES (U.S. CLS. 100, 101 AND 102).

FIRST USE 8-25-2003; IN COMMERCE 8-25-2003.

CLASS 41—EDUCATION AND ENTERTAINMENT

FOR ENTERTAINMENT AND SPORTING ACTIVITIES IN THE NATURE OF SPORTING EVENTS, ATHLETIC COMPETITIONS, YACHT RACES, GOLF TOURNAMENTS, STAND-UP COMEDY PERFORMANCES, MUSICAL PERFORMANCES, ARTISTIC PERFORMANCES, MUSIC CONCERTS, ACTION SPORTS EVENTS, SKIING COMPETITIONS, BASKETBALL TOURNAMENTS, SOCCER TOURNAMENTS, TENNIS TOURNAMENTS, ADVENTURE SPORTS COMPETITIONS AND EVENTS; ORGANIZING SPORTING EXHIBITIONS, DEMONSTRATIONS AND CLINICS; ENTERTAINMENT SERVICES, NAMELY, CONDUCTING PARTIES AND HOSPITALITY ACTIVITIES AT SPORTS COMPETITIONS, SPORTING EVENTS, AND ENTERTAINMENT EVENTS; THE PRODUCTION OF TELEVISION PROGRAMS, AND THE DISTRIBUTION OF TELEVISION PROGRAMMING FOR OTHERS (U.S. CLS. 100, 101 AND 107).

FIRST USE 8-25-2003; IN COMMERCE 8-25-2003.
ALLISON HOLTZ, EXAMINING ATTORNEY

SN 78-323,964. FRANK T. ROSS & SONS LIMITED, TORONTO, ONTARIO, CANADA, FILED 11-6-2003.



THE COLOR(S) GREEN, WHITE, RED, ORANGE, YELLOW, GRAY, PURPLE, AND BROWN IS/ARE CLAIMED AS A FEATURE OF THE MARK.

THE TOP RECTANGULAR BAR IS COLORED GREEN, WITH THE WORDS "NATURE" AND "CLEAN" COLORED IN WHITE. THE SKYLINE AND CLOUDS ARE COLORED IN SHADES OF RED, ORANGE, YELLOW, AND GRAY. THE TREE LINE IN THE BACKGROUND IS COLORED PURPLE. THE BRANCHES OF THE TREE IN THE FOREGROUND ARE COLORED BROWN, AND THE LEAVES OF THE TREE ARE COLORED GREEN. THE ROCK IS COLORED GRAY.

CLASS 3—COSMETICS AND CLEANING PREPARATIONS

FOR CLEANER FOR USE ON CARPETS, FLOORS, TOILET BOWLS AND WINDOWS AND GLASS; LIQUID SOAP; DISHWASHING DETERGENTS; CLEANERS FOR FRUITS AND VEGETABLES; LAUNDRY DETERGENT AND LAUNDRY BLEACH; FABRIC SOFTENERS; STAIN REMOVERS; BAR SOAP; HAIR SHAMPOO; HAIR CONDITIONER (U.S. CLS. 1, 4, 6, 50, 51 AND 52).

CLASS 5—PHARMACEUTICALS

FOR INSECT REPELLENT (U.S. CLS. 6, 18, 44, 46, 51 AND 52).
KARANENDRA S. CHHINA, EXAMINING ATTORNEY

SN 78-326,265. HECKTECH, INC., GILBERT, AZ. FILED 11-11-2003.

SN 78-327,547. ONEOK, INC., TULSA, OK. FILED 11-13-2003.



NEARBIE

THE MARK CONSISTS OF STANDARD CHARACTERS WITHOUT CLAIM TO ANY PARTICULAR FONT, STYLE, SIZE, OR COLOR.

CLASS 9—ELECTRICAL AND SCIENTIFIC APPARATUS

FOR COMPUTER SOFTWARE FOR USE IN CREATING, ORGANIZING, INDEXING AND DISTRIBUTING INFORMATION VIA THE INTERNET TO AND FROM USERS OF HAND-HELD DEVICES, PDAS, TELEPHONES, AND WIRELESS COMMUNICATION DEVICES; COMPUTER SOFTWARE FOR USE IN COLLECTING, EDITING, ORGANIZING, MODIFYING, TRANSMITTING, STORING AND DISTRIBUTING DATA AND DIGITAL PHOTOGRAPHS AND IMAGES; COMPUTER SOFTWARE FOR USE IN ACCESSING INFORMATION THAT MAY BE DOWNLOADED FROM THE GLOBAL COMPUTER NETWORK; COMPUTER SOFTWARE FOR USE IN CONNECTING USERS OF HAND-HELD COMPUTERS, PDAS AND WIRELESS COMMUNICATION DEVICES TO THE INTERNET; COMPUTER SOFTWARE FOR USE IN ACCESSING INFORMATION BASED UPON THE USER'S GEOGRAPHIC LOCATION THROUGH GLOBAL POSITIONING TECHNOLOGY (U.S. CLS. 21, 23, 26, 36 AND 38).

CLASS 42—SCIENTIFIC, COMPUTER AND LEGAL SERVICES

FOR COMPUTER SOFTWARE DEVELOPMENT; COMPUTER SERVICES, NAMELY, ACTING AS AN APPLICATION SERVICE PROVIDER IN THE FIELD OF KNOWLEDGE MANAGEMENT TO HOST COMPUTER APPLICATION SOFTWARE FOR COLLECTING, EDITING, ORGANIZING, MODIFYING, TRANSMITTING, STORING AND SHARING OF DATA AND INFORMATION AND SEARCHING AND RETRIEVING INFORMATION FROM DATABASES AND COMPUTER NETWORKS; COMPUTER SERVICES, NAMELY, ACTING AS AN APPLICATION SERVICE PROVIDER FOR THE COLLECTION, EDITING, ORGANIZING, MODIFYING, TRANSMISSION, STORAGE, AND SHARING OF DATA AND INFORMATION; COMPUTER SERVICES, NAMELY, CREATING INDEXES OF INFORMATION, WEB SITES AND OTHER RESOURCES AVAILABLE ON COMPUTER NETWORKS; COMPUTER SERVICES, NAMELY, DESIGNING, CREATING, HOSTING, AND MAINTAINING WEB SITES FOR OTHERS (U.S. CLS. 100 AND 101).

DEZMONA MIZELLE, EXAMINING ATTORNEY

CLASS 35—ADVERTISING AND BUSINESS

FOR NATURAL GAS, NATURAL GAS LIQUIDS, CRUDE OIL, FUEL OIL, AND ELECTRIC POWER PROCUREMENT SERVICES, NAMELY, THE PURCHASE FOR OTHERS OF NATURAL GAS, NATURAL GAS LIQUIDS, CRUDE OIL, FUEL OIL, ELECTRIC POWER, PETROLEUM AND OTHER FUELS; OPERATION OF BUSINESS FOR OTHERS, NAMELY, OPERATION OF NATURAL GAS PROCESSING AND STORAGE AND ELECTRIC POWER PLANT AND COGENERATION FACILITIES; MARKETING SERVICES, NAMELY, PROMOTING THE USE OF NATURAL GAS IN RESIDENTIAL, COMMERCIAL, INDUSTRIAL, MUNICIPAL AND UTILITY CUSTOMERS; BILLING SERVICES PERTAINING TO THE PROVISION OF GAS AND ELECTRIC, UTILITY, NATURAL GAS PROCESSING AND STORAGE SERVICES; PROMOTING PUBLIC AWARENESS OF THE EFFICIENT USE OF NATURAL GAS; ASSOCIATION SERVICES, NAMELY, PROMOTING USE OF NATURAL GAS AND ENVIRONMENTAL CONCERNS IN CONNECTION WITH ENERGY PRODUCTION (U.S. CLS. 100, 101 AND 102).

FIRST USE 12-9-1980; IN COMMERCE 12-9-1980.

CLASS 37—CONSTRUCTION AND REPAIR

FOR CONSTRUCTION SERVICES, NAMELY, CONSTRUCTING STRUCTURES AND FACILITIES FOR USE IN THE NATURAL GAS AND ELECTRIC POWER PRODUCTION, TRANSPORTATION, PROCESSING, STORAGE, DISTRIBUTION, MARKETING AND TRADING INDUSTRIES; INSTALLATION AND MAINTENANCE OF NATURAL GAS REFUELING STATIONS; VEHICLE REPAIR SERVICES, NAMELY, CONVERTING CONVENTIONAL FUELED VEHICLES TO NATURAL GAS; DRILLING WELLS FOR GAS AND OIL; INSTALLATION AND MAINTENANCE OF GAS, CRUDE OIL AND PETROLEUM PRODUCT PIPELINE (U.S. CLS. 100, 103 AND 106).

FIRST USE 12-9-1980; IN COMMERCE 12-9-1980.

CLASS 39—TRANSPORTATION AND STORAGE

FOR GAS UTILITY SERVICES, NAMELY, TRANSPORTATION, STORAGE AND DISTRIBUTION OF NATURAL GAS, NATURAL GAS LIQUIDS, CRUDE OIL, FUEL OIL, PETROLEUM, AND OTHER FUELS; NATURAL GAS STORAGE SERVICES, NAMELY, THE STORAGE OF NATURAL GAS IN OWNED OR LEASED GAS STORAGE FACILITIES; ELECTRIC UTILITY SERVICES, NAMELY, THE TRANSMISSION AND DISTRIBUTION OF ELECTRIC ENERGY; NATURAL GAS PIPELINE SERVICES, NAMELY, THE TRANSMISSION OF NATURAL GAS THROUGH PIPELINES; PUBLIC UTILITY SERVICES IN THE NATURE OF COMPRESSED NATURAL GAS DISTRIBUTION SERVICES (U.S. CLS. 100 AND 105).

FIRST USE 12-9-1980; IN COMMERCE 12-9-1980.

CLASS 40—MATERIAL TREATMENT

FOR PRODUCTION, PROCESSING AND TREATING OF ENERGY, NAMELY, NATURAL GAS, NATURAL GAS LIQUIDS, CRUDE OIL, FUEL OIL AND OTHER PETROLEUM PRODUCTS AND ELECTRICITY (U.S. CLS. 100, 103 AND 106).

FIRST USE 12-9-1980; IN COMMERCE 12-9-1980.

CLASS 42—SCIENTIFIC, COMPUTER AND LEGAL SERVICES

FOR RESEARCH AND DESIGN SERVICES, NAMELY, DESIGNING, TESTING AND EVALUATING NATURAL GAS STORAGE AND PROCESSING FACILITIES, STORAGE TANKS AND CARBURETION SYSTEMS FOR VEHICULAR USE OF NATURAL GAS, INCLUDING COMPRESSED NATURAL GAS; PROVIDING INFORMATION ON EFFECTIVE USE OF NATURAL GAS AND SAFETY GUIDELINES AND TIPS FOR USE OF NATURAL GAS; TECHNICAL DESIGN OF ENERGY EFFICIENT HOMES AND COMMERCIAL STRUCTURES FOR OTHERS (U.S. CLS. 100 AND 101).

FIRST USE 12-9-1980; IN COMMERCE 12-9-1980.
JIM RINGLE, EXAMINING ATTORNEY

SN 78-329,406. SPITZER-COHN, SUSAN R., GLENCOE, IL. AND SPITZER-COHN, DONALD L., GLENCOE, IL. FILED 11-18-2003.

MESSAGE WEAR

THE MARK CONSISTS OF STANDARD CHARACTERS WITHOUT CLAIM TO ANY PARTICULAR FONT, STYLE, SIZE, OR COLOR.

CLASS 18—LEATHER GOODS

FOR PURSES, FANNY PACKS, BACKPACKS, SPORT BAGS, OVERNIGHT CASES, MAKE-UP CASES SOLD EMPTY, BEACH AND TOTE BAGS, LUGGAGE (U.S. CLS. 1, 2, 3, 22 AND 41).

CLASS 25—CLOTHING

FOR FOOTWEAR, HEADWEAR AND CLOTHING NAMELY, SHOES, BOOTS, SOCKS AND SLIPPERS, HEADBANDS, T-SHIRTS, SWEAT SHIRTS, SHORTS, PANTS, PAJAMAS, HATS, CAPS, BELTS AND SUSPENDERS (U.S. CLS. 22 AND 39).

JENNIFER KRISP, EXAMINING ATTORNEY

SN 78-328,434. BECKMAN COULTER, INC., FULLERTON, CA. FILED 11-14-2003.

SN 78-330,582. KRANSON INDUSTRIES, INC., ST. LOUIS, MO. FILED 11-20-2003.

ITOPIA**TRICORBRAUN**

THE MARK CONSISTS OF STANDARD CHARACTERS WITHOUT CLAIM TO ANY PARTICULAR FONT, STYLE, SIZE, OR COLOR.

CLASS 1—CHEMICALS

FOR CHEMICALS AND CHEMICAL REAGENTS FOR USE IN THE RESEARCH AND DEVELOPMENT OF PROTEIN-BASED VACCINES AND IMMUNOTHERAPIES SOLD TOGETHER AS ASSAY KITS (U.S. CLS. 1, 5, 6, 10, 26 AND 46).

CLASS 9—ELECTRICAL AND SCIENTIFIC APPARATUS

FOR COMPUTER SOFTWARE FOR USE IN THE DEVELOPMENT OF PROTEIN-BASED VACCINES AND IMMUNOTHERAPIES (U.S. CLS. 21, 23, 26, 36 AND 38).
GINA FINK, EXAMINING ATTORNEY

THE MARK CONSISTS OF STANDARD CHARACTERS WITHOUT CLAIM TO ANY PARTICULAR FONT, STYLE, SIZE, OR COLOR.

OWNER OF U.S. REG. NOS. 2,376,069 AND 2,761,767.

CLASS 35—ADVERTISING AND BUSINESS

FOR BUSINESS PLANNING SERVICES, NAMELY, ARRANGING FOR THE PRODUCTION OF PACKAGING FOR OTHERS (U.S. CLS. 100, 101 AND 102).
FIRST USE 10-1-1998; IN COMMERCE 12-1-1998.

CLASS 42—SCIENTIFIC, COMPUTER AND LEGAL SERVICES

FOR PACKAGING DESIGN FOR OTHERS; DESIGN FOR OTHERS IN THE FIELD OF ENGINEERING MANUFACTURING LINES FOR THE PRODUCTION OF PACKAGING MATERIALS; CUSTOM DESIGN AND ENGINEERING OF MOLDS AND MACHINE TOOLS FOR USE IN PRODUCTION OF PACKAGING MATERIALS (U.S. CLS. 100 AND 101).

FIRST USE 10-1-1998; IN COMMERCE 12-1-1998.
HEATHER THOMPSON, EXAMINING ATTORNEY

SN 78-330,695. KRANSON INDUSTRIES, INC., ST. LOUIS, MO. FILED 11-20-2003.

KELLY BOULTON, EXAMINING ATTORNEY



NO CLAIM IS MADE TO THE EXCLUSIVE RIGHT TO USE "OPTIONS", APART FROM THE MARK AS SHOWN.

CLASS 35—ADVERTISING AND BUSINESS

FOR DISTRIBUTORSHIP SERVICES IN THE FIELD OF GLASS, PLASTIC, AND COMPOSITE BOTTLES AND CONTAINERS, CAPS, CLOSURES, SPRAY PUMPS, AND PLASTIC TUBES; BUSINESS PLANNING, NAMELY, ARRANGING FOR THE PRODUCTION OF PACKAGING FOR OTHERS (U.S. CLS. 100, 101 AND 102).

CLASS 42—SCIENTIFIC, COMPUTER AND LEGAL SERVICES

FOR PACKAGING DESIGN FOR OTHERS; DESIGN FOR OTHERS IN THE FIELD OF ENGINEERING MANUFACTURING LINES FOR THE PRODUCTION OF PACKAGING MATERIALS; CUSTOM DESIGN AND ENGINEERING OF MOLDS AND MACHINE TOOLS FOR USE IN PRODUCTION OF PACKAGING MATERIALS (U.S. CLS. 100 AND 101).

CHRISIE B. KING, EXAMINING ATTORNEY

SN 78-330,794. ANVERS, LOS ANGELES, CA. FILED 11-20-2003.

POM POM INTERIORS

THE MARK CONSISTS OF STANDARD CHARACTERS WITHOUT CLAIM TO ANY PARTICULAR FONT, STYLE, SIZE, OR COLOR.

NO CLAIM IS MADE TO THE EXCLUSIVE RIGHT TO USE INTERIORS, APART FROM THE MARK AS SHOWN.

CLASS 20—FURNITURE AND ARTICLES NOT OTHERWISE CLASSIFIED

FOR ANTIQUE FURNISHINGS, NAMELY, ANTIQUE FURNITURE (U.S. CLS. 2, 13, 22, 25, 32 AND 50). FIRST USE 1-1-1989; IN COMMERCE 1-1-1991.

CLASS 42—SCIENTIFIC, COMPUTER AND LEGAL SERVICES

FOR INTERIOR DECORATING (U.S. CLS. 100 AND 101). FIRST USE 1-1-1989; IN COMMERCE 1-1-1991.

SN 78-331,205. BELLSOUTH INTELLECTUAL PROPERTY CORPORATION, WILMINGTON, DE. FILED 11-21-2003.

KNOW-HOW GOLD

THE MARK CONSISTS OF STANDARD CHARACTERS WITHOUT CLAIM TO ANY PARTICULAR FONT, STYLE, SIZE, OR COLOR.

NO CLAIM IS MADE TO THE EXCLUSIVE RIGHT TO USE KNOW HOW, APART FROM THE MARK AS SHOWN.

CLASS 35—ADVERTISING AND BUSINESS

FOR BUSINESS MARKETING CONSULTING SERVICES FOR MARKETING INTELLECTUAL PROPERTY, NAMELY, PATENTS, TRADEMARKS, COPYRIGHTS AND PROPRIETARY INFORMATION TO OTHERS (U.S. CLS. 100, 101 AND 102).

CLASS 42—SCIENTIFIC, COMPUTER AND LEGAL SERVICES

FOR INTELLECTUAL PROPERTY CONSULTING SERVICES; LICENSING OF INTELLECTUAL PROPERTY CONSISTING OF PATENTS, TRADEMARKS, COPYRIGHTS AND PROPRIETARY INFORMATION TO OTHERS (U.S. CLS. 100 AND 101).

NELSON SNYDER, EXAMINING ATTORNEY

SN 78-331,570. COBILAS AG, BERLIN, FED REP GERMANY, FILED 11-21-2003.

COBILAS

THE MARK CONSISTS OF STANDARD CHARACTERS WITHOUT CLAIM TO ANY PARTICULAR FONT, STYLE, SIZE, OR COLOR.

PRIORITY CLAIMED UNDER SEC. 44(D) ON FED REP GERMANY APPLICATION NO. 30353542342, FILED 10-15-2003, REG. NO. 30353542, DATED 11-6-2003, EXPIRES 10-31-2013.

CLASS 9—ELECTRICAL AND SCIENTIFIC APPARATUS

FOR COMPUTER SOFTWARE, NAMELY SOFTWARE FOR BILLING AND ACCOUNTING, NAMELY FOR BILLING AND ACCOUNTING OF COMMERCIAL TRANSACTIONS IN THE FIELDS OF COMMUNICATIONS, TELEMATICS, TRANSPORTATION AND MEDICAL HEALTH; PRE-RECORDED MAGNETIC DATA CARRIERS FEATURING SOFTWARE USED FOR STORING AND INSTALLATION OF THE ABOVE-MENTIONED COMPUTER SOFTWARE, AND COMPUTER HARDWARE, NAMELY, SERVER HARDWARE FOR IMPLEMENTING AND RUNNING THE ABOVE-MENTIONED COMPUTER SOFTWARE (U.S. CLS. 21, 23, 26, 36 AND 38).

CLASS 35—ADVERTISING AND BUSINESS

FOR BILLING AND ACCOUNTING SERVICES RELATING TO COMMERCIAL TRANSACTIONS IN THE FIELDS OF COMMUNICATIONS, TELEMATICS, TRANSPORTATION AND MEDICAL HEALTH (U.S. CLS. 100, 101 AND 102).

CLASS 42—SCIENTIFIC, COMPUTER AND LEGAL SERVICES

FOR DESIGN AND DEVELOPMENT FOR OTHERS, NAMELY, OF SOFTWARE FOR BILLING AND ACCOUNTING, NAMELY FOR BILLING AND ACCOUNTING OF COMMERCIAL TRANSACTIONS IN THE FIELDS OF COMMUNICATIONS, TELEMATICS, TRANSPORTATION AND MEDICAL HEALTH (U.S. CLS. 100 AND 101).

BRETT J. GOLDEN, EXAMINING ATTORNEY

SN 78-332,309. DIVERSIFIED HOLDING CORPORATION, EL MONTE, CA. FILED 11-24-2003.



NO CLAIM IS MADE TO THE EXCLUSIVE RIGHT TO USE "TITLE & ESCROW SERVICES COMPANY AND TITLE INSURANCE COMPANY", APART FROM THE MARK AS SHOWN.

THE MARK CONSISTS OF A SUNBURST DESIGN WITHIN A CAPITAL LETTER "D".

CLASS 36—INSURANCE AND FINANCIAL

FOR REAL ESTATE ESCROW SERVICES AND TITLE INSURANCE SERVICES (U.S. CLS. 100, 101 AND 102).
FIRST USE 8-18-2003; IN COMMERCE 8-18-2003.

CLASS 42—SCIENTIFIC, COMPUTER AND LEGAL SERVICES

FOR REAL ESTATE SETTLEMENT SERVICES (U.S. CLS. 100 AND 101).
FIRST USE 8-18-2003; IN COMMERCE 8-18-2003.
PAUL F. GAST, EXAMINING ATTORNEY

SN 78-332,415. SILVER BURDETT GIN, INC., UPPER SADDLE RIVER, NJ. FILED 11-24-2003.

BLEST ARE WE

THE MARK CONSISTS OF STANDARD CHARACTERS WITHOUT CLAIM TO ANY PARTICULAR FONT, STYLE, SIZE, OR COLOR.

CLASS 9—ELECTRICAL AND SCIENTIFIC APPARATUS

FOR MUSICAL SOUND RECORDINGS; MULTI-MEDIA SOFTWARE RECORDED ON CD-ROM IN THE FIELD OF RELIGION; RELIGIOUS VIDEO RECORDINGS (U.S. CLS. 21, 23, 26, 36 AND 38).

FIRST USE 1-14-2001; IN COMMERCE 1-14-2001.

CLASS 41—EDUCATION AND ENTERTAINMENT

FOR PUBLICATION OF BOOKS; CONDUCTING WORKSHOPS AND SEMINARS ON RELIGIOUS EDUCATION; ENTERTAINMENT, NAMELY LIVE MUSIC CONCERTS (U.S. CLS. 100, 101 AND 107).

FIRST USE 9-30-2001; IN COMMERCE 9-30-2001.

MICHELE SWAIN, EXAMINING ATTORNEY

SN 78-332,975. GLOBAL SEALING TECHNOLOGIES LIMITED, FLINTSHIRE, UNITED KINGDOM, FILED 11-25-2003.

SYSTEM

THE MARK CONSISTS OF STANDARD CHARACTERS WITHOUT CLAIM TO ANY PARTICULAR FONT, STYLE, SIZE, OR COLOR.

PRIORITY CLAIMED UNDER SEC. 44(D) ON UNITED KINGDOM APPLICATION NO. 2333800, FILED 5-31-2003, REG. NO. 2333800, DATED 5-31-2003, EXPIRES 5-31-2013.

CLASS 16—PAPER GOODS AND PRINTED MATTER

FOR PLASTIC WRAP; PLASTIC BAGS FOR PACKAGING; BAGS AND POUCHES FOR MICROWAVE COOKING (U.S. CLS. 2, 5, 22, 23, 29, 37, 38 AND 50).

CLASS 17—RUBBER GOODS

FOR PLASTIC FILMS USED AS PACKAGING FOR FOOD AND PLASTIC FILM FOR INDUSTRIAL AND COMMERCIAL PACKING USE (U.S. CLS. 1, 5, 12, 13, 35 AND 50).

ANGELA M. MICHELI, EXAMINING ATTORNEY

SN 78-333,734. PROLINE BILLIARD FACTORY, LLC, SANFORD, FL. FILED 11-26-2003.

**SERIOUS TABLES FOR
SERIOUS FUN**

THE MARK CONSISTS OF STANDARD CHARACTERS WITHOUT CLAIM TO ANY PARTICULAR FONT, STYLE, SIZE, OR COLOR.

CLASS 28—TOYS AND SPORTING GOODS

FOR BILLIARD TABLES (U.S. CLS. 22, 23, 38 AND 50).

CLASS 35—ADVERTISING AND BUSINESS

FOR RETAIL STORE SERVICES AND ONLINE RETAIL STORE SERVICES IN THE FIELD OF GAME ROOM FURNISHINGS, NAMELY, BILLIARD TABLES, FOOTBALL TABLES, AIR HOCKEY TABLES, GAME TABLES, CARD TABLES, BARS, BAR STOOLS, CUE STICKS, CUE CASES, CUE WALL RACKS AND ELECTRONIC FIREPLACES (U.S. CLS. 100, 101 AND 102).

FIRST USE 10-1-2003; IN COMMERCE 10-1-2003.
BARBARA GAYNOR, EXAMINING ATTORNEY

SN 78-335,658. SIGA SERVICES AG, 6017 RUSWIL, SWITZERLAND, FILED 12-3-2003.

SIGA

THE MARK CONSISTS OF STANDARD CHARACTERS WITHOUT CLAIM TO ANY PARTICULAR FONT, STYLE, SIZE, OR COLOR.

PRIORITY CLAIMED UNDER SEC. 44(D) ON SWITZERLAND APPLICATION NO. 03443/2003, FILED 7-2-2003, REG. NO. 513727, DATED 8-27-2003, EXPIRES 7-2-2013.

CLASS 1—CHEMICALS

FOR ADHESIVES AND GLUTEN GLUE FOR INDUSTRIAL PURPOSES (U.S. CLS. 1, 5, 6, 10, 26 AND 46).

CLASS 7—MACHINERY

FOR ADHESIVE TAPE DISPENSING MACHINES (U.S. CLS. 13, 19, 21, 23, 31, 34 AND 35).

CLASS 8—HAND TOOLS

FOR HAND OPERATED CARTRIDGE AND BAG-FED CAULKING GUNS FOR APPLYING ADHESIVES (U.S. CLS. 23, 28 AND 44).

CLASS 16—PAPER GOODS AND PRINTED MATTER

FOR ADHESIVE TAPES FOR STATIONERY AND HOUSEHOLD PURPOSES AND ADHESIVE TAPES DISPENSERS FOR STATIONERY AND HOUSEHOLD PURPOSES (U.S. CLS. 2, 5, 22, 23, 29, 37, 38 AND 50).

CLASS 17—RUBBER GOODS

FOR ADHESIVE TAPES FOR INDUSTRIAL APPLICATIONS (U.S. CLS. 1, 5, 12, 13, 35 AND 50).

CLASS 41—EDUCATION AND ENTERTAINMENT

FOR ORGANIZATION AND CONDUCTING OF WORKSHOPS IN THE FIELD OF THE USE AND APPLICATION OF ADHESIVES AND IN THE USE OF METHODS AND TOOLS CONNECTED THERETO (U.S. CLS. 100, 101 AND 107).

BARBARA BROWN, EXAMINING ATTORNEY

SN 78-335,677. DYNAMIC PATHWAYS, INC., TUCSON, AZ. FILED 12-3-2003.



NO CLAIM IS MADE TO THE EXCLUSIVE RIGHT TO USE "SPEAKERS BUREAU", APART FROM THE MARK AS SHOWN.

CLASS 35—ADVERTISING AND BUSINESS

FOR BUSINESS CONSULTATION RELATING TO BUSINESS PERFORMANCE AND STRATEGY; TALENT AGENCY SERVICES IN THE FIELD OF PROVIDING SPEAKERS, FACILITATORS, CELEBRITIES, TRAINERS, ENTERTAINERS, AND CONSULTANTS FOR CORPORATIONS, ASSOCIATIONS, AND GOVERNMENT AGENCIES (U.S. CLS. 100, 101 AND 102).

FIRST USE 12-31-1990; IN COMMERCE 12-31-1990.

CLASS 41—EDUCATION AND ENTERTAINMENT

FOR PERSONAL COACHING AND INDIVIDUAL TRAINING SERVICES IN THE FIELD OF DEVELOPING MOTIVATIONAL SPEAKING SKILLS AND THE FIELD OF DEVELOPING SPEAKERS' MARKETING MATERIALS, INCLUDING THEIR DEMONSTRATION VIDEOS AND PRESS KITS (U.S. CLS. 100, 101 AND 107).

FIRST USE 12-31-1990; IN COMMERCE 12-31-1990.
PAUL F. GAST, EXAMINING ATTORNEY

SN 78-335,735. APPLIED ENGINEERING, INC., BISMARCK, ND. FILED 12-3-2003.

SN 78-336,393. THE LEAGUE OF AMERICAN THEATRES AND PRODUCERS, INC., NEW YORK, NY. FILED 12-4-2003.



CLASS 35—ADVERTISING AND BUSINESS

FOR REPROGRAPHICS AND COPYING OF DOCUMENTS FOR OTHERS; RETAIL SERVICES BY DIRECT SOLICITATION BY SALES AGENTS IN THE FIELD OF COMPUTERS AND COMPUTER SOFTWARE (U.S. CLS. 100, 101 AND 102).

FIRST USE 9-5-2003; IN COMMERCE 9-5-2003.

CLASS 37—CONSTRUCTION AND REPAIR

FOR IMPLEMENTING AND ADMINISTERING COMPUTER HARDWARE AND SOFTWARE FOR OTHERS, NAMELY, INSTALLATION OF COMPUTER SYSTEMS, MAINTENANCE, REPAIR AND UPGRADING OF COMPUTER HARDWARE (U.S. CLS. 100, 103 AND 106).

FIRST USE 9-5-2003; IN COMMERCE 9-5-2003.

CLASS 40—MATERIAL TREATMENT

FOR ELECTRONIC SCANNING OF DOCUMENTS FOR OTHERS (U.S. CLS. 100, 103 AND 106).

FIRST USE 9-5-2003; IN COMMERCE 9-5-2003.

CLASS 41—EDUCATION AND ENTERTAINMENT

FOR TRAINING SERVICES, NAMELY CONDUCTING CLASSES, SEMINARS, WORKSHOPS AND CONFERENCES IN THE FIELD OF COMPUTERS AND COMPUTER SOFTWARE (U.S. CLS. 100, 101 AND 107).

FIRST USE 9-5-2003; IN COMMERCE 9-5-2003.

CLASS 42—SCIENTIFIC, COMPUTER AND LEGAL SERVICES

FOR TECHNICAL CONSULTING SERVICES IN THE FIELD OF MECHANICAL ENGINEERING, ELECTRICAL ENGINEERING, ROBOTIC INTEGRATION, FACTORY AUTOMATION, AND INDUSTRIAL DESIGN ENGINEERING; INFORMATION TECHNOLOGY CONSULTING SERVICES, NAMELY, DESIGNING, SELECTING, AND PROGRAMMING COMPUTER HARDWARE AND SOFTWARE SYSTEMS FOR OTHERS; ADMINISTERING OF COMPUTER SOFTWARE FOR OTHERS, NAMELY, UPDATING AND INSTALLATION OF SOFTWARE; SUPPORT SERVICES, NAMELY, TROUBLESHOOTING OF COMPUTER HARDWARE AND SOFTWARE PROBLEMS (U.S. CLS. 100 AND 101).

FIRST USE 9-5-2003; IN COMMERCE 9-5-2003.
MARY CRAWFORD, EXAMINING ATTORNEY

DESTINATION BROADWAY

THE MARK CONSISTS OF STANDARD CHARACTERS WITHOUT CLAIM TO ANY PARTICULAR FONT, STYLE, SIZE, OR COLOR.

NO CLAIM IS MADE TO THE EXCLUSIVE RIGHT TO USE BROADWAY, APART FROM THE MARK AS SHOWN.

CLASS 39—TRANSPORTATION AND STORAGE

FOR TRAVEL AGENCY SERVICES, NAMELY, ARRANGING TRAVEL TOURS AND MAKING BOOKINGS AND RESERVATIONS FOR TRANSPORTATION (U.S. CLS. 100 AND 105).

CLASS 41—EDUCATION AND ENTERTAINMENT

FOR ARRANGING FOR TICKET RESERVATIONS FOR LIVE THEATRICAL PERFORMANCES (U.S. CLS. 100, 101 AND 107).

CLASS 43—HOTEL AND RESTAURANT SERVICES

FOR TRAVEL AGENCY SERVICES, NAMELY, MAKING RESERVATIONS AND BOOKINGS FOR TEMPORARY LODGING (U.S. CLS. 100 AND 101).

DAVID MURRAY, EXAMINING ATTORNEY

SN 78-336,552. SCHERER BROS. LUMBER CO., BROOKLYN PARK, MN. FILED 12-4-2003.

FARNORTH

THE MARK CONSISTS OF STANDARD CHARACTERS WITHOUT CLAIM TO ANY PARTICULAR FONT, STYLE, SIZE, OR COLOR.

CLASS 6—METAL GOODS

FOR METAL WINDOWS AND DOORS (U.S. CLS. 2, 12, 13, 14, 23, 25 AND 50).

CLASS 19—NON-METALLIC BUILDING MATERIALS

FOR NON-METAL WINDOWS AND DOORS (U.S. CLS. 1, 12, 33 AND 50).
MICHELE SWAIN, EXAMINING ATTORNEY

CLASS 31—NATURAL AGRICULTURAL PRODUCTS

FOR LOCALLY GROWN FRESH FRUITS, VEGETABLES, HERBS, PLANTS AND FLOWERS (U.S. CLS. 1 AND 46).
GINA FINK, EXAMINING ATTORNEY

SN 78-338,255. LARKIN, MARK H., WAXAHACHIE, TX. FILED 12-9-2003.

SN 78-339,738. LUKAS, DAVID STEPHEN, SAN DIEGO, CA. FILED 12-11-2003.

OF CORKS WE DO

THE MARK CONSISTS OF STANDARD CHARACTERS WITHOUT CLAIM TO ANY PARTICULAR FONT, STYLE, SIZE, OR COLOR.
NO CLAIM IS MADE TO THE EXCLUSIVE RIGHT TO USE "CORKS", APART FROM THE MARK AS SHOWN.

CLASS 16—PAPER GOODS AND PRINTED MATTER

FOR DECORATIVE CHALKBOARDS AND CORKBOARDS (U.S. CLS. 2, 5, 22, 23, 29, 37, 38 AND 50).

LUKSOR

CLASS 20—FURNITURE AND ARTICLES NOT OTHERWISE CLASSIFIED

FOR PICTURE FRAMES (U.S. CLS. 2, 13, 22, 25, 32 AND 50).
INGA ERVIN, EXAMINING ATTORNEY

SN 78-339,241. BULL, DAVID T, ORIENT, NY. FILED 12-11-2003.

Humble Roots

THE MARK CONSISTS OF STANDARD CHARACTERS WITHOUT CLAIM TO ANY PARTICULAR FONT, STYLE, SIZE, OR COLOR.

CLASS 9—ELECTRICAL AND SCIENTIFIC APPARATUS

FOR COMPUTER, ELECTRONIC, AND VIDEO GAME SOFTWARE AND RELATED PROGRAMS (U.S. CLS. 21, 23, 26, 36 AND 38).

THE MARK CONSISTS OF STANDARD CHARACTERS WITHOUT CLAIM TO ANY PARTICULAR FONT, STYLE, SIZE, OR COLOR.

CLASS 29—MEATS AND PROCESSED FOODS

FOR MEATS AND PROCESSED FOODS, NAMELY, LOCALLY PRODUCED MEAT, FISH, POULTRY AND GAME; MEAT EXTRACTS; PRESERVED, DRIED AND COOKED FRUITS AND VEGETABLES; JELLIES, JAMS, EGGS, MILK, EDIBLE OILS AND FATS (U.S. CL. 46).

CLASS 42—SCIENTIFIC, COMPUTER AND LEGAL SERVICES

FOR PROVIDING INFORMATION IN THE FIELDS OF INFORMATION TECHNOLOGY, COMPUTERS, AND COMPUTER SYSTEMS BY MEANS OF A GLOBAL OR LOCAL INFORMATION NETWORK; CONSULTING IN THE AREAS OF COMPUTERS, COMPUTER SYSTEMS AND COMPUTER SYSTEM DESIGNS; COMPUTER SERVICES, NAMELY, DESIGN OF COMPUTER SYSTEMS FOR OTHERS; INFORMATION AND TECHNOLOGY CONSULTING SERVICES; COMPUTER SOFTWARE DESIGN FOR OTHERS; COMPUTER SITE DESIGN; INSTALLATION, IMPLEMENTATION, MAINTENANCE, AND REPAIR SERVICES WITH RESPECT TO COMPUTER SOFTWARE (U.S. CLS. 100 AND 101).
DAWN FELDMAN, EXAMINING ATTORNEY

SN 78-340,303. THE STATE OF WISCONSIN DEPARTMENT OF PUBLIC INSTRUCTION, MADISON, WI. FILED 12-12-2003.

ACCESS FOR ELLS

THE MARK CONSISTS OF STANDARD CHARACTERS WITHOUT CLAIM TO ANY PARTICULAR FONT, STYLE, SIZE, OR COLOR.

CLASS 16—PAPER GOODS AND PRINTED MATTER

FOR PRINTED MATERIALS, NAMELY, A SERIES OF STANDARDIZED ACHIEVEMENT TESTS TO TEST ENGLISH LANGUAGE PROFICIENCY FOR STUDENTS IN KINDERGARTEN THROUGH TWELFTH GRADE CONSISTING OF TEST BOOKLETS, ANSWER SHEETS, TECHNICAL GUIDES, REVIEWER'S EDITIONS, CLASS MANAGEMENT GUIDES, EXAMINER'S MANUALS, NORMS BOOKLETS AND SCORE REPORTS (U.S. CLS. 2, 5, 22, 23, 29, 37, 38 AND 50).

CLASS 41—EDUCATION AND ENTERTAINMENT

FOR EDUCATIONAL SERVICES, NAMELY, STANDARDIZED TEST SCORING AND REPORTING SERVICES FOR ENGLISH LANGUAGE PROFICIENCY TESTING; CUSTOM DESIGN OF STANDARDIZED TESTS (U.S. CLS. 100, 101 AND 107).

STACY WAHLBERG, EXAMINING ATTORNEY

SN 78-340,633. MR. HANDYMAN INTERNATIONAL LLC, ANN ARBOR, MI. FILED 12-15-2003.



OWNER OF U.S. REG. NOS. 2,620,745 AND 2,714,368. NO CLAIM IS MADE TO THE EXCLUSIVE RIGHT TO USE "HANDYMAN", APART FROM THE MARK AS SHOWN.

THE MARK CONSISTS OF THE WORDING MY HANDYMAN AND THE DESIGN OF A HUMAN FIGURE HOLDING A HAMMER AND NAIL AND WEARING A TOP HAT, BOW TIE AND TOOL BELT.

CLASS 35—ADVERTISING AND BUSINESS

FOR FRANCHISE SERVICES, NAMELY OFFERING TECHNICAL ASSISTANCE IN THE ESTABLISHMENT AND/OR OPERATION OF A HOME REPAIR AND GENERAL MAINTENANCE BUSINESS (U.S. CLS. 100, 101 AND 102).

FIRST USE 8-0-2001; IN COMMERCE 8-0-2001.

CLASS 37—CONSTRUCTION AND REPAIR

FOR HOME REPAIR AND GENERAL MAINTENANCE SERVICES (U.S. CLS. 100, 103 AND 106).
FIRST USE 8-0-2001; IN COMMERCE 8-0-2001.
JENNIFER KRISP, EXAMINING ATTORNEY

SN 78-340,847. LABRADA BODYBUILDING NUTRITION, INC., HOUSTON, TX. FILED 12-15-2003.

CARBWATCHERS

THE MARK CONSISTS OF STANDARD CHARACTERS WITHOUT CLAIM TO ANY PARTICULAR FONT, STYLE, SIZE, OR COLOR.

OWNER OF U.S. REG. NO. 2,800,937.

CLASS 29—MEATS AND PROCESSED FOODS

FOR CANDIED FRUIT SNACKS (U.S. CL. 46).
FIRST USE 8-31-2003; IN COMMERCE 8-31-2003.

CLASS 30—STAPLE FOODS

FOR BAKERY GOODS AND PRODUCTS, BISCUITS, BREAD, BEAD STICKS, BROWNIES, CAKES AND PIES, COOKIES, DANISH PASTRIES, DOUGHNUTS, MUFFINS, TARTS, WAFFLES, WAFERS, BREAKFAST CEREALS, OATMEAL, CANDY COATED POPCORN, CARAMELS, CHOCOLATE COVERED NUTS, CHOCOLATE, CHOCOLATE SYRUP, FROZEN CONFECTIONS, FROZEN YOGURT, ICE CREAM, ICE MILK, PUDDINGS MADE FROM MILK, HOT CHOCOLATE, AND COCOA (U.S. CL. 46).

FIRST USE 11-30-2003; IN COMMERCE 11-30-2003.
JIM RINGLE, EXAMINING ATTORNEY

SN 78-341,742. OPERATION EYESIGHT UNIVERSAL, CALGARY, ALBERTA, CANADA, FILED 12-16-2003.



For All The World To See

CLASS 36—INSURANCE AND FINANCIAL

FOR CHARITABLE FUND RAISING SERVICES (U.S. CLS. 100, 101 AND 102).

CLASS 41—EDUCATION AND ENTERTAINMENT

FOR EDUCATIONAL SERVICES, NAMELY, ON-LINE DISPLAYS AND INTERACTIVE EXHIBITS IN THE FIELD OF PREVENTING BLINDNESS IN THE DEVELOPING WORLD TO PROMOTE PUBLIC AWARENESS; CONDUCTING SEMINARS AND WORKSHOPS ON PREVENTING BLINDNESS IN THE DEVELOPING WORLD; AND TRAINING SERVICES, NAMELY, THE TRAINING OF MEDICAL PERSONNEL IN THE DEVELOPING WORLD (U.S. CLS. 100, 101 AND 107).

CLASS 44—MEDICAL, BEAUTY AND AGRICULTURAL SERVICES

SN 78-345,374. ORCHARD TRADING LIMITED, ST. HE-LIER, UNITED KINGDOM, FILED 12-24-2003.

FOR SURGERY IN THE NATURE OF PROVIDING SIGHT RESTORATION SERVICES NECESSARY TO RE-STORE SIGHT TO THE CURABLE BLIND (U.S. CLS. 100 AND 101).

ALLISON HOLTZ, EXAMINING ATTORNEY

SN 78-344,715. YO! LIMITED, LONDON, UNITED KING-
DOM, FILED 12-23-2003.

WORTH PARIS

YO! JAPAN

THE MARK CONSISTS OF STANDARD CHARACTERS WITHOUT CLAIM TO ANY PARTICULAR FONT, STYLE, SIZE, OR COLOR.

NO CLAIM IS MADE TO THE EXCLUSIVE RIGHT TO USE "JAPAN", APART FROM THE MARK AS SHOWN.

CLASS 9—ELECTRICAL AND SCIENTIFIC APPARATUS

FOR SUNGLASSES (U.S. CLS. 21, 23, 26, 36 AND 38).

CLASS 14—JEWELRY

FOR WATCHES (U.S. CLS. 2, 27, 28 AND 50).

CLASS 16—PAPER GOODS AND PRINTED MATTER

FOR MERCHANDISE BAGS (U.S. CLS. 2, 5, 22, 23, 29, 37, 38 AND 50).

CLASS 18—LEATHER GOODS

FOR HANDBAGS, SCHOOL BAGS, SHOPPING BAGS, COSMETIC BAGS, ATHLETIC BAGS, ALL-PURPOSE SPORTS BAGS, TRAVEL BAGS, BEACH BAGS, CARRY-ON BAGS AND RUCKSACKS (U.S. CLS. 1, 2, 3, 22 AND 41).

CLASS 25—CLOTHING

FOR CLOTHING, NAMELY, COATS, JACKETS, FLEECES, KNITWEAR, NAMELY, JUMPERS, CARDI-GANS, TANK TOPS, VESTS AND KNITTED JACKETS, SHIRTS, BLOUSES, T-SHIRTS, JEANS, SKIRTS, DRESSES, SHORTS, ATHLETIC SHOES, BOOTS, FLIP-FLOP SANDALS, CASUAL SHOES, DECK SHOES, FOOTWEAR, CAPS, BASEBALL CAPS, SUNHATS, AND WOOLEN HATS (U.S. CLS. 22 AND 39).

ARETHA SOMERVILLE, EXAMINING ATTORNEY

THE MARK CONSISTS OF STANDARD CHARACTERS WITHOUT CLAIM TO ANY PARTICULAR FONT, STYLE, SIZE, OR COLOR.

NO CLAIM IS MADE TO THE EXCLUSIVE RIGHT TO USE "PARIS", APART FROM THE MARK AS SHOWN.

CLASS 9—ELECTRICAL AND SCIENTIFIC APPARATUS

FOR SPECTACLES, SUNGLASSES, EYEGLASS FRAMES, OPTICAL FRAMES; CAMERAS; CAMERA CASES; EYEGLASS CASES, COMPUTER CARRYING CASES, CASES FOR TELEPHONES, CASES FOR SPEC-TACLES AND SUNGLASSES, CASES FOR MOBILE PHONES, CASES FOR ELECTRONIC DIARIES, CASES FOR DISKETTES AND COMPACT DISKS; EYEWEAR ACCESSORIES, NAMELY, STRAPS, NECK CORDS AND HEAD STRAPS WHICH RESTRAIN EYEWEAR FROM MOVEMENT ON WEARER (U.S. CLS. 21, 23, 26, 36 AND 38).

CLASS 30—STAPLE FOODS

FOR COFFEE, TEA, COCOA, SUGAR, RICE, TAPIO-CA, SAGO, ARTIFICIAL COFFEE; FLOUR FOR FOODS, BAKERY GOODS, COOKIES, DANISH PASTRIES; HON-EY, TREACLE; YEAST, BAKING-POWDER; SALT, MUS-TARD, VINEGAR, READY-MADE SAUCES; SPICES; ICE; CAKES, CANDY, CHOCOLATE, MACARONI, PIES, CHOCOLATE SYRUP, FLAVORING SYRUP, MAPLE SYRUP, TABLE SYRUP, TOPPING SYRUP (U.S. CL. 46).

CLASS 32—LIGHT BEVERAGES

FOR BEERS; MINERAL AND AERATED WATERS; NON-ALCOHOLIC DRINKS, NAMELY CARBONATED BEVERAGES, BEVERAGES CONTAINING FRUIT JUICES, BEVERAGES WITH TEA FLAVOR; FRUIT DRINKS AND FRUIT JUICES; SYRUPS FOR BEV-ERAGES (U.S. CLS. 45, 46 AND 48).

JIM RINGLE, EXAMINING ATTORNEY

SN 78-346,345. ROYAL CREST DAIRY, INC., DENVER, CO.
FILED 12-30-2003.

SN 78-346,743. B.Y. DEVELOPMENT, RAPID CITY, SD.
FILED S.R. 12-30-2003; AM. P.R. 11-3-2004.

It just tastes
better.
Naturally.

THE MARK CONSISTS OF STANDARD CHARACTERS WITHOUT CLAIM TO ANY PARTICULAR FONT, STYLE, SIZE, OR COLOR.

CLASS 20—FURNITURE AND ARTICLES NOT OTHERWISE CLASSIFIED

FOR NON-METAL CONTAINERS FOR TRANSPORTING MILK (U.S. CLS. 2, 13, 22, 25, 32 AND 50).

CLASS 29—MEATS AND PROCESSED FOODS

FOR MILK, HALF AND HALF MILK AND CREAM MIXTURE, WHIPPING CREAM, SOUR CREAM, COTTAGE CHEESE, BUTTER, SOY-BASED FOOD BEVERAGE USED AS MILK SUBSTITUTE, CREAM, EGGS, MILD CHEEDAR CHEESE, SHARP CHEEDAR CHEESE, STRING CHEESE, AMERICAN CHEESE SLICES, CREAM CHEESE, EGG NOG, DAIRY PRODUCTS EXCLUDING ICE CREAM, ICE MILK AND FROZEN YOGURT (U.S. CL. 46).

CLASS 30—STAPLE FOODS

FOR SNICKERDOODLE COOKIE DOUGH, OATMEAL CRANBERRY WALNUT COOKIE DOUGH, CHOCOLATE CHUNK COOKIE DOUGH, WHITE CHOCOLATE MACADAMIA NUT COOKIE DOUGH, SUGAR COOKIE DOUGH (U.S. CL. 46).

CLASS 32—LIGHT BEVERAGES

FOR FRUIT JUICES IN GENERAL AND DRINKING WATER (U.S. CLS. 45, 46 AND 48).

CLASS 35—ADVERTISING AND BUSINESS

FOR RETAIL GROCERY STORE, CONVENIENCE STORE, AND SUPERMARKET SERVICES; COMPUTERIZED ON-LINE ORDERING SERVICES FEATURING GROCERY PRODUCTS (U.S. CLS. 100, 101 AND 102).

CLASS 39—TRANSPORTATION AND STORAGE

FOR HOME DELIVERY SERVICES OF GOODS, INCLUDING MILK, FRUIT JUICE, WATER, COFFEE, HALF AND HALF MILK AND CREAM MIXTURE, WHIPPING CREAM, SOUR CREAM, COTTAGE CHEESE, BUTTER, VANILLA, CREAM, EGGS, EGG NOG, BREAD, CHEESE, NUTS, COOKIE DOUGH AND DAIRY PRODUCTS (U.S. CLS. 100 AND 105).
TARAH HARDY, EXAMINING ATTORNEY



OWNER OF U.S. REG. NO. 2,617,959.

THE NAME SHOWN IN THE MARK DOES NOT IDENTIFY A PARTICULAR LIVING INDIVIDUAL.

THE COLOR(S) RED, YELLOW, BLUE, BLACK AND WHITE IS/ARE CLAIMED AS A FEATURE OF THE MARK.

THE COLOR "RED" APPEARS ON THE BANNER, ON THE JACK OF CLUBS' HAT, AND ON THE LETTER "J" AND ON THE DIAMOND IN THE JACK OF DIAMONDS CARD, AND IN SMALL PORTIONS OF THE BACKGROUND ON THE JACK OF CLUBS CARD. THE COLOR "BLACK" APPEARS ON THE BORDER OF THE BANNER, ON THE LETTER "J" ALONG WITH THE CLUB AND SPADE DESIGNS, ON PORTIONS OF THE JACK OF CLUBS' CLOTHING AND ON THE BACKGROUND OF THE CARDS. THE COLOR "WHITE" APPEARS ON THE LETTERING IN THE BANNER AND ON THE BACKGROUND OF THE CARDS. THE COLOR "BLUE" APPEARS ON THE JACK OF CLUBS' ROBE AND FACE. THE COLOR "YELLOW" APPEARS ON THE JACK OF CLUBS' HAIR, PORTIONS OF THE ROBE, AND IN THE BACKGROUND DESIGN.

CLASS 41—EDUCATION AND ENTERTAINMENT

FOR GAMBLING CASINO SERVICES (U.S. CLS. 100, 101 AND 107).
FIRST USE 1-25-2002; IN COMMERCE 1-25-2002.

CLASS 43—HOTEL AND RESTAURANT SERVICES

FOR RESTAURANT AND HOTEL SERVICES (U.S. CLS. 100 AND 101).
FIRST USE 1-25-2002; IN COMMERCE 1-25-2002.
PAUL F. GAST, EXAMINING ATTORNEY

SN 78-347,771. ACLARA BIOSCIENCES, INC., MOUNTAIN VIEW, CA. FILED 1-5-2004.

ACLARA

THE MARK CONSISTS OF STANDARD CHARACTERS WITHOUT CLAIM TO ANY PARTICULAR FONT, STYLE, SIZE, OR COLOR.

OWNER OF U.S. REG. NO. 2,491,062.

CLASS 1—CHEMICALS

FOR CHEMICAL REAGENTS AND ASSAYS FOR SCIENTIFIC OR RESEARCH USE (U.S. CLS. 1, 5, 6, 10, 26 AND 46).
FIRST USE 12-3-2002; IN COMMERCE 12-3-2002.

CLASS 5—PHARMACEUTICALS

FOR CHEMICAL REAGENTS AND ASSAYS FOR CLINICAL OR MEDICAL LABORATORY USE (U.S. CLS. 6, 18, 44, 46, 51 AND 52).
FIRST USE 12-3-2002; IN COMMERCE 12-3-2002.

CLASS 9—ELECTRICAL AND SCIENTIFIC APPARATUS

FOR COMPUTER SOFTWARE FOR GENE AND PROTEIN EXPRESSION DATA ANALYSIS AND REPORTS (DATE OF FIRST USE ANYWHERE- 04/09/2002; DATE OF FIRST USE IN COMMERCE- 04/09/2002); PHOTO-ACTIVATION ILLUMINATOR DEVICE FOR LABELING, DETECTING AND IDENTIFYING PROTEINS (DATE OF FIRST USE ANYWHERE- 08/00/2002; DATE OF FIRST USE IN COMMERCE- 08/00/2002) (U.S. CLS. 21, 23, 26, 36 AND 38).
FIRST USE 8-0-2002; IN COMMERCE 8-0-2002.

CLASS 42—SCIENTIFIC, COMPUTER AND LEGAL SERVICES

FOR DESIGN AND DEVELOPMENT OF GENE AND PROTEIN EXPRESSION ASSAYS; INDUSTRIAL ANALYSIS AND RESEARCH SERVICES, NAMELY, PROVIDING SCIENTIFIC FACILITIES, EQUIPMENT, SOFTWARE, REAGENTS AND ASSAYS FOR GENE AND PROTEIN EXPRESSION ANALYSIS AND RESEARCH; COLLABORATIVE RESEARCH IN THE DEVELOPMENT OF A WIDE VARIETY OF PHARMACEUTICALS, MEDICAL DIAGNOSTIC TESTS AND DRUG THERAPIES (U.S. CLS. 100 AND 101).
FIRST USE 6-18-2003; IN COMMERCE 6-18-2003.
MICHAEL SOUDERS, EXAMINING ATTORNEY

CLASS 20—FURNITURE AND ARTICLES NOT OTHERWISE CLASSIFIED

FOR BATH ACCESSORIES, NAMELY, GLASS SHELVES AND NON-METAL ROBE HOOKS (U.S. CLS. 2, 13, 22, 25, 32 AND 50).

CLASS 21—HOUSEWARES AND GLASS

FOR BATH ACCESSORIES, NAMELY, TOWEL BARS, TOWEL RINGS, TOILET PAPER HOLDERS, TISSUE HOLDERS, AND TOOTHBRUSH TUMBLER HOLDERS (U.S. CLS. 2, 13, 23, 29, 30, 33, 40 AND 50).
ELLEN PERKINS, EXAMINING ATTORNEY

SN 78-348,701. BRASSTECH, INC., SANTA ANA, CA. FILED 1-7-2004.

SN 78-348,695. BRASSTECH, INC., SANTA ANA, CA. FILED 1-7-2004.

QUATTRO

SINE

THE MARK CONSISTS OF STANDARD CHARACTERS WITHOUT CLAIM TO ANY PARTICULAR FONT, STYLE, SIZE, OR COLOR.

THE FOREIGN WORDING IN THE MARK TRANSLATES INTO ENGLISH AS FOUR.

CLASS 6—METAL GOODS

FOR ROBE HOOKS MADE OF METAL (U.S. CLS. 2, 12, 13, 14, 23, 25 AND 50).

CLASS 20—FURNITURE AND ARTICLES NOT OTHERWISE CLASSIFIED

FOR BATH ACCESSORIES, NAMELY, GLASS SHELVES AND NON-METAL ROBE HOOKS (U.S. CLS. 2, 13, 22, 25, 32 AND 50).

CLASS 21—HOUSEWARES AND GLASS

FOR BATH ACCESSORIES, NAMELY, TOWEL BARS, TOWEL RINGS, TOILET PAPER HOLDERS, TISSUE HOLDERS, AND TOOTHBRUSH TUMBLER HOLDERS (U.S. CLS. 2, 13, 23, 29, 30, 33, 40 AND 50).
ELLEN PERKINS, EXAMINING ATTORNEY

THE MARK CONSISTS OF STANDARD CHARACTERS WITHOUT CLAIM TO ANY PARTICULAR FONT, STYLE, SIZE, OR COLOR.

CLASS 6—METAL GOODS

FOR ROBE HOOKS MADE OF METAL (U.S. CLS. 2, 12, 13, 14, 23, 25 AND 50).

SN 78-349,389. OVERSTOCK.COM, INC., SALT LAKE CITY, UT. FILED 1-8-2004.

SN 78-349,845. ACCUSCRIPT, INC, HAZLETON, PA. FILED 1-9-2004.

IT'S ALL ABOUT THE
O

THE MARK CONSISTS OF STANDARD CHARACTERS WITHOUT CLAIM TO ANY PARTICULAR FONT, STYLE, SIZE, OR COLOR.

CLASS 35—ADVERTISING AND BUSINESS

FOR ON-LINE WHOLESALE AND RETAIL STORE SERVICES FEATURING ART WORK, ARTIFACTS, FURNITURE, HOME FURNISHINGS, ELECTRICAL LIGHT FIXTURES, DECORATIVE ITEMS FOR THE HOME, FLOOR RUGS, APPLIANCES, VACUUM CLEANERS, BEDDING, TOWELS, POWER TOOLS, HAND TOOLS, GARDEN TOOLS AND ACCESSORIES, APPAREL, JEWELRY, WATCHES, EYEWEAR, FOOTWEAR, HANDBAGS AND PERSONAL ACCESSORIES, LUGGAGE, BACKPACKS, BOOKS, MAGAZINES, MUSICAL RECORDINGS, VIDEO RECORDINGS, SPORTING GOODS AND SPORTSWEAR, AUDIO AND VIDEO ELECTRONICS, CAMERAS, COMPUTERS AND COMPUTER PERIPHERALS, PERSONAL DIGITAL ASSISTANTS, TELEPHONES, ELECTRONIC GAME SYSTEMS, ELECTRONIC AND NON-ELECTRONIC GAMES, AND NOVELTIES (U.S. CLS. 100, 101 AND 102).

CLASS 39—TRANSPORTATION AND STORAGE

FOR AIRLINE, CRUISE SHIP, AND CAR RENTAL RESERVATIONS SERVICES VIA A GLOBAL COMPUTER NETWORK; PROVIDING AIRLINE, CRUISE, CAR RENTAL, AND GENERAL TRAVEL INFORMATION VIA A GLOBAL COMPUTER NETWORK; TOUR PACKAGE RESERVATIONS, NAMELY, TRAVEL AND TOUR TICKET RESERVATION SERVICES AND MAKING RESERVATIONS AND BOOKINGS FOR TRANSPORTATION VIA A GLOBAL COMPUTER NETWORK (U.S. CLS. 100 AND 105).

CLASS 43—HOTEL AND RESTAURANT SERVICES

FOR TOUR PACKAGE RESERVATIONS, NAMELY, MAKING HOTEL RESERVATIONS FOR OTHERS VIA A GLOBAL COMPUTER NETWORK (U.S. CLS. 100 AND 101).

KIM SAITO, EXAMINING ATTORNEY

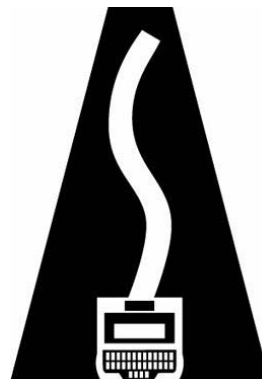

THE MARK CONSISTS OF A STYLIZED LETTER "A", IN THE MIDDLE OF WHICH THERE IS A STENOGRAPHIC SHORTHAND MACHINE WITH A STRIP OF STENOGRAPHIC PAPER COMING OUT OF THE TOP OF THE MACHINE IN THE SHAPE OF A STYLIZED LETTER "S".

CLASS 35—ADVERTISING AND BUSINESS

FOR STENOGRAPHIC TRANSCRIPTION SERVICES, NAMELY, THE PRODUCTION AND DISTRIBUTION OF VERBATIM TRANSCRIPTS OF ALL TYPES OF ORAL COMMUNICATIONS OR JUDICIAL PROCEEDINGS (U.S. CLS. 100, 101 AND 102).

FIRST USE 10-10-1998; IN COMMERCE 10-10-1998.

CLASS 42—SCIENTIFIC, COMPUTER AND LEGAL SERVICES

FOR COURT REPORTING; LITIGATION SUPPORT SERVICES; LITIGATION SUPPORT SERVICES, NAMELY, THE PRODUCTION, ORGANIZATION AND DISPLAY OF DEMONSTRATIVE EVIDENCE FOR COURTROOM PRESENTATION (U.S. CLS. 100 AND 101).

FIRST USE 10-10-1998; IN COMMERCE 10-10-1998.

DANIELLE MATTESSICH, EXAMINING ATTORNEY

SN 78-349,954. GILLISPIE CREATIVE, INC., ERLANGER, KY. FILED 1-9-2004.



gillispie creative, Inc.

NO CLAIM IS MADE TO THE EXCLUSIVE RIGHT TO USE INC., APART FROM THE MARK AS SHOWN.

THE MARK CONSISTS IN PART OF THE STYLIZED LETTERS GC.

CLASS 35—ADVERTISING AND BUSINESS

FOR ADVERTISING SERVICES, NAMELY, CREATING CORPORATE AND BRAND IDENTITY FOR OTHERS; CREATING CORPORATE LOGOS FOR OTHERS AND CONSULTATION SERVICES RELATED THERETO (U.S. CLS. 100, 101 AND 102).

CLASS 42—SCIENTIFIC, COMPUTER AND LEGAL SERVICES

FOR GRAPHIC ART DESIGN AND CONSULTATION SERVICES RELATED THERETO (U.S. CLS. 100 AND 101).

PRISCILLA MILTON, EXAMINING ATTORNEY

SN 78-350,610. CHARLES SCHWAB & CO., INC., SAN FRANCISCO, CA. FILED 1-12-2004.

嘉信貴賓Trader

OWNER OF U.S. REG. NOS. 2,501,268, 2,779,975 AND OTHERS.

NO CLAIM IS MADE TO THE EXCLUSIVE RIGHT TO USE TRADER, APART FROM THE MARK AS SHOWN.

THE FOREIGN WORDING IN THE MARK TRANSLATES INTO ENGLISH AS SCHWAB SIGNATURE TRADER.

THE NON-LATIN CHARACTER(S) IN THE MARK TRANSLITERATES INTO JIA XIN GUI BIN TRADER IN MANDARIN, AND THIS MEANS SCHWAB SIGNATURE TRADER IN ENGLISH.

CLASS 9—ELECTRICAL AND SCIENTIFIC APPARATUS

FOR DOWNLOADABLE ELECTRONIC PUBLICATIONS IN THE NATURE OF BOOKLETS, NEWSLETTERS, RESEARCH REPORTS, WORKBOOKS, LEAFLETS, BROCHURES, AND PAMPHLETS IN THE FIELDS OF INVESTING, FINANCE, FINANCIAL PLANNING, INVESTMENT STRATEGY, BUSINESS, CURRENT EVENTS, GOVERNMENT, FINANCIAL PORTFOLIO MANAGEMENT, AND ECONOMICS; DOWNLOADABLE SOFTWARE FOR USE BY INVESTORS IN THE TRADING AND ANALYSIS OF INVESTMENTS, FINANCES, FINANCIAL MARKETS, AND FINANCIAL PLANNING, VIA A GLOBAL COMPUTER NETWORK, NAMELY, SOFTWARE FOR ELECTRONIC TRADING IN ALL FORMS OF SECURITIES, NAMELY, STOCKS, BONDS, MUTUAL FUNDS, CURRENCIES, COMMODITIES, FUTURES, OPTIONS, MONEY MARKET FUNDS, AND INDICES OF ANY OF THEM; DOWNLOADABLE SOFTWARE FOR PROVIDING FINANCIAL AND INVESTMENT INFORMATION, FINANCIAL AND INVESTMENT NEWS, AND FINANCIAL AND INVESTMENT RESEARCH; DOWNLOADABLE SOFTWARE FOR MAINTAINING FINANCIAL AND INVESTMENT DATABASES (U.S. CLS. 21, 23, 26, 36 AND 38).

CLASS 16—PAPER GOODS AND PRINTED MATTER

FOR PRINTED MATERIALS, NAMELY, BOOKLETS, NEWSLETTERS, RESEARCH REPORTS, WORKBOOKS, LEAFLETS, BROCHURES, AND PAMPHLETS IN THE FIELDS OF INVESTING, FINANCE, FINANCIAL PLANNING, INVESTMENT STRATEGY, BUSINESS, CURRENT EVENTS, GOVERNMENT, FINANCIAL PORTFOLIO MANAGEMENT, AND ECONOMICS (U.S. CLS. 2, 5, 22, 23, 29, 37, 38 AND 50).

CLASS 35—ADVERTISING AND BUSINESS

FOR PROVIDING PROFESSIONAL REFERRALS IN THE FIELDS OF INVESTMENT ADVICE, PORTFOLIO MANAGEMENT, FINANCIAL PLANNING, RETIREMENT PLANNING, AND WEALTH MANAGEMENT; PROVIDING INFORMATION AND ANALYSIS IN THE FIELDS OF ECONOMICS AND BUSINESS, NAMELY, INDUSTRY AND SECTOR REPORTS AND FORECASTS, ECONOMIC REPORTS AND FORECASTS; PROVISION OF NEWS, INFORMATION, RESEARCH, DATABASES, AND ANALYSIS IN THE FIELD OF ECONOMICS VIA ELECTRONIC COMMUNICATION NETWORKS (U.S. CLS. 100, 101 AND 102).

CLASS 36—INSURANCE AND FINANCIAL

FOR FINANCIAL INVESTMENT SERVICES, INVESTMENT ADVICE AND INVESTMENT MANAGEMENT SERVICES, AND INVESTMENT BROKERAGE SERVICES, ALL IN THE FIELDS OF FINANCIAL SECURITIES, STOCKS, BONDS, MONEY MARKET FUNDS, MUTUAL FUNDS, COMMODITIES, FUTURES, STOCK OPTIONS, AND INDICES OF FINANCIAL SECURITIES; FINANCIAL PLANNING AND FINANCIAL PORTFOLIO MANAGEMENT SERVICES; BANKING SERVICES; INSURANCE BROKERAGE SERVICES; ANNUITY INVESTMENT SERVICES; PROVIDING INFORMATION AND ANALYSIS IN THE FIELDS OF FINANCE, INVESTMENT, FINANCIAL PLANNING, AND FINANCIAL INVESTMENT STRATEGY; PROVIDING AN INTERACTIVE ONLINE COMPUTER DATABASE IN THE FIELD OF FINANCIAL PORTFOLIO MANAGEMENT, FINANCIAL INVESTING, FINANCE, FINANCIAL PLANNING, FINANCIAL NEWS, FINANCIAL INFORMATION, AND ANALYSIS IN THE FIELDS OF FINANCIAL INVESTING, FINANCE, FINANCIAL PLANNING, FINANCIAL DECISION MAKING, FINANCIAL INVESTMENT RESEARCH; FINANCIAL ANALYSIS, NAMELY, MONITORING INVESTMENT VALUE AND PERFORMANCE OF INVESTMENTS, ANALYZING INVESTMENT PERFORMANCE, EVALUATING ASSET ALLOCATION, RISK TOLERANCE, FINANCIAL ALTERNATIVE PLANS AND INVESTMENT TIME FRAMES; PROVIDING INFORMATION BY ELECTRONIC MEANS, BY PHONE AND BY ONLINE MEANS IN THE FIELD OF INVESTMENT ACCOUNT INFORMATION AND FINANCIAL RESEARCH; BROKERAGE SERVICES AND INVESTMENT SERVICES PROVIDED ELECTRONICALLY AND VIA GLOBAL INFORMATION NETWORKS, NAMELY, ELECTRONIC TRADING FOR ALL FORMS OF SECURITIES, NAMELY, STOCKS, BONDS, MUTUAL FUNDS, CURRENCIES, COMMODITIES, FUTURES, OPTIONS, MONEY MARKET FUNDS, AND INDICES OF ANY OF THEM; FINANCIAL PORTFOLIO MANAGEMENT SERVICES PROVIDED VIA ELECTRONIC COMMUNICATION NETWORKS; PROVISION OF NEWS, INFORMATION RESEARCH, DATABASES, AND ANALYSIS IN THE FIELDS OF FINANCIAL INVESTING, FINANCE, AND FINANCIAL PLANNING VIA ELECTRONIC COMMUNICATION NETWORKS; SECURITIES BROKERAGE ACCOUNT SERVICES INCLUDING AN INTEREST BEARING FEATURE FOR CASH BETWEEN INVESTMENTS, ACCESS TO CASH, AND MARGIN LOANS; CREDIT CARD AND DEBIT CARD SERVICES; BILL PAYMENT SERVICES, NAMELY, CHECK WRITING; BILL PAYMENT SERVICES; CASH MANAGEMENT ACCOUNT SERVICES; FINANCIAL INVESTMENT SERVICES, NAMELY, FIXED INCOME INVESTMENT SERVICES; ELECTRONIC PAYMENT SERVICES, NAMELY, ELECTRONIC PROCESSING AND TRANSMISSION OF BILL PAYMENT DATA, AND ELECTRONIC FUND TRANSFER SERVICES (U.S. CLS. 100, 101 AND 102).

CLASS 41—EDUCATION AND ENTERTAINMENT

FOR EDUCATIONAL SERVICES, NAMELY, CONDUCTING SEMINARS AND WORKSHOPS IN THE FIELDS OF INVESTMENT, FINANCE, FINANCIAL PLANNING, PORTFOLIO MANAGEMENT, RETIREMENT PLANNING, MONEY MANAGEMENT, INVESTMENT STRATEGY, AND ASSET ALLOCATION (U.S. CLS. 100, 101 AND 107).

MARLENE BELL, EXAMINING ATTORNEY

SN 78-350,775. QUILTS BY DONNA, INC., SHEPHERDSVILLE, KY. FILED 1-12-2004.

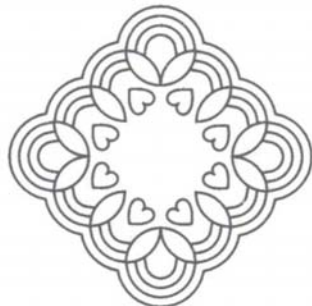

CLASS 20—FURNITURE AND ARTICLES NOT OTHERWISE CLASSIFIED

FOR NON-METAL BOXES, NON-METAL CURTAIN RINGS, PICTURE FRAMES (U.S. CLS. 2, 13, 22, 25, 32 AND 50).

CLASS 21—HOUSEWARES AND GLASS

FOR WASTEPAPER BASKETS, TOOTHBRUSH HOLDERS, SOAP DISHES, DISPENSERS FOR LOTION, CANDLE HOLDERS NOT OF PRECIOUS METAL, TISSUE CONTAINER COVERS, NON-METAL HOUSEHOLD STORAGE JARS, CUPS (U.S. CLS. 2, 13, 23, 29, 30, 33, 40 AND 50).

CLASS 24—FABRICS

FOR WALL DISPLAYS CONSISTING OF MOUNTED AND FRAMED QUILTED ITEMS (U.S. CLS. 42 AND 50).
PAUL F. GAST, EXAMINING ATTORNEY

SN 78-350,841. CHARLES SCHWAB & CO., INC., SAN FRANCISCO, CA. FILED 1-12-2004.

嘉信「卓越自我理財」

OWNER OF U.S. REG. NOS. 2,501,268, 2,779,975 AND OTHERS.

NO CLAIM IS MADE TO THE EXCLUSIVE RIGHT TO USE THE LAST SIX CHINESE CHARACTERS, WHICH TRANSLITERATE TO "ZHUO YUE ZI WO LI CAI", AND TRANSLATE TO "SUPERIOR/OUTSTANDING PERSONAL MONEY MANAGEMENT" PART FROM THE MARK AS SHOWN, APART FROM THE MARK AS SHOWN.

THE FOREIGN WORDING IN THE MARK TRANSLATES INTO ENGLISH AS SCHWAB SUPERIOR/OUTSTANDING PERSONAL MONEY MANAGEMENT.

THE NON-LATIN CHARACTER(S) IN THE MARK TRANSLITERATES INTO JIA XIN ZHUO YUE ZI WO LI CAI IN MANDARIN, AND THIS MEANS SCHWAB SUPERIOR/OUTSTANDING PERSONAL MONEY MANAGEMENT IN ENGLISH.

CLASS 9—ELECTRICAL AND SCIENTIFIC APPARATUS

FOR DOWNLOADABLE ELECTRONIC PUBLICATIONS IN THE NATURE OF BOOKLETS, NEWSLETTERS, RESEARCH REPORTS, WORKBOOKS, LEAFLETS, BROCHURES, AND PAMPHLETS IN THE FIELDS OF INVESTING, FINANCE, FINANCIAL PLANNING, INVESTMENT STRATEGY, BUSINESS, CURRENT EVENTS, GOVERNMENT, FINANCIAL PORTFOLIO MANAGEMENT, AND ECONOMICS; DOWNLOADABLE SOFTWARE FOR USE BY INVESTORS IN THE TRADING AND ANALYSIS OF INVESTMENTS, FINANCES, FINANCIAL MARKETS, AND FINANCIAL PLANNING, VIA A GLOBAL COMPUTER NETWORK, NAMELY, SOFTWARE FOR ELECTRONIC TRADING IN ALL FORMS OF SECURITIES, NAMELY, STOCKS, BONDS, MUTUAL FUNDS, CURRENCIES, COMMODITIES, FUTURES, OPTIONS, MONEY MARKET FUNDS, AND INDICES OF ANY OF THEM; DOWNLOADABLE SOFTWARE FOR PROVIDING FINANCIAL AND INVESTMENT INFORMATION, FINANCIAL AND INVESTMENT NEWS, AND FINANCIAL AND INVESTMENT RESEARCH; DOWNLOADABLE SOFTWARE FOR MAINTAINING FINANCIAL AND INVESTMENT DATABASES (U.S. CLS. 21, 23, 26, 36 AND 38).

CLASS 16—PAPER GOODS AND PRINTED MATTER

FOR PRINTED MATERIALS, NAMELY, BOOKLETS, NEWSLETTERS, RESEARCH REPORTS, WORKBOOKS, LEAFLETS, BROCHURES, AND PAMPHLETS IN THE FIELDS OF INVESTING, FINANCE, FINANCIAL PLANNING, INVESTMENT STRATEGY, BUSINESS, CURRENT EVENTS, GOVERNMENT, FINANCIAL PORTFOLIO MANAGEMENT, AND ECONOMICS (U.S. CLS. 2, 5, 22, 23, 29, 37, 38 AND 50).

CLASS 35—ADVERTISING AND BUSINESS

FOR PROVIDING PROFESSIONAL REFERRALS IN THE FIELDS OF INVESTMENT ADVICE, PORTFOLIO MANAGEMENT, FINANCIAL PLANNING, RETIREMENT PLANNING, AND WEALTH MANAGEMENT; PROVIDING INFORMATION AND ANALYSIS IN THE FIELDS OF ECONOMICS AND BUSINESS, NAMELY, INDUSTRY AND SECTOR REPORTS AND FORECASTS, ECONOMIC REPORTS AND FORECASTS; PROVISION OF NEWS, INFORMATION, RESEARCH, DATABASES, AND ANALYSIS IN THE FIELD OF ECONOMICS VIA ELECTRONIC COMMUNICATION NETWORKS (U.S. CLS. 100, 101 AND 102).

CLASS 36—INSURANCE AND FINANCIAL

FOR FINANCIAL INVESTMENT SERVICES, INVESTMENT ADVICE AND INVESTMENT MANAGEMENT SERVICES, AND INVESTMENT BROKERAGE SERVICES, ALL IN THE FIELDS OF FINANCIAL SECURITIES, STOCKS, BONDS, MONEY MARKET FUNDS, MUTUAL FUNDS, COMMODITIES, FUTURES, STOCK OPTIONS, AND INDICES OF FINANCIAL SECURITIES; FINANCIAL PLANNING AND FINANCIAL PORTFOLIO MANAGEMENT SERVICES; BANKING SERVICES; INSURANCE BROKERAGE SERVICES; ANNUITY INVESTMENT SERVICES; PROVIDING INFORMATION AND ANALYSIS IN THE FIELDS OF FINANCE, INVESTMENT, FINANCIAL PLANNING, AND FINANCIAL INVESTMENT STRATEGY; PROVIDING AN INTERACTIVE ONLINE COMPUTER DATABASE IN THE FIELD OF FINANCIAL PORTFOLIO MANAGEMENT, FINANCIAL INVESTING, FINANCE, FINANCIAL PLANNING, FINANCIAL NEWS, FINANCIAL INFORMATION, AND ANALYSIS IN THE FIELDS OF FINANCIAL INVESTING, FINANCE, FINANCIAL PLANNING, FINANCIAL DECISION MAKING, FINANCIAL INVESTMENT RESEARCH; FINANCIAL ANALYSIS, NAMELY, MONITORING INVESTMENT VALUE AND PERFORMANCE OF INVESTMENTS, ANALYZING INVESTMENT PERFORMANCE, EVALUATING ASSET ALLOCATION, RISK TOLERANCE, FINANCIAL ALTERNATIVE PLANS AND INVESTMENT TIME FRAMES; PROVIDING INFORMATION BY ELECTRONIC MEANS, BY PHONE AND BY ONLINE MEANS IN

THE FIELD OF INVESTMENT ACCOUNT INFORMATION AND FINANCIAL RESEARCH; BROKERAGE SERVICES AND INVESTMENT SERVICES PROVIDED ELECTRONICALLY AND VIA GLOBAL INFORMATION NETWORKS, NAMELY, ELECTRONIC TRADING FOR ALL FORMS OF SECURITIES, NAMELY, STOCKS, BONDS, MUTUAL FUNDS, CURRENCIES, COMMODITIES, FUTURES, OPTIONS, MONEY MARKET FUNDS, AND INDICES OF ANY OF THEM; FINANCIAL PORTFOLIO MANAGEMENT SERVICES PROVIDED VIA ELECTRONIC COMMUNICATION NETWORKS; PROVISION OF NEWS, INFORMATION RESEARCH, DATABASES, AND ANALYSIS IN THE FIELDS OF FINANCIAL INVESTING, FINANCE, AND FINANCIAL PLANNING, VIA ELECTRONIC COMMUNICATION NETWORKS; SECURITIES BROKERAGE ACCOUNT SERVICES INCLUDING AN INTEREST BEARING FEATURE FOR CASH BETWEEN INVESTMENTS, ACCESS TO CASH, AND MARGIN LOANS; CREDIT CARD AND DEBIT CARD SERVICES; BILL PAYMENT SERVICES, NAMELY, CHECK WRITING; BILL PAYMENT SERVICES; CASH MANAGEMENT ACCOUNT SERVICES; FINANCIAL INVESTMENT SERVICES, NAMELY, FIXED INCOME INVESTMENT SERVICES; ELECTRONIC PAYMENT SERVICES, NAMELY, ELECTRONIC PROCESSING AND TRANSMISSION OF BILL PAYMENT DATA, AND ELECTRONIC FUND TRANSFER SERVICES (U.S. CLS. 100, 101 AND 102).

CLASS 41—EDUCATION AND ENTERTAINMENT

FOR EDUCATIONAL SERVICES, NAMELY, CONDUCTING SEMINARS AND WORKSHOPS IN THE FIELDS OF INVESTMENT, FINANCE, FINANCIAL PLANNING, PORTFOLIO MANAGEMENT, RETIREMENT PLANNING, MONEY MANAGEMENT, INVESTMENT STRATEGY, AND ASSET ALLOCATION (U.S. CLS. 100, 101 AND 107).

MARLENE BELL, EXAMINING ATTORNEY

SN 78-351,092. WAVELAND CAPITAL GROUP LLC, IRVINE, CA. FILED 1-13-2004.



THE MARK CONSISTS OF A STYLIZED, BLOCK "W" WITH A DIAMOND SHAPE ABOVE THE MIDPOINT OF THE "W".

CLASS 35—ADVERTISING AND BUSINESS

FOR MERGERS AND ACQUISITIONS ADVISORY SERVICES; BUSINESS CONSULTING SERVICES (U.S. CLS. 100, 101 AND 102).

FIRST USE 11-18-2002; IN COMMERCE 11-18-2002.

CLASS 36—INSURANCE AND FINANCIAL

FOR FINANCIAL SERVICES, NAMELY BROKERAGE SERVICES IN THE FIELDS OF SECURITIES INVESTMENT BANKING SERVICES, INVESTMENT ADVISORY SERVICES, MERCHANT BANKING, FINANCIAL ASSET MANAGEMENT SERVICES AND VENTURE CAPITAL SERVICES, FINANCIAL PLANNING FOR RETIREMENT; FINANCIAL RESEARCH SERVICES (U.S. CLS. 100, 101 AND 102).

FIRST USE 11-18-2002; IN COMMERCE 11-18-2002.

AMOS T. MATTHEWS, JR., EXAMINING ATTORNEY

SN 78-351,146. SCIENCEFIRST, L.L.C., MORRISTOWN, NJ. FILED 1-13-2004.

SCIENCEFIRST

THE MARK CONSISTS OF STANDARD CHARACTERS WITHOUT CLAIM TO ANY PARTICULAR FONT, STYLE, SIZE, OR COLOR.

CLASS 35—ADVERTISING AND BUSINESS

FOR BUSINESS MARKETING, BUSINESS CONSULTING, AND COMMERCIAL INFORMATION AND BUSINESS ADVICE IN THE FIELD OF PHARMACEUTICAL DRUGS FOR PHARMACEUTICAL COMPANIES AND MEDICAL DOCTORS; BUSINESS MEETING PLANNING; PREPARING AND PROVIDING BUSINESS MARKETING INFORMATION AND BUSINESS PRESENTATIONS FOR OTHERS IN THE FIELD OF PHARMACEUTICAL DRUGS; AND, CONDUCTING MARKET RESEARCH FOR OTHERS IN THE FIELD OF PHARMACEUTICAL DRUGS (U.S. CLS. 100, 101 AND 102).

FIRST USE 3-31-2003; IN COMMERCE 5-5-2003.

CLASS 41—EDUCATION AND ENTERTAINMENT

FOR SPECIAL EVENT PLANNING CONSULTATION; TRAINING SERVICES, NAMELY, PROVIDING SEMINARS, WORKSHOPS, CONFERENCES, SYMPOSIA IN THE FIELD OF PHARMACEUTICAL DRUGS; PROVIDING CONTINUING MEDICAL EDUCATION COURSES; PROVIDING EDUCATIONAL SPEAKERS IN THE MEDICAL FIELD; ARRANGING AND CONDUCTING EDUCATIONAL CONFERENCES AND TRAINING PROGRAMS IN THE FIELD OF PHARMACEUTICAL DRUGS, AND DISTRIBUTING COURSE MATERIALS IN CONNECTION THEREWITH (U.S. CLS. 100, 101 AND 107).

FIRST USE 3-31-2003; IN COMMERCE 5-5-2003.

CLASS 42—SCIENTIFIC, COMPUTER AND LEGAL SERVICES

FOR MEDICAL AND SCIENTIFIC RESEARCH IN THE FIELD OF PHARMACEUTICALS, NAMELY CONDUCTING CLINICAL TRIALS, DRUG RESEARCH, ANALYSIS AND EVALUATION; CONSULTING AND RESEARCH IN THE FIELD OF CLINICAL MEDICAL RESEARCH AND PHARMACEUTICAL PRODUCT DEVELOPMENT; PHARMACEUTICAL DRUG DEVELOPMENT SERVICES (U.S. CLS. 100 AND 101).

FIRST USE 3-31-2003; IN COMMERCE 5-5-2003.

WILLIAM P. SHANAHAN, EXAMINING ATTORNEY

SN 78-352,102. CHARLES SCHWAB & CO., INC., SAN FRANCISCO, CA. FILED 1-14-2004.

嘉信「卓越諮詢理財」

OWNER OF U.S. REG. NOS. 2,501,268, 2,779,975 AND OTHERS.

NO CLAIM IS MADE TO THE EXCLUSIVE RIGHT TO USE THE LAST SIX CHINESE CHARACTERS, WHICH TRANSLITERATE TO "ZHUO YUE ZI XUN LI CAI", AND TRANSLATES TO "SUPERIOR/OUTSTANDING ADVICE/CONSULTATION MONEY MANAGEMENT", APART FROM THE MARK AS SHOWN.

THE FOREIGN WORDING IN THE MARK TRANSLATES INTO ENGLISH AS SCHWAB SUPERIOR/OUTSTANDING ADVICE/CONSULTATION MONEY MANAGEMENT.

THE NON-LATIN CHARACTER(S) IN THE MARK TRANSLITERATES INTO JIA XIN ZHUO YUE ZI XUN LI CAI IN MANDARIN, AND THIS MEANS SCHWAB SUPERIOR/OUTSTANDING ADVICE/CONSULTATION MONEY MANAGEMENT IN ENGLISH.

CLASS 9—ELECTRICAL AND SCIENTIFIC APPARATUS

FOR DOWNLOADABLE ELECTRONIC PUBLICATIONS IN THE NATURE OF BOOKLETS, NEWSLETTERS, RESEARCH REPORTS, WORKBOOKS, LEAFLETS, BROCHURES, AND PAMPHLETS IN THE FIELDS OF INVESTING, FINANCE, FINANCIAL PLANNING, INVESTMENT STRATEGY, BUSINESS, CURRENT EVENTS, GOVERNMENT, FINANCIAL PORTFOLIO MANAGEMENT, AND ECONOMICS; DOWNLOADABLE SOFTWARE FOR USE BY INVESTORS IN THE TRADING AND ANALYSIS OF INVESTMENTS, FINANCES, FINANCIAL MARKETS, AND FINANCIAL PLANNING, VIA A GLOBAL COMPUTER NETWORK, NAMELY, SOFTWARE FOR ELECTRONIC TRADING IN ALL FORMS OF SECURITIES, NAMELY, STOCKS, BONDS, MUTUAL FUNDS, CURRENCIES, COMMODITIES, FUTURES, OPTIONS, MONEY MARKET FUNDS, AND INDICES OF ANY OF THEM; DOWNLOADABLE SOFTWARE FOR PROVIDING FINANCIAL AND INVESTMENT INFORMATION, FINANCIAL AND INVESTMENT NEWS, AND FINANCIAL AND INVESTMENT RESEARCH; DOWNLOADABLE SOFTWARE FOR MAINTAINING FINANCIAL AND INVESTMENT DATABASES (U.S. CLS. 21, 23, 26, 36 AND 38).

CLASS 16—PAPER GOODS AND PRINTED MATTER

FOR PRINTED MATERIALS, NAMELY, BOOKLETS, NEWSLETTERS, RESEARCH REPORTS, WORKBOOKS, LEAFLETS, BROCHURES, AND PAMPHLETS IN THE FIELDS OF INVESTING, FINANCE, FINANCIAL PLANNING, INVESTMENT STRATEGY, BUSINESS, CURRENT EVENTS, GOVERNMENT, FINANCIAL PORTFOLIO MANAGEMENT, AND ECONOMICS (U.S. CLS. 2, 5, 22, 23, 29, 37, 38 AND 50).

CLASS 35—ADVERTISING AND BUSINESS

FOR PROVIDING PROFESSIONAL REFERRALS IN THE FIELDS OF INVESTMENT ADVICE, PORTFOLIO MANAGEMENT, FINANCIAL PLANNING, RETIREMENT PLANNING, AND WEALTH MANAGEMENT; PROVIDING INFORMATION AND ANALYSIS IN THE FIELDS OF ECONOMICS AND BUSINESS, NAMELY, INDUSTRY AND SECTOR REPORTS AND FORECASTS, ECONOMICS REPORTS AND FORECASTS; PROVISION OF NEWS, INFORMATION RESEARCH, DATABASES, AND ANALYSIS IN THE FIELD OF ECONOMICS VIA ELECTRONIC COMMUNICATION NETWORKS (U.S. CLS. 100, 101 AND 102).

CLASS 36—INSURANCE AND FINANCIAL

FOR FINANCIAL INVESTMENT SERVICES, INVESTMENT ADVICE AND INVESTMENT MANAGEMENT SERVICES, AND INVESTMENT BROKERAGE SERVICES, ALL IN THE FIELDS OF FINANCIAL SECURITIES, STOCKS, BONDS, MONEY MARKET FUNDS, MUTUAL FUNDS, COMMODITIES, FUTURES, STOCK OPTIONS, AND INDICES OF FINANCIAL SECURITIES; FINANCIAL PLANNING AND FINANCIAL PORTFOLIO MANAGEMENT SERVICES; BANKING SERVICES; INSURANCE BROKERAGE SERVICES; ANNUITY INVESTMENT SERVICES; PROVIDING INFORMATION AND ANALYSIS IN THE FIELDS OF FINANCE, INVESTMENT, FINANCIAL PLANNING, AND FINANCIAL INVESTMENT STRATEGY; PROVIDING AN INTERACTIVE ONLINE COMPUTER DATABASE IN THE FIELD OF FINANCIAL PORTFOLIO MANAGEMENT, FINANCIAL INVESTING, FINANCE, FINANCIAL PLANNING, FINANCIAL NEWS, FINANCIAL INFORMATION, AND ANALYSIS IN THE FIELDS OF FINANCIAL INVESTING, FINANCE, FINANCIAL PLANNING, FINANCIAL DECISION MAKING, FINANCIAL INVESTMENT RESEARCH; FINANCIAL ANALYSIS, NAMELY, MONITORING INVESTMENT VALUE AND PERFORMANCE OF INVESTMENTS, ANALYZING INVESTMENT PERFORMANCE, EVALUATING ASSET ALLOCATION, RISK TOLERANCE, FINANCIAL ALTERNATIVE PLANS AND INVESTMENT TIME FRAMES; PROVIDING INFORMATION BY ELECTRONIC MEANS, BY PHONE AND BY ONLINE MEANS IN THE FIELD OF INVESTMENT ACCOUNT INFORMATION AND FINANCIAL RESEARCH; BROKERAGE SERVICES AND INVESTMENT SERVICES PROVIDED ELECTRONICALLY AND VIA GLOBAL INFORMATION NETWORKS, NAMELY, ELECTRONIC TRADING FOR ALL FORMS OF SECURITIES, NAMELY, STOCKS, BONDS, MUTUAL FUNDS, CURRENCIES, COMMODITIES, FUTURES, OPTIONS, MONEY MARKET FUNDS, AND INDICES OF ANY OF THEM; FINANCIAL PORTFOLIO MANAGEMENT SERVICES PROVIDED VIA ELECTRONIC COMMUNICATION NETWORKS; PROVISION OF NEWS, INFORMATION RESEARCH, DATABASES, AND ANALYSIS IN THE FIELDS OF FINANCIAL INVESTING, FINANCE AND FINANCIAL PLANNING VIA ELECTRONIC COMMUNICATION NETWORKS; SECURITIES BROKERAGE ACCOUNT SERVICES INCLUDING AN INTEREST BEARING FEATURE FOR CASH BETWEEN INVESTMENTS, ACCESS TO CASH, AND MARGIN LOANS; CREDIT CARD AND DEBIT CARD SERVICES; BILL PAYMENT SERVICES, NAMELY, CHECK WRITING; BILL PAYMENT SERVICES; CASH MANAGEMENT ACCOUNT SERVICES; FINANCIAL INVESTMENT SERVICES, NAMELY, FIXED INCOME INVESTMENT SERVICES; ELECTRONIC PAYMENT SERVICES, NAMELY, ELECTRONIC PROCESSING AND TRANSMISSION OF BILL PAYMENT DATA, AND ELECTRONIC FUND TRANSFER SERVICES (U.S. CLS. 100, 101 AND 102).

CLASS 41—EDUCATION AND ENTERTAINMENT

FOR EDUCATIONAL SERVICES, NAMELY, CONDUCTING SEMINARS AND WORKSHOPS IN THE FIELDS OF INVESTMENT, FINANCE, FINANCIAL PLANNING, PORTFOLIO MANAGEMENT, RETIREMENT PLANNING, MONEY MANAGEMENT, INVESTMENT STRATEGY, AND ASSET ALLOCATION (U.S. CLS. 100, 101 AND 107).

MARLENE BELL, EXAMINING ATTORNEY

SN 78-352,108. CHARLES SCHWAB & CO., INC., SAN FRANCISCO, CA. FILED 1-14-2004.

嘉信「理財精選計劃」

OWNER OF U.S. REG. NOS. 2,501,268, 2,779,975 AND OTHERS.

NO CLAIM IS MADE TO THE EXCLUSIVE RIGHT TO USE "THE LAST SIX CHINESE CHARACTERS, WHICH TRANSLITERATE TO 'LI CAI JING XUAN JI HUA' AND TRANSLATES TO MONEY MANAGEMENT SELECT/CAREFULLY CHOSEN PROGRAM/PLAN", APART FROM THE MARK AS SHOWN.

THE FOREIGN WORDING IN THE MARK TRANSLATES INTO ENGLISH AS SCHWAB MONEY MANAGEMENT SELECT/CAREFULLY CHOSEN PROGRAM/PLAN.

THE NON-LATIN CHARACTER(S) IN THE MARK TRANSLITERATES INTO JIA XIN LI CAI JING XUAN JI HUA IN MANDARIN, AND THIS MEANS SCHWAB MONEY MANAGEMENT SELECT/CAREFULLY CHOSEN PROGRAM/PLAN IN ENGLISH.

CLASS 9—ELECTRICAL AND SCIENTIFIC APPARATUS

FOR DOWNLOADABLE ELECTRONIC PUBLICATIONS IN THE NATURE OF BOOKLETS, NEWSLETTERS, RESEARCH REPORTS, WORKBOOKS, LEAFLETS, BROCHURES, AND PAMPHLETS IN THE FIELDS OF INVESTING, FINANCE, FINANCIAL PLANNING, INVESTMENT STRATEGY, BUSINESS, CURRENT EVENTS, GOVERNMENT, FINANCIAL PORTFOLIO MANAGEMENT, AND ECONOMICS; DOWNLOADABLE SOFTWARE FOR USE BY INVESTORS IN THE TRADING AND ANALYSIS OF INVESTMENTS, FINANCES, FINANCIAL MARKETS, AND FINANCIAL PLANNING, VIA A GLOBAL COMPUTER NETWORK, NAMELY, SOFTWARE FOR ELECTRONIC TRADING IN ALL FORMS OF SECURITIES, NAMELY, STOCKS, BONDS, MUTUAL FUNDS, CURRENCIES, COMMODITIES, FUTURES, OPTIONS, MONEY MARKET FUNDS, AND INDICES OF ANY OF THEM; DOWNLOADABLE SOFTWARE FOR PROVIDING FINANCIAL AND INVESTMENT INFORMATION, FINANCIAL AND INVESTMENT NEWS, AND FINANCIAL AND INVESTMENT RESEARCH; DOWNLOADABLE SOFTWARE FOR MAINTAINING FINANCIAL AND INVESTMENT DATABASES (U.S. CLS. 21, 23, 26, 36 AND 38).

CLASS 16—PAPER GOODS AND PRINTED MATTER

FOR PRINTED MATERIALS, NAMELY, BOOKLETS, NEWSLETTERS, RESEARCH REPORTS, WORKBOOKS, LEAFLETS, BROCHURES, AND PAMPHLETS IN THE FIELDS OF INVESTING, FINANCE, FINANCIAL PLANNING, INVESTMENT STRATEGY, BUSINESS, CURRENT EVENTS, GOVERNMENT, FINANCIAL PORTFOLIO MANAGEMENT, AND ECONOMICS (U.S. CLS. 2, 5, 22, 23, 29, 37, 38 AND 50).

CLASS 35—ADVERTISING AND BUSINESS

FOR PROVIDING PROFESSIONAL REFERRALS IN THE FIELDS OF INVESTMENT ADVICE, PORTFOLIO MANAGEMENT, FINANCIAL PLANNING, RETIREMENT PLANNING, AND WEALTH MANAGEMENT; PROVIDING INFORMATION AND ANALYSIS IN THE FIELDS OF ECONOMICS AND BUSINESS, NAMELY, INDUSTRY AND SECTOR REPORTS AND FORECASTS, ECONOMIC REPORTS AND FORECASTS; PROVISION OF NEWS, INFORMATION RESEARCH, DATABASES, AND ANALYSIS IN THE FIELD OF ECONOMICS VIA ELECTRONIC COMMUNICATION NETWORKS (U.S. CLS. 100, 101 AND 102).

CLASS 36—INSURANCE AND FINANCIAL

FOR FINANCIAL INVESTMENT SERVICES, INVESTMENT ADVICE AND INVESTMENT MANAGEMENT SERVICES, AND INVESTMENT BROKERAGE SERVICES, ALL IN THE FIELDS OF FINANCIAL SECURITIES, STOCKS, BONDS, MONEY MARKET FUNDS, MUTUAL FUNDS, COMMODITIES, FUTURES, STOCK OPTIONS, AND INDICES OF FINANCIAL SECURITIES; FINANCIAL PLANNING AND FINANCIAL PORTFOLIO MANAGEMENT SERVICES; BANKING SERVICES; INSURANCE BROKERAGE SERVICES; ANNUITY INVESTMENT SERVICES; PROVIDING INFORMATION AND ANALYSIS IN THE FIELDS OF FINANCE, INVESTMENT, FINANCIAL PLANNING, AND FINANCIAL INVESTMENT STRATEGY; PROVIDING AN INTERACTIVE ONLINE COMPUTER DATABASE IN THE FIELD OF FINANCIAL PORTFOLIO MANAGEMENT, FINANCIAL INVESTING, FINANCE, FINANCIAL PLANNING, FINANCIAL NEWS, FINANCIAL INFORMATION, AND ANALYSIS IN THE FIELDS OF FINANCIAL INVESTING, FINANCE, FINANCIAL PLANNING, FINANCIAL DECISION MAKING, FINANCIAL INVESTMENT RESEARCH; FINANCIAL ANALYSIS, NAMELY, MONITORING INVESTMENT VALUE AND PERFORMANCE OF INVESTMENTS, ANALYZING INVESTMENT PERFORMANCE, EVALUATING ASSET ALLOCATION, RISK TOLERANCE, FINANCIAL ALTERNATIVE PLANS AND INVESTMENT TIME FRAMES; PROVIDING INFORMATION BY ELECTRONIC MEANS, BY PHONE AND BY ONLINE MEANS IN THE FIELD OF INVESTMENT ACCOUNT INFORMATION AND FINANCIAL RESEARCH; BROKERAGE SERVICES AND INVESTMENT SERVICES PROVIDED ELECTRONICALLY AND VIA GLOBAL INFORMATION NETWORKS, NAMELY, ELECTRONIC TRADING FOR ALL FORMS OF SECURITIES, NAMELY, STOCKS, BONDS, MUTUAL FUNDS, CURRENCIES, COMMODITIES, FUTURES, OPTIONS, MONEY MARKET FUNDS, AND INDICES OF ANY OF THEM; FINANCIAL PORTFOLIO MANAGEMENT SERVICES PROVIDED VIA ELECTRONIC COMMUNICATION NETWORKS; PROVISION OF NEWS, INFORMATION RESEARCH, DATABASES, AND ANALYSIS IN THE FIELDS OF FINANCIAL INVESTING, FINANCE AND FINANCIAL PLANNING VIA ELECTRONIC COMMUNICATION NETWORKS; SECURITIES BROKERAGE ACCOUNT SERVICES INCLUDING AN INTEREST BEARING FEATURE FOR CASH BETWEEN INVESTMENTS, ACCESS TO CASH, AND MARGIN LOANS; CREDIT CARD AND DEBIT CARD SERVICES; BILL PAYMENT SERVICES, NAMELY, CHECK WRITING; BILL PAYMENT SERVICES; CASH MANAGEMENT ACCOUNT SERVICES; FINANCIAL INVESTMENT SERVICES, NAMELY, FIXED INCOME INVESTMENT SERVICES; ELECTRONIC PAYMENT SERVICES, NAMELY, ELECTRONIC PROCESSING AND TRANSMISSION OF BILL PAYMENT DATA AND ELECTRONIC FUND TRANSFER SERVICES (U.S. CLS. 100, 101 AND 102).

CLASS 41—EDUCATION AND ENTERTAINMENT

FOR EDUCATIONAL SERVICES, NAMELY, CONDUCTING SEMINARS AND WORKSHOPS IN THE FIELDS OF INVESTMENT, FINANCE, FINANCIAL PLANNING, PORTFOLIO MANAGEMENT, RETIREMENT PLANNING, MONEY MANAGEMENT, INVESTMENT STRATEGY, AND ASSET ALLOCATION (U.S. CLS. 100, 101 AND 107).

MARLENE BELL, EXAMINING ATTORNEY

SN 78-352,115. ROWENTA WERKE GMBH, OFFENBACH, FED REP GERMANY, FILED 1-14-2004.

Rowenta
PRO ACTIVE

PRIORITY CLAIMED UNDER SEC. 44(D) ON FRANCE APPLICATION NO. 033237778, FILED 7-23-2003. OWNER OF U.S. REG. NOS. 1,289,725 AND 2,208,263.

CLASS 9—ELECTRICAL AND SCIENTIFIC APPARATUS

FOR ELECTRIC AND STEAM IRONS (U.S. CLS. 21, 23, 26, 36 AND 38).

CLASS 11—ENVIRONMENTAL CONTROL APPARATUS

FOR STEAM GENERATORS (U.S. CLS. 13, 21, 23, 31 AND 34).

CLASS 21—HOUSEWARES AND GLASS

FOR IRONING BOARDS, IRONING BOARDS FITTED WITH SUCTION AND VENTILATION DEVICES, AND IRONING BOARDS WITH INTEGRATED HEATERS AND FANS AND INTERACTIVE STEAM IRONS (U.S. CLS. 2, 13, 23, 29, 30, 33, 40 AND 50).

DAVID H. STINE, EXAMINING ATTORNEY

SN 78-352,221. DVDPLAY, INC., LOS GATOS, CA. FILED 1-15-2004.



OWNER OF U.S. REG. NOS. 2,463,432 AND 2,573,752. NO CLAIM IS MADE TO THE EXCLUSIVE RIGHT TO USE DVD, APART FROM THE MARK AS SHOWN.

THE COLOR(S) WHITE, GRAY, RED AND BLACK IS/ARE CLAIMED AS A FEATURE OF THE MARK.

THE MARK CONSISTS OF A WHITE OVAL OUTLINED IN GRAY; A RED CIRCLE WITH A WHITE TRIANGLE IN THE CENTER IS IN THE LEFT ONE-THIRD OF THE OVAL; TO THE RIGHT OF THE RED CIRCLE ARE THE WORDS DVD AND PLAY IN BLACK BLOCK LETTER WITH DVD BLOCKED ABOVE PLAY.

CLASS 9—ELECTRICAL AND SCIENTIFIC APPARATUS

FOR AUTOMATED VENDING MACHINE THAT DISPENSES PRERECORDED MEDIA FOR SALE OR RENTAL (U.S. CLS. 21, 23, 26, 36 AND 38).

FIRST USE 2-0-2001; IN COMMERCE 2-0-2001.

CLASS 35—ADVERTISING AND BUSINESS

FOR VENDING SERVICES OF PRERECORDED MEDIA, NAMELY VENDING OF MUSIC, GAMES, VIDEOS AND OTHER RECORDED MATERIALS VIA A STAND-ALONE KIOSK VENDING MACHINE (U.S. CLS. 100, 101 AND 102).

FIRST USE 2-0-2001; IN COMMERCE 2-0-2001.

CLASS 41—EDUCATION AND ENTERTAINMENT

FOR ON-LINE RENTAL OF MUSIC, GAMES, VIDEOS AND OTHER RECORDED MATERIALS; RENTAL OF MUSIC, GAMES, VIDEOS AND OTHER RECORDED MATERIALS VIA A STAND-ALONE KIOSK VENDING MACHINE (U.S. CLS. 100, 101 AND 107).

FIRST USE 2-0-2001; IN COMMERCE 2-0-2001. MARK SPARACINO, EXAMINING ATTORNEY

SN 78-352,223. PERSHING INVESTMENTS LLC, NEWARK, DE. FILED 1-15-2004.

**NETEXCHANGE
INSTITUTIONAL**

THE MARK CONSISTS OF STANDARD CHARACTERS WITHOUT CLAIM TO ANY PARTICULAR FONT, STYLE, SIZE, OR COLOR.

OWNER OF U.S. REG. NOS. 2,369,648, 2,753,684 AND OTHERS.

NO CLAIM IS MADE TO THE EXCLUSIVE RIGHT TO USE INSTITUTE, APART FROM THE MARK AS SHOWN.

CLASS 9—ELECTRICAL AND SCIENTIFIC APPARATUS

FOR COMPUTER SOFTWARE FOR SECURITIES BROKERAGE IN THE FINANCIAL MANAGEMENT AND INVESTMENT AND MANAGEMENT INDUSTRY (U.S. CLS. 21, 23, 26, 36 AND 38).

CLASS 36—INSURANCE AND FINANCIAL

FOR OFFERING A WEB SITE OF INVESTMENT RELATED INFORMATION AND LINKS, OFFERED TO LOCAL BROKERS AND THEIR CUSTOMERS, IN THE FIELD OF AUTOMATED SECURITIES BROKERAGE AND PROVIDING ON-LINE SECURITIES BROKERAGE (U.S. CLS. 100, 101 AND 102).

BRIDGETT SMITH, EXAMINING ATTORNEY

SN 78-354,013. MEKOTA, RYAN M., NEWBURY, OH. FILED 1-20-2004.

QUANTA

THE MARK CONSISTS OF STANDARD CHARACTERS WITHOUT CLAIM TO ANY PARTICULAR FONT, STYLE, SIZE, OR COLOR.

CLASS 9—ELECTRICAL AND SCIENTIFIC APPARATUS

FOR PRERECORDED SOUND RECORDINGS, NAMELY, CDS FEATURING MUSIC (U.S. CLS. 21, 23, 26, 36 AND 38).

CLASS 41—EDUCATION AND ENTERTAINMENT

FOR ENTERTAINMENT, NAMELY, LIVE PERFORMANCES BY A MUSICAL BAND (U.S. CLS. 100, 101 AND 107).

LEIGH CAROLINE CASE, EXAMINING ATTORNEY

SN 78-354,224. WALL, BRIAN T., WOODBRIDGE, NJ. AND WALL, ELLEN M., WOODBRIDGE, NJ. FILED 1-20-2004.

ICECAM

THE MARK CONSISTS OF STANDARD CHARACTERS WITHOUT CLAIM TO ANY PARTICULAR FONT, STYLE, SIZE, OR COLOR.

CLASS 35—ADVERTISING AND BUSINESS

FOR PREPARING AUDIO-VISUAL PRESENTATIONS FOR USE IN ADVERTISING AND DISSEMINATION OF ADVERTISING MATTER (U.S. CLS. 100, 101 AND 102).

CLASS 41—EDUCATION AND ENTERTAINMENT

FOR PRODUCTION OF LIVE VIDEO FEATURING FOOTAGE TAKEN FROM A CAMERA ATTACHED TO AN ICE RESURFACING MACHINE TO BE USED TO ENTERTAIN PEOPLE ATTENDING OR VIEWING ICE RINK SPORTS (U.S. CLS. 100, 101 AND 107).

PAUL F. GAST, EXAMINING ATTORNEY

SN 78-357,206. ENRIQUEZ MATERIALS & QUILTING, INC., COMMERCE, CA. FILED 1-25-2004.

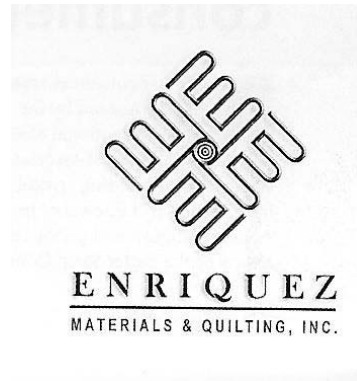

NO CLAIM IS MADE TO THE EXCLUSIVE RIGHT TO USE "MATERIALS & QUILTING, INC.", APART FROM THE MARK AS SHOWN.

THE MARK CONSISTS OF FOUR CAPITAL "E" LETTERS, ARRANGED IN A RECTANGLE, WHEREIN THE BOTTOM LEG OF ONE LETTER FORMS THE VERTICAL EDGE OF THE NEXT LETTER, ALL ROTATING ON A BULLSEYE AXIS.

CLASS 24—FABRICS

FOR BEDDING AND UNFINISHED AUTO UPHOLSTERY, TICKING FABRICS, AND BOX SPRING COVERS (U.S. CLS. 42 AND 50).

FIRST USE 1-1-1993; IN COMMERCE 1-1-1993.

CLASS 40—MATERIAL TREATMENT

FOR TREATMENT OF MATERIALS, NAMELY CONTRACT AND PRIVATE LABEL MANUFACTURING IN THE FIELD OF QUILTING AND AUTO UPHOLSTERY FABRIC BEDDING MATERIALS (U.S. CLS. 100, 103 AND 106).

FIRST USE 1-1-1993; IN COMMERCE 1-1-1993.

RAUL CORDOVA, EXAMINING ATTORNEY

SN 78-360,464. FIRE SCIENCE INC., WILLIAMSVILLE, NY. FILED 1-30-2004.

FIRE ENTERTAINMENT

THE MARK CONSISTS OF STANDARD CHARACTERS WITHOUT CLAIM TO ANY PARTICULAR FONT, STYLE, SIZE, OR COLOR.

NO CLAIM IS MADE TO THE EXCLUSIVE RIGHT TO USE FIRE, APART FROM THE MARK AS SHOWN.

CLASS 35—ADVERTISING AND BUSINESS

FOR RETAIL STORE SERVICES, MAIL ORDER SERVICES, AND ON-LINE RETAIL STORE SERVICES IN THE FIELD OF FIREPLACE, FIRE PIT, HEARTH, BARBECUE, PATIO SUPPLIES, EQUIPMENT, AND ACCESSORIES; TELEPHONE ORDER-TAKING SERVICES FOR OTHERS (U.S. CLS. 100, 101 AND 102).

FIRST USE 12-0-1997; IN COMMERCE 12-0-1997.

CLASS 42—SCIENTIFIC, COMPUTER AND LEGAL SERVICES

FOR DESIGN SERVICES FOR OTHERS IN THE FIELD OF CUSTOMIZED FIRE PITS AND DISPLAYS AND CUSTOMIZED FIREPLACE MANTELS (U.S. CLS. 100 AND 101).

FIRST USE 12-0-1997; IN COMMERCE 12-0-1997.

WILLIAM BRECKENFELD, EXAMINING ATTORNEY

SN 78-360,945. SPORTS REACTION CENTER, INC., P.C., BELLEVUE, WA. FILED 2-2-2004.

SMART METABOLISM

THE MARK CONSISTS OF STANDARD CHARACTERS WITHOUT CLAIM TO ANY PARTICULAR FONT, STYLE, SIZE, OR COLOR.

NO CLAIM IS MADE TO THE EXCLUSIVE RIGHT TO USE "METABOLISM", APART FROM THE MARK AS SHOWN.

CLASS 41—EDUCATION AND ENTERTAINMENT

FOR PHYSICAL FITNESS CONSULTATION AND TRAINING (U.S. CLS. 100, 101 AND 107).

FIRST USE 9-1-2003; IN COMMERCE 10-1-2003.

CLASS 44—MEDICAL, BEAUTY AND AGRICULTURAL SERVICES

FOR DIET AND WEIGHT REDUCTION EVALUATION, PLANNING AND SUPERVISION, NUTRITION COUNSELING (U.S. CLS. 100 AND 101).

FIRST USE 9-1-2003; IN COMMERCE 10-1-2003.

ANNE MADDEN, EXAMINING ATTORNEY

SN 78-361,282. JACUZZI INC., WEST PALM BEACH, FL. FILED 2-2-2004.

LAMORINDA

THE MARK CONSISTS OF STANDARD CHARACTERS WITHOUT CLAIM TO ANY PARTICULAR FONT, STYLE, SIZE, OR COLOR.

CLASS 6—METAL GOODS

FOR BATHROOM ACCESSORIES ALL MADE OF METAL, NAMELY, ROBE HOOKS, RAZOR HOLDERS, AND TUMBLER HOLDERS (U.S. CLS. 2, 12, 13, 14, 23, 25 AND 50).

CLASS 11—ENVIRONMENTAL CONTROL APPARATUS

FOR BATHTUBS, FAUCETS, LAVATORIES, SHOWERHEADS, TOILETS, WHIRLPOOL BATHS, AND SPAS IN THE NATURE OF HEATED POOLS (U.S. CLS. 13, 21, 23, 31 AND 34).

CLASS 20—FURNITURE AND ARTICLES NOT OTHERWISE CLASSIFIED

FOR FURNITURE FOR BATHROOMS, NAMELY, VANITIES, SHELVES, CABINETS, AND TABLES (U.S. CLS. 2, 13, 22, 25, 32 AND 50).

CLASS 21—HOUSEWARES AND GLASS

FOR BATHROOM ACCESSORIES, NAMELY, NON-METAL ROBE HOOKS, CUP HOLDERS, SOAP DISHES, SOAP DISPENSERS, NON-METAL RAZOR HOLDERS, SHOWER CADDIES, TOILET PAPER HOLDERS, TOOTHBRUSH HOLDERS, TOWEL BARS, TOWEL RINGS AND NON-METAL TUMBLER HOLDERS (U.S. CLS. 2, 13, 23, 29, 30, 33, 40 AND 50).

ODESSA BIBBINS, EXAMINING ATTORNEY

SN 78-361,550. HOMER TLC, INC., CLAYMONT, DE. FILED 2-3-2004.

**CLASS 11—ENVIRONMENTAL CONTROL APPARATUS**

FOR PORTABLE PATIO HEATERS, NAMELY, GAS SPACE HEATERS; BARBECUE GRILLS; ELECTRIC AND GAS GRILLS; PATIO LAMPS; DECORATIVE WATER FOUNTAINS; OUTDOOR FIREPLACES (U.S. CLS. 13, 21, 23, 31 AND 34).

CLASS 21—HOUSEWARES AND GLASS

FOR COOKING UTENSILS, NAMELY, GRILL COVERS; BARBECUE UTENSILS, NAMELY, FORKS, TONGS, TURNERS, SCARPERS, AND SPATULAS (U.S. CLS. 2, 13, 23, 29, 30, 33, 40 AND 50).
BRENDAN MCCAULEY, EXAMINING ATTORNEY

SN 78-366,381. PERSHING INVESTMENTS LLC, NEWARK, DE. FILED 2-11-2004.



SN 78-364,522. SFINVEST, CHICO, CA. FILED 2-8-2004.

Studio 25

THE MARK CONSISTS OF STANDARD CHARACTERS WITHOUT CLAIM TO ANY PARTICULAR FONT, STYLE, SIZE, OR COLOR.

NO CLAIM IS MADE TO THE EXCLUSIVE RIGHT TO USE "STUDIO", APART FROM THE MARK AS SHOWN.

OWNER OF U.S. REG. NOS. 2,369,648, 2,753,684 AND OTHERS.
NO CLAIM IS MADE TO THE EXCLUSIVE RIGHT TO USE PRO, APART FROM THE MARK AS SHOWN.

CLASS 9—ELECTRICAL AND SCIENTIFIC APPARATUS

FOR COMPUTER SOFTWARE FOR SECURITIES BROKERAGE IN THE FINANCIAL MANAGEMENT AND INVESTMENT AND MANAGEMENT INDUSTRIES (U.S. CLS. 21, 23, 26, 36 AND 38).

CLASS 36—INSURANCE AND FINANCIAL

FOR OFFERING A WEB SITE OF INVESTMENT RELATED INFORMATION AND LINKS, OFFERED TO LOCAL BROKERS AND THEIR CUSTOMERS, IN THE FIELD OF AUTOMATED SECURITIES BROKERAGE AND PROVIDING ON-LINE SECURITIES BROKERAGE (U.S. CLS. 100, 101 AND 102).
BRIDGETT SMITH, EXAMINING ATTORNEY

CLASS 14—JEWELRY

FOR JEWELRY; JEWELRY CHAINS; JEWELRY FINDINGS; JEWELRY, NAMELY AMULETS; JEWELRY, NAMELY CROSSES; GEMSTONES; PRECIOUS AND SEMI-PRECIOUS GEMS; MINERALS, NAMELY PRECIOUS STONES AND UNWROUGHT AND SEMI-WROUGHT PRECIOUS STONES; PRECIOUS METALS AND THEIR ALLOYS; WATCHES (U.S. CLS. 2, 27, 28 AND 50).

SN 78-366,385. PERSHING INVESTMENTS LLC, NEWARK, DE. FILED 2-11-2004.



CLASS 36—INSURANCE AND FINANCIAL

FOR JEWELRY APPRAISAL (U.S. CLS. 100, 101 AND 102).

OWNER OF U.S. REG. NOS. 2,369,648, 2,753,684 AND OTHERS.
NO CLAIM IS MADE TO THE EXCLUSIVE RIGHT TO USE INSTITUTIONAL, APART FROM THE MARK AS SHOWN.

CLASS 37—CONSTRUCTION AND REPAIR

FOR JEWELRY REMOUNTING, JEWELRY MOUNTING (U.S. CLS. 100, 103 AND 106).

CLASS 9—ELECTRICAL AND SCIENTIFIC APPARATUS

FOR COMPUTER SOFTWARE FOR SECURITIES BROKERAGE IN THE FINANCIAL MANAGEMENT AND INVESTMENT AND MANAGEMENT INDUSTRIES (U.S. CLS. 21, 23, 26, 36 AND 38).

CLASS 40—MATERIAL TREATMENT

FOR JEWELRY CASTING (U.S. CLS. 100, 103 AND 106).

CLASS 36—INSURANCE AND FINANCIAL

FOR OFFERING A WEB SITE OF INVESTMENT RELATED INFORMATION AND LINKS, OFFERED TO LOCAL BROKERS AND THEIR CUSTOMERS, IN THE FIELD OF AUTOMATED SECURITIES BROKERAGE AND PROVIDING ON-LINE SECURITIES BROKERAGE (U.S. CLS. 100, 101 AND 102).
BRIDGETT SMITH, EXAMINING ATTORNEY

CLASS 42—SCIENTIFIC, COMPUTER AND LEGAL SERVICES

FOR JEWELRY DESIGN, COMPUTER-AIDED JEWELRY DESIGN; GEMOLOGICAL SERVICES, NAMELY IDENTIFYING, GRADING AND EVALUATING THE QUALITY OF PRECIOUS STONES, GEMS AND ALLOYS FOR OTHERS (U.S. CLS. 100 AND 101).
ROBERT LORENZO, EXAMINING ATTORNEY

SN 78-367,598. LACKOVICH, JOEL KRISTIN, HALF MOON BAY, CA. FILED 2-13-2004.

GIRL POWDER

THE MARK CONSISTS OF STANDARD CHARACTERS WITHOUT CLAIM TO ANY PARTICULAR FONT, STYLE, SIZE, OR COLOR.

NO CLAIM IS MADE TO THE EXCLUSIVE RIGHT TO USE "GIRL", APART FROM THE MARK AS SHOWN.

CLASS 25—CLOTHING

FOR SNOW BOARDING AND SKI, OUTER WEAR AND SPORTS CLOTHING, NAMELY SKI JACKETS, SKI PANTS, SNOWBOARD JACKETS, SNOWBOARD PANTS, BEANIES, SKI BOOTS, SNOWBOARD BOOTS, HATS, GLOVES, SWEATSHIRTS, T-SHIRTS, AND WRISTBANDS (U.S. CLS. 22 AND 39).

CLASS 41—EDUCATION AND ENTERTAINMENT

FOR PROVIDING ON-LINE ENTERTAINMENT INFORMATION SERVICES IN THE FIELD OF WOMEN'S SNOWBOARDING, SKIING, MUSIC AND CLOTHING (U.S. CLS. 100, 101 AND 107).

MITCHELL FRONT, EXAMINING ATTORNEY

SN 78-367,601. JOSIE GROUP, L.L.C., COLTS NECK, NJ. FILED 2-13-2004.

THE MUSIC MAN

THE MARK CONSISTS OF STANDARD CHARACTERS WITHOUT CLAIM TO ANY PARTICULAR FONT, STYLE, SIZE, OR COLOR.

CLASS 25—CLOTHING

FOR APPAREL, NAMELY SHIRTS, PANTS, JACKETS, SHORTS, APRONS, HATS AND UNDERWEAR (U.S. CLS. 22 AND 39).

FIRST USE 5-23-2003; IN COMMERCE 5-23-2003.

CLASS 41—EDUCATION AND ENTERTAINMENT

FOR ENTERTAINMENT SERVICES, NAMELY, LIVE MUSICAL PERFORMANCES BY SINGERS AND LIVE THEATRICAL PERFORMANCES BY SINGERS AND COSTUMED CHARACTERS IN A RESTAURANT; ENTERTAINMENT SERVICES, NAMELY, CONDUCTING PERSONAL APPEARANCES BY SINGERS AND COSTUMED CHARACTERS AND LIVE MUSICAL PERFORMANCES BY SINGERS FOR PRIVATE FUNCTIONS (U.S. CLS. 100, 101 AND 107).

FIRST USE 5-23-2003; IN COMMERCE 5-23-2003.
MITCHELL FRONT, EXAMINING ATTORNEY

SN 78-368,722. HENNELLY TIRE & AUTO, INC., FORT LAUDERDALE, FL. FILED 2-16-2004.

TIRE CHOICE & TOTAL CAR CARE

THE MARK CONSISTS OF STANDARD CHARACTERS WITHOUT CLAIM TO ANY PARTICULAR FONT, STYLE, SIZE, OR COLOR.

NO CLAIM IS MADE TO THE EXCLUSIVE RIGHT TO USE "TIRE" AND "TOTAL CAR CARE", APART FROM THE MARK AS SHOWN.

CLASS 35—ADVERTISING AND BUSINESS

FOR RETAIL STORE SERVICES AND WHOLESALE DISTRIBUTORSHIP FEATURING TIRES, ACCESSORIES FOR AUTOMOBILES, TRUCKS AND OTHER VEHICLES, AND REPLACEMENT PARTS FOR AUTOMOBILES, TRUCKS AND OTHER VEHICLES (U.S. CLS. 100, 101 AND 102).

CLASS 37—CONSTRUCTION AND REPAIR

FOR MAINTENANCE AND REPAIR SERVICES FOR AUTOMOBILES, TRUCKS AND OTHER VEHICLES (U.S. CLS. 100, 103 AND 106).

JASON TURNER, EXAMINING ATTORNEY

SN 78-369,277. RIPKEN BASEBALL, INC., BALTIMORE, MD. FILED 2-17-2004.

RIPKEN CENTER

THE MARK CONSISTS OF STANDARD CHARACTERS WITHOUT CLAIM TO ANY PARTICULAR FONT, STYLE, SIZE, OR COLOR.

NO CLAIM IS MADE TO THE EXCLUSIVE RIGHT TO USE "CENTER", APART FROM THE MARK AS SHOWN.

CLASS 36—INSURANCE AND FINANCIAL

FOR REAL ESTATE LEASING AND MANAGEMENT SERVICES, NAMELY, LEASING AND MANAGEMENT OF RETAIL, RESIDENTIAL, CONSUMER AND OFFICE SPACE (U.S. CLS. 100, 101 AND 102).

CLASS 37—CONSTRUCTION AND REPAIR

FOR BUILDING CONSTRUCTION, REPAIR AND DEVELOPMENT SERVICES AND RETAIL, OFFICE AND RESIDENTIAL REAL ESTATE AND LAND DEVELOPMENT SERVICES (U.S. CLS. 100, 103 AND 106).

ANNE MADDEN, EXAMINING ATTORNEY

CLASS 45—PERSONAL SERVICES

FOR PREPARATION OF CUSTOMIZED GIFT BASKETS OR GIFT BOXES CONTAINING VARIOUS INDIGENOUS FOOD, WINE, SNACKS, SOUVENIRS, TRINKETS OR OTHER ITEMS IN THE NATURE OF A PARTICULAR STATE'S PRODUCTS, ARTS OR CRAFTS REFLECTING THE UNIQUE CULTURE OF EACH STATE IN THE UNITED STATES. (U.S. CLS. 100 AND 101).

JULIA HARDY COFIELD, EXAMINING ATTORNEY

SN 78-369,754. NEWSTAR FRESH FOODS, LLC, SALINAS, CA. FILED 2-18-2004.

NEWSTAR GRILLERS

THE MARK CONSISTS OF STANDARD CHARACTERS WITHOUT CLAIM TO ANY PARTICULAR FONT, STYLE, SIZE, OR COLOR.

OWNER OF U.S. REG. NOS. 2,351,469 AND 2,646,267.

NO CLAIM IS MADE TO THE EXCLUSIVE RIGHT TO USE "GRILLERS", APART FROM THE MARK AS SHOWN.

CLASS 29—MEATS AND PROCESSED FOODS

FOR PRE-CUT, READY TO SERVE FRESH VEGETABLES (U.S. CL. 46).

CLASS 31—NATURAL AGRICULTURAL PRODUCTS

FOR FRESH VEGETABLES (U.S. CLS. 1 AND 46).
NICHOLAS ALTREE, EXAMINING ATTORNEY

SN 78-370,696. WIENER, WILLIAM B., JR., SHREVEPORT, LA. FILED 2-19-2004.

STATE SECRETS

THE MARK CONSISTS OF STANDARD CHARACTERS WITHOUT CLAIM TO ANY PARTICULAR FONT, STYLE, SIZE, OR COLOR.

CLASS 35—ADVERTISING AND BUSINESS

FOR RETAIL OR ON-LINE (INTERNET) STORE SERVICES FEATURING GIFT BASKETS OR GIFT BOXES CONTAINING VARIOUS INDIGENOUS FOOD, WINE, SNACKS, SOUVENIRS, TRINKETS OR OTHER ITEMS IN THE NATURE OF A PARTICULAR STATE'S PRODUCTS, ARTS OR CRAFTS REFLECTING THE UNIQUE CULTURE OF EACH STATE IN THE UNITED STATES. (U.S. CLS. 100, 101 AND 102).

SN 78-370,894. SEMINIS VEGETABLE SEEDS, INC., OXNARD, CA. AND GRIFFIN PRODUCE COMPANY, INC., SALINAS, CA. FILED 2-19-2004.

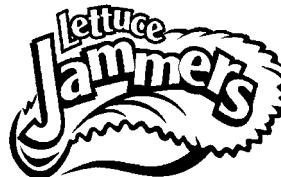

NO CLAIM IS MADE TO THE EXCLUSIVE RIGHT TO USE "LETTUCE", APART FROM THE MARK AS SHOWN.

THE MARK CONSISTS OF STYLIZED LETTERING OF THE WORDS LETTUCE JAMMERS DISPLAYED ACROSS THE TOP AND INSIDE EDGE OF A LETTUCE SHAPED SHELL.

CLASS 29—MEATS AND PROCESSED FOODS

FOR VEGETABLES, NAMELY, LETTUCE THAT IS CUT, FROZEN, COOKED, GRILLED, PROCESSED, PRESERVED, AND SLICED; FROZEN, PREPARED AND PACKAGED ENTREES CONSISTING PRIMARILY OF STUFFED LETTUCE SHELLS; FROZEN, PREPARED AND PACKAGED MEALS CONSISTING PRIMARILY OF STUFFED LETTUCE SHELLS; GARDEN SALADS; VEGETABLE SALADS (U.S. CL. 46).

CLASS 31—NATURAL AGRICULTURAL PRODUCTS

FOR VEGETABLES, NAMELY, LETTUCE THAT IS FRESH, RAW AND UNPROCESSED (U.S. CLS. 1 AND 46).

JIM RINGLE, EXAMINING ATTORNEY

SN 78-370,918. KINGSBURY, CHARLES F, MUIR BEACH, CA. FILED 2-19-2004.

Zumin

THE MARK CONSISTS OF STANDARD CHARACTERS WITHOUT CLAIM TO ANY PARTICULAR FONT, STYLE, SIZE, OR COLOR.

CLASS 18—LEATHER GOODS

FOR FANNY PACKS, BRIEFCASES, DUFFEL BAGS, SUITCASES, WATERPROOF TRAVEL BAGS, BACKPACKS, COURIER BAGS, ATTACHÉ CASES, TOTE BAGS, BOOK BAGS, PURSES, WALLETS, BUSINESS CARD CASES, AND HANDBAGS (U.S. CLS. 1, 2, 3, 22 AND 41).

CLASS 25—CLOTHING

FOR HATS, CAPS, BELTS, JACKETS, PANTS, SHOES, SLIPPERS, SANDALS, TEE SHIRTS, SHIRTS, VESTS, SWEATSHIRTS, SOCKS, GLOVES, SWEATERS, MENS AND WOMENS UNDERWEAR, TIES, MITTENS, SHORTS, EARBANDS, SWIMWEAR, SCARVES (U.S. CLS. 22 AND 39).

PAUL F. GAST, EXAMINING ATTORNEY

SN 78-371,510. SONES, TODD A., VERNON HILLS, IL. FILED 2-20-2004.

Scoring Zone

THE MARK CONSISTS OF STANDARD CHARACTERS WITHOUT CLAIM TO ANY PARTICULAR FONT, STYLE, SIZE, OR COLOR.

CLASS 28—TOYS AND SPORTING GOODS

FOR GOLF CLUBS, GOLF PUTTERS, GOLF IRONS; GOLF CLUB SWING AIDS, NAMELY, A DEVICE TO CORRECT A GOLFER'S SWING PLANE; PUTTER SWING AIDS, NAMELY, A DEVICE TO CORRECT A GOLFER'S ALIGNMENT; CLUB HEAD COVERS, GOLF BAGS, GOLF BALL MARKERS, GOLF FLAGS, GOLF GLOVES, GOLF TEES, HAND GRIPS FOR GOLF CLUBS, AND GOLF PUTTING PRACTICE MATS (U.S. CLS. 22, 23, 38 AND 50).

CLASS 41—EDUCATION AND ENTERTAINMENT

FOR GOLF INSTRUCTION (U.S. CLS. 100, 101 AND 107).

PAUL F. GAST, EXAMINING ATTORNEY

SN 78-371,521. SKILLSOFT PLC, DUBLIN, IRELAND, FILED 2-20-2004.

SKILLBLEND

THE MARK CONSISTS OF STANDARD CHARACTERS WITHOUT CLAIM TO ANY PARTICULAR FONT, STYLE, SIZE, OR COLOR.

CLASS 9—ELECTRICAL AND SCIENTIFIC APPARATUS

FOR EDUCATIONAL COMPUTER SOFTWARE FOR ADMINISTERING, ORGANIZING AND COMBINING TRADITIONAL TRAINING AND E-LEARNING FEATURING INSTRUCTION IN THE FIELDS OF INFORMATION TECHNOLOGY, BUSINESS AND INTERPERSONAL SKILLS; EDUCATIONAL AND INTERACTIVE EDUCATIONAL SOFTWARE FEATURING INSTRUCTION AND TEST PREPARATION IN THE FIELDS OF INFORMATION TECHNOLOGY, BUSINESS, AND INTERPERSONAL SKILLS; SOFTWARE FOR THE DEVELOPMENT, CUSTOMIZATION AND CREATION OF EDUCATIONAL AND INTERACTIVE EDUCATIONAL SOFTWARE FEATURING INSTRUCTION AND TEST PREPARATION IN THE FIELDS OF INFORMATION TECHNOLOGY, BUSINESS, AND INTERPERSONAL SKILLS (U.S. CLS. 21, 23, 26, 36 AND 38).

CLASS 41—EDUCATION AND ENTERTAINMENT

FOR PROVIDING ONLINE-MENTORING IN THE FIELDS OF INFORMATION TECHNOLOGY, BUSINESS, AND INTERPERSONAL SKILLS; PROVIDING EDUCATIONAL SERVICES, NAMELY COURSES OF INSTRUCTION, IN THE FIELD OF INFORMATION TECHNOLOGY, BUSINESS, AND INTERPERSONAL SKILLS (U.S. CLS. 100, 101 AND 107).

TONI HICKEY, EXAMINING ATTORNEY

SN 78-372,842. EMPLOYEASE, INC., NORCROSS, GA. FILED 2-24-2004.

SN 78-373,044. MILLER, THOMAS, T. SR., DULUTH, GA. FILED 2-24-2004.

Vulotteg

HELPING REVOLUTIONIZE HR

THE MARK CONSISTS OF STANDARD CHARACTERS WITHOUT CLAIM TO ANY PARTICULAR FONT, STYLE, SIZE, OR COLOR.

CLASS 9—ELECTRICAL AND SCIENTIFIC APPARATUS

FOR SOUND RECORDINGS FEATURING MUSIC AND/OR COMEDY (U.S. CLS. 21, 23, 26, 36 AND 38).

CLASS 25—CLOTHING

FOR CLOTHING, NAMELY SHIRTS, PANTS, HATS, SOCKS, SHOES, UNDERWEAR, TIES, SCARFS AND JACKETS (U.S. CLS. 22 AND 39).

CLASS 41—EDUCATION AND ENTERTAINMENT

FOR MUSIC COMPOSITION AND ARRANGEMENT FOR OTHERS, MOTION PICTURE AND TELEVISION SHOW PRODUCTION AND DISTRIBUTION, AUDIO AND VIDEO RECORDING AND PRODUCTION OF MUSIC AND VISUAL PERFORMANCES, ENTERTAINMENT SERVICES, NAMELY, LIVE MUSICAL PERFORMANCES BY A BAND (U.S. CLS. 100, 101 AND 107).
PAUL F. GAST, EXAMINING ATTORNEY

THE MARK CONSISTS OF STANDARD CHARACTERS WITHOUT CLAIM TO ANY PARTICULAR FONT, STYLE, SIZE, OR COLOR.
NO CLAIM IS MADE TO THE EXCLUSIVE RIGHT TO USE "HR", APART FROM THE MARK AS SHOWN.

CLASS 35—ADVERTISING AND BUSINESS

FOR CONSULTING SERVICES IN THE FIELDS OF HUMAN RESOURCES, BUSINESS MANAGEMENT AND BUSINESS OPERATIONS; PROVIDING AN ON-LINE ELECTRONIC HUMAN RESOURCES AND BENEFITS MANAGEMENT DATABASE FOR BUSINESSES ON A GLOBAL COMPUTER NETWORK; COMPUTER SERVICES, NAMELY, MANAGING A DATABASE FOR BUSINESSES THAT CAN BE ACCESSED BY MULTIPLE PARTIES, SUCH AS EMPLOYERS, EMPLOYEES, BENEFITS ADMINISTRATIVE FIRMS, INSURANCE CARRIERS AND OTHER SERVICE PROVIDERS; OUTSOURCING IN THE FIELD OF HUMAN RESOURCES AND BENEFITS ADMINISTRATION; ADMINISTRATION OF BUSINESS PAYROLL FOR OTHERS; PROVIDING INFORMATION IN THE FIELD OF HUMAN RESOURCES (U.S. CLS. 100, 101 AND 102).

CLASS 36—INSURANCE AND FINANCIAL

FOR ADMINISTRATION OF EMPLOYEE BENEFIT PLANS ON BEHALF OF EMPLOYERS (U.S. CLS. 100, 101 AND 102).

CLASS 42—SCIENTIFIC, COMPUTER AND LEGAL SERVICES

FOR INTEGRATION OF COMPUTER SYSTEMS AND NETWORKS FOR ON-LINE COMMUNICATION AND PROCESSING OF HUMAN RESOURCES AND BENEFITS INFORMATION VIA THE INTERNET; PROVIDING TEMPORARY USE OF ON-LINE NON-DOWNLOADABLE SOFTWARE FOR MANAGING HUMAN RESOURCES AND BENEFITS FOR BUSINESSES (U.S. CLS. 100 AND 101).
JULIE WATSON, EXAMINING ATTORNEY

SN 78-373,675. CANTRELL, JAY, NAPERVILLE, IL. FILED 2-25-2004.

SCUBAQUARIUM

THE MARK CONSISTS OF STANDARD CHARACTERS WITHOUT CLAIM TO ANY PARTICULAR FONT, STYLE, SIZE, OR COLOR.

CLASS 25—CLOTHING

FOR CLOTHING, NAMELY, HATS, SHIRTS, PANTS, SWEAT PANTS, SWEATSHIRTS, SHORTS, SWIM SUITS AND HOODED SWEATSHIRTS (U.S. CLS. 22 AND 39).

CLASS 35—ADVERTISING AND BUSINESS

FOR RETAIL STORE SERVICES IN THE FIELDS OF SCUBA DIVING AND SNORKELING EQUIPMENT AND ACCESSORIES, APPAREL, FOOTWEAR AND HEADGEAR (U.S. CLS. 100, 101 AND 102).

IRENE D. WILLIAMS, EXAMINING ATTORNEY

CLASS 41—EDUCATION AND ENTERTAINMENT

FOR EDUCATIONAL SERVICES, NAMELY, CONDUCTING CLASSES, DEMONSTRATIONS, SEMINARS, AND CONFERENCES IN THE FIELDS OF SWIMMING, SCUBA DIVING AND SNORKELING, MARINE BIOLOGY, ECOLOGY AND UNDERWATER PHOTOGRAPHY; PROVIDING FACILITIES FOR RECREATIONAL ACTIVITIES AND EDUCATIONAL CONVENTIONS; RENTAL OF SCUBA DIVING AND SNORKELING EQUIPMENT; ENTERTAINMENT AND EDUCATIONAL SERVICES, NAMELY, PROVIDING THEME PARK SERVICES IN THE FIELD OF UNDERSEA MARINE ENVIRONMENT EXHIBITS; PROVIDING FITNESS AND EXERCISE FACILITIES; PERSONAL TRAINING SERVICES, NAMELY, STRENGTH AND CONDITIONING TRAINING (U.S. CLS. 100, 101 AND 107).

NELSON SNYDER, EXAMINING ATTORNEY

SN 78-375,357. ULTRAFABRICS, LLC, ELMSFORD, NY. FILED 2-27-2004.

SWAYED

SN 78-374,847. ASSESSMENT TECHNOLOGIES INSTITUTE, L.L.C., OVERLAND PARK, KS. FILED 2-26-2004.

THE MARK CONSISTS OF STANDARD CHARACTERS WITHOUT CLAIM TO ANY PARTICULAR FONT, STYLE, SIZE, OR COLOR.

ATI-PLAN

CLASS 18—LEATHER GOODS

FOR IMITATION LEATHER SOLD IN BULK (U.S. CLS. 1, 2, 3, 22 AND 41).

CLASS 24—FABRICS

FOR FABRIC FOR USE IN THE MANUFACTURE OF AUTOMOBILE AND BOAT INTERIORS, WALL COVERS, RESIDENTIAL AND COMMERCIAL FURNITURE AND ACCESSORIES, NAMELY, GOLF HEAD COVERS, HANDBAGS, TOTE BAGS, WASTE BASKETS, PILLOWS, PICTURE FRAMES, PICTURE ALBUMS, PHOTO ALBUMS, FLOOR COVERINGS AND JEWELRY BOXES; POLYURETHANE FABRIC (U.S. CLS. 42 AND 50).

ASMAT KHAN, EXAMINING ATTORNEY

THE MARK CONSISTS OF STANDARD CHARACTERS WITHOUT CLAIM TO ANY PARTICULAR FONT, STYLE, SIZE, OR COLOR.

CLASS 9—ELECTRICAL AND SCIENTIFIC APPARATUS

FOR DVDS, AUDIO TAPES, CD-ROMS AND VIDEO RECORDINGS OF LECTURES, TEXT REVIEWS AND WEB-BASED TESTING IN THE FIELDS OF NURSING AND RELATED HEALTH FIELDS (U.S. CLS. 21, 23, 26, 36 AND 38).

SN 78-376,443. BALL HORTICULTURAL COMPANY, WEST CHICAGO, IL. FILED 3-1-2004.

INTEGRATED GROWER SUPPORT

CLASS 16—PAPER GOODS AND PRINTED MATTER

FOR PRINTED EDUCATIONAL MATERIALS IN THE NATURE OF A COMPREHENSIVE EXAMINATION REVIEW IN THE FIELDS OF NURSING AND RELATED HEALTH FIELDS (U.S. CLS. 2, 5, 22, 23, 29, 37, 38 AND 50).

THE MARK CONSISTS OF STANDARD CHARACTERS WITHOUT CLAIM TO ANY PARTICULAR FONT, STYLE, SIZE, OR COLOR.

CLASS 41—EDUCATION AND ENTERTAINMENT

FOR EDUCATIONAL TESTING AND REVIEW COURSES FOR STATE EXAMINATIONS IN THE FIELDS OF NURSING AND RELATED HEALTH FIELDS (U.S. CLS. 100, 101 AND 107).

CLASS 35—ADVERTISING AND BUSINESS

FOR WHOLESALE DISTRIBUTORSHIP SERVICES FEATURING PLANTS, SEEDS, SOIL, NUTRITION PRODUCTS, HERBICIDES, PESTICIDES, AND EQUIPMENT FOR HORTICULTURAL PRODUCTION AND USAGE (U.S. CLS. 100, 101 AND 102).

CLASS 41—EDUCATION AND ENTERTAINMENT

FOR EDUCATIONAL SERVICES, NAMELY, PROVIDING TRAINING COURSES IN THE FIELD OF HORTICULTURE PRODUCTION AND MANAGEMENT (U.S. CLS. 100, 101 AND 107).

SN 78-379,297. BE AS YOU ARE, INC., WASHINGTON, DC. FILED 3-5-2004.

BE AS YOU ARE

THE MARK CONSISTS OF STANDARD CHARACTERS WITHOUT CLAIM TO ANY PARTICULAR FONT, STYLE, SIZE, OR COLOR.
OWNER OF U.S. REG. NO. 1,845,737.

CLASS 44—MEDICAL, BEAUTY AND AGRICULTURAL SERVICES

FOR PROVIDING INFORMATION IN THE FIELD OF HORTICULTURE; AND CONSULTING SERVICES IN THE FIELD OF HORTICULTURE (U.S. CLS. 100 AND 101).

PATRICIA EVANKO, EXAMINING ATTORNEY

CLASS 18—LEATHER GOODS

FOR DUFFEL BAGS, TOTE BAGS, PURSES, HANDBAGS, WALLETS, LUGGAGE, CREDIT CARD CASES, TRAVEL KIT BAGS, BACKPACKS, COIN PURSES, MESSENGER BAGS AND BRIEFCASE-TYPE PORTFOLIOS (U.S. CLS. 1, 2, 3, 22 AND 41).

SN 78-376,512. SAMBA, LLC, NEW YORK, NY. FILED 3-1-2004.

CLASS 21—HOUSEWARES AND GLASS

FOR GLASS AND PORCELAIN DISHWARE, GLASS AND PORCELAIN BEVERAGeware, CONTAINERS FOR HOUSEHOLD USE, TOOTHBRUSHES, COMBS AND HAIR BRUSHES (U.S. CLS. 2, 13, 23, 29, 30, 33, 40 AND 50).

CLASS 24—FABRICS

FOR HOME TEXTILES, NAMELY TABLECLOTHS, TABLE RUNNERS, NAPKINS, PLACEMATS, BATH AND BEACH TOWELS, BED THROWS, BEDSPREADS, QUILTS, COMFORTER COVERS AND BEDDING SETS, NAMELY, SHEETS, PILLOWCASES, SHAMS, COMFORTERS AND DUST RUFFLES (U.S. CLS. 42 AND 50).
YSA DEJESUS, EXAMINING ATTORNEY

SUGARCANE

SN 78-379,672. ADAPTIVE SPECTRUM AND SIGNAL ALIGNMENT, INC., ATHERTON, CA. FILED 3-5-2004.

THE MARK CONSISTS OF STANDARD CHARACTERS WITHOUT CLAIM TO ANY PARTICULAR FONT, STYLE, SIZE, OR COLOR.

CLASS 35—ADVERTISING AND BUSINESS

FOR RESTAURANT FRANCHISING (U.S. CLS. 100, 101 AND 102).

CLASS 41—EDUCATION AND ENTERTAINMENT

FOR NIGHTCLUB SERVICES (U.S. CLS. 100, 101 AND 107).

CLASS 43—HOTEL AND RESTAURANT SERVICES

FOR RESTAURANT SERVICES; BAR SERVICES (U.S. CLS. 100 AND 101).
RICHARD WHITE, EXAMINING ATTORNEY



Adaptive Spectrum and Signal Alignment, Incorporated

NO CLAIM IS MADE TO THE EXCLUSIVE RIGHT TO USE "ADAPTIVE SPECTRUM AND SIGNAL ALIGNMENT, INC.", APART FROM THE MARK AS SHOWN.

THE COLOR(S) RED AND BLUE IS/ARE CLAIMED AS A FEATURE OF THE MARK.

THE MARK CONSISTS OF THE WORD "ASSIA" IN RED AND BLUE ON A BLACK AND WHITE BACKGROUND SHOWING THE SAN FRANCISCO BAY BRIDGE SPANNING TO THE EIFFEL TOWER, WITH THE NAME OF THE COMPANY BELOW.

THE MARK CONSISTS OF THE WORD "ASSIA" IN RED AND BLUE ON A BLACK AND WHITE BACKGROUND SHOWING THE SAN FRANCISCO BAY BRIDGE SPANNING TO THE EIFFEL TOWER, WITH THE NAME OF THE COMPANY BELOW.

CLASS 37—CONSTRUCTION AND REPAIR

FOR MAINTENANCE OF TELECOMMUNICATIONS NETWORKS, AND MACHINES AND APPARATUSES THAT ALLOW THE TRANSFER OF DATA ACROSS TELECOMMUNICATIONS NETWORKS, FOR TELECOMMUNICATION SERVICE PROVIDERS, EQUIPMENT VENDORS, AND SEMICONDUCTOR VENDORS (U.S. CLS. 100, 103 AND 106).

FIRST USE 6-23-2003; IN COMMERCE 7-24-2003.

CLASS 38—COMMUNICATION

FOR TELECOMMUNICATIONS CONSULTING SERVICES TO ENABLE TELECOMMUNICATIONS SERVICE PROVIDERS, EQUIPMENT VENDORS, AND SEMICONDUCTOR VENDORS TO IMPROVE THE PERFORMANCE OF THEIR TELECOMMUNICATIONS NETWORKS, AND COMPUTER SOFTWARE, MACHINES AND APPARATUSES THAT ALLOW THE TRANSFER OF DATA ACROSS TELECOMMUNICATIONS NETWORKS (U.S. CLS. 100, 101 AND 104).

FIRST USE 6-23-2003; IN COMMERCE 7-24-2003.

CLASS 42—SCIENTIFIC, COMPUTER AND LEGAL SERVICES

FOR DESIGN OF AND IMPLEMENTATION OF DESIGNS TO IMPROVE THE PERFORMANCE OF TELECOMMUNICATIONS NETWORKS, AND COMPUTER SOFTWARE, AND MACHINES AND APPARATUSES THAT ALLOW THE TRANSFER OF DATA ACROSS TELECOMMUNICATIONS NETWORKS FOR TELECOMMUNICATIONS SERVICE PROVIDERS, EQUIPMENT VENDORS, AND SEMICONDUCTOR VENDORS; AND MAINTENANCE OF COMPUTER SOFTWARE THAT ALLOWS THE TRANSFER OF DATA ACROSS TELECOMMUNICATIONS NETWORKS, FOR TELECOMMUNICATIONS SERVICE PROVIDERS, EQUIPMENT VENDORS, AND SEMICONDUCTOR VENDORS (U.S. CLS. 100 AND 101).

FIRST USE 6-23-2003; IN COMMERCE 7-24-2003.
AMY GEARIN, EXAMINING ATTORNEY

SN 78-380,435. THE KESSLER ENTERPRISE, INC., ORLANDO, FL. FILED 3-8-2004.

THE BOHEMIAN HOTEL

THE MARK CONSISTS OF STANDARD CHARACTERS WITHOUT CLAIM TO ANY PARTICULAR FONT, STYLE, SIZE, OR COLOR.

OWNER OF U.S. REG. NO. 2,324,739.
NO CLAIM IS MADE TO THE EXCLUSIVE RIGHT TO USE "HOTEL", APART FROM THE MARK AS SHOWN.

CLASS 43—HOTEL AND RESTAURANT SERVICES

FOR HOTEL SERVICES (U.S. CLS. 100 AND 101).

CLASS 44—MEDICAL, BEAUTY AND AGRICULTURAL SERVICES

FOR HEALTH SPA SERVICES, NAMELY, COSMETIC BODY CARE SERVICES (U.S. CLS. 100 AND 101).

JENNIFER MARTIN, EXAMINING ATTORNEY

SN 78-380,631. DAVES, JADA L., CHATTANOOGA, TN. FILED 3-9-2004.

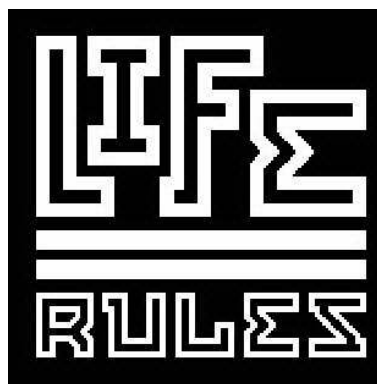

CLASS 16—PAPER GOODS AND PRINTED MATTER

FOR ADDRESS BOOKS, PHOTOGRAPH ALBUMS, AUTOGRAPH BOOKS, BOOK COVERS, EDUCATIONAL BOOKLETS FEATURING CHARACTER EDUCATION VALUES, BOOKMARKS, BUMPER STICKERS, BUSINESS CARDS, CALENDARS, COLORING BOOKS, COUPON BOOKS, DAILY PLANNERS, GRADES 3-12 CHARACTER EDUCATION BOOKS, EDUCATIONAL PUBLICATIONS, NAMELY, TRAINING MANUALS IN THE FIELD OF CHARACTER EDUCATION, EMBROIDERY DESIGN PATTERNS, FLASH CARDS, FOUNTAIN PENS, GREETING CARDS, HIGHLIGHTING MARKERS, HIGHLIGHTING PENS, INFORMATIONAL LETTERS CONCERNING CHARACTER EDUCATION, INFORMATIONAL SHEETS ABOUT CHARACTER EDUCATION, INK PENS, CHARACTER EDUCATION JOURNALS, LEAFLETS ABOUT CHARACTER EDUCATION, LEGAL PADS, LOOSE LEAF BINDERS, CHARACTER EDUCATION MANUALS, MECHANICAL PENCILS, MEMO PADS, MEMORY BOOKS/PHOTO ALBUMS, MERCHANDISE BAGS, MOTIVATIONAL CARDS, MOUNTED POSTERS, CHARACTER EDUCATION NEWSLETTERS, NOTE BOOKS, NOTE CARDS, NOTE PADS, OCCASION CARDS, CHARACTER EDUCATION PAMPHLETS, PAPER MATS, PAPER NAME BADGES, PAPER NOTE TABLETS, PAPER PLACE MATS, PAPER STOCK, CHARACTER EDUCATION PAPER TEACHING MATERIALS, PAPERWEIGHTS, PEN OR PENCIL HOLDERS, PENCIL BOXES, PENCIL CASES, PENCILS, PENS, CHARACTER EDUCATION PERIODICALS IN THE NATURE OF NEWSLETTERS, BOOKS, AND INSTRUCTIONAL, EDUCATIONAL, AND PRINTED TEACHING MATERIALS, PERSONAL ORGANIZERS, PHOTOGRAPH ALBUMS, PICTURE POSTCARDS, POCKET CALENDARS, POCKET SECRETARIES, POSTCARDS, POSTER BOARD, POSTERS, PRESENTATION FOLDERS, PRINTED INSTRUCTIONAL, EDUCATIONAL, AND TEACHING MATERIALS REGARDING CHARACTER EDUCATION, PRINTED LESSONS ON CHARACTER EDUCATION, PRINTED TEACHING MATERIALS ON CHARACTER EDUCATION, PRINTED TEACHING MATERIALS FOR GRADES 3-12 IN THE AREA OF CHARACTER EDUCATION, PROTECTIVE COVERS FOR SHEETS OR PAPER AND PAGES OF BOOKS AND THE LIKE, QUESTIONNAIRES ON CHARACTER EDUCATION, ROLLER BALL PENS, SCRAPBOOKS, SCRATCH PADS, SOUVENIR PROGRAMS CONCERNING CHARACTER EDUCATION, STATIONERY, STATIONERY WRITING PAPER AND ENVELOPES, STICKERS, TRIVIA CARDS, WALL CALENDARS (U.S. CLS. 2, 5, 22, 23, 29, 37, 38 AND 50).

CLASS 25—CLOTHING

SN 78-381,052. PRECISION DOOR SERVICE, INC., ROCKLEDGE, FL. FILED 3-9-2004.

FOR BANDANAS, BASEBALL CAPS, BERMUDA SHORTS, BOXER BRIEFS, BOXER SHORTS, CAPS, CLOTHING, NAMELY, T-SHIRTS, DENIM JACKETS, FLEECE PULLOVERS, GOLF SHIRTS, GYM SHORTS, HATS, HEAD BANDS, HOODS, JACKETS, JERSEYS, JOGGING SUITS, KNIT SHIRTS, LOUNGEWEAR, NIGHT SHIRTS, PAJAMAS, POLO SHIRTS, PONCHOS, PULLOVERS, RAIN JACKETS, SHIRTS, SHORTS, SLEEP SHIRTS, SLEEPWEAR, SOCKS, SUN VISORS, SWEAT BANDS, SWEAT PANTS, SWEAT SHIRTS, SWEAT SHORTS, SWEAT SUITS, SWEATERS, TANK TOPS, TOPS, T-SHIRTS, VESTS, VISORS, V-NECK SWEATERS, WALKING SHORTS, WARM UP SUITS, WIND RESISTANT JACKETS, WIND SHIRTS, WINDSHIRTS (U.S. CLS. 22 AND 39).

SUE LAWRENCE, EXAMINING ATTORNEY

SN 78-381,026. PRECISION DOOR SERVICE, INC., ROCKLEDGE, FL. FILED 3-9-2004.

PRECISION**PRECISION DOOR
SERVICE**

THE MARK CONSISTS OF STANDARD CHARACTERS WITHOUT CLAIM TO ANY PARTICULAR FONT, STYLE, SIZE, OR COLOR.

OWNER OF U.S. REG. NOS. 2,171,000, 2,834,387 AND OTHERS.

NO CLAIM IS MADE TO THE EXCLUSIVE RIGHT TO USE "DOOR SERVICE", APART FROM THE MARK AS SHOWN.

THE MARK CONSISTS OF STANDARD CHARACTERS WITHOUT CLAIM TO ANY PARTICULAR FONT, STYLE, SIZE, OR COLOR.

OWNER OF U.S. REG. NOS. 2,171,000, 2,723,414 AND OTHERS.

CLASS 35—ADVERTISING AND BUSINESS

FOR RETAIL STORE SERVICES FEATURING METAL ROLLING STEEL DOORS, STORAGE UNIT DOORS, ROLLING GRILLE DOORS, ROLLING FIRE DOORS, COILING DOORS, COMMERCIAL DOCK DOORS, AUTOMATED ENTRY CONTROL SYSTEMS FOR DOORS, ELECTRICAL GATES, SECURITY GATES, POWERED GATES, REVOLVING DOORS, SWINGING DOORS, SLIDING DOORS, THEIR ELECTRIC AUTOMATIC OPENERS AND COMPONENT PARTS; FRANCHISING, NAMELY OFFERING TECHNICAL ASSISTANCE IN THE ESTABLISHMENT AND/OR OPERATION OF STORES WHICH OFFER DOOR SERVICES (U.S. CLS. 100, 101 AND 102).

FIRST USE 10-0-1989; IN COMMERCE 10-0-1989.

CLASS 37—CONSTRUCTION AND REPAIR

FOR INSTALLATION, MAINTENANCE AND REPAIR OF METAL ROLLING STEEL DOORS, STORAGE UNIT DOORS, ROLLING GRILLE DOORS, ROLLING FIRE DOORS, COILING DOORS, COMMERCIAL DOCK DOORS, AUTOMATED ENTRY CONTROL SYSTEMS FOR DOORS, ELECTRICAL GATES, SECURITY GATES, POWERED GATES, REVOLVING DOORS, SWINGING DOORS, SLIDING DOORS, THEIR ELECTRIC AUTOMATIC OPENERS AND COMPONENT PARTS THEREOF (U.S. CLS. 100, 103 AND 106).

FIRST USE 10-0-1989; IN COMMERCE 10-0-1989.
LANA PHAM, EXAMINING ATTORNEY**CLASS 35—ADVERTISING AND BUSINESS**

FOR RETAIL STORE SERVICES FEATURING METAL ROLLING STEEL DOORS, STORAGE UNIT DOORS, ROLLING GRILLE DOORS, ROLLING FIRE DOORS, COILING DOORS, COMMERCIAL DOCK DOORS, AUTOMATED ENTRY CONTROL SYSTEMS FOR DOORS, ELECTRICAL GATES, SECURITY GATES, POWERED GATES, REVOLVING DOORS, SWINGING DOORS, SLIDING DOORS, THEIR ELECTRIC AUTOMATIC OPENERS AND COMPONENT PARTS; FRANCHISING, NAMELY OFFERING TECHNICAL ASSISTANCE IN THE ESTABLISHMENT AND/OR OPERATION OF STORES WHICH OFFER DOOR SERVICES (U.S. CLS. 100, 101 AND 102).

FIRST USE 10-0-1989; IN COMMERCE 10-0-1989.

CLASS 37—CONSTRUCTION AND REPAIR

FOR INSTALLATION, MAINTENANCE AND REPAIR OF METAL ROLLING STEEL DOORS, STORAGE UNIT DOORS, ROLLING GRILLE DOORS, ROLLING FIRE DOORS, COILING DOORS, COMMERCIAL DOCK DOORS, AUTOMATED ENTRY CONTROL SYSTEMS FOR DOORS, ELECTRICAL GATES, SECURITY GATES, POWERED GATES, REVOLVING DOORS, SWINGING DOORS, SLIDING DOORS, THEIR ELECTRIC AUTOMATIC OPENERS AND COMPONENT PARTS THEREOF (U.S. CLS. 100, 103 AND 106).

FIRST USE 10-0-1989; IN COMMERCE 10-0-1989.
LANA PHAM, EXAMINING ATTORNEY

SN 78-381,949. BACARDI & COMPANY LIMITED, NASSAU,
NEW PROVIDENCE, BAHAMAS, FILED 3-10-2004.

SN 78-383,270. BIOREGIONAL DEVELOPMENT GROUP,
WALLINGTON, SURREY, SM6 7BZ, UNITED KINGDOM,
FILED 3-12-2004.

GALEÓN 1791

THE MARK CONSISTS OF STANDARD CHARACTERS
WITHOUT CLAIM TO ANY PARTICULAR FONT, STYLE,
SIZE, OR COLOR.

NO CLAIM IS MADE TO THE EXCLUSIVE RIGHT TO
USE "1791", APART FROM THE MARK AS SHOWN.

THE FOREIGN WORDING IN THE MARK TRANSLATES
INTO ENGLISH AS GALLEON.

CLASS 32—LIGHT BEVERAGES

FOR NON-ALCOHOLIC COCKTAIL MIXES. (U.S. CLS.
45, 46 AND 48).

CLASS 33—WINES AND SPIRITS

FOR ALCOHOLIC BEVERAGES, NAMELY, RUM,
RUM SPECIALTY DRINKS AND FLAVORED RUMS;
LOW-ALCOHOLIC RUM-BASED BEVERAGES. (U.S.
CLS. 47 AND 49).

PRISCILLA MILTON, EXAMINING ATTORNEY

SN 78-383,069. UNITED BIO ENERGY, LLC, WICHITA, KS.
FILED 3-12-2004.

United Bio Energy

THE MARK CONSISTS OF STANDARD CHARACTERS
WITHOUT CLAIM TO ANY PARTICULAR FONT, STYLE,
SIZE, OR COLOR.

NO CLAIM IS MADE TO THE EXCLUSIVE RIGHT TO
USE "BIO ENERGY", APART FROM THE MARK AS
SHOWN.

CLASS 35—ADVERTISING AND BUSINESS

FOR BUSINESS MANAGEMENT AND MARKETING
CONSULTING FOR THE ETHANOL INDUSTRY; PRO-
CUREMENT, NAMELY PURCHASING OF MATERIALS
FOR USE BY OTHERS IN THE ETHANOL INDUSTRY
(U.S. CLS. 100, 101 AND 102).

FIRST USE 12-2-2003; IN COMMERCE 12-2-2003.

CLASS 36—INSURANCE AND FINANCIAL

FOR RISK MANAGEMENT SERVICES PROVIDED TO
ETHANOL PRODUCTION FACILITIES (U.S. CLS. 100,
101 AND 102).

FIRST USE 12-2-2003; IN COMMERCE 12-2-2003.
LAURA KOVAISKY, EXAMINING ATTORNEY

ONE PLANET LIVING

THE MARK CONSISTS OF STANDARD CHARACTERS
WITHOUT CLAIM TO ANY PARTICULAR FONT, STYLE,
SIZE, OR COLOR.

CLASS 37—CONSTRUCTION AND REPAIR

FOR BUILDING, CONSTRUCTION, REPAIR, AND
INSTALLATION SERVICES FOR OTHERS; CONSULT-
ING SERVICES IN THE FIELD OF BUILDING, CON-
STRUCTION, REPAIR, AND INSTALLATION (U.S. CLS.
100, 103 AND 106).

CLASS 41—EDUCATION AND ENTERTAIN- MENT

FOR EDUCATIONAL, TEACHING, AND INSTRUC-
TIONAL SERVICES, NAMELY, ARRANGING AND
CONDUCTING CONFERENCES, CONGRESSES, SEMI-
NARS, SYMPOSIUMS, WORKSHOPS, AND DISCUSSION
GROUPS IN THE FIELD OF ENVIRONMENTAL AND
SUSTAINABILITY ISSUES AND PRINTED MATERIALS
DISTRIBUTED IN CONNECTION THEREWITH; PRO-
DUCTION OF TELEVISION PROGRAMS, RADIO PRO-
GRAMS, FILMS, AND VIDEOTAPES (U.S. CLS. 100, 101
AND 107).

CLASS 42—SCIENTIFIC, COMPUTER AND LEGAL SERVICES

FOR SCIENTIFIC SERVICES, RESEARCH SERVICES
AND TECHNOLOGICAL SERVICES IN THE FIELDS OF
BUILDING, CONSTRUCTION, ENVIRONMENTAL IS-
SUES, AND SUSTAINABILITY ISSUES; SCIENTIFIC
AND TECHNOLOGICAL DESIGN SERVICES; ENVIR-
ONMENTAL SERVICES AND CONSULTING SERVICES
IN THE FIELD OF SUSTAINABLE LIVING AND INFRA-
STRUCTURE DEVELOPMENT; CONSULTING SER-
VICES IN THE FIELD OF ENVIRONMENTAL ISSUES
IN BUILDING AND CONSTRUCTION WORK; CON-
SULTING SERVICES IN THE FIELD OF BUILDING
AND PROPERTY DESIGN; ENVIRONMENTAL AND
SUSTAINABILITY DESIGN AND CONSULTING SER-
VICES; ENVIRONMENTAL AND SUSTAINABILITY RE-
SEARCH SERVICES; PROVISION OF INFORMATION IN
THE FIELD OF ENVIRONMENTAL ISSUES (U.S. CLS.
100 AND 101).

CRAIG D. TAYLOR, EXAMINING ATTORNEY

SN 78-383,303. BEANHEAD TOYS & ENTERTAINMENT
LLC, ASHBURN, VA. FILED 3-12-2004.

SN 78-383,708. WEST, TODD HAMILTON, CULVER CITY,
CA. FILED 3-12-2004.



J. GATSBY

THE COLOR(S) ORANGE, BLUE AND YELLOW IS/ARE CLAIMED AS A FEATURE OF THE MARK.

THE MARK CONSISTS OF A STYLIZED ORANGE C WITH A 2-RING ANTENNA EMERGING FROM THE TOP OF THE C SHAPE. THE MARK IS OUTLINED IN BLUE AND FEATURES YELLOW HIGHLIGHTS.

THE MARK CONSISTS OF A STYLIZED C WITH A 2-RING ANTENNA EMERGING FROM THE TOP OF THE C SHAPE.

CLASS 35—ADVERTISING AND BUSINESS

FOR RETAIL STORE AND ONLINE RETAIL STORE SERVICES FEATURING CHILDREN'S TOYS AND GAMES, BABY GOODS, GAMES AND PLAYTHINGS, PUZZLES, HOBBY KITS, SCIENCE LABORATORY EQUIPMENT, ART PRODUCTS, MUSICAL RECORDINGS, VIDEOS, BOOKS, CHILDREN'S ROOM ACCESSORIES, AND PARTY GOODS (U.S. CLS. 100, 101 AND 102).

CLASS 41—EDUCATION AND ENTERTAINMENT

FOR EDUCATIONAL AND ENTERTAINMENT SERVICES, NAMELY HANDS-ON EDUCATIONAL CLASSES AND WORKSHOPS IN SCIENCE AND TECHNOLOGY FOR INFANTS, TODDLERS, PRE-SCHOOL AND ELEMENTARY SCHOOL-AGE CHILDREN AND ENTERTAINMENT SERVICES, IN THE NATURE OF VISUAL AND AUDIO PERFORMANCES NAMELY, LIVE PERFORMANCES WITH A SCIENCE AND TECHNOLOGY THEME FOR INFANTS, TODDLERS, PRE-SCHOOL AND ELEMENTARY SCHOOL-AGE CHILDREN (U.S. CLS. 100, 101 AND 107).

JASON TURNER, EXAMINING ATTORNEY

THE MARK CONSISTS OF STANDARD CHARACTERS WITHOUT CLAIM TO ANY PARTICULAR FONT, STYLE, SIZE, OR COLOR.

THE NAME IN THE MARK DOES NOT IDENTIFY A LIVING INDIVIDUAL.

CLASS 35—ADVERTISING AND BUSINESS

FOR PROMOTING THE GOODS AND SERVICES OF OTHERS THROUGH ONLINE ORDERING AND CATALOGUING OF THOSE GOODS AND SERVICES; PROMOTING THE GOODS AND SERVICES OF OTHERS BY PROVIDING HYPERTEXT LINKS TO THE WEB SITES OF OTHERS; FURNISHING PUBLIC RELATIONS AND MARKETING CONSULTING SERVICES; FURNISHING ADVERTISING AND MARKETING ACCESS OPPORTUNITIES TO UPSCALE CONSUMERS; CREATING AND DISSEMINATING COMMERCIAL INFORMATION DIRECTORIES ABOUT SOUGHT AFTER GOODS VIA THE INTERNET AND THROUGH THE DISTRIBUTION OF PRINTED PROMOTIONAL MATERIALS (U.S. CLS. 100, 101 AND 102).

CLASS 41—EDUCATION AND ENTERTAINMENT

FOR ARRANGING AND CONDUCTING EVENTS AND PARTIES FOR THE ENTERTAINMENT INDUSTRY (U.S. CLS. 100, 101 AND 107).

MARLENE BELL, EXAMINING ATTORNEY

SN 78-384,876. ANGL DIVA, INC., MILFORD, CT. FILED 3-16-2004.



THE NAME(S), PORTRAIT(S), AND/OR SIGNATURE(S) SHOWN IN THE MARK IDENTIFIES CHRISTY CARLSON ROMANO, WHOSE CONSENT(S) TO REGISTER IS SUBMITTED.

CLASS 9—ELECTRICAL AND SCIENTIFIC APPARATUS

FOR PRERECORDED CDS, DVDS, VIDEOCASSETTES, AND AUDIO CASSETTES FEATURING MUSIC AND DRAMATIC PERFORMANCES (U.S. CLS. 21, 23, 26, 36 AND 38).

CLASS 16—PAPER GOODS AND PRINTED MATTER

FOR BUMPER STICKERS, DECALS, STATIONERY (U.S. CLS. 2, 5, 22, 23, 29, 37, 38 AND 50).

CLASS 25—CLOTHING

FOR T-SHIRTS, SWEATSHIRTS, HATS, PANTS, SHIRTS, BLOUSES, SLEEPWEAR, SKIRTS, CULOTTES, JUMPSUITS, SWEATERS, DRESSES, BANDANAS, SHOES; OUTERWEAR, NAMELY, JACKETS, WIND RESISTANT JACKETS, COATS, VESTS (U.S. CLS. 22 AND 39).

CLASS 41—EDUCATION AND ENTERTAINMENT

FOR FAN CLUB SERVICES; PROVIDING ONLINE ENTERTAINMENT IN THE NATURE OF FAN CLUB WEB SITES; LIVE MUSICAL AND DRAMATIC PERFORMANCES AND PERSONAL APPEARANCES (U.S. CLS. 100, 101 AND 107).

PRISCILLA MILTON, EXAMINING ATTORNEY

SN 78-385,931. OFFICIAL PILLOWTEX LLC, COLUMBUS, OH. FILED 3-17-2004.

RESORT & SPA BY FIELDCREST

THE MARK CONSISTS OF STANDARD CHARACTERS WITHOUT CLAIM TO ANY PARTICULAR FONT, STYLE, SIZE, OR COLOR.

OWNER OF U.S. REG. NOS. 500,882, 995,055 AND OTHERS.

CLASS 10—MEDICAL APPARATUS

FOR ELECTRIC MASSAGE APPARATUS IN THE NATURE OF VIBRATING PILLOWS AND MATTRESS PADS. (U.S. CLS. 26, 39 AND 44).

CLASS 20—FURNITURE AND ARTICLES NOT OTHERWISE CLASSIFIED

FOR PILLOWS (U.S. CLS. 2, 13, 22, 25, 32 AND 50).

CLASS 24—FABRICS

FOR TOWELS, BED SHEETS, FABRICS FOR THE MANUFACTURE OF SHEETS AND TOWELS, BLANKETS, PILLOWCASES, DRAPERIES AND CURTAINS, FABRIC VALANCES AND PILLOW SHAMS, BEDSPREADS, DUST RUFFLES, DUVET COVERS, MATTRESS PADS, QUILTS AND COMFORTERS (U.S. CLS. 42 AND 50).

CLASS 27—FLOOR COVERINGS

FOR BATH MATS, BATH RUGS AND CARPETING (U.S. CLS. 19, 20, 37, 42 AND 50).

KAREN BRACEY, EXAMINING ATTORNEY

SN 78-386,323. MP BIOMEDICALS, LLC, IRVINE, CA. FILED 3-17-2004.

NEUROSHUTTLE

THE MARK CONSISTS OF STANDARD CHARACTERS WITHOUT CLAIM TO ANY PARTICULAR FONT, STYLE, SIZE, OR COLOR.

CLASS 1—CHEMICALS

FOR BIOCHEMICALS, NAMELY, PRECURSORS FOR IN VITRO GENETIC ENGINEERING USE; CELLS FOR SCIENTIFIC, LABORATORY OR MEDICAL RESEARCH; DIAGNOSTIC PREPARATIONS OR REAGENTS FOR SCIENTIFIC OR RESEARCH USE; GENETIC IDENTITY TESTS COMPRISED OF REAGENTS; REAGENTS FOR SCIENTIFIC OR MEDICAL RESEARCH USE (U.S. CLS. 1, 5, 6, 10, 26 AND 46).

CLASS 42—SCIENTIFIC, COMPUTER AND LEGAL SERVICES

FOR LABORATORY RESEARCH IN THE FIELDS OF BIOCHEMISTRY, CELL BIOLOGY, MOLECULAR BIOLOGY, IMMUNOLOGY, NEUROSCIENCE, CHEMISTRY, PHARMACEUTICALS, BIOTECHNOLOGY, SIGNAL TRANSDUCTION, NEUROLOGY, GENETICS, PROTEOMICS, GENOMICS (U.S. CLS. 100 AND 101).

JOHN SCHUYLER YARD, EXAMINING ATTORNEY

SN 78-386,936. PALADIN DEVELOPMENT PARTNERS, L.L.C., PARK CITY, UT. FILED 3-18-2004.

SILVER STAR AT PARK CITY

THE MARK CONSISTS OF STANDARD CHARACTERS WITHOUT CLAIM TO ANY PARTICULAR FONT, STYLE, SIZE, OR COLOR.

NO CLAIM IS MADE TO THE EXCLUSIVE RIGHT TO USE "PARK CITY", APART FROM THE MARK AS SHOWN.

CLASS 36—INSURANCE AND FINANCIAL

FOR REAL ESTATE MANAGEMENT (U.S. CLS. 100, 101 AND 102).

CLASS 37—CONSTRUCTION AND REPAIR

FOR REAL ESTATE DEVELOPMENT (U.S. CLS. 100, 103 AND 106).
PAULA MAYS, EXAMINING ATTORNEY

CLASS 42—SCIENTIFIC, COMPUTER AND LEGAL SERVICES

FOR LEGAL SERVICES; LEGAL SERVICES IN THE FIELD OF LITIGATION; LEGAL CONSULTATION; AND PROVIDING INFORMATION REGARDING LEGAL ISSUES IN THE FIELDS OF, AND REGULATORY ISSUES IN THE NATURE OF REVIEWING STANDARDS AND PRACTICES TO ASSURE COMPLIANCE WITH LAWS AND REGULATIONS IN THE FIELDS OF, LIFE AND HEALTH INSURANCE, REINSURANCE, PROPERTY AND CASUALTY INSURANCE, CONSUMER FINANCE, BANKING, CREDIT, BANKRUPTCY, BROKER-DEALERS, FINANCIAL PRODUCT DISTRIBUTION, MUTUAL FUNDS, INVESTMENT BANKS, INVESTMENT ADVICE AND ADVISORS, AND INVESTMENT MANAGEMENT AND MANAGERS, TAX, ERISA, LABOR, EMPLOYMENT, CORPORATE LAW, SECURITIES, INTELLECTUAL PROPERTY, TECHNOLOGY, REAL ESTATE, CONSTITUTIONAL LAW, WHITE COLLAR DEFENSE, AND COMMERCIAL TRIAL, APPELLATE AND CLASS ACTION LITIGATION, PARTICULARLY, BUT NOT EXCLUSIVELY, TO DOMESTIC, MULTINATIONAL AND FOREIGN BUSINESSES IN THE FINANCIAL SERVICES INDUSTRIES (U.S. CLS. 100 AND 101).
KAREN BRACEY, EXAMINING ATTORNEY

SN 78-389,344. ORION FOOD SYSTEMS, LLC, SIOUX FALLS, SD. FILED 3-23-2004.

SN 78-387,860. JORDEN BURT LLP, MIAMI, FL. FILED 3-19-2004.

EXPECT FOCUS

THE MARK CONSISTS OF STANDARD CHARACTERS WITHOUT CLAIM TO ANY PARTICULAR FONT, STYLE, SIZE, OR COLOR.

CLASS 35—ADVERTISING AND BUSINESS

FOR POLITICAL LOBBYING AND POLITICAL CONSULTATION; GOVERNMENT RELATIONS SERVICES, NAMELY, LEGISLATIVE MONITORING AND GOVERNMENT ISSUES MANAGEMENT (U.S. CLS. 100, 101 AND 102).

SUMMIT SUBS

THE MARK CONSISTS OF STANDARD CHARACTERS WITHOUT CLAIM TO ANY PARTICULAR FONT, STYLE, SIZE, OR COLOR.

NO CLAIM IS MADE TO THE EXCLUSIVE RIGHT TO USE "SUBS", APART FROM THE MARK AS SHOWN.

CLASS 30—STAPLE FOODS

FOR HOT SANDWICHES, COLD SANDWICHES (U.S. CL. 46).
FIRST USE 4-0-1999; IN COMMERCE 4-0-1999.

CLASS 35—ADVERTISING AND BUSINESS

FOR FRANCHISING SERVICES IN THE FIELD OF RESTAURANTS AND FOOD KIOSKS (U.S. CLS. 100, 101 AND 102).
FIRST USE 4-0-1999; IN COMMERCE 4-0-1999.
DARRYL SPRUILL, EXAMINING ATTORNEY

SN 78-389,354. ACURA PHARMACEUTICALS, INC., PALATINE, IL. FILED 3-23-2004.

AVERSION

THE MARK CONSISTS OF STANDARD CHARACTERS WITHOUT CLAIM TO ANY PARTICULAR FONT, STYLE, SIZE, OR COLOR.

CLASS 5—PHARMACEUTICALS

FOR PHARMACEUTICAL PREPARATIONS FOR DETERRANCE OF ABUSE OF OPIOID CONTAINING ORALLY ADMINISTERED PRESCRIPTION ANALGESIC PRODUCTS (U.S. CLS. 6, 18, 44, 46, 51 AND 52).

CLASS 42—SCIENTIFIC, COMPUTER AND LEGAL SERVICES

FOR PHARMACEUTICAL RESEARCH AND DEVELOPMENT SERVICES (U.S. CLS. 100 AND 101).
STANLEY I. OSBORNE, EXAMINING ATTORNEY

SN 78-390,918. VIACOM INTERNATIONAL INC., NEW YORK, NY. FILED 3-25-2004.

EVERDARE

THE MARK CONSISTS OF STANDARD CHARACTERS WITHOUT CLAIM TO ANY PARTICULAR FONT, STYLE, SIZE, OR COLOR.

CLASS 16—PAPER GOODS AND PRINTED MATTER

FOR PRINTED MATTER, NAMELY, NOTE PAPER AND LOOSE LEAF PAPER, SERIES OF FICTION BOOKS, DECALS, BUMPER STICKERS, TRADING CARDS, NOTE CARDS, POSTERS, FOLDERS, CALENDARS, STATIONERY WRITING PAPER AND ENVELOPES, ARTS AND CRAFT PAINT KITS; NOTEBOOKS; BLANK JOURNALS; ADDRESS BOOKS; DIARIES; DAILY PLANNERS; DESKTOP PLANNERS; PERSONAL PLANNERS; BOOKMARKS; AND CARDBOARD; CRAFT BOOKS; SCHOOL SUPPLIES, NAMELY, SCHOOL BOXES MADE OF CARDBOARD, PENCILS, PENS, PEN AND PENCIL CASES AND HOLDERS, ERASERS, PENCIL SHARPENERS, HIGHLIGHTS MARKERS, MARKERS, AND DRAWING RULERS; GIFT WRAPPING PAPER; PAPER PARTY DECORATIONS; PARTY PAPER BAGS (U.S. CLS. 2, 5, 22, 23, 29, 37, 38 AND 50).

CLASS 18—LEATHER GOODS

FOR UMBRELLAS, LUGGAGE, LUGGAGE TAGS, TOTE BAGS, BACKPACKS, FANNY PACKS, MESSENGER BAGS, HANDBAGS, WALLETS AND PURSES, ATHLETIC BAGS, GARMENT BAGS FOR TRAVEL, KNAPSACKS, CHANGE PURSES, DUFFLE BAGS, BEACH BAGS (U.S. CLS. 1, 2, 3, 22 AND 41).

CLASS 25—CLOTHING

FOR BATHING SUITS, BATHROBES, BEACHWEAR, CLOTHING BELTS, SHORTS, JACKETS, COATS, SOCKS, FOOTWEAR, BANDANAS, SWEATERS, HALLOWEEN COSTUMES, DRESSES, GLOVES, GYM SHORTS, EAR MUFFS, NECKWEAR, PAJAMAS, PANTS, SHIRTS, SWEAT SHIRTS, SKI WEAR, SLACKS, SUN VISORS, SUSPENDERS, TURTLENECKS, UNDERCLOTHES, VESTS, WARM-UP SUITS, HEADWEAR (U.S. CLS. 22 AND 39).

CLASS 26—FANCY GOODS

FOR HAIR ACCESSORIES, NAMELY, CLAM CLIPS, CLAW CLIPS, SNAP CLIPS, HAIR BANDS, HAIR BOWS, HAIR RIBBONS, SCRUNCHIES, HAIR BUCKLES, HAIR CURL CLIPS, HAIR ORNAMENTS, HAIR PINS, HAIR PIECES, NON-ELECTRIC HAIR CURLERS AND NON-ELECTRIC HAIR ROLLERS; ORNAMENTAL NOVELTY PINS; SEW ON CLOTH PATCHES FOR CLOTHING; ORNAMENTAL NOVELTY BUTTONS; BARRETTES AND SCRUNCHIES (U.S. CLS. 37, 39, 40, 42 AND 50).

JIM RINGLE, EXAMINING ATTORNEY

SN 78-390,927. VIACOM INTERNATIONAL INC., NEW YORK, NY. FILED 3-25-2004.

EVERDAZZLE

THE MARK CONSISTS OF STANDARD CHARACTERS WITHOUT CLAIM TO ANY PARTICULAR FONT, STYLE, SIZE, OR COLOR.

CLASS 16—PAPER GOODS AND PRINTED MATTER

FOR PRINTED MATTER, NAMELY, NOTE PAPER AND LOOSE LEAF PAPER, SERIES OF FICTION BOOKS, DECALS, BUMPER STICKERS, TRADING CARDS, NOTE CARDS, POSTERS, FOLDERS, CALENDARS, STATIONERY WRITING PAPER AND ENVELOPES, ARTS AND CRAFT PAINT KITS; NOTEBOOKS; BLANK JOURNALS; ADDRESS BOOKS; DIARIES; DAILY PLANNERS; DESKTOP PLANNERS; PERSONAL PLANNERS; BOOKMARKS; AND CARDBOARD; CRAFT BOOKS; SCHOOL SUPPLIES, NAMELY, SCHOOL BOXES MADE OF CARDBOARD, PENCILS, PENS, PEN AND PENCIL CASES AND HOLDERS, ERASERS, PENCIL SHARPENERS, HIGHLIGHTS MARKERS, MARKERS, AND DRAWING RULERS; GIFT WRAPPING PAPER; PAPER PARTY DECORATIONS; PARTY PAPER BAGS (U.S. CLS. 2, 5, 22, 23, 29, 37, 38 AND 50).

CLASS 18—LEATHER GOODS

FOR UMBRELLAS, LUGGAGE, LUGGAGE TAGS, TOTE BAGS, BACKPACKS, FANNY PACKS, MESSENGER BAGS, HANDBAGS, WALLETS AND PURSES, ATHLETIC BAGS, GARMENT BAGS FOR TRAVEL, KNAPSACKS, CHANGE PURSES, DUFFLE BAGS, BEACH BAGS (U.S. CLS. 1, 2, 3, 22 AND 41).

CLASS 25—CLOTHING

FOR BATHING SUITS, BATHROBES, BEACHWEAR, CLOTHING BELTS, SHORTS, JACKETS, COATS, SOCKS, FOOTWEAR, BANDANAS, SWEATERS, HALLOWEEN COSTUMES, DRESSES, GLOVES, GYM SHORTS, EAR MUFFS, NECKWEAR, PAJAMAS, PANTS, SHIRTS, SWEAT SHIRTS, SKI WEAR, SLACKS, SUN VISORS, SUSPENDERS, TURTLENECKS, UNDERCLOTHES, VESTS, WARM-UP SUITS, HEADWEAR (U.S. CLS. 22 AND 39).

CLASS 26—FANCY GOODS

FOR HAIR ACCESSORIES, NAMELY, CLAM CLIPS, CLAW CLIPS, SNAP CLIPS, HAIR BANDS, HAIR BOWS, HAIR RIBBONS, SCRUNCHIES, HAIR BUCKLES, HAIR CURL CLIPS, HAIR ORNAMENTS, HAIR PINS, HAIR PIECES, NON-ELECTRIC HAIR CURLERS AND NON-ELECTRIC HAIR ROLLERS; ORNAMENTAL NOVELTY PINS; SEW ON CLOTH PATCHES FOR CLOTHING; ORNAMENTAL NOVELTY BUTTONS; BARRETTES AND SCRUNCHIES (U.S. CLS. 37, 39, 40, 42 AND 50).
JIM RINGLE, EXAMINING ATTORNEY

SN 78-390,936. VIACOM INTERNATIONAL INC., NEW YORK, NY. FILED 3-25-2004.

EVERCHARM

THE MARK CONSISTS OF STANDARD CHARACTERS WITHOUT CLAIM TO ANY PARTICULAR FONT, STYLE, SIZE, OR COLOR.

CLASS 3—COSMETICS AND CLEANING PREPARATIONS

FOR HEALTH AND BEAUTY AIDS, NAMELY, HAIR SHAMPOOS, HAIR GEL, HAIR CONDITIONERS, BUBBLE BATH, SKIN SOAPS, LIQUID SKIN SOAP, COSMETICS, NAMELY, PERFUME AND COLOGNE; TOOTH PASTE, BODY WASH, FRAGRANCES FOR PERSONAL USE; BATH OIL, BODY OIL, MASSAGE OIL, BATH SALTS, BODY LOTION, SKIN LOTION, INCENSE, BODY CREAM, BODY POWDER, SKIN CLEANING CREAM, FACIAL SCRUBS, BATH GEL; MAKEUP, PERSONAL DEODORANTS (U.S. CLS. 1, 4, 6, 50, 51 AND 52).

CLASS 16—PAPER GOODS AND PRINTED MATTER

FOR PRINTED MATTER, NAMELY, NOTE PAPER AND LOOSE LEAF PAPER, SERIES OF FICTION BOOKS, DECALS, BUMPER STICKERS, TRADING CARDS, NOTE CARDS, POSTERS, FOLDERS, CALENDARS, STATIONERY WRITING PAPER AND ENVELOPES, ARTS AND CRAFT PAINT KITS; NOTEBOOKS; BLANK JOURNALS; ADDRESS BOOKS; DIARIES; DAILY PLANNERS; DESKTOP PLANNERS; PERSONAL PLANNERS; BOOKMARKS; AND CARDBOARD; CRAFT BOOKS; SCHOOL SUPPLIES, NAMELY, SCHOOL BOXES MADE OF CARDBOARD, PENCILS, PENS, PEN AND PENCIL CASES AND HOLDERS, ERASERS, PENCIL SHARPENERS, HIGHLIGHTS MARKERS, MARKERS, AND DRAWING RULERS; GIFT WRAPPING PAPER; PAPER PARTY DECORATIONS; PARTY PAPER BAGS (U.S. CLS. 2, 5, 22, 23, 29, 37, 38 AND 50).

CLASS 18—LEATHER GOODS

FOR UMBRELLAS, LUGGAGE, LUGGAGE TAGS, TOTE BAGS, BACKPACKS, FANNY PACKS, MESSENGER BAGS, HANDBAGS, WALLETS AND PURSES, ATHLETIC BAGS, GARMENT BAGS FOR TRAVEL, KNAPSACKS, CHANGE PURSES, DUFFLE BAGS, BEACH BAGS (U.S. CLS. 1, 2, 3, 22 AND 41).

CLASS 25—CLOTHING

FOR BATHING SUITS, BATHROBES, BEACHWEAR, CLOTHING BELTS, SHORTS, JACKETS, COATS, SOCKS, FOOTWEAR, BANDANAS, SWEATERS, HALLOWEEN COSTUMES, DRESSES, GLOVES, GYM SHORTS, EAR MUFFS, NECKWEAR, PAJAMAS, PANTS, SHIRTS, SWEAT SHIRTS, SKI WEAR, SLACKS, SUN VISORS, SUSPENDERS, TURTLENECKS, UNDERCLOTHES, VESTS, WARM-UP SUITS, HEADWEAR (U.S. CLS. 22 AND 39).

CLASS 26—FANCY GOODS

FOR HAIR ACCESSORIES, NAMELY, CLAM CLIPS, CLAW CLIPS, SNAP CLIPS, HAIR BANDS, HAIR BOWS, HAIR RIBBONS, SCRUNCHIES, HAIR BUCKLES, HAIR CURL CLIPS, HAIR ORNAMENTS, HAIR PINS, HAIR PIECES, NON-ELECTRIC HAIR CURLERS AND NON-ELECTRIC HAIR ROLLERS; ORNAMENTAL NOVELTY PINS; SEW ON CLOTH PATCHES FOR CLOTHING; ORNAMENTAL NOVELTY BUTTONS; BARRETTES AND SCRUNCHIES (U.S. CLS. 37, 39, 40, 42 AND 50).
JIM RINGLE, EXAMINING ATTORNEY

SN 78-391,557. RODALE INC., EMMAUS, PA. FILED 3-26-2004.

SMART WAYS TO LIVE WELL

THE MARK CONSISTS OF STANDARD CHARACTERS WITHOUT CLAIM TO ANY PARTICULAR FONT, STYLE, SIZE, OR COLOR.

CLASS 16—PAPER GOODS AND PRINTED MATTER

FOR MAGAZINES AND BOOKS IN THE FIELDS OF HEALTH, FITNESS, DIET AND LIFESTYLE (U.S. CLS. 2, 5, 22, 23, 29, 37, 38 AND 50).

CLASS 35—ADVERTISING AND BUSINESS

FOR ONLINE RETAIL STORE AND DISTRIBUTORSHIP SERVICES IN THE FIELD OF HEALTH-RELATED PRODUCTS; PROMOTING THE GOODS AND SERVICES OF OTHERS IN THE FIELD OF HEALTH BY ONLINE ADVERTISING AND PRODUCT REVIEWS (U.S. CLS. 100, 101 AND 102).

SN 78-391,986. GIANNA ROSE ATELIER, INC., SANTA ANA, CA. FILED 3-27-2004.

CLASS 41—EDUCATION AND ENTERTAINMENT

FOR INFORMATION SERVICES VIA A WEB SITE IN THE FIELDS OF FITNESS, EXERCISE AND ACTIVE LIFESTYLE (U.S. CLS. 100, 101 AND 107).

CLASS 44—MEDICAL, BEAUTY AND AGRICULTURAL SERVICES

FOR INFORMATION SERVICES VIA A WEB SITE IN THE FIELDS OF HEALTH AND DIET (U.S. CLS. 100 AND 101).

MICHAEL KEATING, EXAMINING ATTORNEY

LE CHIC PARISIEN

THE MARK CONSISTS OF STANDARD CHARACTERS WITHOUT CLAIM TO ANY PARTICULAR FONT, STYLE, SIZE, OR COLOR.

OWNER OF U.S. REG. NO. 2,723,193.

THE ENGLISH TRANSLATION OF LE CHIC PARISIEN IS 'STYLISH PARISIAN'.

CLASS 3—COSMETICS AND CLEANING PREPARATIONS

FOR SOAPS, BAR SOAPS, SOAP PETALS, LIQUID HAND SOAPS, HAND AND BODY CREAMS, BODY CREAMS, BODY SCRUB, ESSENTIAL OILS FOR PERSONAL USE, PERFUMED BATH OIL, BATH CAPSULES, AND NON-MEDICATED BATH FIZZES CONSISTING OF BAKING SODA AND FRAGRANCE, HAIR LOTIONS AND INCENSE (U.S. CLS. 1, 4, 6, 50, 51 AND 52).

SN 78-391,639. BAYER AKTIENGESELLSCHAFT, LEVERKUSEN-BAYERWERK, FED REP GERMANY, FILED 3-26-2004.

CLASS 4—LUBRICANTS AND FUELS

FOR CANDLES (U.S. CLS. 1, 6 AND 15).

CLASS 16—PAPER GOODS AND PRINTED MATTER

FOR SCENTED DRAWER LINERS (U.S. CLS. 2, 5, 22, 23, 29, 37, 38 AND 50).

SEPRESTO**CLASS 21—HOUSEWARES AND GLASS**

FOR SOAP BOXES (U.S. CLS. 2, 13, 23, 29, 30, 33, 40 AND 50).

CHARLES L. JENKINS, EXAMINING ATTORNEY

THE MARK CONSISTS OF STANDARD CHARACTERS WITHOUT CLAIM TO ANY PARTICULAR FONT, STYLE, SIZE, OR COLOR.

OWNER OF FED REP GERMANY REG. NO. 30315137, DATED 6-23-2003, EXPIRES 3-31-2013.

SN 78-392,522. BIG ON KIDS ENTERTAINMENT, INC., SAN DIEGO, CA. FILED 3-29-2004.

CLASS 1—CHEMICALS

FOR CHEMICAL PREPARATIONS FOR USE IN AGRICULTURAL, HORTICULTURE AND FORESTRY, NAMELY, CHEMICAL PREPARATIONS FOR THE TREATMENT OF SEEDS; FERTILIZER FOR DOMESTIC AND AGRICULTURAL USE (U.S. CLS. 1, 5, 6, 10, 26 AND 46).

BIG ON KIDS**CLASS 5—PHARMACEUTICALS**

FOR PREPARATIONS FOR KILLING WEEDS AND DESTROYING VERMIN, INSECTICIDES, HERBICIDES FOR DOMESTIC AND AGRICULTURAL USE; FUNGICIDES FOR DOMESTIC AND AGRICULTURAL USE (U.S. CLS. 6, 18, 44, 46, 51 AND 52).

MARLENE BELL, EXAMINING ATTORNEY

THE MARK CONSISTS OF STANDARD CHARACTERS WITHOUT CLAIM TO ANY PARTICULAR FONT, STYLE, SIZE, OR COLOR.

CLASS 16—PAPER GOODS AND PRINTED MATTER

FOR PAPER GOODS AND PRINTED MATTER, NAMELY, PRINTED INSTRUCTIONAL EDUCATIONAL, AND TEACHING MATERIALS IN THE AREA OF CHILD AWARENESS AND SELF-DEFENSE (U.S. CLS. 2, 5, 22, 23, 29, 37, 38 AND 50).

CLASS 41—EDUCATION AND ENTERTAINMENT

FOR ENTERTAINMENT IN THE NATURE OF THEATRE PRODUCTIONS AND MOVIE PRODUCTION; EDUCATIONAL AND ENTERTAINMENT SERVICES, NAMELY, PROVIDING MOTIVATIONAL AND EDUCATIONAL SPEAKERS (U.S. CLS. 100, 101 AND 107).

SHARI SHEFFIELD, EXAMINING ATTORNEY

SN 78-395,896. LONGVIEW SOLUTIONS INC., MARKHAM ONTARIO, CANADA, FILED 4-2-2004.

LONGVIEW SOLUTIONS

THE MARK CONSISTS OF STANDARD CHARACTERS WITHOUT CLAIM TO ANY PARTICULAR FONT, STYLE, SIZE, OR COLOR.

OWNER OF U.S. REG. NO. 2,138,312.

NO CLAIM IS MADE TO THE EXCLUSIVE RIGHT TO USE "SOLUTIONS", APART FROM THE MARK AS SHOWN.

CLASS 9—ELECTRICAL AND SCIENTIFIC APPARATUS

FOR FINANCIAL MODELING COMPUTER SOFTWARE PROGRAMS PRIMARILY FOR FINANCIAL REPORTING AND PLANNING, AND USER MANUALS THEREFOR (U.S. CLS. 21, 23, 26, 36 AND 38).

FIRST USE 2-1-2002; IN COMMERCE 2-1-2002.

CLASS 42—SCIENTIFIC, COMPUTER AND LEGAL SERVICES

FOR CONSULTING IN THE FIELD OF COMPUTER CONSULTING; CREATING AND DEVELOPING TO THE ORDER AND SPECIFICATIONS OF OTHERS COMPUTER SOFTWARE IN THE FIELD OF FINANCIAL REPORTING (U.S. CLS. 100 AND 101).

FIRST USE 2-1-2002; IN COMMERCE 2-1-2002.

KAREN BRACEY, EXAMINING ATTORNEY

SN 78-394,377. TJS&B, LLC, FENTON, MI. FILED 3-31-2004.



NO CLAIM IS MADE TO THE EXCLUSIVE RIGHT TO USE "GYM", APART FROM THE MARK AS SHOWN.

CLASS 16—PAPER GOODS AND PRINTED MATTER

FOR PRINTED MATERIALS, NAMELY, MANUALS, LESSON PLANS AND HANDOUTS IN THE FIELD OF EARLY CHILDHOOD DEVELOPMENT (U.S. CLS. 2, 5, 22, 23, 29, 37, 38 AND 50).

CLASS 35—ADVERTISING AND BUSINESS

FOR BUSINESS CONSULTING SERVICES IN THE FIELD OF EDUCATIONAL AND PLAY/ENTERTAINMENT CLASSES FOR CHILDREN AND PARENTS (U.S. CLS. 100, 101 AND 102).

CLASS 41—EDUCATION AND ENTERTAINMENT

FOR INTERACTIVE CHILD/PARENT EDUCATION AND PLAY CENTER SERVICES, NAMELY, CLASSES FOR CHILDREN AND PARENTS IN THE FIELD OF EARLY CHILDHOOD DEVELOPMENT; ENTERTAINMENT SERVICES, NAMELY, ARRANGING CHILDREN'S BIRTHDAY PARTIES; GROUP ACTIVITIES, NAMELY, PROVIDING RECREATIONAL AREAS FOR GROUPS IN THE NATURE OF CHILDREN'S PLAY AREAS (U.S. CLS. 100, 101 AND 107).

KATHY DE JONGE, EXAMINING ATTORNEY

SN 78-396,163. PFIZER INC., NEW YORK, NY. FILED 4-5-2004.

NATURAL NIGHT

THE MARK CONSISTS OF STANDARD CHARACTERS WITHOUT CLAIM TO ANY PARTICULAR FONT, STYLE, SIZE, OR COLOR.

CLASS 3—COSMETICS AND CLEANING PREPARATIONS

FOR AROMATHERAPY REFILL PADS (U.S. CLS. 1, 4, 6, 50, 51 AND 52).

CLASS 11—ENVIRONMENTAL CONTROL APPARATUS

FOR ELECTRICAL AROMATHERAPY DEVICE TO BE PLUGGED INTO WALL OUTLETS (U.S. CLS. 13, 21, 23, 31 AND 34).

ZACHARY BELLO, EXAMINING ATTORNEY

SN 78-396,970. MCCALL-ELLIE EQUITIES, LLC, AUSTIN, TX. FILED 4-6-2004.

Hellas Sport Tracks

THE MARK CONSISTS OF STANDARD CHARACTERS WITHOUT CLAIM TO ANY PARTICULAR FONT, STYLE, SIZE, OR COLOR.

NO CLAIM IS MADE TO THE EXCLUSIVE RIGHT TO USE SPORTS TRACKS, APART FROM THE MARK AS SHOWN.

CLASS 27—FLOOR COVERINGS

FOR ATHLETIC AND RECREATIONAL SURFACING PRODUCTS, NAMELY, ARTIFICIAL AND SYNTHETIC TURF FOR CONSTRUCTING INDOOR AND OUTDOOR TRACKS, ATHLETIC TRACKS AND RUNNING TRACKS (U.S. CLS. 19, 20, 37, 42 AND 50).

CLASS 37—CONSTRUCTION AND REPAIR

FOR INSTALLATION, REPAIR AND MAINTENANCE OF ATHLETIC AND RECREATIONAL SURFACING PRODUCTS, NAMELY, INDOOR AND OUTDOOR TRACKS, ATHLETIC TRACKS, RUNNING TRACKS (U.S. CLS. 100, 103 AND 106).

CLASS 40—MATERIAL TREATMENT

FOR MANUFACTURE FOR OTHERS OF ATHLETIC AND RECREATIONAL SURFACING PRODUCTS, NAMELY, INDOOR AND OUTDOOR TRACKS, ATHLETIC TRACKS, RUNNING TRACKS (U.S. CLS. 100, 103 AND 106).

CAROLYN CATALDO, EXAMINING ATTORNEY

SN 78-397,520. KALUKIM VENTURES, LLC, DEL MAR, CA. FILED 4-6-2004.

Maui Land & Pineapple Company

THE MARK CONSISTS OF STANDARD CHARACTERS WITHOUT CLAIM TO ANY PARTICULAR FONT, STYLE, SIZE, OR COLOR.

NO CLAIM IS MADE TO THE EXCLUSIVE RIGHT TO USE "COMPANY", APART FROM THE MARK AS SHOWN.

CLASS 20—FURNITURE AND ARTICLES NOT OTHERWISE CLASSIFIED

FOR FURNITURE (U.S. CLS. 2, 13, 22, 25, 32 AND 50).

CLASS 25—CLOTHING

FOR MEN'S, WOMEN'S, BOYS', AND GIRLS' CLOTHING; NAMELY, KNIT AND WOVEN SHIRTS; KNIT AND WOVEN PANTS, SHORTS, AND JEANS; SWEATERS, JACKETS, VESTS, COATS, RAINWEAR, BELTS, HATS, GLOVES, SOCKS, SCARVES, TIES, ASCOTS, AND NECKERCHIEFS (U.S. CLS. 22 AND 39).

JILL C. ALT, EXAMINING ATTORNEY

SN 78-400,698. SELECTIVE CHARTISTS, LLC, HUDSON, MA. FILED 4-13-2004.



THE MARK CONSISTS OF THE LETTERS S AND C WITH A V-SHAPED ARROW EXTENDING FROM THE LETTER S AND TRAVERSING THROUGH THE LETTER C.

CLASS 36—INSURANCE AND FINANCIAL

FOR FINANCIAL RESEARCH, ANALYSIS AND CONSULTATION FOR INVESTING IN THE STOCK MARKET (U.S. CLS. 100, 101 AND 102).

CLASS 41—EDUCATION AND ENTERTAINMENT

FOR PROVIDING FINANCIAL EDUCATION REGARDING INVESTING IN THE STOCK MARKET, IN THE NATURE OF SEMINARS AND WORKSHOPS (U.S. CLS. 100, 101 AND 107).

LAURA KOVAISKY, EXAMINING ATTORNEY

SN 78-400,802. MARRIOTT INTERNATIONAL, INC., BETHESDA, MD. FILED 4-13-2004.

WEDDINGS BY MARRIOTT

THE MARK CONSISTS OF STANDARD CHARACTERS WITHOUT CLAIM TO ANY PARTICULAR FONT, STYLE, SIZE, OR COLOR.

NO CLAIM IS MADE TO THE EXCLUSIVE RIGHT TO USE "WEDDINGS", APART FROM THE MARK AS SHOWN.

CLASS 41—EDUCATION AND ENTERTAINMENT

SN 78-402,374. BARRIER THERAPEUTICS, INC., PRINCETON, NJ. FILED 4-15-2004.

FOR EVENT AND WEDDING PLANNING CONSULTATION; SPECIAL EVENT AND WEDDING PLANNING AND COORDINATING SERVICES (U.S. CLS. 100, 101 AND 107).

CLASS 43—HOTEL AND RESTAURANT SERVICES

FOR HOTEL, RESTAURANT AND CATERING SERVICES PROVIDED IN CONNECTION WITH EVENTS AND WEDDINGS (U.S. CLS. 100 AND 101).
MIDGE BUTLER, EXAMINING ATTORNEY

**A VISION FOR
INNOVATIVE
MEDICINE**

SN 78-401,152. PVF ACQUISITION, LLC, CHICAGO, IL. FILED 4-13-2004.

THE MARK CONSISTS OF STANDARD CHARACTERS WITHOUT CLAIM TO ANY PARTICULAR FONT, STYLE, SIZE, OR COLOR.

NO CLAIM IS MADE TO THE EXCLUSIVE RIGHT TO USE "INNOVATIVE MEDICINE", APART FROM THE MARK AS SHOWN.

CLASS 5—PHARMACEUTICALS

FOR PRESCRIPTION DERMATOLOGICAL PHARMACEUTICALS AND PREPARATIONS (U.S. CLS. 6, 18, 44, 46, 51 AND 52).

CLASS 42—SCIENTIFIC, COMPUTER AND LEGAL SERVICES

FOR RESEARCH, DEVELOPMENT, AND CONSULTATION IN THE FIELD OF PRESCRIPTION DERMATOLOGICAL PHARMACEUTICALS AND PREPARATIONS (U.S. CLS. 100 AND 101).

ALLISON HOLTZ, EXAMINING ATTORNEY

HANNAH'S KITCHEN

SN 78-403,622. GMS PARTNERS, INC., SILVER SPRING, MD. FILED 4-17-2004.

THE MARK CONSISTS OF STANDARD CHARACTERS WITHOUT CLAIM TO ANY PARTICULAR FONT, STYLE, SIZE, OR COLOR.

CLASS 29—MEATS AND PROCESSED FOODS

FOR CHEESE, CHEESE SPREADS, PROCESSED CHEESE, MEAT, HOT DOGS, GROUND POULTRY, GROUND PORK, FRESH AND COOKED STUFFED CHICKEN BREASTS, COOKED CHICKEN BREASTS, DELI MEATS, CHICKEN KABOBS, CHICKEN AND VEGETABLE SKEWERS, MEAT-BASED STUFFING MIXES, FRESH AND COOKED SAUSAGE, NAMELY CHICKEN SAUSAGE, TURKEY SAUSAGE, PORK SAUSAGE, BEEF SAUSAGE, LAMB SAUSAGE, VEAL SAUSAGE, AND DUCK SAUSAGE, AND PREPACKAGED COMBINATIONS CONSISTING PRIMARILY OF MEAT AND CHEESE, AND ALSO CONTAINING CRACKERS (U.S. CL. 46).

HAMSTER WHEEL

THE MARK CONSISTS OF STANDARD CHARACTERS WITHOUT CLAIM TO ANY PARTICULAR FONT, STYLE, SIZE, OR COLOR.

CLASS 30—STAPLE FOODS

FOR RAVIOLIS, STUFFING MIXES CONTAINING BREAD, SANDWICH WRAPS, NAMELY, FULLY COOKED CHICKEN SAUSAGE WRAPPED INSIDE GOURMET BREAD (U.S. CL. 46).
LEIGH CAROLINE CASE, EXAMINING ATTORNEY

CLASS 16—PAPER GOODS AND PRINTED MATTER

FOR PRINTED MATTER, NAMELY, BOOKS, HANDBOOKS, ARTICLES, INSTRUCTIONAL OR TEACHING MATERIALS, MANUALS, WORKSHEETS, WORKBOOKS, AND/OR CHECKLISTS IN THE FIELD OF PERSONAL AND/OR EDUCATIONAL PLANNING, GROWTH, DEVELOPMENT AND/OR CHANGE MANAGEMENT (U.S. CLS. 2, 5, 22, 23, 29, 37, 38 AND 50).

CLASS 25—CLOTHING

FOR CLOTHING, NAMELY, SPORT SHIRTS, T-SHIRTS, SWEAT SHIRTS, PANTS, SHORTS, JACKETS, CAPS AND/OR HEADWEAR (U.S. CLS. 22 AND 39).

CLASS 41—EDUCATION AND ENTERTAINMENT

FOR EDUCATION AND TRAINING SERVICES IN THE FIELD OF PERSONAL AND/OR EDUCATIONAL PLANNING, GROWTH, DEVELOPMENT AND/OR CHANGE MANAGEMENT OFFERED THROUGH SEMINARS, WORKSHOPS, CLASSES, PRINTED MATTER AND/OR VIA THE INTERNET (U.S. CLS. 100, 101 AND 107).

ANDREW BENZMILLER, EXAMINING ATTORNEY

SN 78-405,137. PAYROLLWORKSHOP, INC., IRVINE, CA. FILED 4-20-2004.

**CLASS 35—ADVERTISING AND BUSINESS**

FOR PAYROLL PREPARATION; HUMAN RESOURCE ADMINISTRATIVE SUPPORT SERVICES, NAMELY, SERVING AS A HUMAN RESOURCES DEPARTMENT FOR OTHERS (U.S. CLS. 100, 101 AND 102).

FIRST USE 1-1-2004; IN COMMERCE 1-1-2004.

CLASS 36—INSURANCE AND FINANCIAL

FOR ELECTRONIC PAYMENT, NAMELY, ELECTRONIC PAYROLL PROCESSING AND TRANSMISSION OF DATA RELATED THERETO; ADMINISTRATION OF EMPLOYEE BENEFIT PLANS, INCLUDING 401(K), PENSION AND WELFARE BENEFIT PLANS (U.S. CLS. 100, 101 AND 102).

FIRST USE 1-1-2004; IN COMMERCE 1-1-2004.

ZHALEH DELANEY, EXAMINING ATTORNEY

SN 78-405,583. POMP, JEFF, SOUTH ROCHESTER, IN. FILED 4-21-2004.

SAVE THE MAGIC

THE MARK CONSISTS OF STANDARD CHARACTERS WITHOUT CLAIM TO ANY PARTICULAR FONT, STYLE, SIZE, OR COLOR.

CLASS 25—CLOTHING

FOR T-SHIRTS, HATS AND SWEATSHIRTS (U.S. CLS. 22 AND 39).

FIRST USE 2-17-2003; IN COMMERCE 2-17-2003.

CLASS 35—ADVERTISING AND BUSINESS

FOR PROMOTING PUBLIC AWARENESS OF THE NEED FOR CONSERVATION AND PRESERVATION OF NATURE, WILDLIFE, LAKES AND FISHING (U.S. CLS. 100, 101 AND 102).

FIRST USE 2-17-2003; IN COMMERCE 2-17-2003.

HOWARD B. LEVINE, EXAMINING ATTORNEY

SN 78-406,772. VENTURA FOODS, LLC, BREA, CA. FILED 4-22-2004.

PRODUCTS AND IDEAS THAT WORK

THE MARK CONSISTS OF STANDARD CHARACTERS WITHOUT CLAIM TO ANY PARTICULAR FONT, STYLE, SIZE, OR COLOR.

CLASS 29—MEATS AND PROCESSED FOODS

FOR EDIBLE OILS, MARGARINE, VEGETABLE OIL SPREADS, SHORTENINGS (U.S. CL. 46).

FIRST USE 8-0-2002; IN COMMERCE 8-0-2002.

CLASS 30—STAPLE FOODS

FOR MAYONNAISE, SALAD DRESSINGS, SAUCES (U.S. CL. 46).

FIRST USE 8-0-2002; IN COMMERCE 8-0-2002.

CLASS 35—ADVERTISING AND BUSINESS

FOR MENU, RECIPE AND FOODSERVICE CONSULTATION, NAMELY PROVIDING INFORMATION TO FOODSERVICE OPERATORS AND DISTRIBUTORS REGARDING MARKETING AND MERCHANDISING FOOD PRODUCTS, MENU PLANNING AND ANALYSIS, RECIPE SELECTION, PLANNING AND ANALYSIS, FOOD LABEL REQUIREMENTS, FOOD PREPARATION, AND FOOD SAFETY (U.S. CLS. 100, 101 AND 102).

FIRST USE 2-0-2001; IN COMMERCE 2-0-2001.

CLASS 40—MATERIAL TREATMENT

FOR CUSTOM MANUFACTURE OF FOOD PRODUCTS FOR THE FOODSERVICE INDUSTRY (U.S. CLS. 100, 103 AND 106).

FIRST USE 2-0-2001; IN COMMERCE 2-0-2001.

HENRY S. ZAK, EXAMINING ATTORNEY

SN 78-407,132. ADVANSTAR COMMUNICATIONS INC., DULUTH, MN. FILED 4-23-2004.

L!CENSING 2004
INTERNATIONAL

NO CLAIM IS MADE TO THE EXCLUSIVE RIGHT TO USE "LICENSING 2004 INTERNATIONAL", APART FROM THE MARK AS SHOWN.

CLASS 35—ADVERTISING AND BUSINESS

FOR ARRANGING AND CONDUCTING TRADE SHOWS IN THE FIELDS OF MERCHANDISING AND ACQUISITION OF INTELLECTUAL PROPERTY RIGHTS FOR CONSUMER PRODUCT MANUFACTURERS, RETAILERS AND MARKETERS (U.S. CLS. 100, 101 AND 102).

FIRST USE 6-0-1998; IN COMMERCE 6-0-1998.

CLASS 41—EDUCATION AND ENTERTAINMENT

FOR ARRANGING AND CONDUCTING EDUCATIONAL CONFERENCES IN THE FIELDS OF MERCHANDISING AND ACQUISITION OF INTELLECTUAL PROPERTY RIGHTS FOR CONSUMER PRODUCT MANUFACTURERS, RETAILERS AND MARKETERS (U.S. CLS. 100, 101 AND 107).

FIRST USE 6-0-1998; IN COMMERCE 6-0-1998.
KAREN BRACEY, EXAMINING ATTORNEY

SN 78-408,443. VISTA TECHNOLOGY SERVICES, INC., HERNDON, VA. FILED 4-27-2004.

**Managing Change
from the Ground
Up.**

THE MARK CONSISTS OF STANDARD CHARACTERS WITHOUT CLAIM TO ANY PARTICULAR FONT, STYLE, SIZE, OR COLOR.

CLASS 35—ADVERTISING AND BUSINESS

FOR BUSINESS MANAGEMENT CONSULTING SERVICES, NAMELY, PROVIDING REAL PROPERTY AND FACILITIES ANALYSIS TO BUSINESSES AND GOVERNMENT (U.S. CLS. 100, 101 AND 102).

FIRST USE 7-31-2004; IN COMMERCE 7-31-2004.

SN 78-408,162. AR DESIGNS, LLC, MARINA DEL REY, CA. FILED 4-26-2004.

CLASS 42—SCIENTIFIC, COMPUTER AND LEGAL SERVICES

FOR TECHNOLOGY CONSULTING SERVICES IN THE FIELD OF INFORMATION TECHNOLOGY (U.S. CLS. 100 AND 101).

FIRST USE 7-31-2004; IN COMMERCE 7-31-2004.
JOHN DWYER, EXAMINING ATTORNEY

Suburbia

SN 78-408,492. SHAW INDUSTRIES GROUP, INC., DALTON, GA. FILED 4-27-2004.

POWEREDGE

CLASS 11—ENVIRONMENTAL CONTROL APPARATUS

FOR ELECTRIC LIGHTS FOR CHRISTMAS TREES AND ELECTRIC DECORATIVE LIGHT SETS (U.S. CLS. 13, 21, 23, 31 AND 34).

CLASS 21—HOUSEWARES AND GLASS

FOR PLATES AND DISHES NOT OF PRECIOUS METALS; BEVERAGE GLASSWARE; NAPKIN RINGS NOT OF PRECIOUS METALS, SALT AND PEPPER SHAKERS, SERVINGWARE FOR SERVING FOOD, SERVING TRAYS; HOLIDAY ORNAMENTS OF CERAMIC; HOLIDAY ORNAMENTS OF PORCELAIN (U.S. CLS. 2, 13, 23, 29, 30, 33, 40 AND 50).

CLASS 28—TOYS AND SPORTING GOODS

FOR CHRISTMAS TREE ORNAMENTS; CHRISTMAS TREE DECORATIONS (U.S. CLS. 22, 23, 38 AND 50).
BERYL GARDNER, EXAMINING ATTORNEY

THE MARK CONSISTS OF STANDARD CHARACTERS WITHOUT CLAIM TO ANY PARTICULAR FONT, STYLE, SIZE, OR COLOR.

CLASS 19—NON-METALLIC BUILDING MATERIALS

FOR FLOORING, NAMELY, CERAMIC TILES, LAMINATE AND HARDWOOD FLOORING (U.S. CLS. 1, 12, 33 AND 50).

CLASS 27—FLOOR COVERINGS

FOR CARPETS AND RUGS, AND CARPET BACKING (U.S. CLS. 19, 20, 37, 42 AND 50).
TRACY WHITAKER-BOWN, EXAMINING ATTORNEY

SN 78-408,567. SEGMAN, YOSEF, ZICHRON YAACOV, ISRAEL, FILED 4-27-2004.

CNOGA

THE MARK CONSISTS OF THE TERM "CNOGA" WITH THE "C" APPEARING AS A LARGE CAPITAL LETTER AND THE "NOGA" APPEARING IN SMALLER CAPITAL LETTERS.

CLASS 9—ELECTRICAL AND SCIENTIFIC APPARATUS

FOR DIGITAL CAMERAS; COMPUTER SOFTWARE FOR DIGITAL IMAGE PROCESSING; COMPUTER SOFTWARE THAT MAY BE DOWNLOADED FROM A GLOBAL COMPUTER NETWORK FOR DIGITAL IMAGE PROCESSING (U.S. CLS. 21, 23, 26, 36 AND 38).

CLASS 42—SCIENTIFIC, COMPUTER AND LEGAL SERVICES

FOR PROVIDING TEMPORARY USE OF NON-DOWNLOADABLE COMPUTER SOFTWARE FOR DIGITAL IMAGE PROCESSING (U.S. CLS. 100 AND 101).
JASON TURNER, EXAMINING ATTORNEY

SN 78-409,752. PRICE, JOANNE K, FALLBROOK, CA. FILED 4-28-2004.

**real world
mathematics**

THE MARK CONSISTS OF STANDARD CHARACTERS WITHOUT CLAIM TO ANY PARTICULAR FONT, STYLE, SIZE, OR COLOR.

NO CLAIM IS MADE TO THE EXCLUSIVE RIGHT TO USE "MATHEMATICS", APART FROM THE MARK AS SHOWN.

CLASS 9—ELECTRICAL AND SCIENTIFIC APPARATUS

FOR PRERECORDED COMPACT DISCS FEATURING TRAINING INSTRUCTION IN THE FIELD OF MATH (U.S. CLS. 21, 23, 26, 36 AND 38).

CLASS 16—PAPER GOODS AND PRINTED MATTER

FOR PRINTED INSTRUCTIONAL TRAINING MATERIALS IN THE FIELD OF MATH (U.S. CLS. 2, 5, 22, 23, 29, 37, 38 AND 50).

ELLEN B. AWRICH, EXAMINING ATTORNEY

SN 78-409,807. DREAMWORKS ANIMATION L.L.C., GLENDALE, CA. FILED 4-28-2004.



OWNER OF U.S. REG. NOS. 2,596,916, 2,644,242 AND 2,665,088.

NO CLAIM IS MADE TO THE EXCLUSIVE RIGHT TO USE "ANIMATION", APART FROM THE MARK AS SHOWN.

THE COLORS RED, BLUE, ORANGE, PINK, AND GREEN ARE CLAIMED AS A FEATURE OF THE MARK.

THE MARK CONSISTS OF A BOY IN THE MOON AND THE FOLLOWING COLORS: RED ON THE LETTERS "D" AND "W"; BLUE ON THE LETTERS "R" AND "O"; ORANGE ON THE LETTERS "E" AND "R"; PINK ON THE LETTERS "A" AND "K"; AND GREEN ON THE LETTERS "M" AND "S". BLUE APPEARS IN THE SKY PORTION OF THE MARK. THE WORD ANIMATION APPEARS IN BLUE.

CLASS 9—ELECTRICAL AND SCIENTIFIC APPARATUS

FOR PRERECORDED VIDEO TAPES AND DVD'S CONTAINING ANIMATED MOTION PICTURES, PRERECORDED COMPACT DISCS AND AUDIO TAPES CONTAINING SOUND TRACKS FROM ANIMATED MOTION PICTURES, PRERECORDED AUDIO TAPES CONTAINING MUSIC FROM ANIMATED MOTION PICTURES, AND INTERACTIVE VIDEO GAME PROGRAMS CONTAINING CHARACTERS AND SCENES FROM ANIMATED MOTION PICTURES (U.S. CLS. 21, 23, 26, 36 AND 38).

CLASS 41—EDUCATION AND ENTERTAINMENT

FOR ENTERTAINMENT SERVICES, NAMELY THE PRODUCTION AND DISTRIBUTION OF ANIMATED MOTION PICTURES AND ANIMATED TELEVISION PROGRAMS FOR OTHERS (U.S. CLS. 100, 101 AND 107).
CHRISIE B. KING, EXAMINING ATTORNEY

SN 78-410.073. AEGIS LUXEMBOURG SARL, LUXEMBOURG, LUXEMBOURG, FILED 4-29-2004.

ISOBAR COMMUNICATIONS

THE MARK CONSISTS OF STANDARD CHARACTERS WITHOUT CLAIM TO ANY PARTICULAR FONT, STYLE, SIZE, OR COLOR.

NO CLAIM IS MADE TO THE EXCLUSIVE RIGHT TO USE "COMMUNICATIONS", APART FROM THE MARK AS SHOWN.

CLASS 9—ELECTRICAL AND SCIENTIFIC APPARATUS

FOR DATA PROCESSORS; COMPUTER SOFTWARE FOR USE IN DATABASE MANAGEMENT, AND FOR CREATION OF SPREADSHEETS, WORD PROCESSING AND IMAGE CREATION, DESIGN AND MANAGEMENT, IN THE FIELD OF ADVERTISING AND CORPORATE AND BRAND IDENTITY; INTERCOM SYSTEMS (U.S. CLS. 21, 23, 26, 36 AND 38).

CLASS 35—ADVERTISING AND BUSINESS

FOR ADVERTISING SERVICES AND MANAGEMENT OF COMMERCIAL BUSINESS, NAMELY, DISTRIBUTION OF PUBLICITY MATERIALS, NAMELY, PRINTED FLYERS, PAMPHLETS AND SAMPLES; RENTAL OF PUBLICITY MATERIALS; MAINTAINING OF PUBLICITY MATERIALS, NAMELY, STORING AND UPDATING ADVERTISING MATERIALS FOR OTHERS; COMMERCIAL ASSISTANCE, NAMELY, BUSINESS MANAGEMENT; DISTRIBUTION OF BUSINESS INFORMATION RELATING TO CORPORATE AND BRAND IDENTITY; DISTRIBUTION OF ADVERTISING MATERIALS; DOOR-TO-DOOR ADVERTISING; BUSINESS ORGANIZATION CONSULTANCY; MARKETING RESEARCH AND ANALYSIS, NAMELY, RESEARCH AND CONSULTING WITH REGARD TO PURPOSE COURT SCAN OF MARKET; DIRECT MAIL ADVERTISING; DATA PROCESSING SERVICES; PURCHASING AGENT; BUSINESS MANAGEMENT ACTIVITIES, NAMELY, NEGOTIATE BY AND CLOSING OF COMMERCIAL TRANSACTION FOR OTHERS; BUSINESS STATISTICAL STUDIES AND ANALYSIS; DATA PROCESSING SERVICES AND BUSINESS MANAGEMENT ASSISTANCE; EFFICIENCY EXPERT SERVICES; BUSINESS INFORMATION IN THE FIELDS OF ADVERTISING, AND CORPORATE AND BRAND IDENTITY; COMMERCIAL RESEARCH; BUSINESS AND ORGANIZATION CONSULTANCY; MANAGEMENT OF COMPUTER FILES; ORGANIZATION OF EXHIBITIONS FOR COMMERCIAL AND ADVERTISING PURPOSES, NAMELY, THE PROMOTION OF CORPORATE AND BRAND IDENTITY CREATION SERVICES; ECONOMICAL FORECAST; PRODUCTION AND DISTRIBUTION OF RADIO COMMERCIALS, TELEVISION ADVERTISING, STATISTICAL INFORMATION; MARKET RESEARCH STUDIES USING QUALITATIVE AND QUANTITATIVE RESEARCH METHODS; ARRANGING OF NEWSPAPERS SUBSCRIPTS IN COMMAND OF THIRD PARTY (U.S. CLS. 100, 101 AND 102).

CLASS 38—COMMUNICATION

FOR CABLE TELEVISION BROADCASTING; COMMUNICATION BY MEANS OF COMPUTER TERMINALS, NAMELY, ELECTRONIC TRANSMISSION OF DATA AND DOCUMENTS AMONG USERS OF COMPUTERS; ELECTRONIC TRANSMISSION OF DATA AND DOCUMENTS VIA COMPUTER TERMINALS; TELECOMMUNICATIONS SERVICES, NAMELY PROVIDING FIBER OPTIC NETWORK SERVICES; SENDING OF MESSAGES AND IMAGES WITH ASSISTANCE OF COMPUTERS, NAMELY, DELIVERY OF MESSAGES BY ELECTRONIC TRANSMISSION; PROVIDING ON-LINE ELECTRONIC BULLETIN BOARDS FOR TRANSMISSION OF MESSAGES AMONG COMPUTER USERS CONCERNING ADVERTISING AND CORPORATE AND BRAND IDENTITY; ELECTRONIC MAIL SERVICES; MESSAGE SENDING, NAMELY, ELECTRONIC, ELECTRIC, AND DIGITAL TRANSMISSION OF VOICE, DATA, IMAGES, SIGNALS, AND MESSAGES; WIRE SERVICE; OFFERING OF TELECOMMUNICATION CONNECTIONS VIA GLOBAL COMPUTER NETWORKS, NAMELY, ISP SERVICES; COMMUNICATION SERVICES VIA A GLOBAL COMPUTER NETWORK SYSTEMS, NAMELY, ELECTRONIC TRANSMISSION OF DATA AND DOCUMENTS AMONG USERS OF COMPUTERS; TRANSMISSION OF RADIO PROGRAMS, TRANSMISSION OF SOUND AND IMAGE VIA SATELLITE, TRANSMISSION OF TELEVISION PROGRAMS; ELECTRONIC TRANSMISSION OF COMPUTER FILES; ELECTRONIC TRANSMISSION OF MESSAGES AND DATA (U.S. CLS. 100, 101 AND 104).

CLASS 41—EDUCATION AND ENTERTAINMENT

FOR PRODUCTIONS OF FILMS; ACTIVITIES OF MOVIE STUDIOS; ORGANIZATION OF COMPETITIONS AND EXHIBITIONS FOR CULTURAL, SPORTING, OR ENTERTAINMENT PURPOSE; PRODUCTION OF RADIO AND TELEVISION PROGRAMS; PRODUCTION OF PRESENTATIONS, NAMELY, VIDEO, RADIO AND TELEVISION PRESENTATIONS; PRODUCTION OF VIDEO FILMS; REVIEWING AND PUBLICATION OF TEXTS, NAMELY, BOOKS, MAGAZINES, JOURNALS, MANUALS, ON-LINE MAGAZINE CONTENT, ADVERTISING COPY, BROCHURES; RECORDING STUDIO SERVICES; RENTAL OF AUDIO EQUIPMENT, NAMELY, TAPE RECORDERS, MICROPHONES, DIGITAL AUDIO RECORDERS; RENTAL OF CINEMA FILMS; RENTAL OF MOVIE PROJECTORS AND ACCESSORIES AND PARTS THEREOF; RENTAL OF SOUND RECORDINGS; TELEVISION ENTERTAINMENT, NAMELY, PRODUCTION OF TELEVISION SHOWS; ENTERTAINMENT IN THE NATURE OF ONGOING TELEVISION PROGRAMS IN THE FIELD OF NEWS, COMEDY, VARIETY, SPORTS, DOCUMENTARY; EDITING OF VIDEO FILMS (U.S. CLS. 100, 101 AND 107).

CLASS 42—SCIENTIFIC, COMPUTER AND LEGAL SERVICES

FOR DESIGN AND DEVELOPMENT OF COMPUTER SYSTEMS FOR OTHERS; TECHNICAL SUPPORT SERVICES FOR OTHERS WITH REGARD TO COMPUTER SYSTEMS, TECHNICAL SUPPORT SERVICES WITH REGARD TO COMPUTER PROGRAMS, BOTH PROVIDED BY WAY OF IN-PERSON, REMOTE ACCESS, ON-LINE AND TELEPHONE; MANAGEMENT OF COMPUTER SYSTEMS; PROVIDING DATA STORAGE AND TECHNICAL SUPPORT THEREFOR BY WAY OF COMPUTER NETWORKS; CONSULTANCY WITH REGARD TO TELECOMMUNICATION APPARATUS AND COMPUTERS; DEVELOPMENT OF COMPUTER SYSTEMS FOR OTHERS IN THE FIELD OF OPINION AND MARKETING RESEARCH; DESIGN OF DATA PROCESSING PROGRAMS FOR OTHERS; LEASING OF ACCESS TIME TO A COMPUTER HELP DESK OR COMPUTER DATA BANKS; DESIGN, DEVELOPMENT AND RESEARCH FOR OTHERS IN RELATION TO USE OF COMPUTER DATABASES, MANUFACTURING MANUALS AND ORGANIZATION OF INFORMATION IN DATA FILES; LEGAL SERVICES (U.S. CLS. 100 AND 101).

ROBIN CHOSID, EXAMINING ATTORNEY

SN 78-410,645. FARLEY, MICHAEL P., BOCA RATON, FL.
FILED 4-29-2004.

SN 78-411,575. FADLON, ISACK, LOS ANGELES, CA. FILED
4-30-2004.

EQUIPONE

THE MARK CONSISTS OF STANDARD CHARACTERS
WITHOUT CLAIM TO ANY PARTICULAR FONT, STYLE,
SIZE, OR COLOR.

CLASS 35—ADVERTISING AND BUSINESS

FOR FRANCHISING, NAMELY, OFFERING TECHNICAL
ASSISTANCE IN THE ESTABLISHMENT AND/OR
OPERATION OF EQUIPMENT RENTAL STORES (U.S.
CLS. 100, 101 AND 102).

CLASS 37—CONSTRUCTION AND REPAIR

FOR BUILDING EQUIPMENT, CONSTRUCTION
EQUIPMENT AND INDUSTRIAL EQUIPMENT RENTAL
SERVICES (U.S. CLS. 100, 103 AND 106).
CHERYL CLAYTON, EXAMINING ATTORNEY

SN 78-411,515. RONWOOD PRODUCTS, INC., HOUSTON,
TX. FILED 4-30-2004.

RON'S HOME STYLE FOODS

THE MARK CONSISTS OF STANDARD CHARACTERS
WITHOUT CLAIM TO ANY PARTICULAR FONT, STYLE,
SIZE, OR COLOR.

NO CLAIM IS MADE TO THE EXCLUSIVE RIGHT TO
USE "HOME STYLE FOODS", APART FROM THE MARK
AS SHOWN.

CLASS 29—MEATS AND PROCESSED FOODS

FOR PREPARED FOODS, NAMELY, COLE SLAW,
POTATO SALAD, BEAN SALAD, CHICKEN SALAD,
TUNA SALAD AND HAM SALAD (U.S. CL. 46).

CLASS 30—STAPLE FOODS

FOR PREPARED FOODS, NAMELY, PASTA SALAD
(U.S. CL. 46).
STANLEY I. OSBORNE, EXAMINING ATTORNEY

SPORTIE LA

THE MARK CONSISTS OF STANDARD CHARACTERS
WITHOUT CLAIM TO ANY PARTICULAR FONT, STYLE,
SIZE, OR COLOR.

NO CLAIM IS MADE TO THE EXCLUSIVE RIGHT TO
USE "LA", APART FROM THE MARK AS SHOWN.

CLASS 25—CLOTHING

FOR HATS; BEANIES; T-SHIRTS; SWEAT SHIRTS;
FOOTWEAR (U.S. CLS. 22 AND 39).
FIRST USE 12-0-1996; IN COMMERCE 8-0-1997.

CLASS 35—ADVERTISING AND BUSINESS

FOR RETAIL FOOTWEAR AND APPAREL STORES;
RETAIL STORES AND MAIL ORDER CATALOG SER-
VICES FEATURING FOOTWEAR, ATHLETIC FOOT-
WEAR, SNEAKERS, SHOES, BOOTS, SANDALS,
APPAREL, ATHLETIC APPAREL, JACKETS, WIND-
BREAKERS, GLOVES, SHIRTS, SWEAT SHIRTS, T-
SHIRTS, SHORTS, PANTS, SWEAT PANTS, FIGHTS,
SOCKS, HATS, BEANIES, BELTS, WATCHES, SUN-
GLASSES, SWEAT BANDS, ACCESSORIES, SPORTS
BRAS, UNDERGARMENTS, GYM BAGS, BACKPACKS,
LACES, WALLETS, MESSENGER BAGS, PURSES, JER-
SEYS, AND TANK TOPS (U.S. CLS. 100, 101 AND 102).
FIRST USE 8-0-1985; IN COMMERCE 3-0-1986.
ROBIN CHOSID, EXAMINING ATTORNEY

SN 78-414,863. TSC ARTEFFECTS, INC., ALPHARETTA, GA.
FILED 5-7-2004.

PLANET SOLE

THE MARK CONSISTS OF STANDARD CHARACTERS
WITHOUT CLAIM TO ANY PARTICULAR FONT, STYLE,
SIZE, OR COLOR.

NO CLAIM IS MADE TO THE EXCLUSIVE RIGHT TO
USE "SOLE", AS TO INTERNATIONAL CLASSES 025 AND
035, APART FROM THE MARK AS SHOWN.

CLASS 14—JEWELRY

FOR JEWELRY (U.S. CLS. 2, 27, 28 AND 50).

CLASS 18—LEATHER GOODS

FOR HANDBAGS AND PURSES (U.S. CLS. 1, 2, 3, 22 AND 41).

CLASS 25—CLOTHING

FOR SHOES; FOOTWEAR; CLOTHING APPAREL, NAMELY, SHIRTS, PANTS, TROUSERS, JEANS, DENIM JEANS, SHORTS, TOPS, CROP TOPS, TANK TOPS, HALTER TOPS, SWEATSHIRTS, SWEATSHORTS, SWEATPANTS, WRAPS, BLOUSES, SKIRTS, DRESSES, SWEATERS, PULLOVERS, CAPES, JACKETS, COATS, BLAZERS, SWIMWEAR, BEACHWEAR, UNDERWEAR, BRAS, SPORT BRAS, BRASSIERES, PANTIES, SOCKS, LOUNGEWEAR, ROBES, BATHROBES, UNDERCLOTHES, PAJAMAS, SLEEPWEAR, NIGHT GOWNS, LINGERIE, CAMISOLES, NEGLIGÉES, CHEMISES, CHEMISETTES, SLIPS, SARONGS, HOSIERY, PANTYHOSE, BODY STOCKINGS, KNEE HIGHS, LEGGINGS, TIGHTS, LEOTARDS, BODY SUITS, UNITARDS, BODY SHAPERS AND GLOVES (U.S. CLS. 22 AND 39).

CLASS 35—ADVERTISING AND BUSINESS

FOR RETAIL STORE SERVICES IN THE FIELD OF CLOTHING AND CLOTHING ACCESSORIES (U.S. CLS. 100, 101 AND 102).

ANDREW RHIM, EXAMINING ATTORNEY

SN 78-414,881. TSC ARTEFFECTS, INC., ALPHARETTA, GA. FILED 5-7-2004.

SOLE PLANET

THE MARK CONSISTS OF STANDARD CHARACTERS WITHOUT CLAIM TO ANY PARTICULAR FONT, STYLE, SIZE, OR COLOR.

CLASS 14—JEWELRY

FOR JEWELRY (U.S. CLS. 2, 27, 28 AND 50).

CLASS 18—LEATHER GOODS

FOR HANDBAGS AND PURSES (U.S. CLS. 1, 2, 3, 22 AND 41).

CLASS 25—CLOTHING

FOR SHOES; FOOTWEAR; CLOTHING APPAREL, NAMELY, SHIRTS, PANTS, TROUSERS, JEANS, DENIM JEANS, SHORTS, TOPS, CROP TOPS, TANK TOPS, HALTER TOPS, SWEATSHIRTS, SWEATSHORTS, SWEATPANTS, WRAPS, BLOUSES, SKIRTS, DRESSES, SWEATERS, PULLOVERS, CAPES, JACKETS, COATS, BLAZERS, SWIMWEAR, BEACHWEAR, UNDERWEAR, BRAS, SPORT BRAS, BRASSIERES, PANTIES, SOCKS, LOUNGEWEAR, ROBES, BATHROBES, UNDERCLOTHES, PAJAMAS, SLEEPWEAR, NIGHT GOWNS, LINGERIE, CAMISOLES, NEGLIGÉES, CHEMISES, CHEMISETTES, SLIPS, SARONGS, HOSIERY, PANTYHOSE, BODY STOCKINGS, KNEE HIGHS, LEGGINGS, TIGHTS, LEOTARDS, BODY SUITS, UNITARDS, BODY SHAPERS AND GLOVES (U.S. CLS. 22 AND 39).

CLASS 35—ADVERTISING AND BUSINESS

FOR RETAIL STORE SERVICES IN THE FIELD OF CLOTHING AND CLOTHING ACCESSORIES (U.S. CLS. 100, 101 AND 102).

ANDREW RHIM, EXAMINING ATTORNEY

SN 78-415,118. RODALE INC., EMMAUS, PA. FILED 5-7-2004.

EXECUTIVE MEMO

THE MARK CONSISTS OF STANDARD CHARACTERS WITHOUT CLAIM TO ANY PARTICULAR FONT, STYLE, SIZE, OR COLOR.

NO CLAIM IS MADE TO THE EXCLUSIVE RIGHT TO USE "MEMO" AS TO INTERNATIONAL CLASS 16 ONLY, APART FROM THE MARK AS SHOWN.

CLASS 16—PAPER GOODS AND PRINTED MATTER

FOR SERIES OF BOOKS, MAGAZINES, AND MAGAZINE COLUMNS IN THE FIELDS OF HEALTH, FITNESS, DIET, EXERCISE AND LIFESTYLE (U.S. CLS. 2, 5, 22, 23, 29, 37, 38 AND 50).

CLASS 41—EDUCATION AND ENTERTAINMENT

FOR PROVIDING INFORMATION IN THE FIELDS OF FITNESS, EXERCISE AND LIFESTYLE VIA AN INTERNET WEB SITE; ENTERTAINMENT SERVICES, NAMELY, ONGOING TELEVISION AND RADIO PROGRAMS IN THE FIELDS OF HEALTH, FITNESS, DIET, EXERCISE AND LIFESTYLE (U.S. CLS. 100, 101 AND 107).

ODESSA BIBBINS, EXAMINING ATTORNEY

SN 78-415,261. INTERNATIONAL TECHNIDYNE CORPORATION, EDISON, NJ. FILED 5-7-2004.

**HEMOCHRON
SIGNATURE ELITE**

THE MARK CONSISTS OF STANDARD CHARACTERS WITHOUT CLAIM TO ANY PARTICULAR FONT, STYLE, SIZE, OR COLOR.

OWNER OF U.S. REG. NO. 918,055.

CLASS 5—PHARMACEUTICALS

FOR DIAGNOSTIC REAGENTS AND TEST STRIPS FOR CLINICAL OR MEDICAL LABORATORY USE (U.S. CLS. 6, 18, 44, 46, 51 AND 52).

CLASS 10—MEDICAL APPARATUS

FOR MEDICAL DIAGNOSTIC EQUIPMENT, NAMELY, BLOOD COAGULATION AND BLOOD CHEMISTRY ANALYZERS (U.S. CLS. 26, 39 AND 44).
BILL DAWE, EXAMINING ATTORNEY

SN 78-415,896. MOXA TECHNOLOGIES CO., LTD., TAIPEI HSIEN, TAIWAN, FILED 5-10-2004.

OWNER OF U.S. REG. NO. 2,393,092.

CLASS 9—ELECTRICAL AND SCIENTIFIC APPARATUS

FOR COMPUTER NETWORKING PRODUCTS, NAMELY, MODEMS, MEDIA CONVERTERS, ROUTERS, COMPUTER SERVERS, COMMUNICATION SERVERS, TERMINAL SERVERS, MULTIPLEXERS, GATEWAYS, NETWORK INTERFACE CARDS FOR COMPUTERS IN THE FORM OF PRINTED CIRCUITS, WIRELESS LAN CARDS FOR CONNECTING PORTABLE COMPUTER DEVICES TO COMPUTER NETWORKS, HUBS, FIBER OPTIC COUPLERS, SWITCHES, COMPUTER NETWORK MANAGEMENT HARDWARE AND COMPUTER NETWORK MANAGEMENT SOFTWARE AND ASSOCIATED NETWORKING SOFTWARE USED TO MANAGE VIRTUAL OR PHYSICAL SERVERS; ELECTRICAL POWER SUPPLIES; PRINTED CIRCUIT BOARDS; INTEGRATED CIRCUITS; COMPUTER CHIPS; COMPUTER HARDWARE, NAMELY, MULTIPORT MICROCHIP CARDS FOR CONTROLLING SERIAL DEVICES SUCH AS MODEMS AND OTHER INDUSTRIAL MACHINES (U.S. CLS. 21, 23, 26, 36 AND 38).

CLASS 35—ADVERTISING AND BUSINESS

FOR EXPORT AND IMPORT AGENCIES; PROVIDING CONSUMER PRODUCT INFORMATION VIA THE INTERNET; ADVERTISING AGENCY SERVICES, NAMELY, PROMOTING THE GOODS AND SERVICES OF OTHERS VIA A GLOBAL COMPUTER NETWORK; COMMERCIAL INFORMATION AGENCY WHICH PROVIDES BUSINESS INFORMATION, MARKET AND INDUSTRIAL DATA VIA A GLOBAL COMMUNICATION NETWORK; ELECTRONIC RETAILING SERVICES VIA COMPUTER FEATURING COMPUTER HARDWARE, COMPUTER SOFTWARE, NETWORK COMPUTER SYSTEMS AND COMPUTER PERIPHERALS; ON-LINE RETAIL STORE SERVICES IN THE FIELD OF COMPUTER HARDWARE, COMPUTER SOFTWARE AND COMPUTER ACCESSORIES; RETAIL STORE SERVICES IN THE FIELD OF COMPUTER HARDWARE, COMPUTER SOFTWARE AND COMPUTER ACCESSORIES (U.S. CLS. 100, 101 AND 102).

CLASS 37—CONSTRUCTION AND REPAIR

FOR COMPUTER INSTALLATION AND REPAIR; MAINTENANCE AND REPAIR OF COMPUTER HARDWARE; INSTALLATION OF COMPUTER NETWORKS; INSTALLATION, MAINTENANCE AND REPAIR OF TELECOMMUNICATION SYSTEMS COMPOSED OF TELECOMMUNICATIONS MACHINES AND APPARATUS; INSTALLATION, MAINTENANCE AND REPAIR OF COMMUNICATION SYSTEMS, NAMELY, COMPUTER NETWORKS, DATA AND VOICE CABLING SYSTEMS COMPOSED OF COMPUTER HARDWARE AND TELECOMMUNICATIONS MACHINES, AND VIDEO CONFERENCING SYSTEMS COMPOSED OF COMPUTER HARDWARE AND TELECOMMUNICATIONS MACHINES (U.S. CLS. 100, 103 AND 106).

CLASS 38—COMMUNICATION

FOR ELECTRONIC TRANSMISSION OF MESSAGES AND DATA VIA THE INTERNET; ELECTRONIC TRANSMISSION OF DATA AND DOCUMENTS VIA COMPUTER TERMINALS; DIGITAL TRANSMISSION OF DOCUMENT IMAGES AND DATA; ELECTRONIC MAIL SERVICES; TELECOMMUNICATION SERVICES, NAMELY, ELECTRONIC, ELECTRIC, AND DIGITAL TRANSMISSION OF VOICE, DATA, IMAGES, SOUND, VIDEO AND INFORMATION OVER GLOBAL COMMUNICATION NETWORKS; PROVIDING FACILITIES AND EQUIPMENT FOR VIDEO CONFERENCING (U.S. CLS. 100, 101 AND 104).

CLASS 42—SCIENTIFIC, COMPUTER AND LEGAL SERVICES

FOR COMPUTER SYSTEMS ANALYSIS; COMPUTER SOFTWARE DESIGN FOR OTHERS; MAINTENANCE OF COMPUTER SOFTWARE; UPDATING OF COMPUTER SOFTWARE FOR OTHERS; RENTAL OF COMPUTERS AND SOFTWARE; COMPUTER SOFTWARE DESIGN CONSULTATION; COMPUTER PROGRAM DESIGN FOR OTHERS; COMPUTER GRAPHICS SERVICES; CONSULTING SERVICES IN THE FIELD OF DESIGN, SELECTION, IMPLEMENTATION AND USE OF COMPUTER HARDWARE AND SOFTWARE SYSTEMS FOR OTHERS (U.S. CLS. 100 AND 101).

MELISSA SHELLA, EXAMINING ATTORNEY

SN 78-417,733. BERGENSHAW INTERNATIONAL, SAN JOSE, CA. FILED 5-12-2004.

**SOFTWARE FOR THE
EXPLORATION AND
DISCOVERY OF THE
LOGIC OF LIFE**

THE MARK CONSISTS OF STANDARD CHARACTERS WITHOUT CLAIM TO ANY PARTICULAR FONT, STYLE, SIZE, OR COLOR.

NO CLAIM IS MADE TO THE EXCLUSIVE RIGHT TO USE "SOFTWARE", APART FROM THE MARK AS SHOWN.

CLASS 35—ADVERTISING AND BUSINESS

FOR BUSINESS CONSULTING AND INFORMATION SERVICES (U.S. CLS. 100, 101 AND 102).
FIRST USE 5-12-2004; IN COMMERCE 5-12-2004.

CLASS 42—SCIENTIFIC, COMPUTER AND LEGAL SERVICES

FOR COMPUTER PROGRAMMING FOR OTHERS; COMPUTER PROJECT MANAGEMENT SERVICES; COMPUTER SERVICES, NAMELY PROVIDING DATA MANAGEMENT, DATA ANALYSIS, DATA MINING, MODELING AND SIMULATION SERVICES (U.S. CLS. 100 AND 101).
FIRST USE 5-12-2004; IN COMMERCE 5-12-2004.
INGA ERVIN, EXAMINING ATTORNEY

SN 78-418,020. WATERLOO INDUSTRIES, INC., WATERLOO, IA. FILED 5-13-2004.

MATCH N STACK

THE MARK CONSISTS OF STANDARD CHARACTERS WITHOUT CLAIM TO ANY PARTICULAR FONT, STYLE, SIZE, OR COLOR.

CLASS 6—METAL GOODS

FOR METAL CABINETS FOR STORING TOOLS; METAL CONTAINERS FOR STORING TOOLS (U.S. CLS. 2, 12, 13, 14, 23, 25 AND 50).

CLASS 20—FURNITURE AND ARTICLES NOT OTHERWISE CLASSIFIED

FOR NON-METAL CABINETS FOR STORING TOOLS; NON-METAL CONTAINERS FOR STORING TOOLS (U.S. CLS. 2, 13, 22, 25, 32 AND 50).
BERYL GARDNER, EXAMINING ATTORNEY

SN 78-419,071. EDUKICK, INC., CHICAGO, IL. FILED 5-14-2004.



THE MARK CONSISTS OF THE WORD EDUKICK WITH THE ADDITION OF A PICTURE OF A SOCCER BALL BETWEEN THE LETTERS "U" AND "K"; THE SOCCER BALL ALSO HAS THE APPEARANCE OF A PORTION OF A GLOBE AT THE BOTTOM WITH A RING AROUND THE IMAGE.

CLASS 35—ADVERTISING AND BUSINESS

FOR ADMINISTRATION OF CULTURAL AND EDUCATIONAL SPORTS EXCHANGE PROGRAMS (U.S. CLS. 100, 101 AND 102).
FIRST USE 3-1-2001; IN COMMERCE 3-1-2001.

CLASS 41—EDUCATION AND ENTERTAINMENT

FOR EDUCATIONAL SERVICES, NAMELY, CONDUCTING PROGRAMS IN THE FIELD OF SOCCER SKILLS AND FOREIGN LANGUAGES (U.S. CLS. 100, 101 AND 107).
FIRST USE 3-1-2001; IN COMMERCE 3-1-2001.
STANLEY I. OSBORNE, EXAMINING ATTORNEY

SN 78-419,080. TASTEFULLY SIMPLE, INC., ALEXANDRIA, MN. FILED 5-14-2004.

QUIET COVE MARKET

THE MARK CONSISTS OF STANDARD CHARACTERS WITHOUT CLAIM TO ANY PARTICULAR FONT, STYLE, SIZE, OR COLOR.

NO CLAIM IS MADE TO THE EXCLUSIVE RIGHT TO USE "MARKET", APART FROM THE MARK AS SHOWN.

CLASS 30—STAPLE FOODS

FOR COFFEE (U.S. CL. 46).
FIRST USE 3-10-2004; IN COMMERCE 3-10-2004.

CLASS 35—ADVERTISING AND BUSINESS

FOR RETAIL STORE SERVICES FEATURING COFFEE AND BAKERY ITEMS FOR CONSUMPTION ON OR OFF THE PREMISES, FOOD PRODUCTS, CLOTHING AND OTHER PROMOTIONAL ITEMS (U.S. CLS. 100, 101 AND 102).
FIRST USE 3-10-2004; IN COMMERCE 3-10-2004.
STANLEY I. OSBORNE, EXAMINING ATTORNEY

SN 78-421,592. BEHR PROCESS CORPORATION, SANTA ANA, CA. FILED 5-19-2004.

WOODSMART

THE MARK CONSISTS OF STANDARD CHARACTERS WITHOUT CLAIM TO ANY PARTICULAR FONT, STYLE, SIZE, OR COLOR.

CLASS 1—CHEMICALS

FOR WATERPROOFING CHEMICAL COMPOSITIONS FOR USE ON WOOD (U.S. CLS. 1, 5, 6, 10, 26 AND 46).

CLASS 2—PAINTS

FOR COATINGS IN THE NATURE OF INTERIOR AND EXTERIOR PAINTS, STAINS, AND SEALERS FOR USE ON WOOD (U.S. CLS. 6, 11 AND 16).

CLASS 3—COSMETICS AND CLEANING PREPARATIONS

FOR WOOD STRIPPING AND CLEANING PREPARATIONS (U.S. CLS. 1, 4, 6, 50, 51 AND 52).

CLASS 9—ELECTRICAL AND SCIENTIFIC APPARATUS

FOR INTERACTIVE COMPUTER TERMINALS AND PROGRAMS FOR DISPLAYING INSTRUCTIONAL VIDEOS ON WOOD STAINING AND WATERPROOFING TECHNIQUES (U.S. CLS. 21, 23, 26, 36 AND 38).

CLASS 16—PAPER GOODS AND PRINTED MATTER

FOR PRINTED CARDS FEATURING STAIN COLOR SAMPLES (U.S. CLS. 2, 5, 22, 23, 29, 37, 38 AND 50).

CLASS 20—FURNITURE AND ARTICLES NOT OTHERWISE CLASSIFIED

FOR FURNITURE, NAMELY, KIOSKS FOR DISPLAYING WOOD STAIN COLOR SAMPLES (U.S. CLS. 2, 13, 22, 25, 32 AND 50).
 ASMAT KHAN, EXAMINING ATTORNEY

SN 78-421.780. M2 WORLDWIDE CORPORATION, ROCKVILLE, MD. FILED 5-19-2004.

WEBHEART

THE MARK CONSISTS OF STANDARD CHARACTERS WITHOUT CLAIM TO ANY PARTICULAR FONT, STYLE, SIZE, OR COLOR.

CLASS 9—ELECTRICAL AND SCIENTIFIC APPARATUS

FOR COMPUTER SOFTWARE FOR THE COLLECTION, EDITING, ORGANIZING, MODIFYING, BOOK MARKING, TRANSMISSION, STORAGE AND SHARING OF DATA AND INFORMATION (U.S. CLS. 21, 23, 26, 36 AND 38).

CLASS 42—SCIENTIFIC, COMPUTER AND LEGAL SERVICES

FOR SCIENTIFIC RESEARCH SERVICES FOR MEDICAL PURPOSES (U.S. CLS. 100 AND 101).
 GENE MACIOL, EXAMINING ATTORNEY

SN 78-422.052. INTERCAT, INC., MANASQUAN, NJ. FILED 5-20-2004.

SEA GIRT PRESS

THE MARK CONSISTS OF STANDARD CHARACTERS WITHOUT CLAIM TO ANY PARTICULAR FONT, STYLE, SIZE, OR COLOR.
 NO CLAIM IS MADE TO THE EXCLUSIVE RIGHT TO USE PRESS, APART FROM THE MARK AS SHOWN.

CLASS 16—PAPER GOODS AND PRINTED MATTER

FOR PRINTED PUBLICATIONS, NAMELY, FICTION AND NON-FICTION BOOKS ON A VARIETY OF TOPICS (U.S. CLS. 2, 5, 22, 23, 29, 37, 38 AND 50).

CLASS 41—EDUCATION AND ENTERTAINMENT

FOR PUBLICATION OF BOOKS (U.S. CLS. 100, 101 AND 107).
 TRACY CROSS, EXAMINING ATTORNEY

SN 78-422.062. MENTALITY SKATEBOARDING, INC., HOUSTON, TX. FILED 5-20-2004.



THE MARK CONSISTS OF COLLECTION OF CHEVRONS, HORIZONTAL LINES AND VERTICAL LINES SUGGESTING AN UPPERCASE M.

CLASS 16—PAPER GOODS AND PRINTED MATTER

FOR STICKERS USED IN ASSOCIATION WITH SKATEBOARDING AND RECREATIONAL ACTIVITIES (U.S. CLS. 2, 5, 22, 23, 29, 37, 38 AND 50).

CLASS 25—CLOTHING

FOR CLOTHING, NAMELY SHIRTS, JACKETS, PANTS, HATS, SHORTS, BEANIES, SWEAT SHIRTS, SWEAT PANTS, SHOES, AND SOCKS (U.S. CLS. 22 AND 39).

CLASS 28—TOYS AND SPORTING GOODS

FOR SKATEBOARDS (U.S. CLS. 22, 23, 38 AND 50).
 TRACY CROSS, EXAMINING ATTORNEY

SN 78-422,170. ARMAGEN TECHNOLOGIES, INC., SANTA MONICA, CA. FILED 5-20-2004.

SN 78-424,667. JOHNSON DIVERSEY, INC., STURTEVANT, WI. FILED 5-25-2004.

ARMAGEN

THE MARK CONSISTS OF STANDARD CHARACTERS WITHOUT CLAIM TO ANY PARTICULAR FONT, STYLE, SIZE, OR COLOR.

CLASS 5—PHARMACEUTICALS

FOR PHARMACEUTICAL PREPARATIONS AND DRUG DELIVERY COMPOSITIONS FOR THE TREATMENT OF NEUROLOGICAL, OCULAR, LIVER, SPLEEN, LUNG AND RESPIRATORY DISEASES AND DISORDERS (U.S. CLS. 6, 18, 44, 46, 51 AND 52).

CLASS 35—ADVERTISING AND BUSINESS

FOR LICENSING OF TECHNOLOGY IN THE DEVELOPMENT AND MANUFACTURE OF PHARMACEUTICALS AND DRUG DELIVERY COMPOSITIONS (U.S. CLS. 100, 101 AND 102).
CAROLYN GRAY, EXAMINING ATTORNEY

SN 78-422,225. DAUPHINEY, WEBSTER L., II, DOWNEY, CA. FILED 5-20-2004.

The ICEMAN Webster Dauphiney

THE MARK CONSISTS OF STANDARD CHARACTERS WITHOUT CLAIM TO ANY PARTICULAR FONT, STYLE, SIZE, OR COLOR.
OWNER OF U.S. REG. NO. 2,370,780.

CLASS 25—CLOTHING

FOR T-SHIRTS (U.S. CLS. 22 AND 39).

CLASS 41—EDUCATION AND ENTERTAINMENT

FOR ENTERTAINMENT IN THE NATURE OF LIVE AND PERSONAL APPEARANCES BY A PROFESSIONAL WRESTLER (U.S. CLS. 100, 101 AND 107).
LESLEY LAMOTHE, EXAMINING ATTORNEY

HOT SPOTS

THE MARK CONSISTS OF STANDARD CHARACTERS WITHOUT CLAIM TO ANY PARTICULAR FONT, STYLE, SIZE, OR COLOR.

CLASS 35—ADVERTISING AND BUSINESS

FOR PROFESSIONAL BUSINESS CONSULTATION SERVICES IN THE FIELD OF FOOD SAFETY, CLEANING, SANITATION, PEST ELIMINATION AND PERSONAL HYGIENE; PREPARING BUSINESS REPORTS IN THE FIELD OF FOOD SAFETY, CLEANING, SANITATION, PEST ELIMINATION AND PERSONAL HYGIENE; BUSINESS AUDITING IN THE FIELD OF FOOD SAFETY, CLEANING, SANITATION, PEST ELIMINATION AND PERSONAL HYGIENE (U.S. CLS. 100, 101 AND 102).

CLASS 37—CONSTRUCTION AND REPAIR

FOR PEST CONTROL SERVICES, CLEANING AND SANITATION SERVICES FOR ALL AREAS OF FOOD PREPARATION, FOOD HANDLING AND FOOD STORAGE (U.S. CLS. 100, 103 AND 106).

CLASS 41—EDUCATION AND ENTERTAINMENT

FOR PROVIDING EDUCATION AND TRAINING SERVICES IN THE FIELD OF FOOD SAFETY, CLEANING, SANITATION, PEST ELIMINATION AND PERSONAL HYGIENE (U.S. CLS. 100, 101 AND 107).

CLASS 42—SCIENTIFIC, COMPUTER AND LEGAL SERVICES

FOR CONDUCTING INSPECTIONS REGARDING FOOD SAFETY, CLEANING AND SANITATION; PROVIDING CONSULTING SERVICES IN THE FIELD OF FOOD SAFETY MANUFACTURING RECALLS, DESIGNING FOOD SAFETY PROGRAMS FOR OTHERS (U.S. CLS. 100 AND 101).
HOWARD B. LEVINE, EXAMINING ATTORNEY

SN 78-424,711. VIOLET MEDIA CORP., POUGHKEEPSIE, NY. FILED 5-25-2004.

D-CUP

THE MARK CONSISTS OF STANDARD CHARACTERS WITHOUT CLAIM TO ANY PARTICULAR FONT, STYLE, SIZE, OR COLOR.
OWNER OF U.S. REG. NO. 1,547,314.

CLASS 9—ELECTRICAL AND SCIENTIFIC APPARATUS

FOR PRE-RECORDED VIDEOTAPES AND DIGITAL VIDEO DISKS (DVDS) IN THE FIELD OF ADULT ENTERTAINMENT AND ADULT SUBJECT MATTER (U.S. CLS. 21, 23, 26, 36 AND 38).

CLASS 41—EDUCATION AND ENTERTAINMENT

FOR PROVIDING ON-LINE ENTERTAINMENT, PHOTOGRAPHS, IMAGES, VIDEO AND MOTION PICTURE CLIPS AND OTHER VISUAL AND EDITORIAL CONTENT AND STORIES VIA A GLOBAL COMPUTER NETWORK, THE INTERNET, WORLD WIDE WEB AND OTHER ELECTRONIC AND TELECOMMUNICATIONS TRANSMISSION SYSTEMS, IN THE FIELD OF ADULT ENTERTAINMENT AND ADULT SUBJECT MATTER; PROVIDING AN ON-LINE MAGAZINE IN THE FIELD OF ADULT ENTERTAINMENT AND ADULT SUBJECT MATTER (U.S. CLS. 100, 101 AND 107).

FIRST USE 8-0-1998; IN COMMERCE 8-0-1998.
HOWARD B. LEVINE, EXAMINING ATTORNEY

SN 78-424,729. GRAEBEL COMPANIES, INC., AURORA, CO. FILED 5-25-2004.

THE POWER OF ONE

THE MARK CONSISTS OF STANDARD CHARACTERS WITHOUT CLAIM TO ANY PARTICULAR FONT, STYLE, SIZE, OR COLOR.

CLASS 35—ADVERTISING AND BUSINESS

FOR PERSONNEL AND EMPLOYEE RELOCATION SERVICES; COMMERCIAL, OFFICE AND INDUSTRIAL RELOCATION SERVICES AND INFORMATION PROVIDED IN CONNECTION THEREWITH (U.S. CLS. 100, 101 AND 102).

FIRST USE 2-4-2003; IN COMMERCE 2-4-2003.

CLASS 39—TRANSPORTATION AND STORAGE

FOR RELOCATION PACKING, MOVING AND STORAGE SERVICES (U.S. CLS. 100 AND 105).
FIRST USE 2-4-2003; IN COMMERCE 2-4-2003.
CHARLES L. JENKINS, EXAMINING ATTORNEY

SN 78-425,114. RECKITT BENCKISER INC., PARSIPPANY, NJ. FILED 5-26-2004.

LOTUS FLOWER & BLUE ORCHID

THE MARK CONSISTS OF STANDARD CHARACTERS WITHOUT CLAIM TO ANY PARTICULAR FONT, STYLE, SIZE, OR COLOR.

CLASS 3—COSMETICS AND CLEANING PREPARATIONS

FOR SCENTED ROOM SPRAYS AND ROOM FRAGRANCES; SCENTED OILS FOR HOUSEHOLD USE (U.S. CLS. 1, 4, 6, 50, 51 AND 52).

CLASS 5—PHARMACEUTICALS

FOR AIR FRESHENING PREPARATIONS AND AIR PURIFYING PREPARATIONS, NAMELY, AIR FRESHENERS AND ROOM DEODORANTS FOR FRESHENING THE AIR (U.S. CLS. 6, 18, 44, 46, 51 AND 52).
RICHARD WHITE, EXAMINING ATTORNEY

SN 78-425,205. ACCESS GROUP, INC., WILMINGTON, DE. FILED 5-26-2004.

WISEBORROWER

THE MARK CONSISTS OF STANDARD CHARACTERS WITHOUT CLAIM TO ANY PARTICULAR FONT, STYLE, SIZE, OR COLOR.

CLASS 36—INSURANCE AND FINANCIAL

FOR PROVIDING EDUCATIONAL INFORMATION AND MATERIALS RELATING TO STUDENT FINANCIAL AID, FINANCIAL LITERACY, AND CREDIT BEHAVIOR TO STUDENT LOAN BORROWERS, FINANCIAL AID ADMINISTRATORS AND OTHER PROFESSIONALS IN THE HIGHER EDUCATION COMMUNITY (U.S. CLS. 100, 101 AND 102).

FIRST USE 9-1-2004; IN COMMERCE 9-1-2004.

CLASS 41—EDUCATION AND ENTERTAINMENT

FOR EDUCATIONAL SERVICES, NAMELY, PROVIDING PRESENTATIONS RELATING TO STUDENT FINANCIAL AID, FINANCIAL LITERACY, AND CREDIT BEHAVIOR TO STUDENT LOAN BORROWERS, FINANCIAL AID ADMINISTRATORS AND OTHER PROFESSIONALS IN THE HIGHER EDUCATION COMMUNITY (U.S. CLS. 100, 101 AND 107).

FIRST USE 9-1-2004; IN COMMERCE 9-1-2004.
JOHN HWANG, EXAMINING ATTORNEY

SN 78-425,211. LIVING RHYTHMS, LLC, WINSTON-SALEM, NC. FILED 5-26-2004.

LIVING RHYTHMS

THE MARK CONSISTS OF STANDARD CHARACTERS WITHOUT CLAIM TO ANY PARTICULAR FONT, STYLE, SIZE, OR COLOR.

CLASS 9—ELECTRICAL AND SCIENTIFIC APPARATUS

FOR PRERECORDED CDS, DISCS, AUDIO TAPES, VIDEOTAPES, AND VIDEODISCS CONTAINING MUSIC, DRUMMING PERFORMANCES AND DRUMMING INSTRUCTION (U.S. CLS. 21, 23, 26, 36 AND 38).

FIRST USE 7-31-2003; IN COMMERCE 7-31-2003.

CLASS 41—EDUCATION AND ENTERTAINMENT

FOR EDUCATIONAL SERVICES, NAMELY, DRUMMING INSTRUCTION; ENTERTAINMENT SERVICES, NAMELY, LIVE DRUMMING AND MUSICAL PERFORMANCES (U.S. CLS. 100, 101 AND 107).

FIRST USE 10-15-2002; IN COMMERCE 10-15-2002.
JOHN HWANG, EXAMINING ATTORNEY

SN 78-425,772. PCCI TECHNOLOGY HOLDINGS, INC., WILMINGTON, DE. FILED 5-26-2004.

PCCI

THE MARK CONSISTS OF STANDARD CHARACTERS WITHOUT CLAIM TO ANY PARTICULAR FONT, STYLE, SIZE, OR COLOR.

CLASS 37—CONSTRUCTION AND REPAIR

FOR COMPUTER HARDWARE INSTALLATION (U.S. CLS. 100, 103 AND 106).
FIRST USE 10-1-1997; IN COMMERCE 10-1-1997.

CLASS 42—SCIENTIFIC, COMPUTER AND LEGAL SERVICES

FOR COMPUTER SERVICES, NAMELY, COMPUTER SOFTWARE DESIGN FOR OTHERS, COMPUTER PROGRAMMING FOR OTHERS, COMPUTER SOFTWARE INSTALLATION, MAINTENANCE, SERVICING, AND UPGRADING OF COMPUTER SOFTWARE, COMPUTER CONSULTING IN THE FIELD OF COMPUTERS AND INFORMATION TECHNOLOGY (U.S. CLS. 100 AND 101).

FIRST USE 10-1-1997; IN COMMERCE 10-1-1997.
ALEXANDER L. POWERS, EXAMINING ATTORNEY

SN 78-428,125. SHOEMAKER, DAVID W., SARASOTA, FL. FILED 6-1-2004.

IT'S ALL IN THE GRIND

THE MARK CONSISTS OF STANDARD CHARACTERS WITHOUT CLAIM TO ANY PARTICULAR FONT, STYLE, SIZE, OR COLOR.

CLASS 30—STAPLE FOODS

FOR COFFEE (U.S. CL. 46).

CLASS 43—HOTEL AND RESTAURANT SERVICES

FOR RESTAURANT, CAFE AND COFFEE HOUSE SERVICES (U.S. CLS. 100 AND 101).
JENNIFER KRISP, EXAMINING ATTORNEY

SN 78-428,527. WOVEN THEORY, INC., LOS ANGELES, CA. FILED 6-2-2004.

WOVEN THEORY

THE MARK CONSISTS OF STANDARD CHARACTERS WITHOUT CLAIM TO ANY PARTICULAR FONT, STYLE, SIZE, OR COLOR.

NO CLAIM IS MADE TO THE EXCLUSIVE RIGHT TO USE "WOVEN", APART FROM THE MARK AS SHOWN.

CLASS 20—FURNITURE AND ARTICLES NOT OTHERWISE CLASSIFIED

FOR FURNITURE, WINDOW SHADES, WINDOW BLINDS AND PILLOWS (U.S. CLS. 2, 13, 22, 25, 32 AND 50).

CLASS 24—FABRICS

FOR BED LINEN, BED SHEETS, BED SPREADS, DUVET COVERS, MATTRESS COVERS, UNFITTED FABRIC FURNITURE COVERS, CURTAINS, DRAPERIES, PILLOW CASES AND PILLOW SHAMS (U.S. CLS. 42 AND 50).

THEODORE MCBRIDE, EXAMINING ATTORNEY

SN 78-429,591. BRINE, INC., MILFORD, MA. FILED 6-3-2004.

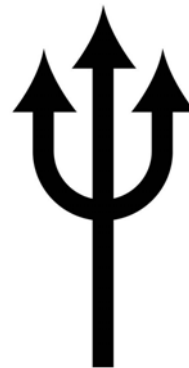

SN 78-428,906. PHILOSOPHICAL RESEARCH SOCIETY, INC., LOS ANGELES, CA. FILED 6-2-2004.



NO CLAIM IS MADE TO THE EXCLUSIVE RIGHT TO USE UNIVERSITY, STUDIES AND 2004, APART FROM THE MARK AS SHOWN.

CLASS 16—PAPER GOODS AND PRINTED MATTER

FOR EDUCATIONAL PUBLICATIONS, NAMELY COURSE CATALOGS, TEXTBOOKS AND MANUALS FOR GRADUATE, UNDERGRADUATE, ADULT AND CONTINUING EDUCATION SERVICES, AND RELATED CURRICULUM DEVELOPMENT AND TRAINING SERVICES (U.S. CLS. 2, 5, 22, 23, 29, 37, 38 AND 50).

CLASS 41—EDUCATION AND ENTERTAINMENT

FOR EDUCATIONAL SERVICES, NAMELY THE PROVISION OF GRADUATE, UNDERGRADUATE, ADULT AND CONTINUING EDUCATION COURSES (U.S. CLS. 100, 101 AND 107).

BRIDGETT SMITH, EXAMINING ATTORNEY

OWNER OF U.S. REG. NO. 2,688,821.
THE MARK CONSISTS OF A STYLIZED DRAWING OF A TRIDENT.

CLASS 9—ELECTRICAL AND SCIENTIFIC APPARATUS

FOR ATHLETIC HEADGEAR, NAMELY, LACROSSE HELMETS; AND PROTECTIVE EYEWEAR, NAMELY, LACROSSE EYEWEAR AND FIELD HOCKEY EYEWEAR (U.S. CLS. 21, 23, 26, 36 AND 38).

CLASS 18—LEATHER GOODS

FOR ALL PURPOSE SPORTS BAGS (U.S. CLS. 1, 2, 3, 22 AND 41).

CLASS 25—CLOTHING

FOR CLOTHING; NAMELY, SHIRTS, HATS, SHORTS, GLOVES, T-SHIRTS, SWEATSHIRTS, SWEATPANTS, RAINWEAR, SINGLETS, TANK TOPS AND JERSEYS (U.S. CLS. 22 AND 39).

CLASS 28—TOYS AND SPORTING GOODS

FOR LACROSSE STICKS, LACROSSE STICK HEADS, LACROSSE HANDLES, LACROSSE POCKET COMPONENTS, LACROSSE BALL STOPS, LACROSSE BALLS, LACROSSE GLOVES, LACROSSE ARM PADS, LACROSSE SHOULDER PADS, LACROSSE RIB PADS, LACROSSE CHEST PROTECTORS, LACROSSE GOALS, LACROSSE NETS, LACROSSE NET ATTACHMENT DEVICES, LACROSSE NET ASSEMBLY AND DISASSEMBLY DEVICES, SOCCER BALLS, SOCCER GOALKEEPER GLOVES, SOCCER SHIN GUARDS, SOCCER GOALS, SOCCER NETS, SOCCER NET ATTACHMENT DEVICES, SOCCER NET ASSEMBLY AND DISASSEMBLY DEVICES, FIELD HOCKEY STICKS, FIELD HOCKEY BALLS, FIELD HOCKEY GLOVES, FIELD HOCKEY SHIN GUARDS, FIELD HOCKEY GOALS, FIELD HOCKEY NETS, FIELD HOCKEY NET ATTACHMENT DEVICES, FIELD HOCKEY NET ASSEMBLY AND DISASSEMBLY DEVICES (U.S. CLS. 22, 23, 38 AND 50).

BRENDAN REGAN, EXAMINING ATTORNEY

SN 78-430,975. VIP FOODS, INC., TULSA, OK. FILED 6-7-2004.

SN 78-432,305. VALUCIRCLE, INC., SAN FRANCISCO, CA. FILED 6-9-2004.

STEAM MAGIC

THE MARK CONSISTS OF STANDARD CHARACTERS WITHOUT CLAIM TO ANY PARTICULAR FONT, STYLE, SIZE, OR COLOR.

NO CLAIM IS MADE TO THE EXCLUSIVE RIGHT TO USE "STEAM", APART FROM THE MARK AS SHOWN.

CLASS 29—MEATS AND PROCESSED FOODS

FOR FROZEN FOODS CONSISTING PRIMARILY OF VEGETABLES, CHICKEN, BEEF, PORK, FISH AND/OR SHRIMP (U.S. CL. 46).

CLASS 30—STAPLE FOODS

FOR FROZEN FOODS CONSISTING PRIMARILY OF RICE AND/OR PASTA (U.S. CL. 46).
SUELLEN HICKEY, EXAMINING ATTORNEY

SN 78-431,964. HAMMOCK, PATRICIA CAROL, MARIETTA, GA. FILED 6-8-2004.

SCHOOL BUILDERS

THE MARK CONSISTS OF STANDARD CHARACTERS WITHOUT CLAIM TO ANY PARTICULAR FONT, STYLE, SIZE, OR COLOR.

CLASS 35—ADVERTISING AND BUSINESS

FOR REAL ESTATE SALES MANAGEMENT; REAL ESTATE ADVERTISING SERVICES (U.S. CLS. 100, 101 AND 102).

CLASS 36—INSURANCE AND FINANCIAL

FOR CHARITABLE FUND RAISING SERVICES, NAMELY, SHARING PROFITS FROM REAL ESTATE TRANSACTIONS WITH NOT-FOR-PROFIT SCHOOLS AND SCHOOL SYSTEMS; REAL ESTATE BROKERAGE SERVICES; REAL ESTATE ACQUISITION SERVICES (U.S. CLS. 100, 101 AND 102).

CLASS 41—EDUCATION AND ENTERTAINMENT

FOR DEVELOPMENT AND DISSEMINATION OF EDUCATIONAL MATERIALS IN THE FIELD OF REAL ESTATE; EDUCATIONAL SERVICES, NAMELY, CONDUCTING SEMINARS AND WORKSHOPS IN THE FIELD OF REAL ESTATE (U.S. CLS. 100, 101 AND 107).
JOHN DALIER, EXAMINING ATTORNEY

GO!NETWORK

THE MARK CONSISTS OF STANDARD CHARACTERS WITHOUT CLAIM TO ANY PARTICULAR FONT, STYLE, SIZE, OR COLOR.

CLASS 35—ADVERTISING AND BUSINESS

FOR BUSINESS MARKETING CONSULTING SERVICES; BUSINESS MARKETING CONSULTING SERVICES WHICH ENABLE BUSINESSES TO CREATE, DISTRIBUTE, MANAGE, AND REDEEM CONSUMER ELECTRONIC COUPONS, PROMOTIONAL OFFERS AND INCENTIVES; BUSINESS MANAGEMENT SERVICES, NAMELY, PROVIDING CONSUMER MANAGEMENT SERVICES AND SALES SUPPORT MANAGEMENT SERVICES; PROMOTING THE GOODS AND SERVICES OF OTHERS THROUGH PROVIDING ACCESS TO AND THE DISTRIBUTION OF CONSUMER ELECTRONIC COUPONS, PROMOTIONAL OFFERS AND INCENTIVES (U.S. CLS. 100, 101 AND 102).

CLASS 42—SCIENTIFIC, COMPUTER AND LEGAL SERVICES

FOR APPLICATION SERVICE PROVIDER PROVIDING TEMPORARY USE OF ON-LINE NON-DOWNLOADABLE SOFTWARE TO CREATE, DISTRIBUTE, MANAGE, OBTAIN AND REDEEM CONSUMER ELECTRONIC COUPONS, PROMOTIONAL OFFERS AND INCENTIVES IN THE FIELDS OF MARKETING, PROMOTIONS, SALES, CONSUMER RELATIONSHIP MANAGEMENT, AND SALES SUPPORT (U.S. CLS. 100 AND 101).

JANICE L. MCMORROW, EXAMINING ATTORNEY

SN 78-432,881. RUSSELL STANDARD CORPORATION, BRIDGEVILLE, PA. FILED 6-10-2004.

AUTOFLEX

THE MARK CONSISTS OF STANDARD CHARACTERS WITHOUT CLAIM TO ANY PARTICULAR FONT, STYLE, SIZE, OR COLOR.

CLASS 4—LUBRICANTS AND FUELS

FOR OIL FOR USE IN MAKING ASPHALT COMPOSITION PAVING (U.S. CLS. 1, 6 AND 15).

CLASS 19—NON-METALLIC BUILDING MATERIALS

FOR ASPHALT COMPOSITION PAVING (U.S. CLS. 1, 12, 33 AND 50).

CLASS 37—CONSTRUCTION AND REPAIR

FOR PAVING CONTRACTOR SERVICE (U.S. CLS. 100, 103 AND 106).
JENNIFER MARTIN, EXAMINING ATTORNEY

SN 78-433,023. SPIRIT AIRLINES, INC., MIRAMAR, FL.
FILED 6-10-2004.



The logo for Spirit Airlines features the word "SPIRIT" in a large, bold, blue sans-serif font. The letter "S" is white and is contained within a red square. Below "SPIRIT", the word "AIRLINES" is written in a smaller, blue, spaced-out sans-serif font.

OWNER OF U.S. REG. NO. 2,339,635.
NO CLAIM IS MADE TO THE EXCLUSIVE RIGHT TO USE "AIRLINES", APART FROM THE MARK AS SHOWN. THE COLORS RED AND BLUE ARE CLAIMED AS A FEATURE OF THE MARK.

THE MARK CONSISTS OF THE WORDS SPIRIT AIRLINES WITH THE LETTER "S" IN WHITE AGAINST A RED RECTANGLE AND THE REMAINING LETTERS IN BLUE.

SN 78-432,990. SPIRIT AIRLINES, INC., MIRAMAR, FL.
FILED 6-10-2004.

CLASS 16—PAPER GOODS AND PRINTED MATTER

FOR STATIONERY, BUSINESS CARDS, PRINTED INSTRUCTIONAL AND TEACHING MATERIALS IN THE FIELD OF AIR TRAVEL, PENS, PENCILS, PRINTED PAPER SIGNS, POSTERS AND CALENDARS (U.S. CLS. 2, 5, 22, 23, 29, 37, 38 AND 50).

CLASS 25—CLOTHING

FOR SHIRTS, HATS, SWEATERS AND JACKETS (U.S. CLS. 22 AND 39).

CLASS 35—ADVERTISING AND BUSINESS

FOR ADVERTISING AND MARKETING IN AIRLINE INDUSTRY, ELECTRONIC BILLBOARD ADVERTISING, AND ADVERTISING SERVICES, NAMELY, PROVIDING ADVERTISING SPACE IN PERIODICALS (U.S. CLS. 100, 101 AND 102).

CLASS 39—TRANSPORTATION AND STORAGE

FOR AIRLINE TRANSPORTATION; TRAVEL SERVICES, NAMELY, BOOKING AIR TRAVEL (U.S. CLS. 100 AND 105).
KATHY DE JONGE, EXAMINING ATTORNEY

SPIRIT PLUS

THE MARK CONSISTS OF STANDARD CHARACTERS WITHOUT CLAIM TO ANY PARTICULAR FONT, STYLE, SIZE, OR COLOR.

OWNER OF U.S. REG. NO. 2,339,635.

CLASS 16—PAPER GOODS AND PRINTED MATTER

FOR STATIONERY, BUSINESS CARDS, PRINTED INSTRUCTIONAL AND TEACHING MATERIALS IN THE FIELD OF AIR TRAVEL, PENS, PENCILS, PRINTED PAPER SIGNS, POSTERS AND CALENDARS (U.S. CLS. 2, 5, 22, 23, 29, 37, 38 AND 50).

CLASS 25—CLOTHING

FOR SHIRTS, HATS, SWEATERS AND JACKETS (U.S. CLS. 22 AND 39).

CLASS 35—ADVERTISING AND BUSINESS

FOR ADVERTISING AND MARKETING IN AIRLINE INDUSTRY, ELECTRONIC BILLBOARD ADVERTISING, AND ADVERTISING SERVICES, NAMELY, PROVIDING ADVERTISING SPACE IN PERIODICALS (U.S. CLS. 100, 101 AND 102).

CLASS 39—TRANSPORTATION AND STORAGE

FOR AIRLINE TRANSPORTATION; TRAVEL SERVICES, NAMELY, BOOKING AIR TRAVEL (U.S. CLS. 100 AND 105).
KATHY DE JONGE, EXAMINING ATTORNEY

SN 78-433,511. NEXXAR GROUP, INC., SADDLE RIVER, NJ.
FILED 6-10-2004.

NEXXAR

THE MARK CONSISTS OF STANDARD CHARACTERS WITHOUT CLAIM TO ANY PARTICULAR FONT, STYLE, SIZE, OR COLOR.

CLASS 36—INSURANCE AND FINANCIAL

FOR FINANCIAL SERVICES, NAMELY, CHECK CASHING, BILL PAYMENT, ELECTRONIC FUNDS TRANSFER AND MONEY WIRING (U.S. CLS. 100, 101 AND 102).

CLASS 38—COMMUNICATION

FOR TELEPHONE TELECOMMUNICATION SERVICES PROVIDED VIA PREPAID TELEPHONE CALLING CARDS USING ENCODED CARDS, PIN CODES AND WIRELESS ACCESS (U.S. CLS. 100, 101 AND 104).
PATRICIA EVANKO, EXAMINING ATTORNEY

CLASS 42—SCIENTIFIC, COMPUTER AND LEGAL SERVICES

FOR COMPUTER SERVICES FOR OTHERS, NAMELY, PROVIDING TROUBLESHOOTING OF COMPUTER HARDWARE AND SOFTWARE PROBLEMS, AND PROVIDING MAINTENANCE OF COMPUTER SOFTWARE, IN THE FIELD OF ELECTRONIC DOCUMENT DISTRIBUTION, FACSIMILE TRANSMISSION, AND WIRELESS MOBILE COMMUNICATIONS; COMPUTER SERVICES FOR OTHERS, NAMELY PROVIDING COMPUTER TECHNICAL ASSISTANCE IN DESIGNING AND DEVELOPMENT OF CUSTOMER RELATIONSHIP MANAGEMENT AND SUPPLY CHAIN MANAGEMENT SOFTWARE (U.S. CLS. 100 AND 101).
MELVIN AXILBUND, EXAMINING ATTORNEY

SN 78-434,174. CAPTARIS, INC., BELLEVUE, WA. FILED 6-11-2004.

SN 78-434,307. 4ALL AGES LLC, EAST ROCKAWAY, NY. FILED 6-12-2004.

THE WAY INFORMATION MOVES

THE MARK CONSISTS OF STANDARD CHARACTERS WITHOUT CLAIM TO ANY PARTICULAR FONT, STYLE, SIZE, OR COLOR.

NO CLAIM IS MADE TO THE EXCLUSIVE RIGHT TO USE "INFORMATION", APART FROM THE MARK AS SHOWN.

CLASS 9—ELECTRICAL AND SCIENTIFIC APPARATUS

FOR COMPUTER HARDWARE AND COMPUTER APPLICATION SOFTWARE FOR USE IN THE FIELD OF TELECOMMUNICATIONS, NAMELY, USED FOR PROVIDING ELECTRONIC TRANSMISSION OF DATA AND DOCUMENTS BY MEANS OF FACSIMILE TRANSMISSION, WIRED TRANSMISSION AND WIRELESS TRANSMISSION; COMPUTER SOFTWARE, NAMELY APPLICATION SOFTWARE IN THE FIELD OF BUSINESS PROCESS AND WORKFLOW MANAGEMENT, CUSTOMER RELATIONSHIP MANAGEMENT AND SUPPLY CHAIN MANAGEMENT; COMPUTER SOFTWARE FOR THE PURPOSE OF INTEGRATING BUSINESS INFORMATION DELIVERY SYSTEMS; COMPUTER SOFTWARE, NAMELY, BUSINESS APPLICATION SOFTWARE ENABLING SMALL, MID SIZE AND ENTERPRISE CLASS BUSINESSES TO CAPTURE DOCUMENTS AND DATA, FROM A VARIETY OF SYSTEMS, TO PROCESS THE CRITICAL BUSINESS INFORMATION REGARDLESS OF SOURCE IN ORDER TO DISSEMINATE THE INFORMATION TO APPROPRIATE DESTINATIONS AND PEOPLE TO IDENTIFY AND SOLVE BUSINESS APPLICATION-SPECIFIC PROBLEMS; COMPUTER HARDWARE AND SOFTWARE FOR TELECOMMUNICATIONS, NAMELY, USED FOR ELECTRONIC DOCUMENT DISTRIBUTION, AND FACILITATING INTEGRATION OF FAX FUNCTIONALITY WITH EMAIL SYSTEMS AND INTERNET DELIVERY OF MESSAGES AND DOCUMENTS; COMPUTER SOFTWARE, NAMELY APPLICATIONS FOR CAPTURING DATA FROM BACK-END OFFICE SYSTEMS FOR DECONSTRUCTION, IDENTIFICATION, TRANSFORMATION AND REDISTRIBUTION (U.S. CLS. 21, 23, 26, 36 AND 38).

Color Pets

THE MARK CONSISTS OF STANDARD CHARACTERS WITHOUT CLAIM TO ANY PARTICULAR FONT, STYLE, SIZE, OR COLOR.

CLASS 16—PAPER GOODS AND PRINTED MATTER

FOR COMIC BOOKS AND CHILDREN'S BOOKS (U.S. CLS. 2, 5, 22, 23, 29, 37, 38 AND 50).

CLASS 25—CLOTHING

FOR SHIRTS, PANTS, HATS, SOCKS AND SHOES (U.S. CLS. 22 AND 39).
KAREN K. BUSH, EXAMINING ATTORNEY

SN 78-434,527. TOZEN CORPORATION, SAITAMA, JAPAN,
FILED 6-14-2004.

SN 78-434,896. COACH 2100, INC., VERO BEACH, FL. FILED
6-14-2004.

SILENSTOPA

THE MARK CONSISTS OF STANDARD CHARACTERS WITHOUT CLAIM TO ANY PARTICULAR FONT, STYLE, SIZE, OR COLOR.

CLASS 6—METAL GOODS

FOR METALLIC PIPE JOINTS AND COUPLINGS; MANUALLY OPERATED METALLIC VALVES (U.S. CLS. 2, 12, 13, 14, 23, 25 AND 50).

CLASS 9—ELECTRICAL AND SCIENTIFIC APPARATUS

FOR AUTOMATIC METALLIC VALVES (U.S. CLS. 21, 23, 26, 36 AND 38).
CHARLES JOYNER, EXAMINING ATTORNEY

SN 78-434,812. CAPITOL HEALTHCARE REVIEW, INC.,
AUSTIN, TX. FILED 6-14-2004.

Prime Dx

THE MARK CONSISTS OF STANDARD CHARACTERS WITHOUT CLAIM TO ANY PARTICULAR FONT, STYLE, SIZE, OR COLOR.

NO CLAIM IS MADE TO THE EXCLUSIVE RIGHT TO USE DX, APART FROM THE MARK AS SHOWN.

CLASS 35—ADVERTISING AND BUSINESS

FOR MANAGED CARE SERVICES, NAMELY, UTILIZATION REVIEW (U.S. CLS. 100, 101 AND 102).

CLASS 44—MEDICAL, BEAUTY AND AGRICULTURAL SERVICES

FOR MEDICAL SERVICES, NAMELY, DISEASE MANAGEMENT (U.S. CLS. 100 AND 101).
ANDREW BENZMILLER, EXAMINING ATTORNEY

COACH2100

THE MARK CONSISTS OF STANDARD CHARACTERS WITHOUT CLAIM TO ANY PARTICULAR FONT, STYLE, SIZE, OR COLOR.

CLASS 9—ELECTRICAL AND SCIENTIFIC APPARATUS

FOR COMPUTER SOFTWARE FOR DEFINING, RECORDING, COMMUNICATING, AND ANALYZING EVENTS AND INFORMATION IN THE FIELD OF NEGOTIATIONS THAT MAY BE DOWNLOADED FROM A GLOBAL COMPUTER NETWORK (U.S. CLS. 21, 23, 26, 36 AND 38).

CLASS 41—EDUCATION AND ENTERTAINMENT

FOR EDUCATIONAL SERVICES, NAMELY, CONDUCTING CLASSES, SEMINARS, CONFERENCES, WORKSHOPS IN THE FIELD OF NEGOTIATION AND FOR DISTRIBUTING COURSE MATERIALS IN CONNECTION THEREWITH (U.S. CLS. 100, 101 AND 107).
JOANNA DUKOVIC, EXAMINING ATTORNEY

SN 78-435,008. VALLEY FRUIT III, LLC, WAPATO, WA.
FILED 6-14-2004.



CLASS 31—NATURAL AGRICULTURAL PRODUCTS

FOR FRESH APPLES, PEARS, CHERRIES, AND ITALIAN PRUNE PLUMS (U.S. CLS. 1 AND 46).
FIRST USE 8-0-1982; IN COMMERCE 8-0-1982.

CLASS 39—TRANSPORTATION AND STORAGE

FOR TRANSPORTATION/SHIPPING OF APPLES, PEARS, CHERRIES AND PRUNES BY MEANS OF AIRPLANE, SHIP, TRUCK AND RAIL CAR, AND PACKAGING OF APPLES, PEARS, PRUNES AND CHERRIES FOR TRANSPORTION (U.S. CLS. 100 AND 105).
FIRST USE 8-0-1982; IN COMMERCE 8-0-1982.
ARETHA SOMERVILLE, EXAMINING ATTORNEY

SN 78-435,247. MAGNA LIFTING PRODUCTS, INC.,
BLAINE, WA. FILED 6-15-2004.

MAGNA

THE MARK CONSISTS OF STANDARD CHARACTERS
WITHOUT CLAIM TO ANY PARTICULAR FONT, STYLE,
SIZE, OR COLOR.

CLASS 6—METAL GOODS

FOR METAL CHAINS AND METAL CHAIN LINKS,
WIRE ROPE PULLERS, METAL BEAM CLAMPS (U.S.
CLS. 2, 12, 13, 14, 23, 25 AND 50).
FIRST USE 3-13-1998; IN COMMERCE 3-13-1998.

CLASS 7—MACHINERY

FOR HOISTS AND PARTS FOR HOISTS, WINCHES
(U.S. CLS. 13, 19, 21, 23, 31, 34 AND 35).
FIRST USE 3-13-1998; IN COMMERCE 3-13-1998.

CLASS 12—VEHICLES

FOR TROLLEYS, PALLET TRUCKS (U.S. CLS. 19, 21,
23, 31, 35 AND 44).
FIRST USE 3-13-1998; IN COMMERCE 3-13-1998.
CYNTHIA SLOAN, EXAMINING ATTORNEY

SN 78-435,799. OAKLEY NETWORKS, INC., SALT LAKE
CITY, UT. FILED 6-15-2004.

InnerVIEW

THE MARK CONSISTS OF STANDARD CHARACTERS
WITHOUT CLAIM TO ANY PARTICULAR FONT, STYLE,
SIZE, OR COLOR.

**CLASS 9—ELECTRICAL AND SCIENTIFIC
APPARATUS**

FOR COMPUTER NETWORK SECURITY SYSTEMS
COMPRISING COMPUTER HARDWARE AND SOFT-
WARE TO MONITOR AND DETECT THE UNAUTHOR-
IZED DISCLOSURE AND MISUSE OF PROPRIETARY
INFORMATION BY INSIDERS, AS WELL AS INSIDER
INTERNET AND EMAIL ABUSE, BY— COLLECTING,
RECORDING, MONITORING, ANALYZING, AND RE-
PORTING ENCRYPTED AND UNENCRYPTED DATA
TRANSMISSIONS AND COMMUNICATIONS BY
AUTHORIZED INSIDERS USING THE INTERNET,
EMAIL, INSTANT MESSAGING, AND MOBILE DE-
VICES; COLLECTING, RECORDING, MONITORING,
ANALYZING, AND REPORTING DATA REGARDING
THE INTERNET ACTIVITY OF INSIDERS; AND DE-
TECTING VIOLATIONS AND POTENTIAL VIOLATIONS
OF SECURITY OR DISCLOSURE RULES, AS WELL AS
VIOLATIONS OF INTERNAL INTERNET AND EMAIL
RULES OR POLICIES (U.S. CLS. 21, 23, 26, 36 AND 38).
FIRST USE 9-7-2003; IN COMMERCE 9-7-2003.

**CLASS 42—SCIENTIFIC, COMPUTER AND
LEGAL SERVICES**

FOR CONSULTING SERVICES IN THE FIELD OF THE
DESIGN, SELECTION, AND IMPLEMENTATION OF
COMPUTER NETWORK SECURITY SYSTEMS (U.S.
CLS. 100 AND 101).
FIRST USE 9-7-2003; IN COMMERCE 9-7-2003.
IRA J. GOODSAD, EXAMINING ATTORNEY

SN 78-435,808. UNITED PARCEL SERVICE OF AMERICA,
INC., ATLANTA, GA. FILED 6-15-2004.



OWNER OF U.S. REG. NO. 2,581,416.
THE MARK CONSISTS OF THE TERM EROADNET WITH
THE LETTER E PLACED IN THE CENTER OF A CIRCLE.

**CLASS 9—ELECTRICAL AND SCIENTIFIC
APPARATUS**

FOR COMPUTER PROGRAMS, COMPUTER HARD-
WARE, COMPUTER SOFTWARE AND COMPUTER
PERIPHERALS FOR ROUTING AND SCHEDULING OF
VEHICLES FOR THE DELIVERY OF PERSONAL PROP-
ERTY (U.S. CLS. 21, 23, 26, 36 AND 38).

CLASS 35—ADVERTISING AND BUSINESS

FOR BUSINESS CONSULTANCY SERVICES IN THE
FIELD OF VEHICLE ROUTING AND SCHEDULING
(U.S. CLS. 100, 101 AND 102).
MICHELE SWAIN, EXAMINING ATTORNEY

SN 78-436,384. JEC II, LLC, NEW YORK, NY. FILED 6-16-2004.

THE ONE

THE MARK CONSISTS OF STANDARD CHARACTERS WITHOUT CLAIM TO ANY PARTICULAR FONT, STYLE, SIZE, OR COLOR.

CLASS 36—INSURANCE AND FINANCIAL

FOR APARTMENT LEASING, RENTAL AND MANAGEMENT (U.S. CLS. 100, 101 AND 102).

CLASS 41—EDUCATION AND ENTERTAINMENT

FOR SKI RESORTS (U.S. CLS. 100, 101 AND 107).

CLASS 43—HOTEL AND RESTAURANT SERVICES

FOR HOTELS, RESTAURANTS, CAFES, BAR SERVICES, COCKTAIL LOUNGE, RESORT HOTELS AND SPA SERVICES, NAMELY, PROVIDING TEMPORARY ACCOMMODATIONS AND MEALS TO CLIENTS OF A HEALTH OR BEAUTY SPA (U.S. CLS. 100 AND 101).

CLASS 44—MEDICAL, BEAUTY AND AGRICULTURAL SERVICES

FOR HEALTH SPA SERVICES FOR HEALTH AND WELLNESS OF THE BODY AND SPIRIT OFFERED AT A HEALTH RESORT (U.S. CLS. 100 AND 101).
KELLEY WELLS, EXAMINING ATTORNEY

SN 78-436,843. RAWLS, CLAIRE, ATLANTA, GA. FILED 6-17-2004.

CLAIRE RAWLS

THE MARK CONSISTS OF STANDARD CHARACTERS WITHOUT CLAIM TO ANY PARTICULAR FONT, STYLE, SIZE, OR COLOR.

CLASS 18—LEATHER GOODS

FOR HANDBAGS, WALLETS, BRIEFCASE-TYPE PORTFOLIOS, CARRYALL BAGS (U.S. CLS. 1, 2, 3, 22 AND 41).

FIRST USE 5-21-2004; IN COMMERCE 5-21-2004.

CLASS 25—CLOTHING

FOR WOMEN'S APPAREL, NAMELY, PONCHOS, SHAWLS, SWEATERS, BLOUSES, DRESSES, SHORTS, COATS, HATS, SCARVES, GLOVES, JACKETS, SHIRTS, TANK TOPS, SWEATSHIRTS, CAMISOLES, SLIPS, PANTSUITS, T-SHIRTS, SKIRTS, BELTS (U.S. CLS. 22 AND 39).

FIRST USE 5-21-2004; IN COMMERCE 5-21-2004.
RONALD AIKENS, EXAMINING ATTORNEY

SN 78-437,340. BUILDERS CONTROL, OAKLAND, CA. FILED 6-17-2004.

BUILDERS CONTROL

THE MARK CONSISTS OF STANDARD CHARACTERS WITHOUT CLAIM TO ANY PARTICULAR FONT, STYLE, SIZE, OR COLOR.

NO CLAIM IS MADE TO THE EXCLUSIVE RIGHT TO USE BUILDERS, APART FROM THE MARK AS SHOWN.

CLASS 36—INSURANCE AND FINANCIAL

FOR ELECTRONIC BILL PAYMENT SERVICE, NAMELY, FUNDS DISBURSEMENT (U.S. CLS. 100, 101 AND 102).

FIRST USE 1-0-2000; IN COMMERCE 1-0-2000.

CLASS 37—CONSTRUCTION AND REPAIR

FOR BUILDING INSPECTION (U.S. CLS. 100, 103 AND 106).

FIRST USE 1-0-2000; IN COMMERCE 1-0-2000.
JOANNA DUKOVIC, EXAMINING ATTORNEY

SN 78-437,464. SHIMOFF & ASSOCIATES, INC., SAN RAFAEL, CA. FILED 6-18-2004.

**THE HEART OF
HAPPINESS**

THE MARK CONSISTS OF STANDARD CHARACTERS WITHOUT CLAIM TO ANY PARTICULAR FONT, STYLE, SIZE, OR COLOR.

CLASS 9—ELECTRICAL AND SCIENTIFIC APPARATUS

FOR AUDIO AND VIDEO TAPES FEATURING MOTIVATIONAL DEVELOPMENT, INSPIRATION, SELF-HELP, SELF-ESTEEM AND ACHIEVEMENT OF PERSONAL AND PROFESSIONAL GOALS (U.S. CLS. 21, 23, 26, 36 AND 38).

SN 78-437,484. AMERICAN EXPRESS COMPANY, NEW YORK, NY. FILED 6-18-2004.

CLASS 16—PAPER GOODS AND PRINTED MATTER

FOR SERIES OF NON-FICTION BOOKS AND MAGAZINES IN THE FIELD OF INSPIRATION, SELF-HELP AND SELF-ESTEEM (U.S. CLS. 2, 5, 22, 23, 29, 37, 38 AND 50).

IN:DALLAS

CLASS 41—EDUCATION AND ENTERTAINMENT

FOR EDUCATIONAL SERVICES, NAMELY, CONDUCTING SEMINARS AND WORKSHOPS IN THE FIELD OF MOTIVATIONAL DEVELOPMENT, INSPIRATION, SELF-ESTEEM AND ACHIEVEMENT OF PERSONAL AND PROFESSIONAL GOALS; PRODUCTION OF TELEVISION PROGRAMS FEATURING DRAMATIZATIONS AND DOCUMENTARIES OF INSPIRATIONAL PERSONAL ACHIEVEMENTS; ENTERTAINMENT SERVICES, NAMELY, A CONTINUING TALK SHOW BROADCAST OVER TELEVISION, SATELLITE, AUDIO, AND VIDEO MEDIA IN THE FIELD OF MOTIVATIONAL DEVELOPMENT, INSPIRATION, SELF-ESTEEM AND ACHIEVEMENT OF PERSONAL AND PROFESSIONAL GOALS (U.S. CLS. 100, 101 AND 107).
JANICE L. MCMORROW, EXAMINING ATTORNEY

THE MARK CONSISTS OF STANDARD CHARACTERS WITHOUT CLAIM TO ANY PARTICULAR FONT, STYLE, SIZE, OR COLOR.

CLASS 35—ADVERTISING AND BUSINESS

FOR PROMOTING THE GOODS AND SERVICES OF OTHERS BY AWARDING PURCHASE POINTS FOR USING CHARGE CARDS AND CREDIT CARDS (U.S. CLS. 100, 101 AND 102).

CLASS 36—INSURANCE AND FINANCIAL

FOR FINANCIAL SERVICES, NAMELY, CHARGE CARD AND CREDIT CARD SERVICES (U.S. CLS. 100, 101 AND 102).
ELLEN PERKINS, EXAMINING ATTORNEY

SN 78-437,483. AMERICAN EXPRESS COMPANY, NEW YORK, NY. FILED 6-18-2004.

SN 78-437,486. AMERICAN EXPRESS COMPANY, NEW YORK, NY. FILED 6-18-2004.

IN:CHICAGO

IN:MIAMI

THE MARK CONSISTS OF STANDARD CHARACTERS WITHOUT CLAIM TO ANY PARTICULAR FONT, STYLE, SIZE, OR COLOR.

CLASS 35—ADVERTISING AND BUSINESS

FOR PROMOTING THE GOODS AND SERVICES OF OTHERS BY AWARDING PURCHASE POINTS FOR USING CHARGE CARDS AND CREDIT CARDS (U.S. CLS. 100, 101 AND 102).

THE MARK CONSISTS OF STANDARD CHARACTERS WITHOUT CLAIM TO ANY PARTICULAR FONT, STYLE, SIZE, OR COLOR.

CLASS 36—INSURANCE AND FINANCIAL

FOR FINANCIAL SERVICES, NAMELY, CHARGE CARD AND CREDIT CARD SERVICES (U.S. CLS. 100, 101 AND 102).
ELLEN PERKINS, EXAMINING ATTORNEY

CLASS 35—ADVERTISING AND BUSINESS

FOR PROMOTING THE GOODS AND SERVICES OF OTHERS BY AWARDING PURCHASE POINTS FOR USING CHARGE CARDS AND CREDIT CARDS (U.S. CLS. 100, 101 AND 102).

CLASS 36—INSURANCE AND FINANCIAL

FOR FINANCIAL SERVICES, NAMELY, CHARGE CARD AND CREDIT CARD SERVICES (U.S. CLS. 100, 101 AND 102).

ELLEN PERKINS, EXAMINING ATTORNEY

CLASS 36—INSURANCE AND FINANCIAL

FOR FINANCIAL SERVICES, NAMELY, CHARGE CARD AND CREDIT CARD SERVICES (U.S. CLS. 100, 101 AND 102).

ELLEN PERKINS, EXAMINING ATTORNEY

SN 78-437,487. AMERICAN EXPRESS COMPANY, NEW YORK, NY. FILED 6-18-2004.

SN 78-437,634. ADVANCE MAGAZINE PUBLISHERS INC., NEW YORK, NY. FILED 6-18-2004.

IN:DETROIT

DOMINO

THE MARK CONSISTS OF STANDARD CHARACTERS WITHOUT CLAIM TO ANY PARTICULAR FONT, STYLE, SIZE, OR COLOR.

THE MARK CONSISTS OF STANDARD CHARACTERS WITHOUT CLAIM TO ANY PARTICULAR FONT, STYLE, SIZE, OR COLOR.

CLASS 35—ADVERTISING AND BUSINESS

FOR PROMOTING THE GOODS AND SERVICES OF OTHERS BY AWARDING PURCHASE POINTS FOR USING CHARGE CARDS AND CREDIT CARDS (U.S. CLS. 100, 101 AND 102).

CLASS 16—PAPER GOODS AND PRINTED MATTER

FOR PRINTED PUBLICATIONS, NAMELY, MAGAZINES COVERING ALL ASPECTS OF SHOPPING (U.S. CLS. 2, 5, 22, 23, 29, 37, 38 AND 50).

CLASS 36—INSURANCE AND FINANCIAL

FOR FINANCIAL SERVICES, NAMELY, CHARGE CARD AND CREDIT CARD SERVICES (U.S. CLS. 100, 101 AND 102).

ELLEN PERKINS, EXAMINING ATTORNEY

CLASS 41—EDUCATION AND ENTERTAINMENT

FOR PROVIDING ONLINE MAGAZINES COVERING ALL ASPECTS OF SHOPPING (U.S. CLS. 100, 101 AND 107).

PAULA MAYS, EXAMINING ATTORNEY

SN 78-437,489. AMERICAN EXPRESS COMPANY, NEW YORK, NY. FILED 6-18-2004.

SN 78-437,645. HOFFMANN-LA ROCHE INC., NUTLEY, NJ. FILED 6-18-2004.

IN:ATLANTA

AMBITION

THE MARK CONSISTS OF STANDARD CHARACTERS WITHOUT CLAIM TO ANY PARTICULAR FONT, STYLE, SIZE, OR COLOR.

THE MARK CONSISTS OF STANDARD CHARACTERS WITHOUT CLAIM TO ANY PARTICULAR FONT, STYLE, SIZE, OR COLOR.

CLASS 35—ADVERTISING AND BUSINESS

FOR PROMOTING THE GOODS AND SERVICES OF OTHERS BY AWARDING PURCHASE POINTS FOR USING CHARGE CARDS AND CREDIT CARDS (U.S. CLS. 100, 101 AND 102).

CLASS 16—PAPER GOODS AND PRINTED MATTER

FOR PRINTED REPORTS COMMUNICATING THE RESULTS OF CLINICAL TRIALS, AND PRINTED REPORTS COMMUNICATING INFORMATION ABOUT A CLINICAL RESEARCH TRIAL; PRESS RELEASES COMMUNICATING INFORMATION AND RESULTS OF A CLINICAL TRIAL (U.S. CLS. 2, 5, 22, 23, 29, 37, 38 AND 50).

SN 78-438,025. TVA FIRE & LIFE SAFETY, INC., SAN DIEGO, CA. FILED 6-18-2004.

CLASS 42—SCIENTIFIC, COMPUTER AND LEGAL SERVICES

FOR MEDICAL AND SCIENTIFIC RESEARCH, NAMELY CONDUCTING CLINICAL TRIALS (U.S. CLS. 100 AND 101).
PAULA MAYS, EXAMINING ATTORNEY

TVA

THE MARK CONSISTS OF STANDARD CHARACTERS WITHOUT CLAIM TO ANY PARTICULAR FONT, STYLE, SIZE, OR COLOR.

CLASS 37—CONSTRUCTION AND REPAIR

FOR INSTALLATION OF FIRE PROTECTION SYSTEMS (U.S. CLS. 100, 103 AND 106).
FIRST USE 7-31-1996; IN COMMERCE 7-31-1996.

SN 78-437,992. MINNETRONIX, INC., SAINT PAUL, MN. FILED 6-18-2004.

CLASS 42—SCIENTIFIC, COMPUTER AND LEGAL SERVICES

FOR SURVEYING AND ENGINEERING IN THE FIELD OF FIRE PROTECTION; TECHNOLOGY CONSULTATION AND RESEARCH IN THE FIELD OF FIRE LOSS CONTROL AND PREVENTION (U.S. CLS. 100 AND 101).
FIRST USE 7-31-1996; IN COMMERCE 7-31-1996.
CURTIS FRENCH, EXAMINING ATTORNEY

Get Embedded With
Us

SN 78-438,394. TRAVELPRO INTERNATIONAL, INC., BOCA RATON, FL. FILED 6-21-2004.

THE MARK CONSISTS OF STANDARD CHARACTERS WITHOUT CLAIM TO ANY PARTICULAR FONT, STYLE, SIZE, OR COLOR.

CLASS 40—MATERIAL TREATMENT

FOR CUSTOM MANUFACTURE OF MEDICAL DEVICES (U.S. CLS. 100, 103 AND 106).
FIRST USE 5-27-2004; IN COMMERCE 5-27-2004.

THE MARK CONSISTS OF STANDARD CHARACTERS WITHOUT CLAIM TO ANY PARTICULAR FONT, STYLE, SIZE, OR COLOR.

CLASS 42—SCIENTIFIC, COMPUTER AND LEGAL SERVICES

FOR DESIGN FOR OTHERS IN THE FIELD OF MEDICAL DEVICES (U.S. CLS. 100 AND 101).
FIRST USE 5-27-2004; IN COMMERCE 5-27-2004.
YONG KIM, EXAMINING ATTORNEY

CLASS 9—ELECTRICAL AND SCIENTIFIC APPARATUS

FOR COMPUTER CARRYING CASES (U.S. CLS. 21, 23, 26, 36 AND 38).

OVERDRIVE

CLASS 18—LEATHER GOODS

FOR LUGGAGE, SUITCASES, GARMENT BAGS FOR TRAVEL, ALL PURPOSE SPORTS BAGS, TOILETRY CASES SOLD EMPTY, SHOULDER BAGS, CARRYING CASES, TOTE BAGS, DUFFLE BAGS, ROLLING DUFFLE BAGS, BACKPACKS, ROLLING BACKPACKS (U.S. CLS. 1, 2, 3, 22 AND 41).

REBECCA SMITH, EXAMINING ATTORNEY

SN 78-438,539. TRAVELPRO INTERNATIONAL, INC., BOCA RATON, FL. FILED 6-21-2004.

FLEXCORE

THE MARK CONSISTS OF STANDARD CHARACTERS WITHOUT CLAIM TO ANY PARTICULAR FONT, STYLE, SIZE, OR COLOR.

CLASS 9—ELECTRICAL AND SCIENTIFIC APPARATUS

FOR COMPUTER CARRYING CASES (U.S. CLS. 21, 23, 26, 36 AND 38).

CLASS 18—LEATHER GOODS

FOR LUGGAGE, SUITCASES, GARMENT BAGS FOR TRAVEL, ALL PURPOSE SPORTS BAGS, TOILETRY CASES SOLD EMPTY, SHOULDER BAGS, CARRYING CASES, TOTE BAGS, DUFFLE BAGS, ROLLING DUFFLE BAGS, BACKPACKS, ROLLING BACKPACKS (U.S. CLS. 1, 2, 3, 22 AND 41).

BRETT J. GOLDEN, EXAMINING ATTORNEY

SN 78-438,834. KANE, MICHAEL W, ATTLEBORO, MA. FILED 6-21-2004.

**CLASS 21—HOUSEWARES AND GLASS**

FOR MUGS (U.S. CLS. 2, 13, 23, 29, 30, 33, 40 AND 50).

CLASS 25—CLOTHING

FOR SHIRTS, HATS (U.S. CLS. 22 AND 39).

IRA J. GOODSaid, EXAMINING ATTORNEY

SN 78-438,852. MICHAEL G FRAMBERGER SEMINARS, INC, SAN LUIS OBISPO, CA. FILED 6-21-2004.

**CLASS 9—ELECTRICAL AND SCIENTIFIC APPARATUS**

FOR AUDIO RECORDINGS FEATURING SELF-IMPROVEMENT (U.S. CLS. 21, 23, 26, 36 AND 38).

CLASS 16—PAPER GOODS AND PRINTED MATTER

FOR BOOKS ON THE SUBJECT OF SELF-IMPROVEMENT; NEWSPAPERS (U.S. CLS. 2, 5, 22, 23, 29, 37, 38 AND 50).

CLASS 41—EDUCATION AND ENTERTAINMENT

FOR EDUCATIONAL SERVICES, NAMELY, CONDUCTING WORKSHOPS AND SEMINARS ON THE SUBJECT OF SELF-IMPROVEMENT (U.S. CLS. 100, 101 AND 107).

DAVID TAYLOR, EXAMINING ATTORNEY

SN 78-438,885. MAX N COCO CO., BELLEVUE, WA. FILED 6-21-2004.

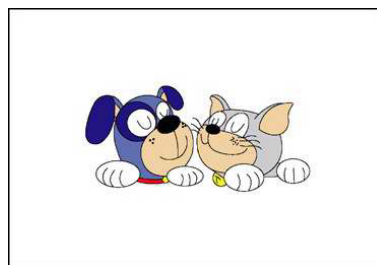

THE COLOR(S) RED, BLUE, TAN, GRAY, WHITE, BLACK, AND YELLOW IS/ARE CLAIMED AS A FEATURE OF THE MARK.

THE MARK CONSISTS OF A DOG AND CAT SHOWING HEAD AND PAWS. THE DOG HAS A BLUE HEAD AND EARS, WHITE EYES AND PAWS, A TAN MOUTH, BLACK NOSE AND OUTLINES, AND A RED COLLAR WITH YELLOW BELL; THE CAT HAS A GRAY HEAD AND EARS, WHITE EYES AND PAWS, A TAN MOUTH, BLACK NOSE AND OUTLINES, AND A YELLOW BELL.

CLASS 18—LEATHER GOODS

FOR CLOTHING, COLLARS AND LEASHES FOR CATS, DOGS AND OTHER PETS (U.S. CLS. 1, 2, 3, 22 AND 41).

CLASS 20—FURNITURE AND ARTICLES NOT OTHERWISE CLASSIFIED

FOR FURNITURE AND CUSHIONS FOR CATS, DOGS AND OTHER PETS (U.S. CLS. 2, 13, 22, 25, 32 AND 50).

CLASS 28—TOYS AND SPORTING GOODS

FOR TOYS FOR CATS, DOGS AND OTHER PETS (U.S. CLS. 22, 23, 38 AND 50).
JEAN IM, EXAMINING ATTORNEY

SN 78-439,027. SYNGENTA PARTICIPATIONS AG, BASEL, SWITZERLAND, FILED 6-22-2004.

HEADWAY

SN 78-438,985. LECG, LLC, EMERYVILLE, CA. FILED 6-22-2004.



The logo for LECG features the letters 'L', 'E', 'C', and 'G' in a sans-serif font. The 'L' is red, the 'E' is red, the 'C' is gray, and the 'G' is gray.

THE MARK CONSISTS OF STANDARD CHARACTERS WITHOUT CLAIM TO ANY PARTICULAR FONT, STYLE, SIZE, OR COLOR.

CLASS 1—CHEMICALS

FOR CHEMICALS USED IN AGRICULTURE, HORTICULTURE AND FORESTRY, NAMELY, SEED TREATMENT PREPARATIONS (U.S. CLS. 1, 5, 6, 10, 26 AND 46).

CLASS 5—PHARMACEUTICALS

FOR PREPARATIONS FOR DESTROYING VERMIN; FUNGICIDES, HERBICIDES, INSECTICIDES AND PESTICIDES FOR AGRICULTURAL AND HORTICULTURAL USE (U.S. CLS. 6, 18, 44, 46, 51 AND 52).
ZACHARY BELLO, EXAMINING ATTORNEY

OWNER OF U.S. REG. NO. 1,720,642 AND OTHERS.
THE COLOR(S) RED (PANTONE 188U) AND GRAY (PANTONE 444U) IS/ARE CLAIMED AS A FEATURE OF THE MARK.

THE LETTERS L, C, AND G APPEAR IN THE COLOR GRAY AND THE COLOR RED APPEARS IN THE LETTER E.

THE MARK CONSISTS OF THE LITERAL ELEMENT "LECG" WITH THE UPPER CASE LETTER "L" IN GRAY (PANTONE 444U), THE LOWER CASE LETTER "E" IN RED (PANTONE 188U), THE UPPER CASE LETTER "C" IN GRAY (PANTONE 444U) AND THE UPPER CASE LETTER "G" IN GRAY (PANTONE 444U).

SN 78-439,031. SYNGENTA PARTICIPATIONS AG, BASEL, SWITZERLAND, FILED 6-22-2004.

CLASS 35—ADVERTISING AND BUSINESS

FOR CONSULTING SERVICES; NAMELY, EXPERT ANALYSIS AND MANAGEMENT CONSULTING IN ECONOMICS AND ACCOUNTING (U.S. CLS. 100, 101 AND 102).
FIRST USE 11-13-2003; IN COMMERCE 11-13-2003.

CLASS 36—INSURANCE AND FINANCIAL

FOR FINANCIAL CONSULTING SERVICES; NAMELY, EXPERT ANALYSIS AND MANAGEMENT CONSULTING IN FINANCE (U.S. CLS. 100, 101 AND 102).
FIRST USE 11-13-2003; IN COMMERCE 11-13-2003.

CLASS 42—SCIENTIFIC, COMPUTER AND LEGAL SERVICES

FOR LITIGATION SUPPORT IN ECONOMICS, ACCOUNTING AND FINANCE (U.S. CLS. 100 AND 101).
FIRST USE 11-13-2003; IN COMMERCE 11-13-2003.
TRICIA SONNEBORN, EXAMINING ATTORNEY

INSTRATA

THE MARK CONSISTS OF STANDARD CHARACTERS WITHOUT CLAIM TO ANY PARTICULAR FONT, STYLE, SIZE, OR COLOR.

CLASS 1—CHEMICALS

FOR CHEMICALS USED IN AGRICULTURE, HORTICULTURE AND FORESTRY, NAMELY, SEED TREATMENT PREPARATIONS (U.S. CLS. 1, 5, 6, 10, 26 AND 46).

CLASS 5—PHARMACEUTICALS

FOR PREPARATIONS FOR DESTROYING VERMIN; FUNGICIDES, HERBICIDES, INSECTICIDES AND PESTICIDES FOR AGRICULTURAL AND HORTICULTURAL USE (U.S. CLS. 6, 18, 44, 46, 51 AND 52).
ZACHARY BELLO, EXAMINING ATTORNEY

SN 78-439,052. SYNGENTA PARTICIPATIONS AG, BASEL, SWITZERLAND, FILED 6-22-2004.

QUALIBRA

THE MARK CONSISTS OF STANDARD CHARACTERS WITHOUT CLAIM TO ANY PARTICULAR FONT, STYLE, SIZE, OR COLOR.

CLASS 1—CHEMICALS

FOR CHEMICALS USED IN AGRICULTURE, HORTICULTURE AND FORESTRY, NAMELY, SEED TREATMENT PREPARATIONS (U.S. CLS. 1, 5, 6, 10, 26 AND 46).

CLASS 5—PHARMACEUTICALS

FOR PREPARATIONS FOR DESTROYING VERMIN; FUNGICIDES, HERBICIDES, INSECTICIDES AND PESTICIDES FOR AGRICULTURAL AND HORTICULTURAL USE (U.S. CLS. 6, 18, 44, 46, 51 AND 52).
ZACHARY BELLO, EXAMINING ATTORNEY

SN 78-439,064. SYNGENTA PARTICIPATIONS AG, BASEL, SWITZERLAND, FILED 6-22-2004.

INCEPT

THE MARK CONSISTS OF STANDARD CHARACTERS WITHOUT CLAIM TO ANY PARTICULAR FONT, STYLE, SIZE, OR COLOR.

CLASS 1—CHEMICALS

FOR CHEMICALS USED IN AGRICULTURE, HORTICULTURE AND FORESTRY, NAMELY, SEED TREATMENT PREPARATIONS (U.S. CLS. 1, 5, 6, 10, 26 AND 46).

CLASS 5—PHARMACEUTICALS

FOR PREPARATIONS FOR DESTROYING VERMIN; FUNGICIDES, HERBICIDES, INSECTICIDES AND PESTICIDES FOR AGRICULTURAL AND HORTICULTURAL USE (U.S. CLS. 6, 18, 44, 46, 51 AND 52).
ZACHARY BELLO, EXAMINING ATTORNEY

SN 78-439,238. DREAM TEAM CONSULTING, INC., MELVILLE, NY. FILED 6-22-2004.

Cossential
what your business needs

CLASS 35—ADVERTISING AND BUSINESS

FOR MARKETING SERVICES, NAMELY, MATCHING SERVICE PROVIDERS WITH OTHER BUSINESSES REQUIRING THOSE SERVICES; LEASING OF OFFICE EQUIPMENT TO OTHERS (U.S. CLS. 100, 101 AND 102).
FIRST USE 9-9-2003; IN COMMERCE 9-9-2003.

CLASS 42—SCIENTIFIC, COMPUTER AND LEGAL SERVICES

FOR COMPUTER SOFTWARE CONSULTATION AND INSTALLATION OF COMPUTER SOFTWARE FOR OTHERS (U.S. CLS. 100 AND 101).
FIRST USE 1-13-2003; IN COMMERCE 1-13-2003.
GEORGE LORENZO, EXAMINING ATTORNEY

SN 78-439,241. CEASARS ENTERTAINMENT, INC., LAS VEGAS, NV. FILED 6-22-2004.

PENNY VILLE

THE MARK CONSISTS OF STANDARD CHARACTERS WITHOUT CLAIM TO ANY PARTICULAR FONT, STYLE, SIZE, OR COLOR.

THE NAME PENNY VILLE DOES NOT IDENTIFY A LIVING INDIVIDUAL.

CLASS 9—ELECTRICAL AND SCIENTIFIC APPARATUS

FOR GAMING EQUIPMENT, NAMELY SLOT MACHINES WITH OR WITHOUT VIDEO OUTPUT (U.S. CLS. 21, 23, 26, 36 AND 38).
FIRST USE 5-27-2004; IN COMMERCE 5-27-2004.

CLASS 41—EDUCATION AND ENTERTAINMENT

FOR CASINO SERVICES (U.S. CLS. 100, 101 AND 107).
FIRST USE 5-27-2004; IN COMMERCE 5-27-2004.
DAWN FELDMAN, EXAMINING ATTORNEY

SN 78-439,289. AMERICAN EXPRESS COMPANY, NEW YORK, NY. FILED 6-22-2004.

SN 78-439,253. STAR COMMUNITY PUBLISHING GROUP, LLC, HICKSVILLE, NY. FILED 6-22-2004.

SUPER SAVERMAN

THE MARK CONSISTS OF STANDARD CHARACTERS WITHOUT CLAIM TO ANY PARTICULAR FONT, STYLE, SIZE, OR COLOR.

CLASS 16—PAPER GOODS AND PRINTED MATTER

FOR COMMUNITY NEWSPAPERS FOR GENERAL CIRCULATION (U.S. CLS. 2, 5, 22, 23, 29, 37, 38 AND 50).

CLASS 35—ADVERTISING AND BUSINESS

FOR PREPARING AND PLACING ADVERTISEMENTS FOR OTHERS (U.S. CLS. 100, 101 AND 102).
SUSAN LESLIE DUBOIS, EXAMINING ATTORNEY

SN 78-439,282. AMERICAN EXPRESS COMPANY, NEW YORK, NY. FILED 6-22-2004.

IN:SAN FRAN

THE MARK CONSISTS OF STANDARD CHARACTERS WITHOUT CLAIM TO ANY PARTICULAR FONT, STYLE, SIZE, OR COLOR.

CLASS 35—ADVERTISING AND BUSINESS

FOR PROMOTING THE GOODS AND SERVICES OF OTHERS BY AWARDING PURCHASE POINTS FOR USING CHARGE CARDS AND CREDIT CARDS (U.S. CLS. 100, 101 AND 102).

CLASS 36—INSURANCE AND FINANCIAL

FOR FINANCIAL SERVICES, NAMELY, CHARGE CARD AND CREDIT CARD SERVICES (U.S. CLS. 100, 101 AND 102).
ELLEN PERKINS, EXAMINING ATTORNEY

IN:SAN FRANCISCO

THE MARK CONSISTS OF STANDARD CHARACTERS WITHOUT CLAIM TO ANY PARTICULAR FONT, STYLE, SIZE, OR COLOR.

CLASS 35—ADVERTISING AND BUSINESS

FOR PROMOTING THE GOODS AND SERVICES OF OTHERS BY AWARDING PURCHASE POINTS FOR USING CHARGE CARDS AND CREDIT CARDS (U.S. CLS. 100, 101 AND 102).

CLASS 36—INSURANCE AND FINANCIAL

FOR FINANCIAL SERVICES, NAMELY, CHARGE CARD AND CREDIT CARD SERVICES (U.S. CLS. 100, 101 AND 102).
ELLEN PERKINS, EXAMINING ATTORNEY

SN 78-439,291. AMERICAN EXPRESS COMPANY, NEW YORK, NY. FILED 6-22-2004.

IN:SF

THE MARK CONSISTS OF STANDARD CHARACTERS WITHOUT CLAIM TO ANY PARTICULAR FONT, STYLE, SIZE, OR COLOR.

CLASS 35—ADVERTISING AND BUSINESS

FOR PROMOTING THE GOODS AND SERVICES OF OTHERS BY AWARDING PURCHASE POINTS FOR USING CHARGE CARDS AND CREDIT CARDS (U.S. CLS. 100, 101 AND 102).

CLASS 36—INSURANCE AND FINANCIAL

FOR FINANCIAL SERVICES, NAMELY, CHARGE CARD AND CREDIT CARD SERVICES (U.S. CLS. 100, 101 AND 102).
ELLEN PERKINS, EXAMINING ATTORNEY

SN 78-439,298. AULTMAN HEALTH FOUNDATION, CANTON, OH. FILED 6-22-2004.

AultComp

THE MARK CONSISTS OF STANDARD CHARACTERS WITHOUT CLAIM TO ANY PARTICULAR FONT, STYLE, SIZE, OR COLOR.

CLASS 35—ADVERTISING AND BUSINESS

FOR OPERATION OF BUSINESS FOR OTHERS, NAMELY OPERATION AS THIRD PARTY ADMINISTRATOR FOR WORKERS COMPENSATION CLAIMS (U.S. CLS. 100, 101 AND 102).
FIRST USE 1-1-1997; IN COMMERCE 1-1-1997.

CLASS 44—MEDICAL, BEAUTY AND AGRICULTURAL SERVICES

FOR MANAGED HEALTH CARE SERVICES (U.S. CLS. 100 AND 101).
FIRST USE 1-1-1997; IN COMMERCE 1-1-1997.
CAROLYN CATALDO, EXAMINING ATTORNEY

SN 78-439,299. MORGAN STANLEY, NEW YORK, NY. FILED 6-22-2004.

FOCUS

THE MARK CONSISTS OF STANDARD CHARACTERS WITHOUT CLAIM TO ANY PARTICULAR FONT, STYLE, SIZE, OR COLOR.

CLASS 9—ELECTRICAL AND SCIENTIFIC APPARATUS

FOR COMPUTER SOFTWARE FOR RISK MANAGEMENT FOR MUTUAL FUNDS AND COMPUTER MANUALS SOLD THEREWITH; COMPUTER SOFTWARE FOR RISK MANAGEMENT FOR MUTUAL FUNDS THAT MAY BE DOWNLOADED FROM A GLOBAL COMPUTER NETWORK AND COMPUTER INSTRUCTION MANUALS SOLD THEREWITH (U.S. CLS. 21, 23, 26, 36 AND 38).

CLASS 36—INSURANCE AND FINANCIAL

FOR FINANCIAL SERVICES IN THE NATURE OF RISK MANAGEMENT FOR MUTUAL FUNDS (U.S. CLS. 100, 101 AND 102).

CLASS 42—SCIENTIFIC, COMPUTER AND LEGAL SERVICES

FOR PROVIDING TEMPORARY USE OF ON-LINE NON-DOWNLOADABLE SOFTWARE AND COMPUTER APPLICATIONS FOR RISK MANAGEMENT FOR MUTUAL FUNDS (U.S. CLS. 100 AND 101).
CAROLYN CATALDO, EXAMINING ATTORNEY

SN 78-439,386. JUSTIN WILSON HOLDINGS, INC., BATON ROUGE, LA. FILED 6-22-2004.

JUSTIN WILSON'S

THE MARK CONSISTS OF STANDARD CHARACTERS WITHOUT CLAIM TO ANY PARTICULAR FONT, STYLE, SIZE, OR COLOR.

THE NAME(S), PORTRAIT(S), AND/OR SIGNATURE(S) SHOWN IN THE MARK DOES NOT IDENTIFY A PARTICULAR LIVING INDIVIDUAL.

CLASS 29—MEATS AND PROCESSED FOODS

FOR PICKLES; SNACK MIX CONSISTING PRIMARILY OF SESAME STICKS, CRACKERS, AND PROCESSED SEEDS AND NUTS (U.S. CL. 46).
FIRST USE 1-31-2002; IN COMMERCE 1-31-2002.

CLASS 30—STAPLE FOODS

FOR SAUCES (U.S. CL. 46).
FIRST USE 1-31-1995; IN COMMERCE 1-31-1995.
BRIDGETT SMITH, EXAMINING ATTORNEY

SN 78-439,628. PHILLIPS, SHELLEY, GOODLETTSVILLE, TN. FILED 6-22-2004.

SN 78-440,343. DKRW ENERGY, LLC, HOUSTON, TX. FILED 6-23-2004.

**KOOKIE KUPKAKE
KIDS**

THE MARK CONSISTS OF STANDARD CHARACTERS WITHOUT CLAIM TO ANY PARTICULAR FONT, STYLE, SIZE, OR COLOR.

CLASS 9—ELECTRICAL AND SCIENTIFIC APPARATUS

FOR PRERECORDED PHONOGRAPH RECORDS, AUDIO AND VIDEO CASSETTES, AUDIO TAPES, VIDEO TAPES, RECORDING DISCS, COMPACT DISCS AND DVDS FEATURING CHILDREN'S PROGRAMS AND MUSIC (U.S. CLS. 21, 23, 26, 36 AND 38).

CLASS 16—PAPER GOODS AND PRINTED MATTER

FOR PRINTED MATTERS, NAMELY, BOOKS, POSTERS, CALENDARS, STATIONERY, MEMO PADS, NOTEBOOKS, GREETING CARDS, STICKERS, AGENDA BOOKS, COLORING BOOKS, JOURNALS, DIARIES, BOOK MARKS, SHEET MUSIC, PHOTOGRAPH AND SCRAPBOOK ALBUMS (U.S. CLS. 2, 5, 22, 23, 29, 37, 38 AND 50).

KATHRYN COWARD, EXAMINING ATTORNEY

SN 78-440,332. DKRW ENERGY, LLC, HOUSTON, TX. FILED 6-23-2004.



THE MARK CONSISTS OF AN ARRANGEMENT OF THREE SQUARES.

CLASS 4—LUBRICANTS AND FUELS

FOR DIESEL FUEL; NAPHTHA; NATURAL GAS; ELECTRICAL ENERGY (U.S. CLS. 1, 6 AND 15).

CLASS 36—INSURANCE AND FINANCIAL

FOR FINANCIAL INVESTMENT IN THE FIELD OF PRODUCTION, GENERATION, AND DISTRIBUTION OF ENERGY; INVESTMENT MANAGEMENT (U.S. CLS. 100, 101 AND 102).

CLASS 40—MATERIAL TREATMENT

FOR PRODUCTION OF ENERGY (U.S. CLS. 100, 103 AND 106).

ANNE MADDEN, EXAMINING ATTORNEY

SN 78-440,938. JOHN M. FLOYD & ASSOCIATES, INC., BAYTOWN, TX. FILED 6-24-2004.

DKRW

THE MARK CONSISTS OF STANDARD CHARACTERS WITHOUT CLAIM TO ANY PARTICULAR FONT, STYLE, SIZE, OR COLOR.

CLASS 36—INSURANCE AND FINANCIAL

FOR FINANCIAL INVESTMENT IN THE FIELD OF PRODUCTION, GENERATION, AND DISTRIBUTION OF ENERGY; INVESTMENT MANAGEMENT (U.S. CLS. 100, 101 AND 102).

CLASS 40—MATERIAL TREATMENT

FOR PRODUCTION OF ENERGY (U.S. CLS. 100, 103 AND 106).

ANNE MADDEN, EXAMINING ATTORNEY

JMFA

THE MARK CONSISTS OF STANDARD CHARACTERS WITHOUT CLAIM TO ANY PARTICULAR FONT, STYLE, SIZE, OR COLOR.

CLASS 9—ELECTRICAL AND SCIENTIFIC APPARATUS

FOR COMPUTER SOFTWARE FOR MONITORING OVERDRAWN CHECKING ACCOUNTS (U.S. CLS. 21, 23, 26, 36 AND 38).

FIRST USE 3-9-1999; IN COMMERCE 3-9-1999.

CLASS 35—ADVERTISING AND BUSINESS

FOR BUSINESS MANAGEMENT SERVICES FOR FINANCIAL INSTITUTIONS; BUSINESS CONSULTING IN THE FIELD OF ECONOMIC PLANNING, REGULATORY PLANNING, STRATEGIC PLANNING, AND EARNINGS IMPROVEMENT FOR FINANCIAL INSTITUTIONS; BUSINESS MARKETING CONSULTING IN THE FIELD OF CHECKING ACCOUNT OVERDRAFT PRIVILEGE MARKETING PROGRAMS (U.S. CLS. 100, 101 AND 102).
FIRST USE 3-9-1999; IN COMMERCE 3-9-1999.

CLASS 36—INSURANCE AND FINANCIAL

FOR FINANCIAL SERVICES, NAMELY, MANAGING CHECKING ACCOUNTS WITH OVERDRAFT PRIVILEGES; FINANCIAL CONSULTATION IN THE FIELDS OF ECONOMIC PLANNING, REGULATORY COMPLIANCE, STRATEGIC PLANNING, AND EARNINGS IMPROVEMENT FOR FINANCIAL INSTITUTIONS (U.S. CLS. 100, 101 AND 102).

FIRST USE 3-9-1999; IN COMMERCE 3-9-1999.

CLASS 41—EDUCATION AND ENTERTAINMENT

FOR TRAINING IN THE FIELDS OF REPORTING, MONITORING, AND IMPLEMENTING OVERDRAFT PRIVILEGE PRODUCTS INTO DATABASE PROCESSING SYSTEMS (U.S. CLS. 100, 101 AND 107).

FIRST USE 3-9-1999; IN COMMERCE 3-9-1999.

CLASS 42—SCIENTIFIC, COMPUTER AND LEGAL SERVICES

FOR COMPUTER CONSULTING SERVICES IN THE FIELD OF INTEGRATION OF OVERDRAFT PRIVILEGE PRODUCTS INTO DATA PROCESSING SYSTEMS (U.S. CLS. 100 AND 101).

FIRST USE 3-9-1999; IN COMMERCE 3-9-1999.

AMY GEARIN, EXAMINING ATTORNEY

SN 78-442,517. UNITEDHEALTH GROUP INCORPORATED, MINNETONKA, MN. FILED 6-28-2004.

**UNITEDHEALTH
ALLIES**

THE MARK CONSISTS OF STANDARD CHARACTERS WITHOUT CLAIM TO ANY PARTICULAR FONT, STYLE, SIZE, OR COLOR.

OWNER OF U.S. REG. NOS. 2,589,777, 2,635,728 AND OTHERS.

CLASS 35—ADVERTISING AND BUSINESS

FOR DEVELOPMENT AND ADMINISTRATION OF GROUP PURCHASING PROGRAMS AS A VALUE-ADDED EMPLOYEE BENEFIT; MEDICAL AND HEALTH-CARE COST/PRICE ANALYSIS; ADMINISTRATION OF A DISCOUNT PROGRAM FOR ENABLING PARTICIPANTS TO OBTAIN HEALTH CARE SERVICES FROM A NETWORK OF HEALTH CARE PROVIDERS (U.S. CLS. 100, 101 AND 102).

CLASS 44—MEDICAL, BEAUTY AND AGRICULTURAL SERVICES

FOR PROVIDING HEALTH-RELATED CONSUMER INFORMATION AND INFORMATION ABOUT HEALTH PROVIDERS VIA A GLOBAL COMPUTER NETWORK (U.S. CLS. 100 AND 101).

STEPHANIE DAVIS, EXAMINING ATTORNEY

SN 78-444,159. FELLOWSHIP CHURCH, IRVING, TX. FILED 6-30-2004.

**CLASS 41—EDUCATION AND ENTERTAINMENT**

FOR EDUCATIONAL AND ENTERTAINMENT SERVICES, NAMELY PROVIDING A WEBSITE FEATURING RELIGIOUS TEACHINGS AND CONTEMPORARY CHRISTIAN MUSIC (U.S. CLS. 100, 101 AND 107).

FIRST USE 1-1-1996; IN COMMERCE 1-1-1996.

CLASS 45—PERSONAL SERVICES

FOR EVANGELISTIC AND MINISTERIAL SERVICES (U.S. CLS. 100 AND 101).

FIRST USE 1-1-1996; IN COMMERCE 1-1-1996.

MELVIN AXILBUND, EXAMINING ATTORNEY

SN 78-444,696. ANIPLEX, INC., TOKYO, JAPAN, FILED 7-1-2004.

**Fullmetal
Alchemist**

THE MARK CONSISTS OF STANDARD CHARACTERS WITHOUT CLAIM TO ANY PARTICULAR FONT, STYLE, SIZE, OR COLOR.

CLASS 16—PAPER GOODS AND PRINTED MATTER

FOR PAPER AND CARDBOARD GOODS, NAMELY, SERIES OF VIDEO GAME STRATEGY GUIDES; SERIES OF CARD GAME INSTRUCTION BOOKS, TRADING CARDS, POSTERS, SERIES OF COLORING BOOKS, STICKERS, AND STATIONERY; POSTCARDS; DESK TOP ORGANIZERS; DESK SETS; DESK PADS; PERSONAL ORGANIZERS; DIARIES; PENS; PENCIL CASES; PEN CASES; DRAWING RULERS; BOOKMARKERS; BOOK PLATES; BOOK COVERS; NOTEBOOKS; NOTE PADS; DESK PADS; NON-ELECTRIC ERASERS; NON ELECTRIC PENCIL SHARPENERS; STENCILS; STATIONERY FOLDERS; RUBBER STAMPS; BULLETIN BOARDS; PAPER BAGS; WRAPPING PAPER; SERIES OF CHILDREN'S ACTIVITY BOOKS; COMPOSITION BOOKS; STICKERS; DECALS; PAPER PLACE MATS; CALENDARS, NAMELY DESK CALENDARS, WALL CALENDARS, DAILY CALENDARS; PAPER, NAMELY, ART PAPER CONSTRUCTION PAPER; ARTS AND CRAFTS PAINT KITS; ART PRINTS; COLOR PRINTS; LITHOGRAPHIC PRINTS; PHOTOGRAPHIC PRINTS, DECORATIVE STICKERS FOR WALLS AND WINDOWS (U.S. CLS. 2, 5, 22, 23, 29, 37, 38 AND 50).

CLASS 25—CLOTHING

FOR CLOTHING, NAMELY, SHOES, CAPS, HATS, PAJAMAS, RAINCOATS, SHIRTS, T-SHIRTS, SHORTS, SLEEPWEAR, SLIPPERS, JACKETS, PANTS, AND SWEAT SUITS (U.S. CLS. 22 AND 39).

PAUL F. GAST, EXAMINING ATTORNEY

SN 78-445,477. BROUSSARD, AMY CULVER, DALLAS, TX. FILED 7-2-2004.

REAL PEACE

THE MARK CONSISTS OF STANDARD CHARACTERS WITHOUT CLAIM TO ANY PARTICULAR FONT, STYLE, SIZE, OR COLOR.

CLASS 14—JEWELRY

FOR COSTUME JEWELRY, NAMELY, RINGS, EARRINGS, BRACELETS, NECKLACES, MEDALLIONS, CHARMS, LAPEL PINS, CUFF LINKS AND WATCHES, MADE OF NON-PRECIOUS METAL, GLASS, RHINESTONES, SILVER, STERLING, AND SIMULATED, SYNTHETIC, AND/OR GENUINE PEARLS AND/OR GEMSTONES, AND PRECIOUS JEWELRY, NAMELY, RINGS, EARRINGS, BRACELETS, NECKLACES, MEDALLIONS, CHARMS, LAPEL PINS, CUFF LINKS AND WATCHES, MADE OF GOLD, SILVER, PLATINUM, STERLING, AND/OR SIMULATED, SYNTHETIC AND/OR GENUINE GEMSTONES AND/OR PEARLS (U.S. CLS. 2, 27, 28 AND 50).

CLASS 25—CLOTHING

FOR APPAREL, NAMELY, BOOTS, SANDALS, SHOES, SLIPPERS, HOSIERY, SOCKS, SWIMWEAR, CAPS, HEADWEAR, APRONS, ROBES, PAJAMAS, NIGHT SHIRTS, NIGHT GOWNS, SHIRTS, T-SHIRTS, SWEAT-PANTS, SWEATSHIRTS, KNIT TOPS, SKIRTS, PANTS, TROUSERS, SHORTS, SWEATERS, JEANS, VESTS, COATS, JACKETS, OVERALLS, BLAZERS, DRESSES, SCARVES, BLOUSES, CARDIGANS, GOWNS, GOLF SHIRTS, JOGGING SUITS, TURTLENECKS, SUITS, POLO SHIRTS, GLOVES, SUSPENDERS, BELTS AND NECKTIES (U.S. CLS. 22 AND 39).

JOHN DALIER, EXAMINING ATTORNEY

SN 78-452,760. AMERICAN EXPRESS COMPANY, NEW YORK, NY. FILED 7-19-2004.

IN:LA

THE MARK CONSISTS OF STANDARD CHARACTERS WITHOUT CLAIM TO ANY PARTICULAR FONT, STYLE, SIZE, OR COLOR.

CLASS 35—ADVERTISING AND BUSINESS

FOR PROMOTING THE GOODS AND SERVICES OF OTHERS BY AWARDING PURCHASE POINTS FOR USING CHARGE CARDS AND CREDIT CARDS (U.S. CLS. 100, 101 AND 102).

CLASS 36—INSURANCE AND FINANCIAL

FOR FINANCIAL SERVICES, NAMELY, CHARGE CARD AND CREDIT CARD SERVICES (U.S. CLS. 100, 101 AND 102).

ELLEN PERKINS, EXAMINING ATTORNEY

SN 78-455,893. MARRIOTT INTERNATIONAL, INC., BETHESDA, MD. FILED 7-23-2004.

FIT FOR YOU

THE MARK CONSISTS OF STANDARD CHARACTERS WITHOUT CLAIM TO ANY PARTICULAR FONT, STYLE, SIZE, OR COLOR.

CLASS 35—ADVERTISING AND BUSINESS

FOR RETAIL STORE SERVICES FEATURING HEALTH-ORIENTED ITEMS (U.S. CLS. 100, 101 AND 102).

CLASS 43—HOTEL AND RESTAURANT SERVICES

FOR CATERING SERVICES (U.S. CLS. 100 AND 101).
ROBIN CHOSID, EXAMINING ATTORNEY

SN 78-466,806. CARDEN TRAN, NEW YORK, NY. FILED 8-12-2004.

TRUST FUND BABY

THE MARK CONSISTS OF STANDARD CHARACTERS WITHOUT CLAIM TO ANY PARTICULAR FONT, STYLE, SIZE, OR COLOR.

CLASS 25—CLOTHING

FOR CLOTHING FOR MEN, WOMEN, AND CHILDREN, NAMELY TOPS, SHORTS, PANTS, JACKETS, JUMPERS, SWEATERS, HATS, SWIMWEAR, COVERS FOR SWIMWEAR, LINGERIE, COATS, GLOVES, SCARVES, HOSIERY, SHIRTS, T-SHIRTS, SOCKS, UNDERWEAR, PAJAMAS, UNDERSHIRTS, SWEATSHIRTS (U.S. CLS. 22 AND 39).

CLASS 35—ADVERTISING AND BUSINESS

FOR RETAIL STORE SERVICES FEATURING APPAREL, FOOTWEAR, BAGS, LUGGAGE, WATCHES AND JEWELRY (U.S. CLS. 100, 101 AND 102).

KIMBERLY PERRY, EXAMINING ATTORNEY

SN 78-471,948. THE IAMS COMPANY, DAYTON, OH. FILED 8-23-2004.

IAMS FRIENDS FOR LIFE

THE MARK CONSISTS OF STANDARD CHARACTERS WITHOUT CLAIM TO ANY PARTICULAR FONT, STYLE, SIZE, OR COLOR.

OWNER OF U.S. REG. NOS. 1,317,225, 1,519,511 AND 1,980,228.

CLASS 9—ELECTRICAL AND SCIENTIFIC APPARATUS

FOR TRANSMITTER AND RECEIVER USED TO LOCATE LOST PETS (U.S. CLS. 21, 23, 26, 36 AND 38).

CLASS 45—PERSONAL SERVICES

FOR LOST PET RECOVERY SERVICES (U.S. CLS. 100 AND 101).
BRETT J. GOLDEN, EXAMINING ATTORNEY

SN 78-975,776. KG ROSS, INC., LOS ANGELES, CA. FILED 12-12-2003.

BE IT NOW!

THE MARK CONSISTS OF STANDARD CHARACTERS WITHOUT CLAIM TO ANY PARTICULAR FONT, STYLE, SIZE, OR COLOR.

CLASS 16—PAPER GOODS AND PRINTED MATTER

FOR ALL PAPER GOODS AND PRINTED MATTER, NAMELY, PRINTED GREETING CARDS WITH ELECTRONIC INFORMATION STORED THEREIN, GREETING CARDS, STICKERS, GIFT WRAPPING PAPER, PAPER GIFT BAGS, PAPER GIFT TAGS, PAPER RIBBONS FOR GIFT WRAPPING, PAPER BOWS FOR GIFT WRAPPING, PAPERWEIGHTS, DESK BASKETS FOR DESK ACCESSORIES, DESK CALENDARS, DESK PADS, DESK CALENDAR PADS, DESK SETS, DESK STANDS AND HOLDERS FOR PENS, PENCILS AND INK, DESK TOP ORGANIZERS, DESK TOP PLANNERS, STATIONERY KITS COMPRISED OF LETTERHEAD AND ENVELOPES AND A WRITING INSTRUMENT, NAMELY, PENS AND PENCILS, WALL CALENDARS, STUDENT DAILY PLANNERS, LOCKER CALENDARS, STICKER BOOKS, PAPER NAPKINS, PAPER TABLE COVERS, NAMELY TABLE CLOTHS OF PAPER AND TABLE LINENS OF PAPER, PRINTED PAPER INVITATIONS, PAPER PARTY HATS, PAPER TREAT BAGS, DECORATIVE PAPER CENTERPIECES, PAPER BANNERS, HANGTAGS, PRODUCT DISPLAYS MADE OF CARDBOARD, PRINTED PAPER DOOR SIGNS, NOTE PAPER, NAMELY, PARTY SIGN-IN SHEETS, NOTE CARDS, NAMELY, THANK YOU NOTES, PAPER CAKE DECORATIONS, PAPER BOARDS, NAMELY, PRINTED CAKE DECORATING BOARDS, PAPER BAKERY BOXES, LITHOGRAPHS, MINI PRINTS, PAPER WALL HANGINGS, NAMELY, PAPER WALL SCROLLS, TRADING CARDS, TRADING CARD BINDERS, CHILDREN'S BOOKS, ARTS AND CRAFTS PAINT KITS, SCHOOL SUPPLIES, NAMELY, PENCILS, PENS, GLUE, PENCIL SHARPENERS, ERASERS AND DESKTOP ORGANIZERS, PAPER TRANSPARENCIES, NAMELY TRANSPARENT CELLO PAPER WITH CHARACTER ART, MEMORANDUM BOARDS, HEAT TRANSFER PAPER, PAINTING SETS, NAMELY, ART ACTIVITY DESK SETS, DECORATIVE PAPER, NAMELY, TISSUE PAPER, STATIONERY PRODUCTS NAMELY, STATIONERY BOXES, STATIONERY FOLDERS, STATIONERY WRITING PAPER AND ENVELOPES, STATIONERY-TYPE PORTFOLIOS, PRINTED BLANK JOURNALS, NAMELY, DIARIES, PHOTOGRAPH ALBUMS, PENCILS, PENS, DRAWING PAPER, POSTERS, WALL DECORATIONS, NAMELY, PAPER PARTY DECORATIONS FOR THE WALL; NAIL AND SKIN STICKERS, CHILDREN'S ACTIVITY BOOKS NAMELY, STICKER PUZZLE ACTIVITY BOOKS, ART DOODLE KITS COMPRISED OF COLORING BOOKS, CHILDREN STORY BOOKS, ADULT BOOKS IN THE SUBJECT OF SELF-DISCOVERY BOOKS, INSPIRATIONAL THOUGHTS AND MESSAGES

BOOKS, SELFHHELP BOOKS FICTION AND NONFICTION, CRAYONS, COLORING PENCILS, BLANK PAPER, RUBBER STAMPS AND MARKERS, PRINTED GUIDES FOR COMPUTER VIDEO GAMES, BEVERAGE NAPKINS, COASTERS, HOW TO BOOKS, SCRAPBOOKS (U.S. CLS. 2, 5, 22, 23, 29, 37, 38 AND 50).

FIRST USE 4-27-2002; IN COMMERCE 6-11-2002.

CLASS 25—CLOTHING

FOR CLOTHING AND WEARING APPAREL FOR MEN, WOMEN AND CHILDREN, NAMELY SHIRTS, BLOUSES, T-SHIRTS, PANTS, SHORTS, SKIRTS, DRESSES, HATS, SLEEPWEAR, UNDERWEAR, PANTIES, SWEATSHIRTS, SWEATPANTS, SUITS, SWIMWEAR, COATS, JACKETS, SWEATERS, CAPS, ROBES, SCARVES, HOSIERY, TIES, DIAPERS, BOOTIES, JUMPSUITS, BELTS, SHOES, AND GLOVES, KNICKERS, VESTS, RAINCOATS, ANORAKS, COATS, CAPES, OVERCOATS, SOCKS, TIGHTS, BELTS, LEISURE OUTFITS, SPORTS OUTFITS, HATS, CAPS, BERETS, VISORS, FLEECE PULLOVERS, INFANT APPAREL FOR BOYS AND GIRLS, NAMELY, CLOTH DIAPER SETS WITH UNDERSHIRT AND DIAPER COVER AND INFANT UNDERWEAR, FOOTWEAR, HEADWEAR, MITTENS AND HALLOWEEN COSTUMES, APRONS, AND NIGHTSHIRTS (U.S. CLS. 22 AND 39).

FIRST USE 4-27-2002; IN COMMERCE 6-11-2002.

CLASS 35—ADVERTISING AND BUSINESS

FOR ADVERTISING SLOGAN AND CARTOON CHARACTER LICENSING, NAMELY, THE LICENSING OF COPYRIGHTED AND TRADEMARKED CUSTOM GRAPHIC ART WORK FOR USE IN RETAIL STORE SERVICES, AVAILABLE THROUGH COMPUTER COMMUNICATIONS AND AT STAND-ALONE AND SHOP WITHIN-A-SHOP STORES WHERE THE LICENSED SLOGAN AND ART WORK IS FEATURED ON APPAREL, COSMETICS, LOTIONS, PERFUMES, EYEWARE, HOUSEWARES, GIFTS, PREPARED FOOD, BAKED GOODS, SPORTING GOODS, TOYS, PAINTS, TRAVEL MANAGEMENT, SEASONAL MERCHANDISE, FLAT PAPER GOODS, STATIONERY (U.S. CLS. 100, 101 AND 102).

FIRST USE 4-27-2002; IN COMMERCE 6-11-2002.

SEAN DWYER, EXAMINING ATTORNEY

SN 79-000,041. NITRO SA, SWITZERLAND, FILED 11-2-2003.



PRIORITY DATE OF 9-16-2003 IS CLAIMED.
OWNER OF INTERNATIONAL REGISTRATION 0814210 DATED 11-2-2003, EXPIRES 11-2-2013.

NO CLAIM IS MADE TO THE EXCLUSIVE RIGHT TO USE OUTERWEAR, APART FROM THE MARK AS SHOWN.

CLASS 25—CLOTHING

FOR CLOTHING, NAMELY, PULLOVERS, SHIRTS, PANTS, SKIRTS, JACKETS, ANORAKS AND GLOVES; FOOTWEAR, NAMELY, SNOWBOARD-SHOES; HEADGEAR, NAMELY, CAPS AND HATS (U.S. CLS. 22 AND 39).

CLASS 28—TOYS AND SPORTING GOODS

FOR SPORTS ARTICLES, NAMELY SNOWBOARDS (U.S. CLS. 22, 23, 38 AND 50).

YSA DEJESUS, EXAMINING ATTORNEY

SN 79-000,190. ALLOUCHE PHILIPPE, FRANCE, FILED 11-19-2003.

MOONSCREEN

PRIORITY DATE OF 10-2-2003 IS CLAIMED.
OWNER OF INTERNATIONAL REGISTRATION 0815304 DATED 11-19-2003, EXPIRES 11-19-2013.

CLASS 3—COSMETICS AND CLEANING PREPARATIONS

FOR SOAPS, PERFUMERY PRODUCTS, NAMELY, PERFUMES, TOILET WATER, EAU DE COLOGNE, ESSENTIAL OILS FOR PERSONAL USE, COSMETICS, SKIN OILS, CREAMS AND LOTIONS FOR THE SKIN FACE AND BODY, HAIR LOTIONS, DENTIFRICES, INCENSE, DEODORANTS FOR PERSONAL USE (U.S. CLS. 1, 4, 6, 50, 51 AND 52).

CLASS 25—CLOTHING

FOR CLOTHES, NAMELY, GLOVES, BELTS, SHIRTS, SWEATERS, JACKETS, TROUSERS, SHIRTS, T-SHIRTS; SHOES, EXCEPT ORTHOPAEDIC SHOES; FOOTWEAR, EXCEPT ORTHOPAEDIC FOOTWEAR, HEADWEAR (U.S. CLS. 22 AND 39).

MARIA-VICTORIA SUAREZ, EXAMINING ATTORNEY

SN 79-000,344. AKZO NOBEL COATINGS INTERNATIONAL; B.V., NETHERLANDS, FILED 11-4-2003.

NOBILAS

THE MARK CONSISTS OF STANDARD CHARACTERS WITHOUT CLAIM TO ANY PARTICULAR FONT, STYLE, SIZE, OR COLOR.

PRIORITY DATE OF 5-28-2003 IS CLAIMED.
OWNER OF INTERNATIONAL REGISTRATION 0816245 DATED 11-4-2003, EXPIRES 11-4-2013.

CLASS 2—PAINTS

FOR PAINTS FOR VEHICLES; VARNISHES, LACQUERS IN THE NATURE AT A COATING; RUST PRESERVATIVES IN THE NATURE OF A COATING FOR USE ON VEHICLES (U.S. CLS. 6, 11 AND 16).

CLASS 9—ELECTRICAL AND SCIENTIFIC APPARATUS

FOR COMPUTER SOFTWARE FOR USE BY CAR REPAIR SHOPS, NAMELY ADMINISTRATIVE AND MANAGEMENT SUPPORT AND INFORMATION SUPPLY (U.S. CLS. 21, 23, 26, 36 AND 38).

CLASS 35—ADVERTISING AND BUSINESS

FOR BUSINESS ADMINISTRATION SERVICES FOR AUTOMOTIVE REPAIR SHOPS; BUSINESS ADMINISTRATION SERVICES RELATING TO THE SETTLEMENT OF VEHICLE DAMAGE AND REPAIR FOR AUTOMOTIVE REPAIR SHOPS; PREPARING AND/OR PROVIDING BUSINESS INVOICES FOR AUTOMOTIVE REPAIR SHOPS; PROVIDING STATISTICAL INFORMATION RELATING TO VEHICLE DAMAGE (U.S. CLS. 100, 101 AND 102).

CLASS 36—INSURANCE AND FINANCIAL

FOR FINANCIAL SERVICES IN THE NATURE OF PROVIDING FINANCIAL SETTLEMENT SERVICES FOR AUTOMOTIVE REPAIR SHOPS FOR OUTSTANDING ACCOUNTS PAYABLE BALANCES (U.S. CLS. 100, 101 AND 102).

CLASS 37—CONSTRUCTION AND REPAIR

FOR DAMAGE VEHICLE MAINTENANCE, REPAIR AND CONSULTATION SERVICES; VEHICLE MAINTENANCE AND REPAIR SERVICES; VEHICLE CLEANING SERVICES—VEHICLE PAINTING SERVICES—ANTI-CORROSIVE TREATMENT OF VEHICLES; VEHICLE PAINTING CONSULTATION SERVICES; PAINTING SERVICES, NAMELY PAINTING, SPRAYING OR PRINTING LOGOS TO BE ATTACHED TO VEHICLES AND APPLYING GRAPHICS TO VEHICLES BY MEANS OF DECALS (U.S. CLS. 100, 103 AND 106).

CLASS 38—COMMUNICATION

FOR COMMUNICATION SERVICES, NAMELY ELECTRONIC TRANSMISSION OF VEHICLE REPAIR DATA AND DOCUMENTS AMONG USERS OF COMPUTERS—ELECTRONIC VOICE MESSAGING, NAMELY THE RECORDING AND SUBSEQUENT TRANSMISSION OF VOICE MESSAGES BY TELEPHONE CONCERNING AUTOMOTIVE REPAIR (U.S. CLS. 100, 101 AND 104).

CLASS 41—EDUCATION AND ENTERTAINMENT

FOR TRAINING AND INSTRUCTION IN THE FIELD OF VEHICLE DAMAGE REPAIR, SPRAYING, PAINTING AND LACQUERING OF VEHICLES; TRAINING AND INSTRUCTION IN THE FIELD OF THE USE OF COMPUTER PROGRAMS RELATING TO VEHICLE DAMAGE REPAIR (U.S. CLS. 100, 101 AND 107).

CLASS 42—SCIENTIFIC, COMPUTER AND LEGAL SERVICES

FOR AUTOMOTIVE INSPECTION SERVICES—AUTOMOTIVE DAMAGE DETERMINATION INSPECTION SERVICES; COMPUTER SOFTWARE CONSULTATION SERVICE RELATING TO COMPUTER SOFTWARE IN THE FIELD OF VEHICLE DAMAGE REPAIR AND VEHICLE REPAIR; MAINTENANCE, UPDATING AND DEVELOPMENT OF COMPUTER SOFTWARE IN THE FIELD OF VEHICLE DAMAGE REPAIR AND VEHICLE REPAIR; LEGAL SERVICES RELATING TO THE LEGAL SETTLEMENT OF VEHICLE DAMAGE (U.S. CLS. 100 AND 101).

CLASS 45—PERSONAL SERVICES

FOR SAFETY ADVISORY CONSULTATION SERVICES IN THE FIELD OF DRIVING BEHAVIOR IN ORDER TO PREVENT AND LIMIT VEHICLE DAMAGE (U.S. CLS. 100 AND 101).

HOWARD SMIGA, EXAMINING ATTORNEY

SN 79-000,392. ROCKWOOL INTERNATIONAL A/S, DENMARK, FILED 12-8-2003.

ROCKFON

THE MARK CONSISTS OF STANDARD CHARACTERS WITHOUT CLAIM TO ANY PARTICULAR FONT, STYLE, SIZE, OR COLOR.

OWNER OF INTERNATIONAL REGISTRATION 0813307 DATED 10-9-2003, EXPIRES 10-9-2013.

CLASS 17—RUBBER GOODS

FOR PANELS, SHEETS, MATS AND BATTS, ALL MADE OF MINERAL FIBERS AND FOR INSULATION AGAINST SOUND, NOISE, HEAT, COLD AND FIRE AND FOR ACOUSTIC REGULATION (U.S. CLS. 1, 5, 12, 13, 35 AND 50).

CLASS 19—NON-METALLIC BUILDING MATERIALS

FOR WALL, FLOOR AND CEILING PANELS OF MINERAL FIBERS (U.S. CLS. 1, 12, 33 AND 50).

SUSAN HAYASH, EXAMINING ATTORNEY

SN 79-000,550. SARL MICHELLE MOISSAC, FRANCE, FILED 12-19-2003.

MICHELLE MOISSAC

THE MARK CONSISTS OF STANDARD CHARACTERS WITHOUT CLAIM TO ANY PARTICULAR FONT, STYLE, SIZE, OR COLOR.

OWNER OF INTERNATIONAL REGISTRATION 0817079 DATED 12-19-2003, EXPIRES 12-19-2013.

MICHELLE MOISSAC DOES NOT IDENTIFY THE NAME OF A PARTICULAR LIVING INDIVIDUAL.

CLASS 14—JEWELRY

FOR JEWELRY, PRECIOUS STONES, TIMEPIECES, NAMELY WATCHES, POCKET WATCHES, AND CHRONOMETERS (U.S. CLS. 2, 27, 28 AND 50).

CLASS 18—LEATHER GOODS

FOR LEATHER SOLD IN BULK, IMITATION LEATHER SOLD IN BULK, GOODS MADE OF LEATHER AND IMITATION LEATHER NOT INCLUDED IN OTHER CLASSES, NAMELY KEY CASES, DOCUMENT HOLDERS, NAMELY BRIEFCASES AND BRIEFCASE TYPE PORTFOLIOS, WALLETS, PURSES NOT OF PRECIOUS METAL, HANDBAGS, BACKPACKS, TRAVELING BAGS, HAT BOXES OF LEATHER OR LEATHER BOARD, LEATHER STRAPS, NAMELY HARNESS STRAPS, STRAPS FOR LUGGAGE, STRAPS FOR HANDBAGS (U.S. CLS. 1, 2, 3, 22 AND 41).

CLASS 25—CLOTHING

FOR CLOTHING, NAMELY SHIRTS, SHOES, JEANS, TROUSERS, SKIRTS; OUTERWEAR, NAMELY COATS, PARKAS, RAINCOATS AND JACKETS; FOOTWEAR, HEADGEAR, NAMELY HATS AND CAPS (U.S. CLS. 22 AND 39).

KATHY DE JONGE, EXAMINING ATTORNEY

SN 79-000,641. NAULOVER, S.A., SPAIN, FILED 12-10-2003.

NAULOVER

THE MARK CONSISTS OF STANDARD CHARACTERS WITHOUT CLAIM TO ANY PARTICULAR FONT, STYLE, SIZE, OR COLOR.

OWNER OF INTERNATIONAL REGISTRATION 0373167 DATED 11-16-1970, EXPIRES 11-16-2010.

CLASS 24—FABRICS

FOR TABLE CLOTHS NOT OF PAPER; HANDKERCHIEFS; WHITE LINEN OF FABRIC; DUVET COVERS; BED BLANKETS; FACE TOWELS MADE OF CLOTH (U.S. CLS. 42 AND 50).

CLASS 25—CLOTHING

FOR UNDERWEAR, NAMELY, PANTIES AND SLIPS; PAJAMAS; SHAWLS; KIMONOS; HEADWEAR, NAMELY, HATS AND CAPS; FOUNDATION GARMENTS, NAMELY, CORSETS AND GIRDLES; JUMPERS; SWEATERS; VESTS; JACKETS; SWIMSUITS; SHORT SLEEVE SHIRTS; BOXER SHORTS; AND RAINCOATS (U.S. CLS. 22 AND 39).

HELEN BRYAN, EXAMINING ATTORNEY

SN 79-000,953. MAST-JÄGERMEISTER AG, FED REP GERMANY, FILED 1-26-2004.



OWNER OF INTERNATIONAL REGISTRATION 0789491 DATED 6-5-2002, EXPIRES 6-5-2012.

THE COLOR(S) GRAY IS/ARE CLAIMED AS A FEATURE OF THE MARK.

THE COLOR GRAY APPEARS IN THE RECTANGULAR BACKGROUND PORTION OF THE MARK.

CLASS 9—ELECTRICAL AND SCIENTIFIC APPARATUS

FOR COMPUTER SCREEN SAVER SOFTWARE (U.S. CLS. 21, 23, 26, 36 AND 38).

CLASS 16—PAPER GOODS AND PRINTED MATTER

FOR CARDBOARD, PHOTOGRAPHS, STATIONERY, PRINTERS' TYPE AND PRINTING BLOCKS; ART PAPER, BOND PAPER, COPY PAPER, ENVELOPE PAPER, DRAWING PAPER, PHOTOCOPY PAPER AND PRINTING PAPER; CARDBOARD BOXES, CARTONS AND CONTAINERS; PRINTED MATERIALS, NAMELY, PRESS RELEASES FEATURING COMMERCIAL AND CULTURAL ACTIVITIES IN THE PROMOTION OF ALCOHOLIC BEVERAGES; PLASTIC BAGS FOR PACKAGING (U.S. CLS. 2, 5, 22, 23, 29, 37, 38 AND 50).

CLASS 21—HOUSEWARES AND GLASS

FOR BEVERAGE GLASSWARE; PORCELAIN BUSTS, SCULPTURES, STATUETTES, FIGURES, FIGURINES, DESKTOP STATUARY, MUGS; EARTHENWARE BUSTS, SCULPTURES, FIGURES, FIGURINES, DESKTOP STATUARY AND STATUETTES AND MUGS; EARTHENWARE OR PORCELAIN JARS FOR JAMS AND JELLIES (U.S. CLS. 2, 13, 23, 29, 30, 33, 40 AND 50).

CLASS 24—FABRICS

FOR TEXTILE FABRICS FOR THE MANUFACTURE OF CLOTHING; HAND TOWELS OF TEXTILE; FELT AND NON-WOVEN TEXTILE FABRICS; CURTAINS MADE OF TEXTILE FABRICS; FACE TOWELS OF TEXTILE MATERIALS (U.S. CLS. 42 AND 50).

CLASS 25—CLOTHING

FOR CLOTHING, NAMELY, SHIRTS, SHORTS, PANTS, JACKETS, SUITS, UNDERWEAR, SOCKS, PAJAMAS, LINGERIE, SWEAT SHIRTS AND SWEAT PANTS, HEADGEAR, NAMELY, HATS AND CAPS (U.S. CLS. 22 AND 39).

CLASS 28—TOYS AND SPORTING GOODS

FOR PLAYING CARDS; GAMES AND PLAYTHINGS, NAMELY, BOARD GAMES, CARD GAMES, ACTION TARGET GAMES, ARCADE GAMES, ARCADE-TYPE ELECTRONIC EDUCATION VIDEO GAMES, AMUSEMENT GAME MACHINES, HAND HELD UNIT FOR PLAYING ELECTRONIC GAMES, MECHANICAL AND ELECTRONIC ACTION TOYS, CHILDREN'S MULTIPLE ACTIVITY TOYS, BATH TOYS, BENDABLE TOYS AND INFANT TOYS (U.S. CLS. 22, 23, 38 AND 50).

CLASS 32—LIGHT BEVERAGES

FOR MINERAL AND AERATED WATERS; NON-ALCOHOLIC DRINKS, NAMELY, SOFT DRINKS, FRUIT DRINKS, FRUIT FLAVORED DRINKS, ENERGY DRINKS, SPORTS DRINKS AND ISOTONIC DRINKS (U.S. CLS. 45, 46 AND 48).

CLASS 33—WINES AND SPIRITS

FOR ALCOHOLIC BEVERAGES, NAMELY, HERBAL LIQUEURS, PREPARED ALCOHOLIC COCKTAIL, AND ALCOHOLIC PUNCH (U.S. CLS. 47 AND 49).

CLASS 34—SMOKERS' ARTICLES

FOR MATCHES (U.S. CLS. 2, 8, 9 AND 17).

CLASS 35—ADVERTISING AND BUSINESS

FOR ADVERTISING VIA ELECTRONIC MEDIA AND SPECIFICALLY THE INTERNET (U.S. CLS. 100, 101 AND 102).

CLASS 41—EDUCATION AND ENTERTAINMENT

FOR ORGANIZING EXHIBITIONS FOR CULTURAL, SPORTING AND ENTERTAINMENT PURPOSE; ORGANIZING COMMUNITY SPORTING AND CULTURAL EVENTS; ORGANIZING CULTURAL COMMUNITY FESTIVALS FEATURING A VARIETY OF ACTIVITIES, NAMELY SPORTING EVENTS, ART EXHIBITIONS, FLEA MARKETS, ETHNIC DANCES AND THE LIKE; PUBLICATION OF ELECTRONIC MAGAZINES THAT CONTAIN ELECTRONIC REPRODUCIBLE TEXT, GRAPHIC, IMAGE AND SOUND INFORMATION (U.S. CLS. 100, 101 AND 107).

CLASS 43—HOTEL AND RESTAURANT SERVICES

FOR PROVIDING TEMPORARY ACCOMMODATION; CATERING AND SERVING OF FOOD AND DRINKS (U.S. CLS. 100 AND 101).
CHRISTOPHER ADKINS, EXAMINING ATTORNEY

SN 79-001,027. 7 HOUSEWIVES SRL, ITALY, FILED 12-1-2003.

Zsa Zsa Lawinsky

PRIORITY DATE OF 7-9-2003 IS CLAIMED.
OWNER OF INTERNATIONAL REGISTRATION 0819046 DATED 12-1-2003, EXPIRES 12-1-2013.
THE STIPPLING IS A FEATURE OF THE MARK.
ZSA ZSA LAWINSKY DOES NOT IDENTIFY A PARTICULAR LIVING INDIVIDUAL.

CLASS 18—LEATHER GOODS

FOR IMITATION LEATHER SOLD IN BULK, LEATHER KEY CHAINS, LEATHER SOLD IN BULK, ANIMAL SKINS AND HIDES, TRUNKS AND TRAVELING BAGS, UMBRELLAS, PARASOLS AND WALKING STICKS, WHIPS, HARNESS AND SADDLERY (U.S. CLS. 1, 2, 3, 22 AND 41).

CLASS 25—CLOTHING

FOR CLOTHING, NAMELY; TROUSERS, SKIRTS, SUITS AND DRESSES, OVER COATS, COATS AND JACKETS; KNITWEAR, NAMELY, SWEATERS, SCARVES, SKIRTS AND DRESSES; UNDERWEAR, SHIRTS, FOOTWEAR, HEADWEAR (U.S. CLS. 22 AND 39).
GINNY ISAACSON, EXAMINING ATTORNEY

SN 79-001,265. LIFE LIGHT GENERATION VERTRIEBS GMBH, FED REP GERMANY, FILED 12-16-2003.

NANOSAN

THE MARK CONSISTS OF STANDARD CHARACTERS WITHOUT CLAIM TO ANY PARTICULAR FONT, STYLE, SIZE, OR COLOR.
PRIORITY DATE OF 6-23-2003 IS CLAIMED.
OWNER OF INTERNATIONAL REGISTRATION 0819856 DATED 12-16-2003, EXPIRES 12-16-2013.

CLASS 3—COSMETICS AND CLEANING PREPARATIONS

FOR GENERAL USE CLEANING, POLISHING, SCOURING AND ABRASIVE LIQUIDS AND POWDERS; SOAPS, NAMELY SKIN SOAP, MEDICATED SOAP, HAND SOAP; PERFUMERY, ESSENTIAL OILS FOR PERSONAL USE; HAIR LOTIONS; DENTIFRICES (U.S. CLS. 1, 4, 6, 50, 51 AND 52).

CLASS 5—PHARMACEUTICALS

FOR DIETETIC PREPARATIONS FOR MEDICAL USE; BABY FOOD; DIETARY FOOD SUPPLEMENTS FOR MEDICAL PURPOSES; VITAMIN AND MINERAL SUPPLEMENTS, WHICH MAY ALSO CONTAIN TRACE ELEMENTS; MEDICINAL HERBAL TEAS (U.S. CLS. 6, 18, 44, 46, 51 AND 52).

CLASS 31—NATURAL AGRICULTURAL PRODUCTS

FOR SEEDS, NAMELY AGRICULTURAL SEEDS, FLOWER SEEDS, VEGETABLE SEEDS; NATURAL PLANTS AND FLOWERS, NAMELY DRIED PLANTS, CUT FLOWERS; FOODSTUFFS FOR ANIMALS (U.S. CLS. 1 AND 46).
ESTHER BELENKER, EXAMINING ATTORNEY

SN 79-001,319. SIEMENS AKTIENGESELLSCHAFT, FED REP GERMANY, FILED 12-3-2003.

SITRIS

THE MARK CONSISTS OF STANDARD CHARACTERS WITHOUT CLAIM TO ANY PARTICULAR FONT, STYLE, SIZE, OR COLOR.
PRIORITY DATE OF 6-13-2003 IS CLAIMED.
OWNER OF INTERNATIONAL REGISTRATION 0820365 DATED 12-3-2003, EXPIRES 12-3-2013.

CLASS 9—ELECTRICAL AND SCIENTIFIC APPARATUS

FOR COMPUTER GAME SOFTWARE FOR MOBILE TELEPHONES (U.S. CLS. 21, 23, 26, 36 AND 38).

CLASS 28—TOYS AND SPORTING GOODS

FOR HAND-HELD UNITS FOR PLAYING ELECTRONIC GAMES (U.S. CLS. 22, 23, 38 AND 50).
JENNIFER MARTIN, EXAMINING ATTORNEY

SN 79-001,550. YAMATOMO KOSAN KABUSHIKI KAISHA, JAPAN, FILED 11-20-2003.

MAZATROL

THE MARK CONSISTS OF STANDARD CHARACTERS WITHOUT CLAIM TO ANY PARTICULAR FONT, STYLE, SIZE, OR COLOR.
OWNER OF INTERNATIONAL REGISTRATION 0821079 DATED 11-20-2003, EXPIRES 11-20-2013.
OWNER OF U.S. REG. NO. 1,335,216.

CLASS 7—MACHINERY

FOR METAL WORKING MACHINES, NAMELY, MACHINING CENTERS, DRILLING MACHINES, CUTTING MACHINES, LATHES, BORING MACHINES, THREADING MACHINES, MILLING MACHINES, BENDING MACHINES; PLASTIC PROCESSING MACHINES, NAMELY, COMPRESSION MOLDING MACHINES, INJECTION MOLDING MACHINES AND EXTRUSION MOLDING MACHINES; AND WOODWORKING MACHINES, NAMELY, CIRCULAR SAWS, PLANERS, WOOD LATHES AND WOOD DRILLS (U.S. CLS. 13, 19, 21, 23, 31, 34 AND 35).

CLASS 9—ELECTRICAL AND SCIENTIFIC APPARATUS

FOR COMPUTERS; COMPUTER SOFTWARE FOR OPERATING METAL WORKING MACHINES, PLASTIC PROCESSING MACHINES AND WOODWORKING MACHINES; AND COMPUTER OPERATED NUMERICAL CONTROLLERS USED FOR MACHINE TOOLS (U.S. CLS. 21, 23, 26, 36 AND 38).

PATRICIA EVANKO, EXAMINING ATTORNEY

SN 79-001,564. SOCIETE ANONYME DES BAINS DE MER; ET DU CERCLE DES ETRANGERS A MONACO, MONACO, FILED 12-1-2003.

HOTEL DE PARIS - MONTE-CARLO

THE MARK CONSISTS OF STANDARD CHARACTERS WITHOUT CLAIM TO ANY PARTICULAR FONT, STYLE, SIZE, OR COLOR.

PRIORITY DATE OF 8-28-2003 IS CLAIMED.

OWNER OF INTERNATIONAL REGISTRATION 0821192 DATED 12-1-2003, EXPIRES 12-1-2013.

THE ENGLISH TRANSLATION OF HOTEL DE PARIS IS HOTEL OF PARIS.
SEC. 2(F).

CLASS 9—ELECTRICAL AND SCIENTIFIC APPARATUS

FOR DIGITAL CAMERAS; EYEGLASSES AND SUNGLASSES; RADIO RECEIVERS; VIDEO MONITORS, TELEVISION SETS AND VIDEO CAMERAS; BLANK AUDIO; DISCS; SLOT MACHINES, COIN CHANGERS, GAMING MACHINES AND COIN SEPARATORS FOR SEPARATING AUTHENTIC COINS FROM COUNTERFEITS; DATA PROCESSING EQUIPMENT, NAMELY COMMUNICATION SERVERS, COMPUTERS, COMMUNICATION SOFTWARE FOR CONNECTING GLOBAL COMPUTER NETWORKS, CAMERAS FOR COMPUTERS, COMPUTER GAME SOFTWARE, AND COMPUTER SOFTWARE FOR ALLOWING USERS TO CARRY OUT BUSINESS TRANSACTIONS VIA A GLOBAL COMPUTER NETWORK (U.S. CLS. 21, 23, 26, 36 AND 38).

CLASS 11—ENVIRONMENTAL CONTROL APPARATUS

FOR REFRIGERATORS; CLOTHES DRYERS; HAIR DRYERS; PORTABLE ELECTRIC HEATERS; HOT WATER HEATERS; AIR CONDITIONERS; ELECTRIC BEVERAGE HEATERS, AND ELECTRIC COFFEE POTS (U.S. CLS. 13, 21, 23, 31 AND 34).

CLASS 21—HOUSEWARES AND GLASS

FOR GLASSWARE FOR BEVERAGES; PORCELAIN AND EARTHENWARE BOWLS AND DISHES; PORCELAIN ORNAMENTS AND SCULPTURE; EARTHENWARE STATUES; CONTAINERS FOR HOUSEHOLD USE; HOUSEHOLD OR KITCHEN UTENSILS, NAMELY, CLOTHES BRUSHES, POT AND PAN SCRAPERS, ROLLING PINS, WHISKS, GRATERS, SIEVES, STRAINERS, SKIMMERS, TURNERS, AND SPATULAS (U.S. CLS. 2, 13, 23, 29, 30, 33, 40 AND 50).

CLASS 24—FABRICS

FOR BED COVERS AND TABLE COVERS MADE OF FABRIC, NAMELY BED LINEN, BLANKETS, SHEETS, TABLE CLOTHS, NAPKINS AND PLACE MATS (U.S. CLS. 42 AND 50).

CLASS 38—COMMUNICATION

FOR PROVIDING TELECOMMUNICATION CONNECTION TO A GLOBAL COMPUTER NETWORK; REAL-TIME CONNECTION SERVICES BETWEEN COMPUTER USERS FOR THE EXCHANGE OF INFORMATION RELATING TO ENTERTAINMENT, HOTEL SERVICES AND CATERING (U.S. CLS. 100, 101 AND 104).

CLASS 41—EDUCATION AND ENTERTAINMENT

FOR ENTERTAINMENT IN THE NATURE OF PRESENTATION OF LIVE MUSICAL GROUPS, TELEVISION COMEDY SERIES, BEAUTY, PAGEANTS, DANCE PERFORMANCES; PROVIDING AN ONLINE DATABASE FEATURING ENTERTAINMENT IN THE NATURE OF GAMES, COMPETITIONS, DISCUSSION FORUMS; AND ORGANIZING COMMUNITY CULTURAL EVENTS (U.S. CLS. 100, 101 AND 107).

CLASS 43—HOTEL AND RESTAURANT SERVICES

FOR HOTEL SERVICES; HOTEL RESERVATION SERVICES FOR OTHERS; CATERING SERVICES; RESTAURANT AND BAR SERVICES (U.S. CLS. 100 AND 101).
JACQUELINE A. LAVINE, EXAMINING ATTORNEY

SN 79-001,860. CLAUDIUS PETERS TECHNOLOGIES GMBH, FED REP GERMANY, FILED 3-10-2004.

PRIORITY DATE OF 11-24-2003 IS CLAIMED.

OWNER OF INTERNATIONAL REGISTRATION 0822251 DATED 3-10-2004, EXPIRES 3-10-2014.

THE GREEK SYMBOL WHICH LOOKS LIKE AN "N" IS THE GREEK LETTER, "ETA" WHICH SUGGESTS "TECHNICAL EFFICIENCY".

CLASS 7—MACHINERY

FOR CONVEYER MACHINES, CRUSHERS AND SIEVES FOR MATERIAL TO BE COOLED (U.S. CLS. 13, 19, 21, 23, 31, 34 AND 35).

CLASS 11—ENVIRONMENTAL CONTROL APPARATUS

FOR COOLING APPARATUS AND COOLING MACHINES FOR INDUSTRIAL PURPOSES, PARTICULARLY COOLERS FOR BURNED MATERIAL (U.S. CLS. 13, 21, 23, 31 AND 34).

CLASS 42—SCIENTIFIC, COMPUTER AND LEGAL SERVICES

FOR ENGINEERING (U.S. CLS. 100 AND 101).
AMY HELLA, EXAMINING ATTORNEY

SN 79-001,965. REMEDENT, BELGIUM, FILED 3-18-2004.

CleverWhite

THE MARK CONSISTS OF STANDARD CHARACTERS WITHOUT CLAIM TO ANY PARTICULAR FONT, STYLE, SIZE, OR COLOR.

PRIORITY DATE OF 10-24-2003 IS CLAIMED.
OWNER OF INTERNATIONAL REGISTRATION 0822670 DATED 3-18-2004, EXPIRES 3-18-2014.

CLASS 3—COSMETICS AND CLEANING PREPARATIONS

FOR TOOTHPASTE; PREPARATIONS FOR CLEANING TEETH, BRACES AND DENTURES; PREPARATIONS FOR WHITENING TEETH; NON-MEDICATED PREPARATIONS FOR ORAL HYGIENE (U.S. CLS. 1, 4, 6, 50, 51 AND 52).

CLASS 5—PHARMACEUTICALS

FOR MEDICATED PREPARATIONS FOR ORAL HYGIENE; DENTAL CEMENTS; DENTAL IMPRESSION MATERIALS; LACQUER AND FILLER MATERIAL FOR TEETH; MEDICATED DENTAL PREPARATIONS FOR CLEANING AND WHITENING OF TEETH, BRACES AND DENTURES; DISINFECTANTS, NAMELY, ALL-PURPOSE DISINFECTANTS; DISINFECTANTS FOR HYGIENIC PURPOSES; DISINFECTANTS FOR MEDICAL INSTRUMENTS; DISINFECTANTS FOR SANITARY PURPOSES; DISINFECTANTS FOR CONTACT LENSES; STERILIZING PREPARATIONS, NAMELY, SANITARY STERILIZING PREPARATIONS (U.S. CLS. 6, 18, 44, 46, 51 AND 52).

CLASS 10—MEDICAL APPARATUS

FOR TONGUE SCRAPERS (U.S. CLS. 26, 39 AND 44).
MICHAEL HALL, EXAMINING ATTORNEY

SN 79-002,530. MODI & MODA S.P.A., ITALY, FILED 12-4-2003.



PRIORITY DATE OF 6-17-2003 IS CLAIMED.
OWNER OF INTERNATIONAL REGISTRATION 0824736 DATED 12-4-2003, EXPIRES 12-4-2013.

NO CLAIM IS MADE TO THE EXCLUSIVE RIGHT TO USE "FASHION", APART FROM THE MARK AS SHOWN.

THE MARK CONSISTS OF THE EXPRESSION MODI & MODA IN BLOCK CAPITAL LETTERS; MODI IS INSIDE A GEOMETRIC SHAPE MADE OF A RECTANGLE, THE BASE OF WHICH IS BIGGER THAN THE HEIGHT; IT IS COMBINED WITH THE BASE BY A SEMI-CIRCUMFERENCE TOWARDS THE BOTTOM AND IT HAS ITS DIAMETER AS THE BASE OF THE SAME RECTANGLE; MODA IS INSIDE A GEOMETRIC SHAPE MADE BY A RECTAN-

GLE, THE BASE OF WHICH IS SMALLER THAN THE HEIGHT; AT THE LEVEL OF THE HEIGHT IT IS COMBINED WITH A SEMI-CIRCUMFERENCE OUTSIDE, AND IT HAS THE DIAMETER AS THE HEIGHT OF THE SAME RECTANGLE; THE HEIGHT OF THE GEOMETRIC SHAPE WHERE MODI IS, IS THE SAME AS THE HEIGHT OF THE RECTANGLE OF THE GEOMETRIC SHAPE WHERE MODA IS; BOTH GEOMETRIC SHAPES COME UP BY THE SIDE OF EACH OTHER AND ARE ALIGNED AND DIVIDED BY THE LETTER "&".

THE ENGLISH TRANSLATION OF THE WORDING MODI AND MODA IN THE MARK IS "MANNERS AND FASHION."

CLASS 18—LEATHER GOODS

FOR LEATHER AND IMITATION SOLD IN BULK; HANDBAGS, SHOULDER BAGS, CLUTCH BAGS, DUFFEL BAGS, ATHLETIC BAGS, TRAVELING BAGS, SUITCASES, COSMETIC CASES SOLD EMPTY, WALLET; ANIMAL SKINS, HIDES; TRUNKS; UMBRELLAS, PARASOLS AND WALKING STICKS WHIPS AND SADDLERY (U.S. CLS. 1, 2, 3, 22 AND 41).

CLASS 25—CLOTHING

FOR CLOTHING, NAMELY, TROUSERS, PANTS, KNICKERS, SHORTS, UNDERWEAR, BRAS, CORSETS, SINGLET, SHIRTS, CHEMISETTES, PAJAMAS, SWEATSHIRTS, PULLOVERS, HOUSECOATS, JACKETS, RAINWEAR, ANORAKS, COATS, TOPCOATS, PELERINES, SKIRTS, DRESSES, FROCKS, BLOUSES, SUITS, SLACKS, OVERALLS, JOGGING SUITS, FUR COATS, FUR JACKETS, FUR STOLE, SASHES, SHAWLS, SCARVES, SOCKS, STOCKINGS, TIGHTS, SPORT AND ATHLETIC CLOTHING, NAMELY, SWEATPANTS, SWEATSHIRTS, SWEAT SUITS, T-SHIRTS, SOCKS, SHIRTS; GLOVES, BATHING SUITS, BATHROBES, BELTS, TIES; HEADGEAR, NAMELY, HATS AND CAPS; FOOTWEAR (U.S. CLS. 22 AND 39).

ESTHER A. BORSUK, EXAMINING ATTORNEY

SN 79-002,657. SICHUAN PIXIANDOUBAN CO., LTD., CHENGDU, SICHUAN 611730, CHINA, FILED 3-19-2004.



OWNER OF INTERNATIONAL REGISTRATION 0825206 DATED 3-19-2004, EXPIRES 3-19-2014.

THE ENGLISH TRANSLATION OF THE FOREIGN CHARACTER IN THE MARK IS BENEFIT, PLENTIFUL, MILD OR PEACE, AND TRUMPET.

THE TRANSLITERATION OF THE MARK IS "YI FENG HE HAO".

CLASS 29—MEATS AND PROCESSED FOODS

FOR SAUERKRAUT, PRESERVED VEGETABLES, GINGER JAM, VEGETABLE SOUP PREPARATIONS, PICKLES, PRESERVED SZECHUAN PICKLES, PRESERVED BEAN CURD, PRESERVED KOHLRABI, DRIED TURNIP, SESAME OIL (U.S. CL. 46).

MAY 24, 2005

U.S. PATENT AND TRADEMARK OFFICE

TM 181

CLASS 30—STAPLE FOODS

DOUGLAS LEE, EXAMINING ATTORNE

FOR SEASONINGS, SOY SAUCE, VINEGAR, AND
CONDIMENTS, NAMELY, BLACK BEAN SAUCE,
SAUCES, CHOW-CHOW, RELISH, MASHED GARLIC,
AND THICK CHILI SAUCE (U.S. CL. 46).

* * * * *

SECTION 2.— INTERNATIONAL CLASSIFICATION

The short titles associated below with the international class numbers are terms designed merely for quick identification and are not an official part of the international classification. The full names of international classes are given in section 6.1 of the trademark rules of practice.

The designation "U.S. Cl." appearing in this section refers to the U.S. class in effect prior to Sep. 1, 1973 rather than the international class which applies to applications filed on or after that date. For adoption of international classification see notice in the OFFICIAL GAZETTE of Jun. 26, 1973 (911 O.G. TM 210).

Application in one class

CLASS 1—CHEMICALS

SN 76-577,871. CIBA SPECIALTY CHEMICAL CORPORATION, TARRYTOWN, NY. FILED 2-26-2004.

CLASS 1—(Continued).

SN 76-588,176. EASTERN LEISURE LTD., NEW ROCHELLE, NY. FILED 4-22-2004.

KRYVALIS

THE MARK CONSISTS OF STANDARD CHARACTERS WITHOUT CLAIM TO ANY PARTICULAR FONT, STYLE, SIZE, OR COLOR.

OWNER OF U.S. REG. NO. 2,802,759.

FOR POLYMERS FOR USE AS FLOCCULANTS, COAGULANTS, RETENTION AIDS, RUNNABILITY AID, DEWATERING AIDS, PROCESS AIDS, VISCOSIFIERS, SEPARATION AND CLARIFICATION AIDS FOR USE IN THE MANUFACTURE OF PAPER, WASTE WATER TREATMENTS AND MINING USED IN MUNICIPAL, INDUSTRIAL AND EXTRACTIVE INDUSTRIES (U.S. CLS. 1, 5, 6, 10, 26 AND 46).

FIRST USE 3-20-2003; IN COMMERCE 3-20-2003.
ELISSA GARBER KON, EXAMINING ATTORNEY

EASTERN LEISURE

THE MARK CONSISTS OF STANDARD CHARACTERS WITHOUT CLAIM TO ANY PARTICULAR FONT, STYLE, SIZE, OR COLOR.

FOR CHEMICALS FOR SWIMMING POOLS AND SPAS (U.S. CLS. 1, 5, 6, 10, 26 AND 46).

FIRST USE 0-0-1991; IN COMMERCE 0-0-1991.
ROBERT COGGINS, EXAMINING ATTORNEY

SN 76-584,685. LADD, NANCY L., SEMINOLE, OK. FILED 3-29-2004.

MAN-DIRT

Rich and Healthy

FOR DIRT, NAMELY, POTTING SOIL IN BAGS OR JARS AS A GAG GIFT FAITH-BUILDING TOOL (U.S. CLS. 1, 5, 6, 10, 26 AND 46).

FIRST USE 1-1-1976; IN COMMERCE 8-1-2003.
ALLISON HOLTZ, EXAMINING ATTORNEY

SN 76-590,866. ROYSTER-CLARK RESOURCES, LLC, NEW YORK, NY. FILED 5-6-2004.

NUTRITION MAX

NO CLAIM IS MADE TO THE EXCLUSIVE RIGHT TO USE NUTRITION, APART FROM THE MARK AS SHOWN. FOR LIQUID MICRONUTRIENT FERTILIZER (U.S. CLS. 1, 5, 6, 10, 26 AND 46).

FIRST USE 4-0-2004; IN COMMERCE 4-0-2004.
JENNIFER KRISP, EXAMINING ATTORNEY

CLASS 1—(Continued).

SN 76-592,838. STRATAGENE CALIFORNIA, LA JOLLA, CA.
FILED 5-18-2004.

PROLYTICA

THE MARK CONSISTS OF STANDARD CHARACTERS
WITHOUT CLAIM TO ANY PARTICULAR FONT, STYLE,
SIZE, OR COLOR.

FOR SCIENTIFIC REAGENTS FOR LIFE SCIENCES
RESEARCH USE (U.S. CLS. 1, 5, 6, 10, 26 AND 46).
WON TEAK OH, EXAMINING ATTORNEY

SN 76-597,026. MBL INTERNATIONAL CORPORATION,
WOBURN, MA. FILED 6-10-2004.

CORALHUE

THE MARK CONSISTS OF STANDARD CHARACTERS
WITHOUT CLAIM TO ANY PARTICULAR FONT, STYLE,
SIZE, OR COLOR.

FOR PROTEINS, ANTIBODIES AND VECTORS RE-
LATED TO FLUORESCENT PROTEINS USED FOR
BIOLOGICAL ASSAYS AND RESEARCH (U.S. CLS. 1, 5,
6, 10, 26 AND 46).

FIRST USE 3-26-2004; IN COMMERCE 3-26-2004.
BARBARA BROWN, EXAMINING ATTORNEY

SN 76-597,431. SELECTO SCIENTIFIC, INC., SUWANEE, GA.
FILED 6-16-2004.

NANOSTICK

THE MARK CONSISTS OF STANDARD CHARACTERS
WITHOUT CLAIM TO ANY PARTICULAR FONT, STYLE,
SIZE, OR COLOR.

FOR CHEMICAL COMPOUNDS AND MEDIA FOR
USE IN THE REDUCTION AND DESTRUCTION OF
MICROORGANISMS (U.S. CLS. 1, 5, 6, 10, 26 AND 46).

DOMINIC J. FERRAIUOLO, EXAMINING ATTORNEY

CLASS 1—(Continued).

SN 76-598,125. SPECIALTY POLYMERS PRODUCTS, INC.,
WOODBURN, OR. FILED 6-18-2004.

RAYREZ

THE MARK CONSISTS OF STANDARD CHARACTERS
WITHOUT CLAIM TO ANY PARTICULAR FONT, STYLE,
SIZE, OR COLOR.

FOR HOUSE MARK FOR A LINE OF WATER BASED
POLYMERIC BINDERS USED IN THE MANUFACTURE
OF COATINGS FOR THE ARCHITECTURAL, ROOF
TILE, CONCRETE, INDUSTRIAL WOOD, GRAPHIC
ARTS AND PAPER COATING MARKETS (U.S. CLS. 1,
5, 6, 10, 26 AND 46).

FIRST USE 5-15-2004; IN COMMERCE 5-15-2004.
CIMMERIAN COLEMAN, EXAMINING ATTORNEY

SN 76-599,366. BECKER-UNDERWOOD, INC., AMES, IA.
FILED 6-24-2004.

VAULT

THE MARK CONSISTS OF STANDARD CHARACTERS
WITHOUT CLAIM TO ANY PARTICULAR FONT, STYLE,
SIZE, OR COLOR.

FOR LIQUID SEED TREATMENT POLYMERS (U.S.
CLS. 1, 5, 6, 10, 26 AND 46).

FRED MANDIR, EXAMINING ATTORNEY

SN 78-150,708. TURTLE WAX, INC., CHICAGO, IL. FILED 8-
5-2002.

ADRENALINE

FOR CHEMICAL MOTOR OIL ADDITIVES (U.S. CLS.
1, 5, 6, 10, 26 AND 46).

MARIA-VICTORIA SUAREZ, EXAMINING ATTORNEY

SN 78-180,859. CAY HOLDINGS LTD., WILMINGTON, DE.
FILED 11-1-2002.

SOLUMITE

FOR CHEMICAL POLYMER FOR USE IN SAND AND
SOIL, USED TO STABILIZE AND PREVENT DUST AND
EROSION ON SUCH SURFACES, FOR USE IN AGRI-
CULTURE, HORTICULTURE, VITACULTURE, AND
CONSTRUCTION (U.S. CLS. 1, 5, 6, 10, 26 AND 46).

FIRST USE 1-1-2001; IN COMMERCE 1-1-2001.
STEVEN R. FOSTER, EXAMINING ATTORNEY

CLASS 1—(Continued).

SN 78-200,609. APPLERA CORPORATION, FOSTER CITY, CA. FILED 1-7-2003.

ZIPCHUTE

FOR REAGENTS FOR SCIENTIFIC OR RESEARCH USE; DIAGNOSTIC PREPARATIONS AND REAGENTS FOR SCIENTIFIC OR RESEARCH USE; REAGENTS FOR FORENSICS AND PATERNITY USE; CHEMICALS USED FOR SCIENTIFIC OR MEDICAL RESEARCH USE; CHEMICALS USED FOR FORENSICS AND PATERNITY USE (U.S. CLS. 1, 5, 6, 10, 26 AND 46).

REBECCA GILBERT, EXAMINING ATTORNEY

CLASS 1—(Continued).

SN 78-323,010. LESLIE'S POOLMART, INC., PHOENIX, AZ. FILED 11-4-2003.



SN 78-291,152. NATIONAL AUTOMOTIVE PARTS ASSOCIATION, ATLANTA, GA. FILED 8-22-2003.



NO CLAIM IS MADE TO THE EXCLUSIVE RIGHT TO USE "PROFESSIONAL", APART FROM THE MARK AS SHOWN.

THE STIPPLING IS A FEATURE OF THE MARK. FOR CHEMICAL FORMULATIONS FOR TREATING VEHICLE OIL CRANKCASES, FUEL SYSTEMS, TRANSMISSIONS, POWER STEERING SYSTEMS AND COOLING SYSTEMS (U.S. CLS. 1, 5, 6, 10, 26 AND 46).

ANN LINNEHAN, EXAMINING ATTORNEY

THE NAME LESLIE IDENTIFIES A LIVING INDIVIDUAL WHOSE CONSENT IS OF RECORD.

THE MARK CONSIST OF THE WORD LESLIE'S WITH AN UMBRELLA SHAPED DESIGN OF WAVES AT THE L AND E AND A WAVE BELOW THE WORDS.

FOR CHEMICALS USED TO SANITIZE AND TREAT WATER; SWIMMING POOLS AND SPAS; WATER TEST KITS, NAMELY, CHEMICAL ANALYSIS KIT FOR TESTING SWIMMING POOLS AND SPAS (U.S. CLS. 1, 5, 6, 10, 26 AND 46).

FIRST USE 1-31-1994; IN COMMERCE 1-31-1994. CAROLYN GRAY, EXAMINING ATTORNEY

SN 78-327,645. COLETICA, LYON, FRANCE, FILED 11-13-2003.

SN 78-301,857. DANNIER CHEMICAL, INC., TUSTIN, CA. FILED 9-17-2003.

PolyAid
POLYMER PERFORMANCE ADDITIVES

NO CLAIM IS MADE TO THE EXCLUSIVE RIGHT TO USE "POLYMER PERFORMANCE ADDITIVES", APART FROM THE MARK AS SHOWN.

THE STIPPLING IS FOR SHADING PURPOSES ONLY. THE MARK CONSISTS OF STYLIZED LETTERS DESCRIBING THE MARK, POLY AID, AND ASSOCIATED PRODUCTS, POLYMER PERFORMANCE ADDITIVES.

FOR CHEMICAL ADDITIVES FOR USE IN THE MANUFACTURE OF LUBRICANTS, PAINT AND COATINGS, RUBBER AND PLASTICS, AND TEXTILES (U.S. CLS. 1, 5, 6, 10, 26 AND 46).

FIRST USE 1-30-2003; IN COMMERCE 1-30-2003. NAAKWAMA ANKRAH, EXAMINING ATTORNEY

CYTOVECTOR

THE MARK CONSISTS OF STANDARD CHARACTERS WITHOUT CLAIM TO ANY PARTICULAR FONT, STYLE, SIZE, OR COLOR.

OWNER OF FRANCE REG. NO. 013093363, DATED 4-4-2001, EXPIRES 4-4-2011.

FOR BIOLOGICAL OR CHEMICAL ADDITIONS FOR USE IN THE MANUFACTURE OF COSMETICS FORMULATIONS (U.S. CLS. 1, 5, 6, 10, 26 AND 46).

RONALD MCMORROW, EXAMINING ATTORNEY

CLASS 1—(Continued).

SN 78-334,233. STEFANDL, ROLAND, PENNINGTON, NJ. FILED 11-30-2003.

CLASS 1—(Continued).

SN 78-344,243. INTEGRATED DNA TECHNOLOGIES, INC., SKOKIE, IL. FILED 12-22-2003.

NANOLON

SAMEDAY

THE MARK CONSISTS OF STANDARD CHARACTERS WITHOUT CLAIM TO ANY PARTICULAR FONT, STYLE, SIZE, OR COLOR.

FOR RESINOUS PLASTICS AND POLYMERS IN THE FORM OF POWDER, GRANULES, FLAKES, PELLETS, BEADS, FIBERS, BLANKS, SLABS, CHIPS, SHEETS, AND THE LIKE FOR MOLDING APPLICATIONS AND ALL OTHER USE IN INDUSTRIAL ARTS AND INDUSTRIAL TECHNOLOGIES (U.S. CLS. 1, 5, 6, 10, 26 AND 46).

FIRST USE 9-15-2001; IN COMMERCE 11-1-2003.
PRISCILLA MILTON, EXAMINING ATTORNEY

THE MARK CONSISTS OF STANDARD CHARACTERS WITHOUT CLAIM TO ANY PARTICULAR FONT, STYLE, SIZE, OR COLOR.

FOR CHEMICAL REAGENTS FOR SCIENTIFIC OR MEDICAL RESEARCH USE, NAMELY, OLIGONUCLEOTIDES (U.S. CLS. 1, 5, 6, 10, 26 AND 46).

FIRST USE 1-14-1999; IN COMMERCE 1-14-1999.
JIM RINGLE, EXAMINING ATTORNEY

SN 78-344,273. INTEGRATED DNA TECHNOLOGIES, INC., SKOKIE, IL. FILED 12-22-2003.

SN 78-344,189. INTEGRATED DNA TECHNOLOGIES, INC., SKOKIE, IL. FILED 12-22-2003.

IOWA BLACK

XXIDT

THE MARK CONSISTS OF STANDARD CHARACTERS WITHOUT CLAIM TO ANY PARTICULAR FONT, STYLE, SIZE, OR COLOR.

NO CLAIM IS MADE TO THE EXCLUSIVE RIGHT TO USE "BLACK", APART FROM THE MARK AS SHOWN.

FOR REAGENTS FOR SCIENTIFIC OR MEDICAL RESEARCH USE, NAMELY, DYES (U.S. CLS. 1, 5, 6, 10, 26 AND 46).

FIRST USE 9-25-2002; IN COMMERCE 9-25-2002.
JIM RINGLE, EXAMINING ATTORNEY

THE MARK CONSISTS OF STANDARD CHARACTERS WITHOUT CLAIM TO ANY PARTICULAR FONT, STYLE, SIZE, OR COLOR.

OWNER OF U.S. REG. NO. 1,686,878.

FOR REAGENTS FOR SCIENTIFIC OR MEDICAL RESEARCH USE, NAMELY, OLIGONUCLEOTIDES AND CHEMICALS USED FOR THEIR SYNTHESIS (U.S. CLS. 1, 5, 6, 10, 26 AND 46).

FIRST USE 8-7-1990; IN COMMERCE 8-7-1990.
JIM RINGLE, EXAMINING ATTORNEY

CLASS 1—(Continued).

SN 78-349,188. EASTMAN KODAK COMPANY, ROCHESTER, NY. FILED 1-8-2004.

EKTACOLOR

THE MARK CONSISTS OF STANDARD CHARACTERS WITHOUT CLAIM TO ANY PARTICULAR FONT, STYLE, SIZE, OR COLOR.
OWNER OF U.S. REG. NOS. 763,900, 1,905,212 AND OTHERS.

FOR PHOTOGRAPHIC CHEMICALS (U.S. CLS. 1, 5, 6, 10, 26 AND 46).

FIRST USE 10-31-1975; IN COMMERCE 10-31-1975.
LANA PHAM, EXAMINING ATTORNEY

SN 78-356,892. FLEXSYS AMERICA, L.P., AKRON, OH. FILED 1-23-2004.

FLEXSYS

THE MARK CONSISTS OF STANDARD CHARACTERS WITHOUT CLAIM TO ANY PARTICULAR FONT, STYLE, SIZE, OR COLOR.

FOR CHEMICALS FOR RUBBER PROCESSING SUCH AS VULCANIZATION ACCELERATORS, ANTIOXIDANTS, ANTIDEGRADANTS AND ANTIOZONANTS FOR USE IN THE TIRE AND RUBBER PROCESSING INDUSTRIES (U.S. CLS. 1, 5, 6, 10, 26 AND 46).

FIRST USE 5-0-1995; IN COMMERCE 5-0-1995.
SCOTT BALDWIN, EXAMINING ATTORNEY

CLASS 1—(Continued).

SN 78-356,899. FLEXSYS AMERICA, L.P., AKRON, OH. FILED 1-23-2004.



FOR CHEMICALS FOR RUBBER PROCESSING SUCH AS VULCANIZATION ACCELERATORS, ANTIOXIDANTS, ANTIDEGRADANTS AND ANTIOZONANTS FOR USE IN THE TIRE AND RUBBER PROCESSING INDUSTRIES (U.S. CLS. 1, 5, 6, 10, 26 AND 46).

FIRST USE 5-0-1995; IN COMMERCE 5-0-1995.
SCOTT BALDWIN, EXAMINING ATTORNEY

SN 78-365,558. GENERAL ELECTRIC COMPANY, SCHENECTADY, NY. FILED 2-10-2004.

ANCHORSIL 2000

THE MARK CONSISTS OF STANDARD CHARACTERS WITHOUT CLAIM TO ANY PARTICULAR FONT, STYLE, SIZE, OR COLOR.

FOR SILICONE ADDITIVES FOR USE WITH THERMALLY CURED, SOLVENTLESS RELEASE SYSTEMS CROSSLINKED TO A SOLID ADHESIVE RELEASE SURFACE ON PAPER, FILM OR FILM LAMINATE SUBSTRATES (U.S. CLS. 1, 5, 6, 10, 26 AND 46).

DAVID TAYLOR, EXAMINING ATTORNEY

SN 78-372,048. KURITA WATER INDUSTRIES LTD., TOKYO, JAPAN, FILED 2-23-2004.

KURIVERTER

THE MARK CONSISTS OF STANDARD CHARACTERS WITHOUT CLAIM TO ANY PARTICULAR FONT, STYLE, SIZE, OR COLOR.

FOR CHEMICAL AGENT USED FOR NEUTRALIZING RESIDUAL PEROXIDE OR RESIDUAL CHLORINE FROM WATER, NAMELY WASTEWATER OR WATER FOR INDUSTRIAL USE IN PRODUCING PURE OR ULTRA PURE WATER, AND FROM WASTEWATER TREATMENT UNITS, FOR INDUSTRIAL USE (U.S. CLS. 1, 5, 6, 10, 26 AND 46).

STEVEN R. FOSTER, EXAMINING ATTORNEY

CLASS 1—(Continued).

SN 78-381,972. BAKER, BARBRA L, BATON ROUGE, LA. FILED 3-10-2004.



NO CLAIM IS MADE TO THE EXCLUSIVE RIGHT TO USE "SUPER POLY ABSORBENT", APART FROM THE MARK AS SHOWN.
THE COLOR(S) BLUE, BLUEGREEN, & WHITE IS/ARE CLAIMED AS A FEATURE OF THE MARK.
THE MARK CONSISTS OF A BLUE BAND AROUND AND OVAL. THE INSIDE OF THE OVAL IS BLUEGREEN ON A BACKGROUND OF WATER DROPLETS.
FOR ABSORBENT MATERIAL IN THE NATURE OF A POWDER USED FOR THE ENCAPSULATION AND CLEANUP OF LIQUID WASTER MATERIALS (U.S. CLS. 1, 5, 6, 10, 26 AND 46).
PAULA MAYS, EXAMINING ATTORNEY

CLASS 1—(Continued).

SN 78-411,410. J.M. HUBER CORPORATION, EDISON, NJ. FILED 4-30-2004.

HUBERPRIME

THE MARK CONSISTS OF STANDARD CHARACTERS WITHOUT CLAIM TO ANY PARTICULAR FONT, STYLE, SIZE, OR COLOR.
OWNER OF U.S. REG. NOS. 507,848, 2,827,863 AND OTHERS.
FOR KAOLIN CLAY PARTICLES, WHICH MAY BE USED IN THE MANUFACTURE OF PAPER OR PAPERBOARD AS A COATING PIGMENT OR FILLER (U.S. CLS. 1, 5, 6, 10, 26 AND 46).
FIRST USE 4-5-2004; IN COMMERCE 4-5-2004.
ELIZABETH J. WINTER, EXAMINING ATTORNEY

SN 78-397,975. VANSON HALOSOURCE, INC., REDMOND, WA. FILED 4-7-2004.

STORM KLEAR

THE MARK CONSISTS OF STANDARD CHARACTERS WITHOUT CLAIM TO ANY PARTICULAR FONT, STYLE, SIZE, OR COLOR.
NO CLAIM IS MADE TO THE EXCLUSIVE RIGHT TO USE "CLEAR", APART FROM THE MARK AS SHOWN.
FOR COAGULANT AND LIQUID CLEARING AND SETTLING COMPOUNDS AND SOLUTIONS TO CLEAR FRESH AND SALT WATER OF SILT, SUSPENDED MATERIAL OR COLORED MATTER (U.S. CLS. 1, 5, 6, 10, 26 AND 46).
FIRST USE 8-3-2001; IN COMMERCE 8-3-2001.
BRETT J. GOLDEN, EXAMINING ATTORNEY

SN 78-424,262. SETO HOLDINGS, INC., BRIARCLIFF MANOR, NY. FILED 5-25-2004.

RootShooter

THE MARK CONSISTS OF STANDARD CHARACTERS WITHOUT CLAIM TO ANY PARTICULAR FONT, STYLE, SIZE, OR COLOR.
FOR ORGANIC FERTILIZER FOR AGRICULTURAL AND CONSUMER LAWN AND GARDEN USES (U.S. CLS. 1, 5, 6, 10, 26 AND 46).
DOUGLAS LEE, EXAMINING ATTORNEY

CLASS 1—(Continued).

SN 78-425,548. MEADWESTVACO CORPORATION, STAMFORD, CT. FILED 5-26-2004.

STACAT

THE MARK CONSISTS OF STANDARD CHARACTERS WITHOUT CLAIM TO ANY PARTICULAR FONT, STYLE, SIZE, OR COLOR.

OWNER OF U.S. REG. NO. 1,223,048.
FOR TALL OIL ROSIN SIZING AGENTS FOR USE IN THE MANUFACTURE OF PAPER (U.S. CLS. 1, 5, 6, 10, 26 AND 46).

BRETT J. GOLDEN, EXAMINING ATTORNEY

CLASS 1—(Continued).

SN 78-428,678. CP INDUSTRIES INC, SALT LAKE CITY, UT. FILED 6-2-2004.

MELTIUM SUB-ZERO

THE MARK CONSISTS OF STANDARD CHARACTERS WITHOUT CLAIM TO ANY PARTICULAR FONT, STYLE, SIZE, OR COLOR.

OWNER OF U.S. REG. NO. 2,848,951.
NO CLAIM IS MADE TO THE EXCLUSIVE RIGHT TO USE "SUB-ZERO", APART FROM THE MARK AS SHOWN, FOR CHEMICAL PREPARATIONS FOR MELTING SNOW AND ICE (U.S. CLS. 1, 5, 6, 10, 26 AND 46).
BARBARA RUTLAND, EXAMINING ATTORNEY

SN 78-428,909. FASTER BETTER MEDIA LLC, HUNT VALLEY, MD. FILED 6-2-2004.

SN 78-428,130. EARTHGREEN PRODUCTS INC., DALLAS, TX. FILED 6-1-2004.

BIO-GP

THE MARK CONSISTS OF STANDARD CHARACTERS WITHOUT CLAIM TO ANY PARTICULAR FONT, STYLE, SIZE, OR COLOR.

FOR AGRICULTURAL SOIL AMENDMENTS (U.S. CLS. 1, 5, 6, 10, 26 AND 46).
FIRST USE 3-0-2004; IN COMMERCE 3-0-2004.
JENNIFER KRISP, EXAMINING ATTORNEY

LB

THE MARK CONSISTS OF STANDARD CHARACTERS WITHOUT CLAIM TO ANY PARTICULAR FONT, STYLE, SIZE, OR COLOR.

FOR REAGENTS FOR SCIENTIFIC AND MEDICAL RESEARCH, NAMELY, A CONDUCTIVE CHEMICAL SOLUTION FOR ELECTROPHORETIC SEPARATION OF POLYNUCLEOTIDES COMPRISED OF A MIXTURE OF LITHIUM AND BORIC ACID (U.S. CLS. 1, 5, 6, 10, 26 AND 46).

FIRST USE 8-8-2004; IN COMMERCE 8-8-2004.
BRIDGETT SMITH, EXAMINING ATTORNEY

CLASS 1—(Continued).

SN 78-433,989. UNITED STEEL PRODUCTS COMPANY, INC., MONTGOMERY, MN. FILED 6-11-2004.

CLASS 1—(Continued).

SN 78-436,729. HUNTSMAN POLYMERS CORPORATION, SALT LAKE CITY, UT. FILED 6-17-2004.

COVERT OPERATIONS

REXHERE

THE MARK CONSISTS OF STANDARD CHARACTERS WITHOUT CLAIM TO ANY PARTICULAR FONT, STYLE, SIZE, OR COLOR.

FOR EPOXY ADHESIVES AND SYNTHETIC RESINS FOR REPAIRING AND BONDING BUILDING MATERIALS TO CONCRETE MASONRY, WOOD AND STEEL (U.S. CLS. 1, 5, 6, 10, 26 AND 46).

FIRST USE 12-31-1990; IN COMMERCE 12-31-1991.
ELLEN PERKINS, EXAMINING ATTORNEY

THE MARK CONSISTS OF STANDARD CHARACTERS WITHOUT CLAIM TO ANY PARTICULAR FONT, STYLE, SIZE, OR COLOR.

FOR ADHESIVE MODIFIED POLYETHYLENE RESINS FOR INDUSTRIAL USE (U.S. CLS. 1, 5, 6, 10, 26 AND 46).

BARNEY CHARLON, EXAMINING ATTORNEY

SN 78-434,039. GENERAL ELECTRIC COMPANY, SCHE-NECTADY, NY. FILED 6-11-2004.

SN 78-437,019. CELANESE INTERNATIONAL CORPORATION, DALLAS, TX. FILED 6-17-2004.

FORMASIL

AOPLUS

THE MARK CONSISTS OF STANDARD CHARACTERS WITHOUT CLAIM TO ANY PARTICULAR FONT, STYLE, SIZE, OR COLOR.

FOR SILICONE RESINS USED IN THE MAKING OF HOUSEHOLD GOODS (U.S. CLS. 1, 5, 6, 10, 26 AND 46).
LINDA POWELL, EXAMINING ATTORNEY

THE MARK CONSISTS OF STANDARD CHARACTERS WITHOUT CLAIM TO ANY PARTICULAR FONT, STYLE, SIZE, OR COLOR.

FOR ACETIC ACID FOR INDUSTRIAL APPLICATIONS (U.S. CLS. 1, 5, 6, 10, 26 AND 46).
LAURA KOVAISKY, EXAMINING ATTORNEY

CLASS 1—(Continued).

SN 78-438,000. GENENCOR INTERNATIONAL, INC., PALO ALTO, CA. FILED 6-18-2004.

AMYLEX

THE MARK CONSISTS OF STANDARD CHARACTERS WITHOUT CLAIM TO ANY PARTICULAR FONT, STYLE, SIZE, OR COLOR.

FOR ENZYMES FOR USE IN THE FOOD AND BEVERAGE INDUSTRIES (U.S. CLS. 1, 5, 6, 10, 26 AND 46).

YONG KIM, EXAMINING ATTORNEY

SN 78-439,629. WESTERN FARM SERVICE, INC., FRESNO, CA. FILED 6-22-2004.

CHARGER

THE MARK CONSISTS OF STANDARD CHARACTERS WITHOUT CLAIM TO ANY PARTICULAR FONT, STYLE, SIZE, OR COLOR.

FOR FERTILIZER, STARTER FERTILIZER, PRE-PLANT, SIDEDRESS AND WATER RUN FERTILIZER, DIRECT SEEDING FERTILIZER, SOIL FERTILIZER, FERTILIZER FOR USE IN DRIP IRRIGATION AND MICRO-SPRINKLERS, FERTILIZER FOR USE IN TRANSPORT WATER SOLUTIONS, FERTILIZER FOR USE IN AGRICULTURE, INDUSTRY AND RESIDENCE, FERTILIZER FOR USE WITH CROPS INCLUDING VEGETABLE CROPS, ROW CROPS, FIELD CROPS, TREES, VINES, ORNAMENTALS, LAWNS, GARDENS AND LANDSCAPING (U.S. CLS. 1, 5, 6, 10, 26 AND 46).

KATHRYN COWARD, EXAMINING ATTORNEY

CLASS 1—(Continued).

SN 79-002,743. TAKASAGO KORYO KOGYO KABUSHIKI KAISHA, TA TAKASAGO INTERNATIONAL CORPORATION, OHTA-KU, TOKYO 144-8721, JAPAN, FILED 4-7-2004.

LAURINAL

THE MARK CONSISTS OF STANDARD CHARACTERS WITHOUT CLAIM TO ANY PARTICULAR FONT, STYLE, SIZE, OR COLOR.

PRIORITY DATE OF 3-17-2004 IS CLAIMED. OWNER OF INTERNATIONAL REGISTRATION 0825484 DATED 4-7-2004, EXPIRES 4-7-2014.

OWNER OF U.S. REG. NO. 1,906,992.

FOR CHEMICALS FOR USE IN THE MANUFACTURE OF PERFUMERY, FLAVORINGS, COSMETICS, TOILETRIES AND HOUSEHOLD PRODUCTS; AROMATIC CHEMICALS FOR USE IN THE MANUFACTURE OF PERFUMERY, FLAVORINGS, COSMETICS, TOILETRIES AND HOUSEHOLD PRODUCTS (U.S. CLS. 1, 5, 6, 10, 26 AND 46).

DAVID C. REIHNER, EXAMINING ATTORNEY

SN 79-007,052. CHINA MINMETALS NONFERROUS METALS CO., LTD., CHINA, FILED 6-11-2004.

BRIGHTSUN

PRIORITY DATE OF 5-13-2004 IS CLAIMED. OWNER OF INTERNATIONAL REGISTRATION 0838171 DATED 6-11-2004, EXPIRES 6-11-2014.

FOR ALKALINE METALS; ALUMINIUM HYDRATE; RARE EARTHS; SILICON FOR INDUSTRIAL PURPOSES; ANTIMONY; FIRE EXTINGUISHING COMPOSITIONS; ALUMINIUM OXIDE; ANTIMONY OXIDE; AMMONIUM TUNGSTATE; TUNGSTEN CARBIDE (U.S. CLS. 1, 5, 6, 10, 26 AND 46).

THEODORE MCBRIDE, EXAMINING ATTORNEY

CLASS 2—PAINTS

SN 76-576,805. FAUX EFFECTS INTERNATIONAL, INC., VERO BEACH, FL. FILED 2-19-2004.

METALGLOW

THE MARK CONSISTS OF STANDARD CHARACTERS WITHOUT CLAIM TO ANY PARTICULAR FONT, STYLE, SIZE, OR COLOR.

FOR INTERIOR AND EXTERIOR GLAZES, DECORATIVE FINISHES AND PAINTS (U.S. CLS. 6, 11 AND 16). FIRST USE 2-13-2004; IN COMMERCE 2-13-2004.

PAUL F. GAST, EXAMINING ATTORNEY

CLASS 2—(Continued).

SN 76-577,119. INSL-X PRODUCTS CORPORATION, STONY POINT, NY. FILED 2-24-2004.

THYBONY STOCKHOLM PREMIUM FINISHES

THE MARK CONSISTS OF STANDARD CHARACTERS WITHOUT CLAIM TO ANY PARTICULAR FONT, STYLE, SIZE, OR COLOR.

NO CLAIM IS MADE TO THE EXCLUSIVE RIGHT TO USE "PREMIUM FINISHES", APART FROM THE MARK AS SHOWN.

SEC. 2(F).
FOR PREMIUM-GRADE INTERIOR AND EXTERIOR PAINTS FOR USE BY CONSUMERS AND CONTRACTORS (U.S. CLS. 6, 11 AND 16).

FIRST USE 7-31-1985; IN COMMERCE 7-31-1985.
PAUL F. GAST, EXAMINING ATTORNEY

SN 76-591,017. FLAME SEAL PRODUCTS, INC., HOUSTON, TX. FILED 5-7-2004.

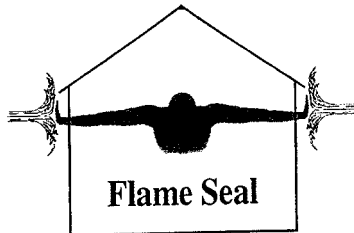

OWNER OF U.S. REG. NOS. 2,422,742, 2,431,363 AND 2,431,645.

FOR WATER BASED FIRE RETARDANT COATINGS FOR BUILDING CONSTRUCTION MATERIALS (U.S. CLS. 6, 11 AND 16).

FIRST USE 7-28-1997; IN COMMERCE 8-6-1997.
MARLENE BELL, EXAMINING ATTORNEY

SN 76-598,890. ZO MINERAL PARTNERS, LTD, SAN ANTONIO, TX. FILED 6-23-2004.

ZOBRITE

THE MARK CONSISTS OF STANDARD CHARACTERS WITHOUT CLAIM TO ANY PARTICULAR FONT, STYLE, SIZE, OR COLOR.

FOR PIGMENT (U.S. CLS. 6, 11 AND 16).
FIRST USE 1-0-1999; IN COMMERCE 1-0-1999.
KELLEY WELLS, EXAMINING ATTORNEY

CLASS 2—(Continued).

SN 76-599,579. RHINO LININGS USA, INC., SAN DIEGO, CA. FILED 6-25-2004.

TUFF STUFF TUFFER THAN A TORNADO

THE MARK CONSISTS OF STANDARD CHARACTERS WITHOUT CLAIM TO ANY PARTICULAR FONT, STYLE, SIZE, OR COLOR.

OWNER OF U.S. REG. NO. 2,187,019.

FOR SPRAYABLE POLYURETHANE COATINGS IN THE NATURE OF LININGS, FOR APPLICATION ON A WIDE VARIETY OF SURFACES, INCLUDING VEHICLES THAT MAY BE DRIVEN INTO A TORNADO (U.S. CLS. 6, 11 AND 16).

SUSAN HAYASH, EXAMINING ATTORNEY

SN 78-175,147. SOUTHERN MILLWORK COMPANY, HOUSTON, TX. FILED 10-16-2002.

THERMOTECH

FOR FINISH COATING APPLIED TO EXTERIOR BUILDING MATERIALS (U.S. CLS. 6, 11 AND 16).
JAMES GRIFFIN, EXAMINING ATTORNEY

SN 78-254,762. SAMHWA PAINTS INDUSTRIES CO. LTD., KYUNGGI-DO, REPUBLIC OF KOREA, FILED 5-27-2003.

SPICLEAR

FOR PAINTS AND STAINS; NAMELY CHEMICAL PROOF PAINTS, VARNISH, LACQUERS, ALUMINUM PAINTS, ENAMELS FOR PAINTING, ANTI-FOULING PAINTS, SYNTHETIC RESIN PAINTS; PRIMING PUTTY, UNDERSEALING FOR VEHICLE CHASSIS; AND THINNERS FOR PAINTS; CHEMICAL PROOF PAINTS, VARNISH, PRIMING PUTTY, LACQUERS, UNDERSEALING FOR VEHICLE CHASSIS, THINNERS FOR PAINTS, ALUMINUM PAINTS, ENAMELS FOR PAINTING, ANTI-FOULING PAINTS, SYNTHETIC RESIN PAINTS (U.S. CLS. 6, 11 AND 16).

FIRST USE 6-13-2003; IN COMMERCE 6-13-2003.

ANDREW BENZMILLER, EXAMINING ATTORNEY

SN 78-291,607. CH2M ENTERPRISES INC., HAMILTON, OH. FILED 8-25-2003.

TEAKGUARD

FOR PAINT FOR USE IN THE MANUFACTURE OF FURNITURE, PAINT FOR USE IN THE MANUFACTURE OF TEAK WOOD PRODUCTS (U.S. CLS. 6, 11 AND 16).

FIRST USE 1-1-1981; IN COMMERCE 1-1-1981.

AISHA CLARKE, EXAMINING ATTORNEY

CLASS 2—(Continued).

SN 78-341,959. RHINO-HIDE, L.L.C., EATON PARK, FL.
FILED 12-17-2003.

CLASS 2—(Continued).

SN 78-428,126. SUNCREST MANUFACTURING, L.L.C.,
CLINTON, UT. FILED 6-1-2004.

ALL WEATHER ARMOR

THE MARK CONSISTS OF STANDARD CHARACTERS
WITHOUT CLAIM TO ANY PARTICULAR FONT, STYLE,
SIZE, OR COLOR.

NO CLAIM IS MADE TO THE EXCLUSIVE RIGHT TO
USE ALL WEATHER, APART FROM THE MARK AS
SHOWN.

FOR EXTERIOR ACRYLIC COATINGS FOR WOOD
APPLICATION FOR THE RESIDENTIAL AND COM-
MERCIAL BUILDING INDUSTRIES (U.S. CLS. 6, 11
AND 16).

FIRST USE 3-12-2001; IN COMMERCE 3-12-2001.
TARAH HARDY, EXAMINING ATTORNEY

EMBOSSART

THE MARK CONSISTS OF STANDARD CHARACTERS
WITHOUT CLAIM TO ANY PARTICULAR FONT, STYLE,
SIZE, OR COLOR.

OWNER OF U.S. REG. NO. 1,589,591.

FOR PAINT KITS, NAMELY, PAINTS FOR USE BY
ARTISTS AND ARTISANS, SOLD WITH GLUE, CERA-
MIC SLIP AND SPECIALIZED SYRINGES FOR APPLI-
CATION OF SUCH MATERIALS (U.S. CLS. 6, 11 AND
16).

FIRST USE 3-31-1984; IN COMMERCE 3-31-1984.
JENNIFER KRISP, EXAMINING ATTORNEY

SN 78-425,203. PARKER PAINT MFG. CO., INC., TACOMA,
WA. FILED 5-26-2004.

SN 78-438,689. N. SIPERSTEIN, INC., JERSEY CITY, NJ.
FILED 6-21-2004.

Pro Prime

THE MARK CONSISTS OF STANDARD CHARACTERS
WITHOUT CLAIM TO ANY PARTICULAR FONT, STYLE,
SIZE, OR COLOR.

NO CLAIM IS MADE TO THE EXCLUSIVE RIGHT TO
USE "PRIME", APART FROM THE MARK AS SHOWN.

FOR READY MIXED ARCHITECTURAL COATINGS,
NAMELY PAINTS, FOR INTERIOR AND EXTERIOR
USE (U.S. CLS. 6, 11 AND 16).

FIRST USE 0-0-1987; IN COMMERCE 0-0-1987.
JOHN HWANG, EXAMINING ATTORNEY

SIPERSTEIN'S

THE MARK CONSISTS OF STANDARD CHARACTERS
WITHOUT CLAIM TO ANY PARTICULAR FONT, STYLE,
SIZE, OR COLOR.

SEC. 2(F).

FOR PAINTS, VARNISHES AND PRESERVATIVES
AGAINST RUST AND AGAINST DETERIORATION OF
WOOD (U.S. CLS. 6, 11 AND 16).

FIRST USE 6-1-1915; IN COMMERCE 6-1-1915.
AMY HELLA, EXAMINING ATTORNEY

CLASS 2—(Continued).

SN 78-438,781. N. SIPERSTEIN, INC., JERSEY CITY, NJ.
FILED 6-21-2004.

SIPERSTEIN

THE MARK CONSISTS OF STANDARD CHARACTERS WITHOUT CLAIM TO ANY PARTICULAR FONT, STYLE, SIZE, OR COLOR.

SEC. 2(F).

FOR PAINTS (U.S. CLS. 6, 11 AND 16).

FIRST USE 6-1-1915; IN COMMERCE 6-1-1915.

AMY HELLA, EXAMINING ATTORNEY

SN 79-000,785. BRANOPAC GMBH, FED REP GERMANY,
FILED 11-13-2003.

BRANOROST

THE MARK CONSISTS OF STANDARD CHARACTERS WITHOUT CLAIM TO ANY PARTICULAR FONT, STYLE, SIZE, OR COLOR.

OWNER OF INTERNATIONAL REGISTRATION 0818094 DATED 11-13-2003, EXPIRES 11-13-2013.

FOR PACKAGING MATERIALS, NAMELY PACKAGING PAPERS IMPREGNATED WITH A CORROSION INHIBITOR FOR USE IN PACKAGING METAL PRODUCTS (U.S. CLS. 6, 11 AND 16).

JOANNA DUKOVIC, EXAMINING ATTORNEY

CLASS 3—COSMETICS AND CLEANING PREPARATIONS

SN 76-516,841. LES LABORATOIRES ASEPTA, MC-98000,
MONACO, FILED 5-1-2003.

LIPESTERS

OWNER OF MONACO REG. NO. 01-22029, DATED 2-27-2001, EXPIRES 12-1-2010.

FOR (BASED ON USE IN COMMERCE) AND (BASED ON 44(E)) SILK PROTEINS FOR USE AS AN INGREDIENT FOR USE IN THE MANUFACTURE OF COSMETICS, NAMELY, NAIL HARDENERS AND SHAMPOO (BASED ON 44(E)) SILK PROTEINS FOR USE AS AN INGREDIENT FOR USE IN THE MANUFACTURE OF COSMETICS, NAMELY, SKIN CREAMS, ANTI-PERSPIRANT FOR PERSONAL USE, FOOT POWDER, FOOT SPRAY, NAIL POLISH REMOVER, SOAP FOR PERSONAL USE AND PET SHAMPOO (U.S. CLS. 1, 4, 6, 50, 51 AND 52).

FIRST USE 10-0-2001; IN COMMERCE 10-0-2001.

TRACY WHITAKER-BOWN, EXAMINING ATTORNEY

CLASS 3—(Continued).

SN 76-564,128. BRAGERY COMPANY LTD., TAIPEI CITY,
TAIWAN, FILED 12-9-2003.

BOCHING

OWNER OF U.S. REG. NO. 2,185,613.

FOR HAIR CARE PREPARATIONS, HAND CREAM, COLD CREAM, SKIN TONER, BODY TREATMENT OIL, BODY TREATMENT CREAM, TOILET WATER, PERFUME, HAND LOTION, BABY LOTION, SHAVING LOTION, BLUSH, FOUNDATION STICK, FOUNDATION PASTE, LIP TREATMENT OIL, LIQUID FOUNDATION, MASSAGE CREAM, FACIAL MASK PREPARATIONS, CLEANSING CREAM, CLEANSING LOTION, MASCARA, EYE CLEANSING CREAM, SUN TAN LOTION, SUNSCREEN PREPARATIONS, ANTI-WRINKLE CREAM, SKIN WHITENING CREAM, BODY SCRUBS, FACIAL SCRUBS, BODY WHITENING GEL, SHOWER OIL, NAIL ENAMEL, HAIR SHAMPOO, FACE WASH MILK, FACE WASH LOTION, HAIR CONDITIONER, COMPACT (U.S. CLS. 1, 4, 6, 50, 51 AND 52).

FIRST USE 8-16-1995; IN COMMERCE 10-1-1998.

ALEX KEAM, EXAMINING ATTORNEY

SN 76-569,077. JILDA BEVERLY HILLS, INC., PALM DESERT, CA. FILED 1-9-2004.

JILDA BEVERLY HILLS

THE MARK CONSISTS OF STANDARD CHARACTERS WITHOUT CLAIM TO ANY PARTICULAR FONT, STYLE, SIZE, OR COLOR.

NO CLAIM IS MADE TO THE EXCLUSIVE RIGHT TO USE "BEVERLY HILLS", APART FROM THE MARK AS SHOWN.

FOR COSMETICS, NAMELY, LIP GLOSS, LIP STICK, BLUSH, EYE LINER PENCILS, EYE SHADOWS, LIP PENCILS, MASCARA, FACE POWDER, CREAM BLUSH, KITS CONTAINING EYE SHADOWS AND EYE BRUSHES (U.S. CLS. 1, 4, 6, 50, 51 AND 52).

FIRST USE 8-24-2004; IN COMMERCE 8-24-2004.

ZACHARY BELLO, EXAMINING ATTORNEY

SN 76-578,956. HEALTH-TECH, INC., TOTOWA, NJ. FILED 3-3-2004.

CLEAR SIGHT

THE MARK CONSISTS OF STANDARD CHARACTERS WITHOUT CLAIM TO ANY PARTICULAR FONT, STYLE, SIZE, OR COLOR.

OWNER OF U.S. REG. NO. 1,288,433.

FOR CLEANER FOR USE ON EYEGLASSES (U.S. CLS. 1, 4, 6, 50, 51 AND 52).

FIRST USE 8-5-1981; IN COMMERCE 8-5-1981.

NELSON SNYDER, EXAMINING ATTORNEY

CLASS 3—(Continued).

SN 76-581,564. SCHMERTZ, TIMOTHY, SEQUIM, WA.
FILED 3-17-2004.

TS-

THE MARK CONSISTS OF STANDARD CHARACTERS WITHOUT CLAIM TO ANY PARTICULAR FONT, STYLE, SIZE, OR COLOR.

FOR LAUNDRY BLEACH AND ALL-PURPOSE CLEANING AND POLISHING PREPARATIONS (U.S. CLS. 1, 4, 6, 50, 51 AND 52).

PAUL F. GAST, EXAMINING ATTORNEY

SN 76-588,185. VOTIVO, LTD., SEATTLE, WA. FILED 4-22-2004.

VENETIAN PEAR

THE MARK CONSISTS OF STANDARD CHARACTERS WITHOUT CLAIM TO ANY PARTICULAR FONT, STYLE, SIZE, OR COLOR.

NO CLAIM IS MADE TO THE EXCLUSIVE RIGHT TO USE "PEAR", APART FROM THE MARK AS SHOWN.

FOR INCENSE, SCENTED BODY SOAPS AND SPRAYS (U.S. CLS. 1, 4, 6, 50, 51 AND 52).

JOHN LINCOSKI, EXAMINING ATTORNEY

SN 76-588,832. FERRIGNO, ELISA, WHITE PLAINS, NY.
FILED 4-23-2004.

n o v i a

THE ENGLISH TRANSLATION OF NOVIA IS BRIDE OR GIRLFRIEND.

FOR ESSENTIAL OILS FOR PERSONAL USE (U.S. CLS. 1, 4, 6, 50, 51 AND 52).

JANICE L. MCMORROW, EXAMINING ATTORNEY

CLASS 3—(Continued).

SN 76-590,271. SPPC PARIS BLEU, 75017 PARIS, FRANCE,
FILED 5-3-2004.

OLD DRY

THE MARK CONSISTS OF STANDARD CHARACTERS WITHOUT CLAIM TO ANY PARTICULAR FONT, STYLE, SIZE, OR COLOR.

NO CLAIM IS MADE TO THE EXCLUSIVE RIGHT TO USE DRY, APART FROM THE MARK AS SHOWN.

FOR PERFUMERY (U.S. CLS. 1, 4, 6, 50, 51 AND 52).

FIRST USE 4-0-1997; IN COMMERCE 4-0-1997.

MARY I. SPARROW, EXAMINING ATTORNEY

SN 76-590,771. SPPC PARIS BLEU, 75017 PARIS, FRANCE,
FILED 5-3-2004.

OGALIE

THE MARK CONSISTS OF STANDARD CHARACTERS WITHOUT CLAIM TO ANY PARTICULAR FONT, STYLE, SIZE, OR COLOR.

FOR PERFUMERY (U.S. CLS. 1, 4, 6, 50, 51 AND 52).

FIRST USE 7-0-1998; IN COMMERCE 7-0-1998.

ROBIN CHOSID, EXAMINING ATTORNEY

SN 76-594,036. HAIRMARKER LLC, SANTA FE, NM. FILED
5-26-2004.

LOK

FOR HAIR CARE PREPARATIONS, NAMELY, HAIR SHAMPOOS, HAIR CONDITIONERS, HAIR COLORING PREPARATIONS, HAIR BLEACHES, HAIR LIGHTENERS; HIGHLIGHTING PREPARATIONS; COLOR STAIN REMOVERS; HAIR SETTING PREPARATIONS; PERMANENT WAVING AND CURLING PREPARATIONS; BODY AND ROOT LIFT MOUSSES AND GELS; HAIR SPRAYS; HAIR STYLING LOTIONS, GELS AND MOUSSES; HAIR DRESSINGS; COLOR COSMETICS, NAMELY, LIPSTICKS, LIPSTICK LINERS, MASCARAS, EYE SHADOWS, BLUSHES, EYE LINERS, FOUNDATION, NAIL POLISHES, NAIL CARE PREPARATIONS; SKIN TREATMENT PRODUCTS, NAMELY, CLEANSERS, TONERS, MOISTURIZERS, EYE CREAMS, HAND AND BODY LOTIONS AND BODY AND FACIAL SOAP; AND FRAGRANCE PRODUCTS, NAMELY, COLOGNE, PERFUME SPLASHING WATER, SCENTED SOAPS, BODY POWDERS, BATH OILS; AND SUN CARE AND SUN SCREEN PREPARATIONS (U.S. CLS. 1, 4, 6, 50, 51 AND 52).

DAVID TAYLOR, EXAMINING ATTORNEY

CLASS 3—(Continued).

SN 76-596,304. LA JOLLA SPA MD, INC., LA JOLLA, CA. FILED 6-7-2004.



THE MARK CONSISTS OF STANDARD CHARACTERS WITHOUT CLAIM TO ANY PARTICULAR FONT, STYLE, SIZE, OR COLOR.

FOR NON-MEDICATED SERUM APPLIED TO THE SKIN TO IMPROVE SKIN TEXTURE AND TONE (U.S. CLS. 1, 4, 6, 50, 51 AND 52).

FIRST USE 12-31-2002; IN COMMERCE 12-31-2002.
MICHAEL TANNER, EXAMINING ATTORNEY

CLASS 3—(Continued).

SN 76-616,137. ALDI INC., BATAVIA, IL. FILED 10-13-2004.



THE MARK CONSISTS OF STANDARD CHARACTERS WITHOUT CLAIM TO ANY PARTICULAR FONT, STYLE, SIZE, OR COLOR.

FOR STAIN REMOVERS (U.S. CLS. 1, 4, 6, 50, 51 AND 52).

FIRST USE 8-18-2004; IN COMMERCE 8-18-2004.
GRETTA YAO, EXAMINING ATTORNEY

SN 76-597,139. DELTA INTERNATIONAL MACHINERY CORP., NORTH JACKSON, TN. FILED 6-14-2004.

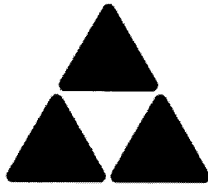

FOR BUFFING AND POLISHING COMPOUNDS FOR METAL AND PLASTIC SURFACES; SANDPAPER; ABRASIVE PAPER (U.S. CLS. 1, 4, 6, 50, 51 AND 52).

FIRST USE 6-0-1986; IN COMMERCE 6-0-1986.
ZACHARY BELLO, EXAMINING ATTORNEY

SN 78-160,416. FAULTLESS STARCH / BON AMI COMPANY, DBA PRIVATE GARDENS, KANSAS CITY, MO. FILED 9-4-2002.

SN 76-598,886. GOTTSCHALKS, INC., FRESNO, CA. FILED 6-23-2004.



THE MARK CONSISTS OF STANDARD CHARACTERS WITHOUT CLAIM TO ANY PARTICULAR FONT, STYLE, SIZE, OR COLOR.

NO CLAIM IS MADE TO THE EXCLUSIVE RIGHT TO USE "COLOR", APART FROM THE MARK AS SHOWN.

THE NAME "SARAH B" DOES NOT IDENTIFY A PARTICULAR LIVING INDIVIDUAL.

FOR EYE, FACIAL AND FOUNDATION MAKEUP, PERFUME, COLOGNE, FACIAL CREAM, HAND CREAM, BODY LOTION, NAIL POLISH, SUN SCREEN, SUN BLOCK AND SUN TANNING LOTION (U.S. CLS. 1, 4, 6, 50, 51 AND 52).

FIRST USE 11-15-2003; IN COMMERCE 11-15-2003.
DANIEL BRODY, EXAMINING ATTORNEY



OWNER OF U.S. REG. NO. 1,277,665.
THE FOREIGN WORDING IN THE MARK TRANSLATES INTO ENGLISH AS "READY TO WEAR".

FOR COMBINATION CLOTHES FRESHENER AND WRINKLE REMOVAL IN AEROSOL FORM (U.S. CLS. 1, 4, 6, 50, 51 AND 52).

ARETHA SOMERVILLE, EXAMINING ATTORNEY

CLASS 3—(Continued).

SN 78-207,743. INDUSTRIAS ALEN, S.A. DE C.V., SANTA CATARINA, N.L., MEXICO, FILED 1-28-2003.



OWNER OF U.S. REG. NO. 2,849,604.
NO CLAIM IS MADE TO THE EXCLUSIVE RIGHT TO USE "EDICIÓN NAVIDEÑA", APART FROM THE MARK AS SHOWN.

THE STIPPLING IN THE DRAWING IS INTENDED TO INDICATE SHADING AND IS NOT INTENDED TO INDICATE ANY PARTICULAR COLOR.

THE MARK CONSISTS OF THE WORDING FLASH EDICIÓN NAVIDEÑA" AND A STYLIZED DESIGN OF A FLOWERS AND A CHRISTMAS TREE WITH DECORATIONS ON IT.

THE WORDING "EDICIÓN NAVIDEÑA" TRANSLATES INTO ENGLISH AS "CHRISTMAS EDITION".

FOR ALL PURPOSE CLEANING PREPARATIONS (U.S. CLS. 1, 4, 6, 50, 51 AND 52).

JOHN DWYER, EXAMINING ATTORNEY

SN 78-219,773. SEA TO SKY INNOVATIONS, LTD., COQUITLAM, BRITISH COLUMBIA, CANADA, FILED 2-27-2003.

SPC TECHNOLOGY

PRIORITY CLAIMED UNDER SEC. 44(D) ON CANADA APPLICATION NO. 1,151,497, FILED 8-30-2002, REG. NO. TMA620262, DATED 9-22-2004, EXPIRES 9-22-2019.

FOR RUST REMOVING PREPARATIONS, PAINT REMOVING PREPARATIONS AND DEGREASING PREPARATIONS NOT USED IN MANUFACTURING PROCESSES FOR USE ON METAL, CONCRETE, BRICK, WOOD, COMPOSITE MATERIALS, PLASTICS, FIBERGLASS AND GLASS (U.S. CLS. 1, 4, 6, 50, 51 AND 52).

KAREN BRACEY, EXAMINING ATTORNEY

SN 78-223,677. HENKEL KGAA, DUESSELDORF, FED REP GERMANY, FILED 3-10-2003.

CURATIN

OWNER OF FED REP GERMANY REG. NO. 2087010, DATED 12-13-1994, EXPIRES 10-31-2014.

FOR HAIR CARE PREPARATIONS, HAIR PERMANENT WAVING PREPARATIONS, AND HAIR STYLING PREPARATIONS; INGREDIENTS SOLD AS A COMPONENT OF HAIR PERMANENT WAVING PREPARATIONS, AND HAIR CARE AND STYLING PREPARATIONS. (U.S. CLS. 1, 4, 6, 50, 51 AND 52).

PRISCILLA MILTON, EXAMINING ATTORNEY

CLASS 3—(Continued).

SN 78-238,884. BEAUTY HOLDING COMPANY, INC., HAMILTON, BERMUDA, FILED 4-17-2003.

BLACK BRILLIANCE

OWNER OF U.S. REG. NO. 2,562,797.

NO CLAIM IS MADE TO THE EXCLUSIVE RIGHT TO USE "BLACK", APART FROM THE MARK AS SHOWN.

FOR HAIR CARE PREPARATIONS (U.S. CLS. 1, 4, 6, 50, 51 AND 52).

CHERYL STEPLIGHT, EXAMINING ATTORNEY

SN 78-255,469. PARLAIN CO., LTD., NEW TERRITORIES, HONG KONG, FILED 5-28-2003.



OWNER OF HONG KONG REG. NO. 05622OF2003, DATED 7-22-2002, EXPIRES 7-22-2009.

FOR COSMETICS; NON-MEDICATED SKIN CARE PREPARATIONS; PERFUMERY, ESSENTIAL OILS FOR PERSONAL USE; COSMETIC, DEODORANT AND SKIN SOAPS; TOILETRIES, NAMELY, SHAVING CREAM, AFTER SHAVE, TALCUM POWDER FOR TOILET USE; DENTIFRICES, NAMELY, TOOTHPASTE AND MOUTHWASH; PREPARATIONS FOR USE ON THE SKIN, HAIR AND NAIL AND FOR USE IN THE BATH, NAMELY, SKIN LOTION, SKIN CREAM, SKIN CLEANSER, SKIN CLARIFIER, SKIN TONER, SKIN MOISTURIZER, BATH SOAP IN LIQUID, SOLID OR GEL FORM, BATH OIL FOR COSMETIC PURPOSES, BATH LOTION, BATH CRYSTALS, BATH BEADS, SHAMPOOS, HAIR CONDITIONERS, NAIL CREAM, NAIL POLISH, NAIL POLISH REMOVERS; GENERAL PURPOSE CLEANING, POLISHING, SCOURING AND ABRASIVE PREPARATIONS; COLOR MAKEUP (U.S. CLS. 1, 4, 6, 50, 51 AND 52).

CURTIS FRENCH, EXAMINING ATTORNEY

SN 78-260,790. THE PROCTER & GAMBLE COMPANY, CINCINNATI, OH. FILED 6-11-2003.

DAILY FACIALS INTENSIVES

OWNER OF U.S. REG. NOS. 2,304,851 AND 2,589,349.

FOR NON-MEDICATED SKIN CARE PREPARATIONS, NAMELY FACIAL SCRUB AND TOWELETTES IMPREGNATED WITH SKIN CLEANSER (U.S. CLS. 1, 4, 6, 50, 51 AND 52).

GWEN STOKOLS, EXAMINING ATTORNEY

CLASS 3—(Continued).

SN 78-272,119. ELLIOTT, KAREN, ESSEX FELLS, NJ. FILED 7-9-2003.

ALLEGRA

FOR COSMETICS, NAMELY FACIAL SCRUB, SKIN CLEANSER, REVITALIZING SKIN TONER, SKIN MOISTURIZER, HAIR SHAMPOO, HAIRSPRAY, HAIR GEL, SUNSCREEN, HAIR REPAIR CONDITIONERS, HAIR CONDITIONER, BEAUTY MASKS MADE OF MUD, BATH GETS IN THE FORM OF MILK, BATH OIL, BATH GEL, BATH CRYSTALS, BODY LOTIONS, BODY SCRUB, HAIR SHAMPOO, FACE AND BODY SOAPS, FRAGRANCES, NAMELY PERFUMES AND COLOGNES, FRAGRANCES, SOAPS, SHAMPOO; AND POTPOURRI (U.S. CLS. 1, 4, 6, 50, 51 AND 52).
MARY I. SPARROW, EXAMINING ATTORNEY

SN 78-294,309. DISNEY ENTERPRISES, INC., BURBANK, CA. FILED 8-29-2003.



OWNER OF U.S. REG. NOS. 2,415,566, 2,623,099 AND OTHERS.

FOR HAIR SHAMPOO; HAIR CONDITIONER; HAIR MOUSSE; HAIR CREAM RINSE; SKIN CLEANSING CREAM; FACIAL, HAND, AND BODY CREAM; FACIAL, HAND, AND BODY LOTION; FACIAL, HAND AND BODY MOISTURIZER; BATH OIL; BATH POWDER; BODY POWDER; PERFUME; COLOGNE; AFTER-SHAVE; BAR SOAP; LIQUID SOAP; SKIN SOAP; MASCARA; LIP STICK; LIP GLOSS; EYELINER; BLUSH; ROUGE; EYESHADOW; EYEBROW PENCILS; NAIL POLISH; FACIAL SCRUBS; FACIAL MASKS; TALCUM POWDER; BUBBLE BATH; TOILET WATER; DENTIFRICES (U.S. CLS. 1, 4, 6, 50, 51 AND 52).
PAUL F. GAST, EXAMINING ATTORNEY

SN 78-306,636. ES COSMETIC LABORATORIES, INC., MIAMI, FL. FILED 9-29-2003.

THE MARK CONSISTS OF THE LETTERS "E" AND "S" PRESENTED IN A STYLIZED FORM. BOTH LETTERS ARE CAPITALIZED AND ARE PLACED APART AND SIDE-BY-

CLASS 3—(Continued).

SIDE, SO THAT THE TRADEMARK COULD BE READ FROM LEFT TO RIGHT. THE MIDDLE HORIZONTAL BAR OF THE LETTER "E" IS SKEWED AND BENDS UPWARD AT A SUBTLE ANGLE. THE TOP AND BOTTOM HORIZONTAL BARS OF THE LETTER "E" ARE DETACHED AND DO NOT CONNECT TO THE SOLE VERTICAL BAR. THE LETTER "S" IS SWIRLED AND ITS ENDS REACH OUT ABOVE AND BELOW THE CONFINES OF THE LETTER "E". THERE ARE NO ADDITIONAL ELEMENTS IN APPLICANT'S MARK OTHER THAN THE LETTERS "E" AND "S".

FOR COSMETICS FOR HAIR CARE, NAMELY, SHAMPOO, CONDITIONER, RELAXERS, DETANGLERS, HAIR TREATMENTS, STYLING AND MOLDING GELS, OIL MOISTURIZERS, CHOLESTEROL CREAMS, SPRITZS, SETTING LOTIONS, HAIR POLISHERS, HAIR POMADES, HOT OIL TREATMENTS, LEAVE-IN TREATMENTS, FOAM WRAPS LOTIONS, AND BRAID SPRAYS; AND COSMETICS FOR SKIN CARE, NAMELY, ALFA-HYDROXY ACID CREAMS, BETA-HYDROXY ACID CREAMS, HAND AND BODY LOTIONS, SHOWER GELS, BUBBLE BATH, EXFOLIATING CREAMS, DEPILATORIES, RAZOR BUMP CREAM, NON-MEDICATED ACNE PREPARATIONS, STRETCH MARK CREAM, TONERS, CLEANSING CREAMS, FACIAL MASKS, FACIAL SCRUBS, CLARIFYING SKIN TREATMENT AND FADE CREAMS, FOOT LOTIONS, MOISTURIZING BODY SPRAYS, HAND, BODY AND FACE CREAMS, AND MOISTURIZING BODY OILS (U.S. CLS. 1, 4, 6, 50, 51 AND 52).

FIRST USE 11-0-1999; IN COMMERCE 11-0-1999.
PAUL F. GAST, EXAMINING ATTORNEY

SN 78-306,974. DIANA DE SILVA COSMETIQUES S.P.A., MILANO, ITALY, FILED 9-29-2003.

DEPIL-END

OWNER OF ITALY REG. NO. 00749018, DATED 5-18-1998, EXPIRES 7-16-2006.

FOR COSMETIC PREPARATIONS TO DELAY HAIR GROWTH AND PREPARATIONS FOR HAIR REMOVAL (U.S. CLS. 1, 4, 6, 50, 51 AND 52).

JEFFERY COWARD, EXAMINING ATTORNEY

SN 78-320,441. STRATEGEM, PARIS, FRANCE, FILED 10-29-2003.

LUBIN

OWNER OF GERMAN DEM REP REG. NO. 1103780, DATED 3-18-1987, EXPIRES 7-31-2013.

FOR SOAP; PERFUMES; ETHEREAL OILS NAMELY, ESSENTIAL OILS FOR PERSONAL USE; COSMETICS; HAIR LOTIONS; TOILET WATER; PERFUMES; COSMETIC PREPARATIONS FOR BATHS, NAMELY, BATH SALTS, NOT FOR MEDICAL PURPOSES; BEAUTY MASKS; COSMETIC CREAMS; CLEANSING MILK FOR SKIN CARE; LOTIONS FOR COSMETIC PURPOSES; COSMETIC SKINCARE PREPARATIONS; CAKES OF TOILET SOAP; SHAMPOOS; DENTIFRICES; PREPARATIONS AND SUBSTANCES FOR LAUNDRY USE, NAMELY, BLEACHES, STARCH, PRE-SOAK AND DETERGENTS (U.S. CLS. 1, 4, 6, 50, 51 AND 52).

ALICE BENMAMAN, EXAMINING ATTORNEY

CLASS 3—(Continued).

SN 78-321,639. W. M. BARR & COMPANY, INC., MEMPHIS, TN. FILED 10-31-2003.

ENDIRT

FOR CLEANER FOR CLEANING A VARIETY OF RESIDENTIAL AND COMMERCIAL SURFACES; REMOVER FOR REMOVING PAINT, DIRT, GREASE, SMOKE, AND OTHER RESIDUE FROM A VARIETY OF RESIDENTIAL AND COMMERCIAL SURFACES. (U.S. CLS. 1, 4, 6, 50, 51 AND 52).

JASON TURNER, EXAMINING ATTORNEY

CLASS 3—(Continued).

SN 78-333,099. BEAUTYBANK INC., NEW YORK, NY. FILED 11-25-2003.

TWO PERFECT

SN 78-322,247. TANCOGNE, XAVIER, PYLA SUR MER, FRANCE, FILED 11-3-2003.

Labo. DERMA

THE MARK CONSISTS OF STANDARD CHARACTERS WITHOUT CLAIM TO ANY PARTICULAR FONT, STYLE, SIZE, OR COLOR.

OWNER OF FRANCE REG. NO. 003054242, DATED 9-25-2000, EXPIRES 9-25-2010.

NO CLAIM IS MADE TO THE EXCLUSIVE RIGHT TO USE LABO, APART FROM THE MARK AS SHOWN.

THE TERM LABO IS AN ABBREVIATION FOR THE FRENCH TERM "LABORATOIRE", WHICH MEANS "LABORATORY" IN ENGLISH.

FOR COSMETICS; PERFUMERY; EAU DE COLOGNE AND EAU DE TOILET SKIN CARE PRODUCTS, NAMELY LOTIONS, MILKS, FACE AND BODY CREAMS AND GELS; BATH SALTS, OILS, GELS, AND BATH LOTIONS; ESSENTIAL OILS, POWDER AND TALCUM; HAIR SHAMPOOS, HAIR AND SCALP LOTIONS AND GELS; PERSONAL DEODORANTS; TOILET SOAPS; DENTIFRICES (U.S. CLS. 1, 4, 6, 50, 51 AND 52).
LEIGH CAROLINE CASE, EXAMINING ATTORNEY

THE MARK CONSISTS OF STANDARD CHARACTERS WITHOUT CLAIM TO ANY PARTICULAR FONT, STYLE, SIZE, OR COLOR.

FOR COSMETICS; FRAGRANCES FOR PERSONAL USE; NON-MEDICATED SKINCARE PREPARATIONS; HAIRCARE PREPARATIONS; TOILETRIES, NAMELY BATH AND BODY SOAPS, CLEANSERS FOR THE FACE AND BODY, GELS FOR THE FACE AND BODY, LOTIONS FOR THE FACE AND BODY, CREAMS FOR THE FACE AND BODY AND SPRAYS FOR THE FACE AND BODY; SUN SCREEN PREPARATIONS (U.S. CLS. 1, 4, 6, 50, 51 AND 52).

HEATHER THOMPSON, EXAMINING ATTORNEY

SN 78-334,016. INSTAGONE CONSUMER PRODUCTS LLC, WALL TOWNSHIP, NJ. FILED 11-28-2003.

SN 78-324,632. WM. WRIGLEY JR. COMPANY, CHICAGO, IL. FILED 11-7-2003.

AIRWAVES DROPS

THE MARK CONSISTS OF STANDARD CHARACTERS WITHOUT CLAIM TO ANY PARTICULAR FONT, STYLE, SIZE, OR COLOR.

NO CLAIM IS MADE TO THE EXCLUSIVE RIGHT TO USE "DROPS", APART FROM THE MARK AS SHOWN.

FOR BREATH FRESHENING DISSOLVING STRIPS (U.S. CLS. 1, 4, 6, 50, 51 AND 52).

AMOS T. MATTHEWS, JR., EXAMINING ATTORNEY

SPRAY IT ON! STAINS ARE GONE!

THE MARK CONSISTS OF STANDARD CHARACTERS WITHOUT CLAIM TO ANY PARTICULAR FONT, STYLE, SIZE, OR COLOR.

FOR HOUSEHOLD CLEANING PREPARATIONS, NAMELY ALL PURPOSE CLEANING PREPARATIONS (U.S. CLS. 1, 4, 6, 50, 51 AND 52).

FIRST USE 9-1-2003; IN COMMERCE 9-2-2003.

RENEE MCCRAY, EXAMINING ATTORNEY

CLASS 3—(Continued).

SN 78-336,676. AZTEC FINANCE CORPORATION, LLC, PORT LOUIS, MAURITIUS, FILED 12-4-2003.

CLASS 3—(Continued).

SN 78-365,363. BUCKEYE INTERNATIONAL, INC., MARYLAND HEIGHTS, MO. FILED 2-10-2004.

IDOL SPIRIT

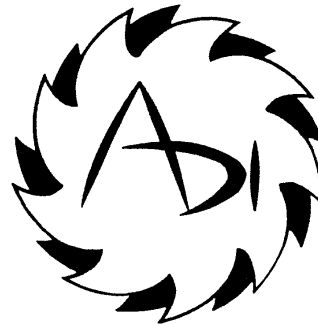

THE MARK CONSISTS OF STANDARD CHARACTERS WITHOUT CLAIM TO ANY PARTICULAR FONT, STYLE, SIZE, OR COLOR.

FOR FRAGRANCES FOR PERSONAL USE, NAMELY COLOGNES, PERFUMES, EAU DE TOILETTE, EAU DE PARFUM; LOTIONS AND CREAMS FOR PERSONAL USE, NAMELY FACE AND BODY CREAMS, BODY LOTIONS; BODY POWDERS; DEODORANTS FOR PERSONAL USE; SOAPS FOR PERSONAL USE, NAMELY SKIN AND BODY SOAPS, SHOWER AND BATH GELS (U.S. CLS. 1, 4, 6, 50, 51 AND 52).
CIMMERIAN COLEMAN, EXAMINING ATTORNEY

FOR WATER-BASED FLOOR FINISH STRIPPER AND ALL PURPOSE CLEANER (U.S. CLS. 1, 4, 6, 50, 51 AND 52).

FIRST USE 12-0-2003; IN COMMERCE 12-0-2003.
ANDREW BENZMILLER, EXAMINING ATTORNEY

SN 78-355,296. NEWAYS, INC., SPRINGVILLE, UT. FILED 1-21-2004.

SN 78-381,918. LITANI, INC., BURBANK, CA. FILED 3-10-2004.

"S" CREAM

Dream Tan

THE MARK CONSISTS OF STANDARD CHARACTERS WITHOUT CLAIM TO ANY PARTICULAR FONT, STYLE, SIZE, OR COLOR.

OWNER OF U.S. REG. NO. 2,253,221.
NO CLAIM IS MADE TO THE EXCLUSIVE RIGHT TO USE CREAM, APART FROM THE MARK AS SHOWN.
FOR PERSONAL CARE PREPARATIONS; NAMELY, BODY LOTION AND CREAM (U.S. CLS. 1, 4, 6, 50, 51 AND 52).

FIRST USE 1-1-1990; IN COMMERCE 1-1-1990.
BRIDGETT SMITH, EXAMINING ATTORNEY

THE MARK CONSISTS OF STANDARD CHARACTERS WITHOUT CLAIM TO ANY PARTICULAR FONT, STYLE, SIZE, OR COLOR.

NO CLAIM IS MADE TO THE EXCLUSIVE RIGHT TO USE "TAN", APART FROM THE MARK AS SHOWN.
FOR SUNLESS TANNING LOTIONS AND SPRAYS (U.S. CLS. 1, 4, 6, 50, 51 AND 52).

FIRST USE 5-30-1995; IN COMMERCE 5-30-1995.
ZACHARY BELLO, EXAMINING ATTORNEY

CLASS 3—(Continued).

SN 78-382,053. LITANI, INC., BURBANK, CA. FILED 3-10-2004.

Dream Tan System

THE MARK CONSISTS OF STANDARD CHARACTERS WITHOUT CLAIM TO ANY PARTICULAR FONT, STYLE, SIZE, OR COLOR.

NO CLAIM IS MADE TO THE EXCLUSIVE RIGHT TO USE "TAN SYSTEM", APART FROM THE MARK AS SHOWN.

FOR SUNLESS TANNING LOTIONS AND SPRAYS (U.S. CLS. 1, 4, 6, 50, 51 AND 52).

FIRST USE 5-30-1995; IN COMMERCE 5-30-1995.
ZACHARY BELLO, EXAMINING ATTORNEY

CLASS 3—(Continued).

SN 78-405,633. CLASSIC MOTORING ACCESSORIES, INC., TAMPA, FL. FILED 4-21-2004.



NO CLAIM IS MADE TO THE EXCLUSIVE RIGHT TO USE "FABRIK", APART FROM THE MARK AS SHOWN.

THE MARK CONSISTS OF A STYLIZED PRESENTATION OF THE LETTERS "EF" TO THE LEFT OF THE WORDING "EIMANN FABRIK".

THE FOREIGN WORDING IN THE MARK TRANSLATES INTO ENGLISH AS FACTORY.

FOR CAR CARE PRODUCTS, NAMELY, AUTOMOBILE POLISH, AND AUTOMOBILE CLEANERS, NAMELY, SHAMPOO AND CONDITIONER FOR PAINTED SURFACES, AND UPHOLSTERY, CARPET, VINYL, LEATHER, TIRE AND WHEEL CLEANERS (U.S. CLS. 1, 4, 6, 50, 51 AND 52).

FIRST USE 3-1-1993; IN COMMERCE 3-1-1993.
JASON TURNER, EXAMINING ATTORNEY

SN 78-409,455. WARNER-LAMBERT COMPANY LLC, MORRIS PLAINS, NJ. FILED 4-28-2004.

EFFERDENT PLUS EZ TUBE

THE MARK CONSISTS OF STANDARD CHARACTERS WITHOUT CLAIM TO ANY PARTICULAR FONT, STYLE, SIZE, OR COLOR.

OWNER OF U.S. REG. NOS. 728,959, 1,952,935 AND OTHERS.

NO CLAIM IS MADE TO THE EXCLUSIVE RIGHT TO USE "TUBE", APART FROM THE MARK AS SHOWN.

FOR DENTURE CLEANSER (U.S. CLS. 1, 4, 6, 50, 51 AND 52).

CYNTHIA SLOAN, EXAMINING ATTORNEY

SN 78-382,107. POTHIER, ELISE P, NEW BEDFORD, MA. AND MICHAELS, VICTORIA A, WAREHAM, MA. FILED 3-10-2004.

Card Scents

THE MARK CONSISTS OF STANDARD CHARACTERS WITHOUT CLAIM TO ANY PARTICULAR FONT, STYLE, SIZE, OR COLOR.

NO CLAIM IS MADE TO THE EXCLUSIVE RIGHT TO USE "CARD", APART FROM THE MARK AS SHOWN.

FOR SCENTED OILS USED FOR CARD APPLICATION (U.S. CLS. 1, 4, 6, 50, 51 AND 52).

MARGERÝ A. TIERNEY, EXAMINING ATTORNEY

SN 78-417,167. AVON PRODUCTS, INC., NEW YORK, NY. FILED 5-12-2004.

DREAMLIFE BOUQUET

THE MARK CONSISTS OF STANDARD CHARACTERS WITHOUT CLAIM TO ANY PARTICULAR FONT, STYLE, SIZE, OR COLOR.

OWNER OF U.S. REG. NO. 2,718,138.

NO CLAIM IS MADE TO THE EXCLUSIVE RIGHT TO USE "BOUQUET", APART FROM THE MARK AS SHOWN.

FOR FRAGRANCE PRODUCTS, NAMELY, EAU DE TOILETTE (U.S. CLS. 1, 4, 6, 50, 51 AND 52).

ARETHA SOMERVILLE, EXAMINING ATTORNEY

CLASS 3—(Continued).

SN 78-417,401. PROSTRONG, INC., OAKVILLE, CT. FILED 5-12-2004.

BioFusion

THE MARK CONSISTS OF STANDARD CHARACTERS WITHOUT CLAIM TO ANY PARTICULAR FONT, STYLE, SIZE, OR COLOR.

FOR NAIL CARE PREPARATIONS, NAMELY, NAIL REPAIR FORMULAS FOR USE ON WEAK, SPLITTING, DRY, CRACKED, PEELING, CHIPPED AND DAMAGED FINGERNAILS OR TOENAILS, NAIL POLISH, NAIL ENAMEL, NAIL HARDENER, NAIL STRENGTHENER, NAIL BUILDER, NAIL SEALER FOR USE OVER FINGERNAIL OR TOENAIL POLISH, NAIL POLISH BASE COAT AND TOP COAT, NAIL CLEANSER, NAIL BUFFER CREAM, NAIL POLISH REMOVER, LIQUID NAIL POLISH DRYER, NAIL POLISH SMUDGE CORRECTOR, NAIL CONDITIONER, NAIL CREAM, NAIL MOISTURIZER, CUTICLE REMOVER CREAM, CUTICLE CONDITIONER, CUTICLE CREAM, AND CUTICLE MOISTURIZER; HAND CARE PREPARATIONS, NAMELY, HAND CREAM AND MOISTURIZER (U.S. CLS. 1, 4, 6, 50, 51 AND 52).

REGINA DRUMMOND, EXAMINING ATTORNEY

CLASS 3—(Continued).

SN 78-422,266. L'OREAL USA CREATIVE, INC., NEW YORK, NY. FILED 5-20-2004.

LASH STYLIST

THE MARK CONSISTS OF STANDARD CHARACTERS WITHOUT CLAIM TO ANY PARTICULAR FONT, STYLE, SIZE, OR COLOR.

NO CLAIM IS MADE TO THE EXCLUSIVE RIGHT TO USE "LASH", APART FROM THE MARK AS SHOWN.

THE MARK IS PRESENTED IN STANDARD CHARACTER WITHOUT CLAIM TO ANY PARTICULAR FONT, STYLE, SIZE OR COLOR

FOR COSMETICS, NAMELY, MASCARA (U.S. CLS. 1, 4, 6, 50, 51 AND 52).

VERNA BETH RIRIE, EXAMINING ATTORNEY

SN 78-423,972. CIRILLO-HYLAND, VICTORIA, PENN VALLEY, PA. FILED 5-24-2004.

BALL PARK BLOCK

SN 78-419,096. EARTH ESSENTIALS, SANTA BARBARA, CA. FILED 5-14-2004.

KITCHEN GARDEN

THE MARK CONSISTS OF STANDARD CHARACTERS WITHOUT CLAIM TO ANY PARTICULAR FONT, STYLE, SIZE, OR COLOR.

NO CLAIM IS MADE TO THE EXCLUSIVE RIGHT TO USE "KITCHEN", APART FROM THE MARK AS SHOWN.

FOR LIQUID SOAPS AND DISH DETERGENTS FOR KITCHEN AND BATH USE (U.S. CLS. 1, 4, 6, 50, 51 AND 52).

ANNE MADDEN, EXAMINING ATTORNEY

THE MARK CONSISTS OF STANDARD CHARACTERS WITHOUT CLAIM TO ANY PARTICULAR FONT, STYLE, SIZE, OR COLOR.

NO CLAIM IS MADE TO THE EXCLUSIVE RIGHT TO USE BLOCK, APART FROM THE MARK AS SHOWN.

FOR SUN SCREEN AND SUN SCREEN PREPARATIONS, NAMELY, SKIN LOTION (U.S. CLS. 1, 4, 6, 50, 51 AND 52).

ANGELA M. MICHELI, EXAMINING ATTORNEY

CLASS 3—(Continued).

SN 78-425,757. GROARK, MARYANN S., REDONDO BEACH, CA. FILED 5-26-2004.

CLASS 3—(Continued).

SN 78-428,209. HONG, SHEN, PLAINSBORO, NJ. FILED 6-1-2004.

Baby Moon

organin

THE MARK CONSISTS OF STANDARD CHARACTERS WITHOUT CLAIM TO ANY PARTICULAR FONT, STYLE, SIZE, OR COLOR.

NO CLAIM IS MADE TO THE EXCLUSIVE RIGHT TO USE "BABY", APART FROM THE MARK AS SHOWN.

FOR BABY SHAMPOO (U.S. CLS. 1, 4, 6, 50, 51 AND 52).

RICHARD A. STRASER, EXAMINING ATTORNEY

THE MARK CONSISTS OF STANDARD CHARACTERS WITHOUT CLAIM TO ANY PARTICULAR FONT, STYLE, SIZE, OR COLOR.

FOR HAIR CARE PREPARATIONS (U.S. CLS. 1, 4, 6, 50, 51 AND 52).

PAM WILLIS, EXAMINING ATTORNEY

SN 78-428,163. U.S. NONWOVENS CORPORATION, BRENTWOOD, NY. FILED 6-1-2004.

SN 78-429,250. SIGNATURE CLUB A LTD., TAMPA, FL. FILED 6-3-2004.

Suavisol

LONG, LONGER, LONGEST LASTING LIPSTICK

THE MARK CONSISTS OF STANDARD CHARACTERS WITHOUT CLAIM TO ANY PARTICULAR FONT, STYLE, SIZE, OR COLOR.

FOR LIQUID AND DRYER SHEET FABRIC SOFTENER (U.S. CLS. 1, 4, 6, 50, 51 AND 52).

JEFFERY COWARD, EXAMINING ATTORNEY

THE MARK CONSISTS OF STANDARD CHARACTERS WITHOUT CLAIM TO ANY PARTICULAR FONT, STYLE, SIZE, OR COLOR.

NO CLAIM IS MADE TO THE EXCLUSIVE RIGHT TO USE LIPSTICK, APART FROM THE MARK AS SHOWN.

FOR LIPSTICK (U.S. CLS. 1, 4, 6, 50, 51 AND 52).

NICHOLAS ALTREE, EXAMINING ATTORNEY

CLASS 3—(Continued).

SN 78-429,340. DOORSTAM RESEARCH & DEVELOPMENT, LLC, DANIA, FL. FILED 6-3-2004.

CLASS 3—(Continued).

SN 78-430,223. AVON PRODUCTS, INC., NEW YORK, NY. FILED 6-4-2004.

WHIBOUT

VISUAL PERFECTION

THE MARK CONSISTS OF STANDARD CHARACTERS WITHOUT CLAIM TO ANY PARTICULAR FONT, STYLE, SIZE, OR COLOR.

FOR CLEANING PRODUCT NAMELY STAIN REMOVER (U.S. CLS. 1, 4, 6, 50, 51 AND 52). FIRST USE 1-26-2004; IN COMMERCE 1-26-2004. TRACY CROSS, EXAMINING ATTORNEY

THE MARK CONSISTS OF STANDARD CHARACTERS WITHOUT CLAIM TO ANY PARTICULAR FONT, STYLE, SIZE, OR COLOR.

FOR SKIN CARE PRODUCTS, NAMELY, TINTED SKIN MOISTURIZER (U.S. CLS. 1, 4, 6, 50, 51 AND 52). WANDA KAY PRICE, EXAMINING ATTORNEY

SN 78-429,587. DIAL BRANDS, INC., SCOTTSDALE, AZ. FILED 6-3-2004.

SN 78-430,772. GERBER PRODUCTS COMPANY, FREMONT, MI. FILED 6-7-2004.

PUREX

GERBER

THE MARK CONSISTS OF STANDARD CHARACTERS WITHOUT CLAIM TO ANY PARTICULAR FONT, STYLE, SIZE, OR COLOR.

OWNER OF U.S. REG. NOS. 578,630, 1,876,275 AND OTHERS.

FOR LAUNDRY CARE PREPARATIONS, NAMELY, FABRIC SOFTENER, FABRIC FRESHENER, WRINKLE REDUCERS, ANTI-STATIC REDUCERS, DRYER SHEETS (U.S. CLS. 1, 4, 6, 50, 51 AND 52). BRENDAN REGAN, EXAMINING ATTORNEY

THE MARK CONSISTS OF STANDARD CHARACTERS WITHOUT CLAIM TO ANY PARTICULAR FONT, STYLE, SIZE, OR COLOR.

OWNER OF U.S. REG. NOS. 1,070,145, 2,631,970 AND OTHERS.

SEC. 2(F). FOR BABY CLEANSING WIPES (U.S. CLS. 1, 4, 6, 50, 51 AND 52). MICHAEL HALL, EXAMINING ATTORNEY

CLASS 3—(Continued).

SN 78-431,839. FRAN WILSON CREATIVE COSMETICS, INC., NEW YORK, NY. FILED 6-8-2004.

CLASS 3—(Continued).

SN 78-432,850. BEAUTY HOLDING COMPANY, INC., HAMILTON, BERMUDA, FILED 6-10-2004.

SILAFECT

MEGASILK

THE MARK CONSISTS OF STANDARD CHARACTERS WITHOUT CLAIM TO ANY PARTICULAR FONT, STYLE, SIZE, OR COLOR.

FOR NON-MEDICATED SKIN CARE PREPARATIONS; COSMETICS AND MAKEUP (U.S. CLS. 1, 4, 6, 50, 51 AND 52).

WILLIAM BRECKENFELD, EXAMINING ATTORNEY

THE MARK CONSISTS OF STANDARD CHARACTERS WITHOUT CLAIM TO ANY PARTICULAR FONT, STYLE, SIZE, OR COLOR.

FOR HAIR CARE PREPARATIONS (U.S. CLS. 1, 4, 6, 50, 51 AND 52).

JOHN E. MICHOS, EXAMINING ATTORNEY

SN 78-432,851. HOUSE OF MOHAN CORPORATION, WASHINGTON, DC. FILED 6-10-2004.

SN 78-432,844. INTERNATIONAL FLORA TECHNOLOGIES, LTD., GILBERT, AZ. FILED 6-10-2004.

CUTISTICK

Sri Ganesh

THE MARK CONSISTS OF STANDARD CHARACTERS WITHOUT CLAIM TO ANY PARTICULAR FONT, STYLE, SIZE, OR COLOR.

FOR NON-MEDICATED CUTICLE TREATMENT PREPARATION (U.S. CLS. 1, 4, 6, 50, 51 AND 52).

JOHN GARTNER, EXAMINING ATTORNEY

THE MARK CONSISTS OF STANDARD CHARACTERS WITHOUT CLAIM TO ANY PARTICULAR FONT, STYLE, SIZE, OR COLOR.

FOR STICK INCENSE AND ESSENTIAL OILS FOR PERSONAL USE (U.S. CLS. 1, 4, 6, 50, 51 AND 52).

FIRST USE 6-14-2004; IN COMMERCE 6-14-2004.

JOHN E. MICHOS, EXAMINING ATTORNEY

CLASS 3—(Continued).

SN 78-433,465. GAP (APPAREL), LLC, SAN FRANCISCO, CA. FILED 6-10-2004.

CLASS 3—(Continued).

SN 78-434,126. FAULTLESS STARCH/BON AMI COMPANY, KANSAS CITY, MO. FILED 6-11-2004.

TORN VERBENA

THE MARK CONSISTS OF STANDARD CHARACTERS WITHOUT CLAIM TO ANY PARTICULAR FONT, STYLE, SIZE, OR COLOR.

NO CLAIM IS MADE TO THE EXCLUSIVE RIGHT TO USE "VERBENA", APART FROM THE MARK AS SHOWN.

FOR PERFUME, EAU DE TOILETTE, EAU DE PARFUM, COLOGNE, BODY AND SKIN LOTION, BODY AND SKIN SOAPS, INCENSE, BODY OIL, ESSENTIAL OILS FOR PERSONAL USE (U.S. CLS. 1, 4, 6, 50, 51 AND 52).

BRIAN PINO, EXAMINING ATTORNEY

CITRASTAR

THE MARK CONSISTS OF STANDARD CHARACTERS WITHOUT CLAIM TO ANY PARTICULAR FONT, STYLE, SIZE, OR COLOR.

FOR COMMERCIAL LAUNDRY DETERGENT (U.S. CLS. 1, 4, 6, 50, 51 AND 52).

FIRST USE 5-24-2004; IN COMMERCE 5-24-2004.
MICHAEL TANNER, EXAMINING ATTORNEY

SN 78-433,664. CLINIQUE LABORATORIES, INC., NEW YORK, NY. FILED 6-11-2004.

SN 78-434,249. ALCIS HEALTH, INC., SAN JOSE, CA. FILED 6-11-2004.

SKIN SUPPLIES FOR MEN

THE MARK CONSISTS OF STANDARD CHARACTERS WITHOUT CLAIM TO ANY PARTICULAR FONT, STYLE, SIZE, OR COLOR.

SEC. 2(F).

FOR "SKIN CARE PREPARATIONS, NAMELY AFTER SHAVE CREAMS, LOTIONS AND GELS, AFTER SHAVE HEALING LOTIONS, EYE CREAMS AND GELS, FACE CREAMS, GELS AND LOTIONS, FACIAL EXFOLIATING SCRUBS, FACIAL MOISTURIZERS, FACIAL SOAPS, FACIAL TONERS, NON-MEDICATED ANTI-WRINKLE CREAMS, LOTIONS AND GELS, NON-MEDICATED SKIN RENEWAL CREAMS, SHAVING FOAMS, CREAMS, LOTIONS AND GELS, SKIN BRONZING CREAMS, LOTIONS AND GELS (U.S. CLS. 1, 4, 6, 50, 51 AND 52).

FIRST USE 12-31-1977; IN COMMERCE 12-31-1977.
THEODORE MCBRIDE, EXAMINING ATTORNEY

ALCIS

THE MARK CONSISTS OF STANDARD CHARACTERS WITHOUT CLAIM TO ANY PARTICULAR FONT, STYLE, SIZE, OR COLOR.

FOR SKIN CARE PRODUCTS AND PREPARATIONS, NAMELY SKIN SOAPS, SKIN LOTIONS AND CREAMS (U.S. CLS. 1, 4, 6, 50, 51 AND 52).

CATHERINE CAIN, EXAMINING ATTORNEY

CLASS 3—(Continued).

SN 78-434,526. BLOCK DRUG COMPANY, INC., WEST TRENTON, NJ. FILED 6-14-2004.



THE MARK CONSISTS OF THE STYLIZED WORD OASIS WITH A WATER DROP AROUND THE LETTER O. FOR NON-MEDICATED MOUTH MOISTURIZERS AND BREATH FRESHENERS (U.S. CLS. 1, 4, 6, 50, 51 AND 52).

RONALD MCMORROW, EXAMINING ATTORNEY

SN 78-434,870. CONSUMER PRODUCT INNOVATIONS, LLC, COLUMBUS, OH. FILED 6-14-2004.

PERSONAL BEST

THE MARK CONSISTS OF STANDARD CHARACTERS WITHOUT CLAIM TO ANY PARTICULAR FONT, STYLE, SIZE, OR COLOR.

FOR SHAMPOO, HAIR CONDITIONER, NON-MEDICATED LIQUID SOAP, AND NON-MEDICATED SKIN LOTIONS AND SKIN CREAMS (U.S. CLS. 1, 4, 6, 50, 51 AND 52).

MICHAEL HALL, EXAMINING ATTORNEY

SN 78-435,576. CCA INDUSTRIES, INC., EAST RUTHERFORD, NJ. FILED 6-15-2004.

SUNSET CAFÉ

THE MARK CONSISTS OF STANDARD CHARACTERS WITHOUT CLAIM TO ANY PARTICULAR FONT, STYLE, SIZE, OR COLOR.

OWNER OF U.S. REG. NO. 2,205,934. FOR TOILETRIES, NAMELY, PERFUME, COLOGNE AND EAU DE PARFUM SPRAYS (U.S. CLS. 1, 4, 6, 50, 51 AND 52).

ELLEN B. AWRICH, EXAMINING ATTORNEY

CLASS 3—(Continued).

SN 78-435,819. GISEWHITE, MARYJO, WARREN, OH. FILED 6-15-2004.

FRENCH CREEK COTTAGE

THE MARK CONSISTS OF STANDARD CHARACTERS WITHOUT CLAIM TO ANY PARTICULAR FONT, STYLE, SIZE, OR COLOR.

FOR "FACIAL CLEANSERS" "FACIAL CREAMS" "SKIN CLEANSERS" "SKIN CONDITIONERS" "SOAPS" "HAND CREAM" "POLYMER SEALANT FOR CLEANING, SHINING & PROTECTING AUTOMOBILE EXTERIOR" "SKIN CLEANSING CREAM" "SKIN CLEANSING LOTION" "SKIN CREAM" "SKIN LOTION" "SKIN MOISTURIZER" "HAND LOTIONS" "ANTI WRINKLE CREAM" "SHAVING CREAM" (U.S. CLS. 1, 4, 6, 50, 51 AND 52).

CHARLES JOYNER, EXAMINING ATTORNEY

SN 78-436,087. HANNA-BARBERA PRODUCTIONS, INC., SHERMAN OAKS, CA. FILED 6-16-2004.

THE JETSONS

THE MARK CONSISTS OF STANDARD CHARACTERS WITHOUT CLAIM TO ANY PARTICULAR FONT, STYLE, SIZE, OR COLOR.

FOR COSMETICS, NAMELY LIPSTICK, LIP GLOSS AND NON-MEDICATED LIP BALM; MASCARA; NAIL ENAMEL; FACE POWDER, FACE CREAM, SKIN LOTION AND SKIN GEL; BATH POWDER AND PERFUMED BODY POWDER; BATH OIL, BATH GEL AND NON-MEDICATED BATH SALTS; BABY OIL, BABY POWDER, BABY GEL AND BABY LOTION; HAND CREAM AND LOTION; BODY CREAM AND LOTION; SUNSCREEN PREPARATION, NAMELY CREAM AND LOTION; SHAVING CREAM AND AFTER-SHAVE LOTION, SKIN CLEANSER AND NON-MEDICATED BODY SOAKS; BODY DEODORANT, COLOGNE AND PERFUME; SOAPS, NAMELY, LIQUID BATH SOAP, GEL SOAP AND BAR SOAP; DETERGENT SOAP, NAMELY, LIQUID AND POWDER; FABRIC SOFTENER; DEODORANT SOAP, SKIN SOAP; AND SHAMPOO AND SHAMPOO CONDITIONER (U.S. CLS. 1, 4, 6, 50, 51 AND 52).

ALICE BENMAMAN, EXAMINING ATTORNEY

CLASS 3—(Continued).

SN 78-436,542. ALEX AND ANI, INC., CRANSTON, RI.
FILED 6-16-2004.

CLASS 3—(Continued).

SN 78-436,979. 200 KELSEY ASSOCIATES, LLC, NEW RO-
CHELLE, NY. FILED 6-17-2004.

SEE NO EVIL

THE MARK CONSISTS OF STANDARD CHARACTERS
WITHOUT CLAIM TO ANY PARTICULAR FONT, STYLE,
SIZE, OR COLOR.

FOR COSMETICS, NAMELY, EYE CREAM, EYE
MOISTURIZER (U.S. CLS. 1, 4, 6, 50, 51 AND 52).

FIRST USE 6-0-2002; IN COMMERCE 6-0-2002.
SUSAN STIGLITZ, EXAMINING ATTORNEY

SN 78-436,705. PENNZOIL-QUAKER STATE COMPANY,
HOUSTON, TX. FILED 6-17-2004.

STEAM PREMIUM

THE MARK CONSISTS OF STANDARD CHARACTERS
WITHOUT CLAIM TO ANY PARTICULAR FONT, STYLE,
SIZE, OR COLOR.

FOR ENGINE CLEANER AND DEGREASER (U.S.
CLS. 1, 4, 6, 50, 51 AND 52).

FIRST USE 7-1-2004; IN COMMERCE 7-1-2004.
DARRYL SPRUILL, EXAMINING ATTORNEY

SN 78-436,867. ALCIS HEALTH, INC., SAN JOSE, CA. FILED
6-17-2004.

**The Science of
Relief**

THE MARK CONSISTS OF STANDARD CHARACTERS
WITHOUT CLAIM TO ANY PARTICULAR FONT, STYLE,
SIZE, OR COLOR.

FOR SKIN CARE PRODUCTS AND PREPARATIONS,
NAMELY SKIN SOAPS, SKIN LOTIONS AND CREAMS
(U.S. CLS. 1, 4, 6, 50, 51 AND 52).

RONALD AIKENS, EXAMINING ATTORNEY

JERIS

THE MARK CONSISTS OF STANDARD CHARACTERS
WITHOUT CLAIM TO ANY PARTICULAR FONT, STYLE,
SIZE, OR COLOR.

THE NAME "JERIS" IN THE MARK DOES NOT IDENTI-
FY A LIVING INDIVIDUAL.

FOR HAIR CARE PREPARATIONS, HAIR CONDI-
TIONERS, HAIR GEL, HAIR MOUSSE, HAIR SHAM-
POO, HAIR STYLING PREPARATIONS AND HAIR
TONIC (U.S. CLS. 1, 4, 6, 50, 51 AND 52).

ALICIA COLLINS, EXAMINING ATTORNEY

SN 78-437,106. ORLY INTERNATIONAL, INC., CHATS-
WORTH, CA. FILED 6-17-2004.

Free Hand

THE MARK CONSISTS OF STANDARD CHARACTERS
WITHOUT CLAIM TO ANY PARTICULAR FONT, STYLE,
SIZE, OR COLOR.

FOR HAND AND NAIL TREATMENT PREPARA-
TIONS; NAMELY, LIQUID AND CREAM EXFOLIA-
TORS, MOISTURE MASK, HAND AND NAIL CREME
(U.S. CLS. 1, 4, 6, 50, 51 AND 52).

DANIEL CAPSHAW, EXAMINING ATTORNEY

CLASS 3—(Continued).

SN 78-437,466. SMITHKLINE BEECHAM CORPORATION, PHILADELPHIA, PA. FILED 6-18-2004.

AQUAMINT

THE MARK CONSISTS OF STANDARD CHARACTERS WITHOUT CLAIM TO ANY PARTICULAR FONT, STYLE, SIZE, OR COLOR.

OWNER OF U.S. REG. NOS. 1,006,820, 2,304,437 AND OTHERS.

FOR MOUTHWASH (U.S. CLS. 1, 4, 6, 50, 51 AND 52).
JANICE L. MCMORROW, EXAMINING ATTORNEY

SN 78-437,467. SMITHKLINE BEECHAM CORPORATION, PHILADELPHIA, PA. FILED 6-18-2004.

AQUAFRESH AQUAMINT

THE MARK CONSISTS OF STANDARD CHARACTERS WITHOUT CLAIM TO ANY PARTICULAR FONT, STYLE, SIZE, OR COLOR.

OWNER OF U.S. REG. NOS. 1,006,820, 2,304,437 AND OTHERS.

FOR MOUTHWASH (U.S. CLS. 1, 4, 6, 50, 51 AND 52).
JANICE L. MCMORROW, EXAMINING ATTORNEY

SN 78-437,557. BLISSWORLD LLC, BROOKLYN, NY. FILED 6-18-2004.

no motion lotion

THE MARK CONSISTS OF STANDARD CHARACTERS WITHOUT CLAIM TO ANY PARTICULAR FONT, STYLE, SIZE, OR COLOR.

FOR FACE SLIMMING SERUM, FIRING FACE GEL, FIRING FACE MASK, FIRING GEL, FIRING SERUM, FACE SLIMMING GEL, FAC SLIMMING MASK (U.S. CLS. 1, 4, 6, 50, 51 AND 52).
SHARI SHEFFIELD, EXAMINING ATTORNEY

CLASS 3—(Continued).

SN 78-437,711. SUPER TEST CORPORATION (STC INTERNATIONAL), TAIPEI, TAIWAN, FILED 6-18-2004.

Black Thunder

THE MARK CONSISTS OF STANDARD CHARACTERS WITHOUT CLAIM TO ANY PARTICULAR FONT, STYLE, SIZE, OR COLOR.

FOR COAL SLAG SANDBLASTING ABRASIVE (U.S. CLS. 1, 4, 6, 50, 51 AND 52).

CHARLES JOYNER, EXAMINING ATTORNEY

SN 78-437,713. U.S. NONWOVENS CORP., BRENTWOOD, NY. FILED 6-18-2004.

Suavisoft

THE MARK CONSISTS OF STANDARD CHARACTERS WITHOUT CLAIM TO ANY PARTICULAR FONT, STYLE, SIZE, OR COLOR.

FOR DRYER SHEET FABRIC SOFTENER (U.S. CLS. 1, 4, 6, 50, 51 AND 52).

JEFFERY COWARD, EXAMINING ATTORNEY

CLASS 3—(Continued).

SN 78-437,983. ALVA INTERNATIONAL L.L.C., NILES, IL. FILED 6-18-2004.

CLASS 3—(Continued).

SN 78-439,159. KISS'D, INC., SANTA MONICA, CA. FILED 6-22-2004.

PROSACEA

THE MARK CONSISTS OF STANDARD CHARACTERS WITHOUT CLAIM TO ANY PARTICULAR FONT, STYLE, SIZE, OR COLOR.
FOR COSMETIC PREPARATION FOR SKIN CARE (U.S. CLS. 1, 4, 6, 50, 51 AND 52).
YONG KIM, EXAMINING ATTORNEY

SN 78-438,872. D-AGE NAIL & SPA, INC., NEW YORK, NY. FILED 6-21-2004.

D-AGE

THE MARK CONSISTS OF STANDARD CHARACTERS WITHOUT CLAIM TO ANY PARTICULAR FONT, STYLE, SIZE, OR COLOR.
FOR NAIL CARE PREPARATIONS, NAMELY, NAIL POLISH, NAIL POLISH REMOVER, NAIL CREAM, NAIL ENAMEL, NAIL HARDENERS, AND NAIL TIPS; SKIN CARE PREPARATIONS, NAMELY, SKIN CONDITIONER AND MOISTURIZER, FACIAL CREAMS, CLEANSING LOTION, FACIAL CLEANSERS, FACIAL SCRUBS, SKIN EXFOLIANTS, FACIAL TONERS, AND FACIAL MASKS; HAIR CARE PREPARATIONS, NAMELY, HAIR SHAMPOO, HAIR CONDITIONER, HAIR RINSES, HAIR OILS, HAIR GELS, HAIR SPRAY, AND HAIR MOUSSE; BODY CARE PREPARATIONS, NAMELY, BODY CREAMS AND LOTIONS, BODY OIL, BODY SCRUBS, AND MASSAGE LOTION; BATH PRODUCTS, NAMELY, BATH GEL, BATH OIL, BUBBLE BATH, BATH SALTS, BODY WASHES, AND SHOWER GELS; SCENTED AND UNSCENTED SKIN SOAPS; COSMETICS, NAMELY, MASCARA, EYELINER, EYE SHADOW, LIPSTICK, BLUSH, POWDER, FOUNDATION; AND PERFUME (U.S. CLS. 1, 4, 6, 50, 51 AND 52).
ELIZABETH HUGHITT, EXAMINING ATTORNEY

HEAT PLAY

THE MARK CONSISTS OF STANDARD CHARACTERS WITHOUT CLAIM TO ANY PARTICULAR FONT, STYLE, SIZE, OR COLOR.
FOR HAIR CARE PRODUCTS, NAMELY, SHAMPOO, CONDITIONER, FINISHING RINSE, HAIR SHINE SPRAY, HAIR SETTING LOTION, SCULPTING GEL, HAIR MOUSSE, SPRAY GEL AND HAIR SPRAY (U.S. CLS. 1, 4, 6, 50, 51 AND 52).
SUSAN HAYASH, EXAMINING ATTORNEY

SN 79-002,553. TEMMENTEC AG, CH-3454 SUMISWALD, SWITZERLAND, FILED 3-17-2004.

CREVITAL

THE MARK CONSISTS OF STANDARD CHARACTERS WITHOUT CLAIM TO ANY PARTICULAR FONT, STYLE, SIZE, OR COLOR.
OWNER OF INTERNATIONAL REGISTRATION 0824807 DATED 3-17-2004, EXPIRES 3-17-2014.
FOR COSMETICS AND HAIR LOTIONS (U.S. CLS. 1, 4, 6, 50, 51 AND 52).
DAVID ELTON, EXAMINING ATTORNEY

CLASS 3—(Continued).

SN 79-002,740. BRETAGNE COSMETIQUES MARINS, FRANCE, FILED 11-6-2003.

ISOMARINE

THE MARK CONSISTS OF STANDARD CHARACTERS WITHOUT CLAIM TO ANY PARTICULAR FONT, STYLE, SIZE, OR COLOR.

OWNER OF INTERNATIONAL REGISTRATION 0825476 DATED 11-6-2003, EXPIRES 11-6-2013.

FOR PERFUMERY; NON-MEDICATED COSMETIC PREPARATIONS BASED ON ALGAE AND ACTIVE MARINE COMPONENTS FOR CARE OF THE FACE, BODY AND HAIR; BODY AND FACIAL CLEANSING EMULSIONS; FACE, BODY AND BATH CLEANSING MILKS; NON-MEDICATED TONIC LOTIONS FOR FACE, BODY AND HAIR; BEAUTY MASKS; EXFOLIANTS, NAMELY, SKIN PEELING PREPARATIONS AND SCRUBBING PREPARATIONS FOR FACE AND BODY; BODY, COLD, EYE AND FACE CREAMS; BODY, EYE AND FACE GELS AND SKIN CARE PRODUCTS, NAMELY, NON-MEDICATED SKIN SERUMS FOR BEAUTY CARE; HYDRATING BATH AND BODY MILKS, OILS AND ESSENTIAL OILS FOR PERSONAL USE, BODY LOTIONS, SOAPS, AND ALGAE POWDER FOR FACE, BODY AND HAIR CARE; SHAMPOOS, SHOWER GELS, BATH FOAM AND NON FOAM BATH PREPARATIONS, NAMELY, BATH GELS, OILS, MILKS, PEARLS, SALTS AND POWDERS; EFFERVESCENT SHOWER AND BATH TABLETS IN THE NATURE OF BUBBLE BATH (U.S. CLS. 1, 4, 6, 50, 51 AND 52).
GINA FINK, EXAMINING ATTORNEY

CLASS 4—(Continued).

SN 76-568,546. CHS INC., INVER GROVE HEIGHTS, MN. FILED 12-22-2003.

SUPERLUBE 518

THE MARK CONSISTS OF STANDARD CHARACTERS WITHOUT CLAIM TO ANY PARTICULAR FONT, STYLE, SIZE, OR COLOR.

OWNER OF U.S. REG. NO. 2,768,021.

NO CLAIM IS MADE TO THE EXCLUSIVE RIGHT TO USE SUPERLUBE, APART FROM THE MARK AS SHOWN. FOR MONO-GRADE DIESEL AND GASOLINE MOTOR VEHICLE ENGINE LUBRICANT FOR USE IN ANY INTERNAL COMBUSTION ENGINE REQUIRING A MONO-GRADE DIESEL OR GASOLINE ENGINE LUBRICANT (U.S. CLS. 1, 6 AND 15).

FIRST USE 9-26-1956; IN COMMERCE 9-26-1956.

CHARLES L. JENKINS, EXAMINING ATTORNEY

SN 76-588,186. VOTIVO, LTD., SEATTLE, WA. FILED 4-22-2004.

CLASS 4—LUBRICANTS AND FUELS

SN 76-541,986. FUCHS PETROLUB AG, D-68169 MAN-
NHEIM, FED REP GERMANY, FILED 9-3-2003.

MC Syn

THE MARK CONSISTS OF STANDARD CHARACTERS WITHOUT CLAIM TO ANY PARTICULAR FONT, STYLE, SIZE, OR COLOR.

PRIORITY CLAIMED UNDER SEC. 44(D) ON FED REP GERMANY APPLICATION NO. 30337252.4/0, FILED 7-25-2003, REG. NO. 30337252, DATED 10-30-2003, EXPIRES 7-31-2013.

NO CLAIM IS MADE TO THE EXCLUSIVE RIGHT TO USE "SYN", APART FROM THE MARK AS SHOWN.

FOR INDUSTRIAL OILS AND GREASES, GENERAL PURPOSE LUBRICANTS; SOLID, LIQUID AND GASEOUS FUELS, NAMELY ENGINE FUELS (U.S. CLS. 1, 6 AND 15).

WON TEAK OH, EXAMINING ATTORNEY

VENETIAN LILY

THE MARK CONSISTS OF STANDARD CHARACTERS WITHOUT CLAIM TO ANY PARTICULAR FONT, STYLE, SIZE, OR COLOR.

NO CLAIM IS MADE TO THE EXCLUSIVE RIGHT TO USE "LILY", APART FROM THE MARK AS SHOWN.

FOR CANDLES AND TAPERS (U.S. CLS. 1, 6 AND 15).

JOHN LINCOSKI, EXAMINING ATTORNEY

SN 76-588,188. VOTIVO, LTD., SEATTLE, WA. FILED 4-22-2004.

VENETIAN PEAR

THE MARK CONSISTS OF STANDARD CHARACTERS WITHOUT CLAIM TO ANY PARTICULAR FONT, STYLE, SIZE, OR COLOR.

NO CLAIM IS MADE TO THE EXCLUSIVE RIGHT TO USE "PEAR", APART FROM THE MARK AS SHOWN.

FOR CANDLES AND TAPERS (U.S. CLS. 1, 6 AND 15).

JOHN LINCOSKI, EXAMINING ATTORNEY

CLASS 4—(Continued).

SN 76-594,625. SANRIO COMPANY, LTD., TOKYO 141, JAPAN, FILED 5-27-2004.

CLASS 4—(Continued).

SN 78-344,997. CANDLE CORPORATION OF AMERICA, DES PLAINES, IL. FILED 12-23-2003.

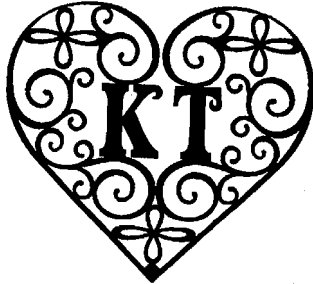

HOLIDAY MAGIC

FOR CANDLES, SCENTED CANDLES; LAMP WICKS, WICKS FOR CANDLES (U.S. CLS. 1, 6 AND 15).
EUGENIA MARTIN, EXAMINING ATTORNEY

THE MARK CONSISTS OF STANDARD CHARACTERS WITHOUT CLAIM TO ANY PARTICULAR FONT, STYLE, SIZE, OR COLOR.
NO CLAIM IS MADE TO THE EXCLUSIVE RIGHT TO USE HOLIDAY, APART FROM THE MARK AS SHOWN.
FOR CANDLES (U.S. CLS. 1, 6 AND 15).
JOHN E. MICHOS, EXAMINING ATTORNEY

SN 78-080,616. RUG DOCTOR, L.P., PLANO, TX. FILED 8-22-2001.

STARRY NIGHT

FOR CANDLES (U.S. CLS. 1, 6 AND 15).
MICHAEL WEBSTER, EXAMINING ATTORNEY

SN 78-426,458. WHOLESALE FUELS, INC., BAKERSFIELD, CA. FILED 5-27-2004.

SN 78-326,186. LATINA MEDIA VENTURES LLC, NEW YORK, NY. FILED 11-11-2003.



LUBE LOCKER

IN ITS ENGLISH TRANSLATION THE TERM "LATINA" RELATES TO WOMEN OF HISPANIC ORIGIN.
FOR CANDLES (U.S. CLS. 1, 6 AND 15).
INGRID C. EULIN, EXAMINING ATTORNEY

THE MARK CONSISTS OF STANDARD CHARACTERS WITHOUT CLAIM TO ANY PARTICULAR FONT, STYLE, SIZE, OR COLOR.
NO CLAIM IS MADE TO THE EXCLUSIVE RIGHT TO USE LUBE, APART FROM THE MARK AS SHOWN.
FOR COMMERCIAL AND INDUSTRIAL OILS AND LUBRICANTS (U.S. CLS. 1, 6 AND 15).
FIRST USE 2-1-2004; IN COMMERCE 2-1-2004.
H. M. FISHER, EXAMINING ATTORNEY

CLASS 4—(Continued).

SN 78-432,687. AMS MATERIALS, LLC, FRUIT COVE, FL.
FILED 6-9-2004.

CLASS 4—(Continued).

SN 78-435,400. SEQUENTIAL BIOFUELS LLC, PORTLAND,
OR. FILED 6-15-2004.

GUN SNOT

SEQUENTIAL

THE MARK CONSISTS OF STANDARD CHARACTERS
WITHOUT CLAIM TO ANY PARTICULAR FONT, STYLE,
SIZE, OR COLOR.

FOR BIODIESEL FUELS (U.S. CLS. 1, 6 AND 15).

FIRST USE 7-0-2002; IN COMMERCE 6-0-2003.

ANDREW BENZMILLER, EXAMINING ATTORNEY

THE MARK CONSISTS OF STANDARD CHARACTERS
WITHOUT CLAIM TO ANY PARTICULAR FONT, STYLE,
SIZE, OR COLOR.

NO CLAIM IS MADE TO THE EXCLUSIVE RIGHT TO
USE "GUN", APART FROM THE MARK AS SHOWN.

FOR LUBRICANTS FOR RIFLES, WEAPONS, FIRE-
ARMS, KNIVES, AMMUNITION AND RELATED
SHOOTING AND HUNTING EQUIPMENT (U.S. CLS. 1,
6 AND 15).

VERNA BETH RIRIE, EXAMINING ATTORNEY

SN 78-436,693. PENNZOIL-QUAKER STATE COMPANY,
HOUSTON, TX. FILED 6-17-2004.

PENNZOIL PLATINUM

SN 78-434,309. CALIFORNIA WINE WORKS, LLC., MISSION
VIEJO, CA. FILED 6-12-2004.

THE MARK CONSISTS OF STANDARD CHARACTERS
WITHOUT CLAIM TO ANY PARTICULAR FONT, STYLE,
SIZE, OR COLOR.

FOR MOTOR OIL (U.S. CLS. 1, 6 AND 15).

ZHALEH DELANEY, EXAMINING ATTORNEY

CALIFORNIA WINE CHIPS

SN 78-436,698. PENNZOIL-QUAKER STATE COMPANY,
HOUSTON, TX. FILED 6-17-2004.

PENNZOIL PLUS

THE MARK CONSISTS OF STANDARD CHARACTERS
WITHOUT CLAIM TO ANY PARTICULAR FONT, STYLE,
SIZE, OR COLOR.

NO CLAIM IS MADE TO THE EXCLUSIVE RIGHT TO
USE "CALIFORNIA" AND "CHIPS", APART FROM THE
MARK AS SHOWN.

FOR WOOD FOR COOKING AND BURNING,
NAMELY PIECES OF WOOD FOR USE IN COOKING,
BARBEQUING, GRILLING, SMOKING, AND BURNING
(U.S. CLS. 1, 6 AND 15).

KAREN K. BUSH, EXAMINING ATTORNEY

THE MARK CONSISTS OF STANDARD CHARACTERS
WITHOUT CLAIM TO ANY PARTICULAR FONT, STYLE,
SIZE, OR COLOR.

FOR MOTOR OIL (U.S. CLS. 1, 6 AND 15).

FIRST USE 9-19-2004; IN COMMERCE 9-19-2004.

DARRYL SPRUILL, EXAMINING ATTORNEY

CLASS 4—(Continued).

SN 78-516,203. WICKER WORLD ENTERPRISES, INC.,
GLENDALE HEIGHTS, IL. FILED 11-12-2004.

HOMEGLOW

THE MARK CONSISTS OF STANDARD CHARACTERS
WITHOUT CLAIM TO ANY PARTICULAR FONT, STYLE,
SIZE, OR COLOR.

FOR CANDLES (U.S. CLS. 1, 6 AND 15).
SKYE YOUNG, EXAMINING ATTORNEY

CLASS 5—(Continued).

SN 76-425,196. ANDOVER COATED PRODUCTS, INC.,
SALISBURY, MA. FILED 6-27-2002.

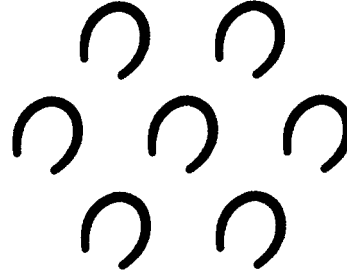

THE MARK CONSISTS OF A SERIES OF HORSESHOES
FORMING A CONTINUOUS PATTERN.
SEC. 2(F).

FOR ADHESIVE BANDAGES AND SURGICAL BAN-
DAGES, MEDICAL ADHESIVE TAPE (U.S. CLS. 6, 18, 44,
46, 51 AND 52).

FIRST USE 3-0-2001; IN COMMERCE 3-0-2001.
CURTIS FRENCH, EXAMINING ATTORNEY

SN 78-516,205. WICKER WORLD ENTERPRISES, INC.,
GLENDALE HEIGHTS, IL. FILED 11-12-2004.



FOR CANDLES (U.S. CLS. 1, 6 AND 15).
SKYE YOUNG, EXAMINING ATTORNEY

SN 76-481,282. Q. B. ENTERPRISES, INC., CULPEPER, VA.
FILED 1-9-2003.

QUICK DRY

OWNER OF U.S. REG. NO. 1,905,680.
FOR AIR DEODORIZERS AND CAR DEODORIZERS
(U.S. CLS. 6, 18, 44, 46, 51 AND 52).

FIRST USE 1-22-1999; IN COMMERCE 1-22-1999.
GWEN STOKOLS, EXAMINING ATTORNEY

SN 76-491,390. YASOO HEALTH INC., JOHNSON CITY, TN.
FILED 2-21-2003.

**CLASS 5—PHARMACEUTICALS**

SN 76-008,441. AVENTIS PHARMA HOLDING GMBH,
FRANKFURT, FED REP GERMANY, FILED 3-23-2000.

DYNEPO

OWNER OF FED REP GERMANY REG. NO. 30010356,
DATED 4-11-2000, EXPIRES 2-28-2010.

FOR PHARMACEUTICAL PREPARATIONS FOR THE
TREATMENT OF CARDIOVASCULAR AND BLOOD
DISORDERS (U.S. CLS. 6, 18, 44, 46, 51 AND 52).
ALICIA COLLINS, EXAMINING ATTORNEY

FOR PHARMACEUTICALS IN THE NATURE OF
DIETARY SUPPLEMENTS FOR MEDICAL USE (U.S.
CLS. 6, 18, 44, 46, 51 AND 52).

DARRYL SPRUILL, EXAMINING ATTORNEY

CLASS 5—(Continued).

SN 76-565,846. LAINE ENTERPRISES LTD., DBA BEST VALUE PRODUCTS, WYNCOTE, PA. FILED 12-18-2003.

SUDDENLY FEM

THE MARK CONSISTS OF STANDARD CHARACTERS WITHOUT CLAIM TO ANY PARTICULAR FONT, STYLE, SIZE, OR COLOR.

NO CLAIM IS MADE TO THE EXCLUSIVE RIGHT TO USE "FEM", APART FROM THE MARK AS SHOWN.

FOR DIETARY SUPPLEMENTS IN CAPSULES AND TOPICAL CREAMS FOR ENHANCING FEMININE CHARACTERISTICS IN MEN (U.S. CLS. 6, 18, 44, 46, 51 AND 52).

MITCHELL FRONT, EXAMINING ATTORNEY

SN 76-567,520. PHYTOWAY USA, FLORIDA, NY. FILED 12-18-2003.

PHYTOWAY

FOR PLANT NUTRIENTS FOR THE GENERAL CONSUMER MARKET, NAMELY, NUTRITIONAL SUPPLEMENTS (U.S. CLS. 6, 18, 44, 46, 51 AND 52).

FIRST USE 11-1-2003; IN COMMERCE 11-1-2003.

JANICE L. MCMORROW, EXAMINING ATTORNEY

SN 76-567,894. FEMPRO INC., QUEBEC J2C 2Z5, CANADA, FILED 12-31-2003.

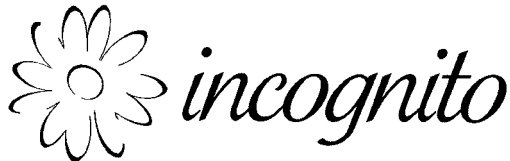

PRIORITY CLAIMED UNDER SEC. 44(D) ON CANADA APPLICATION NO. 1192239, FILED 9-29-2003, REG. NO. TMA627755, DATED 12-7-2004, EXPIRES 12-7-2019.

OWNER OF U.S. REG. NOS. 2,175,449, 2,234,733 AND 2,261,951.

FOR FEMININE HYGIENIC PRODUCTS, NAMELY – PANTY LINERS, SANITARY NAPKINS, TAMPONS, ABSORBENT PADS (U.S. CLS. 6, 18, 44, 46, 51 AND 52).

VIVIAN MICZNIK FIRST, EXAMINING ATTORNEY

CLASS 5—(Continued).

SN 76-567,895. FEMPRO INC., QUEBEC J2C 2Z5, CANADA, FILED 12-31-2003.



PRIORITY CLAIMED UNDER SEC. 44(D) ON CANADA APPLICATION NO. 1192240, FILED 9-29-2003, REG. NO. TMA627960, DATED 12-8-2004, EXPIRES 12-8-2019.

OWNER OF U.S. REG. NOS. 2,175,449, 2,234,733 AND 2,261,951.

FOR FEMININE HYGIENIC PRODUCTS, NAMELY – PANTY LINERS, SANITARY NAPKINS, TAMPONS, ABSORBENT PADS (U.S. CLS. 6, 18, 44, 46, 51 AND 52).

VIVIAN MICZNIK FIRST, EXAMINING ATTORNEY

SN 76-569,353. LAI YUNG SHANG SUNG FEN TANG LTD., HONG KONG, FILED 1-12-2004.



THE ENGLISH TRANSLATION OF THE CHINESE CHARACTERS IN THE MARK IS "PORTRAIT OF LUI YUN SHANG, THE FOUNDER OF SONG FEN TANG, ORIGINALLY THE NAME OF THE FAMILY MEMORIAL HALL OF MS. PIK FAN LU'S FAMILY".

FOR HEALTH FOOD SUPPLEMENTS AND NUTRITIONAL SUPPLEMENTS (U.S. CLS. 6, 18, 44, 46, 51 AND 52).

FIRST USE 4-1-2003; IN COMMERCE 7-15-2003.

BRIDGETT SMITH, EXAMINING ATTORNEY

CLASS 5—(Continued).

SN 76-570,016. ABUNDANT LIFE INTERNATIONAL, INC.,
LAS VEGAS, NV. FILED 12-22-2003.

THE ELEPHANT

THE MARK CONSISTS OF STANDARD CHARACTERS
WITHOUT CLAIM TO ANY PARTICULAR FONT, STYLE,
SIZE, OR COLOR.

FOR HERBAL SUPPLEMENTS (U.S. CLS. 6, 18, 44, 46,
51 AND 52).

FIRST USE 7-1-1994; IN COMMERCE 7-1-1994.

CIMMERIAN COLEMAN, EXAMINING ATTORNEY

SN 76-570,022. ABUNDANT LIFE INTERNATIONAL, INC.,
LAS VEGAS, NV. FILED 12-22-2003.

INTERNAL LIFE PRODUCTS

THE MARK CONSISTS OF STANDARD CHARACTERS
WITHOUT CLAIM TO ANY PARTICULAR FONT, STYLE,
SIZE, OR COLOR.

NO CLAIM IS MADE TO THE EXCLUSIVE RIGHT TO
USE "PRODUCTS", APART FROM THE MARK AS SHOWN.

FOR HERBAL SUPPLEMENTS (U.S. CLS. 6, 18, 44, 46,
51 AND 52).

FIRST USE 7-1-1994; IN COMMERCE 7-1-1994.

CIMMERIAN COLEMAN, EXAMINING ATTORNEY

SN 76-576,821. ULTIMATE NUTRITION, INC., FARMING-
TON, CT. FILED 2-19-2004.

ULTIMATE NUTRITION, INC - THE FUTURE OF SPORTS NUTRITION

THE MARK CONSISTS OF STANDARD CHARACTERS
WITHOUT CLAIM TO ANY PARTICULAR FONT, STYLE,
SIZE, OR COLOR.

OWNER OF U.S. REG. NO. 1,541,169.

NO CLAIM IS MADE TO THE EXCLUSIVE RIGHT TO
USE "NUTRITION INC" AND "SPORTS NUTRITION",
APART FROM THE MARK AS SHOWN.

FOR NUTRITIONAL PRODUCTS, NAMELY DIETARY
SUPPLEMENTS (U.S. CLS. 6, 18, 44, 46, 51 AND 52).

LINDA E. BLOHM, EXAMINING ATTORNEY

SN 76-578,108. MAXIMUM HUMAN PERFORMANCE, INC.,
CEDAR GROVE, NJ. FILED 2-27-2004.

OPTIMONE-5

THE MARK CONSISTS OF STANDARD CHARACTERS
WITHOUT CLAIM TO ANY PARTICULAR FONT, STYLE,
SIZE, OR COLOR.

FOR DIETARY SUPPLEMENT (U.S. CLS. 6, 18, 44, 46,
51 AND 52).

JAMES A. RAUEN, EXAMINING ATTORNEY

CLASS 5—(Continued).

SN 76-578,792. BRECKENRIDGE PHARMACEUTICAL, INC.,
BOCA RATON, FL. FILED 3-1-2004.

VINATE ULTRAGEN

THE MARK CONSISTS OF STANDARD CHARACTERS
WITHOUT CLAIM TO ANY PARTICULAR FONT, STYLE,
SIZE, OR COLOR.

OWNER OF U.S. REG. NOS. 2,520,191 AND 2,520,192.

FOR PHARMACEUTICAL PREPARATIONS FOR THE
TREATMENT OF PRENATAL CONDITIONS (U.S. CLS.
6, 18, 44, 46, 51 AND 52).

AMY HELLA, EXAMINING ATTORNEY

SN 76-581,280. HIKARI HOLDINGS, L.C., VALLEY CENTER,
CA. FILED 3-15-2004.

DOC BROC'S

THE MARK CONSISTS OF STANDARD CHARACTERS
WITHOUT CLAIM TO ANY PARTICULAR FONT, STYLE,
SIZE, OR COLOR.

THE NAME "DOC BROC" DOES NOT IDENTIFY A
LIVING INDIVIDUAL.

FOR DIETARY AND NUTRITIONAL SUPPLEMENTS,
NAMELY VITAMINS (U.S. CLS. 6, 18, 44, 46, 51 AND 52).

FIRST USE 1-0-2001; IN COMMERCE 1-0-2001.

ANN E. SAPPENFIELD, EXAMINING ATTORNEY

SN 76-585,392. HEALTH EXPRESS PLUS INC., LAS VEGAS,
NV. FILED 4-2-2004.

HEALTH EXPRESS PLUS

THE MARK CONSISTS OF STANDARD CHARACTERS
WITHOUT CLAIM TO ANY PARTICULAR FONT, STYLE,
SIZE, OR COLOR.

NO CLAIM IS MADE TO THE EXCLUSIVE RIGHT TO
USE "HEALTH", APART FROM THE MARK AS SHOWN.

THE MARK CONSISTS OF THE TEXT HEALTH EXPRESS
PLUS IN ALL CAPITALS.

FOR HEALTH FOOD PRODUCTS, NAMELY LOW-
CARB PRODUCTS IN THE NATURE OF VITAMINS
AND SUPPLEMENTS, HIGH-PROFIT VITAMINS AND
FOOD SUPPLEMENTS (U.S. CLS. 6, 18, 44, 46, 51 AND
52).

KIMBERLY PERRY, EXAMINING ATTORNEY

CLASS 5—(Continued).

SN 76-592,924. NATURAL ORGANICS INC., MELVILLE, NY.
FILED 5-19-2004.

NATURE'S PLUS HANGOVER REMEDY

THE MARK CONSISTS OF STANDARD CHARACTERS WITHOUT CLAIM TO ANY PARTICULAR FONT, STYLE, SIZE, OR COLOR.

OWNER OF U.S. REG. NOS. 2,055,168, 2,078,813 AND OTHERS.

NO CLAIM IS MADE TO THE EXCLUSIVE RIGHT TO USE "HANGOVER REMEDY", APART FROM THE MARK AS SHOWN.

FOR DIETARY SUPPLEMENTS (U.S. CLS. 6, 18, 44, 46, 51 AND 52).

RUDY R. SINGLETON, EXAMINING ATTORNEY

SN 76-594,626. SANRIO COMPANY, LTD., TOKYO 141,
JAPAN, FILED 5-27-2004.



FOR ADHESIVE BANDAGES; FIRST AID KITS COMPRISED OF ADHESIVE BANDAGES, COTTON SWABS AND FIRST AID CREAM IN A CASE; AIR FRESHENERS; THROAT LOZENGES (U.S. CLS. 6, 18, 44, 46, 51 AND 52).

EUGENIA MARTIN, EXAMINING ATTORNEY

SN 76-595,746. WARNER HEALTH CARE, INC., CINCINNATI, OH. FILED 6-4-2004.

RECLAIM YOUR SENSUALITY

THE MARK CONSISTS OF STANDARD CHARACTERS WITHOUT CLAIM TO ANY PARTICULAR FONT, STYLE, SIZE, OR COLOR.

FOR HERBAL SUPPLEMENTS (U.S. CLS. 6, 18, 44, 46, 51 AND 52).

FIRST USE 11-3-2002; IN COMMERCE 11-3-2002.
STACY WAHLBERG, EXAMINING ATTORNEY

CLASS 5—(Continued).

SN 76-597,754. IMPAX LABORATORIES, INC., HAYWARD, CA. FILED 6-17-2004.



FOR PHARMACEUTICAL PREPARATIONS FOR USE IN THE TREATMENT OF CARDIOVASCULAR, NEUROLOGICAL, ONCOLOGICAL, HORMONAL, IMMUNOLOGICAL, MUSCULOSKELETAL, RESPIRATORY, ALIMENTARY AND METABOLIC DISEASES AND CONDITIONS; AND ANTI-INFECTIVES (U.S. CLS. 6, 18, 44, 46, 51 AND 52).

MARC LEIPZIG, EXAMINING ATTORNEY

SN 76-597,855. COLLINS, JAMES F., JR., LONG ISLAND CITY, NY. FILED 6-17-2004.

MEDULE

THE MARK CONSISTS OF STANDARD CHARACTERS WITHOUT CLAIM TO ANY PARTICULAR FONT, STYLE, SIZE, OR COLOR.

FOR VIALS CONTAINING LIQUID MEDICATION FOR THE TREATMENT OF EYE CONDITIONS (U.S. CLS. 6, 18, 44, 46, 51 AND 52).

ALICIA COLLINS, EXAMINING ATTORNEY

SN 76-598,111. NATREN INC., WESTLAKE VILLAGE, CA. FILED 6-18-2004.

HEALTHY START SYSTEM

THE MARK CONSISTS OF STANDARD CHARACTERS WITHOUT CLAIM TO ANY PARTICULAR FONT, STYLE, SIZE, OR COLOR.

OWNER OF U.S. REG. NOS. 1,496,526, 2,036,482 AND OTHERS.

NO CLAIM IS MADE TO THE EXCLUSIVE RIGHT TO USE "SYSTEM", APART FROM THE MARK AS SHOWN.

FOR DIETARY SUPPLEMENT CONSISTING OF THREE PRODUCTS SOLD AS A UNIT CONTAINING LACTOBACILLUS ACIDOPHILUS CULTURE, LACTOBACILLUS BULGARICUS CULTURE, AND BIFIDOBACTERIUM BIFIDUM CULTURE (U.S. CLS. 6, 18, 44, 46, 51 AND 52).

FIRST USE 6-0-1999; IN COMMERCE 6-0-1999.
ROBERT COGGINS, EXAMINING ATTORNEY

CLASS 5—(Continued).

SN 76-598,505. C.B. FLEET INVESTMENT CORPORATION, WILMINGTON, DE. FILED 6-22-2004.

PHOSPHO-PREP

THE MARK CONSISTS OF STANDARD CHARACTERS WITHOUT CLAIM TO ANY PARTICULAR FONT, STYLE, SIZE, OR COLOR.

FOR BOWEL CLEANSING PREPARATION KIT CONSISTING OF LAXATIVE SOLUTIONS AND TABLETS, ENEMAS, SUPPOSITORIES, ENEMA BOTTLES, ENEMA BAGS, AND RECTAL CLOTH WIPES FOR PAIN RELIEF (U.S. CLS. 6, 18, 44, 46, 51 AND 52).

WILLIAM VERHOSEK, EXAMINING ATTORNEY

SN 76-599,141. OCEAN SPRAY CRANBERRIES, INC., LAKEVILLE-MIDDLEBORO, MA. FILED 6-24-2004.

PREFER

THE MARK CONSISTS OF STANDARD CHARACTERS WITHOUT CLAIM TO ANY PARTICULAR FONT, STYLE, SIZE, OR COLOR.

FOR JUICE BASED MEAL REPLACEMENT BEVERAGE (U.S. CLS. 6, 18, 44, 46, 51 AND 52).

PRISCILLA MILTON, EXAMINING ATTORNEY

SN 78-054,125. PARADISE MARKETING SERVICES, SOLANA BEACH, CA. FILED 3-20-2001.

TANTRA PERSONAL LUBRICANT

NO CLAIM IS MADE TO THE EXCLUSIVE RIGHT TO USE "PERSONAL LUBRICANT", APART FROM THE MARK AS SHOWN.

FOR GELS FOR USE AS PERSONAL LUBRICANT (U.S. CLS. 6, 18, 44, 46, 51 AND 52).

REBECCA SMITH, EXAMINING ATTORNEY

SN 78-055,373. GUSTAFSON, L.L.C., PLANO, TX. FILED 3-27-2001.

SECURE

FOR INSECTICIDES FOR COMMERCIAL-AGRICULTURAL USE, NAMELY, CLOTHIANIDIN APPLIED DIRECTLY ON CORN SEEDS, WHICH IS DISTRIBUTED BY INDEPENDENT REPRESENTATIVES TO SEED COMPANIES IN THE AGRICULTURE INDUSTRY (U.S. CLS. 6, 18, 44, 46, 51 AND 52).

JOHN GARTNER, EXAMINING ATTORNEY

CLASS 5—(Continued).

SN 78-180,831. VELCURA THERAPEUTICS, INC, NN ARBOR, MI. FILED 11-1-2002.

OSTEOCHIP

FOR DNA MICRO ARRAY CONTAINING BONE CELL GENES FOR CLINICAL OR MEDICAL LABORATORY USE (U.S. CLS. 6, 18, 44, 46, 51 AND 52).

MARTHA FROMM, EXAMINING ATTORNEY

SN 78-210,836. BOOTS HEALTHCARE USA, INC., WILMINGTON, DE. FILED 2-4-2003.

ELEVA

FOR PHARMACEUTICAL PREPARATIONS FOR THE TREATMENT AND/OR PREVENTION OF NASAL CONGESTION, SORE THROAT, ASTHMA, ALLERGIES, CONSTIPATION, DIARRHEA, ACNE, DERMATITIS, PSORIASIS, FUNGAL INFECTION, COLD SORES, ANXIETY, SLEEP DISTURBANCE, EAR WAX AND TO ASSIST IN THE CESSATION OF SMOKING (U.S. CLS. 6, 18, 44, 46, 51 AND 52).

STEVEN BERK, EXAMINING ATTORNEY

SN 78-227,672. CHUGAI SEIYAKU KABUSHIKI KAISHA, TOKYO, JAPAN, FILED 3-19-2003.

ACTEMRA

OWNER OF JAPAN REG. NO. 4696835, DATED 8-1-2003, EXPIRES 8-1-2013.

FOR PHARMACEUTICAL PREPARATIONS, NAMELY, ANTI-INTERLEUKIN-6 (IL-6) RECEPTOR MONOCLONAL ANTIBODY FOR THE TREATMENT OF DISEASE CAUSED BY IL-6 PRODUCTION (U.S. CLS. 6, 18, 44, 46, 51 AND 52).

LEIGH CAROLINE CASE, EXAMINING ATTORNEY

SN 78-227,677. CHUGAI SEIYAKU KABUSHIKI KAISHA, TOKYO, JAPAN, FILED 3-19-2003.

LOGIVIK

OWNER OF JAPAN REG. NO. 4726332, DATED 11-14-2003, EXPIRES 11-14-2013.

FOR PHARMACEUTICAL PREPARATIONS, NAMELY, ANTI-INTERLEUKIN-6 (IL-6) RECEPTOR MONOCLONAL ANTIBODY FOR THE TREATMENT OF DISEASES CAUSED BY IL-6 PRODUCTION (U.S. CLS. 6, 18, 44, 46, 51 AND 52).

LEIGH CAROLINE CASE, EXAMINING ATTORNEY

CLASS 5—(Continued).

SN 78-233,636. NOVARTIS AG, BASEL, SWITZERLAND, FILED 4-3-2003.

PREXEEGE

PRIORITY CLAIMED UNDER SEC. 44(D) ON SWITZERLAND APPLICATION NO. 1860/2003, FILED 4-1-2003, REG. NO. 509131, DATED 4-3-2003, EXPIRES 4-1-2013.

FOR PHARMACEUTICAL PREPARATIONS FOR PREVENTION AND/OR TREATMENT OF DISORDERS OF THE NERVOUS SYSTEM, THE IMMUNE SYSTEM, THE CARDIOVASCULAR SYSTEM, THE RESPIRATORY SYSTEM, THE MUSCULOSKELETAL SYSTEM, THE GENITOURINARY SYSTEM, FOR THE TREATMENT OF INFLAMMATORY DISORDERS, FOR USE IN DERMATOLOGY, IN ONCOLOGY, FOR USE IN THE GASTROENTEROLOGICAL AREA, AND THE PREVENTION AND TREATMENT OF OCULAR DISORDERS OR DISEASES (U.S. CLS. 6, 18, 44, 46, 51 AND 52).

JILL C. ALT, EXAMINING ATTORNEY

CLASS 5—(Continued).

SN 78-283,625. QUANDAHL, WENDY T., DALLAS, TX, FILED 8-6-2003.

NUTRIRIGHT

FOR VITAMINS, NUTRITIONAL SUPPLEMENTS, VITAMIN AND MINERAL SUPPLEMENTS, BATH SALTS FOR MEDICINAL PURPOSES, HERBAL MUD PACKS FOR THERAPEUTIC PURPOSES, HERBAL SUPPLEMENTS, HERBAL TEAS FOR MEDICINAL PURPOSES, DIETARY SUPPLEMENT DRINKS, DIETARY DRINK MIX FOR USE AS A MEAL REPLACEMENT, HOUSEHOLD DEODORIZER, SHOE DEODORIZERS, MEDICATED FOOT POWDER, MEDICATED LIP BALM, MEDICATED PRE-MOISTENED WIPES, MEDICATED SKIN-CARE PREPARATIONS, MENTHOL VAPOR BATH PREPARATIONS FOR BABIES, SINUS PILLOWS CONTAINING AROMATIC SUBSTANCES (U.S. CLS. 6, 18, 44, 46, 51 AND 52).

ALICE SUE CARRUTHERS, EXAMINING ATTORNEY

SN 78-240,493. MUSCLETECH RESEARCH AND DEVELOPMENT, INC., MISSISSAUGA ONTARIO, CANADA, FILED 4-22-2003.

Supplements That Work!

NO CLAIM IS MADE TO THE EXCLUSIVE RIGHT TO USE "SUPPLEMENTS", APART FROM THE MARK AS SHOWN.

FOR FOOD AND SPORTS NUTRITION SUPPLEMENTS FOR STRENGTH AND PERFORMANCE ENHANCEMENT (U.S. CLS. 6, 18, 44, 46, 51 AND 52).

FIRST USE 2-0-1999; IN COMMERCE 2-0-1999.
SUELLEN HICKEY, EXAMINING ATTORNEY

SN 78-288,467. NOVARTIS AG, BASEL, SWITZERLAND, FILED 8-18-2003.

EFFEGREX

PRIORITY CLAIMED UNDER SEC. 44(D) ON SWITZERLAND APPLICATION NO. 38632003, FILED 7-23-2003, REG. NO. 513118, DATED 7-30-2003, EXPIRES 7-23-2013.

FOR PHARMACEUTICALS PREPARATIONS FOR THE PREVENTION AND/OR TREATMENT OF DISORDERS OF THE NERVOUS SYSTEM, THE IMMUNE SYSTEM, THE CARDIO-VASCULAR SYSTEM, THE RESPIRATORY SYSTEM, THE MUSCULO-SKELETAL SYSTEM, THE GENITOURINARY SYSTEM, FOR THE TREATMENT OF INFLAMMATORY DISORDERS, FOR USE IN DERMATOLOGY, IN ONCOLOGY, IN OPHTHALMOLOGY, FOR USE IN THE GASTROENTEROLOGICAL AREA AND THE PREVENTION AND TREATMENT OF OCULAR DISORDERS OR DISEASES; ANTI-INFECTIVES, ANTIBACTERIALS, ANTIVIRALS, ANTIBIOTICS, AND ANTIFUNGALS (U.S. CLS. 6, 18, 44, 46, 51 AND 52).

ANN LINNEHAN, EXAMINING ATTORNEY

SN 78-258,312. PROMAX NUTRITION, INC., CONCORD, CA, FILED 6-4-2003.

**FLAVOR AND NUTRITION
ON A HIGHER PLANE.**

FOR NUTRITIONAL SUPPLEMENTS; NUTRITIONAL SUPPLEMENTS IN THE NATURE OF ENERGY BARS (U.S. CLS. 6, 18, 44, 46, 51 AND 52).

MICHAEL SOUDERS, EXAMINING ATTORNEY

SN 78-288,485. NOVARTIS AG, BASEL, SWITZERLAND, FILED 8-18-2003.

EFFLIGREX

PRIORITY CLAIMED UNDER SEC. 44(D) ON SWITZERLAND APPLICATION NO. 38652003, FILED 7-23-2003, REG. NO. 513120, DATED 7-20-2003, EXPIRES 7-23-2013.

FOR PHARMACEUTICAL PREPARATIONS FOR THE PREVENTION AND/OR TREATMENT OF DISORDERS OF THE NERVOUS SYSTEM, THE IMMUNE SYSTEM, THE CARDIO-VASCULAR SYSTEM, THE RESPIRATORY SYSTEM, THE MUSCULO-SKELETAL SYSTEM, THE GENITOURINARY SYSTEM, FOR THE TREATMENT OF INFLAMMATORY DISORDERS, FOR USE IN DERMATOLOGY, IN ONCOLOGY, IN OPHTHALMOLOGY, FOR USE IN THE GASTROENTEROLOGICAL AREA AND THE PREVENTION AND TREATMENT OF OCULAR DISORDERS OR DISEASES; ANTI-INFECTIVES, ANTIBACTERIALS, ANTIVIRALS, ANTIBIOTICS, AND ANTIFUNGALS (U.S. CLS. 6, 18, 44, 46, 51 AND 52).

ANN LINNEHAN, EXAMINING ATTORNEY

SN 78-276,089. INTERVET INC., MILLSBORO, DE. FILED 7-18-2003.

TREAT EASE

FOR PHARMACEUTICALS FOR HORSES, NAMELY, VETERINARY ANTHELMINTICS (U.S. CLS. 6, 18, 44, 46, 51 AND 52).

TRACY WHITAKER-BOWN, EXAMINING ATTORNEY

CLASS 5—(Continued).

SN 78-288,490. NOVARTIS AG, BASEL, SWITZERLAND,
FILED 8-18-2003.

EFFYGREX

PRIORITY CLAIMED UNDER SEC. 44(D) ON SWITZERLAND APPLICATION NO. 38662003, FILED 7-23-2003, REG. NO. 513121, DATED 7-30-2003, EXPIRES 7-23-2013.

FOR PHARMACEUTICAL PREPARATIONS FOR THE PREVENTION AND/OR TREATMENT OF DISORDERS OF THE NERVOUS SYSTEM, THE IMMUNE SYSTEM, THE CARDIO-VASCULAR SYSTEM, THE RESPIRATORY SYSTEM, THE MUSCULO-SKELETAL SYSTEM, THE GENITOURINARY SYSTEM, FOR THE TREATMENT OF INFLAMMATORY DISORDERS, FOR USE IN DERMATOLOGY, IN ONCOLOGY, IN OPHTHALMOLOGY, FOR USE IN THE GASTROENTEROLOGICAL AREA AND THE PREVENTION AND TREATMENT OF OCULAR DISORDERS OR DISEASES; ANTI-INFECTIVES, ANTIBACTERIALS, ANTIVIRALS, ANTIBIOTICS, AND ANTIFUNGALS (U.S. CLS. 6, 18, 44, 46, 51 AND 52).

ANN LINNEHAN, EXAMINING ATTORNEY

SN 78-304,423. BODYONICS, LTD., HICKSVILLE, NY. FILED
9-23-2003.

THERMOXCEL

FOR BLEND OF THERMOGENIC HERBS AND NUTRIENTS SOLD AS AN INTEGRAL COMPONENT OF DIETARY AND NUTRITIONAL SUPPLEMENTS (U.S. CLS. 6, 18, 44, 46, 51 AND 52).

FIRST USE 12-0-2002; IN COMMERCE 12-0-2002.
JOANNA DUKOVIC, EXAMINING ATTORNEY

SN 78-304,891. INTEGRATED BIOPHARMA, INC., HILLSIDE, NJ. FILED 9-24-2003.

NATURALLY NONI

NO CLAIM IS MADE TO THE EXCLUSIVE RIGHT TO USE "NONI", APART FROM THE MARK AS SHOWN.

FOR NUTRITIONAL SUPPLEMENTS (U.S. CLS. 6, 18, 44, 46, 51 AND 52).
FIRST USE 8-0-2002; IN COMMERCE 6-0-2003.
KARLA PERKINS, EXAMINING ATTORNEY

CLASS 5—(Continued).

SN 78-325,539. PRESTIGE BRANDS INTERNATIONAL, INC.,
BONITA SPRINGS, FL. FILED 11-10-2003.

**CHLORASEPTIC
RELIEF STRIPS**

THE MARK CONSISTS OF STANDARD CHARACTERS WITHOUT CLAIM TO ANY PARTICULAR FONT, STYLE, SIZE, OR COLOR.

OWNER OF U.S. REG. NO. 837,014.

NO CLAIM IS MADE TO THE EXCLUSIVE RIGHT TO USE "RELIEF STRIPS", APART FROM THE MARK AS SHOWN.

FOR PHARMACEUTICAL PREPARATIONS FOR THE RELIEF OF THROAT AND MOUTH SORENESS (U.S. CLS. 6, 18, 44, 46, 51 AND 52).

FIRST USE 5-0-2003; IN COMMERCE 7-0-2003.
ALICIA COLLINS, EXAMINING ATTORNEY

SN 78-328,094. PRINCETON BIOMEDITECH CORPORATION,
MONMOUTH JUNCTION, NJ. FILED 11-14-2003.

STATUSFIRST

THE MARK CONSISTS OF STANDARD CHARACTERS WITHOUT CLAIM TO ANY PARTICULAR FONT, STYLE, SIZE, OR COLOR.

FOR MEDICAL DIAGNOSTIC TEST KITS COMPRISED PRIMARILY OF CARDIAC MARKERS AND DIAGNOSTIC REAGENTS FOR USE IN CONNECTION WITH RAPID IMMUNOASSAY TESTING IN THE FIELDS OF ABUSED DRUGS, CANCER DIAGNOSIS, CARDIAC DISORDERS, CHEMICAL DISORDERS, COAGULATION, ENDOCRINOLOGICAL DISORDERS, FERTILITY, INFECTIOUS DISEASE, HEMATOLOGY, IMMUNOLOGICAL DISORDERS, AND PHYSIOLOGICAL AND NEUROLOGICAL DISORDERS (U.S. CLS. 6, 18, 44, 46, 51 AND 52).

HOWARD B. LEVINE, EXAMINING ATTORNEY

CLASS 5—(Continued).

SN 78-328,953. MILLENNIUM BIOTECHNOLOGIES, INC.,
BASKING RIDGE, NJ. FILED 11-17-2003.

RESURGEX PLUS

THE MARK CONSISTS OF STANDARD CHARACTERS
WITHOUT CLAIM TO ANY PARTICULAR FONT, STYLE,
SIZE, OR COLOR.

OWNER OF U.S. REG. NO. 2,609,741.
FOR NUTRITIONAL SUPPLEMENT (U.S. CLS. 6, 18,
44, 46, 51 AND 52).

FIRST USE 6-0-2004; IN COMMERCE 6-0-2004.
ANN E. SAPPENFIELD, EXAMINING ATTORNEY

SN 78-330,080. PARKE, DAVIS & COMPANY LLC, MORRIS
PLAINS, NJ. FILED 11-19-2003.



LYRICA
PREGABALIN

NO CLAIM IS MADE TO THE EXCLUSIVE RIGHT TO
USE PREGABALIN, APART FROM THE MARK AS
SHOWN.

THE STIPLING IS A FEATURE OF THE MARK.

FOR PHARMACEUTICAL PREPARATIONS FOR THE
TREATMENT OF CARDIOVASCULAR DISEASE, CENTRAL
NERVOUS SYSTEM DISEASES AND DISORDERS,
NEUROLOGICAL DISORDERS, UROLOGICAL DISOR-
DERS, UROGENITAL DISORDERS, GASTROINTEST-
INAL DISORDERS, MUSCULOSKELETAL DISORDERS,
ALLERGIES, DIABETES, HYPERTENSION, ERECTILE
DYSFUNCTION, SEXUAL DYSFUNCTION, STROKE,
CANCER, MIGRAINES, PAIN, OBESITY, INFLAMMA-
TION, INFLAMMATORY DISEASES, RESPIRATORY
DISEASES, INFECTIOUS DISEASES, IMMUNOLOGICAL
DISORDERS, VIRAL DISORDERS, FUNGAL DISOR-
DERS; PHARMACEUTICAL PREPARATIONS, NAME-
LY, CHOLESTEROL PREPARATIONS, SMOKING
CESSATION PREPARATIONS, DERMATOLOGICAL
PREPARATIONS, GYNECOLOGICAL PREPARATIONS,
OSTEOPOROSIS PREPARATIONS, OPHTHALMOLOGI-
CAL PREPARATIONS, PREPARATIONS FOR THE
TREATMENT OF HIV AND AIDS (U.S. CLS. 6, 18, 44,
46, 51 AND 52).

MARC LEIPZIG, EXAMINING ATTORNEY

CLASS 5—(Continued).

SN 78-333,334. CYTODYNE LLC, FARMINGDALE, NY.
FILED 11-25-2003.

**REAL SCIENCE REAL
PEOPLE REAL
SUCCESS**

THE MARK CONSISTS OF STANDARD CHARACTERS
WITHOUT CLAIM TO ANY PARTICULAR FONT, STYLE,
SIZE, OR COLOR.

FOR DIETARY AND NUTRITIONAL SUPPLEMENTS
(U.S. CLS. 6, 18, 44, 46, 51 AND 52).

LINDA ESTRADA, EXAMINING ATTORNEY

SN 78-333,481. VDF FUTURECEUTICALS, INC., MOMENCE,
IL. FILED 11-26-2003.



CoffeeBerry

THE COLOR(S) RED AND GREEN IS/ARE CLAIMED AS
A FEATURE OF THE MARK.

THE MARK CONSISTS OF THE STYLIZED WORD
COFFEEBERRY IN THE COLOR RED AND THE DESIGN
OF FRUIT IN THE COLORS RED AND GREEN.

FOR NUTRICEUTICALS FOR USE AS A DIETARY
SUPPLEMENT AND AS A DIETARY SUPPLEMENT
INGREDIENT (U.S. CLS. 6, 18, 44, 46, 51 AND 52).

MELVIN AXILBUND, EXAMINING ATTORNEY

SN 78-335,195. UNIVERSITY OF SOUTH FLORIDA, TAMPA,
FL. FILED 12-2-2003.

VIGILANT STEM CELL

THE MARK CONSISTS OF STANDARD CHARACTERS
WITHOUT CLAIM TO ANY PARTICULAR FONT, STYLE,
SIZE, OR COLOR.

NO CLAIM IS MADE TO THE EXCLUSIVE RIGHT TO
USE STEM CELL, APART FROM THE MARK AS SHOWN.

FOR PHARMACEUTICAL PREPARATION, NAMELY
AN ADENO-ASSOCIATED VECTOR, FOR THE REPAIR
OF DAMAGED BIOLOGICAL TISSUE BY PROTECTING
STEM CELLS AGAINST LOW OXYGEN AND CELL
DEATH (U.S. CLS. 6, 18, 44, 46, 51 AND 52).

BRIAN NEVILLE, EXAMINING ATTORNEY

CLASS 5—(Continued).

SN 78-338,131. BAYER PHARMACEUTICALS CORPORATION, WEST HAVEN, CT. FILED 12-9-2003.

CLASS 5—(Continued).

SN 78-355,468. WYETH HOLDINGS CORPORATION, MADISON, NJ. FILED 1-22-2004.

**HEY, YOU GOT A
CHOICE**

**IT'S YOUR ENERGY.
UNLEASH IT.**

THE MARK CONSISTS OF STANDARD CHARACTERS WITHOUT CLAIM TO ANY PARTICULAR FONT, STYLE, SIZE, OR COLOR.

FOR PHARMACEUTICAL PREPARATIONS, NAMELY, AN LH-RH (LUTEINIZING HORMONE-RELEASING HORMONE) AGONIST PREPARATION FOR USE IN THE TREATMENT OF CANCER; PHARMACEUTICAL PREPARATIONS, NAMELY, AN LH-RH (LUTEINIZING HORMONE-RELEASING HORMONE) AGONIST PREPARATION AND AN IMPLANTABLE DRUG DELIVERY SYSTEM COMPRISED OF AN IMPERMEABLE RESERVOIR, A PISTON, A WATER-SWELLABLE AGENT FORMULATION, AN LH-RH (LUTEINIZING HORMONE-RELEASING HORMONE) AGONIST FORMULATION, A SEMI-PERMEABLE PLUG, AND A BACK-DIFFUSION REGULATING OUTLET FOR USE IN THE TREATMENT OF CANCER, SOLD AS A UNIT. (U.S. CLS. 6, 18, 44, 46, 51 AND 52).
SEAN DWYER, EXAMINING ATTORNEY

THE MARK CONSISTS OF STANDARD CHARACTERS WITHOUT CLAIM TO ANY PARTICULAR FONT, STYLE, SIZE, OR COLOR.

FOR DIETARY AND NUTRITIONAL SUPPLEMENTS (U.S. CLS. 6, 18, 44, 46, 51 AND 52).
FIRST USE 9-6-2003; IN COMMERCE 9-6-2003.
TARAH HARDY, EXAMINING ATTORNEY

SN 78-345,397. BAYER AKTIENGESELLSCHAFT, LEVERKUSEN-BAYERWERK, FED REP GERMANY, FILED 12-24-2003.

SN 78-384,289. KLEARSEN CORPORATION, BOULDER, CO. FILED 3-15-2004.

BANDIT

Arthritis Rescue

THE MARK CONSISTS OF STANDARD CHARACTERS WITHOUT CLAIM TO ANY PARTICULAR FONT, STYLE, SIZE, OR COLOR.

FOR PREPARATIONS FOR KILLING WEEDS AND DESTROYING VERMIN, INSECTICIDES, HERBICIDES, FUNGICIDES (U.S. CLS. 6, 18, 44, 46, 51 AND 52).
MARY CRAWFORD, EXAMINING ATTORNEY

THE MARK CONSISTS OF STANDARD CHARACTERS WITHOUT CLAIM TO ANY PARTICULAR FONT, STYLE, SIZE, OR COLOR.

NO CLAIM IS MADE TO THE EXCLUSIVE RIGHT TO USE "ARTHRITIS", APART FROM THE MARK AS SHOWN. FOR HERBAL GEL FOR TREATMENT OF ARTHRITIS PAIN. (U.S. CLS. 6, 18, 44, 46, 51 AND 52).
GRETTA YAO, EXAMINING ATTORNEY

CLASS 5—(Continued).

SN 78-398,778. WYETH, MADISON, NJ. FILED 4-8-2004.

SMA

THE MARK CONSISTS OF STANDARD CHARACTERS WITHOUT CLAIM TO ANY PARTICULAR FONT, STYLE, SIZE, OR COLOR.

OWNER OF U.S. REG. NOS. 781,494 AND 1,463,263.
FOR INFANT FORMULA FOR BABIES, TODDLERS AND CHILDREN (U.S. CLS. 6, 18, 44, 46, 51 AND 52).
ZACHARY BELLO, EXAMINING ATTORNEY

SN 78-412,275. ZIOPHARM, INC., NEW YORK, NY. FILED 5-3-2004.

ZIOPHARM

THE MARK CONSISTS OF STANDARD CHARACTERS WITHOUT CLAIM TO ANY PARTICULAR FONT, STYLE, SIZE, OR COLOR.

FOR PHARMACEUTICALS FOR THE TREATMENT OF CANCER (U.S. CLS. 6, 18, 44, 46, 51 AND 52).
JOANNA DUKOVIC, EXAMINING ATTORNEY

CLASS 5—(Continued).

SN 78-416,671. ISI BRANDS, INC., GRAND RAPIDS, MI. FILED 5-11-2004.

**CREATINE NITRATE 3
FUEL**

THE MARK CONSISTS OF STANDARD CHARACTERS WITHOUT CLAIM TO ANY PARTICULAR FONT, STYLE, SIZE, OR COLOR.

NO CLAIM IS MADE TO THE EXCLUSIVE RIGHT TO USE CREATINE NITRATE, APART FROM THE MARK AS SHOWN.

FOR DIETARY SUPPLEMENTS (U.S. CLS. 6, 18, 44, 46, 51 AND 52).
CAROLYN CATALDO, EXAMINING ATTORNEY

SN 78-419,156. FIRST QUALITY PRODUCTS, INC., GREAT NECK, NY. FILED 5-14-2004.

PREVAIL CLASSICS

THE MARK CONSISTS OF STANDARD CHARACTERS WITHOUT CLAIM TO ANY PARTICULAR FONT, STYLE, SIZE, OR COLOR.

OWNER OF U.S. REG. NOS. 1,986,312, 2,390,758 AND 2,720,118.

FOR ADULT INCONTINENCE PRODUCTS, NAMELY BRIEFS, DIAPERS, UNDERGARMENTS, PADS AND PANTS, ADULT WETWIPES, SHIELDS, INCONTINENCE PADS, AND GUARDS (U.S. CLS. 6, 18, 44, 46, 51 AND 52).
GWEN STOKOLS, EXAMINING ATTORNEY

SN 78-421,257. NEXEL INDUSTRIES, INC, PORT WASHINGTON, NY. FILED 5-19-2004.

NEX  **Gard**
Anti-Microbial Protection

NO CLAIM IS MADE TO THE EXCLUSIVE RIGHT TO USE ANTI-MICROBIAL PROTECTION, APART FROM THE MARK AS SHOWN.

FOR ANTIMICROBIAL AGENT, NAMELY, ANTIMICROBIAL COATINGS TO PREVENT THE GROWTH OF MOLD, MILDEW, BACTERIA AND FUNGUS FOR USE ON SHELVES AND SHELVING SYSTEMS (U.S. CLS. 6, 18, 44, 46, 51 AND 52).

GEORGE LORENZO, EXAMINING ATTORNEY

CLASS 5—(Continued).

SN 78-421,740. PFIZER INC., NEW YORK, NY. FILED 5-19-2004.

CLASS 5—(Continued).

SN 78-424,794. ISOTECHNIKA INC., SCOTTSDALE, AZ. FILED 5-25-2004.

ZMAX SOLO

CALCIMUNE

THE MARK CONSISTS OF STANDARD CHARACTERS WITHOUT CLAIM TO ANY PARTICULAR FONT, STYLE, SIZE, OR COLOR.

OWNER OF U.S. REG. NOS. 1,702,392, 1,963,626 AND 2,648,750.

FOR ANTIBIOTIC PREPARATION (U.S. CLS. 6, 18, 44, 46, 51 AND 52).

MARC LEIPZIG, EXAMINING ATTORNEY

THE MARK CONSISTS OF STANDARD CHARACTERS WITHOUT CLAIM TO ANY PARTICULAR FONT, STYLE, SIZE, OR COLOR.

FOR PHARMACEUTICAL PREPARATIONS FOR USE AS AN IMMUNOMODULATOR (U.S. CLS. 6, 18, 44, 46, 51 AND 52).

BARBARA GAYNOR, EXAMINING ATTORNEY

SN 78-423,551. SCHEURINGER, KIM, BADEN, AUSTRIA, FILED 5-24-2004.

SN 78-424,945. WEIGHT LOSS BY DESIGN THE DOCTOR'S CHOICE INC., HUNTINGDON VALLEY, PA. FILED 5-25-2004.

CARE FSH

NUTRI-ESSENTIALS

THE MARK CONSISTS OF STANDARD CHARACTERS WITHOUT CLAIM TO ANY PARTICULAR FONT, STYLE, SIZE, OR COLOR.

NO CLAIM IS MADE TO THE EXCLUSIVE RIGHT TO USE FSH, APART FROM THE MARK AS SHOWN.

FOR MEDICAL DIAGNOSTIC DEVICES, NAMELY, REAGENTS, TEST STRIPS AND TEST STRIP HOLDERS FOR USE IN THE ANALYSIS OF BLOOD OR URINE; AND KITS FEATURING REAGENTS, TEST STRIPS AND TEST STRIP HOLDERS FOR USE IN THE ANALYSIS OF BLOOD OR URINE (U.S. CLS. 6, 18, 44, 46, 51 AND 52).

DARRYL SPRUILL, EXAMINING ATTORNEY

THE MARK CONSISTS OF STANDARD CHARACTERS WITHOUT CLAIM TO ANY PARTICULAR FONT, STYLE, SIZE, OR COLOR.

FOR NUTRITIONAL SUPPLEMENTS (U.S. CLS. 6, 18, 44, 46, 51 AND 52).

FIRST USE 0-0-2002; IN COMMERCE 0-0-2002.

JASON TURNER, EXAMINING ATTORNEY

CLASS 5—(Continued).

SN 78-425,478. LIFEWORKS PHARMA, LTD., ATLANTA, GA. FILED 5-26-2004.

CLASS 5—(Continued).

SN 78-428,123. RCMEDICAL LLC, BURR RIDGE, IL. FILED 6-1-2004.

CYSTINEX

BIG RED

THE MARK CONSISTS OF STANDARD CHARACTERS WITHOUT CLAIM TO ANY PARTICULAR FONT, STYLE, SIZE, OR COLOR.

FOR FOLIC ACID BASED MEDICAL FOOD AND NUTRITIONAL SUPPLEMENTS (U.S. CLS. 6, 18, 44, 46, 51 AND 52).

JULIA HARDY COFIELD, EXAMINING ATTORNEY

THE MARK CONSISTS OF STANDARD CHARACTERS WITHOUT CLAIM TO ANY PARTICULAR FONT, STYLE, SIZE, OR COLOR.

NO CLAIM IS MADE TO THE EXCLUSIVE RIGHT TO USE "RED", APART FROM THE MARK AS SHOWN.

FOR BANDAGES AND WOUND CARE DRESSINGS FOR TREATMENT OF HUMAN OR ANIMAL SKIN WOUNDS (U.S. CLS. 6, 18, 44, 46, 51 AND 52).

JENNIFER KRISP, EXAMINING ATTORNEY

SN 78-427,126. CYNTHIA BOXRUD, M.D., LLC, SANTA MONICA, CA. FILED 5-28-2004.

SN 78-428,715. VIVELLE VENTURES LLC, C/O NOVEN PHARMACEUTICALS, INC., MIAMI, FL. FILED 6-2-2004.

EYETOPIA

ESTALIS

THE MARK CONSISTS OF STANDARD CHARACTERS WITHOUT CLAIM TO ANY PARTICULAR FONT, STYLE, SIZE, OR COLOR.

FOR MEDICATED SKIN AND EYE CARE PREPARATIONS (U.S. CLS. 6, 18, 44, 46, 51 AND 52).

GRETTA YAO, EXAMINING ATTORNEY

THE MARK CONSISTS OF STANDARD CHARACTERS WITHOUT CLAIM TO ANY PARTICULAR FONT, STYLE, SIZE, OR COLOR.

FOR PHARMACEUTICAL PREPARATION, NAMELY, A HORMONE REPLACEMENT THERAPY (U.S. CLS. 6, 18, 44, 46, 51 AND 52).

JOHN LINCOSKI, EXAMINING ATTORNEY

CLASS 5—(Continued).

SN 78-429,905. DLH, INC., TINTON FALLS, NJ. FILED 6-4-2004.

Talking First Aid

THE MARK CONSISTS OF STANDARD CHARACTERS WITHOUT CLAIM TO ANY PARTICULAR FONT, STYLE, SIZE, OR COLOR.

NO CLAIM IS MADE TO THE EXCLUSIVE RIGHT TO USE "FIRST AID", APART FROM THE MARK AS SHOWN. FOR FIRST AID KITS (U.S. CLS. 6, 18, 44, 46, 51 AND 52).

JENNIFER KRISP, EXAMINING ATTORNEY

CLASS 5—(Continued).

SN 78-431,805. GREENVALLEY, LLC, FARMINGDALE, NY. FILED 6-8-2004.

精力威剛

THE FOREIGN WORDING IN THE MARK TRANSLATES INTO ENGLISH AS VIM, VIGOR AND MIGHTY POWER.

THE NON-LATIN CHARACTER(S) IN THE MARK TRANSLITERATES INTO JING LI WEI GANG, AND THIS MEANS VIM, VIGOR AND MIGHTY POWER IN ENGLISH.

FOR DIETARY SUPPLEMENT, HERB SUPPLEMENT, NUTRITION SUPPLEMENT (U.S. CLS. 6, 18, 44, 46, 51 AND 52).

FIRST USE 12-1-2002; IN COMMERCE 12-1-2002. JEFFERY COWARD, EXAMINING ATTORNEY

SN 78-430,558. RAINFOREST NUTRITIONALS, INC., RALEIGH, NC. AND RAINFOREST NUTRITIONALS, INC., RALEIGH, NC. FILED 6-5-2004.

ZINC THE COLD
KILLER

THE MARK CONSISTS OF STANDARD CHARACTERS WITHOUT CLAIM TO ANY PARTICULAR FONT, STYLE, SIZE, OR COLOR.

NO CLAIM IS MADE TO THE EXCLUSIVE RIGHT TO USE "ZINC", APART FROM THE MARK AS SHOWN.

FOR MEDICATED, NON-MEDICATED, NUTRITIONAL AND DIETARY SUPPLEMENTS CONTAINING ZINC (U.S. CLS. 6, 18, 44, 46, 51 AND 52).

FLORENTINA BLANDU, EXAMINING ATTORNEY

SN 78-432,337. HARRY J. BOSWORTH COMPANY, SKOKIE, IL. FILED 6-9-2004.

ORIGINAL TRULINER

THE MARK CONSISTS OF STANDARD CHARACTERS WITHOUT CLAIM TO ANY PARTICULAR FONT, STYLE, SIZE, OR COLOR.

NO CLAIM IS MADE TO THE EXCLUSIVE RIGHT TO USE "ORIGINAL", APART FROM THE MARK AS SHOWN.

FOR DENTURE RELINES (U.S. CLS. 6, 18, 44, 46, 51 AND 52).

FIRST USE 1-1-1973; IN COMMERCE 1-1-1973. KIM SAITO, EXAMINING ATTORNEY

CLASS 5—(Continued).

SN 78-432,761. TAKEMOTO, ARNOLD, SCOTTSDALE, AZ.
FILED 6-9-2004.

CLASS 5—(Continued).

SN 78-433,176. WINDOW ROCK ENTERPRISES, INC., YOR-
BA LINDA, CA. FILED 6-10-2004.

Geometals

THE MARK CONSISTS OF STANDARD CHARACTERS
WITHOUT CLAIM TO ANY PARTICULAR FONT, STYLE,
SIZE, OR COLOR.

FOR NUTRACEUTICAL SUPPLEMENTS (U.S. CLS. 6,
18, 44, 46, 51 AND 52).

JOHN SCHUYLER YARD, EXAMINING ATTORNEY

THE MARK CONSISTS OF STANDARD CHARACTERS
WITHOUT CLAIM TO ANY PARTICULAR FONT, STYLE,
SIZE, OR COLOR.

FOR DIETARY SUPPLEMENTS (U.S. CLS. 6, 18, 44, 46,
51 AND 52).

FIRST USE 10-15-2004; IN COMMERCE 10-15-2004.

REBECCA GILBERT, EXAMINING ATTORNEY

SN 78-434,190. ZHANG, DAN DAN, SAMMANISH, WA.
FILED 6-11-2004.

OsteoKing
骨王

THE FOREIGN WORDING IN THE MARK TRANSLATES
INTO ENGLISH AS BONE KING.

THE NON-LATIN CHARACTER(S) IN THE MARK
TRANSLITERATES INTO GU WANG, AND THIS MEANS
BONE KING IN ENGLISH.

FOR HERBAL SUPPLEMENTS AND DIETARY SUP-
PLEMENTS (U.S. CLS. 6, 18, 44, 46, 51 AND 52).

NANCY CLARKE, EXAMINING ATTORNEY

SN 78-432,919. SOCIETE DES PRODUITS NESTLE S. A.,
VEVEY, SWITZERLAND, FILED 6-10-2004.

SN 78-434,354. BODYONICS, LTD., FARMINGDALE, NY.
FILED 6-13-2004.

SYMFLORA

THE MARK CONSISTS OF STANDARD CHARACTERS
WITHOUT CLAIM TO ANY PARTICULAR FONT, STYLE,
SIZE, OR COLOR.

FOR DIETARY AND NUTRITIONAL SUPPLEMENTS
FOR ANIMALS (U.S. CLS. 6, 18, 44, 46, 51 AND 52).

NICHOLAS ALTREE, EXAMINING ATTORNEY

THE MARK CONSISTS OF STANDARD CHARACTERS
WITHOUT CLAIM TO ANY PARTICULAR FONT, STYLE,
SIZE, OR COLOR.

FOR DIETARY AND NUTRITIONAL SUPPLEMENTS
(U.S. CLS. 6, 18, 44, 46, 51 AND 52).

FIRST USE 8-6-2004; IN COMMERCE 9-28-2004.

NANCY CLARKE, EXAMINING ATTORNEY

CORTISCUPT

CLASS 5—(Continued).

SN 78-434,520. BLOCK DRUG COMPANY, INC., WEST TRENTON, NJ. FILED 6-14-2004.



THE COLOR(S) BLUE IS/ARE CLAIMED AS A FEATURE OF THE MARK.

THE MARK CONSISTS OF THE STYLIZED WORD OASIS IN THE COLOR BLUE WITH A WATER DROP AROUND THE LETTER O IN THE COLOR BLUE; COLOR IS CLAIMED AS A FEATURE OF THE MARK.

FOR PREPARATIONS FOR RELIEF OF DRY MOUTH AND ASSOCIATED SYMPTOMS AND CONDITIONS (U.S. CLS. 6, 18, 44, 46, 51 AND 52).

RONALD MCMORROW, EXAMINING ATTORNEY

CLASS 5—(Continued).

SN 78-435,259. PHARMACIA & UPJOHN COMANY LLC, PEAPACK, NJ. FILED 6-15-2004.

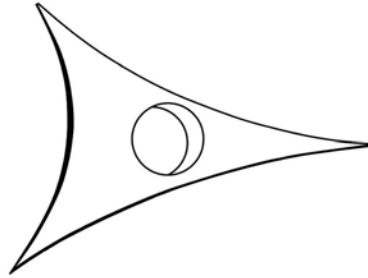

THE MARK CONSISTS OF A TRIANGULAR SHAPE FOR PHARMACEUTICAL PREPARATIONS, NAMELY, PREPARATIONS FOR THE TREATMENT OF CARDIOVASCULAR DISEASES AND CONDITIONS (U.S. CLS. 6, 18, 44, 46, 51 AND 52).

FIRST USE 1-31-2004; IN COMMERCE 1-31-2004. REGINA DRUMMOND, EXAMINING ATTORNEY

SN 78-434,584. CHURCH & DWIGHT CO., INC., PRINCETON, NJ. FILED 6-14-2004.

TROJAN MAGNUM

THE MARK CONSISTS OF STANDARD CHARACTERS WITHOUT CLAIM TO ANY PARTICULAR FONT, STYLE, SIZE, OR COLOR.

OWNER OF U.S. REG. NOS. 544,931, 2,637,237 AND OTHERS.

FOR DIETARY SUPPLEMENTS, CONTAINING MINERALS AND VITAMINS (U.S. CLS. 6, 18, 44, 46, 51 AND 52).

RONALD AIKENS, EXAMINING ATTORNEY

SN 78-435,376. FRANK, BRIAN DAVID, WHITEFISH, MT. FILED 6-15-2004.

HEED



OWNER OF U.S. REG. NOS. 639,422, 2,832,179 AND OTHERS.

FOR DIETARY SUPPLEMENTS, CONTAINING MINERALS AND VITAMINS (U.S. CLS. 6, 18, 44, 46, 51 AND 52).

RONALD AIKENS, EXAMINING ATTORNEY

THE MARK CONSISTS OF STANDARD CHARACTERS WITHOUT CLAIM TO ANY PARTICULAR FONT, STYLE, SIZE, OR COLOR.

FOR HIGH ENERGY ELECTROLYTE DRINK FOR ATHLETES (U.S. CLS. 6, 18, 44, 46, 51 AND 52).

FIRST USE 4-28-2004; IN COMMERCE 4-28-2004. ANN LINNEHAN, EXAMINING ATTORNEY

CLASS 5—(Continued).

SN 78-435,389. FRANK, BRIAN DAVID, WHITEFISH, MT.
FILED 6-15-2004.

CLASS 5—(Continued).

SN 78-435,521. ANDERSON, MARY JO, ORLANDO, FL.
FILED 6-15-2004.

Recoverite

BUDDY BREW

THE MARK CONSISTS OF STANDARD CHARACTERS
WITHOUT CLAIM TO ANY PARTICULAR FONT, STYLE,
SIZE, OR COLOR.
FOR PROTEIN AND CARBOHYDRATE DRINK FOR
ATHLETES (U.S. CLS. 6, 18, 44, 46, 51 AND 52).
FIRST USE 6-15-2004; IN COMMERCE 6-15-2004.
ANN LINNEHAN, EXAMINING ATTORNEY

THE MARK CONSISTS OF STANDARD CHARACTERS
WITHOUT CLAIM TO ANY PARTICULAR FONT, STYLE,
SIZE, OR COLOR.
FOR NUTRITIONAL SUPPLEMENTS FOR PETS (U.S.
CLS. 6, 18, 44, 46, 51 AND 52).
CHARLES JOYNER, EXAMINING ATTORNEY

SN 78-435,393. GASPARI NUTRITION, LLC, NEPTUNE, NJ.
FILED 6-15-2004.

SN 78-435,527. JONES, JEFF A., WEST BARNSTABLE, MA.
FILED 6-15-2004.

NOVEDEX

Testo Load

THE MARK CONSISTS OF STANDARD CHARACTERS
WITHOUT CLAIM TO ANY PARTICULAR FONT, STYLE,
SIZE, OR COLOR.
FOR DIETARY AND NUTRITIONAL SUPPLEMENTS
(U.S. CLS. 6, 18, 44, 46, 51 AND 52).
FIRST USE 8-1-2003; IN COMMERCE 8-1-2003.
STEVEN BERK, EXAMINING ATTORNEY

THE MARK CONSISTS OF STANDARD CHARACTERS
WITHOUT CLAIM TO ANY PARTICULAR FONT, STYLE,
SIZE, OR COLOR.
FOR VITAMIN AND MINERAL SUPPLEMENTS (U.S.
CLS. 6, 18, 44, 46, 51 AND 52).
DORITT L. CARROLL, EXAMINING ATTORNEY

CLASS 5—(Continued).

SN 78-435,530. INTERVET INC., MILLSBORO, DE. FILED 6-15-2004.

CLASS 5—(Continued).

SN 78-436,081. BLISTEX INC., OAK BROOK, IL. FILED 6-16-2004.

INDIVIA

BP POWER

THE MARK CONSISTS OF STANDARD CHARACTERS WITHOUT CLAIM TO ANY PARTICULAR FONT, STYLE, SIZE, OR COLOR.

FOR VACCINE FOR DOMESTIC ANIMALS (U.S. CLS. 6, 18, 44, 46, 51 AND 52).
KIMBERLY PERRY, EXAMINING ATTORNEY

THE MARK CONSISTS OF STANDARD CHARACTERS WITHOUT CLAIM TO ANY PARTICULAR FONT, STYLE, SIZE, OR COLOR.

FOR MEDICATED TOPICAL PREPARATIONS FOR HUMAN USE FOR CLEANSING THE SKIN, MEDICATED SKIN CARE PREPARATIONS TO PREVENT OR ALLEVIATE THE SYMPTOMS OF ACNE AND OTHER SKIN AFFLICTIONS, AND APPLICATORS OR PADS SOLD AS A UNIT THEREWITH (U.S. CLS. 6, 18, 44, 46, 51 AND 52).
DORITT L. CARROLL, EXAMINING ATTORNEY

SN 78-435,800. FITNESS LABS NUTRITION CORPORATION, TORRANCE, CA. FILED 6-15-2004.

SN 78-436,447. MADE FOR YOU FITNESS, LLC, ORLANDO, FL. FILED 6-16-2004.

ProstaFit

**CHANGING TODAY'S
BODY FOR
TOMORROW'S FUTURE**

THE MARK CONSISTS OF STANDARD CHARACTERS WITHOUT CLAIM TO ANY PARTICULAR FONT, STYLE, SIZE, OR COLOR.

FOR DIETARY SUPPLEMENT (U.S. CLS. 6, 18, 44, 46, 51 AND 52).
IRA J. GOODSaid, EXAMINING ATTORNEY

THE MARK CONSISTS OF STANDARD CHARACTERS WITHOUT CLAIM TO ANY PARTICULAR FONT, STYLE, SIZE, OR COLOR.

FOR NUTRITIONAL SUPPLEMENTS (U.S. CLS. 6, 18, 44, 46, 51 AND 52).
BARBARA RUTLAND, EXAMINING ATTORNEY

CLASS 5—(Continued).

SN 78-436,673. SIGNAL INVESTMENT & MANAGEMENT CO., WILMINGTON, DE. FILED 6-17-2004.

NEVER WEAR BLACK WITHOUT THE BLUE

THE MARK CONSISTS OF STANDARD CHARACTERS WITHOUT CLAIM TO ANY PARTICULAR FONT, STYLE, SIZE, OR COLOR.

FOR MEDICATED HAIR SHAMPOO; MEDICATED HAIR CARE PRODUCTS, NAMELY, CONDITIONERS AND PREPARATIONS (U.S. CLS. 6, 18, 44, 46, 51 AND 52).

FIRST USE 6-0-2002; IN COMMERCE 6-0-2002.
JOANNA DUKOVIC, EXAMINING ATTORNEY

SN 78-437,333. ADVANCED PROTEIN SYSTEMS, LLC, PHOENIX, AZ. FILED 6-17-2004.

Viralox

THE MARK CONSISTS OF STANDARD CHARACTERS WITHOUT CLAIM TO ANY PARTICULAR FONT, STYLE, SIZE, OR COLOR.

FOR NATURAL HEALTH PRODUCT, NAMELY, A DIETARY SUPPLEMENT EXTRACTED FROM BOVINE COLOSTRUM USED TO ENHANCE IMMUNITY (U.S. CLS. 6, 18, 44, 46, 51 AND 52).

KATHY DE JONGE, EXAMINING ATTORNEY

CLASS 5—(Continued).

SN 78-437,638. BEAUTYBANK INC., NEW YORK, NY. FILED 6-18-2004.

AIR CONDITIONER

THE MARK CONSISTS OF STANDARD CHARACTERS WITHOUT CLAIM TO ANY PARTICULAR FONT, STYLE, SIZE, OR COLOR.

FOR ROOM DEODORANT PET SPRAY (U.S. CLS. 6, 18, 44, 46, 51 AND 52).

CHARLES JOYNER, EXAMINING ATTORNEY

SN 78-437,747. TAP PHARMACEUTICAL PRODUCTS INC., LAKE FOREST, IL. FILED 6-18-2004.

KIVARA

THE MARK CONSISTS OF STANDARD CHARACTERS WITHOUT CLAIM TO ANY PARTICULAR FONT, STYLE, SIZE, OR COLOR.

FOR PHARMACEUTICAL PREPARATIONS FOR THE TREATMENT OF INFECTIOUS DISEASES, PAIN, INFLAMMATION, GYNECOLOGICAL, SEXUAL DYSFUNCTION, CARDIOVASCULAR, CARDIOPULMONARY, METABOLIC DISORDERS AND DISEASES (U.S. CLS. 6, 18, 44, 46, 51 AND 52).

STEPHANIE DAVIS, EXAMINING ATTORNEY

SN 78-437,856. BODY DYNAMICS, INC., CARMEL, IN. FILED 6-18-2004.

SWEET SURRENDER

THE MARK CONSISTS OF STANDARD CHARACTERS WITHOUT CLAIM TO ANY PARTICULAR FONT, STYLE, SIZE, OR COLOR.

FOR CREAM FOR USE AS A FEMALE SEXUAL STIMULANT (U.S. CLS. 6, 18, 44, 46, 51 AND 52).

CHRISIE B. KING, EXAMINING ATTORNEY

CLASS 5—(Continued).

SN 78-438,868. ZIRB ENTERPRISES, INC., WATERTOWN, SD. FILED 6-21-2004.

**LIQUID SCIENCE IN
A CAPSULE**

THE MARK CONSISTS OF STANDARD CHARACTERS WITHOUT CLAIM TO ANY PARTICULAR FONT, STYLE, SIZE, OR COLOR.

FOR NUTRITIONAL SUPPLEMENT (U.S. CLS. 6, 18, 44, 46, 51 AND 52).
ELIZABETH HUGHITT, EXAMINING ATTORNEY

CLASS 5—(Continued).

SN 78-452,641. PFIZER INC., NEW YORK, NY. FILED 7-19-2004.

SKYLENCE

THE MARK CONSISTS OF STANDARD CHARACTERS WITHOUT CLAIM TO ANY PARTICULAR FONT, STYLE, SIZE, OR COLOR.

FOR PHARMACEUTICAL PREPARATIONS FOR THE TREATMENT OF CARDIOVASCULAR DISEASES, CENTRAL NERVOUS SYSTEM DISEASES AND DISORDERS, NEUROLOGICAL DISORDERS, UROLOGICAL DISORDERS, UROGENITAL DISORDERS, GASTROINTESTINAL DISORDERS, MUSCULOSKELETAL DISORDERS, ALLERGIES, DIABETES, HYPERTENSION, ERECTILE DYSFUNCTION, SEXUAL DYSFUNCTION, STROKE, CANCER, MIGRAINES, PAIN, OBESITY, INFLAMMATION, INFLAMMATORY DISEASES, RESPIRATORY DISEASES, INFECTIOUS DISEASES, IMMUNOLOGICAL DISORDERS, VIRAL DISORDERS, FUNGAL DISORDERS; PHARMACEUTICAL PREPARATIONS, NAMELY, CHOLESTEROL PREPARATIONS, SMOKING CESSATION PREPARATIONS, DERMATOLOGICAL PREPARATIONS, GYNECOLOGICAL PREPARATIONS, OSTEOPOROSIS PREPARATIONS, OPHTHALMOLOGICAL PREPARATIONS (U.S. CLS. 6, 18, 44, 46, 51 AND 52).
ZACHARY BELLO, EXAMINING ATTORNEY

SN 78-439,480. MELON LABORATORIES, LLC, ALPHARETTA, GA. FILED 6-22-2004.

CORTILOSS

THE MARK CONSISTS OF STANDARD CHARACTERS WITHOUT CLAIM TO ANY PARTICULAR FONT, STYLE, SIZE, OR COLOR.

FOR STRESS HORMONE (U.S. CLS. 6, 18, 44, 46, 51 AND 52).
TRACY FLETCHER, EXAMINING ATTORNEY

SN 78-455,043. DLH, INC., TINTON FALLS, NJ. FILED 7-22-2004.

TALKIN FIRST AID

SN 78-440,364. S. C. JOHNSON & SON, INC., RACINE, WI. FILED 6-23-2004.

**A FRESH NEW LOOK
TO FRESHNESS**

THE MARK CONSISTS OF STANDARD CHARACTERS WITHOUT CLAIM TO ANY PARTICULAR FONT, STYLE, SIZE, OR COLOR.

FOR AIR FRESHENERS (U.S. CLS. 6, 18, 44, 46, 51 AND 52).
GIANCARLO CASTRO, EXAMINING ATTORNEY

THE MARK CONSISTS OF STANDARD CHARACTERS WITHOUT CLAIM TO ANY PARTICULAR FONT, STYLE, SIZE, OR COLOR.

NO CLAIM IS MADE TO THE EXCLUSIVE RIGHT TO USE "FIRST AID", APART FROM THE MARK AS SHOWN. FOR FIRST AID KITS (U.S. CLS. 6, 18, 44, 46, 51 AND 52).
JENNIFER KRISP, EXAMINING ATTORNEY

CLASS 5—(Continued).

SN 78-474,247. SYNGENTA PARTICIPATIONS AG, BASEL, SWITZERLAND, FILED 8-26-2004.

CLASS 5—(Continued).

SN 78-503,572. GOEN TECHNOLOGIES CORPORATION, CEDAR KNOLLS, NJ. FILED 10-21-2004.

CONCERT

SlimH2O

THE MARK CONSISTS OF STANDARD CHARACTERS WITHOUT CLAIM TO ANY PARTICULAR FONT, STYLE, SIZE, OR COLOR.

FOR FUNGICIDES AND FUNGICIDE PRE-MIXES FOR COMMERCIAL AND AGRICULTURAL USE (U.S. CLS. 6, 18, 44, 46, 51 AND 52).

JUDITH HELFMAN, EXAMINING ATTORNEY

THE MARK CONSISTS OF STANDARD CHARACTERS WITHOUT CLAIM TO ANY PARTICULAR FONT, STYLE, SIZE, OR COLOR.

FOR DIETARY AND NUTRITIONAL SUPPLEMENTS (U.S. CLS. 6, 18, 44, 46, 51 AND 52).

WENDY GOODMAN, EXAMINING ATTORNEY

SN 78-474,268. SYNGENTA PARTICIPATIONS AG, BASEL, SWITZERLAND, FILED 8-26-2004.

SN 78-503,626. GOEN TECHNOLOGIES CORPORATION, CEDAR KNOLLS, NJ. FILED 10-21-2004.

MEDLEY

H2OSlim

THE MARK CONSISTS OF STANDARD CHARACTERS WITHOUT CLAIM TO ANY PARTICULAR FONT, STYLE, SIZE, OR COLOR.

FOR FUNGICIDES AND FUNGICIDE PRE-MIXES FOR COMMERCIAL AND AGRICULTURAL USE (U.S. CLS. 6, 18, 44, 46, 51 AND 52).

JUDITH HELFMAN, EXAMINING ATTORNEY

THE MARK CONSISTS OF STANDARD CHARACTERS WITHOUT CLAIM TO ANY PARTICULAR FONT, STYLE, SIZE, OR COLOR.

FOR DIETARY AND NUTRITIONAL SUPPLEMENTS (U.S. CLS. 6, 18, 44, 46, 51 AND 52).

WENDY GOODMAN, EXAMINING ATTORNEY

CLASS 5—(Continued).

SN 78-503,630. GOEN TECHNOLOGIES CORPORATION,
CEDAR KNOLLS, NJ. FILED 10-21-2004.

CLASS 5—(Continued).

SN 78-528,971. DOW AGROSCIENCES LLC, INDIANAPOLIS,
IN. FILED 12-8-2004.

H2OSlim

OVERTIME

THE MARK CONSISTS OF STANDARD CHARACTERS
WITHOUT CLAIM TO ANY PARTICULAR FONT, STYLE,
SIZE, OR COLOR.

FOR DIETARY AND NUTRITIONAL SUPPLEMENTS
(U.S. CLS. 6, 18, 44, 46, 51 AND 52).
WENDY GOODMAN, EXAMINING ATTORNEY

THE MARK CONSISTS OF STANDARD CHARACTERS
WITHOUT CLAIM TO ANY PARTICULAR FONT, STYLE,
SIZE, OR COLOR.

FOR PESTICIDES AND PREPARATIONS FOR DE-
STROYING VERMIN, NAMELY HERBICIDES, INSECTI-
CIDES AND FUNGICIDES FOR AGRICULTURE,
HORTICULTURE, FORESTRY, TURF AND ORNAMENTAL,
COMMERCIAL, INDUSTRIAL AND DOMESTIC
USE (U.S. CLS. 6, 18, 44, 46, 51 AND 52).
REGINA DRUMMOND, EXAMINING ATTORNEY

SN 78-503,633. GOEN TECHNOLOGIES CORPORATION,
CEDAR KNOLLS, NJ. FILED 10-21-2004.

SN 79-002,258. CALLIOPE, FRANCE, FILED 3-1-2004.

SlimH2O

BEMISTOP

THE MARK CONSISTS OF STANDARD CHARACTERS
WITHOUT CLAIM TO ANY PARTICULAR FONT, STYLE,
SIZE, OR COLOR.

FOR DIETARY AND NUTRITIONAL SUPPLEMENTS
(U.S. CLS. 6, 18, 44, 46, 51 AND 52).
WENDY GOODMAN, EXAMINING ATTORNEY

THE MARK CONSISTS OF STANDARD CHARACTERS
WITHOUT CLAIM TO ANY PARTICULAR FONT, STYLE,
SIZE, OR COLOR.

PRIORITY DATE OF 9-4-2003 IS CLAIMED.
OWNER OF INTERNATIONAL REGISTRATION 0823832
DATED 3-1-2004, EXPIRES 3-1-2014.
FOR DOMESTIC PESTICIDES, AGRICULTURAL PES-
TICIDES; PESTICIDES FOR AGRICULTURAL, COM-
MERCIAL, INDUSTRIAL, AND DOMESTIC USE (U.S.
CLS. 6, 18, 44, 46, 51 AND 52).
PAUL F. GAST, EXAMINING ATTORNEY

CLASS 6—METAL GOODS

SN 76-582,970. THOMSEN, VERNE E., AMES, NE. FILED 3-22-2004.

SLIKLOC SECURITY SYSTEM

THE MARK CONSISTS OF STANDARD CHARACTERS WITHOUT CLAIM TO ANY PARTICULAR FONT, STYLE, SIZE, OR COLOR.

NO CLAIM IS MADE TO THE EXCLUSIVE RIGHT TO USE "SECURITY SYSTEM", APART FROM THE MARK AS SHOWN.

FOR METAL LOCK MECHANISMS, METAL LOCKS AND KEYS THEREFORE, METAL LOCK SETS (U.S. CLS. 2, 12, 13, 14, 23, 25 AND 50).

FIRST USE 12-10-2003; IN COMMERCE 12-10-2003.
KIMBERLY FRYE, EXAMINING ATTORNEY

SN 76-596,640. GRIPNAIL CORPORATION, EAST PROVIDENCE, RI. FILED 6-9-2004.

TWIST-TACK

THE MARK CONSISTS OF STANDARD CHARACTERS WITHOUT CLAIM TO ANY PARTICULAR FONT, STYLE, SIZE, OR COLOR.

FOR NAIL TYPE SELF LOCKING METAL FASTENERS (U.S. CLS. 2, 12, 13, 14, 23, 25 AND 50).

FIRST USE 5-12-2004; IN COMMERCE 5-12-2004.
STANLEY I. OSBORNE, EXAMINING ATTORNEY

SN 76-597,802. AWI LICENSING COMPANY, WILMINGTON, DE. FILED 6-16-2004.

PEAKFORM

THE MARK CONSISTS OF STANDARD CHARACTERS WITHOUT CLAIM TO ANY PARTICULAR FONT, STYLE, SIZE, OR COLOR.

FOR METAL GRID FOR SUSPENDED CEILING PANELS, NAMELY, MAIN BEAMS AND CROSS TEES (U.S. CLS. 2, 12, 13, 14, 23, 25 AND 50).

FIRST USE 6-0-2001; IN COMMERCE 6-0-2001.
MARK SPARACINO, EXAMINING ATTORNEY

CLASS 6—(Continued).

SN 76-598,449. COPPERFIELD CHIMNEY SUPPLY, INC., FAIRFIELD, IA. FILED 6-21-2004.

LYEMANCE

THE MARK CONSISTS OF STANDARD CHARACTERS WITHOUT CLAIM TO ANY PARTICULAR FONT, STYLE, SIZE, OR COLOR.

FOR METAL CHIMNEY DAMPERS (U.S. CLS. 2, 12, 13, 14, 23, 25 AND 50).

FIRST USE 0-0-1976; IN COMMERCE 0-0-1976.
KAREN BRACEY, EXAMINING ATTORNEY

SN 76-599,220. COPPERFIELD CHIMNEY SUPPLY, INC., FAIRFIELD, IA. FILED 6-21-2004.

GELCO

THE MARK CONSISTS OF STANDARD CHARACTERS WITHOUT CLAIM TO ANY PARTICULAR FONT, STYLE, SIZE, OR COLOR.

FOR METAL CHIMNEY CAPS (U.S. CLS. 2, 12, 13, 14, 23, 25 AND 50).

FIRST USE 0-0-1979; IN COMMERCE 0-0-1979.
SUSAN STIGLITZ, EXAMINING ATTORNEY

SN 78-223,191. AMERIWEST INDUSTRIES, INC., ONTARIO, CA. FILED 3-7-2003.

TEMPO

FOR METAL DOOR HINGES (U.S. CLS. 2, 12, 13, 14, 23, 25 AND 50).

STEVEN BERK, EXAMINING ATTORNEY

SN 78-229,016. ENERFAB, INC., CINCINNATI, OH. FILED 3-24-2003.

BRIGHTON

SEC. 2(F).

FOR METALS IN THE FORM OF SHEETS AND PLATE HEADS FOR FURTHER MANUFACTURE (U.S. CLS. 2, 12, 13, 14, 23, 25 AND 50).

FIRST USE 10-15-1959; IN COMMERCE 10-15-1959.
PAUL F. GAST, EXAMINING ATTORNEY

CLASS 6—(Continued).

SN 78-290,252. ECO LIPS, INC., MARION, IA. FILED 8-21-2003.

ECO CLIP

NO CLAIM IS MADE TO THE EXCLUSIVE RIGHT TO USE "CLIP", APART FROM THE MARK AS SHOWN.

FOR CARABINERS IN THE NATURE OF A METAL CLIP, AFFIXED TO LIP BALM (U.S. CLS. 2, 12, 13, 14, 23, 25 AND 50).

FIRST USE 4-15-2003; IN COMMERCE 4-15-2003.
DOMINICK J. SALEMI, EXAMINING ATTORNEY

SN 78-343,719. MACEK MARINE SERVICES, INC., DBA CORSE MECCANICA, CARY, NC. FILED 12-19-2003.

corse meccanica

THE MARK CONSISTS OF STANDARD CHARACTERS WITHOUT CLAIM TO ANY PARTICULAR FONT, STYLE, SIZE, OR COLOR.

THE ENGLISH TRANSLATION OF CORSE MECCANICA IS RACES MECHANICAL OR RACING MECHANICALS.

FOR N G 006 A 4/2/91 METAL FASTENERS, NAMELY BOLTS, SCREWS, NUTS, WASHERS, AND THREADED STUDS PRODUCED IN TITANIUM (U.S. CLS. 2, 12, 13, 14, 23, 25 AND 50).

DARRYL SPRUILL, EXAMINING ATTORNEY

SN 78-366,705. SPICER, DAVID, WHITEFIELD, ME. FILED 2-12-2004.

WIND-FALL

THE MARK CONSISTS OF STANDARD CHARACTERS WITHOUT CLAIM TO ANY PARTICULAR FONT, STYLE, SIZE, OR COLOR.

FOR MECHANICAL TREE PROTECTION SYSTEM COMPRISED OF A PLURALITY OF GROUND ANCHORS AND ONE OR MORE NON-ELECTRIC RETENTION CABLES REMOVABLY AFFIXABLE THERETO FOR MAINTAINING TREE ROOTS IN PLACE (U.S. CLS. 2, 12, 13, 14, 23, 25 AND 50).

GINA FINK, EXAMINING ATTORNEY

CLASS 6—(Continued).

SN 78-394,410. TURNER, ROBERT, S, PORTSMOUT, VA. FILED 3-31-2004.

Nasty Nuts

THE MARK CONSISTS OF STANDARD CHARACTERS WITHOUT CLAIM TO ANY PARTICULAR FONT, STYLE, SIZE, OR COLOR.

FOR METAL BOLTS FOR FASTENING TRUCKS TO SKATEBOARD DECKS (U.S. CLS. 2, 12, 13, 14, 23, 25 AND 50).

SALLY SHIN, EXAMINING ATTORNEY

SN 78-404,160. TRICAM INDUSTRIES, INC., EDEN PRAIRIE, MN. FILED 4-19-2004.

TRICAM INDUSTRIES

THE MARK CONSISTS OF STANDARD CHARACTERS WITHOUT CLAIM TO ANY PARTICULAR FONT, STYLE, SIZE, OR COLOR.

NO CLAIM IS MADE TO THE EXCLUSIVE RIGHT TO USE INDUSTRIES, APART FROM THE MARK AS SHOWN.

FOR LADDERS, ACCESSORY SHELVES FOR LADDERS, LADDER TIE-DOWNS, LADDER STABILIZERS LADDER JACKS, EXTENSION LADDERS, ARTICULATED LADDERS, COMBINATION LADDERS, PLATFORM LADDERS, STEP STOOLS, PREFABRICATED PLATFORMS, SCAFFOLDING, SCAFFOLD HORSES, SCAFFOLD PLATFORMS, CATWALKS, WORK TOWERS, STAIR TOWERS, DECK BOARDS, AND GUARD RAILS, ALL MADE PRIMARILY OF METAL (U.S. CLS. 2, 12, 13, 14, 23, 25 AND 50).

FIRST USE 6-28-1993; IN COMMERCE 6-28-1993.

CIMMERIAN COLEMAN, EXAMINING ATTORNEY

CLASS 6—(Continued).

SN 78-404,184. TRICAM INDUSTRIES, INC., EDEN PRAIRIE, MN. FILED 4-19-2004.



THE COLOR(S) RED, BLACK AND WHITE IS/ARE CLAIMED AS A FEATURE OF THE MARK.

THE COLOR RED APPEARS IN THE BOTTOM LEFT PORTION OF THE CIRCLE AND IN THE HORIZONTAL LINES TO THE UPPER RIGHT OF THE CIRCLE. THE COLOR BLACK APPEARS IN THE UPPER RIGHT HALF OF THE CIRCLE WITH WHITE HORIZONTAL LINES IN THE CIRCLE.

FOR LADDERS, ACCESSORY SHELVES FOR LADDERS, LADDER TIE-DOWNS, LADDER STABILIZERS LADDER JACKS, EXTENSION LADDERS, ARTICULATED LADDERS, COMBINATION LADDERS, PLATFORM LADDERS, STEP STOOLS, PREFABRICATED PLATFORMS, SCAFFOLDING, SCAFFOLD HORSES, SCAFFOLD PLATFORMS, CATWALKS, WORK TOWERS, STAIR TOWERS, DECK BOARDS, AND GUARD RAILS, ALL MADE PRIMARILY OF METAL (U.S. CLS. 2, 12, 13, 14, 23, 25 AND 50).

FIRST USE 6-28-1993; IN COMMERCE 6-28-1993.
JENNIFER MARTIN, EXAMINING ATTORNEY

SN 78-404,972. ITT INDUSTRIES, INC., WHITE PLAINS, NY. FILED 4-20-2004.

CHECK-TROL

THE MARK CONSISTS OF STANDARD CHARACTERS WITHOUT CLAIM TO ANY PARTICULAR FONT, STYLE, SIZE, OR COLOR.

FOR MANUALLY OPERATED METAL VALVES EACH CONSISTING OF AN ISOLATION VALVE, A CHECK VALVE, AND A COMPANION FLANGE SOLD AS A UNIT (U.S. CLS. 2, 12, 13, 14, 23, 25 AND 50).

FIRST USE 3-0-2004; IN COMMERCE 3-0-2004.
ROBERT COGGINS, EXAMINING ATTORNEY

CLASS 6—(Continued).

SN 78-435,957. BY JOEY INC., LONG VALLEY, NJ. FILED 6-16-2004.

CHICKLETS

THE MARK CONSISTS OF STANDARD CHARACTERS WITHOUT CLAIM TO ANY PARTICULAR FONT, STYLE, SIZE, OR COLOR.

FOR SCULPTURES MADE OF NON PRECIOUS METAL (U.S. CLS. 2, 12, 13, 14, 23, 25 AND 50).
MARGERY A. TIERNEY, EXAMINING ATTORNEY

SN 79-000,248. GEORG FISCHER FAHRZEUGTECHNIK AG, SWITZERLAND, FILED 12-2-2003.

SIBODUR

THE MARK CONSISTS OF STANDARD CHARACTERS WITHOUT CLAIM TO ANY PARTICULAR FONT, STYLE, SIZE, OR COLOR.

PRIORITY DATE OF 7-24-2003 IS CLAIMED.
OWNER OF INTERNATIONAL REGISTRATION 0815775 DATED 12-2-2003, EXPIRES 12-2-2013.

FOR METALLIC MATERIALS USED FOR NODULAR CASTING (U.S. CLS. 2, 12, 13, 14, 23, 25 AND 50).
DOUGLAS LEE, EXAMINING ATTORNEY

CLASS 7—MACHINERY

SN 76-453,571. MOLECULAR IMPRINTS, INC., AUSTIN, TX. FILED 9-27-2002.

S-FIL

FOR EQUIPMENT FOR APPLYING A MOLD TO A FORMABLE SUBSTRATE, NAMELY MACHINES TO MANUFACTURE MICRO AND NANO-SCALE STRUCTURES BY SOLIDIFYING A FLUID COMPOUND TO CONFORM TO A SHAPE OF A MOLD (U.S. CLS. 13, 19, 21, 23, 31, 34 AND 35).

BRENDAN REGAN, EXAMINING ATTORNEY

CLASS 7—(Continued).

SN 76-457,253. BLUE LINE EQUIPMENT, LLC, PRESCOTT, AZ. FILED 10-10-2002.

BLUELINE

FOR CARPET AND FLOOR CLEANING MACHINES (U.S. CLS. 13, 19, 21, 23, 31, 34 AND 35).
FIRST USE 7-15-2002; IN COMMERCE 7-15-2002.
JOHN SCHUYLER YARD, EXAMINING ATTORNEY

CLASS 7—(Continued).

SN 76-558,266. WITTMAR ENGINEERING & CONSTRUCTION, INC., LONG BEACH, CA. FILED 10-24-2003.



NO CLAIM IS MADE TO THE EXCLUSIVE RIGHT TO USE COLD IRONING, APART FROM THE MARK AS SHOWN.

FOR LNG OR LPG FUELED MODULAR ELECTRIC POWER GENERATION SYSTEMS TO PROVIDE ELECTRIC POWER TO LARGE OCEAN GOING VESSELS WHILE AT DOCK, THUS MINIMIZING THE AIR POLLUTION (U.S. CLS. 13, 19, 21, 23, 31, 34 AND 35).
MARY ROSSMAN, EXAMINING ATTORNEY

SN 76-481,852. CHANGZHOU NEEDLE ROLLER BEARING FACTORY CO., LTD., JIANGU PROVINCE, CHINA, FILED 1-13-2003.

CTC

PRIORITY CLAIMED UNDER SEC. 44(D) ON CHINA APPLICATION NO. 3376538, FILED 11-20-2002, REG. NO. 3376538, DATED 11-20-2002, EXPIRES 11-20-2012.

FOR BEARINGS FOR GEAR SHIFTING BOXES, BEARINGS FOR STEERING GEAR SYSTEMS, BEARINGS FOR ENGINES, BEARINGS FOR CLUTCH DISENGAGING SYSTEMS, BEARINGS FOR TRANSFER CASES, BEARINGS FOR POWER TAKE-OFF CASES, BEARINGS FOR AUTOMOTIVE AIR CONDITIONING, AND BEARINGS FOR CONSTRUCTION MACHINERY (U.S. CLS. 13, 19, 21, 23, 31, 34 AND 35).
JANICE L. MCMORROW, EXAMINING ATTORNEY

SN 76-570,179. HYPERTHERM, INC., HANOVER, NH. FILED 12-29-2003.

SN 76-519,471. INLINE SERVICES, INC., HOUSTON, TX. FILED 5-9-2003.

PIT CLEANING PIG

NO CLAIM IS MADE TO THE EXCLUSIVE RIGHT TO USE "PIT" OR "PIG", APART FROM THE MARK AS SHOWN.

SEC. 2(F) AS TO "CLEANING".
FOR POWER-OPERATED TOOLS, NAMELY, PIPE CLEANING PIGS CONSTRUCTED OF URETHANE SEALING OR SCRAPING ELEMENTS, FURTHER COMPRISING OF SMALL PENCIL BRUSHES AND MOUNTED ON THE BODY FOR CLEANING CORROSION PITS ON THE INTERNAL SURFACE OF THE PIPE WALL (U.S. CLS. 13, 19, 21, 23, 31, 34 AND 35).
FIRST USE 9-18-1991; IN COMMERCE 9-18-1991.
MITCHELL FRONT, EXAMINING ATTORNEY

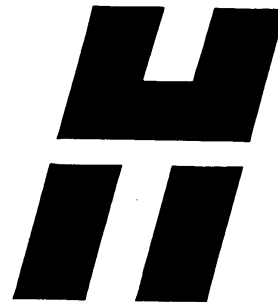

FOR PLASMA ARC CUTTING MACHINES, NOZZLES AND REPLACEMENT PARTS THEREFOR; HIGH-TEMPERATURE CUTTING MACHINES, NOZZLES AND REPLACEMENT PARTS THEREFOR; PLASMA ARC CUTTING MACHINES AND LASERS, SOLD AS A UNIT; HIGH-TEMPERATURE CUTTING MACHINES AND LASERS, SOLD AS A UNIT (U.S. CLS. 13, 19, 21, 23, 31, 34 AND 35).

FIRST USE 5-6-2001; IN COMMERCE 5-6-2001.
PRISCILLA MILTON, EXAMINING ATTORNEY

CLASS 7—(Continued).

SN 76-581,834. TOKUSHU KIKA KOGYO KABUSHIKI KAISHA, TA TOKUSHU KIKA KOGYO CO., LTD., OSAKA, JAPAN, FILED 3-19-2004.

T.K. FILMICS

THE MARK CONSISTS OF STANDARD CHARACTERS WITHOUT CLAIM TO ANY PARTICULAR FONT, STYLE, SIZE, OR COLOR.

FOR MECHANICAL MIXING MACHINES FOR AGITATING LIQUIDS IN A MANUFACTURING PROCESS AND STRUCTURAL PARTS THEREFOR (U.S. CLS. 13, 19, 21, 23, 31, 34 AND 35).

FIRST USE 2-0-2003; IN COMMERCE 2-0-2003.
ROBERT LORENZO, EXAMINING ATTORNEY

SN 76-583,800. BAYSAVER, INC., MOUNT AIRY, MD. FILED 3-29-2004.



OWNER OF U.S. REG. NO. 2,293,095.
NO CLAIM IS MADE TO THE EXCLUSIVE RIGHT TO USE "TECHNOLOGIES, INC.", APART FROM THE MARK AS SHOWN.

FOR DEVICES FOR TREATING STORMWATER AND IMPROVING WATER QUALITY, NAMELY SEPARATION AND FILTRATION UNITS TO REMOVE AND TRAP SEDIMENTS, SOLID WASTE, TRASH, ORGANIC DEBRIS, PETROLEUM HYDROCARBONS, HEAVY METALS AND NUTRIENTS FROM WATER (U.S. CLS. 13, 19, 21, 23, 31, 34 AND 35).

FIRST USE 3-1-2004; IN COMMERCE 3-15-2004.
GIANCARLO CASTRO, EXAMINING ATTORNEY

SN 76-595,262. FRANKLIN INTERNATIONAL, INC., COLUMBUS, OH. FILED 6-3-2004.

FLX-VALVE

THE MARK CONSISTS OF STANDARD CHARACTERS WITHOUT CLAIM TO ANY PARTICULAR FONT, STYLE, SIZE, OR COLOR.

FOR HOT MELT POLYURETHANE ADHESIVE GUN CARTRIDGE VALVES (U.S. CLS. 13, 19, 21, 23, 31, 34 AND 35).

Alice Sue Carruthers, Examining Attorney

CLASS 7—(Continued).

SN 76-597,104. PARKER INTANGIBLES LLC, CLEVELAND, OH. FILED 6-10-2004.

TIRESAVER

THE MARK CONSISTS OF STANDARD CHARACTERS WITHOUT CLAIM TO ANY PARTICULAR FONT, STYLE, SIZE, OR COLOR.

FOR MACHINES FOR THE PRODUCTION OF NITROGEN GAS; MACHINES FOR THE FILLING OF TIRES WITH GAS (U.S. CLS. 13, 19, 21, 23, 31, 34 AND 35).

FIRST USE 4-14-2004; IN COMMERCE 4-14-2004.
TRICIA THOMPCKINS, EXAMINING ATTORNEY

SN 76-598,908. REPUBLIC SHEET METAL AND MANUFACTURING CO., INC., DBA REPUBLIC SALES & MANUFACTURING, DALLAS, TX. FILED 6-23-2004.

REPUBLIC SALES & MANUFACTURING

THE MARK CONSISTS OF STANDARD CHARACTERS WITHOUT CLAIM TO ANY PARTICULAR FONT, STYLE, SIZE, OR COLOR.

NO CLAIM IS MADE TO THE EXCLUSIVE RIGHT TO USE SALES & MANUFACTURING, APART FROM THE MARK AS SHOWN.

FOR REGENERATIVE BLOWERS, REGENERATIVE BLOWER SYSTEMS COMPOSED PRIMARILY OF A MOTOR, VALVES, BELTS, PULLEYS, PIPING, GAUGES AND MOUNTS, POSITIVE DISPLACEMENT BLOWERS, POSITIVE DISPLACEMENT BLOWER SYSTEMS PRIMARILY OF A MOTOR, VALVES, BELTS, PULLEYS, PIPING, GAUGES AND MOUNTS, FILTERS AND HOUSINGS THEREFOR, VACUUM PUMPS, AIR COMPRESSORS, AND VALVES, TUBING, PIPING, STANDS, ENCLOSURES AND SILENCERS (U.S. CLS. 13, 19, 21, 23, 31, 34 AND 35).

FIRST USE 0-0-1992; IN COMMERCE 0-0-1992.
ANDREW BENZMILLER, EXAMINING ATTORNEY

CLASS 7—(Continued).

SN 76-598,911. REPUBLIC SHEET METAL AND MANUFACTURING CO., INC., DBA REPUBLIC SALES & MANUFACTURING, DALLAS, TX. FILED 6-23-2004.



REPUBLIC
Sales & Manufacturing

NO CLAIM IS MADE TO THE EXCLUSIVE RIGHT TO USE SALES & MANUFACTURING, APART FROM THE MARK AS SHOWN.

FOR REGENERATIVE BLOWERS, REGENERATIVE BLOWER SYSTEMS COMPOSED PRIMARILY OF A MOTOR, VALVES, BELTS, PULLEYS, PIPING, GAUGES AND MOUNTS, POSITIVE DISPLACEMENT BLOWERS, POSITIVE DISPLACEMENT BLOWER SYSTEMS PRIMARILY OF A MOTOR, VALVES, BELTS, PULLEYS, PIPING, GAUGES AND MOUNTS, FILTERS AND HOUSINGS THEREFOR, VACUUM PUMPS, AIR COMPRESSORS, AND VALVES, TUBING, PIPING, STANDS, ENCLOSURES AND SILENCERS (U.S. CLS. 13, 19, 21, 23, 31, 34 AND 35).

FIRST USE 7-30-1999; IN COMMERCE 7-30-1999.
ANDREW BENZMILLER, EXAMINING ATTORNEY

SN 78-081,426. FIRME C.O.G.I.T.E.S. INC., VILLE SAINT-GEORGES, QUEBEC, CANADA, FILED 8-28-2001.

LICO

PRIORITY CLAIMED UNDER SEC. 44(D) ON CANADA APPLICATION NO. 1098053, FILED 4-2-2001, REG. NO. TMA585209, DATED 7-15-2003, EXPIRES 7-15-2018.

FOR POWER-OPERATED WOOD TRANSFORMATION EQUIPMENT FOR USE IN BOTH SAWMILL AND REMANUFACTURING IN THE FOREST INDUSTRY, NAMELY, HOISTS, UNSCRABLERS, EDGERS, RE-SAWS, BOARD SORTERS, OSCILLATING TABLES, CONVEYERS, TRANSFERS, HYDRAULIC PUMPING UNITS, IN-FEED AND OUT-FEED FOR GANG EDGERS, SAWING UNITS, EDGER OPTIMIZER UNIT, OPTIMIZED RIPS AW UNITS, SAW POSITIONERS, SPIT SAW, DEBARCLER, SCREEN CHIPPERS, PLANNER IN-FEED, TRIMMER, CARRIAGE, BAND SAWS, AND RIPS A WS (U.S. CLS. 13, 19, 21, 23, 31, 34 AND 35).

KHANH LE, EXAMINING ATTORNEY

CLASS 7—(Continued).

SN 78-234,868. LINK NEW TECH INC, COSTA MESA, CA. FILED 4-7-2003.

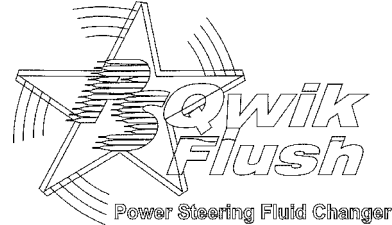

NO CLAIM IS MADE TO THE EXCLUSIVE RIGHT TO USE "QUICK FLUSH POWER STEERING FLUID CHANGER", APART FROM THE MARK AS SHOWN.

FOR AUTOMOTIVE POWER STEERING FLUSH MACHINE FEATURING TWO TANKS (U.S. CLS. 13, 19, 21, 23, 31, 34 AND 35).

ALLISON HOLTZ, EXAMINING ATTORNEY

SN 78-238,711. ROWAN ELECTRIC, INC., HOUSTON, TX. FILED 4-17-2003.

DoubleT

FOR AC VARIABLE FREQUENCY MOTORS USED IN THE OIL AND GAS, MARINE BOAT AND BARGE, MINING, DREDGING AND PETROCHEMICAL INDUSTRIES (U.S. CLS. 13, 19, 21, 23, 31, 34 AND 35).

DEZMONA MIZELLE, EXAMINING ATTORNEY

SN 78-242,300. ERMANCO INCORPORATED, SPRING LAKE, MI. FILED 4-25-2003.

QUIKMELD

THE MARK CONSISTS OF STANDARD CHARACTERS WITHOUT CLAIM TO ANY PARTICULAR FONT, STYLE, SIZE, OR COLOR.

FOR BELT-WELDING DEVICES FOR SPLICING CONVEYOR BELTS (U.S. CLS. 13, 19, 21, 23, 31, 34 AND 35).

LOURDES AYALA, EXAMINING ATTORNEY

CLASS 7—(Continued).

SN 78-261,488. ULMA C Y E, S. COOP., 20560 OÑATI (GUIPUZCOA), SPAIN, FILED 6-12-2003.

FLOW-VAC

PRIORITY CLAIMED UNDER SEC. 44(D) ON ERP N CMNTY TM OFC APPLICATION NO. 003223005, FILED 6-12-2003, REG. NO. 003223005, DATED 9-15-2004, EXPIRES 6-12-2013.

FOR MACHINES FOR WRAPPING AND PACKAGING OF GOODS (U.S. CLS. 13, 19, 21, 23, 31, 34 AND 35).

JILL C. ALT, EXAMINING ATTORNEY

SN 78-305,762. THE SPENCER TURBINE COMPANY, WINDSOR, CT. FILED 9-26-2003.

MIZERPAK

FOR POSITIVE DISPLACEMENT BLOWERS WITH SOUND ATTENUATION (U.S. CLS. 13, 19, 21, 23, 31, 34 AND 35).

FIRST USE 11-21-2002; IN COMMERCE 11-21-2002.

NANCY CLARKE, EXAMINING ATTORNEY

SN 78-312,332. TERASEN INC., FORMERLY BC GAS INC., VANCOUVER, BRITISH COLUMBIA, CANADA, FILED 10-10-2003.



PRIORITY CLAIMED UNDER SEC. 44(D) ON CANADA APPLICATION NO. 1,173,585, FILED 4-11-2003, REG. NO. TMA627436, DATED 12-3-2004, EXPIRES 12-3-2019.

FOR AIR COMPRESSORS AND AIR FILTERS THEREFOR; ELECTRIC PUMPS AND AIR FILTERS THEREFOR (U.S. CLS. 13, 19, 21, 23, 31, 34 AND 35).

KIMBERLY FRYE, EXAMINING ATTORNEY

SN 78-362,642. BACK TO BASICS PRODUCTS, INC., BLUFFDALE, UT. FILED 2-4-2004.

SMOOTHIE PLUS 700

THE MARK CONSISTS OF STANDARD CHARACTERS WITHOUT CLAIM TO ANY PARTICULAR FONT, STYLE, SIZE, OR COLOR.

NO CLAIM IS MADE TO THE EXCLUSIVE RIGHT TO USE "SMOOTHIE", APART FROM THE MARK AS SHOWN.

FOR ELECTRIC FOOD BLENDERS; ELECTRIC FOOD BLENDERS FOR MAKING SMOOTHIES (U.S. CLS. 13, 19, 21, 23, 31, 34 AND 35).

FIRST USE 11-0-2003; IN COMMERCE 11-0-2003.

LESLEY LAMOTHE, EXAMINING ATTORNEY

CLASS 7—(Continued).

SN 78-380,390. STRONGARM SECURITY, INC., SOUTH SAN FRANCISCO, CA. FILED 3-8-2004.



OWNER OF U.S. REG. NO. 1,842,689.

NO CLAIM IS MADE TO THE EXCLUSIVE RIGHT TO USE "SAFE DRILLS AND RIGS", APART FROM THE MARK AS SHOWN.

FOR MACHINERY NAMELY, PORTABLE POWER DRILL RIGS AND CARBIDE TIP DRILL BITS FOR POWER OPERATED DRILLS; SAFE OPENING TOOLS NAMELY DRILL BITS, DRILL MOTORS, PORTABLE DRILL PRESSES, DRILL RIGS, DIAMOND CORE DRILL BITS, AND CARBIDE CUTTING TOOLS; LOCKSMITH TOOLS NAMELY LOCK PICKS, SAFE LOCK TOOLS FOR REPAIRING OR DEFEATING A SAFE LOCK, AND SAFE PENETRATION TOOLS (U.S. CLS. 13, 19, 21, 23, 31, 34 AND 35).

PAULA MAYS, EXAMINING ATTORNEY

SN 78-382,962. HURCO TECHNOLOGIES, INC., HARRISBURG, SD. FILED 3-12-2004.

SPINDOCTOR

THE MARK CONSISTS OF STANDARD CHARACTERS WITHOUT CLAIM TO ANY PARTICULAR FONT, STYLE, SIZE, OR COLOR.

FOR MACHINERY FOR THE EXERCISING OF VALVES, NAMELY, TESTING VALVES FOR THE PURPOSE OF PREVENTING CORROSION (U.S. CLS. 13, 19, 21, 23, 31, 34 AND 35).

FIRST USE 0-0-2002; IN COMMERCE 0-0-2002.

STEVEN JACKSON, EXAMINING ATTORNEY

CLASS 7—(Continued).

SN 78-385,511. MILLER, ANTHONY, NEVADA CITY, CA. AND MILLER, KATHY, NEVADA CITY, CA. FILED 3-16-2004.

CLASS 7—(Continued).

SN 78-404,876. CREDO TECHNOLOGY CORPORATION, BROADVIEW, IL. FILED 4-20-2004.

PEANUT EATER

RAPIDFEED

THE MARK CONSISTS OF STANDARD CHARACTERS WITHOUT CLAIM TO ANY PARTICULAR FONT, STYLE, SIZE, OR COLOR.

NO CLAIM IS MADE TO THE EXCLUSIVE RIGHT TO USE "PEANUT", APART FROM THE MARK AS SHOWN.

FOR VACUUM POWERED COLLECTOR COMPRISED OF SPECIALIZED CONTAINER TO BE ATTACHED TO A VACUUM CLEANER TO COLLECT LOOSE FILL PACKAGING MATERIAL SUCH AS PACKING PEANUTS (U.S. CLS. 13, 19, 21, 23, 31, 34 AND 35).

VERNA BETH RIRIE, EXAMINING ATTORNEY

THE MARK CONSISTS OF STANDARD CHARACTERS WITHOUT CLAIM TO ANY PARTICULAR FONT, STYLE, SIZE, OR COLOR.

FOR SPADE BITS FOR POWER TOOLS (U.S. CLS. 13, 19, 21, 23, 31, 34 AND 35).

FIRST USE 6-30-2003; IN COMMERCE 6-30-2003.

RON FAIRBANKS, EXAMINING ATTORNEY

SN 78-404,607. H&S TOOL, INC., WADSWORTH, OH. FILED 4-20-2004.

SN 78-420,413. UNIWELD PRODUCTS, INC., FORT LAUDERDALE, FL. FILED 5-18-2004.

MULTI-PREP

SLUDGE BLASTER

THE MARK CONSISTS OF STANDARD CHARACTERS WITHOUT CLAIM TO ANY PARTICULAR FONT, STYLE, SIZE, OR COLOR.

FOR MILLING HEAD FOR A MILLING MACHINE; CUFFING TOOL FOR A MILLING MACHINE; MILLING MACHINE; ROTARY MILLING MACHINE; MILLING HEAD FOR ROTARY MILLING MACHINE; TOOL BIT FOR A MACHINE (U.S. CLS. 13, 19, 21, 23, 31, 34 AND 35).

FIRST USE 4-7-2004; IN COMMERCE 4-7-2004.

TRACY FLETCHER, EXAMINING ATTORNEY

THE MARK CONSISTS OF STANDARD CHARACTERS WITHOUT CLAIM TO ANY PARTICULAR FONT, STYLE, SIZE, OR COLOR.

NO CLAIM IS MADE TO THE EXCLUSIVE RIGHT TO USE "SLUDGE", APART FROM THE MARK AS SHOWN.

FOR PIPE CLEANING DEVICE USING COMPRESSED FLUID OR GAS FOR CLEANING SLUDGE FROM PLUMBING PIPES (U.S. CLS. 13, 19, 21, 23, 31, 34 AND 35).

FIRST USE 4-11-2002; IN COMMERCE 4-11-2002.

THEODORE MCBRIDE, EXAMINING ATTORNEY

CLASS 7—(Continued).

SN 78-421,921. MUDGE, FUJIMI, ANAHEIM, CA. FILED 5-19-2004.

DEBURR MASTER

THE MARK CONSISTS OF STANDARD CHARACTERS WITHOUT CLAIM TO ANY PARTICULAR FONT, STYLE, SIZE, OR COLOR.

NO CLAIM IS MADE TO THE EXCLUSIVE RIGHT TO USE "DEBURR", APART FROM THE MARK AS SHOWN.

FOR MACHINES AND MACHINE TOOLS FOR THE CUTTING AND FORMING OF MATERIALS (U.S. CLS. 13, 19, 21, 23, 31, 34 AND 35).

FIRST USE 12-0-1978; IN COMMERCE 1-0-1979.

THEODORE MCBRIDE, EXAMINING ATTORNEY

CLASS 7—(Continued).

SN 78-433,742. HP INTELLECTUAL CORP., WILMINGTON, DE. FILED 6-11-2004.

NO MORE TIRED HANDS

THE MARK CONSISTS OF STANDARD CHARACTERS WITHOUT CLAIM TO ANY PARTICULAR FONT, STYLE, SIZE, OR COLOR.

FOR HANDHELD POWER SPRAYERS FOR DOMESTIC USE (U.S. CLS. 13, 19, 21, 23, 31, 34 AND 35).

BRIAN PINO, EXAMINING ATTORNEY

SN 78-433,809. AEROTECH, INC., PITTSBURGH, PA. FILED 6-11-2004.

LASERTURN

THE MARK CONSISTS OF STANDARD CHARACTERS WITHOUT CLAIM TO ANY PARTICULAR FONT, STYLE, SIZE, OR COLOR.

FOR WORKPIECE POSITIONING SYSTEM FOR USE IN MACHINING OF OBJECTS, COMPRISING A MOTOR-DRIVEN ROTATING APPARATUS FOR GRIPPING AND ROTATING THE WORKPIECE ABOUT A ROTARY AXIS AND A MOTOR-DRIVEN CARRIAGE FOR SUPPORTING THE ROTATING APPARATUS AND MOVING IT ALONG THE ROTARY AXIS (U.S. CLS. 13, 19, 21, 23, 31, 34 AND 35).

ANDREW BENZMILLER, EXAMINING ATTORNEY

SN 78-425,581. KASCO MARINE, INC., PRESCOTT, WI. FILED 5-26-2004.

KASCO

SN 78-435,399. HP INTELLECTUAL CORP., WILMINGTON, DE. FILED 6-15-2004.



LIDS OFF

THE STIPPLING IS FOR SHADING PURPOSES. THE MARK CONSISTS OF A REPRESENTATION OF A LID BEING REMOVED FROM A JAR AND THE LITERAL ELEMENT.

FOR ELECTRIC JAR OPENERS FOR DOMESTIC USE (U.S. CLS. 13, 19, 21, 23, 31, 34 AND 35).

FIRST USE 3-31-2003; IN COMMERCE 3-31-2003.

ANDREW BENZMILLER, EXAMINING ATTORNEY

THE MARK CONSISTS OF STANDARD CHARACTERS WITHOUT CLAIM TO ANY PARTICULAR FONT, STYLE, SIZE, OR COLOR.

OWNER OF U.S. REG. NO. 1,279,640.

FOR MOTORS AND PUMPS FOR AERATING AND GENERATING FOUNTAIN SPRAYS FOR LAKES AND PONDS, AND DECORATIVE LIGHTS; THEREFOR SOLD AS A UNIT (U.S. CLS. 13, 19, 21, 23, 31, 34 AND 35).

FIRST USE 0-0-1988; IN COMMERCE 0-0-1988.

MIDGE BUTLER, EXAMINING ATTORNEY

CLASS 7—(Continued).

SN 78-437,586. KABUSHIKI KAISHA YASKAWA DENKI, KITAKYUSHU-SHI, FUKUOKA, JAPAN, FILED 6-18-2004.

CLASS 7—(Continued).

SN 78-439,329. TITAN TOOL, INC., OAKLAND, NJ. FILED 6-22-2004.

MOTOMAN

CYCLONE

THE MARK CONSISTS OF STANDARD CHARACTERS WITHOUT CLAIM TO ANY PARTICULAR FONT, STYLE, SIZE, OR COLOR.

FOR INDUSTRIAL ROBOTS FOR USES OF WELDING, HANDLING, ASSEMBLING AND COATING ARTICLES OF MANUFACTURE (U.S. CLS. 13, 19, 21, 23, 31, 34 AND 35).

FIRST USE 5-31-1977; IN COMMERCE 10-30-1980.
TRICIA SONNEBORN, EXAMINING ATTORNEY

THE MARK CONSISTS OF STANDARD CHARACTERS WITHOUT CLAIM TO ANY PARTICULAR FONT, STYLE, SIZE, OR COLOR.

FOR POWERED PAINT SPRAYERS (U.S. CLS. 13, 19, 21, 23, 31, 34 AND 35).
KEVON CHISOLM, EXAMINING ATTORNEY

SN 78-439,319. TITAN TOOL, INC., OAKLAND, NJ. FILED 6-22-2004.

SN 78-439,332. TITAN TOOL, INC., OAKLAND, NJ. FILED 6-22-2004.

TYPHOON

TORNADO

THE MARK CONSISTS OF STANDARD CHARACTERS WITHOUT CLAIM TO ANY PARTICULAR FONT, STYLE, SIZE, OR COLOR.

FOR POWERED PAINT SPRAYERS (U.S. CLS. 13, 19, 21, 23, 31, 34 AND 35).

ALEXANDER L. POWERS, EXAMINING ATTORNEY

THE MARK CONSISTS OF STANDARD CHARACTERS WITHOUT CLAIM TO ANY PARTICULAR FONT, STYLE, SIZE, OR COLOR.

FOR POWERED PAINT SPRAYERS (U.S. CLS. 13, 19, 21, 23, 31, 34 AND 35).

KEVON CHISOLM, EXAMINING ATTORNEY

CLASS 7—(Continued).

SN 78-439,334. TITAN TOOL, INC., OAKLAND, NJ. FILED 6-22-2004.

HURRICANE

THE MARK CONSISTS OF STANDARD CHARACTERS WITHOUT CLAIM TO ANY PARTICULAR FONT, STYLE, SIZE, OR COLOR.

FOR POWERED PAINT SPRAYERS (U.S. CLS. 13, 19, 21, 23, 31, 34 AND 35).

KEVON CHISOLM, EXAMINING ATTORNEY

SN 79-001,343. BHS CORRUGATED MASCHINEN- UND ANLAGENBAU GMBH, FED REP GERMANY, FILED 2-9-2004.

BHS CORRUGATED

THE MARK CONSISTS OF STANDARD CHARACTERS WITHOUT CLAIM TO ANY PARTICULAR FONT, STYLE, SIZE, OR COLOR.

OWNER OF INTERNATIONAL REGISTRATION 0682172 DATED 10-4-1997, EXPIRES 10-4-2007.

OWNER OF U.S. REG. NOS. 1,418,942 AND 2,224,020.

NO CLAIM IS MADE TO THE EXCLUSIVE RIGHT TO USE CORRUGATED, APART FROM THE MARK AS SHOWN.

FOR MACHINES FOR MANUFACTURING AND PROCESSING OF CORRUGATED BOARD (U.S. CLS. 13, 19, 21, 23, 31, 34 AND 35).

ANDREW BENZMILLER, EXAMINING ATTORNEY

CLASS 8—(Continued).

SN 76-600,100. SHELL STORES CORPORATION, DBA JOY ENTERPRISES, RIVIERA BEACH, FL. FILED 7-1-2004.

FURY

THE MARK CONSISTS OF STANDARD CHARACTERS WITHOUT CLAIM TO ANY PARTICULAR FONT, STYLE, SIZE, OR COLOR.

OWNER OF U.S. REG. NO. 1,393,767.

FOR KNIVES, NAMELY, CARPET KNIVES; CUTLERY, NAMELY FORKS, SPOONS AND KNIVES; FISHING KNIVES; HUNTING KNIVES; JACK KNIVES; MULTI-FUNCTION HAND TOOLS COMPRISED OF SCREWDRIVERS, KNIVES, CAN OPENERS, FILES AND PLIERS; PEN KNIVES; POCKET KNIVES; PRUNING KNIVES; SPORT KNIVES; THROWING KNIVES; UTILITY KNIVES; WHITTLING KNIVES; WORKING KNIVES; SWORDS (U.S. CLS. 23, 28 AND 44).

FIRST USE 9-28-1983; IN COMMERCE 9-28-1983.

JIM RINGLE, EXAMINING ATTORNEY

SN 78-340,774. SWENSON SHEAR, KEYES, CA. FILED 12-15-2003.

SNAP TABLE

CLASS 8—HAND TOOLS

SN 76-589,452. COSTA, JOHN, BOCA RATON, FL. FILED 4-29-2004.

THREAD WIZARD

NO CLAIM IS MADE TO THE EXCLUSIVE RIGHT TO USE "THREAD", APART FROM THE MARK AS SHOWN.

FOR HAND TOOLS, NAMELY, DIES, NAMELY, GARDEN SPRINKLER REPAIR TOOLS (U.S. CLS. 23, 28 AND 44).

TIMOTHY FINNEGAN, EXAMINING ATTORNEY

THE MARK CONSISTS OF STANDARD CHARACTERS WITHOUT CLAIM TO ANY PARTICULAR FONT, STYLE, SIZE, OR COLOR.

NO CLAIM IS MADE TO THE EXCLUSIVE RIGHT TO USE "TABLE", APART FROM THE MARK AS SHOWN.

FOR CONSTRUCTION HAND TOOLS, NAMELY NOTCHING TOOLS TO PREPARE ROOFING PANELS FOR INSTALLATION (U.S. CLS. 23, 28 AND 44).

CYNTHIA SLOAN, EXAMINING ATTORNEY

CLASS 8—(Continued).

SN 78-418,163. CGE ENTERPRISES, LLC, WESTON, VT. FILED 5-13-2004.

CLASS 8—(Continued).

SN 78-462,810. PANASONIC CORPORATION OF NORTH AMERICA, SECAUCUS, NJ. FILED 8-5-2004.

TAP-ICER

FORCE

THE MARK CONSISTS OF STANDARD CHARACTERS WITHOUT CLAIM TO ANY PARTICULAR FONT, STYLE, SIZE, OR COLOR.

FOR MANUALLY OPERATED HAND TOOLS; NAMELY, ICE CHIPPERS, ICE PICKS, ICE CRACKING IMPLEMENTS IN THE FORM OF HAND-OPERATED VIBRATORY DEVICES (U.S. CLS. 23, 28 AND 44).

KIMBERLY FRYE, EXAMINING ATTORNEY

THE MARK CONSISTS OF STANDARD CHARACTERS WITHOUT CLAIM TO ANY PARTICULAR FONT, STYLE, SIZE, OR COLOR.

FOR PROFESSIONAL HAIR TRIMMERS (U.S. CLS. 23, 28 AND 44).

SANI KHOURI, EXAMINING ATTORNEY

SN 78-438,485. BUCK KNIVES, INC., EL CAJON, CA. FILED 6-21-2004.

CLASS 9—ELECTRICAL AND SCIENTIFIC APPARATUS

SN 75-913,490. ENVENERGY, LLC, SANTA BARBARA, CA. FILED 2-8-2000.

ADRENALINE

MPX MULTIPLE PROTOCOL EXCHANGE

THE MARK CONSISTS OF STANDARD CHARACTERS WITHOUT CLAIM TO ANY PARTICULAR FONT, STYLE, SIZE, OR COLOR.

FOR SPORTS CUTLERY, NAMELY, ONE-HAND OPENING KNIVES (U.S. CLS. 23, 28 AND 44).

FIRST USE 1-0-2003; IN COMMERCE 1-0-2003.

MARK RADEMACHER, EXAMINING ATTORNEY

NO CLAIM IS MADE TO THE EXCLUSIVE RIGHT TO USE "MULTIPLE PROTOCOL EXCHANGE", APART FROM THE MARK AS SHOWN.

FOR COMPUTER HARDWARE AND SOFTWARE FOR ENABLING THE CLOSED LOOP CONTROL AND MONITORING OF BUILDING SUBSYSTEMS AND COMMUNICATING THIS DATA OVER COMPUTER NETWORKS (U.S. CLS. 21, 23, 26, 36 AND 38).

GINA FINK, EXAMINING ATTORNEY

CLASS 9—(Continued).

SN 76-157,782. MANGOS TROPICAL CAFE, INC., MIAMI BEACH, FL. FILED 11-1-2000.



NO CLAIM IS MADE TO THE EXCLUSIVE RIGHT TO USE "TROPICAL CAFE", APART FROM THE MARK AS SHOWN.

THE COLORS RED, PINK, BROWN, BLUE, GRAY, PURPLE, GREEN, ORANGE, AND YELLOW ARE CLAIMED AS A FEATURE OF THE MARK.

RED CAN BE FOUND ON THE LETTERS MANGO'S TROPICAL CAFE, AS WELL AS ON THE CIRCLE AROUND THE PARROT AND ON THE TWO SETS OF PARALLEL LINES EMANATING FROM EACH SIDE OF THE CIRCLE. RED CAN ALSO BE FOUND ON THE PARROT, INCLUDING PATCHES ABOVE THE EYE, ON THE AREA JUST BELOW AND TO THE RIGHT OF THE BEAK, IN THE AREA JUST BELOW THE BROAD BAND ACROSS THE MIDDLE OF THE PARROT, AND STREAKS IN THE TAIL FEATHERS. PINK CAN BE FOUND ON PATCHES TO THE RIGHT OF THE EYE AND NEAR THE RIGHT EDGE OF THE PARROT, EXTENDING DOWNWARD, TOWARDS THE BROAD BAND ACROSS THE MIDDLE OF THE PARROT, AND TOWARDS THE TWO COCONUTS DEPICTED. THERE ARE STREAKS OF PINK IN THE TAIL FEATHERS AND SPECKLES OF PINK CAN ALSO BE FOUND JUST TO THE RIGHT AND BELOW THE BEAK. BROWN MAY BE FOUND IN THE COCONUTS AND AS A FAINT TRACE AT THE APEX OF THE CURVE OF THE PARROT ON THE RIGHT SIDE. BLUE CAN BE FOUND IN A PATCH ABOUT THE EYE, COMPRISES THE MAJORITY OF THE COLOR OF THE BROAD BAND ACROSS THE MIDDLE OF THE PARROT AND COMPRISES THE TOP THIRD OF THE TAIL FEATHERS. BLUE MAY ALSO BE FOUND SPECKLED ABOVE AND TO THE RIGHT OF THE BEAK. THE TWO PARALLEL BARS LOCATED ABOVE AND BELOW THE WORDS "TROPICAL CAFE" ARE GRAY. PURPLE STREAKS CAN BE FOUND ON THE PARROT AT THE END OF THE TAIL, NEAR THE RIGHT AND LEFT SIDES OF THE PARROT, AS PART OF THE BORDER BETWEEN THE BLUE BAND ACROSS THE MIDDLE AND THE RED SECTIONS ABOVE AND BELOW THE BLUE BAND, AND AS SMALL STREAKS ON THE HEAD OF THE PARROT. GREEN IS THE PRIMARY COLOR OF THE LEAVES OF THE PALM TREE AND SOME GREEN CAN BE FOUND AS SPECKLED PATCHES, FORMING A BORDER BETWEEN THE BLUE BAND ACROSS THE MIDDLE OF THE PARROT AND THE RED AREA ABOVE THE BLUE BAND. ORANGE STREAKS CAN BE FOUND IN THE COCONUTS. YELLOW COMPRISES THE BORDER AND THE VEINS OF THE PALM LEAVES. FAINT TRACES OF YELLOW CAN ALSO BE FOUND BELOW THE PARROT'S EYE.

FOR PRE-RECORDED AUDIOCASSETTES, CD-ROMS FEATURING MUSIC AND LIVE ENTERTAINMENT (U.S. CLS. 21, 23, 26, 36 AND 38).

FIRST USE 1-0-1996; IN COMMERCE 1-0-1997.

MARY BOAGNI, EXAMINING ATTORNEY

CLASS 9—(Continued).

SN 76-293,314. LEICA MICROSYSTEMS HEIDELBERG GMBH, MANNHEIM, FED REP GERMANY, FILED 8-1-2001.

SP

PRIORITY CLAIMED UNDER SEC. 44(D) ON FED REP GERMANY APPLICATION NO. 30108106.9/0, FILED 2-7-2001, REG. NO. 30108106, DATED 3-30-2001, EXPIRES 2-28-2011.

FOR SPECTROMETERS, OPTICAL DETECTORS, LIGHT SPECTRUM ANALYZERS, ANALYSIS SYSTEMS COMPRISED OF THE FOREGOING COMPONENTS, COMBINATIONS OF SPECTROMETERS, OPTICAL DETECTORS AND SPECTRAL ANALYZERS WITH OPTICAL MICROSCOPES, ESPECIALLY WITH STEREOMICROSCOPES, LASER SCANNING MICROSCOPES, CONFOCAL SCANNING MICROSCOPES, MEASURING MICROSCOPES, PHOTOMICROSCOPES, AND FLUORESCENCE MICROSCOPES; SOFTWARE FOR CONTROLLING AND OPERATING ANALYTICAL MICROSCOPES (U.S. CLS. 21, 23, 26, 36 AND 38).

HEATHER THOMPSON, EXAMINING ATTORNEY

SN 76-473,302. CYTONOME, INC., WATERTOWN, MA. FILED 12-9-2002.

PICOSOCKET

FOR CHIP TO WORLD INTERFACE, NAMELY, A RECEPTOR FORMED IN A SEMICONDUCTOR OR INSULATING MATERIAL WAFER OR CHIP WHERE PICOLITER TO NANOLITER SIZE LIQUID DROPLETS ARE INJECTED INTO THE INTERFACE RECEPTOR TO PERFORM LIQUID PHASE CHEMICAL OR BIOLOGICAL MATERIAL ANALYSIS (U.S. CLS. 21, 23, 26, 36 AND 38).

WENDY GOODMAN, EXAMINING ATTORNEY

SN 76-479,267. D—SKIN, LLC, WEST CHICAGO, IL. FILED 12-30-2002.



THE COLOR GREEN APPEARS AS AN UNDERScoreD LINE BETWEEN "D" AND "SKIN" IN THE CENTER REGION OF THE CIRCLE CONTAINING THE WORD

CLASS 9—(Continued).

"D—SKIN". THE COLOR ORANGE APPEARS AS AN ARCULATE BAR ON OUTSIDE OF THE CIRCLE CONTAINING THE WORD "D—SKIN;" THE BAR EXTENDS ALONG APPROXIMATELY ONE-QUARTER OF THE CIRCLE'S CIRCUMFERENCE IN THE UPPER-RIGHT-HAND QUADRANT. THE COLOR GRAY APPEARS AS THE WORD "D—SKIN" IN A LIGHTER SHADE OF GRAY. THE COLOR GRAY ALSO APPEARS AS A PERSON'S TORSO IN A DARKER SHADE OF THE GRAY BEHIND THE WORD "D—SKIN".

FOR PROTECTIVE PLASTIC COVERS FOR THE READ SIDE OF OPTICAL DISCS (U.S. CLS. 21, 23, 26, 36 AND 38).

ANDREA SAUNDERS, EXAMINING ATTORNEY

CLASS 9—(Continued).

SN 76-496,563. IKON OFFICE SOLUTIONS WEST, INC., PORTLAND, OR. FILED 3-12-2003.

IKON DocSend . . .

SN 76-486,293. HSU LI, HSIU CHU, CHU PEI CITY, TAIWAN, FILED 1-31-2003.

MAXCALL

FOR COMPUTER SOFTWARE AND HARDWARE FOR USE IN WORKFLOW MANAGEMENT, DOCUMENT EDITING, SCANNING AND ARCHIVING THAT PERMITS USERS TO SCAN PAPER DOCUMENTS, EDIT THE RESULTING IMAGE, PRINT THE IMAGE TO A PRINTER, STORE THE IMAGE IN A DOCUMENT MANAGEMENT SYSTEM OR DISTRIBUTE THE RESULTING IMAGE VIA ELECTRONIC MAIL OR A FACSIMILE MACHINE (U.S. CLS. 21, 23, 26, 36 AND 38).

TRACY WHITAKER-BOWN, EXAMINING ATTORNEY

FOR MOBILE PHONE CAR CHARGER SOCKETS; MOBILE PHONE CHARGERS; MOBILE PHONE CASES; MICROPHONES FOR CAR PHONES; CAR PHONES; MOBILE PHONE HOLDERS; MOBILE PHONE CAR CHARGERS; POWER SUPPLIES FOR MOBILE PHONES; GLOBAL POSITIONING SYSTEM, NAMELY GPS, CONSISTING OF COMPUTERS, COMPUTER SOFTWARE, TRANSMITTERS, RECEIVERS, AND NETWORK INTERFACE DEVICES (U.S. CLS. 21, 23, 26, 36 AND 38).

FIRST USE 3-11-2001; IN COMMERCE 3-11-2001.
LESLEY LAMOTHE, EXAMINING ATTORNEY

SN 76-507,447. NOVA CO., LTD., OSAKA, JAPAN, FILED 3-31-2003.

WARPGATE

SN 76-495,924. ACTIVEPDF, INC., MISSION VIEJO, CA. FILED 3-10-2003.

activePDF

OWNER OF U.S. REG. NO. 2,762,962.
THE CROSS-HATCHED PORTION OF THE DRAWING IS LINED FOR THE COLOR ORANGE.
SEC. 2(F).

FOR COMPUTER SOFTWARE, NAMELY SERVER-SIDE SOFTWARE FOR CREATING PORTABLE DOCUMENT FORMAT FILES PROGRAMATICALLY AND FROM VARIABLY FORMATTED CLIENT FILES (U.S. CLS. 21, 23, 26, 36 AND 38).

FIRST USE 1-17-2000; IN COMMERCE 1-17-2000.
ROBERT C. CLARK JR., EXAMINING ATTORNEY

OWNER OF JAPAN REG. NO. 4503981, DATED 9-7-2001, EXPIRES 9-7-2011.

FOR SCIENTIFIC AND ELECTRONIC APPARATUS, NAMELY, TELECOMMUNICATIONS AND ELECTRONIC INFORMATION TRANSMISSION APPARATUS AND INSTRUMENTS, NAMELY, VIDEO TELEPHONES, TELEPHONE SETS, CELLULAR TELEPHONES, FACSIMILE MACHINES, MODEMS, TELEVISION RECEIVERS, AND REPLACEMENT PARTS THEREFOR; COMPUTER HARDWARE, COMPUTER SOFTWARE PROGRAMS FOR USE IN DATABASE MANAGEMENT, FOR USE IN REMOTE EDUCATION, FOR USE IN LINGUISTIC EDUCATION, AND FOR USE AS A SPREADSHEET, AND FOR WORD PROCESSING, BLANK MAGNETIC DATA CARRIERS, MAGNETIC CODED CARD READERS, AND MAGNETIC CODED CARDS, FOR USE IN TELECOMMUNICATIONS AND ELECTRONIC INFORMATION TRANSMISSION (U.S. CLS. 21, 23, 26, 36 AND 38).

ASMAT KHAN, EXAMINING ATTORNEY

CLASS 9—(Continued).

SN 76-508,211. J & S GAMING INC., MERRICK, NY. FILED 4-22-2003.

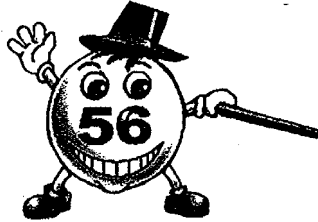

NO CLAIM IS MADE TO THE EXCLUSIVE RIGHT TO USE "56", APART FROM THE MARK AS SHOWN.

THE STIPPLING IN THE DRAWING IS FOR SHADING PURPOSES ONLY AND DOES NOT INDICATE COLOR.

THE MARK CONSISTS OF A BALL REPRESENTING A HUMAN FIGURE WITH THE NUMBERS 56 APPEARING BETWEEN THE EYES AND THE MOUTH OF THE HUMAN FIGURE. THE HUMAN FIGURE IS WEARING A TOP HAT AND HOLDING A CANE.

FOR GAMING MACHINES, NAMELY, SLOT MACHINES AND VIDEO LOTTERY TERMINALS (U.S. CLS. 21, 23, 26, 36 AND 38).

FIRST USE 5-0-2003; IN COMMERCE 5-0-2003.
ALICIA COLLINS, EXAMINING ATTORNEY

SN 76-511,235. LAM RESEARCH CORPORATION, FREMONT, CA. FILED 5-2-2003.

DFC

THE MARK CONSISTS OF STANDARD CHARACTERS WITHOUT CLAIM TO ANY PARTICULAR FONT, STYLE, SIZE, OR COLOR.

FOR COMPUTER HARDWARE AND SOFTWARE TO ENABLE ADVANCED PLASMA SOURCE CONDUCTOR APPLICATIONS FOR USE IN SEMICONDUCTOR FABRICATION EQUIPMENT (U.S. CLS. 21, 23, 26, 36 AND 38).

ZACHARY BELLO, EXAMINING ATTORNEY

SN 76-512,102. SEIKO EPSON KABUSHIKI KAISHA, DBA SEIKO EPSON CORPORATION, SHINJUKU-KU, TOKYO, JAPAN, FILED 4-16-2003.

EPSONNET INSTALL WIZARD

NO CLAIM IS MADE TO THE EXCLUSIVE RIGHT TO USE INSTALL WIZARD, APART FROM THE MARK AS SHOWN.

FOR COMPUTER SOFTWARE FOR CONFIGURATION AND CONTROL OF PRINTERS FOR COMPUTERS (U.S. CLS. 21, 23, 26, 36 AND 38).

FIRST USE 1-31-2003; IN COMMERCE 4-16-2003.
SHARON MEIER, EXAMINING ATTORNEY

CLASS 9—(Continued).

SN 76-512,766. ACTEBIS HOLDING GMBH, 59494 SOEST, FED REP GERMANY, FILED 5-8-2003.

ACTEBIS

OWNER OF FED REP GERMANY REG. NO. 1,181,217, DATED 10-1-1991, EXPIRES 12-31-2009.

FOR COMPUTERS; MONITORS; KEYBOARDS; MATRIX PRINTERS, LASER PRINTERS AND INK JET PRINTERS; FLOPPY DISK DRIVES, HARD DISK DRIVES AND MAGNETIC TAPE DRIVES; BLANK COMPUTER DISKS; BLANK COMPUTER CARTRIDGES FOR STORING DATA, HARD DISK CONTROL APPARATUS, NAMELY, COMPUTER DISK DRIVES, COMPUTER INTERFACE BOARDS; PC CARDS; SCANNERS; ACOUSTIC COUPLERS; MODEMS; SOUND SAMPLERS; MICE; COMPUTER CABLES; COMPUTER MONITOR STANDS AND PRINTER STANDS; SINGLE SHEET FEEDER FOR PRINTERS; COMPUTER PROGRAMS AND INSTRUCTION MANUALS ALL SOLD AS A UNIT FOR A FULL LINE OF APPLICATIONS USED AS A HOUSEMARK FOR COMMERCIAL, GOVERNMENTAL, AND EDUCATIONAL APPLICATIONS AND FOR USE BY DISTRIBUTORS AND DEALERS FOR SALE TO WHOLESALERS AND END CONSUMERS; APPARATUS AND INSTRUMENTS ASSEMBLED FROM SEMICONDUCTOR COMPONENTS FOR USE IN COMPUTER PRODUCTS, NAMELY, INTERFACE CARDS, MICRO-PROCESSORS, COMPUTER CHIPS, MOTHER BOARDS, PLUG-IN CIRCUIT BOARDS AND INTEGRATED CIRCUITS; SEMICONDUCTORS (U.S. CLS. 21, 23, 26, 36 AND 38).

GWEN STOKOLS, EXAMINING ATTORNEY

SN 76-516,939. BEHNKE, STEPHEN, NEW ALBANY, OH. FILED 5-16-2003.

HEALTHFOLIO

FOR COMPUTER SOFTWARE FOR DATABASE MANAGEMENT IN THE FIELDS OF MEDICAL TREATMENT AND MEDICAL RECORDS MANAGEMENT (U.S. CLS. 21, 23, 26, 36 AND 38).

SUSAN STIGLITZ, EXAMINING ATTORNEY

SN 76-518,978. LUNA CHICA RECORDS, LLC, BOULDER, CO. FILED 6-2-2003.

BURRITO DELUXE

FOR PRERECORDED PHONOGRAPH RECORDS, COMPACT DISCS, PRE-RECORDED DAT-TAPES, NAMELY, DIGITAL AUDIO TAPES FEATURING MUSIC, AND VIDEOTAPES FEATURING MUSIC (U.S. CLS. 21, 23, 26, 36 AND 38).

FIRST USE 3-31-2003; IN COMMERCE 3-31-2003.
TRACY WHITAKER-BOWN, EXAMINING ATTORNEY

CLASS 9—(Continued).

SN 76-519,858. WIRELESS GENERATION, INC., NEW YORK, NY. FILED 5-2-2003.

WIRELESS GENERATION

NO CLAIM IS MADE TO THE EXCLUSIVE RIGHT TO USE "WIRELESS", APART FROM THE MARK AS SHOWN.
FOR COMPUTER SOFTWARE FOR USE IN DATABASE MANAGEMENT FOR OBSERVATIONAL ASSESSMENT AND ASSESSMENT IN CLASSROOM SETTINGS AND OTHER TRAINING AND LEARNING ENVIRONMENTS; COMPUTER SOFTWARE PLATFORMS AND DOWNLOADABLE SOFTWARE FOR OBSERVATIONAL ASSESSMENT AND ASSESSMENT IN CLASSROOM SETTINGS AND OTHER TRAINING AND LEARNING ENVIRONMENTS; COMPUTER SOFTWARE TO PERFORM DIAGNOSTIC ANALYSIS AND FOR SYNCHRONIZING DATA BETWEEN REMOTE MOBILE DEVICES AND THE INTERNET OR OTHER WAN OR LAN-BASED ENTERPRISE DATA SYSTEM AND BACKEND DATA SYSTEMS; COMPUTER HARDWARE AND PERSONAL DIGITAL ASSISTANTS (U.S. CLS. 21, 23, 26, 36 AND 38).
FIRST USE 10-1-2000; IN COMMERCE 2-1-2001.
JASON TURNER, EXAMINING ATTORNEY

SN 76-523,496. ARTESYN NORTH AMERICA, INC., FRAMINGHAM, MA. FILED 6-18-2003.

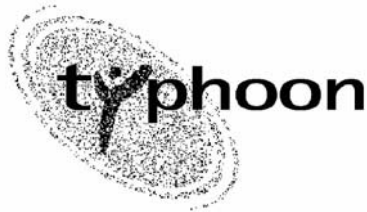

THE STIPPLING IN THE LETTER "Y" OF THE WORD TYPHOON AND THE STIPPLING IN THE BACKGROUND SLANTED OVAL SWIRL OF THE DRAWING IS FOR SHADING PURPOSES ONLY.

FOR AC/DC CONVERTERS; DC/DC CONVERTERS; ELECTRICAL POWER SUPPLIES AND POWER CONVERTERS; AND ELECTRICAL POWER SUPPLY AND POWER CONVERTER CIRCUITS AND COMPONENTS, NAMELY, BOARD-MOUNTED POWER CONVERTER MODULES, ISOLATED BRICKS, BUS CONVERTERS, POINT-OF-LOAD CONVERTER MODULES, VOLTAGE REGULATOR MODULES, FRONT-END BULK POWER SUPPLIES, CENTRALIZED POWER SUPPLIES, AND RECTIFIERS (U.S. CLS. 21, 23, 26, 36 AND 38).
HOWARD SMIGA, EXAMINING ATTORNEY

SN 76-526,163. SOUTHWEST RESEARCH INSTITUTE, SAN ANTONIO, TX. FILED 6-26-2003.

R-FOCAS

OWNER OF U.S. REG. NOS. 2,640,591 AND 2,707,605.
FOR TESTING EQUIPMENT FOR SIMULATING ENGINE AGING OF CATALYTIC CONVERTERS, PARTICULATE TRAPS, NOX ABSORBERS, HG TRAPS, EMISSION CONTROLS, AFTER TREATMENT SYSTEMS, EXHAUST PIPES, TURBOCHARGERS, MUFFLERS, EGR VALVES, EGR COOLERS, SENSORS, EXHAUST MANIFOLDS, HEAT EXCHANGERS, SPARK PLUGS, AND GLOW PLUGS THAT ARE EXPOSED TO AN EXHAUST GAS ENVIRONMENT (U.S. CLS. 21, 23, 26, 36 AND 38).
STEVEN JACKSON, EXAMINING ATTORNEY

CLASS 9—(Continued).

SN 76-531,162. FILTRE-EXPERT INC, LEVIS (QUEBEC), CANADA, FILED 7-22-2003.

Relax

FOR SYSTEM FOR THE DETECTION OF ELECTRICAL POWER OUTAGES IN THE AGRICULTURAL AND FARMING INDUSTRIES COMPRISING SENSORS THAT DETECT ELECTRICAL FAULT, MONITORS FOR SHOWING THE STATUS OF THE ELECTRICAL NETWORK, TRANSFORMERS FOR LOWERING ELECTRICAL VOLTAGE, RECEIVERS FOR RECEIVING DATA REMOTELY, AND COMPUTER SOFTWARE FOR MANAGING THE DETECTED ELECTRICAL FAULTS VIA COMPUTER (U.S. CLS. 21, 23, 26, 36 AND 38).
FIRST USE 10-10-2000; IN COMMERCE 10-10-2000.
ALEX KEAM, EXAMINING ATTORNEY

SN 76-535,330. MATSUSHITA ELECTRIC INDUSTRIAL CO., LTD., OSAKA 571-8501, JAPAN, FILED 7-21-2003.

ANALOG KEY

NO CLAIM IS MADE TO THE EXCLUSIVE RIGHT TO USE "ANALOG", APART FROM THE MARK AS SHOWN.
FOR CONTROLLER UNITS FOR MOBILE TOOLS, NAMELY CELLULAR MOBILE TELEPHONES, PERSONAL DIGITAL ASSISTANTS; SMART PHONES; PORTABLE DIGITAL STILL CAMERAS, PORTABLE DIGITAL VIDEO CAMERAS, PORTABLE VIDEO CAMERAS, PORTABLE CASSETTE TAPE PLAYERS, PORTABLE MINI DISK PLAYERS, PORTABLE COMPACT DISC PLAYERS AND PORTABLE HARD DISK PLAYERS; CONTROLLER UNITS FOR COMPUTERS, DATA PROCESSING APPARATUS, AUDIO-VISUAL APPARATUS; AND ACOUSTIC APPARATUS; POINTING DEVICE, NAMELY COMPUTER MOUSE, JOYSTICKS, TOUCH PADS, TOUCH PANELS, TOUCH TABLETS, TRACKPOINTS, TRACKBALLS, LIGHT PENS, STYLUS, AND DATA GLOVES FOR CONTROLLING MOVEMENT OF THE POINTER TO SCROLL, POSITION AND/OR SELECT ITEMS ON A DISPLAY SCREEN; DIGITAL VIDEO CAMERAS AND DIGITAL STILL CAMERAS USED WITH IC MEMORY CARDS HAVING FUNCTIONS OF AN AUDIO PLAYER AND A VOICE RECORDER; CURSOR CONTROL DEVICES, NAMELY TRACKBALLS; PHOTOCOPIERS; ENTRANCE VIDEOPHONES; RADIOS; CASSETTE TAPE PLAYERS AND OR RECORDERS; RADIO CASSETTE PLAYERS AND/OR RECORDERS; DIGITAL AUDIO TAPE RECORDERS; PORTABLE CASSETTE TAPE PLAYERS ADAPTED FOR USE WITH HEADPHONES; POTABLE CASSETTE PLAYERS WITH RADIO ADAPTED FOR USE WITH HEADPHONES; COMPACT DISC PLAYERS AND/OR RECORDERS; MINI DISC PLAYERS; MINI DISC PLAYERS AND/OR RECORDERS; DVD AUDIO PLAYERS AND/OR RECORDERS; SECURE DIGITAL AUDIO PLAYERS AND/OR RECORDERS; SECURE DIGITAL VIDEO PLAYERS AND/OR RECORDERS; PORTABLE LISTENING DEVICES, NAMELY MP3 PLAYERS; CAR AUDIO DEVICES, NAMELY AM/FM RADIO, SATELLITE RADIO, CD PLAYERS; CD RECEIVERS, DVD AUDIO PLAYERS, DVD AUDIO RECEIVERS, CASSETTE PLAYERS, CASSETTE RECEIVERS; AUDIO MIXERS; TELEVISION RECEIVERS; LIQUID CRYSTAL DISPLAY PROJECTORS; VIDEO CASSETTE RECORDERS; CAMCORDERS; DIGITAL STILL CAMERAS; VIDEO DISK PLAYERS; VIDEO CD PLAYERS; DVD VIDEO PLAYERS AND/OR RECORDERS; OPTICAL

CLASS 9—(Continued).

DISC RECORDERS; OPTICAL DISC PLAYERS; FACSIMILE TRANSCIVERS; TELEPHONES; CELLULAR MOBILE TELEPHONES; TELEPHONE ANSWERING MACHINES; RADIO TELEPHONES; RADIO PAGING RECEIVERS; PERSONAL HANDY-PHONES; IN-CAR NAVIGATION AND/OR ROUTE GUIDANCE APPLIANCE; REMOTE CONTROLLERS FOR TELEVISION RECEIVERS, IMAGE DISPLAYS, DVD PLAYERS OR RECORDERS, STEREO DEVICES, VIDEO TAPE RECORDERS, RADIOS; AIR CONDITIONERS, ELECTRIC FANS, AND LIGHTING APPARATUS NAMELY FLUORESCENT LAMPS AND ELECTRIC LAMP; COMPUTERS; COMPUTER KEYBOARDS; COMPUTER MOUSE; DATA COLLECTION TERMINALS; PERSONAL DIGITAL ASSISTANTS; VIDEO GAME APPARATUS FOR USE WITH TELEVISIONS ONLY; ENCODERS; ELECTRIC AND/OR ELECTRONIC SWITCH COMPONENTS, NAMELY LEVER SWITCHES, TOUCH SENSITIVE SWITCHES, MULTI-DIRECTIONAL OPERATION SWITCHES, PUSH-TYPE SWITCHES, STICK SWITCHES, ROTARY-TYPE SWITCHES, SLIDE-TYPE SWITCHES; REMOTE CONTROL UNITS FOR TELEVISION RECEIVERS, IMAGE DISPLAY; DVD PLAYERS OR CAMCORDERS OR RECORDERS, STEREO DEVICES, VIDEO TAPE RECORDERS, RADIOS, AIR CONDITIONERS, ELECTRIC FANS AND LIGHTING APPARATUS, NAMELY FLUORESCENT LAMPS AND ELECTRIC LAMPS (U.S. CLS. 21, 23, 26, 36 AND 38).

ESTHER A. BORSUK, EXAMINING ATTORNEY

SN 76-543,475. WINTEK CORPORATION, TAICHUNG, TAIWAN, FILED 9-8-2003.

勝華科技

OWNER OF U.S. REG. NO. 2,153,475.

THE NON-LATIN CHARACTERS IN THE MARK TRANSLITERATE TO "SHENG, HUA, KE AND GI" AND THIS MEANS "VICTORY, MAGNIFICENT, TECHNOLOGY".

FOR FLAT PANEL DISPLAY SCREENS, LIQUID CRYSTAL DISPLAY; LIQUID CRYSTAL DISPLAY MODULE; ORGANIC LIGHT EMITTING DIODE DISPLAY; COLOR THIN FILM TRANSISTOR LCD; COLOR THIN FILM TRANSISTOR LCD MODULE; MONOCHROME THIN FILM TRANSISTOR LCD, MONOCHROME THIN FILM TRANSISTOR LCD MODULE; LIQUID CRYSTAL ON SILICON DISPLAY; COLOR THIN FILM TRANSISTOR OLED DISPLAY; MONOCHROME THIN FILM TRANSISTOR OLED DISPLAY; ACTIVE MATRIX DISPLAY; PASSIVE MATRIX DISPLAY; EMISSIVE DISPLAY; EMISSIVE DISPLAY MODULE; DISPLAY TESTING MACHINE, NAMELY MEASURING DEVICE WHICH MEASURES THE ELECTRONIC AND OPTICAL CHARACTERISTIC FOR FLAT PANEL DISPLAY; COLOR FILTER FOR THE PURPOSE OF MAKING WHITE-LIGHT SOURCE OF DISPLAY INTO A FULL COLOR DISPLAY OR LED DISPLAY; TOUCH PANEL, NAMELY A HUMAN-INTERFACE INPUT DEVICE WHICH CAN UTILIZE A KEYBOARD AND/OR MOUSE AT THE SAME TIME; ELECTRO LUMINESCENT, MULTI-LAYER MATERIAL CONSISTING OF SPECIAL FLUORESCENT DIE DISPERSED IN A BINDER WITH A HIGH ELECTRIC PROPERTY; LIGHT GUIDE; BACK LIGHT MODULE CONSISTING OF HOUSING, REFLECTOR, LIGHT GUIDE, PRISM SHEET, DIFFUSER, LIGHT SOURCE FOR THE PURPOSE OF TRANSFERRING THE LIGHT SOURCE INTO THE UNIFORM PLANE LIGHT SOURCE AND SUPPLY TO LCD; PHOTO MASK WHICH IS FABRICATED BY MEANS OF ELECTRIC BEAM LITHOGRAPHY, USED IN PHOTOLITHOGRAPHY THAT ALLOWS SELECTIVE EXPOSURE OF PHOTSENSITIVE SURFACE; GLASS WITH ELECTRONIC CONDUCTOR UNDER SURFACE WHICH IS A NON-CONDUCTIVE SUBSTRATE AND CAN BE COATING THINNER METAL OR OXIDE METAL AS CON-

CLASS 9—(Continued).

DUCTIVE LAYER ON THE SURFACE; INDIUM TIN OXIDE WHICH IS A NON-CONDUCTIVE SUBSTRATE AND CAN BE COATING THINNER METAL OR OXIDE METAL AS CONDUCTIVE LAYER ON THE SURFACE; LCD DRIVING EQUIPMENT COMPRISED OF DIGITAL SIGNAL GENERATORS, ANALOG SIGNAL GENERATORS, VIDEO SIGNAL GENERATORS TO FUNCTION TO GENERATE SIGNAL TO LCD; ANTI STATIC ELECTRICITY TESTING PLATFORM EQUIPMENT COMPRISED OF ELECTROSTATIC CHARGING, DISCHARGING AND MEASURING PART FOR GENERATING ESD SIGNAL AND MEASURING MODES NAMELY, HUMAN-BODY MODEL, MACHINE MODEL, CHARGED-DEVICE MODEL, AND FIELD-INDUCED MODEL; SEMICONDUCTOR DRIVER FOR LCD DISPLAY; INTEGRATED CIRCUIT; PRINTED CIRCUIT BOARD; ELECTRONIC CIRCUIT; LIGHT EMITTING DIODES; LED INDICATOR FOR THE PURPOSE OF INDICATING INFORMATION OR IMAGE; LED DISPLAY; LED DISPLAY MODULE COMPOSED OF UNIT OF ORGANIC OR INORGANIC LED; SEMICONDUCTOR CHIPS; SHADOW MASK WHICH IS METAL SHEET LOCATED BETWEEN ORGANIC VAPOR SOURCE AND GLASS SUBSTRATE DURING OLED EVAPORATION PROCESS; SILICON CRYSTAL, NAMELY SILICON CONDUCTOR MATERIAL IN CRYSTAL PHASE WHICH IS THE SOURCE MATERIAL OF SILICON CHIPS; SILICON CHIP; COMPUTER LCD; COMPUTER MONITOR; OLED HALF-LIFE TESTING MACHINE FOR THE SUPPORT OF THE DETERMINATION OF THE HALF-LIFETIME OF OLED AND OPTO-ELECTROCHARACTERISTICS MEASUREMENT; VACUUM FORMING MOLD WHICH IS A MEAN THAT MOLD USED TO RAISE TEMPERATURE TO MAKE POLYMERS SOFTENED, THEN ADSORPTIVE AND ADHERED TO MOLD'S SURFACE BY THE MOLD; PLASTIC INJECTION MOLD WHICH IS USED FOR THE PURPOSE OF FORMING A LIGHT GUIDE; COF FUNCTION TESTING MACHINE FOR THE PURPOSE OF GENERATING TEST SIGNALS AND INSPECTING THE FUNCTION OF COF (U.S. CLS. 21, 23, 26, 36 AND 38).

FIRST USE 11-9-1994; IN COMMERCE 11-9-1994.
SCOTT OSLICK, EXAMINING ATTORNEY

SN 76-555,883. THX LTD., SAN RAFAEL, CA. FILED 10-31-2003.

THX

OWNER OF U.S. REG. NOS. 1,419,801 AND 2,552,064.
FOR HEADPHONES; VIDEO GAME CONSOLES; AND NETWORK CONTROLLERS (U.S. CLS. 21, 23, 26, 36 AND 38).

LINDA E. BLOHM, EXAMINING ATTORNEY

SN 76-555,884. THX LTD., SAN RAFAEL, CA. FILED 10-31-2003.

THX

OWNER OF U.S. REG. NOS. 1,419,801 AND 2,552,064.
FOR HEADPHONES; VIDEO GAME CONSOLES; AND NETWORK CONTROLLERS (U.S. CLS. 21, 23, 26, 36 AND 38).

LINDA E. BLOHM, EXAMINING ATTORNEY

CLASS 9—(Continued).

SN 76-556,456. ACCESS INTERNATIONAL GROUP, INC., FLORHAM PARK, NJ. FILED 11-4-2003.

BI-OPPORTUNITY CENTER

FOR COMPUTER SOFTWARE FOR USE IN BUSINESS DATA MANAGEMENT, NAMELY SORTING, ORGANIZING AND ANALYZING COLLECTED DATA INTO MODULES FOR USE IN THE FIELD OF BUSINESS MANAGEMENT (U.S. CLS. 21, 23, 26, 36 AND 38).
FIRST USE 2-0-2000; IN COMMERCE 2-0-2000.
APRIL L. RADEMACHER, EXAMINING ATTORNEY

SN 76-562,299. MENTALEDGE MEDIA, LLP, WARMINSTER, PA. FILED 11-28-2003.

WINNING ABOVE THE SHOULDERS

THE MARK CONSISTS OF STANDARD CHARACTERS WITHOUT CLAIM TO ANY PARTICULAR FONT, STYLE, SIZE, OR COLOR.
FOR PRERECORDED VIDEO TAPES AND AUDIO CASSETTES FEATURING INFORMATION PROMOTING THE POSITIVE PSYCHOLOGICAL ASPECTS OF SPORTS INCLUDING ATTITUDE, KNOWLEDGE, MINDSET, AND CONCENTRATION SO THAT PARENTS AND CHILDREN BOTH FIND MORE ENJOYMENT FORM A CHILD'S SPORT RELATED ACTIVITY (U.S. CLS. 21, 23, 26, 36 AND 38).
DARRYL SPRUILL, EXAMINING ATTORNEY

SN 76-562,302. MENTALEDGE MEDIA, LLP, WARMINSTER, PA. FILED 11-28-2003.

WHEN THEY WERE JUST KIDS

THE MARK CONSISTS OF STANDARD CHARACTERS WITHOUT CLAIM TO ANY PARTICULAR FONT, STYLE, SIZE, OR COLOR.
FOR PRERECORDED VIDEO TAPES AND AUDIO CASSETTES FEATURING INFORMATION PROMOTING THE POSITIVE PSYCHOLOGICAL ASPECTS OF SPORTS INCLUDING ATTITUDE, KNOWLEDGE, MINDSET, AND CONCENTRATION SO THAT PARENTS AND CHILDREN BOTH FIND MORE ENJOYMENT FORM A CHILD'S SPORT RELATED ACTIVITY (U.S. CLS. 21, 23, 26, 36 AND 38).
DARRYL SPRUILL, EXAMINING ATTORNEY

CLASS 9—(Continued).

SN 76-562,308. MENTALEDGE MEDIA, LLP, WARMINSTER, PA. FILED 11-28-2003.

KIDS JUST WANT TO HAVE FUN

THE MARK CONSISTS OF STANDARD CHARACTERS WITHOUT CLAIM TO ANY PARTICULAR FONT, STYLE, SIZE, OR COLOR.
FOR PRERECORDED VIDEO TAPES AND AUDIO CASSETTES FEATURING INFORMATION PROMOTING THE POSITIVE PSYCHOLOGICAL ASPECTS OF SPORTS INCLUDING ATTITUDE, KNOWLEDGE, MINDSET, AND CONCENTRATION SO THAT PARENTS AND CHILDREN BOTH FIND MORE ENJOYMENT FORM A CHILD'S SPORT RELATED ACTIVITY (U.S. CLS. 21, 23, 26, 36 AND 38).
DARRYL SPRUILL, EXAMINING ATTORNEY

SN 76-562,310. MENTALEDGE MEDIA, LLP, WARMINSTER, PA. FILED 11-28-2003.

BETTER SPORTS IN MIND

THE MARK CONSISTS OF STANDARD CHARACTERS WITHOUT CLAIM TO ANY PARTICULAR FONT, STYLE, SIZE, OR COLOR.
FOR PRERECORDED VIDEO TAPES AND AUDIO CASSETTES FEATURING INFORMATION PROMOTING THE POSITIVE PSYCHOLOGICAL ASPECTS OF SPORTS INCLUDING ATTITUDE, KNOWLEDGE, MINDSET, AND CONCENTRATION SO THAT PARENTS AND CHILDREN BOTH FIND MORE ENJOYMENT FORM A CHILD'S SPORT RELATED ACTIVITY (U.S. CLS. 21, 23, 26, 36 AND 38).
PATRICIA EVANKO, EXAMINING ATTORNEY

SN 76-565,427. SONY KABUSHIKI KAISHA, TA SONY CORPORATION, TOKYO, JAPAN, FILED 12-3-2003.

MOTION BLADE

THE MARK CONSISTS OF STANDARD CHARACTERS WITHOUT CLAIM TO ANY PARTICULAR FONT, STYLE, SIZE, OR COLOR.
FOR CAR AUDIO SYSTEM COMPONENTS, NAMELY, AUDIO TAPE PLAYERS AND RECORDERS, AUDIO DISC PLAYERS AND RECORDERS, STEREO TUNERS, AMPLIFIERS, RADIOS, SPEAKERS AND REMOTE CONTROLS FOR OPERATING CAR STEREO (U.S. CLS. 21, 23, 26, 36 AND 38).
ELISSA GARBER KON, EXAMINING ATTORNEY

CLASS 9—(Continued).

SN 76-565,500. FUJITSU LIMITED, KANAGAWA-KEN, JAPAN, FILED 12-16-2003.

Genesphere

THE MARK CONSISTS OF STANDARD CHARACTERS WITHOUT CLAIM TO ANY PARTICULAR FONT, STYLE, SIZE, OR COLOR.

PRIORITY CLAIMED UNDER SEC. 44(D) ON JAPAN APPLICATION NO. 2003-071215, FILED 8-21-2003, REG. NO. 4748418, DATED 2-20-2004, EXPIRES 2-20-2014.

FOR COMPUTER HARDWARE AND SOFTWARE FOR USE IN BIOINFORMATICS AND GENOMICS, NAMELY, FOR USE IN THE PROCESSING, ANALYZING, STORING AND RETRIEVAL OF COMPLEX BIOLOGICAL INFORMATION WITH PARTICULAR REFERENCE TO THE HUMAN GENOME AND HUMAN PROTEOME (U.S. CLS. 21, 23, 26, 36 AND 38).

ANN LINNEHAN, EXAMINING ATTORNEY

CLASS 9—(Continued).

SN 76-565,920. MYPUBLISHER, INC., VALHALLA, NY. FILED 12-5-2003.



NO CLAIM IS MADE TO THE EXCLUSIVE RIGHT TO USE BOOKMAKER, APART FROM THE MARK AS SHOWN.

FOR DOWNLOADABLE SOFTWARE, NAMELY, SOFTWARE USED FOR DESIGNING AND LAYING OUT PHOTO BOOKS AND PHOTO ALBUMS (U.S. CLS. 21, 23, 26, 36 AND 38).

SUELLEN HICKEY, EXAMINING ATTORNEY

SN 76-565,720. INNOVATIVE DATA PROCESSING SOLUTIONS, LTD., ROCHESTER, NY. FILED 12-8-2003.

WEB CRAFT

THE MARK CONSISTS OF STANDARD CHARACTERS WITHOUT CLAIM TO ANY PARTICULAR FONT, STYLE, SIZE, OR COLOR.

NO CLAIM IS MADE TO THE EXCLUSIVE RIGHT TO USE "WEB", APART FROM THE MARK AS SHOWN.

FOR DOWNLOADABLE SOFTWARE FOR DEVELOPING AND MAINTAINING WEBSITES (U.S. CLS. 21, 23, 26, 36 AND 38).

FIRST USE 11-30-2001; IN COMMERCE 11-30-2001.
ROBERT LORENZO, EXAMINING ATTORNEY

SN 76-565,923. MYPUBLISHER, INC., VALHALLA, NY. FILED 12-5-2003.



NO CLAIM IS MADE TO THE EXCLUSIVE RIGHT TO USE BOOKMAKER, APART FROM THE MARK AS SHOWN.

FOR DOWNLOADABLE SOFTWARE, NAMELY, SOFTWARE USED FOR DESIGNING AND LAYING OUT PHOTO BOOKS AND PHOTO ALBUMS (U.S. CLS. 21, 23, 26, 36 AND 38).

SUELLEN HICKEY, EXAMINING ATTORNEY

SN 76-565,915. MYPUBLISHER, INC., VALHALLA, NY. FILED 12-5-2003.



NO CLAIM IS MADE TO THE EXCLUSIVE RIGHT TO USE BOOKMAKER, APART FROM THE MARK AS SHOWN.

FOR DOWNLOADABLE SOFTWARE, NAMELY, SOFTWARE USED FOR DESIGNING AND LAYING OUT PHOTO BOOKS AND PHOTO ALBUMS (U.S. CLS. 21, 23, 26, 36 AND 38).

STEVEN JACKSON, EXAMINING ATTORNEY

SN 76-566,086. WESTON SOLUTIONS (IPR), INC., WILMINGTON, DE. FILED 12-10-2003.

RESPONDFAST

THE MARK CONSISTS OF STANDARD CHARACTERS WITHOUT CLAIM TO ANY PARTICULAR FONT, STYLE, SIZE, OR COLOR.

FOR COMPUTER SOFTWARE FOR THE USE IN INFORMATION COLLECTION, UPDATING, AND MANAGEMENT IN THE FIELD OF ENVIRONMENTAL REMEDIATION (U.S. CLS. 21, 23, 26, 36 AND 38).

ROBERT C. CLARK JR., EXAMINING ATTORNEY

CLASS 9—(Continued).

SN 76-566,087. WESTON SOLUTIONS (IPR), INC., WILMINGTON, DE. FILED 12-10-2003.



FOR COMPUTER SOFTWARE FOR THE USE IN INFORMATION COLLECTION, UPDATING, AND MANAGEMENT IN THE FIELD OF ENVIRONMENTAL REMEDIATION (U.S. CLS. 21, 23, 26, 36 AND 38).
ROBERT C. CLARK JR., EXAMINING ATTORNEY

SN 76-566,206. T&G2, INC., BERNARDSVILLE, NJ. FILED 12-9-2003.

SecureTime

THE MARK CONSISTS OF STANDARD CHARACTERS WITHOUT CLAIM TO ANY PARTICULAR FONT, STYLE, SIZE, OR COLOR.

FOR COMPUTERIZED TIME CLOCK WITH FINGER-PRINT RECOGNITION (U.S. CLS. 21, 23, 26, 36 AND 38).
FIRST USE 1-1-2002; IN COMMERCE 1-1-2002.
MICHAEL KEATING, EXAMINING ATTORNEY

SN 76-568,213. YORK INTERNATIONAL CORPORATION, YORK, PA. FILED 1-2-2004.

ISN CONNEXSYS

THE MARK CONSISTS OF STANDARD CHARACTERS WITHOUT CLAIM TO ANY PARTICULAR FONT, STYLE, SIZE, OR COLOR.

NO CLAIM IS MADE TO THE EXCLUSIVE RIGHT TO USE NO CLAIM IS MADE TO THE EXCLUSIVE RIGHT TO USE ISN APART FROM THE MARK AS SHOWN, APART FROM THE MARK AS SHOWN.

FOR MICROPROCESSOR BASED CONTROLLER FOR DIRECT CONTROL OF BUILDING AND COOLING SYSTEMS IN THE HEATER, VENTILATION AND AIR CONDITIONING INDUSTRY (U.S. CLS. 21, 23, 26, 36 AND 38).

MARTHA SANTOMARTINO, EXAMINING ATTORNEY

CLASS 9—(Continued).

SN 76-568,246. AMT DATASOUTH CORP., CAMARILLO, CA. FILED 12-22-2003.

IT SPEAKS YOUR LANGUAGE

THE MARK CONSISTS OF STANDARD CHARACTERS WITHOUT CLAIM TO ANY PARTICULAR FONT, STYLE, SIZE, OR COLOR.

FOR COMPUTER SOFTWARE, NAMELY, SOFTWARE USED IN OPERATING PRINTERS AND MANUALS SOLD THEREWITH (U.S. CLS. 21, 23, 26, 36 AND 38).

MICHAEL WEBSTER, EXAMINING ATTORNEY

SN 76-569,482. AMERICAN ACADEMY OF ACHIEVEMENT, WASHINGTON, DC. FILED 1-12-2004.



THE MARK CONSISTS OF A TRIANGLE WITH A HEAD IN THE CENTER, WITH STARS TO THE RIGHT OF THE TRIANGLE. THE MARK IS IN BLACK AND WHITE AND THE COLORS ARE NOT A FEATURE OF THE MARK.

FOR VIDEOTAPES, AUDIO TAPES, DVDS, COMPACT DISCS, FEATURING EDUCATIONAL INFORMATION FOR CHILDREN (U.S. CLS. 21, 23, 26, 36 AND 38).

FIRST USE 9-16-1992; IN COMMERCE 9-16-1992.

MICHAEL KAZAZIAN, EXAMINING ATTORNEY

SN 76-569,525. SONY KABUSHIKI KAISHA, TA SONY CORPORATION, TOKYO, JAPAN, FILED 12-29-2003.

HAB

THE MARK CONSISTS OF STANDARD CHARACTERS WITHOUT CLAIM TO ANY PARTICULAR FONT, STYLE, SIZE, OR COLOR.

FOR VIDEO CAMERAS; DIGITAL STILL CAMERAS, PERSONAL DIGITAL ASSISTANTS, CELLULAR TELEPHONES, PERSONAL COMPUTERS, TELEVISIONS; REMOTE CONTROLLERS FOR USE WITH VIDEO CAMERAS, DIGITAL STILL CAMERAS, PERSONAL COMPUTERS AND TELEVISIONS; COMPUTER SOFTWARE THAT ENABLES THE DISPLAY OF LARGE IMAGES ON SMALL SCREENS BUILT INTO VIDEO CAMERAS, DIGITAL STILL CAMERAS, PERSONAL DIGITAL ASSISTANTS, CELLULAR TELEPHONES, PERSONAL COMPUTERS AND TELEVISIONS (U.S. CLS. 21, 23, 26, 36 AND 38).

ELISSA GARBER KON, EXAMINING ATTORNEY

CLASS 9—(Continued).

SN 76-570,180. HYPERTHERM, INC., HANOVER, NH. FILED 12-29-2003.

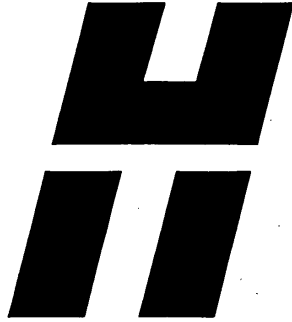

FOR ELECTRONIC, ELECTRICAL AND COMPUTER-GENERATED CONTROLS FOR PLASMA ARC CUTTING MACHINES AND REPLACEMENT PARTS THEREFOR, AND LASERS AND NOZZLES FOR PLASMA ARC CUTTING MACHINES SOLD AS A UNIT; ELECTRONIC, ELECTRICAL AND COMPUTER-GENERATED CONTROLS FOR HIGH-TEMPERATURE CUTTING MACHINES AND REPLACEMENT PARTS THEREFOR, AND LASERS, AND NOZZLES FOR HIGH-TEMPERATURE CUTTING MACHINES SOLD AS A UNIT; LASERS FOR PLASMA ARC CUTTING MACHINES; LASERS FOR HIGH-TEMPERATURE CUTTING MACHINES (U.S. CLS. 21, 23, 26, 36 AND 38).

FIRST USE 5-6-2001; IN COMMERCE 5-6-2001.
PRISCILLA MILTON, EXAMINING ATTORNEY

SN 76-570,183. DATA QUALITY SOLUTIONS, INC., SILVER SPRING, MD. FILED 1-7-2004.

ROME

THE MARK CONSISTS OF STANDARD CHARACTERS WITHOUT CLAIM TO ANY PARTICULAR FONT, STYLE, SIZE, OR COLOR.

FOR COMPUTER SOFTWARE, NAMELY, VISUAL OPEN SOFTWARE ARCHITECTURE FOR MANAGING DATA AND SOFTWARE APPLICATIONS ACROSS MULTIPLE COMPUTING ENVIRONMENTS; COMPUTER SOFTWARE, NAMELY, VISUAL OPEN SOFTWARE ARCHITECTURE FOR DEVELOPING NEW PROCESSES AND APPLICATIONS FROM SOFTWARE COMPONENTS THAT RESIDE IN MULTIPLE COMPUTING ENVIRONMENTS (U.S. CLS. 21, 23, 26, 36 AND 38).

FIRST USE 1-0-2003; IN COMMERCE 1-0-2003.
MATTHEW KLINE, EXAMINING ATTORNEY

CLASS 9—(Continued).

SN 76-570,396. SCHOLASTIC INC., NEW YORK, NY. FILED 1-12-2004.

READ@BOUT

THE MARK CONSISTS OF STANDARD CHARACTERS WITHOUT CLAIM TO ANY PARTICULAR FONT, STYLE, SIZE, OR COLOR.

FOR ONLINE DOWNLOADABLE COLLECTIBLE CARDS IN THE FIELD OF READING IMPROVEMENT (U.S. CLS. 21, 23, 26, 36 AND 38).

NORA BUCHANAN WILL, EXAMINING ATTORNEY

SN 76-570,397. SCHOLASTIC INC., NEW YORK, NY. FILED 1-12-2004.

READABOUT

THE MARK CONSISTS OF STANDARD CHARACTERS WITHOUT CLAIM TO ANY PARTICULAR FONT, STYLE, SIZE, OR COLOR.

FOR ONLINE DOWNLOADABLE COLLECTIBLE CARDS IN THE FIELD OF READING IMPROVEMENT (U.S. CLS. 21, 23, 26, 36 AND 38).

NORA BUCHANAN WILL, EXAMINING ATTORNEY

SN 76-571,521. GUNDRUM, JOHN, SUN CITY CENTER, FL. AND GUNDRUM, DORIS, SUN CITY CENTER, FL. FILED 1-21-2004.

WIND CADDY

THE MARK CONSISTS OF STANDARD CHARACTERS WITHOUT CLAIM TO ANY PARTICULAR FONT, STYLE, SIZE, OR COLOR.

NO CLAIM IS MADE TO THE EXCLUSIVE RIGHT TO USE "WIND", APART FROM THE MARK AS SHOWN.

FOR WIND DETECTION TOOL, NAMELY A PELLET EJECTOR FOR VISUALLY DETERMINING WIND DIRECTION AND SPEED (U.S. CLS. 21, 23, 26, 36 AND 38).

PAUL F. GAST, EXAMINING ATTORNEY

CLASS 9—(Continued).

SN 76-573,278. AMERICAN HI-FI INDUSTRIAL 26, INC., VERNON, CA. FILED 2-2-2004.

CLASS 9—(Continued).

SN 76-577,003. SPORTS IMPORTS, INC., COLUMBUS, OH. FILED 2-18-2004.

XPLORE

THE MARK CONSISTS OF STANDARD CHARACTERS WITHOUT CLAIM TO ANY PARTICULAR FONT, STYLE, SIZE, OR COLOR.

FOR DVD PLAYERS, CD PLAYERS, AUDIO SPEAKERS AND AMPLIFIERS, EQUALIZERS, ELECTRICAL WIRING FOR CONNECTING AUDIO EQUIPMENT, POWER CAPACITORS FOR ENHANCING AUDIO EQUIPMENT, IN-DASH AUTOMOTIVE TELEVISION MONITORS, TELEVISION RECEIVERS BUILT INTO AUTOMOTIVE REAR VIEW MIRRORS, AND AUTOMOTIVE TELEVISION ANTENNAS (U.S. CLS. 21, 23, 26, 36 AND 38).

FIRST USE 7-0-2002; IN COMMERCE 7-0-2002.
PAUL F. GAST, EXAMINING ATTORNEY

VERTEC

THE MARK CONSISTS OF STANDARD CHARACTERS WITHOUT CLAIM TO ANY PARTICULAR FONT, STYLE, SIZE, OR COLOR.

OWNER OF U.S. REG. NOS. 2,631,764 AND 2,637,784. FOR MEASURING APPARATUS FOR MEASURING THE ABILITY OF AN ATHLETE TO JUMP VERTICALLY FROM A STANDING OR RUNNING POSITION (U.S. CLS. 21, 23, 26, 36 AND 38).

FIRST USE 3-22-1979; IN COMMERCE 3-22-1979.
PAUL F. GAST, EXAMINING ATTORNEY

SN 76-577,755. SAFETY OPTICAL SERVICE CO., LEWISVILLE, TX. FILED 2-23-2004.

Sidewear

THE MARK CONSISTS OF STANDARD CHARACTERS WITHOUT CLAIM TO ANY PARTICULAR FONT, STYLE, SIZE, OR COLOR.

FOR PROTECTIVE SIDESHIELDS, FOR USE ON EYEWEAR (U.S. CLS. 21, 23, 26, 36 AND 38).

FIRST USE 10-15-2004; IN COMMERCE 10-15-2004.
TANYA AMOS, EXAMINING ATTORNEY

SN 76-576,326. THOUGHTSPEED, L.L.C., CHICAGO, IL. FILED 2-19-2004.

VISIONLIFT

THE MARK CONSISTS OF STANDARD CHARACTERS WITHOUT CLAIM TO ANY PARTICULAR FONT, STYLE, SIZE, OR COLOR.

FOR DOWNLOADABLE AND PREPACKAGED COMPUTER SOFTWARE FOR USE IN REMOTELY VIEWING, MANIPULATING AND CONTROLLING MEDIA, INFORMATION OR OPERATIONAL STATE FROM ONE ELECTRONIC DEVICE OR COMPUTER USING ANOTHER ELECTRONIC DEVICE OR COMPUTER OVER A WIRED OR WIRELESS NETWORK OR VIA THE INTERNET (U.S. CLS. 21, 23, 26, 36 AND 38).

PAUL F. GAST, EXAMINING ATTORNEY

SN 76-577,758. SAFETY OPTICAL SERVICE CO., LEWISVILLE, TX. FILED 2-23-2004.

B52+

THE MARK CONSISTS OF STANDARD CHARACTERS WITHOUT CLAIM TO ANY PARTICULAR FONT, STYLE, SIZE, OR COLOR.

FOR PROTECTIVE SIDESHIELDS, FOR USE ON EYEWEAR (U.S. CLS. 21, 23, 26, 36 AND 38).

FIRST USE 8-4-2003; IN COMMERCE 8-4-2003.
TANYA AMOS, EXAMINING ATTORNEY

CLASS 9—(Continued).

SN 76-577,791. GIRARD SYSTEMS, IRVINE, CA. FILED 2-26-2004.

ACS

THE MARK CONSISTS OF STANDARD CHARACTERS WITHOUT CLAIM TO ANY PARTICULAR FONT, STYLE, SIZE, OR COLOR.

FOR ELECTRICAL CONTROLLERS FOR RETRACTABLE AWNINGS (U.S. CLS. 21, 23, 26, 36 AND 38).

FIRST USE 4-0-2003; IN COMMERCE 4-0-2003.
ELISSA GARBER KON, EXAMINING ATTORNEY

SN 76-577,919. ABOUNDI NETWORK TECHNOLOGIES, LLC, HOLLIS, NH. FILED 2-23-2004.

ABOUNDI

THE MARK CONSISTS OF STANDARD CHARACTERS WITHOUT CLAIM TO ANY PARTICULAR FONT, STYLE, SIZE, OR COLOR.

FOR LOCAL AREA NETWORKING CONNECTIVITY HARDWARE AND COMPONENTS IN THE NATURE OF GATEWAY DEVICES, ROUTERS, HUBS, SWITCHES, TRANSCEIVERS, CONVERTERS, AND NETWORK INTERFACE CARDS; CUSTOMER PREMISE EQUIPMENT ACCESS HARDWARE; FIRMWARE FOR NETWORK MANAGEMENT, INTERFACING, AND CONTROL; COMPUTERS, COMPUTER PERIPHERALS, WIDE AREA NETWORKING DEVICES AND COMPONENTS IN THE NATURE OF MODEMS AND GATEWAY DEVICES; STORAGE AREA NETWORKING DEVICES AND COMPONENTS IN THE NATURE OF SWITCHES; WIRED COAXIAL CABLES; WIRED SHIELDED AND WIRED UNSHIELDED TWISTED PAIR COPPER WIRES; WIRED POWER LINES; OPTICAL FIBER SOLD AS A COMPONENT OF OPTICAL FIBER CABLES; WIRELESS NETWORK INTERFACE DEVICES IN THE NATURE OF NETWORK INTERFACE CARDS, PCMCIA CARDS, ACCESS POINT DEVICES, AND SWITCHES; REMOTE ACCESS EQUIPMENT IN THE NATURE OF BROADBAND MODEMS, ROUTERS, AND GATEWAY DEVICES; TELEPHONES AND TELECONFERENCE SYSTEMS COMPRISING ACCESS EQUIPMENT AND VOIP (VOICE OVER INTERNET PROTOCOL); INTERNET PROTOCOL TELEPHONY AND VIDEO SYSTEMS, AND RELATED COMPONENTS COMPRISING VIDEO- AND VOICE-OVER INTERNET PROTOCOL ACCESS DEVICES; PERSONAL COMPUTER CARD, HUB, SWITCH AND TRANSCEIVER CABLES; FIREWALLS IN THE NATURE OF ROUTERS; FILTERS WITHIN ROUTING DEVICES; EMBEDDED FIREWALL PRODUCTS IN THE NATURE OF SECURITY PROTECTION AND ANTI-VIRUS, ANTI-SPAM APPLICATIONS; NETWORK INTERFACE CARDS; NETWORK PLUG CONNECTORS; POWER SUPPLIES; IN-WALL NETWORK INTERFACE CONNEC-

CLASS 9—(Continued).

TIVITY SYSTEMS AND ASSOCIATED DEVICES IN THE NATURE OF IN-WALL INSTALLATION AND PACKAGING; AC- AND DC-POWERED DEVICES IN THE NATURE OF POWER SUPPLIES; REDUNDANT POWER PROTECTION SYSTEMS AND ASSOCIATED COMPONENTS IN THE NATURE OF POWER SUPPLIES; DATA COMMUNICATIONS INTERFACE CARDS AND MODULES; WIRELESS ACCESS POINTS IN THE NATURE OF NETWORKING COMMUNICATIONS; ANTENNAS; COMPUTER CABLES; LAN CLIENT DEVICES IN THE NATURE OF THIN CLIENT DEVICES; AND RELATED SOFTWARE AND FIRMWARE FOR ALL OF THE FOREGOING FOR EMBEDDED APPLICATIONS FOR SNMP (SIMPLE NETWORK MANAGEMENT PROTOCOL) CONFIGURATION SET UPS, AND OPERATIONAL CONTROLS; COMPUTER SOFTWARE FOR DIAGNOSING, INSTALLING, SUPPORTING, MANAGING, MONITORING, CONFIGURING, CONNECTING, UPGRADING AND CONTROLLING COMPUTER HARDWARE, FIRMWARE, AND SOFTWARE (U.S. CLS. 21, 23, 26, 36 AND 38).

FIRST USE 6-3-2004; IN COMMERCE 6-3-2004.
ANN E. SAPPENFIELD, EXAMINING ATTORNEY

SN 76-577,921. SAFETY OPTICAL SERVICE CO., LEWISVILLE, TX. FILED 2-23-2004.

 The logo for B52+ features the letters 'B52' in a large, bold, stylized font. The 'B' is on the left, '5' is in the middle, and '2' is on the right. A plus sign '+' is positioned to the upper right of the '2'. The letters have a thick, black outline and a white fill.

FOR PROTECTIVE SIDESHIELDS, FOR USE ON EYEWEAR (U.S. CLS. 21, 23, 26, 36 AND 38).

FIRST USE 8-4-2003; IN COMMERCE 8-4-2003.
TANYA AMOS, EXAMINING ATTORNEY

SN 76-581,333. XCEEDID CORPORATION, GOLDEN, CO. FILED 3-11-2004.

XCEEDID

THE MARK CONSISTS OF STANDARD CHARACTERS WITHOUT CLAIM TO ANY PARTICULAR FONT, STYLE, SIZE, OR COLOR.

FOR CONTACTLESS RADIO FREQUENCY IDENTIFICATION CARD READERS FOR SECURITY ACCESS CONTROL; ENCODED CONTACTLESS SMART CARDS FOR BADGES FOR GAINING ACCESS TO BUILDINGS, COMPUTER NETWORKS, TIME AND ATTENDANCE DEVICES, ETC. AND CONTAINING PROGRAMMING FOR USE WITH SAID CARD READERS (U.S. CLS. 21, 23, 26, 36 AND 38).

DAVID ELTON, EXAMINING ATTORNEY

CLASS 9—(Continued).

SN 76-581,577. VARTA MICROBATTERY, INC., WHITE PLAINS, NY. FILED 3-17-2004.

ECOPACK

THE MARK CONSISTS OF STANDARD CHARACTERS WITHOUT CLAIM TO ANY PARTICULAR FONT, STYLE, SIZE, OR COLOR.

FOR RECHARGEABLE 9-VOLT GENERAL PURPOSE ELECTRIC BATTERIES, SOLD TO CONSUMERS (U.S. CLS. 21, 23, 26, 36 AND 38).

H. M. FISHER, EXAMINING ATTORNEY

SN 76-586,902. HORMEL FOODS, LLC, AUSTIN, MN. FILED 4-15-2004.

SPAM

THE MARK CONSISTS OF STANDARD CHARACTERS WITHOUT CLAIM TO ANY PARTICULAR FONT, STYLE, SIZE, OR COLOR.

OWNER OF U.S. REG. NOS. 755,187, 2,639,240 AND OTHERS.

FOR DOWNLOADABLE SOFTWARE, NAMELY SCREEN SAVERS (U.S. CLS. 21, 23, 26, 36 AND 38).

FIRST USE 6-0-1994; IN COMMERCE 11-15-2002.

PAUL F. GAST, EXAMINING ATTORNEY

SN 76-587,556. EDWARDS SYSTEMS TECHNOLOGY, INC., CHESHIRE, CT. FILED 4-20-2004.

MINI-MI

THE MARK CONSISTS OF STANDARD CHARACTERS WITHOUT CLAIM TO ANY PARTICULAR FONT, STYLE, SIZE, OR COLOR.

FOR MULTIPURPOSE INDUSTRIAL AND COMMERCIAL SIGNALING DEVICE IN THE NATURE OF AUDIO SPEAKERS FOR FIELD RECORDED VOICE, TONE GENERATION, AND SPEAKER AMPLIFICATION ON CONVENTIONAL AND RS485 NETWORKS (U.S. CLS. 21, 23, 26, 36 AND 38).

ELLEN PERKINS, EXAMINING ATTORNEY

CLASS 9—(Continued).

SN 76-589,747. A & A OPTICAL COMPANY, CARROLLTON, TX. FILED 4-30-2004.

**NG
180's**

FOR EYEWEAR, NAMELY, EYEGLASSES AND EYEGLASS FRAMES (U.S. CLS. 21, 23, 26, 36 AND 38).

ALEXANDER L. POWERS, EXAMINING ATTORNEY

SN 76-589,880. COLOR IQ, INC., PORTLAND, OR. FILED 5-3-2004.

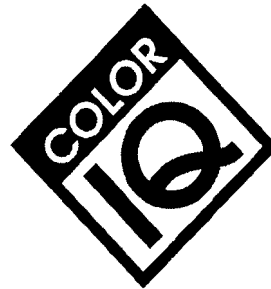

NO CLAIM IS MADE TO THE EXCLUSIVE RIGHT TO USE "COLOR", APART FROM THE MARK AS SHOWN.

FOR COMPUTER SOFTWARE FOR COLOR MANAGEMENT OF OPERATING SYSTEMS (U.S. CLS. 21, 23, 26, 36 AND 38).

DAWN FELDMAN, EXAMINING ATTORNEY

SN 76-591,501. DATAPAQ, INC., WILMINGTON, MA. FILED 5-10-2004.

DATAPAQ

THE MARK CONSISTS OF STANDARD CHARACTERS WITHOUT CLAIM TO ANY PARTICULAR FONT, STYLE, SIZE, OR COLOR.

FOR COMPUTER SOFTWARE FOR TEMPERATURE PROFILING SYSTEMS IN THE FIELDS OF HEAVY CLAY AND CERAMICS, HEAT TREATING, ELECTRONICS MANUFACTURING AND THE FINISHING INDUSTRY (U.S. CLS. 21, 23, 26, 36 AND 38).

FIRST USE 8-0-1985; IN COMMERCE 8-0-1985.

RONALD MCMORROW, EXAMINING ATTORNEY

CLASS 9—(Continued).

SN 76-592,328. THE WEATHER UNDERGROUND, INC., ANN ARBOR, MI. FILED 5-17-2004.

WEATHER EXCHANGE

THE MARK CONSISTS OF STANDARD CHARACTERS WITHOUT CLAIM TO ANY PARTICULAR FONT, STYLE, SIZE, OR COLOR.

NO CLAIM IS MADE TO THE EXCLUSIVE RIGHT TO USE WEATHER, APART FROM THE MARK AS SHOWN.

FOR SOFTWARE, USED TO GATHER AND DISPLAY REAL-TIME WEATHER DATA (U.S. CLS. 21, 23, 26, 36 AND 38).

FIRST USE 10-5-2003; IN COMMERCE 10-5-2003.
TERESA M. RUPP, EXAMINING ATTORNEY

SN 76-593,928. BBC ICE CREAM, LLC, NEW YORK, NY. FILED 5-18-2004.



FOR PROTECTIVE EYEWEAR; SUNGLASSES; EYEGLASSES; EYEGLASS FRAMES; EYEGLASS, SUNGLASS AND SPECTACLE CASES; EYEGLASS, SUNGLASS AND SPECTACLE STRAPS; EYEGLASS, SUNGLASS AND SPECTACLE CHAINS; EYEGLASS, SUNGLASS AND SPECTACLE CLEANING CLOTHS; MAGNETS; DECORATIVE MAGNETS; REFRIGERATOR MAGNETS; NOVELTY MAGNETS; MOUSE PADS; COMPACT DISC CASES; FITTED CASES FOR STORAGE AND TRANSPORTATION, NAMELY, CASES FOR COMPACT DISCS, AUDIO CASSETTES, VIDEO CASSETTES, CD-ROMS, HOME VIDEO GAMES, HOME VIDEO GAME ACCESSORIES, COMPUTERS, COMPUTER ACCESSORIES, CAMERAS, CAMCORDERS AND PORTABLE PHONES; COMPUTER CARRYING CASES; WRIST RESTS AND SUPPORTS FOR COMPUTER MOUSE USERS; WRIST RESTS FOR COMPUTER PRODUCTS; COMPUTER KEYBOARD WRIST PADS; DOWNLOADABLE ELECTRONIC PUBLICATIONS IN THE NATURE OF BOOKS, BOOKLETS, MAGAZINES, JOURNALS, MANUALS, BROCHURES, LEAFLETS, PAMPHLETS AND NEWSLETTERS, ALL IN THE FIELD OF MUSIC, FASHION, LIFESTYLES, ENTERTAINMENT, THE ARTS, CULTURE AND POLITICS; ELECTRONIC PUBLICATIONS, NAMELY, BOOKS, BOOKLETS, MAGAZINES, JOURNALS, MANUALS, BROCHURES, LEAFLETS, PAMPHLETS AND NEWSLETTERS, ALL IN THE FIELD OF MUSIC, FASHION, LIFESTYLES, ENTERTAINMENT, THE ARTS, CULTURE AND POLITICS, RECORDED ON CD-ROMS, DISKETTES, FLOPPY DISKS, VIDEO CASSETTES, AND MAGNETIC TAPES (U.S. CLS. 21, 23, 26, 36 AND 38).

RAUL CORDOVA, EXAMINING ATTORNEY

CLASS 9—(Continued).

SN 76-593,972. MEDICO INDUSTRIES, INC., WILKES-BARRE, PA. FILED 5-25-2004.



FOR WARNING AND SAFETY EQUIPMENT, NAMELY, MECHANICAL SAFETY SIGNS AND ELECTRONIC SAFETY SIGNS INCORPORATING SOUND DEVICES (U.S. CLS. 21, 23, 26, 36 AND 38).

FIRST USE 9-8-2003; IN COMMERCE 9-8-2003.
GEOFFREY FOSDICK, EXAMINING ATTORNEY

SN 76-594,396. EVANS, ALEXANDER, DBA DR. NEON'S LABORATORY, ASHEVILLE, NC. FILED 5-27-2004.

DR. NEON'S

THE MARK CONSISTS OF STANDARD CHARACTERS WITHOUT CLAIM TO ANY PARTICULAR FONT, STYLE, SIZE, OR COLOR.

FOR SUNGLASSES (U.S. CLS. 21, 23, 26, 36 AND 38).
JOHN SCHUYLER YARD, EXAMINING ATTORNEY

SN 76-594,603. LEVITON MANUFACTURING CO., INC., LITTLE NECK, NY. FILED 5-27-2004.



FOR COMPUTER PROGRAM FOR USE IN CONTROLLING AND EDITING LIGHTING CONTROL HARDWARE (U.S. CLS. 21, 23, 26, 36 AND 38).

FIRST USE 6-23-2003; IN COMMERCE 6-23-2003.
MICHAEL ENGEL, EXAMINING ATTORNEY

CLASS 9—(Continued).

SN 76-595,750. AVID TECHNOLOGY, INC., TEWKSBURY, MA. FILED 6-3-2004.

LUNA

THE MARK CONSISTS OF STANDARD CHARACTERS WITHOUT CLAIM TO ANY PARTICULAR FONT, STYLE, SIZE, OR COLOR.
FOR MICRO-PHONES (U.S. CLS. 21, 23, 26, 36 AND 38).
FIRST USE 12-10-2003; IN COMMERCE 12-10-2003.
TONJA GASKINS, EXAMINING ATTORNEY

CLASS 9—(Continued).

SN 76-596,552. S-MATRIX CORPORATION, EUREKA, CA. FILED 6-10-2004.

FUSION METHOD VALIDATION

THE MARK CONSISTS OF STANDARD CHARACTERS WITHOUT CLAIM TO ANY PARTICULAR FONT, STYLE, SIZE, OR COLOR.
NO CLAIM IS MADE TO THE EXCLUSIVE RIGHT TO USE "METHOD VALIDATION", APART FROM THE MARK AS SHOWN.
FOR COMPUTER SOFTWARE FOR USE IN THE DESIGN OF SCIENTIFIC EXPERIMENTS AND ANALYSIS OF EXPERIMENTAL RESULTS (U.S. CLS. 21, 23, 26, 36 AND 38).
BRENDAN REGAN, EXAMINING ATTORNEY

SN 76-595,919. OSL SOLUTIONS, INC., SARATOGA, CA. FILED 6-4-2004.

OSL

THE MARK CONSISTS OF STANDARD CHARACTERS WITHOUT CLAIM TO ANY PARTICULAR FONT, STYLE, SIZE, OR COLOR.
FOR COMPUTER SOFTWARE FOR USE IN THE MEDICAL AND HEALTH CARE INDUSTRY FOR EDUCATIONAL, DATABASE MANAGEMENT, AND INFORMATION TRACKING PURPOSES (U.S. CLS. 21, 23, 26, 36 AND 38).
GEOFFREY FOSDICK, EXAMINING ATTORNEY

SN 76-596,553. S-MATRIX CORPORATION, EUREKA, CA. FILED 6-10-2004.

FUSION DATA EXCHANGE

THE MARK CONSISTS OF STANDARD CHARACTERS WITHOUT CLAIM TO ANY PARTICULAR FONT, STYLE, SIZE, OR COLOR.
NO CLAIM IS MADE TO THE EXCLUSIVE RIGHT TO USE "DATA EXCHANGE", APART FROM THE MARK AS SHOWN.
FOR COMPUTER SOFTWARE FOR USE IN THE DESIGN OF SCIENTIFIC EXPERIMENTS AND ANALYSIS OF EXPERIMENTAL RESULTS (U.S. CLS. 21, 23, 26, 36 AND 38).
BRENDAN REGAN, EXAMINING ATTORNEY

SN 76-596,551. S-MATRIX CORPORATION, EUREKA, CA. FILED 6-10-2004.

FUSION METHOD DEVELOPMENT

THE MARK CONSISTS OF STANDARD CHARACTERS WITHOUT CLAIM TO ANY PARTICULAR FONT, STYLE, SIZE, OR COLOR.
NO CLAIM IS MADE TO THE EXCLUSIVE RIGHT TO USE "METHOD DEVELOPMENT", APART FROM THE MARK AS SHOWN.
FOR COMPUTER SOFTWARE FOR USE IN THE DESIGN OF SCIENTIFIC EXPERIMENTS AND ANALYSIS OF EXPERIMENTAL RESULTS (U.S. CLS. 21, 23, 26, 36 AND 38).
BRENDAN REGAN, EXAMINING ATTORNEY

SN 76-596,556. S-MATRIX CORPORATION, EUREKA, CA. FILED 6-10-2004.

FUSION PRO

THE MARK CONSISTS OF STANDARD CHARACTERS WITHOUT CLAIM TO ANY PARTICULAR FONT, STYLE, SIZE, OR COLOR.
NO CLAIM IS MADE TO THE EXCLUSIVE RIGHT TO USE "PRO", APART FROM THE MARK AS SHOWN.
FOR COMPUTER SOFTWARE FOR USE IN THE DESIGN OF SCIENTIFIC EXPERIMENTS AND ANALYSIS OF EXPERIMENTAL RESULTS (U.S. CLS. 21, 23, 26, 36 AND 38).
FIRST USE 2-3-2000; IN COMMERCE 2-3-2000.
BRENDAN REGAN, EXAMINING ATTORNEY

CLASS 9—(Continued).

SN 76-596,900. SCIENCE APPLICATIONS INTERNATIONAL CORPORATION, SAN DIEGO, CA. FILED 6-14-2004.

SCOPTIMA

THE MARK CONSISTS OF STANDARD CHARACTERS WITHOUT CLAIM TO ANY PARTICULAR FONT, STYLE, SIZE, OR COLOR.

FOR COMPUTER SOFTWARE FOR MANAGING THE DELIVERY OF GOODS, SERVICES, AND INFORMATION FROM THE SUPPLIER TO THE CUSTOMER (U.S. CLS. 21, 23, 26, 36 AND 38).

INGRID C. EULIN, EXAMINING ATTORNEY

SN 76-597,016. EYE Q EYEWEAR CORPORATION, HOLLISTON, MA. FILED 6-15-2004.

LA PETITE FEMME

THE MARK CONSISTS OF STANDARD CHARACTERS WITHOUT CLAIM TO ANY PARTICULAR FONT, STYLE, SIZE, OR COLOR.

THE FOREIGN WORDING IN THE MARK TRANSLATES INTO ENGLISH AS "THE LITTLE WOMAN".

FOR EYEGLASS FRAMES (U.S. CLS. 21, 23, 26, 36 AND 38).

RONALD MCMORROW, EXAMINING ATTORNEY

SN 76-597,154. TWO STEP SOFTWARE, INC., WALTHAM, MA. FILED 6-11-2004.

TWO STEP SOFTWARE

THE MARK CONSISTS OF STANDARD CHARACTERS WITHOUT CLAIM TO ANY PARTICULAR FONT, STYLE, SIZE, OR COLOR.

NO CLAIM IS MADE TO THE EXCLUSIVE RIGHT TO USE "SOFTWARE", APART FROM THE MARK AS SHOWN.

FOR COMPUTER SOFTWARE FOR CORPORATE RECORDS AND DATA MANAGEMENT, CORPORATE ENTITY MANAGEMENT, AND CORPORATE GOVERNANCE MANAGEMENT; DOWNLOADABLE WEB-BASED SOFTWARE FOR CORPORATE RECORDS AND DATA MANAGEMENT, CORPORATE ENTITY MANAGEMENT, AND CORPORATE GOVERNANCE MANAGEMENT (U.S. CLS. 21, 23, 26, 36 AND 38).

FIRST USE 5-0-1995; IN COMMERCE 5-0-1995.

JEFFERY COWARD, EXAMINING ATTORNEY

CLASS 9—(Continued).

SN 76-597,336. GLOBAL INFORMATION LICENSING CORPORATION, CLAYMONT, DE. FILED 6-15-2004.

QUICKFINDER

THE MARK CONSISTS OF STANDARD CHARACTERS WITHOUT CLAIM TO ANY PARTICULAR FONT, STYLE, SIZE, OR COLOR.

OWNER OF U.S. REG. NO. 2,162,231.

FOR COMPUTER SOFTWARE, NAMELY, A CD-ROM ON THE TOPIC OF INCOME TAX AND FINANCIAL PLANNING (U.S. CLS. 21, 23, 26, 36 AND 38).

FIRST USE 0-0-2000; IN COMMERCE 0-0-2000.

ZHALEH DELANEY, EXAMINING ATTORNEY

SN 76-597,537. DUMATOL, GERARD B., LOS ALAMITOS, CA. FILED 6-14-2004.

SERVERALL

THE MARK CONSISTS OF STANDARD CHARACTERS WITHOUT CLAIM TO ANY PARTICULAR FONT, STYLE, SIZE, OR COLOR.

FOR COMPUTERS AND INSTRUCTIONAL MANUALS SOLD AS A UNIT; COMPUTER HARDWARE; COMPUTER HARDWARE, NAMELY, SERVERS; AND, COMPUTER SERVERS AND INSTRUCTIONAL MANUALS SOLD AS A UNIT (U.S. CLS. 21, 23, 26, 36 AND 38).

FIRST USE 8-0-2002; IN COMMERCE 10-0-2002.

BRIAN PINO, EXAMINING ATTORNEY

SN 76-597,576. FISHMAN TRANSDUCERS, INC., WILMINGTON, MA. FILED 6-16-2004.

ELLIPSE

THE MARK CONSISTS OF STANDARD CHARACTERS WITHOUT CLAIM TO ANY PARTICULAR FONT, STYLE, SIZE, OR COLOR.

FOR SIGNAL CONDITIONING CIRCUITRY, NAMELY, PREAMPLIFIERS, EQUALIZERS, AND TONE CONTROLLERS (U.S. CLS. 21, 23, 26, 36 AND 38).

DOMINIC J. FERRAIUOLO, EXAMINING ATTORNEY

CLASS 9—(Continued).

SN 76-597,657. CONDE, JOAN M., MILLBURN, NJ. FILED 6-16-2004.

MAMACITA

THE MARK CONSISTS OF STANDARD CHARACTERS WITHOUT CLAIM TO ANY PARTICULAR FONT, STYLE, SIZE, OR COLOR.

THE ENGLISH TRANSLATION OF THE WORD MAMACITA IS THE SPANISH TERM OF ENDEARMENT FOR "MOTHER".

FOR DOWNLOADABLE ELECTRONIC PUBLICATIONS IN THE NATURE OF MAGAZINES IN THE FIELD OF GENERAL INTEREST, EXCLUDING HEALTHCARE (U.S. CLS. 21, 23, 26, 36 AND 38).

FIRST USE 5-1-2004; IN COMMERCE 5-1-2004.
TRICIA SONNEBORN, EXAMINING ATTORNEY

SN 76-598,163. SONY KABUSHIKI KAISHA, TA SONY CORPORATION, TOKYO, JAPAN, FILED 6-18-2004.

TRILUMINOS

THE MARK CONSISTS OF STANDARD CHARACTERS WITHOUT CLAIM TO ANY PARTICULAR FONT, STYLE, SIZE, OR COLOR.

FOR TELEVISIONS (U.S. CLS. 21, 23, 26, 36 AND 38).
KAREN K. BUSH, EXAMINING ATTORNEY

SN 76-598,220. WMD HOLDINGS GROUP, INC., GRAND TERRACE, CA. FILED 6-21-2004.

NAVITOUCH

THE MARK CONSISTS OF STANDARD CHARACTERS WITHOUT CLAIM TO ANY PARTICULAR FONT, STYLE, SIZE, OR COLOR.

FOR ELECTRONIC INTERACTIVE DISPLAY MACHINES FOR ADVERTISING (U.S. CLS. 21, 23, 26, 36 AND 38).

LINDA E. BLOHM, EXAMINING ATTORNEY

CLASS 9—(Continued).

SN 76-599,024. MOBILE DIGITAL MEDIA, INC., WESTPORT, CT. FILED 6-24-2004.

QUICKOFFICE

THE MARK CONSISTS OF STANDARD CHARACTERS WITHOUT CLAIM TO ANY PARTICULAR FONT, STYLE, SIZE, OR COLOR.

OWNER OF U.S. REG. NO. 2,834,857.

FOR SUITE OF COMPUTER APPLICATION SOFTWARE FOR PERSONAL DIGITAL ASSISTANTS, CONVERGED DEVICES AND SMART PHONES FOR PERFORMING SPREADSHEET, WORD PROCESSING AND CHARTING FUNCTIONS (U.S. CLS. 21, 23, 26, 36 AND 38).

FIRST USE 11-1-2001; IN COMMERCE 11-1-2001.

RONALD MCMORROW, EXAMINING ATTORNEY

SN 76-599,465. JL AUDIO, INC., MIRAMAR, FL. FILED 6-28-2004.

CLEANSWEEP

THE MARK CONSISTS OF STANDARD CHARACTERS WITHOUT CLAIM TO ANY PARTICULAR FONT, STYLE, SIZE, OR COLOR.

FOR AUDIO INTERFACE DEVICES FOR CONNECTING AFTERMARKET AUDIO EQUIPMENT TO FACTORY AUDIO SYSTEMS INSTALLED IN VEHICLES (U.S. CLS. 21, 23, 26, 36 AND 38).

TARAH HARDY, EXAMINING ATTORNEY

SN 76-600,348. MOHNEN, JORG, WEST HOLLYWOOD, CA. FILED 7-1-2004.

WAVGEN

THE MARK CONSISTS OF STANDARD CHARACTERS WITHOUT CLAIM TO ANY PARTICULAR FONT, STYLE, SIZE, OR COLOR.

FOR COMPUTER SOFTWARE, NAMELY WAVELET SOFTWARE MODULES THAT ALLOW USERS TO VIEW, MODIFY, COMPRESS, SHADE, MODEL AND ANIMATE ENORMOUS FILE SIZES; AND COMPUTER SOFTWARE INCORPORATING WAVELET TECHNOLOGIES FOR USE IN CREATING AND RENDERING REALISTIC TWO-DIMENSIONAL AND THREE-DIMENSIONAL LANDSCAPES AND TERRAINS USING SATELLITE AND AERIAL FOOTAGE (U.S. CLS. 21, 23, 26, 36 AND 38).

FIRST USE 8-0-2003; IN COMMERCE 8-0-2003.

FLORENTINA BLANDU, EXAMINING ATTORNEY

CLASS 9—(Continued).

SN 76-617,518. WHOLE FOODS MARKET IP, L.P., AUSTIN, TX. FILED 10-21-2004.

WFM-U

THE MARK CONSISTS OF STANDARD CHARACTERS WITHOUT CLAIM TO ANY PARTICULAR FONT, STYLE, SIZE, OR COLOR.

FOR DOWNLOADABLE ELECTRONIC PUBLICATIONS IN THE NATURE OF INSTRUCTIONAL, EDUCATIONAL AND TEACHING MATERIALS IN THE FIELD OF LEADERSHIP, MANAGEMENT, CUSTOMER SERVICE, RETAILING, PROFESSIONAL DEVELOPMENT, FOOD, NUTRITION, DIET, COOKING, HEALTH, FITNESS, LIFESTYLE AND PERSONAL IMPROVEMENT; PRERECORDED VIDEOTAPES, COMPACT DISCS, DVD'S AND LASER DISCS FEATURING INSTRUCTION AND INFORMATION ON LEADERSHIP, MANAGEMENT, CUSTOMER SERVICE, RETAILING, PROFESSIONAL DEVELOPMENT, FOOD, NUTRITION, DIET, COOKING, HEALTH, FITNESS, LIFESTYLE AND PERSONAL IMPROVEMENT (U.S. CLS. 21, 23, 26, 36 AND 38).

JOHN DALIER, EXAMINING ATTORNEY

SN 78-120,166. ANTEK INC., TA ANTEK HEALTHWARE, REISTERSTOWN, MD. FILED 4-8-2002.

DAQREPORTER

OWNER OF U.S. REG. NOS. 2,106,213, 2,727,203 AND OTHERS.

FOR COMPUTER SOFTWARE FOR HEALTH CARE INFORMATION MANAGEMENT, NAMELY, TO CREATE, MAINTAIN, MANAGE AND UPDATE A DATABASE OF PATIENT LABORATORY TESTS AND TEST RESULTS OVER CONTROLLED COMPUTER INFORMATION NETWORKS AND MULTIPLE-USER GLOBAL COMPUTER INFORMATION NETWORKS (U.S. CLS. 21, 23, 26, 36 AND 38).

FIRST USE 11-30-2000; IN COMMERCE 11-30-2000.
JOHN DWYER, EXAMINING ATTORNEY

SN 78-153,333. NLU PRODUCTS, LLC, DRAPER, UT. FILED 8-12-2002.

SCREENGUARDZ

FOR ACCESSORIES FOR PERSONAL DIGITAL ASSISTANTS, CELLULAR TELEPHONES, DIGITAL CAMERAS, AND COMPUTERS, NAMELY SCREEN OVERLAYS FOR REDUCING GLARE, IMPROVING HANDWRITING RECOGNITION AND PROTECTION (U.S. CLS. 21, 23, 26, 36 AND 38).

TRICIA SONNEBORN, EXAMINING ATTORNEY

CLASS 9—(Continued).

SN 78-160,603. ASTUTE NETWORKS, INC., SAN DIEGO, CA. FILED 9-4-2002.

PERICLES

FOR COMPUTER HARDWARE, NAMELY SEMICONDUCTORS AND SEMICONDUCTOR DEVICES; PRINTED CIRCUIT BOARDS, INTEGRATED CIRCUITS AND MICROPROCESSORS. (U.S. CLS. 21, 23, 26, 36 AND 38).

KELLY BOULTON, EXAMINING ATTORNEY

SN 78-178,324. TERMOELETTRONICA S.P.A. AZZANO SAN PAOLO PROVINCE OF BERGAMO, ITALY, FILED 10-25-2002.



PRIORITY CLAIMED UNDER SEC. 44(D) ON ITALY APPLICATION NO. MI2002C00760, FILED 7-25-2002, REG. NO. 00879686, DATED 11-28-2002, EXPIRES 7-25-2012.

FOR ELECTRONIC MICROPROCESSOR CONTROLLERS FOR AUTOMATICALLY DIAGNOSING WHETHER MECHANICAL SEALS ARE OPERATING AND FUNCTIONING PROPERLY, FOR USE IN ANY INDUSTRIAL PLANT OF PROCESS MACHINERY USING MECHANICAL SEALS (U.S. CLS. 21, 23, 26, 36 AND 38).

PAUL F. GAST, EXAMINING ATTORNEY

SN 78-189,854. IMEDCO AG, CH-4614 HAGENDORF, SWITZERLAND, FILED 11-29-2002.

SILENTSHIELD

FOR SOUNDPROOF RADIO FREQUENCY (RF) ROOM ENCLOSURES FOR RF SHIELDING AND FOR ACOUSTICALLY INSULATING ELECTRONIC EQUIPMENT, AND PARTS THEREFOR (U.S. CLS. 21, 23, 26, 36 AND 38).

ALICE BENMAMAN, EXAMINING ATTORNEY

CLASS 9—(Continued).

SN 78-193,176. CALDERONE, JOE, KENSINGTON, AUSTRALIA, AND TARTAGLIA, TONY, KENSINGTON, AUSTRALIA, FILED 12-11-2002.



NO CLAIM IS MADE TO THE EXCLUSIVE RIGHT TO USE "USA LOTTO CHECKER", APART FROM THE MARK AS SHOWN.

THE COLOR GRAY IS CLAIMED AS A FEATURE OF THE MARK.

THE COLOR GRAY APPEARS IN THE BALLS AND AROUND SOME OF THE NUMBERS ON THE BINGO CARD.

THE MARK CONSISTS OF A BINGO CARD WITH GRAY SHADED BALLS WITH DOLLAR SIGNS ON THEM, AND THE WORDING USA LOTTO CHECKER WRITTEN ON A BANNER ATTACHED TO THE BINGO CARD.

FOR COMPUTER PROGRAM SPECIFICALLY FOR CHECKING LOTTERY RESULTS (U.S. CLS. 21, 23, 26, 36 AND 38).

DARRYL SPRUILL, EXAMINING ATTORNEY

SN 78-205,001. ZEOSOFT TECHNOLOGY GROUP, INC., TAMPA, FL. FILED 1-20-2003.

ZEOSPHERE

FOR COMPUTER SOFTWARE PLATFORM USED FOR DEVELOPING, DEPLOYING, MANAGING AND RUNNING ENTERPRISE PEER TO PEER APPLICATIONS AND SERVICES OVER NETWORKS AND WIRELESS HANDHELD DEVICES (U.S. CLS. 21, 23, 26, 36 AND 38).

FIRST USE 5-1-2001; IN COMMERCE 3-1-2002.
SUSAN HAYASH, EXAMINING ATTORNEY

SN 78-209,174. BAKER HUGHES INCORPORATED, HOUSTON, TX. FILED 1-30-2003.

SEISLINK

FOR COMPUTER SOFTWARE FOR PROCESSING BOREHOLE SEISMIC DATA FOR AND BY THE OIL AND GAS INDUSTRY (U.S. CLS. 21, 23, 26, 36 AND 38).

FIRST USE 3-10-1990; IN COMMERCE 3-10-1990.
KATHY DE JONGE, EXAMINING ATTORNEY

CLASS 9—(Continued).

SN 78-212,959. QUALCOMM INCORPORATED, SAN DIEGO, CA. FILED 2-10-2003.



FOR COMPUTER APPLICATION AND OPERATIONS SOFTWARE USED TO FACILITATE INTERFACES BETWEEN SOFTWARE AND/OR HARDWARE USED IN WIRELESS COMMUNICATION DEVICES; COMPUTER APPLICATION AND OPERATIONS SOFTWARE USED TO FACILITATE THE MANAGING, BILLING, AND TRANSFERRING OF INFORMATION TO AND FROM A WIRELESS DEVICE; COMPUTER APPLICATION SOFTWARE FOR DEVELOPING AND MANAGING DISTRIBUTED APPLICATION SOFTWARE IN A WIRELESS OR MIXED NETWORK EMPLOYING WIRELESS OR NON-WIRELESS COMMUNICATION INTERFACE. (U.S. CLS. 21, 23, 26, 36 AND 38).

FIRST USE 2-1-2001; IN COMMERCE 2-1-2001.
CHRISTOPHER BUONGIORNO, EXAMINING ATTORNEY

SN 78-220,402. RETROPOLIS LLC, LOS ANGELES, CA. FILED 2-28-2003.

SHOUT! FACTORY

FOR SOUND RECORDINGS AND DOWNLOADABLE SOUND RECORDINGS FEATURING SOUNDTRACKS FROM THEATRICAL STAGE PRODUCTIONS, COMEDY ROUTINES, DOCUMENTARIES, UNSCRIPTED REALITY PROGRAMS, MOTION PICTURES FEATURING GENERAL FEATURE ENTERTAINMENT, LIVE ACTION, SCIENCE FICTION AND DRAMA AND TELEVISION PROGRAMS FEATURING SITCOMS, GAMES, DRAMA AND LIVE ACTION; AND VIDEO RECORDINGS, DVDS AND DOWNLOADABLE VIDEO RECORDINGS FEATURING THEATRICAL STAGE PRODUCTIONS, COMEDY ROUTINES, DOCUMENTARIES, UNSCRIPTED REALITY PROGRAMS, MOTION PICTURES FEATURING GENERAL FEATURE ENTERTAINMENT, LIVE ACTION, SCIENCE FICTION, AND DRAMA AND TELEVISION PROGRAMS FEATURING SITCOMS, GAMES, DRAMA AND LIVE ACTION; VIDEO GAME SOFTWARE (U.S. CLS. 21, 23, 26, 36 AND 38).

GINNY ISAACSON, EXAMINING ATTORNEY

CLASS 9—(Continued).

SN 78-222,107. THE MIAMI HEAT LIMITED PARTNERSHIP, MIAMI, FL. FILED 3-5-2003.



OWNER OF U.S. REG. NOS. 2,575,672, 2,606,919 AND 2,606,920.

SEC. 2(F) AS TO "MIAMI".

FOR COMPUTER ACCESSORIES, NAMELY MOUSE PADS, MICE, DISC CASES, COMPUTER CARRY-ON CASES, KEYBOARD WRIST PADS, COMPUTER MONITOR CARDBOARD FRAMES ALL FEATURING THEMES RELATED TO BASKETBALL; DISCOUNT CARDS MAGNETICALLY ENCODED, MEMBERSHIP CARDS MAGNETICALLY ENCODED, MAGNETICALLY ENCODED CREDIT CARDS, PRE-PAID TELEPHONE CALLING CARDS MAGNETICALLY ENCODED, DOWNLOADABLE VIDEO RECORDINGS, VIDEO STREAM RECORDINGS, AND AUDIO RECORDINGS FEATURING BASKETBALL GAMES AND HIGHLIGHTS, MUSIC, INTERVIEWS, NEWS AND COMMENTARY IN THE FIELD OF BASKETBALL PROVIDED OVER THE INTERNET; DOWNLOADABLE COMPUTER SOFTWARE FOR VIEWING DATABASES OF INFORMATION, STATISTICAL INFORMATION, TRIVIA, POLLING INFORMATION, AND INTERACTIVE POLLING IN THE FIELD OF BASKETBALL PROVIDED OVER THE INTERNET; DOWNLOADABLE COMPUTER SOFTWARE FOR USE AS SCREENSAVERS, WALLPAPER, BROWSERS, SKINS, AVATARS AND CURSORS OVER THE INTERNET; DOWNLOADABLE ELECTRONIC PUBLICATIONS IN THE NATURE OF MAGAZINES, NEWSLETTERS, YEARBOOKS, MEDIA GUIDES, AND COLORING BOOKS FEATURING BASKETBALL THEMES PROVIDED OVER THE INTERNET; DOWNLOADABLE GREETING CARDS PROVIDED OVER THE INTERNET; MAGNETS, SUNGLASSES AND CASES FOR SUNGLASSES (U.S. CLS. 21, 23, 26, 36 AND 38).

FIRST USE 4-2-2000; IN COMMERCE 4-2-2000.

DAVID TAYLOR, EXAMINING ATTORNEY

CLASS 9—(Continued).

SN 78-229,332. CHINA FACTORY OUTLET, INC., DBA FACTORY OUTLET, LOS ANGELES, CA. FILED 3-24-2003.

ZMEX

THE MARK CONSISTS OF STANDARD CHARACTERS WITHOUT CLAIM TO ANY PARTICULAR FONT, STYLE, SIZE, OR COLOR.

FOR HEADPHONES; EARPHONES, AM/FM RADIOS INCORPORATING CLOCKS, AUDIO CASSETTE PLAYERS, PRERECORDED AUDIO AND VIDEO CASSETTE TAPES FEATURING MUSIC AND CHILDREN'S STORIES, BLANK AUDIO AND VIDEO CASSETTE TAPES, BATTERIES, CALCULATORS, HEAD CLEANING TAPES FOR AUDIO AND VIDEO RECORDERS, BLACK AND WHITE TELEVISION SETS, VIDEO CAMERAS, AND PHOTOGRAPHIC CAMERAS (U.S. CLS. 21, 23, 26, 36 AND 38).

FIRST USE 5-1-2003; IN COMMERCE 5-20-2003.

DANIELLE MATTESSICH, EXAMINING ATTORNEY

SN 78-229,460. EPSON INTERNATIONAL, INC., HOUSTON, TX. FILED 3-25-2003.

SYSTEM 7 PROCESS EXPLORER

FOR COMPUTER SOFTWARE FOR USE AS A SIMULATION OF CHEMICAL AND PETROLEUM REFINERY OPERATIONS (U.S. CLS. 21, 23, 26, 36 AND 38).

FIRST USE 3-1-2003; IN COMMERCE 3-14-2003.

PAUL F. GAST, EXAMINING ATTORNEY

CLASS 9—(Continued).

SN 78-231,905. ALTAIR GRID TECHNOLOGIES, L.L.C., TROY, MI. FILED 3-31-2003.

PBS PRO

NO CLAIM IS MADE TO THE EXCLUSIVE RIGHT TO USE "PRO", APART FROM THE MARK AS SHOWN.

FOR DOWNLOADABLE COMPUTER SOFTWARE AND COMPUTER SOFTWARE, NAMELY, FLEXIBLE BATCH QUEUING SYSTEM WITH A FEATURE FOR SUPPORTING BOTH BATCH AND INTERACTIVE JOBS IN NETWORK ENVIRONMENTS; DISTRIBUTION JOB MANAGEMENT TOOLS IN THE NATURE OF A COMPUTER SOFTWARE WHICH PROVIDES AN INTERFACE TO ALL OF THE SITE COMPUTING RESOURCES FOR WORKLOAD MANAGEMENT IN THE NATURE OF ALLOCATION OF COMPUTER RESOURCES AND JOB SCHEDULING; GRID COMPUTING TOOLS, NAMELY, COMPUTER SOFTWARE WHICH PROVIDE POLICY-DIRECTED SCHEDULING AND MANAGEMENT OF JOBS; COMPUTER SOFTWARE FOR INDICATING AVAILABLE COMPUTING RESOURCES AND PROVIDING DATA IN THE FIELD OF COMPUTER RESOURCES; COMPUTER SOFTWARE FOR MANAGING INFORMATION IN THE FIELD OF SOFTWARE LICENSES WITHIN A SINGLE ADMINISTRATIVE DOMAIN AND ACROSS ADMINISTRATIVE DOMAINS (U.S. CLS. 21, 23, 26, 36 AND 38).

FIRST USE 4-0-2000; IN COMMERCE 4-0-2000.
PAULA MAYS, EXAMINING ATTORNEY

CLASS 9—(Continued).

SN 78-259,492. ALPINE LAND INFORMATION SERVICES, INC., ANDERSON, CA. FILED 6-6-2003.

VISUAL FORESTER

FOR COMPUTER SOFTWARE FOR USE IN THE FOREST PRODUCTS AND FOREST MANAGEMENT INDUSTRY, WHICH ENABLES THE USER TO ENGAGE IN DECISION SUPPORT, CONDUCT FEASIBILITY ANALYSIS AND PREPARE SITE-SPECIFIC, LONG TERM SUSTAINED YIELD PLANNING BY INTEGRATING PROFESSIONALLY DESIGNED FOREST MANAGEMENT TOOLS, GROWTH AND YIELD MODULES AND AN INTERACTIVE, THREE DIMENSIONAL RENDERING OF THE FOREST ECOSYSTEM; COMPUTER SOFTWARE FOR USE IN THE FOREST PRODUCTS AND FOREST MANAGEMENT INDUSTRY WHICH ALLOWS USER TO CREATE AND MANAGE A FORESTED LANDSCAPE USING A WIDE VARIETY OF SILVICULTURAL AND FOREST MANAGEMENT TECHNIQUES (U.S. CLS. 21, 23, 26, 36 AND 38).

FIRST USE 1-1-2003; IN COMMERCE 1-1-2003.
GWEN STOKOLS, EXAMINING ATTORNEY

SN 78-236,123. DIGISENZ LLC, DURHAM, NC. FILED 4-10-2003.

SLEEP ASSURED

FOR SIGNAL PROCESSING SYSTEMS TO SIGNAL PROCESSORS (U.S. CLS. 21, 23, 26, 36 AND 38).
DOMINICK J. SALEMI, EXAMINING ATTORNEY

SN 78-265,023. SOURCE ENTERPRISES, INC., NEW YORK, NY. FILED 6-20-2003.

THE SOURCE HIP-HOP MUSIC AWARDS

SN 78-246,351. MAG-TEK, INC., CARSON, CA. FILED 5-6-2003.

MAGNESCORE

FOR SOFTWARE FOR ANALYZING AND COMPARING MAGNETIC STRIPES (U.S. CLS. 21, 23, 26, 36 AND 38).
FLORENTINA BLANDU, EXAMINING ATTORNEY

OWNER OF U.S. REG. NOS. 1,954,494, 2,325,708 AND 2,331,475.

NO CLAIM IS MADE TO THE EXCLUSIVE RIGHT TO USE HIP-HOP MUSIC AWARDS, APART FROM THE MARK AS SHOWN.

FOR PRE-RECORDED AUDIO CASSETTES AND COMPACT DISCS FEATURING AWARDS SHOWS AND MUSIC AND VARIETY PERFORMANCES; PRE-RECORDED VIDEO TAPES AND DVDS FEATURING AWARDS SHOWS AND MUSIC AND VARIETY PERFORMANCES (U.S. CLS. 21, 23, 26, 36 AND 38).

FIRST USE 8-17-1999; IN COMMERCE 8-17-1999.
CYNTHIA SLOAN, EXAMINING ATTORNEY

CLASS 9—(Continued).

SN 78-265,758. CIRCUIT CITY STORES WEST COAST, INC., GREENWOOD VILLAGE, CO. FILED 6-23-2003.

VERGE

FOR AUDIO, VIDEO, AND ELECTRONIC EQUIPMENT, NAMELY MP3 PLAYERS, DVD PLAYERS AND RECORDERS, CD PLAYERS AND RECORDERS, PORTABLE CD PLAYERS AND RECORDERS, TELEVISIONS, STEREO RECEIVERS, AUDIO SPEAKERS, VCRS, AUDIO CASSETTE PLAYERS, BOOMBOXES, NAMELY PORTABLE COMBINATION RADIO AND CD PLAYERS, PORTABLE COMBINATION RADIO AND AUDIO CASSETTE PLAYERS, MINI SYSTEMS, NAMELY SPEAKERS, SUBWOOFERS, RECEIVERS, TUNERS, AMPLIFIERS, DVD AND CD PLAYERS SOLD AS A UNIT, HOME THEATER SYSTEMS, NAMELY SPEAKERS, SUBWOOFERS, RECEIVERS, TUNERS, AMPLIFIERS, DVD AND CD PLAYERS SOLD AS A UNIT, MINIDISC PLAYERS AND RECORDERS, TWO-WAY RADIOS, AND SATELLITE NAVIGATION SYSTEMS, NAMELY GLOBAL POSITIONING SYSTEMS (GPS); AUDIO, VIDEO AND ELECTRONIC EQUIPMENT ACCESSORIES, NAMELY HEADPHONES, HEADSETS FOR MP3 PLAYERS, DVD PLAYERS, CD PLAYERS, TELEVISIONS, STEREO RECEIVERS, VCRS, BOOMBOXES, AUDIO CASSETTE PLAYERS, MINI SYSTEMS AND HOME THEATER SYSTEMS, STORAGE AND CARRYING CASES FOR MP3 PLAYERS, DVD PLAYERS, CD PLAYERS, AND BLANK MEDIA, NAMELY CDS AND DVDS, CONVERTERS, ADAPTERS FOR MP3 PLAYERS, DVD PLAYERS, CD PLAYERS, AND GPS NAVIGATION SYSTEMS, REMOTE CONTROLS FOR DVD PLAYERS, CD PLAYERS, TELEVISIONS, STEREO RECEIVERS, BOOMBOXES, MINI SYSTEMS AND HOME THEATER SYSTEMS, AND MOUNTS FOR MP3 PLAYERS, DVD PLAYERS, CD PLAYERS, TELEVISIONS, STEREO RECEIVERS, SPEAKERS, VCRS, AUDIO CASSETTE PLAYERS, AND HOME THEATER SYSTEMS (U.S. CLS. 21, 23, 26, 36 AND 38).

FRED MANDIR, EXAMINING ATTORNEY

SN 78-272,900. E-GOVERNMENT CONSULTING, INC., GARDEN CITY, NY. FILED 7-10-2003.

ELECTION CENTRAL

NO CLAIM IS MADE TO THE EXCLUSIVE RIGHT TO USE ELECTION, APART FROM THE MARK AS SHOWN.

FOR COMPUTER SOFTWARE FOR USE IN THE FIELD OF ELECTIONS, NAMELY, SOFTWARE FOR PROVIDING ELECTRONIC INFORMATION FOR ELECTION MANAGEMENT, ON-LINE VOTING, BALLOT DESIGN, BALLOT DEFINITION AND BALLOT TRANSMISSION, VOTER REGISTRATION AND AUTHENTICATION, MEMBERSHIP MANAGEMENT, ELECTRONIC VOTING, ELECTION TABULATION AND REPORTING, VIA THE INTERNET (U.S. CLS. 21, 23, 26, 36 AND 38).

DAVID ELTON, EXAMINING ATTORNEY

SN 78-280,592. SPONSLEER CO, INC., BRICK TOWN, NJ. FILED 7-29-2003.

SPONSLEER

SEC. 2(F).

FOR FLOW METERS FOR MEASURING THE FLOW OF LIQUIDS OR GASSES THROUGH CONDUITS (U.S. CLS. 21, 23, 26, 36 AND 38).

FIRST USE 1-1-1979; IN COMMERCE 2-5-1981.

TINA L. SNAPP, EXAMINING ATTORNEY

CLASS 9—(Continued).

SN 78-283,393. EJA LIMITED, WIGAN, UNITED KINGDOM, FILED 8-5-2003.



OWNER OF U.S. REG. NOS. 1,600,521 AND 2,098,855.

FOR ELECTRICAL AND ELECTRONIC CONTROLS AND SYSTEMS NAMELY, PROGRAMMABLE LOGIC CONTROLLERS, INPUT/OUTPUT COMMUNICATION CONTROLS, OPERATOR INTERFACES, CIRCUIT PROTECTION CONTROLS, PUSH BUTTONS, TOUCH BUTTONS, RELAYS, TIMERS, SIGNALING CONTROLS, TERMINAL BLOCKS, NETWORK COMMUNICATION CONTROLS, CONTACTORS, RELAYS, EMERGENCY STOPS AND INTERLOCK SWITCHES; SENSORS, NAMELY PHOTOELECTRIC SENSORS, INDUCTIVE, CAPACITIVE AND ULTRASONIC PROXIMITY SENSORS, OPTICAL SENSORS, LIMIT SWITCHES, ENCODERS, SPEED SENSORS, PRESSURE SENSORS, TEMPERATURE SENSORS AND SAFETY SWITCHES; COMPUTER SOFTWARE FOR PROVIDING HUMAN MACHINE INTERFACE AND VISUALIZATION; COMPUTER SOFTWARE FOR USE IN THE DESIGN, OPERATION AND MAINTENANCE OF INDUSTRIAL AUTOMATION PROCESSES (U.S. CLS. 21, 23, 26, 36 AND 38).

FIRST USE 1-1-1983; IN COMMERCE 1-1-1983.

PAUL F. GAST, EXAMINING ATTORNEY

SN 78-285,888. TANNER, MATHEW, SANFORD, FL. FILED 8-11-2003.

CHRIST MEDIA

NO CLAIM IS MADE TO THE EXCLUSIVE RIGHT TO USE "MEDIA", APART FROM THE MARK AS SHOWN.

FOR SOUND RECORDINGS FEATURING MUSIC; PRE-RECORDED CD'S, VIDEOS, TAPES, LASER DISKS AND DVD'S FEATURING MUSIC; VIDEO GAME SOFTWARE, VIDEO GAME PROGRAMS, VIDEO GAME CARTRIDGES, ELECTRONIC GAME SOFTWARE, ELECTRONIC GAME PROGRAMS, ELECTRONIC GAME CARTRIDGES; PRE-RECORDED ANIMATED CD'S, VIDEOS, TAPES, LASER DISKS AND DVD'S FEATURING MUSIC (U.S. CLS. 21, 23, 26, 36 AND 38).

ESTHER A. BORSUK, EXAMINING ATTORNEY

SN 78-291,167. BNY BROKERAGE INC., NEW YORK, NY. FILED 8-22-2003.

EPASS

FOR COMPUTER SOFTWARE FOR USE BY INSTITUTIONS AND PROFESSIONAL TRADERS IN THE MANAGEMENT OF SECURITIES TRADE FLOW (U.S. CLS. 21, 23, 26, 36 AND 38).

FIRST USE 7-16-2003; IN COMMERCE 7-16-2003.

TRACY CROSS, EXAMINING ATTORNEY

CLASS 9—(Continued).

SN 78-300,218. WAH FOO NG, DAVE, MARKHAM, ONTARIO, CANADA, FILED 9-15-2003.



THE MARK CONSISTS OF THE STYLIZED LETTERS AC. FOR EYEWEAR AND EYEWEAR ACCESSORIES, NAMELY, EYEGLASSES, SUNGLASSES, CLIP-ON SUNGLASSES, CLIP-ON NOVELTY LENSES, EYEGLASS CASES, EYEGLASS BRIDGES AND ATTACHMENT CLIPS, LENSES, AND KITS, PRINCIPALLY COMPOSED OF DECORATIVE OR IMPRINTED CLIP-ON ATTACHMENTS, FOR ASSEMBLY TO EYEGLASS LENSES, TO EYEGLASS BRIDGES, AND TO EYEGLASS FRAMES (U.S. CLS. 21, 23, 26, 36 AND 38).

FIRST USE 7-8-2002; IN COMMERCE 7-8-2002.
JEFFERY COWARD, EXAMINING ATTORNEY

SN 78-303,684. DISNEY ENTERPRISES, INC., BURBANK, CA. FILED 9-22-2003.

BRING ON THE MOVIES

FOR APPARATUS FOR RECEIVING, RECORDING, TRANSMISSION AND REPRODUCTION OF SOUND OR IMAGES, NAMELY, PERSONAL VIDEO RECORDERS, RECEIVERS, COMPACT DISC, CD-ROM DISC, DIGITAL VIDEO DISC, AND DIGITAL VERSATILE DISC PLAYERS AND RECORDERS, AND VCR'S; TELECOMMUNICATIONS PRODUCTS, NAMELY, RECEIVERS, RECEIVER MODULES, TRANSMITTERS, MULTIPLEXERS, DECODER BOXES, DATA PROCESSORS, SET-TOP BOXES, COMPUTER CONTROLLING HARDWARE AND SOFTWARE USE IN THE AFOREMENTIONED GOODS; ELECTRONIC, OPTICAL AND MAGNETIC DATA CARRIERS FEATURING ENTERTAINMENT AND MUSIC; COMPUTER HARDWARE; COMPUTER SOFTWARE FOR USE IN CONNECTION WITH INTERACTIVE TELEVISION PROGRAMMING, NAMELY, PROGRAMMING, SEARCHING, RECORDING, PLAYING AND DOWNLOADING ENTERTAINMENT MEDIA; ACCOMPANYING MANUALS SOLD TOGETHER AS A UNIT; AND AUDIO AND VISUAL RECORDINGS IN ALL MEDIA, NAMELY, PRE-RECORDED AUDIO AND VIDEOCASSETTES, COMPACT DISCS, DIGITAL VIDEO DISCS, DIGITAL VERSATILE DISCS, AND CD-ROM DISCS FEATURING ENTERTAINMENT AND MUSIC (U.S. CLS. 21, 23, 26, 36 AND 38).

JEFFERY COWARD, EXAMINING ATTORNEY

SN 78-307,953. ASTROLABE ANALYTICA INC., PHILADELPHIA, PA. FILED 10-1-2003.

ASTROMETRYX

FOR COMPUTER SOFTWARE IN THE FIELD OF INFORMATION STORAGE, MANAGEMENT, AND RETRIEVAL (U.S. CLS. 21, 23, 26, 36 AND 38).
HOWARD SMIGA, EXAMINING ATTORNEY

CLASS 9—(Continued).

SN 78-307,956. ASTROLABE ANALYTICA INC., PHILADELPHIA, PA. FILED 10-1-2003.

ASTROCITE

FOR COMPUTER SOFTWARE IN THE FIELD OF INFORMATION STORAGE, MANAGEMENT, AND RETRIEVAL (U.S. CLS. 21, 23, 26, 36 AND 38).
HOWARD SMIGA, EXAMINING ATTORNEY

SN 78-307,960. ASTROLABE ANALYTICA INC., PHILADELPHIA, PA. FILED 10-1-2003.

ASTROLYTIX

FOR COMPUTER SOFTWARE IN THE FIELD OF INFORMATION STORAGE, MANAGEMENT, AND RETRIEVAL (U.S. CLS. 21, 23, 26, 36 AND 38).
HOWARD SMIGA, EXAMINING ATTORNEY

SN 78-307,966. ASTROLABE ANALYTICA INC., PHILADELPHIA, PA. FILED 10-1-2003.

ASTROLYTICA

FOR COMPUTER SOFTWARE IN THE FIELD OF INFORMATION STORAGE, MANAGEMENT, AND RETRIEVAL (U.S. CLS. 21, 23, 26, 36 AND 38).
HOWARD SMIGA, EXAMINING ATTORNEY

CLASS 9—(Continued).

SN 78-308,036. ALPS ELECTRIC CO., LTD., TOKYO, 145-8501, JAPAN, FILED 10-1-2003.

SWINGMOVER

FOR ELECTRONIC TESTING EQUIPMENT, NAMELY, ELECTRICAL ACTUATORS; AERIALS, NAMELY, ANTENNA MASTS FOR CAR RADIOS, AERIALS FOR RADIO TRANSMISSION AND BROADCASTING; ELECTRONIC AGENDAS, NAMELY, HAND-HELD ELECTRONIC DEVICES FOR SCHEDULING PERSONAL APPOINTMENTS, PERSONAL DIGITAL ASSISTANTS; AMUSEMENT APPARATUS ADAPTED FOR USE WITH TELEVISION RECEIVERS, NAMELY, VIDEO GAME MACHINES FOR USE WITH TELEVISIONS, VIDEO OUTPUT GAME MACHINES FOR USE WITH TELEVISIONS; ANTENNAS; APPARATUS AND INSTRUMENTS FOR ASTRONOMY, NAMELY, TELESCOPES; CAMCORDERS; CINEMATOGRAPHIC CAMERAS; PHOTOGRAPHY CAMERAS; ELECTRICITY CELL SWITCHES; COIN-OPERATED MECHANISMS FOR TELEVISION SETS; COMPUTER PERIPHERALS; COMPUTERS; PRINTERS FOR USE WITH COMPUTERS; INSTRUMENTS CONTAINING EYEPIECES, NAMELY, MICROSCOPES; OPTICAL MIRRORS; ELECTRONIC MONITORING APPARATUS, NAMELY, COMPUTER MONITORS; SURVEILLANCE CAMERAS, COMPUTER MONITORING OPERATION SYSTEM SOFTWARE; COMPUTER HARDWARE, NAMELY, COMPUTER MONITORS AND NOTEBOOK COMPUTERS; OPTICAL APPARATUS AND INSTRUMENTS, NAMELY, BINOCULARS, CAMERA LENSES; OPTICAL CHARACTER READERS; COMPUTER CURSOR CONTROL DEVICES, NAMELY, LIGHT-EMITTING ELECTRONIC POINTERS; PORTABLE TELEPHONES; RADAR APPARATUS, NAMELY, RADAR DETECTORS; FIRE SPRINKLERS FOR FIRE PROTECTION; PERSONAL STEREOS; STEREOSCOPIC CAMERAS AND PROJECTORS; ELECTRIC SWITCHES; TELEVISIONS; VIDEO CASSETTE RECORDERS; VIDEO PHONES; AND PHOTOGRAPHIC VIEWFINDERS (U.S. CLS. 21, 23, 26, 36 AND 38).

HOWARD SMIGA, EXAMINING ATTORNEY

SN 78-310,671. INNOVATIONS INTRACUBATOR INC., SOUTH ORANGE, NJ. FILED 10-7-2003.

INTRACUBATOR

OWNER OF CANADA REG. NO. TMA606759, DATED 3-31-2004, EXPIRES 3-31-2019.

FOR COMPUTER SOFTWARE, NAMELY, BUSINESS MANAGEMENT SOFTWARE FOR USE IN TRACKING BUSINESS DEVELOPMENT OPPORTUNITIES, MONITORING PROJECT TEAMS, IDENTIFYING AND MAINTAINING RELATIONS WITH PARTNERS OUTSIDE THE BUSINESS, MANAGING TECHNOLOGICAL RESOURCES FOR BUSINESS PROJECTS (U.S. CLS. 21, 23, 26, 36 AND 38).

BERYL GARDNER, EXAMINING ATTORNEY

CLASS 9—(Continued).

SN 78-312,333. TERASEN INC., FORMERLY BC GAS INC., VANCOUVER, BRITISH COLUMBIA, CANADA, FILED 10-10-2003.



PRIORITY CLAIMED UNDER SEC. 44(D) ON CANADA APPLICATION NO. 1,173,585, FILED 4-11-2003, REG. NO. TMA627436, DATED 12-3-2004, EXPIRES 12-3-2019.

FOR NATURAL GAS AND PROPANE GAS EQUIPMENT AND ACCESSORIES, NAMELY, AUTOMATIC VALVES, REGULATORS AND GAUGES; ELECTRIC, GAS AND FLUID FLOW METERS; ENERGY MONITORING DEVICES, NAMELY GAS AND WATER METERS AND AUTOMATIC METER READERS (U.S. CLS. 21, 23, 26, 36 AND 38).

KIMBERLY FRYE, EXAMINING ATTORNEY

SN 78-314,566. GUTHY-RENKER CORPORATION, PALM DESERT, CA. FILED 10-16-2003.

ENDLESS FITNESS SERIES

NO CLAIM IS MADE TO THE EXCLUSIVE RIGHT TO USE "FITNESS SERIES", APART FROM THE MARK AS SHOWN.

FOR SERIES OF PRE-RECORDED VIDEOCASSETTES AND DVD'S FEATURING AN EXERCISE PROGRAM (U.S. CLS. 21, 23, 26, 36 AND 38).

FIRST USE 1-13-2004; IN COMMERCE 1-13-2004.

JASON TURNER, EXAMINING ATTORNEY

SN 78-316,524. BAYER AKTIENGESELLSCHAFT, LEVERKUSEN-BAYERWERK, FED REP GERMANY, FILED 10-21-2003.

UVIVATEC

FOR ELECTRONIC VIRUS INACTIVATION AND DISINFECTION APPARATUS FOR THE ULTRAVIOLET TREATMENT OF BIOTECHNOLOGICAL OR HUMAN BLOOD PLASMA-DERIVED PRODUCTS, NAMELY, PHARMACEUTICALS (U.S. CLS. 21, 23, 26, 36 AND 38).

WENDY GOODMAN, EXAMINING ATTORNEY

SN 78-317,035. CONVOQ, INC., LEXINGTON, MA. FILED 10-22-2003.

CONVOQ

FOR COMPUTER SOFTWARE FOR CREATING, ENHANCING, MANAGING, SENDING AND RECEIVING DATA, MESSAGES, VOICE AND TELEPHONY OVER COMPUTER NETWORKS AND THE INTERNET, AND FOR USE ON OR WITH PERSONAL COMPUTERS, COMPUTER SERVERS, WIRELESS AND OTHER MOBILE TECHNOLOGIES AND DEVICES (U.S. CLS. 21, 23, 26, 36 AND 38).

GWEN STOKOLS, EXAMINING ATTORNEY

CLASS 9—(Continued).

SN 78-317,901. IGT, RENO, NV. FILED 10-23-2003.

BIG GAME KENO

NO CLAIM IS MADE TO THE EXCLUSIVE RIGHT TO USE "KENO", APART FROM THE MARK AS SHOWN.

FOR GAMING MACHINES, NAMELY, SLOT MACHINES OR LOTTERY TERMINALS WITH OR WITHOUT VIDEO OUTPUT (U.S. CLS. 21, 23, 26, 36 AND 38).
DAWN FELDMAN, EXAMINING ATTORNEY

SN 78-320,050. SFC INTERACTIVE, LLC, MANCHESTER, NH. FILED 10-29-2003.

FIND IT NOW. FIND IT FAST.

FOR COMPUTER SOFTWARE FOR USE IN COLLECTING AND STORING GEOGRAPHIC, TEXTUAL, AND GRAPHIC INFORMATION ABOUT ONE OR MORE OBJECTS; AND FOR RETRIEVING ANALYZING, MANIPULATING, AND DISPLAYING SELECTED, COLLECTED, STORED, AND RETRIEVED INFORMATION (U.S. CLS. 21, 23, 26, 36 AND 38).

WILLIAM P. SHANAHAN, EXAMINING ATTORNEY

SN 78-321,589. ITERA, INC., SALT LAKE CITY, UT. FILED 10-31-2003.

Echo²

FOR COMPUTER DATA BACKUP SYSTEM IN THE NATURE OF A HIGH AVAILABILITY PRODUCTION COMPUTER SYSTEM COMPRISING COMPUTER HARDWARE AND COMPUTER SOFTWARE FEATURING A FILE SYSTEM, A JOURNAL, AND A JOURNAL RECEIVER, AND A HIGH AVAILABILITY BACKUP COMPUTER SYSTEM COMPRISING COMPUTER HARDWARE AND COMPUTER SOFTWARE FEATURING A FILE SYSTEM, A JOURNAL, AND TWO JOURNAL RECEIVERS, THAT PERFORM DATA REPLICATION USING REMOTE JOURNALING (U.S. CLS. 21, 23, 26, 36 AND 38).

ALLISON HOLTZ, EXAMINING ATTORNEY

CLASS 9—(Continued).

SN 78-321,627. WEALTEC BIOSCIENCE CO., LTD., TAIPEI, TAIWAN, FILED 10-31-2003.



FOR LABORATORY EXPERIMENTAL APPARATUS AND INSTRUMENTS, NAMELY, POWER CONTROL UNITS FOR ELECTROPHORESIS INSTRUMENTS; ELECTROPHORESIS INSTRUMENTS; ELECTRO-BLOTTING INSTRUMENTS; HEATING AND CHILLING INSTRUMENTS, NAMELY, INCUBATORS, CENTRIFUGES, LIGHT RADIATION CONTROL BOXES, SPECTROPHOTOMETERS, AND GENE HYBRIDIZATION REACTORS; LIFE SCIENCE RESEARCH APPARATUS, NAMELY, IMAGE APPARATUS, NAMELY, GEL IMAGE DOCUMENTATION SYSTEM, COMPRISED OF CCD CAMERA, LENS, MONITOR, OPERATING SOFTWARE AND ANALYSIS SOFTWARE FOR USAGE OF GEL AND SAMPLE IMAGE ACQUIRED AND DATA ANALYSIS; AND COMPUTER SOFTWARE PROGRAMS FOR DATA RECORDING AND ANALYSIS IN THE FIELD OF LIFE SCIENCE RESEARCH (U.S. CLS. 21, 23, 26, 36 AND 38).

FIRST USE 1-15-2001; IN COMMERCE 1-15-2001.

JASON TURNER, EXAMINING ATTORNEY

SN 78-323,203. UNIVERSITY OF CENTRAL FLORIDA, ORLANDO, FL. FILED 11-5-2003.

RAINBOWL

THE MARK CONSISTS OF STANDARD CHARACTERS WITHOUT CLAIM TO ANY PARTICULAR FONT, STYLE, SIZE, OR COLOR.

FOR COMPUTERS, COMPUTER MONITORS, COMPUTER PERIPHERALS, AND COMPUTERIZED TIMER CONTROLS, ALL FOR AUTOMATED WATER STORAGE CONTAINERS, COLLECTORS, AND REDISTRIBUTORS OF STORM WATER, ROOF TOP COLLECTED RAINWATER, MELTED SNOW AND ACCUMULATED ICE FOR USE AND CONNECTION TO SPRINKLERS AND IRRIGATION DISTRIBUTION LINES FOR REHYDRATION OF WETLANDS, LAWNS, GARDENS AND AGRICULTURAL FIELDS, NOT SOLD AS COMPONENT PARTS OF WATER COLLECTION SYSTEMS (U.S. CLS. 21, 23, 26, 36 AND 38).

RICHARD A. STRASER, EXAMINING ATTORNEY

CLASS 9—(Continued).

SN 78-324,130. DENOYER, TODD, DELTONA, FL. FILED 11-6-2003.

THE LIVE YEARBOOK

THE MARK CONSISTS OF STANDARD CHARACTERS WITHOUT CLAIM TO ANY PARTICULAR FONT, STYLE, SIZE, OR COLOR.

NO CLAIM IS MADE TO THE EXCLUSIVE RIGHT TO USE "YEARBOOK", APART FROM THE MARK AS SHOWN.

FOR ANNUAL STUDENT YEARBOOKS RECORDED ON DVDS (U.S. CLS. 21, 23, 26, 36 AND 38).

FIRST USE 9-1-2001; IN COMMERCE 9-1-2002.
PAUL F. GAST, EXAMINING ATTORNEY

CLASS 9—(Continued).

SN 78-326,124. EDUSTRUCTURES LLC, SOUTH JORDAN, UT. FILED 11-11-2003.

Edustructures

THE MARK CONSISTS OF STANDARD CHARACTERS WITHOUT CLAIM TO ANY PARTICULAR FONT, STYLE, SIZE, OR COLOR.

FOR COMMUNICATIONS SOFTWARE PROGRAMS FOR CONNECTING EDUCATIONAL COMPUTER NETWORK SYSTEMS TO EACH OTHER AND TO A GLOBAL COMPUTER NETWORK (U.S. CLS. 21, 23, 26, 36 AND 38).

FIRST USE 10-16-2001; IN COMMERCE 11-30-2001.
PAUL F. GAST, EXAMINING ATTORNEY

SN 78-324,929. PARACEL, INC., PASADENA, CA. FILED 11-7-2003.

CYCLONE

THE MARK CONSISTS OF STANDARD CHARACTERS WITHOUT CLAIM TO ANY PARTICULAR FONT, STYLE, SIZE, OR COLOR.

FOR COMPUTER SOFTWARE USED FOR COLLECTION, ORGANIZATION, ANALYSIS, INTEGRATION, AND COMMUNICATION OF SCIENTIFIC DATA IN THE FIELD OF BIOTECHNOLOGY AND LIFE SCIENCE (U.S. CLS. 21, 23, 26, 36 AND 38).

LANA PHAM, EXAMINING ATTORNEY

SN 78-328,021. COLEMAN AUDIO, LLC, WESTBURY, NY. FILED 11-14-2003.



The logo for Coleman Audio features the word "Coleman" in a large, stylized, serif font with a decorative flourish under the 'C'. Below it, the word "Audio" is written in a smaller, simpler serif font.

SN 78-325,887. JOYCE SECURITY SOLUTIONS, INC, BRIARCLIFF MANOR, NY. FILED 11-11-2003.



The logo for ByteScreen features the word "Byte" in blue and "Screen" in yellow, with a stylized gray swoosh element between them.

THE COLOR(S) BLUE GRAY AND YELLOW IS/ARE CLAIMED AS A FEATURE OF THE MARK.

THE LETTERS "BYTE" APPEAR IN THE COLOR BLUE, THE LETTER "S" APPEARS IN THE COLOR GRAY, AND THE LETTERS "CREEN" APPEAR IN THE COLOR YELLOW.

FOR COMPUTER SOFTWARE AND HARDWARE PROVIDING APPLICATION AND NETWORK PROTECTION, SECURITY, AND ENCRYPTION (U.S. CLS. 21, 23, 26, 36 AND 38).

FIRST USE 11-9-2003; IN COMMERCE 11-9-2003.
ALICIA COLLINS, EXAMINING ATTORNEY

SEC. 2(F).

FOR PROFESSIONAL AUDIO EQUIPMENT FOR THE RECORDING AND BROADCASTING INDUSTRY, NAMELY, STEREO VU METERS, VU QUAD METERS, VOICE DISPLAY MONITORS, DIGITAL WORKSTATION MONITORS FOR THE RECORDING AND BROADCASTING INDUSTRY; SURROUND LEVEL CONTROLS FOR RECORDING AND BROADCASTING APPARATUS; INSTRUMENT ROUTERS, VUI COMPUTER MONITOR SWITCHES, COMPUTER MONITOR CONTROLLERS, AND UNIVERSAL CABLE TESTERS (U.S. CLS. 21, 23, 26, 36 AND 38).

FIRST USE 11-0-1992; IN COMMERCE 11-0-1992.
EVELYN BRADLEY, EXAMINING ATTORNEY

CLASS 9—(Continued).

SN 78-329,202. PROPERTY SOLUTIONS INTERNATIONAL, INC., PROVO, UT. FILED 11-17-2003.



PROPERTY SOLUTIONS

NO CLAIM IS MADE TO THE EXCLUSIVE RIGHT TO USE "PROPERTY", APART FROM THE MARK AS SHOWN. FOR COMPUTER SOFTWARE TO AID IN ACCOUNTING, MARKETING, AND MANAGEMENT TASKS FOR PROPERTY MANAGEMENT COMPANIES (U.S. CLS. 21, 23, 26, 36 AND 38).

FIRST USE 2-10-2003; IN COMMERCE 5-15-2003.
IRA J. GOODSAY, EXAMINING ATTORNEY

CLASS 9—(Continued).

SN 78-331,575. BY ANY MEANS MUSIC, PALMDALE, CA. FILED 11-21-2003.



NO CLAIM IS MADE TO THE EXCLUSIVE RIGHT TO USE "MUSIC", APART FROM THE MARK AS SHOWN.

FOR PRERECORDED PHONOGRAPH RECORDS, AUDIO CASSETTES, PRE-RECORDED CD'S, VIDEO TAPES, LASER DISCS, AND DVD'S, FEATURING MUSIC BY VARIOUS RAP, ROCK, R AND B, SINGERS AND MUSICIANS (U.S. CLS. 21, 23, 26, 36 AND 38).

ANNE MADDEN, EXAMINING ATTORNEY

SN 78-331,068. INTER-TEL, INC., TEMPE, AZ. FILED 11-20-2003.

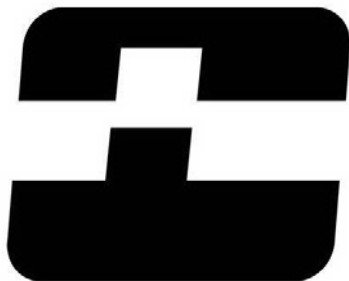

THE MARK CONSISTS OF STYLIZED LETTER "I". FOR BUSINESS COMMUNICATIONS APPARATUS NAMELY, VOICE, DATA AND VIDEO TELEPHONY EQUIPMENT COMPRISING DESKTOP ENDPOINTS, COMMUNICATION ROUTING AND SWITCHING DEVICES, MESSAGING AND CONFERENCING SOFTWARE OR HARDWARE, CALL CENTER PROCESSING SERVERS AND SOFTWARE, AND SOFTWARE FOR MANAGING TELEPHONY FUNCTIONS (U.S. CLS. 21, 23, 26, 36 AND 38).

RENEE MCCRAY, EXAMINING ATTORNEY

SN 78-331,695. DATABASE SOLUTIONS INC., NORTH YORK, CANADA, FILED 11-21-2003.

PADministrator

THE MARK CONSISTS OF STANDARD CHARACTERS WITHOUT CLAIM TO ANY PARTICULAR FONT, STYLE, SIZE, OR COLOR.

FOR COMPUTER SOFTWARE USED FOR MANAGING OF DATA RELATING TO PUBLIC ACCESS DEFIBRILLATION PROGRAMS WHICH KEEPS TRACK OF AEDS, OR AUTOMATED EXTERNAL DEFIBRILLATORS, RESPONDERS, TRAINING CLASSES, STUDENTS, AND CARDIAC INCIDENTS RELATING TO SUCH PROGRAMS (U.S. CLS. 21, 23, 26, 36 AND 38).

LOURDES AYALA, EXAMINING ATTORNEY

CLASS 9—(Continued).

SN 78-333,397. MEMORYSOLUTION GMBH, BREISACH, FED REP GERMANY, FILED 11-26-2003.

PRIME
MEMORYSOLUTION

THE MARK CONSISTS OF STANDARD CHARACTERS WITHOUT CLAIM TO ANY PARTICULAR FONT, STYLE, SIZE, OR COLOR.

NO CLAIM IS MADE TO THE EXCLUSIVE RIGHT TO USE "MEMORYSOLUTION", APART FROM THE MARK AS SHOWN.

FOR COMPUTER HARDWARE (U.S. CLS. 21, 23, 26, 36 AND 38).

SUELLEN HICKEY, EXAMINING ATTORNEY

CLASS 9—(Continued).

SN 78-342,456. SOMADYNAMICS PTY LTD, ADELAIDE, AUSTRALIA, FILED 12-17-2003.

SOMADYNAMICS

THE MARK CONSISTS OF STANDARD CHARACTERS WITHOUT CLAIM TO ANY PARTICULAR FONT, STYLE, SIZE, OR COLOR.

PRIORITY CLAIMED UNDER SEC. 44(D) ON AUSTRALIA APPLICATION NO. 981662, FILED 12-11-2003.

FOR COMPUTER SOFTWARE FOR USE IN HUMAN MODELING (U.S. CLS. 21, 23, 26, 36 AND 38).

FIRST USE 9-11-2003; IN COMMERCE 11-17-2003.

KAREN BRACEY, EXAMINING ATTORNEY

SN 78-342,479. SILICON RIDGE, INC., MENLO PARK, CA. FILED 12-17-2003.

SN 78-338,014. STORAGE TECHNOLOGY CORPORATION, LOUISVILLE, CO. FILED 12-8-2003.

MIRRORSTORE

THE MARK CONSISTS OF STANDARD CHARACTERS WITHOUT CLAIM TO ANY PARTICULAR FONT, STYLE, SIZE, OR COLOR.

FOR COMPUTER HARDWARE AND SOFTWARE FOR DATA STORAGE APPLICATIONS PROVIDING DISK-TO-DISK DATA REPLICATION, SYNCHRONOUS AND ASYNCHRONOUS DATA COPYING, AND DATA BACK-UP AND RECOVERY AND A DUAL-PROCESSOR COMMUNICATIONS SERVER (U.S. CLS. 21, 23, 26, 36 AND 38).

FIRST USE 10-0-2003; IN COMMERCE 10-0-2003.

BARBARA BROWN, EXAMINING ATTORNEY

OUTBACK

THE MARK CONSISTS OF STANDARD CHARACTERS WITHOUT CLAIM TO ANY PARTICULAR FONT, STYLE, SIZE, OR COLOR.

FOR COMPUTER SOFTWARE FOR APPLICATION AND DATABASE INTEGRATION FOR USE WITHIN THE COMMUNICATIONS INDUSTRY; COMPUTER GROUPWARE USED TO COLLECT, STORE AND ORGANIZE EMAIL COMMUNICATIONS, INSTANT MESSAGES, RSS NEWS FEEDS FOR USE BY BUSINESSES AND CONSUMERS (U.S. CLS. 21, 23, 26, 36 AND 38).

KAREN BRACEY, EXAMINING ATTORNEY

CLASS 9—(Continued).

SN 78-344,653. BRENDLE, RON, CHARLOTTE, NC. FILED 12-23-2003.

CLASS 9—(Continued).

SN 78-345,541. SECUGEN CORPORATION, SANTA CLARA, CA. FILED 12-24-2003.

LONOTE RECORDS

THE MARK CONSISTS OF STANDARD CHARACTERS WITHOUT CLAIM TO ANY PARTICULAR FONT, STYLE, SIZE, OR COLOR.

NO CLAIM IS MADE TO THE EXCLUSIVE RIGHT TO USE "RECORDS", APART FROM THE MARK AS SHOWN, FOR SOUND RECORDINGS FEATURING MUSIC (U.S. CLS. 21, 23, 26, 36 AND 38).
FIRST USE 6-22-1992; IN COMMERCE 6-22-1992.
KATHERINE STOIDES, EXAMINING ATTORNEY

FDA02

THE MARK CONSISTS OF STANDARD CHARACTERS WITHOUT CLAIM TO ANY PARTICULAR FONT, STYLE, SIZE, OR COLOR.

FOR COMPUTER HARDWARE, SOFTWARE, AND FIRMWARE FOR BIOMETRIC RECOGNITION, IDENTIFICATION AND AUTHENTICATION (U.S. CLS. 21, 23, 26, 36 AND 38).
FIRST USE 10-28-2002; IN COMMERCE 12-5-2002.
ANDREW BENZMILLER, EXAMINING ATTORNEY

SN 78-345,163. BLUE SEAL FEEDS, INC., LONDONDERRY, NH. FILED 12-23-2003.

SN 78-346,310. PACIFIC LINK TRADE USA, INC., DALTON, GA. FILED 12-29-2003.

FORFLEX

THE MARK CONSISTS OF STANDARD CHARACTERS WITHOUT CLAIM TO ANY PARTICULAR FONT, STYLE, SIZE, OR COLOR.

FOR FEED MANAGEMENT SOFTWARE FOR PROPERLY SELECTING THE CORRECT RATIOS OF FEED INGREDIENTS FOR CUSTOMERS (U.S. CLS. 21, 23, 26, 36 AND 38).
ARETHA SOMERVILLE, EXAMINING ATTORNEY

THE MARK CONSISTS OF A HUMAN HEAD WITH MEDIUM LENGTH HAIR FLOATING OUT TO EACH SIDE OF THE HEAD. THE HEAD IS WEARING A PAIR OF SUNGLASSES. FROM BEHIND THE HEAD RADIATE MANY LONG, CURVED LINES, THE COMBINATION OF WHICH IMPLIES A SUN-LIKE IMAGE.

FOR EYEGLASSES, SUNGLASSES, EYEGLASS FRAMES, EYEGLASS CASES (U.S. CLS. 21, 23, 26, 36 AND 38).
FIRST USE 1-1-2000; IN COMMERCE 1-1-2000.
KIMBERLY FRYE, EXAMINING ATTORNEY

CLASS 9—(Continued).

SN 78-346,709. KODICOM CO., LTD., SEOUL, REPUBLIC OF KOREA, FILED 12-30-2003.



OWNER OF U.S. REG. NO. 2,767,678.
NO CLAIM IS MADE TO THE EXCLUSIVE RIGHT TO USE "AMERICA", APART FROM THE MARK AS SHOWN. THE COLOR(S) GREEN AND BLUE IS/ARE CLAIMED AS A FEATURE OF THE MARK.

THE STYLIZED LETTER K AND FOLLOWING LETTERS IN THE MARK ARE THE COLOR BLUE. THE FIRST LEG OF THE STYLIZED LETTER K IS THE COLOR GREEN.

FOR COMPUTER PROGRAMS, SOFTWARE AND OPERATING SYSTEMS FOR THE RECORDING AND EDITING OF SOUND AND VIDEO; DIGITAL AND ANALOG CAMERAS; VIDEO CAMERAS; VIDEO TAPE RECORDERS; DIGITAL VIDEO RECORDERS; BLANK VIDEO TAPES, BLANK AUDIO TAPES, BLANK COMPACT DISKS; ANALOG AND DIGITAL AUDIO RECORDERS; VIDEO TRANSMITTERS; CLOSED CIRCUIT TELEVISION CAMERAS, MONITORS AND TRANSMITTERS (U.S. CLS. 21, 23, 26, 36 AND 38).

MICHAEL SOUDERS, EXAMINING ATTORNEY

SN 78-349,802. TOLLETT, WAYNE J., SPICEWOOD, TX. FILED 1-9-2004.

Web-Type Ahead

THE MARK CONSISTS OF STANDARD CHARACTERS WITHOUT CLAIM TO ANY PARTICULAR FONT, STYLE, SIZE, OR COLOR.

FOR COMPUTER SOFTWARE FOR PROVIDING MULTIPLE KEY STROKE SEARCH OF WEB DROP-DOWN LIST TO A WEB APPLICATION PROGRAM (U.S. CLS. 21, 23, 26, 36 AND 38).

INGA ERVIN, EXAMINING ATTORNEY

CLASS 9—(Continued).

SN 78-349,852. D B INDUSTRIES, INC., RED WING, MN. FILED 1-9-2004.

LAD-SAF

THE MARK CONSISTS OF STANDARD CHARACTERS WITHOUT CLAIM TO ANY PARTICULAR FONT, STYLE, SIZE, OR COLOR.

OWNER OF U.S. REG. NOS. 1,026,608 AND 1,263,437.
FOR FALL ARREST AND FALL PROTECTION EQUIPMENT, NAMELY, LADDER SAFETY SYSTEMS CONSISTING OF CABLE, ANCHORS, CABLE GUIDES, HARNESSSES, AND CARABINERS AND ROPE GRABS (U.S. CLS. 21, 23, 26, 36 AND 38).

FIRST USE 0-0-1979; IN COMMERCE 0-0-1979.

PAUL F. GAST, EXAMINING ATTORNEY

SN 78-350,456. THE MCGRAW-HILL COMPANIES, INC., NEW YORK, NY. FILED 1-12-2004.

FLUENCY FIRST

THE MARK CONSISTS OF STANDARD CHARACTERS WITHOUT CLAIM TO ANY PARTICULAR FONT, STYLE, SIZE, OR COLOR.

NO CLAIM IS MADE TO THE EXCLUSIVE RIGHT TO USE "FLUENCY", APART FROM THE MARK AS SHOWN.

FOR AUDIO AND VIDEO RECORDINGS AND COMPUTER PROGRAMS FOR TEACHING READING AND LANGUAGE SKILLS (U.S. CLS. 21, 23, 26, 36 AND 38).

ELIZABETH PIGNATELLO, EXAMINING ATTORNEY

CLASS 9—(Continued).

SN 78-352,398. OPTRA, INC., TOPSFIELD, MA. FILED 1-15-2004.

OPTRA

THE MARK CONSISTS OF STANDARD CHARACTERS WITHOUT CLAIM TO ANY PARTICULAR FONT, STYLE, SIZE, OR COLOR.

FOR TWO FREQUENCY LASERS AND LASER BASED METROLOGY INSTRUMENTATION (U.S. CLS. 21, 23, 26, 36 AND 38).

FIRST USE 10-31-1980; IN COMMERCE 10-31-1980.
RENEE MCCRAY, EXAMINING ATTORNEY



SN 78-357,909. TAMALE SOFTWARE, INC., BOSTON, MA. FILED 1-27-2004.

TAMALE

THE MARK CONSISTS OF STANDARD CHARACTERS WITHOUT CLAIM TO ANY PARTICULAR FONT, STYLE, SIZE, OR COLOR.

FOR COMPUTER SOFTWARE FOR THE COLLECTION, EDITING, ORGANIZING, MODIFYING, BOOK-MARKING, TRANSMISSION, STORAGE AND SHARING OF DATA AND INFORMATION (U.S. CLS. 21, 23, 26, 36 AND 38).

FIRST USE 4-1-2004; IN COMMERCE 4-1-2004.
CAROLINE WOOD, EXAMINING ATTORNEY

CLASS 9—(Continued).

SN 78-358,829. DIGITAL INNOVATIONS, L.L.C., ARLINGTON HEIGHTS, IL. FILED 1-28-2004.

AIRDR.

THE MARK CONSISTS OF STANDARD CHARACTERS WITHOUT CLAIM TO ANY PARTICULAR FONT, STYLE, SIZE, OR COLOR.

FOR BATTERY OPERATED DUST BLOWERS, CANNED AIR AND BATTERY OPERATED LED SOLD AS A COMPONENT THEREOF FOR ILLUMINATING HARD TO SEE AREAS, CO2 OPERATED DUST BLOWERS AND CO2 REPLACEMENT CARTRIDGES THEREFOR, AND BATTERY OPERATED SPINNING BRUSHES FOR REMOVING DUST AND CLEANING ELECTRONIC COMPONENTS AND EQUIPMENT, NAMELY, LASER DISCS, COMPUTERS, AUDIO AND VIDEO COMPONENTS, CD AND DVD PLAYERS, AND GAME SYSTEMS (U.S. CLS. 21, 23, 26, 36 AND 38).

JENNIFER MARTIN, EXAMINING ATTORNEY



SN 78-363,953. FULL SPEED PRODUCTIONS INC., LAS VEGAS, NV. FILED 2-6-2004.

NWWL

THE MARK CONSISTS OF STANDARD CHARACTERS WITHOUT CLAIM TO ANY PARTICULAR FONT, STYLE, SIZE, OR COLOR.

FOR PRE-RECORDED CD ROMS, VIDEO TAPES, LASER DISKS AND DVDS FEATURING WRESTLING SHOWS (U.S. CLS. 21, 23, 26, 36 AND 38).

LINDA MICKLEBURGH, EXAMINING ATTORNEY

CLASS 9—(Continued).

SN 78-364,084. SKIPSNES, STEINAR H., LAS VEGAS, NV.
FILED 2-6-2004.

CLASS 9—(Continued).

SN 78-365,228. SCOTT, BAKER, HUNTINGTON BEACH, CA.
FILED 2-10-2004.

GlovesPlay

GUITARBOY

THE MARK CONSISTS OF STANDARD CHARACTERS WITHOUT CLAIM TO ANY PARTICULAR FONT, STYLE, SIZE, OR COLOR.

FOR VIDEO GAME ACCESSORIES, NAMELY, PADDED VIDEO GAME CONTROLLER COVERS (U.S. CLS. 21, 23, 26, 36 AND 38).

FIRST USE 1-15-2004; IN COMMERCE 1-15-2004.
JIM RINGLE, EXAMINING ATTORNEY

THE MARK CONSISTS OF STANDARD CHARACTERS WITHOUT CLAIM TO ANY PARTICULAR FONT, STYLE, SIZE, OR COLOR.

FOR SERIES OF MUSICAL SOUND RECORDINGS (U.S. CLS. 21, 23, 26, 36 AND 38).

FIRST USE 3-16-1991; IN COMMERCE 11-26-1999.
HEATHER THOMPSON, EXAMINING ATTORNEY

SN 78-364,262. FULL SPEED PRODUCTIONS INC., LAS VEGAS, NV. FILED 2-6-2004.

SN 78-370,705. EBERLE DESIGN, INC., PHOENIX, AZ.
FILED 2-19-2004.



DEFLECTOMETER

NO CLAIM IS MADE TO THE EXCLUSIVE RIGHT TO USE "NAKED WOMEN WRESTLING", APART FROM THE MARK AS SHOWN.

THE STIPPLING IS FOR SHADING PURPOSES ONLY.
FOR PRE-RECORDED CD-ROMS, VIDEO TAPES, LASER DISKS AND DVDS FEATURING WRESTLING SHOWS (U.S. CLS. 21, 23, 26, 36 AND 38).

LINDA MICKLEBURGH, EXAMINING ATTORNEY

THE MARK CONSISTS OF STANDARD CHARACTERS WITHOUT CLAIM TO ANY PARTICULAR FONT, STYLE, SIZE, OR COLOR.

FOR INDUCTIVE LOOP VEHICLE DETECTOR FOR MONITORING VEHICULAR TRAFFIC (U.S. CLS. 21, 23, 26, 36 AND 38).

PAUL F. GAST, EXAMINING ATTORNEY

CLASS 9—(Continued).

SN 78-374,596. BOSTON ACOUSTICS, INC., PEABODY, MA.
FILED 2-26-2004.

CLASS 9—(Continued).

SN 78-374,602. BOSTON ACOUSTICS, INC., BOSTON, MA.
FILED 2-26-2004.

SURESET

LINEARADIAL

THE MARK CONSISTS OF STANDARD CHARACTERS
WITHOUT CLAIM TO ANY PARTICULAR FONT, STYLE,
SIZE, OR COLOR.
FOR ACOUSTIC SPEAKERS (U.S. CLS. 21, 23, 26, 36
AND 38).
ROBERT LORENZO, EXAMINING ATTORNEY

THE MARK CONSISTS OF STANDARD CHARACTERS
WITHOUT CLAIM TO ANY PARTICULAR FONT, STYLE,
SIZE, OR COLOR.
FOR ACOUSTIC SPEAKERS (U.S. CLS. 21, 23, 26, 36
AND 38).
ROBERT LORENZO, EXAMINING ATTORNEY

SN 78-374,600. BOSTON ACOUSTICS, INC., BOSTON, MA.
FILED 2-26-2004.

SN 78-374,605. BOSTON ACOUSTICS, INC., PEABODY, MA.
FILED 2-26-2004.

TWINSTAGE

COILOVER

THE MARK CONSISTS OF STANDARD CHARACTERS
WITHOUT CLAIM TO ANY PARTICULAR FONT, STYLE,
SIZE, OR COLOR.
FOR ACOUSTIC SPEAKERS (U.S. CLS. 21, 23, 26, 36
AND 38).
ROBERT LORENZO, EXAMINING ATTORNEY

THE MARK CONSISTS OF STANDARD CHARACTERS
WITHOUT CLAIM TO ANY PARTICULAR FONT, STYLE,
SIZE, OR COLOR.
FOR ACOUSTIC SPEAKERS (U.S. CLS. 21, 23, 26, 36
AND 38).
ROBERT LORENZO, EXAMINING ATTORNEY

CLASS 9—(Continued).

SN 78-377,562. FUNKWARE PC, LLC, OLDSMAR, FL. FILED 3-3-2004.

CAN YOU DIG IT?

THE MARK CONSISTS OF STANDARD CHARACTERS WITHOUT CLAIM TO ANY PARTICULAR FONT, STYLE, SIZE, OR COLOR.

FOR PERSONAL COMPUTERS AND RELATED ACCESSORIES AND EQUIPMENT, NAMELY FLAT PANEL DISPLAYS, SPEAKERS, HEADPHONES AND UNINTERRUPTIBLE POWER SUPPLIES (U.S. CLS. 21, 23, 26, 36 AND 38).

ERNEST SHOSHO, EXAMINING ATTORNEY

SN 78-378,628. FONG, KENDALL, LOS ALTOS, CA. FILED 3-4-2004.

First Wordz

THE MARK CONSISTS OF STANDARD CHARACTERS WITHOUT CLAIM TO ANY PARTICULAR FONT, STYLE, SIZE, OR COLOR.

FOR COMPUTER CONSUMER SOFTWARE FOR RECORDING AND E-MAILING CHILDREN'S VOICES TO COMPUTERS AND CELLULAR PHONES; PROVIDING DOWNLOADABLE CONSUMER SOFTWARE FOR RECORDING AND E-MAILING CHILDREN'S VOICES TO COMPUTERS AND CELLULAR PHONES (U.S. CLS. 21, 23, 26, 36 AND 38).

RON FAIRBANKS, EXAMINING ATTORNEY

CLASS 9—(Continued).

SN 78-383,594. ORONAFILM INC., WOODLAND HILLS, CA. FILED 3-12-2004.

HOTEL EROTICA

THE MARK CONSISTS OF STANDARD CHARACTERS WITHOUT CLAIM TO ANY PARTICULAR FONT, STYLE, SIZE, OR COLOR.

FOR PRE-RECORDED DVD'S, VIDEOTAPES AND CD'S FEATURING A TELEVISION SERIES (U.S. CLS. 21, 23, 26, 36 AND 38).

LESLEY LAMOTHE, EXAMINING ATTORNEY

SN 78-384,042. GENTILIN, JOHN C., CASTRO VALLEY, CA. FILED 3-14-2004.

RapidXSL Server

THE MARK CONSISTS OF STANDARD CHARACTERS WITHOUT CLAIM TO ANY PARTICULAR FONT, STYLE, SIZE, OR COLOR.

NO CLAIM IS MADE TO THE EXCLUSIVE RIGHT TO USE SERVER, APART FROM THE MARK AS SHOWN.

FOR COMPUTER SOFTWARE PLATFORM FOR USE IN CREATING, CONTROLLING AND MANAGING WEB BASED APPLICATIONS (U.S. CLS. 21, 23, 26, 36 AND 38).

FIRST USE 9-1-2001; IN COMMERCE 9-1-2001.

HOWARD SMIGA, EXAMINING ATTORNEY

SN 78-385,277. PROVIDUS SOFTWARE SOLUTIONS, INC., ROCKVILLE, MD. FILED 3-16-2004.

**ACTIVE RISK
MANAGEMENT**

THE MARK CONSISTS OF STANDARD CHARACTERS WITHOUT CLAIM TO ANY PARTICULAR FONT, STYLE, SIZE, OR COLOR.

NO CLAIM IS MADE TO THE EXCLUSIVE RIGHT TO USE "RISK MANAGEMENT", APART FROM THE MARK AS SHOWN.

FOR COMPUTER SOFTWARE FOR MANAGEMENT OF BUSINESS PROCESSES ASSOCIATED WITH RISK MANAGEMENT AND REGULATORY COMPLIANCE (U.S. CLS. 21, 23, 26, 36 AND 38).

STANLEY I. OSBORNE, EXAMINING ATTORNEY

CLASS 9—(Continued).

SN 78-385,918. CLARIA CORPORATION, REDWOOD CITY, CA. FILED 3-17-2004.

WEBSECUREALERT

THE MARK CONSISTS OF STANDARD CHARACTERS WITHOUT CLAIM TO ANY PARTICULAR FONT, STYLE, SIZE, OR COLOR.

FOR COMPUTER SOFTWARE TO PROVIDE SECURE ACCESS TO A GLOBAL ELECTRONIC COMMUNICATIONS NETWORK AND PREVENT UNAUTHORIZED ACCESS TO COMPUTER NETWORKS (U.S. CLS. 21, 23, 26, 36 AND 38).

LESLEY LAMOTHE, EXAMINING ATTORNEY

CLASS 9—(Continued).

SN 78-386,979. MEL BAY PUBLICATIONS, INC., PACIFIC, MO. FILED 3-18-2004.

YOU CAN TEACH YOURSELF

THE MARK CONSISTS OF STANDARD CHARACTERS WITHOUT CLAIM TO ANY PARTICULAR FONT, STYLE, SIZE, OR COLOR.

OWNER OF U.S. REG. NO. 1,876,567. SEC. 2(F).

FOR AUDIO AND VIDEOTAPES, COMPACT DISCS, DIGITAL VIDEO DISCS, AND CD ROMS, ALL FEATURING MUSIC INSTRUCTION (U.S. CLS. 21, 23, 26, 36 AND 38).

FIRST USE 5-12-1989; IN COMMERCE 5-12-1989. SHARI SHEFFIELD, EXAMINING ATTORNEY

SN 78-389,488. RENAISSANCE CASINO SOLUTIONS, INC., HENDERSON, NV. FILED 3-23-2004.

SN 78-386,535. FRONTLINE PCB SOLUTIONS LTD., YAVNE, ISRAEL, FILED 3-18-2004.



GenFlex

THE MARK GENFLEX APPEARS WITH STYLIZED LETTER 'G' MADE FROM A COMPUTER BELT TYPE CABLE.

FOR DEDICATED COMPUTER AIDED MANUFACTURING SOFTWARE, KNOWN AS CAM SOFTWARE, IN THE FIELD OF PRINTED CIRCUIT BOARD AND ELECTRONICS INDUSTRY (U.S. CLS. 21, 23, 26, 36 AND 38).

FIRST USE 3-1-2004; IN COMMERCE 3-1-2004. PAUL F. GAST, EXAMINING ATTORNEY

RAINING SHAMROCKS

THE MARK CONSISTS OF STANDARD CHARACTERS WITHOUT CLAIM TO ANY PARTICULAR FONT, STYLE, SIZE, OR COLOR.

FOR GAMING EQUIPMENT, NAMELY, SLOT MACHINES, GAMING MACHINES, AND GAME SOFTWARE USED THEREWITH (U.S. CLS. 21, 23, 26, 36 AND 38).

MARY ROSSMAN, EXAMINING ATTORNEY

SN 78-389,492. RENAISSANCE CASINO SOLUTIONS, INC., HENDERSON, NV. FILED 3-23-2004.

SUPER SHAMROCKS

THE MARK CONSISTS OF STANDARD CHARACTERS WITHOUT CLAIM TO ANY PARTICULAR FONT, STYLE, SIZE, OR COLOR.

FOR GAMING EQUIPMENT, NAMELY, SLOT MACHINES, GAMING MACHINES, AND GAME SOFTWARE USED THEREWITH (U.S. CLS. 21, 23, 26, 36 AND 38).

MARY ROSSMAN, EXAMINING ATTORNEY

CLASS 9—(Continued).

SN 78-391,253. ASSETS ANYWHERE, INC., SAN CLEMENTE, CA. FILED 3-26-2004.

CLASS 9—(Continued).

SN 78-400,635. CORRELATION SYSTEMS LTD, TEL AVIV, ISRAEL, FILED 4-13-2004.

ASSETS ANYWHERE

THE MARK CONSISTS OF STANDARD CHARACTERS WITHOUT CLAIM TO ANY PARTICULAR FONT, STYLE, SIZE, OR COLOR.

NO CLAIM IS MADE TO THE EXCLUSIVE RIGHT TO USE ASSETS, APART FROM THE MARK AS SHOWN.

FOR COMPUTER SOFTWARE THAT ALLOWS USERS TO TRACK AND MANAGE TANGIBLE PROPERTY AND CORPORATE DOCUMENTATION (U.S. CLS. 21, 23, 26, 36 AND 38).

BRIDGETT SMITH, EXAMINING ATTORNEY



SN 78-395,135. GUNST, HENRY, SAN FRANCISCO, CA. FILED 4-1-2004.

Xpectrum

THE MARK CONSISTS OF STANDARD CHARACTERS WITHOUT CLAIM TO ANY PARTICULAR FONT, STYLE, SIZE, OR COLOR.

FOR REMOTE CONTROL RADIO RECEIVERS (U.S. CLS. 21, 23, 26, 36 AND 38).

DOMINICK J. SALEMI, EXAMINING ATTORNEY



SN 78-400,873. ORBAZ TECHNOLOGIES, WESTBOROUGH, MA. FILED 4-13-2004.

CamTrip

THE MARK CONSISTS OF STANDARD CHARACTERS WITHOUT CLAIM TO ANY PARTICULAR FONT, STYLE, SIZE, OR COLOR.

FOR COMPUTER SOFTWARE USED TO SIMULATE THE VISUAL EXPERIENCE OF TRAVEL USING A DATABASE OF VIDEO CLIPS OR SIMILAR MEDIA TO DEPICT WHAT WOULD BE SEEN IF SUCH A TRIP HAD BEEN MADE FOR ANY HOME, EDUCATIONAL, BUSINESS OR GOVERNMENTAL PURPOSE THAT INVOLVES LOOKING AT THAT VIDEO SUBJECT MATTER (U.S. CLS. 21, 23, 26, 36 AND 38).

MELISSA SHELLA, EXAMINING ATTORNEY

PARTICLE FLOW TOOLS

THE MARK CONSISTS OF STANDARD CHARACTERS WITHOUT CLAIM TO ANY PARTICULAR FONT, STYLE, SIZE, OR COLOR.

NO CLAIM IS MADE TO THE EXCLUSIVE RIGHT TO USE "PARTICLE" OR "TOOLS", APART FROM THE MARK AS SHOWN.

FOR COMPUTER SOFTWARE FOR GENERATING, ANIMATING AND VISUALIZING COMPUTER GRAPHICS PARTICLE SYSTEMS (U.S. CLS. 21, 23, 26, 36 AND 38).

FIRST USE 6-20-2004; IN COMMERCE 7-28-2004.
JOANNA DUKOVIC, EXAMINING ATTORNEY

CLASS 9—(Continued).

SN 78-401,761. MICROVIEW TECHNOLOGIES PTE LTD., KALLANG BASIN IND. ESTATE, SINGAPORE, FILED 4-14-2004.



FOR COMPUTER SOFTWARE IN THE NATURE OF A VISION OPERATING SOFTWARE SYSTEM FOR USE IN THE FIELD OF DEVELOPMENT OF PRODUCT PROTOTYPES AND FINAL PRODUCTS (U.S. CLS. 21, 23, 26, 36 AND 38).

LEIGH LOWRY, EXAMINING ATTORNEY

CLASS 9—(Continued).

SN 78-407,041. BARTRON MEDICAL IMAGING, LLC, NEW HAVEN, CT. FILED 4-23-2004.



THE MARK CONSISTS OF STANDARD CHARACTERS WITHOUT CLAIM TO ANY PARTICULAR FONT, STYLE, SIZE, OR COLOR.

NO CLAIM IS MADE TO THE EXCLUSIVE RIGHT TO USE "MEDICAL IMAGING MED-SEG", APART FROM THE MARK AS SHOWN.

FOR ELECTRONIC AND SCIENTIFIC APPARATUS, NAMELY, COMPUTER HARDWARE SYSTEMS AND SOFTWARE USED TO ANALYZE X-RAY IMAGES AND IMAGES OF CELLS, BACTERIA, AND PATHOGENS (U.S. CLS. 21, 23, 26, 36 AND 38).

MELISSA SHELLA, EXAMINING ATTORNEY

SN 78-408,074. KEMPER, GERD, VREDEN, FED REP GERMANY, FILED 4-26-2004.



THE MARK CONSISTS OF STANDARD CHARACTERS WITHOUT CLAIM TO ANY PARTICULAR FONT, STYLE, SIZE, OR COLOR.

FOR WELDING HELMETS (U.S. CLS. 21, 23, 26, 36 AND 38).

FIRST USE 1-1-2003; IN COMMERCE 1-1-2003.

LEIGH LOWRY, EXAMINING ATTORNEY

SN 78-409,517. BOOK THONGS, INC., WHEATON, IL. FILED 4-28-2004.



THE MARK CONSISTS OF STANDARD CHARACTERS WITHOUT CLAIM TO ANY PARTICULAR FONT, STYLE, SIZE, OR COLOR.

FOR COMPUTER SOFTWARE DEVELOPMENT TOOLS (U.S. CLS. 21, 23, 26, 36 AND 38).

FIRST USE 1-15-2004; IN COMMERCE 2-5-2004.

JENNIFER KRISP, EXAMINING ATTORNEY

THE MARK CONSISTS OF STANDARD CHARACTERS WITHOUT CLAIM TO ANY PARTICULAR FONT, STYLE, SIZE, OR COLOR.

FOR EYEGLASS CHAINS (U.S. CLS. 21, 23, 26, 36 AND 38).

BRIDGETT SMITH, EXAMINING ATTORNEY

CLASS 9—(Continued).

SN 78-410,005. POWERDSINE LTD, HOD HASHARON, ISRAEL, FILED 4-29-2004.



OWNER OF U.S. REG. NO. 2,201,925.
FOR POWER SUPPLY INTEGRATED CIRCUIT MODULES, POWER SUPPLY CIRCUIT BOARDS PROVIDED WITH INTEGRATED CIRCUITS AND POWER SUPPLY MODULES PROVIDED WITH INTEGRATED CIRCUITS (U.S. CLS. 21, 23, 26, 36 AND 38).
FIRST USE 1-1-1998; IN COMMERCE 1-1-1998.
JASON TURNER, EXAMINING ATTORNEY

SN 78-412,892. HATCH, INC., WINSTON-SALEM, NC. FILED 5-4-2004.

JOURNEYS INTO EARLY MATH

THE MARK CONSISTS OF STANDARD CHARACTERS WITHOUT CLAIM TO ANY PARTICULAR FONT, STYLE, SIZE, OR COLOR.

NO CLAIM IS MADE TO THE EXCLUSIVE RIGHT TO USE "EARLY MATH", APART FROM THE MARK AS SHOWN.

FOR EDUCATIONAL KIT COMPRISED PRIMARILY OF COMPUTER SOFTWARE, AND ALSO INCLUDING MANIPULATIVES AND A TEACHER'S MANUAL, ALL SOLD TOGETHER AS A UNIT, DESIGNED TO INTRODUCE AND BUILD MATH SKILLS FOR CHILDREN IN THE PRESCHOOL AND KINDERGARTEN CLASSROOM (U.S. CLS. 21, 23, 26, 36 AND 38).

WILLIAM P. SHANAHAN, EXAMINING ATTORNEY

SN 78-414,260. SHOW AND PROVE, LLC, SOUTH RIVER, NJ. FILED 5-6-2004.



THE NAME MARC ECKO IDENTIFIES A LIVING INDIVIDUAL WHOSE CONSENT IS OF RECORD.

THE MARK CONSISTS OF MARCK ECKO'S GETTING UP CONTENTS UNDER PRESSURE WITH AN "X" DESIGN WITH A LIQUID DRIPPING OFF OF IT.

FOR INTERACTIVE VIDEO GAME PROGRAMS AND COMPUTER GAME PROGRAMS (U.S. CLS. 21, 23, 26, 36 AND 38).

INGA ERVIN, EXAMINING ATTORNEY

CLASS 9—(Continued).

SN 78-415,966. EMERSON ELECTRIC CO., ST. LOUIS, MO. FILED 5-10-2004.

NAVITRACK SCOUT

THE MARK CONSISTS OF STANDARD CHARACTERS WITHOUT CLAIM TO ANY PARTICULAR FONT, STYLE, SIZE, OR COLOR.

OWNER OF U.S. REG. NO. 2,799,243.
FOR ELECTRONIC DEVICES FOR LOCATING PIPES AND LINES (U.S. CLS. 21, 23, 26, 36 AND 38).
CHRISTOPHER BUONGIORNO, EXAMINING ATTORNEY

SN 78-419,056. SABINE INC., ALACHUA, FL. FILED 5-14-2004.

SMARTFILTERS

THE MARK CONSISTS OF STANDARD CHARACTERS WITHOUT CLAIM TO ANY PARTICULAR FONT, STYLE, SIZE, OR COLOR.

FOR WIRELESS MICROPHONES, AUTOMATIC ACOUSTICAL FEEDBACK CONTROLLERS, ELECTRONIC FEEDBACK CONTROLLERS, ELECTRONIC EQUALIZERS, ELECTRONIC EQUALIZER/FEEDBACK CONTROLLERS FOR USE IN CONNECTION WITH THE REPRODUCTION AND DISTRIBUTION OF AUDIO SIGNALS, DIGITAL SIGNAL PROCESSORS (U.S. CLS. 21, 23, 26, 36 AND 38).

FIRST USE 4-30-2004; IN COMMERCE 5-7-2004.

STANLEY I. OSBORNE, EXAMINING ATTORNEY

CLASS 9—(Continued).

SN 78-419,237. WHA YU INDUSTRIAL CO., LTD., HSIN CHU CITY, TAIWAN, FILED 5-14-2004.



The logo features a stylized 'M' symbol followed by the word 'gear' in a lowercase, sans-serif font.

FOR DIGITAL AUDIO PLAYERS, PORTABLE DIGITAL AUDIO PLAYERS, MP3 PLAYERS, WIRELESS MP3 PLAYERS, PARTS AND ACCESSORIES FOR THE AFOREMENTIONED GOODS; ELECTRICAL EXTENSION CORDS, ELECTRICAL POWER CORDS, TELEPHONE CORDS, ELECTRICAL SURGE PROTECTORS, COMPUTER CONNECTION WIRES AND CABLES, COMPUTER USB CABLES, VIDEO CONNECTION WIRES AND CABLES, DATA TRANSMISSION LINES, COAXIAL CABLE, FIBER OPTIC WIRE AND CABLE, AUDIO AND VIDEO ANTENNAS, AUTOMOBILE ANTENNAS, ANTENNA STANDS AND RACKS, AUDIO RECEIVERS, RADIO RECEIVERS, AUDIO SPEAKERS, COMPUTER AUDIO SPEAKERS, HEADPHONES, COMPUTER MEMORY, REMOVABLE COMPUTER MEMORY CARDS, COMPUTER HARD DRIVES, PORTABLE COMPUTER HARD DRIVES, COMPUTER MODEMS, CABLE MODEMS, COMPUTER NETWORK CARDS AND ADAPTERS, WIRELESS COMPUTER NETWORK ADAPTERS, COMPUTER NETWORK SIGNAL INTENSIFIERS, DIGITAL COMPUTER INPUT/OUTPUT CARDS, FREQUENCY MODULATION SIGNAL PRODUCERS, BILLBOARD MONITORS, ELECTRONIC SIGNAL TRANSPONDERS, ELECTRONIC SIGNAL INTENSIFIERS (U.S. CLS. 21, 23, 26, 36 AND 38).

FIRST USE 4-0-2004; IN COMMERCE 4-0-2004.
CHERYL CLAYTON, EXAMINING ATTORNEY

SN 78-419,713. SAFE FIRE DETECTION, INC., MONROE, NC. FILED 5-17-2004.



The logo consists of the text 'Pro Locator Fire Sniffer' in a serif font, with 'Pro' and 'Sniffer' on separate lines and 'Locator Fire' in the middle.

THE MARK CONSISTS OF STANDARD CHARACTERS WITHOUT CLAIM TO ANY PARTICULAR FONT, STYLE, SIZE, OR COLOR.

NO CLAIM IS MADE TO THE EXCLUSIVE RIGHT TO USE "FIRE", APART FROM THE MARK AS SHOWN, FOR ULTRA SENSITIVE AIR SAMPLING SMOKE DETECTOR (U.S. CLS. 21, 23, 26, 36 AND 38).

FIRST USE 12-15-2003; IN COMMERCE 12-15-2003.
LAURA KOVAISKY, EXAMINING ATTORNEY

CLASS 9—(Continued).

SN 78-419,834. THREE OCEANS DISTRIBUTION, LLC, COSTA MESA, CA. FILED 5-17-2004.

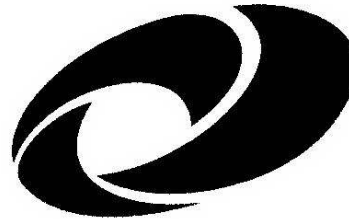

THE MARK CONSISTS OF OFF AXIS TRI-WAVE LOGO. FOR SUNGLASSES (U.S. CLS. 21, 23, 26, 36 AND 38).
GEOFFREY FOSDICK, EXAMINING ATTORNEY

SN 78-420,740. E2INTERACTIVE, INC., ATLANTA, GA. FILED 5-18-2004.



The logo consists of the word 'FASTTOUCH' in a bold, uppercase, sans-serif font.

THE MARK CONSISTS OF STANDARD CHARACTERS WITHOUT CLAIM TO ANY PARTICULAR FONT, STYLE, SIZE, OR COLOR.

FOR ELECTRONIC POINT-OF-SALE TERMINAL FOR RETAIL TRANSACTIONS USING A COMPUTER-BASED NETWORK (U.S. CLS. 21, 23, 26, 36 AND 38).

WON TEAK OH, EXAMINING ATTORNEY

CLASS 9—(Continued).

SN 78-421,711. FORENSIC TECHNOLOGY WAI INC., MONTREAL, QUEBEC, CANADA, FILED 5-19-2004.

hard

THE MARK CONSISTS OF THE STYLIZED LETTERS B, A, R, D EACH SEPARATED BY THE PUNCTUATION SHOWN.

FOR INTEGRATED CRIMINAL JUSTICE FORENSIC INFORMATION CASE MANAGEMENT SYSTEM CONSISTING OF COMPUTER HARDWARE AND SOFTWARE FOR HANDLING FORENSIC EVIDENCE AND OTHER CRIME RELATED INFORMATION AND SPECIFICALLY EXCLUDING ANY MEDICAL EVIDENCE OR INFORMATION OTHER THAN NORMALLY USED IN PATHOLOGY CRIME LABORATORIES (U.S. CLS. 21, 23, 26, 36 AND 38).

KATHY DE JONGE, EXAMINING ATTORNEY

SN 78-421,712. MULTIMEDIA GAMES, INC., AUSTIN, TX. FILED 5-19-2004.

Casino Commander

THE MARK CONSISTS OF STANDARD CHARACTERS WITHOUT CLAIM TO ANY PARTICULAR FONT, STYLE, SIZE, OR COLOR.

NO CLAIM IS MADE TO THE EXCLUSIVE RIGHT TO USE "CASINO", APART FROM THE MARK AS SHOWN.

FOR COMPUTER OPERATING SYSTEMS FOR CONTROL AND PLAY OF ELECTRONIC GAMING MACHINES (U.S. CLS. 21, 23, 26, 36 AND 38).

CHERYL CLAYTON, EXAMINING ATTORNEY

CLASS 9—(Continued).

SN 78-421,905. MONTALTO, BARRY, METUCHEN, NJ. FILED 5-19-2004.

Optique Unique

THE MARK CONSISTS OF STANDARD CHARACTERS WITHOUT CLAIM TO ANY PARTICULAR FONT, STYLE, SIZE, OR COLOR.

THE ENGLISH TRANSLATION OF THE WORD OPTIQUE IN THE MARK IS "OPTICAL".

FOR PROTECTIVE EYEWEAR; OPTICAL GLASSES; READING GLASSES; OPTICAL FRAMES; OPTICAL LENSES; SUNGLASSES (U.S. CLS. 21, 23, 26, 36 AND 38).

CATHERINE CAIN, EXAMINING ATTORNEY

SN 78-422,035. COMPUTICA, INC., RICHMOND, VA. FILED 5-20-2004.

**TOTAL PARTY
PLANNER**

THE MARK CONSISTS OF STANDARD CHARACTERS WITHOUT CLAIM TO ANY PARTICULAR FONT, STYLE, SIZE, OR COLOR.

NO CLAIM IS MADE TO THE EXCLUSIVE RIGHT TO USE "PARTY PLANNER", APART FROM THE MARK AS SHOWN.

FOR COMPUTER SOFTWARE TO MANAGE CATERING AND BANQUET MANAGEMENT (U.S. CLS. 21, 23, 26, 36 AND 38).

FIRST USE 3-10-1998; IN COMMERCE 3-10-1998.

DOMINIC J. FERRAIUOLO, EXAMINING ATTORNEY

CLASS 9—(Continued).

SN 78-422,606. RAZA MICROELECTRONICS, INC., CUPERTINO, CA. FILED 5-20-2004.

ADVANCED PROCESSOR SOLUTIONS

THE MARK CONSISTS OF STANDARD CHARACTERS WITHOUT CLAIM TO ANY PARTICULAR FONT, STYLE, SIZE, OR COLOR.

NO CLAIM IS MADE TO THE EXCLUSIVE RIGHT TO USE "ADVANCED PROCESSOR", APART FROM THE MARK AS SHOWN.

FOR INTEGRATED CIRCUITS; FIBER OPTICS; COMPUTERS; TELECOMMUNICATION SYSTEMS, NAMELY, TELECOMMUNICATION SWITCHES, INTERFACE CIRCUITS, HUBS, ROUTERS, AND MODEMS; COMPUTER SOFTWARE FOR TELECOMMUNICATIONS SYSTEMS, NAMELY, FOR FACILITATING OPERATION OF TELECOMMUNICATION SWITCHES, INTERFACE CIRCUITS, HUBS, ROUTERS, AND MODEMS (U.S. CLS. 21, 23, 26, 36 AND 38).

JOHN E. MICHOS, EXAMINING ATTORNEY

CLASS 9—(Continued).

SN 78-423,555. MILTENYI BIOTEC GMBH, BERGISCH GLADBACH, FED REP GERMANY, FILED 5-24-2004.

QUANTAMACS

THE MARK CONSISTS OF STANDARD CHARACTERS WITHOUT CLAIM TO ANY PARTICULAR FONT, STYLE, SIZE, OR COLOR.

FOR LABORATORY EQUIPMENT, NAMELY, CYTOMETERS USED TO MEASURE PHYSICAL AND/OR CHEMICAL CHARACTERISTICS OF CELLS AND OTHER PARTICLES AS THEY MOVE, OR FLOW, IN LIQUID SUSPENSIONS (U.S. CLS. 21, 23, 26, 36 AND 38).

PAULA MAYS, EXAMINING ATTORNEY

SN 78-423,066. BAYER AKTIENGESELLSCHAFT, LEVERKUSEN-BAYERWERK, FED REP GERMANY, FILED 5-21-2004.

SPECTROBAY

THE MARK CONSISTS OF STANDARD CHARACTERS WITHOUT CLAIM TO ANY PARTICULAR FONT, STYLE, SIZE, OR COLOR.

FOR SCIENTIFIC APPARATUS AND DEVICES FOR RESEARCH IN LABORATORIES, NAMELY, LABORATORY AND PROCESS CHROMATOGRAPHS; LABORATORY AND PROCESS SPECTROMETERS; DATA PROCESSING DEVICES AND SOFTWARE FOR THE CONTROL AND CONNECTION OF ANALYTICAL DEVICES, LABORATORY AND PROCESS CHROMATOGRAPHS, AND LABORATORY AND PROCESS SPECTROMETERS TO PROCESS CONTROL SYSTEMS (U.S. CLS. 21, 23, 26, 36 AND 38).

JOHN SCHUYLER YARD, EXAMINING ATTORNEY

SN 78-423,556. MILTENYI BIOTEC GMBH, BERGISCH GLADBACH, FED REP GERMANY, FILED 5-24-2004.

QUANTIMACS

THE MARK CONSISTS OF STANDARD CHARACTERS WITHOUT CLAIM TO ANY PARTICULAR FONT, STYLE, SIZE, OR COLOR.

FOR LABORATORY EQUIPMENT, NAMELY, CYTOMETERS USED TO MEASURE PHYSICAL AND/OR CHEMICAL CHARACTERISTICS OF CELLS AND OTHER PARTICLES AS THEY MOVE, OR FLOW, IN LIQUID SUSPENSIONS (U.S. CLS. 21, 23, 26, 36 AND 38).

PAULA MAYS, EXAMINING ATTORNEY

CLASS 9—(Continued).

SN 78-425,002. MAG-TEK, INC., CARSON, CA. FILED 5-25-2004.

MAGNE PRINT

THE MARK CONSISTS OF STANDARD CHARACTERS WITHOUT CLAIM TO ANY PARTICULAR FONT, STYLE, SIZE, OR COLOR.

FOR MAGNETIC STRIPE READERS, MAGNETIC STRIPE READING CIRCUITRY, AND SOFTWARE FOR ANALYZING AND COMPARING MAGNETIC STRIPES (U.S. CLS. 21, 23, 26, 36 AND 38).

MAUREEN DALL, EXAMINING ATTORNEY

SN 78-425,162. MINE SAFETY APPLIANCES COMPANY, PITTSBURGH, PA. FILED 5-26-2004.

INTIMIDATOR 2020

THE MARK CONSISTS OF STANDARD CHARACTERS WITHOUT CLAIM TO ANY PARTICULAR FONT, STYLE, SIZE, OR COLOR.

FOR PROTECTIVE HELMETS FOR FIREFIGHTING AND OTHER RESCUE PERSONNEL (U.S. CLS. 21, 23, 26, 36 AND 38).

RICHARD WHITE, EXAMINING ATTORNEY

SN 78-425,487. HUANG, CHANG-FU, FREMONT, CA. FILED 5-26-2004.

TOP RAM

NO CLAIM IS MADE TO THE EXCLUSIVE RIGHT TO USE RAM, APART FROM THE MARK AS SHOWN.

FOR COMPUTER MEMORY, MULTIMEDIA CARDS, SECURE DIGITAL (SD) CARDS, MEMORY EXPANSION MODULE, UNIVERSAL SERIAL BUS (USB) FLASH DRIVE, NOTEBOOK COMPUTER MEMORY, DOUBLE DATA RATE (DDR) AND DDR II MEMORY, SMALL OUTLINE DUAL INLINE MEMORY MODULE (SODIMM) (U.S. CLS. 21, 23, 26, 36 AND 38).

ESTHER BELENKER, EXAMINING ATTORNEY

CLASS 9—(Continued).

SN 78-425,490. PHENOMENEX, INC., TORRANCE, CA. FILED 5-26-2004.

LUNA

THE MARK CONSISTS OF STANDARD CHARACTERS WITHOUT CLAIM TO ANY PARTICULAR FONT, STYLE, SIZE, OR COLOR.

FOR LIQUID CHROMATOGRAPHY COLUMNS (U.S. CLS. 21, 23, 26, 36 AND 38).

FIRST USE 7-31-1995; IN COMMERCE 7-31-1995.

MIDGE BUTLER, EXAMINING ATTORNEY

SN 78-425,499. FAIRCHILD SEMICONDUCTOR CORPORATION, SOUTH PORTLAND, ME. FILED 5-26-2004.

the **power**
franchise

OWNER OF U.S. REG. NO. 2,757,476.

THE MARK CONSISTS OF THE WORDS THE POWER FRANCHISE IN STYLIZED FORM, INCLUDING A DESIGN CONSISTING OF A CIRCLE BROKEN AT THE TOP WITH A VERTICAL LINE THROUGH THE BREAK IN THE CIRCLE SUBSTITUTED FOR THE LETTER "O" IN THE WORD POWER.

FOR SEMICONDUCTOR DEVICES (U.S. CLS. 21, 23, 26, 36 AND 38).

SCOTT OSLICK, EXAMINING ATTORNEY

CLASS 9—(Continued).

SN 78-426,063. JMI REALTY, INC, SAN DIEGO, CA. FILED 5-27-2004.

CLASS 9—(Continued).

SN 78-427,820. METRICVISION, INC., NEWINGTON, VA. FILED 6-1-2004.

**WESTERN METAL
SUPPLY COMPANY**

METRICVISION

THE MARK CONSISTS OF STANDARD CHARACTERS WITHOUT CLAIM TO ANY PARTICULAR FONT, STYLE, SIZE, OR COLOR.

NO CLAIM IS MADE TO THE EXCLUSIVE RIGHT TO USE "COMPANY", APART FROM THE MARK AS SHOWN. FOR ENTERPRISE-WIDE COMPUTER SOFTWARE THAT ENHANCES INFORMATION TECHNOLOGY DEPARTMENTS TO SERVICE THEIR USERS AND CUSTOMERS (U.S. CLS. 21, 23, 26, 36 AND 38).

KARANENDRA S. CHHINA, EXAMINING ATTORNEY

THE MARK CONSISTS OF STANDARD CHARACTERS WITHOUT CLAIM TO ANY PARTICULAR FONT, STYLE, SIZE, OR COLOR.

FOR MEASURING SYSTEM COMPRISED OF AN INFRARED LASER OVEN, INTEGRATED OPTICS, WAVE FORM AND RANGING ELECTRONICS, MOTION CONTROL ELECTRONICS AND POINTING MIRROR ASSEMBLY TOGETHER WITH COMPUTER SOFTWARE AND EMBEDDED COMPUTER CODE FOR ALL OF THE FOREGOING THAT INSPECTS, DIGITIZES, SCANS AND MEASURES OBJECTS IN THREE DIMENSIONAL SPACE (U.S. CLS. 21, 23, 26, 36 AND 38).

FIRST USE 1-4-1999; IN COMMERCE 1-4-1999.
RAUL CORDOVA, EXAMINING ATTORNEY

SN 78-427,328. KUZYK, ROMAN, TRENTON, NJ. FILED 5-28-2004.

SN 78-427,821. SARIN TECHNOLOGIES, LTD., RAMATGAN, ISRAEL, FILED 6-1-2004.

CytoTherm

DIAEXPERT

THE MARK CONSISTS OF STANDARD CHARACTERS WITHOUT CLAIM TO ANY PARTICULAR FONT, STYLE, SIZE, OR COLOR.

FOR LABORATORY EQUIPMENT FOR THAWING, HEATING OR COOLING BLOOD, PLASMA AND OTHER BIOLOGICAL MATERIALS, NAMELY, WATER BATHS, CHILLERS, WARMING AIR BLOWERS, MICROWAVE OVENS, AND DRY THAWING WARMERS THAT PASS LIQUIDS THROUGH A BLADDER (U.S. CLS. 21, 23, 26, 36 AND 38).

FIRST USE 4-20-1982; IN COMMERCE 4-20-1982.
RONALD MCMORROW, EXAMINING ATTORNEY

THE MARK CONSISTS OF STANDARD CHARACTERS WITHOUT CLAIM TO ANY PARTICULAR FONT, STYLE, SIZE, OR COLOR.

FOR HARDWARE AND COMPUTER SOFTWARE FOR MEASURING AND PLANNING DIAMONDS AND GEMSTONES (U.S. CLS. 21, 23, 26, 36 AND 38).

FIRST USE 12-31-1996; IN COMMERCE 12-31-1996.
RAUL CORDOVA, EXAMINING ATTORNEY

CLASS 9—(Continued).

SN 78-427,826. SARIN TECHNOLOGIES, LTD., RAMAT-GAN, ISRAEL, FILED 6-1-2004.

DIAMARK

THE MARK CONSISTS OF STANDARD CHARACTERS WITHOUT CLAIM TO ANY PARTICULAR FONT, STYLE, SIZE, OR COLOR.

FOR HARDWARE AND COMPUTER SOFTWARE FOR LASER MARKING DIAMONDS AND GEMSTONES (U.S. CLS. 21, 23, 26, 36 AND 38).

FIRST USE 12-31-2000; IN COMMERCE 12-31-2000.
RAUL CORDOVA, EXAMINING ATTORNEY

SN 78-427,993. BRUNSWICK CORPORATION, LAKE FOREST, IL. FILED 6-1-2004.

REDBERRI

THE MARK CONSISTS OF STANDARD CHARACTERS WITHOUT CLAIM TO ANY PARTICULAR FONT, STYLE, SIZE, OR COLOR.

FOR COMPUTER SOFTWARE AND COMPUTER PROGRAMS ENABLING DATA INTEGRATION VIA A WORLDWIDE COMPUTER NETWORK AND OTHER NETWORKS (U.S. CLS. 21, 23, 26, 36 AND 38).

BARBARA A. GOLD, EXAMINING ATTORNEY

CLASS 9—(Continued).

SN 78-428,198. NOMIS SOLUTIONS, INC., SAN BRUNO, CA. FILED 6-1-2004.

NOMIS SOLUTIONS

THE MARK CONSISTS OF STANDARD CHARACTERS WITHOUT CLAIM TO ANY PARTICULAR FONT, STYLE, SIZE, OR COLOR.

NO CLAIM IS MADE TO THE EXCLUSIVE RIGHT TO USE SOLUTIONS, APART FROM THE MARK AS SHOWN.

FOR COMPUTER SOFTWARE FOR PRICING ANALYSIS IN THE FINANCIAL SERVICES INDUSTRY (U.S. CLS. 21, 23, 26, 36 AND 38).

TARAH HARDY, EXAMINING ATTORNEY

SN 78-428,385. INNOTEK, INC., GARRETT, IN. FILED 6-2-2004.

CONSTELLATION

THE MARK CONSISTS OF STANDARD CHARACTERS WITHOUT CLAIM TO ANY PARTICULAR FONT, STYLE, SIZE, OR COLOR.

FOR ELECTRONIC ANIMAL CONFINEMENT UNIT COMPRISING TRANSMITTERS, ELECTRICAL TRANSFORMERS, WIRES, AND RECEIVER COLLARS (U.S. CLS. 21, 23, 26, 36 AND 38).

MIDGE BUTLER, EXAMINING ATTORNEY

SN 78-428,673. BRIO POWER PRODUCTS, LLC, AUSTIN, TX. FILED 6-2-2004.

brio

POWER PRODUCTS, LLC

NO CLAIM IS MADE TO THE EXCLUSIVE RIGHT TO USE POWER PRODUCTS, LLC, APART FROM THE MARK AS SHOWN.

THE ENGLISH TRANSLATION OF BRIO IS "VIGOR", "SPIRIT" OR "VITALITY".

FOR SURGE SUPPRESSION EQUIPMENT, NAMELY, VOLTAGE SURGE PROTECTORS AND VOLTAGE SURGE SUPPRESSORS (U.S. CLS. 21, 23, 26, 36 AND 38).

NICHOLAS ALTREE, EXAMINING ATTORNEY

CLASS 9—(Continued).

SN 78-428,910. TALONSOFT, INC., BALTIMORE, MD. FILED 6-2-2004.

CLASS 9—(Continued).

SN 78-429,110. EN TECHNOLOGY CORPORATION, NEWPORT, NH. FILED 6-3-2004.

Maximum Underworld

THE MARK CONSISTS OF STANDARD CHARACTERS WITHOUT CLAIM TO ANY PARTICULAR FONT, STYLE, SIZE, OR COLOR.
FOR SOFTWARE COMPUTER GAMES (U.S. CLS. 21, 23, 26, 36 AND 38).
BRIDGETT SMITH, EXAMINING ATTORNEY

OMNISNAKE

THE MARK CONSISTS OF STANDARD CHARACTERS WITHOUT CLAIM TO ANY PARTICULAR FONT, STYLE, SIZE, OR COLOR.
FOR COMBINATION OF A BREAK-OUT BOX AND A STAGE BOX FOR TRANSPORTING MULTIPLE AUDIO SIGNALS; ANALOG-TO-DIGITAL CONVERTER/MULTI- PLEXER BOX AND DE-MULTIPLYER BOX SOLD AS A UNIT (U.S. CLS. 21, 23, 26, 36 AND 38).
MIDGE BUTLER, EXAMINING ATTORNEY

SN 78-429,291. TALONSOFT, BALTIMORE, MD. FILED 6-3-2004.

SN 78-428,934. FINIS, INC., LIVERMORE, CA. FILED 6-2-2004.

Maximum Tycoon

THE MARK CONSISTS OF STANDARD CHARACTERS WITHOUT CLAIM TO ANY PARTICULAR FONT, STYLE, SIZE, OR COLOR.
FOR SOFTWARE COMPUTER GAMES (U.S. CLS. 21, 23, 26, 36 AND 38).
BRIDGETT SMITH, EXAMINING ATTORNEY

SwiMP3

SN 78-429,326. TALONSOFT, BALTIMORE, MD. FILED 6-3-2004.

Maximum Action

THE MARK CONSISTS OF STANDARD CHARACTERS WITHOUT CLAIM TO ANY PARTICULAR FONT, STYLE, SIZE, OR COLOR.
FOR PORTABLE LISTENING DEVICES, NAMELY, MP3 PLAYERS (U.S. CLS. 21, 23, 26, 36 AND 38).
NICHOLAS ALTREE, EXAMINING ATTORNEY

THE MARK CONSISTS OF STANDARD CHARACTERS WITHOUT CLAIM TO ANY PARTICULAR FONT, STYLE, SIZE, OR COLOR.
FOR SOFTWARE COMPUTER GAMES (U.S. CLS. 21, 23, 26, 36 AND 38).
BRIDGETT SMITH, EXAMINING ATTORNEY

CLASS 9—(Continued).

SN 78-429,375. EN TECHNOLOGY CORPORATION, NEWPORT, NH. FILED 6-3-2004.

MAESTRO SERIES

THE MARK CONSISTS OF STANDARD CHARACTERS WITHOUT CLAIM TO ANY PARTICULAR FONT, STYLE, SIZE, OR COLOR.

NO CLAIM IS MADE TO THE EXCLUSIVE RIGHT TO USE "SERIES", APART FROM THE MARK AS SHOWN.

THE FOREIGN WORDING IN THE MARK TRANSLATES INTO ENGLISH AS TEACHER.

FOR ANALOG-TO-DIGITAL AND DIGITAL-TO-ANALOG CONVERTERS (U.S. CLS. 21, 23, 26, 36 AND 38).

FIRST USE 4-30-2003; IN COMMERCE 4-30-2003.

RICHARD A. STRASER, EXAMINING ATTORNEY

CLASS 9—(Continued).

SN 78-429,833. OSMAN, WAYNE H., GREENFIELD, IN. FILED 6-4-2004.

Debris Music

THE MARK CONSISTS OF STANDARD CHARACTERS WITHOUT CLAIM TO ANY PARTICULAR FONT, STYLE, SIZE, OR COLOR.

NO CLAIM IS MADE TO THE EXCLUSIVE RIGHT TO USE "MUSIC", APART FROM THE MARK AS SHOWN.

FOR AUDIO RECORDING FEATURING MUSIC (U.S. CLS. 21, 23, 26, 36 AND 38).

FLORENTINA BLANDU, EXAMINING ATTORNEY

SN 78-430,196. FASKI, JEFFREY FRANCIS, WESTON, CT. FILED 6-4-2004.

SN 78-429,637. KENNETH A ROSE, KLAMATH FALLS, OR. FILED 6-3-2004.

ADVENTURE**Visualmarkets**

THE MARK CONSISTS OF STANDARD CHARACTERS WITHOUT CLAIM TO ANY PARTICULAR FONT, STYLE, SIZE, OR COLOR.

FOR SOFTWARE FOR DAYTRADING (U.S. CLS. 21, 23, 26, 36 AND 38).

FIRST USE 8-1-2003; IN COMMERCE 1-19-2004.

JULIA HARDY COFIELD, EXAMINING ATTORNEY

THE MARK CONSISTS OF STANDARD CHARACTERS WITHOUT CLAIM TO ANY PARTICULAR FONT, STYLE, SIZE, OR COLOR.

FOR COMPUTER SOFTWARE FOR PROVIDING FUNCTIONALITY FOR WEBSITES WHEREBY ELECTRONIC ADVERTISEMENTS OR OTHER INFORMATION IN VARIOUS SIZES AND FILE FORMATS CAN BE DEFINED, ORGANIZED AND THEN DISPLAYED ON ONE OR MORE WEB PAGES ACCORDING TO A DEFINED SCHEDULE AND WHERE REPORTING IS PROVIDED, INCLUDING BUT NOT LIMITED TO, THE NUMBER OF AD IMPRESSIONS AND AD CLICK-THRU FOR A GIVEN AD OR CAMPAIGN (U.S. CLS. 21, 23, 26, 36 AND 38).

FIRST USE 3-24-2003; IN COMMERCE 9-1-2003.

BARNEY CHARLON, EXAMINING ATTORNEY

CLASS 9—(Continued).

SN 78-430,251. DELACRUZ, VALERIE, NISKAYUNA, NY. FILED 6-4-2004.

My Girlfriends Quilt

THE MARK CONSISTS OF STANDARD CHARACTERS WITHOUT CLAIM TO ANY PARTICULAR FONT, STYLE, SIZE, OR COLOR.
FOR SOUND AND VIDEO RECORDINGS FEATURING MUSIC (U.S. CLS. 21, 23, 26, 36 AND 38).
GINA HAYES, EXAMINING ATTORNEY

SN 78-430,336. ROPER SCIENTIFIC, INC., TUSCON, AZ. FILED 6-4-2004.

PIXIS

THE MARK CONSISTS OF STANDARD CHARACTERS WITHOUT CLAIM TO ANY PARTICULAR FONT, STYLE, SIZE, OR COLOR.
FOR ELECTRONIC INSTRUMENTS AND SCIENTIFIC EQUIPMENT, NAMELY, CAMERAS, DIGITAL CAMERAS, AND SPECTROMETERS (U.S. CLS. 21, 23, 26, 36 AND 38).
FIRST USE 7-1-2004; IN COMMERCE 7-1-2004.
AMY ALFIERI, EXAMINING ATTORNEY

CLASS 9—(Continued).

SN 78-430,524. TALONSOFT, BALTIMORE, MD. FILED 6-5-2004.

Maximum Strategy

THE MARK CONSISTS OF STANDARD CHARACTERS WITHOUT CLAIM TO ANY PARTICULAR FONT, STYLE, SIZE, OR COLOR.
NO CLAIM IS MADE TO THE EXCLUSIVE RIGHT TO USE STRATEGY, APART FROM THE MARK AS SHOWN.
FOR COMPUTER GAME SOFTWARE (U.S. CLS. 21, 23, 26, 36 AND 38).
BRIDGETT SMITH, EXAMINING ATTORNEY

SN 78-430,880. TALONSOFT, BALTIMORE, MD. FILED 6-7-2004.

Ultimate Tycoon Pack

THE MARK CONSISTS OF STANDARD CHARACTERS WITHOUT CLAIM TO ANY PARTICULAR FONT, STYLE, SIZE, OR COLOR.
NO CLAIM IS MADE TO THE EXCLUSIVE RIGHT TO USE PACK, APART FROM THE MARK AS SHOWN.
FOR COMPUTER GAME SOFTWARE (U.S. CLS. 21, 23, 26, 36 AND 38).
BRIDGETT SMITH, EXAMINING ATTORNEY

SN 78-430,889. TALONSOFT, BALTIMORE, MD. FILED 6-7-2004.

Maximum Rescue

THE MARK CONSISTS OF STANDARD CHARACTERS WITHOUT CLAIM TO ANY PARTICULAR FONT, STYLE, SIZE, OR COLOR.
FOR COMPUTER GAME SOFTWARE (U.S. CLS. 21, 23, 26, 36 AND 38).
BRIDGETT SMITH, EXAMINING ATTORNEY

CLASS 9—(Continued).

SN 78-431,158. ILLINOIS TOOL WORKS INC., GLENVIEW, IL. FILED 6-7-2004.

CLASS 9—(Continued).

SN 78-431,838. XEROX CORPORATION, STAMFORD, CT. FILED 6-8-2004.

WAVEWRITER

THE MARK CONSISTS OF STANDARD CHARACTERS WITHOUT CLAIM TO ANY PARTICULAR FONT, STYLE, SIZE, OR COLOR.

FOR SOFTWARE FOR CONTROLLING WELDING MACHINES (U.S. CLS. 21, 23, 26, 36 AND 38).
FIRST USE 10-0-2003; IN COMMERCE 10-0-2003.
CAROL SPILS, EXAMINING ATTORNEY

THE MARK CONSISTS OF TWO CONNECTED STYLIZED LOWER CASE "F" LETTERS.

FOR LASER PRINTERS, COMPUTER PRINTERS, INKJET PRINTERS, DIGITAL PRESSES, MULTIFUNCTIONAL DEVICES COMPOSED OF PRINTER, PHOTOCOPIER, OPTICAL CHARACTER RECOGNITION SCANNER AND FACSIMILE MACHINE, COMPUTER SOFTWARE FOR IMAGING; FOR ACCESS, DISTRIBUTION OF MANAGEMENT OF INFORMATION STORED ON DATABASES; FOR OPERATING SYSTEMS; FOR MANAGEMENT OF COMPUTER NETWORKS; FOR MANAGEMENT AND OPERATION OF PRINTERS AND PRINTER NETWORKS, FOR OPTICAL CHARACTER RECOGNITION; FOR WORKFLOW MANAGEMENT; AND FOR DATA MERGING (U.S. CLS. 21, 23, 26, 36 AND 38).

WILLIAM BRECKENFELD, EXAMINING ATTORNEY

SN 78-431,730. MICROTEK INTERNATIONAL INC., HSINCHU, TAIWAN, FILED 6-8-2004.

SN 78-431,971. THUMBWORKS, INC., TUSTIN, CA. FILED 6-8-2004.

SCAN-IN-DEX**CELLTOONS**

THE MARK CONSISTS OF STANDARD CHARACTERS WITHOUT CLAIM TO ANY PARTICULAR FONT, STYLE, SIZE, OR COLOR.

FOR SCANNERS, BUSINESS CARD SCANNERS, COMPUTER OPERATING SOFTWARE USED IN SCANNERS, COMPUTER OPERATING SOFTWARE USED IN BUSINESS CARD RECOGNITION AND MANAGEMENT SYSTEM (U.S. CLS. 21, 23, 26, 36 AND 38).
CHRISIE B. KING, EXAMINING ATTORNEY

THE MARK CONSISTS OF STANDARD CHARACTERS WITHOUT CLAIM TO ANY PARTICULAR FONT, STYLE, SIZE, OR COLOR.

FOR SOFTWARE APPLICATION THAT PLAYS ANIMATIONS, PARTICULARLY ON A CELL PHONE (U.S. CLS. 21, 23, 26, 36 AND 38).
KIMBERLY FRYE, EXAMINING ATTORNEY

CLASS 9—(Continued).

SN 78-432,020. NYE, BLAINE F. JR., SAN RAMON, CA. FILED 6-8-2004.

CLASS 9—(Continued).

SN 78-433,061. WILDSEED LTD., KIRKLAND, WA. FILED 6-10-2004.

MobileScore

SPEED LIGHTS

THE MARK CONSISTS OF STANDARD CHARACTERS WITHOUT CLAIM TO ANY PARTICULAR FONT, STYLE, SIZE, OR COLOR.

FOR COMPUTER SOFTWARE FOR THE COLLECTION, EDITING, ORGANIZING, MODIFYING, TRANSMISSION, STORAGE AND SHARING OF DATA AND INFORMATION USING MOBILE, WIRELESS HAND-HELD COMPUTERS, SERVERS AND DESKTOP COMPUTERS (U.S. CLS. 21, 23, 26, 36 AND 38).

WILLIAM BRECKENFELD, EXAMINING ATTORNEY

THE MARK CONSISTS OF STANDARD CHARACTERS WITHOUT CLAIM TO ANY PARTICULAR FONT, STYLE, SIZE, OR COLOR.

FOR INTERACTIVE COMPUTER SOFTWARE THAT INTERFACES WITH THE MESSAGING APPLICATION SOFTWARE IN WIRELESS DEVICES TO ENABLE USERS TO TRANSFER AND RETRIEVE INFORMATION TO AND FROM ANY FORM OF ELECTRONIC COMMUNICATION DEVICE (U.S. CLS. 21, 23, 26, 36 AND 38).

MICHAEL TANNER, EXAMINING ATTORNEY

SN 78-433,066. CARRIUS TECHNOLOGIES, INC., RICHARDSON, TX. FILED 6-10-2004.

SN 78-432,280. ST. BERNARD SOFTWARE, INC., SAN DIEGO, CA. FILED 6-9-2004.

SECURITYEXPERT

COMPLEAT

THE MARK CONSISTS OF STANDARD CHARACTERS WITHOUT CLAIM TO ANY PARTICULAR FONT, STYLE, SIZE, OR COLOR.

OWNER OF U.S. REG. NOS. 2,488,930, 2,656,874 AND 2,708,506.

FOR SOFTWARE FOR ADMINISTRATION, DATABASE AND NETWORK VULNERABILITY ASSESSMENT (U.S. CLS. 21, 23, 26, 36 AND 38).

MARIA-VICTORIA SUAREZ, EXAMINING ATTORNEY

THE MARK CONSISTS OF STANDARD CHARACTERS WITHOUT CLAIM TO ANY PARTICULAR FONT, STYLE, SIZE, OR COLOR.

FOR COMPUTER HARDWARE AND SOFTWARE FOR PROVIDING VOICE, DATA, AND MULTI-MEDIA SERVICES FOR TELECOMMUNICATION SWITCHES USED IN CIRCUIT- AND PACKET-BASED NETWORKS (U.S. CLS. 21, 23, 26, 36 AND 38).

TRICIA SONNEBORN, EXAMINING ATTORNEY

CLASS 9—(Continued).

SN 78-433,083. MISSION CONTROLS AUTOMATION INC., COSTA MESA, CA. FILED 6-10-2004.



FOR SOFTWARE FOR COLLECTING MANUFACTURING RELATED INFORMATION AND FOR GENERATING PRODUCTION REPORTS (U.S. CLS. 21, 23, 26, 36 AND 38).

ALEXANDER L. POWERS, EXAMINING ATTORNEY

SN 78-433,153. EGAMES, INC., LANGHORNE, PA. FILED 6-10-2004.

GAMEBUTLER

THE MARK CONSISTS OF STANDARD CHARACTERS WITHOUT CLAIM TO ANY PARTICULAR FONT, STYLE, SIZE, OR COLOR.

FOR INTERACTIVE COMPUTER SOFTWARE FOR USE IN CENTRALIZING, MANAGING, AND PROVIDING ACCESS TO APPLICANT'S INTERACTIVE COMPUTER GAME SOFTWARE, INCLUDING CENTRALIZED LISTS OF INSTALLED COMPUTER GAME SOFTWARE, AND FOR PROVIDING INFORMATION AND SUPPORT SUCH AS TECHNICAL, HELP, CUSTOMER SERVICE, PRODUCT INSTRUCTIONS, COPYRIGHT INFORMATION AND PRODUCT REGISTRATION FOR APPLICANT'S COMPUTER GAME SOFTWARE PRODUCTS (U.S. CLS. 21, 23, 26, 36 AND 38).

FIRST USE 6-2-2004; IN COMMERCE 6-2-2004.

MICHAEL KAZAZIAN, EXAMINING ATTORNEY

CLASS 9—(Continued).

SN 78-433,498. TRS QUALITY, INC., FORT WORTH, TX. FILED 6-10-2004.

ACCURIAN

THE MARK CONSISTS OF STANDARD CHARACTERS WITHOUT CLAIM TO ANY PARTICULAR FONT, STYLE, SIZE, OR COLOR.

FOR HOME AUDIO AND VIDEO COMPONENTS, NAMELY RECEIVERS, CD PLAYERS, DVD PLAYERS, HOME THEATER SYSTEM COMPRISING RECEIVERS, LCD DISPLAY SCREENS, LOUDSPEAKERS AND REMOTE CONTROLS FOR SUCH ITEMS; RADIOS, CLOCK RADIOS, AND HD RECEIVERS AND TUNERS; AND PORTABLE AUDIO AND VIDEO COMPONENTS, NAMELY CD PLAYERS, BOOM BOXES, DVD PLAYERS, MP3 PLAYERS, AND HEADPHONES (U.S. CLS. 21, 23, 26, 36 AND 38).

MICHELE SWAIN, EXAMINING ATTORNEY

SN 78-433,561. BUILD-A-BEAR RETAIL MANAGEMENT, INC., ST. LOUIS, MO. FILED 6-10-2004.

**GIVE A GREAT GIFT
EXPERIENCE!**

THE MARK CONSISTS OF STANDARD CHARACTERS WITHOUT CLAIM TO ANY PARTICULAR FONT, STYLE, SIZE, OR COLOR.

FOR PREPAID GIFT CARDS WITH MAGNETIC CODING (U.S. CLS. 21, 23, 26, 36 AND 38).

FIRST USE 12-1-2002; IN COMMERCE 12-1-2002.

ANDREW BENZMILLER, EXAMINING ATTORNEY

CLASS 9—(Continued).

SN 78-434,146. AMERICAN GAMING TECHNOLOGIES LLC, MONMOUTH JUNCTION, NJ. FILED 6-11-2004.

CLASS 9—(Continued).

SN 78-434,671. THE VENDO COMPANY, FRESNO, CA. FILED 6-14-2004.

BOX O' GOLD

VUE-30

THE MARK CONSISTS OF STANDARD CHARACTERS WITHOUT CLAIM TO ANY PARTICULAR FONT, STYLE, SIZE, OR COLOR.

FOR GAMING EQUIPMENT, NAMELY, INTERACTIVE GAMING MACHINES FOR SIMULATING A BINGO GAME VIA VIDEO DISPLAY; COIN-OPERATED VIDEO OUTPUT GAMING MACHINES (U.S. CLS. 21, 23, 26, 36 AND 38).

ZHALEH DELANEY, EXAMINING ATTORNEY

THE MARK CONSISTS OF STANDARD CHARACTERS WITHOUT CLAIM TO ANY PARTICULAR FONT, STYLE, SIZE, OR COLOR.

FOR VENDING MACHINES (U.S. CLS. 21, 23, 26, 36 AND 38).

RAMONA ORTIGA, EXAMINING ATTORNEY

SN 78-434,471. KRUCZYNA, ROGER, BAD HOMBURG, FED REP GERMANY, FILED 6-14-2004.

SN 78-434,674. THE VENDO COMPANY, FRESNO, CA. FILED 6-14-2004.

LOOPLENS

VUE-40

THE MARK CONSISTS OF STANDARD CHARACTERS WITHOUT CLAIM TO ANY PARTICULAR FONT, STYLE, SIZE, OR COLOR.

FOR CONTACT LENSES (U.S. CLS. 21, 23, 26, 36 AND 38).

ARETHA SOMERVILLE, EXAMINING ATTORNEY

THE MARK CONSISTS OF STANDARD CHARACTERS WITHOUT CLAIM TO ANY PARTICULAR FONT, STYLE, SIZE, OR COLOR.

FOR VENDING MACHINES (U.S. CLS. 21, 23, 26, 36 AND 38).

RAMONA ORTIGA, EXAMINING ATTORNEY

CLASS 9—(Continued).

SN 78-434,808. MARKET CENTRAL, INC., PITTSBURGH, PA. FILED 6-14-2004.

CLASS 9—(Continued).

SN 78-434,878. EURONET USA INC., LITTLE ROCK, AR. FILED 6-14-2004.

**RELIABILITY AT THE
EDGE**

ITM

THE MARK CONSISTS OF STANDARD CHARACTERS WITHOUT CLAIM TO ANY PARTICULAR FONT, STYLE, SIZE, OR COLOR.

FOR SHIELDED ELECTRICAL SWITCHES AND ISOLATED FIBER OPTIC SWITCHES FOR SWITCHING DATA IN SECURE AND COMMERCIAL TELECOMMUNICATIONS NETWORKS (U.S. CLS. 21, 23, 26, 36 AND 38).

FRED MANDIR, EXAMINING ATTORNEY

THE MARK CONSISTS OF STANDARD CHARACTERS WITHOUT CLAIM TO ANY PARTICULAR FONT, STYLE, SIZE, OR COLOR.

FOR COMPUTER SOFTWARE USED FOR MAKING FINANCIAL TRANSACTIONS AND EXCHANGING INFORMATION AMONG VARIOUS DATA DEVICES, SUCH AS AUTOMATED TELLER MACHINES, POINT-OF-SALE TERMINALS, TELEPHONES, MOBILE PHONES, MOBILE HANDHELD E-MAIL UNITS, COMPUTER SERVERS AND DATABASES, AND THE INTERNET (U.S. CLS. 21, 23, 26, 36 AND 38).

FIRST USE 1-1-1990; IN COMMERCE 1-1-1990.

YSA DEJESUS, EXAMINING ATTORNEY

SN 78-434,822. MARKET CENTRAL, INC., PITTSBURGH, PA. FILED 6-14-2004.

SN 78-434,932. MRSI INTERNATIONAL, INC., STANSBURY PARK, UT. FILED 6-14-2004.

**SECURITY AT THE
EDGE**

MIKROLITE

THE MARK CONSISTS OF STANDARD CHARACTERS WITHOUT CLAIM TO ANY PARTICULAR FONT, STYLE, SIZE, OR COLOR.

FOR SHIELDED ELECTRICAL SWITCHES AND ISOLATED FIBER OPTIC SWITCHES FOR SWITCHING DATA IN SECURE AND COMMERCIAL TELECOMMUNICATIONS NETWORKS (U.S. CLS. 21, 23, 26, 36 AND 38).

FRED MANDIR, EXAMINING ATTORNEY

THE MARK CONSISTS OF STANDARD CHARACTERS WITHOUT CLAIM TO ANY PARTICULAR FONT, STYLE, SIZE, OR COLOR.

FOR TRACKING DEVICE INTEGRATED INTO A KEY FOB FOR USE IN TRACKING PERSONS AND OBJECTS (U.S. CLS. 21, 23, 26, 36 AND 38).

JAMES GRIFFIN, EXAMINING ATTORNEY

CLASS 9—(Continued).

SN 78-435,140. MANATRON, INC., PORTAGE, MI. FILED 6-15-2004.

CLASS 9—(Continued).

SN 78-435,221. HALLIBURTON ENERGY SERVICES, INC., CARROLLTON, TX. FILED 6-15-2004.

GRM

EZ-GAUGE

THE MARK CONSISTS OF STANDARD CHARACTERS WITHOUT CLAIM TO ANY PARTICULAR FONT, STYLE, SIZE, OR COLOR.

FOR COMPUTER SOFTWARE FOR USE IN GOVERNMENTAL FUNCTIONS, NAMELY PROPERTY TAX RECORDING, VALUATION, ASSESSMENT, ADMINISTRATION, TAX BILLING AND COLLECTION, DELINQUENTS AND TAX SALES (U.S. CLS. 21, 23, 26, 36 AND 38).

BRIAN BROWN, EXAMINING ATTORNEY

THE MARK CONSISTS OF STANDARD CHARACTERS WITHOUT CLAIM TO ANY PARTICULAR FONT, STYLE, SIZE, OR COLOR.

FOR POWER-OPERATED PRESSURE MONITORING SYSTEM, NAMELY, USING CAPILLARY TUBING TO MONITOR DOWNHOLE PRESSURE IN OIL AND GAS WELL TESTING AND DRILLING OPERATIONS (U.S. CLS. 21, 23, 26, 36 AND 38).

YSA DEJESUS, EXAMINING ATTORNEY

SN 78-435,406. CCISTECH, INC., IRVING, TX. FILED 6-15-2004.

SN 78-435,145. UNION SWITCH & SIGNAL, INC., PITTSBURGH, PA. FILED 6-15-2004.

MICROBLOK

Excentus

THE MARK CONSISTS OF STANDARD CHARACTERS WITHOUT CLAIM TO ANY PARTICULAR FONT, STYLE, SIZE, OR COLOR.

FOR ELECTRICAL AND ELECTRONIC APPARATUS FOR RAILWAY SIGNALING (U.S. CLS. 21, 23, 26, 36 AND 38).

BRIAN BROWN, EXAMINING ATTORNEY

THE MARK CONSISTS OF STANDARD CHARACTERS WITHOUT CLAIM TO ANY PARTICULAR FONT, STYLE, SIZE, OR COLOR.

FOR COMPUTER SOFTWARE FOR MANAGING CROSS-MARKETING, CONSUMER LOYALTY, AND REWARD PROGRAMS (U.S. CLS. 21, 23, 26, 36 AND 38).

KELLEY WELLS, EXAMINING ATTORNEY

CLASS 9—(Continued).

SN 78-435,453. LUMERA CORPORATION, BOTHELL, WA.
FILED 6-15-2004.

CLASS 9—(Continued).

SN 78-436,522. ATTACHMATE CORPORATION, BELLEVUE,
WA. FILED 6-16-2004.

BIOSABER

THE MARK CONSISTS OF STANDARD CHARACTERS WITHOUT CLAIM TO ANY PARTICULAR FONT, STYLE, SIZE, OR COLOR.

FOR FIBER OPTIC BIOSENSOR USED TO DETECT AND ANALYZE CHEMICAL AND BIOLOGICAL REAGENTS FOR CLINICAL, FOOD PROCESSING AND MILITARY APPLICATIONS (U.S. CLS. 21, 23, 26, 36 AND 38).

JOHN DALIER, EXAMINING ATTORNEY

SN 78-436,059. SIGNS NOW CORPORATION, BRADENTON,
FL. FILED 6-16-2004.

FLEETCALC

THE MARK CONSISTS OF STANDARD CHARACTERS WITHOUT CLAIM TO ANY PARTICULAR FONT, STYLE, SIZE, OR COLOR.

FOR SOFTWARE FOR ESTIMATING COST OF PRODUCTION MATERIALS AND SUPPLIES FOR SIGNS (U.S. CLS. 21, 23, 26, 36 AND 38).

FIRST USE 1-21-2004; IN COMMERCE 1-21-2004.

KATHERINE STOIDES, EXAMINING ATTORNEY

SYNAPTA

THE MARK CONSISTS OF STANDARD CHARACTERS WITHOUT CLAIM TO ANY PARTICULAR FONT, STYLE, SIZE, OR COLOR.

OWNER OF U.S. REG. NO. 2,419,120.

FOR COMPUTER SOFTWARE FOR OPTIMIZING HOST APPLICATIONS; COMPUTER SOFTWARE FOR PROVIDING INTERFACES TO DATA AND APPLICATIONS; COMPUTER SOFTWARE FOR TRANSFORMING HOST APPLICATIONS INTO BROWSER-BASED APPLICATIONS, PROVIDING CONNECTOR TOOLS AND TECHNOLOGIES TO PROGRAMMATICALLY INTEGRATE HOST INFORMATION AND BUSINESS LOGIC WITH E-BUSINESS APPLICATIONS, AND TO CAPTURE LEGACY DATA AND APPLICATIONS AS STANDARDS-BASED CALLABLE SERVICES (U.S. CLS. 21, 23, 26, 36 AND 38).

LINDA MICKLEBURGH, EXAMINING ATTORNEY

SN 78-436,735. NAUTICA APPAREL, INC., NEW YORK, NY.
FILED 6-17-2004.

NAVIGATE LIFE

THE MARK CONSISTS OF STANDARD CHARACTERS WITHOUT CLAIM TO ANY PARTICULAR FONT, STYLE, SIZE, OR COLOR.

FOR SPECTACLES, NAMELY EYEGASSES AND SUNGLASSES, AND ACCESSORIES, NAMELY CASES AND STRAPS (U.S. CLS. 21, 23, 26, 36 AND 38).

WON TEAK OH, EXAMINING ATTORNEY

CLASS 9—(Continued).

SN 78-436,860. PERMAR SYSTEMS, INC., WOLCOTT, NY.
FILED 6-17-2004.

CLASS 9—(Continued).

SN 78-437,566. BARBIZON INTERNATIONAL, LLC, CORAL
SPRINGS, FL. FILED 6-18-2004.

Badge-in-a-Box

BARBIZON

THE MARK CONSISTS OF STANDARD CHARACTERS
WITHOUT CLAIM TO ANY PARTICULAR FONT, STYLE,
SIZE, OR COLOR.
FOR COMPUTER SOFTWARE FOR MAKING
BADGES (U.S. CLS. 21, 23, 26, 36 AND 38).
FIRST USE 6-0-2000; IN COMMERCE 6-0-2000.
RONALD AIKENS, EXAMINING ATTORNEY

THE MARK CONSISTS OF STANDARD CHARACTERS
WITHOUT CLAIM TO ANY PARTICULAR FONT, STYLE,
SIZE, OR COLOR.
OWNER OF U.S. REG. NO. 902,816.
FOR SUNGLASSES, EYEGLASSES, SWIM GOGGLES,
SWIM FLOTATION AND SAFETY VESTS (U.S. CLS. 21,
23, 26, 36 AND 38).
TRICIA SONNEBORN, EXAMINING ATTORNEY

SN 78-437,480. PITTER, SHERMAN, BROOKLYN, NY.
FILED 6-18-2004.

SN 78-437,718. PILOT SOFTWARE, INC., MOUNTAIN VIEW,
CA. FILED 6-18-2004.

BUSZDEM

PILOTWEB

THE MARK CONSISTS OF STANDARD CHARACTERS
WITHOUT CLAIM TO ANY PARTICULAR FONT, STYLE,
SIZE, OR COLOR.
FOR PRE-RECORDED COMPACT DISKS AND PRE-
RECORDED DIGITAL AUDIO TAPES, ALL FEATUR-
ING MUSIC (U.S. CLS. 21, 23, 26, 36 AND 38).
STANLEY I. OSBORNE, EXAMINING ATTORNEY

THE MARK CONSISTS OF STANDARD CHARACTERS
WITHOUT CLAIM TO ANY PARTICULAR FONT, STYLE,
SIZE, OR COLOR.
OWNER OF U.S. REG. NOS. 1,536,113 AND 2,126,755.
FOR COMPUTER PROGRAMS FOR USE IN MARKET-
ING ANALYSIS; COMPUTER PROGRAMS FOR ACCES-
SING, MONITORING, ANALYZING AND
SUMMARIZING INFORMATION ABOUT NETWORK
AND WEB SITE USE AND FINANCIAL, HUMAN RE-
SOURCE, SALES AND MARKETING INFORMATION
AND DATA; COMPUTER PROGRAMS FOR REPORT
GENERATION, DISTRIBUTION AND DATABASE MAN-
AGEMENT (U.S. CLS. 21, 23, 26, 36 AND 38).
ARETHA SOMERVILLE, EXAMINING ATTORNEY

CLASS 9—(Continued).

SN 78-437,959. CHRISTIAN COPYRIGHT LICENSING, INC.,
PORTLAND, OR. FILED 6-18-2004.

SONGTOUCH

THE MARK CONSISTS OF STANDARD CHARACTERS
WITHOUT CLAIM TO ANY PARTICULAR FONT, STYLE,
SIZE, OR COLOR.

FOR DOWNLOADABLE MUSICAL SONG RECORD-
INGS (U.S. CLS. 21, 23, 26, 36 AND 38).

STEPHANIE DAVIS, EXAMINING ATTORNEY

CLASS 9—(Continued).

SN 78-438,810. HOUND DOG ENTERPRISES LLC, KAILUA,
HI. FILED 6-21-2004.

HOUNDDOG

THE MARK CONSISTS OF STANDARD CHARACTERS
WITHOUT CLAIM TO ANY PARTICULAR FONT, STYLE,
SIZE, OR COLOR.

FOR SERIES OF SOUND RECORDINGS FEATURING
MUSIC, MONOLOG AND DIALOG (U.S. CLS. 21, 23, 26,
36 AND 38).

ANDREW BENZMILLER, EXAMINING ATTORNEY

SN 78-438,331. MICRON TECHNOLOGY, INC., BOISE, ID.
FILED 6-21-2004.

BALLISTIX

THE MARK CONSISTS OF STANDARD CHARACTERS
WITHOUT CLAIM TO ANY PARTICULAR FONT, STYLE,
SIZE, OR COLOR.

FOR COMPUTER MEMORY HARDWARE; GRAPHICS
CARDS; PERSONAL COMPUTER COMPONENTS,
NAMELY, MEMORY MODULES AND VIDEO CARDS
(U.S. CLS. 21, 23, 26, 36 AND 38).

WON TEAK OH, EXAMINING ATTORNEY

SN 78-439,217. INGENIX, INC., EDEN PRAIRIE, MN. FILED
6-22-2004.

INGENIX ENROLLPRO

THE MARK CONSISTS OF STANDARD CHARACTERS
WITHOUT CLAIM TO ANY PARTICULAR FONT, STYLE,
SIZE, OR COLOR.

OWNER OF U.S. REG. NOS. 2,390,360, 2,676,239 AND
OTHERS.

FOR DATABASE MANAGEMENT SOFTWARE PRO-
VIDED TO HEALTH CARE PROVIDERS IN THE
HEALTH CARE AND INSURANCE INDUSTRIES FOR
HEALTH INFORMATION AND PHYSICIAN CREDEN-
TIALING MANAGEMENT AND TRACKING (U.S. CLS.
21, 23, 26, 36 AND 38).

FIRST USE 4-1-2004; IN COMMERCE 4-1-2004.

DAWN FELDMAN, EXAMINING ATTORNEY

CLASS 9—(Continued).

SN 78-439,304. GENESIS INTERNATIONAL CORP., NEW YORK, NY. FILED 6-22-2004.

CLASS 9—(Continued).

SN 78-439,610. IS SOFTWARE SYSTEMS, INC., DBA INTEGRASYS, ESCONDIDO, CA. FILED 6-22-2004.

BEVI

ORSUITE

THE MARK CONSISTS OF STANDARD CHARACTERS WITHOUT CLAIM TO ANY PARTICULAR FONT, STYLE, SIZE, OR COLOR.

FOR PROTECTIVE EYEWEAR, NAMELY SPECTACLES, PRESCRIPTION EYEWEAR, ANTI-GLARE GLASSES AND SUNGLASSES AND THEIR PARTS AND ACCESSORIES, NAMELY REPLACEMENT LENSES, FRAMES, EARSTEMS, AND NOSE PIECES; CASES SPECIALLY ADAPTED FOR SPECTACLES AND SUNGLASSES AND THEIR PARTS AND ACCESSORIES (U.S. CLS. 21, 23, 26, 36 AND 38).

FIRST USE 6-1-2004; IN COMMERCE 6-1-2004.
KEVON CHISOLM, EXAMINING ATTORNEY

THE MARK CONSISTS OF STANDARD CHARACTERS WITHOUT CLAIM TO ANY PARTICULAR FONT, STYLE, SIZE, OR COLOR.

OWNER OF U.S. REG. NO. 2,308,077.
SEC. 2(F).
FOR COMPUTER SOFTWARE FOR USE IN THE FIELD OF HEALTH CARE, NAMELY, FOR PATIENT DATA COLLECTION, FOR DISPLAYING PATIENT DATA, FOR PLANNING AND MONITORING PATIENT CARE, AND INSTRUCTION MANUALS PROVIDED AS A UNIT (U.S. CLS. 21, 23, 26, 36 AND 38).
FIRST USE 3-0-1997; IN COMMERCE 3-0-1997.
CURTIS FRENCH, EXAMINING ATTORNEY

SN 78-439,344. GENERAL CABLE TECHNOLOGIES CORPORATION, HIGHLAND HEIGHTS, KY. FILED 6-22-2004.

SN 78-442,259. TALONSOFT, BALTIMORE, MD. FILED 6-28-2004.

QUIK-PREP

**Amusement Park
Tycoon**

THE MARK CONSISTS OF STANDARD CHARACTERS WITHOUT CLAIM TO ANY PARTICULAR FONT, STYLE, SIZE, OR COLOR.

FOR ELECTRICAL CABLES FOR USE IN MILITARY APPLICATIONS, NAMELY, POWER, LIGHTING AND WEAPON CONTROL SYSTEM INTERCONNECTION (U.S. CLS. 21, 23, 26, 36 AND 38).

KEVON CHISOLM, EXAMINING ATTORNEY

THE MARK CONSISTS OF STANDARD CHARACTERS WITHOUT CLAIM TO ANY PARTICULAR FONT, STYLE, SIZE, OR COLOR.

NO CLAIM IS MADE TO THE EXCLUSIVE RIGHT TO USE AMUSEMENT PARK, APART FROM THE MARK AS SHOWN.

FOR COMPUTER GAME SOFTWARE (U.S. CLS. 21, 23, 26, 36 AND 38).
BRIDGETT SMITH, EXAMINING ATTORNEY

CLASS 9—(Continued).

SN 78-452,533. TAMALE SOFTWARE, INC., BOSTON, MA. FILED 7-19-2004.

TAMALE RESEARCH

THE MARK CONSISTS OF STANDARD CHARACTERS WITHOUT CLAIM TO ANY PARTICULAR FONT, STYLE, SIZE, OR COLOR.

NO CLAIM IS MADE TO THE EXCLUSIVE RIGHT TO USE "RESEARCH", APART FROM THE MARK AS SHOWN. FOR COMPUTER SOFTWARE FOR THE COLLECTION, EDITING, ORGANIZATION, MODIFYING, BOOKMARKING, TRANSMISSION, STORAGE, AND SHARING OF DATA AND INFORMATION (U.S. CLS. 21, 23, 26, 36 AND 38).

FIRST USE 4-1-2004; IN COMMERCE 4-1-2004.
CAROLINE WOOD, EXAMINING ATTORNEY

SN 79-000,033. ANALYTICAL SYSTEMS PTY LTD, AUSTRALIA, FILED 11-5-2003.



OWNER OF INTERNATIONAL REGISTRATION 0811357 DATED 10-1-2003, EXPIRES 10-1-2013.

FOR COMPUTER SOFTWARE PROGRAMS FOR USE IN MAKING RESTAURANT RESERVATIONS, MANAGING RESTAURANT TABLES AND MANAGING BOOKINGS FOR FUNCTIONS AND CONFERENCES, ALL WITHIN THE HOSPITALITY INDUSTRY (U.S. CLS. 21, 23, 26, 36 AND 38).

JOHN GARTNER, EXAMINING ATTORNEY

CLASS 9—(Continued).

SN 79-001,823. SIM2 MULTIMEDIA SPA, ITALY, FILED 11-28-2003.

DIGI-OPTIC

THE MARK CONSISTS OF STANDARD CHARACTERS WITHOUT CLAIM TO ANY PARTICULAR FONT, STYLE, SIZE, OR COLOR.

OWNER OF INTERNATIONAL REGISTRATION 0822068 DATED 11-28-2003, EXPIRES 11-28-2013.

FOR CASH REGISTERS, RADIOS AND TELEVISIONS, VIDEO TAPE RECORDERS AND DIGITAL VIDEO TAPE RECORDERS, TELEVISION SETS, MOVIE PROJECTORS, PROJECTION TELEVISIONS, VIDEO MONITORS, ENCODERS AND DECODERS OF VIDEO SIGNALS, AUDIO AND VIDEO RECEIVERS FOR TERRESTRIAL AND SATELLITE TRANSMISSIONS; HIGH-FIDELITY STEREO SYSTEMS COMPRISING AMPLIFIERS, LOUD-SPEAKERS, RECEIVERS AND TUNERS, VIDEO PHONES AND VIDEO CONFERENCE PHONES, VIDEO-TELEPHONES, MOBILE AND HOME TELEPHONES, TELEVISION CAMERAS INCORPORATING VIDEO TAPE RECORDERS, APPARATUSES FOR SIGNAL DISTRIBUTION, NAMELY CABLES FOR ELECTRICAL OR OPTICAL SIGNAL TRANSMISSION, AMPLIFIERS, MODEMS, ROUTERS, AND APPARATUSES FOR CLOSED CIRCUIT TELEVISION SYSTEMS, NAMELY TELEVISION TRANSMITTERS AND TELEVISION RECEIVERS, COMPACT DISC AUDIO AND DIGITAL VIDEO PLAYERS AND RECORDERS (U.S. CLS. 21, 23, 26, 36 AND 38).

WILLIAM BRECKENFELD, EXAMINING ATTORNEY

SN 79-002,151. LICO SPA, ITALY, FILED 12-4-2003.

Lico TURBOPEX

OWNER OF INTERNATIONAL REGISTRATION 0823362 DATED 12-4-2003, EXPIRES 12-4-2013.

FOR ELECTRONIC APPARATUS, NAMELY FEEDERS FOR CONTINUOUS GRAVIMETRIC DOSING AND MIXING OF CHEMICAL INGREDIENTS TO PRODUCE CABLES AND PIPES FABRICATED OF POLYETHYLENE CROSS-LINKED WITH SILANE (U.S. CLS. 21, 23, 26, 36 AND 38).

ZACHARY BELLO, EXAMINING ATTORNEY

SN 79-002,705. KANGOL LIMITED, UNITED KINGDOM, FILED 4-27-2004.



OWNER OF INTERNATIONAL REGISTRATION 0825362 DATED 4-27-2004, EXPIRES 4-27-2014.

FOR PROTECTIVE EYEWEAR AND ANTI-GLARE EYEGLASSES; SUNGLASSES; SPECTACLES; GOGGLES FOR SPORTS; PARTS AND ACCESSORIES FOR THE AFORESAID GOODS, NAMELY, REPLACEMENT LENSES, FRAMES AND NOSE PIECES (U.S. CLS. 21, 23, 26, 36 AND 38).

MAUREEN DALL, EXAMINING ATTORNEY

CLASS 9—(Continued).

SN 79-004,669. KONINKLIJKE PHILIPS ELECTRONICS N.V., NETHERLANDS, FILED 6-22-2004.

SUPERSKIP

THE MARK CONSISTS OF STANDARD CHARACTERS WITHOUT CLAIM TO ANY PARTICULAR FONT, STYLE, SIZE, OR COLOR.

PRIORITY DATE OF 1-14-2004 IS CLAIMED. OWNER OF INTERNATIONAL REGISTRATION 0831482 DATED 6-22-2004, EXPIRES 6-22-2014.

FOR SOFTWARE AND INTERFACES FOR SEARCHING, NAVIGATING, STORING, ARRANGING, REPRODUCING AND BROWSING DATA AND DATA FILES AND FOR DATABASE MANAGEMENT (U.S. CLS. 21, 23, 26, 36 AND 38).

LEIGH CAROLINE CASE, EXAMINING ATTORNEY

CLASS 10—(Continued).

SN 76-511,794. IMPLADENT, LTD., HOLLIS HILLS, NY. FILED 4-17-2003.

SUPERSPLINT

SEC. 2(F). FOR INTERLOCKING ATTACHMENT MECHANISM FOR DENTAL IMPLANT PROSTHESIS (U.S. CLS. 26, 39 AND 44).

FIRST USE 10-31-2000; IN COMMERCE 10-31-2000. DAWN FELDMAN, EXAMINING ATTORNEY

SN 76-529,748. MEDICAL COMPONENTS, INC., HARLEYSVILLE, PA. FILED 7-15-2003.

SPLIT STREAM

CLASS 10—MEDICAL APPARATUS

SN 76-256,582. MAGNA LAB INC., SYOSSET, NY. FILED 5-14-2001.

ILLUMINATOR

FOR MRI RECEIVER COILS (U.S. CLS. 26, 39 AND 44). HEATHER THOMPSON, EXAMINING ATTORNEY

FOR CATHETERS AND CATHETER KITS CONSISTING PRIMARILY OF CATHETERS, REMOVABLE HUBS, INJECTION CAPS; J-FLEX GUIDE WIRES; INTRODUCER NEEDLES; SCALPELS; ADHESIVE WOUND DRESSINGS; TUNNELING TOOLS; TEAR AWAY SHEATH INTRODUCERS; VESSEL DILATORS; EXTENSION SETS; AND CLAMPS (U.S. CLS. 26, 39 AND 44).

FIRST USE 4-30-2003; IN COMMERCE 4-30-2003. MARTHA SANTOMARTINO, EXAMINING ATTORNEY

SN 76-566,457. SAFETY MEDICAL INTERNATIONAL, INCORPORATED, APOPKA, FL. FILED 12-22-2003.

SN 76-425,940. ANDOVER COATED PRODUCTS, INC., SAILBURY, MA. FILED 6-27-2002.

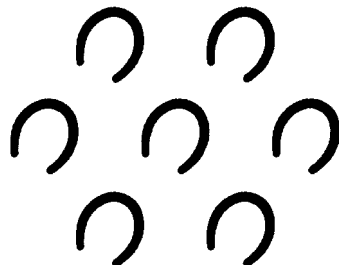

THE MARK CONSISTS OF A SERIES OF HORSESHOES FORMING A CONTINUOUS PATTERN.

SEC. 2(F). FOR COMPRESSION, ORTHOPEDIC SUPPORT AND ELASTIC BANDAGES (U.S. CLS. 26, 39 AND 44). FIRST USE 3-0-2001; IN COMMERCE 3-0-2001. CURTIS FRENCH, EXAMINING ATTORNEY



NO CLAIM IS MADE TO THE EXCLUSIVE RIGHT TO USE SAFETY MEDICAL, APART FROM THE MARK AS SHOWN.

FOR RETRACTABLE SAFETY MEDICAL SYRINGES AND RETRACTABLE MEDICAL DEVICES IN THE NATURE OF BLOOD COLLECTION TUBE HOLDERS (U.S. CLS. 26, 39 AND 44).

SUE LAWRENCE, EXAMINING ATTORNEY

CLASS 10—(Continued).

SN 76-581,080. AESCULAP AG & CO. KG, TUTTLINGEN, FED REP GERMANY, FILED 3-11-2004.

SILKAM

THE MARK CONSISTS OF STANDARD CHARACTERS WITHOUT CLAIM TO ANY PARTICULAR FONT, STYLE, SIZE, OR COLOR.

FOR NON-ABSORBABLE BRAIDED AND COATED SUTURE MADE OF NATURAL SILK FILAMENTS (U.S. CLS. 26, 39 AND 44).

FIRST USE 7-1-1997; IN COMMERCE 0-0-2002.
CIMMERIAN COLEMAN, EXAMINING ATTORNEY

SN 76-593,528. EXACTECH, INC., GAINESVILLE, FL. FILED 5-24-2004.

NOVATION

FOR SURGICAL IMPLANTS, NAMELY, IMPLANTABLE ORTHOPEDIC HIP PROSTHESIS, AS WELL AS KITS AND SYSTEMS CONTAINING AN IMPLANTABLE HIP PROSTHESIS AND AN ASSORTMENT OF FIXATION HARDWARE, INCLUDING SCREWS, CABLES AND HOOKS, AND WRITTEN INSTRUCTIONS (U.S. CLS. 26, 39 AND 44).

ANGELA M. MICHELI, EXAMINING ATTORNEY

SN 76-595,731. ICAD, INC., NASHUA, NH. FILED 6-3-2004.

CLICKCAD

THE MARK CONSISTS OF STANDARD CHARACTERS WITHOUT CLAIM TO ANY PARTICULAR FONT, STYLE, SIZE, OR COLOR.

FOR MEDICAL APPARATUS, NAMELY, EQUIPMENT FOR COMPUTER ASSISTED DETECTION OF HEALTH RELATED ABNORMALITIES IN MEDICAL IMAGES, AND SOFTWARE SOLD AS A UNIT (U.S. CLS. 26, 39 AND 44).

NICHOLAS ALTREE, EXAMINING ATTORNEY

CLASS 10—(Continued).

SN 76-596,969. BIRDSONG MEDICAL DEVICES INC., BREWSTER, NY. FILED 6-14-2004.

LEVERHALER

THE MARK CONSISTS OF STANDARD CHARACTERS WITHOUT CLAIM TO ANY PARTICULAR FONT, STYLE, SIZE, OR COLOR.

FOR MEDICAL DEVICE FOR DELIVERING MEDICAL AEROSOL PRODUCED BY A METERED DOSE INHALER TO THE LUNGS OF A PATIENT (U.S. CLS. 26, 39 AND 44).

GRETTA YAO, EXAMINING ATTORNEY

SN 76-598,085. RAMVAC DENTAL PRODUCTS, INC., SPEARFISH, SD. FILED 6-18-2004.

BRONTO

THE MARK CONSISTS OF STANDARD CHARACTERS WITHOUT CLAIM TO ANY PARTICULAR FONT, STYLE, SIZE, OR COLOR.

FOR DENTAL SOURCES FOR DENTAL USES, NAMELY, A VACUUM PUMP, CONTROLS AND STRUCTURAL PARTS THEREOF (U.S. CLS. 26, 39 AND 44).

RONALD AIKENS, EXAMINING ATTORNEY

SN 76-598,126. ALPHATEC MANUFACTURING, INC., CARLSBAD, CA. FILED 6-18-2004.

NOVEL

THE MARK CONSISTS OF STANDARD CHARACTERS WITHOUT CLAIM TO ANY PARTICULAR FONT, STYLE, SIZE, OR COLOR.

FOR VERTEBRAL BODY REPLACEMENT CAGES (U.S. CLS. 26, 39 AND 44).

CIMMERIAN COLEMAN, EXAMINING ATTORNEY

CLASS 10—(Continued).

SN 76-600,454. TOMEY CORPORATION, NAGOYA-SHI, AICHI-KEN, JAPAN, FILED 6-30-2004.

TOMEY

THE MARK CONSISTS OF STANDARD CHARACTERS WITHOUT CLAIM TO ANY PARTICULAR FONT, STYLE, SIZE, OR COLOR.

OWNER OF U.S. REG. NO. 1,843,555.

FOR MEDICAL ELECTRONICS AND MEDICAL EQUIPMENTS; NAMELY, ULTRASONIC DIAGNOSTIC IMAGING EQUIPMENTS, AXIAL LENGTH BIOMETERS, PACHYMETERS, REFRACTO METERS, KERATO METERS, TOPOGRAPHERS, SPECULAR MICROSCOPES AND ELECTRORETINOGRAPHS (U.S. CLS. 26, 39 AND 44).

KELLY BOULTON, EXAMINING ATTORNEY

SN 76-600,455. TOMEY CORPORATION, NAGOYA-SHI, AICHI-KEN, JAPAN, FILED 6-30-2004.



OWNER OF U.S. REG. NO. 1,834,513.

FOR MEDICAL ELECTRONICS AND MEDICAL EQUIPMENTS; NAMELY, ULTRASONIC DIAGNOSTIC IMAGING EQUIPMENTS, AXIAL LENGTH BIOMETERS, PACHYMETERS, REFRACTO METERS, KERATO METERS, TOPOGRAPHERS, SPECULAR MICROSCOPES AND ELECTRORETINOGRAPHS (U.S. CLS. 26, 39 AND 44).

KELLY BOULTON, EXAMINING ATTORNEY

SN 78-177,898. MEDTRONIC AVE, INC., SANTA ROSA, CA. FILED 10-24-2002.

MX

FOR MEDICAL DEVICES FOR USE IN VASCULAR AND INTRAVASCULAR PROCEDURES, NAMELY, STENTS, CATHETERS, BALLOONS AND ANGIOPLASTY DEVICES NAMELY ANGIOPLASTY BALLOONS AND CATHETERS. (U.S. CLS. 26, 39 AND 44).

CAROL SPILS, EXAMINING ATTORNEY

CLASS 10—(Continued).

SN 78-227,558. CAVE SPRINGS, INC., WILMINGTON, DE. FILED 3-19-2003.

MOTHERHOOD

OWNER OF U.S. REG. NOS. 1,055,611, 1,900,180 AND OTHERS.

FOR BABY BOTTLES, NIPPLES FOR BABY BOTTLES, BABY NURSERS; BREASTFEEDING PADS, SHIELDS, AND PUMPS (U.S. CLS. 26, 39 AND 44).

ALICIA COLLINS, EXAMINING ATTORNEY

SN 78-256,103. ADVANCED LASER HEALTH, CORP., WOODBRIDGE, CANADA, FILED 5-30-2003.

VET-WELL

FOR FLEXIBLY CONTROLLED DEVICE USING COHERENT RADIATION FOR PET OR OTHER ANIMAL MEDICAL, DIAGNOSIS, THERAPY, AND SURGERY THAT APPLIES HEAT OR VIBRATIONS FOR THE PURPOSES OF THERAPEUTIC EFFECTS ON THE TISSUES AT OR CLOSE TO THE CONTACT AREA (U.S. CLS. 26, 39 AND 44).

ROBIN CHOSID, EXAMINING ATTORNEY

SN 78-282,897. BIOTRONIX CLINICAL ENGINEERING, AMARILLO, TX. FILED 8-4-2003.

BIOTRONIX CLINICAL ENGINEERING

NO CLAIM IS MADE TO THE EXCLUSIVE RIGHT TO USE CLINICAL ENGINEERING, APART FROM THE MARK AS SHOWN.

FOR INFECTION CONTROL DEVICES, NAMELY A REMOVABLE SLEEVE TO COVER HOSPITAL EQUIPMENT AND NURSE CALL UNITS; SHOWER PULL CABLES HAVING A SURFACE THAT CONTROLS THE SPREAD OF GERMS USED IN HOSPITALS AND MEDICAL CLINICS (U.S. CLS. 26, 39 AND 44).

KEVON CHISOLM, EXAMINING ATTORNEY

SN 78-284,226. HONEYWELL INTERNATIONAL INC., MORRISTOWN, NJ. FILED 8-7-2003.

GENESIS

FOR IN-HOME PATIENT VITAL SIGN MONITORING SYSTEM SOLD AS A UNIT COMPRISED OF ONE OR MORE OF A SCALE, BLOOD PRESSURE CUFF, GLUCOMETER, SPIROMETER AND A MAGNETIC CARD READER AND FURTHER INCLUDING A DEVICE FOR TRANSMITTING VITAL SIGN INFORMATION (U.S. CLS. 26, 39 AND 44).

REBECCA SMITH, EXAMINING ATTORNEY

CLASS 10—(Continued).

SN 78-305,512. DEPUY, INC., WARSAW, IN. FILED 9-25-2003.

ELITE PLUS

FOR MEDICAL DEVICES, NAMELY HIP IMPLANTS COMPRISING ARTIFICIAL MATERIALS AND PARTS THEREFOR, SURGICAL INSTRUMENTS FOR USE WITH ORTHOPAEDIC HIP IMPLANTS (U.S. CLS. 26, 39 AND 44).

FIRST USE 6-0-2003; IN COMMERCE 6-0-2003.
JEFFERY COWARD, EXAMINING ATTORNEY

CLASS 10—(Continued).

SN 78-309,886. IMTEC CORPORATION, ARDMORE, OK. FILED 10-6-2003.

SENDAX MDI

FOR DENTAL IMPLANT SYSTEM COMPRISING DENTAL IMPLANTS AND DELIVERY, PLACEMENT, SITE HEALING, AND PROSTHETIC INSTRUMENTS AND PARTS THEREOF (U.S. CLS. 26, 39 AND 44).

FIRST USE 3-1-1999; IN COMMERCE 3-1-1999.
ANN E. SAPPENFIELD, EXAMINING ATTORNEY

SN 78-306,069. BRAINCHILD, LLC, PITTSBURG, KS. FILED 9-26-2003.



NO CLAIM IS MADE TO THE EXCLUSIVE RIGHT TO USE LLC, APART FROM THE MARK AS SHOWN.

THE STIPPLING IS FOR SHADING PURPOSES ONLY. FOR EXERCISE MACHINES FOR THERAPEUTIC PURPOSES, NAMELY, PHYSICAL REHABILITATION CYCLES FOR REHABILITATION INCLUDING THE PROMOTION OF ERGONOMICS, IMPROVED FITNESS AND MAINTENANCE OF WELLNESS (U.S. CLS. 26, 39 AND 44).

LANA PHAM, EXAMINING ATTORNEY

SN 78-319,900. BIRD PRODUCTS CORPORATION, PALM SPRINGS, CA. FILED 10-28-2003.

APRV/BIPHASIC

FOR CONTROL SYSTEM FOR RESPIRATORY DEVICES AND MEDICAL VENTILATORS (U.S. CLS. 26, 39 AND 44).

ANNE MADDEN, EXAMINING ATTORNEY

SN 78-306,090. BRAINCHILD, LLC, PITTSBURG, KS. FILED 9-26-2003.



SoundSeal

FOR EXERCISE MACHINES FOR THERAPEUTIC PURPOSES, NAMELY, PHYSICAL REHABILITATION CYCLES FOR REHABILITATION INCLUDING THE PROMOTION OF ERGONOMICS, IMPROVED FITNESS AND MAINTENANCE OF WELLNESS (U.S. CLS. 26, 39 AND 44).

LANA PHAM, EXAMINING ATTORNEY

THE MARK CONSISTS OF STANDARD CHARACTERS WITHOUT CLAIM TO ANY PARTICULAR FONT, STYLE, SIZE, OR COLOR.

FOR TRANSPARENT PLASTIC FILMS FOR MEDICAL USE, NAMELY, TRANSPARENT FILMS FOR USE DURING DIAGNOSTIC OR THERAPEUTIC ULTRASOUND TREATMENTS (U.S. CLS. 26, 39 AND 44).

REBECCA SMITH, EXAMINING ATTORNEY

CLASS 10—(Continued).

SN 78-333,625. BIOMEDTECH AUSTRALIA PTY LTD, MOORABBIN, VICTORIA, AUSTRALIA, FILED 11-26-2003.

CLASS 10—(Continued).

SN 78-346,788. CORBITRON, INC., ARROYO GRANDE, CA, FILED 12-31-2003.

ERA

DURASENSE

THE MARK CONSISTS OF STANDARD CHARACTERS WITHOUT CLAIM TO ANY PARTICULAR FONT, STYLE, SIZE, OR COLOR.

PRIORITY CLAIMED UNDER SEC. 44(D) ON AUSTRALIA APPLICATION NO. 955488, FILED 5-27-2003, REG. NO. 955488, DATED 5-27-2003, EXPIRES 5-27-2013.

FOR RESPIRATORY DEVICES, NAMELY, HIGH ALTITUDE SIMULATORS FOR SIMULATING LOW OXYGEN LEVELS AND PARTS AND FITTINGS RELATING THERETO, AND ASSOCIATED MONITORING EQUIPMENT FOR USE IN MEDICAL AND VETERINARY APPLICATIONS (U.S. CLS. 26, 39 AND 44).

JOANNA DUKOVIC, EXAMINING ATTORNEY

THE MARK CONSISTS OF STANDARD CHARACTERS WITHOUT CLAIM TO ANY PARTICULAR FONT, STYLE, SIZE, OR COLOR.

FOR PATIENT LOCATION MONITORING SYSTEM COMPRISED OF SENSING PADS AND RELATED ELECTRONIC INDICATOR MODULES (U.S. CLS. 26, 39 AND 44).

ALEXANDER L. POWERS, EXAMINING ATTORNEY

SN 78-336,372. OXYSURE SYSTEMS, INC., FRISCO, TX, FILED 12-4-2003.

SN 78-354,358. A MAJOR DIFFERENCE, INC., AURORA, CO, FILED 1-20-2004.



Excalibur

NO CLAIM IS MADE TO THE EXCLUSIVE RIGHT TO USE "PURE OXYGEN", APART FROM THE MARK AS SHOWN.

THE COLOR(S) BLUE AND GREEN IS/ARE CLAIMED AS A FEATURE OF THE MARK.

THE MARK CONSISTS OF THE WORD "OXYSURE" IN GREEN WITH A STYLIZED LETTER O. THE WORDS "PURE OXYGEN" IN DARK BLUE. ALL THE WORDS "OXYSURE" AND "PURE OXYGEN" ARE SUBSTANTIALLY ENCIRCLED BY A DARK BLUE OVAL SHAPED CIRCLE.

THE COLOR GREEN APPEARS IN THE STYLIZED LETTER O AND THE COLOR DARK BLUE APPEARS IN THE OVAL.

FOR MEDICAL DEVICES, NAMELY, OXYGEN GENERATING APPARATUS, PARTS AND FITTINGS FOR SUCH APPARATUS, NAMELY, OXYGEN MASKS FOR MEDICAL USE AND REFILL PACKS (U.S. CLS. 26, 39 AND 44).

GIANCARLO CASTRO, EXAMINING ATTORNEY

THE MARK CONSISTS OF STANDARD CHARACTERS WITHOUT CLAIM TO ANY PARTICULAR FONT, STYLE, SIZE, OR COLOR.

FOR LASER LIGHT GENERATOR FOR APPLICATION OF LASER BEAM TO HUMAN BODY FOR THERAPEUTIC USE (U.S. CLS. 26, 39 AND 44).

KAREN BRACEY, EXAMINING ATTORNEY

CLASS 10—(Continued).

SN 78-364,796. FERRARIS GROUP, INC., LOUISVILLE, CO.
FILED 2-9-2004.

EAGLE

THE MARK CONSISTS OF STANDARD CHARACTERS WITHOUT CLAIM TO ANY PARTICULAR FONT, STYLE, SIZE, OR COLOR.

FOR MEDICAL DEVICES FOR MEASURING LUNG FUNCTION, NAMELY, PORTABLE SPIROMETERS (U.S. CLS. 26, 39 AND 44).

FIRST USE 11-26-2003; IN COMMERCE 11-26-2003.
ROBERT C. CLARK JR., EXAMINING ATTORNEY

CLASS 10—(Continued).

SN 78-386,560. OSTEOBIOLOGICS, INC., SAN ANTONIO, TX.
FILED 3-18-2004.



THE COLOR(S) LIGHT BLUE, DARKER BLUE, AND WHITE IS/ARE CLAIMED AS A FEATURE OF THE MARK. THE MARK CONSISTS OF A LIGHT BLUE OVAL ENCIRCLING THE WORD TRU IN WHITE FONT. IMMEDIATELY TO THE RIGHT OF THE OVAL (AS IF ONE WORD) IS THE WORD BLOCK IN A DARKER SHADE OF BLUE.

FOR SURGICAL IMPLANTS COMPRISING ARTIFICIAL MATERIALS (U.S. CLS. 26, 39 AND 44).
TRICIA SONNEBORN, EXAMINING ATTORNEY

SN 78-368,438. D4D TECHNOLOGIES, L.P., RICHARDSON, TX. FILED 2-16-2004.

EVOLUTION4D

THE MARK CONSISTS OF STANDARD CHARACTERS WITHOUT CLAIM TO ANY PARTICULAR FONT, STYLE, SIZE, OR COLOR.

FOR DENTAL CAD/CAM SYSTEMS, NAMELY, DENTAL IMAGING AND MILLING MACHINES FOR MANUFACTURING DENTAL PROSTHETICS (U.S. CLS. 26, 39 AND 44).

FIRST USE 2-13-2004; IN COMMERCE 2-13-2004.
TRACY CROSS, EXAMINING ATTORNEY

SN 78-403,388. ROCHE DIAGNOSTICS CORPORATION, INDIANAPOLIS, IN. FILED 4-16-2004.

LIFE NEEDS ANSWERS

THE MARK CONSISTS OF STANDARD CHARACTERS WITHOUT CLAIM TO ANY PARTICULAR FONT, STYLE, SIZE, OR COLOR.

FOR MEDICAL AND VETERINARY APPARATUS FOR THE ANALYSIS OF BIOLOGICAL SAMPLES FOR CLINICAL MEDICAL DIAGNOSTIC PURPOSES (U.S. CLS. 26, 39 AND 44).

CHARLES JOYNER, EXAMINING ATTORNEY

CLASS 10—(Continued).

SN 78-407,001. ZEVEX, INC., SALT LAKE CITY, UT. FILED 4-23-2004.

CLASS 10—(Continued).

SN 78-428,569. BUCK, CRAIG W, SANTA BARBARA, CA. FILED 6-2-2004.

INFINITY

Molar Monitor

THE MARK CONSISTS OF STANDARD CHARACTERS WITHOUT CLAIM TO ANY PARTICULAR FONT, STYLE, SIZE, OR COLOR.

FOR MEDICAL DEVICES, NAMELY INFUSION PUMPS FOR INFUSION OF MEDICAL FEEDING SOLUTIONS (U.S. CLS. 26, 39 AND 44).

FIRST USE 5-11-2004; IN COMMERCE 5-11-2004.
ELLEN B. AWRICH, EXAMINING ATTORNEY

THE MARK CONSISTS OF STANDARD CHARACTERS WITHOUT CLAIM TO ANY PARTICULAR FONT, STYLE, SIZE, OR COLOR.

FOR ELECTRONIC APPLIANCE FOR THE MONITORING AND TIMING OF TEETH BRUSHING ACTIVITY (U.S. CLS. 26, 39 AND 44).

JULIA HARDY COFIELD, EXAMINING ATTORNEY

SN 78-429,594. VISIONQUEST INDUSTRIES, INC., DBA VQ ORTHOCARE, IRVINE, CA. FILED 6-3-2004.

SN 78-420,738. EAGLE VISION, INC., MEMPHIS, TN. FILED 5-18-2004.

GELLANSERT

EXO

THE MARK CONSISTS OF STANDARD CHARACTERS WITHOUT CLAIM TO ANY PARTICULAR FONT, STYLE, SIZE, OR COLOR.

FOR MEDICAL DEVICES, NAMELY, PUNCTUM PLUGS (U.S. CLS. 26, 39 AND 44).

WON TEAK OH, EXAMINING ATTORNEY

THE MARK CONSISTS OF STANDARD CHARACTERS WITHOUT CLAIM TO ANY PARTICULAR FONT, STYLE, SIZE, OR COLOR.

OWNER OF U.S. REG. NO. 2,833,265.
FOR ORTHOPEDIC BRACES NAMELY, ANKLE BRACES, WRIST BRACES, BACK BRACES, ELBOW BRACES, SHOULDER BRACES AND NECK BRACES (U.S. CLS. 26, 39 AND 44).

BRENDAN REGAN, EXAMINING ATTORNEY

CLASS 10—(Continued).

SN 78-429,603. VISIONQUEST INDUSTRIES, INC., DBA VQ ORTHOCARE, IRVINE, CA. FILED 6-3-2004.

FALCON

THE MARK CONSISTS OF STANDARD CHARACTERS WITHOUT CLAIM TO ANY PARTICULAR FONT, STYLE, SIZE, OR COLOR.

FOR ORTHOPEDIC BRACES NAMELY, ANKLE BRACES, WRIST BRACES, BACK BRACES, ELBOW BRACES, SHOULDER BRACES, NECK BRACES AND KNEE BRACES (U.S. CLS. 26, 39 AND 44).

BRENDAN REGAN, EXAMINING ATTORNEY

SN 78-429,925. S.S. WHITE BURS, INC., LAKEWOOD, NJ. FILED 6-4-2004.

GREAT WHITE

THE MARK CONSISTS OF STANDARD CHARACTERS WITHOUT CLAIM TO ANY PARTICULAR FONT, STYLE, SIZE, OR COLOR.

FOR DENTAL BURRS (U.S. CLS. 26, 39 AND 44).

FIRST USE 1-1-1991; IN COMMERCE 1-1-1991.

JENNIFER KRISP, EXAMINING ATTORNEY

CLASS 10—(Continued).

SN 78-431,965. ADVANCED BIONICS CORPORATION, SANTA CLARITA, CA. FILED 6-8-2004.

HiFocus Helix

THE MARK CONSISTS OF STANDARD CHARACTERS WITHOUT CLAIM TO ANY PARTICULAR FONT, STYLE, SIZE, OR COLOR.

OWNER OF U.S. REG. NO. 2,427,427.

NO CLAIM IS MADE TO THE EXCLUSIVE RIGHT TO USE "HELIX", APART FROM THE MARK AS SHOWN.

FOR IMPLANTABLE ELECTRODE ARRAYS FOR USE WITH IMPLANTABLE COCHLEAR STIMULATION SYSTEMS (U.S. CLS. 26, 39 AND 44).

KIMBERLY FRYE, EXAMINING ATTORNEY

SN 78-431,970. ADVANCED BIONICS CORPORATION, SANTA CLARITA, CA. FILED 6-8-2004.

HiFocus Apex

THE MARK CONSISTS OF STANDARD CHARACTERS WITHOUT CLAIM TO ANY PARTICULAR FONT, STYLE, SIZE, OR COLOR.

OWNER OF U.S. REG. NO. 2,427,427.

NO CLAIM IS MADE TO THE EXCLUSIVE RIGHT TO USE "APEX", APART FROM THE MARK AS SHOWN.

FOR IMPLANTABLE ELECTRODE ARRAYS FOR USE WITH IMPLANTABLE COCHLEAR STIMULATION SYSTEMS (U.S. CLS. 26, 39 AND 44).

KIMBERLY FRYE, EXAMINING ATTORNEY

CLASS 10—(Continued).

SN 78-432,924. MEDTRONIC XOMED, INC., JACKSONVILLE, FL. FILED 6-10-2004.

CLASS 10—(Continued).

SN 78-434,814. ORO-HEALTH INTERNATIONAL INC., NEW YORK, NY. FILED 6-14-2004.

TRICUT

THE MARK CONSISTS OF STANDARD CHARACTERS WITHOUT CLAIM TO ANY PARTICULAR FONT, STYLE, SIZE, OR COLOR.
SEC. 2(F).
FOR SURGICAL CUTTING INSTRUMENTS AND BLADES (U.S. CLS. 26, 39 AND 44).
FIRST USE 3-31-1996; IN COMMERCE 3-31-1996.
ROBIN CHOSID, EXAMINING ATTORNEY

BOND-A-BRIDGE

THE MARK CONSISTS OF STANDARD CHARACTERS WITHOUT CLAIM TO ANY PARTICULAR FONT, STYLE, SIZE, OR COLOR.
FOR DENTAL PROSTHESIS AND DENTAL RESTORATION KITS CONSISTING OF SIZED BRIDGE SUPPORTS, COMPOSITES AND BONDING AGENTS, RESINS, ADHESIVES AND ETCHANTS, AND INSTRUCTION SHEETS DETAILING A METHOD OF REPLACING MISSING TEETH (U.S. CLS. 26, 39 AND 44).
ANDREW BENZMILLER, EXAMINING ATTORNEY

SN 78-435,202. CONTROL RESEARCH INC., ROLLING MEADOWS, IL. FILED 6-15-2004.

SN 78-434,171. JOINT TECHNOLOGY, INC., EDMOND, OK. FILED 6-11-2004.

Rolloscope

RE-VERT BACK

THE MARK CONSISTS OF STANDARD CHARACTERS WITHOUT CLAIM TO ANY PARTICULAR FONT, STYLE, SIZE, OR COLOR.
FOR MEDICAL BRACES FOR THE BACK FOR TEMPORARY USE (U.S. CLS. 26, 39 AND 44).
GINA FINK, EXAMINING ATTORNEY

THE MARK CONSISTS OF STANDARD CHARACTERS WITHOUT CLAIM TO ANY PARTICULAR FONT, STYLE, SIZE, OR COLOR.
FOR APPARATUS FOR VIEWING RADIOGRAPHS AND COMPONENTS FOR SUCH APPARATUS (U.S. CLS. 26, 39 AND 44).
FIRST USE 12-15-2000; IN COMMERCE 12-15-2000.
KARANENDRA S. CHHINA, EXAMINING ATTORNEY

CLASS 10—(Continued).

SN 78-435,418. ORION LASERS, INC., WILMINGTON, DE. FILED 6-15-2004.

SONATA

THE MARK CONSISTS OF STANDARD CHARACTERS WITHOUT CLAIM TO ANY PARTICULAR FONT, STYLE, SIZE, OR COLOR.

FOR LASERS FOR MEDICAL USE (U.S. CLS. 26, 39 AND 44).

FIRST USE 10-1-2003; IN COMMERCE 10-1-2003.
KELLEY WELLS, EXAMINING ATTORNEY

CLASS 10—(Continued).

SN 78-435,448. NPS PHARMACEUTICALS, INC., SALT LAKE CITY, UT. FILED 6-15-2004.

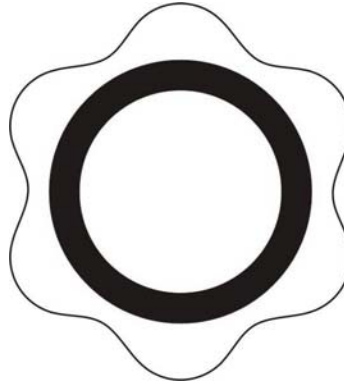

FOR DRUG DELIVERY APPARATUS, NAMELY, PATIENT TRIGGERED INJECTOR FOR THE DELIVERY OF PHARMACEUTICALS (U.S. CLS. 26, 39 AND 44).

ELLEN B. AWRICH, EXAMINING ATTORNEY

SN 78-435,442. CADWELL INDUSTRIES, INC., KENNEWICK, WA. FILED 6-15-2004.

Q-RESP

THE MARK CONSISTS OF STANDARD CHARACTERS WITHOUT CLAIM TO ANY PARTICULAR FONT, STYLE, SIZE, OR COLOR.

OWNER OF U.S. REG. NOS. 2,636,498 AND 2,724,312.
FOR MEDICAL DEVICES USED TO MONITOR PATIENT VITAL SIGNS DURING SLEEP, NAMELY, RESPIRATORY EFFORT SENSORS (U.S. CLS. 26, 39 AND 44).

ELLEN B. AWRICH, EXAMINING ATTORNEY

SN 78-436,625. ALVEOLUS INC, CHARLOTTE, NC. FILED 6-17-2004.

AERO

THE MARK CONSISTS OF STANDARD CHARACTERS WITHOUT CLAIM TO ANY PARTICULAR FONT, STYLE, SIZE, OR COLOR.

FOR MEDICAL APPARATUS, NAMELY, THERAPEUTIC STENT DEVICES FOR USE IN VARIOUS PARTS OF A PATIENT'S ANATOMY (U.S. CLS. 26, 39 AND 44).

WON TEAK OH, EXAMINING ATTORNEY

CLASS 10—(Continued).

SN 78-436,665. ALVEOLUS INC, CHARLOTTE, NC. FILED 6-17-2004.

AERO-DV

THE MARK CONSISTS OF STANDARD CHARACTERS WITHOUT CLAIM TO ANY PARTICULAR FONT, STYLE, SIZE, OR COLOR.

FOR MEDICAL APPARATUS, NAMELY, THERAPEUTIC STENT DEVICES AND VISUALIZATION DELIVERY CATHETERS FOR USE IN VARIOUS PARTS OF A PATIENT'S ANATOMY (U.S. CLS. 26, 39 AND 44).

JOANNA DUKOVIC, EXAMINING ATTORNEY

CLASS 11—ENVIRONMENTAL CONTROL APPARATUS

SN 75-803,899. SEMCO INCORPORATED, COLUMBIA, MO. FILED 9-21-1999.

PINNACLE

FOR VENTILATION SYSTEMS, NAMELY, AN AIR CONDITIONER WHICH SUPPLIES FRESH OUTDOOR AIR INTO A BUILDING AND CONDITIONS THE OUTDOOR AIR TO COOL AND DEHUMIDIFY THE OUTDOOR AIR AS NECESSARY (U.S. CLS. 13, 21, 23, 31 AND 34).

YSA DEJESUS, EXAMINING ATTORNEY

SN 76-530,662. LEXALITE INTERNATIONAL CORPORATION, CHARLEVOIX, MI. FILED 7-18-2003.

LLEDGE WEDGELIT

OWNER OF U.S. REG. NO. 2,700,117. FOR LIGHTING FIXTURE COMPONENTS, NAMELY, ELECTRIC EDGELIT LUMINARIES (U.S. CLS. 13, 21, 23, 31 AND 34).

FIRST USE 6-30-2003; IN COMMERCE 6-30-2003. TRACY WHITAKER-BOWN, EXAMINING ATTORNEY

SN 76-538,869. WDI INTERNATIONAL, INC., IRVINE, CA. FILED 8-20-2003.

PROFLUSH

FOR TOILETS, BIDETS, FAUCETS, TOILET SEATS, TOILET LID COVERS, PLUMBING FITTINGS NAMELY, BIBBS, BALL COCKS, TRAPS, VALVES, SINK STRAINERS, TOILET BOWLS, TOILET LATCH BALLS, TOILET TANKS, BATH TUBS, TOILET SEAT DAMPERS, TOILET FLUSHING SYSTEMS AND PRESSURE ASSISTED TOILET FLUSH SYSTEMS INCLUDING TANKS, FLOATS, HANDLES, CHAINS, FLUSH VALVES, WATER VALVES, AIR VALVES, ANTI-SIPHON VALVES, CHECK VALVES, FLUSH GLANDS, FLUSH BAFFLES, HOSES, SEALS, COVERS, FLANGES, AND FLAPPERS (U.S. CLS. 13, 21, 23, 31 AND 34).

SCOTT OSLICK, EXAMINING ATTORNEY

SN 78-436,868. MICARDIA CORPORATION, IRVINE, CA. FILED 6-17-2004.

MICARDIA

THE MARK CONSISTS OF STANDARD CHARACTERS WITHOUT CLAIM TO ANY PARTICULAR FONT, STYLE, SIZE, OR COLOR.

FOR MEDICAL DEVICES, NAMELY, HEART REPAIR ANNULOPLASTY RINGS (U.S. CLS. 26, 39 AND 44).

RONALD AIKENS, EXAMINING ATTORNEY

SN 76-561,856. WATER TECH INDUSTRIES, INC., PORTLAND, OR. FILED 11-24-2003.

SoftWATER DIRECT

NO CLAIM IS MADE TO THE EXCLUSIVE RIGHT TO USE SOFTWATER, APART FROM THE MARK AS SHOWN. FOR WATER CONDITIONING UNITS, WATER SOFTENING UNITS, AND COMMERCIAL AND DOMESTIC WATER FILTERING UNITS (U.S. CLS. 13, 21, 23, 31 AND 34).

FIRST USE 9-19-2003; IN COMMERCE 9-19-2003. MARY ROSSMAN, EXAMINING ATTORNEY

CLASS 11—(Continued).

SN 76-574,668. SUMITOMO HEAVY INDUSTRIES, LTD., SHINAGAWA-KU, TOKYO, JAPAN, FILED 2-9-2004.

VESPA

THE MARK CONSISTS OF STANDARD CHARACTERS WITHOUT CLAIM TO ANY PARTICULAR FONT, STYLE, SIZE, OR COLOR.
 PRIORITY CLAIMED UNDER SEC. 44(D) ON JAPAN APPLICATION NO. 2003-109290, FILED 12-9-2003, REG. NO. 4777633, DATED 6-11-2004, EXPIRES 6-11-2014.
 FOR FREEZERS (U.S. CLS. 13, 21, 23, 31 AND 34).
 DOMINIC J. FERRAIUOLO, EXAMINING ATTORNEY

SN 76-579,609. WAHL CLIPPER CORPORATION, STERLING, IL. FILED 3-8-2004.

ION CHIC

THE MARK CONSISTS OF STANDARD CHARACTERS WITHOUT CLAIM TO ANY PARTICULAR FONT, STYLE, SIZE, OR COLOR.
 FOR HAND-HELD ELECTRIC HAIR DRYERS (U.S. CLS. 13, 21, 23, 31 AND 34).
 DOMINICK J. SALEMI, EXAMINING ATTORNEY

SN 76-594,630. SANRIO COMPANY, LTD., TOKYO 141, JAPAN, FILED 5-27-2004.



FOR ELECTRIC NIGHT LIGHTS, BICYCLE LIGHTS, PEN LIGHTS, CHRISTMAS TREE ELECTRIC LIGHTS, ELECTRIC BLANKETS NOT FOR MEDICAL PURPOSES, HAND HELD ELECTRIC HAIR DRYERS, LAMPS, LAMP SHADES, ELECTRIC WAFFLE MAKERS, ELECTRIC SANDWICH MAKERS, ELECTRIC RICE COOKERS, ELECTRIC TOASTERS, ELECTRIC COFFEE MAKERS, ELECTRIC FANS AND MICROWAVE OVENS (U.S. CLS. 13, 21, 23, 31 AND 34).
 EUGENIA MARTIN, EXAMINING ATTORNEY

CLASS 11—(Continued).

SN 76-595,129. ENVIROPURE INDUSTRIES, INC., MARTINSVILLE, IN. FILED 5-28-2004.



FOR EXHAUST GAS AND STACK GAS SCRUBBERS (U.S. CLS. 13, 21, 23, 31 AND 34).
 ANNE MADDEN, EXAMINING ATTORNEY

SN 76-595,282. KEITH BROTHERS, INC., MORROW, OH. FILED 6-3-2004.



NO CLAIM IS MADE TO THE EXCLUSIVE RIGHT TO USE ORIGINAL AND FILTER, APART FROM THE MARK AS SHOWN.
 FOR DISPOSABLE FILTERS FOR FILTERING SPA WATER (U.S. CLS. 13, 21, 23, 31 AND 34).
 NICHOLAS ALTREE, EXAMINING ATTORNEY

SN 76-598,048. HD ELECTRIC COMPANY, WAUKEGAN, IL. FILED 6-18-2004.

CYCLOPS

THE MARK CONSISTS OF STANDARD CHARACTERS WITHOUT CLAIM TO ANY PARTICULAR FONT, STYLE, SIZE, OR COLOR.
 FOR HARD-HAT LIGHT (U.S. CLS. 13, 21, 23, 31 AND 34).
 FIRST USE 3-0-2001; IN COMMERCE 3-0-2001.
 RONALD AIKENS, EXAMINING ATTORNEY

CLASS 11—(Continued).

SN 76-598,122. SEVERN TRENT DE NORA, SUGAR LAND, TX. FILED 6-18-2004.

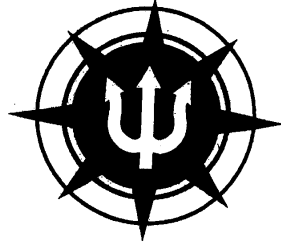

FOR UNITS FOR TREATMENT AND PURIFICATION OF WATER AND WASTEWATER FOR MARINE VESSELS AND OFFSHORE RIGS (U.S. CLS. 13, 21, 23, 31 AND 34).

CIMMERIAN COLEMAN, EXAMINING ATTORNEY

SN 76-598,305. M.K. PLASTICS CORPORATION, MONTREAL, QUEBEC, CANADA, FILED 6-21-2004.

TWISTAIR

THE MARK CONSISTS OF STANDARD CHARACTERS WITHOUT CLAIM TO ANY PARTICULAR FONT, STYLE, SIZE, OR COLOR.

FOR ROOF MOUNTED FANS FOR INDUSTRIAL AND COMMERCIAL USE (U.S. CLS. 13, 21, 23, 31 AND 34).

RONALD MCMORROW, EXAMINING ATTORNEY

SN 76-598,545. RHEEM MANUFACTURING COMPANY, NEW YORK, NY. FILED 6-18-2004.

ENCORE.

THE MARK CONSISTS OF STANDARD CHARACTERS WITHOUT CLAIM TO ANY PARTICULAR FONT, STYLE, SIZE, OR COLOR.

FOR TANKLESS (INSTANTANEOUS GAS) WATER HEATERS (U.S. CLS. 13, 21, 23, 31 AND 34).

WILLIAM P. SHANAHAN, EXAMINING ATTORNEY

CLASS 11—(Continued).

SN 76-617,451. RHEEM MANUFACTURING COMPANY, NEW YORK, NY. FILED 10-25-2004.

INTEGRA.

THE MARK CONSISTS OF STANDARD CHARACTERS WITHOUT CLAIM TO ANY PARTICULAR FONT, STYLE, SIZE, OR COLOR.

FOR FLAMMABLE VAPOR IGNITION RESISTANT GAS STORAGE WATER HEATERS (U.S. CLS. 13, 21, 23, 31 AND 34).

FIRST USE 7-1-2003; IN COMMERCE 7-1-2003.

WILLIAM P. SHANAHAN, EXAMINING ATTORNEY

SN 78-232,572. KIFCO, INC., HAVANA, IL. FILED 4-1-2003.

KIFCO

FOR TRAVELING WATER SPRINKLERS, HOSES, PUMPS AND CLAMPS FOR IRRIGATION (U.S. CLS. 13, 21, 23, 31 AND 34).

FIRST USE 10-0-1986; IN COMMERCE 10-0-1986.

ANNE MADDEN, EXAMINING ATTORNEY

SN 78-248,600. KAZ INCORPORATED, NEW YORK, NY. FILED 5-12-2003.

ODOR-LOCK

FOR AIR CLEANERS AND AIR FILTERS FOR DOMESTIC AND OFFICE USE (U.S. CLS. 13, 21, 23, 31 AND 34).

FIRST USE 12-0-2000; IN COMMERCE 12-0-2000.

KATHLEEN M. VANSTON, EXAMINING ATTORNEY

SN 78-316,254. INNOVATIVE MARKETING & DISTRIBUTION INC., JUPITER, FL. FILED 10-21-2003.

STEADYTEMP

THE MARK CONSISTS OF STANDARD CHARACTERS WITHOUT CLAIM TO ANY PARTICULAR FONT, STYLE, SIZE, OR COLOR.

FOR CONSTANT TEMPERATURE 12 VOLT REFRIGERATOR DESIGNED FOR USE IN VEHICLES (U.S. CLS. 13, 21, 23, 31 AND 34).

FIRST USE 7-11-2003; IN COMMERCE 7-11-2003.

GEOFFREY FOSDICK, EXAMINING ATTORNEY

CLASS 11—(Continued).

SN 78-344,598. MASCO CORPORATION OF INDIANA, INDIANAPOLIS, IN. FILED 12-23-2003.

CLASS 11—(Continued).

SN 78-348,155. RSI COMPANY, CLEVELAND, OH. FILED 1-6-2004.

BRIZO

Edpac

THE MARK CONSISTS OF STANDARD CHARACTERS WITHOUT CLAIM TO ANY PARTICULAR FONT, STYLE, SIZE, OR COLOR.
FOR PLUMBING PRODUCTS, NAMELY FAUCETS, SHOWERHEADS AND BATH SPOUTS (U.S. CLS. 13, 21, 23, 31 AND 34).
KIMBERLY PERRY, EXAMINING ATTORNEY

THE MARK CONSISTS OF STANDARD CHARACTERS WITHOUT CLAIM TO ANY PARTICULAR FONT, STYLE, SIZE, OR COLOR.
FOR AIR CONDITIONING UNITS (U.S. CLS. 13, 21, 23, 31 AND 34).
STEVEN R. FINE, EXAMINING ATTORNEY

SN 78-345,102. COMFORT CLASSICS, INC, HUNTINGTON BEACH, CA. FILED 12-23-2003.

SN 78-349,480. WATKINS MANUFACTURING CORPORATION, VISTA, CA. FILED 1-8-2004.

Wonderbar



THE MARK CONSISTS OF STANDARD CHARACTERS WITHOUT CLAIM TO ANY PARTICULAR FONT, STYLE, SIZE, OR COLOR.
FOR COMBINATION ELECTRIC TOWEL WARMER AND DRYING RACK (U.S. CLS. 13, 21, 23, 31 AND 34).
FIRST USE 12-1-2003; IN COMMERCE 12-1-2003.
MATTHEW PAPPAS, EXAMINING ATTORNEY

NO CLAIM IS MADE TO THE EXCLUSIVE RIGHT TO USE "HIGH PERFORMANCE", APART FROM THE MARK AS SHOWN.
FOR HOT TUBS AND SPAS IN THE NATURE OF HEATED WHIRLPOOLS (U.S. CLS. 13, 21, 23, 31 AND 34).
TARAH HARDY, EXAMINING ATTORNEY

CLASS 11—(Continued).

SN 78-355,022. BEACH FILTER PRODUCTS, INC., GLEN ROCK, PA. FILED 1-21-2004.

AQUAGUARD

THE MARK CONSISTS OF STANDARD CHARACTERS WITHOUT CLAIM TO ANY PARTICULAR FONT, STYLE, SIZE, OR COLOR.
FOR DESICCANT BREATHERS FOR REMOVING MOISTURE AND OTHER IMPURITIES FROM OIL BATH LUBRICATION ENCLOSURE ATMOSPHERE (U.S. CLS. 13, 21, 23, 31 AND 34).
AISHA CLARKE, EXAMINING ATTORNEY

SN 78-369,725. ANGLES BEAUTYCARE GROUP, INC., SAN DIEGO, CA. FILED 2-18-2004.

HAIONIC

THE MARK CONSISTS OF STANDARD CHARACTERS WITHOUT CLAIM TO ANY PARTICULAR FONT, STYLE, SIZE, OR COLOR.
FOR HANDHELD HAIR BLOW DRYERS (U.S. CLS. 13, 21, 23, 31 AND 34).
AMOS T. MATTHEWS, JR., EXAMINING ATTORNEY

CLASS 11—(Continued).

SN 78-369,905. THE ORUP COMPANY, INC., DBA REP-CAL RESEARCH LABS, LOS GATOS, CA. FILED 2-18-2004.

CALCIUM ACTIVATOR

THE MARK CONSISTS OF STANDARD CHARACTERS WITHOUT CLAIM TO ANY PARTICULAR FONT, STYLE, SIZE, OR COLOR.
NO CLAIM IS MADE TO THE EXCLUSIVE RIGHT TO USE "CALCIUM", APART FROM THE MARK AS SHOWN.
FOR UV LAMP FOR SIMULATING NATURAL SUNLIGHT, PARTICULARLY ADAPTED FOR USE WITH TERRARIA AND REPTILE, AMPHIBIAN AND INSECT ENCLOSURES (U.S. CLS. 13, 21, 23, 31 AND 34).
FIRST USE 9-30-2003; IN COMMERCE 9-30-2003.
STEVEN R. FINE, EXAMINING ATTORNEY

SN 78-395,094. VISIONAIRE PRODUCTS, INC., CHICAGO, IL. FILED 4-1-2004.



NO CLAIM IS MADE TO THE EXCLUSIVE RIGHT TO USE "PRODUCTS INCORPORATED", APART FROM THE MARK AS SHOWN.
THE COLORS BLACK AND RED ARE CLAIMED AS A FEATURE OF THE MARK.
THE MARK CONSISTS OF A BLACK, UPPER CASE "V" AND A BLACK UPPER CASE "P" THAT SHARE THE RIGHT SIDE OF THE "V" AND THE LEG OF THE "P". THERE IS A RED LOWER CASE "I" UNDERNEATH THE LOOP OF THE "P" AND THE RED DOT OF THE "I" IS ON THE "P" AT THE JUNCTURE OF THE LEG AND LOOP. UNDERNEATH THE IMAGE, THE NAME OF THE COMPANY, VISIONAIRE PRODUCTS INCORPORATED IS WRITTEN IN BLACK WITH UPPER CASE "V", "P" AND "I".
FOR TODDLER URINALS (U.S. CLS. 13, 21, 23, 31 AND 34).
STEVEN R. FINE, EXAMINING ATTORNEY

CLASS 11—(Continued).

SN 78-405,987. LOOMINOCITY, INC., NAPA, CA. FILED 4-21-2004.

LOOMINOCITY

THE MARK CONSISTS OF STANDARD CHARACTERS WITHOUT CLAIM TO ANY PARTICULAR FONT, STYLE, SIZE, OR COLOR.
FOR LIGHTING APPARATUS, NAMELY, ELECTRIC LIGHT FIXTURES, AND ELECTRIC CHRISTMAS TREE ORNAMENTS (U.S. CLS. 13, 21, 23, 31 AND 34).
SALLY SHIN, EXAMINING ATTORNEY

CLASS 11—(Continued).

SN 78-429,108. BARBEQUES GALORE, INC., LAKE FOREST, CA. FILED 6-3-2004.

ONYX

THE MARK CONSISTS OF STANDARD CHARACTERS WITHOUT CLAIM TO ANY PARTICULAR FONT, STYLE, SIZE, OR COLOR.
FOR BARBECUE GRILLS (U.S. CLS. 13, 21, 23, 31 AND 34).
TONJA GASKINS, EXAMINING ATTORNEY

SN 78-418,245. BE AEROSPACE, INC., WELLINGTON, FL. FILED 5-13-2004.

AEROGUARD

THE MARK CONSISTS OF STANDARD CHARACTERS WITHOUT CLAIM TO ANY PARTICULAR FONT, STYLE, SIZE, OR COLOR.
FOR ULTRA-VIOLET GERMICIDAL IRRADIATION APPARATUS USED FOR AIRCRAFT AIR PURIFICATION (U.S. CLS. 13, 21, 23, 31 AND 34).
CHERYL CLAYTON, EXAMINING ATTORNEY

SN 78-431,975. SOCIETE DES PRODUITS NESTLE S.A., 1800 VEVEY, SWITZERLAND, FILED 6-8-2004.

NESPRESSO ESSENZA

THE MARK CONSISTS OF STANDARD CHARACTERS WITHOUT CLAIM TO ANY PARTICULAR FONT, STYLE, SIZE, OR COLOR.
OWNER OF U.S. REG. NOS. 1,607,148 AND 2,009,751.
THE ENGLISH TRANSLATION OF ESSENZA IS ESSENCE.
FOR ELECTRIC APPARATUS FOR PREPARING BEVERAGES, NAMELY, COFFEE MACHINES, ELECTRIC COFFEE POTS AND ELECTRIC PERCOLATORS, MILK HEATING AND MILK FROTHING MACHINES, PARTS AND FITTINGS FOR THE AFORESAID GOODS (U.S. CLS. 13, 21, 23, 31 AND 34).
KIMBERLY FRYE, EXAMINING ATTORNEY

CLASS 11—(Continued).

SN 78-435,435. STREAMION, INC., WHEAT RIDGE, CO. FILED 6-15-2004.

iStream

THE MARK CONSISTS OF STANDARD CHARACTERS WITHOUT CLAIM TO ANY PARTICULAR FONT, STYLE, SIZE, OR COLOR.

FOR WATER PURIFICATION UNITS; WATER PURIFYING UNITS FOR POTABLE WATER FOR DOMESTIC USE; WATER PURIFYING UNITS FOR POTABLE WATER FOR COMMERCIAL USE; WATER PURIFIERS AND APPARATUS FOR USE IN CONNECTION WITH BATHING AND CLEANSING BODY PARTS (U.S. CLS. 13, 21, 23, 31 AND 34).

JEAN IM, EXAMINING ATTORNEY

SN 78-435,906. PRECISION ARCHITECTURAL LIGHTING, INC., HOUSTON, TX. FILED 6-16-2004.

ACCENTRA

THE MARK CONSISTS OF STANDARD CHARACTERS WITHOUT CLAIM TO ANY PARTICULAR FONT, STYLE, SIZE, OR COLOR.

FOR ELECTRIC LIGHTING FIXTURES (U.S. CLS. 13, 21, 23, 31 AND 34).

JOHN SCHUYLER YARD, EXAMINING ATTORNEY

CLASS 11—(Continued).

SN 78-439,470. THE BABCOCK & WILCOX COMPANY, BARBERTON, OH. FILED 6-22-2004.

SWUP

THE MARK CONSISTS OF STANDARD CHARACTERS WITHOUT CLAIM TO ANY PARTICULAR FONT, STYLE, SIZE, OR COLOR.

FOR STEAM GENERATORS AND PARTS THEREOF (U.S. CLS. 13, 21, 23, 31 AND 34).

GLENN CLARK, EXAMINING ATTORNEY

SN 79-004,993. TEFAL, FRANCE, FILED 6-3-2004.

FIT'N CLEAN

PRIORITY DATE OF 12-10-2003 IS CLAIMED. OWNER OF INTERNATIONAL REGISTRATION 0832319 DATED 6-3-2004, EXPIRES 6-3-2014.

FOR ELECTRIC COOKING APPLIANCES, NAMELY: GRILLS (U.S. CLS. 13, 21, 23, 31 AND 34).

ANDREA SAUNDERS, EXAMINING ATTORNEY

CLASS 12—VEHICLES

SN 76-435,925. O'DELL, GRAHAM, EAST FREMANTLE, AUSTRALIA, AND O'DELL, MARISA, EAST FREMANTLE, AUSTRALIA, FILED 7-29-2002.

LEGBEDS

PRIORITY CLAIMED UNDER SEC. 44(D) ON AUSTRALIA APPLICATION NO. 902171, FILED 2-4-2002, REG. NO. 902171, DATED 2-4-2002, EXPIRES 2-4-2012.

FOR STRUCTURAL PARTS FOR LAND MOTOR VEHICLES, NAMELY, GROUND BASED SUPPORT PADS FOR CARAVANS, TRAVEL TRAILERS AND CAMPER STABILIZER LEGS OR JACKS; AND GROUND BASED SUPPORT PADS FOR TRAILERS, CARAVANS, TRAVEL TRAILERS AND CAMPER JOCKEY WHEELS OR SWIVEL JACKS (U.S. CLS. 19, 21, 23, 31, 35 AND 44).

MATTHEW KLINE, EXAMINING ATTORNEY

CLASS 12—(Continued).

SN 76-482,354. KABUSHIKI KAISHA EXEDY, NEYAGAWASHI, OSAKA, JAPAN, FILED 1-14-2003.



OWNER OF JAPAN REG. NO. 3367320, DATED 12-19-1997, EXPIRES 12-19-2007.

OWNER OF U.S. REG. NO. 2,278,590.

THE DRAWING IS LINED FOR THE COLOR(S) RED AND BLUE.

THE MARK IS BLUE, EXCEPT FOR THE THREE CURVED LINES THAT FORM PART OF THE "X", WHICH ARE RED.

THE MARK HAS NO FOREIGN TRANSLATION OR MEANING IN THE FIELD OF GOODS IDENTIFIED HEREIN.

FOR SHIPS AND BOATS AND STRUCTURAL PARTS THEREFOR; AIRCRAFT AND PLANES AND STRUCTURAL PARTS THEREFOR; RAIL TRANSIT VEHICLES, NAMELY, TRAINS, FREIGHT CARS, LOCOMOTIVES, SUBWAY CARS, MONORAIL TRAINS, ELEVATED SKY-TRAINS, AND STRUCTURAL PARTS THEREFOR; AUTOMOBILES, CARS AND MOTOR CARS AND STRUCTURAL PARTS THEREFOR; TWO-WHEELED MOTOR VEHICLES, NAMELY MOTORCYCLES AND STRUCTURAL PARTS THEREFOR; BICYCLES AND STRUCTURAL PARTS THEREFOR; BABY CARRIAGES AND PRAMS; RICKSHAWS; SLEIGHS FOR TRANSPORTATION; WHEEL BARROWS; TROLLEYS; TILTING HAND CARTS; CARTS, NAMELY, SHOPPING CARTS, HOSPITAL CARTS, CARTS FOR GARDEN HOSES AND MOTORIZED GOLF CARTS; HORSE DRAWN CARRIAGES FOR TRANSPORTATION; BICYCLE TRAILERS; WHEELCHAIRS; CABLE CARS FOR CARGO AND/OR FREIGHT HANDLING; UNLOADING TIPPLERS IN THE NATURE OF FORK LIFTS FOR TILTING RAILWAY FREIGHT CARS; MINE-CAR PUSHERS, NAMELY, A VEHICLE FOR PUSHING MINE-CARS A SHORT DISTANCE; MINE-CAR PULLERS, NAMELY, A VEHICLE FOR PULLING MINE-CARS A SHORT DISTANCE; TRACTORS; NON-ELECTRIC INTERNAL COMBUSTION ENGINES FOR LAND VEHICLES; STEAM ENGINES FOR LAND VEHICLES; JET ENGINES FOR LAND VEHICLES; NON-ELECTRIC TURBINES FOR LAND VEHICLES; LAND VEHICLE PARTS, NAMELY, DRIVE SHAFTS AND AXLES FOR LAND VEHICLES, LAND VEHICLE SUSPENSION PARTS IN THE NATURE OF SPINDLES, CLUTCH RELEASE BEARINGS FOR LAND VEHICLES, DRIVE SHAFT COUPLINGS FOR LAND VEHICLES, PARTS OF DIFFERENTIALS FOR LAND VEHICLES IN THE NATURE OF IDLING PULLEYS, BELT PULLEYS AND CAMSHAFTS, REVERSING GEARS FOR LAND VEHICLES, REDUCTION GEARS FOR LAND VEHICLES, POWER TRANSMISSION BELTS FOR LAND VEHICLES, TOOTHED DRIVE GEARS FOR LAND VEHICLES, SPEED CHANGE GEARS FOR LAND VEHICLES, POWER TRANSMITTED FLUID COUPLINGS FOR LAND VEHICLES, HYDRAULIC TORQUE CONVERTERS FOR LAND VEHICLES, ROLLER CHAINS FOR LAND VEHICLES, CLUTCHES FOR LAND VEHICLES, CLUTCH DISCS FOR LAND VEHICLES, CLUTCH COVERS FOR LAND VEHICLES, POWER TRANSMITTED FLY-WHEELS FOR LAND VEHICLES, CLUTCH RELEASE DEVICES FOR LAND VEHICLES, TORQUE CONVERTERS FOR LAND VEHICLES, TRANSMISSIONS FOR LAND VEHICLES, CLUTCH LININGS FOR LAND VEHICLES, BRAKE LININGS FOR LAND VEHICLES, POWER TRANSMITTED REAR DRIVERS FOR LAND VEHICLES, SHOCK ABSORBERS FOR LAND VEHICLES, SPRINGS FOR LAND VEHICLES, AND BRAKES FOR LAND VEHICLES; AC OR DC ENGINES FOR LAND VEHICLES; ADHESIVE RUBBER PATCHES FOR REPAIRING TUBES OR TIRES; ANTI-THEFT ALARMS FOR VEHICLES (U.S. CLS. 19, 21, 23, 31, 35 AND 44).

TRACY FLETCHER, EXAMINING ATTORNEY

CLASS 12—(Continued).

SN 76-491,075. ISRAEL AIRCRAFT INDUSTRIES LTD., LOD 70100, ISRAEL, FILED 2-13-2003.

HERON

PRIORITY CLAIMED UNDER SEC. 44(D) ON ISRAEL APPLICATION NO. 158849, FILED 8-15-2002, REG. NO. 158849, DATED 11-4-2003, EXPIRES 8-15-2009.

FOR UNMANNED AERIAL VEHICLES (UAV); UAV SYSTEMS COMPOSED OF UAVS AND COMPONENT PARTS, NAMELY, SENSORS, DOWNSIZED, PORTABLE, PASSIVE AND ACTIVE REMOTE GROUND CONTROL TERMINALS, DATA LINKS COMPRISED OF GROUND CONTROL TERMINALS AND AIRBORNE DATA TERMINALS THAT ALLOW THE UAV TO BE CONTROLLED BY THE GROUND OPERATORS AND FURTHER ALLOW DATA TO BE TRANSMITTED FROM THE UAV TO THE GROUND OPERATORS (U.S. CLS. 19, 21, 23, 31, 35 AND 44).

DAWN FELDMAN, EXAMINING ATTORNEY

SN 76-491,760. TURNAGE, JOHNNY MILTON, JR, KINSTON, NC. FILED 2-24-2003.

"WE LOVE TO HUNT"

NO CLAIM IS MADE TO THE EXCLUSIVE RIGHT TO USE "CAMO", APART FROM THE MARK AS SHOWN.

FOR CUSTOM CAMOUFLAGED AUTOMOBILE AND TRUCK COVERS MADE OF VINYL THAT ATTACH TO THE EXTERIOR OF THE VEHICLES TO AID IN HUNTING (U.S. CLS. 19, 21, 23, 31, 35 AND 44).

CHRISTOPHER ADKINS, EXAMINING ATTORNEY

SN 76-513,189. WICKED CHOPPERS CORPORATION, PIQUA, OH. FILED 5-9-2003.



NO CLAIM IS MADE TO THE EXCLUSIVE RIGHT TO USE "CHOPPERS", APART FROM THE MARK AS SHOWN.

FOR MOTORCYCLES AND MOTORCYCLE STRUCTURAL PARTS AND ACCESSORIES NAMELY, ENGINE AND DRIVE COVERS AND CUSTOM SEATS (U.S. CLS. 19, 21, 23, 31, 35 AND 44).

ALICE SUE CARRUTHERS, EXAMINING ATTORNEY

CLASS 12—(Continued).

SN 76-518,149. DURA AUTOMOTIVE SYSTEMS, INC., ROCHESTER HILLS, MI. FILED 5-30-2003.

DURATRONIX

FOR SEAT POSITION ADJUSTERS FOR MOTOR VEHICLES, SEAT TRACK POSITION ADJUSTERS FOR MOTOR VEHICLES, MOTOR VEHICLE SLIDING WINDOWS, AND TAILGATES AS STRUCTURAL PARTS OF MOTOR VEHICLES; LIFTGATES AS STRUCTURAL PARTS OF MOTOR VEHICLES; WINDOW AND LIFTGATE REGULATORS FOR MOTOR VEHICLES; SLIDING PANEL REGULATORS FOR CLOSURE WINDOWS, SUNROOFS AND LIFTGATES IN MOTOR VEHICLES; WINCH OPERATION REGULATORS FOR STOWING AND ACCESSING SPARE TIRES FOR MOTOR VEHICLES; SPARE TIRE STOWAGE REGULATORS FOR MOTOR VEHICLES; AND ELECTRONIC PARK BRAKES FOR MOTOR VEHICLES, ALL FOR USE IN AUTOMOBILES, RECREATIONAL VEHICLES, AND HEAVY DUTY TRUCKS (U.S. CLS. 19, 21, 23, 31, 35 AND 44).

STEVEN R. FOSTER, EXAMINING ATTORNEY

SN 76-522,715. INCLINE, LLC, PROVIDENCE, RI. FILED 6-16-2003.

INCLINE

FOR BICYCLES (U.S. CLS. 19, 21, 23, 31, 35 AND 44). FIRST USE 9-0-2002; IN COMMERCE 9-0-2002.

PAUL F. GAST, EXAMINING ATTORNEY

SN 76-541,107. GULFSTREAM AEROSPACE CORPORATION, SAVANNAH, GA. FILED 8-28-2003.

G225

OWNER OF U.S. REG. NOS. 2,527,504, 2,527,506 AND OTHERS.
FOR AIRPLANES (U.S. CLS. 19, 21, 23, 31, 35 AND 44).
SCOTT OSCLICK, EXAMINING ATTORNEY

CLASS 12—(Continued).

SN 76-543,072. EDWARD L. PAXTON AND LLOYD M. PAXTON PARTNERSHIP, THE, SALEM, UT. FILED 8-20-2003.



THE COLOR(S) ARE YELLOW, GREEN, RED, AND BLACK IS/ARE CLAIMED AS A FEATURE OF THE MARK.

THE MARK CONSISTS OF THE HEAD OF THE DRAGON HAS YELLOW, GREEN, RED WITH YELLOW LIGHTING BOLT COMING FROM MOUTH TO FROM THE LETTER Z IN YELLOW BACKED IN BLACK WITH THE LETTERS E Z PACKER BY E Z D IN BLACK THE Z YELLOW WITH BLACK BACKING.

FOR INFLATABLE POONTOON BOAT ACCESSORIES, NAMELY, CARRIERS ATTACHED TO THE BACK OF VEHICLES AND WHEELS TO MOVE AROUND ON LAND BY HAND (U.S. CLS. 19, 21, 23, 31, 35 AND 44).

PAM WILLIS, EXAMINING ATTORNEY

SN 76-545,959. GO! PRODUCTS, INC., ELMHURST, IL. FILED 9-22-2003.

GO! PRODUCTS

NO CLAIM IS MADE TO THE EXCLUSIVE RIGHT TO USE "PRODUCTS", APART FROM THE MARK AS SHOWN.
FOR WHEELED AND REMOVABLE AND ATTACHABLE TAILGATES FOR TRUCKS (U.S. CLS. 19, 21, 23, 31, 35 AND 44).

FIRST USE 6-1-2003; IN COMMERCE 6-1-2003.

BILL DAWE, EXAMINING ATTORNEY

SN 76-561,640. DURABRAKES, INC., ONTARIO, CA. FILED 11-12-2003.

DURABRAKES

THE MARK CONSISTS OF STANDARD CHARACTERS WITHOUT CLAIM TO ANY PARTICULAR FONT, STYLE, SIZE, OR COLOR.

FOR AUTOMOTIVE BRAKE SYSTEMS AND PARTS, NAMELY, FINISHED BRAKE SHOES, DISK BRAKE PADS AND COMPONENTS, BRAKE LININGS, BRAKE DRUMS, BRAKE ROTORS, BRAKE CALIPERS, AND BRAKE HARDWARE FOR LAND VEHICLES, INCLUDING, CARS, TRUCKS, HEAVY-DUTY TRUCKS AND COMMERCIAL TRUCKS (U.S. CLS. 19, 21, 23, 31, 35 AND 44).

DANIELLE MATTESSICH, EXAMINING ATTORNEY

CLASS 12—(Continued).

SN 76-565,625. SUZUKI MOTOR CORPORATION, SHIZUOKA-KEN, JAPAN, FILED 12-17-2003.

GSX-R

THE MARK CONSISTS OF STANDARD CHARACTERS WITHOUT CLAIM TO ANY PARTICULAR FONT, STYLE, SIZE, OR COLOR.

FOR MOTORCYCLES AND STRUCTURAL PARTS THEREFOR (U.S. CLS. 19, 21, 23, 31, 35 AND 44). FIRST USE 0-0-1986; IN COMMERCE 0-0-1986. BARBARA BROWN, EXAMINING ATTORNEY

SN 76-569,918. THRESHOLD SPORTS, LLC, NORRISTOWN, PA. FILED 1-2-2004.

Pro Cycling Tour

THE MARK CONSISTS OF STANDARD CHARACTERS WITHOUT CLAIM TO ANY PARTICULAR FONT, STYLE, SIZE, OR COLOR.

FOR BICYCLES (U.S. CLS. 19, 21, 23, 31, 35 AND 44). DAVID MURRAY, EXAMINING ATTORNEY

SN 76-570,444. DAIMLERCHRYSLER AG, 70567 STUTTGART, FED REP GERMANY, FILED 1-16-2004.

EASY-VARIO

THE MARK CONSISTS OF STANDARD CHARACTERS WITHOUT CLAIM TO ANY PARTICULAR FONT, STYLE, SIZE, OR COLOR.

PRIORITY CLAIMED UNDER SEC. 44(D) ON FED REP GERMANY APPLICATION NO. 30336059.3/1, FILED 7-16-2003, REG. NO. 30336059, DATED 8-12-2003, EXPIRES 7-31-2013.

FOR AUTOMOBILES AND THEIR STRUCTURAL PARTS (U.S. CLS. 19, 21, 23, 31, 35 AND 44). MARTHA FROMM, EXAMINING ATTORNEY

CLASS 12—(Continued).

SN 76-586,982. WINNEBAGO INDUSTRIES, INC., FOREST CITY, IA. FILED 4-15-2004.

TRIMLINE CONSOLE

THE MARK CONSISTS OF STANDARD CHARACTERS WITHOUT CLAIM TO ANY PARTICULAR FONT, STYLE, SIZE, OR COLOR.

NO CLAIM IS MADE TO THE EXCLUSIVE RIGHT TO USE "CONSOLE", APART FROM THE MARK AS SHOWN.

FOR INTERIOR ENGINE COVERS WITH BEVERAGE HOLDERS, STORAGE TRAY AND STORAGE COMPARTMENT SOLD AS PARTS OF MOTOR HOMES (U.S. CLS. 19, 21, 23, 31, 35 AND 44).

BARBARA GAYNOR, EXAMINING ATTORNEY

SN 76-586,983. WINNEBAGO INDUSTRIES, INC., FOREST CITY, IA. FILED 4-15-2004.

SMART STORAGE

THE MARK CONSISTS OF STANDARD CHARACTERS WITHOUT CLAIM TO ANY PARTICULAR FONT, STYLE, SIZE, OR COLOR.

NO CLAIM IS MADE TO THE EXCLUSIVE RIGHT TO USE "STORAGE", APART FROM THE MARK AS SHOWN.

FOR SLIDEOUT BOXES AND CONTAINERS FOR HOLDING HOSES, CHAIRS AND TOOLS, HINGED CONTAINER FOR STORING A FOLDING LADDER AND SLIDEOUT BOX USED AS AN EXTERIOR TABLE OR TV STAND COMPRISING PARTS OF MOTOR HOMES (U.S. CLS. 19, 21, 23, 31, 35 AND 44).

BARBARA GAYNOR, EXAMINING ATTORNEY

SN 76-592,227. ADAMS, JOSEPH E., JR., GRANGER, IN. FILED 5-14-2004.



NO CLAIM IS MADE TO THE EXCLUSIVE RIGHT TO USE CHOPPERS, APART FROM THE MARK AS SHOWN.

FOR MOTORCYCLES (U.S. CLS. 19, 21, 23, 31, 35 AND 44).

MICHAEL WEBSTER, EXAMINING ATTORNEY

CLASS 12—(Continued).

SN 76-594,928. REIDVILLE PRODUCTS INTERNATIONAL LLC., REIDVILLE, SC. FILED 6-1-2004.

KWIK GATE

THE MARK CONSISTS OF STANDARD CHARACTERS WITHOUT CLAIM TO ANY PARTICULAR FONT, STYLE, SIZE, OR COLOR.

NO CLAIM IS MADE TO THE EXCLUSIVE RIGHT TO USE GATE, APART FROM THE MARK AS SHOWN.

FOR TAILGATE ACCESSORY IN THE NATURE OF A TAILGATE EXTENDER FOR ACCESSING AND EXTENDING A PICKUP TRUCK BED (U.S. CLS. 19, 21, 23, 31, 35 AND 44).

STEVEN BERK, EXAMINING ATTORNEY

SN 76-598,544. R. A. ALLEN COMPANY, INC., NEW BEDFORD, MA. FILED 6-22-2004.



OWNER OF U.S. REG. NO. 1,463,413.

NO CLAIM IS MADE TO THE EXCLUSIVE RIGHT TO USE "BIKE RACKS", APART FROM THE MARK AS SHOWN.

FOR EQUIPMENT CARRIER THAT IS MOUNTABLE ON A MOTOR VEHICLE FOR CARRYING BICYCLES, SKIS AND THE LIKE (U.S. CLS. 19, 21, 23, 31, 35 AND 44).

FIRST USE 5-7-2004; IN COMMERCE 5-7-2004.
AISHA CLARKE, EXAMINING ATTORNEY

SN 78-147,181. FOUND AIRCRAFT DEVELOPMENT INC., PARRY SOUND, ONTARIO, FILED 7-24-2002.



PRIORITY CLAIMED UNDER SEC. 44(D) ON CANADA APPLICATION NO. 1131499, FILED 2-18-2002, REG. NO. TMA601794, DATED 2-10-2004, EXPIRES 2-10-2019.

NO CLAIM IS MADE TO THE EXCLUSIVE RIGHT TO USE "AIRCRAFT CANADA INC" AND REPRESENTATION OF AN AIRCRAFT, APART FROM THE MARK AS SHOWN.

THE STIPPLING IS FOR SHADING PURPOSES ONLY.
FOR AIRPLANES (U.S. CLS. 19, 21, 23, 31, 35 AND 44).
SUSAN HAYASH, EXAMINING ATTORNEY

CLASS 12—(Continued).

SN 78-295,404. ANGELS LANDING, INC., KETTERING, OH. FILED 9-3-2003.

COMPASS

FOR BABY STROLLERS, VEHICLE CAR SEATS AND COMPONENT PARTS THEREOF (U.S. CLS. 19, 21, 23, 31, 35 AND 44).

FIRST USE 1-5-2004; IN COMMERCE 1-5-2004.
STEVEN BERK, EXAMINING ATTORNEY

SN 78-318,802. 4620 LLC, AVONDALE, AZ. FILED 10-27-2003.

RBARS

FOR HANDLEBARS FOR MOTORCYCLES, ALL TERRAIN VEHICLES AND BICYCLES (U.S. CLS. 19, 21, 23, 31, 35 AND 44).

JIM RINGLE, EXAMINING ATTORNEY

SN 78-319,006. BELL, ERHARDT, MEDINA, OH. FILED 10-27-2003.

SADDLE BRA

NO CLAIM IS MADE TO THE EXCLUSIVE RIGHT TO USE "BRA", APART FROM THE MARK AS SHOWN.

FOR VEHICLE ACCESSORIES NAMELY, FITTED COVERS FOR PORTIONS OF VEHICLES (U.S. CLS. 19, 21, 23, 31, 35 AND 44).

THEODORE MCBRIDE, EXAMINING ATTORNEY

SN 78-325,446. GSE LOGISTICS, INC., SHERMAN OAKS, CA. FILED 11-10-2003.

RAMP RHINO

THE MARK CONSISTS OF STANDARD CHARACTERS WITHOUT CLAIM TO ANY PARTICULAR FONT, STYLE, SIZE, OR COLOR.

NO CLAIM IS MADE TO THE EXCLUSIVE RIGHT TO USE "RAMP", APART FROM THE MARK AS SHOWN.

FOR ACCESSORIES FOR CARGO AND FREIGHT VEHICLES, NAMELY LOAD PUSHERS. (U.S. CLS. 19, 21, 23, 31, 35 AND 44).

SAMUEL E. SHARPER JR., EXAMINING ATTORNEY

CLASS 12—(Continued).

SN 78-331,219. GENERAL MOTORS CORPORATION, DETROIT, MI. FILED 11-21-2003.

CLASS 12—(Continued).

SN 78-408,311. CHINA DIRECT INC., WOODMERE, NY. FILED 4-26-2004.

THE JUDGE

Generalist

THE MARK CONSISTS OF STANDARD CHARACTERS WITHOUT CLAIM TO ANY PARTICULAR FONT, STYLE, SIZE, OR COLOR.

FOR PARTS, RESTORATION PARTS, AND ACCESSORIES FOR MOTOR LAND VEHICLES, NAMELY, FENDER COVERS, SHIFT KNOBS AND BADGES, NAMELY INTERIOR AND EXTERIOR TRIM BADGES (U.S. CLS. 19, 21, 23, 31, 35 AND 44).

FIRST USE 7-1-1992; IN COMMERCE 7-1-1992.
NICHOLAS ALTREE, EXAMINING ATTORNEY

THE MARK CONSISTS OF STANDARD CHARACTERS WITHOUT CLAIM TO ANY PARTICULAR FONT, STYLE, SIZE, OR COLOR.

FOR WINDSHIELD WIPER BLADES (U.S. CLS. 19, 21, 23, 31, 35 AND 44).

ALLISON HOLTZ, EXAMINING ATTORNEY

SN 78-418,496. PACIFIC ASIAN ENTERPRISES, INC., DANA POINT, CA. FILED 5-13-2004.

SN 78-354,342. MKW ALLOY INC., CITY OF INDUSTRY, CA. FILED 1-20-2004.

Avenue Wheels

MASON

THE MARK CONSISTS OF STANDARD CHARACTERS WITHOUT CLAIM TO ANY PARTICULAR FONT, STYLE, SIZE, OR COLOR.

NO CLAIM IS MADE TO THE EXCLUSIVE RIGHT TO USE "WHEELS", APART FROM THE MARK AS SHOWN.

FOR AUTOMOTIVE ALLOY WHEELS (U.S. CLS. 19, 21, 23, 31, 35 AND 44).

PAUL F. GAST, EXAMINING ATTORNEY

THE MARK CONSISTS OF STANDARD CHARACTERS WITHOUT CLAIM TO ANY PARTICULAR FONT, STYLE, SIZE, OR COLOR.

OWNER OF U.S. REG. NO. 1,771,341.

SEC. 2(F).

FOR SAILBOATS (U.S. CLS. 19, 21, 23, 31, 35 AND 44).
FIRST USE 5-4-1979; IN COMMERCE 5-29-1979.

WENDY GOODMAN, EXAMINING ATTORNEY

CLASS 12—(Continued).

SN 78-419,979. ASC INCORPORATED, SOUTHGATE, MI. FILED 5-17-2004.

CLASS 12—(Continued).

SN 78-423,592. PENNZOIL-QUAKER STATE COMPANY, HOUSTON, TX. FILED 5-24-2004.



ACTION GRIP

FOR INTERIOR AND EXTERIOR PANELS AND TRIM FOR AUTOMOTIVE VEHICLES; STEERING WHEELS; SHIFTER KNOBS; AND VEHICULAR PARTS, NAMELY FENDERS, HOODS, TRUNK LIDS, ROOFS, DOORS, SPOILERS, ROCKER MOLDINGS, FACIAS, INSTRUMENT PANELS, CONSOLES, PACKAGE SHELVES AND PILLAR MOLDINGS (U.S. CLS. 19, 21, 23, 31, 35 AND 44).
NICHOLAS ALTREE, EXAMINING ATTORNEY

THE MARK CONSISTS OF STANDARD CHARACTERS WITHOUT CLAIM TO ANY PARTICULAR FONT, STYLE, SIZE, OR COLOR.

FOR AUTOMOTIVE ACCESSORIES NAMELY: STEERING WHEEL COVERS (U.S. CLS. 19, 21, 23, 31, 35 AND 44).
FIRST USE 10-1-2000; IN COMMERCE 10-1-2000.
PAULA MAYS, EXAMINING ATTORNEY

SN 78-423,368. SPRATT CYCLE SUPPORT, INC., PONTE VEDRA BEACH, FL. FILED 5-22-2004.

SN 78-426,278. HYUNDAI MOTOR AMERICA, FOUNTAIN VALLEY, CA. FILED 5-27-2004.

PIRATE

DIMENSION

THE MARK CONSISTS OF STANDARD CHARACTERS WITHOUT CLAIM TO ANY PARTICULAR FONT, STYLE, SIZE, OR COLOR.
FOR BICYCLES (U.S. CLS. 19, 21, 23, 31, 35 AND 44).
FIRST USE 5-1-2004; IN COMMERCE 5-1-2004.
HOWARD SMIGA, EXAMINING ATTORNEY

THE MARK CONSISTS OF STANDARD CHARACTERS WITHOUT CLAIM TO ANY PARTICULAR FONT, STYLE, SIZE, OR COLOR.
FOR AUTOMOBILES AND STRUCTURAL PARTS THEREFOR (U.S. CLS. 19, 21, 23, 31, 35 AND 44).
ALICE SUE CARRUTHERS, EXAMINING ATTORNEY

CLASS 12—(Continued).

SN 78-429,588. GOOD ROADS AUTO SYSTEM INC, FORT LAUDERDALE, FL. FILED 6-3-2004.

CLASS 12—(Continued).

SN 78-436,162. HONDA MOTOR CO., LTD., TOKYO 107-8556, JAPAN, FILED 6-16-2004.

Status Alloy Wheels

RIDGELINE

THE MARK CONSISTS OF STANDARD CHARACTERS WITHOUT CLAIM TO ANY PARTICULAR FONT, STYLE, SIZE, OR COLOR.

NO CLAIM IS MADE TO THE EXCLUSIVE RIGHT TO USE "ALLOY WHEELS", APART FROM THE MARK AS SHOWN.

FOR WHEELS FOR MOTOR VEHICLES; LIGHT ALLOY WHEELS FOR MOTOR VEHICLES; LIGHT METAL WHEELS FOR MOTOR VEHICLES AND MOTOR VEHICLE WHEELS ACCESSORIES—NAMELY, CENTER CAPS (U.S. CLS. 19, 21, 23, 31, 35 AND 44).

FIRST USE 1-1-2004; IN COMMERCE 1-1-2004.
BRENDAN REGAN, EXAMINING ATTORNEY

THE MARK CONSISTS OF STANDARD CHARACTERS WITHOUT CLAIM TO ANY PARTICULAR FONT, STYLE, SIZE, OR COLOR.

FOR SPORTS UTILITY TRUCKS (U.S. CLS. 19, 21, 23, 31, 35 AND 44).

BRIAN BROWN, EXAMINING ATTORNEY

SN 78-436,179. HONDA MOTOR CO., LTD., TOKYO 107-8556, JAPAN, FILED 6-16-2004.

SN 78-430,316. PILLINGS F.R.P. INC., NEW COLUMBIA, PA. FILED 6-4-2004.

ROCKLINE

Car Go Pal

FOR ENCLOSED UTILITY TRAILERS AND FLATBED TRAILERS (U.S. CLS. 19, 21, 23, 31, 35 AND 44).
NICHOLAS ALTREE, EXAMINING ATTORNEY

THE MARK CONSISTS OF STANDARD CHARACTERS WITHOUT CLAIM TO ANY PARTICULAR FONT, STYLE, SIZE, OR COLOR.

FOR SPORTS UTILITY TRUCKS (U.S. CLS. 19, 21, 23, 31, 35 AND 44).

MICHAEL HALL, EXAMINING ATTORNEY

CLASS 12—(Continued).

SN 78-437,107. BRAKE PRO, LTD., CONCORD, ON, CANADA, FILED 6-17-2004.

CLASS 12—(Continued).

SN 78-438,079. STARCHILD, ADAM, MIAMI, FL. FILED 6-18-2004.

INTEGRASHOE

Starchild

THE MARK CONSISTS OF STANDARD CHARACTERS WITHOUT CLAIM TO ANY PARTICULAR FONT, STYLE, SIZE, OR COLOR.

OWNER OF U.S. REG. NO. 1,807,354.
FOR LAND MOTOR VEHICLE PARTS, NAMELY, ASBESTOS-FREE INTEGRALLY MOLDED BRAKE SHOES FOR BUSES AND HEAVY DUTY TRUCKS (U.S. CLS. 19, 21, 23, 31, 35 AND 44).
DANIEL CAPSHAW, EXAMINING ATTORNEY

THE MARK CONSISTS OF STANDARD CHARACTERS WITHOUT CLAIM TO ANY PARTICULAR FONT, STYLE, SIZE, OR COLOR.

OWNER OF U.S. REG. NOS. 1,826,422 AND 2,159,824.
SEC. 2(F).
FOR BABY CARRIAGES, BABY STROLLERS, BICYCLE RACKS FOR VEHICLES, BICYCLE SADDLES, BICYCLE SADDLE COVERS, CHILDREN'S CAR SEATS, CHILD RESTRAINTS FOR VEHICLE SEATS, CHILD SAFETY HARNESSSES FOR VEHICLE SEATS, COVERS FOR BABY STROLLERS, CUP HOLDERS FOR USE IN VEHICLES, DRINK HOLDERS FOR VEHICLES, LICENSE PLATE FRAMES, LICENSE PLATE HOLDERS, WAGONS (U.S. CLS. 19, 21, 23, 31, 35 AND 44).
FIRST USE 7-31-1974; IN COMMERCE 7-31-1974.
LESLEY LAMOTHE, EXAMINING ATTORNEY

SN 78-437,598. DIAMONDSTAR TRAILERS, INC., NEW YORK, NY. FILED 6-18-2004.

SN 78-438,256. SOLO, MATHU, SUGAR LAND, TX. FILED 6-21-2004.

DIAMONDSTAR

DIAMO

THE MARK CONSISTS OF STANDARD CHARACTERS WITHOUT CLAIM TO ANY PARTICULAR FONT, STYLE, SIZE, OR COLOR.

FOR TRAILERS AND STRUCTURAL PARTS THEREFOR (U.S. CLS. 19, 21, 23, 31, 35 AND 44).
CHARLES JOYNER, EXAMINING ATTORNEY

THE MARK CONSISTS OF STANDARD CHARACTERS WITHOUT CLAIM TO ANY PARTICULAR FONT, STYLE, SIZE, OR COLOR.

FOR LAND MOTOR VEHICLES, NAMELY, MOTORIZED SCOOTERS, ALL-TERRAIN VEHICLES, MOTORCYCLES, DIRT BIKES, AND STRUCTURAL PARTS THEREFOR; MOTORIZED, WHEELED PERSONAL MOBILITY DEVICES, NAMELY CHARIOTS (U.S. CLS. 19, 21, 23, 31, 35 AND 44).
FIRST USE 10-0-2003; IN COMMERCE 10-0-2003.
WON TEAK OH, EXAMINING ATTORNEY

CLASS 12—(Continued).

SN 78-439,155. FINCH, THOMAS, SPRING BRANCH, TX.
FILED 6-22-2004.

TEXELEN

THE MARK CONSISTS OF STANDARD CHARACTERS WITHOUT CLAIM TO ANY PARTICULAR FONT, STYLE, SIZE, OR COLOR.

FOR AIRPLANES AND STRUCTURAL PARTS THEREFOR (U.S. CLS. 19, 21, 23, 31, 35 AND 44).

SUSAN HAYASH, EXAMINING ATTORNEY

CLASS 13—(Continued).

SN 78-319,938. TANG, HUA KEN, GUANGZHOU, CHINA,
FILED 10-28-2003.

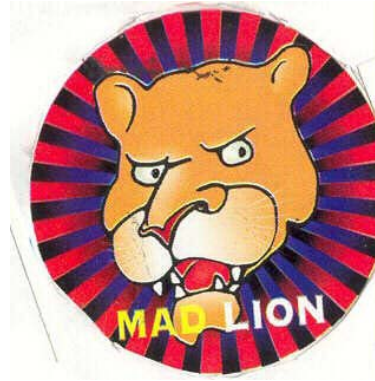

THE COLOR(S) RED, BLUE, BROWN AND YELLOW IS/ ARE CLAIMED AS A FEATURE OF THE MARK.

THE COLOR RED APPEARS IN HALF OF THE STRIPES THAT SURROUND THE LION'S HEAD (EVERY OTHER STRIPE). THE ALTERNATING STRIPES ARE BLACK AT THE PERIMETER OF THE CIRCLE, FADING TO BLUE AS THE STRIPES MOVE TOWARD THE CENTER. THE LION'S TONGUE IS RED. THE WORD "MAD" IS IN YELLOW. THE LION'S BODY IS BROWN.

FOR FIREWORKS (U.S. CLS. 2 AND 9).

FIRST USE 12-1-2001; IN COMMERCE 12-1-2001.

DANIEL CAPSHAW, EXAMINING ATTORNEY

CLASS 13—FIREARMS

SN 76-588,257. HENRY REPEATING ARMS COMPANY,
INC., BROOKLYN, NY. FILED 4-22-2004.

HENRY AMERICAN BEAUTY

THE MARK CONSISTS OF STANDARD CHARACTERS WITHOUT CLAIM TO ANY PARTICULAR FONT, STYLE, SIZE, OR COLOR.

OWNER OF U.S. REG. NO. 2,482,079.

FOR GUNS, RIFLES AND FIREARMS (U.S. CLS. 2 AND 9).

NAKWAMA ANKRAH, EXAMINING ATTORNEY

SN 78-323,352. SIGARMS INC., EXETER, NH. FILED 11-5-2003.

**GRANITE SERIES
RAIL**

THE MARK CONSISTS OF STANDARD CHARACTERS WITHOUT CLAIM TO ANY PARTICULAR FONT, STYLE, SIZE, OR COLOR.

NO CLAIM IS MADE TO THE EXCLUSIVE RIGHT TO USE SERIES RAIL, APART FROM THE MARK AS SHOWN. FOR FIREARMS (U.S. CLS. 2 AND 9).

ANN E. SAPPENFIELD, EXAMINING ATTORNEY

CLASS 13—(Continued).

SN 78-323,363. SIGARMS INC., EXETER, NH. FILED 11-5-2003.

**GRANITE SERIES
COMPACT**

THE MARK CONSISTS OF STANDARD CHARACTERS WITHOUT CLAIM TO ANY PARTICULAR FONT, STYLE, SIZE, OR COLOR.

NO CLAIM IS MADE TO THE EXCLUSIVE RIGHT TO USE SERIES COMPACT, APART FROM THE MARK AS SHOWN.

FOR FIREARMS (U.S. CLS. 2 AND 9).
ANN E. SAPPENFIELD, EXAMINING ATTORNEY

CLASS 13—(Continued).

SN 78-329,822. ALLIANT TECHSYSTEMS INC., EDINA, MN. FILED 11-19-2003.

ROCK MOUNT

THE MARK CONSISTS OF STANDARD CHARACTERS WITHOUT CLAIM TO ANY PARTICULAR FONT, STYLE, SIZE, OR COLOR.

FOR SHOOTING ACCESSORIES FOR USE WITH FIREARMS, NAMELY GUN RESTS AND STANDS (U.S. CLS. 2 AND 9).

STEVEN BERK, EXAMINING ATTORNEY

SN 78-323,370. SIGARMS INC., EXETER, NH. FILED 11-5-2003.

**GRANITE SERIES
TARGET**

THE MARK CONSISTS OF STANDARD CHARACTERS WITHOUT CLAIM TO ANY PARTICULAR FONT, STYLE, SIZE, OR COLOR.

NO CLAIM IS MADE TO THE EXCLUSIVE RIGHT TO USE SERIES TARGET, APART FROM THE MARK AS SHOWN.

FOR FIREARMS (U.S. CLS. 2 AND 9).
ANN E. SAPPENFIELD, EXAMINING ATTORNEY

SN 78-336,890. ALLIANT TECHSYSTEMS INC., EDINA, MN. FILED 12-5-2003.

STEADY BAG

SN 78-323,380. SIGARMS INC., EXETER, NH. FILED 11-5-2003.

**GRANITE TARGET
EXTREME**

THE MARK CONSISTS OF STANDARD CHARACTERS WITHOUT CLAIM TO ANY PARTICULAR FONT, STYLE, SIZE, OR COLOR.

NO CLAIM IS MADE TO THE EXCLUSIVE RIGHT TO USE TARGET EXTREME, APART FROM THE MARK AS SHOWN.

FOR FIREARMS (U.S. CLS. 2 AND 9).
ANN E. SAPPENFIELD, EXAMINING ATTORNEY

THE MARK CONSISTS OF STANDARD CHARACTERS WITHOUT CLAIM TO ANY PARTICULAR FONT, STYLE, SIZE, OR COLOR.

NO CLAIM IS MADE TO THE EXCLUSIVE RIGHT TO USE "BAG", APART FROM THE MARK AS SHOWN.

FOR SHOOTING ACCESSORIES, NAMELY, GUN RESTS (U.S. CLS. 2 AND 9).
FIRST USE 12-0-2003; IN COMMERCE 3-0-2004.
APRIL L. RADEMACHER, EXAMINING ATTORNEY

CLASS 13—(Continued).

SN 78-350,077. ALLIANT TECHSYSTEMS INC., EDINA, MN.
FILED 1-9-2004.



THE COLORS BLACK AND SILVER ARE CLAIMED AS A FEATURE OF THE MARK.

THE MARK CONSISTS OF A VERTICAL BLACK COLORED BAND EXTENDING UPWARD FROM A SEMICIRCULAR DESIGN. THE COLOR BLACK APPEARS IN THE VERTICAL BAND, AND THE COLOR SILVER APPEARS IN THE SEMI-CIRCULAR DESIGN.

FOR AMMUNITION AND AMMUNITION COMPONENTS (U.S. CLS. 2 AND 9).

FIRST USE 1-17-2003; IN COMMERCE 2-7-2003.

RENEE MCCRAY, EXAMINING ATTORNEY

SN 78-438,860. ENVIRON-METAL, INC., SWEET HOME, OR.
FILED 6-21-2004.

OUR "FAST" LITTLE BROTHER

THE MARK CONSISTS OF STANDARD CHARACTERS WITHOUT CLAIM TO ANY PARTICULAR FONT, STYLE, SIZE, OR COLOR.

FOR METAL SHOT, SHOT SHELLS, SHOTGUN SHELLS, BULLETS, FIREARMS CARTRIDGES AND CORES, AND AMMUNITION FOR FIREARMS (U.S. CLS. 2 AND 9).

LINDA E. BLOHM, EXAMINING ATTORNEY

CLASS 14—JEWELRY

SN 76-089,614. COLIBRI CORPORATION, PROVIDENCE, RI.
FILED 7-13-2000.

DIAMONELLE

FOR JEWELRY (U.S. CLS. 2, 27, 28 AND 50).

FIRST USE 5-31-2000; IN COMMERCE 5-31-2000.

ALICE SUE CARRUTHERS, EXAMINING ATTORNEY

CLASS 14—(Continued).

SN 76-247,024. CHRISTIAN BERNARD DIFFUSION, 75002
PARIS, FRANCE, FILED 4-27-2001.

MEMORY

SEC. 2(F).

FOR WATCHES NAMELY FINE QUARTZ WATCHES, WITHOUT ELECTRONIC DATA STORAGE, THAT HAVE A LOCKET CONTAINING AN IMAGE AND MESSAGE OF A LOVED ONE ENGRAVED THEREIN, AT THE REQUEST OF THE PURCHASER, AND SOLD AT FINE JEWELRY RETAILERS (U.S. CLS. 2, 27, 28 AND 50).

FIRST USE 6-1-1999; IN COMMERCE 6-1-1999.

BARNEY CHARLON, EXAMINING ATTORNEY

SN 76-569,365. THE FOREST HIGHLANDS ASSOCIATION,
FLAGSTAFF, AZ. FILED 1-12-2004.



THE MARK CONSISTS OF PINE CONES DESIGN. FOR JEWELRY, NAMELY, COSTUME JEWELRY; MONEY CLIPS MADE OF PRECIOUS METAL (U.S. CLS. 2, 27, 28 AND 50).

FIRST USE 1-1-1985; IN COMMERCE 1-1-1988.

BRIDGETT SMITH, EXAMINING ATTORNEY

SN 76-575,582. MARKETABLE MARKETING, INC., BOCA RATON, FL. FILED 2-17-2004.

MEDICLIP

THE MARK CONSISTS OF STANDARD CHARACTERS WITHOUT CLAIM TO ANY PARTICULAR FONT, STYLE, SIZE, OR COLOR.

FOR JEWELRY (U.S. CLS. 2, 27, 28 AND 50).

ELISSA GARBER KON, EXAMINING ATTORNEY

CLASS 14—(Continued).

SN 76-587,865. LHH&F INC., NEW YORK, NY. FILED 4-21-2004.

THE UNCONTESTABLE TEN

THE MARK CONSISTS OF STANDARD CHARACTERS WITHOUT CLAIM TO ANY PARTICULAR FONT, STYLE, SIZE, OR COLOR.
FOR JEWELRY, NAMELY, NECKLACES, PENDANTS, BRACELETS (U.S. CLS. 2, 27, 28 AND 50).
ALICIA COLLINS, EXAMINING ATTORNEY

SN 76-590,993. SEIKO KABUSHIKI KAISHA, TA SEIKO CORPORATION, TOKYO, JAPAN, FILED 5-7-2004.

SOLAR 4000

THE MARK CONSISTS OF STANDARD CHARACTERS WITHOUT CLAIM TO ANY PARTICULAR FONT, STYLE, SIZE, OR COLOR.
NO CLAIM IS MADE TO THE EXCLUSIVE RIGHT TO USE "SOLAR", APART FROM THE MARK AS SHOWN.
FOR WATCHES, STOP WATCHES, CASES AND PARTS THEREOF (U.S. CLS. 2, 27, 28 AND 50).
MARLENE BELL, EXAMINING ATTORNEY

SN 76-591,456. E.F.D. DIAMONDS COMPANY LIMITED, RAMAT-GAN, ISRAEL, FILED 5-10-2004.

**BE INDEPENDENT.
YOU DON'T NEED A MAN
TO MAKE YOU A PRINCESS.**

THE MARK CONSISTS OF STANDARD CHARACTERS WITHOUT CLAIM TO ANY PARTICULAR FONT, STYLE, SIZE, OR COLOR.
FOR DIAMONDS AND JEWELRY (U.S. CLS. 2, 27, 28 AND 50).
RON FAIRBANKS, EXAMINING ATTORNEY

CLASS 14—(Continued).

SN 76-591,457. E.F.D. DIAMONDS COMPANY LIMITED, RAMAT-GAN, ISRAEL, FILED 5-10-2004.

**NO MATTER WHERE YOU COME
FROM, A DIAMOND IS THE
UNIVERSAL CHOICE**

THE MARK CONSISTS OF STANDARD CHARACTERS WITHOUT CLAIM TO ANY PARTICULAR FONT, STYLE, SIZE, OR COLOR.
FOR DIAMONDS AND JEWELRY (U.S. CLS. 2, 27, 28 AND 50).
RON FAIRBANKS, EXAMINING ATTORNEY

SN 76-591,464. E.F.D. DIAMONDS COMPANY LIMITED, RAMAT-GAN, ISRAEL, FILED 5-10-2004.

**ONLY YOU KNOW WHAT YOU WANT,
GET YOUR DIAMOND TODAY**

THE MARK CONSISTS OF STANDARD CHARACTERS WITHOUT CLAIM TO ANY PARTICULAR FONT, STYLE, SIZE, OR COLOR.
FOR DIAMONDS AND JEWELRY (U.S. CLS. 2, 27, 28 AND 50).
RON FAIRBANKS, EXAMINING ATTORNEY

SN 76-591,465. E.F.D. DIAMONDS COMPANY LIMITED, RAMAT-GAN, ISRAEL, FILED 5-10-2004.

**ONLY YOU KNOW WHAT YOU WANT,
GET YOUR PRINCESS TODAY**

THE MARK CONSISTS OF STANDARD CHARACTERS WITHOUT CLAIM TO ANY PARTICULAR FONT, STYLE, SIZE, OR COLOR.
FOR DIAMONDS AND JEWELRY (U.S. CLS. 2, 27, 28 AND 50).
RON FAIRBANKS, EXAMINING ATTORNEY

CLASS 14—(Continued).

SN 76-594,631. SANRIO COMPANY, LTD., TOKYO 141, JAPAN, FILED 5-27-2004.



FOR CLOCKS, ALARM CLOCKS, WALL CLOCKS, JEWELRY, COSTUME JEWELRY, WRIST WATCHES, WATCH BANDS, WATCH STRAPS AND WATCH CHAINS (U.S. CLS. 2, 27, 28 AND 50).

EUGENIA MARTIN, EXAMINING ATTORNEY

SN 76-596,765. JACK DANIEL'S PROPERTIES, INC., SAN RAFAEL, CA. FILED 6-14-2004.

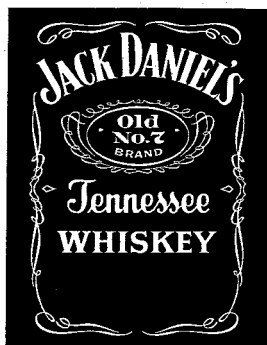

OWNER OF U.S. REG. NOS. 582,789, 1,923,981 AND OTHERS.

NO CLAIM IS MADE TO THE EXCLUSIVE RIGHT TO USE "BRAND", APART FROM THE MARK AS SHOWN.

THE NAME JACK DANIEL'S IN THE MARK IS NOT THE NAME OF A LIVING INDIVIDUAL.

FOR ORNAMENTAL LAPEL PINS, CLOCKS AND WATCHES (U.S. CLS. 2, 27, 28 AND 50).

FIRST USE 1-31-2004; IN COMMERCE 1-31-2004.

CURTIS FRENCH, EXAMINING ATTORNEY

SN 76-598,935. MONTRES ANTIMA SA, 1227 CAROUGE, SWITZERLAND, FILED 6-23-2004.

SEA DRAGON

THE MARK CONSISTS OF STANDARD CHARACTERS WITHOUT CLAIM TO ANY PARTICULAR FONT, STYLE, SIZE, OR COLOR.

FOR WATCHES (U.S. CLS. 2, 27, 28 AND 50).

APRIL L. RADEMACHER, EXAMINING ATTORNEY

CLASS 14—(Continued).

SN 76-599,572. SUPER JEWELS INC., NEWBURGH, NY. FILED 6-28-2004.

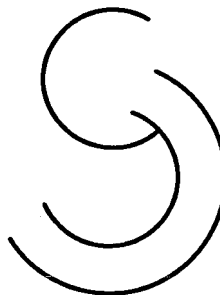

THE MARK CONSISTS OF THE HIGHLY STYLIZED LETTERS S AND J.

FOR JEWELRY, NAMELY NECKLACES, BRACELETS, EARRINGS, RINGS, PENDANTS, PINS, ALL MADE OF PRECIOUS METAL (U.S. CLS. 2, 27, 28 AND 50).

TRICIA SONNEBORN, EXAMINING ATTORNEY

SN 76-599,603. M.K.D. DESIGN PTY LTD., VICTORIA, 3142, AUSTRALIA, FILED 6-28-2004.

PURE ELEMENTS

THE MARK CONSISTS OF STANDARD CHARACTERS WITHOUT CLAIM TO ANY PARTICULAR FONT, STYLE, SIZE, OR COLOR.

OWNER OF AUSTRALIA REG. NO. 933258, DATED 11-4-2002, EXPIRES 11-4-2012.

FOR JEWELRY; STERLING SILVER JEWELRY AND NATURAL GEMSTONE JEWELRY (U.S. CLS. 2, 27, 28 AND 50).

YSA DEJESUS, EXAMINING ATTORNEY

SN 78-204,030. VIACOM INTERNATIONAL INC., NEW YORK, NY. FILED 1-16-2003.

HEADBANGER'S BALL

FOR JEWELRY IN THE NATURE OF LAPEL PINS, ORNAMENTAL LAPEL PINS, ORNAMENTAL PINS, TIE PINS; BELT BUCKLES OF PRECIOUS METAL FOR CLOTHING (U.S. CLS. 2, 27, 28 AND 50).

DANIELLE MATTESSICH, EXAMINING ATTORNEY

CLASS 14—(Continued).

SN 78-206,867. MAINLINE FASHIONS INC., TORONTO, ONTARIO, CANADA, FILED 1-24-2003.

TRIED AND TRUE

PRIORITY CLAIMED UNDER SEC. 44(D) ON CANADA APPLICATION NO. 1164887, FILED 1-15-2003, REG. NO. TMA622,183, DATED 10-7-2004, EXPIRES 10-7-2019.

FOR COSTUME JEWELRY (U.S. CLS. 2, 27, 28 AND 50).

NAAKWAMA ANKRAH, EXAMINING ATTORNEY

SN 78-227,121. THE ADMINISTRATORS OF THE TULANE EDUCATIONAL FUND, NEW ORLEANS, LA. FILED 3-18-2003.



OWNER OF U.S. REG. NOS. 2,737,647 AND 2,743,096.
NO CLAIM IS MADE TO THE EXCLUSIVE RIGHT TO USE "UNIVERSITY", APART FROM THE MARK AS SHOWN.

THE MARK CONSISTS OF A SHIELD BEARING AN OVERLAPPING "T" AND "U".

FOR GIFTS AND NOVELTIES OF PRECIOUS METALS, NAMELY, WATCHES AND CIGARETTE LIGHTERS; JEWELRY AND CLOCKS (U.S. CLS. 2, 27, 28 AND 50).

MICHAEL TANNER, EXAMINING ATTORNEY

SN 78-227,306. THE ADMINISTRATORS OF THE TULANE EDUCATIONAL FUND, NEW ORLEANS, LA. FILED 3-19-2003.

TULANE

OWNER OF U.S. REG. NOS. 1,915,719, 2,737,647 AND 2,743,096.

FOR GIFTS AND NOVELTIES OF PRECIOUS METALS, NAMELY WATCHES AND CIGARETTE LIGHTERS; JEWELRY AND CLOCKS (U.S. CLS. 2, 27, 28 AND 50).

MICHAEL TANNER, EXAMINING ATTORNEY

CLASS 14—(Continued).

SN 78-269,665. RAMSEY, JOHN, WOODINVILLE, WA. FILED 7-2-2003.



FOR JEWELRY (U.S. CLS. 2, 27, 28 AND 50).
FIRST USE 6-27-2003; IN COMMERCE 6-27-2003.

MICHAEL SOUDERS, EXAMINING ATTORNEY

SN 78-277,165. SALTON, INC., LAKE FOREST, IL. FILED 7-22-2003.

LITTLE BEN

OWNER OF U.S. REG. NOS. 72,178 AND 91,054.
FOR CLOCKS AND WATCHES (U.S. CLS. 2, 27, 28 AND 50).

ALICE BENMAMAN, EXAMINING ATTORNEY

SN 78-314,116. ZABOYAN, JOHN, PASADENA, CA. FILED 10-15-2003.

CRYSTALMAID

OWNER OF U.S. REG. NO. 2,696,649.
FOR JEWELRY (U.S. CLS. 2, 27, 28 AND 50).

BRIDGETT SMITH, EXAMINING ATTORNEY

SN 78-314,122. ZABOYAN, JOHN, PASADENA, CA. FILED 10-15-2003.

SILVERMAID

OWNER OF U.S. REG. NO. 2,696,649.
FOR JEWELRY (U.S. CLS. 2, 27, 28 AND 50).

BRIDGETT SMITH, EXAMINING ATTORNEY

CLASS 14—(Continued).

SN 78-316,552. DISNEY ENTERPRISES, INC., BURBANK, CA. FILED 10-21-2003.

WALT DISNEY WORLD

OWNER OF U.S. REG. NOS. 980,995, 1,189,727 AND 2,189,177.

THE NAME IN THE MARK DOES NOT IDENTIFY A PARTICULAR LIVING INDIVIDUAL.

FOR JEWELRY, WATCHES AND CLOCKS (U.S. CLS. 2, 27, 28 AND 50).

PAUL F. GAST, EXAMINING ATTORNEY

SN 78-316,881. ZABOYAN, JOHN, PASADENA, CA. FILED 10-22-2003.

ICEMAID

OWNER OF U.S. REG. NO. 2,696,649.
FOR JEWELRY (U.S. CLS. 2, 27, 28 AND 50).
BRIDGETT SMITH, EXAMINING ATTORNEY

SN 78-346,922. BALONICK, JULIE, ENCINO, CA. FILED 12-31-2003.

Gandy Baubles

NO CLAIM IS MADE TO THE EXCLUSIVE RIGHT TO USE "BAUBLES", APART FROM THE MARK AS SHOWN.

FOR JEWELRY, JEWELRY CHAINS, JEWELRY BRACELETS, JEWELRY PINS, BROOCHES, RINGS, EARRINGS, PENDANTS, NECKLACES AND CHARMS (U.S. CLS. 2, 27, 28 AND 50).

TANYA AMOS, EXAMINING ATTORNEY

SN 78-369,203. LYDSTER, ROSALINA, WALNUT CREEK, CA. FILED 2-17-2004.

R

THE MARK CONSISTS OF A STYLIZED LETTER R.
FOR JEWELRY (U.S. CLS. 2, 27, 28 AND 50).
JEFF DEFORD, EXAMINING ATTORNEY

CLASS 14—(Continued).

SN 78-381,263. NEWNHAM, KEN, KLAMATH FALLS, OR. FILED 3-9-2004.

Juniper Ridge Opal

THE MARK CONSISTS OF STANDARD CHARACTERS WITHOUT CLAIM TO ANY PARTICULAR FONT, STYLE, SIZE, OR COLOR.

NO CLAIM IS MADE TO THE EXCLUSIVE RIGHT TO USE "OPAL", APART FROM THE MARK AS SHOWN.

FOR PRECIOUS / SEMI-PRECIOUS ROUGH AND CUT OPAL GEMSTONES (U.S. CLS. 2, 27, 28 AND 50).

FIRST USE 9-1-2002; IN COMMERCE 12-5-2002.

ESTHER A. BORSUK, EXAMINING ATTORNEY

SN 78-383,740. AVI ARAD & ASSOCIATES, LLC, WESTPORT, CT. FILED 3-12-2004.

RESCUE LAMB

THE MARK CONSISTS OF STANDARD CHARACTERS WITHOUT CLAIM TO ANY PARTICULAR FONT, STYLE, SIZE, OR COLOR.

FOR WATCHES FEATURING ANIMATED CHARACTERS (U.S. CLS. 2, 27, 28 AND 50).

KIMBERLY FRYE, EXAMINING ATTORNEY

SN 78-383,744. AVI ARAD & ASSOCIATES, LLC, WESTPORT, CT. FILED 3-12-2004.

RESCUE SEAL

THE MARK CONSISTS OF STANDARD CHARACTERS WITHOUT CLAIM TO ANY PARTICULAR FONT, STYLE, SIZE, OR COLOR.

FOR WATCHES FEATURING ANIMATED CHARACTERS (U.S. CLS. 2, 27, 28 AND 50).

KIMBERLY FRYE, EXAMINING ATTORNEY

CLASS 14—(Continued).

SN 78-418,289. HEARTS ON FIRE COMPANY LLC, BOSTON, MA. FILED 5-13-2004.

CLASS 14—(Continued).

SN 78-424,506. GEM SENSATIONS, INC., NEW YORK, NY. FILED 5-25-2004.

MOSAIC

LGS

THE MARK CONSISTS OF STANDARD CHARACTERS WITHOUT CLAIM TO ANY PARTICULAR FONT, STYLE, SIZE, OR COLOR.

FOR JEWELRY (U.S. CLS. 2, 27, 28 AND 50).
HOWARD B. LEVINE, EXAMINING ATTORNEY

THE MARK CONSISTS OF STANDARD CHARACTERS WITHOUT CLAIM TO ANY PARTICULAR FONT, STYLE, SIZE, OR COLOR.

FOR JEWELRY, WATCHES, PEARLS, DIAMONDS AND PRECIOUS AND SEMI-PRECIOUS GEMSTONES (U.S. CLS. 2, 27, 28 AND 50).
HOWARD B. LEVINE, EXAMINING ATTORNEY

SN 78-422,009. ROLEX WATCH U.S.A., INC., NEW YORK, NY. FILED 5-20-2004.

GMT-MASTER II

**Lost Marbles
Society**

THE MARK CONSISTS OF STANDARD CHARACTERS WITHOUT CLAIM TO ANY PARTICULAR FONT, STYLE, SIZE, OR COLOR.

OWNER OF U.S. REG. NO. 683,249.
NO CLAIM IS MADE TO THE EXCLUSIVE RIGHT TO USE "II", APART FROM THE MARK AS SHOWN.
FOR WATCHES AND PARTS THEREOF (U.S. CLS. 2, 27, 28 AND 50).
FIRST USE 12-31-1984; IN COMMERCE 12-31-1984.
DOMINIC J. FERRAIUOLO, EXAMINING ATTORNEY

SN 78-428,249. CLARK, SUZIE, ALBUQUERQUE, NM. AND APPLETON, PAULA, ALBUQUERQUE, NM. AND REINHART, BONNY, ALBUQUERQUE, NM. FILED 6-1-2004.

SN 78-423,642. KAREN'S KONCEPTS, LTD., PATTERSON, NY. FILED 5-24-2004.

CLEVER CRITTERS

THE MARK CONSISTS OF STANDARD CHARACTERS WITHOUT CLAIM TO ANY PARTICULAR FONT, STYLE, SIZE, OR COLOR.

FOR JEWELRY (U.S. CLS. 2, 27, 28 AND 50).
BRETT J. GOLDEN, EXAMINING ATTORNEY

THE MARK CONSISTS OF STANDARD CHARACTERS WITHOUT CLAIM TO ANY PARTICULAR FONT, STYLE, SIZE, OR COLOR.

FOR JEWELRY (U.S. CLS. 2, 27, 28 AND 50).
FIRST USE 2-20-2004; IN COMMERCE 2-20-2004.
ELIZABETH PIGNATELLO, EXAMINING ATTORNEY

CLASS 14—(Continued).

SN 78-429,121. SHARABY, YIGAL A., HOLLYWOOD, FL. FILED 6-3-2004.



FOR JEWELRY, NAMELY NECKLACES, CHARMS, BRACELETS, CHAINS, RINGS AND EARRINGS (U.S. CLS. 2, 27, 28 AND 50).
PAUL F. GAST, EXAMINING ATTORNEY

CLASS 14—(Continued).

SN 78-434,406. KWIAT, INC., NEW YORK, NY. FILED 6-13-2004.

ICEDROPS

THE MARK CONSISTS OF STANDARD CHARACTERS WITHOUT CLAIM TO ANY PARTICULAR FONT, STYLE, SIZE, OR COLOR.
FOR JEWELRY (U.S. CLS. 2, 27, 28 AND 50).
MICHAEL WEBSTER, EXAMINING ATTORNEY

SN 78-434,245. SCHULTZ, JAMES ALLEN, NEW MARKET, MD. FILED 6-11-2004.

Surpassion

THE MARK CONSISTS OF STANDARD CHARACTERS WITHOUT CLAIM TO ANY PARTICULAR FONT, STYLE, SIZE, OR COLOR.
FOR DIAMONDS AND JEWELRY (U.S. CLS. 2, 27, 28 AND 50).
LANA PHAM, EXAMINING ATTORNEY

SN 78-434,676. RITANI LLC, NEW YORK, NY. FILED 6-14-2004.

MICROCHANNEL

THE MARK CONSISTS OF STANDARD CHARACTERS WITHOUT CLAIM TO ANY PARTICULAR FONT, STYLE, SIZE, OR COLOR.
FOR DIAMOND JEWELRY (U.S. CLS. 2, 27, 28 AND 50).
RONALD MCMORROW, EXAMINING ATTORNEY

CLASS 14—(Continued).

SN 78-435,419. ROMEL, INC., CANTON, MI. FILED 6-15-2004.

CLASS 14—(Continued).

SN 78-437,023. STEINWAY, INC., LONG ISLAND CITY, NY. FILED 6-17-2004.

YAVANA



THE MARK CONSISTS OF STANDARD CHARACTERS WITHOUT CLAIM TO ANY PARTICULAR FONT, STYLE, SIZE, OR COLOR.
FOR JEWELRY (U.S. CLS. 2, 27, 28 AND 50).
JEAN IM, EXAMINING ATTORNEY

OWNER OF U.S. REG. NOS. 45,411 AND 607,992.
THE MARK CONSISTS OF IN PART THE LETTER "S" FORWARD AND BACKWARD IN CONJUNCTION WITH AN AMPERSAND.
FOR WATCHES; JEWELRY IN THE NATURE OF WATCHES (U.S. CLS. 2, 27, 28 AND 50).
LAURA KOVAISKY, EXAMINING ATTORNEY

SN 78-437,013. STEINWAY, INC., LONG ISLAND CITY, NY. FILED 6-17-2004.

SN 78-437,996. OUSLEY, MITCHELL, FORT LAUDERDALE, FL. FILED 6-18-2004.

STEINWAY & SONS

54° 40' HOOK

THE MARK CONSISTS OF STANDARD CHARACTERS WITHOUT CLAIM TO ANY PARTICULAR FONT, STYLE, SIZE, OR COLOR.
OWNER OF U.S. REG. NOS. 45,846, 141,687 AND OTHERS.
FOR WATCHES; JEWELRY IN THE NATURE OF WATCHES (U.S. CLS. 2, 27, 28 AND 50).
LAURA KOVAISKY, EXAMINING ATTORNEY

THE MARK CONSISTS OF STANDARD CHARACTERS WITHOUT CLAIM TO ANY PARTICULAR FONT, STYLE, SIZE, OR COLOR.
FOR JEWELRY, NAMELY, BRACELETS, RINGS, EARRINGS, NECKLACES, AND PENDANTS (U.S. CLS. 2, 27, 28 AND 50).
YONG KIM, EXAMINING ATTORNEY

CLASS 14—(Continued).

SN 78-439,387. NEW WORLD JEWELRY INC., NEW YORK, NY. FILED 6-22-2004.

a promise
forevermore...

THE MARK CONSISTS OF STANDARD CHARACTERS WITHOUT CLAIM TO ANY PARTICULAR FONT, STYLE, SIZE, OR COLOR.

FOR JEWELRY, NAMELY EARRINGS, RINGS, BRACELETS, NECKLACES AND PENDANTS (U.S. CLS. 2, 27, 28 AND 50).

DANIEL BRODY, EXAMINING ATTORNEY

SN 78-495,369. PET BLINKERS, LLC, LASALLE, IL. FILED 10-6-2004.

KIDDI BLINKERS

THE MARK CONSISTS OF STANDARD CHARACTERS WITHOUT CLAIM TO ANY PARTICULAR FONT, STYLE, SIZE, OR COLOR.

NO CLAIM IS MADE TO THE EXCLUSIVE RIGHT TO USE KIDDI, APART FROM THE MARK AS SHOWN.

FOR CHILDREN'S ACCESSORIES, NAMELY LIGHTED CHILDREN'S PENDANT (U.S. CLS. 2, 27, 28 AND 50).

FIRST USE 10-5-2004; IN COMMERCE 10-5-2004.
YSA DEJESUS, EXAMINING ATTORNEY

SN 79-000,737. TIME FORCE EUROPE SPA, ITALY, FILED 12-2-2003.

CHRONOTECH

THE MARK CONSISTS OF STANDARD CHARACTERS WITHOUT CLAIM TO ANY PARTICULAR FONT, STYLE, SIZE, OR COLOR.

OWNER OF INTERNATIONAL REGISTRATION 0684623 DATED 12-5-1997, EXPIRES 12-5-2007.

FOR WATCHES (U.S. CLS. 2, 27, 28 AND 50).
KIMBERLY FRYE, EXAMINING ATTORNEY

CLASS 15—MUSICAL INSTRUMENTS

SN 76-410,325. BALDWIN PIANO, INC., NASHVILLE, TN. FILED 5-20-2002.

SCHROEDER

SEC. 2(F).
FOR PIANOS (U.S. CLS. 2, 21 AND 36).
BRIAN NEVILLE, EXAMINING ATTORNEY

SN 76-597,140. SOLID STAND, INC., OMAHA, NE. FILED 6-14-2004.

MOVE WITH THE MUSIC

THE MARK CONSISTS OF STANDARD CHARACTERS WITHOUT CLAIM TO ANY PARTICULAR FONT, STYLE, SIZE, OR COLOR.

FOR STANDS FOR MUSICAL INSTRUMENTS AND ACCESSORIES, NAMELY, KEYBOARD STANDS (U.S. CLS. 2, 21 AND 36).

BRIAN PINO, EXAMINING ATTORNEY

SN 76-598,087. PROSOUND COMMUNICATIONS, INC., SAN FERNANDO, CA. FILED 6-18-2004.



FOR ELECTRICAL GUITARS AND ELECTRIC BASS GUITARS (U.S. CLS. 2, 21 AND 36).

FIRST USE 6-19-1995; IN COMMERCE 6-19-1995.
RONALD AIKENS, EXAMINING ATTORNEY

CLASS 15—(Continued).

SN 78-398,126. K.H.S. MUSICAL INSTRUMENT CO., LTD.,
LU CHOW CITY, TAIPEI HSIEN, TAIWAN, FILED 4-7-
2004.

Walden
Natura

OWNER OF U.S. REG. NO. 2,344,050.
THE MARK CONSISTS OF THE WORDS "WALDEN
NATURA" IN STYLIZED LETTERING.
THE ENGLISH TRANSLATION OF THE WORD "NAT-
URA" IN THE MARK IS "NATURE" IN ITALIAN.
FOR GUITARS, GUITAR PICKS AND GUITAR
STRINGS (U.S. CLS. 2, 21 AND 36).
FIRST USE 12-30-2003; IN COMMERCE 12-30-2003.
CHARLES L. JENKINS, EXAMINING ATTORNEY

SN 78-437,798. SHERMAN, CLAY & CO., SAN BRUNO, CA.
FILED 6-18-2004.

H.F. MILLER

THE MARK CONSISTS OF STANDARD CHARACTERS
WITHOUT CLAIM TO ANY PARTICULAR FONT, STYLE,
SIZE, OR COLOR.

OWNER OF U.S. REG. NOS. 2,384,260 AND 2,557,063.
THE NAME "H.F. MILLER" IN THE MARK DOES NOT
IDENTIFY A PARTICULAR LIVING INDIVIDUAL.
FOR MUSICAL INSTRUMENTS (U.S. CLS. 2, 21 AND
36).

KATHLEEN M. VANSTON, EXAMINING ATTORNEY

CLASS 15—(Continued).

SN 78-437,800. SHERMAN, CLAY & CO., SAN BRUNO, CA.
FILED 6-18-2004.

HENRY F. MILLER

THE MARK CONSISTS OF STANDARD CHARACTERS
WITHOUT CLAIM TO ANY PARTICULAR FONT, STYLE,
SIZE, OR COLOR.

OWNER OF U.S. REG. NOS. 2,384,260 AND 2,557,063.
THE NAME "H.F. MILLER" IN THE MARK DOES NOT
IDENTIFY A PARTICULAR LIVING INDIVIDUAL.
FOR MUSICAL INSTRUMENTS (U.S. CLS. 2, 21 AND
36).

KATHLEEN M. VANSTON, EXAMINING ATTORNEY

**CLASS 16—PAPER GOODS AND PRINTED
MATTER**

SN 76-055,673. KABUSHIKI KAISHA PILOT, TA PILOT
CORPORATION, SHINAGAWA-KU, TOKYO, JAPAN,
FILED 5-24-2000.

 **PILOT Gel Marker**

OWNER OF JAPAN REG. NO. 4440481, DATED 12-15-2000,
EXPIRES 12-15-2010.

OWNER OF U.S. REG. NOS. 678,114, 2,287,180 AND
OTHERS.

NO CLAIM IS MADE TO THE EXCLUSIVE RIGHT TO
USE "GEL MARKER", APART FROM THE MARK AS
SHOWN.

THE MARK CONSISTS OF THE WORDS "PILOT GEL
MARKER" WITH AN ARBITRARY DEVICE.

FOR MARKING PENS (U.S. CLS. 2, 5, 22, 23, 29, 37, 38
AND 50).

GLENN CLARK, EXAMINING ATTORNEY

SN 76-435,846. MEADOWS, MISTY M., HAVELOCK, NC.
AND BROWN, JANET E., LAS VEGAS, NV. FILED 7-30-
2002.

SANI SHOPPER

NO CLAIM IS MADE TO THE EXCLUSIVE RIGHT TO
USE "SHOPPER", APART FROM THE MARK AS SHOWN.

FOR DISPOSABLE PAPER SLIP COVERS DESIGNED
TO COVER THE SEATING AREA OF SHOPPING CARTS
FOR THE PURPOSE OF PROTECTING BABIES AND
TODDLERS FROM THE GERMS THERE (U.S. CLS. 2, 5,
22, 23, 29, 37, 38 AND 50).

VIVIAN MICZNIK FIRST, EXAMINING ATTORNEY

CLASS 16—(Continued).

SN 76-477,535. SOLUTION SELLING, INC., CHARLOTTE, NC. FILED 12-20-2002.

PAIN SHEETS

NO CLAIM IS MADE TO THE EXCLUSIVE RIGHT TO USE "SHEETS", APART FROM THE MARK AS SHOWN.

FOR PRINTED MATTER, NAMELY MANUALS, FORMS, AND PAMPHLETS RELATED TO SALES, SALES TECHNIQUES, AND IMPROVEMENT OF THE SAME (U.S. CLS. 2, 5, 22, 23, 29, 37, 38 AND 50).

FIRST USE 9-30-1983; IN COMMERCE 9-30-1983.
DAVID ELTON, EXAMINING ATTORNEY

SN 76-477,546. SOLUTION SELLING, INC., CHARLOTTE, NC. FILED 12-20-2002.

PAIN CHAINS

FOR PRINTED MATTER, NAMELY MANUALS, FORMS, AND PAMPHLETS RELATED TO SALES, SALES TECHNIQUES, AND IMPROVEMENT OF THE SAME (U.S. CLS. 2, 5, 22, 23, 29, 37, 38 AND 50).

FIRST USE 7-31-1994; IN COMMERCE 7-31-1994.
DAVID ELTON, EXAMINING ATTORNEY

SN 76-525,192. LUMINA PUBLISHING GROUP, INC., ODESSA, FL. FILED 6-24-2003.

LPG CONFERENCE PROCEEDINGS

NO CLAIM IS MADE TO THE EXCLUSIVE RIGHT TO USE CONFERENCE PROCEEDINGS, APART FROM THE MARK AS SHOWN.

FOR PUBLICATIONS, NAMELY, REPORTS ON HEALTHCARE MEETINGS (U.S. CLS. 2, 5, 22, 23, 29, 37, 38 AND 50).

FIRST USE 5-10-2003; IN COMMERCE 5-10-2003.
SUSAN LESLIE DUBOIS, EXAMINING ATTORNEY

SN 76-530,268. KB HOLDINGS, LLC, LAS VEGAS, NV. FILED 7-18-2003.

COLORFUL EXPRESSIONS HAVE FUN EXPRESSING YOURSELF

FOR ARTS AND CRAFTS SUPPLIES, NAMELY CRAYONS, MARKERS, PENCILS, PAINT BRUSHES, GLUE FOR STATIONERY OR HOUSEHOLD USE, SKETCH PADS, CONSTRUCTION PAPER, EASELS, AND STICKERS (U.S. CLS. 2, 5, 22, 23, 29, 37, 38 AND 50).

LESLIE LAMOTHE, EXAMINING ATTORNEY

CLASS 16—(Continued).

SN 76-542,492. MENTALEDGE MEDIA, LLP, WARMINSTER, PA. FILED 9-4-2003.

HEAD IN THE GAME

THE MARK CONSISTS OF STANDARD CHARACTERS WITHOUT CLAIM TO ANY PARTICULAR FONT, STYLE, SIZE, OR COLOR.

FOR PRINTED MATERIALS IN THE NATURE OF PAMPHLETS, BROCHURES, TRANSCRIPTS OF AUDIO TAPES AND NEWSLETTERS THAT PROMOTE THE POSITIVE PSYCHOLOGICAL ASPECTS OF SPORTS INCLUDING ATTITUDE, KNOWLEDGE, MINDSET AND CONCENTRATION SO THAT PARENTS AND CHILDREN BOTH FIND MORE ENJOYMENT FROM A CHILD'S SPORT RELATED ACTIVITY (U.S. CLS. 2, 5, 22, 23, 29, 37, 38 AND 50).

ANN E. SAPPENFIELD, EXAMINING ATTORNEY

SN 76-544,886. HINDUSTAN PENCILS LIMITED, FORT MUMBAI - 400001, INDIA, FILED 9-5-2003.



FOR PENCILS; PENCIL SHARPENERS; ERASERS; PENCIL LEADS; CRAYONS; OFFICE REQUISITES, NAMELY, GUM PASTE, PROTRACTORS AND TRIANGLES (U.S. CLS. 2, 5, 22, 23, 29, 37, 38 AND 50).

FIRST USE 0-0-1956; IN COMMERCE 3-14-2000.
SUSAN HAYASH, EXAMINING ATTORNEY

SN 76-553,040. SEALAND HOLDINGS CO., LTD., KWUN TONG, KOWLOON, HONG KONG, FILED 10-21-2003.



FOR AQUARIUM TANKS; AQUARIUM ACCESSORIES, NAMELY, AQUARIUM COVERS (U.S. CLS. 2, 5, 22, 23, 29, 37, 38 AND 50).

ELISSA GARBER KON, EXAMINING ATTORNEY

CLASS 16—(Continued).

SN 76-555,989. DUMPY, LLC, BEVERLY HILLS, CA. FILED 11-3-2003.

DUMPY THE DUMP TRUCK

THE MARK CONSISTS OF STANDARD CHARACTERS WITHOUT CLAIM TO ANY PARTICULAR FONT, STYLE, SIZE, OR COLOR.

NO CLAIM IS MADE TO THE EXCLUSIVE RIGHT TO USE DUMP TRUCK, APART FROM THE MARK AS SHOWN.

FOR SERIES OF CHILDREN'S BOOKS AND SERIES OF FICTION BOOKS; SERIES OF CHILDREN'S ACTIVITY BOOKS; SERIES OF CHILDREN'S STORYBOOKS; ADDRESS BOOKS; AGENDAS; APPOINTMENT BOOKS; ARTS AND CRAFT PAINT KITS; AUTOGRAPH BOOKS; SERIES OF BABY BOOKS; BINDERS; BOOKENDS; BOOKMARKS; SERIES OF CHILDREN'S EDUCATIONAL BOOKS; SERIES OF COLORING BOOKS; COMIC BOOKS; CRAYONS; CROSSWORD PUZZLES; DECALS; DRAWING PADS; DISPENSERS FOR ADHESIVE TAPE FOR STATIONERY OR HOUSEHOLD PURPOSES; DRAWING PENCILS; ENVELOPES; ERASERS; FOLDERS; GIFT CARDS; GIFT WRAPPING-PAPER; GREETING CARDS; HIGHLIGHTING PENS; HOLDERS FOR DESK ACCESSORIES; LUNCH BAGS; SERIES OF MEMORY BOOKS; MODELING CLAY FOR CHILDREN; NOTEBOOKS; PAINTING SETS FOR CHILDREN; PAPER BANNERS; PAPER MATS; PAPER NAPKINS; PAPER PARTY BAGS; PAPER PARTY DECORATIONS; PAPER CAKE DECORATIONS; PAPER PARTY FAVORS; PAPER PARTY HATS; PAPER PENNANTS; PAPER PLACE MATS; PAPER TABLE CLOTHS; PAPERWEIGHTS; PENCIL CASES; PENCILS; PENS; SERIES OF PICTURE BOOKS; POSTCARDS; SCRAPBOOKS; STATIONERY AND TRADING CARDS (U.S. CLS. 2, 5, 22, 23, 29, 37, 38 AND 50).

PAUL F. GAST, EXAMINING ATTORNEY

SN 76-558,800. LONG MOTOR CORPORATION, LENEXA, KS. FILED 11-10-2003.

VICTORIA BRITISH LTD

THE MARK CONSISTS OF STANDARD CHARACTERS WITHOUT CLAIM TO ANY PARTICULAR FONT, STYLE, SIZE, OR COLOR.

OWNER OF U.S. REG. NOS. 1,823,367, 1,825,593 AND 1,843,278.

SEC. 2(F) AS TO "BRITISH LTD".

FOR CATALOGS IN THE FIELD OF AUTOMOTIVE PARTS AND ACCESSORIES (U.S. CLS. 2, 5, 22, 23, 29, 37, 38 AND 50).

FIRST USE 3-1-1981; IN COMMERCE 3-1-1981.

KIMBERLY PERRY, EXAMINING ATTORNEY

CLASS 16—(Continued).

SN 76-563,245. LINTEC KABUSHIKI KAISHA, TA LINTEC CORPORATION, ITABASHI-KU, TOKYO, JAPAN, FILED 12-4-2003.

CLINTEC

THE MARK CONSISTS OF STANDARD CHARACTERS WITHOUT CLAIM TO ANY PARTICULAR FONT, STYLE, SIZE, OR COLOR.

FOR LINT-FREE PAPER AND CLEAN PAPER, NAMELY, COMPUTER PAPER, COPIER PAPER, COPY PAPER, FILLER PAPER, LAMINATED PAPER, LOOSE LEAF PAPER, NOTE PAPER, NOTEBOOK PAPER, PRINTING PAPER, THERMO SENSITIVE PAPER, XEROGRAPHIC PAPER, LABEL PAPER, INK JET PRINTING PAPER, CARDBOARD, LINT-FREE PAPER AND CLEAN PAPER IN THE FORM OF SHEETS AND ROLLS (U.S. CLS. 2, 5, 22, 23, 29, 37, 38 AND 50).

ROBERT LORENZO, EXAMINING ATTORNEY

SN 76-563,324. KEY ITEM SALES, INC., CANOGA PARK, CA. FILED 12-4-2003.



THE GRAY TONES ARE INTENDED TO INDICATE SHADING ONLY, ARE NOT INTENDED TO INDICATE COLOR AND ARE NOT A FEATURE OF THE MARK.

FOR PAPER TEMPLATES FOR REDUCING THE SIZE OF PHOTOGRAPHS TO PREDETERMINED DIMENSIONS, INCLUDING PRINTED AND GRAPHIC ILLUSTRATED INSTRUCTIONS THEREWITH (U.S. CLS. 2, 5, 22, 23, 29, 37, 38 AND 50).

BRENDAN MCCAULEY, EXAMINING ATTORNEY

SN 76-563,923. YOUNG PEOPLE'S PRESS, SAN DIEGO, CA. FILED 11-24-2003.

YOUNG PEOPLE'S PRESS

NO CLAIM IS MADE TO THE EXCLUSIVE RIGHT TO USE "PRESS", APART FROM THE MARK AS SHOWN.

SEC. 2(F).

FOR SERIES OF CHILDREN'S AND ADOLESCENT'S BOOKS AND MAGAZINES ON ETHICS, CHARACTER AND SOCIAL ISSUES; TEXTBOOKS ON ETHICS, CHARACTER AND SOCIAL ISSUES (U.S. CLS. 2, 5, 22, 23, 29, 37, 38 AND 50).

FIRST USE 5-16-1994; IN COMMERCE 5-16-1994.

ANN E. SAPPENFIELD, EXAMINING ATTORNEY

CLASS 16—(Continued).

SN 76-564,078. LIVEWIRE SPORTS GROUP, INC., ANAHEIM, CA. FILED 12-8-2003.

CLASS 16—(Continued).

SN 76-577,889. OLYMPIC GENERAL CORPORATION, RENO, NV. FILED 2-25-2004.

90:00

THE MARK CONSISTS OF STANDARD CHARACTERS WITHOUT CLAIM TO ANY PARTICULAR FONT, STYLE, SIZE, OR COLOR.

FOR PUBLICATIONS IN THE NATURE OF MAGAZINES IN THE FIELD OF SPORTS, NAMELY, SOCCER (U.S. CLS. 2, 5, 22, 23, 29, 37, 38 AND 50).

FIRST USE 6-0-2002; IN COMMERCE 6-0-2002.
ROBERT LORENZO, EXAMINING ATTORNEY

THE MARK CONSISTS OF STANDARD CHARACTERS WITHOUT CLAIM TO ANY PARTICULAR FONT, STYLE, SIZE, OR COLOR.

FOR PLASTIC TRASH BAGS (U.S. CLS. 2, 5, 22, 23, 29, 37, 38 AND 50).

ELISSA GARBER KON, EXAMINING ATTORNEY

SN 76-565,977. BAPTIST STATE CONVENTION OF NORTH CAROLINA, CARY, NC. FILED 12-18-2003.

SN 76-577,892. OLYMPIC GENERAL CORPORATION, RENO, NV. FILED 2-25-2004.

ROAD MAPS

THE MARK CONSISTS OF STANDARD CHARACTERS WITHOUT CLAIM TO ANY PARTICULAR FONT, STYLE, SIZE, OR COLOR.

FOR BROCHURES AND PROMOTIONAL AND INSTRUCTIONAL MATERIALS IN THE NATURE OF PAMPHLETS ON THE SUBJECT OF DISCIPLESHIP EDUCATION TO IMPROVE CHURCHES' AND CHURCH MEMBERS' AWARENESS OF THEIR STEWARDSHIP RESPONSIBILITIES AND BETTER ENABLE CHURCH MEMBERS TO FINANCIALLY SUPPORT THEIR CHURCH'S MISSIONS AND MINISTRIES (U.S. CLS. 2, 5, 22, 23, 29, 37, 38 AND 50).

FIRST USE 7-25-2002; IN COMMERCE 7-25-2002.
HELEN BRYAN, EXAMINING ATTORNEY

THE MARK CONSISTS OF STANDARD CHARACTERS WITHOUT CLAIM TO ANY PARTICULAR FONT, STYLE, SIZE, OR COLOR.

FOR PLASTIC TRASH BAGS (U.S. CLS. 2, 5, 22, 23, 29, 37, 38 AND 50).

ELISSA GARBER KON, EXAMINING ATTORNEY

SN 76-577,888. OLYMPIC GENERAL CORPORATION, RENO, NV. FILED 2-25-2004.

SN 76-578,596. BAINTON, STEPHEN L., DARIEN, CT. FILED 3-2-2004.

THE ORANGE BOX

THE MARK CONSISTS OF STANDARD CHARACTERS WITHOUT CLAIM TO ANY PARTICULAR FONT, STYLE, SIZE, OR COLOR.

FOR PLASTIC TRASH BAGS (U.S. CLS. 2, 5, 22, 23, 29, 37, 38 AND 50).

ELISSA GARBER KON, EXAMINING ATTORNEY

EXECUTIVE TOOLS

THE MARK CONSISTS OF STANDARD CHARACTERS WITHOUT CLAIM TO ANY PARTICULAR FONT, STYLE, SIZE, OR COLOR.

NO CLAIM IS MADE TO THE EXCLUSIVE RIGHT TO USE "EXECUTIVE", APART FROM THE MARK AS SHOWN.

FOR NEWSPAPERS, BOOKS AND PERIODICALS IN THE FIELDS OF SALES, MARKETING, AND BUSINESS (U.S. CLS. 2, 5, 22, 23, 29, 37, 38 AND 50).

ALLISON HOLTZ, EXAMINING ATTORNEY

CLASS 16—(Continued).

SN 76-585,329. HILTON HEAD ISLAND PERFORMANCE GROUP, INC., HILTON HEAD ISLAND, SC. FILED 4-6-2004.

THE TOTAL STUDENT SUCCESS PLANNER

THE MARK CONSISTS OF STANDARD CHARACTERS WITHOUT CLAIM TO ANY PARTICULAR FONT, STYLE, SIZE, OR COLOR.

NO CLAIM IS MADE TO THE EXCLUSIVE RIGHT TO USE "STUDENT" AND "PLANNER", APART FROM THE MARK AS SHOWN.

FOR APPOINTMENT AND CALENDAR BOOKS, PERSONAL PLANNERS AND SCHEDULERS CONTAINING INFORMATION REGARDING ACADEMICS, LIFESTYLE, AND TIME MANAGEMENT (U.S. CLS. 2, 5, 22, 23, 29, 37, 38 AND 50).

FIRST USE 3-0-2004; IN COMMERCE 3-0-2004.

IRENE D. WILLIAMS, EXAMINING ATTORNEY

SN 76-587,379. CREATIVE INDUSTRIES INC., LA CANADA, CA. FILED 4-15-2004.



NO CLAIM IS MADE TO THE EXCLUSIVE RIGHT TO USE "INDUSTRIES, INC.", APART FROM THE MARK AS SHOWN.

THE MARK CONSISTS OF THE WORDS AND QUESTION MARK "CREATIVE INDUSTRIES INC. WHAT CAN WE CREATE FOR YOU?" AND THE DESIGN, AS SHOWN IN THE DRAWING.

FOR ACTIVITY AND COLORING BOOKS FOR THE TRAVEL INDUSTRY (U.S. CLS. 2, 5, 22, 23, 29, 37, 38 AND 50).

IRENE D. WILLIAMS, EXAMINING ATTORNEY

SN 76-589,272. TPI HOLDINGS, INC., NORFOLK, VA. FILED 4-29-2004.

TRUCK & VAN TRADER

THE MARK CONSISTS OF STANDARD CHARACTERS WITHOUT CLAIM TO ANY PARTICULAR FONT, STYLE, SIZE, OR COLOR.

NO CLAIM IS MADE TO THE EXCLUSIVE RIGHT TO USE TRUCK & VAN, APART FROM THE MARK AS SHOWN.

FOR PERIODIC PUBLICATIONS, NAMELY MAGAZINES FEATURING CLASSIFIED AND DISPLAY ADVERTISING (U.S. CLS. 2, 5, 22, 23, 29, 37, 38 AND 50).

FIRST USE 4-28-1997; IN COMMERCE 4-28-1997.

YSA DEJESUS, EXAMINING ATTORNEY

CLASS 16—(Continued).

SN 76-595,864. NEW YORK MAGAZINE HOLDINGS LLC, NEW YORK, NY. FILED 6-7-2004.



OWNER OF U.S. REG. NO. 1,135,730.

NO CLAIM IS MADE TO THE EXCLUSIVE RIGHT TO USE "WEDDINGS", APART FROM THE MARK AS SHOWN. SEC. 2(F) AS TO "NEW YORK".

FOR MAGAZINES FEATURING TOPICS OF INTEREST TO BRIDES AND GROOMS IN THE NEW YORK METROPOLITAN AREA (U.S. CLS. 2, 5, 22, 23, 29, 37, 38 AND 50).

FIRST USE 4-0-2002; IN COMMERCE 4-0-2002.

LAURA KOVAISKY, EXAMINING ATTORNEY

SN 76-597,388. PELIKAN VERTRIEBSGESELLSCHAFT MBH & CO. KG, 30163 HANNOVER, FED REP GERMANY, FILED 6-15-2004.

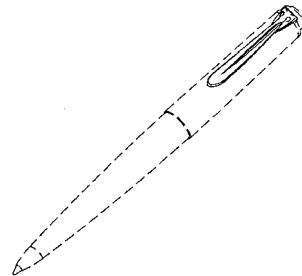

SEC. 2(F).

FOR PENS, PENCILS, AND ROLLER WRITING INSTRUMENTS (U.S. CLS. 2, 5, 22, 23, 29, 37, 38 AND 50).

FIRST USE 6-5-1930; IN COMMERCE 6-5-1930.

CHARLES JOYNER, EXAMINING ATTORNEY

SN 76-598,437. SNAPSHOT MAGAZINE, LLC, GREAT NECK, NY. FILED 6-21-2004.

INCREDIBLE PHOTOGRAPHY

THE MARK CONSISTS OF STANDARD CHARACTERS WITHOUT CLAIM TO ANY PARTICULAR FONT, STYLE, SIZE, OR COLOR.

NO CLAIM IS MADE TO THE EXCLUSIVE RIGHT TO USE "PHOTOGRAPHY", APART FROM THE MARK AS SHOWN.

FOR PERIODICAL PUBLICATION; NAMELY, ENTERTAINMENT MAGAZINE DEALING WITH CELEBRITY PHOTOS (U.S. CLS. 2, 5, 22, 23, 29, 37, 38 AND 50).

KAREN BRACEY, EXAMINING ATTORNEY

CLASS 16—(Continued).

SN 76-598,627. BASIC ORGANICS, INC., COLUMBUS, OH.
FILED 6-22-2004.

GET ACTIVE

THE MARK CONSISTS OF STANDARD CHARACTERS WITHOUT CLAIM TO ANY PARTICULAR FONT, STYLE, SIZE, OR COLOR.

FOR MAGAZINES IN THE FIELD OF HEALTH AND FITNESS (U.S. CLS. 2, 5, 22, 23, 29, 37, 38 AND 50).
NANCY CLARKE, EXAMINING ATTORNEY

SN 76-617,350. WHOLE FOODS MARKET IP, L.P., AUSTIN, TX. FILED 10-21-2004.

WFM-U

THE MARK CONSISTS OF STANDARD CHARACTERS WITHOUT CLAIM TO ANY PARTICULAR FONT, STYLE, SIZE, OR COLOR.

FOR PRINTED INSTRUCTIONAL, EDUCATIONAL AND TEACHING MATERIALS, BROCHURES AND PAMPHLETS IN THE FIELD OF LEADERSHIP, MANAGEMENT, CUSTOMER SERVICE, RETAILING, PROFESSIONAL DEVELOPMENT, FOOD, NUTRITION, DIET, COOKING, HEALTH, FITNESS, LIFESTYLE AND PERSONAL IMPROVEMENT (U.S. CLS. 2, 5, 22, 23, 29, 37, 38 AND 50).
JOHN DALIER, EXAMINING ATTORNEY

SN 78-240,035. CHRISTIAN COMMUNICATIONS OF CHICAGO, IL. AND GRIZZLY ADAMS PRODUCTIONS, CARSON CITY, NV. FILED 4-21-2003.

ENCOUNTERS WITH THE UNEXPLAINED

OWNER OF U.S. REG. NO. 2,772,030.
FOR SERIES OF BOOKS CONCERNING INFORMATION RELATING TO MYSTERIOUS AND UNUSUAL OCCURRENCES AND PHENOMENA (U.S. CLS. 2, 5, 22, 23, 29, 37, 38 AND 50).
JASON TURNER, EXAMINING ATTORNEY

CLASS 16—(Continued).

SN 78-241,892. BECVAR, AARON BRANDT, PHOENIX, AZ.
FILED 4-24-2003.



NO CLAIM IS MADE TO THE EXCLUSIVE RIGHT TO USE "CARDS", APART FROM THE MARK AS SHOWN.

FOR GREETING CARDS (U.S. CLS. 2, 5, 22, 23, 29, 37, 38 AND 50).
ANNE MADDEN, EXAMINING ATTORNEY

SN 78-242,930. ABDUL, PAULA, NEW YORK, NY. FILED 4-28-2003.

RAH!

FOR PRINTED AND RELATED MATTER, NAMELY, POSTERS, CALENDARS, TEMPORARY TATTOOS, STICKERS, DECALS, IRON-ON OR PLASTIC TRANSFERS, BUMPER STICKERS, NOTE CARDS, POSTCARDS, PICTURE POSTCARDS, GREETING CARDS, MUSICAL GREETING CARDS, PRINTED GREETING CARDS WITH ELECTRONIC INFORMATION STORED THEREIN, GIFT CARDS, OCCASION CARDS, SOCIAL NOTE CARDS, MOTIVATIONAL CARDS, CARDS BEARING UNIVERSAL GREETINGS, BLANK CARDS, BLANK NOTE CARDS, PLACE CARDS, BLANK AND PARTIALLY PRINTED CARDS, RECORD CARDS, SCORE CARDS, TRADING CARDS, SCRAPBOOKS, STATIONERY, NOTE PADS, PAPER NOTE TABLETS, WRITING TABLETS, NOTEBOOKS, FOLDERS, FILE FOLDERS, STATIONERY FOLDERS, BOOKMARKS, PAPER PENNANTS, BINDERS, WRITING PAPER, ENVELOPES, APPOINTMENT BOOKS, ADDRESS BOOKS, DESK PADS AND PAPER TAGS; PASSPORT HOLDERS, PERSONAL ORGANIZERS, DESK TOP ORGANIZERS, ORGANIZERS FOR STATIONERY USE AND STATIONERY-TYPE PORTFOLIOS, PAPER FLAGS, MOUNTS FOR STAMPS, RUBBER STAMPS, RUBBER DOCUMENT STAMPS, STAMP ALBUMS, STAMP PAD INKS, STAMP PADS, SLEEVES FOR HOLDING AND PROTECTING STAMPS,

CLASS 16—(Continued).

PAPER BANNERS, HOLDERS FOR DESK ACCESSORIES, LETTER OPENERS, LETTER TRAYS, LETTER RACKS, PEN AND PENCIL CUPS, PENS, PENCILS, MARKERS, PEN AND PENCIL SETS, STICK MARKERS, ERASERS, DRAWING AND DRAFTING RULERS, PENCIL SHARPENERS, BOOK ENDS, BOOK COVERS, CHECKBOOK COVERS, BOOK HOLDERS, PHOTOGRAPH AND COIN ALBUMS; BULLETIN BOARDS; PHOTOGRAPH MOUNTS; PHOTOGRAPHIC OR ART MOUNTS; PHOTOGRAPHIC PRINTS; PHOTOGRAPHS; LITHOGRAPHS; DECORATIVE PAPER CENTERPIECES; DECORATIVE PENCIL-TOP ORNAMENTS; PICTURE BOOKS; PAPER AND CARDBOARD PICTURE MOUNTS; GLOBES; PAPERWEIGHTS; PAPER CLIP HOLDERS; PAPER SIGN HOLDERS; PRINTED PAPER SIGNS; CLIP BOARDS; TOUR BOOK; CONCERT PROGRAMS; MAGAZINES, LEAFLETS, JOURNALS, NEWSLETTERS, BOOKLETS, PAMPHLETS AND BROCHURES, ALL OF THE AFORESAID FEATURING MUSIC, ENTERTAINMENT, ARTS, FASHION, LIFESTYLES, CULTURE AND POLITICS (U.S. CLS. 2, 5, 22, 23, 29, 37, 38 AND 50).

BRETT J. GOLDEN, EXAMINING ATTORNEY

CLASS 16—(Continued).

SN 78-265,076. EAGLE-TRIBUNE PUBLISHING COMPANY, NORTH ANDOVER, MA. FILED 6-20-2003.

LAWRENCE-EAGLE TRIBUNE

OWNER OF U.S. REG. NOS. 1,122,360 AND 1,671,743. FOR NEWSPAPERS FOR GENERAL CIRCULATION (U.S. CLS. 2, 5, 22, 23, 29, 37, 38 AND 50). FIRST USE 9-28-1959; IN COMMERCE 9-28-1959. SOPHIA S. KIM, EXAMINING ATTORNEY

SN 78-251,918. VERLANEY, DAVID N., SCOTTSDALE, AZ. FILED 5-20-2003.

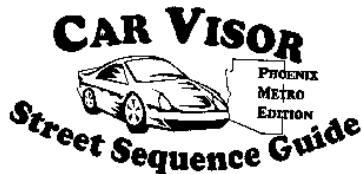

NO CLAIM IS MADE TO THE EXCLUSIVE RIGHT TO USE THE REPRESENTATION OF ARIZONA AND "CAR VISOR" AND "PHOENIX METRO EDITION" AND "STREET SEQUENCE GUIDE", APART FROM THE MARK AS SHOWN.

FOR STREET VISOR GUIDES, NAMELY PRINTED GUIDES FOR STREET TRAVEL; STREET VISOR GUIDES, NAMELY ROAD MAPS (U.S. CLS. 2, 5, 22, 23, 29, 37, 38 AND 50).

FIRST USE 5-19-2003; IN COMMERCE 5-19-2003. MELVIN AXILBUND, EXAMINING ATTORNEY

SN 78-263,763. INDUSTRIAL MOTION CONTROL, LLC, WHEELING, IL. FILED 6-18-2003.

CAMCO-FERGUSON

FOR MAGAZINES AND NEWSLETTERS ABOUT INDUSTRIAL AND COMMERCIAL MACHINERY; STATIONERY, PRINTED PAPER SIGNS, AND PAPER LABELS (U.S. CLS. 2, 5, 22, 23, 29, 37, 38 AND 50).

DAWN FELDMAN, EXAMINING ATTORNEY

SN 78-283,874. GENERAL MOTORS CORPORATION, DETROIT, MI. FILED 8-6-2003.

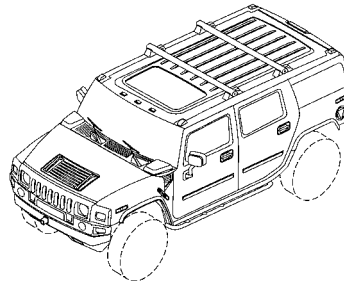

THE LINING IS A FEATURE OF THE MARK AND DOES NOT INDICATE COLOR.

THE MARK CONSISTS OF THE PRODUCT CONFIGURATION OF A MOTOR VEHICLE. THE DOTTED LINES ARE USED TO INDICATE THE POSITION OF THE WHEELS, AND ARE NOT A PART OF THE MARK.

FOR PENS, PENCILS, PEN AND PENCIL HOLDERS, MARKERS, TRADING AND COLLECTOR CARDS, STATIONERY FOLDERS, DESK TOP HOLDERS, TELEPHONE INDICES, CALENDARS, POCKET PEN SHIELDS, PAPERWEIGHTS, PAPER CUTTERS, LETTER OPENERS, POSTERS, NOTE PADS, SELF-ADHERING NOTE PAPER PADS, NOTE PAD HOLDERS, POCKET SECRETARIES, BUSINESS CARD HOLDERS, PAPER LUGGAGE IDENTIFICATION TAGS, LAMINATED PAPER TAGS, DECALS, REPRODUCTION LITHOGRAPHIC PRINTS, BANK CHECKS, CHECKBOOK COVERS, AUTOMOTIVE HISTORY BOOKS, CHILDREN'S ACTIVITY BOOKS, COOKBOOKS, ALMANACS, GIFT WRAPPING PAPER, PAPER NAPKINS, PAPER BANNERS, PAPER FLAGS, POSTCARDS, BUMPER STICKERS, PAPER COASTERS, PLASTIC BAGS FOR MERCHANDISE PACKING, GREETING CARDS, AND PICTURES. (U.S. CLS. 2, 5, 22, 23, 29, 37, 38 AND 50).

BILL DAWE, EXAMINING ATTORNEY

CLASS 16—(Continued).

SN 78-294,313. DISNEY ENTERPRISES, INC., BURBANK, CA. FILED 8-29-2003.



OWNER OF U.S. REG. NOS. 2,415,566, 2,623,099 AND OTHERS.

FOR ADDRESS BOOKS; PHOTOGRAPH ALBUMS; APPLIQUES IN THE FORM OF DECALS; APPOINTMENT BOOKS; ARTS AND CRAFT PAINT KITS; AUTOGRAPH BOOKS; BABY BOOKS; PAPER PARTY BAGS; BALL-POINT PENS; BINDERS; BOOKENDS; BOOKMARKS; A SERIES OF FICTION BOOKS FOR CHILDREN; PERIODICALS, MAGAZINES AND NEWSPAPERS, FEATURING STORIES, GAMES AND ACTIVITIES FOR CHILDREN; PAPER GIFT WRAP BOWS; PAPER CAKE DECORATIONS; CALENDARS; GIFT CARDS; GREETING CARDS; CARTOON PRINTS; CARTOON STRIPS AND NEWSPAPER CARTOONS; PEN AND PENCIL CASES; DECORATIVE PAPER CENTERPIECES; CHALK; CHILDREN'S ACTIVITY BOOKS; MODELING CLAY; PAPER TABLE CLOTHS; COLORING BOOKS; COMIC STRIPS; COMIC BOOKS; PAPER PARTY DECORATIONS; DIARIES; GIFT WRAPPING PAPER; PAPER PARTY HATS; PAPER NAPKINS; PENS; PENCILS; STATIONERY; STICKERS; POSTERS; NOTEBOOKS; MEMO PADS; ERASERS; PENCIL SHARPENERS; STAPLERS; WRITING PAPER; ENVELOPES; PAPER WEIGHTS; PAPER COASTERS; PAPER MATS; NON-CALIBRATED DRAWING RULERS; PHOTOGRAPHS; POSTCARDS; TRADING CARDS (U.S. CLS. 2, 5, 22, 23, 29, 37, 38 AND 50).

PAUL F. GAST, EXAMINING ATTORNEY

SN 78-304,467. BACICH, NANCY, NEW YORK, NY. FILED 9-23-2003.

EVE KITTEN

NO CLAIM IS MADE TO THE EXCLUSIVE RIGHT TO USE "KITTEN" APART FROM THE MARK AS SHOWN, APART FROM THE MARK AS SHOWN.

FOR CARTOON FEATURES APPEARING IN MAGAZINES, NEWSPAPERS, PAMPHLETS, AND BOOKS (U.S. CLS. 2, 5, 22, 23, 29, 37, 38 AND 50).

KEVON CHISOLM, EXAMINING ATTORNEY

SN 78-307,261. PAPER PRINCE INC., MINNEAPOLIS, MN. FILED 9-30-2003.

BLUE MARMALADE

FOR PAPER PRODUCTS, NAMELY, GREETING CARDS, INVITATIONS, WRAPPING PAPER, STATIONERY, PAPER AND PAPER GIFT BOXES (U.S. CLS. 2, 5, 22, 23, 29, 37, 38 AND 50).

FIRST USE 5-16-1994; IN COMMERCE 5-16-1994.
MARC LEIPZIG, EXAMINING ATTORNEY

CLASS 16—(Continued).

SN 78-307,375. DEUTSCHE TELEKOM AG, BONN, FED REP GERMANY, FILED 9-30-2003.

T-MOBILE SMA

OWNER OF U.S. REG. NOS. 2,156,145, 2,611,449 AND OTHERS.

NO CLAIM IS MADE TO THE EXCLUSIVE RIGHT TO USE "SMA", APART FROM THE MARK AS SHOWN.

FOR PRINTED MATTER, NAMELY, TELEPHONE DIRECTORIES, BOOKS, NEWSLETTERS, PAMPHLETS, BROCHURES, MAGAZINES AND PAPERBACKS ALL IN THE FIELD OF TELECOMMUNICATIONS, PRINTED AND STAMPED PLASTIC AND CARDBOARD GREETING, BLANK, NOTE, AND INDEX CARDS; NOTE PAPER AND ENVELOPES, RUBBER STAMPS, NAME TAGS AND LABELS MADE FROM PAPER OR CARDBOARD, NOTEBOOKS, DIARIES, NOTE PAPERS, NOTE PADS, ADDRESS BOOKS, FOLDERS FOR LETTERS AND LOOSE PAPERS, CLEAR HOLE REINFORCEMENTS, STUDENT CALENDARS, STAMP ALBUMS AND PHOTO-ALBUMS; PAPER WEIGHTS, LETTER OPENERS, BLOTTING PADS; DESK TRAYS, DESK STANDS AND HOLDERS FOR HOLDING STATIONERY AND OFFICE IMPLEMENTS; PRINTED INSTRUCTIONAL AND TEACHING MATERIALS ALL IN THE FIELDS OF TELECOMMUNICATIONS, INFORMATION TECHNOLOGY, SAFETY, NEWS, SPORTS, ENTERTAINMENT, CULTURE, BUSINESS AND FINANCE, WEATHER AND TRAVEL; STATIONERY, RULERS, ERASERS, STAPLERS, STAPLES, PAPER CLIPS, BOOK MARKERS, CUTOUT SAMPLES AND STENCILS; SCRATCH PICTURES, PAPER, NAMELY, BOND PAPER AND ART PAPER, PVC STICKERS, GIFT WRAP PAPER; BLACKBOARDS, CHALK STICKS, ADHESIVES FOR STATIONERY OR HOUSEHOLD PURPOSES; DRAWING AND PAINTING MATERIALS, NAMELY, PENCILS, DRAWING PENCILS, PENS, DRAWING PENS, PAINT TRAYS, PAINTING SETS FOR ARTISTS, PAINTING SETS FOR CHILDREN, CRAFT PAINT KITS, AND PENCIL CASES; NON-MAGNETICALLY ENCODED, TELEPHONE CALLING CARDS (U.S. CLS. 2, 5, 22, 23, 29, 37, 38 AND 50).

PAUL F. GAST, EXAMINING ATTORNEY

CLASS 16—(Continued).

SN 78-317,920. PADRES L.P., SAN DIEGO, CA. FILED 10-23-2003.

CLASS 16—(Continued).

SN 78-323,267. GLOBALHOUSE PUBLISHING, MILL VALLEY, CA. FILED 11-5-2003.

GLOBALHOUSE



THE MARK CONSISTS OF STANDARD CHARACTERS WITHOUT CLAIM TO ANY PARTICULAR FONT, STYLE, SIZE, OR COLOR.

FOR PRINTED MATTER, NAMELY, SERIES OF FICTION AND NONFICTION BOOKS IN THE FIELD OF CURRENT AFFAIRS (U.S. CLS. 2, 5, 22, 23, 29, 37, 38 AND 50).

ANDREA SAUNDERS, EXAMINING ATTORNEY

OWNER OF U.S. REG. NO. 1,585,635.
SEC. 2(F).

FOR PAPER GOODS AND PRINTED MATTER, NAMELY, TRADING CARDS, POSTERS, STICKERS, DECALS, TEMPORARY TATTOOS, BUMPER STICKERS, SCORE BOOKS, SCORECARDS, PRINTED BASEBALL GAME PROGRAMS, MAGAZINES AND BOOKS FEATURING BASEBALL, NEWSLETTERS, BROCHURES AND PAMPHLETS FEATURING BASEBALL, WRITING PADS, NOTE PAPER, NOTEBOOKS, BINDERS, STATIONERY-TYPE PORTFOLIOS, STATIONERY FOLDERS, STATIONERY SETS COMPRISED OF WRITING PAPER, CARDS, AND ENVELOPES, PAPER ACTIVITY SETS COMPRISED OF BOOKLETS CONTAINING CHILDREN'S GAMES AND ACTIVITIES, COLORING PAGES, STORIES AND CRAFT IDEAS, FLIP BOOKS, PREPRINTED AGENDA ORGANIZERS, MEMO BOARDS, SCRAPBOOKS, AUTOGRAPH BOOKS, BASEBALL CARD ALBUMS, BOOK COVERS, BOOKMARKS, BOOKENDS, CALENDARS, GREETING CARDS, POSTCARDS, PRINTED BANK CHECKBOOKS, CHECKBOOK COVERS, CREDIT CARDS WITHOUT MAGNETIC CODING, COLLECTIBLE STAMPS, RUBBER STAMPS, INK STAMPS, COMMEMORATIVE STAMPS, PAPER PENNANTS, GIFT WRAPPING PAPER, PAPER GIFT AND PARTY BAGS, PAPER PARTY GOODS, NAMELY, PAPER PARTY DECORATIONS, PAPER COASTERS, PAPER FLAGS, PAPER NAPKINS, FACIAL TISSUE, PAPER TABLECLOTHS, MOUNTED AND UNMOUNTED PHOTOGRAPHS, PHOTOGRAPH ALBUMS, LITHOGRAPHS, PRINTED PAPER SIGNS, PRINTED PAPER DOOR SIGNS, PLASTIC BASEBALL CARD HOLDERS AND COLLECTORS CASES, METAL BULLETIN BOARDS, PAPERWEIGHTS, LETTER OPENERS, PENS, PENCILS, PENCIL TOP ORNAMENTS, CRAYONS, MARKERS, DESK STANDS AND HOLDER FOR PENS, PENCILS AND INK, NON-ELECTRIC ERASERS, PENCIL SHARPENERS, PENCIL CASES, UNGRADUATED RULERS, PAPER TICKET HOLDERS AND NON-METAL LANYARDS FOR PAPER TICKET HOLDERS SOLD AS A UNIT, ART PICTURES, ART PRINTS (U.S. CLS. 2, 5, 22, 23, 29, 37, 38 AND 50).

BRIDGETT SMITH, EXAMINING ATTORNEY

SN 78-323,758. MULIA, HU-ANN, FREMONT, CA. FILED 11-5-2003.

PSYCHOTEERS

THE MARK CONSISTS OF STANDARD CHARACTERS WITHOUT CLAIM TO ANY PARTICULAR FONT, STYLE, SIZE, OR COLOR.

FOR ORIGINAL ILLUSTRATIONS AND COMIC WORKS, NAMELY, COMIC BOOKS, GRAPHIC NOVELS, ORIGINAL COMIC OR ARTWORK REPRODUCED IN MAGAZINES OR BY INDEPENDENT PUBLISHERS; COMMISSIONED ARTWORK, NAMELY, ART PRINTS, ART SKETCHES, TRADITIONAL MEDIA PAINTINGS (U.S. CLS. 2, 5, 22, 23, 29, 37, 38 AND 50).

DAVID TAYLOR, EXAMINING ATTORNEY

CLASS 16—(Continued).

SN 78-323,821. KIM, DAIGON, GLENDALE, CA. FILED 11-6-2003.

Asiatic Soul

THE MARK CONSISTS OF STANDARD CHARACTERS WITHOUT CLAIM TO ANY PARTICULAR FONT, STYLE, SIZE, OR COLOR.

OWNER OF U.S. REG. NO. 2,872,668.

NO CLAIM IS MADE TO THE EXCLUSIVE RIGHT TO USE "ASIATIC", APART FROM THE MARK AS SHOWN.

FOR GENERAL INTEREST MAGAZINE AND PRINTED MATERIALS, NAMELY, POSTERS, CALENDARS, POST CARDS, DATE BOOKS, PAPER BANNERS, ACADEMIC PLANNERS, STATIONERY, PRINTED PAPER SIGNS, BUSINESS CARDS, COLLECTIBLE CARDS FEATURING PHOTOGRAPHS OF MALE AND FEMALE MODELS, STICKERS; AND PRINTED DESK SUPPLIES, NAMELY, DESK PADS AND DESK TOP PLANNERS (U.S. CLS. 2, 5, 22, 23, 29, 37, 38 AND 50).

NELSON SNYDER, EXAMINING ATTORNEY

CLASS 16—(Continued).

SN 78-324,993. LEGAL AMERICA LTD., DBA LIGHTHOUSE LEGAL COPY SERVICE, SEATTLE, WA. FILED 11-7-2003.



THE MARK CONSISTS OF THE OUTLINE OF A LIGHTHOUSE.

FOR CORRUGATED AND CARDBOARD RECORD STORAGE BOXES; FILE BOXES FOR STORAGE OF BUSINESS RECORDS (U.S. CLS. 2, 5, 22, 23, 29, 37, 38 AND 50).

MITCHELL FRONT, EXAMINING ATTORNEY

SN 78-328,642. J&L PAPERS AND IMPORTS, L.L.C., ELIZABETH, NJ. FILED 11-16-2003.

SN 78-324,992. ROSE ART INDUSTRIES, INC., LIVINGSTON, NJ. FILED 11-7-2003.

Quest

FOR WRITING INSTRUMENTS (U.S. CLS. 2, 5, 22, 23, 29, 37, 38 AND 50).

LAURA KOVAISKY, EXAMINING ATTORNEY



FOR NOTEBOOKS (U.S. CLS. 2, 5, 22, 23, 29, 37, 38 AND 50).

TRACY FLETCHER, EXAMINING ATTORNEY

CLASS 16—(Continued).

SN 78-329,598. EMILY S. DESAI, DBA LITTLE ORANGES OF CALIFORNIA, LOS ANGELES, CA. FILED 11-18-2003.



NO CLAIM IS MADE TO THE EXCLUSIVE RIGHT TO USE "CALIFORNIA", APART FROM THE MARK AS SHOWN.

FOR STATIONERY, GREETING CARDS, GREETING CARDS THAT HAVE BEEN BOTH WATERCOLORED AND LETTERPRESSED TO FORM A SINGLE DESIGN, GIFT TAGS, LETTERPRESSED GREETING CARDS, NOTE CARDS BEARING WATERCOLOR DESIGNS, PRINTED INVITATIONS, PAPER LABELS, AND ENVELOPES (U.S. CLS. 2, 5, 22, 23, 29, 37, 38 AND 50).
STEVEN R. FOSTER, EXAMINING ATTORNEY

SN 78-344,316. MATSUI INTERNATIONAL CO., INC., GARDENA, CA. FILED 12-22-2003.

COMFORT STEP

THE MARK CONSISTS OF STANDARD CHARACTERS WITHOUT CLAIM TO ANY PARTICULAR FONT, STYLE, SIZE, OR COLOR.

FOR THERMALLY APPLIED HEAT TRANSFER GRAPHICS (U.S. CLS. 2, 5, 22, 23, 29, 37, 38 AND 50).
FIRST USE 7-1-2003; IN COMMERCE 7-1-2003.
ARETHA SOMERVILLE, EXAMINING ATTORNEY

SN 78-344,342. MATSUI INTERNATIONAL CO., INC., GARDENA, CA. FILED 12-22-2003.

COMFORT TOUCH

THE MARK CONSISTS OF STANDARD CHARACTERS WITHOUT CLAIM TO ANY PARTICULAR FONT, STYLE, SIZE, OR COLOR.

FOR THERMALLY APPLIED HEAT TRANSFER GRAPHICS (U.S. CLS. 2, 5, 22, 23, 29, 37, 38 AND 50).
FIRST USE 7-1-2003; IN COMMERCE 7-1-2003.
ARETHA SOMERVILLE, EXAMINING ATTORNEY

CLASS 16—(Continued).

SN 78-344,362. MATSUI INTERNATIONAL CO., INC., GARDENA, CA. FILED 12-22-2003.

COMFORT PLUS

THE MARK CONSISTS OF STANDARD CHARACTERS WITHOUT CLAIM TO ANY PARTICULAR FONT, STYLE, SIZE, OR COLOR.

FOR THERMALLY APPLIED HEAT TRANSFER GRAPHICS (U.S. CLS. 2, 5, 22, 23, 29, 37, 38 AND 50).
FIRST USE 1-1-2003; IN COMMERCE 1-1-2003.
ARETHA SOMERVILLE, EXAMINING ATTORNEY

SN 78-348,900. CRAIG, LAURA, WOODLANDS, TX. FILED 1-7-2004.

**FUN-N-FACTS FOR
BRAIN-IACS!**

THE MARK CONSISTS OF STANDARD CHARACTERS WITHOUT CLAIM TO ANY PARTICULAR FONT, STYLE, SIZE, OR COLOR.

FOR SYNDICATED CITY AND COMMUNITY NEWSPAPER SECTIONS DEALING WITH EDUCATIONAL TOPICS FOR CHILDREN (U.S. CLS. 2, 5, 22, 23, 29, 37, 38 AND 50).
FRED MANDIR, EXAMINING ATTORNEY

SN 78-350,465. THE MCGRAW-HILL COMPANIES, INC., NEW YORK, NY. FILED 1-12-2004.

FLUENCY FIRST

THE MARK CONSISTS OF STANDARD CHARACTERS WITHOUT CLAIM TO ANY PARTICULAR FONT, STYLE, SIZE, OR COLOR.

NO CLAIM IS MADE TO THE EXCLUSIVE RIGHT TO USE "FLUENCY", APART FROM THE MARK AS SHOWN.

FOR PRINTED MATERIALS, NAMELY, A SERIES OF BOOKS, WORKBOOKS, WORKSHEETS, TEACHER'S GUIDES, MANUALS FOR TEACHING READING AND LANGUAGE SKILLS (U.S. CLS. 2, 5, 22, 23, 29, 37, 38 AND 50).

ELIZABETH PIGNATELLO, EXAMINING ATTORNEY

CLASS 16—(Continued).

SN 78-351,801. PEARSON EDUCATION, INC., UPPER SADDLE RIVER, NJ. FILED 1-14-2004.

CLASS 16—(Continued).

SN 78-354,456. DENNEY, CHRISTOPHER, ACWORTH, GA. FILED 1-20-2004.

VISUAL QUICKSTEP



THE MARK CONSISTS OF STANDARD CHARACTERS WITHOUT CLAIM TO ANY PARTICULAR FONT, STYLE, SIZE, OR COLOR.
NO CLAIM IS MADE TO THE EXCLUSIVE RIGHT TO USE "VISUAL", APART FROM THE MARK AS SHOWN.
FOR BOOKS AND MANUALS, FEATURING COMPUTER TOPICS (U.S. CLS. 2, 5, 22, 23, 29, 37, 38 AND 50).
ALICIA COLLINS, EXAMINING ATTORNEY

THE MARK CONSISTS OF THE LETTER R SLANTED 45 DEGREES ENCLOSED IN A 3-D DIAMOND SHAPE BOX WITH THE LETTERS MX ENCLOSED ON THE LEFT AND RIGHT SIDE. THE WORD ROOST WITH A LARGE R UNDERLINING OOST WITH THE LETTERS MX UNDER THE WORD ROOST.
FOR DECALS AND STICKERS (U.S. CLS. 2, 5, 22, 23, 29, 37, 38 AND 50).
STEVEN R. FINE, EXAMINING ATTORNEY

SN 78-354,251. PORCELLI ASSOCIATES INC., OSSINING, NY. FILED 1-20-2004.

SN 78-359,745. GERLEVE', MARK L, CORDOVA, TN. FILED 1-29-2004.

zigzagzoo



THE MARK CONSISTS OF STANDARD CHARACTERS WITHOUT CLAIM TO ANY PARTICULAR FONT, STYLE, SIZE, OR COLOR.
FOR SERIES OF CHILDREN'S STORYBOOKS (U.S. CLS. 2, 5, 22, 23, 29, 37, 38 AND 50).
JANICE L. MCMORROW, EXAMINING ATTORNEY

NO CLAIM IS MADE TO THE EXCLUSIVE RIGHT TO USE "ENTERPRISES", APART FROM THE MARK AS SHOWN.
FOR ART AND RELATED PRODUCTS, NAMELY, PAINTINGS AND PHOTOGRAPHS (U.S. CLS. 2, 5, 22, 23, 29, 37, 38 AND 50).
MARLENE BELL, EXAMINING ATTORNEY

CLASS 16—(Continued).

SN 78-360,789. ROSE ART INDUSTRIES, INC., LIVINGSTON, NJ. FILED 2-2-2004.

SMART ERASE

THE MARK CONSISTS OF STANDARD CHARACTERS WITHOUT CLAIM TO ANY PARTICULAR FONT, STYLE, SIZE, OR COLOR.

NO CLAIM IS MADE TO THE EXCLUSIVE RIGHT TO USE "ERASE", APART FROM THE MARK AS SHOWN.

FOR DRY ERASE BOARDS AND ERASERS (U.S. CLS. 2, 5, 22, 23, 29, 37, 38 AND 50).

STEVEN R. FOSTER, EXAMINING ATTORNEY

CLASS 16—(Continued).

SN 78-367,659. COOK COMMUNICATIONS MINISTRIES, COLORADO SPRINGS, CO. FILED 2-13-2004.

Emerge

THE MARK CONSISTS OF STANDARD CHARACTERS WITHOUT CLAIM TO ANY PARTICULAR FONT, STYLE, SIZE, OR COLOR.

FOR PRINTED TEACHING AND INSTRUCTIONAL MATERIALS AND CURRICULUM OF A RELIGIOUS NATURE, NAMELY, BOOKS, PAMPHLETS, NEWSLETTERS, BIBLES, BROCHURES, POSTERS, PAPER BOOKS CONTAINING GAMES, MAZES, AND CROSSWORD PUZZLES, STUDENT BOOKS, TEACHING GUIDES, ADULT STUDY BOOKS, STUDY GUIDES, DEVOTIONAL BOOKS, TAKE-HOME PAPERS, WORKBOOKS, INFORMATIONAL FLYERS, BOOKMARKS, COOK BOOKS, PENCIL BOOKS, MUSIC BOOKS, FICTION BOOKS, NON-FICTION BOOKS, ALL IN THE FIELD OF CHRISTIAN EDUCATION (U.S. CLS. 2, 5, 22, 23, 29, 37, 38 AND 50).

GWEN STOKOLS, EXAMINING ATTORNEY

SN 78-366,744. ENGLANDER COMMUNICATIONS, LLC, NORWALK, CT. FILED 2-12-2004.

**DIABETES
PERSPECTIVE**

THE MARK CONSISTS OF STANDARD CHARACTERS WITHOUT CLAIM TO ANY PARTICULAR FONT, STYLE, SIZE, OR COLOR.

NO CLAIM IS MADE TO THE EXCLUSIVE RIGHT TO USE "DIABETES", APART FROM THE MARK AS SHOWN.

FOR PRINTED PUBLICATIONS, NAMELY, NEWSLETTERS DEALING WITH MEDICAL ISSUES OF INTEREST TO DIABETICS AND THEIR CAREGIVERS (U.S. CLS. 2, 5, 22, 23, 29, 37, 38 AND 50).

PAUL F. GAST, EXAMINING ATTORNEY

SN 78-367,731. RESIDENTIAL MARKETING CONCEPTS, INC., SOUTHFIELD, MI. FILED 2-13-2004.

**ALTERNATIVES FOR
SENIORS**

THE MARK CONSISTS OF STANDARD CHARACTERS WITHOUT CLAIM TO ANY PARTICULAR FONT, STYLE, SIZE, OR COLOR.

OWNER OF U.S. REG. NO. 2,494,368.

NO CLAIM IS MADE TO THE EXCLUSIVE RIGHT TO USE SENIORS, APART FROM THE MARK AS SHOWN.

FOR PUBLICATIONS, NAMELY, HOUSING GUIDES (U.S. CLS. 2, 5, 22, 23, 29, 37, 38 AND 50).

FIRST USE 1-15-2004; IN COMMERCE 1-15-2004.

DAVID TAYLOR, EXAMINING ATTORNEY

CLASS 16—(Continued).

SN 78-376,075. RODALE INC., EMMAUS, PA. FILED 3-1-2004.

CLASS 16—(Continued).

SN 78-379,960. CHRIST, THOMAS F., JAMUL, CA. FILED 3-7-2004.

WAYPOINTS

THE MARK CONSISTS OF STANDARD CHARACTERS WITHOUT CLAIM TO ANY PARTICULAR FONT, STYLE, SIZE, OR COLOR.

FOR MAPS (U.S. CLS. 2, 5, 22, 23, 29, 37, 38 AND 50).
FIRST USE 4-15-2004; IN COMMERCE 4-15-2004.
IRENE D. WILLIAMS, EXAMINING ATTORNEY



SN 78-376,126. LIVING ROOM LEARNING, L.L.C., NEW YORK, NY. FILED 3-1-2004.



FOR BOOKS AND PUBLICATIONS, NAMELY, NEWSLETTERS, MAGAZINES, AND JOURNALS, RELATING TO EDUCATION, NATURE, HISTORY, SPORTS, SOCIAL STUDIES, GUIDANCE AND SAFETY, CULTURAL DIVERSITY, SCIENCE AND HEALTH, BIOGRAPHIES, AND EDUCATIONAL MANIPULATABLES (U.S. CLS. 2, 5, 22, 23, 29, 37, 38 AND 50).

FIRST USE 8-0-2003; IN COMMERCE 8-0-2003.
JOSETTE BEVERLY, EXAMINING ATTORNEY

ART BIB

THE MARK CONSISTS OF STANDARD CHARACTERS WITHOUT CLAIM TO ANY PARTICULAR FONT, STYLE, SIZE, OR COLOR.

NO CLAIM IS MADE TO THE EXCLUSIVE RIGHT TO USE "BIB", APART FROM THE MARK AS SHOWN.
FOR PAPER BABY BIB (U.S. CLS. 2, 5, 22, 23, 29, 37, 38 AND 50).

SAMUEL E. SHARPER JR., EXAMINING ATTORNEY



SN 78-395,386. PCXMODS, SALT LAKE CITY, UT. FILED 4-2-2004.



FOR SELF ADHESIVE PRE-CUT NEOPRENE SHAPES FOR IMPROVED GRIP ON COMPUTER MICE, TRACKBALLS AND CONSOLE GAMING CONTROLLERS (U.S. CLS. 2, 5, 22, 23, 29, 37, 38 AND 50).

KIMBERLY PERRY, EXAMINING ATTORNEY

CLASS 16—(Continued).

SN 78-405,744. THOMPSON, JOHN D., PADUCAH, KY.
FILED 4-21-2004.



THE COLORS SILVER, BLACK, RED, ORANGE AND YELLOW ARE CLAIMED AS A FEATURE OF THE MARK.

THE MARK CONSISTS OF A SILVER SWORD HAVING A HANDLE FORMING THE LIKENESS OF THE LETTERS "F" AND "S". A RED, ORANGE AND YELLOW FLAME ENGULFS THE BLADE PORTION OF THE SWORD. THE WORDS "FLAMING SWORD" ARE SHOWN IN THE COLOR BLACK AND ARE ADJACENT TO THE FLAME. THE STYLIZED LETTERS "F" AND "S" AND THE FLAME ARE OUTLINED IN THE COLOR BLACK.

FOR COLLECTIBLE CARDS, ESPECIALLY SUITED FOR CHILDREN; NAMELY, COLLECTIBLE CARDS BEARING THE LIKENESS OF BIBLE CHARACTERS AND/OR SCRIPTURE REFERENCES (U.S. CLS. 2, 5, 22, 23, 29, 37, 38 AND 50).

FIRST USE 4-1-2004; IN COMMERCE 11-5-2004.
ELIZABETH J. WINTER, EXAMINING ATTORNEY

CLASS 16—(Continued).

SN 78-407,951. O'HARRA, LAURIE JEAN, REDMOND, OR.
FILED 4-26-2004.

Premier Builders

THE MARK CONSISTS OF STANDARD CHARACTERS WITHOUT CLAIM TO ANY PARTICULAR FONT, STYLE, SIZE, OR COLOR.

NO CLAIM IS MADE TO THE EXCLUSIVE RIGHT TO USE "BUILDERS", APART FROM THE MARK AS SHOWN. FOR ANNUAL DIRECTORIES OF BUILDERS (U.S. CLS. 2, 5, 22, 23, 29, 37, 38 AND 50).

CHERYL CLAYTON, EXAMINING ATTORNEY

SN 78-411,320. DRG TEXAS, LP, BIG SANDY, TX. FILED 4-30-2004.

SN 78-407,915. VERSA-TAGS, INC., CUBA, MO. FILED 4-26-2004.

VT HIGHLIGHTS

THE MARK CONSISTS OF STANDARD CHARACTERS WITHOUT CLAIM TO ANY PARTICULAR FONT, STYLE, SIZE, OR COLOR.

FOR PRE-PRINTED AND BLANK VINYL DECALS FOR AUTOMOTIVE ADVERTISING (U.S. CLS. 2, 5, 22, 23, 29, 37, 38 AND 50).

LESLEY LAMOTHE, EXAMINING ATTORNEY

SIMPLY BEADS

THE MARK CONSISTS OF STANDARD CHARACTERS WITHOUT CLAIM TO ANY PARTICULAR FONT, STYLE, SIZE, OR COLOR.

NO CLAIM IS MADE TO THE EXCLUSIVE RIGHT TO USE "BEADS", APART FROM THE MARK AS SHOWN.

FOR PRINTED PUBLICATIONS, NAMELY MAGAZINES IN THE AREA OF CRAFTS (U.S. CLS. 2, 5, 22, 23, 29, 37, 38 AND 50).

CHARLES L. JENKINS, EXAMINING ATTORNEY

CLASS 16—(Continued).

SN 78-416,084. CRYLLICON CREATIONS, LONGMONT, CO.
FILED 5-10-2004.

Druidawn

THE MARK CONSISTS OF STANDARD CHARACTERS
WITHOUT CLAIM TO ANY PARTICULAR FONT, STYLE,
SIZE, OR COLOR.

FOR SERIES OF FICTION BOOKS FEATURING
SCIENCE FICTION/FANTASY SHORT STORIES (U.S.
CLS. 2, 5, 22, 23, 29, 37, 38 AND 50).

FIRST USE 1-1-1991; IN COMMERCE 1-1-1991.

KATHLEEN M. VANSTON, EXAMINING ATTORNEY

CLASS 16—(Continued).

SN 78-418,911. THE NEW YORK TIMES COMPANY, NEW
YORK, NY. FILED 5-14-2004.

THE NEW YORK TIMES STYLE MAGAZINE

THE MARK CONSISTS OF STANDARD CHARACTERS
WITHOUT CLAIM TO ANY PARTICULAR FONT, STYLE,
SIZE, OR COLOR.

OWNER OF U.S. REG. NOS. 227,904 AND 2,120,865.

NO CLAIM IS MADE TO THE EXCLUSIVE RIGHT TO
USE "STYLE MAGAZINE", APART FROM THE MARK AS
SHOWN.

SEC. 2(F) AS TO "NEW YORK TIMES".

FOR GENERAL INTEREST MAGAZINES (U.S. CLS. 2,
5, 22, 23, 29, 37, 38 AND 50).

FIRST USE 8-29-2004; IN COMMERCE 8-29-2004.

GEORGE LORENZO, EXAMINING ATTORNEY

SN 78-421,455. WEBER, JOHNATHAN, MISSOULA, MT.
FILED 5-19-2004.

SN 78-416,840. BRIGHTER IDEAS, INC, METUCHEN, NJ.
FILED 5-11-2004.

MARINE IMPRESSIONS

THE MARK CONSISTS OF STANDARD CHARACTERS
WITHOUT CLAIM TO ANY PARTICULAR FONT, STYLE,
SIZE, OR COLOR.

NO CLAIM IS MADE TO THE EXCLUSIVE RIGHT TO
USE "MARINE", APART FROM THE MARK AS SHOWN.

FOR PRINTS OF FINE ART; FABRIC DESIGNS,
NAMELY EMBROIDERY DESIGN PATTERNS; BOOK
COVERS; STATIONERY; NOTE CARDS; PAPER COAST-
ERS; BOOKMARKS; GREETING CARDS; PAPER-
WEIGHTS; CALENDARS (U.S. CLS. 2, 5, 22, 23, 29, 37,
38 AND 50).

SUSAN STIGLITZ, EXAMINING ATTORNEY

NEW WEST

THE MARK CONSISTS OF STANDARD CHARACTERS
WITHOUT CLAIM TO ANY PARTICULAR FONT, STYLE,
SIZE, OR COLOR.

NO CLAIM IS MADE TO THE EXCLUSIVE RIGHT TO
USE "WEST", APART FROM THE MARK AS SHOWN.

FOR MONTHLY MAGAZINE ABOUT THE ROCKY
MOUNTAIN WEST (U.S. CLS. 2, 5, 22, 23, 29, 37, 38 AND
50).

KAREN BRACEY, EXAMINING ATTORNEY

CLASS 16—(Continued).

SN 78-421,702. CAMBRIDGE ADVANTAGE, LLC, HONOLULU, HI. FILED 5-19-2004.

CLASS 16—(Continued).

SN 78-422,633. PHILLIPS ENVIRONMENTAL PRODUCTS, INC., BELGRADE, MT. FILED 5-20-2004.

True Moments

THE MARK CONSISTS OF STANDARD CHARACTERS WITHOUT CLAIM TO ANY PARTICULAR FONT, STYLE, SIZE, OR COLOR.

FOR PRINTED INSTRUCTIONAL, EDUCATIONAL AND TEACHING MATERIALS FOR EARLY CHILDHOOD EDUCATION (U.S. CLS. 2, 5, 22, 23, 29, 37, 38 AND 50).

RUSS HERMAN, EXAMINING ATTORNEY

WEE BAG

THE MARK CONSISTS OF STANDARD CHARACTERS WITHOUT CLAIM TO ANY PARTICULAR FONT, STYLE, SIZE, OR COLOR.

NO CLAIM IS MADE TO THE EXCLUSIVE RIGHT TO USE BAG, APART FROM THE MARK AS SHOWN.

FOR HUMAN WASTE DISPOSAL SYSTEM FOR PERSONAL USE COMPRISED PRIMARILY OF DISPOSABLE PLASTIC SANITATION BAGS AND GELLING POWDER (U.S. CLS. 2, 5, 22, 23, 29, 37, 38 AND 50).

HEATHER THOMPSON, EXAMINING ATTORNEY

SN 78-422,171. TWENTIETH CENTURY FOX FILM CORPORATION, LOS ANGELES, CA. FILED 5-20-2004.



SN 78-422,636. PHILLIPS ENVIRONMENTAL PRODUCTS, INC., BELGRADE, MT. FILED 5-20-2004.

TOILET IN A BAG

FOR CALENDARS; POSTCARDS; TRADING CARDS; TRADING CARD ALBUMS; COLORING BOOKS; POSTERS; STICKERS; STICKER ALBUMS; STATIONERY; WRITING PAPER AND ENVELOPES; NOTEBOOKS; LOOSE-LEAF BINDERS; PAPER BOOKMARKS; MEMO PADS; ADDRESS BOOKS; DATE BOOKS; DIARIES; BLANK WRITING JOURNALS; BOOK COVERS; GREETING CARDS; WRAPPING PAPER; PAPER GIFT BAGS; PAPER GIFT TAGS; THANK YOU NOTES; BUMPER STICKERS; PENS AND PENCILS; PEN AND PENCIL CUPS; PEN AND PENCIL CASES; TEMPORARY TATTOOS; MOUNTED AND UNMOUNTED PHOTOGRAPHS; PHOTOGRAPH ALBUMS; DESKTOP ORGANIZERS; DECALS (U.S. CLS. 2, 5, 22, 23, 29, 37, 38 AND 50).

RUSS HERMAN, EXAMINING ATTORNEY

THE MARK CONSISTS OF STANDARD CHARACTERS WITHOUT CLAIM TO ANY PARTICULAR FONT, STYLE, SIZE, OR COLOR.

NO CLAIM IS MADE TO THE EXCLUSIVE RIGHT TO USE BAG, APART FROM THE MARK AS SHOWN.

FOR HUMAN WASTE DISPOSAL SYSTEM FOR PERSONAL USE COMPRISED PRIMARILY OF DISPOSABLE PLASTIC SANITATION BAGS AND GELLING POWDER (U.S. CLS. 2, 5, 22, 23, 29, 37, 38 AND 50).

HEATHER THOMPSON, EXAMINING ATTORNEY

CLASS 16—(Continued).

SN 78-423,131. RODALE INC., EMMAUS, PA. FILED 5-21-2004.

FRESH THINKING FRESH LIVING

THE MARK CONSISTS OF STANDARD CHARACTERS WITHOUT CLAIM TO ANY PARTICULAR FONT, STYLE, SIZE, OR COLOR.

FOR MAGAZINE IN THE FIELDS OF HEALTH, FITNESS, DIET, EXERCISE AND LIFESTYLE (U.S. CLS. 2, 5, 22, 23, 29, 37, 38 AND 50).

BRENDAN MCCAULEY, EXAMINING ATTORNEY

SN 78-425,497. MEADWESTVACO CORPORATION, STAMFORD, CT. FILED 5-26-2004.

GRIP-SEAL SECURITY

THE MARK CONSISTS OF STANDARD CHARACTERS WITHOUT CLAIM TO ANY PARTICULAR FONT, STYLE, SIZE, OR COLOR.

OWNER OF U.S. REG. NOS. 616,567, 1,567,128 AND OTHERS.

NO CLAIM IS MADE TO THE EXCLUSIVE RIGHT TO USE "SECURITY", APART FROM THE MARK AS SHOWN. FOR ENVELOPES (U.S. CLS. 2, 5, 22, 23, 29, 37, 38 AND 50).

FIRST USE 11-10-2003; IN COMMERCE 11-10-2003.
SCOTT OSCLICK, EXAMINING ATTORNEY

SN 78-427,469. CALLAHAN, PHIL, LAS VEGAS, NV. FILED 5-30-2004.

Closed Coffin

THE MARK CONSISTS OF STANDARD CHARACTERS WITHOUT CLAIM TO ANY PARTICULAR FONT, STYLE, SIZE, OR COLOR.

FOR CALENDARS; PHOTOGRAPHS; AND POSTERS (U.S. CLS. 2, 5, 22, 23, 29, 37, 38 AND 50).

STEVEN R. FOSTER, EXAMINING ATTORNEY

CLASS 16—(Continued).

SN 78-428,298. BECKER, LESLIE, NEW YORK, NY. FILED 6-1-2004.

The Organized Artist

THE MARK CONSISTS OF STANDARD CHARACTERS WITHOUT CLAIM TO ANY PARTICULAR FONT, STYLE, SIZE, OR COLOR.

NO CLAIM IS MADE TO THE EXCLUSIVE RIGHT TO USE "ARTIST", APART FROM THE MARK AS SHOWN.

FOR DAY PLANNER FOR ORGANIZING ARTISTS AND ARTISTICALLY CREATIVE PEOPLE (U.S. CLS. 2, 5, 22, 23, 29, 37, 38 AND 50).

G. MAYERSCHOFF, EXAMINING ATTORNEY

SN 78-428,621. LIFE TIME ATHLETE, LLC, CAPE ELIZABETH, ME. FILED 6-2-2004.

Life Time Athlete

THE MARK CONSISTS OF STANDARD CHARACTERS WITHOUT CLAIM TO ANY PARTICULAR FONT, STYLE, SIZE, OR COLOR.

NO CLAIM IS MADE TO THE EXCLUSIVE RIGHT TO USE "ATHLETE", APART FROM THE MARK AS SHOWN.

FOR MAGAZINES PROVIDING INFORMATION ABOUT, AND PROFILES OF, AMATEUR ATHLETES AND OTHERWISE RELATING TO SPORTS AND ATHLETICS (U.S. CLS. 2, 5, 22, 23, 29, 37, 38 AND 50).

MARGERIE A. TIERNEY, EXAMINING ATTORNEY

CLASS 16—(Continued).

SN 78-430,216. MARK KELLER INC., SAUSALITO, CA.
FILED 6-4-2004.

Music on Canvas

THE MARK CONSISTS OF STANDARD CHARACTERS WITHOUT CLAIM TO ANY PARTICULAR FONT, STYLE, SIZE, OR COLOR.

NO CLAIM IS MADE TO THE EXCLUSIVE RIGHT TO USE "CANVAS", APART FROM THE MARK AS SHOWN.

FOR PAINTINGS - ORIGINAL AND REPRODUCTIONS OF SAME (U.S. CLS. 2, 5, 22, 23, 29, 37, 38 AND 50).

FIRST USE 1-1-1998; IN COMMERCE 1-1-1999.
GINA HAYES, EXAMINING ATTORNEY

CLASS 16—(Continued).

SN 78-432,315. PREMIER PAINT ROLLER MFG. CO. INC.,
RICHMOND HILL, NY. FILED 6-9-2004.

Premier Plus

THE MARK CONSISTS OF STANDARD CHARACTERS WITHOUT CLAIM TO ANY PARTICULAR FONT, STYLE, SIZE, OR COLOR.

FOR PAINT APPLICATORS AND ACCESSORIES, NAMELY PAINT ROLLERS, PAINT BRUSHES, PAINT TRAYS, EXTENSION POLES FOR PAINT APPLICATORS, PAINT MITTS, GRIDS FOR REMOVING EXCESS PAINT FROM ROLLER TYPE APPLICATORS AND CAGE FRAMES (U.S. CLS. 2, 5, 22, 23, 29, 37, 38 AND 50).

FIRST USE 5-27-2004; IN COMMERCE 5-27-2004.
JANICE L. MCMORROW, EXAMINING ATTORNEY

SN 78-431,306. LANGUAGE SUCCESS PRESS, ANN ARBOR,
MI. FILED 6-7-2004.

Speak English Like an American

THE MARK CONSISTS OF STANDARD CHARACTERS WITHOUT CLAIM TO ANY PARTICULAR FONT, STYLE, SIZE, OR COLOR.

FOR BOOKS FOR LEARNING ENGLISH (U.S. CLS. 2, 5, 22, 23, 29, 37, 38 AND 50).

FIRST USE 4-1-2002; IN COMMERCE 1-15-2003.
INGA ERVIN, EXAMINING ATTORNEY

SN 78-433,345. CASE IT, LLC, LYNDHURST, NJ. FILED 6-10-
2004.

Case It SchoolGear

SN 78-431,327. EPANA NETWORKS, INC., NEW YORK, NY.
FILED 6-7-2004.

SIGO SIENDO EL REY

THE MARK CONSISTS OF STANDARD CHARACTERS WITHOUT CLAIM TO ANY PARTICULAR FONT, STYLE, SIZE, OR COLOR.

THE FOREIGN WORDING IN THE MARK TRANSLATES INTO ENGLISH AS "I'LL ALWAYS BE THE KING".

FOR PREPAID TELEPHONE CALLING CARDS, NOT MAGNETICALLY ENCODED (U.S. CLS. 2, 5, 22, 23, 29, 37, 38 AND 50).

FIRST USE 3-1-2004; IN COMMERCE 3-1-2004.
INGA ERVIN, EXAMINING ATTORNEY

THE MARK CONSISTS OF STANDARD CHARACTERS WITHOUT CLAIM TO ANY PARTICULAR FONT, STYLE, SIZE, OR COLOR.

OWNER OF U.S. REG. NO. 2,066,665.

NO CLAIM IS MADE TO THE EXCLUSIVE RIGHT TO USE "SCHOOLGEAR", APART FROM THE MARK AS SHOWN.

FOR BINDERS, PENCIL CASES AND NOTEBOOKS (U.S. CLS. 2, 5, 22, 23, 29, 37, 38 AND 50).

BRIAN PINO, EXAMINING ATTORNEY

CLASS 16—(Continued).

SN 78-433,644. CASE IT, LLC, LYNDHURST, NJ. FILED 6-11-2004.

Case It School
Gear

THE MARK CONSISTS OF STANDARD CHARACTERS WITHOUT CLAIM TO ANY PARTICULAR FONT, STYLE, SIZE, OR COLOR.

OWNER OF U.S. REG. NO. 2,066,665.

NO CLAIM IS MADE TO THE EXCLUSIVE RIGHT TO USE "SCHOOL GEAR", APART FROM THE MARK AS SHOWN.

FOR BINDERS, NOTEBOOKS AND PENCIL CASES (U.S. CLS. 2, 5, 22, 23, 29, 37, 38 AND 50).

BRIAN PINO, EXAMINING ATTORNEY

CLASS 16—(Continued).

SN 78-434,445. PRETTY PUNCH LLC, CHANDLER, AZ. FILED 6-14-2004.



FOR EMBROIDERY KITS CONSISTING PRIMARILY OF TRANSFER PENS AND DESIGN PATTERNS (U.S. CLS. 2, 5, 22, 23, 29, 37, 38 AND 50).

FIRST USE 1-31-1980; IN COMMERCE 1-31-1980.

ALEXANDER L. POWERS, EXAMINING ATTORNEY

SN 78-434,804. RUDICH, CARIN M., NEW YORK, NY. FILED 6-14-2004.

curlyshirley

HEEDLEBEE'S

THE MARK CONSISTS OF STANDARD CHARACTERS WITHOUT CLAIM TO ANY PARTICULAR FONT, STYLE, SIZE, OR COLOR.

FOR CHILDREN'S BOOKS FEATURING CHARACTERS AND STORIES (U.S. CLS. 2, 5, 22, 23, 29, 37, 38 AND 50).

EVELYN BRADLEY, EXAMINING ATTORNEY

THE MARK CONSISTS OF STANDARD CHARACTERS WITHOUT CLAIM TO ANY PARTICULAR FONT, STYLE, SIZE, OR COLOR.

FOR STATIONARY (U.S. CLS. 2, 5, 22, 23, 29, 37, 38 AND 50).

YSA DEJESUS, EXAMINING ATTORNEY

CLASS 16—(Continued).

SN 78-435,665. CONTINENTAL WEB PRESS, INC., ITASCA, IL. FILED 6-15-2004.

CLASS 16—(Continued).

SN 78-436,193. MEADWESTVACO CORPORATION, STAMFORD, CT. FILED 6-16-2004.

Scent-A-Line

**PERMANENTLY
TEMPORARY**

THE MARK CONSISTS OF STANDARD CHARACTERS WITHOUT CLAIM TO ANY PARTICULAR FONT, STYLE, SIZE, OR COLOR.

FOR PRINTED ADVERTISING MATERIALS, NAMELY, BROCHURES, CARDS, BUSINESS REPLY CARDS, ENVELOPES, AND MAGAZINE INSERTS FOR USE BY OTHERS TO PROMOTE FRAGRANCED PRODUCTS (U.S. CLS. 2, 5, 22, 23, 29, 37, 38 AND 50).

ASMAT KHAN, EXAMINING ATTORNEY

THE MARK CONSISTS OF STANDARD CHARACTERS WITHOUT CLAIM TO ANY PARTICULAR FONT, STYLE, SIZE, OR COLOR.

FOR NOTEBOOKS, BINDERS AND DIVIDERS; STATIONERY-TYPE PORTFOLIOS; EXPANDING FILES; FILE FOLDERS; BOOK COVERS; PENS, MARKERS AND ERASERS (U.S. CLS. 2, 5, 22, 23, 29, 37, 38 AND 50).

JOHN DALIER, EXAMINING ATTORNEY

SN 78-437,132. PINK STREET LLC, ATLANTA, GA. FILED 6-17-2004.

SN 78-435,912. NIR, MARNIE, JUPITER, FL. FILED 6-16-2004.

THE SUBOURBON

PINK

THE MARK CONSISTS OF STANDARD CHARACTERS WITHOUT CLAIM TO ANY PARTICULAR FONT, STYLE, SIZE, OR COLOR.

FOR SERIES OF NEWSPAPER COLUMNS DEALING WITH FAMILY LIFE, MOTHERHOOD AND DOMESTIC ISSUES (U.S. CLS. 2, 5, 22, 23, 29, 37, 38 AND 50).

FIRST USE 6-0-2003; IN COMMERCE 6-9-2004.
JOHN SCHUYLER YARD, EXAMINING ATTORNEY

THE MARK CONSISTS OF STANDARD CHARACTERS WITHOUT CLAIM TO ANY PARTICULAR FONT, STYLE, SIZE, OR COLOR.

FOR WOMEN'S MAGAZINE FOCUSED ON THE CAREER WOMAN (U.S. CLS. 2, 5, 22, 23, 29, 37, 38 AND 50).

DAWN FELDMAN, EXAMINING ATTORNEY

CLASS 16—(Continued).

SN 78-437,204. HANNAFORD LICENSING CORP., SCARBOROUGH, ME. FILED 6-17-2004.

fresh

THE MARK CONSISTS OF STANDARD CHARACTERS WITHOUT CLAIM TO ANY PARTICULAR FONT, STYLE, SIZE, OR COLOR.

FOR SUPERMARKET FOOD MAGAZINE FEATURING RECIPES, BEVERAGE SELECTIONS, COOKING, DECORATING AND PARTY PLANNING IDEAS, AND OTHER TIPS FOR CUSTOMERS (U.S. CLS. 2, 5, 22, 23, 29, 37, 38 AND 50).

FIRST USE 6-17-2004; IN COMMERCE 6-17-2004.
STEVEN R. FINE, EXAMINING ATTORNEY

CLASS 16—(Continued).

SN 78-437,533. MILLER, ELIZABETH M., MOSCOW, ID. FILED 6-18-2004.

**Whispering Pines
Porcelain**

THE MARK CONSISTS OF STANDARD CHARACTERS WITHOUT CLAIM TO ANY PARTICULAR FONT, STYLE, SIZE, OR COLOR.

NO CLAIM IS MADE TO THE EXCLUSIVE RIGHT TO USE PORCELAIN, APART FROM THE MARK AS SHOWN. FOR PAPER AND DECALS FOR USE IN PORCELAIN PAINTING, AND BOOKS AND PRINTED INSTRUCTIONAL MATERIALS FEATURING THE ART OF PORCELAIN PAINTING (U.S. CLS. 2, 5, 22, 23, 29, 37, 38 AND 50).

PATRICIA EVANKO, EXAMINING ATTORNEY

SN 78-437,314. LINDA A. SCHOTBORGH, DBA 3D PEARL, LA MIRADA, CA. FILED 6-17-2004.

3D Pearl

THE MARK CONSISTS OF STANDARD CHARACTERS WITHOUT CLAIM TO ANY PARTICULAR FONT, STYLE, SIZE, OR COLOR.

NO CLAIM IS MADE TO THE EXCLUSIVE RIGHT TO USE "3D", APART FROM THE MARK AS SHOWN.

FOR PRINTED PRODUCTS, NAMELY, LISTS FEATURING DESIGNS FROM DIGITAL IMAGES (U.S. CLS. 2, 5, 22, 23, 29, 37, 38 AND 50).

SUSAN STIGLITZ, EXAMINING ATTORNEY

SN 78-437,784. CORPORATE EXPRESS DOCUMENT & PRINT MANAGEMENT, INC., BROOMFIELD, CO. FILED 6-18-2004.



THE MARK CONSISTS OF A STYLIZED VERSION OF THE LETTERS EK.

FOR FINANCIAL REGISTERS FOR INDICATING CREDITS, DEBITS AND BALANCES OF VARIOUS ACCOUNTS; CHECK REGISTERS; BLANK CHECKS; PRINTED FINANCIAL FORMS; BOOKKEEPING FORMS; ACCOUNTING FORMS; WIRE BOUND BINDERS; LOOSE-LEAF BINDERS; FINANCIAL JOURNALS (U.S. CLS. 2, 5, 22, 23, 29, 37, 38 AND 50).

FIRST USE 0-0-1984; IN COMMERCE 0-0-1984.
STEVEN JACKSON, EXAMINING ATTORNEY

CLASS 16—(Continued).

SN 78-437,791. THE PROCTER & GAMBLE COMPANY, CINCINNATI, OH. FILED 6-18-2004.



THE MARK CONSISTS OF FRONT FACING, HEAD AND SHOULDERS, SMILING BEAR.
FOR TOILET TISSUE (U.S. CLS. 2, 5, 22, 23, 29, 37, 38 AND 50).
FIRST USE 12-1-2003; IN COMMERCE 12-1-2003.
KATHLEEN M. VANSTON, EXAMINING ATTORNEY

SN 78-437,923. KONAMI GAMING, INC., LAS VEGAS, NV. FILED 6-18-2004.

JUST SPIN IT

THE MARK CONSISTS OF STANDARD CHARACTERS WITHOUT CLAIM TO ANY PARTICULAR FONT, STYLE, SIZE, OR COLOR.
FOR PRINTED MATTER, NAMELY, CATALOGUES, BROCHURES, AND FLYERS FEATURING INFORMATION IN THE FIELD OF GAMING (U.S. CLS. 2, 5, 22, 23, 29, 37, 38 AND 50).
ASMAT KHAN, EXAMINING ATTORNEY

SN 78-438,919. CARRIE BISHOP, OAKLAND, CA. FILED 6-21-2004.



THE MARK CONSISTS OF THE SLASH IS A SEWING NEEDLE; THE UNDERLINE IS A THREAD.
FOR SEWING PATTERNS (U.S. CLS. 2, 5, 22, 23, 29, 37, 38 AND 50).
FIRST USE 5-1-2003; IN COMMERCE 5-1-2003.
REBECCA SMITH, EXAMINING ATTORNEY

CLASS 16—(Continued).

SN 78-439,312. R* ART, INC., PORTLAND, OR. FILED 6-22-2004.

identi*FLY

THE MARK CONSISTS OF STANDARD CHARACTERS WITHOUT CLAIM TO ANY PARTICULAR FONT, STYLE, SIZE, OR COLOR.
FOR ADHESIVE-BACKED FABRIC DECALS FOR CUSTOMIZING LUGGAGE AND PERSONAL BAGS (U.S. CLS. 2, 5, 22, 23, 29, 37, 38 AND 50).
KARANENDRA S. CHHINA, EXAMINING ATTORNEY

SN 78-439,626. MORGAN, LEWIS & BOCKIUS LLP, PHILADELPHIA, PA. FILED 6-22-2004.

**MORGAN LEWIS FACE
TO FACE**

THE MARK CONSISTS OF STANDARD CHARACTERS WITHOUT CLAIM TO ANY PARTICULAR FONT, STYLE, SIZE, OR COLOR.
OWNER OF U.S. REG. NO. 2,469,580.
THE NAME MORGAN LEWIS DOES NOT IDENTIFY A LIVING INDIVIDUAL.
FOR PRINTED MATERIALS, NAMELY MAGAZINES, IN THE LEGAL FIELD FOCUSING ON TECHNOLOGY, LIFE SCIENCES, AND EMERGING GROWTH COMPANIES (U.S. CLS. 2, 5, 22, 23, 29, 37, 38 AND 50).
FIRST USE 10-0-2004; IN COMMERCE 10-0-2004.
KATHRYN COWARD, EXAMINING ATTORNEY

CLASS 16—(Continued).

SN 78-440,363. HUBERT P. MILLS TRUST, FULLERTON, CA. FILED 6-23-2004.

ROBERT E. WOOD

THE MARK CONSISTS OF STANDARD CHARACTERS WITHOUT CLAIM TO ANY PARTICULAR FONT, STYLE, SIZE, OR COLOR.

THE NAME(S), PORTRAIT(S), AND/OR SIGNATURE(S) SHOWN IN THE MARK DOES NOT IDENTIFY A PARTICULAR LIVING INDIVIDUAL.

FOR PAINTING PALETTES (U.S. CLS. 2, 5, 22, 23, 29, 37, 38 AND 50).

FIRST USE 5-7-1997; IN COMMERCE 5-7-1997.

GIANCARLO CASTRO, EXAMINING ATTORNEY

SN 78-442,081. PFIZER INC., NEW YORK, NY. FILED 6-28-2004.

**PROTECTION. LIKE
NO OTHER.**

THE MARK CONSISTS OF STANDARD CHARACTERS WITHOUT CLAIM TO ANY PARTICULAR FONT, STYLE, SIZE, OR COLOR.

FOR PRINTED MATERIALS, NAMELY, BOOKLETS, BROCHURES AND PAMPHLETS FEATURING INFORMATION ON VETERINARY PHARMACEUTICAL PREPARATIONS (U.S. CLS. 2, 5, 22, 23, 29, 37, 38 AND 50).

ZACHARY BELLO, EXAMINING ATTORNEY

CLASS 17—RUBBER GOODS

SN 76-582,418. BRADFORD COMPANY, HOLLAND, MI. FILED 3-19-2004.

ECO-PEARL

THE MARK CONSISTS OF STANDARD CHARACTERS WITHOUT CLAIM TO ANY PARTICULAR FONT, STYLE, SIZE, OR COLOR.

FOR EXTRUDED PLASTIC IN THE FORM OF SHEETS, BLOCKS, RODS, AND TUBES FOR USE IN MANUFACTURING PACKAGING, SHIPPING CONTAINERS, FURNITURE, LOAD CARRIERS, CONSTRUCTION, AND MOTOR VEHICLE COMPONENT PARTS (U.S. CLS. 1, 5, 12, 13, 35 AND 50).

KELLY BOULTON, EXAMINING ATTORNEY

SN 76-595,199. 3FORM, INC., SALT LAKE CITY, UT. FILED 6-1-2004.

3FORM

THE MARK CONSISTS OF STANDARD CHARACTERS WITHOUT CLAIM TO ANY PARTICULAR FONT, STYLE, SIZE, OR COLOR.

FOR BUILDING MATERIALS, NAMELY PLASTIC SHEETING FOR USE IN CONSTRUCTION OR MANUFACTURE OF A WIDE VARIETY OF PRODUCTS INCLUDING PANELS, WALLS, FLOORING, CEILINGS, WORK SURFACES, FURNITURE, FIXTURES AND DECORATIVE ELEMENTS (U.S. CLS. 1, 5, 12, 13, 35 AND 50).

FIRST USE 8-1-2002; IN COMMERCE 8-1-2002.

BRENDAN REGAN, EXAMINING ATTORNEY

SN 76-595,271. OTTAWA FIBRE INC., OTTAWA, ONTARIO K1G 3N2, CANADA, FILED 6-3-2004.

BUILDGREEN

THE MARK CONSISTS OF STANDARD CHARACTERS WITHOUT CLAIM TO ANY PARTICULAR FONT, STYLE, SIZE, OR COLOR.

FOR RESIDENTIAL AND COMMERCIAL FIBER-GLASS INSULATION (U.S. CLS. 1, 5, 12, 13, 35 AND 50).

ALICE SUE CARRUTHERS, EXAMINING ATTORNEY

CLASS 17—(Continued).

SN 76-597,436. HANCOR, INC., FINDLAY, OH. FILED 6-16-2004.



FOR POLYETHYLENE PIPE; FITTINGS AND RELATED PARTS TO SERVICE THE POLYETHYLENE PIPE, NAMELY, LATERAL TAP TEE FITTING CONNECTIONS AND CONNECTIONS TO MANHOLES (U.S. CLS. 1, 5, 12, 13, 35 AND 50).

FIRST USE 6-29-2004; IN COMMERCE 6-29-2004.
DOMINIC J. FERRAIUOLO, EXAMINING ATTORNEY

CLASS 17—(Continued).

SN 78-295,532. KLOCKNER PENTAPLAST GMBH & CO. KG, HEILIGENROTH, FED REP GERMANY, FILED 9-3-2003.

PENTACARD

PRIORITY CLAIMED UNDER SEC. 44(D) ON FED REP GERMANY APPLICATION NO. 30321443.0, FILED 4-25-2003, REG. NO. 30321443, DATED 5-9-2003, EXPIRES 4-30-2013.

FOR PLASTIC IN THE FORM OF SHEETS AND ROLLS, NAMELY, HARD FOILS MADE OF POLYVINYLCHLORIDE, POLYESTER, POLYSTYRENE AND ABS PLASTICS FOR THE MANUFACTURE OF CHIP AND CHECKING CARDS (U.S. CLS. 1, 5, 12, 13, 35 AND 50).

TRACY CROSS, EXAMINING ATTORNEY

SN 78-244,023. QUIET SOLUTION, INC., SUNNYVALE, CA. FILED 4-30-2003.



FOR SOUNDPROOFING MATERIALS FOR VEHICLES (U.S. CLS. 1, 5, 12, 13, 35 AND 50).

FIRST USE 4-15-2002; IN COMMERCE 1-1-2003.
JERI J. FICKES, EXAMINING ATTORNEY

SN 78-312,334. TERASEN INC., FORMERLY BC GAS INC., VANCOUVER, BRITISH COLUMBIA, CANADA, FILED 10-10-2003.



PRIORITY CLAIMED UNDER SEC. 44(D) ON CANADA APPLICATION NO. 1,173,585, FILED 4-11-2003, REG. NO. TMA627436, DATED 12-3-2004, EXPIRES 12-3-2019.

FOR PLASTIC PIPES AND FITTINGS THEREFOR (U.S. CLS. 1, 5, 12, 13, 35 AND 50).

KIMBERLY FRYE, EXAMINING ATTORNEY

SN 78-272,286. ALLRED & ASSOCIATES, INC., AUBURN, OH. FILED 7-9-2003.

DRAGONPLATE

FOR LAMINATED COMPOSITE MATERIAL MADE OF FACE LAYERS OF CARBON FIBER IN EPOXY RESIN OVER EITHER A RIGID OR FLEXIBLE CORE IN THE FORM OF BOARDS AND SHEETS FOR USE IN FABRICATING ROBOTS, ARMORING ROBOTS, AND AS STRUCTURAL COMPONENTS FOR SUCH GOODS AS MODELS, ROBOTS, RADIO-CONTROLLED VEHICLES, DASHBOARDS AND KNIFE HANDLES. (U.S. CLS. 1, 5, 12, 13, 35 AND 50).

JOHN GARTNER, EXAMINING ATTORNEY

SN 78-432,893. ELECTROLOCK, INC., HIRAM, OH. FILED 6-10-2004.

ARXON

THE MARK CONSISTS OF STANDARD CHARACTERS WITHOUT CLAIM TO ANY PARTICULAR FONT, STYLE, SIZE, OR COLOR.

FOR ELECTRICAL INSULATING GLASS FLAKE TAPE AND PAPER (U.S. CLS. 1, 5, 12, 13, 35 AND 50).
BRIDGETT SMITH, EXAMINING ATTORNEY

CLASS 17—(Continued).

SN 79-003,886. DENKI KAGAKU KOGYO KABUSHIKI KAISHA, JAPAN, FILED 6-11-2004.

DENKA ER

THE MARK CONSISTS OF STANDARD CHARACTERS WITHOUT CLAIM TO ANY PARTICULAR FONT, STYLE, SIZE, OR COLOR.

PRIORITY DATE OF 3-30-2004 IS CLAIMED.

OWNER OF INTERNATIONAL REGISTRATION 0829008 DATED 6-11-2004, EXPIRES 6-11-2014.

FOR ETHYLENE-VINYL ACETATE RUBBER; ACRYLIC RUBBER; ETHYLENE-VINYL ACETATE ESTER COPOLYMER RUBBER (U.S. CLS. 1, 5, 12, 13, 35 AND 50).

CHRISTOPHER BUONGIORNO, EXAMINING ATTORNEY

CLASS 18—(Continued).

SN 76-551,647. DARDASHTI, SHEILA, BEVERLY HILLS, CA. AND OSBOURNE, LAURA, ENCINITAS, CA. FILED 10-16-2003.

TREESJE

THE NAME(S), PORTRAIT(S), AND/OR SIGNATURE(S) SHOWN IN THE MARK IDENTIFIES A LIVING INDIVIDUAL, WHOSE CONSENT(S) TO REGISTER WILL BE SUBMITTED.

FOR PURSES AND COSMETIC BAGS SOLD EMPTY, SHOULDER BAGS, BELT BAGS, TOTE BAGS, LEATHER KEY CHAINS AND BAGS, LEATHER AND IMITATION LEATHER BAGS, ALL PURPOSE CARRYING AND TRAVELING BAGS (U.S. CLS. 1, 2, 3, 22 AND 41).

FIRST USE 8-22-2003; IN COMMERCE 8-22-2003.
ZACHARY BELLO, EXAMINING ATTORNEY

CLASS 18—LEATHER GOODS

SN 76-524,754. A.D. SUTTON & SONS, NEW YORK, NY. FILED 5-13-2003.

BABY ESSENTIALS

OWNER OF U.S. REG. NO. 1,917,345.
NO CLAIM IS MADE TO THE EXCLUSIVE RIGHT TO USE BABY, APART FROM THE MARK AS SHOWN.
FOR DIAPER BAGS, BACK PACKS AND OVERNIGHT BAGS (U.S. CLS. 1, 2, 3, 22 AND 41).

RUDY R. SINGLETON, EXAMINING ATTORNEY

SN 76-578,373. EDELMAN, MICHELLE, NEW YORK, NY. FILED 3-1-2004.

SN 76-534,384. LOUIS VUITTON MALLETIER, 75001 PARIS, FRANCE, FILED 8-1-2003.

SUHALI

PRIORITY CLAIMED UNDER SEC. 44(D) ON FRANCE APPLICATION NO. 033210576, FILED 2-19-2003, REG. NO. 033210576, DATED 2-19-2003, EXPIRES 2-19-2013.

FOR GOODS MADE OF LEATHER, NAMELY, TRAVELING BAGS, GARMENT BAGS FOR TRAVEL, SHOULDER BAGS, HANDBAGS, POUCHES, POCKET WALLETS, PURSES, KEY HOLDERS, BUSINESS CARD CASES, CALLING CARD CASES, CREDIT CARD CASES (U.S. CLS. 1, 2, 3, 22 AND 41).

SCOTT OSCLICK, EXAMINING ATTORNEY

TAP

THE MARK CONSISTS OF STANDARD CHARACTERS WITHOUT CLAIM TO ANY PARTICULAR FONT, STYLE, SIZE, OR COLOR.

FOR PURSES, TOTE BAGS, CLUTCH BAGS, SHOULDER BAGS, AND COSMETICS BAGS SOLD EMPTY (U.S. CLS. 1, 2, 3, 22 AND 41).

PATRICIA EVANKO, EXAMINING ATTORNEY

CLASS 18—(Continued).

SN 76-593,930. BBC ICE CREAM, LLC, NEW YORK, NY.
FILED 5-18-2004.



FOR ALL-PURPOSE SPORTS AND ATHLETIC BAGS, FANNY PACKS, BACKPACKS, KNAPSACKS, SPORTS PACKS, WAIST PACKS, GYM BAGS, DUFFEL BAGS, TOTE BAGS, BOOK BAGS, HAND BAGS, PURSES, CLUTCH PURSES, CHANGE PURSES, SHOULDER BAGS, CARRY-ON BAGS, TRAVEL BAGS, GARMENT BAGS FOR TRAVEL, LEATHER SHOPPING BAGS, BEACH BAGS, SATCHELS, LUGGAGE, LUGGAGE TAGS, TRUNKS, SUITCASES, COSMETIC CASES SOLD EMPTY, TOILETRY CASES SOLD EMPTY, VANITY CASES SOLD EMPTY, COSMETIC BAGS SOLD EMPTY, TOOL BAGS SOLD EMPTY, ATTACHE CASES, BRIEF-CASES, BRIEFCASE-TYPE PORTFOLIOS, MEN'S CLUTCHES, BUSINESS CASES, BUSINESS CARD CASES, CREDIT CARD CASES, CALLING CARD CASES, PASSPORT CASES, KEY CASES, LEATHER KEY CHAINS, COIN POUCHES, WALLETS, BILLFOLDS, UMBRELLAS AND PARASOLS (U.S. CLS. 1, 2, 3, 22 AND 41).

RAUL CORDOVA, EXAMINING ATTORNEY

SN 76-593,958. SANRIO COMPANY, LTD., TOKYO 141,
JAPAN, FILED 5-21-2004.

CHARMMYKITTY

THE MARK CONSISTS OF STANDARD CHARACTERS WITHOUT CLAIM TO ANY PARTICULAR FONT, STYLE, SIZE, OR COLOR.

FOR TOTE BAGS, SHOULDER BAGS, TRAVEL BAGS, SCHOOL BAGS, BEACH BAGS, QUILTED HAND BAGS, QUILTED BOOK BAGS, ALL PURPOSE SPORT BAGS, VINYL ATHLETIC BAGS, DRAWSTRING BARREL BAGS, DRAWSTRING CARRY-ON BAGS, DRAWSTRING CLUTCH BAGS, BACKPACKS, WAIST PACKS, UMBRELLAS, PURSES, COIN PURSES, WALLETS, CALLING CARD CASES, OVERNIGHT CARRYING CASES, VANITY CASES SOLD EMPTY, GARMENT BAGS FOR TRAVEL, KEY CASES, BRIEFCASES AND HANDBAGS (U.S. CLS. 1, 2, 3, 22 AND 41).

JASON LOTT, EXAMINING ATTORNEY

CLASS 18—(Continued).

SN 78-259,647. SILVA, DAVID, DBA GROUP 27 COMPANY,
PARLIER, CA. FILED 6-7-2003.



FOR SCHOOL BAGS, SCHOOL BOOK BAGS (U.S. CLS. 1, 2, 3, 22 AND 41).

PAM WILLIS, EXAMINING ATTORNEY

SN 78-272,559. ESPRIT IP LIMITED, ROAD TOWN, TORTO-
LA, BR. VIRGIN ISLANDS, FILED 7-10-2003.



OWNER OF U.S. REG. NOS. 1,480,858, 1,559,014 AND OTHERS.

NO CLAIM IS MADE TO THE EXCLUSIVE RIGHT TO USE "SINCE 1969" AND "SAN FRANCISCO CALIFORNIA USA", APART FROM THE MARK AS SHOWN.

FOR HANDBAGS; SHOULDER BAGS; TOTE BAGS; BOSTON BAGS, NAMELY, ALL PURPOSE SPORTS BAGS AND BAGS FOR CARRYING CLOTHING AND ACCESSORIES; WAIST PACKS, BRIEF CASE TYPE PORTFOLIOS, POCKETBOOKS, LEATHER, MESH AND TEXTILE SHOPPING BAGS; KNAPSACKS; DAYPACKS DESIGNED TO CARRY BOOKS, CLOTHES AND SCHOOL ACCESSORIES; BACKPACKS; SCHOOL BAGS; BOOK BAGS; BRIEFCASES; SMALL LEATHER CARRYING CASES, NAMELY, KEY CASES; LEATHER KEY CHAINS; WALLETS; PURSES; CHANGE PURSES; COIN PURSES; CLUTCH PURSES; CREDIT CARD CASES; COSMETIC CASES SOLD EMPTY; TOILETRY BAGS SOLD EMPTY; BUSINESS CARD CASES; AGENDA CASES; LIPSTICK HOLDERS; LUGGAGE; SUITCASES; DUFFEL BAGS; SOFT LUGGAGE AND OVERNIGHT BAGS OF ANY SIZE OR DIMENSION; GARMENT BAGS FOR TRAVEL; WHEELED LUGGAGE; CARRYON CASES; HARD SIDED LUGGAGE; UMBRELLAS; GOLF UMBRELLAS (U.S. CLS. 1, 2, 3, 22 AND 41).

DAVID ELTON, EXAMINING ATTORNEY

CLASS 18—(Continued).

SN 78-310,464. JACOB THE JEWELER, INC., NEW YORK, NY. FILED 10-7-2003.

JACOB JEWELS

NO CLAIM IS MADE TO THE EXCLUSIVE RIGHT TO USE "JEWELS", APART FROM THE MARK AS SHOWN.

FOR HANDBAGS, SHOULDER BAGS, EVENING BAGS, COSMETIC BAGS SOLD EMPTY, TOILETRY BAGS SOLD EMPTY, WALLETS, CREDIT CARD CASES, BUSINESS CARD CASES, KEY CASES, COIN PURSES, CLUTCH PURSES, GENERAL PURPOSE PURSES, POUCHES, NAMELY DRAWSTRING POUCHES, CLOTH POUCHES, LEATHER POUCHES, BELT BAGS, TOTE BAGS, SADDLE BAGS, ROLL BAGS, SLING BAGS, TRAVEL BAGS, OVERNIGHT BAGS, DUFFEL BAGS, SUIT BAGS, GARMENT BAGS FOR TRAVEL, GYM BAGS, TIE CASES, BACKPACKS, ATTACHE CASES, SATCHELS, SUITCASES, TRUNKS, UMBRELLAS (U.S. CLS. 1, 2, 3, 22 AND 41).

JANICE L. MCMORROW, EXAMINING ATTORNEY

CLASS 18—(Continued).

SN 78-330,488. ALVAREZ CASTILLO, FEDERICO, ARGENTINA, AND CAHEN D'ANVERS, JUAN, ARGENTINA, FILED 11-19-2003.

ETIQUETA NEGRA

THE MARK CONSISTS OF STANDARD CHARACTERS WITHOUT CLAIM TO ANY PARTICULAR FONT, STYLE, SIZE, OR COLOR.

THE FOREIGN WORDING IN THE MARK TRANSLATES INTO ENGLISH AS BLACK LABEL.

FOR BAGS, NAMELY, TRAVEL BAGS, PURSES, WALLETS AND LUGGAGE (U.S. CLS. 1, 2, 3, 22 AND 41).

BARNEY CHARLON, EXAMINING ATTORNEY

SN 78-329,445. HARRIS, JAN L., SOUTHFIELD, MI. FILED 11-18-2003.



SN 78-423,688. FOUR PAWS PRODUCTS, LTD., HAUPAUGE, NY. FILED 5-24-2004.

SKI SLOPE

NO CLAIM IS MADE TO THE EXCLUSIVE RIGHT TO USE "CLOTHING COMPANY", APART FROM THE MARK AS SHOWN.

THE NAME "GYE NYAME" DOES NOT IDENTIFY A LIVING INDIVIDUAL.

THE COLOR(S) GREY IS/ARE CLAIMED AS A FEATURE OF THE MARK.

THE COLOR GRAY APPEARS IN THE WHOLE RECTANGLE BEHIND THE TERMS GYE NYAME CLOTHING COMPANY AND DESIGN.

FOR HANDBAGS (U.S. CLS. 1, 2, 3, 22 AND 41).
CAROLINE WOOD, EXAMINING ATTORNEY

THE MARK CONSISTS OF STANDARD CHARACTERS WITHOUT CLAIM TO ANY PARTICULAR FONT, STYLE, SIZE, OR COLOR.

FOR CAT SCRATCHING POST (U.S. CLS. 1, 2, 3, 22 AND 41).

NICHOLAS ALTREE, EXAMINING ATTORNEY

CLASS 18—(Continued).

SN 78-424,634. AQUILINE INNOVATIONS CORPORATION, SUTTER, CA. FILED 5-25-2004.



NO CLAIM IS MADE TO THE EXCLUSIVE RIGHT TO USE "THE GOOD PET STUFF COMPANY", APART FROM THE MARK AS SHOWN.

THE COLOR(S) YELLOW AND BROWN IS/ARE CLAIMED AS A FEATURE OF THE MARK.

THE MARK CONSISTS, IN PART, OF A CAT'S HEAD THAT IS YELLOW AND A DOG'S HEAD THAT IS BROWN.

FOR PET RESTRAINT DEVICES IN THE NATURE OF HARNESSSES FOR USE IN VEHICLES (U.S. CLS. 1, 2, 3, 22 AND 41).

FIRST USE 8-1-2000; IN COMMERCE 8-1-2000.
ELIZABETH J. WINTER, EXAMINING ATTORNEY

SN 78-424,641. CERVANTES, SILVIA P., DALLAS, TX. FILED 5-25-2004.



BABY PAK

NO CLAIM IS MADE TO THE EXCLUSIVE RIGHT TO USE "PAK", APART FROM THE MARK AS SHOWN.

THE COLOR PINK IS CLAIMED AS A FEATURE OF THE MARK.

THE COLOR PINK APPEARS IN THE FACIAL CHEEKS OF THE STYLIZED BABY.

FOR BACK PACKS, NAMELY, A DIAPER BAG WORN ON THE BACK FOR CARRYING BABY CARE AND MATERNITY-RELATED ITEMS, WHICH MAY CONTAIN A PORTABLE COOLER SOLD AS A UNIT (U.S. CLS. 1, 2, 3, 22 AND 41).

FIRST USE 3-13-2004; IN COMMERCE 3-13-2004.
ELIZABETH J. WINTER, EXAMINING ATTORNEY

CLASS 18—(Continued).

SN 78-428,127. SEATTLE POPULAR MONORAIL AUTHORITY, SEATTLE, WA. FILED 6-1-2004.



OWNER OF U.S. REG. NO. 2,785,170.

NO CLAIM IS MADE TO THE EXCLUSIVE RIGHT TO USE "SEATTLE", APART FROM THE MARK AS SHOWN.

THE MARK CONSISTS OF THE STYLIZED DESIGN OF A TRAIN.

FOR LUGGAGE, NAMELY, SUITCASES, ATHLETIC BAGS, ATTACHE CASES, BABY BACK PACKS, DUFFEL BAGS, TOTE BAGS, DOG COLLARS, ANIMAL CARRIERS AND LEASHES, BILLFOLDS, BRIEFCASES, CANES, PASSPORT HOLDERS, BUSINESS AND CREDIT CARD CASES, PURSES, FANNY PACKS, BELLY PACKS, SUIT BAGS, COSMETIC CASES SOLD EMPTY, GARMENT BAGS FOR TRAVEL, BRIEFCASE-TYPE PORTFOLIOS, HANDBAGS, KEY CASES, KNAPSACKS, RUCKSACKS, TOILETRY CASES SOLD EMPTY, TRUNKS FOR TRAVELING AND UMBRELLAS (U.S. CLS. 1, 2, 3, 22 AND 41).

JENNIFER KRISP, EXAMINING ATTORNEY

SN 78-430,331. BECARRO INTERNATIONAL LTD., NEW YORK, NY. FILED 6-4-2004.

SONDRA ROBERTS

THE MARK CONSISTS OF STANDARD CHARACTERS WITHOUT CLAIM TO ANY PARTICULAR FONT, STYLE, SIZE, OR COLOR.

THE MARK IS A FANCIFUL COMBINATION OF TWO NAMES AND DOES NOT REPRESENT A PARTICULAR REAL OR LIVING PERSON.

FOR HANDBAGS, ALL-PURPOSE CARRYING BAGS, TOTE BAGS, TRAVELING BAGS, SHOULDER BAGS, CLUTCH PURSES, ALL PURPOSE ATHLETIC BAGS, BACKPACKS, WALLETS, COIN PURSES, AND COSMETIC BAGS SOLD EMPTY (U.S. CLS. 1, 2, 3, 22 AND 41).

FIRST USE 7-0-1999; IN COMMERCE 7-0-1999.
RUSS HERMAN, EXAMINING ATTORNEY

CLASS 18—(Continued).

SN 78-430,592. LANDES, KAREN MARGARET, FPO, AP. FILED 6-6-2004.

go-yen

THE MARK CONSISTS OF STANDARD CHARACTERS WITHOUT CLAIM TO ANY PARTICULAR FONT, STYLE, SIZE, OR COLOR.

THE ENGLISH TRANSLATION OF THE JAPANESE WORDING "GO" IS "FIVE", A NUMBER CONSIDERED LUCKY IN JAPAN. "YEN" IS THE JAPANESE CURRENCY. FOR PURSES, HANDBAGS (U.S. CLS. 1, 2, 3, 22 AND 41).

FIRST USE 3-15-2004; IN COMMERCE 4-15-2004.
JOHN LINCOSKI, EXAMINING ATTORNEY

SN 78-433,280. YANG, ROGER, CITY OF INDUSTRY, CA. FILED 6-10-2004.

U.S. TRAVELER

THE MARK CONSISTS OF STANDARD CHARACTERS WITHOUT CLAIM TO ANY PARTICULAR FONT, STYLE, SIZE, OR COLOR.

OWNER OF U.S. REG. NOS. 1,995,571, 2,642,088 AND 2,680,390.

NO CLAIM IS MADE TO THE EXCLUSIVE RIGHT TO USE "U.S.", APART FROM THE MARK AS SHOWN.

FOR LUGGAGE AND ALL-PURPOSE SPORTING BAGS (U.S. CLS. 1, 2, 3, 22 AND 41).

ELIZABETH HUGHITT, EXAMINING ATTORNEY

CLASS 18—(Continued).

SN 78-435,068. SENIZERGUES, PIERRE ANDRE, NEWPORT BEACH, CA. FILED 6-14-2004.

EMERICA

THE MARK CONSISTS OF STANDARD CHARACTERS WITHOUT CLAIM TO ANY PARTICULAR FONT, STYLE, SIZE, OR COLOR.

OWNER OF U.S. REG. NOS. 2,225,586, 2,289,173 AND 2,372,421.

FOR LUGGAGE, BACKPACKS, DUFFEL BAGS, WALLET, ALL-PURPOSE SPORT BAGS, BEACH BAGS, TRAVEL BAGS (U.S. CLS. 1, 2, 3, 22 AND 41).

FIRST USE 3-1-1999; IN COMMERCE 3-1-1999.

TIMOTHY FINNEGAN, EXAMINING ATTORNEY

SN 78-435,079. SENIZERGUES, PIERRE ANDRE, NEWPORT BEACH, CA. FILED 6-14-2004.



OWNER OF U.S. REG. NOS. 2,224,086, 2,225,586 AND 2,372,421.

FOR LUGGAGE, BACKPACKS, DUFFEL BAGS, WALLET, ALL-PURPOSE SPORT BAGS, BEACH BAGS, TRAVEL BAGS (U.S. CLS. 1, 2, 3, 22 AND 41).

FIRST USE 3-1-1999; IN COMMERCE 3-1-1999.

LEIGH CAROLINE CASE, EXAMINING ATTORNEY

CLASS 18—(Continued).

SN 78-435,397. L.C. LICENSING, INC., NEW YORK, NY. FILED 6-15-2004.

CLASS 18—(Continued).

SN 78-438,850. HUNTING WORLD LLC, RENO, NV. FILED 6-21-2004.

RUSS

Battue

THE MARK CONSISTS OF STANDARD CHARACTERS WITHOUT CLAIM TO ANY PARTICULAR FONT, STYLE, SIZE, OR COLOR.

OWNER OF U.S. REG. NOS. 827,207 AND 2,839,751. FOR HANDBAGS, WALLETS AND CHANGE PURSES (U.S. CLS. 1, 2, 3, 22 AND 41). ANDREW BENZMILLER, EXAMINING ATTORNEY

THE MARK CONSISTS OF STANDARD CHARACTERS WITHOUT CLAIM TO ANY PARTICULAR FONT, STYLE, SIZE, OR COLOR.

FOR WALLETS, BILLFOLDS, KEY CASES, COIN PURSES, HAND LUGGAGE, ATTACHE CASES, BRIEF-CASES, AND HANDBAGS FOR MEN AND WOMEN, ALL BEING MADE IN WHOLE OR IN PART OF LEATHER (U.S. CLS. 1, 2, 3, 22 AND 41). FIRST USE 12-31-1970; IN COMMERCE 12-31-1970. REBECCA SMITH, EXAMINING ATTORNEY

SN 78-438,782. HUNTING WORLD LLC, RENO, NV. FILED 6-21-2004.

SN 78-439,740. MARTEL, SCOTT RICHARD, NEW YORK, NY. FILED 6-22-2004.

Habinature

QTU

THE MARK CONSISTS OF STANDARD CHARACTERS WITHOUT CLAIM TO ANY PARTICULAR FONT, STYLE, SIZE, OR COLOR.

FOR LEATHER GOODS, NAMELY, LUGGAGE, DUFFEL BAGS, TOTE BAGS, HAND BAGS FOR MEN AND WOMEN, KEY CASES, WALLETS, COIN PURSES AND BRIEF CASES (U.S. CLS. 1, 2, 3, 22 AND 41). AMY HELLA, EXAMINING ATTORNEY

THE MARK CONSISTS OF STANDARD CHARACTERS WITHOUT CLAIM TO ANY PARTICULAR FONT, STYLE, SIZE, OR COLOR.

FOR COSMETIC CASES SOLD EMPTY (U.S. CLS. 1, 2, 3, 22 AND 41). WILLIAM VERHOSEK, EXAMINING ATTORNEY

CLASS 19—NON-METALLIC BUILDING MATERIALS

SN 76-496,504. YOUNG MANUFACTURING COMPANY INCORPORATED, BEAVER DAM, KY. FILED 3-10-2003.



FOR STAIR TREADS; RISERS; LANDING TREADS; NON-METAL HAND RAILS; SKIRT BOARDS; NOSINGS; DOOR SILLS MADE PRIMARILY OF WOOD; NON METAL DOOR FRAMES; ROUGH LUMBER (U.S. CLS. 1, 12, 33 AND 50).

FIRST USE 12-31-1972; IN COMMERCE 12-31-1972.
GINA HAYES, EXAMINING ATTORNEY

SN 76-510,851. OCEANSIDE GLASSTILE COMPANY, CARLSBAD, CA. FILED 4-30-2003.

CASA CALIFORNIA

NO CLAIM IS MADE TO THE EXCLUSIVE RIGHT TO USE "CALIFORNIA", APART FROM THE MARK AS SHOWN.

"CASA" IS A SPANISH WORD FOR "HOUSE".
FOR GLASS TILES FOR COMMERCIAL AND RESIDENTIAL USE ON WALLS, FLOORS, CEILINGS, AND OTHER SURFACES (U.S. CLS. 1, 12, 33 AND 50).
FIRST USE 8-0-1996; IN COMMERCE 8-0-1996.
DAWN FELDMAN, EXAMINING ATTORNEY

SN 76-565,755. STONE INTERNATIONAL, INC., EAST GRENWICH, RI. FILED 12-17-2003.

MARIANA SOAPSTONE

THE MARK CONSISTS OF STANDARD CHARACTERS WITHOUT CLAIM TO ANY PARTICULAR FONT, STYLE, SIZE, OR COLOR.

NO CLAIM IS MADE TO THE EXCLUSIVE RIGHT TO USE "SOAPSTONE", APART FROM THE MARK AS SHOWN.

FOR NATURAL STONE PRODUCT, NAMELY, SOAPSTONE (U.S. CLS. 1, 12, 33 AND 50).
FIRST USE 12-19-1990; IN COMMERCE 1-28-1994.
ZHALEH DELANEY, EXAMINING ATTORNEY

CLASS 19—(Continued).

SN 76-594,496. MAGNUSSON, TRYGGVI, WAUSAU, WI. FILED 5-27-2004.

FROM THE FOREST

THE MARK CONSISTS OF STANDARD CHARACTERS WITHOUT CLAIM TO ANY PARTICULAR FONT, STYLE, SIZE, OR COLOR.

FOR HARDWOOD FLOORING (U.S. CLS. 1, 12, 33 AND 50).

BRIDGETT SMITH, EXAMINING ATTORNEY

SN 76-597,585. LANUZA, CRAIG SCOTT, VENTURA, CA. FILED 6-4-2004.



FOR EXTRUDED PLASTIC TRACK, USED FOR THE HANGING AND STRETCHING OF FABRIC WALL COVERINGS (U.S. CLS. 1, 12, 33 AND 50).

FIRST USE 2-20-1990; IN COMMERCE 2-20-1990.
INGA ERVIN, EXAMINING ATTORNEY

SN 78-303,508. RANCH HOUSE DOORS, INC., SANTA FE SPRINGS, CA. FILED 9-22-2003.



FOR BUILDING COMPONENTS, NAMELY, NON-METAL GARAGE DOORS (U.S. CLS. 1, 12, 33 AND 50).
FIRST USE 7-5-2001; IN COMMERCE 7-5-2001.
GIANCARLO CASTRO, EXAMINING ATTORNEY

CLASS 19—(Continued).

SN 78-336,388. DAIKEN CORPORATION, HIGASHITONA-MI-GUN, TOYAMA, JAPAN, FILED 12-4-2003.



FOR (BASED ON USE IN COMMERCE) CEILING PANELS, NOT OF METAL; BUILDING PANELS, NOT OF METAL; NON-METALLIC TILES FOR BUILDING; NON-COMBUSTIBLE BUILDING MATERIALS, NAMELY, CEILING BOARDS, WALL BOARDS AND FLOOR BOARDS FOR FIRE RESISTANT PURPOSES; AND (BASED ON INTENT TO USE) FLOORS, NOT OF METAL; BUILDING LUMBER (U.S. CLS. 1, 12, 33 AND 50).

FIRST USE 1-0-1991; IN COMMERCE 7-0-2002.
MITCHELL FRONT, EXAMINING ATTORNEY

SN 78-337,329. COLUMBIA FOREST PRODUCTS, INC., PORTLAND, OR. FILED 12-5-2003.



THE MARK CONSISTS OF THE WORD EXPRESSLOC IN ALL CAPITALS WITH TWO THICK LINES BELOW THE WORD THAT INTERLOCK.

FOR WOOD LAMINATE FLOORING (U.S. CLS. 1, 12, 33 AND 50).

VERNA BETH RIRIE, EXAMINING ATTORNEY

SN 78-368,735. TECHSPACE, INC., MONONA, IA. FILED 2-16-2004.



NO CLAIM IS MADE TO THE EXCLUSIVE RIGHT TO USE "INC.", APART FROM THE MARK AS SHOWN.

THE STIPPLING IS A FEATURE OF THE MARK.

THE MARK CONSISTS OF SLANTED ROOFTOP OVER THE STYLIZED WORDS TECHSPACE, INC.

FOR MANUFACTURED MODULAR BUILDINGS (U.S. CLS. 1, 12, 33 AND 50).

JIM RINGLE, EXAMINING ATTORNEY

CLASS 19—(Continued).

SN 78-371,562. MELE COMPANIES, INC., UTICA, NY. FILED 2-20-2004.

TILEFLEX

THE MARK CONSISTS OF STANDARD CHARACTERS WITHOUT CLAIM TO ANY PARTICULAR FONT, STYLE, SIZE, OR COLOR.

FOR MODULAR NON-METAL FLOOR TILES (U.S. CLS. 1, 12, 33 AND 50).

FIRST USE 1-25-2002; IN COMMERCE 1-25-2002.
HOWARD SMIGA, EXAMINING ATTORNEY

SN 78-376,449. P. I., INC., ATHENS, TN. FILED 3-1-2004.

CORNERSTONE POOLS

THE MARK CONSISTS OF STANDARD CHARACTERS WITHOUT CLAIM TO ANY PARTICULAR FONT, STYLE, SIZE, OR COLOR.

NO CLAIM IS MADE TO THE EXCLUSIVE RIGHT TO USE "POOLS", APART FROM THE MARK AS SHOWN.

FOR NON-METAL SWIMMING POOLS (U.S. CLS. 1, 12, 33 AND 50).

FIRST USE 12-31-1997; IN COMMERCE 12-31-1997.
PATRICIA EVANKO, EXAMINING ATTORNEY

CLASS 19—(Continued).

SN 78-377,602. FLAMEDXX LLC, NASHVILLE, TN. FILED 3-3-2004.

FLAMEDXX

THE MARK CONSISTS OF STANDARD CHARACTERS WITHOUT CLAIM TO ANY PARTICULAR FONT, STYLE, SIZE, OR COLOR.
FOR BUILDING MATERIALS MADE OF WOOD, NAMELY, ORIENTED STRAND BOARD (U.S. CLS. 1, 12, 33 AND 50).
PAUL F. GAST, EXAMINING ATTORNEY

CLASS 19—(Continued).

SN 78-412,179. INTERNATIONAL ROAD RESEARCH LLP, HUMBLE, TX. FILED 5-3-2004.



THE COLOR(S) RED IS/ARE CLAIMED AS A FEATURE OF THE MARK.
THE MARK CONSISTS OF THE WORDING "STAYPUT" IN TIMES NEW ROMAN, FONT SIZE 72, BOLD, AND THE WORDS "OUR NAME SAYS IT ALL!" IN TIMES NEW ROMAN, FONT 24, BOLD AND ITALICS, AND ALL WORDING IS IN RED.
FOR CLASS II ROADWAY ASPHALT PATCH (U.S. CLS. 1, 12, 33 AND 50).
JENNIFER KRISP, EXAMINING ATTORNEY

SN 78-393,323. GLOBAL VISTA TRADING, LLC, NEW YORK, NY. FILED 3-30-2004.

GV FLOORS

THE MARK CONSISTS OF STANDARD CHARACTERS WITHOUT CLAIM TO ANY PARTICULAR FONT, STYLE, SIZE, OR COLOR.
NO CLAIM IS MADE TO THE EXCLUSIVE RIGHT TO USE "FLOORS", APART FROM THE MARK AS SHOWN.
FOR WOOD TILE FLOORING (U.S. CLS. 1, 12, 33 AND 50).
MARK T. MULLEN, EXAMINING ATTORNEY

SN 78-420,382. CFMT LLC, BOULDER, CO. FILED 5-18-2004.



FOR BUILDING MATERIALS, NAMELY, PLASTIC SIDING AND NON-METAL WALL PANELS (U.S. CLS. 1, 12, 33 AND 50).
DOUGLAS LEE, EXAMINING ATTORNEY

CLASS 19—(Continued).

SN 78-425,656. MODERNFOLD, INC., NEW CASTLE, IN. FILED 5-26-2004.

CLASS 19—(Continued).

SN 78-435,086. DELAWARE QUARRIES, INC., NEW HOPE, PA. FILED 6-14-2004.

MODERNFOLD

CRICROC

THE MARK CONSISTS OF STANDARD CHARACTERS WITHOUT CLAIM TO ANY PARTICULAR FONT, STYLE, SIZE, OR COLOR.

OWNER OF U.S. REG. NO. 671,393.
FOR SPACE DIVIDERS, NAMELY, NON-METAL MOVABLE FOLDING DOORS, RAILS, TROLLEYS, FOLDING PARTITIONS, FOLDING ROOM DIVIDERS, ROUTING SYSTEMS COMPRISED OF METAL TRACK, METAL TROLLEYS AND PUCKS, AND COMPONENT PARTS THEREOF IN THE NATURE OF HAND PULLS, LATCHES AND ESCUTCHEON CUPS SOLD AS A UNIT (U.S. CLS. 1, 12, 33 AND 50).

FIRST USE 3-10-1937; IN COMMERCE 3-10-1937.
BRIDGETT SMITH, EXAMINING ATTORNEY

THE MARK CONSISTS OF STANDARD CHARACTERS WITHOUT CLAIM TO ANY PARTICULAR FONT, STYLE, SIZE, OR COLOR.

FOR STONE, GRAVEL OR SIMILAR PRODUCTS, NAMELY, BOULDERS, STONE VENEER, AND CRUSHED STONE FOR USE IN LANDSCAPING, BUILDING CONSTRUCTION, AND PAVING (U.S. CLS. 1, 12, 33 AND 50).

CHARLES L. JENKINS, EXAMINING ATTORNEY

SN 78-436,852. HEIKKILA, KURT E., MARINE ON ST. CROIX, MN. FILED 6-17-2004.

SN 78-429,605. PROFILE PRODUCTS LLC, BUFFALO GROVE, IL. FILED 6-3-2004.

FLEXTERRA FGM

TUNDRA

THE MARK CONSISTS OF STANDARD CHARACTERS WITHOUT CLAIM TO ANY PARTICULAR FONT, STYLE, SIZE, OR COLOR.

FOR HYDRAULICALLY-APPLIED, FLEXIBLE EROSION CONTROL BLANKETS COMPOSED OF LONG STRAND, THERMALLY PROCESSED WOOD FIBERS, CRIMPED INTERLOCKING FIBERS AND PERFORMANCE ENHANCING ADDITIVES; ABSORBENT, EROSION RESISTANT BLANKETS FOR RAPID GERMINATION AND ACCELERATED PLANT GROWTH (U.S. CLS. 1, 12, 33 AND 50).

MIDGE BUTLER, EXAMINING ATTORNEY

THE MARK CONSISTS OF STANDARD CHARACTERS WITHOUT CLAIM TO ANY PARTICULAR FONT, STYLE, SIZE, OR COLOR.

FOR POLYMER COMPOSITE MATERIALS SUITABLE FOR A METAL SUBSTITUTE IN PRODUCTS SUCH AS SPORTING EQUIPMENT, FISHING EQUIPMENT, AUTOMOTIVE AND AIRPLANE COMPONENTS, ELECTRONICS, MEDICAL SHIELDING, STENTS AND AMMUNITION (U.S. CLS. 1, 12, 33 AND 50).

RONALD AIKENS, EXAMINING ATTORNEY

CLASS 20—FURNITURE AND ARTICLES NOT OTHERWISE CLASSIFIED

SN 76-497,468. MAGLA WORLDWIDE, LTD., VEGA BAJA, PUERTO RICO, FILED 3-14-2003.

PINCH LOADER

NO CLAIM IS MADE TO THE EXCLUSIVE RIGHT TO USE "LOADER", APART FROM THE MARK AS SHOWN.

FOR PLASTIC DEVICES USED FOR PLACING MERCHANDISE ONTO DISPLAY PEGS IN THE NATURE OF GROUPING AND ALIGNING THE MERCHANDISE (U.S. CLS. 2, 13, 22, 25, 32 AND 50).

ANN E. SAPPENFIELD, EXAMINING ATTORNEY

SN 76-542,212. TAKEFORM ARCHITECTURAL GRAPHICS, INC., MEDINA, NY. FILED 9-2-2003.

ADAPT

FOR MODULAR ARCHITECTURAL SIGNAGE FOR CORPORATE, HOSPITALITY, HEALTH CARE AND INSTITUTIONAL ENVIRONMENTS, NAMELY NON-LUMINOUS, NON-MECHANICAL SIGNS NOT OF METAL FOR USE AS ROOM IDENTIFICATIONS, DIRECTIONAL SIGNAGE, DIRECTORIES, AND FIRE AND EVACUATION SIGNAGE (U.S. CLS. 2, 13, 22, 25, 32 AND 50).

JOHN LINCOSKI, EXAMINING ATTORNEY

SN 76-548,700. CORPORATION ZEDBED INTERNATIONAL INC., GRAND-MERE, PROVINCE OF QUEBEC, CANADA, FILED 10-2-2003.

ZEDPUR

PRIORITY CLAIMED UNDER SEC. 44(D) ON CANADA APPLICATION NO. 1,190,563, FILED 9-26-2003, REG. NO. TMA620188, DATED 9-21-2004, EXPIRES 9-21-2019.

FOR MATTRESSES, BOX SPRINGS, ADJUSTABLE BEDS, PILLOWS (U.S. CLS. 2, 13, 22, 25, 32 AND 50).

JILL C. ALT, EXAMINING ATTORNEY

SN 76-566,503. PAINE, FRANK J., JR., YPSILANTI, MI. FILED 12-15-2003.

THE BATON OF TEAMWORK

FOR NON-METAL TROPHIES AND PLAQUES (U.S. CLS. 2, 13, 22, 25, 32 AND 50).

TRACY FLETCHER, EXAMINING ATTORNEY

CLASS 20—(Continued).

SN 76-566,504. PAINE FRANK J., JR., YPSILANTI, MI. FILED 12-15-2003.

THE BATON OF WORDS

FOR NON-METAL TROPHIES AND PLAQUES (U.S. CLS. 2, 13, 22, 25, 32 AND 50).

TRACY FLETCHER, EXAMINING ATTORNEY

SN 76-566,505. PAINE, FRANK J., JR., YPSILANTI, MI. FILED 12-15-2003.

THE BATON OF INSPIRATION

FOR NON-METAL TROPHIES AND PLAQUES (U.S. CLS. 2, 13, 22, 25, 32 AND 50).

TRACY FLETCHER, EXAMINING ATTORNEY

SN 76-566,506. PAINE, FRANK J., JR., YPSILANTI, MI. FILED 12-15-2003.

THE BABY BATON OF LIFE

FOR NON-METAL TROPHIES AND PLAQUES (U.S. CLS. 2, 13, 22, 25, 32 AND 50).

TRACY FLETCHER, EXAMINING ATTORNEY

SN 76-566,509. PAINE, FRANK J., JR., YPSILANTI, MI. FILED 12-15-2003.

THE BATON OF HEROISM

FOR NON-METAL TROPHIES AND PLAQUES (U.S. CLS. 2, 13, 22, 25, 32 AND 50).

TRACY FLETCHER, EXAMINING ATTORNEY

CLASS 20—(Continued).

SN 76-566,511. PAINE, FRANK J., JR., YPSILANTI, MI.
FILED 12-15-2003.

THE BATON OF LIGHT

FOR NON-METAL TROPHIES AND PLAQUES (U.S.
CLS. 2, 13, 22, 25, 32 AND 50).
TRACY FLETCHER, EXAMINING ATTORNEY

SN 76-566,512. PAINE, FRANK J., JR., YPSILANTI, MI.
FILED 12-15-2003.

THE BATON OF MATRIMONY

FOR NON-METAL TROPHIES AND PLAQUES (U.S.
CLS. 2, 13, 22, 25, 32 AND 50).
TRACY FLETCHER, EXAMINING ATTORNEY

SN 76-566,513. PAINE, FRANK J., JR., YPSILANTI, MI.
FILED 12-15-2003.

THE BATON OF LOVE

FOR NON-METAL TROPHIES AND PLAQUES (U.S.
CLS. 2, 13, 22, 25, 32 AND 50).
FIRST USE 7-0-2002; IN COMMERCE 7-0-2002.
TRACY FLETCHER, EXAMINING ATTORNEY

SN 76-566,539. PAINE, FRANK J., JR., YPSILANTI, MI.
FILED 12-15-2003.

THE BATON OF MIRACLES

FOR NON-METAL TROPHIES AND PLAQUES (U.S.
CLS. 2, 13, 22, 25, 32 AND 50).
TRACY FLETCHER, EXAMINING ATTORNEY

CLASS 20—(Continued).

SN 76-566,540. PAINE, FRANK J., JR., YPSILANTI, MI.
FILED 12-15-2003.

THE BATON OF PATRIOTISM

FOR NON-METAL TROPHIES AND PLAQUES (U.S.
CLS. 2, 13, 22, 25, 32 AND 50).
TRACY FLETCHER, EXAMINING ATTORNEY

SN 76-566,541. PAINE, FRANK J., JR., YPSILANTI, MI.
FILED 12-15-2003.

THE BATON OF VISION

FOR NON-METAL TROPHIES AND PLAQUES (U.S.
CLS. 2, 13, 22, 25, 32 AND 50).
TRACY FLETCHER, EXAMINING ATTORNEY

SN 76-566,542. PAINE, FRANK J., JR., YPSILANTI, MI.
FILED 12-15-2003.

THE BATON OF TECHNOLOGY

FOR NON-METAL TROPHIES AND PLAQUES (U.S.
CLS. 2, 13, 22, 25, 32 AND 50).
TRACY FLETCHER, EXAMINING ATTORNEY

SN 76-566,543. PAINE, FRANK J., JR., YPSILANTI, MI.
FILED 12-15-2003.

THE BATON OF VICTORY

FOR NON-METAL TROPHIES AND PLAQUES (U.S.
CLS. 2, 13, 22, 25, 32 AND 50).
TRACY FLETCHER, EXAMINING ATTORNEY

SN 76-566,544. PAINE, FRANK J., JR., YPSILANTI, MI.
FILED 12-15-2003.

THE BATON OF DETERMINATION

FOR NON-METAL TROPHIES AND PLAQUES (U.S.
CLS. 2, 13, 22, 25, 32 AND 50).
TRACY FLETCHER, EXAMINING ATTORNEY

CLASS 20—(Continued).

SN 76-566,545. PAINE, FRANK J., JR., YPSILANTI, MI.
FILED 12-15-2003.

THE BATON OF JOY

FOR NON-METAL TROPHIES AND PLAQUES (U.S.
CLS. 2, 13, 22, 25, 32 AND 50).
TRACY FLETCHER, EXAMINING ATTORNEY

SN 76-566,546. PAINE, FRANK J., JR., YPSILANTI, MI.
FILED 12-15-2003.

THE BATON OF RIGHTEOUSNESS

FOR NON-METAL TROPHIES AND PLAQUES (U.S.
CLS. 2, 13, 22, 25, 32 AND 50).
TRACY FLETCHER, EXAMINING ATTORNEY

SN 76-566,547. PAINE, FRANK J., JR., YPSILANTI, MI.
FILED 12-15-2003.

THE BATON OF FRIENDSHIP

FOR NON-METAL TROPHIES AND PLAQUES (U.S.
CLS. 2, 13, 22, 25, 32 AND 50).
TRACY FLETCHER, EXAMINING ATTORNEY

SN 76-566,548. PAINE, FRANK J., JR., YPSILANTI, MI.
FILED 12-15-2003.

THE BATON OF WISDOM

FOR NON-METAL TROPHIES AND PLAQUES (U.S.
CLS. 2, 13, 22, 25, 32 AND 50).
TRACY FLETCHER, EXAMINING ATTORNEY

SN 76-566,549. PAINE, FRANK J., JR., YPSILANTI, MI.
FILED 12-15-2003.

THE BATON OF HUMANITY

FOR NON-METAL TROPHIES AND PLAQUES (U.S.
CLS. 2, 13, 22, 25, 32 AND 50).
TRACY FLETCHER, EXAMINING ATTORNEY

CLASS 20—(Continued).

SN 76-566,988. PAINE, FRANK J., JR., YPSILANTI, MI.
FILED 12-15-2003.

THE BATON OF FREEDOM

FOR NON-METAL TROPHIES AND PLAQUES (U.S.
CLS. 2, 13, 22, 25, 32 AND 50).
TRACY FLETCHER, EXAMINING ATTORNEY

SN 76-566,989. PAINE, FRANK J., JR., YPSILANTI, MI.
FILED 12-15-2003.

THE BATON OF HOPE

FOR NON-METAL TROPHIES AND PLAQUES (U.S.
CLS. 2, 13, 22, 25, 32 AND 50).
TRACY FLETCHER, EXAMINING ATTORNEY

SN 76-566,990. PAINE, FRANK J., JR., YPSILANTI, MI.
FILED 12-15-2003.

THE BATON OF PROTECTION

FOR NON-METAL TROPHIES AND PLAQUES (U.S.
CLS. 2, 13, 22, 25, 32 AND 50).
TRACY FLETCHER, EXAMINING ATTORNEY

SN 76-566,991. PAINE, FRANK J., JR., YPSILANTI, MI.
FILED 12-15-2003.

THE BATON OF LIFE

FOR NON-METAL TROPHIES AND PLAQUES (U.S.
CLS. 2, 13, 22, 25, 32 AND 50).
FIRST USE 5-0-2002; IN COMMERCE 5-0-2002.
TRACY FLETCHER, EXAMINING ATTORNEY

CLASS 20—(Continued).

SN 76-566,992. PAINE, FRANK J., JR., YPSILANTI, MI.
FILED 12-15-2003.

CLASS 20—(Continued).

SN 76-566,996. PAINE, FRANK J., JR., YPSILANTI, MI.
FILED 12-15-2003.

THE BATON OF WORSHIP

FOR NON-METAL TROPHIES AND PLAQUES (U.S.
CLS. 2, 13, 22, 25, 32 AND 50).
TRACY FLETCHER, EXAMINING ATTORNEY

THE BATON OF MUSIC

FOR NON-METAL TROPHIES AND PLAQUES (U.S.
CLS. 2, 13, 22, 25, 32 AND 50).
TRACY FLETCHER, EXAMINING ATTORNEY

SN 76-566,993. PAINE, FRANK J., JR., YPSILANTI, MI.
FILED 12-15-2003.

SN 76-566,997. PAINE, FRANK J., JR., YPSILANTI, MI.
FILED 12-15-2003.

THE BATON OF ENDURANCE

FOR NON-METAL TROPHIES AND PLAQUES (U.S.
CLS. 2, 13, 22, 25, 32 AND 50).
TRACY FLETCHER, EXAMINING ATTORNEY

THE BATON OF SUCCESS

FOR NON-METAL TROPHIES AND PLAQUES (U.S.
CLS. 2, 13, 22, 25, 32 AND 50).
TRACY FLETCHER, EXAMINING ATTORNEY

SN 76-566,994. PAINE, FRANK J., JR., YPSILANTI, MI.
FILED 12-15-2003.

SN 76-566,998. PAINE, FRANK J., JR., YPSILANTI, MI.
FILED 12-15-2003.

THE BATON OF HONOR

FOR NON-METAL TROPHIES AND PLAQUES (U.S.
CLS. 2, 13, 22, 25, 32 AND 50).
TRACY FLETCHER, EXAMINING ATTORNEY

THE BATON OF LEADERSHIP

FOR NON-METAL TROPHIES AND PLAQUES (U.S.
CLS. 2, 13, 22, 25, 32 AND 50).
FIRST USE 7-0-2002; IN COMMERCE 7-0-2002.
TRACY FLETCHER, EXAMINING ATTORNEY

SN 76-566,995. PAINE, FRANK J., JR., YPSILANTI, MI.
FILED 12-15-2003.

SN 76-566,999. PAINE, FRANK J., JR., YPSILANTI, MI.
FILED 12-15-2003.

THE BATON OF FAITH

FOR NON-METAL TROPHIES AND PLAQUES (U.S.
CLS. 2, 13, 22, 25, 32 AND 50).
FIRST USE 7-0-2002; IN COMMERCE 7-0-2002.
TRACY FLETCHER, EXAMINING ATTORNEY

THE BATON OF STRENGTH

FOR NON-METAL TROPHIES AND PLAQUES (U.S.
CLS. 2, 13, 22, 25, 32 AND 50).
TRACY FLETCHER, EXAMINING ATTORNEY

CLASS 20—(Continued).

SN 76-567,016. PAINE, FRANK J., JR., YPSILANTI, MI.
FILED 12-15-2003.

THE BATON OF JUSTICE

FOR NON-METAL TROPHIES AND PLAQUES (U.S.
CLS. 2, 13, 22, 25, 32 AND 50).
TRACY FLETCHER, EXAMINING ATTORNEY

SN 76-571,627. PAINE, FRANK J., JR., YPSILANTI, MI.
FILED 12-15-2003.

THE YOUTH BATON OF LIFE

FOR NON-METAL TROPHIES AND PLAQUES (U.S.
CLS. 2, 13, 22, 25, 32 AND 50).
TRACY FLETCHER, EXAMINING ATTORNEY

SN 76-572,532. CERULEAN EQUIPMENT INC., SECAUCUS,
NJ. FILED 1-27-2004.

PRESTO

THE MARK CONSISTS OF STANDARD CHARACTERS
WITHOUT CLAIM TO ANY PARTICULAR FONT, STYLE,
SIZE, OR COLOR.
FOR PEDICURE CHAIR (U.S. CLS. 2, 13, 22, 25, 32
AND 50).
FIRST USE 2-0-2003; IN COMMERCE 2-0-2003.
ELISSA GARBER KON, EXAMINING ATTORNEY

SN 76-578,213. TODDLERS JOY, WOODLAND HILLS, CA.
FILED 2-26-2004.

TODDLERS JOY

THE MARK CONSISTS OF STANDARD CHARACTERS
WITHOUT CLAIM TO ANY PARTICULAR FONT, STYLE,
SIZE, OR COLOR.
NO CLAIM IS MADE TO THE EXCLUSIVE RIGHT TO
USE "TODDLERS", APART FROM THE MARK AS SHOWN.
FOR JUVENILE FURNITURE (U.S. CLS. 2, 13, 22, 25,
32 AND 50).
FIRST USE 9-15-1989; IN COMMERCE 9-15-1989.
TONI HICKEY, EXAMINING ATTORNEY

CLASS 20—(Continued).

SN 76-591,833. DESIGNER FURNITURE WAREHOUSE,
INC., COLUMBUS, OH. FILED 5-12-2004.



NO CLAIM IS MADE TO THE EXCLUSIVE RIGHT TO
USE FURNITURE WAREHOUSE, APART FROM THE
MARK AS SHOWN.
FOR FURNITURE (U.S. CLS. 2, 13, 22, 25, 32 AND 50).
TARAH HARDY, EXAMINING ATTORNEY

SN 76-594,982. THE INNOVATIVE COMPANIES, LLC,
HAUPPAUGE, NY. FILED 6-1-2004.

COUNTERTOP VILLAGE

THE MARK CONSISTS OF STANDARD CHARACTERS
WITHOUT CLAIM TO ANY PARTICULAR FONT, STYLE,
SIZE, OR COLOR.
NO CLAIM IS MADE TO THE EXCLUSIVE RIGHT TO
USE COUNTERTOP, APART FROM THE MARK AS
SHOWN.
FOR KITCHEN COUNTERTOPS (U.S. CLS. 2, 13, 22, 25,
32 AND 50).
KHANH LE, EXAMINING ATTORNEY

SN 76-595,718. TOB INTERNATIONAL MARKETING CORP.,
NEW YORK, NY. FILED 6-4-2004.

THOMAS O'BRIEN

THE MARK CONSISTS OF STANDARD CHARACTERS
WITHOUT CLAIM TO ANY PARTICULAR FONT, STYLE,
SIZE, OR COLOR.
OWNER OF U.S. REG. NO. 2,648,415.
THOMAS O'BRIEN IS THE NAME OF A LIVING INDIVI-
DUAL, WHOSE CONSENT IS IMPLIED BY EXECUTION OF
THIS APPLICATION AS PRESIDENT OF APPLICANT.
FOR (BASED ON USE IN COMMERCE) FURNITURE,
NAMESLY CHAIRS, SOFAS, TABLES, CABINETS,
DESKS, BEDS, STOOLS, CHESTS, BENCHES, MIRRORS,
PICTURE FRAMES, DECORATIVE PILLOWS, AND
MATTRESS CUSHIONS, DECORATIVE CUSHIONS
AND MATTRESSES (BASED ON INTENT TO USE)
MATTRESS TOPPERS, CURTAIN RODS, POLES, HOOKS
AND FINIALS, NON-METAL CURTAIN RINGS, WIN-
DOW BLINDS, WINDOW SHADES (U.S. CLS. 2, 13, 22, 25,
32 AND 50).
FIRST USE 10-0-1999; IN COMMERCE 10-0-1999.
BRIAN NEVILLE, EXAMINING ATTORNEY

CLASS 20—(Continued).

SN 76-599,003. KING KOIL LICENSING COMPANY, INC., HINSDALE, IL. FILED 6-24-2004.

PURE FLOW

THE MARK CONSISTS OF STANDARD CHARACTERS WITHOUT CLAIM TO ANY PARTICULAR FONT, STYLE, SIZE, OR COLOR.

FOR BEDS, MATTRESSES, BOX SPRINGS AND PILLOWS (U.S. CLS. 2, 13, 22, 25, 32 AND 50).

RONALD MCMORROW, EXAMINING ATTORNEY

CLASS 20—(Continued).

SN 78-318,855. HAWORTH LTD., DBA SMED INTERNATIONAL, CALGARY, CANADA, FILED 10-27-2003.

EXO

PRIORITY CLAIMED UNDER SEC. 44(D) ON CANADA APPLICATION NO. 1188694, FILED 9-18-2003, REG. NO. TMA62483, DATED 11-5-2004, EXPIRES 11-5-2019.

FOR OFFICE FURNITURE (U.S. CLS. 2, 13, 22, 25, 32 AND 50).

ELLEN B. AWRICH, EXAMINING ATTORNEY

SN 76-599,460. SUPERIOR UNLIMITED, CORPORATION, BRISTOL, TN. FILED 6-28-2004.

SUCCESS

THE MARK CONSISTS OF STANDARD CHARACTERS WITHOUT CLAIM TO ANY PARTICULAR FONT, STYLE, SIZE, OR COLOR.

FOR CHAIRS AND STOOLS (U.S. CLS. 2, 13, 22, 25, 32 AND 50).

FIRST USE 7-31-2001; IN COMMERCE 8-31-2001.

TARAH HARDY, EXAMINING ATTORNEY

SN 78-330,105. KAMRIN, LORI S., SEATTLE, WA. FILED 11-19-2003.

SN 78-117,921. WORKPLACE SYSTEMS, INC., LONDON-DERRY, NH. FILED 3-27-2002.

WORKPLACE

OWNER OF U.S. REG. NOS. 868,061 AND 2,806,024. SEC. 2(F).

FOR METAL FURNITURE, NAMELY, DESKS, CHAIRS, TABLES, FILE CABINETS, STORAGE CABINETS, MOBILE CARTS, WORK STATIONS, WORK BENCHES, AND LAB STATIONS; FURNITURE DESIGN AND CONSULTING SERVICES, NAMELY, PLANNING, LAYOUT, ASSEMBLY, AND INSTALLATION OF FURNITURE; INSTALLATION OF METAL FURNITURE (U.S. CLS. 2, 13, 22, 25, 32 AND 50).

FIRST USE 5-1-1967; IN COMMERCE 5-1-1967.

DARRYL SPRUILL, EXAMINING ATTORNEY

Bootles

SN 78-251,948. SHADES OF COLOUR, WACO, TX. FILED 5-20-2003.

SHADES OF COLOUR

NO CLAIM IS MADE TO THE EXCLUSIVE RIGHT TO USE "SHADES", APART FROM THE MARK AS SHOWN. FOR ART AND DESIGN-IMPRINTED WINDOW SHADES (U.S. CLS. 2, 13, 22, 25, 32 AND 50).

JOHN DWYER, EXAMINING ATTORNEY

THE MARK CONSISTS OF STANDARD CHARACTERS WITHOUT CLAIM TO ANY PARTICULAR FONT, STYLE, SIZE, OR COLOR.

FOR BABY MAT CONTAINING BOLSTERS FROM WHICH SOUND AND VIBRATION COME FOR PLACEMENT IN A CRIB TO HELP BABY SLEEP (U.S. CLS. 2, 13, 22, 25, 32 AND 50).

KATHLEEN M. VANSTON, EXAMINING ATTORNEY

CLASS 20—(Continued).

SN 78-346,320. ALLTRADE TOOLS LLC, LONG BEACH, CA. FILED 12-29-2003.

CREWLINE

THE MARK CONSISTS OF STANDARD CHARACTERS WITHOUT CLAIM TO ANY PARTICULAR FONT, STYLE, SIZE, OR COLOR.

FOR METAL UTILITY CABINETS, METAL PORTABLE FOLDING PLATFORM STEPS (U.S. CLS. 2, 13, 22, 25, 32 AND 50).

FIRST USE 12-1-2003; IN COMMERCE 12-1-2003.
STANLEY I. OSBORNE, EXAMINING ATTORNEY

CLASS 20—(Continued).

SN 78-372,172. GIBBY, DANIEL K., TOCCOA, GA. FILED 2-23-2004.

TANK TAMER

THE MARK CONSISTS OF STANDARD CHARACTERS WITHOUT CLAIM TO ANY PARTICULAR FONT, STYLE, SIZE, OR COLOR.

NO CLAIM IS MADE TO THE EXCLUSIVE RIGHT TO USE "TANK", APART FROM THE MARK AS SHOWN.

FOR PORTABLE CONTAINERS NOT OF METAL FOR GAS CYLINDERS (U.S. CLS. 2, 13, 22, 25, 32 AND 50).

BERYL GARDNER, EXAMINING ATTORNEY

SN 78-380,622. PLASMABED CANADA 680934 BC INC, WEST VANCOUVER, CANADA, FILED 3-8-2004.

SN 78-353,779. KITTRICH CORPORATION, LA MIRADA, CA. FILED 1-19-2004.

SHELF MAGIC

THE MARK CONSISTS OF STANDARD CHARACTERS WITHOUT CLAIM TO ANY PARTICULAR FONT, STYLE, SIZE, OR COLOR.

OWNER OF U.S. REG. NOS. 632,406, 2,522,024 AND OTHERS.

NO CLAIM IS MADE TO THE EXCLUSIVE RIGHT TO USE "SHELF", APART FROM THE MARK AS SHOWN.

FOR PLASTIC SHELF AND DRAWER LINING MATERIAL (U.S. CLS. 2, 13, 22, 25, 32 AND 50).

MICHAEL HALL, EXAMINING ATTORNEY



THE MARK CONSISTS OF A SPACESHIP WITH A WHITE CROSS. THE PORTION OF THE MARK COMPRISED OF A CROSS DESIGN IS NOT DISPLAYED IN THE COLOR RED OR A COLORABLE IMITATION THEREOF.

FOR G&S-BEDS, MATTRESSES, CUSHIONS, PILLOWS, AND CHAIR PADS. (U.S. CLS. 2, 13, 22, 25, 32 AND 50).

DOMINICK J. SALEMI, EXAMINING ATTORNEY

CLASS 20—(Continued).

SN 78-382,004. GANDER MOUNTAIN COMPANY, ST. PAUL, MN. FILED 3-10-2004.

CLASS 20—(Continued).

SN 78-382,750. RICHARD A ORENSTEIN, BENSENVILLE, IL. FILED 3-11-2004.

CREEKSIDE

American Beauty Equipment Incorporated

THE MARK CONSISTS OF STANDARD CHARACTERS WITHOUT CLAIM TO ANY PARTICULAR FONT, STYLE, SIZE, OR COLOR.

FOR SLEEPING BAGS, COTS, INFLATABLE MATTRESSES FOR USE WHEN CAMPING, CAMPING MIRRORS, CAMPING FURNITURE, NAMELY, CHAIRS AND SEATS (U.S. CLS. 2, 13, 22, 25, 32 AND 50).

MARIA-VICTORIA SUAREZ, EXAMINING ATTORNEY

THE MARK CONSISTS OF STANDARD CHARACTERS WITHOUT CLAIM TO ANY PARTICULAR FONT, STYLE, SIZE, OR COLOR.

NO CLAIM IS MADE TO THE EXCLUSIVE RIGHT TO USE "EQUIPMENT INCORPORATED", APART FROM THE MARK AS SHOWN.

FOR FURNITURE, NAMELY BEAUTY SALON CHAIRS, TABLES, HAIR DRYER HOLDERS AND MIRRORS (U.S. CLS. 2, 13, 22, 25, 32 AND 50).

DOMINIC J. FERRAIUOLO, EXAMINING ATTORNEY

SN 78-382,008. GANDER MOUNTAIN COMPANY, ST. PAUL, MN. FILED 3-10-2004.

SN 78-418,517. DO+ABLE PRODUCTS, INC., CHINO, CA. FILED 5-13-2004.



PRO GARAGE

FOR SLEEPING BAGS, COTS, INFLATABLE MATTRESSES FOR USE WHEN CAMPING, CAMPING MIRRORS, CAMPING FURNITURE, NAMELY, CHAIRS AND SEATS (U.S. CLS. 2, 13, 22, 25, 32 AND 50).

MARIA-VICTORIA SUAREZ, EXAMINING ATTORNEY

THE MARK CONSISTS OF STANDARD CHARACTERS WITHOUT CLAIM TO ANY PARTICULAR FONT, STYLE, SIZE, OR COLOR.

NO CLAIM IS MADE TO THE EXCLUSIVE RIGHT TO USE "GARAGE", APART FROM THE MARK AS SHOWN.

FOR GARAGE ORGANIZERS, NAMELY READY TO ASSEMBLE STORAGE UNITS, SHELVES, AND CABINETS PRIMARILY MADE OF WOOD AND WOOD COMPOSITION (U.S. CLS. 2, 13, 22, 25, 32 AND 50).

FIRST USE 4-1-2004; IN COMMERCE 4-1-2004.

GWEN STOKOLS, EXAMINING ATTORNEY

CLASS 20—(Continued).

SN 78-419,297. DO+ABLE PRODUCTS, INC., CHINO, CA.
FILED 5-14-2004.



NO CLAIM IS MADE TO THE EXCLUSIVE RIGHT TO USE "GARAGE", APART FROM THE MARK AS SHOWN.
FOR GARAGE ORGANIZERS, NAMELY READY TO ASSEMBLY STORAGE UNITS, SHELVES, AND CABINETS PRIMARILY MADE OF WOOD AND WOOD COMPOSITION (U.S. CLS. 2, 13, 22, 25, 32 AND 50).
FIRST USE 4-1-2004; IN COMMERCE 4-1-2004.
GWEN STOKOLS, EXAMINING ATTORNEY

CLASS 20—(Continued).

SN 78-424,043. BERGSMA, JODY, BELLINGHAN, WA.
FILED 5-24-2004.

SEA FAIRIES

THE MARK CONSISTS OF STANDARD CHARACTERS WITHOUT CLAIM TO ANY PARTICULAR FONT, STYLE, SIZE, OR COLOR.
OWNER OF U.S. REG. NO. 2,848,711.
FOR COLD CAST RESIN FIGURINES (U.S. CLS. 2, 13, 22, 25, 32 AND 50).
JOHN GARTNER, EXAMINING ATTORNEY

SN 78-423,213. DOBOY INC., NEW RICHMOND, WI. FILED
5-21-2004.

EASY GO

THE MARK CONSISTS OF STANDARD CHARACTERS WITHOUT CLAIM TO ANY PARTICULAR FONT, STYLE, SIZE, OR COLOR.
FOR PORTABLE PLASTIC FLEXIBLE FILM CONTAINER FOR PACKAGING CONSUMER GOODS (U.S. CLS. 2, 13, 22, 25, 32 AND 50).
DAVID H. STINE, EXAMINING ATTORNEY

SN 78-425,580. IMPEX INTERNATIONAL, INC., MARLTON, NJ. FILED 5-26-2004.

X-treme Clip

THE MARK CONSISTS OF STANDARD CHARACTERS WITHOUT CLAIM TO ANY PARTICULAR FONT, STYLE, SIZE, OR COLOR.
NO CLAIM IS MADE TO THE EXCLUSIVE RIGHT TO USE "CLIP", APART FROM THE MARK AS SHOWN.
FOR PLASTIC CLIPS FOR HOLDING SUNGLASSES, PENS AND NOTES (U.S. CLS. 2, 13, 22, 25, 32 AND 50).
MIDGE BUTLER, EXAMINING ATTORNEY

CLASS 20—(Continued).

SN 78-434,111. SWAN, RODGER A., DBA CYGNET DESIGNS, SANTA ROSA, CA. AND SWAN, JOYCE T., DBA JTSWAN GALLERIES, SANTA ROSA, CA. FILED 6-11-2004.

CLASS 20—(Continued).

SN 78-436,846. PERMAR SYSTEMS, INC., WOLCOTT, NY. FILED 6-17-2004.

DON'T BE DEFEETED!

DownUnders

THE MARK CONSISTS OF STANDARD CHARACTERS WITHOUT CLAIM TO ANY PARTICULAR FONT, STYLE, SIZE, OR COLOR.
FOR PLASTIC NOVELTY SCULPTURE (U.S. CLS. 2, 13, 22, 25, 32 AND 50).
FIRST USE 12-6-2003; IN COMMERCE 12-6-2003.
AMY HELLA, EXAMINING ATTORNEY

THE MARK CONSISTS OF STANDARD CHARACTERS WITHOUT CLAIM TO ANY PARTICULAR FONT, STYLE, SIZE, OR COLOR.
FOR PLASTIC SIGNS (U.S. CLS. 2, 13, 22, 25, 32 AND 50).
FIRST USE 12-0-2002; IN COMMERCE 12-0-2002.
RONALD AIKENS, EXAMINING ATTORNEY

SN 78-438,082. STARCHILD, ADAM, MIAMI, FL. FILED 6-18-2004.

SN 78-436,456. ROBINSON & ROBINSON INC., SAN DIEGO, CA. FILED 6-16-2004.

Starchild

SOFA WORLD

THE MARK CONSISTS OF STANDARD CHARACTERS WITHOUT CLAIM TO ANY PARTICULAR FONT, STYLE, SIZE, OR COLOR.
NO CLAIM IS MADE TO THE EXCLUSIVE RIGHT TO USE "SOFA", APART FROM THE MARK AS SHOWN.
FOR UPHOLSTERED FURNITURE (U.S. CLS. 2, 13, 22, 25, 32 AND 50).
ELIZABETH PIGNATELLO, EXAMINING ATTORNEY

THE MARK CONSISTS OF STANDARD CHARACTERS WITHOUT CLAIM TO ANY PARTICULAR FONT, STYLE, SIZE, OR COLOR.
OWNER OF U.S. REG. NOS. 1,826,422 AND 2,159,824. SEC. 2(F).
FOR ARMCHAIRS, BEDROOM FURNITURE, BEDS, BOOKCASES, BENCHES, BOOK RESTS, BOOK STANDS, CHAIRS, CHESTS OF DRAWERS, CLOTHES HANGERS, COAT HANGERS, COAT RACKS, COATSTANDS, CRIBS, CUSHIONS, DECORATIVE MOBILES, DESKS, DRINKING STRAWS, FABRIC FIGURINES, FITTED FABRIC FURNITURE COVERS, HAND-HELD MIRRORS, HIGH CHAIRS, INFANT CRADLES, INFANT WALKERS, JEWELRY BOXES NOT OF METAL, LEATHER JEWELRY AND ACCESSORY BOXES, LEATHER PICTURE FRAMES, NIGHTSTANDS, NON-METAL CLOTHES HOOKS, NON-METAL KEY RINGS, PERSONAL COMPACT MIRRORS, PICTURE FRAMES, PILLOWS, PLAYPENS, SOFT SCULPTURE WALL DECORATIONS, TABLES, TEA CARTS, TOY BOXES, TOY CHESTS, UMBRELLA STANDS (U.S. CLS. 2, 13, 22, 25, 32 AND 50).
FIRST USE 7-31-1974; IN COMMERCE 7-31-1974.
CIMMERIAN COLEMAN, EXAMINING ATTORNEY

CLASS 20—(Continued).

SN 78-439,721. LEGENDS OF THE WEST, INC., MIAMI, FL.
FILED 6-22-2004.

Pecos Bill

THE MARK CONSISTS OF STANDARD CHARACTERS WITHOUT CLAIM TO ANY PARTICULAR FONT, STYLE, SIZE, OR COLOR.

OWNER OF U.S. REG. NOS. 1,857,724, 1,886,929 AND OTHERS.

THE NAME(S), PORTRAIT(S), AND/OR SIGNATURE(S) SHOWN IN THE MARK DOES NOT IDENTIFY A PARTICULAR LIVING INDIVIDUAL.

FOR AIR MATTRESSES FOR USE WHEN CAMPING, ARMCHAIRS, BEDROOM FURNITURE, BEDS, BOOKCASES, BENCHES, CABINETS, CAST STONE HOUSEHOLD AND GARDEN FURNITURE, CHAIR PADS, CHAIRS, CHESTS OF DRAWERS, CHAISE LOUNGES, COAT RACKS, COTS, CRIBS, CUSHIONS, DECORATIVE MOBILES, DRINKING STRAWS, FABRIC FIGURINES, FITTED FABRIC FURNITURE COVERS, HAMPERS, HAND-HELD MIRRORS, HIGH CHAIRS, INFANT CRADLES, INFANT WALKERS, INFLATABLE MATTRESSES FOR USE WHEN CAMPING, JEWELRY BOXES NOT OF METAL, LEATHER PICTURE FRAMES, LIVING ROOM FURNITURE, NIGHTSTANDS, NON-METAL CLOTHES HOOKS, NON-METAL KEY RINGS, OUTDOOR FURNITURE, PICTURE FRAMES, PILLOWS, PLAQUES, PLASTIC KEY CHAIN TAGS, PLASTIC KEY RINGS, PLASTIC KEY TAGS, PLAYPENS, SLEEPING BAGS, SOFT SCULPTURE WALL DECORATIONS, STUFFED ANIMALS, TABLES, TOY BOXES, TOY CHESTS, UMBRELLA STANDS (U.S. CLS. 2, 13, 22, 25, 32 AND 50).

FIRST USE 8-14-1969; IN COMMERCE 8-14-1969.
LINDA E. BLOHM, EXAMINING ATTORNEY

SN 78-511,093. COLUMBIA INSURANCE COMPANY, OMAHA, NE. FILED 11-4-2004.

CONCERTO

THE MARK CONSISTS OF STANDARD CHARACTERS WITHOUT CLAIM TO ANY PARTICULAR FONT, STYLE, SIZE, OR COLOR.

FOR PICTURE FRAMES (U.S. CLS. 2, 13, 22, 25, 32 AND 50).

REGINA DRUMMOND, EXAMINING ATTORNEY

CLASS 21—HOUSEWARES AND GLASS

SN 75-896,990. SUNSHINE INDUSTRIES, INC., CLEVELAND, OH. FILED 1-14-2000.

The logo features the word "WOW" in a large, bold, black, sans-serif font. Below it, the phrase "what a cloth!" is written in a smaller, black, sans-serif font, following the curve of the bottom of the "WOW" letters.

NO CLAIM IS MADE TO THE EXCLUSIVE RIGHT TO USE "CLOTH", APART FROM THE MARK AS SHOWN.

FOR CLEANING CLOTHS (U.S. CLS. 2, 13, 23, 29, 30, 33, 40 AND 50).

HEATHER THOMPSON, EXAMINING ATTORNEY

SN 76-384,512. JMB CREATIVE IDEAS, INC., NEW YORK, NY. FILED 3-19-2002.

PINT PAL

NO CLAIM IS MADE TO THE EXCLUSIVE RIGHT TO USE "PINT", APART FROM THE MARK AS SHOWN.

FOR INSULATED SLEEVES FOR USE WITH FOOD OR BEVERAGE CONTAINERS, INCLUDING ICE CREAM CONTAINERS (U.S. CLS. 2, 13, 23, 29, 30, 33, 40 AND 50).

INGRID C. EULIN, EXAMINING ATTORNEY

SN 76-492,439. ISOCLEAR, INC., CHICAGO, IL. FILED 2-11-2003.

ISOCLEAR

FOR CONTACT LENS CLEANING APPARATUS, NAMELY, SINGLE USE DISPOSABLE CONTACT LENS CASES DESIGNED TO REMOVE CONTAMINANTS FROM THE CONTACT LENSES (U.S. CLS. 2, 13, 23, 29, 30, 33, 40 AND 50).

ALLISON HOLTZ, EXAMINING ATTORNEY

SN 76-517,080. GRAHAM PACKAGING COMPANY, L.P., YORK, PA. FILED 5-27-2003.

FLEXA TUBE

NO CLAIM IS MADE TO THE EXCLUSIVE RIGHT TO USE TUBE, APART FROM THE MARK AS SHOWN.

FOR PLASTIC BOTTLES, SOLD EMPTY, FOR USE IN THE FOOD AND BEVERAGE, HOUSEHOLD AND PERSONAL CARE, AND AUTOMOTIVE INDUSTRIES (U.S. CLS. 2, 13, 23, 29, 30, 33, 40 AND 50).

SCOTT OSLICK, EXAMINING ATTORNEY

CLASS 21—(Continued).

SN 76-558,925. WEIDER HEALTH AND FITNESS, WOODLAND HILLS, CA. FILED 11-10-2003.

JOE WEIDER

THE MARK CONSISTS OF STANDARD CHARACTERS WITHOUT CLAIM TO ANY PARTICULAR FONT, STYLE, SIZE, OR COLOR.

THE NAME JOE WEIDER IDENTIFIES A LIVING INDIVIDUAL WHOSE CONSENT IS OF RECORD.

FOR MUGS, JUGS, PORTABLE BEVERAGE COOLERS, BEVERAGE GLASSWARE, PORTABLE BEVERAGE DISPENSERS, BEVERAGEWARE, BOTTLE OPENERS, CORK SCREWS, COMB CASES, PAPER CUPS, PLASTIC CUPS, ICE BUCKETS, PORTABLE ICE CHESTS FOR FOOD AND BEVERAGES, COMMEMORATIVE PLATES, ALL-PURPOSE PORTABLE HOUSEHOLD CONTAINERS, TOOTHBRUSHES AND WASTEPAPER BASKETS (U.S. CLS. 2, 13, 23, 29, 30, 33, 40 AND 50).

AMOS T. MATTHEWS, JR., EXAMINING ATTORNEY

SN 76-572,253. NALGE NUNC INTERNATIONAL CORPORATION, ROCHESTER, NY. FILED 1-26-2004.

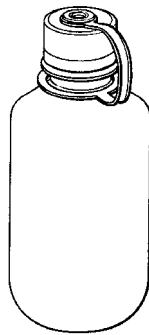

OWNER OF U.S. REG. NO. 2,755,757.

THE MARK CONSISTS OF A PLASTIC WATER BOTTLE AS SHOWN, NAMELY, A PLASTIC WATER BOTTLE HAVING A TRANSPARENT, GENERALLY CYLINDRICAL CONTAINER BODY WITH ROUNDED SHOULDERS INTERCONNECTING THE UPPER AND LOWER EXTREMITIES OF A CYLINDRICAL SIDEWALL TO A RELATIVELY NARROW CONTAINER NECK AND A GENERALLY FLAT, CIRCULAR CONTAINER BOTTOM, RESPECTIVELY; AN OPAQUE SCREW CAP RELEASABLY ENGAGED WITH THREADS ON THE UPPER PORTION OF THE NECK AND HAVING A BUTTON CONNECTED TO THE CENTER OF ITS TOP SURFACE VIA A SHORT STEM; AND A STRAP TERMINATING IN SMALL AND LARGE ANNULAR RINGS RESPECTIVELY ENCIRCLING THE BUTTON STEM AND THE LOWER PORTION OF THE NECK SUCH THAT

CLASS 21—(Continued).

THE LARGE ANNULAR RING IS SPACED APART AND VISUALLY DISTINCT FROM THE SCREW CAP, WHEREIN THE RATIO OF THE DIAMETER OF THE GENERALLY CYLINDRICAL CONTAINER BODY TO THE OVERALL HEIGHT OF THE WATER BOTTLE IS APPROXIMATELY 0.4 AND THE RATIO OF THE HEIGHT OF THE GENERALLY CYLINDRICAL CONTAINER BODY EXTENDING BETWEEN THE NECK AND THE CONTAINER BOTTOM TO THE OVERALL HEIGHT OF THE WATER BOTTLE IS APPROXIMATELY 0.8.

SEC. 2(F).

FOR PLASTIC WATER BOTTLE, SOLD EMPTY (U.S. CLS. 2, 13, 23, 29, 30, 33, 40 AND 50).

FIRST USE 4-19-1992; IN COMMERCE 4-19-1992.

ELISSA GARBER KON, EXAMINING ATTORNEY

SN 76-582,691. DART INDUSTRIES INC., ORLANDO, FL. FILED 3-23-2004.

THATSA

THE MARK CONSISTS OF STANDARD CHARACTERS WITHOUT CLAIM TO ANY PARTICULAR FONT, STYLE, SIZE, OR COLOR.

FOR CONTAINERS FOR HOUSEHOLD OR KITCHEN USE NOT OF PRECIOUS METAL (U.S. CLS. 2, 13, 23, 29, 30, 33, 40 AND 50).

FIRST USE 8-31-1992; IN COMMERCE 8-31-1992.

ELLEN PERKINS, EXAMINING ATTORNEY

SN 76-587,048. RETAIL IMPORT, L.L.C., TACOMA, WA. FILED 4-15-2004.

PURE BODY

THE MARK CONSISTS OF STANDARD CHARACTERS WITHOUT CLAIM TO ANY PARTICULAR FONT, STYLE, SIZE, OR COLOR.

NO CLAIM IS MADE TO THE EXCLUSIVE RIGHT TO USE "BODY", APART FROM THE MARK AS SHOWN.

FOR BATH AND BODY ACCESSORIES; NAMELY, BODY BRUSHES, LOOFAH SPONGES, EXFOLIATING BRUSHES, SISAL HAIR BRUSHES, BODY SPONGES, MESH SPONGES, NYLON GLOVES FOR GENERAL HOUSEHOLD USE, NAIL BRUSHES, SOAP DISPENSERS, BATH GLOVES FOR CLEANSING AND EXFOLIATING THE BODY, HAIR BRUSHES, FOOT BRUSHES, HAIR COMBS, HAIR COLORING BRUSHES; CANDLE BASES IN THE NATURE OF HOLDERS, NOT OF PRECIOUS METAL, CANDLE HOLDERS NOT OF PRECIOUS METAL, BOWLS; ALL PURPOSE PORTABLE CONTAINERS FOR HOUSEHOLD USE (U.S. CLS. 2, 13, 23, 29, 30, 33, 40 AND 50).

FIRST USE 10-1-2001; IN COMMERCE 10-1-2001.

MAUREEN DALL, EXAMINING ATTORNEY

CLASS 21—(Continued).

SN 76-599,081. GLENFAIR ENTERPRISES, OAKVILLE, ONTARIO L6M 4N8, CANADA, FILED 6-24-2004.

THE ORIGINAL ROASTER HAMMOCK

THE MARK CONSISTS OF STANDARD CHARACTERS WITHOUT CLAIM TO ANY PARTICULAR FONT, STYLE, SIZE, OR COLOR.

NO CLAIM IS MADE TO THE EXCLUSIVE RIGHT TO USE ORIGINAL ROASTER, APART FROM THE MARK AS SHOWN.

FOR MEAT LIFTER (U.S. CLS. 2, 13, 23, 29, 30, 33, 40 AND 50).

ESTHER BELENKER, EXAMINING ATTORNEY

SN 76-599,731. MILD ENTERPRISE CORP., HICKSVILLE, NY. FILED 6-29-2004.

SAND PALS

THE MARK CONSISTS OF STANDARD CHARACTERS WITHOUT CLAIM TO ANY PARTICULAR FONT, STYLE, SIZE, OR COLOR.

FOR FOOD AND BEVERAGE TRAY (U.S. CLS. 2, 13, 23, 29, 30, 33, 40 AND 50).

REBECCA GILBERT, EXAMINING ATTORNEY

SN 78-183,259. WILLIAMS INDUSTRIES, INC., SHELBYVILLE, IN. FILED 11-8-2002.

OMEGA

FOR PLASTIC TRAVEL MUGS (U.S. CLS. 2, 13, 23, 29, 30, 33, 40 AND 50).

FIRST USE 1-30-2003; IN COMMERCE 1-30-2003.

KAREN BRACEY, EXAMINING ATTORNEY

SN 78-228,167. CAVE SPRINGS, INC., WILMINGTON, PA. FILED 3-20-2003.

MOTHERHOOD

FOR INFANT TRAINING CUPS (U.S. CLS. 2, 13, 23, 29, 30, 33, 40 AND 50).

ALICIA COLLINS, EXAMINING ATTORNEY

SN 78-314,256. CLOVIS ENTERPRISES LLC, MYAKKA CITY, FL. FILED 10-15-2003.

ANNIE'S POT PEEPERS

FOR KITS FOR CREATING FIGURINES AND SCULPTURES MADE OF TERRA COTTA FOR THE LAWN, GARDEN OR HOME, OR FOR USE AS ARTWORK. (U.S. CLS. 2, 13, 23, 29, 30, 33, 40 AND 50).

NICHOLAS ALTREE, EXAMINING ATTORNEY

CLASS 21—(Continued).

SN 78-322,206. GATTSEK, JANET ANN, BROOKLYN, NY. FILED 11-3-2003.

THE REIKI MEZUZAH

THE MARK CONSISTS OF STANDARD CHARACTERS WITHOUT CLAIM TO ANY PARTICULAR FONT, STYLE, SIZE, OR COLOR.

NO CLAIM IS MADE TO THE EXCLUSIVE RIGHT TO USE "MEZUZAH", APART FROM THE MARK AS SHOWN.

FOR DECORATIVE ORNAMENTS COMPRISED PRIMARILY OF GLASS FEATURING SPIRITUAL THEMES FOR HANGING ON WALLS (U.S. CLS. 2, 13, 23, 29, 30, 33, 40 AND 50).

MONIQUE MILLER, EXAMINING ATTORNEY

SN 78-344,522. MONTOYA, CANDICE J., SAN DIEGO, CA. FILED 12-22-2003.

THE LIVING URN

THE MARK CONSISTS OF STANDARD CHARACTERS WITHOUT CLAIM TO ANY PARTICULAR FONT, STYLE, SIZE, OR COLOR.

NO CLAIM IS MADE TO THE EXCLUSIVE RIGHT TO USE URNS, APART FROM THE MARK AS SHOWN.

FOR CREATIVE AND PERSONALIZED FUNERARY URNS TO HOLD THE ASHES OF THE LOVED ONES DEPARTED (U.S. CLS. 2, 13, 23, 29, 30, 33, 40 AND 50).

ARETHA SOMERVILLE, EXAMINING ATTORNEY

CLASS 21—(Continued).

SN 78-345,614. MURPHY, JAMES E., DOWNERS GROVE, IL.
FILED 12-25-2003.

NOMOCOR

THE MARK CONSISTS OF STANDARD CHARACTERS WITHOUT CLAIM TO ANY PARTICULAR FONT, STYLE, SIZE, OR COLOR.

FOR SCULPTURES OF FIRED CLAY CONSISTING OF PORCELAIN, EARTHENWARE, TERRA COTTA, CAST GLASS (U.S. CLS. 2, 13, 23, 29, 30, 33, 40 AND 50).

FIRST USE 9-8-1995; IN COMMERCE 11-28-2002.
IRENE D. WILLIAMS, EXAMINING ATTORNEY

SN 78-364,097. LIFETIME HOAN CORPORATION, WEST-BURY, NY. FILED 2-6-2004.

THE PURITY OF GLASS

THE MARK CONSISTS OF STANDARD CHARACTERS WITHOUT CLAIM TO ANY PARTICULAR FONT, STYLE, SIZE, OR COLOR.

FOR SYRUP POURERS, OLIVE OIL BOTTLE DISPENSERS, GLASS BOWLS SETS, SAUCE AND CONDIMENT BOWLS, SPICE JARS, SALT AND PEPPER SHAKER SETS, SUGAR POURERS, CHEESE SHAKERS, CRUETS, SALT AND PEPPER SHAKERS, TOOTHPICK DISPENSERS, SUGAR SHAKERS, CONDIMENT SERVERS, TOOTHPICK DISPENSERS WITH TOOTHPICKS, BUTTER/CREAM CHEESE DISHES, SALAD DRESSING BOTTLES, SALSA/CONDIMENT BOWLS, NON-ELECTRIC JUICERS, CONDIMENT SETS COMPRISING CARRYING TRAY AND CONDIMENT DISPENSERS, LEMONADE JARS, BBQ CADDY SETS COMPRISING CARRYING TRAY AND CONDIMENT DISPENSERS, NUT MILLS, OIL AND VINEGAR DISPENSERS, STRAW DISPENSERS, CANDY DISPENSERS, SUGAR AND CREAMER SETS COMPRISING SUGAR DISPENSERS AND CREAMERS; CREAMERS, NESTING BOWL SETS, GIFT SETS, NAMELY, GLASS BOWL SETS, SALT AND PEPPER SHAKER SETS WITH AND WITHOUT TRAYS, CONDIMENT DISPENSER AND SERVER SETS AND SAUCE AND CONDIMENT BOWL SETS. (U.S. CLS. 2, 13, 23, 29, 30, 33, 40 AND 50).

BRIAN NEVILLE, EXAMINING ATTORNEY

CLASS 21—(Continued).

SN 78-371,903. DEMIRJIAN, GEORGE C. III, CINNAMINSON, NJ. FILED 2-21-2004.

ChillWare

THE MARK CONSISTS OF STANDARD CHARACTERS WITHOUT CLAIM TO ANY PARTICULAR FONT, STYLE, SIZE, OR COLOR.

FOR THERMAL INSULATED CONTAINERS FOR FOOD OR BEVERAGE (U.S. CLS. 2, 13, 23, 29, 30, 33, 40 AND 50).

DAVID TAYLOR, EXAMINING ATTORNEY

SN 78-373,469. WELL TRAVELED IMPORTS, INC., AMELIA ISLAND, FL. FILED 2-24-2004.

THE COLOR(S) GREEN IS/ARE CLAIMED AS A FEATURE OF THE MARK.

THE COLOR(S) GREEN IS/ARE CLAIMED AS A DISTINCTIVE FEATURE OF THE MARK.

THE LITERAL ELEMENT OF THE MARK CONSISTS OF GARDEN SENSE.

FOR PLANT AND GARDEN POTS (U.S. CLS. 2, 13, 23, 29, 30, 33, 40 AND 50).

FIRST USE 1-3-2003; IN COMMERCE 3-1-2003.

STANLEY I. OSBORNE, EXAMINING ATTORNEY

CLASS 21—(Continued).

SN 78-402,291. FORT JAMES OPERATING COMPANY, ATLANTA, GA. FILED 4-15-2004.



THE NAME(S), PORTRAIT(S), AND/OR SIGNATURE(S) SHOWN IN THE MARK DOES NOT IDENTIFY A PARTICULAR LIVING INDIVIDUAL.

THE MARK CONSISTS OF AN IMAGE OF A MAN WITH TREES IN THE BACKGROUND.

FOR HOUSEHOLD HAND CLEANING SUPPLIES, NAMELY, MANUAL COPPER SCRUBBERS, MANUAL STAINLESS STEEL SCRUBBERS, MANUAL PLASTIC SCRUBBERS, MANUAL NYLON SCRUBBERS, CLEANING SPONGES, SCOURING SPONGES, HOUSEHOLD GLOVES FOR GENERAL USE, DISPOSABLE LATEX GLOVES FOR GENERAL USE, CLEANING PADS, SCRUBBER SPONGE (U.S. CLS. 2, 13, 23, 29, 30, 33, 40 AND 50).

FIRST USE 7-19-2004; IN COMMERCE 7-19-2004.
BERYL GARDNER, EXAMINING ATTORNEY

CLASS 21—(Continued).

SN 78-406,605. ZAPP, ANNA, LAFAYETTE, CO. FILED 4-22-2004.

Iron Genie

THE MARK CONSISTS OF STANDARD CHARACTERS WITHOUT CLAIM TO ANY PARTICULAR FONT, STYLE, SIZE, OR COLOR.

NO CLAIM IS MADE TO THE EXCLUSIVE RIGHT TO USE "IRON", APART FROM THE MARK AS SHOWN.

FOR PLASTIC WATER RESERVOIR DESIGNED TO DELIVER WATER TO A STEAM IRON ON DEMAND (U.S. CLS. 2, 13, 23, 29, 30, 33, 40 AND 50).

BARBARA GAYNOR, EXAMINING ATTORNEY

SN 78-404,682. THE EVERCARE COMPANY, ALPHARETTA, GA. FILED 4-20-2004.

ULTRA SCOUR

THE MARK CONSISTS OF STANDARD CHARACTERS WITHOUT CLAIM TO ANY PARTICULAR FONT, STYLE, SIZE, OR COLOR.

NO CLAIM IS MADE TO THE EXCLUSIVE RIGHT TO USE "SCOUR", APART FROM THE MARK AS SHOWN.

FOR CLEANING SPONGES (U.S. CLS. 2, 13, 23, 29, 30, 33, 40 AND 50).

FIRST USE 7-26-2004; IN COMMERCE 7-26-2004.
HOWARD B. LEVINE, EXAMINING ATTORNEY

SN 78-420,860. MAPA SPONTEX, INC., COLUMBIA, TN. FILED 5-18-2004.

SCOUR MAX

THE MARK CONSISTS OF STANDARD CHARACTERS WITHOUT CLAIM TO ANY PARTICULAR FONT, STYLE, SIZE, OR COLOR.

NO CLAIM IS MADE TO THE EXCLUSIVE RIGHT TO USE "SCOUR", APART FROM THE MARK AS SHOWN.

FOR SCRUBBER SPONGES (U.S. CLS. 2, 13, 23, 29, 30, 33, 40 AND 50).

CATHERINE CAIN, EXAMINING ATTORNEY

CLASS 21—(Continued).

SN 78-425,154. RUBBERMAID INCORPORATED, FREE-PORT, IL. FILED 5-26-2004.

CLASS 21—(Continued).

SN 78-429,288. MEGUIAR'S, INC., IRVINE, CA. FILED 6-3-2004.

DURABOWL

THE MARK CONSISTS OF STANDARD CHARACTERS WITHOUT CLAIM TO ANY PARTICULAR FONT, STYLE, SIZE, OR COLOR.

FOR HOUSEHOLD CONTAINERS, NAMELY, SERVING AND STORING BOWLS MADE OF PLASTIC (U.S. CLS. 2, 13, 23, 29, 30, 33, 40 AND 50).

JULIA HARDY COFIELD, EXAMINING ATTORNEY

ACCU-GRIP

THE MARK CONSISTS OF STANDARD CHARACTERS WITHOUT CLAIM TO ANY PARTICULAR FONT, STYLE, SIZE, OR COLOR.

FOR CLEANING PRODUCTS FOR HOUSEHOLD USE AND FOR USE ON THE INTERIOR AND EXTERIOR SURFACES OF MOTOR VEHICLES AND BOATS, NAMELY, CLEANING, DRYING, DUSTING AND POLISHING CLOTHS, CHAMOIS MADE FROM NATURAL MATERIALS, CHAMOIS MADE FROM SYNTHETIC MATERIALS, PADS FOR APPLYING WAX AND POLISHES TO VEHICLES, WASHING PADS, POLISHING BONNETS FOR BUFFING AND POLISHING VEHICLES, SPONGES, SQUEEGEES, GARDEN HOSE SPRAYERS, BRUSHES AND SCRUBBING BRUSHES (U.S. CLS. 2, 13, 23, 29, 30, 33, 40 AND 50).

LINDA E. BLOHM, EXAMINING ATTORNEY

SN 78-428,085. MID-WEST METAL PRODUCTS COMPANY, INC., MUNCIE, IN. FILED 6-1-2004.

SN 78-433,722. HP INTELLECTUAL CORP., WILMINGTON, DE. FILED 6-11-2004.



ELITE

NO CLAIM IS MADE TO THE EXCLUSIVE RIGHT TO USE "SERIES", APART FROM THE MARK AS SHOWN.

THE MARK CONSISTS OF STYLIZED LETTERS SPELLING THE WORD "ULTIMA." A DESIGN OF A SUN PARTIALLY COVERS THE DOT IN THE LETTER "I" IN THE WORD "ULTIMA."

FOR CAGES FOR PETS (U.S. CLS. 2, 13, 23, 29, 30, 33, 40 AND 50).

LINDA ESTRADA, EXAMINING ATTORNEY

THE MARK CONSISTS OF STANDARD CHARACTERS WITHOUT CLAIM TO ANY PARTICULAR FONT, STYLE, SIZE, OR COLOR.

FOR ELECTRIC SELF-CLEANING CAT LITTER BOXES (U.S. CLS. 2, 13, 23, 29, 30, 33, 40 AND 50).

PATRICIA EVANKO, EXAMINING ATTORNEY

CLASS 21—(Continued).

SN 78-434,956. CREATIVE CHARACTERS, INC., MIAMI, FL.
FILED 6-14-2004.

CLASS 21—(Continued).

SN 78-435,898. FORT JAMES OPERATING COMPANY,
ATLANTA, GA. FILED 6-16-2004.

Oscar Wilde

DIXIE

THE MARK CONSISTS OF STANDARD CHARACTERS WITHOUT CLAIM TO ANY PARTICULAR FONT, STYLE, SIZE, OR COLOR.

THE NAME(S), PORTRAIT(S), AND/OR SIGNATURE(S) SHOWN IN THE MARK DOES NOT IDENTIFY A PARTICULAR LIVING INDIVIDUAL.

SEC. 2(F).

FOR MUGS, BOWLS, PLATES, CUPS, DRINKING GLASSES, WATER BOTTLES SOLD EMPTY, NONMETAL COOKIE JARS OF EARTHENWARE, GLASS, PORCELAIN AND/OR TERRA COTTA, LUNCH BOXES, SERVING TRAYS NOT OF PRECIOUS METAL, CANDLESTICKS NOT OF PRECIOUS METAL, FOAM BEVERAGE CAN HOLDERS, INSULATED BOTTLES FOR BEVERAGES, VACUUM BOTTLES, BOTTLE OPENERS, FIGURINES MADE OF CHINA, CRYSTAL, EARTHENWARE, GLASS, PORCELAIN AND/OR TERRA COTTA, ICE BUCKETS, FOOD STORAGE CONTAINERS FOR PERSONAL USE, PLANT POTS, VASES, DRINK PITCHERS, TEAPOTS NOT OF PRECIOUS METAL, COASTERS NOT MADE OF PAPER AND NOT BEING OF TABLE LINEN, CANDY DISHES, NON-METAL PIGGY BANKS (U.S. CLS. 2, 13, 23, 29, 30, 33, 40 AND 50).

FIRST USE 9-20-1964; IN COMMERCE 9-20-1964.

ARETHA SOMERVILLE, EXAMINING ATTORNEY

THE MARK CONSISTS OF STANDARD CHARACTERS WITHOUT CLAIM TO ANY PARTICULAR FONT, STYLE, SIZE, OR COLOR.

OWNER OF U.S. REG. NOS. 732,447, 2,420,129 AND OTHERS.

FOR PLASTIC CONTAINER WITH LID FOR FOOD OR BEVERAGE (U.S. CLS. 2, 13, 23, 29, 30, 33, 40 AND 50).

FIRST USE 9-30-2002; IN COMMERCE 9-30-2003.

ALICE BENMAMAN, EXAMINING ATTORNEY

CLASS 21—(Continued).

SN 78-436,575. CREATIVE CHARACTERS, INC., MIAMI, FL.
FILED 6-16-2004.

Mark Twain

THE MARK CONSISTS OF STANDARD CHARACTERS WITHOUT CLAIM TO ANY PARTICULAR FONT, STYLE, SIZE, OR COLOR.

THE NAME(S), PORTRAIT(S), AND/OR SIGNATURE(S) SHOWN IN THE MARK DOES NOT IDENTIFY A PARTICULAR LIVING INDIVIDUAL.

FOR MUGS, BOWLS, PLATES, CUPS, DRINKING GLASSES, WATER BOTTLES SOLD EMPTY, NONMETAL COOKIE JARS OF EARTHENWARE, GLASS, PORCELAIN AND/OR TERRA COTTA, LUNCH BOXES, SERVING TRAYS NOT OF PRECIOUS METAL, CANDLESTICKS NOT OF PRECIOUS METAL, FOAM BEVERAGE CAN HOLDERS, INSULATED BOTTLES FOR BEVERAGES, VACUUM BOTTLES, BOTTLE OPENERS, FIGURINES MADE OF CHINA, CRYSTAL, EARTHENWARE, GLASS, PORCELAIN AND/OR TERRA COTTA, ICE BUCKETS, FOOD STORAGE CONTAINERS FOR PERSONAL USE, PLANT POTS, VASES, DRINK PITCHERS, TEAPOTS NOT OF PRECIOUS METAL, COASTERS NOT MADE OF PAPER AND NOT BEING OF TABLE LINEN, CANDY DISHES, NON-METAL PIGGY BANKS, BACK SCRATCHERS, BEER MUGS, BEVERAGE GLASSWARE, BEVERAGEWARE, COOKIE CUTTERS, WASTE-PAPER BASKETS (U.S. CLS. 2, 13, 23, 29, 30, 33, 40 AND 50).

FIRST USE 10-10-1964; IN COMMERCE 10-10-1964.
LINDA E. BLOHM, EXAMINING ATTORNEY

SN 78-437,061. HP INTELLECTUAL CORP., WILMINGTON, DE. FILED 6-17-2004.

COLOSSAL

THE MARK CONSISTS OF STANDARD CHARACTERS WITHOUT CLAIM TO ANY PARTICULAR FONT, STYLE, SIZE, OR COLOR.

FOR NON-ELECTRIC HAIR BRUSHES (U.S. CLS. 2, 13, 23, 29, 30, 33, 40 AND 50).

ALICIA COLLINS, EXAMINING ATTORNEY

CLASS 21—(Continued).

SN 78-437,121. CONAIR CORPORATION, STAMFORD, CT.
FILED 6-17-2004.

CLASSIC COLORS

THE MARK CONSISTS OF STANDARD CHARACTERS WITHOUT CLAIM TO ANY PARTICULAR FONT, STYLE, SIZE, OR COLOR.

NO CLAIM IS MADE TO THE EXCLUSIVE RIGHT TO USE "COLORS", APART FROM THE MARK AS SHOWN.

FOR COOKWARE, NAMELY, POTS AND PANS (U.S. CLS. 2, 13, 23, 29, 30, 33, 40 AND 50).

WINSTON FOLMAR, EXAMINING ATTORNEY

SN 78-439,324. HEEKIN, TIMOTHY K., MORROW, OH.
FILED 6-22-2004.

BOTTLED MOMENTUM

THE MARK CONSISTS OF STANDARD CHARACTERS WITHOUT CLAIM TO ANY PARTICULAR FONT, STYLE, SIZE, OR COLOR.

FOR NOVELTY ITEMS, NAMELY BOTTLES SOLD EMPTY (U.S. CLS. 2, 13, 23, 29, 30, 33, 40 AND 50).

KEVON CHISOLM, EXAMINING ATTORNEY

SN 78-448,194. SMITHKLINE BEECHAM CORPORATION, PHILADELPHIA, PA. FILED 7-9-2004.

AQUAFRESH

THE MARK CONSISTS OF STANDARD CHARACTERS WITHOUT CLAIM TO ANY PARTICULAR FONT, STYLE, SIZE, OR COLOR.

OWNER OF U.S. REG. NOS. 1,662,981, 2,814,290 AND OTHERS.

FOR TOOTHBRUSHES (U.S. CLS. 2, 13, 23, 29, 30, 33, 40 AND 50).

FIRST USE 7-15-1990; IN COMMERCE 7-15-1990.

JANICE L. MCMORROW, EXAMINING ATTORNEY

CLASS 21—(Continued).

SN 78-453,391. SMITHKLINE BEECHAM CORPORATION,
PHILADELPHIA, PA. FILED 7-20-2004.

AQUAFRESH MAX- ACTIVE

THE MARK CONSISTS OF STANDARD CHARACTERS
WITHOUT CLAIM TO ANY PARTICULAR FONT, STYLE,
SIZE, OR COLOR.

OWNER OF U.S. REG. NOS. 1,006,821, 2,759,361 AND
OTHERS.

FOR TOOTHBRUSHES (U.S. CLS. 2, 13, 23, 29, 30, 33, 40
AND 50).

FIRST USE 9-30-2002; IN COMMERCE 9-30-2002.

JANICE L. MCMORROW, EXAMINING ATTORNEY

SN 78-453,397. SMITHKLINE BEECHAM CORPORATION,
PHILADELPHIA, PA. FILED 7-20-2004.

MAX-ACTIVE

THE MARK CONSISTS OF STANDARD CHARACTERS
WITHOUT CLAIM TO ANY PARTICULAR FONT, STYLE,
SIZE, OR COLOR.

OWNER OF U.S. REG. NO. 2,759,361.

FOR TOOTHBRUSHES (U.S. CLS. 2, 13, 23, 29, 30, 33, 40
AND 50).

FIRST USE 9-30-2002; IN COMMERCE 9-30-2002.

JANICE L. MCMORROW, EXAMINING ATTORNEY

SN 78-453,790. SMITHKLINE BEECHAM CORPORATION,
PHILADELPHIA, PA. FILED 7-21-2004.

AQUAFRESH DIRECT

THE MARK CONSISTS OF STANDARD CHARACTERS
WITHOUT CLAIM TO ANY PARTICULAR FONT, STYLE,
SIZE, OR COLOR.

OWNER OF U.S. REG. NOS. 1,006,821, 2,326,773 AND
OTHERS.

FOR TOOTHBRUSHES (U.S. CLS. 2, 13, 23, 29, 30, 33, 40
AND 50).

FIRST USE 9-30-2002; IN COMMERCE 9-30-2002.

JANICE L. MCMORROW, EXAMINING ATTORNEY

CLASS 21—(Continued).

SN 78-453,791. SMITHKLINE BEECHAM CORPORATION,
PHILADELPHIA, PA. FILED 7-21-2004.

DIRECT

THE MARK CONSISTS OF STANDARD CHARACTERS
WITHOUT CLAIM TO ANY PARTICULAR FONT, STYLE,
SIZE, OR COLOR.

OWNER OF U.S. REG. NO. 1,906,569.

FOR TOOTHBRUSHES (U.S. CLS. 2, 13, 23, 29, 30, 33, 40
AND 50).

FIRST USE 9-30-2002; IN COMMERCE 9-30-2002.

JANICE L. MCMORROW, EXAMINING ATTORNEY

SN 78-474,316. JOHNSON DIVERSEY, INC., STURTEVANT,
WI. FILED 8-26-2004.

ZORBA

THE MARK CONSISTS OF STANDARD CHARACTERS
WITHOUT CLAIM TO ANY PARTICULAR FONT, STYLE,
SIZE, OR COLOR.

FOR CLEANING MATERIALS AND PADS, SPILL
CONTROL MATERIALS, NAMELY, FLAT ABSORBENT
PADS USED TO CONTROL AND ABSORB LIQUID
SPILLS; ALL FOR COMMERCIAL, INDUSTRIAL AND
INSTITUTIONAL USE (U.S. CLS. 2, 13, 23, 29, 30, 33, 40
AND 50).

JUDITH HELFMAN, EXAMINING ATTORNEY

CLASS 24—FABRICS

SN 76-578,372. EDELMAN, MICHELLE, NEW YORK, NY.
FILED 3-1-2004.

TAP

THE MARK CONSISTS OF STANDARD CHARACTERS WITHOUT CLAIM TO ANY PARTICULAR FONT, STYLE, SIZE, OR COLOR.

FOR BED SHEETS, TABLE CLOTHS NOT OF PAPER, CLOTH NAPKINS, CUSHION COVERS, TOWELS AND SHOWER CURTAINS (U.S. CLS. 42 AND 50).

PATRICIA EVANKO, EXAMINING ATTORNEY

SN 76-594,674. CROWN CRAFTS INFANT PRODUCTS, INC.,
GONZALES, LA. FILED 5-28-2004.

SOFT DREAMS

THE MARK CONSISTS OF STANDARD CHARACTERS WITHOUT CLAIM TO ANY PARTICULAR FONT, STYLE, SIZE, OR COLOR.

FOR BED BLANKETS, COMFORTERS AND BLANKET TROWS (U.S. CLS. 42 AND 50).

BRENDAN MCCAULEY, EXAMINING ATTORNEY

SN 76-595,719. TOB INTERNATIONAL MARKETING CORP.,
NEW YORK, NY. FILED 6-4-2004.

THOMAS O'BRIEN

THE MARK CONSISTS OF STANDARD CHARACTERS WITHOUT CLAIM TO ANY PARTICULAR FONT, STYLE, SIZE, OR COLOR.

OWNER OF U.S. REG. NO. 2,648,415.

THOMAS O'BRIEN IS THE NAME OF A LIVING INDIVIDUAL, WHOSE CONSENT IS IMPLIED BY EXECUTION OF THIS APPLICATION AS PRESIDENT OF APPLICANT.

FOR (BASED ON USE IN COMMERCE) BED AND BATH LINENS; FABRICS FOR UPHOLSTERY AND DRAPERY (BASED ON INTENT TO USE) TABLE LINENS AND KITCHEN LINENS; CURTAIN DRAPERIES AND FABRIC WINDOW TREATMENTS; TAPES-TRIES AND FABRIC WALL HANGINGS (U.S. CLS. 42 AND 50).

FIRST USE 2-0-2003; IN COMMERCE 2-0-2003.

BRIAN NEVILLE, EXAMINING ATTORNEY

CLASS 24—(Continued).

SN 76-597,911. PHILLIPPS, VICTORIA, RIEGELSVILLE, PA.
FILED 6-17-2004.

CLI-MATES

THE MARK CONSISTS OF STANDARD CHARACTERS WITHOUT CLAIM TO ANY PARTICULAR FONT, STYLE, SIZE, OR COLOR.

FOR BEDDING, NAMELY, SHEETS, COMFORTERS, BLANKETS AND PILLOW COVERS (U.S. CLS. 42 AND 50).

PRISCILLA MILTON, EXAMINING ATTORNEY

SN 78-227,528. ADMINISTRATORS OF THE TULANE EDUCATIONAL FUND, THE, NEW ORLEANS, LA. FILED 3-19-2003.

TULANE

OWNER OF U.S. REG. NOS. 2,737,647 AND 2,743,096.
FOR TOWELS; FABRIC LINENS; BLANKETS, NAMELY, BED BLANKETS, AFGHANS, STADIUM BLANKETS, AND TROWS; AND CLOTH FLAGS AND PENNANTS (U.S. CLS. 42 AND 50).

MICHAEL TANNER, EXAMINING ATTORNEY

SN 78-294,314. DISNEY ENTERPRISES, INC., BURBANK,
CA. FILED 8-29-2003.



OWNER OF U.S. REG. NOS. 2,415,566, 2,623,099 AND OTHERS.

FOR AFGHANS; BATH LINEN; BED BLANKETS; BED SHEETS; CRIB BUMPERS; PILLOW CASES; COMFORTERS; CURTAINS; BED SKIRTS; KITCHEN TOWELS; TABLE LINEN; BED LINEN; QUILTS; TOWELS; WASH-CLOTHS; HANDKERCHIEFS; BED SPREADS; FLAGS AND PENNANTS OF TEXTILE (U.S. CLS. 42 AND 50).

PAUL F. GAST, EXAMINING ATTORNEY

CLASS 24—(Continued).

SN 78-311,160. JOE BOXER COMPANY, LLC, WESTPORT, CT. FILED 10-8-2003.

SNOOZE KIT

NO CLAIM IS MADE TO THE EXCLUSIVE RIGHT TO USE "KIT", APART FROM THE MARK AS SHOWN.

FOR BED SHEETS, PILLOW CASES, COMFORTERS, BED SPREADS, BLANKETS, BED SKIRTS AND MATTRESS PADS, SOLD AS SETS (U.S. CLS. 42 AND 50).

FIRST USE 7-1-2002; IN COMMERCE 7-1-2002.

JANICE L. MCMORROW, EXAMINING ATTORNEY

SN 78-391,020. A-1TEXTILES & HOSPITALITY PRODUCTS, INC., PACOIMA, CA. FILED 3-25-2004.

Golden Mills

THE MARK CONSISTS OF STANDARD CHARACTERS WITHOUT CLAIM TO ANY PARTICULAR FONT, STYLE, SIZE, OR COLOR.

NO CLAIM IS MADE TO THE EXCLUSIVE RIGHT TO USE "MILLS", APART FROM THE MARK AS SHOWN.

FOR 100% COTTON TOWELS (U.S. CLS. 42 AND 50).

LANA PHAM, EXAMINING ATTORNEY

SN 78-438,282. SHOWOFFS, LLC, WESTPORT, CT. FILED 6-21-2004.

Down-velope

THE MARK CONSISTS OF STANDARD CHARACTERS WITHOUT CLAIM TO ANY PARTICULAR FONT, STYLE, SIZE, OR COLOR.

FOR COVERS THAT FIT OVER DOWN, POLYESTER OR COTTON FILLED COMFORTERS AND PILLOWS TO HOLD THE COMFORTERS AND PILLOWS IN PLACE (U.S. CLS. 42 AND 50).

KATHLEEN M. VANSTON, EXAMINING ATTORNEY

CLASS 24—(Continued).

SN 78-438,436. T&Q IMPORT-EXPORT CORP., FAIRFAX, VA. FILED 6-21-2004.

**T COMPACT SYSTEM
KITCHEN TOWEL**

THE MARK CONSISTS OF STANDARD CHARACTERS WITHOUT CLAIM TO ANY PARTICULAR FONT, STYLE, SIZE, OR COLOR.

NO CLAIM IS MADE TO THE EXCLUSIVE RIGHT TO USE "COMPACT SYSTEM KITCHEN TOWEL", APART FROM THE MARK AS SHOWN.

FOR TEXTILES AND TEXTILE GOODS, NAMELY KITCHEN TOWELS (U.S. CLS. 42 AND 50).

CHRISTOPHER ADKINS, EXAMINING ATTORNEY

SN 79-001,665. CHRISTIAN ESCHLER AG, SWITZERLAND, FILED 3-12-2004.



OWNER OF INTERNATIONAL REGISTRATION 0482257 DATED 12-9-1983, EXPIRES 12-9-2013.

FOR SYNTHETIC KNIT FABRIC (100% POLYESTER) (U.S. CLS. 42 AND 50).

TARAH HARDY, EXAMINING ATTORNEY

CLASS 25—CLOTHING

SN 75-932,214. BAYER CLOTHING GROUP, INC., NEW YORK, NY. FILED 3-1-2000.

ALIGN

FOR MEN'S CLOTHING, NAMELY SUITS, SPORTS COATS, TROUSERS, SHIRTS, SWEATERS, TIES, TOP-COATS AND OUTERWEAR, NAMELY RAINCOATS, OVERCOATS AND NECKWEAR (U.S. CLS. 22 AND 39).

LINDA MICKLEBURGH, EXAMINING ATTORNEY

CLASS 25—(Continued).

SN 76-084,968. DYNASTY FASHIONS, INC., LOS ANGELES, CA. FILED 7-7-2000.

CHRISTINE V

FOR CLOTHING; NAMELY, BLAZERS, JACKETS, COATS, SUITS, VESTS, CARDIGANS, SWEATERS, KNIT SHIRTS, SWEATSHIRTS, BLOUSES, SHIRTS, TOPS, HALTER TOPS, TANK TOPS, TUBE TOPS, CROP TOPS, TEE SHIRTS, PANTS, CAPRI PANTS, SLACKS, JEANS, DRESSES, SUNDRESSES, OVERALLS, JUMPERS, CULOTTES, SHORTS, SKIRTS, MINISKIRTS, AND JUMPSUITS (U.S. CLS. 22 AND 39).

ALICE SUE CARRUTHERS, EXAMINING ATTORNEY

SN 76-420,758. ONE 2 ONE LINGERIE INC., MONTREAL, QUEBEC, CANADA, FILED 6-13-2002.

ONE 2 ONE

PRIORITY CLAIMED UNDER SEC. 44(D) ON CANADA APPLICATION NO. 1141999, FILED 5-27-2002, REG. NO. TMA614276, DATED 7-7-2004, EXPIRES 7-7-2019.

FOR LADIES', WOMEN'S, TEENS' AND CHILDREN'S LINGERIE, NAMELY UNDERGARMENTS, FOUNDATION GARMENTS, BRAS, CHEMISES, CAMISOLES, TEDDIES, BODY SHAPERS, BUSTIERS, TANK TOPS, GARTER BELTS, UNDERWEAR CONSISTING OF PANTIES, BRIEFS, STEP-INS, BIKINIS, THONGS, BOY-LEG BRIEFS, GIRDLES AND PANTY GIRDLES (U.S. CLS. 22 AND 39).

SHARI SHEFFIELD, EXAMINING ATTORNEY

SN 76-432,650. COLUMBIA INSURANCE COMPANY, OMAHA, NE. FILED 7-22-2002.

PIVIT

FOR GOLF SHOES (U.S. CLS. 22 AND 39).
KATHERINE STOIDES, EXAMINING ATTORNEY

SN 76-494,533. BROWN, CHARLIE, PLANO, TX. FILED 3-4-2003.



THE WORD "KARLIE" IS PRINTED IN RED WITH THE OUTLINE OF A HEART, PRINTED IN RED, AS THE DOT ON THE LETTER "I." "KARLIE" IS ENCLOSED IN A RECTANGLE OF A SINGLE RED LINE. THE BACKGROUND IS YELLOW.

FOR WOMEN, MISSES, AND CHILDREN'S CLOTHING, NAMELY, PANTS, SKIRTS, JACKETS, SUITS, BLOUSES, SHIRTS, T-SHIRTS (U.S. CLS. 22 AND 39).

FIRST USE 1-2-2003; IN COMMERCE 1-2-2003.

THEODORE MCBRIDE, EXAMINING ATTORNEY

CLASS 25—(Continued).

SN 76-500,736. SHEPLERS, INC., WICHITA, KS. FILED 3-26-2003.

DAWSON CREEK

FOR BOOTS AND CLOTHING, NAMELY, SHIRTS, JACKETS, AND COATS (U.S. CLS. 22 AND 39).
ANDREW BENZMILLER, EXAMINING ATTORNEY

SN 76-505,423. ART DIFFUS, 75002 PARIS, FRANCE, FILED 4-10-2003.

SATELLITE

PRIORITY CLAIMED UNDER SEC. 44(D) ON FRANCE APPLICATION NO. 023189989, FILED 10-21-2002, REG. NO. 023189989, DATED 10-21-2002, EXPIRES 10-21-2012.

FOR CLOTHING, NAMELY, SKIRTS, DRESSES, TROUSERS, BERMUDA SHORT, SHORTS, PULLOVERS, SLEEVELESS JACKETS, JACKETS, SWEATERS, SHIRTS, BLOUSES, STOCKINGS, TIGHTS, UNDERWEAR, TIES, SCARVES, HEADSCARF; SHAWL; WAISTCOATS, COSTUMES NAMELY REDINGOTES; CARDIGANS, COATS, RAINCOATS, FROCK COATS, CLOAKS, FOOTWEAR AND HEADWEAR (U.S. CLS. 22 AND 39).

KIM SAITO, EXAMINING ATTORNEY

SN 76-527,697. MARK BRADLEY, INCORPORATED, GOLD HILL, NC. FILED 7-2-2003.

RACE FEVER

NO CLAIM IS MADE TO THE EXCLUSIVE RIGHT TO USE "RACE", APART FROM THE MARK AS SHOWN.

FOR CLOTHING, NAMELY, T-SHIRTS, SWEATSHIRTS, JACKETS, PANTS, RAIN JACKETS, HATS, CAPS AND SCARVES (U.S. CLS. 22 AND 39).

FIRST USE 1-0-2000; IN COMMERCE 1-0-2000.

DAVID TAYLOR, EXAMINING ATTORNEY

SN 76-558,463. DILLARD'S, INC., LITTLE ROCK, AR. FILED 11-10-2003.

ROYAL OXFORD

THE MARK CONSISTS OF STANDARD CHARACTERS WITHOUT CLAIM TO ANY PARTICULAR FONT, STYLE, SIZE, OR COLOR.

NO CLAIM IS MADE TO THE EXCLUSIVE RIGHT TO USE "OXFORD", APART FROM THE MARK AS SHOWN.

FOR MEN'S DRESS SHIRTS (U.S. CLS. 22 AND 39).

PAUL F. GAST, EXAMINING ATTORNEY

CLASS 25—(Continued).

SN 76-564,070. NELSON, GREGORY A., NEW YORK, NY.
FILED 12-8-2003.

ARUNA COUTURE

NO CLAIM IS MADE TO THE EXCLUSIVE RIGHT TO
USE COUTURE, APART FROM THE MARK AS SHOWN.

FOR MENS CLOTHING AND ACCESSORIES,
NAMESLY SHIRTS, T-SHIRTS, SWEATERS, JACKETS,
COATS, VESTS, HATS, PANTS, JEANS, SWEAT SUITS,
FLEECEWEAR, SPORTSWEAR, UNDERWEAR, SOCKS,
LOUNGE WEAR, ROBES, SLIPPERS, AND PAJAMAS
(U.S. CLS. 22 AND 39).

RAUL CORDOVA, EXAMINING ATTORNEY

SN 76-568,632. A.H. SCHREIBER COMPANY, INC., NEW
YORK, NY. FILED 1-2-2004.

OCEAN FRONT PROPERTIES

THE MARK CONSISTS OF STANDARD CHARACTERS
WITHOUT CLAIM TO ANY PARTICULAR FONT, STYLE,
SIZE, OR COLOR.

FOR CLOTHING, NAMESLY, SWIMWEAR (U.S. CLS. 22
AND 39).

MITCHELL FRONT, EXAMINING ATTORNEY

SN 76-569,246. VALUE CITY OF MICHIGAN, INC., WEST-
LAND, MI. FILED 1-12-2004.

LUCA ROSSI

THE MARK CONSISTS OF STANDARD CHARACTERS
WITHOUT CLAIM TO ANY PARTICULAR FONT, STYLE,
SIZE, OR COLOR.

THE NAME IN THE MARK DOES NOT IDENTIFY A
LIVING INDIVIDUAL.

FOR SUITS, SPORT COATS, SLACKS, ALL-WEATHER
COATS, TOPCOATS, OVERCOATS, AND SUIT SEPA-
RATES, NAMESLY, SUIT JACKETS, SUIT PANTS AND
SUIT VESTS (U.S. CLS. 22 AND 39).

FIRST USE 8-0-2002; IN COMMERCE 8-0-2002.

PRISCILLA MILTON, EXAMINING ATTORNEY

CLASS 25—(Continued).

SN 76-569,620. ZABANEH, ALBERTO PONS, ZONE 7 PANA-
MA, PANAMA, FILED 1-5-2004.

ALBERTO PONS

THE MARK CONSISTS OF STANDARD CHARACTERS
WITHOUT CLAIM TO ANY PARTICULAR FONT, STYLE,
SIZE, OR COLOR.

FOR CLOTHING, NAMESLY GUAYABERAS, SHIRTS,
T-SHIRTS, TOPS, HALTER TOPS, TURTLE NECKS,
TANK TOPS, GOLF SHIRTS, SPORT SHIRTS, SWEAT-
SHIRTS, SHORTS, PANTS, SWEATPANTS, JEANS,
SKIRTS, DRESSES, BLOUSES, SWEATERS, JACKETS,
JERSEYS, VESTS, SUITS, BLAZERS, BODY SUITS,
JUMPSUITS, COATS, OVERALLS, OVERCOATS, ROBES,
BATHROBES, SWIMWEAR, BIKINIS, SWIM TRUNKS,
BATHING SUITS, COVER-UPS, WRAP-AROUNDS, SAR-
ONGS, PAJAMAS, LINGERIE, HOSIERY, SOCKS,
GLOVES, SCARVES, BELTS, SUSPENDERS, TIES, UN-
DERWEAR, BRAS, PANTIES, BOXER SHORTS, HATS,
CAPS, AND FOOTWEAR (U.S. CLS. 22 AND 39).

PAUL F. GAST, EXAMINING ATTORNEY

SN 76-573,454. PIGGLY WIGGLY, LLC, FLOWER MOUND,
TX. FILED 1-30-2004.



OWNER OF U.S. REG. NOS. 583,054, 1,583,733 AND
OTHERS.

THE LINING SHOWN IN THE DRAWING IS A FEATURE
OF THE MARK AND IS NOT INTENDED TO INDICATE
COLOR.

FOR ARTICLES OF APPAREL, NAMESLY, SHIRTS
(U.S. CLS. 22 AND 39).

FIRST USE 7-2-1992; IN COMMERCE 7-2-1992.

TRACY CROSS, EXAMINING ATTORNEY

CLASS 25—(Continued).

SN 76-573,783. NEW SHOES MEDIA, LLC, NASHVILLE, TN.
FILED 2-3-2004.

THE RISK AND REWARD NETWORK

THE MARK CONSISTS OF STANDARD CHARACTERS
WITHOUT CLAIM TO ANY PARTICULAR FONT, STYLE,
SIZE, OR COLOR.

FOR SHIRTS, HATS AND JACKETS (U.S. CLS. 22 AND
39).

PAUL F. GAST, EXAMINING ATTORNEY

SN 76-574,259. IMATEX S.P.A., 41012 CARPI (MO), ITALY,
FILED 2-6-2004.

MAURICE ABOT

THE MARK CONSISTS OF STANDARD CHARACTERS
WITHOUT CLAIM TO ANY PARTICULAR FONT, STYLE,
SIZE, OR COLOR.

MAURICE ABOT DOES NOT IDENTIFY A PARTICULAR
LIVING INDIVIDUAL.

FOR MEN'S, WOMEN'S AND CHILDREN'S CLOTH-
ING, NAMELY, DRESSES, JACKETS, COATS, TROU-
SERS, VESTS, SKIRTS, KNITWEAR, NAMELY,
SWEATERS, SPORTSWEAR, NAMELY, JACKETS,
OVERALLS, LEISURE WEAR, NAMELY, SHORTS, T-
SHIRTS, SHIRTS, UNDERSHIRTS, BLOUSES, RAIN-
COATS, SWIMSUITS, BATHING SUITS, FOULARDS;
TIES; GLOVES; HEADGEAR, NAMELY, HATS,
SCARVES AND CAPS; SHOES, SLIPPERS, SANDALS,
BOOTS (U.S. CLS. 22 AND 39).

VIVIAN MICZNIK FIRST, EXAMINING ATTORNEY

SN 76-575,081. COOLEY BRAND CLOTHING COMPANY,
GRAND RAPIDS, MI. FILED 2-9-2004.

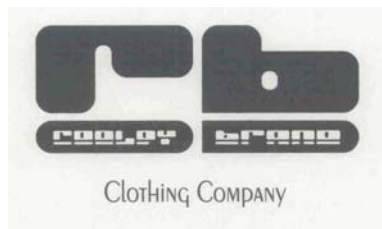

NO CLAIM IS MADE TO THE EXCLUSIVE RIGHT TO
USE "BRAND" AND "CLOTHING COMPANY", APART
FROM THE MARK AS SHOWN.

FOR JEANS, JACKETS, SWEATER, HATS, WARM-UP
SUITS, T-SHIRTS, SOCKS, PANTS NOT SUITABLE FOR
SWIMWEAR (U.S. CLS. 22 AND 39).

FIRST USE 8-3-2003; IN COMMERCE 8-3-2003.

CAROLINE WEIMER, EXAMINING ATTORNEY

CLASS 25—(Continued).

SN 76-576,822. TRACEY, ROBERT J., BROOKLYN, NY.
FILED 2-19-2004.

WHERE DID YOUR PRIDE ORIGINATE?

THE MARK CONSISTS OF STANDARD CHARACTERS
WITHOUT CLAIM TO ANY PARTICULAR FONT, STYLE,
SIZE, OR COLOR.

FOR CLOTHING, NAMELY SHIRTS, VESTS, SWEA-
TERS, SHOES, CAPS, BANDANNAS, SHORTS, SWEAT
SHIRTS, PANTS, BELTS FOR CLOTHING, SOCKS,
SWIMWEAR, JACKETS, RAINWEAR, BLOUSES,
DRESSES, FOOTWEAR, HOSIERY, SCARVES, HATS,
HEAD BANDS, PAJAMAS AND SLEEPWEAR (U.S. CLS.
22 AND 39).

PAUL F. GAST, EXAMINING ATTORNEY

SN 76-577,579. RICHARDSON, WAYNE, LEXINGTON, KY.
FILED 2-20-2004.

SOULFIST

THE MARK CONSISTS OF STANDARD CHARACTERS
WITHOUT CLAIM TO ANY PARTICULAR FONT, STYLE,
SIZE, OR COLOR.

FOR SHIRTS (U.S. CLS. 22 AND 39).

PAUL F. GAST, EXAMINING ATTORNEY

SN 76-577,837. CHAVARIN, DANIEL P., SANTEE, CA. AND
LAURIA, BLAIR A., SANTEE, CA. FILED 2-26-2004.

Demented Industries

THE MARK CONSISTS OF STANDARD CHARACTERS
WITHOUT CLAIM TO ANY PARTICULAR FONT, STYLE,
SIZE, OR COLOR.

NO CLAIM IS MADE TO THE EXCLUSIVE RIGHT TO
USE INDUSTRIES, APART FROM THE MARK AS SHOWN.

FOR SHIRTS, PANTS, SHORTS, SWEATSHIRTS,
SWEATPANTS, SWEATSHORTS, JACKETS, HATS, BEA-
NIES, SOCKS, UNDER GARMENTS, GLOVES, AND
BELTS (U.S. CLS. 22 AND 39).

ELISSA GARBER KON, EXAMINING ATTORNEY

CLASS 25—(Continued).

SN 76-577,841. ONE SPOT, INC., ST. CHARLES, MO. FILED 2-26-2004.

RACECAR SPELLED BACKWARDS IS RACECAR

THE MARK CONSISTS OF STANDARD CHARACTERS WITHOUT CLAIM TO ANY PARTICULAR FONT, STYLE, SIZE, OR COLOR.

FOR CLOTHING, NAMELY, HATS, CAPS, T-SHIRTS, SWEATSHIRTS, HOODED SWEATSHIRTS, JACKETS, JERSEYS, SHORTS, SOCKS, HEADBANDS, SHOES, TIES, SUSPENDERS, APRONS, CLOTH BIBS, PANTS, SKIRTS, SWEATERS, GLOVES, AND SCARVES (U.S. CLS. 22 AND 39).

ELISSA GARBER KON, EXAMINING ATTORNEY

SN 76-580,828. SUAREZ, BEATRICE, CHICAGO, IL. FILED 3-15-2004.

BONNIE & CLYDE NATION WIDE

THE MARK CONSISTS OF STANDARD CHARACTERS WITHOUT CLAIM TO ANY PARTICULAR FONT, STYLE, SIZE, OR COLOR.

FOR CLOTHING, NAMELY SHIRTS, T-SHIRTS, SWEATSHIRTS, JACKETS, COATS, HATS, CAPS, PANTS, AND SHORTS (U.S. CLS. 22 AND 39).

ROBERT LORENZO, EXAMINING ATTORNEY

SN 76-585,766. AMERICAN APPAREL, INC., LOS ANGELES, CA. FILED 4-8-2004.

SUSTAINABLE EDITION

THE MARK CONSISTS OF STANDARD CHARACTERS WITHOUT CLAIM TO ANY PARTICULAR FONT, STYLE, SIZE, OR COLOR.

FOR MEN'S, WOMEN'S, BOYS' AND GIRLS' WEARING APPAREL, NAMELY SHIRTS, PANTS, BLAZERS, JACKETS, VESTS, SKIRTS, SHORTS, SWEATER AND T-SHIRTS, TOGETHER WITH ALL ACCESSORIES, NAMELY BELTS, SOCKS, TIES, UNDERCLOTHING, CAPS AND HATS (U.S. CLS. 22 AND 39).

FIRST USE 7-1-2003; IN COMMERCE 7-1-2003.

STANLEY I. OSBORNE, EXAMINING ATTORNEY

CLASS 25—(Continued).

SN 76-590,839. LEMME, INGRID, MONTAUK, NY. FILED 5-7-2004.

AMERICAN DREAM BOAT

THE MARK CONSISTS OF STANDARD CHARACTERS WITHOUT CLAIM TO ANY PARTICULAR FONT, STYLE, SIZE, OR COLOR.

OWNER OF U.S. REG. NO. 2,700,256.

FOR BOATING APPAREL, NAMELY, BOAT SHOES, SHIRTS, SHOES, BATHING SUITS AND RAIN COATS (U.S. CLS. 22 AND 39).

PATRICIA EVANKO, EXAMINING ATTORNEY

SN 76-592,895. REBEL FORCES, LLC, SPARTA, NJ. FILED 5-18-2004.

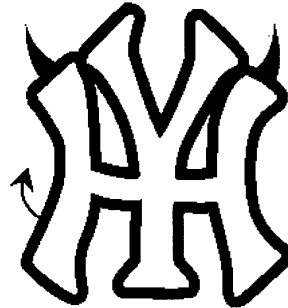

FOR BASEBALL CAPS, BATH SLIPPERS, BATHING SUITS, BATHING TRUNKS, BATH ROBES, BEACH SHOES, BEACH WEAR, BEANIES, BELTS, BERMUDA SHORTS, BOTTOMS, BOXER BRIEFS, BOXER SHORTS, BRIEFS, CAMP SHIRTS, CAPS, FLEECE PULLOVERS, FLIGHT SUITS, GOLF SHIRTS, GYM SHORTS, GYM SUITS, HATS, HEAD BANDS, HEADWEAR, HOODS, JACKETS, JERSEYS, JOGGING SUITS, JUMP SUITS, KNIT SHIRTS, MITTENS, MOCCASINS, NECKTIES, PAJAMAS, PANTS, PARKAS, POLO SHIRTS, PONCHOS, PULLOVERS, RAIN JACKETS, RAINWEAR, ROBES, SANDALS, SCARVES, SHIRT FRONTS, SHIRTS, SHORTS, SKI WEAR, SLEEPWEAR, SLIPPERS, SOCKS, SPORT SHIRTS, SUN VISORS, SURF WEAR, SUSPENDERS, SWEAT BANDS, SWEAT PANTS, SWEAT SHIRTS, SWEAT SHORTS, SWEAT SUITS, SWEATERS, SWEAT SOCKS, SWIM TRUNKS, SWIM WEAR, SWIM SUITS, TANK TOPS, T-SHIRTS, UNDERCLOTHES, UNDERSHIRTS, UNDERWEAR, VISORS, WALKING SHORTS, WARM-UP SUITS, WIND RESISTANT JACKETS AND WRIST BANDS (U.S. CLS. 22 AND 39).

FIRST USE 4-21-2004; IN COMMERCE 4-21-2004.

DEZMONA MIZELLE, EXAMINING ATTORNEY

CLASS 25—(Continued).

SN 76-592,898. REBEL FORCES, LLC, SPARTA, NJ. FILED 5-18-2004.



FOR BASEBALL CAPS, BATH SLIPPERS, BATHING SUITS, BATHING TRUNKS, BATH ROBES, BEACH SHOES, BEACH WEAR, BEANIES, BELTS, BERMUDA SHORTS, BOTTOMS, BOXER BRIEFS, BOXER SHORTS, BRIEFS, CAMP SHIRTS, CAPS, FLEECE PULLOVERS, FLIGHT SUITS, GOLF SHIRTS, GYM SHORTS, GYM SUITS, HATS, HEAD BANDS, HEADWEAR, HOODS, JACKETS, JERSEYS, JOGGING SUITS, JUMP SUITS, KNIT SHIRTS, MITTENS, MOCCASINS, NECKTIES, PAJAMAS, PANTS, PARKAS, POLO SHIRTS, PONCHOS, PULLOVERS, RAIN JACKETS, RAINWEAR, ROBES, SANDALS, SCARVES, SHIRT FRONTS, SHIRTS, SHORTS, SKI WEAR, SLEEPWEAR, SLIPPERS, SOCKS, SPORT SHIRTS, SUN VISORS, SURF WEAR, SUSPENDERS, SWEAT BANDS, SWEAT PANTS, SWEAT SHIRTS, SWEAT SHORTS, SWEAT SUITS, SWEATERS, SWEAT SOCKS, SWIM TRUNKS, SWIM WEAR, SWIM SUITS, TANK TOPS, T-SHIRTS, UNDERCLOTHES, UNDERSHIRTS, UNDERWEAR, VISORS, WALKING SHORTS, WARM-UP SUITS, WIND RESISTANT JACKETS AND WRIST BANDS (U.S. CLS. 22 AND 39).

FIRST USE 4-21-2004; IN COMMERCE 4-21-2004.
DEZMONA MIZELLE, EXAMINING ATTORNEY

CLASS 25—(Continued).

SN 76-592,899. REBEL FORCES, LLC, SPARTA, NJ. FILED 5-18-2004.

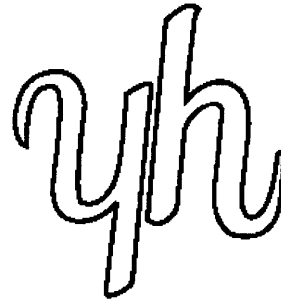

FOR BASEBALL CAPS, BATH SLIPPERS, BATHING SUITS, BATHING TRUNKS, BATH ROBES, BEACH SHOES, BEACH WEAR, BEANIES, BELTS, BERMUDA SHORTS, BOTTOMS, BOXER BRIEFS, BOXER SHORTS, BRIEFS, CAMP SHIRTS, CAPS, FLEECE PULLOVERS, FLIGHT SUITS, GOLF SHIRTS, GYM SHORTS, GYM SUITS, HATS, HEAD BANDS, HEADWEAR, HOODS, JACKETS, JERSEYS, JOGGING SUITS, JUMP SUITS, KNIT SHIRTS, MITTENS, MOCCASINS, NECKTIES, PAJAMAS, PANTS, PARKAS, POLO SHIRTS, PONCHOS, PULLOVERS, RAIN JACKETS, RAINWEAR, ROBES, SANDALS, SCARVES, SHIRT FRONTS, SHIRTS, SHORTS, SKI WEAR, SLEEPWEAR, SLIPPERS, SOCKS, SPORT SHIRTS, SUN VISORS, SURF WEAR, SUSPENDERS, SWEAT BANDS, SWEAT PANTS, SWEAT SHIRTS, SWEAT SHORTS, SWEAT SUITS, SWEATERS, SWEAT SOCKS, SWIM TRUNKS, SWIM WEAR, SWIM SUITS, TANK TOPS, T-SHIRTS, UNDERCLOTHES, UNDERSHIRTS, UNDERWEAR, VISORS, WALKING SHORTS, WARM-UP SUITS, WIND RESISTANT JACKETS AND WRIST BANDS (U.S. CLS. 22 AND 39).

FIRST USE 4-21-2004; IN COMMERCE 4-21-2004.
DEZMONA MIZELLE, EXAMINING ATTORNEY

SN 76-593,781. BOOT ROYALTY COMPANY, L.P., FORT WORTH, TARRANT COUNTY, TX. FILED 5-24-2004.

EL REY DE BOTAS

THE MARK CONSISTS OF STANDARD CHARACTERS WITHOUT CLAIM TO ANY PARTICULAR FONT, STYLE, SIZE, OR COLOR.

NO CLAIM IS MADE TO THE EXCLUSIVE RIGHT TO USE "BOTAS", APART FROM THE MARK AS SHOWN.

THE ENGLISH TRANSLATION OF EL REY DE BOTAS IS "KING OF BOOTS".

FOR FOOTWEAR, NAMELY, BOOTS (U.S. CLS. 22 AND 39).

SAMUEL E. SHARPER JR., EXAMINING ATTORNEY

CLASS 25—(Continued).

SN 76-593,931. BBC ICE CREAM, LLC, NEW YORK, NY.
FILED 5-18-2004.



FOR CLOTHING, NAMELY, SHIRTS, T-SHIRTS, UNDER SHIRTS, NIGHT SHIRTS, RUGBY SHIRTS, POLO SHIRTS, CARDIGANS, JERSEYS, UNIFORMS, ATHLETIC UNIFORMS, PANTS, TROUSERS, SLACKS, JEANS, DENIM JEANS, OVERALLS, COVERALLS, JUMPERS, JUMP SUITS, SHORTS, BOXER SHORTS, TOPS, CROP TOPS, TANK TOPS, HALTER TOPS, SWEAT SHIRTS, SWEAT SHORTS, SWEAT PANTS, WRAPS, WARM-UP SUITS, JOGGING SUITS, TRACK SUITS, BLOUSES, SKIRTS, DRESSES, GOWNS, SWEATERS, VESTS, FLEECE VESTS, PULLOVERS, SNOW SUITS, PARKAS, CAPES, ANORAKS, PONCHOS, JACKETS, REVERSIBLE JACKETS, COATS, BLAZERS, SUITS, TURTLENECKS, CLOTH SKI BIBS, SWIMWEAR, BEACHWEAR, TENNIS WEAR, SURF WEAR, SKI WEAR, INFANTWEAR, BABY BIBS NOT OF PAPER, CAPS, SWIM CAPS, BERETS, BEANIES, HATS, VISORS, HEADBANDS, WRIST BANDS, SWEAT BANDS, HEADWEAR, EAR MUFFS, APRONS, SCARVES, BANDANAS, BELTS, SUSPENDERS, NECKWEAR, NECKTIES, TIES, NECKERCHIEFS, ASCOTS, UNDERWEAR, BRIEFS, SWIM AND BATHING TRUNKS, BRAS, SPORTS BRAS, BRASSIERES, BUSTIERS, CORSETS, PANTIES, GARTERS AND GARTER BELTS, TEDDIES, GIRDLES, FOUNDATION GARMENTS, SINGLET, SOCKS, LOUNGEWEAR, ROBES, BATHROBES, UNDERCLOTHES, PJAMAS, SLEEPWEAR, NIGHT GOWNS, LINGERIE, CAMISOLES, NEGLIGEEES, CHEMISES, CHEMISSETTES, SLIPS, SARONGS, LEG WARMERS, HOSIERY, PANTYHOSE, BODY STOCKINGS, KNEE HIGHS, LEGGINGS, TIGHTS, LEOTARDS, BODY SUITS, UNITARDS, BODY SHAPERS, GLOVES, MITTENS, FOOTWEAR, SHOES, SNEAKERS, BOOTS, GALOSHES, SANDALS, ZORI, SLIPPERS AND RAINWEAR (U.S. CLS. 22 AND 39).

RAUL CORDOVA, EXAMINING ATTORNEY

SN 76-595,556. SHRAM, MOSHE, LOS ANGELES, CA. FILED
6-4-2004.

CYBERZONE

THE MARK CONSISTS OF STANDARD CHARACTERS WITHOUT CLAIM TO ANY PARTICULAR FONT, STYLE, SIZE, OR COLOR.

OWNER OF U.S. REG. NOS. 2,134,119, 2,157,358 AND 2,235,302.

FOR MEN'S, WOMEN'S, AND CHILDREN'S CLOTHING, NAMELY, COATS, JACKETS, UNDERWEAR, UNDERSHIRTS, T-SHIRTS, PLASTIC AND LEATHER FOOTWEAR, BLOUSES, BOTTOMS, SKIRTS, DRESSES, SHIRTS, PANTS, SHORTS, AND TOPS (U.S. CLS. 22 AND 39).

FIRST USE 2-1-1997; IN COMMERCE 2-1-1997.

JERI J. FICKES, EXAMINING ATTORNEY

CLASS 25—(Continued).

SN 76-596,137. THATS INTERNATIONAL, LTD., KATONAH, NY. FILED 6-8-2004.

REALFLEX

THE MARK CONSISTS OF STANDARD CHARACTERS WITHOUT CLAIM TO ANY PARTICULAR FONT, STYLE, SIZE, OR COLOR.

FOR HEADWEAR, NAMELY, HATS, CAPS AND VISORS (U.S. CLS. 22 AND 39).

NICHOLAS ALTREE, EXAMINING ATTORNEY

SN 76-596,644. TURNER, COLLIE C., JR., SAN JOSE, CA.
FILED 6-10-2004.

N

FOR CLOTHING, NAMELY, CASUAL HATS, CAPS, T-SHIRTS, SHOES AND HEADBANDS (U.S. CLS. 22 AND 39).

MARGERY A. TIERNEY, EXAMINING ATTORNEY

SN 76-597,335. OFFICIAL STARTER, LLC, COLUMBUS, OH.
FILED 6-15-2004.

HALL OF HEROES

THE MARK CONSISTS OF STANDARD CHARACTERS WITHOUT CLAIM TO ANY PARTICULAR FONT, STYLE, SIZE, OR COLOR.

FOR CLOTHING AND WEARING APPAREL, NAMELY, SHIRTS, SHORTS, PANTS, COATS, JACKETS, WIND-RESISTANT SUITS, JOGGING SUITS, SWEATERS AND HEADWEAR (U.S. CLS. 22 AND 39).

H. M. FISHER, EXAMINING ATTORNEY

CLASS 25—(Continued).

SN 76-597,528. PREMIER CONCEPTS GROUP, INC., SUWANEE, GA. FILED 6-14-2004.



FOR CLOTHING, NAMELY ATHLETIC JERSEYS AND SHORTS, CAPS, HATS, SHIRTS, PANTS, T-SHIRTS, JACKETS, WARM UP SUITS, GOLF SHIRTS, SWEAT SHIRTS, SWEAT PANTS, SWEAT SHORTS, SWEAT SUITS, SWEAT BANDS, HEADBANDS AND SOCKS (U.S. CLS. 22 AND 39).
FIRST USE 3-10-2003; IN COMMERCE 7-7-2003.
MICHAEL KAZAZIAN, EXAMINING ATTORNEY

CLASS 25—(Continued).

SN 76-597,661. AHTEs, WILLIAM J., SALISBURY, MD. FILED 6-16-2004.



OWNER OF U.S. REG. NO. 2,336,783.
FOR CLOTHING, NAMELY, SHIRTS, HATS, CAPS, VISORS, SWEATPANTS, PANTS, GLOVES, TIES, HEADBANDS, WRIST BANDS (U.S. CLS. 22 AND 39).
EVELYN BRADLEY, EXAMINING ATTORNEY

SN 76-597,905. EVEDEN INC., BOSTON, MA. FILED 6-17-2004.

FREYA

SN 76-597,660. AHTEs, WILLIAM J., SALISBURY, MD. FILED 6-16-2004.

THE MARK CONSISTS OF STANDARD CHARACTERS WITHOUT CLAIM TO ANY PARTICULAR FONT, STYLE, SIZE, OR COLOR.
OWNER OF U.S. REG. NO. 2,319,284.
FOR SWIMWEAR, BEACHWEAR, BIKINIS, BATHING SUITS (U.S. CLS. 22 AND 39).
JOHN GARTNER, EXAMINING ATTORNEY

SN 76-597,906. EVEDEN INC., BOSTON, MA. FILED 6-17-2004.

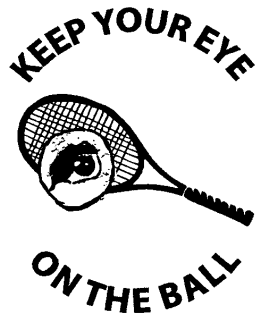

FANTASIE

OWNER OF U.S. REG. NO. 2,336,783.
FOR CLOTHING, NAMELY, SHIRTS, HATS, CAPS, VISORS, SWEATERS, PANTS, GLOVES, TIES, HEADBANDS, WRIST BANDS (U.S. CLS. 22 AND 39).
EVELYN BRADLEY, EXAMINING ATTORNEY

THE MARK CONSISTS OF STANDARD CHARACTERS WITHOUT CLAIM TO ANY PARTICULAR FONT, STYLE, SIZE, OR COLOR.
OWNER OF U.S. REG. NOS. 2,403,415 AND 2,447,377.
FOR SWIMWEAR, BEACHWEAR, BIKINIS, BATHING SUITS (U.S. CLS. 22 AND 39).
JOHN GARTNER, EXAMINING ATTORNEY

CLASS 25—(Continued).

SN 76-598,167. GENEXUS INTERNATIONAL, INC., INGLEWOOD, CA. FILED 6-18-2004.

OME I

THE MARK CONSISTS OF STANDARD CHARACTERS WITHOUT CLAIM TO ANY PARTICULAR FONT, STYLE, SIZE, OR COLOR.

FOR MEN'S WEARING APPAREL, NAMELY, T-SHIRTS, SWEATSHIRTS, TANK TOPS, WOVEN SHIRTS, SWEATERS, CARDIGANS, VESTS, JACKETS, PANTS, SWEATPANTS, JEANS, SHORTS, HATS, CAPS, COATS, PAJAMAS, SHOES, SOCKS, AND UNDERWEAR; AND WOMEN'S WEARING APPAREL, NAMELY, T-SHIRTS, SWEATSHIRTS, TANK TOPS, WOVEN SHIRTS, SWEATERS, CARDIGANS, VESTS, JACKETS, PANTS, SWEATPANTS, JEANS, SHORTS, HATS, CAPS, COATS, PAJAMAS, SHOES, SKIRTS, DRESSES, BLOUSES, SOCKS, LINGERIE, UNDERWEAR, PANTYHOSE, HOSIERY, TEDDIES, BRAS, PANTIES, SLIPS, FOUNDATIONS GARMENTS, GIRDLES, ROBES, AND LOUNGEWEAR (U.S. CLS. 22 AND 39).

KAREN K. BUSH, EXAMINING ATTORNEY

CLASS 25—(Continued).

SN 76-598,772. BARAN, STEFAN, SANTA MONICA, CA. FILED 6-21-2004.

SAND SKINS

THE MARK CONSISTS OF STANDARD CHARACTERS WITHOUT CLAIM TO ANY PARTICULAR FONT, STYLE, SIZE, OR COLOR.

NO CLAIM IS MADE TO THE EXCLUSIVE RIGHT TO USE "SAND", APART FROM THE MARK AS SHOWN.

FOR BEACH FOOTWEAR, NAMELY RESILIENT ATHLETIC BEACH SHOES FOR PROTECTING THE USERS' FEET FROM SAND ABRASION (U.S. CLS. 22 AND 39).

ELIZABETH PIGNATELLO, EXAMINING ATTORNEY

SN 76-598,189. RUBENSTEIN BROS., INC., NEW ORLEANS, LA. FILED 6-18-2004.

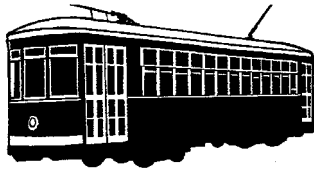

THE MARK CONSISTS OF STREET CAR DESIGN.

FOR SHIRTS, DRESS SHIRTS, KNIT SHIRTS, SPORT SHIRTS, SWEAT SHIRTS, WINDSHIRTS, TURTLENECKS, T-SHIRTS, PANTS, SHORTS, CAPS, HATS, VISORS, SWEATERS, CARDIGANS, SOCKS, JACKETS, JEANS, NECKWEAR, AND TIES (U.S. CLS. 22 AND 39).

KATHY DE JONGE, EXAMINING ATTORNEY

GRAND STREET CLOTHING COMPANY

THE MARK CONSISTS OF STANDARD CHARACTERS WITHOUT CLAIM TO ANY PARTICULAR FONT, STYLE, SIZE, OR COLOR.

NO CLAIM IS MADE TO THE EXCLUSIVE RIGHT TO USE "CLOTHING COMPANY", APART FROM THE MARK AS SHOWN.

FOR MEN'S, WOMEN'S AND CHILDREN'S CLOTHING NAMELY SUITS, DRESSES, BLOUSES, SKIRTS, SHIRTS, PANTS, SHORTS, SWEATSHIRTS, SWEATERS, SLEEPWEAR, UNDERWEAR, VESTS, SWIMWEAR, HATS, SHOES, SOCKS, HEADWEAR, PULLOVERS, COATS, GLOVES, JACKETS, WAISTCOATS, RAINCOATS (U.S. CLS. 22 AND 39).

TARAH HARDY, EXAMINING ATTORNEY

SN 76-598,190. RUBENSTEIN BROS., INC., NEW ORLEANS, LA. FILED 6-18-2004.

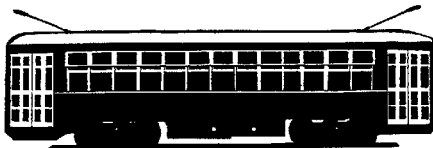

THE MARK CONSISTS OF STREET CAR DESIGN.

FOR SHIRTS, DRESS SHIRTS, KNIT SHIRTS, SPORT SHIRTS, SWEAT SHIRTS, WINDSHIRTS, TURTLENECKS, T-SHIRTS, PANTS, SHORTS, CAPS, HATS, VISORS, SWEATERS, CARDIGANS, SOCKS, JACKETS, JEANS, NECKWEAR, AND TIES (U.S. CLS. 22 AND 39).

KATHY DE JONGE, EXAMINING ATTORNEY

SN 78-204,108. DOG MAFIA, INC., TAMARAC, FL. FILED 1-16-2003.

DOG MAFIA

FOR CLOTHING AND APPAREL NAMELY BELTS, CAMP SHIRTS, CAPS, DUSTERS, GOLF SHIRTS, HATS, HOODS, JACKETS, JERSEYS, KNIT SHIRTS, NIGHT SHIRTS, PANTS, POLO SHIRTS, SHIRTS, SKIRTS, SPORT SHIRTS, SHORTS SETS, SOCKS, SWEAT PANTS, SWEAT SHIRTS, SWEATERS, T-SHIRTS, TOPS, AND WRAPS (U.S. CLS. 22 AND 39).

FIRST USE 2-3-2003; IN COMMERCE 3-1-2003.

JEFFERY COWARD, EXAMINING ATTORNEY

CLASS 25—(Continued).

SN 78-221,092. MOTION WEAR (BVI) LIMITED, ROAD TOWN, TORTOLA, BR. VIRGIN ISLANDS, FILED 3-3-2003.



THE MARK CONSISTS OF A FANCY DESIGN OF A LETTER "A" ENCLOSED INSIDE A CURVE.

FOR CLOTHING, NAMELY, SHIRTS, SUITS, JEANS, TOPCOATS, TROUSERS, JACKETS, SWEATERS AND DRESS; SHOES; BOOTS; GAITERS; SANDALS; SPORT SHOES; HATS (U.S. CLS. 22 AND 39).

FIRST USE 11-1-2002; IN COMMERCE 11-1-2002.
ESTHER A. BORSUK, EXAMINING ATTORNEY

SN 78-232,565. JUSTERINI & BROOKS LIMITED, LONDON, UNITED KINGDOM, FILED 4-1-2003.



FOR CLOTHING, NAMELY JEANS, VESTS, SHIRTS, SWEATSHIRTS, T-SHIRTS, RUGBY JERSEYS, POLO KNITTED TOPS, TRACK PANTS, FLEECE TOPS AND TROUSERS, SHORTS, SWIMSUITS, PAJAMAS, NIGHT DRESSES, BOXER SHORTS, SOCKS, HEAD BANDS, WRIST BANDS, SCARVES, NECK TIES, BELTS, SHOES, BOOTS, STOCKINGS, TIGHTS, GLOVES, SPORTS FOOTWEAR, BODY WARMERS, SUITS, OVERALLS, AND WATERPROOF CLOTHING, NAMELY, JACKETS, COATS, PANTS, AND UNIFORMS (U.S. CLS. 22 AND 39).
BRIDGETT SMITH, EXAMINING ATTORNEY

CLASS 25—(Continued).

SN 78-242,924. ABDUL, PAULA, NEW YORK, NY. FILED 4-28-2003.

RAH!

FOR CLOTHING, NAMELY, SHIRTS, T-SHIRTS, UNDER SHIRTS, NIGHT SHIRTS, RUGBY SHIRTS, POLO SHIRTS, JERSEYS, UNIFORMS, ATHLETIC UNIFORMS, PANTS, TROUSERS, SLACKS, JEANS, DENIM JEANS, OVERALLS, COVERALLS, JUMPERS, JUMP SUITS, SHORTS, BOXER SHORTS, TOPS, CROP TOPS, TANK TOPS, HALTER TOPS, SWEAT SHIRTS, SWEAT SHORTS, SWEAT PANTS, WRAPS, WARM-UP SUITS, JOGGING SUITS, BLOUSES, SKIRTS, DRESSES, SWEATERS, VESTS, FLEECE VESTS, PULLOVERS, SNOW SUITS, PARKAS, ANORAKS, PONCHOS, JACKETS, REVERSIBLE JACKETS, COATS, BLAZERS, SUITS, TURTLENECKS, SKI BIBS, SWIMWEAR, BEACHWEAR, INFANTWEAR, BABY BIBS NOT OF PAPER, CAPS, BERETS, BEANIES, HATS, VISORS, HEADBANDS, WRIST BANDS, SWEAT BANDS, HEADWEAR, EAR MUFFS, APRONS, SCARVES, BANDANAS, BELTS, SUSPENDERS, NECKWEAR, NECKTIES, TIES, UNDERWEAR, BRIEFS, SWIMMING AND BATHING TRUNKS, BRAS, SPORTS BRAS, BRASSIERES, BUSTIERS, CORSETS, PANTIES, GARTERS AND GARTER BELTS, TEDDIES, GIRDLES, FOUNDATION GARMENTS, SINGLET, SOCKS, LOUNGEWEAR, ROBES, BATHROBES, UNDERCLOTHES, PAJAMAS, SLEEPWEAR, NIGHT GOWNS, LINGERIE, CAMISOLES, NEGLIGEEES, SLIPS, SARONGS, LEG WARMERS, HOSIERY, KNEE HIGHS, LEGGINGS, TIGHTS, LEOTARDS, BODY SUITS, UNITARDS, BODY SHAPERS, GLOVES, MITTENS, FOOTWEAR, SHOES, SNEAKERS, BOOTS, GALOSHES, SANDALS, ZORI, SLIPPERS AND RAINWEAR (U.S. CLS. 22 AND 39).
BRETT J. GOLDEN, EXAMINING ATTORNEY

SN 78-251,972. HAWKS, KELLEY MICHELLE, SAN FRANCISCO, CA. FILED 5-20-2003.



FOR CLOTHING, NAMELY, APRONS, JACKETS, SHIRTS AND HATS (U.S. CLS. 22 AND 39).
FIRST USE 6-3-2000; IN COMMERCE 6-3-2000.
GIANCARLO CASTRO, EXAMINING ATTORNEY

CLASS 25—(Continued).

SN 78-259,100. FIKSE, JULIA C., WOODLAND HILLS, CA.
FILED 6-6-2003.



NO CLAIM IS MADE TO THE EXCLUSIVE RIGHT TO USE ANGELS, APART FROM THE MARK AS SHOWN.
FOR DRESSES, SKIRTS, SHIRTS, MASQUERADE COSTUMES-NAMELY HALOS, JACKETS, SWEATERS, PANTS AND SHORTS (U.S. CLS. 22 AND 39).
FIRST USE 2-1-2003; IN COMMERCE 3-3-2003.
YSA DEJESUS, EXAMINING ATTORNEY

SN 78-268,085. BELLE GROUP USA LLC, NEW YORK, NY.
FILED 6-27-2003.

BELLE
USA

NO CLAIM IS MADE TO THE EXCLUSIVE RIGHT TO USE USA, APART FROM THE MARK AS SHOWN.
THE ENGLISH TRANSLATION OF THE WORD BELLE IN THE MARK IS BEAUTIFUL.
FOR SHOES (U.S. CLS. 22 AND 39).
FIRST USE 10-3-2002; IN COMMERCE 10-3-2002.
MARY BOAGNI, EXAMINING ATTORNEY

SN 78-269,775. VANITY FAIR, INC., WILMINGTON, DE.
FILED 7-2-2003.

BODY CASUALS

OWNER OF U.S. REG. NOS. 1,930,975, 2,583,300 AND OTHERS.
NO CLAIM IS MADE TO THE EXCLUSIVE RIGHT TO USE "CASUALS", APART FROM THE MARK AS SHOWN.
FOR LINGERIE (U.S. CLS. 22 AND 39).
FIRST USE 8-6-2001; IN COMMERCE 8-6-2001.
KHANH LE, EXAMINING ATTORNEY

CLASS 25—(Continued).

SN 78-272,329. CHRISTINA AMERICA INC., MONTREAL QUEBEC, CANADA, FILED 7-9-2003.

FANTASIZER

PRIORITY CLAIMED UNDER SEC. 44(D) ON CANADA APPLICATION NO. 1180316, FILED 6-16-2003, REG. NO. TMA627700, DATED 12-7-2004, EXPIRES 12-7-2019.
FOR SWIMWEAR AND BEACHWEAR, NAMELY, SWIMSUITS, PAREOS, BEACH COVERUPS, SHORTS, SHIRTS, TOPS, JACKETS AND T-SHIRTS (U.S. CLS. 22 AND 39).
VERNA BETH RIRIE, EXAMINING ATTORNEY

SN 78-273,606. OKPAKU, TEMISAN F., LOS ANGELES, CA.
FILED 7-13-2003.

OBAKU

FOR ATHLETIC CLOTHING, NAMELY, T-SHIRTS, SWEATSHIRTS, BASEBALL CAPS, KNIT CAPS, SWEAT-PANTS, SOCKS AND ATHLETIC FOOTWEAR (U.S. CLS. 22 AND 39).
SUSAN LESLIE DUBOIS, EXAMINING ATTORNEY

SN 78-276,223. KABUSHIKI KAISHA NARUMIYA INTERNATIONAL, TOKYO, JAPAN, FILED 7-18-2003.

DAISY LOVERS

FOR CLOTHING FOR BABIES AND CHILDREN, NAMELY, HATS, CAPS, BANDANAS, SCARVES, NECK-TIES, MUFFLERS, WRIST BANDS, SHIRTS, T-SHIRTS, TANK TOPS, BLOUSES, PULLOVERS, TOPS, SUITS, JACKETS, PARKAS, COATS, SWEATERS, VESTS, SWEAT SHIRTS, PANTS, SLACKS, JEANS, OVERALLS, SWEAT PANTS, SHORTS, BOTTOMS, SKIRTS, DRESSES, GOWNS, BOXER SHORTS, UNDER SHORTS, UNDER-PANTS, BRAS, LINGERIE, PANTYHOSE, SOCKS, HOSIERY, STOCKINGS, GLOVES, MITTENS, SWIMWEAR, RAINWEAR, BEACHWEAR, SWIM SUITS, TIGHTS, PAJAMAS, ROBES, SLEEPWEAR AND LOUNGEWEAR; GARTER BELTS; SOCK SUSPENDERS; SUSPENDERS; CLOTHING WAISTBANDS; BELTS FOR CLOTHING; FOOTWEAR (U.S. CLS. 22 AND 39).
TRACY CROSS, EXAMINING ATTORNEY

CLASS 25—(Continued).

SN 78-294,310. DISNEY ENTERPRISES, INC., BURBANK, CA. FILED 8-29-2003.



OWNER OF U.S. REG. NOS. 2,415,566, 2,623,099 AND OTHERS.

FOR BATHING SUITS; BEACHWEAR; BELTS; CLOTH BIBS FOR BABIES; UNDERWEAR; SWEATERS; HALLOWEEN COSTUMES; DRESSES; GLOVES; HATS; CAPS; HOSIERY; INFANT WEAR; JACKETS; MITTENS; PAJAMAS; PANTS; SWEAT PANTS; SWEAT SHIRTS; SHIRTS; SHOES; SHORTS; SLEEPERS; SOCKS; T-SHIRTS; TANK TOPS; TIGHTS; VESTS; JERSEYS; SCARVES; NECKTIES; ROBES; NIGHT SHIRTS; NIGHT GOWNS; HEAD BANDS; WRIST BANDS; SKIRTS; COATS; LEOTARDS; LEG WARMERS; STOCKINGS; PANTY HOSE; ATHLETIC SHOES; SLIPPERS; BOOTS; SANDALS AND RAINWEAR (U.S. CLS. 22 AND 39).

PAUL F. GAST, EXAMINING ATTORNEY

CLASS 25—(Continued).

SN 78-302,200. CHOI, YON-GU, DONGRAE-GU, BUSAN, REPUBLIC OF KOREA, FILED 9-18-2003.



NO CLAIM IS MADE TO THE EXCLUSIVE RIGHT TO USE "NEW & OUTERWEAR" AND "BREATHABLE", APART FROM THE MARK AS SHOWN.

FOR RAINWEAR, WATERPROOF CLOTHING, NAMELY, RAINCOATS, PARKAS, JUMPERS, UNIFORMS FOR SPORTS, T-SHIRTS, JACKETS, OVER TROUSERS; CLOTHES FOR MOUNTAIN CLIMBING, NAMELY, JACKETS, TOPS, BOTTOMS, PANTS, HEADWEAR, SOCKS, FOOTWEAR (U.S. CLS. 22 AND 39).

DARRYL SPRULL, EXAMINING ATTORNEY

SN 78-307,686. UNITED STATES POSTAL SERVICE, WASHINGTON, DC. FILED 9-30-2003.

SN 78-299,920. MARQUES ASSOCIEES, F-49280 LA SEGUI-NIERE, FRANCE, FILED 9-12-2003.



616

OWNER OF FRANCE REG. NO. 033208797, DATED 2-10-2003, EXPIRES 2-10-2013.

FOR CHILDREN'S SHIRTS, TEE-SHIRTS, BLOUSES, PULLOVERS, TROUSERS, OVERALLS, ROMPERS, ANORAKS, SKIRTS, DRESSES, JACKETS; WINDCHEATERS, RAINCOATS, COATS, PAJAMAS, NIGHTDRESSES, UNDERWEAR, TIGHTS, SOCKS, SLIPPERS, SWIMSUITS, ACCESSORIES, NAMELY, BELTS, GLOVES, HEADBANDS, SCARVES, TIES, BOW TIES, SHOES, HATS AND HOSIERY (U.S. CLS. 22 AND 39).

FLORENTINA BLANDU, EXAMINING ATTORNEY

THE MARK CONSISTS OF, IN PART, OF STYLIZED HUMAN LIPS.

FOR CLOTHING FOR MEN, WOMEN, AND CHILDREN, NAMELY T-SHIRTS, TANK TOPS, LONG-SLEEVE SHIRTS, SHIRTS, BLOUSES, SWEATERS, JACKETS, COATS, SHORTS, PANTS, JEANS, SWEATSHIRTS, SWEATPANTS, SWEATSUITS, FLEECE WARMUP SUITS, OVERALLS, SKIRTS, DRESSES, SLEEPWEAR, UNDERWEAR, SOCKS, SHOES, SCARVES, HATS, VISORS, HEADBANDS, FOOTWEAR, AND HEADWEAR (U.S. CLS. 22 AND 39).

JEFFERY COWARD, EXAMINING ATTORNEY

CLASS 25—(Continued).

SN 78-313,250. INDIANO, I. MICHAEL, YARDLEY, RI. AND VEROLA, THOMAS, UPPER SADDLE RIVER, NJ. AND INDIANO, BARBARA, YARDLEY, PA. FILED 10-14-2003.

CLASS 25—(Continued).

SN 78-323,820. KIM, DAIGON, GLENDALE, CA. FILED 11-6-2003.

MICROSILVERWEAR

FOR WEARING APPAREL, NAMELY, JEANS, SWEATERS, SHIRTS, SHORTS, PANTS JACKETS, UNDERGARMENTS, LINGERIE, SOCKS, TIES, BELTS (U.S. CLS. 22 AND 39).

KIMBERLY PERRY, EXAMINING ATTORNEY

Asiatic Soul

SN 78-316,594. DISNEY ENTERPRISES, INC., BURBANK, CA. FILED 10-21-2003.

WALT DISNEY WORLD

OWNER OF U.S. REG. NOS. 980,995, 1,189,727 AND 2,189,177.

THE NAME IN THE MARK DOES NOT IDENTIFY A PARTICULAR LIVING INDIVIDUAL.

FOR BATHING SUITS; BEACHWEAR; BELTS; CLOTH BIBS FOR BABIES; UNDERWEAR; SWEATERS; HALLOWEEN COSTUMES; DRESSES; GLOVES; HATS; CAPS; HOSIERY; INFANT WEAR; JACKETS; MITTENS; PAJAMAS; PANTS; SWEAT PANTS; SWEAT SHIRTS; SHIRTS; SHOES; SHORTS; SLEEPERS; SOCKS; T-SHIRTS; TANK TOPS; TIGHTS; VESTS; JERSEYS; SCARVES; NECKTIES; ROBES; NIGHT SHIRTS; NIGHT GOWNS; HEAD BANDS; WRIST BANDS; SKIRTS; COATS; LEOTARDS; LEG WARMERS; STOCKINGS; PANTY HOSE; ATHLETIC SHOES; SLIPPERS; BOOTS; SANDALS; RAINWEAR (U.S. CLS. 22 AND 39).

PAUL F. GAST, EXAMINING ATTORNEY

THE MARK CONSISTS OF STANDARD CHARACTERS WITHOUT CLAIM TO ANY PARTICULAR FONT, STYLE, SIZE, OR COLOR.

OWNER OF U.S. REG. NO. 2,872,668.

NO CLAIM IS MADE TO THE EXCLUSIVE RIGHT TO USE "ASIATIC", APART FROM THE MARK AS SHOWN.

FOR CLOTHING, NAMELY, JERSEYS, UNIFORMS, ATHLETIC UNIFORMS, PANTS, CYCLE PANTS, TROUSERS, SLACKS, JEANS, DENIM JEANS, OVERALLS, COVERALLS, JUMPERS, JUMP SUITS, SHORTS, BOXER SHORTS, SHIRTS, T-SHIRTS, UNDER SHIRTS, NIGHT SHIRTS, RUGBY SHIRTS, POLO SHIRTS, TOPS, CROP TOPS, TANK TOPS, HALTER TOPS, SWEAT SHIRTS, SWEAT SHORTS, SWEAT PANTS, WARM-UP SUITS, JOGGING SUITS, BLOUSES, SKIRTS, DRESSES, SWEATERS, VESTS, FLEECE VESTS, PULLOVERS, FLEECE PULLOVERS, SNOW SUITS, PARKAS, ANORAKS, PONCHOS, JACKETS, DINNER JACKETS, SPORTS JACKETS, MOTORCYCLE JACKETS, GOLF AND SKI JACKETS, REVERSIBLE JACKETS, COATS, BLAZERS, SUITS, TURTLENECKS, SWIMWEAR, BEACHWEAR, CAPS, BERETS, HATS, HEADBANDS, WRIST BANDS, HEADWEAR, EAR MUFFS, APRONS, SCARVES, BANDANAS, BELTS, SUSPENDERS, NECKWEAR, NECKTIES, TIES, BOW TIES, CLOTH BABY BIBS, CLOTH SKI BIBS, CLOTH DIAPERS, BOOTIES, INFANTWEAR, UNDERWEAR, BRIEFS, TRUNKS, BRAS, SPORTS BRAS, SINGLETS, SOCKS, LOUNGEWEAR, ROBES, BATHROBES, PAJAMAS, SLEEPWEAR, NIGHT GOWNS, LINGERIE, CAMISOLES, SLIPS, STOCKINGS, BODY STOCKINGS, PANTYHOSE, HOSIERY, KNIT HOSIERY, LEG WARMERS, BODYSUITS, LEGGINGS, TIGHTS, LEOTARDS, UNITARDS, GLOVES, MITTENS, FOOTWEAR, SHOES, SNEAKERS, BOOTS, GALOSHES, SANDALS, ZORI, SLIPPERS AND RAINWEAR (U.S. CLS. 22 AND 39).

NELSON SNYDER, EXAMINING ATTORNEY

CLASS 25—(Continued).

SN 78-327,132. CORBALEY, STACIE L., POWAY, CA. FILED 11-12-2003.

HOTMOM

THE MARK CONSISTS OF STANDARD CHARACTERS WITHOUT CLAIM TO ANY PARTICULAR FONT, STYLE, SIZE, OR COLOR.

FOR CUSTOMIZED T-SHIRTS, TANK TOPS AND SWEATSHIRTS FOR WOMEN (U.S. CLS. 22 AND 39).
RONALD MCMORROW, EXAMINING ATTORNEY

CLASS 25—(Continued).

SN 78-327,217. BELLA SCARPA, DULUTH, GA. FILED 11-13-2003.

Bella Scarpa

Bella Scarpa

THE MARK CONSISTS OF STANDARD CHARACTERS WITHOUT CLAIM TO ANY PARTICULAR FONT, STYLE, SIZE, OR COLOR.

NO CLAIM IS MADE TO THE EXCLUSIVE RIGHT TO USE SCARPA, APART FROM THE MARK AS SHOWN.

THE ENGLISH TRANSLATION OF BELLA SCARPA IS "BEAUTIFUL SHOE".

FOR WOMENS SHOES (U.S. CLS. 22 AND 39).
JAMES GRIFFIN, EXAMINING ATTORNEY

SN 78-327,240. INDUS APPAREL, U.S.A, INC., NEW YORK, NY. FILED 11-13-2003.

SN 78-327,167. STEWART, GARY, DULUTH, GA. FILED 11-13-2003.



Urban Stylz

NO CLAIM IS MADE TO THE EXCLUSIVE RIGHT TO USE "URBAN STYLE", APART FROM THE MARK AS SHOWN.

THE COLOR(S) YELLOW AND BLACK ARE CLAIMED AS FEATURES OF THE MARK

THE COLOR YELLOW APPEARS ON THE HIKING BOOTS AND THE STICK FIGURES IN THE MARK APPEAR IN THE COLOR BLACK.

FOR CLOTHING APPAREL, NAMELY, SHIRTS, HATS, JACKETS, UNDERGARMENTS, FOOTWEAR, SWEAT PANTS, SWEAT SUITS, BANDANAS AND PANTS (U.S. CLS. 22 AND 39).

FIRST USE 1-6-2003; IN COMMERCE 5-3-2003.
CHARLES JOYNER, EXAMINING ATTORNEY

Halle Sport

THE MARK CONSISTS OF STANDARD CHARACTERS WITHOUT CLAIM TO ANY PARTICULAR FONT, STYLE, SIZE, OR COLOR.

NO CLAIM IS MADE TO THE EXCLUSIVE RIGHT TO USE SPORT, APART FROM THE MARK AS SHOWN.

FOR LADIES KNITTED AND WOVEN SHIRTS, BLOUSES, PANTS AND SKIRTS (U.S. CLS. 22 AND 39).

FIRST USE 11-13-2003; IN COMMERCE 11-13-2003.
DAWN FELDMAN, EXAMINING ATTORNEY

SN 78-329,698. WATLING, DAVID, BROADSTAIRS, KENT, UNITED KINGDOM, FILED 11-18-2003.



MD
MILLION DOLLAR

OWNER OF ERPN CMNTY TM OFC REG. NO. 1080845, DATED 5-29-2000, EXPIRES 2-18-2009.

FOR MEN'S AND WOMEN'S CLOTHING, NAMELY, SHIRTS, T-SHIRTS, SWEATSHIRTS, PANTS, JACKETS, SWEATERS, SHOES, HATS, SCARVES AND BELTS (U.S. CLS. 22 AND 39).

LINDA MICKLEBURGH, EXAMINING ATTORNEY

CLASS 25—(Continued).

SN 78-330,731. COLUMBIA SPORTSWEAR NORTH AMERICA, INC., PORTLAND, OR. FILED 11-20-2003.



THE MARK CONSISTS OF THE STYLIZED LETTERS DH, CATTAIL, DUCK IN FLIGHT.

FOR PARKAS; JACKETS; PANTS; SHIRTS; HATS; GLOVES; BIB OVERALLS; SHELLS, NAMELY, OUTERWEAR IN THE NATURE OF PANTS AND SHIRTS; LINERS FOR PANTS AND JACKETS (U.S. CLS. 22 AND 39).

FIRST USE 10-1-1999; IN COMMERCE 10-1-1999.
KELLEY WELLS, EXAMINING ATTORNEY

SN 78-332,467. DANI DRURY BERRONG, HENDERSON, KY. FILED 11-24-2003.

Hemp Huggers

THE MARK CONSISTS OF STANDARD CHARACTERS WITHOUT CLAIM TO ANY PARTICULAR FONT, STYLE, SIZE, OR COLOR.

NO CLAIM IS MADE TO THE EXCLUSIVE RIGHT TO USE "HEMP", APART FROM THE MARK AS SHOWN.

FOR LOW-RISE HEMP OR HEMP-BLEND DENIM PANTS (U.S. CLS. 22 AND 39).

LINDA MICKLEBURGH, EXAMINING ATTORNEY

SN 78-333,615. MENTAL FLOSS, LLC, HOOVER, AL. FILED 11-26-2003.

MENTAL FLOSS

THE MARK CONSISTS OF STANDARD CHARACTERS WITHOUT CLAIM TO ANY PARTICULAR FONT, STYLE, SIZE, OR COLOR.

OWNER OF U.S. REG. NO. 2,562,547.

FOR CLOTHING, NAMELY, SHIRTS AND CAPS (U.S. CLS. 22 AND 39).

FIRST USE 12-23-2002; IN COMMERCE 12-23-2002.

SUELLEN HICKEY, EXAMINING ATTORNEY

CLASS 25—(Continued).

SN 78-336,439. PORTSIDE - CALCADO, LDA, FELGUEIRAS, PORTUGAL, FILED 12-4-2003.

PORTSIDE

THE MARK CONSISTS OF STANDARD CHARACTERS WITHOUT CLAIM TO ANY PARTICULAR FONT, STYLE, SIZE, OR COLOR.

FOR SHOES (U.S. CLS. 22 AND 39).

MICHAEL SOUDERS, EXAMINING ATTORNEY

SN 78-337,996. BOB'S WOODWORKS, INC., LUBBOCK, TX. FILED 12-8-2003.

Bubba-Alls

THE MARK CONSISTS OF STANDARD CHARACTERS WITHOUT CLAIM TO ANY PARTICULAR FONT, STYLE, SIZE, OR COLOR.

FOR CLOTHING, NAMELY, OVERALLS, FOOTWEAR, HEADWEAR (U.S. CLS. 22 AND 39).

ANNE MADDEN, EXAMINING ATTORNEY

CLASS 25—(Continued).

SN 78-338,832. BALEGA INTERNATIONAL, LLC, HICKORY, NC. FILED 12-10-2003.

TO MOVE WITH SPEED

THE MARK CONSISTS OF STANDARD CHARACTERS WITHOUT CLAIM TO ANY PARTICULAR FONT, STYLE, SIZE, OR COLOR.

FOR ATHLETIC APPAREL, NAMELY, SOCKS, SPORTS PERFORMANCE UNDERWEAR, SPORTS BRAS, UNDERWEAR BOTTOMS, UNDERWEAR TOPS, UNITARY UNDERWEAR SUITS, RUNNING SHORTS, ATHLETIC PANTS, LEGGINGS, ATHLETIC SHIRTS, STRETCH SHIRTS AND T-SHIRTS, WARMUP SUITS, SWEAT SUITS, SWEAT SHIRTS, SWEAT PANTS, SWEAT BANDS, WIND RESISTANT JACKETS, WIND PANTS, JACKETS, HATS CAPS AND GLOVES (U.S. CLS. 22 AND 39).

GINA FINK, EXAMINING ATTORNEY



SN 78-338,853. BALEGA INTERNATIONAL, LLC, HICKORY, NC. FILED 12-10-2003.

balēga

THE MARK CONSISTS OF THE WORD BALEGA WHERE THE "E" IS COMPRISED OF THE GRAPHIC REPRESENTATION OF A MAN RUNNING.

FOR ATHLETIC APPAREL, NAMELY, SOCKS, SPORTS PERFORMANCE UNDERWEAR, SPORTS BRAS, UNDERWEAR BOTTOMS, UNDERWEAR TOPS, UNITARY UNDERWEAR SUITS, RUNNING SHORTS, ATHLETIC PANTS, LEGGINGS, ATHLETIC SHIRTS, STRETCH SHIRTS AND T-SHIRTS, WARMUP SUITS, SWEAT SUITS, SWEAT SHIRTS, SWEAT PANTS, SWEAT BANDS, WIND RESISTANT JACKETS, WIND PANTS, JACKETS, HATS CAPS AND GLOVES (U.S. CLS. 22 AND 39).

GINA FINK, EXAMINING ATTORNEY

CLASS 25—(Continued).

SN 78-338,866. BALEGA INTERNATIONAL, LLC, HICKORY, NC. FILED 12-10-2003.



THE MARK CONSISTS OF THE GRAPHIC REPRESENTATION OF A MAN RUNNING.

FOR ATHLETIC APPAREL, NAMELY, SOCKS, SPORTS PERFORMANCE UNDERWEAR, SPORTS BRAS, UNDERWEAR BOTTOMS, UNDERWEAR TOPS, UNITARY UNDERWEAR SUITS, RUNNING SHORTS, ATHLETIC PANTS, LEGGINGS, ATHLETIC SHIRTS, STRETCH SHIRTS AND T-SHIRTS, WARMUP SUITS, SWEAT SUITS, SWEAT SHIRTS, SWEAT PANTS, SWEAT BANDS, WIND RESISTANT JACKETS, WIND PANTS, JACKETS, HATS CAPS AND GLOVES (U.S. CLS. 22 AND 39).

GINA FINK, EXAMINING ATTORNEY



SN 78-340,183. ON HOLIDAY, LLC, ORLEANS, MA. FILED 12-12-2003.

ON HOLIDAY

THE MARK CONSISTS OF STANDARD CHARACTERS WITHOUT CLAIM TO ANY PARTICULAR FONT, STYLE, SIZE, OR COLOR.

FOR CLOTHING, NAMELY, SHIRTS, T-SHIRTS, PANTS, SKIRTS, BLOUSES, HATS, DRESSES, SOCKS, STOCKINGS, COATS, JACKETS, BATHING SUITS, BELTS, FOOTWEAR, GLOVES, LINGERIE, VESTS, SHORTS, NIGHTWEAR, SCARVES, SHAWLS, SUITS, AND SWEATERS (U.S. CLS. 22 AND 39).

MITCHELL FRONT, EXAMINING ATTORNEY

CLASS 25—(Continued).

SN 78-340,571. REED, WILLIAM O., ROSEVILLE, CA. FILED 12-14-2003.

Surf Baby

THE MARK CONSISTS OF THE STYLIZED WORDS SURF BABY.

FOR INFANTS AND CHILDRENS CLOTHING, NAMELY, SHIRTS, T-SHIRTS, POLO-SHIRTS, SWEAT-SHIRTS, TANK TOPS, CAPS, HATS, VISORS, PANTS, SHORTS, CREEPERS, ROMPERS, SWIMWEAR, SWIM-SUITS, SLEEPWEAR, DRESSES, BLOUSES, AND SKIRTS (U.S. CLS. 22 AND 39).

FIRST USE 8-1-2003; IN COMMERCE 11-24-2003.
SUSAN HAYASH, EXAMINING ATTORNEY

CLASS 25—(Continued).

SN 78-342,458. MRS. FIELDS' BRAND, INC., THE, SALT LAKE, UT. FILED 12-17-2003.

DEBBI FIELDS

THE MARK CONSISTS OF STANDARD CHARACTERS WITHOUT CLAIM TO ANY PARTICULAR FONT, STYLE, SIZE, OR COLOR.

THE NAME DEBBI FIELDS IDENTIFIES A LIVING INDIVIDUAL WHOSE CONSENT IS OF RECORD.

FOR CLOTHING, NAMELY, APRONS, HATS AND SHIRTS (U.S. CLS. 22 AND 39).

GINA HAYES, EXAMINING ATTORNEY

SN 78-343,626. SEA CORPORATION, CHICAGO, IL. FILED 12-19-2003.

SN 78-340,600. DEBATES, LINDSEY J., ST. CHARLES, IL. FILED 12-14-2003.

BAA COUTURE

THE MARK CONSISTS OF STANDARD CHARACTERS WITHOUT CLAIM TO ANY PARTICULAR FONT, STYLE, SIZE, OR COLOR.

NO CLAIM IS MADE TO THE EXCLUSIVE RIGHT TO USE "COUTURE", APART FROM THE MARK AS SHOWN. FOR KNITWEAR, NAMELY, HATS, SCARVES, MITTENS, PONCHOS, SOCKS, VESTS, SWEATERS AND HEAD BANDS (U.S. CLS. 22 AND 39).

MARTHA FROMM, EXAMINING ATTORNEY

ULABLUE

THE MARK CONSISTS OF STANDARD CHARACTERS WITHOUT CLAIM TO ANY PARTICULAR FONT, STYLE, SIZE, OR COLOR.

FOR CHILDREN, ADULT, AND INFANT CLOTHING, NAMELY, BATHING SUITS, BEACHWEAR, BEACH ROBES, WRAPS, COVERUPS, SARONGS, SUITS, DRESSES, BLOUSES, SHIRTS, TUNICS, SKIRTS, SHORTS, PANTS, JACKETS, COATS, VESTS, TIES, HOSIERY, UNDERGARMENTS, LINGERIE, BATH-ROBES, LOUNGEWEAR, SLEEPWEAR, SCARVES, ASCOTS, BELTS, HEADWEAR IN THE NATURE OF SUN HATS, CAPS AND SUN VISORS, AND FOOTWEAR (U.S. CLS. 22 AND 39).

JENNIFER MARTIN, EXAMINING ATTORNEY

CLASS 25—(Continued).

SN 78-345,157. ELEGANCE FOOTWEAR, INC., NEW YORK, NY. FILED 12-23-2003.



OWNER OF U.S. REG. NO. 2,798,597.
"PAOLA" DOES NOT IDENTIFY A PARTICULAR LIVING INDIVIDUAL.

THE COLOR(S) RED AND BLACK IS/ARE CLAIMED AS A FEATURE OF THE MARK.

THE MARK CONSISTS OF A STYLIZED REPRESENTATION OF THE LETTERS PAOLA ELLE WITH A RED "P" AND "O".

THE MARK CONSISTS OF A STYLIZED REPRESENTATION OF THE LETTERS PAOLA ELLE WITH A RED "P" AND "O".

FOR SHOES AND FOOTWEAR (U.S. CLS. 22 AND 39).
SOPHIA S. KIM, EXAMINING ATTORNEY

SN 78-349,008. HANENKRIS CORPORATION, CARLSTADT, NJ. FILED 1-7-2004.



THE MARK CONSISTS OF THE WORD ZICONY IN ALL CAPITAL, BLOCK LETTERS OF THE SAME SIZE, WITH FOUR SOLID CIRCLES EXTENDING FROM THE TOP OF THE LETTER "I" TO THE TOP OF THE LETTER "O" IN AN ARCH FORMATION, ASCENDING IN SIZE FROM SMALLEST TO LARGEST.

FOR CLOTHING FOR MEN, WOMEN, CHILDREN AND INFANTS, NAMELY SOCKS, PANTS, SHIRTS, BLOUSES, SLACKS, JACKETS, T-SHIRTS, UNDERWEAR, GLOVES, HATS, BELTS, SCARVES AND SHOES (U.S. CLS. 22 AND 39).

FIRST USE 6-25-2001; IN COMMERCE 6-25-2001.
GIANCARLO CASTRO, EXAMINING ATTORNEY

CLASS 25—(Continued).

SN 78-350,187. BRIDGES, CHRISTOPHER B., CENTREVILLE, VA. FILED 1-9-2004.



OWNER OF U.S. REG. NO. 2,791,443.
FOR CLOTHING, NAMELY, BELTS, CAPS, HOODS, JERSEYS, SHORT SETS, TIES, TOPS, WRAPS, ATHLETIC FOOTWEAR, ATHLETIC UNIFORMS, BANDANAS, BATHING SUITS, BATHROBES, BEACHWEAR, BEACH SHOES, BLAZERS, BOOTS, UNDERWEAR, COATS, DRESSES, DUSTERS, FOOTWEAR, GLOVES, GOWNS, HATS, HEADWEAR, HOSIERY, JEANS, KERICHS, JUMPSUITS, LINGERIE, LOUNGEWEAR, PAJAMAS, PANTS, RAIN SUITS, SANDALS, SHIRTS, T-SHIRTS, SOCKS, SWEATSHIRTS (U.S. CLS. 22 AND 39).
ANN E. SAPPENFIELD, EXAMINING ATTORNEY

SN 78-352,848. LANDS' END DIRECT MERCHANTS, INC., EDINA, MN. FILED 1-16-2004.

KINDEST CUT

THE MARK CONSISTS OF STANDARD CHARACTERS WITHOUT CLAIM TO ANY PARTICULAR FONT, STYLE, SIZE, OR COLOR.

NO CLAIM IS MADE TO THE EXCLUSIVE RIGHT TO USE "CUT", APART FROM THE MARK AS SHOWN.

FOR CLOTHING, NAMELY BATHING SUITS (U.S. CLS. 22 AND 39).

FIRST USE 6-1-1990; IN COMMERCE 6-1-1990.
ALICIA COLLINS, EXAMINING ATTORNEY

CLASS 25—(Continued).

SN 78-355,357. PRADELLA, JAMES FRANCIS, PEREGIAN BEACH, QUEENSLAND, AUSTRALIA, FILED 1-21-2004.

WATERWOMAN

THE MARK CONSISTS OF STANDARD CHARACTERS WITHOUT CLAIM TO ANY PARTICULAR FONT, STYLE, SIZE, OR COLOR.

FOR CLOTHING, NAMELY SHIRTS, T-SHIRTS, TANK TOPS, SINGLETS, SWIMWEAR, SHORTS, PANTS, DRESSES AND SKIRTS; FOOTWEAR, NAMELY, THONGS, SANDSHOES, DRESS SHOES, SNEAKERS, AND SANDLES; HEADWEAR, NAMELY SPORT CAPS, BROAD RIM HATS, SWIMMING HATS, KNITTED CAPS, AND HEADBANDS (U.S. CLS. 22 AND 39).

STEVEN BERK, EXAMINING ATTORNEY

SN 78-360,144. PAXTON, QUAN L., DULUTH, GA. FILED 1-30-2004.

Go.gettaz

THE MARK CONSISTS OF STANDARD CHARACTERS WITHOUT CLAIM TO ANY PARTICULAR FONT, STYLE, SIZE, OR COLOR.

FOR SHIRTS, HATS AND HEAD BANDS (U.S. CLS. 22 AND 39).

DANIELLE MATTESSICH, EXAMINING ATTORNEY

CLASS 25—(Continued).

SN 78-361,976. ANNE COLE DESIGN STUDIO, LTD., BEVERLY HILLS, CA. FILED 2-3-2004.

ANNE COLE STUDIO

THE MARK CONSISTS OF STANDARD CHARACTERS WITHOUT CLAIM TO ANY PARTICULAR FONT, STYLE, SIZE, OR COLOR.

OWNER OF U.S. REG. NOS. 1,344,683 AND 1,923,772.

NO CLAIM IS MADE TO THE EXCLUSIVE RIGHT TO USE "STUDIO", APART FROM THE MARK AS SHOWN.

THE NAME(S), PORTRAIT(S), AND/OR SIGNATURE(S) SHOWN IN THE MARK IDENTIFIES ANNE COLE, WHOSE CONSENT(S) TO REGISTER IS SUBMITTED.

FOR CLOTHING, NAMELY, WOMEN'S AND CHILDREN'S SWIMWEAR, BEACHWEAR, BATHING SUITS, COVER-UPS, TANK TOPS, BOTTOMS, UNITARDS, SHORTS, SHIRTS, T-SHIRTS, BLOUSES, DRESSES, SKIRTS, JACKETS, PANTS, SWEATSHIRTS, CROP TOPS, BRA TOPS AND LEGGINGS (U.S. CLS. 22 AND 39).

LOURDES AYALA, EXAMINING ATTORNEY

SN 78-363,704. CHRIS MADDEN, INC., PORT CHESTER, NY. FILED 2-6-2004.

CHRIS MADDEN

THE MARK CONSISTS OF STANDARD CHARACTERS WITHOUT CLAIM TO ANY PARTICULAR FONT, STYLE, SIZE, OR COLOR.

THE NAME SHOWN IN THE MARK IDENTIFIES CHRIS MADDEN, A LIVING INDIVIDUAL WHOSE CONSENT IS OF RECORD.

FOR BATHROBES, PAJAMAS, SLIPPERS, HEADBANDS, APRONS, HEADWEAR, AND SPA WEAR, NAMELY, WRAP-AROUNDS, COVER-UPS, SMOCKS, HOUSECOATS, AND KIMONOS (U.S. CLS. 22 AND 39).

JOANNA DUKOVIC, EXAMINING ATTORNEY

CLASS 25—(Continued).

SN 78-365,454. FULL ARMOR GROUP, DBA FULL ARMOR WEAR, SAN ANTONIO, TX. FILED 2-10-2004.

FULLARMORGROUP



PUT IT ON.

THE COLOR(S) GRAY IS/ARE CLAIMED AS A FEATURE OF THE MARK.

THE COLOR GRAY AND SHADES THEREOF APPEAR IN THE TERM ARMOR AND THE SHIELD DESIGN EXCEPT FOR THE CROSS.

FOR CHRISTIAN ATHLETIC APPAREL FOR MEN AND WOMEN, NAMELY, SHIRTS, HEADWEAR, SOCKS, UNDERWEAR, WRIST BANDS, AND HEAD BANDS (U.S. CLS. 22 AND 39).

YONG KIM, EXAMINING ATTORNEY

CLASS 25—(Continued).

SN 78-369,659. MANOUKIAN, BORIS, MARSEILLE, FRANCE, FILED 2-18-2004.

AcquaRossa
B E A C H W E A R
C A S S I S

NO CLAIM IS MADE TO THE EXCLUSIVE RIGHT TO USE "BEACHWEAR CASSIS", APART FROM THE MARK AS SHOWN.

FOR BATHING SUITS, T-SHIRTS, SHIRTS, PULL-OVERS, SWEATERS, SWEAT-SHIRTS, SHORTS, PANTS, SHOES, CAPS, JOGGING SUITS, HATS, SUITS, TIES, UNDERWEAR, SKI SUITS, WATER-SKIING SUITS, SPORT SHOES, BEACH SHOES AND SANDALS, JACKETS, PARKAS, DRESSING-GOWNS, PEIGNOIRS, COATS (U.S. CLS. 22 AND 39).

RONALD MCMORROW, EXAMINING ATTORNEY

SN 78-373,578. POTOMAC APPAREL GROUP, LLC, POTOMAC, MD. FILED 2-25-2004.

SUNNY DYES

SN 78-369,231. ALBERT JOSHUA, SAN FRANCISCO, CA. FILED 2-17-2004.

MARIMBONDO 

THE ENGLISH TRANSLATION OF MARIMBONDO IS A BEE OR A WASP.

FOR SPORT PANTS, SPORT BRAS, SPORT JERSEYS, SWEATSHIRTS, SPORT SKIRTS, SWIMWEAR (U.S. CLS. 22 AND 39).

FIRST USE 8-29-2003; IN COMMERCE 8-29-2003.
DAWN FELDMAN, EXAMINING ATTORNEY

THE MARK CONSISTS OF STANDARD CHARACTERS WITHOUT CLAIM TO ANY PARTICULAR FONT, STYLE, SIZE, OR COLOR.

FOR MEN'S, WOMEN'S, CHILDREN'S AND INFANT'S CLOTHING, NAMELY, APRONS, BABY BIBS NOT OF PAPER, BABY BOOTIES AND SHORT SETS, BABY CREEPERS, BABY PANTS, BATHROBES, BATHING CAPS, BANDANNAS, BEACH COVER-UPS, BELTS, BERMUDA SHORTS, BLAZERS, BLOOMERS, BLOUSES, BOTTOMS, BUSTIERS, CAFTANS, CAPS, CAPES, COATS, CORSELETS, CORSETS, CRAVATS, CULOTTES, DRESSES, DRESSING GOWNS, EVENING GOWNS, FOUNDATION GARMENTS, FROCKS, GIRDLES, GOWNS, HALTER TOPS, HATS, HEADWEAR, HOSIERY, INFANTWEAR, JACKETS, JEANS, KNICKERS, KNIT SHIRTS, KNITTED HATS, MANTLES, MINISKIRTS, ONE-PIECE INFANTWEAR, OVERCOATS, PANTS, PARKAS, PETTICOATS, SHIFTS, SHIRTS, SHOES, SHORTS, SINGLET, SKIRTS, SLACKS, SOCKS, SPORT SHIRTS, SUITS, SWEATERS, SWIMWEAR, SWIMSUITS, T-SHIRTS, TANK TOPS, TOPS, TROUSERS, VESTS, WAISTCOATS, ASCOTS, BONNETS, BOW TIES, BOWLING SHIRTS, BRAS, BREECHES, CAMISOLES, CHEMISES, COVER-UPS, CROP TOPS, CUMMERBUNDS, DUSTERS, FLEECE PULLOVERS, GARTER BELTS, GLOVES, GYM SUITS, HEADBANDS, HOODS, JERKINS, JOGGING SUITS, JUMPERS, JUMPSUITS, KERCHEIFS, KILTS, LEGGINGS, MITTENS, MUFFLERS, NECKBANDS, NECKWEAR, NECK TIES,

CLASS 25—(Continued).

NIGHTSHIRTS, OVERALLS, PAJAMAS, PANTIES, PEDAL PUSHERS, PINAFORES, PULLOVERS, RAINCOATS, RAINWEAR, ROMPERS, SARONGS, SCARVES, SHAWLS, SLIPPERS, SLIPS, STOLEs, SUSPENDERS, SWEAT SHIRTS, SWEAT PANTS, SWEAT SUITS, TAP PANTS, THONGS, TOPCOATS, TUNICS, UNDERCLOTHES, UNDERGARMENTS, VEILS, VISORS AND WEDDING GOWNS, WIND RESISTANT JACKETS, LINGERIE, POLO SHIRTS, GOLF SHIRTS, PANTYHOSE, LEOTARDS, PONCHOS, FOOTWEAR, TENNIS SHOES, BOOTS, SANDALS, BOXER SHORTS, BRIEFS, TRENCH COATS, HOUSECOATS, LOUNGEWEAR, SLEEPWEAR, NIGHT GOWNS, PEIGNOIRS, ROBES, TEDDIES, WARM-UP SUITS, SHRUGS, BOLEROS, KIMONOS, SMOCKS, SWIMMING TRUNKS, WET SUITS, THERMAL UNDERWEAR, TURTLENECK SWEATERS, CARDIGANS, SKI SUITS, SKI PANTS, SKI BIBS, ELASTIC WAIST SHORTS, FIXED WAIST SHORTS, DENIM SHORTS, DENIM JACKETS, UNITARDS, FOULARDS, FACE WARMING MASKS, EAR BANDS, AND WRAPS (U.S. CLS. 22 AND 39).

DANIELLE MATTESSICH, EXAMINING ATTORNEY

CLASS 25—(Continued).

SN 78-377,590. FOSTER, RAY G., FOSTORIA, OH. AND FOSTER, PAULA C., FOSTORIA, OH. FILED 3-3-2004.

nocolorline

THE MARK CONSISTS OF STANDARD CHARACTERS WITHOUT CLAIM TO ANY PARTICULAR FONT, STYLE, SIZE, OR COLOR.

FOR SHIRTS, COATS, JACKETS, HATS, CAPS, HEAD BANDS, T-SHIRTS, PANTS, SHORTS, AND UNDERWEAR (U.S. CLS. 22 AND 39).

TRACY FLETCHER, EXAMINING ATTORNEY

SN 78-373,685. JONES INVESTMENT CO. INC., WILMINGTON, DE. FILED 2-25-2004.

SN 78-382,040. GANDER MOUNTAIN COMPANY, ST. PAUL, MN. FILED 3-10-2004.

L.E.I.

CREEKSIDE

THE MARK CONSISTS OF STANDARD CHARACTERS WITHOUT CLAIM TO ANY PARTICULAR FONT, STYLE, SIZE, OR COLOR.

OWNER OF U.S. REG. NOS. 515,529, 2,643,652 AND OTHERS.

FOR SLEEPWEAR, LOUNGEWEAR, PAJAMAS (U.S. CLS. 22 AND 39).

CIMMERIAN COLEMAN, EXAMINING ATTORNEY

THE MARK CONSISTS OF STANDARD CHARACTERS WITHOUT CLAIM TO ANY PARTICULAR FONT, STYLE, SIZE, OR COLOR.

FOR SPORTSWEAR, NAMELY, PANTS, SHIRTS, T-SHIRTS, SWEATSHIRTS, JACKETS, PARKAS, HATS, GLOVES, SOCKS, MITTENS; FOOTWEAR; RAINWEAR (U.S. CLS. 22 AND 39).

AMOS T. MATTHEWS, JR., EXAMINING ATTORNEY

CLASS 25—(Continued).

SN 78-382,193. VASSA & CO. SRL, 37012 BUSSOLENGO, VERONA, ITALY, FILED 3-11-2004.



NO CLAIM IS MADE TO THE EXCLUSIVE RIGHT TO USE "ITALIA", APART FROM THE MARK AS SHOWN.

THE NAME(S), PORTRAIT(S), AND/OR SIGNATURE(S) SHOWN IN THE MARK DOES NOT IDENTIFY A PARTICULAR LIVING INDIVIDUAL.

THE MARK CONSISTS OF THE WORDS MARIA PIA ITALIA, UNDER TWO BIRDS, SURROUNDED BY AN OVAL.

THE ENGLISH TRANSLATION OF THE WORD ITALIA IN THE MARK IS ITALY.

FOR FOOTWEAR (U.S. CLS. 22 AND 39).
SUSAN LESLIE DUBOIS, EXAMINING ATTORNEY

CLASS 25—(Continued).

SN 78-392,024. IGLEHART, THOMAS ANTHONY, SUNNY ISLES BEACH, FL. FILED 3-27-2004.



THE MARK CONSISTS OF A STICKMAN FIGURE DRAGGING AWAY AN OVERSIZED LOWER CASE LETTER "T".

FOR CLOTHING, NAMELY DOWN JACKETS, FISHERMEN'S JACKETS, HEAVY JACKETS, LONG JACKETS, RAINPROOF JACKETS, WIND RESISTANT JACKETS, OPEN-NECKED SHIRTS, PIQUET SHIRTS, POLO SHIRTS, SPORT SHIRTS, SWEAT SHIRTS, T-SHIRTS, CAPS WITH VISORS, GOLF CAPS, KNITTED CAPS, BASEBALL CAPS, COATS FOR MEN AND WOMEN AND RAINCOATS (U.S. CLS. 22 AND 39).
ESTHER A. BORSUK, EXAMINING ATTORNEY

SN 78-391,862. WRFF USA, LLC, WILSONVILLE, OR. FILED 3-26-2004.

WRFF

THE MARK CONSISTS OF STANDARD CHARACTERS WITHOUT CLAIM TO ANY PARTICULAR FONT, STYLE, SIZE, OR COLOR.

FOR CLOTHING, NAMELY, SHIRTS, T-SHIRTS, SWEATERS, SWEATSHIRTS, HOODED SWEATSHIRTS, JACKETS, COATS, WIND RESISTANT JACKETS, PANTS, SHORTS, SKIRTS, SWIMSUITS, GLOVES, SCARVES, SOCKS, VISORS, HATS, BASEBALL CAPS AND FOOTWEAR (U.S. CLS. 22 AND 39).
WINSTON FOLMAR, EXAMINING ATTORNEY

SN 78-396,278. NATIONAL HOT ROD ASSOCIATION, GLEN-DORA, CA. FILED 4-5-2004.



OWNER OF U.S. REG. NOS. 1,402,535, 2,220,219 AND OTHERS.

THE MARK CONSISTS OF STYLIZED OVAL DESIGNS AND THE WORDS NHRA CHAMPIONSHIP DRAG RACING.

FOR CLOTHING, NAMELY, SLEEPWEAR, FOOTWEAR, HEADWEAR, TEE-SHIRTS, SHIRTS, JACKETS, SWEATSHIRTS, TANK TOPS, SHORTS, PANTS, UNDERWEAR, SOCKS, SWEATERS, SWEATPANTS, SWEATSUITS, DRESSES, JUMPSUITS, OVERALLS, TIES, CLOTH BABY BIBS, BABY CLOTHES, NAMELY, TRAINING PANTS, DRESSES, JUMPSUITS, OVERALLS, SWEATSUITS, JUMPERS, SHORTS, TEE SHIRTS, SNAP TEE SHIRTS, SLEEPWEAR, SOCKS, SWEATERS, PREWALK SHOES, VISORS, HATS AND BANDANAS (U.S. CLS. 22 AND 39).

FIRST USE 12-31-1969; IN COMMERCE 12-31-1969.
DAWN FELDMAN, EXAMINING ATTORNEY

CLASS 25—(Continued).

SN 78-405,737. AGHABI, SUHEIL G., SHERMAN OAKS, CA.
FILED 4-21-2004.

hugs make
everything better

THE MARK CONSISTS OF STANDARD CHARACTERS
WITHOUT CLAIM TO ANY PARTICULAR FONT, STYLE,
SIZE, OR COLOR.
FOR SHIRTS (U.S. CLS. 22 AND 39).
ELIZABETH J. WINTER, EXAMINING ATTORNEY

SN 78-408,297. GARLAND, ROMI, SHERMAN OAKS, CA.
FILED 4-26-2004.

mint chocolat

THE MARK CONSISTS OF STANDARD CHARACTERS
WITHOUT CLAIM TO ANY PARTICULAR FONT, STYLE,
SIZE, OR COLOR.

FOR CHILDREN'S APPAREL, NAMELY BATHING
SUITS, BEACH COVERUPS, BEANIES, BERMUDA
SHORTS, BLOUSES, CARDIGANS, DRESSES, INFANT
DIAPER COVERS, PAJAMAS, PANTS, PONCHOS, SAR-
ONGS, SKIRTS AND DRESSES, SCARVES, SWEATERS,
SWIM WEAR, TANK TOPS, T-SHIRTS, WRAPS, HATS,
LAYETTES, LOUNGEWEAR (U.S. CLS. 22 AND 39).
WILLIAM VERHOSEK, EXAMINING ATTORNEY

CLASS 25—(Continued).

SN 78-410,001. ATHLETE'S FOOT BRANDS, INC., KENNE-
SAW, GA. FILED 4-29-2004.

TAFTECH

THE MARK CONSISTS OF STANDARD CHARACTERS
WITHOUT CLAIM TO ANY PARTICULAR FONT, STYLE,
SIZE, OR COLOR.
FOR ATHLETIC CLOTHING NAMELY, T-SHIRTS,
SHORTS AND JERSEYS (U.S. CLS. 22 AND 39).
LESLEY LAMOTHE, EXAMINING ATTORNEY

SN 78-410,820. FIRST PRIZE ENTERPRISES, INC., NEW
YORK, NY. FILED 4-29-2004.

schtik

THE MARK CONSISTS OF 6 HAND-LETTERED LET-
TERS TO FORM SCHTIK.
FOR SHIRTS, PANTS, HATS/CAPS, TIES (U.S. CLS. 22
AND 39).
JOHN KELLY, EXAMINING ATTORNEY

SN 78-413,899. WYLIE, TERRY, FLORENCE, AL. FILED 5-6-
2004.

Hampton Bay

FOR APPAREL, NAMELY, POLO SHIRTS, JACKETS,
CAPS, SHOES, AND POLAR FLEECE ITEMS, NAMELY,
SWEATSHIRTS, SHIRTS, PULLOVERS, AND PANTS
(U.S. CLS. 22 AND 39).
KATHLEEN M. VANSTON, EXAMINING ATTORNEY

CLASS 25—(Continued).

SN 78-420,385. CARLEVARINI, IAN, NEW YORK, NY. AND FINE, JENNIFER, NEW YORK, NY. FILED 5-18-2004.

PURE T

THE MARK CONSISTS OF STANDARD CHARACTERS WITHOUT CLAIM TO ANY PARTICULAR FONT, STYLE, SIZE, OR COLOR.

FOR WOMEN'S MATERNITY APPAREL, NAMELY, SHIRTS, SKIRTS, PANTS, JACKETS AND UNDERGARMENTS (U.S. CLS. 22 AND 39).

DOUGLAS LEE, EXAMINING ATTORNEY

CLASS 25—(Continued).

SN 78-426,069. NINE WEST DEVELOPMENT CORPORATION, WILMINGTON, DE. FILED 5-27-2004.

SPIRIT LEVEL 3

THE MARK CONSISTS OF STANDARD CHARACTERS WITHOUT CLAIM TO ANY PARTICULAR FONT, STYLE, SIZE, OR COLOR.

OWNER OF U.S. REG. NOS. 1,506,050, 2,276,352 AND OTHERS.

FOR FOOTWEAR (U.S. CLS. 22 AND 39).
FIRST USE 6-13-2001; IN COMMERCE 6-13-2001.
DOUGLAS LEE, EXAMINING ATTORNEY

SN 78-423,708. PRIME TIME INTERNATIONAL, INC., NEW YORK, NY. FILED 5-24-2004.

THIRD FLOOR

THE MARK CONSISTS OF STANDARD CHARACTERS WITHOUT CLAIM TO ANY PARTICULAR FONT, STYLE, SIZE, OR COLOR.

FOR LADIES APPAREL, NAMELY, SHIRTS, PANTS, JEANS, SHORTS, T-SHIRTS, TANK TOPS, BLOUSES, SKIRTS, SWEATERS, JACKETS, SUITS, UNDERGARMENTS, COATS, GLOVES, SCARVES, PAJAMAS AND BELTS NOT MADE OF LEATHER (U.S. CLS. 22 AND 39).

NICHOLAS ALTREE, EXAMINING ATTORNEY

SN 78-432,264. JORDAN, KARLA A., SOUTH BARRINGTON, IL. AND ELBRECHT, ROBERT, C., VERNON HILLS, IL. FILED 6-9-2004.

Jet Fuel

SN 78-426,036. NINE WEST DEVELOPMENT CORPORATION, WILMINGTON, DE. FILED 5-27-2004.

SPIRIT LEVEL 2

THE MARK CONSISTS OF STANDARD CHARACTERS WITHOUT CLAIM TO ANY PARTICULAR FONT, STYLE, SIZE, OR COLOR.

OWNER OF U.S. REG. NOS. 1,506,050, 2,748,857 AND OTHERS.

FOR FOOTWEAR (U.S. CLS. 22 AND 39).
FIRST USE 6-13-2001; IN COMMERCE 6-13-2001.
DOUGLAS LEE, EXAMINING ATTORNEY

THE MARK CONSISTS OF STANDARD CHARACTERS WITHOUT CLAIM TO ANY PARTICULAR FONT, STYLE, SIZE, OR COLOR.

FOR CLOTHING, NAMELY, HATS, SHIRTS, SHOES, PANTS, SKIRTS, JACKETS, AND SWEATSHIRTS (U.S. CLS. 22 AND 39).

AISHA CLARKE, EXAMINING ATTORNEY

CLASS 25—(Continued).

SN 78-432,721. NYMAN, ADRIAN A, LOS ANGELES, CA.
FILED 6-9-2004.

UNIFIED

THE MARK CONSISTS OF STANDARD CHARACTERS WITHOUT CLAIM TO ANY PARTICULAR FONT, STYLE, SIZE, OR COLOR.

FOR CLOTHING, NAMELY, PANTS, JEANS, SHORTS, SHIRTS, TEE-SHIRTS, SWEATSHIRTS, BLOUSES, SKIRTS, DRESSES, JACKETS, VESTS, COATS, RAINWEAR, SHOES, LINGERIE, SLEEPWEAR, SWIMWEAR, GLOVES, SOCKS, HOSIERY, BELTS, SCARVES, HATS, TIES, HEAD BANDS, SLIPPERS (U.S. CLS. 22 AND 39).
RUDY R. SINGLETON, EXAMINING ATTORNEY

SN 78-433,851. STEVO INC., FULLERTON, CA. FILED 6-11-2004.

Molly Maxi

THE MARK CONSISTS OF STANDARD CHARACTERS WITHOUT CLAIM TO ANY PARTICULAR FONT, STYLE, SIZE, OR COLOR.

THE MARK DOES NOT IDENTIFY A LIVING INDIVIDUAL.

FOR CLOTHING FOR WOMEN AND KIDS, NAMELY, TOPS, BOTTOMS, SLEEPWEAR, COATS, SWIMWEAR, AND SWEATERS (U.S. CLS. 22 AND 39).

BRIDGETT SMITH, EXAMINING ATTORNEY

CLASS 25—(Continued).

SN 78-434,023. JACOB ASH HOLDINGS, INC., GRAND RAPIDS, MI. FILED 6-11-2004.

AQUA E4

THE MARK CONSISTS OF STANDARD CHARACTERS WITHOUT CLAIM TO ANY PARTICULAR FONT, STYLE, SIZE, OR COLOR.

FOR GLOVES, HATS AND HEADWEAR (U.S. CLS. 22 AND 39).

MICHAEL KEATING, EXAMINING ATTORNEY

SN 78-434,045. BENDON LIMITED, EAST TAMAKI, AUCKLAND, NEW ZEALAND, FILED 6-11-2004.

AFTERWEAR

THE MARK CONSISTS OF STANDARD CHARACTERS WITHOUT CLAIM TO ANY PARTICULAR FONT, STYLE, SIZE, OR COLOR.

THE MARK CONSISTS OF .
FOR LINGERIE, UNDERWEAR, AND NIGHTWEAR FOR MEN, WOMEN, AND CHILDREN (U.S. CLS. 22 AND 39).

LINDA POWELL, EXAMINING ATTORNEY

CLASS 25—(Continued).

SN 78-434,758. SARAMAR, L.L.C., CHICAGO, IL. FILED 6-14-2004.

PERMALASTIC

THE MARK CONSISTS OF STANDARD CHARACTERS WITHOUT CLAIM TO ANY PARTICULAR FONT, STYLE, SIZE, OR COLOR.

FOR ELASTIC EDGING SOLD AS A COMPONENT OF PANTIES (U.S. CLS. 22 AND 39).

FIRST USE 12-31-1996; IN COMMERCE 12-31-1996.
EVELYN BRADLEY, EXAMINING ATTORNEY

SN 78-435,066. WASSILIAN, BERGE, LOS ANGELES, CA. FILED 6-14-2004.

BEAR JIG

THE MARK CONSISTS OF STANDARD CHARACTERS WITHOUT CLAIM TO ANY PARTICULAR FONT, STYLE, SIZE, OR COLOR.

FOR CLOTHING, NAMELY, SHIRTS, T-SHIRTS, KNIT SHIRTS, POLO SHIRTS, SPORT SHIRTS, PANTS, JEANS, SHORTS, SWEATERS, VESTS, JACKETS, COATS, PARKAS, PONCHOS, SPORT COATS, SUITS, UNDERCLOTHES, UNDERWEAR, UNDERSHIRTS, UNDERGARMENTS, UNDERPANTS, THERMAL UNDERWEAR, THERMAL SOCKS, SOCKS, STOCKINGS, SWEATSOCKS, NECKERCHIEFS, NECKTIES [CLOTHING], MUFFLERS [CLOTHING], GLOVES, BELTS [CLOTHING], AND SUSPENDERS; FOOTWEAR, NAMELY, SHOES, BOOTS; HEADGEAR, NAMELY, HATS, CAPS; AND RAINWEAR, NAMELY, RAIN COATS, RAIN JACKETS, RAIN BOOTS (U.S. CLS. 22 AND 39).

TIMOTHY FINNEGAN, EXAMINING ATTORNEY

CLASS 25—(Continued).

SN 78-435,088. SENIZERGUES, PIERRE ANDRE, NEWPORT BEACH, CA. FILED 6-14-2004.

SKATECHNOLOGY

THE MARK CONSISTS OF STANDARD CHARACTERS WITHOUT CLAIM TO ANY PARTICULAR FONT, STYLE, SIZE, OR COLOR.

FOR FOOTWEAR (U.S. CLS. 22 AND 39).

FIRST USE 3-31-2004; IN COMMERCE 3-31-2004.
CHARLES L. JENKINS, EXAMINING ATTORNEY

SN 78-435,110. NIETO, ADRIAN M., MONTEREY PARK, CA. FILED 6-14-2004.



THE MARK CONSISTS OF A STYLIZED LETTER "B", THE LETTER "I" IS THE FORM OF A KEY HOLE, STYLIZED LETTERS "G", "H", "O", "U", "S", "E". STYLIZED LETTERS SPELL OUT "CLOTHING FOR THOSE WHO KNOW".

FOR CLOTHING, NAMELY T-SHIRTS, SWEATSHIRTS, SPORTS JERSEYS, SWEATSUITS, PANTS, JACKETS, BASEBALL CAPS, BEENIE CAPS, MITTENS (U.S. CLS. 22 AND 39).

BERYL GARDNER, EXAMINING ATTORNEY

SN 78-435,173. HARLEY CONSULTING & COACHING, WEST SAINT PAUL, MN. FILED 6-15-2004.

WALL SEEKER

THE MARK CONSISTS OF STANDARD CHARACTERS WITHOUT CLAIM TO ANY PARTICULAR FONT, STYLE, SIZE, OR COLOR.

FOR SHIRTS; SHORTS; JACKETS; SWEATERS; TURTLENECKS; JERSEYS; HEADWEAR AND SCARVES; EARBANDS AND HEADBANDS; HATS; CAPS; VISORS; T-SHIRTS; SWEATSHIRTS; SWEATPANTS; BASEBALL CAPS; PULLOVERS; POLO SHIRTS AND HATS (U.S. CLS. 22 AND 39).

FRED MANDIR, EXAMINING ATTORNEY

CLASS 25—(Continued).

SN 78-435,203. ZORKA L.L.C., BOONTON, NJ. FILED 6-15-2004.

Zorka by T

THE MARK CONSISTS OF STANDARD CHARACTERS WITHOUT CLAIM TO ANY PARTICULAR FONT, STYLE, SIZE, OR COLOR.

FOR MEN'S AND WOMEN'S WEARING APPAREL, NAMELY WOVEN AND KNIT SHIRTS, BLOUSES, SKIRTS, SWEATSHIRTS, SWEATPANTS, T-SHIRTS, SHORTS, JEANS, PANTS, SLACKS, LINGERIE, PANTIES, UNDERWEAR, BRIEFS, BRASSIERES, PAJAMAS, NIGHTGOWNS, JACKETS, BLAZERS, SWEATERS, TOP COATS, SPORT COATS, DRESSES, SUITS, HATS, SCARVES (U.S. CLS. 22 AND 39).

KARANENDRA S. CHHINA, EXAMINING ATTORNEY

SN 78-435,392. MULLINS, LISA SASHA ANN, NEW YORK, NY. FILED 6-15-2004.

Chrome Cougar

THE MARK CONSISTS OF STANDARD CHARACTERS WITHOUT CLAIM TO ANY PARTICULAR FONT, STYLE, SIZE, OR COLOR.

FOR CLOTHING, NAMELY, T-SHIRTS, TANK TOPS, HALTER TOPS, SCARVES, BANDANAS, PANTS, JACKETS, COATS, SHORTS, DRESSES, SKIRTS, SWEATERS, SWEAT PANTS, CHAPS, SOCKS, SHOES, GLOVES, LEG WARMERS, WRIST BANDS, PAJAMAS, UNDERWEAR, VESTS AND HATS (U.S. CLS. 22 AND 39).

LINDA E. BLOHM, EXAMINING ATTORNEY

CLASS 25—(Continued).

SN 78-435,439. TALENT SPORT, INC., JENKINTOWN, PA. FILED 6-15-2004.

XTRA-DRI

THE MARK CONSISTS OF STANDARD CHARACTERS WITHOUT CLAIM TO ANY PARTICULAR FONT, STYLE, SIZE, OR COLOR.

FOR CLOTHING, NAMELY, MEN'S, WOMEN'S AND CHILDREN'S SHIRTS, SHORTS AND TIGHTS (U.S. CLS. 22 AND 39).

RICHARD A. STRASER, EXAMINING ATTORNEY

SN 78-435,573. SNOW-FUN-PARK WITTENBURG GMBH & CO., HAMBURG, FED REP GERMANY, FILED 6-15-2004.



FOR CLOTHING, NAMELY, SWEATSHIRTS, SWEATERS, TURTLENECK SHIRTS, T-SHIRTS, HATS, PARKAS, JACKETS, VESTS, GLOVES, SCARVES, HEADBANDS, PANTS, SHORTS AND SOCKS; FOOTWEAR (U.S. CLS. 22 AND 39).

MICHAEL SOUDERS, EXAMINING ATTORNEY

SN 78-435,798. SENIZERGUES, PIERRE ANDRE, NEWPORT BEACH, CA. FILED 6-15-2004.

thirtytwo

OWNER OF U.S. REG. NOS. 2,063,796, 2,372,420 AND OTHERS.

FOR CLOTHING, NAMELY, T-SHIRTS, SHIRTS, PANTS, SHORTS, JACKETS, SWEAT PANTS, SWEAT SHIRTS, SOCKS, SKI PANTS, SKI JACKETS, FOOTWEAR, PARKAS AND HATS (U.S. CLS. 22 AND 39).

FIRST USE 12-15-1998; IN COMMERCE 12-15-1998.

IRA J. GOODSaid, EXAMINING ATTORNEY

CLASS 25—(Continued).

SN 78-435,848. BORDEAUX, MARK R., GREENDALE, WI. FILED 6-16-2004.

CLASS 25—(Continued).

SN 78-435,916. JASIONOWSKI, JONATHAN, CLEARWATER, FL. FILED 6-16-2004.

Salem Sportswear

THE MARK CONSISTS OF STANDARD CHARACTERS WITHOUT CLAIM TO ANY PARTICULAR FONT, STYLE, SIZE, OR COLOR.

NO CLAIM IS MADE TO THE EXCLUSIVE RIGHT TO USE "SPORTSWEAR", APART FROM THE MARK AS SHOWN.

FOR MEN'S, WOMEN'S, CHILDREN'S, TODDLER'S AND INFANT'S FOOTWEAR, HEADWEAR AND CLOTHING; NAMELY T-SHIRTS, SWEATSHIRTS, SWEATPANTS, JERSEYS, TANK TOPS, MATERNITY TOPS, JACKETS, WARM-UP SUITS, DOWN JACKETS, JEANS, COATS, FOOTBALL JERSEYS, SHORTS, PULL-OVER JACKET, ROBES, PAJAMAS, KNICKERS, APRONS, SKIRTS, KNIT TOPS, SCARVES, LONG JOHNS, SNOW SUITS, DRESSES, JOGGING SUITS, BIB OVERALLS, POLO SHIRTS, SWEATERS, SLACKS, TURTLENECKS, FLEECE PULLOVERS, JERSEY PANTS, SHORTS, NECK GAITERS, THERMAL SHIRTS, GLOVES, PARKAS, STADIUM COATS, WIND RESISTANT JACKETS, WRAPS, BATHING SUITS, RAIN-COATS, PONCHOS, NIGHT SHIRTS, LEATHER JACKET, LEG WARMERS, LEOTARDS, CARDIGANS, BOXER SHORTS, NECKTIES, SUSPENDERS, BELTS, ROMPERS, MITTENS, WRISTBANDS, UNDERWEAR, SNEAKERS, SOCKS, COACHES' CAPS, WOOL AND KNIT HATS, BEANIES, VISOR, HEAD GAITERS, KNIT FACE MASKS, BASEBALL CAPS, HEADBANDS, EAR MUFFS, PAINTER'S CAPS, BANDANAS (U.S. CLS. 22 AND 39).

BARNEY CHARLON, EXAMINING ATTORNEY



THE MARK CONSISTS OF A TORCH DESIGN. FOR APPAREL, NAMELY, T-SHIRTS, SHOES, HATS, WRIST BANDS, AND SWEAT BANDS (U.S. CLS. 22 AND 39).

ANDREW BENZMILLER, EXAMINING ATTORNEY

SN 78-435,885. WOLVERINE WORLD WIDE, INC., ROCK-FORD, MI. FILED 6-16-2004.

NO GUFF

THE MARK CONSISTS OF STANDARD CHARACTERS WITHOUT CLAIM TO ANY PARTICULAR FONT, STYLE, SIZE, OR COLOR.

FOR FOOTWEAR (U.S. CLS. 22 AND 39).
CHERYL CLAYTON, EXAMINING ATTORNEY

POSTCARD T-SHIRT

THE MARK CONSISTS OF STANDARD CHARACTERS WITHOUT CLAIM TO ANY PARTICULAR FONT, STYLE, SIZE, OR COLOR.

NO CLAIM IS MADE TO THE EXCLUSIVE RIGHT TO USE "T-SHIRT", APART FROM THE MARK AS SHOWN.

FOR CLOTHING, NAMELY T-SHIRTS (U.S. CLS. 22 AND 39).
CHERYL CLAYTON, EXAMINING ATTORNEY

CLASS 25—(Continued).

SN 78-436,055. FOSSIL, INC., RICHARDSON, TX. FILED 6-16-2004.

THREE GIRLS

THE MARK CONSISTS OF STANDARD CHARACTERS WITHOUT CLAIM TO ANY PARTICULAR FONT, STYLE, SIZE, OR COLOR.

FOR CLOTHING, NAMELY, T-SHIRTS, SHIRTS, PANTS, SKIRTS, JACKETS, COATS, SWEATERS, JEANS, DRESSES, SHORTS; HATS; BELTS (U.S. CLS. 22 AND 39).
KATHERINE STOIDES, EXAMINING ATTORNEY

SN 78-436,092. NAUTICA APPAREL, INC., NEW YORK, NY.
FILED 6-16-2004.

BI*STAR

THE MARK CONSISTS OF STANDARD CHARACTERS WITHOUT CLAIM TO ANY PARTICULAR FONT, STYLE, SIZE, OR COLOR.

FOR MEN, WOMEN AND CHILDREN'S WEARING APPAREL, NAMELY, HOSIERY, SHOES, SNEAKERS, BOOTS, MOCCASINS, UNDERSHIRTS, BOXER SHORTS, SHIRTS, BLOUSES, TROUSERS, PANTS, JACKETS, COATS, SUITS, BATHING SUITS, BATHROBES, SLIPPERS, SHORTS, TIES, NECKWEAR, SCARVES, SOCKS, HATS AND CAPS, GLOVES AND MUFFLERS, AND FOUL WEATHER GEAR, BELTS AND SUSPENDERS (U.S. CLS. 22 AND 39).
WON TEAK OH, EXAMINING ATTORNEY

CLASS 25—(Continued).

SN 78-436,168. DONOVAN, GWEN PATRICE, COCOA, FL.
FILED 6-16-2004.

GOT CORE?

THE MARK CONSISTS OF STANDARD CHARACTERS WITHOUT CLAIM TO ANY PARTICULAR FONT, STYLE, SIZE, OR COLOR.

FOR ARTICLES OF CLOTHING FOR MEN, WOMEN AND CHILDREN, NAMELY, PAJAMAS, NIGHTSHIRTS, ROBES, JOGGING SUITS, SWEAT SUITS, T-SHIRTS, SWEATSHIRTS, JERSEYS, MUSCLE SHIRTS, TANK TOPS, COLLAR SHIRTS, BLOUSES, SHORTS, TROUSERS, PANTS, JUMPERS, OVERALLS, ROMPERS, DRESSES, SKIRTS, SHORT SETS COMPRISED OF SHORTS AND TOPS, SWEATERS, CARDIGANS, JACKETS, COATS, ANORAKS, PONCHOS, RAINCOATS, SCARVES, BANDANNAS, HEAD AND WRIST SWEATBANDS, JOGGING AND SPORTS BRAS, UNDERWEAR, KNITTED HEADWEAR, HATS AND CAPS, VISORS, TIES, BELTS AND SUSPENDERS, SOCKS, TIGHTS, LEGGINGS, UNITARDS, HOSIERY, GLOVES, MITTENS, APRONS, SWIMSUITS, CLOTH BABY BIBS, FOOTWEAR AND MASQUERADE COSTUMES (U.S. CLS. 22 AND 39).
BRIDGETT SMITH, EXAMINING ATTORNEY

SN 78-436,474. BRIGATA INTERNATIONAL, INC., HAYWARD, CA. FILED 6-16-2004.

ISLAND WAY

THE MARK CONSISTS OF STANDARD CHARACTERS WITHOUT CLAIM TO ANY PARTICULAR FONT, STYLE, SIZE, OR COLOR.

FOR CLOTHING, NAMELY MEN'S AND WOMEN'S PANTS, SHIRTS, SUITS, COATS, JACKETS, SHORTS AND UNDERGARMENTS (U.S. CLS. 22 AND 39).
LINDA MICKLEBURGH, EXAMINING ATTORNEY

CLASS 25—(Continued).

SN 78-436,648. FIELDS, KAURIE, VALLEY COTTAGE, NY. FILED 6-17-2004.

CLASS 25—(Continued).

SN 78-438,185. TANNER, INC., VENTURA, CA. FILED 6-20-2004.

Waddle Warmers

THE MARK CONSISTS OF STANDARD CHARACTERS WITHOUT CLAIM TO ANY PARTICULAR FONT, STYLE, SIZE, OR COLOR.

FOR INFANT'S AND CHILDREN'S SCARVES, HATS, MITTENS, BOOTIES AND PONCHOS (U.S. CLS. 22 AND 39).

KATHY DE JONGE, EXAMINING ATTORNEY

Swim n Toss

THE MARK CONSISTS OF STANDARD CHARACTERS WITHOUT CLAIM TO ANY PARTICULAR FONT, STYLE, SIZE, OR COLOR.

NO CLAIM IS MADE TO THE EXCLUSIVE RIGHT TO USE "SWIM", APART FROM THE MARK AS SHOWN.

FOR SWIMSUITS (U.S. CLS. 22 AND 39).
JASON LOTT, EXAMINING ATTORNEY

SN 78-436,650. NAUTICA APPAREL, INC., NEW YORK, NY. FILED 6-17-2004.

NAVIGATE LIFE

THE MARK CONSISTS OF STANDARD CHARACTERS WITHOUT CLAIM TO ANY PARTICULAR FONT, STYLE, SIZE, OR COLOR.

FOR MEN'S, WOMEN'S AND CHILDREN'S WEARING APPAREL, NAMELY, HOSIERY, SHOES, SNEAKERS, BOOTS, MOCCASINS, UNDERSHIRTS, BOXER SHORTS, UNDERWEAR, SHIRTS, BLOUSES, TROUSERS, PANTS, JACKETS, COATS, SUITS, BATHING SUITS, BATH-ROBES, SLIPPERS, SHORTS, TIES, NECKWEAR, SCARVES, SOCKS, HATS AND CAPS, GLOVES AND MUFFLERS, BELTS AND SUSPENDERS AND FOUL WEATHER GEAR (U.S. CLS. 22 AND 39).

WON TEAK OH, EXAMINING ATTORNEY

SN 78-438,356. WARNACO U.S., INC., MILFORD, CT. FILED 6-21-2004.

SMOOTH BENEFITS

SN 78-437,628. UNISA AMERICA, INC., MIAMI, FL. FILED 6-18-2004.



FOR WOMEN'S SHOES (U.S. CLS. 22 AND 39).
DAVID TAYLOR, EXAMINING ATTORNEY

THE MARK CONSISTS OF STANDARD CHARACTERS WITHOUT CLAIM TO ANY PARTICULAR FONT, STYLE, SIZE, OR COLOR.

OWNER OF U.S. REG. NOS. 1,491,224 AND 2,489,317.
FOR INTIMATE APPAREL AND FIGURE ENHANCING GARMENTS, NAMELY, BRAS, PANTIES, UNDERWEAR, UNDERPANTS, UNDERGARMENTS, UNDERCLOTHES, TEDDIES, SLIPS, SARONGS, NEGLIGEEES, LINGERIE, FOUNDATION GARMENTS, GIRDLES, CORSETS, CAMISOLES, BODY SLIPS AND BODY SUITS, SLEEPWEAR AND NIGHTGOWNS (U.S. CLS. 22 AND 39).

WON TEAK OH, EXAMINING ATTORNEY

CLASS 25—(Continued).

SN 78-438,865. CHOI, JOHNNY, SAN YSIDRO, CA. FILED 6-21-2004.

2127AHTAQ

THE MARK CONSISTS OF STANDARD CHARACTERS WITHOUT CLAIM TO ANY PARTICULAR FONT, STYLE, SIZE, OR COLOR.

FOR CLOTHING, NAMELY, SHIRTS, T-SHIRTS, SWEATSHIRTS, SPORT SHIRTS, VESTS, SWEATERS, SHOES, CAPS, BANDANNAS, SHORTS, PANTS, SHORTS, BELTS FOR CLOTHING, SOCKS, SWIMWEAR, JACKETS, RAINWEAR, BLOUSES, DRESSES, FOOTWEAR, HOSIERY, SCARVES, HATS, HEAD BANDS, PAJAMAS AND SLEEPWEAR (U.S. CLS. 22 AND 39).
STEVEN R. FINE, EXAMINING ATTORNEY

SN 78-439,160. HADDAD, CLAUDE, PARIS, FRANCE, FILED 6-22-2004.

Oscar et Valentine

THE MARK CONSISTS OF STANDARD CHARACTERS WITHOUT CLAIM TO ANY PARTICULAR FONT, STYLE, SIZE, OR COLOR.

FOR CHILDREN'S CLOTHING, NAMELY COATS, DRESSES, PANTS, SHIRTS, SKIRTS, SCARVES, GLOVES, VESTS, SWIMSUITS, BELTS, JACKETS AND SOCKS (U.S. CLS. 22 AND 39).

FIRST USE 7-16-2004; IN COMMERCE 7-16-2004.
SUSAN HAYASH, EXAMINING ATTORNEY

CLASS 25—(Continued).

SN 78-439,337. GENESIS INTERNATIONAL CORP., NEW YORK, NY. FILED 6-22-2004.

BEVI

THE MARK CONSISTS OF STANDARD CHARACTERS WITHOUT CLAIM TO ANY PARTICULAR FONT, STYLE, SIZE, OR COLOR.

FOR CLOTHING FOR MEN, WOMEN AND CHILDREN, NAMELY, DRESSES, SUITS, SKIRTS, TROUSERS, SHIRTS, T-SHIRTS, SPORTS SHIRTS, JERSEYS, JACKETS, SCARVES, COATS, OVERCOATS, TOPCOATS, RAINCOATS, FOULARDS, SCARVES, GLOVES, SOCKS, BELTS, PULLOVERS, SWEATERS, TRACK SUITS, PARKAS, WRAPS, BATHING SUITS, BEACH CLOTHES; SHOES, BOOTS, SANDALS, SABOTS, SLIPPERS; HEADGEAR, NAMELY, BERETS, CAPS, HATS; PEAKS AND VISORS (U.S. CLS. 22 AND 39).

FIRST USE 6-1-2004; IN COMMERCE 6-1-2004.
KEVON CHISOLM, EXAMINING ATTORNEY

SN 78-439,493. MAY DEPARTMENT STORES INTERNATIONAL, INC., ST. LOUIS, MO. FILED 6-22-2004.

STITCHWORKS

THE MARK CONSISTS OF STANDARD CHARACTERS WITHOUT CLAIM TO ANY PARTICULAR FONT, STYLE, SIZE, OR COLOR.

FOR WOMEN'S APPAREL, NAMELY, DRESSES, SKIRTS, SHIRTS, PANTS, JACKETS, SWEATERS AND COATS; WOMEN'S LINGERIE AND NIGHTWEAR, NAMELY, BRAS, PANTIES, SLIPS, NIGHTGOWNS, PAJAMAS AND ROBES; AND WOMEN'S FOOTWEAR (U.S. CLS. 22 AND 39).

STEVEN R. FINE, EXAMINING ATTORNEY

CLASS 25—(Continued).

SN 78-447,749. PAISANO PUBLICATIONS, LLC, AGOURA HILLS, CA. FILED 7-8-2004.



OWNER OF U.S. REG. NO. 1,979,118.
NO CLAIM IS MADE TO THE EXCLUSIVE RIGHT TO USE "TATTOO", APART FROM THE MARK AS SHOWN.
THE STIPPLING IS A FEATURE OF THE MARK.
THE MARK CONSISTS OF A STYLISTIC DESIGN OF THE WORDS TATTOO SAVAGE.

FOR SPORTSWEAR FOR MEN, WOMEN, CHILDREN AND JUNIORS, NAMELY SHIRTS, TEE SHIRTS, KNIT TOPS; TANK TOPS; FLEECE SWEAT SHIRTS, FLEECE SWEAT PANTS, CAMP SHIRTS, HEAD WEAR AND LOUNGE WEAR; AND SPECIFICALLY EXCLUDING FOOTWEAR, NAMELY, DRESS SHOES, WALKING SHOES, ATHLETIC SHOES, SLIPPERS, SANDALS AND BOOTS FOR MEN, WOMEN AND CHILDREN; AND ALSO SPECIFICALLY EXCLUDING DRESSES, SKIRTS, PANTS AND SHORTS FOR WOMEN (U.S. CLS. 22 AND 39).

KIMBERLY PERRY, EXAMINING ATTORNEY

SN 78-461,872. CREATIVE CHARACTERS, INC., MIAMI, FL. FILED 8-4-2004.

Oscar Wilde

THE MARK CONSISTS OF STANDARD CHARACTERS WITHOUT CLAIM TO ANY PARTICULAR FONT, STYLE, SIZE, OR COLOR.

THE NAME(S), PORTRAIT(S), AND/OR SIGNATURE(S) SHOWN IN THE MARK DOES NOT IDENTIFY A PARTICULAR LIVING INDIVIDUAL.

SEC. 2(F).

FOR APRONS, SHIRTS, T-SHIRTS, BLOUSES, SKIRTS, DRESSES, HATS, JACKETS, SOCKS, PANTS, SHORTS, BELTS, SUSPENDERS, SWEATERS, GLOVES, SWEATBANDS, COATS, APRONS, BATHROBES, BEACHWEAR, BLAZERS, FOOTWEAR, PAJAMAS, SCARVES, SUN VISORS, SWEAT BANDS, SWIM WEAR, TIES, UNDERGARMENTS, VESTS (U.S. CLS. 22 AND 39).

FIRST USE 10-2-1964; IN COMMERCE 10-2-1964.

ARETHA SOMERVILLE, EXAMINING ATTORNEY

CLASS 25—(Continued).

SN 78-498,924. COLUMBIA INSURANCE COMPANY, OMAHA, NE. FILED 10-13-2004.

OAK ICE

THE MARK CONSISTS OF STANDARD CHARACTERS WITHOUT CLAIM TO ANY PARTICULAR FONT, STYLE, SIZE, OR COLOR.

FOR FOOTWEAR (U.S. CLS. 22 AND 39).

REGINA DRUMMOND, EXAMINING ATTORNEY

SN 78-511,324. CHERLE COMMUNICATIONS, INC., OAK BROOK, IL. FILED 11-4-2004.

EAT, SLEEP, RIDE MOTOCROSS

THE MARK CONSISTS OF STANDARD CHARACTERS WITHOUT CLAIM TO ANY PARTICULAR FONT, STYLE, SIZE, OR COLOR.

FOR MEN'S, WOMEN'S, AND CHILDREN'S CLOTHING, NAMELY, SWEAT SHIRTS, HOODS, PULLOVERS, SPORTS SHIRTS, POLO SHIRTS, KNIT SHIRTS, T-SHIRTS, JEANS, SWEAT PANTS, DRESSES, WRISTBANDS, BELTS, UNDER GARMENTS, UNDERWEAR, NECKTIES, SHORTS; HEADGEAR, NAMELY, HATS, HEAD BANDS, VISORS, CAPS, SWEATBANDS, BASEBALL CAPS (U.S. CLS. 22 AND 39).

JOHN E. MICHOS, EXAMINING ATTORNEY

CLASS 25—(Continued).

SN 78-511,352. CHERLE COMMUNICATIONS, INC., OAK BROOK, IL. FILED 11-4-2004.

I ♥ Dirt

FOR MEN'S, WOMEN'S, AND CHILDREN'S CLOTHING, NAMELY, SWEAT SHIRTS, HOODS, PULLOVERS, SPORTS SHIRTS, POLO SHIRTS, KNIT SHIRTS, T-SHIRTS, JEANS, SWEAT PANTS, DRESSES, WRISTBANDS, BELTS, UNDER GARMENTS, UNDERWEAR, NECKTIES, SHORTS; HEADGEAR, NAMELY, HATS, HEAD BANDS, VISORS, CAPS, SWEATBANDS, BASEBALL CAPS (U.S. CLS. 22 AND 39).

JOHN E. MICHOŠ, EXAMINING ATTORNEY

SN 79-000,097. PROVEA, SWITZERLAND, FILED 11-14-2003.



OWNER OF INTERNATIONAL REGISTRATION 0761337 DATED 7-12-2001, EXPIRES 7-12-2011.

NO CLAIM IS MADE TO THE EXCLUSIVE RIGHT TO USE INTERNATIONAL, APART FROM THE MARK AS SHOWN.

FOR FULL LINE OF CLOTHING; UNDERWEAR; FOOTWEAR; HEADWEAR (U.S. CLS. 22 AND 39).
TONI HICKEY, EXAMINING ATTORNEY

SN 79-000,098. PROVEA, CH-1033 CHESEAUX S/LAUSANNE, SWITZERLAND, FILED 11-14-2003.

TONO

OWNER OF INTERNATIONAL REGISTRATION 0761550 DATED 7-12-2001, EXPIRES 7-12-2011.

FOR FULL LINE OF CLOTHING; UNDERWEAR; FOOTWEAR; HEADWEAR (U.S. CLS. 22 AND 39).
TONI HICKEY, EXAMINING ATTORNEY

CLASS 25—(Continued).

SN 79-000,099. PROVEA, CH-1033 CHESEAUX S/LAUSANNE, SWITZERLAND, FILED 11-14-2003.

MIRIALE INTERNATIONAL

THE MARK CONSISTS OF STANDARD CHARACTERS WITHOUT CLAIM TO ANY PARTICULAR FONT, STYLE, SIZE, OR COLOR.

OWNER OF INTERNATIONAL REGISTRATION 0761874 DATED 6-18-2001, EXPIRES 6-18-2011.

NO CLAIM IS MADE TO THE EXCLUSIVE RIGHT TO USE INTERNATIONAL, APART FROM THE MARK AS SHOWN.

FOR FULL LINE OF CLOTHING; UNDERWEAR; FOOTWEAR; HEADWEAR (U.S. CLS. 22 AND 39).
TONI HICKEY, EXAMINING ATTORNEY

SN 79-000,171. PROVEA, CH-1033 CHESEAUX S/LAUSANNE, SWITZERLAND, FILED 11-14-2003.

Miriale
INTERNATIONAL

OWNER OF INTERNATIONAL REGISTRATION 0761875 DATED 6-18-2001, EXPIRES 6-18-2011.

NO CLAIM IS MADE TO THE EXCLUSIVE RIGHT TO USE INTERNATIONAL, APART FROM THE MARK AS SHOWN.

FOR FULL LINE OF CLOTHING; UNDERWEAR; FOOTWEAR; HEADWEAR (U.S. CLS. 22 AND 39).
TONI HICKEY, EXAMINING ATTORNEY

SN 79-000,857. CÜNO TEKSTİL KONFEKSİYON; SANAYİ VE TİCARET LIMITED SİRKETİ, TURKEY, FILED 12-22-2003.



OWNER OF INTERNATIONAL REGISTRATION 0786613 DATED 6-21-2002, EXPIRES 6-21-2012.

FOR CLOTHING, NAMELY, PANTS, SHIRTS, SKIRTS, T-SHIRTS, SHORTS, JACKETS, OVERCOATS, SOCKS, EXCLUDING CLIMBING CLOTHING; FOOTWEAR, EXCLUDING CLIMBING FOOTWEAR (U.S. CLS. 22 AND 39).

GRETTA YAO, EXAMINING ATTORNEY

CLASS 25—(Continued).

SN 79-002,074. MICHAEL ZIMMERMANN, FED REP GERMANY, FILED 3-25-2004.



PRIORITY DATE OF 11-24-2003 IS CLAIMED.
OWNER OF INTERNATIONAL REGISTRATION 0823133 DATED 3-25-2004, EXPIRES 3-25-2014.
THE COLOR WHITE AND RED IS CLAIMED AS A FEATURE OF THE MARK.
THE COLOR RED APPEARS IN THE FOUR SQUARES AND THE WORD "SWISSOCCOLI".
THE MARK CONSISTS OF THE WORD SWISSOCCOLI AND THE DESIGN OF FOUR SQUARES.
FOR PANTS, SKIRTS, BELTS, CAPS, DUSTERS, FOU-LARDS, HOODS, JERSEYS, MANTLES, BATHING SUITS, UNDERWEAR, SHORT SETS, TIES, TOPS, T-SHIRTS, JEANS, HATS, SOCKS, SUITS, HEADWEAR, FOOTWEAR (U.S. CLS. 22 AND 39).
DAVID C. REIHNER, EXAMINING ATTORNEY

SN 79-003,123. HAZAL TEKSTIL TABL DOT GIDA: SANAYI VE TICARET LIMITED SIRKETI, TURKEY, FILED 3-31-2004.



OWNER OF INTERNATIONAL REGISTRATION 0826655 DATED 3-31-2004, EXPIRES 3-31-2014.
THE COLOR(S) GRAY IS/ARE CLAIMED AS A FEATURE OF THE MARK.
THE COLOR GRAY APPEARS BOTH INSIDE AND OUT-LINING THE DESIGN, AND OUTLINING THE NUMBER 21.
FOR CLOTHING, NAMELY, SHORTS, SHIRTS, T-SHIRTS, SWIMSUITS, BLOUSES, SKINS, SCARVES, GLOVES, PANTS, SWEATERS, JERSEYS, SOCKS, JACKETS, SUITS, TRAINING SUITS, VESTS, NECKTIES, BELTS, SUSPENDERS, DRESSES, COATS, RAINCOATS, OVERCOATS, SMOCKS, UNDERWEAR, PAJAMAS, BRASSIERES, CORSETS, SLIPS, LINGERIE; HEADWEAR, NAMELY, HATS, CAPS AND BERETS; FOOTWEAR, NAMELY, BOOTS, SANDALS, SHOES AND SLIPPERS (U.S. CLS. 22 AND 39).
KAREN BRACEY, EXAMINING ATTORNEY

CLASS 25—(Continued).

SN 79-005,972. BLUEPRINT S.P.A., ITALY, FILED 6-17-2004.



OWNER OF INTERNATIONAL REGISTRATION 0835023 DATED 6-17-2004, EXPIRES 6-17-2014.
THE MARK CONSISTS OF THE WORD 'APPIE', WRITTEN IN LOWER CASE FANCIFUL CHARACTERS, WITH THE LETTER 'A' BEARING THE STYLIZED DEVICE OF A CLOVER.
FOR SHOES; HEADGEAR, NAMELY HATS AND CAPS; SOCKS, CASUAL SOCKS, SPORT SOCKS FOR MEN; WOMEN AND CHILDREN; STOCKINGS; TIGHTS (U.S. CLS. 22 AND 39).
ELLEN B. AWRICH, EXAMINING ATTORNEY

CLASS 26—FANCY GOODS

SN 76-381,073. NMC GROUP, INC., POMONA, CA. FILED 3-11-2002.

NYLON MOLDING CORPORATION

NO CLAIM IS MADE TO THE EXCLUSIVE RIGHT TO USE "MOLDING CORPORATION", APART FROM THE MARK AS SHOWN.
SEC. 2(F).
FOR NON-METAL SLIDE FASTENERS AND SNAP FASTENERS (U.S. CLS. 37, 39, 40, 42 AND 50).
FIRST USE 0-0-1946; IN COMMERCE 0-0-1946.
GENE MACIOL, EXAMINING ATTORNEY

SN 76-565,845. LAINE ENTERPRISES LTD., DBA BEST VALUE PRODUCTS, WYNCOTE, PA. FILED 12-18-2003.

SUDDENLY FEM

THE MARK CONSISTS OF STANDARD CHARACTERS WITHOUT CLAIM TO ANY PARTICULAR FONT, STYLE, SIZE, OR COLOR.
NO CLAIM IS MADE TO THE EXCLUSIVE RIGHT TO USE "FEM", APART FROM THE MARK AS SHOWN.
FOR FEMININE WIGS FOR MEN (U.S. CLS. 37, 39, 40, 42 AND 50).
MITCHELL FRONT, EXAMINING ATTORNEY

CLASS 26—(Continued).

SN 76-594,639. SANRIO COMPANY, LTD., TOKYO 141, JAPAN, FILED 5-27-2004.

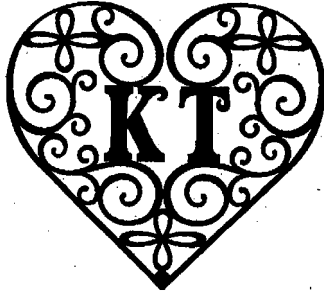

FOR HAIR BANDS, HAIR BOWS, HAIR RIBBONS, HAIR ORNAMENTS, HAIR CLIPS, FABRIC COVERED ELASTIC BANDS FOR HAIR, PONYTAIL HOLDERS, BARRETTES; CLOTHING BUCKLES NOT OF PRECIOUS METAL; SHOE LACES; SAFETY PIN SETS; SEWING KITS COMPRISED OF SHIRT BUTTONS, SNAP FASTENERS, SAFETY PINS, NEEDLES, SCISSORS AND THREAD; BOWS FOR GIFT WRAPPING, AND RIBBONS FOR GIFT WRAPPING; NON-ELECTRIC HAIR CURLERS; SHOE ORNAMENTS NOT OF PRECIOUS METAL (U.S. CLS. 37, 39, 40, 42 AND 50).

EUGENIA MARTIN, EXAMINING ATTORNEY

SN 76-596,161. VILLALOBOS, CRUZ, VICTORVILLE, CA. AND WARKENTIN, SHIRLEY, VICTORVILLE, CA. FILED 6-8-2004.

HANDS BY CRUZ

THE MARK CONSISTS OF STANDARD CHARACTERS WITHOUT CLAIM TO ANY PARTICULAR FONT, STYLE, SIZE, OR COLOR.

FOR CLOTH PATCHES FOR CLOTHING (U.S. CLS. 37, 39, 40, 42 AND 50).

NORA BUCHANAN WILL, EXAMINING ATTORNEY

SN 78-316,598. DISNEY ENTERPRISES, INC., BURBANK, CA. FILED 10-21-2003.

WALT DISNEY WORLD

OWNER OF U.S. REG. NOS. 980,995, 1,189,727 AND 2,189,177.

THE NAME IN THE MARK DOES NOT IDENTIFY A PARTICULAR LIVING INDIVIDUAL.

FOR LACE TRIMMING; EMBROIDERY; RIBBONS; BRAIDS; BUTTONS FOR CLOTHING, CAMPAIGN BUTTONS, ORNAMENTAL NOVELTY BUTTONS, PRESS BUTTONS, RIVET BUTTONS, SHIRT BUTTONS; HOOKS AND EYES; ARTIFICIAL FLOWERS (U.S. CLS. 37, 39, 40, 42 AND 50).

PAUL F. GAST, EXAMINING ATTORNEY

CLASS 26—(Continued).

SN 78-436,601. DIRECT CAMPAIGNS, INC., WOODLAND HILLS, CA. FILED 6-17-2004.

UNDETECTABLES

THE MARK CONSISTS OF STANDARD CHARACTERS WITHOUT CLAIM TO ANY PARTICULAR FONT, STYLE, SIZE, OR COLOR.

FOR HAIR PIECES AND EXTENSIONS (U.S. CLS. 37, 39, 40, 42 AND 50).

FIRST USE 8-1-2003; IN COMMERCE 8-1-2003.

DORITT L. CARROLL, EXAMINING ATTORNEY

CLASS 27—FLOOR COVERINGS

SN 76-587,591. MANNINGTON CARPETS, INC., CALHOUN, GA. FILED 4-20-2004.

MCARE

THE MARK CONSISTS OF STANDARD CHARACTERS WITHOUT CLAIM TO ANY PARTICULAR FONT, STYLE, SIZE, OR COLOR.

FOR CARPET (U.S. CLS. 19, 20, 37, 42 AND 50).

BARBARA GAYNOR, EXAMINING ATTORNEY

SN 76-604,160. PREST-O-FIT MFG., INC., CHANDLER, AZ. FILED 7-27-2004.



FOR RUGS (U.S. CLS. 19, 20, 37, 42 AND 50).
STEVEN BERK, EXAMINING ATTORNEY

MAY 24, 2005

U.S. PATENT AND TRADEMARK OFFICE

TM 429

CLASS 27—(Continued).

SN 78-289,743. PEACHTREE INTERNATIONAL LIMITED,
HAMILTON HM, BERMUDA, FILED 8-20-2003.

STRONGSTONE

FOR HARD SURFACE COVERINGS FOR FLOORS;
VINYL FLOOR COVERINGS (U.S. CLS. 19, 20, 37, 42
AND 50).

JANICE L. MCMORROW, EXAMINING ATTORNEY

SN 78-423,594. PENNZOIL-QUAKER STATE COMPANY,
HOUSTON, TX. FILED 5-24-2004.

STEP ON IT

THE MARK CONSISTS OF STANDARD CHARACTERS
WITHOUT CLAIM TO ANY PARTICULAR FONT, STYLE,
SIZE, OR COLOR.

FOR FLOOR MATS FOR USE IN MOTOR VEHICLES
(U.S. CLS. 19, 20, 37, 42 AND 50).

FIRST USE 3-1-2004; IN COMMERCE 3-1-2004.

BRETT J. GOLDEN, EXAMINING ATTORNEY

SN 78-975,508. ELEGANT USA, LLC, TOTOWA, NJ. FILED 3-
25-2003.

X-BOUND

THE MARK CONSISTS OF STANDARD CHARACTERS
WITHOUT CLAIM TO ANY PARTICULAR FONT, STYLE,
SIZE, OR COLOR.

FOR FLOOR MATS FOR AUTOMOBILES (U.S. CLS.
19, 20, 37, 42 AND 50).

LOURDES AYALA, EXAMINING ATTORNEY

CLASS 28—TOYS AND SPORTING GOODS

SN 76-484,301. KENNEDY, KEN, OAKVILLE, ONTARIO,
CANADA, FILED 1-23-2003.

SPINMARK

PRIORITY CLAIMED UNDER SEC. 44(D) ON CANADA
APPLICATION NO. 1158905, FILED 11-13-2002, REG. NO.
TMA607542, DATED 4-14-2004, EXPIRES 4-14-2019.

FOR GOLF BALL MARKERS (U.S. CLS. 22, 23, 38 AND
50).

PAUL F. GAST, EXAMINING ATTORNEY

SN 76-507,511. SPIN MASTER LTD. TORONTO, ONTARIO
M5V 1B6, CANADA, FILED 4-18-2003.

TRIPLE BOOSTER

FOR TOY AIRCRAFT (U.S. CLS. 22, 23, 38 AND 50).
DORITT L. CARROLL, EXAMINING ATTORNEY

SN 76-565,304. FINK, MICHAEL, LAKE MARY, FL. FILED
12-15-2003.

SNUGGABUNCH

THE MARK CONSISTS OF STANDARD CHARACTERS
WITHOUT CLAIM TO ANY PARTICULAR FONT, STYLE,
SIZE, OR COLOR.

FOR TOYS; NAMELY, PLUSH TOYS AND PLUSH
TOYS SOLD AS A UNIT WITH A DETACHABLE NIGHT
LIGHT (U.S. CLS. 22, 23, 38 AND 50).

MATTHEW KLINE, EXAMINING ATTORNEY

CLASS 28—(Continued).

SN 76-573,438. GARY Z, CINCINNATI, OH. FILED 2-2-2004.

CREATIVE KIDS FACTORY

THE MARK CONSISTS OF STANDARD CHARACTERS WITHOUT CLAIM TO ANY PARTICULAR FONT, STYLE, SIZE, OR COLOR.

NO CLAIM IS MADE TO THE EXCLUSIVE RIGHT TO USE "KIDS", APART FROM THE MARK AS SHOWN.

FOR TOYS, GAMES AND PLAYTHINGS, NAMELY, PARLOR GAMES, BOARD GAMES, CARD GAMES, ROLE-PLAYING GAMES, DOLLS, DOLL CLOTHING, DOLL ACCESSORIES, DOLL PLAY SETS, TOY ACTION FIGURES AND ACCESSORIES THEREFOR, TOY ACTION FIGURE PLAY SETS, TOY ANIMAL FIGURES AND PLAY SETS AND ACCESSORIES THEREFOR, YO-YOS, JUMP ROPES, RUBBER BALLS, PLASTIC BALLS, FOAM BALLS, BASKETBALLS, FOOTBALLS, BASEBALLS, BALLOONS, BATHTUB TOYS, WATER SQUIRTING TOYS, RIDE-ON TOYS, PLUSH TOYS, STUFFED ANIMALS, TOY VEHICLES, TOY SPACESHIPS, FLYING DISCS, TOY MODEL HOBBY KITS, ARTS AND CRAFTS KITS FOR MAKING TOY JEWELRY, TOY GUNS, MUSICAL TOYS, JIGSAW AND MANIPULATIVE PUZZLES, BUBBLE MAKING WANDS AND SOLUTIONS SETS, TOY FIGURES, PUPPETS, TOY PLAY HOUSES, HAND HELD UNITS FOR PLAYING ELECTRONIC VIDEO GAMES AND STAND ALONE VIDEO GAME MACHINES (U.S. CLS. 22, 23, 38 AND 50).

ROBERT COGGINS, EXAMINING ATTORNEY

SN 76-574,355. GT MERCHANDISING & LICENSING LLC, NEW YORK, NY. FILED 2-6-2004.

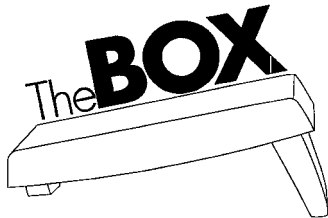

NO CLAIM IS MADE TO THE EXCLUSIVE RIGHT TO USE "BOX", APART FROM THE MARK AS SHOWN.

FOR EXERCISE EQUIPMENT NAMELY, AN ADJUSTABLE BENCH (U.S. CLS. 22, 23, 38 AND 50).

RONALD MCMORROW, EXAMINING ATTORNEY

SN 76-587,042. TONNER DOLL COMPANY, INC., HURLEY, NY. FILED 4-13-2004.

BELIEVE IN THE POWER OF PLAY

THE MARK CONSISTS OF STANDARD CHARACTERS WITHOUT CLAIM TO ANY PARTICULAR FONT, STYLE, SIZE, OR COLOR.

FOR DOLLS, DOLL ACCESSORIES, DOLL FURNITURE, DOLL JEWELRY AND DOLL CLOTHING (U.S. CLS. 22, 23, 38 AND 50).

FIRST USE 7-1-2001; IN COMMERCE 7-1-2001.

DOUGLAS LEE, EXAMINING ATTORNEY

CLASS 28—(Continued).

SN 76-587,869. THE HARTZ MOUNTAIN CORPORATION, SECAUCUS, NJ. FILED 4-21-2004.

TRIPLE HEADER

THE MARK CONSISTS OF STANDARD CHARACTERS WITHOUT CLAIM TO ANY PARTICULAR FONT, STYLE, SIZE, OR COLOR.

FOR PET TOYS (U.S. CLS. 22, 23, 38 AND 50).

ALICIA COLLINS, EXAMINING ATTORNEY

SN 76-589,453. LADDER GOLF, LLC, SANTEE, CA. FILED 4-29-2004.

LADDER GOLF

NO CLAIM IS MADE TO THE EXCLUSIVE RIGHT TO USE LADDER, APART FROM THE MARK AS SHOWN.

FOR ACTION TYPE TARGET GAMES; ACTION SKILL GAMES; EQUIPMENT SOLD AS A UNIT FOR PLAYING ACTION TYPE TARGET GAMES; EQUIPMENT SOLD AS A UNIT FOR PLAYING ACTION SKILL GAMES; OUTDOOR ACTIVITY GAMES IN THE NATURE OF GAME THROWING DEVICES, WITH TARGETS AND INSTRUCTIONS (U.S. CLS. 22, 23, 38 AND 50).

FIRST USE 7-1-2003; IN COMMERCE 7-14-2003.

TIMOTHY FINNEGAN, EXAMINING ATTORNEY

SN 76-591,500. WAVE INDUSTRIES, INC., ALBA, TX. FILED 5-10-2004.

TIKI-MOKO LIZARD

THE MARK CONSISTS OF STANDARD CHARACTERS WITHOUT CLAIM TO ANY PARTICULAR FONT, STYLE, SIZE, OR COLOR.

OWNER OF U.S. REG. NO. 2,785,756.

NO CLAIM IS MADE TO THE EXCLUSIVE RIGHT TO USE LIZARD, APART FROM THE MARK AS SHOWN.

THE ENGLISH TRANSLATION OF THE MAUI WORD "MOKO" IN THE MARK IS "LIZARD" OR A STYLE OF TATTOOING.

FOR FISHING LURES (U.S. CLS. 22, 23, 38 AND 50).

MICHELLE S. WISEMAN, EXAMINING ATTORNEY

CLASS 28—(Continued).

SN 76-594,060. ASHAWAY LINE & TWINE MFG. CO., ASHAWAY, RI. FILED 5-26-2004.

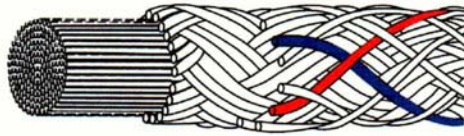

RED AND BLUE
THE MARK COMPRISES A BRAIDED RACKET STRING HAVING A RED FILAMENT AND A BLUE FILAMENT INTERSECTING EACH OTHER AT SPACED LOCATIONS THROUGHOUT THE LENGTH OF THE STRING.
SEC. 2(F).
FOR RACKET STRINGS (U.S. CLS. 22, 23, 38 AND 50).
FIRST USE 10-0-1978; IN COMMERCE 10-0-1978.
RON FAIRBANKS, EXAMINING ATTORNEY

SN 76-595,585. HASBRO, INC., PAWTUCKET, RI. FILED 6-4-2004.

FAIR WEATHER

THE MARK CONSISTS OF STANDARD CHARACTERS WITHOUT CLAIM TO ANY PARTICULAR FONT, STYLE, SIZE, OR COLOR.
FOR TOY PONIES AND ACCESSORIES FOR USE THEREWITH (U.S. CLS. 22, 23, 38 AND 50).
HENRY S. ZAK, EXAMINING ATTORNEY

SN 76-596,164. MOLINA, MELINDA, VISTA, CA. FILED 6-8-2004.

MY LITTLE LOVED ONE

THE MARK CONSISTS OF STANDARD CHARACTERS WITHOUT CLAIM TO ANY PARTICULAR FONT, STYLE, SIZE, OR COLOR.
FOR TOYS, NAMELY STUFFED ANIMALS HAVING A RECORDING ELEMENT FOR ALLOWING MESSAGES TO BE RECORDED AND PLAYED BACK UPON ACTIVATION OF THE RECORDING ELEMENT IN THE STUFFED ANIMAL (U.S. CLS. 22, 23, 38 AND 50).
NORA BUCHANAN WILL, EXAMINING ATTORNEY

CLASS 28—(Continued).

SN 76-596,172. TIPM, INC., ROCKFORD, IL. FILED 6-8-2004.

PRO CUT

THE MARK CONSISTS OF STANDARD CHARACTERS WITHOUT CLAIM TO ANY PARTICULAR FONT, STYLE, SIZE, OR COLOR.
OWNER OF U.S. REG. NO. 2,186,126.
FOR BASEBALL BAT (U.S. CLS. 22, 23, 38 AND 50).
FIRST USE 1-1-1996; IN COMMERCE 1-1-1996.
NORA BUCHANAN WILL, EXAMINING ATTORNEY

SN 76-596,302. PETSTAGES, INC., NORTHBROOK, IL. FILED 6-7-2004.

ORKA

THE MARK CONSISTS OF STANDARD CHARACTERS WITHOUT CLAIM TO ANY PARTICULAR FONT, STYLE, SIZE, OR COLOR.
FOR PET TOYS, NAMELY, PLASTIC TEETHING AND CHEWING TOYS FOR DOGS (U.S. CLS. 22, 23, 38 AND 50).
MICHAEL TANNER, EXAMINING ATTORNEY

SN 76-596,305. PLACO CORPORATION LIMITED, KOW-LOON, HONG KONG, FILED 6-7-2004.

AMAZING BUBBLES FREE BATTERIES READY TO PLAY!

THE MARK CONSISTS OF STANDARD CHARACTERS WITHOUT CLAIM TO ANY PARTICULAR FONT, STYLE, SIZE, OR COLOR.
OWNER OF U.S. REG. NO. 2,876,672.
NO CLAIM IS MADE TO THE EXCLUSIVE RIGHT TO USE "BUBBLES" "FREE BATTERIES" AND "READY TO PLAY!", APART FROM THE MARK AS SHOWN.
FOR BATTERY OPERATED, HAND-HELD BUBBLE TOYS, NAMELY BUBBLE GUNS, BUBBLE MACHINES, BUBBLE WANDS, AND BUBBLE SOLUTION CONTAINERS; AND NON-BATTERY OPERATED, HAND-HELD TOYS, NAMELY BUBBLE GUNS, BUBBLE MACHINES, BUBBLE WANDS, AND BUBBLE SOLUTION CONTAINERS (U.S. CLS. 22, 23, 38 AND 50).
FIRST USE 6-1-2004; IN COMMERCE 6-1-2004.
MICHAEL TANNER, EXAMINING ATTORNEY

CLASS 28—(Continued).

SN 76-596,306. PLACO CORPORATION LIMITED, KOW-
LOON, HONG KONG, FILED 6-7-2004.

AMAZING BUBBLES READY TO PLAY!

THE MARK CONSISTS OF STANDARD CHARACTERS
WITHOUT CLAIM TO ANY PARTICULAR FONT, STYLE,
SIZE, OR COLOR.

OWNER OF U.S. REG. NO. 2,876,672.

NO CLAIM IS MADE TO THE EXCLUSIVE RIGHT TO
USE "BUBBLES" AND "READY TO PLAY!", APART FROM
THE MARK AS SHOWN.

FOR BATTERY OPERATED, HAND-HELD BUBBLE
TOYS, NAMELY BUBBLE GUNS, BUBBLE MACHINES,
BUBBLE WANDS, AND BUBBLE SOLUTION CONTAIN-
ERS; AND NON-BATTERY OPERATED, HAND-HELD
BUBBLE TOYS, NAMELY BUBBLE GUNS, BUBBLE
MACHINES, BUBBLE WANDS, AND BUBBLE SOLU-
TION CONTAINERS (U.S. CLS. 22, 23, 38 AND 50).

FIRST USE 6-1-2004; IN COMMERCE 6-1-2004.

MICHAEL TANNER, EXAMINING ATTORNEY

SN 76-596,972. FORMATE INDUSTRIAL CO., LTD., TAIPEI,
TAIWAN, FILED 6-14-2004.



FOR DOLL CARRIAGES, DOLL PLAYPENS, DOLL
PRAMS, DOLL STROLLERS, DOLL CRIBS AND PUSH
TOYS (U.S. CLS. 22, 23, 38 AND 50).

FIRST USE 5-15-1993; IN COMMERCE 5-15-1993.

GRETTA YAO, EXAMINING ATTORNEY

SN 76-597,300. HASBRO, INC., PAWTUCKET, RI. FILED 6-
15-2004.

FRANKEN'PUNKER

THE MARK CONSISTS OF STANDARD CHARACTERS
WITHOUT CLAIM TO ANY PARTICULAR FONT, STYLE,
SIZE, OR COLOR.

FOR TOY ACTION FIGURES AND ACCESSORIES
FOR USE THEREWITH (U.S. CLS. 22, 23, 38 AND 50).

KELLY BOULTON, EXAMINING ATTORNEY

CLASS 28—(Continued).

SN 76-597,582. HASBRO, INC., PAWTUCKET, RI. FILED 6-
15-2004.

REPTOSAUR

THE MARK CONSISTS OF STANDARD CHARACTERS
WITHOUT CLAIM TO ANY PARTICULAR FONT, STYLE,
SIZE, OR COLOR.

FOR TOY ACTION FIGURES AND ACCESSORIES
FOR USE THEREWITH (U.S. CLS. 22, 23, 38 AND 50).

ASMAT KHAN, EXAMINING ATTORNEY

SN 76-597,610. PENN FISHING TACKLE MANUFACTUR-
ING CO., PHILADELPHIA, PA. FILED 6-16-2004.

PENN SPINFISHER

THE MARK CONSISTS OF STANDARD CHARACTERS
WITHOUT CLAIM TO ANY PARTICULAR FONT, STYLE,
SIZE, OR COLOR.

OWNER OF U.S. REG. NOS. 647,119, 1,838,443 AND
OTHERS.

FOR FISHING TACKLE, NAMELY FISHING REELS
(U.S. CLS. 22, 23, 38 AND 50).

FIRST USE 0-0-1962; IN COMMERCE 0-0-1962.

ZACHARY BELLO, EXAMINING ATTORNEY

SN 76-598,355. HASBRO, INC., PAWTUCKET, RI. FILED 6-
22-2004.

WILD BLUE

THE MARK CONSISTS OF STANDARD CHARACTERS
WITHOUT CLAIM TO ANY PARTICULAR FONT, STYLE,
SIZE, OR COLOR.

FOR TOY PONIES AND ACCESSORIES FOR USE
THEREWITH (U.S. CLS. 22, 23, 38 AND 50).

WILLIAM VERHOSEK, EXAMINING ATTORNEY

CLASS 28—(Continued).

SN 76-598,356. HASBRO, INC., PAWTUCKET, RI. FILED 6-22-2004.

SKY GRINDER

THE MARK CONSISTS OF STANDARD CHARACTERS WITHOUT CLAIM TO ANY PARTICULAR FONT, STYLE, SIZE, OR COLOR.

FOR TOY ACTION FIGURES AND ACCESSORIES FOR USE THEREWITH (U.S. CLS. 22, 23, 38 AND 50).
WILLIAM VERHOSEK, EXAMINING ATTORNEY

SN 76-598,357. HASBRO, INC., PAWTUCKET, RI. FILED 6-22-2004.

SWERVE

THE MARK CONSISTS OF STANDARD CHARACTERS WITHOUT CLAIM TO ANY PARTICULAR FONT, STYLE, SIZE, OR COLOR.

FOR TOY ACTION FIGURES, TOY VEHICLES AND TOY ROBOTS CONVERTIBLE INTO OTHER VISUAL TOY FORMS AND ACCESSORIES FOR USE THEREWITH (U.S. CLS. 22, 23, 38 AND 50).

WILLIAM VERHOSEK, EXAMINING ATTORNEY

SN 76-598,358. HASBRO, INC., PAWTUCKET, RI. FILED 6-22-2004.

THUNDER SHAMAN

THE MARK CONSISTS OF STANDARD CHARACTERS WITHOUT CLAIM TO ANY PARTICULAR FONT, STYLE, SIZE, OR COLOR.

FOR TOY ACTION FIGURES AND ACCESSORIES FOR USE THEREWITH (U.S. CLS. 22, 23, 38 AND 50).
WILLIAM VERHOSEK, EXAMINING ATTORNEY

SN 76-598,366. HASBRO, INC., PAWTUCKET, RI. FILED 6-22-2004.

WHISTLE TOE

THE MARK CONSISTS OF STANDARD CHARACTERS WITHOUT CLAIM TO ANY PARTICULAR FONT, STYLE, SIZE, OR COLOR.

FOR TOY PONIES AND ACCESSORIES FOR USE THEREWITH (U.S. CLS. 22, 23, 38 AND 50).
WILLIAM VERHOSEK, EXAMINING ATTORNEY

CLASS 28—(Continued).

SN 76-598,467. HASBRO, INC., PAWTUCKET, RI. FILED 6-22-2004.

CLOUD CLIMBER

THE MARK CONSISTS OF STANDARD CHARACTERS WITHOUT CLAIM TO ANY PARTICULAR FONT, STYLE, SIZE, OR COLOR.

FOR TOY PONIES AND ACCESSORIES FOR USE THEREWITH (U.S. CLS. 22, 23, 38 AND 50).
ALLISON HOLTZ, EXAMINING ATTORNEY

SN 76-598,490. WIZARDS OF THE COAST, INC., PAWTUCKET, RI. FILED 6-22-2004.

SURVIVORS OF THE MEGAPOCALYPSE

THE MARK CONSISTS OF STANDARD CHARACTERS WITHOUT CLAIM TO ANY PARTICULAR FONT, STYLE, SIZE, OR COLOR.

FOR TRADING CARD GAMES (U.S. CLS. 22, 23, 38 AND 50).
WILLIAM VERHOSEK, EXAMINING ATTORNEY

SN 76-598,492. WIZARDS OF THE COAST, INC., PAWTUCKET, RI. FILED 6-22-2004.

SHADOWCLASH OF THE BLINDING NIGHT

THE MARK CONSISTS OF STANDARD CHARACTERS WITHOUT CLAIM TO ANY PARTICULAR FONT, STYLE, SIZE, OR COLOR.

FOR TRADING CARD GAMES (U.S. CLS. 22, 23, 38 AND 50).
WILLIAM VERHOSEK, EXAMINING ATTORNEY

SN 76-598,493. WIZARDS OF THE COAST, INC., PAWTUCKET, RI. FILED 6-22-2004.

EPIC DRAGONS OF HYPER CHAOS

THE MARK CONSISTS OF STANDARD CHARACTERS WITHOUT CLAIM TO ANY PARTICULAR FONT, STYLE, SIZE, OR COLOR.

FOR TRADING CARD GAMES (U.S. CLS. 22, 23, 38 AND 50).
ALLISON HOLTZ, EXAMINING ATTORNEY

SN 76-598,494. WIZARDS OF THE COAST, INC., PAWTUCKET, RI. FILED 6-22-2004.

STOMP-A-TRONS OF INVINCIBLE WRATH

THE MARK CONSISTS OF STANDARD CHARACTERS WITHOUT CLAIM TO ANY PARTICULAR FONT, STYLE, SIZE, OR COLOR.

FOR TRADING CARD GAMES (U.S. CLS. 22, 23, 38 AND 50).
TIMOTHY FINNEGAN, EXAMINING ATTORNEY

CLASS 28—(Continued).

SN 76-598,495. WIZARDS OF THE COAST, INC., PAWTUCKET, RI. FILED 6-22-2004.

THUNDERCHARGE OF ULTRA DESTRUCTION

THE MARK CONSISTS OF STANDARD CHARACTERS WITHOUT CLAIM TO ANY PARTICULAR FONT, STYLE, SIZE, OR COLOR.

FOR TRADING CARD GAMES (U.S. CLS. 22, 23, 38 AND 50).

TIMOTHY FINNEGAN, EXAMINING ATTORNEY



SN 76-598,496. WIZARDS OF THE COAST, INC., PAWTUCKET, RI. FILED 6-22-2004.

BOLSHACK DRAGON

THE MARK CONSISTS OF STANDARD CHARACTERS WITHOUT CLAIM TO ANY PARTICULAR FONT, STYLE, SIZE, OR COLOR.

FOR TOY ACTION FIGURES AND ACCESSORIES FOR USE THEREWITH (U.S. CLS. 22, 23, 38 AND 50).

TIMOTHY FINNEGAN, EXAMINING ATTORNEY



SN 76-598,634. HASBRO, INC., PAWTUCKET, RI. FILED 6-22-2004.



FOR TOY ACTION FIGURES AND ACCESSORIES FOR USE THEREWITH (U.S. CLS. 22, 23, 38 AND 50). FIRST USE 5-5-2003; IN COMMERCE 5-5-2003. CIMMERIAN COLEMAN, EXAMINING ATTORNEY

CLASS 28—(Continued).

SN 76-598,635. HASBRO, INC., PAWTUCKET, RI. FILED 6-22-2004.



FOR TOY ACTION FIGURES AND ACCESSORIES FOR USE THEREWITH (U.S. CLS. 22, 23, 38 AND 50). FIRST USE 5-5-2003; IN COMMERCE 5-5-2003. CIMMERIAN COLEMAN, EXAMINING ATTORNEY



SN 76-598,636. HASBRO, INC., PAWTUCKET, RI. FILED 6-22-2004.



FOR TOY ACTION FIGURES AND ACCESSORIES FOR USE THEREWITH (U.S. CLS. 22, 23, 38 AND 50). FIRST USE 5-5-2003; IN COMMERCE 5-5-2003. CIMMERIAN COLEMAN, EXAMINING ATTORNEY

CLASS 28—(Continued).

SN 76-598,637. HASBRO, INC., PAWTUCKET, RI. FILED 6-22-2004.



FOR TOY ACTION FIGURES AND ACCESSORIES FOR USE THEREWITH (U.S. CLS. 22, 23, 38 AND 50).
FIRST USE 5-5-2003; IN COMMERCE 5-5-2003.
CIMMERIAN COLEMAN, EXAMINING ATTORNEY

SN 76-598,638. HASBRO, INC., PAWTUCKET, RI. FILED 6-22-2004.

AUTOBOT JAZZ

THE MARK CONSISTS OF STANDARD CHARACTERS WITHOUT CLAIM TO ANY PARTICULAR FONT, STYLE, SIZE, OR COLOR.

OWNER OF U.S. REG. NO. 1,348,233.
FOR TOY ACTION FIGURES, TOY VEHICLES AND TOY ROBOTS CONVERTIBLE INTO OTHER VISUAL TOY FORMS AND ACCESSORIES FOR USE THEREWITH (U.S. CLS. 22, 23, 38 AND 50).
FIRST USE 10-4-2001; IN COMMERCE 10-4-2001.
CIMMERIAN COLEMAN, EXAMINING ATTORNEY

SN 76-598,639. HASBRO, INC., PAWTUCKET, RI. FILED 6-22-2004.

DIRGE

THE MARK CONSISTS OF STANDARD CHARACTERS WITHOUT CLAIM TO ANY PARTICULAR FONT, STYLE, SIZE, OR COLOR.

FOR TOY ACTION FIGURES, TOY VEHICLES AND TOY ROBOTS CONVERTIBLE INTO OTHER VISUAL TOY FORMS AND ACCESSORIES FOR USE THEREWITH (U.S. CLS. 22, 23, 38 AND 50).
FIRST USE 10-6-2003; IN COMMERCE 10-6-2003.
CIMMERIAN COLEMAN, EXAMINING ATTORNEY

CLASS 28—(Continued).

SN 76-598,649. HASBRO, INC., PAWTUCKET, RI. FILED 6-22-2004.

RODIMUS

THE MARK CONSISTS OF STANDARD CHARACTERS WITHOUT CLAIM TO ANY PARTICULAR FONT, STYLE, SIZE, OR COLOR.

OWNER OF U.S. REG. NO. 1,415,171.
FOR TOY ACTION FIGURES, TOY VEHICLES AND TOY ROBOTS CONVERTIBLE INTO OTHER VISUAL TOY FORMS AND ACCESSORIES FOR USE THEREWITH (U.S. CLS. 22, 23, 38 AND 50).
FIRST USE 5-5-2003; IN COMMERCE 5-5-2003.
MARK T. MULLEN, EXAMINING ATTORNEY

SN 76-598,876. "BECAUSE WE CARE" MINISTRIES, SCHWENKSVILLE, PA. FILED 6-23-2004.



FOR TOY STUFFED DOGS (U.S. CLS. 22, 23, 38 AND 50).
MARC LEIPZIG, EXAMINING ATTORNEY

SN 76-599,059. BIKINI LURES INC., BUFFALO, NY. FILED 6-22-2004.

BIKINI LURES

THE MARK CONSISTS OF STANDARD CHARACTERS WITHOUT CLAIM TO ANY PARTICULAR FONT, STYLE, SIZE, OR COLOR.

NO CLAIM IS MADE TO THE EXCLUSIVE RIGHT TO USE LURES, APART FROM THE MARK AS SHOWN.
FOR FISHING LURES (U.S. CLS. 22, 23, 38 AND 50).
NANCY CLARKE, EXAMINING ATTORNEY

SN 78-056,261. MATTEL, INC., EL SEGUNDO, CA. FILED 4-2-2001.

IN THE SPOTLIGHT

FOR TOYS, GAMES AND PLAYTHINGS, NAMELY, DOLL CLOTHING AND DOLL ACCESSORIES (U.S. CLS. 22, 23, 38 AND 50).

REBECCA SMITH, EXAMINING ATTORNEY

CLASS 28—(Continued).

SN 78-093,079. KAY ENTERPRISES, INC., CAVE CREEK, AZ. FILED 11-13-2001.



FOR TOYS, NAMELY, DEVICES IN THE NATURE OF AIRCRAFT AND ROCKETS THAT ARE LAUNCHED AND FLY INTO THE AIR BY THE USE OF A CATALYST (U.S. CLS. 22, 23, 38 AND 50).

TRICIA SONNEBORN, EXAMINING ATTORNEY

SN 78-223,693. JLB STUDIOS, L.L.C., LAWRENCE, KS. FILED 3-10-2003.



JLB STUDIOS L.L.C. 2003

NO CLAIM IS MADE TO THE EXCLUSIVE RIGHT TO USE "MINIATURES" AND "STUDIOS, L.L.C. 2003", APART FROM THE MARK AS SHOWN.

FOR MINIATURE TOY FIGURES FOR USE IN COLLECTING AND FOR USE IN HOBBY OR GAMING (U.S. CLS. 22, 23, 38 AND 50).

YONG KIM, EXAMINING ATTORNEY

SN 78-236,625. MOAD GOLF USA, LLC, EDINA, MN. FILED 4-11-2003.

M.O.A.D. SHOCKWAVE

FOR GOLF CLUBS (U.S. CLS. 22, 23, 38 AND 50). LINDA MICKLEBURGH, EXAMINING ATTORNEY

CLASS 28—(Continued).

SN 78-237,373. MATTEL, INC., EL SEGUNDO, CA. FILED 4-14-2003.

HOLIDAY VISIONS

NO CLAIM IS MADE TO THE EXCLUSIVE RIGHT TO USE "HOLIDAY", APART FROM THE MARK AS SHOWN. FOR TOYS, GAMES, AND PLAYTHINGS, NAMELY, DOLLS, DOLL CLOTHING AND DOLL ACCESSORIES (U.S. CLS. 22, 23, 38 AND 50).

ESTHER A. BORSUK, EXAMINING ATTORNEY

SN 78-255,891. HAMER, ANTHONY, G. MONTEVALLO, AL. AND SIMS, DONNIE, L. TALLADEGA, AL. FILED 5-29-2003.

SPOTSTICKER

FOR ARTIFICIAL FISHING BAITS (U.S. CLS. 22, 23, 38 AND 50).

FIRST USE 10-0-1999; IN COMMERCE 1-0-2001.

ANDREW BENZMILLER, EXAMINING ATTORNEY

SN 78-256,360. MATTEL, INC., EL SEGUNDO, CA. FILED 5-30-2003.

SKATE STRIKE

NO CLAIM IS MADE TO THE EXCLUSIVE RIGHT TO USE "SKATE", APART FROM THE MARK AS SHOWN.

FOR TOYS, GAMES AND PLAYTHINGS, NAMELY, TOY FIGURES, TOY VEHICLES AND ACCESSORIES AND PLAYSETS FOR THE FOREGOING; DOLLS, DOLL CLOTHING AND DOLL ACCESSORIES (U.S. CLS. 22, 23, 38 AND 50).

JOHN KELLY, EXAMINING ATTORNEY

SN 78-262,028. INVERSO, CHARLES, ROBBINSVILLE, NJ. FILED 6-13-2003.

WHO SINGS THIS?

FOR GAMES, NAMELY, INTERACTIVE GAME BOARD EMPLOYING AN ELECTRONIC COMPONENT WHICH PLAYS SOUND (U.S. CLS. 22, 23, 38 AND 50).

BARBARA RUTLAND, EXAMINING ATTORNEY

CLASS 28—(Continued).

SN 78-277,238. ROLLEY, R. THOMASINE, BLOOMINGTON, IL. FILED 7-22-2003.

CARSON THE CAMEL

FOR TOYS, NAMELY, TOY MODEL CARS; BABY MULTIPLE ACTIVITY TOYS; BABY RATTLES; BALLS OF ALL KINDS; BEAN BAG DOLLS; BEAN BAGS; CASES FOR PLAY ACCESSORIES; CASES FOR TOY STRUCTURES; CHILDREN'S MULTIPLE ACTIVITY TOYS; CHILDREN'S WIRE CONSTRUCTION AND ART ACTIVITY TOYS; CHRISTMAS STOCKINGS; CHRISTMAS TREE DECORATIONS; CHRISTMAS TREE ORNAMENTS, NAMELY, BELLS; CHRISTMAS TREE ORNAMENT; CHRISTMAS TREE ORNAMENTS WITH A MUSIC FEATURE; CHRISTMAS TREE SKIRTS; CHRISTMAS TREE STAND COVER; COLLECTABLE TOY FIGURES; CRIB MOBILES; CRIB TOYS; DOLL ACCESSORIES; DOLL CASES; DOLL CLOTHING; DOLL COSTUMES; DOLL FURNITURE; DOLLS; DOLLS AND ACCESSORIES THEREFORE; DOLLS AND PLAYSETS THEREFORE; DOLLS FOR PLAYING; EUROPEAN STYLE DOLLS; FANTASY CHARACTER TOYS; HAND PUPPETS; INFANT ACTION CRIB TOYS; INFANT DEVELOPMENT TOYS; INFANT TOYS; INFANT'S RATTLES; JACK-IN-THE-BOXES; JIGSAW PUZZLES; KALEIDOSCOPIES; MARIONETTE PUPPETS; MOBILES FOR CHILDREN; MUSICAL TOYS; PAPER DOLLS; PLAY FIGURES; PLAY MATS CONTAINING INFANT TOYS; PLAYSET BUILDINGS; PLAYSETS FOR DOLLS; PLUSH TOYS; POP UP TOYS; PULL TOYS; PUPPETS; PUSH TOYS; PUZZLES; RAG DOLLS; RIDE-ON TOYS; ROCKING HORSES; SAND TOYS; SANDBOX TOYS; SOFT SCULPTURE PLUSH TOYS; STUFFED DOLLS AND ANIMALS; STUFFED PUPPETS; STUFFED TOY ANIMALS; STUFFED TOYS; TOY ANIMALS AND ACCESSORIES THEREFORE; TOY BOXES; TOY BUILDING BLOCKS; TOY BUILDING BLOCKS CAPABLE OF INTERCONNECTION; TOY CHRISTMAS TREES; TOY FIGURES; TOY MUSIC BOXES; TOYS DESIGNED TO BE ATTACHED TO CAR SEATS, STROLLERS, CRIBS, HIGH CHAIRS; AND YO-YOS (U.S. CLS. 22, 23, 38 AND 50).

REBECCA SMITH, EXAMINING ATTORNEY

SN 78-282,440. K. MILLER DESIGNS, LLC, HILLTOWN, PA. FILED 8-6-2003.



FOR DOG CHEW TOYS; PET TOYS (U.S. CLS. 22, 23, 38 AND 50).
GENE MACIOL, EXAMINING ATTORNEY

SN 78-284,468. LICKLE, BRETT, HAIKU, HI. FILED 8-7-2003.

SURF BALL

FOR BALANCING PLATFORM AND BALL FOR SURF SIMULATION IN SPORTS TRAINING (U.S. CLS. 22, 23, 38 AND 50).
CAROLYN GRAY, EXAMINING ATTORNEY

CLASS 28—(Continued).

SN 78-302,130. GENERAL MOTORS CORPORATION, DETROIT, MI. FILED 9-18-2003.

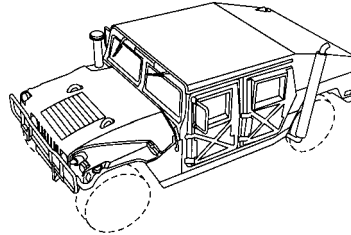

THE MARK CONSISTS OF THE PRODUCT CONFIGURATION OF A MOTOR VEHICLE. THE DOTTED LINES ARE USED TO INDICATE THE POSITION OF THE WHEELS, AND ARE NOT A PART OF THE MARK.

SEC. 2(F).

FOR TOYS, NAMELY MINIATURE MODELS OF VEHICLES, TOY VEHICLES, HOBBY KITS FOR THE CONSTRUCTION OF TOY VEHICLES, COLLECTABLE TOY CARS, RADIO CONTROLLED CARS AND PEDAL CARS (U.S. CLS. 22, 23, 38 AND 50).

FIRST USE 6-30-1997; IN COMMERCE 6-30-1997.

SCOTT OSLICK, EXAMINING ATTORNEY

SN 78-304,190. IMPACT GEL CORPORATION, MELROSE, WI. FILED 9-23-2003.

EXTREME ARMOR

FOR ATHLETIC SPORTING GOODS, NAMELY, BASEBALL EQUIPMENT, NAMELY, BASEBALL LEG GUARDS, BASEBALL GLOVES, BASEBALL MASKS, BASEBALL BODY PROTECTORS AND BASEBALL UMPIRE BODY PROTECTORS; SOFTBALL EQUIPMENT, NAMELY, SOFTBALL MASKS, SOFTBALL LEG GUARDS, SOFTBALL BODY PROTECTORS, GIRLS SOFTBALL MASKS, GIRLS SOFTBALL LEG GUARDS, AND GIRLS SOFTBALL BODY PROTECTORS; FOOTBALL EQUIPMENT, NAMELY, FOOTBALL SHOULDER PADS, SHOULDER AND ARM BRACES, FOOTBALL INJURY PROTECTIVE PADS, FOOTBALL THIGH GUARDS, FOOTBALL KNEE PADS, FOOTBALL ELBOW PADS, FOOTBALL KNEE BRACES, FOOTBALL HIP PADS, FOOTBALL BLOCKING PADS AND FOOTBALL SHIN GUARDS; HOCKEY EQUIPMENT, NAMELY, HOCKEY SHOULDER PADS, HOCKEY HIP PADS, HOCKEY LEG GUARDS, AND HOCKEY GLOVES; BASKETBALL EQUIPMENT, NAMELY, BASKETBALL KNEE PADS; SOCCER EQUIPMENT, NAMELY, SOCCER LEG GUARDS AND SOCCER INJURY PROTECTIVE PADS; HORSESHOES FOR RECREATIONAL PURPOSES; AND ATHLETIC AND GYMNASIUM EQUIPMENT, NAMELY, PADDING FOR WALLS (U.S. CLS. 22, 23, 38 AND 50).

ESTHER BELENKER, EXAMINING ATTORNEY

CLASS 28—(Continued).

SN 78-316,597. DISNEY ENTERPRISES, INC., BURBANK, CA. FILED 10-21-2003.

WALT DISNEY WORLD

OWNER OF U.S. REG. NOS. 980,995, 1,189,727 AND 2,189,177.

THE NAME IN THE MARK DOES NOT IDENTIFY A PARTICULAR LIVING INDIVIDUAL.

FOR RUBBER ACTION BALLS; ACTION FIGURES AND ACCESSORIES; ACTION SKILL GAMES; BEAN BAG DOLLS; PLUSH TOYS; BALLOONS; GOLF BALLS; TENNIS BALLS; BATH TOYS; CHRISTMAS TREE ORNAMENTS; BOARD GAMES; TOY BUILDING BLOCKS; EQUIPMENT SOLD AS A UNIT FOR PLAYING CARD GAMES; PLAYING CARDS; DOLLS AND DOLL CLOTHING; DOLL PLAYSETS; CHILDREN'S PLAY COSMETICS; CRIB TOYS; ELECTRIC ACTION TOYS; MANIPULATIVE GAMES; GOLF GLOVES; GOLF BALL MARKERS; JIGSAW PUZZLES; KITES; DECORATIVE, CRIB AND TOY MOBILES; MUSIC BOX TOYS; PARTY FAVORS IN THE NATURE OF SMALL TOYS; INFLATABLE POOL TOYS; BABY AND CHILDREN'S MULTIPLE ACTIVITY TOYS; WIND-UP TOYS; TARGET GAMES; DISC-TYPE TOSS TOYS; TOY BOWS AND ARROWS; TOY VEHICLES; MODEL TOY CARS; MODEL TOY TRUCKS; TOY BUCKET AND SHOVEL SETS; ROLLER SKATES; TOY MODEL HOBBYCRAFT KITS; TOY ROCKETS; TOY GUNS; TOY HOLSTERS; MUSICAL TOYS; TOY BADMINTON SETS; BUBBLE MAKING WANDS AND SOLUTION SETS; MODELED PLASTIC TOY FIGURINES; TOY BANKS; PUPPETS; YO-YOS; SKATEBOARDS; TOY SCOOTERS; FACE MASKS; HAND-HELD UNIT FOR PLAYING ELECTRONIC GAMES; TALKING TOYS; TOY MODEL WALKIE-TALKIES; TOY MODEL ELECTRONIC VOICE RECORDERS (U.S. CLS. 22, 23, 38 AND 50).

PAUL F. GAST, EXAMINING ATTORNEY

CLASS 28—(Continued).

SN 78-328,460. BEIJING XIMA FURNITURE COMPANY PTY. LTD., BEIJING, CHINA, FILED 11-14-2003.



FOR BOWLING EQUIPMENT, NAMELY, PINSETTERS AND PARTS THEREFOR, BOWLING BALL RETURNS, BOWLING BALLS, BOWLING PINS AND BOWLING DEFLECTORS (U.S. CLS. 22, 23, 38 AND 50).

FIRST USE 10-31-1994; IN COMMERCE 6-30-2000.
GINA FINK, EXAMINING ATTORNEY

SN 78-322,814. DIGITRAX, INC., NORCROSS, GA. FILED 11-4-2003.

DCS 50

THE MARK CONSISTS OF STANDARD CHARACTERS WITHOUT CLAIM TO ANY PARTICULAR FONT, STYLE, SIZE, OR COLOR.

FOR TOY AND MODEL TRAINS, ENGINES, CARS AND ACCESSORIES THEREFOR (U.S. CLS. 22, 23, 38 AND 50).

FIRST USE 9-15-2002; IN COMMERCE 9-15-2002.
SOPHIA S. KIM, EXAMINING ATTORNEY

SN 78-329,600. REYNOLDS, KAY, BECKENHAM, KENT, UNITED KINGDOM, FILED 11-18-2003.

SOMEONE TO WATCH OVER YOU

THE MARK CONSISTS OF STANDARD CHARACTERS WITHOUT CLAIM TO ANY PARTICULAR FONT, STYLE, SIZE, OR COLOR.

OWNER OF ERP N CMNTY TM OFC REG. NO. 001236884, DATED 9-19-2000, EXPIRES 7-7-2009.

FOR TOYS, AND PLAYTHINGS, NAMELY, SOFT SCULPTURE TOYS, TEDDY BEARS, DOLLS, PLAYSETS FOR DOLLS AND ACCESSORIES THEREFOR (U.S. CLS. 22, 23, 38 AND 50).

TRICIA SONNEBORN, EXAMINING ATTORNEY

CLASS 28—(Continued).

SN 78-333,605. KABUSHIKI KAISHA NARUMIYA INTERNATIONAL, TOKYO, JAPAN, FILED 11-26-2003.

CLASS 28—(Continued).

SN 78-335,279. MATTEL, INC., EL SEGUNDO, CA. FILED 12-2-2003.

BLUECROSS

BRUTALISTIC

THE MARK CONSISTS OF STANDARD CHARACTERS WITHOUT CLAIM TO ANY PARTICULAR FONT, STYLE, SIZE, OR COLOR.

OWNER OF JAPAN REG. NO. 4645449, DATED 2-21-2003, EXPIRES 2-21-2013.

FOR DOLLS, PLASTIC CHARACTER TOYS, UR-ETHANE CHARACTER TOYS (U.S. CLS. 22, 23, 38 AND 50).

JOANNA DUKOVIC, EXAMINING ATTORNEY

THE MARK CONSISTS OF STANDARD CHARACTERS WITHOUT CLAIM TO ANY PARTICULAR FONT, STYLE, SIZE, OR COLOR.

FOR TOYS, GAMES AND PLAYTHINGS, NAMELY, TOY VEHICLES AND ACCESSORIES THEREFOR (U.S. CLS. 22, 23, 38 AND 50).

ARETHA SOMERVILLE, EXAMINING ATTORNEY

SN 78-335,290. MATTEL, INC., EL SEGUNDO, CA. FILED 12-2-2003.

SN 78-333,617. KABUSHIKI KAISHA NARUMIYA INTERNATIONAL, TOKYO, JAPAN, FILED 11-26-2003.

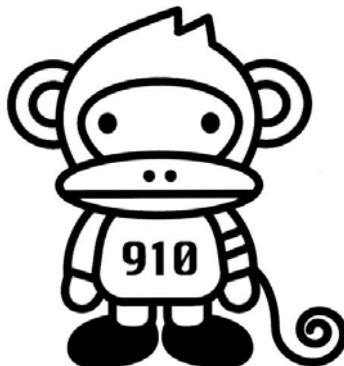

DUPLIFIED

THE MARK CONSISTS OF STANDARD CHARACTERS WITHOUT CLAIM TO ANY PARTICULAR FONT, STYLE, SIZE, OR COLOR.

FOR TOYS, GAMES AND PLAYTHINGS, NAMELY, TOY VEHICLES AND ACCESSORIES THEREFOR (U.S. CLS. 22, 23, 38 AND 50).

ARETHA SOMERVILLE, EXAMINING ATTORNEY

FOR DOLLS, PLASTIC CHARACTER TOYS, UR-ETHANE CHARACTER TOYS (U.S. CLS. 22, 23, 38 AND 50).

MARK SPARACINO, EXAMINING ATTORNEY

CLASS 28—(Continued).

SN 78-335,291. MATTEL, INC., EL SEGUNDO, CA. FILED 12-2-2003.

EASTER SWEETIE

THE MARK CONSISTS OF STANDARD CHARACTERS WITHOUT CLAIM TO ANY PARTICULAR FONT, STYLE, SIZE, OR COLOR.

FOR TOYS, GAMES AND PLAYTHINGS, NAMELY, DOLLS, DOLL CLOTHING AND DOLL ACCESSORIES (U.S. CLS. 22, 23, 38 AND 50).

ARETHA SOMERVILLE, EXAMINING ATTORNEY

SN 78-335,560. DEAR AUNT POLLY & COMPANY, LLC, ROCKPORT, ME. FILED 12-3-2003.

THE COUSINS CLUB

THE MARK CONSISTS OF STANDARD CHARACTERS WITHOUT CLAIM TO ANY PARTICULAR FONT, STYLE, SIZE, OR COLOR.

FOR BATH TOYS; SPORTS BALLS; PLAYGROUND BALLS; TOY BALLS; BOARD GAMES; TOY BUILDING BLOCKS; DOLLS; DOLL ACCESSORIES; CRIB TOYS; DOLL CLOTHING; DOLL HOUSE FURNISHINGS; MUSICAL TOYS; PUPPETS; PUZZLES, EXCEPT FOR CROSSWORD PUZZLES; ROLLER SKATES; JUMP ROPES; ICE SKATES; STUFFED TOYS; TOY FIGURES; HOBBY CRAFT SETS FOR— KNITTING, SEWING, CERAMICS, WOODWORKING, COOKING, BAKING, IDENTIFYING BIRDS, PLANTS, TREES, ANIMALS, INSECTS, FISH, AND SEA AND FRESH WATER CREATURES, MAKING CHILDREN'S INDOOR AND OUTDOOR ACTIVITY GAMES, RESEARCHING AND MAKING FAMILY TREES, GARDENING, MAKING JEWELRY, MAKING MAGIC TRICKS, MAKING JUGGLING EQUIPMENT, AND MAKING HOLIDAY DECORATIONS AND ORNAMENTS, AND TOY MODEL HOBBY CRAFT KITS, AND GUIDES SOLD AS A UNIT (U.S. CLS. 22, 23, 38 AND 50).

PAUL F. GAST, EXAMINING ATTORNEY

CLASS 28—(Continued).

SN 78-340,637. LITTLE, NEIL A., MAUMEE, OH. FILED 12-15-2003.



THE COLORS RED AND YELLOW ARE CLAIMED AS A FEATURE OF THE MARK.

THE COLOR YELLOW APPEARS ON THE FEET AND THE DOT OF THE LETTER "I", AND THE COLOR RED APPEARS ON THE LETTERING.

FOR TOYS, NAMELY, TEETHING TOYS (U.S. CLS. 22, 23, 38 AND 50).

FIRST USE 12-0-2004; IN COMMERCE 12-0-2004.

ANN LINNEHAN, EXAMINING ATTORNEY

SN 78-340,789. J. RICHARD INDUSTRIES, INC., TOLEDO, OH. FILED 12-15-2003.



THE MARK CONSISTS, IN PART, OF A DESIGN OF A FLAME.

FOR BASEBALL AND SOFTBALL BATS (U.S. CLS. 22, 23, 38 AND 50).

ALICIA COLLINS, EXAMINING ATTORNEY

SN 78-341,185. NJ CROCE COMPANY, LA VERNE, CA. FILED 12-15-2003.



THE COLOR(S) RED, BLUE, YELLOW AND WHITE ARE CLAIMED AS A FEATURE OF THE MARK.

THE MARK CONSISTS OF THE COLOR RED APPEARS IN THE LETTERS CROCE, AND THE CURVED GRAPHIC ELEMENT ORIGINATING FROM THE LETTER N, THEN CURVING OVER THE WORD NJ CROCE, ENDING INSIDE THE YELLOW STAR ABOVE THE LETTERS C AND E. THE COLOR BLUE APPEARS IN THE LETTERS N AND J, AS A

CLASS 28—(Continued).

THIN OUTLINE ON TOP OF THE RED CURVED GRAPHIC DESCRIBED ABOVE, AS AN OUTLINE AND BORDER OF THE LETTERS NJ CROCE, AND AS THE OUTLINE/BORDER OF THE YELLOW STAR ABOVE THE LETTERS C AND E. THE COLOR YELLOW APPEARS AS THE INSIDE AND FILL COLOR OF THE STAR. THE COLOR WHITE APPEARS AS AN OUTLINE AND FILLED SPACE BETWEEN THE BLUE LETTERS NJ, THE RED LETTERS CROCE, AND THE BLUE OUTLINE OF THE LETTERS NJ CROCE.

SEC. 2(F) AS TO "NJ CROCE".
FOR PLASTIC CHARACTER TOYS (U.S. CLS. 22, 23, 38 AND 50).
FIRST USE 1-7-2003; IN COMMERCE 1-7-2003.
YSA DEJESUS, EXAMINING ATTORNEY



SN 78-342,054. MATTEL, INC., EL SEGUNDO, CA. FILED 12-17-2003.

ALL-THAT PLAYMAT

THE MARK CONSISTS OF STANDARD CHARACTERS WITHOUT CLAIM TO ANY PARTICULAR FONT, STYLE, SIZE, OR COLOR.

NO CLAIM IS MADE TO THE EXCLUSIVE RIGHT TO USE "PLAYMAT", APART FROM THE MARK AS SHOWN.
FOR TOYS, GAMES AND PLAYTHINGS, NAMELY, A PLAY ENVIRONMENT THAT ROLLS UP FOR STORAGE AND PORTABILITY (U.S. CLS. 22, 23, 38 AND 50).
MARTHA SANTOMARTINO, EXAMINING ATTORNEY



SN 78-342,057. MATTEL, INC., EL SEGUNDO, CA. FILED 12-17-2003.

BADZOOKA

THE MARK CONSISTS OF STANDARD CHARACTERS WITHOUT CLAIM TO ANY PARTICULAR FONT, STYLE, SIZE, OR COLOR.

FOR TOYS, GAMES AND PLAYTHINGS, NAMELY, TOY ACTION FIGURES AND ACCESSORIES THEREFOR (U.S. CLS. 22, 23, 38 AND 50).
KIMBERLY PERRY, EXAMINING ATTORNEY

CLASS 28—(Continued).

SN 78-343,355. MATTEL, INC., EL SEGUNDO, CA. FILED 12-19-2003.

16 ANGELS

THE MARK CONSISTS OF STANDARD CHARACTERS WITHOUT CLAIM TO ANY PARTICULAR FONT, STYLE, SIZE, OR COLOR.

FOR TOYS, GAMES AND PLAYTHINGS, NAMELY, TOY VEHICLES AND ACCESSORIES THEREFOR (U.S. CLS. 22, 23, 38 AND 50).
SCOTT BALDWIN, EXAMINING ATTORNEY



SN 78-344,726. MATTEL, INC., EL SEGUNDO, CA. FILED 12-23-2003.

CAFFIEND

THE MARK CONSISTS OF STANDARD CHARACTERS WITHOUT CLAIM TO ANY PARTICULAR FONT, STYLE, SIZE, OR COLOR.

FOR TOYS, GAMES AND PLAYTHINGS, NAMELY, TOY VEHICLES AND ACCESSORIES THEREFOR (U.S. CLS. 22, 23, 38 AND 50).
ARETHA SOMERVILLE, EXAMINING ATTORNEY

CLASS 28—(Continued).

SN 78-344,728. MATTEL, INC., EL SEGUNDO, CA. FILED 12-23-2003.

CLASS 28—(Continued).

SN 78-344,745. MATTEL, INC., EL SEGUNDO, CA. FILED 12-23-2003.

CYBERTOOTH

EXPELLED

THE MARK CONSISTS OF STANDARD CHARACTERS WITHOUT CLAIM TO ANY PARTICULAR FONT, STYLE, SIZE, OR COLOR.

FOR TOYS, GAMES AND PLAYTHINGS, NAMELY, TOY VEHICLES AND ACCESSORIES THEREFOR (U.S. CLS. 22, 23, 38 AND 50).

ARETHA SOMERVILLE, EXAMINING ATTORNEY

THE MARK CONSISTS OF STANDARD CHARACTERS WITHOUT CLAIM TO ANY PARTICULAR FONT, STYLE, SIZE, OR COLOR.

FOR TOYS, GAMES AND PLAYTHINGS, NAMELY, TOY VEHICLES AND ACCESSORIES THEREFOR (U.S. CLS. 22, 23, 38 AND 50).

ARETHA SOMERVILLE, EXAMINING ATTORNEY

SN 78-344,739. MATTEL, INC., EL SEGUNDO, CA. FILED 12-23-2003.

SN 78-344,748. MATTEL, INC., EL SEGUNDO, CA. FILED 12-23-2003.

BOO-TIFUL HALLOWEEN

FURIOSITY

THE MARK CONSISTS OF STANDARD CHARACTERS WITHOUT CLAIM TO ANY PARTICULAR FONT, STYLE, SIZE, OR COLOR.

FOR TOYS, GAMES AND PLAYTHINGS, NAMELY, DOLLS, DOLL CLOTHING AND DOLL ACCESSORIES (U.S. CLS. 22, 23, 38 AND 50).

ARETHA SOMERVILLE, EXAMINING ATTORNEY

THE MARK CONSISTS OF STANDARD CHARACTERS WITHOUT CLAIM TO ANY PARTICULAR FONT, STYLE, SIZE, OR COLOR.

FOR TOYS, GAMES AND PLAYTHINGS, NAMELY, TOY VEHICLES AND ACCESSORIES THEREFOR (U.S. CLS. 22, 23, 38 AND 50).

ARETHA SOMERVILLE, EXAMINING ATTORNEY

CLASS 28—(Continued).

SN 78-344,751. MATTEL, INC., EL SEGUNDO, CA. FILED 12-23-2003.

GREAT BITE

THE MARK CONSISTS OF STANDARD CHARACTERS WITHOUT CLAIM TO ANY PARTICULAR FONT, STYLE, SIZE, OR COLOR.

FOR TOYS, GAMES AND PLAYTHINGS, NAMELY, TOY VEHICLES AND ACCESSORIES THEREFOR (U.S. CLS. 22, 23, 38 AND 50).

ARETHA SOMERVILLE, EXAMINING ATTORNEY

CLASS 28—(Continued).

SN 78-345,296. PRISM TECHNOLOGY LIMITED, KOWLOON BAY, KOWLOON, HONG KONG, FILED 12-24-2003.

GAMEXPERT

THE MARK CONSISTS OF STANDARD CHARACTERS WITHOUT CLAIM TO ANY PARTICULAR FONT, STYLE, SIZE, OR COLOR.

FOR GAMING EQUIPMENT, NAMELY, GAME WHEELS AND TOY LIGHT GUN (U.S. CLS. 22, 23, 38 AND 50).

DAWN HAN, EXAMINING ATTORNEY

SN 78-361,839. ANIPLEX, INC., TOKYO, JAPAN, FILED 2-3-2004.

Fullmetal Alchemist

SN 78-345,175. MATTEL, INC., EL SEGUNDO, CA. FILED 12-23-2003.

BOULEVARD

THE MARK CONSISTS OF STANDARD CHARACTERS WITHOUT CLAIM TO ANY PARTICULAR FONT, STYLE, SIZE, OR COLOR.

FOR TOYS, GAMES AND PLAYTHINGS, NAMELY, DOLLS, DOLL CLOTHING AND DOLL ACCESSORIES (U.S. CLS. 22, 23, 38 AND 50).

KIMBERLY PERRY, EXAMINING ATTORNEY

THE MARK CONSISTS OF STANDARD CHARACTERS WITHOUT CLAIM TO ANY PARTICULAR FONT, STYLE, SIZE, OR COLOR.

FOR GAMES, PLAYTHINGS AND SPORTING GOODS, NAMELY, COLLECTIBLE TOY FIGURES AND ACTION FIGURES AND ACTION FIGURE ACCESSORIES, ACTIVITY SETS AND PLAYSET ENVIRONMENTS COMPRISED OF MINI FIGURES/SCENE DISPLAYS, TOY FIGURES (U.S. CLS. 22, 23, 38 AND 50).

PAUL F. GAST, EXAMINING ATTORNEY

CLASS 28—(Continued).

SN 78-368,749. DO-ALL TRAPS, LLC, NASHVILLE, TN.
FILED 2-16-2004.



THE MARK CONSISTS OF THE WORDS "DO-ALL TARGETING" ENCLOSED WITHIN A STYLIZED BULL'S EYE AND TARGET.

FOR TARGETS FOR PAINTBALL, AIR GUNS, RIFLES, SHOTGUNS AND HANDGUNS; TARGET LAUNCHERS NAMELY FOR SKEET SHOOTING (U.S. CLS. 22, 23, 38 AND 50).

FIRST USE 12-1-2003; IN COMMERCE 12-1-2003.
LESLEY LAMOTHE, EXAMINING ATTORNEY

CLASS 28—(Continued).

SN 78-380,227. LAUNCH SNOWBOARDS LLC, LIVINGSTON, NJ. FILED 3-8-2004.

LAUNCH

THE MARK CONSISTS OF STANDARD CHARACTERS WITHOUT CLAIM TO ANY PARTICULAR FONT, STYLE, SIZE, OR COLOR.

FOR SNOWBOARDS, SNOWBOARD BINDINGS AND SNOWBOARD BAGS (U.S. CLS. 22, 23, 38 AND 50).

FIRST USE 2-17-2004; IN COMMERCE 2-17-2004.
DAVID TAYLOR, EXAMINING ATTORNEY

SN 78-376,051. GAME CABINETS, INC., BOTHELL, WA.
FILED 3-1-2004.

ClassiCade

THE MARK CONSISTS OF STANDARD CHARACTERS WITHOUT CLAIM TO ANY PARTICULAR FONT, STYLE, SIZE, OR COLOR.

FOR VIDEO ARCADE SYSTEM PRIMARILY COMPOSED OF VIDEO ARCADE GAMES (U.S. CLS. 22, 23, 38 AND 50).

FIRST USE 3-1-2004; IN COMMERCE 3-1-2004.
BERYL GARDNER, EXAMINING ATTORNEY

SN 78-380,242. LAUNCH SNOWBOARDS LLC, LIVINGSTON, NJ. FILED 3-8-2004.

LAUNCH

THE MARK CONSISTS OF STANDARD CHARACTERS WITHOUT CLAIM TO ANY PARTICULAR FONT, STYLE, SIZE, OR COLOR.

FOR SKATEBOARDS, SKATEBOARD TRUCKS, SKATEBOARD WHEELS, SKATEBOARD BEARINGS, SURFBOARDS, SURFBOARD FINS, SURFBOARD BAGS, SURFBOARD LEASHES, WAKEBOARD LEASHES, SNOWSKATES AND SNOWSKATE BAGS (U.S. CLS. 22, 23, 38 AND 50).

DAVID TAYLOR, EXAMINING ATTORNEY

CLASS 28—(Continued).

SN 78-391,539. NCSOFT CORPORATION, SEOUL, REPUBLIC OF KOREA, FILED 3-26-2004.

CLASS 28—(Continued).

SN 78-398,967. TAKARA U.S.A. CORPORATION, NEW YORK, NY. FILED 4-8-2004.

PLAY AND SEE

**ROCK ON! INSTANT
ROCKSTAR GUITAR**

THE MARK CONSISTS OF STANDARD CHARACTERS WITHOUT CLAIM TO ANY PARTICULAR FONT, STYLE, SIZE, OR COLOR.

FOR GAMES, NAMELY, ROLE PLAYING AND ACTION SKILL GAMES (U.S. CLS. 22, 23, 38 AND 50).
ARETHA SOMERVILLE, EXAMINING ATTORNEY

THE MARK CONSISTS OF STANDARD CHARACTERS WITHOUT CLAIM TO ANY PARTICULAR FONT, STYLE, SIZE, OR COLOR.

NO CLAIM IS MADE TO THE EXCLUSIVE RIGHT TO USE "GUITAR", APART FROM THE MARK AS SHOWN.

FOR SIMULATED TOY GUITAR HAVING A SENSOR PAD RESPONSIVE TO THE USER'S HAND AND FRET BUTTONS WITH STORAGE OF PRE-SET SONGS AND AUTOMATIC ADJUSTMENT OF THE CHORDS DURING PLAYING BY THE USER (U.S. CLS. 22, 23, 38 AND 50).

FLORENTINA BLANDU, EXAMINING ATTORNEY

SN 78-397,218. NOMACO, INC., ZEBULON, NC. FILED 4-6-2004.

SN 78-407,521. AQUA-LEISURE INDUSTRIES, INC., AVON, MA. FILED 4-24-2004.

OODLE BOARD

AQUA LEISURE

THE MARK CONSISTS OF STANDARD CHARACTERS WITHOUT CLAIM TO ANY PARTICULAR FONT, STYLE, SIZE, OR COLOR.

NO CLAIM IS MADE TO THE EXCLUSIVE RIGHT TO USE "BOARDS", APART FROM THE MARK AS SHOWN.

FOR TOYS IN THE NATURE OF FLEXIBLE FOAM RODS FOR RECREATIONAL USE; FLEXIBLE FOAM FLOTATION DEVICES IN THE NATURE OF SWIM FLOATS FOR RECREATIONAL USE; FLEXIBLE FOAM INDOOR AND OUTDOOR FLOAT TOYS (U.S. CLS. 22, 23, 38 AND 50).
KIMBERLY PERRY, EXAMINING ATTORNEY

THE MARK CONSISTS OF STANDARD CHARACTERS WITHOUT CLAIM TO ANY PARTICULAR FONT, STYLE, SIZE, OR COLOR.

OWNER OF U.S. REG. NOS. 1,651,572, 1,695,416 AND OTHERS.

FOR INFLATABLE SWIMMING POOLS FOR RECREATIONAL USE (U.S. CLS. 22, 23, 38 AND 50).

FIRST USE 10-1-2001; IN COMMERCE 10-1-2001.
JULIE WATSON, EXAMINING ATTORNEY

CLASS 28—(Continued).

SN 78-409,516. INTERNATIONAL PLAYTHINGS, INC., PAR-SIPPANY, NJ. FILED 4-28-2004.

BEWARE OF THE SPIDER

THE MARK CONSISTS OF STANDARD CHARACTERS WITHOUT CLAIM TO ANY PARTICULAR FONT, STYLE, SIZE, OR COLOR.

FOR STAND-ALONE ELECTRONIC INTERACTIVE GAME MACHINE FOR CHILDREN 5 AND UP (U.S. CLS. 22, 23, 38 AND 50).

BRIDGETT SMITH, EXAMINING ATTORNEY

SN 78-409,863. WILD PLANET TOYS, INC., SAN FRANCISCO, CA. FILED 4-28-2004.

PATHFINDER TOOL

THE MARK CONSISTS OF STANDARD CHARACTERS WITHOUT CLAIM TO ANY PARTICULAR FONT, STYLE, SIZE, OR COLOR.

NO CLAIM IS MADE TO THE EXCLUSIVE RIGHT TO USE "TOOL", APART FROM THE MARK AS SHOWN.

FOR TOYS AND PLAYTHINGS, NAMELY A SMALL TOY THAT CONTAINS A TOY FLASHLIGHT, TOY FLIP-OUT MAGNIFYING LENS THAT WORKS WITH TOY TWEEZERS AND A TOY KARABINER STYLE CLIP (U.S. CLS. 22, 23, 38 AND 50).

STEVEN JACKSON, EXAMINING ATTORNEY

SN 78-414,183. KLE MANAGEMENT, INC., ANAHEIM, CA. FILED 5-6-2004.

BODY-BLASTER

THE MARK CONSISTS OF STANDARD CHARACTERS WITHOUT CLAIM TO ANY PARTICULAR FONT, STYLE, SIZE, OR COLOR.

FOR MANUALLY-OPERATED EXERCISE EQUIPMENT, NAMELY, RESISTANCE TYPE EQUIPMENT FOR TRAINING AND EXERCISING (U.S. CLS. 22, 23, 38 AND 50).

JOHN GARTNER, EXAMINING ATTORNEY

CLASS 28—(Continued).

SN 78-415,368. WAI LANA, INC., KAILUA, HI. FILED 5-7-2004.

ENVIROMAT

THE MARK CONSISTS OF STANDARD CHARACTERS WITHOUT CLAIM TO ANY PARTICULAR FONT, STYLE, SIZE, OR COLOR.

FOR YOGA MATS; YOGA BAGS AND YOGA TOTES BOTH SPECIALLY ADAPTED FOR YOGA EQUIPMENT (U.S. CLS. 22, 23, 38 AND 50).

BARBARA BROWN, EXAMINING ATTORNEY

SN 78-417,708. KMC PRODUCTS, INC., RIVERSIDE, CA. FILED 5-12-2004.

XD SERIES

THE MARK CONSISTS OF STANDARD CHARACTERS WITHOUT CLAIM TO ANY PARTICULAR FONT, STYLE, SIZE, OR COLOR.

NO CLAIM IS MADE TO THE EXCLUSIVE RIGHT TO USE "SERIES", APART FROM THE MARK AS SHOWN.

FOR TOYS, GAMES AND PLAYTHINGS, NAMELY MODEL VEHICLES AND RELATED ACCESSORIES SOLD AS UNITS, DIE CAST TOY CARS, TOY TRUCKS, AND TOY VEHICLES AND RELATED ACCESSORIES, TOY SCOOTERS, TOY MODEL SCOOTERS AND RELATED ACCESSORIES, REMOTE-CONTROLLED VEHICLES AND RELATED ACCESSORIES, MINIATURE SKATEBOARDS AND MINIATURE SKATEBOARD PARTS; SPORTING GOODS, NAMELY, SKATEBOARDS, SKATEBOARD DECKS, SKATEBOARD TRUCKS, SKATEBOARD WHEELS, SKATEBOARD WHEEL ASSEMBLIES AND PARTS AND FITTINGS FOR ANY THEREOF; SKATEBOARD BUMPERS, BEARINGS, RAILS, SHOCK ABSORBERS AND PADS, WHEEL CAPS AND WHEEL SPINNERS; SKATEBOARD GRIP TAPE; SNOWBOARDS, SNOWBOARD BINDINGS AND PARTS THEREFORE; SAFETY PADDING AND PROTECTIVE PADDING FOR SKATEBOARDING AND SNOWBOARDING; BODY BOARDS, RIDE-ON TOYS; SURFBOARDS, LONGBOARDS, SHORTBOARDS, WINDSURFBOARDS, SAILBOARDS WAKEBOARDS, BODYBOARDS, KNEEBOARDS, SURF FINS, LEASHES USED IN CONJUNCTION WITH SURFING (U.S. CLS. 22, 23, 38 AND 50).

THEODORE MCBRIDE, EXAMINING ATTORNEY

CLASS 28—(Continued).

SN 78-418,175. ALLIANT TECHSYSTEMS INC., EDINA, MN.
FILED 5-13-2004.

CLASS 28—(Continued).

SN 78-422,206. BATTAT INCORPORATED, PLATTSBURGH,
NY. FILED 5-20-2004.

SST

DESIGNER GIRL

THE MARK CONSISTS OF STANDARD CHARACTERS
WITHOUT CLAIM TO ANY PARTICULAR FONT, STYLE,
SIZE, OR COLOR.
FOR CLAY TARGET LAUNCHERS (U.S. CLS. 22, 23, 38
AND 50).
CHERYL CLAYTON, EXAMINING ATTORNEY

THE MARK CONSISTS OF STANDARD CHARACTERS
WITHOUT CLAIM TO ANY PARTICULAR FONT, STYLE,
SIZE, OR COLOR.
NO CLAIM IS MADE TO THE EXCLUSIVE RIGHT TO
USE "GIRL", APART FROM THE MARK AS SHOWN.
FOR TOYS, NAMELY DOLLS AND DOLL ACCES-
SORIES (U.S. CLS. 22, 23, 38 AND 50).
NELSON SNYDER, EXAMINING ATTORNEY

SN 78-422,050. COUSIN CORPORATION OF AMERICA,
LARGO, FL. FILED 5-20-2004.

SN 78-422,334. SUTHERLAND, BRIAN, SANTA BARBARA,
CA. FILED 5-20-2004.

Class in a Box!

LOST GRAVITY

THE MARK CONSISTS OF STANDARD CHARACTERS
WITHOUT CLAIM TO ANY PARTICULAR FONT, STYLE,
SIZE, OR COLOR.
FOR HOBBY CRAFT KITS COMPRISING INSTRU-
CTION BOOK, TOOLS, AND MATERIALS FOR MAKING
ARTS AND CRAFTS PROJECTS (U.S. CLS. 22, 23, 38
AND 50).
FIRST USE 5-18-2004; IN COMMERCE 5-18-2004.
BRIDGETT SMITH, EXAMINING ATTORNEY

THE MARK CONSISTS OF STANDARD CHARACTERS
WITHOUT CLAIM TO ANY PARTICULAR FONT, STYLE,
SIZE, OR COLOR.
FOR JUGGLING EQUIPMENT, NAMELY, BEAN-
BAGS, BALLS, CLUBS, RINGS, JUGGLING KNIVES,
JUGGLING TORCHES, DIABOLOS, DEVIL STICKS,
AND SPINNING PLATES (U.S. CLS. 22, 23, 38 AND 50).
ANNE FARRELL, EXAMINING ATTORNEY

CLASS 28—(Continued).

SN 78-422,494. KARSTEN MANUFACTURING CORPORATION, PHOENIX, AZ. FILED 5-20-2004.

ISI

THE MARK CONSISTS OF STANDARD CHARACTERS WITHOUT CLAIM TO ANY PARTICULAR FONT, STYLE, SIZE, OR COLOR.

FOR GOLF CLUBS (U.S. CLS. 22, 23, 38 AND 50).
FIRST USE 1-0-1996; IN COMMERCE 1-0-1996.
MICHAEL ENGEL, EXAMINING ATTORNEY

SN 78-426,581. BANDAI ENTERTAINMENT, INC., CYPRESS, CA. FILED 5-27-2004.

KNIGHTSTEGO

THE MARK CONSISTS OF STANDARD CHARACTERS WITHOUT CLAIM TO ANY PARTICULAR FONT, STYLE, SIZE, OR COLOR.

FOR ELECTRONIC GAME MACHINES, NAMELY VIDEO AND STAND ALONE OUTPUT GAMES MACHINES; LCD GAME MACHINES; PINBALL MACHINES; ARCADE GAMES; BALLS FOR GAMES, NAMELY RUBBER BALLS AND SPORTS BALLS, NAMELY BASKETBALLS, BASEBALLS, SOCCER BALLS, HANDBALLS, FOOTBALLS AND BEACH BALLS; STUFFED TOYS; TOY VEHICLES; TOY FIGURES; TOY ROBOTS; TOYS FOR INTELLECTUAL TRAINING, NAMELY ACTIVITY TOYS AND BOARD GAMES, PUZZLES, NAMELY, JIGSAW AND MANIPULATIVE PUZZLES; CARD GAMES, AND PROMOTIONAL CARD GAMES; PLASTIC MODEL KITS, NAMELY TOY MODEL HOBBY KITS COMPRISING OF PIECES TO PUT TOGETHER TO CREATE FIGURES, AIRPLANES, AUTOMOBILES, MOTORCYCLES ROBOTS AND SPACECRAFTS; AND SCALE MODEL VEHICLES NAMELY AIRPLANES, AUTOMOBILES, MOTORCYCLES AND SPACECRAFTS; TOYS IN THE NATURE OF CANDY DISPENSERS; TOY CONSTRUCTION SETS AND TOY BUILDING BLOCKS (U.S. CLS. 22, 23, 38 AND 50).

JILL C. ALT, EXAMINING ATTORNEY

CLASS 28—(Continued).

SN 78-428,470. KRAZYPETS, INC., NEW HOPE, MN. FILED 6-2-2004.

NuttyPets

THE MARK CONSISTS OF STANDARD CHARACTERS WITHOUT CLAIM TO ANY PARTICULAR FONT, STYLE, SIZE, OR COLOR.

FOR STUFFED PLUSH TOY ANIMALS (U.S. CLS. 22, 23, 38 AND 50).
MICHAEL ENGEL, EXAMINING ATTORNEY

SN 78-430,726. HONG KONG CITY TOYS FACTORY LIMITED, KOWLOON, HONG KONG, FILED 6-7-2004.

SHEER BLISS

THE MARK CONSISTS OF STANDARD CHARACTERS WITHOUT CLAIM TO ANY PARTICULAR FONT, STYLE, SIZE, OR COLOR.

FOR DOLLS, DOLL CLOTHING AND DOLL ACCESSORIES (U.S. CLS. 22, 23, 38 AND 50).
ALLISON HOLTZ, EXAMINING ATTORNEY

CLASS 28—(Continued).

SN 78-430,731. HONG KONG CITY TOYS FACTORY LIMITED, KOWLOON, HONG KONG, FILED 6-7-2004.

BABY'S FIRST YEAR

THE MARK CONSISTS OF STANDARD CHARACTERS WITHOUT CLAIM TO ANY PARTICULAR FONT, STYLE, SIZE, OR COLOR.

NO CLAIM IS MADE TO THE EXCLUSIVE RIGHT TO USE BABY'S, APART FROM THE MARK AS SHOWN.

FOR DOLLS, DOLL CLOTHING AND DOLL ACCESSORIES (U.S. CLS. 22, 23, 38 AND 50).

ALLISON HOLTZ, EXAMINING ATTORNEY

CLASS 28—(Continued).

SN 78-431,934. LDS SERVICE, FRIEDRICHS DORF, FED REP GERMANY, FILED 6-8-2004.

MORMONAIRE

THE MARK CONSISTS OF STANDARD CHARACTERS WITHOUT CLAIM TO ANY PARTICULAR FONT, STYLE, SIZE, OR COLOR.

FOR GAME EQUIPMENT SOLD AS A UNIT FOR PLAYING A BOARD GAME (U.S. CLS. 22, 23, 38 AND 50).

WANDA KAY PRICE, EXAMINING ATTORNEY

SN 78-432,030. VECTRA FITNESS, INC., KENT, WA. FILED 6-8-2004.

SN 78-431,772. BINNEY & SMITH PROPERTIES, INC., EASTON, PA. FILED 6-8-2004.

CORNERSTONE

THE MARK CONSISTS OF STANDARD CHARACTERS WITHOUT CLAIM TO ANY PARTICULAR FONT, STYLE, SIZE, OR COLOR.

FOR EXERCISE MACHINES (U.S. CLS. 22, 23, 38 AND 50).

JIM RINGLE, EXAMINING ATTORNEY

SN 78-433,808. STRATEGIC FOCUS INTERNATIONAL INC., SCOTTSDALE, AZ. FILED 6-11-2004.

CRAYOLA

Freaky Flickers

THE MARK CONSISTS OF STANDARD CHARACTERS WITHOUT CLAIM TO ANY PARTICULAR FONT, STYLE, SIZE, OR COLOR.

OWNER OF U.S. REG. NOS. 641,294, 1,279,429 AND OTHERS.

FOR EQUIPMENT SOLD AS A UNIT FOR PLAYING BOARD GAMES; EQUIPMENT SOLD AS A UNIT FOR PLAYING HAND-HELD GAMES (U.S. CLS. 22, 23, 38 AND 50).

FIRST USE 5-31-2003; IN COMMERCE 5-31-2003.
WANDA KAY PRICE, EXAMINING ATTORNEY

THE MARK CONSISTS OF STANDARD CHARACTERS WITHOUT CLAIM TO ANY PARTICULAR FONT, STYLE, SIZE, OR COLOR.

FOR FANTASY CHARACTER TOYS (U.S. CLS. 22, 23, 38 AND 50).

ANDREW BENZMILLER, EXAMINING ATTORNEY

CLASS 28—(Continued).

SN 78-434,147. MONDOBOX, LLC, ORINDA, CA. FILED 6-11-2004.



THE COLOR(S) BLUE, BLACK, AND WHITE IS/ARE CLAIMED AS A FEATURE OF THE MARK.
 ABOVE THE WORD "MONDOBOX" IS A BLACK DRAWING OF AN ANTENNA. BLUE AND WHITE OVAL BANDS (3 OF EACH) RADIATE FROM THE ANTENNA TIP.
 FOR AMUSEMENT GAME MACHINES (U.S. CLS. 22, 23, 38 AND 50).
 LEIGH CAROLINE CASE, EXAMINING ATTORNEY

CLASS 28—(Continued).

SN 78-434,941. O. MUSTAD & SON (U.S.A.) INC., AUBURN, NY. FILED 6-14-2004.

Pro Plus

THE MARK CONSISTS OF STANDARD CHARACTERS WITHOUT CLAIM TO ANY PARTICULAR FONT, STYLE, SIZE, OR COLOR.
 FOR FISHING TACKLE (U.S. CLS. 22, 23, 38 AND 50).
 JAMES GRIFFIN, EXAMINING ATTORNEY

SN 78-434,936. O. MUSTAD & SON (U.S.A.) INC., AUBURN, NY. FILED 6-14-2004.

SN 78-435,434. ARROW INTERNATIONAL, INC., BROOKLYN, OH. FILED 6-15-2004.

UL Max

BOOK KEEPER

THE MARK CONSISTS OF STANDARD CHARACTERS WITHOUT CLAIM TO ANY PARTICULAR FONT, STYLE, SIZE, OR COLOR.
 FOR FISHING TACKLE (U.S. CLS. 22, 23, 38 AND 50).
 JAMES GRIFFIN, EXAMINING ATTORNEY

THE MARK CONSISTS OF STANDARD CHARACTERS WITHOUT CLAIM TO ANY PARTICULAR FONT, STYLE, SIZE, OR COLOR.
 NO CLAIM IS MADE TO THE EXCLUSIVE RIGHT TO USE "BOOK", APART FROM THE MARK AS SHOWN.
 FOR BINGO PAPER (U.S. CLS. 22, 23, 38 AND 50).
 ELLEN B. AWRICH, EXAMINING ATTORNEY

CLASS 28—(Continued).

SN 78-435,538. KMC PRODUCTS, INC., RIVERSIDE, CA.
FILED 6-15-2004.



OWNER OF U.S. REG. NO. 2,731,970.
FOR TOYS, GAMES AND PLAYTHINGS, NAMELY
MODEL VEHICLES AND RELATED ACCESSORIES
SOLD AS UNITS, DIE CAST TOY CARS, TOY TRUCKS,
AND TOY VEHICLES AND RELATED ACCESSORIES,
TOY SCOOTERS, TOY MODEL SCOOTERS AND RE-
LATED ACCESSORIES, REMOTE-CONTROLLED VEHI-
CLES AND RELATED ACCESSORIES, MINIATURE
SKATEBOARDS AND MINIATURE SKATEBOARD
PARTS; SPORTING GOODS, NAMELY, SKATEBOARDS,
SKATEBOARD DECKS, SKATEBOARD TRUCKS, SKA-
TEBOARD WHEELS, SKATEBOARD WHEEL ASSEM-
BLIES AND PARTS AND FITTINGS FOR ANY
THEREOF; SKATEBOARD BUMPERS, BEARINGS,
RAILS, SHOCK ABSORBERS AND PADS, WHEEL CAPS
AND WHEEL SPINNERS; SKATEBOARD GRIP TAPE;
SNOWBOARDS, SNOWBOARD BINDINGS AND PARTS
THEREFORE; SAFETY PADDING AND PROTECTIVE
PADDING FOR SKATEBOARDING AND SNOWBOARD-
ING; BODY BOARDS, RIDE-ON TOYS; SURFBOARDS,
LONGBOARDS, SHORTBOARDS, WINDSURFBOARDS,
SAILBOARDS WAKEBOARDS, BODYBOARDS, KNEE-
BOARDS, SURF FINS, LEASHES USED IN CONJUNC-
TION WITH SURFING (U.S. CLS. 22, 23, 38 AND 50).
GRETTA YAO, EXAMINING ATTORNEY

CLASS 28—(Continued).

SN 78-436,198. IMAI, STUART, REDONDO BEACH, CA.
FILED 6-16-2004.

Terraingame

THE MARK CONSISTS OF STANDARD CHARACTERS
WITHOUT CLAIM TO ANY PARTICULAR FONT, STYLE,
SIZE, OR COLOR.
FOR BOARD GAMES (U.S. CLS. 22, 23, 38 AND 50).
PRISCILLA MILTON, EXAMINING ATTORNEY

SN 78-436,045. ZOOM BAIT COMPANY, INC., BOGART, GA.
FILED 6-16-2004.

ZBC

THE MARK CONSISTS OF STANDARD CHARACTERS
WITHOUT CLAIM TO ANY PARTICULAR FONT, STYLE,
SIZE, OR COLOR.
FOR ARTIFICIAL FISHING LURES (U.S. CLS. 22, 23,
38 AND 50).
FIRST USE 3-31-2003; IN COMMERCE 3-31-2003.
KATHERINE STOIDES, EXAMINING ATTORNEY

SN 78-436,232. UCHINO, STEPHEN PEPPER, CORAL GA-
BLES, FL. AND UCHINO, JOHN TAKESHI, MIAMI, FL.
FILED 6-16-2004.

STRATEEGERY

THE MARK CONSISTS OF STANDARD CHARACTERS
WITHOUT CLAIM TO ANY PARTICULAR FONT, STYLE,
SIZE, OR COLOR.
FOR BOARD GAMES (U.S. CLS. 22, 23, 38 AND 50).
CHARLES L. JENKINS, EXAMINING ATTORNEY

CLASS 28—(Continued).

SN 78-436,527. FISHER, DALE, FOUNTAIN VALLEY, CA.
FILED 6-16-2004.

smart insert
technology

THE MARK CONSISTS OF STANDARD CHARACTERS
WITHOUT CLAIM TO ANY PARTICULAR FONT, STYLE,
SIZE, OR COLOR.

NO CLAIM IS MADE TO THE EXCLUSIVE RIGHT TO
USE "INSERT TECHNOLOGY", APART FROM THE MARK
AS SHOWN.

FOR GOLF CLUBS (U.S. CLS. 22, 23, 38 AND 50).
MICHAEL KEATING, EXAMINING ATTORNEY

CLASS 28—(Continued).

SN 78-436,913. CLARKE, CRISTY, DBA RUBYMINE, OR-
INDA, CA. FILED 6-17-2004.

RUBYMINE

THE MARK CONSISTS OF STANDARD CHARACTERS
WITHOUT CLAIM TO ANY PARTICULAR FONT, STYLE,
SIZE, OR COLOR.

FOR PARLOR GAME (U.S. CLS. 22, 23, 38 AND 50).
RAMONA ORTIGA, EXAMINING ATTORNEY

SN 78-437,387. MATTEL, INC., EL SEGUNDO, CA. FILED 6-
17-2004.

SN 78-436,632. BRENTWOOD TELEVISION FUNNIES, INC.,
ENCINO, CA. FILED 6-17-2004.

BIKER MICE FROM
MARS

THE MARK CONSISTS OF STANDARD CHARACTERS
WITHOUT CLAIM TO ANY PARTICULAR FONT, STYLE,
SIZE, OR COLOR.

FOR TOYS, GAMES, AND PLAYTHINGS; NAMELY,
ACTION FIGURES, TOY MOTORCYCLES AND OTHER
TOY VEHICLES, AND TOY WEAPONS (U.S. CLS. 22, 23,
38 AND 50).
WON TEAK OH, EXAMINING ATTORNEY

OPAL

THE MARK CONSISTS OF STANDARD CHARACTERS
WITHOUT CLAIM TO ANY PARTICULAR FONT, STYLE,
SIZE, OR COLOR.

FOR DOLLS, DOLL CLOTHING AND DOLL ACCES-
SORIES (U.S. CLS. 22, 23, 38 AND 50).
ALLISON HOLTZ, EXAMINING ATTORNEY

CLASS 28—(Continued).

SN 78-437,574. BARBIZON INTERNATIONAL, LLC, CORAL SPRINGS, FL. FILED 6-18-2004.

CLASS 28—(Continued).

SN 78-437,772. JOHNSTONE, JEREMY S., LAKE STEVENS, WA. FILED 6-18-2004.

BARBIZON

COUPLES

THE MARK CONSISTS OF STANDARD CHARACTERS WITHOUT CLAIM TO ANY PARTICULAR FONT, STYLE, SIZE, OR COLOR.
FOR BOARD GAME (U.S. CLS. 22, 23, 38 AND 50).
BARNEY CHARLON, EXAMINING ATTORNEY

SN 78-438,837. MISSION CITY PRESS, INC., SAN ANTONIO, TX. FILED 6-21-2004.

THE MARK CONSISTS OF STANDARD CHARACTERS WITHOUT CLAIM TO ANY PARTICULAR FONT, STYLE, SIZE, OR COLOR.

OWNER OF U.S. REG. NO. 902,816.
FOR TOYS, GAMES, PLAYTHINGS, NAMELY, ACTION FIGURES AND ACCESSORIES THEREFOR, STUFFED TOY ANIMALS, TOY AIRPLANES, BALLOONS, TOY BAKEWARE AND COOKWARE, SPORT BALLS, TOY BANKS, BATH TOYS, BEAN BAGS, TOY BUILDING BLOCKS, PLAY WANDS, MUSIC BOX TOYS, BUBBLE MAKING WAND AND SOLUTION SETS, CARD GAMES, CHRISTMAS TREE ORNAMENTS, CHRISTMAS TREE SKIRTS, CHILDREN'S PLAY COSMETICS, PARTY FAVORS IN THE NATURE OF CRACKERS OR NOISE-MAKERS, TOY MOBILES, FLYING DISCS, PORCELAIN DOLLS, PAPER DOLLS, PARTY FAVORS IN THE NATURE OF SMALL TOYS, ICE SKATES, JIGSAW PUZZLES, JUMP ROPES, KITES, MUSICAL TOYS, PLAY SWIMMING POOLS, PLUSH TOYS, PUPPETS, RIDE-ON TOYS, MANIPULATIVE PUZZLES, ROLLER SKATES, WATER-SQUIRTING TOYS, YO-YOS, ADULT AND CHILDREN PARTY GAMES, CHRISTMAS STOCKINGS, COLLECTIBLE TOY FIGURES, DOLL HOUSES, DRAWING TOYS, IN-LINE SKATES, PLAY TENTS, PLAY HOUSES, RADIO CONTROLLED TOY VEHICLES, SAND TOYS, SAND BOX TOYS, TALKING TOYS; SLIDE PUZZLES, PADDLE BALL GAMES; DOLLS; PLAYSETS, NAMELY, DOLL FURNITURE, DOLL FURNITURE ACCESSORIES AND FOOD MAKING ACCESSORIES; DOLL CLOTHES AND DOLL ACCESSORIES; BOARD GAMES; ACCESSORIES FOR DOLL CLOTHES, TOY FURNITURE, SPECIFICALLY BEDS, WARDROBES, CHIFFEROBES, VANITIES AND CHESTS; DOLL CASES; TOY VEHICLES; KITS FOR BUILDING OUTDOOR PLAY EQUIPMENT, COIN-OPERATED ARCADE GAMES, ELECTRONIC HAND-HELD GAMES (U.S. CLS. 22, 23, 38 AND 50).

TRICIA SONNEBORN, EXAMINING ATTORNEY

GODLY GIRLS

THE MARK CONSISTS OF STANDARD CHARACTERS WITHOUT CLAIM TO ANY PARTICULAR FONT, STYLE, SIZE, OR COLOR.
FOR DOLLS, DOLL CLOTHING AND DOLL ACCESSORIES (U.S. CLS. 22, 23, 38 AND 50).
IRA J. GOODSAD, EXAMINING ATTORNEY

SN 78-438,871. BURROWS GOLF, LLC, VALENCIA, CA. FILED 6-21-2004.

CRACK OF THE BAT

THE MARK CONSISTS OF STANDARD CHARACTERS WITHOUT CLAIM TO ANY PARTICULAR FONT, STYLE, SIZE, OR COLOR.
FOR GOLF CLUBS AND COMPONENT PARTS THEREOF, NAMELY, HEADS, SHAFTS AND GRIPS (U.S. CLS. 22, 23, 38 AND 50).
ELIZABETH HUGHITT, EXAMINING ATTORNEY

CLASS 28—(Continued).

SN 78-439,182. PAULSON, ROBERT, EAST MORICHES, NY.
FILED 6-22-2004.

Gagi

THE MARK CONSISTS OF STANDARD CHARACTERS
WITHOUT CLAIM TO ANY PARTICULAR FONT, STYLE,
SIZE, OR COLOR.
FOR CHARACTER DOLL (U.S. CLS. 22, 23, 38 AND
50).
GEOFFREY FOSDICK, EXAMINING ATTORNEY

SN 78-526,746. HONG KONG CITY TOYS FACTORY LIM-
ITED, KOWLOON, HONG KONG, FILED 12-3-2004.

NOEL'S CHRISTMAS
ENSEMBLE

THE MARK CONSISTS OF STANDARD CHARACTERS
WITHOUT CLAIM TO ANY PARTICULAR FONT, STYLE,
SIZE, OR COLOR.
OWNER OF U.S. REG. NO. 1,938,660.
NO CLAIM IS MADE TO THE EXCLUSIVE RIGHT TO
USE "CHRISTMAS ENSEMBLE", APART FROM THE
MARK AS SHOWN.
FOR DOLLS, DOLL CLOTHING, DOLL PLAYSETS
AND DOLL ACCESSORIES (U.S. CLS. 22, 23, 38 AND 50).
ALLISON HOLTZ, EXAMINING ATTORNEY

CLASS 28—(Continued).

SN 78-526,747. HONG KONG CITY TOYS FACTORY LIM-
ITED, KOWLOON, HONG KONG, FILED 12-3-2004.

LAURA'S PLAY SET

THE MARK CONSISTS OF STANDARD CHARACTERS
WITHOUT CLAIM TO ANY PARTICULAR FONT, STYLE,
SIZE, OR COLOR.
OWNER OF U.S. REG. NO. 1,938,657.
NO CLAIM IS MADE TO THE EXCLUSIVE RIGHT TO
USE "PLAY SET", APART FROM THE MARK AS SHOWN.
FOR DOLLS, DOLL CLOTHING, DOLL PLAYSETS
AND DOLL ACCESSORIES (U.S. CLS. 22, 23, 38 AND 50).
ALLISON HOLTZ, EXAMINING ATTORNEY

SN 78-526,751. HONG KONG CITY TOYS FACTORY LIM-
ITED, KOWLOON, HONG KONG, FILED 12-3-2004.

LIFE LIKE LISA

THE MARK CONSISTS OF STANDARD CHARACTERS
WITHOUT CLAIM TO ANY PARTICULAR FONT, STYLE,
SIZE, OR COLOR.
OWNER OF U.S. REG. NO. 1,938,659.
NO CLAIM IS MADE TO THE EXCLUSIVE RIGHT TO
USE "LIFE LIKE", APART FROM THE MARK AS SHOWN.
FOR DOLLS, DOLL CLOTHING, DOLL PLAYSETS
AND DOLL ACCESSORIES (U.S. CLS. 22, 23, 38 AND 50).
ALLISON HOLTZ, EXAMINING ATTORNEY

SN 78-526,757. HONG KONG CITY TOYS FACTORY LIM-
ITED, KOWLOON, HONG KONG, FILED 12-3-2004.

SARA AND HER
SECRET TRUNK

THE MARK CONSISTS OF STANDARD CHARACTERS
WITHOUT CLAIM TO ANY PARTICULAR FONT, STYLE,
SIZE, OR COLOR.
OWNER OF U.S. REG. NO. 1,939,838.
FOR DOLLS, DOLL CLOTHING, DOLL PLAYSETS
AND DOLL ACCESSORIES (U.S. CLS. 22, 23, 38 AND 50).
ALLISON HOLTZ, EXAMINING ATTORNEY

CLASS 29—MEATS AND PROCESSED FOODS

SN 76-456,411. ACEITES COOSUR, S.A., SEVILLA, SPAIN,
FILED 10-7-2002.

COOSUR

OWNER OF SPAIN REG. NO. 422537, DATED 7-20-1964,
EXPIRES 4-26-2013.
FOR OLIVE OILS, EDIBLE OILS, PRESERVED OLIVES
(U.S. CL. 46).
DARRYL SPRUILL, EXAMINING ATTORNEY

SN 76-510,911. DAVIS MOUNTAINS ORGANIC BEEF, L.L.C.,
DALLAS, TX. FILED 5-1-2003.



NO CLAIM IS MADE TO THE EXCLUSIVE RIGHT TO
USE DAVIS MOUNTAINS, 100% ORGANIC BEEF P.O. BOX
1095 FT. DAVIS, TX 79734, APART FROM THE MARK AS
SHOWN.

THE MARK CONSISTS OF THE LITERAL ELEMENT SET
INSIDE A CIRCLE OF GRADUATED COLOR. THE COLOR
IS REDDISH ORANGE AT THE TOP AND FADES TO
YELLOW IN THE MIDDLE OF THE CIRCLE. IN THE
CENTER OF THE MARK IS A BLACKENED COWBOY ON
A BLACKENED HORSE STANDING ON BLACKENED
GROUND. THE WORDS "DAVIS MOUNTAINS" ARE IN
BLACK LETTERS OUTLINED IN WHITE WITH INITIAL
CAPITAL LETTERS. THE REMAINING WORDS ARE IN A
WHITE FONT WITH INITIAL CAPITAL LETTERS.

FOR BEEF (U.S. CL. 46).
FIRST USE 10-31-2002; IN COMMERCE 10-31-2002.
SOPHIA S. KIM, EXAMINING ATTORNEY

SN 76-548,399. DULCICH, INC., CLACKAMAS, OR. FILED 9-
15-2003.

PACIFIC SEAFOOD

NO CLAIM IS MADE TO THE EXCLUSIVE RIGHT TO
USE "SEAFOOD", APART FROM THE MARK AS SHOWN.
SEC. 2(F).
FOR FRESH AND FROZEN FISH AND SEAFOOD
(U.S. CL. 46).
FIRST USE 10-31-1946; IN COMMERCE 10-31-1948.
PAUL F. GAST, EXAMINING ATTORNEY

CLASS 29—(Continued).

SN 76-567,762. THE LAST TWIST, INC., CONSHOHOCKEN,
PA. FILED 12-30-2003.



OWNER OF U.S. REG. NO. 2,823,034.
NO CLAIM IS MADE TO THE EXCLUSIVE RIGHT TO
USE "NEW YORK", APART FROM THE MARK AS SHOWN.
THE NAME CHUBBY CHECKER IDENTIFIES A LIVING
INDIVIDUAL WHOSE CONSENT IS OF RECORD.
FOR HOT DOGS, STEAKS, LAMB CHOPS, PORK
CHOPS, VEAL CHOPS, HAMBURGER (U.S. CL. 46).
BRENDAN REGAN, EXAMINING ATTORNEY

SN 76-582,160. DONGWON F&B CO., LTD., SEOUL 137-717,
REPUBLIC OF KOREA, FILED 3-22-2004.

스테이크사이드
steakside

OWNER OF REPUBLIC OF KOREA REG. NO. 571803,
DATED 1-14-2004, EXPIRES 1-14-2014.

THE NON-LATIN CHARACTERS IN THE MARK
TRANSLITERATE FROM KOREAN TO A WORD SOUND-
ING LIKE "STEAKSIDE," WHICH HAS NO TRANSLATION
FROM KOREAN INTO ENGLISH, EXCEPT AS THE WORD
"STEAKSIDE."

FOR PROCESSED VEGETABLES AND FRUITS (U.S.
CL. 46).
RONALD MCMORROW, EXAMINING ATTORNEY

CLASS 29—(Continued).

SN 76-587,814. PROVISTA SPECIALTY FOODS, INC., PORTLAND, OR. FILED 4-19-2004.

PROVVISTA

THE MARK CONSISTS OF STANDARD CHARACTERS WITHOUT CLAIM TO ANY PARTICULAR FONT, STYLE, SIZE, OR COLOR.
OWNER OF U.S. REG. NOS. 2,302,301, 2,545,651 AND OTHERS.

THE ENGLISH TRANSLATION OF THE WORD PROVISTA IN THE MARK IS SUPPLY.

FOR CHEESE, OLIVE OIL, JAM (U.S. CL. 46).
FIRST USE 10-24-2003; IN COMMERCE 2-20-2004.
PATRICIA EVANKO, EXAMINING ATTORNEY

SN 76-593,882. KING & PRINCE SEAFOOD CORPORATION, BRUNSWICK, GA. FILED 5-25-2004.

MAUI MUNCHERS

THE MARK CONSISTS OF STANDARD CHARACTERS WITHOUT CLAIM TO ANY PARTICULAR FONT, STYLE, SIZE, OR COLOR.

FOR FROZEN SHRIMP (U.S. CL. 46).
JAMES A. RAUEN, EXAMINING ATTORNEY

SN 76-597,304. LAMB-WESTON, INC., KENNEWICK, WA. FILED 6-15-2004.

ULTRAMASHED

THE MARK CONSISTS OF STANDARD CHARACTERS WITHOUT CLAIM TO ANY PARTICULAR FONT, STYLE, SIZE, OR COLOR.

FOR FROZEN VEGETABLES (U.S. CL. 46).
KELLY BOULTON, EXAMINING ATTORNEY

SN 76-597,356. NOVA CHEESE, INC., ORANGEVILLE, ONTARIO, CANADA, FILED 6-9-2004.

CHEBRIE

FOR CHEESE (U.S. CL. 46).
WANDA KAY PRICE, EXAMINING ATTORNEY

CLASS 29—(Continued).

SN 76-597,726. SARGENTO FOODS, INC., PLYMOUTH, WI. FILED 6-17-2004.

BACK TO THE KITCHEN

THE MARK CONSISTS OF STANDARD CHARACTERS WITHOUT CLAIM TO ANY PARTICULAR FONT, STYLE, SIZE, OR COLOR.

FOR IMPORTED AND DOMESTIC, WHOLE, SLICED, AND SHREDDED NATURAL CHEESES, PROCESSED CHEESES, CHEESE SPREADS AND CHEESE FOODS (U.S. CL. 46).

TINA L. SNAPP, EXAMINING ATTORNEY

SN 76-620,305. ALDI INC., BATAVIA, IL. FILED 11-12-2004.

MAMA COZZI

THE MARK CONSISTS OF STANDARD CHARACTERS WITHOUT CLAIM TO ANY PARTICULAR FONT, STYLE, SIZE, OR COLOR.

OWNER OF U.S. REG. NOS. 1,625,101 AND 2,503,837.

FOR MEAT (U.S. CL. 46).
GRETTA YAO, EXAMINING ATTORNEY

SN 76-620,306. ALDI INC., BATAVIA, IL. FILED 11-12-2004.

BRIARGATE

THE MARK CONSISTS OF STANDARD CHARACTERS WITHOUT CLAIM TO ANY PARTICULAR FONT, STYLE, SIZE, OR COLOR.

OWNER OF U.S. REG. NOS. 2,011,591, 2,541,664 AND 2,848,927.

FOR MEAT (U.S. CL. 46).
GRETTA YAO, EXAMINING ATTORNEY

SN 78-223,509. MY HUSBAND'S NUTS, INC., BAKERSFIELD, CA. FILED 3-10-2003.

MY HUSBAND'S NUTS

FOR CANDIED, SHELLED, ROASTED AND SEASONED NUTS; CANDIED, SHELLED, ROASTED AND SEASONED ALMONDS (U.S. CL. 46).

FIRST USE 8-1-2003; IN COMMERCE 8-1-2003.
PAUL F. GAST, EXAMINING ATTORNEY

CLASS 29—(Continued).

SN 78-267,922. HALWANI BROTHERS CO., CODE 21421, SAUDI ARABIA, FILED 6-27-2003.



THE FOREIGN WORDING IN THE MARK TRANSLATES INTO ENGLISH AS NADIYA, A COINED TERM.

FOR TAHINA, MEAT AND MEAT EXTRACT; DOMESTIC BIRDS, NAMELY CHICKEN, TURKEY AND QUAIL; JAMS, MARMALADES, YOGURT AND OTHER DAIRY PRODUCTS AND DERIVATIVES, NAMELY CHEESE AND BUTTER; PRESERVED DRIED AND COOKED FRUITS AND VEGETABLES; AND PICKLES (U.S. CL. 46).

FIRST USE 1-1-2003; IN COMMERCE 1-1-2003.
SUSAN HAYASH, EXAMINING ATTORNEY

SN 78-310,578. THE OLD FASHIONED KITCHEN, INC., LAKEWOOD, NJ. FILED 10-7-2003.



OWNER OF U.S. REG. NO. 1,332,472.
FOR POTATO PANCAKES, SWEET POTATO PANCAKES, AND ZUCCHINI PANCAKES (U.S. CL. 46).
FIRST USE 1-1-1998, THE MARK WAS FIRST USED ANYWHERE IN A DIFFERENT FORM OTHER THAN THAT SOUGHT TO BE REGISTERED ON 03/26/1963.; IN COMMERCE 1-1-1998, THE MARK WAS FIRST USED IN COMMERCE IN A DIFFERENT FORM OTHER THAN THAT SOUGHT TO BE REGISTERED ON 03/26/1963..
CATHERINE CAIN, EXAMINING ATTORNEY

SN 78-316,600. DISNEY ENTERPRISES, INC., BURBANK, CA. FILED 10-21-2003.

WALT DISNEY WORLD

OWNER OF U.S. REG. NOS. 980,995, 1,189,727 AND 2,189,177.

THE NAME IN THE MARK DOES NOT IDENTIFY A PARTICULAR LIVING INDIVIDUAL.

FOR FRUIT PRESERVES; FRUIT-BASED SNACK FOOD; JAMS; JELLIES; POTATO CHIPS; CANDIED, ROASTED AND SHELLED NUTS; MILK; MILK-BASED BEVERAGES CONTAINING COFFEE; CHOCOLATE MILK (U.S. CL. 46).

PAUL F. GAST, EXAMINING ATTORNEY

CLASS 29—(Continued).

SN 78-329,550. PUTNAM COMPANY, WELLSBORO, PA. FILED 11-18-2003.



NO CLAIM IS MADE TO THE EXCLUSIVE RIGHT TO USE "HOMESTYLE CHICKEN", APART FROM THE MARK AS SHOWN.

FOR CHICKEN FOR CONSUMPTION ON OR OFF THE PREMISES (U.S. CL. 46).

JEFF DEFORD, EXAMINING ATTORNEY

SN 78-350,057. BRIMSTONE ORIGINALS, LLC, LARGO, FL. FILED 1-9-2004.

**BRIMSTONE
ORIGINALS**

THE MARK CONSISTS OF STANDARD CHARACTERS WITHOUT CLAIM TO ANY PARTICULAR FONT, STYLE, SIZE, OR COLOR.

NO CLAIM IS MADE TO THE EXCLUSIVE RIGHT TO USE "ORIGINALS", APART FROM THE MARK AS SHOWN.

FOR JELLIES (U.S. CL. 46).

FIRST USE 5-0-2003; IN COMMERCE 5-0-2003.

RENEE MCCRAY, EXAMINING ATTORNEY

CLASS 29—(Continued).

SN 78-359,727. CACIQUE, INC., CITY OF INDUSTRY, CA. FILED 1-29-2004.

CLASS 29—(Continued).

SN 78-379,195. ALEXIS INTERNATIONAL, KATONAH, NY. FILED 3-5-2004.

RANCHO DE CARDENAS

THE MARK CONSISTS OF STANDARD CHARACTERS WITHOUT CLAIM TO ANY PARTICULAR FONT, STYLE, SIZE, OR COLOR.

THE NAME(S), PORTRAIT(S), AND/OR SIGNATURE(S) SHOWN IN THE MARK IDENTIFIES GILBERT L. DE CARDENAS, WHOSE CONSENT(S) TO REGISTER IS SUBMITTED.

THE FOREIGN WORDING IN THE MARK TRANSLATES INTO ENGLISH AS "RANCHO" TRANSLATES TO "RANCH".

FOR DAIRY PRODUCTS, NAMELY CHEESE AND CREAM, AND MEAT (U.S. CL. 46).
MARLENE BELL, EXAMINING ATTORNEY

KING KONG

THE MARK CONSISTS OF STANDARD CHARACTERS WITHOUT CLAIM TO ANY PARTICULAR FONT, STYLE, SIZE, OR COLOR.

FOR FRUIT BASED SNACK FOODS, NAMELY, DRIED FRUIT CHEWS MADE WITH ORGANIC INGREDIENTS (U.S. CL. 46).
CHRISTOPHER ADKINS, EXAMINING ATTORNEY

SN 78-359,732. CACIQUE, INC., CITY OF INDUSTRY, CA. FILED 1-29-2004.

SN 78-380,490. HUA, TUNG VO, SAN GABRIEL, CA. FILED 3-8-2004.

DE CARDENAS



THE MARK CONSISTS OF STANDARD CHARACTERS WITHOUT CLAIM TO ANY PARTICULAR FONT, STYLE, SIZE, OR COLOR.

THE NAME(S), PORTRAIT(S), AND/OR SIGNATURE(S) SHOWN IN THE MARK IDENTIFIES GILBERT L. DE CARDENAS, WHOSE CONSENT(S) TO REGISTER IS SUBMITTED.

FOR DAIRY PRODUCTS, NAMELY, CHEESE AND CREAM, AND MEAT (U.S. CL. 46).
MARLENE BELL, EXAMINING ATTORNEY

THE COLOR(S) GREEN AND BLACK IS/ARE CLAIMED AS A FEATURE OF THE MARK.

THE COLOR GREEN APPEARS IN THE THREE POINTED LEAF, AND THE COLOR BLACK APPEARS IN THE WORDING "NATURNUTRI".

THE MARK CONSISTS OF GREEN THREE POINTED LEAF NEXT TO "NATURNUTRI" WITH TWO CAPITAL "N'S" AND NO SPACE BETWEEN "NATUR" AND "NUTRI".

FOR SPRAY DRIED HEALTH FOOD PRODUCTS, NAMELY FRUITS AND VEGETABLES (U.S. CL. 46).
AMY ALFIERI, EXAMINING ATTORNEY

CLASS 29—(Continued).

SN 78-400,115. PPC MARKETING, LTD., PITTSBURGH, TX.
FILED 4-12-2004.

CLASS 29—(Continued).

SN 78-423,622. CHEEZWHSE.COM, INC., ARMONK, NY.
FILED 5-24-2004.



WISBERG

THE NAME(S), PORTRAIT(S), AND/OR SIGNATURE(S)
SHOWN IN THE MARK IDENTIFIES BO PILGRIM, WHOSE
CONSENT(S) TO REGISTER IS SUBMITTED.
FOR TURKEY (U.S. CL. 46).
STEVEN R. FINE, EXAMINING ATTORNEY

THE MARK CONSISTS OF STANDARD CHARACTERS
WITHOUT CLAIM TO ANY PARTICULAR FONT, STYLE,
SIZE, OR COLOR.
FOR CHEESE (U.S. CL. 46).
MONIQUE MILLER, EXAMINING ATTORNEY

SN 78-401,725. ST. JAMES SMOKEHOUSE, MIAMI, FL.
FILED 4-14-2004.

SN 78-425,391. FRANK BRUNCKHORST CO., L.L.C.,
BROOKLYN, NY. FILED 5-26-2004.

**ST. JAMES
SMOKEHOUSE SCOTCH
CHOICE**

**GOURMET WITHOUT
THE SILVERWARE**

THE MARK CONSISTS OF STANDARD CHARACTERS
WITHOUT CLAIM TO ANY PARTICULAR FONT, STYLE,
SIZE, OR COLOR.
NO CLAIM IS MADE TO THE EXCLUSIVE RIGHT TO
USE "SCOTCH", APART FROM THE MARK AS SHOWN.
FOR SMOKED SCOTTISH SALMON, SMOKED SAL-
MON, SMOKED SEAFOOD, SMOKED FISH, FISH, SEA-
FOOD (U.S. CL. 46).
FIRST USE 4-14-2004; IN COMMERCE 4-14-2004.
GRETTA YAO, EXAMINING ATTORNEY

THE MARK CONSISTS OF STANDARD CHARACTERS
WITHOUT CLAIM TO ANY PARTICULAR FONT, STYLE,
SIZE, OR COLOR.
FOR PROCESSED MEATS, NAMELY PORK (U.S. CL.
46).
MARK SPARACINO, EXAMINING ATTORNEY

CLASS 29—(Continued).

SN 78-434,853. STONYFIELD FARM, INC., LONDONDER-
RY, NH. FILED 6-14-2004.

CLASS 29—(Continued).

SN 78-439,339. NOVARTIS AG, BASEL, SWITZERLAND,
FILED 6-22-2004.

YO BABY

YOSIPS

THE MARK CONSISTS OF STANDARD CHARACTERS
WITHOUT CLAIM TO ANY PARTICULAR FONT, STYLE,
SIZE, OR COLOR.

FOR YOGURT AND DAIRY PRODUCTS EXCLUDING
ICE CREAM, ICE MILK, AND FROZEN YOGURT (U.S.
CL. 46).

FIRST USE 8-26-1999; IN COMMERCE 8-26-1999.
MICHAEL HALL, EXAMINING ATTORNEY

THE MARK CONSISTS OF STANDARD CHARACTERS
WITHOUT CLAIM TO ANY PARTICULAR FONT, STYLE,
SIZE, OR COLOR.

FOR DAIRY BASED FOOD BEVERAGES (U.S. CL. 46).
KEVON CHISOLM, EXAMINING ATTORNEY

SN 78-435,818. PUREGIG, INC, PHOENIX, AZ. FILED 6-15-
2004.

SN 78-439,384. CHEF JAY'S FOOD PRODUCTS, LAS VEGAS,
NV. FILED 6-22-2004.

SERVER JERKY

TRI-O-PLEX

THE MARK CONSISTS OF STANDARD CHARACTERS
WITHOUT CLAIM TO ANY PARTICULAR FONT, STYLE,
SIZE, OR COLOR.

NO CLAIM IS MADE TO THE EXCLUSIVE RIGHT TO
USE "JERKY", APART FROM THE MARK AS SHOWN.

FOR MEAT PRODUCTS, NAMELY MEAT JERKY (U.S.
CL. 46).

MELVIN AXILBUND, EXAMINING ATTORNEY

THE MARK CONSISTS OF STANDARD CHARACTERS
WITHOUT CLAIM TO ANY PARTICULAR FONT, STYLE,
SIZE, OR COLOR.

FOR PROTEIN BASED, NUTRIENT-DENSE SNACK
BARS (U.S. CL. 46).

FIRST USE 10-0-2002; IN COMMERCE 10-0-2002.
JENNIFER CHICOSKI, EXAMINING ATTORNEY

CLASS 29—(Continued).

SN 78-440,204. SOKOLOFF, MARTIN, NEW YORK, NY. FILED 6-23-2004.

BIG EASY

THE MARK CONSISTS OF STANDARD CHARACTERS WITHOUT CLAIM TO ANY PARTICULAR FONT, STYLE, SIZE, OR COLOR.

FOR SARDINES, CRAB, LOBSTER, SHRIMP AND MACKEREL PACKAGED IN CONSUMER TINS OR SOFT RETORT POUCHES (U.S. CL. 46).

RONALD AIKENS, EXAMINING ATTORNEY

SN 78-474,284. MONSANTO TECHNOLOGY LLC, SAINT LOUIS, MO. FILED 8-26-2004.

VISTIVE

THE MARK CONSISTS OF STANDARD CHARACTERS WITHOUT CLAIM TO ANY PARTICULAR FONT, STYLE, SIZE, OR COLOR.

FOR EDIBLE OILS (U.S. CL. 46).

JUDITH HELFMAN, EXAMINING ATTORNEY

CLASS 29—(Continued).

SN 78-478,930. RUNNING W, LTD., HOUSTON, TX. FILED 9-3-2004.



FOR BARBECUE BEEF BRISKETS; PICKLED GREEN BEANS, BEAN JELLY, CHILI JELLY, PEPPER, AND CACTUS JELLY (U.S. CL. 46).

FIRST USE 11-16-1991; IN COMMERCE 11-16-1991. YSA DEJESUS, EXAMINING ATTORNEY

SN 78-975,807. SOCIETE DES PRODUITS NESTLE S.A., 1800 VEVEY, SWITZERLAND, FILED 7-24-2003.

CINO CINO

FOR PRESERVED, DRIED AND COOKED VEGETABLES AND FRUITS; MEAT; POULTRY; GAME; FISH; SEAFOOD; MEAT EXTRACTS; SOUPS; JELLIES; PASTES, NAMELY, ANCHOVY, ARTICHOKE, FRUIT, GUAVA, LIVER, MEAT, TOMATO, VEGETABLE; FROZEN, PREPARED OR PACKAGED ENTREES CONSISTING PRIMARILY OF MEAT, FISH, POULTRY OR VEGETABLES; JAMS; EGGS; MILK; CREAM; BUTTER; CHEESE; YOGURT; SOY MILK; SOY-BASED BEVERAGE USED AS A MILK SUBSTITUTE; EDIBLE OILS AND FATS; PROTEIN FOR USE AS A FOOD ADDITIVE; NON-DAIRY CREAMER; SAUSAGE; CHARCUTERIE; PEANUT BUTTER; SOUP CONCENTRATES; BROTH; STOCK CUBES; BOUILLON; CONSOMME; DAIRY-BASED AND VEGETABLE-BASED CHOCOLATE FOOD BEVERAGES (U.S. CL. 46).

KAREN BRACEY, EXAMINING ATTORNEY

CLASS 30—STAPLE FOODS

SN 75-800,315. PROCTER & GAMBLE COMPANY, THE, CINCINNATI, OH. FILED 10-8-1999.

GOTTA GETTA JAKADA

FOR COFFEE-BASED BEVERAGE (U.S. CL. 46). FIRST USE 7-30-1998; IN COMMERCE 7-30-1998.

CAROLYN GRAY, EXAMINING ATTORNEY

CLASS 30—(Continued).

SN 76-096,373. JESUS NAVARRO, S.A., 03660- NOVELDA, ALICANTE, SPAIN, FILED 7-24-2000.



PRIORITY CLAIMED UNDER SEC. 44(D) ON ERPN CMNTY TM OFC APPLICATION NO. 001408871, FILED 3-10-2000, REG. NO. 001408871, DATED 2-13-2001, EXPIRES 3-10-2010.

CARMENCITA DOES NOT REFER TO THE NAME OF A LIVING INDIVIDUAL.

THE ENGLISH TRANSLATION OF "CARMENCITA" IS "LITTLE CARMEN".

FOR SAFFRON AND SAFFRON SUBSTITUTES; SEASONINGS AND SPICES; CINNAMON; CAPERS; ANISEED USED AS SEASONING OR SPICES; SEASONINGS AND SPICES WITH AROMATIC QUALITIES; CLOVE; SALT; ROYAL JELLY FOR FOODS PURPOSES; CURRY; FOOD FLAVORINGS; ESSENCES FOR FOODSTUFFS USED AS SEASONING AND SPICES; GINGER; HERBS FOR NON-MEDICINAL INFUSIONS; PAPRIKA; PEPPER; TAPIOCA; VANILLA AND VANILLIN FOR FOOD FLAVORING; COCOA; SUGAR; RICE; SAGO; FLOUR; PREPARED DRIED CEREALS; BREAD; PASTRIES; FROZEN CONFECTIONS; CAKES; PIES; CHOCOLATE; ICE-CREAM; TREACLE; VINEGAR; CONDIMENTS, NAMELY, KETCHUP AND MUSTARD; MAYONNAISE AND ICE (U.S. CL. 46).

CHRISTOPHER ADKINS, EXAMINING ATTORNEY

SN 76-364,675. ZATARAIN'S PARTNERSHIP, L.P., GRETNA, LA. FILED 1-30-2002.

PRO BOIL

NO CLAIM IS MADE TO THE EXCLUSIVE RIGHT TO USE BOIL, APART FROM THE MARK AS SHOWN.

FOR CRAB BOIL (U.S. CL. 46).

FIRST USE 2-27-2002; IN COMMERCE 3-30-2002.

CRAIG D. TAYLOR, EXAMINING ATTORNEY

SN 76-365,987. SAKAI, SHIRO, URAWA, SAITAMA 338-0822, JAPAN, FILED 2-1-2002.

MUSTARD POWDER 21

PRIORITY CLAIMED UNDER SEC. 44(D) ON CANADA APPLICATION NO. 1,111,952, FILED 8-8-2001, REG. NO. TMA619622, DATED 9-15-2004, EXPIRES 9-15-2019.

NO CLAIM IS MADE TO THE EXCLUSIVE RIGHT TO USE "MUSTARD POWDER", APART FROM THE MARK AS SHOWN.

FOR MUSTARD, MUSTARD POWDER, MUSTARD SEED USED AS SPICE, MUSTARD POWDER BLENDS CONTAINING OTHER SPICES AND INGREDIENTS, WET MUSTARD, HORSERADISH, WASABI POWDER, WASABI PASTE AND SEASONINGS (U.S. CL. 46).

YSA DEJESUS, EXAMINING ATTORNEY

CLASS 30—(Continued).

SN 76-552,926. KIM-SENG COMPANY, MONTEBELLO, CA. FILED 10-2-2003.

KAM WAH

THE ENGLISH TRANSLATION OF THE CANTONESE LANGUAGE WORDING "KAM WAH" IS "GOLD AND BRILLIANCE."

FOR PASTRIES AND CONFECTIONERY, NAMELY MOONCAKES, CAKES, AND PIES (U.S. CL. 46).

FIRST USE 8-0-1999; IN COMMERCE 8-0-1999.

KEVON CHISOLM, EXAMINING ATTORNEY

SN 76-564,080. INTERNATIONAL COFFEE & TEA, LLC, DBA THE COFFEE BEAN AND TEA LEAF, LOS ANGELES, CA. FILED 12-8-2003.

THE ORIGINAL ICE BLENDED

THE MARK CONSISTS OF STANDARD CHARACTERS WITHOUT CLAIM TO ANY PARTICULAR FONT, STYLE, SIZE, OR COLOR.

OWNER OF U.S. REG. NO. 1,920,010.

SEC. 2(F).

FOR COFFEE AND CHOCOLATE AND VANILLA SHAKES AND MIXES FOR MAKING THE SAME (U.S. CL. 46).

FIRST USE 11-0-1994; IN COMMERCE 11-0-1994.

ROBERT LORENZO, EXAMINING ATTORNEY

SN 76-571,449. GHIRINGHELLI BROTHERS PIZZA INC., SAN PABLO, CA. FILED 1-22-2004.

MR. G'S

THE MARK CONSISTS OF STANDARD CHARACTERS WITHOUT CLAIM TO ANY PARTICULAR FONT, STYLE, SIZE, OR COLOR.

FOR FROZEN AND FRESH PIZZAS, PIZZA CRUSTS, PIZZA APPETIZERS AND PIZZA ENTREES (U.S. CL. 46).

GWEN STOKOLS, EXAMINING ATTORNEY

CLASS 30—(Continued).

SN 76-574,921. KETO, L.L.C., TINTON, NJ. FILED 2-9-2004.

**THE LOW CARB
LEADER**

THE MARK CONSISTS OF STANDARD CHARACTERS WITHOUT CLAIM TO ANY PARTICULAR FONT, STYLE, SIZE, OR COLOR.

NO CLAIM IS MADE TO THE EXCLUSIVE RIGHT TO USE LOW CARB, APART FROM THE MARK AS SHOWN.
FOR LOW CARBOHYDRATE PASTA (U.S. CL. 46).
FIRST USE 6-29-2000; IN COMMERCE 6-29-2000.
DAVID TAYLOR, EXAMINING ATTORNEY

CLASS 30—(Continued).

SN 76-580,002. INTERNATIONAL SALES BROKERAGE, L.L.C., COVINGTON, LA. FILED 3-9-2004.

BLASTER POP

THE MARK CONSISTS OF STANDARD CHARACTERS WITHOUT CLAIM TO ANY PARTICULAR FONT, STYLE, SIZE, OR COLOR.

NO CLAIM IS MADE TO THE EXCLUSIVE RIGHT TO USE "POP", APART FROM THE MARK AS SHOWN.
FOR LIQUID CANDY DISPENSED THROUGH A LOLLIPOP (U.S. CL. 46).
RON FAIRBANKS, EXAMINING ATTORNEY

SN 76-575,122. M.M. GOURMET, L.C., WEST VALLEY CITY, UT. FILED 2-12-2004.

**serious
popcorn**

NO CLAIM IS MADE TO THE EXCLUSIVE RIGHT TO USE "POPCORN", APART FROM THE MARK AS SHOWN.
FOR FLAVORED POPCORN (U.S. CL. 46).
FIRST USE 1-31-2004; IN COMMERCE 1-31-2004.
LINDA POWELL, EXAMINING ATTORNEY

SN 76-580,001. INTERNATIONAL SALES BROKERAGE, L.L.C., COVINGTON, LA. FILED 3-9-2004.

SPRAY POP

THE MARK CONSISTS OF STANDARD CHARACTERS WITHOUT CLAIM TO ANY PARTICULAR FONT, STYLE, SIZE, OR COLOR.

NO CLAIM IS MADE TO THE EXCLUSIVE RIGHT TO USE "POP", APART FROM THE MARK AS SHOWN.
FOR LIQUID CANDY DISPENSED THROUGH A LOLLIPOP (U.S. CL. 46).
RON FAIRBANKS, EXAMINING ATTORNEY

SN 76-581,828. REAL TORINO, INC., MENDHAM, NJ. FILED 3-19-2004.



OWNER OF U.S. REG. NOS. 1,397,017 AND 1,687,279.
FOR COOKIES, BISCOTTI, JAMS, FLATBREADS,
CROSTINI, AND RICE (U.S. CL. 46).
ROBERT LORENZO, EXAMINING ATTORNEY

SN 76-585,774. GREENE, RAY, ST AUGUSTINE, FL. FILED 4-8-2004.

APPLE/CINNAMON BARBEQUE SAUCE

NO CLAIM IS MADE TO THE EXCLUSIVE RIGHT TO USE BARBEQUE SAUCE, APART FROM THE MARK AS SHOWN.

FOR NAMELY FOOD SAUCES (U.S. CL. 46).
FIRST USE 8-0-2000; IN COMMERCE 8-0-2000.
STANLEY I. OSBORNE, EXAMINING ATTORNEY

CLASS 30—(Continued).

SN 76-590,687. CONAGRA BRANDS, INC., OMAHA, NE.
FILED 5-4-2004.

DESSERT BAKES

THE MARK CONSISTS OF STANDARD CHARACTERS WITHOUT CLAIM TO ANY PARTICULAR FONT, STYLE, SIZE, OR COLOR.

OWNER OF U.S. REG. NOS. 2,510,975 AND 2,797,154.
NO CLAIM IS MADE TO THE EXCLUSIVE RIGHT TO USE "DESSERT", APART FROM THE MARK AS SHOWN.
FOR PIE MIXES (U.S. CL. 46).
GRETTA YAO, EXAMINING ATTORNEY

SN 76-592,450. GOLDEN CROWN FOODS, INC., ONTARIO,
CA. FILED 5-17-2004.

**EGG ROLL
SENSATIONS**

NO CLAIM IS MADE TO THE EXCLUSIVE RIGHT TO USE "EGG ROLL", APART FROM THE MARK AS SHOWN.
FOR FROZEN FOODS, NAMELY FROZEN EGG ROLLS, NAMELY, FROZEN MEAT-STUFFED EGG ROLLS, FROZEN VEGETABLE EGG ROLLS, FROZEN CHEESE-STUFFED EGG ROLLS (U.S. CL. 46).
FIRST USE 5-4-2004; IN COMMERCE 5-4-2004.
BRENDAN REGAN, EXAMINING ATTORNEY

SN 76-595,496. SOUTHEAST FOOD SYSTEMS, INC., DURHAM, NC. FILED 6-1-2004.

REAL SERIOUS

THE MARK CONSISTS OF STANDARD CHARACTERS WITHOUT CLAIM TO ANY PARTICULAR FONT, STYLE, SIZE, OR COLOR.
FOR BARBEQUE SAUCE (U.S. CL. 46).
FIRST USE 4-0-2001; IN COMMERCE 4-0-2001.
ELISSA GARBER KON, EXAMINING ATTORNEY

CLASS 30—(Continued).

SN 76-595,740. JEREMIAH'S PICK COFFEE CO., SAN FRANCISCO, CA. FILED 6-4-2004.

**Pick of the
Harvest**

THE MARK CONSISTS OF STANDARD CHARACTERS WITHOUT CLAIM TO ANY PARTICULAR FONT, STYLE, SIZE, OR COLOR.

FOR COFFEE (U.S. CL. 46).
FIRST USE 1-1-2002; IN COMMERCE 4-1-2002.
STACY WAHLBERG, EXAMINING ATTORNEY

SN 76-596,118. MARS, INCORPORATED, MCLEAN, VA.
FILED 6-8-2004.

IRRESISTIBLY RASPBERRY

THE MARK CONSISTS OF STANDARD CHARACTERS WITHOUT CLAIM TO ANY PARTICULAR FONT, STYLE, SIZE, OR COLOR.

NO CLAIM IS MADE TO THE EXCLUSIVE RIGHT TO USE "RASPBERRY", APART FROM THE MARK AS SHOWN.
FOR FROZEN CONFECTIONS (U.S. CL. 46).
AMY ALFIERI, EXAMINING ATTORNEY

SN 76-596,704. SLEEP CO, INC., SAN PEDRO, CA. FILED 6-9-2004.

SLEEP SWEETS

OWNER OF U.S. REG. NOS. 2,761,494, 2,790,794 AND OTHERS.

NO CLAIM IS MADE TO THE EXCLUSIVE RIGHT TO USE SWEETS, APART FROM THE MARK AS SHOWN.

FOR CANDY, CANDY BARS, CANDY MINTS, CANDY MADE OF CAROB, FLAVORED SWEETENED GELATIN DESSERTS, FLAVORED SWEETENED PUDDING DESSERTS, BAKERY DESSERTS, CAKE MIXES, PASTRIES, TARTS, PIES, COOKIES, CHOCOLATE-BASED FILLINGS FOR CAKES AND PIES, CUSTARDBASED FILLINGS FOR CAKES AND PIES, COCOA, COCOA MIXES, CHOCOLATE, CHOCOLATE MOUSSE, CHOCOLATE SYRUP, CHOCOLATE TOPPING, CHOCOLATE BASED READY TO EAT FOOD BARS, HOT CHOCOLATE, CHOCOLATE FOOD BEVERAGES NOT BEING DAIRY-BASED OR VEGETABLE BASED, ICE CREAM, ICE CREAM DRINKS, ICE CREAM SUBSTITUTE, CONES FOR ICE CREAM, FROZEN YOGURT, TEA BASED BEVERAGES WITH FRUIT FLAVORING, HERBAL FOOD BEVERAGES WITH FRUIT FLAVORING, CARAMEL POPCORN AND FOOD PACKAGE COMBINATIONS CONSISTING PRIMARILY OF COOKIES, CAKES AND/OR PIES (U.S. CL. 46).

STANLEY I. OSBORNE, EXAMINING ATTORNEY

CLASS 30—(Continued).

SN 76-596,770. PEACEWORKS, NEW YORK, NY. FILED 6-14-2004.

KIND

THE MARK CONSISTS OF STANDARD CHARACTERS WITHOUT CLAIM TO ANY PARTICULAR FONT, STYLE, SIZE, OR COLOR.

FOR READY TO EAT, CEREAL DERIVED FOOD BARS CONTAINING NUTS (U.S. CL. 46).
FIRST USE 2-18-2003; IN COMMERCE 2-18-2003.
CURTIS FRENCH, EXAMINING ATTORNEY

SN 76-597,396. CENTRAL TEXAS INGREDIENTS, INC., GONZALEZ, TX. FILED 6-15-2004.

COCINA DEL REY

THE MARK CONSISTS OF STANDARD CHARACTERS WITHOUT CLAIM TO ANY PARTICULAR FONT, STYLE, SIZE, OR COLOR.

THE ENGLISH TRANSLATION OF COCINA DEL REY IS "KITCHEN OF THE KING" OR "KING'S KITCHEN".
FOR SPICES AND EXTRACTS USED AS FLAVORING (U.S. CL. 46).
GWEN STOKOLS, EXAMINING ATTORNEY

SN 76-597,711. NICOLET, CHRISTOPHER ANDRE, FOX POINT, WI. FILED 6-17-2004.

JAWLIPOPS

THE MARK CONSISTS OF STANDARD CHARACTERS WITHOUT CLAIM TO ANY PARTICULAR FONT, STYLE, SIZE, OR COLOR.

FOR CANDY (U.S. CL. 46).
FIRST USE 9-0-1997; IN COMMERCE 9-0-1997.
KELLY CHOE, EXAMINING ATTORNEY

SN 76-597,796. FIERA FOODS COMPANY, TORONTO, ONTARIO, CANADA, FILED 6-16-2004.

IN A MOMENT.

THE MARK CONSISTS OF STANDARD CHARACTERS WITHOUT CLAIM TO ANY PARTICULAR FONT, STYLE, SIZE, OR COLOR.

FOR BAKED GOODS NAMELY CINNAMON BUNS, DANISHES, CROISSANTS, PASTRIES, MUFFINS, CAKES AND COOKIES (U.S. CL. 46).
MARK SPARACINO, EXAMINING ATTORNEY

CLASS 30—(Continued).

SN 76-597,957. KAUAI COFFEE COMPANY, INC., ELEELE, KAUAI, HI. FILED 6-18-2004.

ISLAND MORNINGS

THE MARK CONSISTS OF STANDARD CHARACTERS WITHOUT CLAIM TO ANY PARTICULAR FONT, STYLE, SIZE, OR COLOR.

FOR COFFEE (U.S. CL. 46).
SONYA STEPHENS, EXAMINING ATTORNEY

SN 76-598,340. DOLCE FOOD CORPORATION, SAN ANTONIO, TX. FILED 6-17-2004.

IL DOLCE FUTURO

THE MARK CONSISTS OF STANDARD CHARACTERS WITHOUT CLAIM TO ANY PARTICULAR FONT, STYLE, SIZE, OR COLOR.

THE ENGLISH TRANSLATION OF "IL DOLCE FUTURO" IS "THE SWEET FUTURE".
FOR ICE CREAM (U.S. CL. 46).
FRED MANDIR, EXAMINING ATTORNEY

SN 76-598,836. CONCORD CONFECTIONS INC., CONCORD, ONTARIO, CANADA, FILED 6-23-2004.

BLOX

THE MARK CONSISTS OF STANDARD CHARACTERS WITHOUT CLAIM TO ANY PARTICULAR FONT, STYLE, SIZE, OR COLOR.

OWNER OF U.S. REG. NO. 2,153,179.
SEC. 2(F).
FOR CONFECTIONARY, NAMELY, CANDY AND CHEWING GUM (U.S. CL. 46).
FIRST USE 9-26-1996; IN COMMERCE 9-26-1996.
AISHA CLARKE, EXAMINING ATTORNEY

CLASS 30—(Continued).

SN 78-110,066. CANADA BREAD COMPANY, LIMITED, ETOBICOKE, ONTARIO, CANADA, FILED 2-20-2002.



OWNER OF CANADA REG. NO. 522,475, DATED 1-28-2000, EXPIRES 1-28-2015.

NO CLAIM IS MADE TO THE EXCLUSIVE RIGHT TO USE "HEARTH BREADS", APART FROM THE MARK AS SHOWN.

THE STIPPLING IS FOR SHADING PURPOSES. FOR BREADS AND ROLLS (U.S. CL. 46). FIRST USE 12-31-1997; IN COMMERCE 12-31-1997. LAURA KOVAISKY, EXAMINING ATTORNEY

SN 78-113,570. VOLPATI-KEDRA, PAOLO, V., BRIGHTON, MA. FILED 3-8-2002.



NO CLAIM IS MADE TO THE EXCLUSIVE RIGHT TO USE "SAUCES" AND "HOMEMADE", APART FROM THE MARK AS SHOWN.

THE MARK CONSISTS OF THE DRAWING DEPICTS THE WORDS SAUCES 'N LOVE AND HOMEMADE ABOVE AND BELOW THE FOLLOWING TEXT: IN ITALY, WE BELIEVE IN LONG MEALS AND LINGERING AT THE TABLE. WE BELIEVE IN FAMILY, FRIENDS AND GOOD FOOD. IT IS IMPORTANT TO SHARE THE DAY'S EVENTS OVER A HOT DINNER. BE MY GUEST AND ENJOY THE PASSION. FROM MY TABLE TO YOURS. WITH LOVE. PAOLO.

FOR PERISHABLE FRESH PASTA SAUCES PACKAGED IN MICROWAVEABLE AND FREEZABLE CONTAINERS (U.S. CL. 46).

KAREN BRACEY, EXAMINING ATTORNEY

CLASS 30—(Continued).

SN 78-229,168. DEAN INTELLECTUAL PROPERTY SERVICES, L.P., DALLAS, TX. FILED 3-24-2003.



NO CLAIM IS MADE TO THE EXCLUSIVE RIGHT TO USE "ICE CREAM ", APART FROM THE MARK AS SHOWN.

FOR ICE CREAM, ICE CREAM NOVELTIES, AND FROZEN CONFECTIONS (U.S. CL. 46). PAUL F. GAST, EXAMINING ATTORNEY

SN 78-242,606. FIGUEROA, RAFAEL, NORTH BERGEN, NJ. FILED 4-28-2003.



San Jorge
ESTATE COFFEE

NO CLAIM IS MADE TO THE EXCLUSIVE RIGHT TO USE ESTATE COFFEE, APART FROM THE MARK AS SHOWN.

FOR GREEN COFFEE BEANS (U.S. CL. 46). FIRST USE 4-15-2003; IN COMMERCE 4-15-2003. YSA DEJESUS, EXAMINING ATTORNEY

CLASS 30—(Continued).

SN 78-252,339. VITAPATH FOODS INC., BEVERLY HILLS, CA. FILED 5-20-2003.

IMPACT

THE MARK CONSISTS OF STANDARD CHARACTERS WITHOUT CLAIM TO ANY PARTICULAR FONT, STYLE, SIZE, OR COLOR.

FOR CEREAL-BASED SNACK FOOD, READY TO EAT CEREAL DERIVED FOOD BARS, GRAIN-BASED FOOD BARS, BAKERY GOODS, COOKIES AND PUDDINGS (U.S. CL. 46).

ODESSA BIBBINS, EXAMINING ATTORNEY

CLASS 30—(Continued).

SN 78-257,956. HANGZHOU YUHANG ADMINISTRATIVE ASSOCIATION OF JINGSHAN BRAND TEA, ZHEJIANG PROVINCE, CHINA, FILED 6-4-2003.

徑山茶

NO CLAIM IS MADE TO THE EXCLUSIVE RIGHT TO USE CHA, APART FROM THE MARK AS SHOWN.

THE NON-LATIN CHARACTER(S) IN THE MARK transliterates into JING SHAN CHA, AND THIS MEANS PATH MOUNTAIN TEA LEAVES IN ENGLISH.

FOR TEA, NAMELY CHINESE MATRIMONY VINE TEA; GREEN TEA; BARLEY TEA; SWEET FLAG TEA; OGAPI TEA; OOLONG TEA (CHINESE TEA); WONGI TEA; GINSENG TEA; TEA LEAVES; BLACK TEA (U.S. CL. 46).

FIRST USE 2-18-1978; IN COMMERCE 4-7-1999.
GINNY ISAACSON, EXAMINING ATTORNEY

SN 78-256,776. DANONE ASIA PTE. LTD., SINGAPORE, SINGAPORE, FILED 6-2-2003.

SN 78-262,368. OVAHN CORPORATION, INC., BOUNTIFUL, UT. FILED 6-13-2003.

SEÑOR SANTOS



THE FOREIGN WORDING IN THE MARK TRANSLATES INTO ENGLISH AS MR. SAINTS.

FOR ENCHILADA SAUCE AND SALSA (U.S. CL. 46).
DOUGLAS LEE, EXAMINING ATTORNEY

SN 78-280,217. AHOLD RETAIL SERVICES AG, KLOSTERS, SWITZERLAND, FILED 7-29-2003.

CRISPERS

OWNER OF U.S. REG. NOS. 2,178,809 AND 2,715,913.
NO CLAIM IS MADE TO THE EXCLUSIVE RIGHT TO USE "SOY SAUCE", APART FROM THE MARK AS SHOWN.
THE CHINESE CHARACTERS IN THE MARK TRANSLITERATE TO "TOH TAI" WHICH MEANS "TO SIFT, BIG" IN CHINESE.

FOR SAUCES, NAMELY, SOY SAUCE. (U.S. CL. 46).
PAM WILLIS, EXAMINING ATTORNEY

FOR BREAKFAST CEREAL (U.S. CL. 46).
FIRST USE 9-15-2003; IN COMMERCE 9-15-2003.
GENE MACIOL, EXAMINING ATTORNEY

CLASS 30—(Continued).

SN 78-288,587. INTELLIGENT NUTRIENTS, INC., MINNEAPOLIS, MN. FILED 8-18-2003.



NO CLAIM IS MADE TO THE EXCLUSIVE RIGHT TO USE "IN FUSED CHOCOLATE", APART FROM THE MARK AS SHOWN.

THE STIPPLING IN THE DRAWING IS FOR SHADING PURPOSES ONLY AND NOT A FEATURE OF THE MARK. FOR CANDY, NAMELY CHOCOLATES (U.S. CL. 46). SUSAN LESLIE DUBOIS, EXAMINING ATTORNEY

SN 78-298,565. CARGILL, INCORPORATED, WAYZATA, MN. FILED 9-10-2003.

HEART HEALTHY

FOR MIXES FOR MAKING BAKERY GOODS FOR USE BY COMMERCIAL BAKERS AND MANUFACTURERS FOR FURTHER PROCESSING (U.S. CL. 46). FIRST USE 7-31-2003; IN COMMERCE 7-31-2003. AISHA CLARKE, EXAMINING ATTORNEY

SN 78-298,590. CARGILL, INCORPORATED, WAYZATA, MN. FILED 9-10-2003.



NO CLAIM IS MADE TO THE EXCLUSIVE RIGHT TO USE "BREAD PREMIX", APART FROM THE MARK AS SHOWN.

FOR MIXES FOR MAKING BAKERY GOODS FOR USE BY COMMERCIAL BAKERS AND MANUFACTURERS FOR FURTHER PROCESSING (U.S. CL. 46). FIRST USE 7-31-2003; IN COMMERCE 7-31-2003. AISHA CLARKE, EXAMINING ATTORNEY

SN 78-303,971. DONG WHA PHARM. IND. CO., LTD., SEOUL, REPUBLIC OF KOREA, FILED 9-23-2003.

GAS WHAL MYUNG SU-Q

FOR HERBAL FOOD BEVERAGE (U.S. CL. 46). FIRST USE 3-8-1993; IN COMMERCE 3-8-1993. PAUL F. GAST, EXAMINING ATTORNEY

CLASS 30—(Continued).

SN 78-303,972. DONG WHA PHARM. IND. CO., LTD., SEOUL, REPUBLIC OF KOREA, FILED 9-23-2003.

WHAL MYUNG SU

FOR HERBAL FOOD BEVERAGE (U.S. CL. 46). FIRST USE 11-1-1981; IN COMMERCE 11-1-1981. PAUL F. GAST, EXAMINING ATTORNEY

SN 78-316,601. DISNEY ENTERPRISES, INC., BURBANK, CA. FILED 10-21-2003.

WALT DISNEY WORLD

OWNER OF U.S. REG. NOS. 980,995, 1,189,727 AND 2,189,177.

THE NAME IN THE MARK DOES NOT IDENTIFY A PARTICULAR LIVING INDIVIDUAL.

FOR CONFECTIONERY, NAMELY CANDY AND FROZEN CONFECTIONS; CHEWING GUM; BREAKFAST CEREALS; PREPARATIONS MADE FROM CEREALS, NAMELY, CEREAL-BASED SNACK FOOD AND CEREAL-DERIVED FOOD BARS; CEREAL BARS; BREAD; MUFFINS; MUFFIN BARS; PASTRY; WAFFLES; PANCAKES; COOKIES; CRACKERS; BISCUITS; CANDY-COATED POPCORN; POPPED POPCORN; PROCESSED POPCORN; CORN CHIPS; PRETZELS; PUDDINGS (U.S. CL. 46).

PAUL F. GAST, EXAMINING ATTORNEY

SN 78-329,056. HEB GROCERY COMPANY, L.P., SAN ANTONIO, TX. FILED 11-17-2003.

H-E-B BAKE SHOP

THE MARK CONSISTS OF STANDARD CHARACTERS WITHOUT CLAIM TO ANY PARTICULAR FONT, STYLE, SIZE, OR COLOR.

OWNER OF U.S. REG. NO. 1,530,250 AND OTHERS. NO CLAIM IS MADE TO THE EXCLUSIVE RIGHT TO USE BAKE SHOP, APART FROM THE MARK AS SHOWN. FOR BAKERY GOODS, CAKES, PASTRIES, AND MUFFINS FOR CONSUMPTION ON OR OFF PREMISES (U.S. CL. 46).

STEVEN R. FINE, EXAMINING ATTORNEY

CLASS 30—(Continued).

SN 78-335,306. MARS, INCORPORATED, MCLEAN, VA.
FILED 12-2-2003.

RICE IT UP

THE MARK CONSISTS OF STANDARD CHARACTERS
WITHOUT CLAIM TO ANY PARTICULAR FONT, STYLE,
SIZE, OR COLOR.

FOR RICE, RICE MIXES, ENTREES CONSISTING OF
RICE (U.S. CL. 46).

DAVID TAYLOR, EXAMINING ATTORNEY

CLASS 30—(Continued).

SN 78-339,547. DIASPORA FOODS, INC., NORTH MIAMI,
FL. FILED 12-11-2003.

DIASPORA FOODS

THE MARK CONSISTS OF STANDARD CHARACTERS
WITHOUT CLAIM TO ANY PARTICULAR FONT, STYLE,
SIZE, OR COLOR.

NO CLAIM IS MADE TO THE EXCLUSIVE RIGHT TO
USE "FOODS", APART FROM THE MARK AS SHOWN.

FOR GOURMET FOOD PRODUCTS, NAMELY,
SAUCES, SPICES, AND PINEAPPLE AND TOMATO
CHUTNEY (U.S. CL. 46).

FIRST USE 6-0-1999; IN COMMERCE 8-0-1999.
ZACHARY BELLO, EXAMINING ATTORNEY

SN 78-348,892. RAMIREZ, LISA R., MESQUITE, TX. FILED 1-
7-2004.

HealthyWay Gourmet

SN 78-335,406. LUC DINH KY CORPORATION, SANTA
ANA, CA. FILED 12-2-2003.



THE NON-LATIN CHARACTERS IN THE MARK TRANS-
LITERATE TO LUC DINH KY AND THIS MEANS A SIGN
OF THRIVING AND FLOURISHING PROSPERITY IN
ENGLISH.

FOR TEA, HERB TEA OR HERBAL TEA, TEA-BASED
BEVERAGES WITH FRUIT FLAVORING, RICE, RICE
CAKES, MEALS OR ENTREES CONSISTING PRIMAR-
ILY OF PASTA OR RICE, EITHER PREPARED OR
PACKAGED, SOY SAUCE, AND SOY-BASED ICE
CREAM SUBSTITUTE (U.S. CL. 46).

FIRST USE 9-1-2003; IN COMMERCE 9-2-2003.
ALLISON HOLTZ, EXAMINING ATTORNEY

THE MARK CONSISTS OF STANDARD CHARACTERS
WITHOUT CLAIM TO ANY PARTICULAR FONT, STYLE,
SIZE, OR COLOR.

NO CLAIM IS MADE TO THE EXCLUSIVE RIGHT TO
USE "GOURMET", APART FROM THE MARK AS SHOWN.

FOR GOURMET FOODS, NAMELY, BAKERY GOODS,
SAUCES, CHOCOLATE, COFFEE AND COCOA (U.S. CL.
46).

GIANCARLO CASTRO, EXAMINING ATTORNEY

SN 78-355,676. GENERAL MILLS IP HOLDINGS II, LLC,
MINNEAPOLIS, MN. FILED 1-22-2004.

**WAKE UP TO A
GOLDEN MORNING**

THE MARK CONSISTS OF STANDARD CHARACTERS
WITHOUT CLAIM TO ANY PARTICULAR FONT, STYLE,
SIZE, OR COLOR.

FOR PROCESSED CEREAL-DERIVED FOOD PRO-
DUCTS TO BE USED AS A BREAKFAST CEREAL,
SNACK FOOD, OR INGREDIENT FOR MAKING FOOD
(U.S. CL. 46).

FIRST USE 9-30-2003; IN COMMERCE 9-30-2003.
LINDA MICKLEBURGH, EXAMINING ATTORNEY

CLASS 30—(Continued).

SN 78-357,842. TSINGTAO FOOD, INC., SAN GABRIEL, CA. FILED 1-26-2004.

TSINGTAO
青島

THE MARK CONSISTS OF TSINGTAO IN ENGLISH AND CHINESE CHARACTERS.

THE NON-LATIN CHARACTER(S) IN THE MARK TRANSLITERATES INTO "TSINGTAO", AND THIS MEANS "GREEN ISLAND" IN ENGLISH.

FOR TEA (U.S. CL. 46).

JENNIFER MARTIN, EXAMINING ATTORNEY

CLASS 30—(Continued).

SN 78-381,002. HOP KEE INC., DBA ORIENTAL DELICACIES INC., CHICAGO, IL. FILED 3-9-2004.

ORIENTAL
DELICACIES

THE MARK CONSISTS OF STANDARD CHARACTERS WITHOUT CLAIM TO ANY PARTICULAR FONT, STYLE, SIZE, OR COLOR.

NO CLAIM IS MADE TO THE EXCLUSIVE RIGHT TO USE "DELICACIES", APART FROM THE MARK AS SHOWN.

SEC. 2(F).

FOR ORIENTAL SAUCES, INCLUDING SWEET AND SOUR SAUCE, SOY SAUCE AND HOT MUSTARD; ORIENTAL ALMOND COOKIES (U.S. CL. 46).

FIRST USE 8-1-1970; IN COMMERCE 8-1-1970.

ANDREW BENZMILLER, EXAMINING ATTORNEY

SN 78-386,481. BLUE MOON LICENSING, LLC, NEW LEXINGTON, OH. FILED 3-18-2004.

CARB CONCEPTS

THE MARK CONSISTS OF STANDARD CHARACTERS WITHOUT CLAIM TO ANY PARTICULAR FONT, STYLE, SIZE, OR COLOR.

NO CLAIM IS MADE TO THE EXCLUSIVE RIGHT TO USE "CARB", APART FROM THE MARK AS SHOWN.

FOR PREPARED FOODS, NAMELY, PIZZAS (U.S. CL. 46).

PAUL F. GAST, EXAMINING ATTORNEY

SN 78-373,570. SONAFI, VIROFLAY, FRANCE, FILED 2-25-2004.

NOIR GASTRONOMIE

THE MARK CONSISTS OF STANDARD CHARACTERS WITHOUT CLAIM TO ANY PARTICULAR FONT, STYLE, SIZE, OR COLOR.

THE ENGLISH TRANSLATION OF NOIR GASTRONOMIE IS "BLACK GASTRONOMY".

FOR CHOCOLATE PRODUCTS, NAMELY DARK CHOCOLATE (U.S. CL. 46).

FIRST USE 12-31-2002; IN COMMERCE 12-31-2002.

MARGERY A. TIERNEY, EXAMINING ATTORNEY

SN 78-388,460. MALT-O-MEAL COMPANY, MINNEAPOLIS, MN. FILED 3-22-2004.

THE TASTE THAT'S
TOPS

THE MARK CONSISTS OF STANDARD CHARACTERS WITHOUT CLAIM TO ANY PARTICULAR FONT, STYLE, SIZE, OR COLOR.

FOR BREAKFAST CEREAL (U.S. CL. 46).

ZHALEH DELANEY, EXAMINING ATTORNEY

CLASS 30—(Continued).

SN 78-389,358. ROBIN HOOD MULTIFOODS CORPORATION, MARKHAM, ONTARIO, CANADA, FILED 3-23-2004.

WHEAT WISE

THE MARK CONSISTS OF STANDARD CHARACTERS WITHOUT CLAIM TO ANY PARTICULAR FONT, STYLE, SIZE, OR COLOR.

NO CLAIM IS MADE TO THE EXCLUSIVE RIGHT TO USE "WHEAT", APART FROM THE MARK AS SHOWN. FOR BAKING MIXES (U.S. CL. 46).
STANLEY I. OSBORNE, EXAMINING ATTORNEY

SN 78-391,586. HOP KEE INC., DBA ORIENTAL DELICACIES INC., CHICAGO, IL. FILED 3-26-2004.



NO CLAIM IS MADE TO THE EXCLUSIVE RIGHT TO USE DONG FONG, APART FROM THE MARK AS SHOWN. THE NON-LATIN CHARACTER(S) IN THE MARK TRANSLITERATES INTO DONG FONG, AND THIS MEANS ORIENTAL IN ENGLISH.

FOR ORIENTAL SAUCES, INCLUDING SWEET AND SOUR SAUCE AND HOT MUSTARD (U.S. CL. 46).
FIRST USE 8-1-1970; IN COMMERCE 8-1-1970.
ANDREW BENZMILLER, EXAMINING ATTORNEY

CLASS 30—(Continued).

SN 78-395,167. BULLY BLENDS COFFEE & TEA, INC., RAPID CITY, SD. FILED 4-1-2004.



NO CLAIM IS MADE TO THE EXCLUSIVE RIGHT TO USE "BLENDS" AND "COFFEE & TEA SHOP", APART FROM THE MARK AS SHOWN.

THE LINING IS A FEATURE OF THE MARK AND DOES NOT INDICATE COLOR.

THE MARK CONSISTS OF THE WORDS "BULLY BLENDS" IN STYLIZED FORM SHOWN ABOVE A COFFEE CUP DESIGN. THE WORDS "COFFEE & TEA SHOP" ARE IN STYLIZED FORM SHOWN BELOW THE COFFEE CUP DESIGN. A PORTRAIT OF TEDDY ROOSEVELT IS SHOWN ON THE COFFEE CUP DESIGN. A DESIGN CONSISTING OF A CURVED WISP OF STEAM IS SHOWN RISING OUT OF THE COFFEE CUP. COLOR IS NOT CLAIMED AS A FEATURE OF THE MARK.

FOR STAPLE FOODS, NAMELY COFFEE, COFFEE BEANS, TEA, LOOSE LEAF TEA, BAGGED TEA; COCOA; BREAD; PASTRIES; CONFECTIONERY, NAMELY PEPPERMINT CANDY; SAUCES; CHOCOLATE FOOD BEVERAGES NOT BEING DAIRY-BASED OR VEGETABLE BASED (U.S. CL. 46).

CIMMERIAN COLEMAN, EXAMINING ATTORNEY

SN 78-407,741. BRINKHOFF & MONOSON, INC., GOLDEN CITY, MO. FILED 4-26-2004.

RED MONKEY

THE MARK CONSISTS OF STANDARD CHARACTERS WITHOUT CLAIM TO ANY PARTICULAR FONT, STYLE, SIZE, OR COLOR.

FOR SEASONINGS; SPICES; CONDIMENTS, NAMELY, KETCHUP, MUSTARD, RELISH, FLAVORED OILS, FLAVORED MARINADES, FLAVORED SAUCES; AND FOOD ADDITIVES FOR NON-NUTRITIONAL PURPOSES FOR USE AS A FLAVORING, INGREDIENT OR FILLER (U.S. CL. 46).

ALICE BENMAMAN, EXAMINING ATTORNEY

CLASS 30—(Continued).

SN 78-417,116. COMBS, MARK E., ANDERSON, IN. FILED 5-12-2004.



NO CLAIM IS MADE TO THE EXCLUSIVE RIGHT TO USE "HOT SAUCE CO.", APART FROM THE MARK AS SHOWN.

THE COLOR(S) CORAL AND GOLD IS/ARE CLAIMED AS A FEATURE OF THE MARK.

THE MARK CONSISTS OF THE WORDS "VENOM HOT SAUCE CO." COLORED IN A BLACK AND WHITE "SOUTHWESTERN" FONT SUPPLANTED OVER A COILED COBRA SNAKE COLORED GOLD AND CORAL.

THE MARK CONSISTS OF THE WORDS "VENOM HOT SAUCE CO." IN "SOUTHWESTERN" FONT SUPPLANTED OVER A COILED COBRA SNAKE.

FOR FOOD PRODUCTS, NAMELY HOT SAUCE, SALSA, MARINADES AND BARBECUE SAUCE (U.S. CL. 46).

FIRST USE 3-1-2004; IN COMMERCE 3-1-2004.

PAULA MAYS, EXAMINING ATTORNEY

CLASS 30—(Continued).

SN 78-425,555. NATURAL SUPPLEMENT ASSOCIATION, INCORPORATED, DBA EXPERIMENTAL AND APPLIED SCIENCES, INC., GOLDEN, CO. FILED 5-26-2004.



OWNER OF U.S. REG. NOS. 2,443,296, 2,853,852 AND OTHERS.

NO CLAIM IS MADE TO THE EXCLUSIVE RIGHT TO USE SUGAR FREE, APART FROM THE MARK AS SHOWN.

THE MARK CONSISTS OF A CIRCLE BEHIND THE WORDS ADVANT EDGE AND A RIBBON CONTAINING THE STYLIZED WORD PERFECTION.

FOR SUGAR FREE CANDY BARS (U.S. CL. 46).

FIRST USE 8-27-2003; IN COMMERCE 8-27-2003.

BRETT J. GOLDEN, EXAMINING ATTORNEY

SN 78-424,615. THE HAIN CELESTIAL GROUP, INC., MELVILLE, NY. FILED 5-25-2004.

**ORGANIC ON-THE-GO
O'S CEREAL**

THE MARK CONSISTS OF STANDARD CHARACTERS WITHOUT CLAIM TO ANY PARTICULAR FONT, STYLE, SIZE, OR COLOR.

NO CLAIM IS MADE TO THE EXCLUSIVE RIGHT TO USE "ORGANIC AND CEREAL", APART FROM THE MARK AS SHOWN.

FOR BREAKFAST CEREALS (U.S. CL. 46).

FIRST USE 9-8-2004; IN COMMERCE 9-8-2004.

ELIZABETH J. WINTER, EXAMINING ATTORNEY

SN 78-430,093. KRAFT FOODS HOLDINGS, INC., NORTHFIELD, IL. FILED 6-4-2004.

MILK'S OTHER HALF

THE MARK CONSISTS OF STANDARD CHARACTERS WITHOUT CLAIM TO ANY PARTICULAR FONT, STYLE, SIZE, OR COLOR.

FOR COOKIES (U.S. CL. 46).

MONIQUE MILLER, EXAMINING ATTORNEY

CLASS 30—(Continued).

SN 78-434,202. NOKA COMPANY, PLANO, TX. FILED 6-11-2004.

NOKA

THE MARK CONSISTS OF STANDARD CHARACTERS WITHOUT CLAIM TO ANY PARTICULAR FONT, STYLE, SIZE, OR COLOR.

FOR CHOCOLATE, CHOCOLATES, CHOCOLATE TRUFFLES, VARIETAL CHOCOLATE, CHOCOLATE COVERED NUTS, CANDY, FROZEN CONFECTIONS (U.S. CL. 46).

FIRST USE 8-10-2004; IN COMMERCE 8-10-2004.
TARAH HARDY, EXAMINING ATTORNEY

SN 78-434,759. ABRAMS, MICHAEL S., MAKAWAO, HI. FILED 6-14-2004.

Teanita

THE MARK CONSISTS OF STANDARD CHARACTERS WITHOUT CLAIM TO ANY PARTICULAR FONT, STYLE, SIZE, OR COLOR.

FOR TEA-BASED BEVERAGE (U.S. CL. 46).
EVELYN BRADLEY, EXAMINING ATTORNEY

CLASS 30—(Continued).

SN 78-434,775. ABRAMS, MICHAEL S., MAKAWAO, HI. FILED 6-14-2004.

teanita

FOR NON-ALCOHOLIC TEA-BASED BEVERAGE (U.S. CL. 46).

JOHN DWYER, EXAMINING ATTORNEY

SN 78-436,407. TUMARO'S INC., LOS ANGELES, CA. FILED 6-16-2004.

WRAPP-AROUNDS

THE MARK CONSISTS OF STANDARD CHARACTERS WITHOUT CLAIM TO ANY PARTICULAR FONT, STYLE, SIZE, OR COLOR.

OWNER OF U.S. REG. NO. 2,267,475.
FOR TORTILLAS AND CREPES (U.S. CL. 46).
FIRST USE 6-10-2004; IN COMMERCE 6-20-2004.
KAREN BRACEY, EXAMINING ATTORNEY

SN 78-437,134. FRECHTMAN, JILL, PLAINVIEW, NY. FILED 6-17-2004.

fretzels

FOR CONFECTIONARY FOOD PRODUCT, NAMELY CHOCOLATE-COVERED PRETZELS WITH A VARIETY OF TOPPINGS AND/OR FLAVORS (U.S. CL. 46).

FIRST USE 6-0-2003; IN COMMERCE 12-0-2003.
DAWN FELDMAN, EXAMINING ATTORNEY

CLASS 30—(Continued).

SN 78-438,234. VOSGES, LTD., CHICAGO, IL. FILED 6-20-2004.

BLACK PEARL

THE MARK CONSISTS OF STANDARD CHARACTERS WITHOUT CLAIM TO ANY PARTICULAR FONT, STYLE, SIZE, OR COLOR.

FOR SPECIALTY CONFECTIONERY PRODUCTS, NAMELY SPECIALTY CHOCOLATES, TRUFFLES AND CAKES (U.S. CL. 46).

FIRST USE 12-1-1997; IN COMMERCE 12-1-1997.
ALLISON HOLTZ, EXAMINING ATTORNEY

CLASS 30—(Continued).

SN 78-438,824. KRAFT FOODS HOLDINGS, INC., NORTH-FIELD, IL. FILED 6-21-2004.

**MILK'S FAVORITE
COOKIE**

THE MARK CONSISTS OF STANDARD CHARACTERS WITHOUT CLAIM TO ANY PARTICULAR FONT, STYLE, SIZE, OR COLOR.

OWNER OF U.S. REG. NOS. 2,149,887 AND 2,572,410.

NO CLAIM IS MADE TO THE EXCLUSIVE RIGHT TO USE "COOKIE", APART FROM THE MARK AS SHOWN.
FOR COOKIES (U.S. CL. 46).

JENNIFER CHICOSKI, EXAMINING ATTORNEY

SN 78-438,862. AMES INTERNATIONAL, INC., FIFE, WA. FILED 6-21-2004.

TEAOSOPHY

THE MARK CONSISTS OF STANDARD CHARACTERS WITHOUT CLAIM TO ANY PARTICULAR FONT, STYLE, SIZE, OR COLOR.

FOR TEA, WHOLE LEAF TEA, WHOLE LEAF BLACK TEA, WHOLE LEAF GREEN TEA, TEA LEAVES SOLD IN TEA PODS (U.S. CL. 46).

FIRST USE 4-8-2004; IN COMMERCE 4-8-2004.
STEVEN R. FINE, EXAMINING ATTORNEY

SN 78-438,695. GRUPO BIMBO, S.A. DE C.V., MEXICO CITY, MEXICO, FILED 6-21-2004.

**ETHANOL RED**

THE MARK CONSISTS OF STANDARD CHARACTERS WITHOUT CLAIM TO ANY PARTICULAR FONT, STYLE, SIZE, OR COLOR.

NO CLAIM IS MADE TO THE EXCLUSIVE RIGHT TO USE "ETHANOL", APART FROM THE MARK AS SHOWN.
FOR YEAST (U.S. CL. 46).

REBECCA SMITH, EXAMINING ATTORNEY

FOR BAKERY PRODUCTS, NAMELY, PASTRIES, COOKIES AND SNACK CAKES (U.S. CL. 46).

FIRST USE 8-31-2003; IN COMMERCE 8-31-2003.
DAWN FELDMAN, EXAMINING ATTORNEY

CLASS 30—(Continued).

SN 78-439,323. SUPERVALU INC., EDEN PRAIRIE, MN. FILED 6-22-2004.

CARLITA

THE MARK CONSISTS OF STANDARD CHARACTERS WITHOUT CLAIM TO ANY PARTICULAR FONT, STYLE, SIZE, OR COLOR.

FOR GROUND COFFEE; COFFEE BEANS (U.S. CL. 46).
KEVON CHISOLM, EXAMINING ATTORNEY

SN 78-441,955. NOKA COMPANY, PLANO, TX. FILED 6-27-2004.

N Ō K A

CHOCOLATE

NO CLAIM IS MADE TO THE EXCLUSIVE RIGHT TO USE "CHOCOLATE", APART FROM THE MARK AS SHOWN.

THE MARK CONSISTS OF STYLIZED WORD "NOKA" (WITH A MACRON OR LINE ABOVE THE STYLIZED LETTER "O") UNDERSCORED BY THE STYLIZED WORD "CHOCOLATE".

FOR CHOCOLATE, CHOCOLATES, CHOCOLATE TRUFFLES, VARIETAL CHOCOLATE, CHOCOLATE COVERED NUTS, CANDY, FROZEN CONFECTIONS (U.S. CL. 46).

FIRST USE 8-10-2004; IN COMMERCE 8-10-2004.
TARAH HARDY, EXAMINING ATTORNEY

CLASS 30—(Continued).

SN 78-468,637. THE HAIN CELESTIAL GROUP, INC., MELVILLE, NY. FILED 8-17-2004.

**ORGANIC CRUNCHIN'
BLOCKS**

THE MARK CONSISTS OF STANDARD CHARACTERS WITHOUT CLAIM TO ANY PARTICULAR FONT, STYLE, SIZE, OR COLOR.

NO CLAIM IS MADE TO THE EXCLUSIVE RIGHT TO USE "ORGANIC", APART FROM THE MARK AS SHOWN. FOR COOKIES AND CRACKERS (U.S. CL. 46).
FIRST USE 11-1-2003; IN COMMERCE 11-1-2003.
SUELLEN HICKEY, EXAMINING ATTORNEY

SN 78-474,325. MONSANTO TECHNOLOGY LLC, SAINT LOUIS, MO. FILED 8-26-2004.

VISTIVE

THE MARK CONSISTS OF STANDARD CHARACTERS WITHOUT CLAIM TO ANY PARTICULAR FONT, STYLE, SIZE, OR COLOR.

FOR PROCESSED GRAINS (U.S. CL. 46).
JUDITH HELFMAN, EXAMINING ATTORNEY

CLASS 31—NATURAL AGRICULTURAL PRODUCTS

SN 76-498,969. ELMORE, SUSAN S., KNOXVILLE, TN. FILED 3-20-2003.

Holly Haven Hybrids

NO CLAIM IS MADE TO THE EXCLUSIVE RIGHT TO USE "HYBRIDS", APART FROM THE MARK AS SHOWN. FOR LIVE PLANTS, NAMELY HOLLY CULTIVARS SOLD AS CONTAINER PLANTS (U.S. CLS. 1 AND 46).

FIRST USE 0-0-1990; IN COMMERCE 0-0-1990.
PAM WILLIS, EXAMINING ATTORNEY

CLASS 31—(Continued).

SN 76-500,946. S.D.J. TRADING, INC., BROOKLYN, NY.
FILED 3-26-2003.



THE NON-LATIN CHARACTERS IN THE MARK (BETWEEN THE WORDS FORTUNE AND HARVEST) TRANSLITERATE TO SHIL, QUAN, FU, GUI AND THIS MEANS "ONE HUNDRED PERCENT WEALTH" IN ENGLISH. THE THREE NON LATIN CHARACTERS AT THE BOTTOM OF THE MARK TRANSLITERATE TO FU, GUI AND HUA AND THIS MEANS "WEALTH FLOWER" IN ENGLISH.

FOR FRESH VEGETABLES, NAMELY BROCCOLI, NAPPA CABBAGE, CHINESE BOK CHOY SCALLION, SNOW PEAS AND CABBAGE (U.S. CLS. 1 AND 46).

FIRST USE 6-18-2002; IN COMMERCE 6-18-2002.
SUE LAWRENCE, EXAMINING ATTORNEY

CLASS 31—(Continued).

SN 76-599,940. PET VALU CANADA INC., MARKHAM, ONTARIO, L3R 3L3, CANADA, FILED 6-30-2004.



SN 76-596,712. CIPOLLONE, BONNIE L., MIAMITOWN, OH.
FILED 6-9-2004.

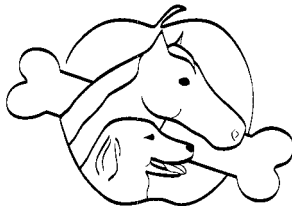

FOR NATURAL EDIBLE PET TREATS (U.S. CLS. 1 AND 46).

FIRST USE 10-28-2003; IN COMMERCE 3-18-2004.
STANLEY I. OSBORNE, EXAMINING ATTORNEY

OWNER OF U.S. REG. NOS. 1,572,264 AND 2,144,850.
NO CLAIM IS MADE TO THE EXCLUSIVE RIGHT TO USE "ULTRA", APART FROM THE MARK AS SHOWN.
FOR PET FOOD (U.S. CLS. 1 AND 46).
TRACY WHITAKER-BOWN, EXAMINING ATTORNEY

SN 76-597,106. CAL/WEST SEEDS, WOODLAND, CA. FILED
6-10-2004.

CAL/WEST

THE MARK CONSISTS OF STANDARD CHARACTERS WITHOUT CLAIM TO ANY PARTICULAR FONT, STYLE, SIZE, OR COLOR.

FOR AGRICULTURAL SEEDS (U.S. CLS. 1 AND 46).
FIRST USE 9-29-1969; IN COMMERCE 11-24-1970.
TRICIA THOMPSON, EXAMINING ATTORNEY

SN 78-190,720. TECHMIX, INC., STEWART, MN. FILED 12-3-2002.

NUTRISOURCE

OWNER OF U.S. REG. NO. 1,905,825.
FOR PET AND FARM ANIMAL FOOD AND SUPPLEMENTS (U.S. CLS. 1 AND 46).
FIRST USE 12-16-1993; IN COMMERCE 12-16-1993.
SHARI SHEFFIELD, EXAMINING ATTORNEY

CLASS 31—(Continued).

SN 78-265,344. LIDL STIFTUNG & CO. KG, NECKARSULM, FED REP GERMANY, FILED 6-20-2003.

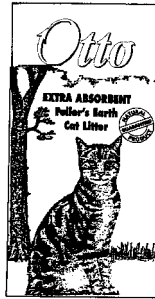

OWNER OF IRELAND REG. NO. 213022, DATED 8-21-2000, EXPIRES 2-8-2009.

NO CLAIM IS MADE TO THE EXCLUSIVE RIGHT TO USE "EXTRA ABSORBENT FULLER'S EARTH CAT LITTER NATURAL GUARANTEED PRODUCT", APART FROM THE MARK AS SHOWN.

THE MARK CONSISTS OF THE WORD OTTO AND A CAT SITTING ON A LAWN UNDER A TREE WITH THE ADDITIONAL WORDS 'EXTRA ABSORBENT FULLER'S EARTH CAT LITTER AND A SEAL CONTAINING THE WORDS NATURAL GUARANTEED PRODUCT.

FOR PET LITTER, CAT LITTER, DOG LITTER. (U.S. CLS. 1 AND 46).

H. M. FISHER, EXAMINING ATTORNEY

CLASS 31—(Continued).

SN 78-342,588. TIERRA VERDE INDUSTRIES, IRVINE, CA. FILED 12-18-2003.

**BODYGUARD PLAY
CHIPS**

THE MARK CONSISTS OF STANDARD CHARACTERS WITHOUT CLAIM TO ANY PARTICULAR FONT, STYLE, SIZE, OR COLOR.

NO CLAIM IS MADE TO THE EXCLUSIVE RIGHT TO USE "PLAY CHIPS", APART FROM THE MARK AS SHOWN.

FOR WOOD CHIPS FOR USE AS A GROUND COVER NEAR OR UNDER PLAYGROUND EQUIPMENT OR AS ANIMAL BEDDING OR HORSE PATH FILL (U.S. CLS. 1 AND 46).

DAVID MURRAY, EXAMINING ATTORNEY

SN 78-349,253. ROSEN'S DIVERSIFIED, INC., FAIRMONT, MN. FILED 1-8-2004.

SN 78-283,979. K. MILLER DESIGNS, LLC, HILLTOWN, PA. FILED 8-6-2003.



FOR EDIBLE DOG CHEWS (U.S. CLS. 1 AND 46).
GENE MACIOL, EXAMINING ATTORNEY



NO CLAIM IS MADE TO THE EXCLUSIVE RIGHT TO USE "PET PRODUCTS", APART FROM THE MARK AS SHOWN.

THE MARK CONSISTS OF STYLIZED LETTER P WITH PAW PRINT.

FOR PET TREATS (U.S. CLS. 1 AND 46).
SUSAN HAYASH, EXAMINING ATTORNEY

CLASS 31—(Continued).

SN 78-403,732. TROPICAL BAMBOO, INC., LOXAHATCHEE, FL. FILED 4-18-2004.



NO CLAIM IS MADE TO THE EXCLUSIVE RIGHT TO USE "TROPICAL BAMBOO", APART FROM THE MARK AS SHOWN.

FOR LIVING BAMBOO PLANTS (U.S. CLS. 1 AND 46).
FIRST USE 2-1-2002; IN COMMERCE 5-1-2002.
MICHAEL WEBSTER, EXAMINING ATTORNEY

CLASS 31—(Continued).

SN 78-419,446. STANEK, FRANK J., SR., MANSFIELD, OH. FILED 5-15-2004.

"HEALTHY FOOD
WITHOUT A HEALTHY
PRICE"

THE MARK CONSISTS OF STANDARD CHARACTERS WITHOUT CLAIM TO ANY PARTICULAR FONT, STYLE, SIZE, OR COLOR.

FOR AGRICULTURAL PRODUCE, NAMELY, FRESH ORGANIC FRUITS, VEGETABLES, AND HERBS (U.S. CLS. 1 AND 46).

FIRST USE 5-6-2004; IN COMMERCE 5-6-2004.

MELVIN AXILBUND, EXAMINING ATTORNEY

SN 78-416,337. MOGADAM, MASOUD MIKE, SUNNYVALE, CA. FILED 5-11-2004.

maqito

THE MARK CONSISTS OF STANDARD CHARACTERS WITHOUT CLAIM TO ANY PARTICULAR FONT, STYLE, SIZE, OR COLOR.

FOR NATURAL AGRICULTURAL PRODUCTS, NAMELY, FRESH FRUITS AND VEGETABLES (U.S. CLS. 1 AND 46).

CIMMERIAN COLEMAN, EXAMINING ATTORNEY

SN 78-423,770. SLEEPY PAW, LLC, ANCHORAGE, AK. FILED 5-24-2004.



NO CLAIM IS MADE TO THE EXCLUSIVE RIGHT TO USE "COOKIES", APART FROM THE MARK AS SHOWN.

FOR EDIBLE PET TREATS AND FOOD IN AN ASSORTMENT OF ROUND SHAPES (U.S. CLS. 1 AND 46).

FIRST USE 5-5-2004; IN COMMERCE 5-5-2004.

WINSTON FOLMAR, EXAMINING ATTORNEY

CLASS 31—(Continued).

SN 78-423,812. THE IAMS COMPANY, DAYTON, OH. FILED 5-24-2004.

CLASS 31—(Continued).

SN 78-426,037. CALIFORNIA OILS CORPORATION, RICHMOND, CA. FILED 5-27-2004.

IAMS SAVORY SAUCE

THE MARK CONSISTS OF STANDARD CHARACTERS WITHOUT CLAIM TO ANY PARTICULAR FONT, STYLE, SIZE, OR COLOR.
OWNER OF U.S. REG. NOS. 1,317,225, 1,980,228 AND OTHERS.
NO CLAIM IS MADE TO THE EXCLUSIVE RIGHT TO USE "SAVORY SAUCE", APART FROM THE MARK AS SHOWN.
FOR FOODSTUFFS FOR ANIMALS (U.S. CLS. 1 AND 46).
BRETT J. GOLDEN, EXAMINING ATTORNEY



SN 78-424,803. KENT FEEDS, INC., MUSCATINE, IA. FILED 5-25-2004.

SEEDTEC

THE MARK CONSISTS OF STANDARD CHARACTERS WITHOUT CLAIM TO ANY PARTICULAR FONT, STYLE, SIZE, OR COLOR.
FOR PLANTING SEEDS (U.S. CLS. 1 AND 46).
FIRST USE 3-23-1981; IN COMMERCE 3-23-1981.
BRETT J. GOLDEN, EXAMINING ATTORNEY



SN 78-429,682. MONROVIA NURSERY COMPANY, AZUSA, CA. FILED 6-3-2004.

EZ-GAIT

THE MARK CONSISTS OF STANDARD CHARACTERS WITHOUT CLAIM TO ANY PARTICULAR FONT, STYLE, SIZE, OR COLOR.
FOR HORSE FEED (U.S. CLS. 1 AND 46).
BARBARA GAYNOR, EXAMINING ATTORNEY

FALL FAVORITES

THE MARK CONSISTS OF STANDARD CHARACTERS WITHOUT CLAIM TO ANY PARTICULAR FONT, STYLE, SIZE, OR COLOR.
FOR LIVE ORNAMENTAL PLANTS (U.S. CLS. 1 AND 46).
NICHOLAS ALTREE, EXAMINING ATTORNEY

CLASS 31—(Continued).

SN 78-430,392. TURF MERCHANTS, INC., TANGENT, OR.
FILED 6-4-2004.

N.E.O.

THE MARK CONSISTS OF STANDARD CHARACTERS WITHOUT CLAIM TO ANY PARTICULAR FONT, STYLE, SIZE, OR COLOR.
FOR GRASS SEED (U.S. CLS. 1 AND 46).
LINDA ESTRADA, EXAMINING ATTORNEY

CLASS 31—(Continued).

SN 78-431,793. THE IAMS COMPANY, DAYTON, OH. FILED 6-8-2004.

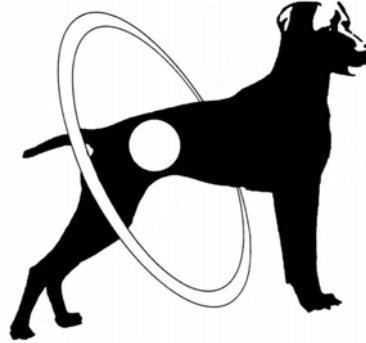

THE MARK CONSISTS OF A PICTURE OF A DOG WITH AN ELLIPSE AROUND THE MIDDLE OF THE DOG WITH A CIRCLE AREA IN THE BODY OF THE DOG WHERE A PORTION OF THE DIGESTIVE TRACT IS LOCATED.
FOR FOODSTUFFS FOR ANIMALS (U.S. CLS. 1 AND 46).
RAMONA ORTIGA, EXAMINING ATTORNEY

SN 78-433,125. SCHELL & KAMPETER, INC., META, MO.
FILED 6-10-2004.

HEALTHY WEIGHT

THE MARK CONSISTS OF STANDARD CHARACTERS WITHOUT CLAIM TO ANY PARTICULAR FONT, STYLE, SIZE, OR COLOR.
NO CLAIM IS MADE TO THE EXCLUSIVE RIGHT TO USE "WEIGHT", APART FROM THE MARK AS SHOWN.
FOR PET FOOD (U.S. CLS. 1 AND 46).
FIRST USE 6-1-2004; IN COMMERCE 6-1-2004.
INGA ERVIN, EXAMINING ATTORNEY

SN 78-430,427. TURF MERCHANTS, INC., TANGENT, OR.
FILED 6-4-2004.



FOR GRASS SEED (U.S. CLS. 1 AND 46).
LINDA ESTRADA, EXAMINING ATTORNEY

SN 78-435,050. SMITH, WYMAN G., NAPA, CA. FILED 6-14-2004.

ONE LANE BRIDGE

THE MARK CONSISTS OF STANDARD CHARACTERS WITHOUT CLAIM TO ANY PARTICULAR FONT, STYLE, SIZE, OR COLOR.
FOR UNPROCESSED GRAPES FOR USE IN MAKING WINE (U.S. CLS. 1 AND 46).
BRIAN PINO, EXAMINING ATTORNEY

CLASS 31—(Continued).

SN 78-437,109. WICKED WILDS, INCORPORATED, DEL MAR, CA. FILED 6-17-2004.

CLASS 31—(Continued).

SN 78-439,489. THE IAMS COMPANY, DAYTON, OH. FILED 6-22-2004.

**UNFORGETTABLE
FLAVOR**

**SPOIL YOUR DOG
HEALTHY**

THE MARK CONSISTS OF STANDARD CHARACTERS WITHOUT CLAIM TO ANY PARTICULAR FONT, STYLE, SIZE, OR COLOR.

NO CLAIM IS MADE TO THE EXCLUSIVE RIGHT TO USE "FLAVOR", APART FROM THE MARK AS SHOWN.

FOR FRESH FRUITS AND FRESH VEGATABLES (U.S. CLS. 1 AND 46).

ALICIA COLLINS, EXAMINING ATTORNEY

THE MARK CONSISTS OF STANDARD CHARACTERS WITHOUT CLAIM TO ANY PARTICULAR FONT, STYLE, SIZE, OR COLOR.

FOR FOODSTUFFS FOR ANIMALS, NAMELY DOG FOOD (U.S. CLS. 1 AND 46).

STEVEN R. FINE, EXAMINING ATTORNEY

SN 78-438,964. CAMELOT NURSERIES, INC., DBA MOUNTAIN STATES WHOLESALE NURSERY, LITCHFIELD PARK, AZ. FILED 6-21-2004.

SN 78-451,346. SOCIETE DES PRODUITS NESTLE S. A., VEVEY, SWITZERLAND, FILED 7-15-2004.

PHOENIX



THE MARK CONSISTS OF STANDARD CHARACTERS WITHOUT CLAIM TO ANY PARTICULAR FONT, STYLE, SIZE, OR COLOR.

SEC. 2(F).
FOR LIVE TREES IN THE NATURE OF PROSOPIS HYBRID GRAFTED TREES USED ON LANDSCAPE PROJECTS IN THE SOUTHWESTERN US (U.S. CLS. 1 AND 46).

FIRST USE 6-1-1998; IN COMMERCE 6-1-1998.
ALLISON HOLTZ, EXAMINING ATTORNEY

NO CLAIM IS MADE TO THE EXCLUSIVE RIGHT TO USE "FOR GUARANTEED FRESHNESS", APART FROM THE MARK AS SHOWN.

THE MARK CONSISTS OF THE WORDS QUICKZIP FOR GUARANTEED FRESHNESS AND A PICTURE OF THE TOP OF A BAG WITH CLOSURE INSIDE OF A CIRCLE.

FOR PET FOOD (U.S. CLS. 1 AND 46).
ROBERT LORENZO, EXAMINING ATTORNEY

CLASS 31—(Continued).

SN 78-474,307. MONSANTO TECHNOLOGY LLC, SAINT LOUIS, MO. FILED 8-26-2004.

VISTIVE

THE MARK CONSISTS OF STANDARD CHARACTERS WITHOUT CLAIM TO ANY PARTICULAR FONT, STYLE, SIZE, OR COLOR.

FOR AGRICULTURAL SEEDS; UNPROCESSED GRAIN (U.S. CLS. 1 AND 46).

JUDITH HELFMAN, EXAMINING ATTORNEY

SN 79-000,368. BULBS & FLOWERS INTERNATIONAL GROUP BV, NETHERLANDS, FILED 11-7-2003.

TRIANGLE PLANTS

THE MARK CONSISTS OF STANDARD CHARACTERS WITHOUT CLAIM TO ANY PARTICULAR FONT, STYLE, SIZE, OR COLOR.

OWNER OF INTERNATIONAL REGISTRATION 0781967 DATED 4-5-2002, EXPIRES 4-5-2012.

NO CLAIM IS MADE TO THE EXCLUSIVE RIGHT TO USE "PLANTS", APART FROM THE MARK AS SHOWN.

FOR AGRICULTURAL, HORTICULTURAL AND FORESTRY PRODUCTS, NAMELY, BULBS, SEEDLINGS, LIVE PLANTS, LIVE FLOWERING PLANTS, CUT FLOWERS, AND PARTS OF LIVE PLANTS, NAMELY, TISSUE CULTURE MATERIAL, PARTS OF THE ROOTS, AND PARTS OF THE STEM (U.S. CLS. 1 AND 46).

SCOTT OSICK, EXAMINING ATTORNEY

CLASS 32—LIGHT BEVERAGES

SN 76-549,514. FALAISE, CLIFFORD, SOMERVILLE, MA. FILED 10-6-2003.

SMASH

FOR NON-ALCOHOLIC BEVERAGES, NAMELY, SODAS MADE WITHOUT CRUSHED FRUIT, FRUIT DRINKS, FRUIT JUICES, ENERGY DRINKS, SPORT DRINKS, SMOOTHIES AND FLAVORED WATER (U.S. CLS. 45, 46 AND 48).

KARANENDRA S. CHHINA, EXAMINING ATTORNEY

CLASS 32—(Continued).

SN 76-549,825. COTT CORPORATION, TORONTO, ONTARIO, CANADA, FILED 10-8-2003.

AFTERSHOCK

FOR NON-ALCOHOLIC BEVERAGES, NAMELY, CARBONATED AND NON-CARBONATED SOFT DRINKS, FRUIT DRINKS; WATER BEVERAGES, NAMELY, SPRING WATER, FLAVORED DRINKING WATER, PURIFIED DRINKING WATER AND FILTERED WATER (U.S. CLS. 45, 46 AND 48).

YSA DEJESUS, EXAMINING ATTORNEY

SN 76-549,826. COTT CORPORATION, TORONTO, ONTARIO, CANADA, FILED 10-8-2003.

FRUIT MEADOWS

NO CLAIM IS MADE TO THE EXCLUSIVE RIGHT TO USE "FRUIT", APART FROM THE MARK AS SHOWN.

FOR NON-ALCOHOLIC BEVERAGES, NAMELY, NON-CARBONATED SOFT DRINKS, FRUIT DRINKS; WATER BEVERAGES, NAMELY, SPRING WATER, FLAVORED DRINKING WATER, PURIFIED DRINKING WATER AND FILTERED WATER (U.S. CLS. 45, 46 AND 48).

YSA DEJESUS, EXAMINING ATTORNEY

SN 76-549,827. COTT CORPORATION, TORONTO, ONTARIO, CANADA, FILED 10-8-2003.

SASSIFRUIT

FOR NON-ALCOHOLIC BEVERAGES, NAMELY, NON-CARBONATED SOFT DRINKS, FRUIT DRINKS; WATER BEVERAGES, NAMELY, SPRING WATER, FLAVORED DRINKING WATER, PURIFIED DRINKING WATER AND FILTERED WATER (U.S. CLS. 45, 46 AND 48).

BRENDAN MCCAULEY, EXAMINING ATTORNEY

SN 76-572,967. KAGOME CO., LTD., NAGOYA, JAPAN, FILED 1-29-2004.

ORANGE CARROT BLOSSOM

THE MARK CONSISTS OF STANDARD CHARACTERS WITHOUT CLAIM TO ANY PARTICULAR FONT, STYLE, SIZE, OR COLOR.

NO CLAIM IS MADE TO THE EXCLUSIVE RIGHT TO USE ORANGE CARROT, APART FROM THE MARK AS SHOWN.

FOR FRUIT AND VEGETABLE JUICES (U.S. CLS. 45, 46 AND 48).

JENNIFER MARTIN, EXAMINING ATTORNEY

CLASS 32—(Continued).

SN 76-573,145. CERVECERIA MODELO, S.A. DE C.V., 11320 MEXICO, D.F., MEXICO, FILED 2-2-2004.

PARTY WITH THE AY-YI-YI-IRISH

THE MARK CONSISTS OF STANDARD CHARACTERS WITHOUT CLAIM TO ANY PARTICULAR FONT, STYLE, SIZE, OR COLOR.

FOR BEER (U.S. CLS. 45, 46 AND 48).
PAUL F. GAST, EXAMINING ATTORNEY

CLASS 32—(Continued).

SN 76-598,983. FIREFIGHTER BEVERAGES, LLC, NORWALK, CT. FILED 6-23-2004.

HYDRANT MAN

THE MARK CONSISTS OF STANDARD CHARACTERS WITHOUT CLAIM TO ANY PARTICULAR FONT, STYLE, SIZE, OR COLOR.

FOR BEVERAGES, NAMELY, SOFT DRINKS, POP, COLAS, FRUIT FLAVORED SOFT DRINKS, COFFEE-FLAVORED SOFT DRINKS, SOFT DRINKS FLAVORED WITH TEA, FRUIT DRINKS, FRUIT-FLAVORED DRINKS, FRUIT AND VEGETABLE JUICES, SPORTS DRINKS, ENERGY DRINKS, ALOE VERA DRINKS, AND ISOTONIC DRINKS; WATER BEVERAGES, NAMELY, MINERAL, SPRING, FLAVORED, SELTZER, AERATED, SODA, QUININE, TABLE, TONIC, AND DRINKING WATER; SYRUPS FOR MAKING SOFT DRINKS AND FRUIT DRINKS; CONCENTRATES, SYRUPS AND POWDERS USED IN THE PREPARATION OF SOFT DRINKS; ESSENCES FOR USE IN MAKING SOFT DRINKS; PREPARATIONS FOR MAKING SOFT DRINKS AND FRUIT DRINKS (U.S. CLS. 45, 46 AND 48).

ELIZABETH PIGNATELLO, EXAMINING ATTORNEY

SN 76-578,969. CITRUS WORLD, INC., LAKE WALES, FL. FILED 3-3-2004.



OWNER OF U.S. REG. NOS. 1,745,985 AND 2,042,992.
NO CLAIM IS MADE TO THE EXCLUSIVE RIGHT TO USE "BRAND", APART FROM THE MARK AS SHOWN.
THE STIPPLING IS FOR SHADING PURPOSES ONLY.
SEC. 2(F) FLORIDA'S NATURAL.
FOR FRUIT JUICES AND FRUIT DRINKS (U.S. CLS. 45, 46 AND 48).
FIRST USE 9-0-1997; IN COMMERCE 9-0-1997.
DAVID ELTON, EXAMINING ATTORNEY

SN 76-597,562. THE BEVERAGE GROUP, INC., PASADENA, CA. FILED 6-14-2004.



NO CLAIM IS MADE TO THE EXCLUSIVE RIGHT TO USE "ENERGY DRINK", APART FROM THE MARK AS SHOWN.

THE LINING IS A FEATURE OF THE MARK AND DOES NOT INDICATE COLOR.

FOR ENERGY DRINKS (U.S. CLS. 45, 46 AND 48).
FIRST USE 5-0-2004; IN COMMERCE 5-0-2004.
NANCY CLARKE, EXAMINING ATTORNEY

SN 76-599,561. IMPULSE BEVERAGE CORPORATION, MIAMI, FL. FILED 6-28-2004.

ELEVATE YOUR PERFORMANCE

THE MARK CONSISTS OF STANDARD CHARACTERS WITHOUT CLAIM TO ANY PARTICULAR FONT, STYLE, SIZE, OR COLOR.

FOR BEVERAGES, NAMELY ENERGY AND SPORTS DRINKS (U.S. CLS. 45, 46 AND 48).

TRICIA SONNEBORN, EXAMINING ATTORNEY

CLASS 32—(Continued).

SN 76-601,931. FIREFIGHTER BEVERAGES, LLC, NORWALK, CT. FILED 7-12-2004.



FOR BEVERAGES, NAMELY, SOFT DRINKS, POP, COLAS, FRUIT FLAVORED SOFT DRINKS, COFFEE-FLAVORED SOFT DRINKS, SOFT DRINKS FLAVORED WITH TEA, FRUIT DRINKS, FRUIT-FLAVORED DRINKS, FRUIT AND VEGETABLE JUICES, SPORTS DRINKS, ENERGY DRINKS, ALOE VERA DRINKS, AND ISOTONIC DRINKS; WATER BEVERAGES, NAMELY, MINERAL, SPRING, FLAVORED, SELTZER, AERATED, SODA, QUININE, TABLE, TONIC, AND DRINKING WATER; SYRUPS FOR MAKING SOFT DRINKS AND FRUIT DRINKS; CONCENTRATES, SYRUPS AND POWDERS USED IN THE PREPARATION OF SOFT DRINKS; ESSENCES FOR USE IN MAKING SOFT DRINKS; PREPARATIONS FOR MAKING SOFT DRINKS AND FRUIT DRINKS (U.S. CLS. 45, 46 AND 48).

ELIZABETH PIGNATELLO, EXAMINING ATTORNEY

SN 76-603,522. FIREFIGHTER BEVERAGES, LLC, NORWALK, CT. FILED 7-21-2004.

FLASHOVER

THE MARK CONSISTS OF STANDARD CHARACTERS WITHOUT CLAIM TO ANY PARTICULAR FONT, STYLE, SIZE, OR COLOR.

FOR BEVERAGES, NAMELY, SOFT DRINKS, POP, COLAS, FRUIT FLAVORED SOFT DRINKS, COFFEE-FLAVORED SOFT DRINKS, SOFT DRINKS FLAVORED WITH TEA, FRUIT DRINKS, FRUIT-FLAVORED DRINKS, FRUIT AND VEGETABLE JUICES; WATER BEVERAGES, NAMELY, MINERAL, SPRING, FLAVORED, SELTZER, AERATED, SODA, QUININE, TABLE, TONIC, AND DRINKING WATER; SYRUPS FOR MAKING SOFT DRINKS AND FRUIT DRINKS; CONCENTRATES, SYRUPS AND POWDERS USED IN THE PREPARATION OF SOFT DRINKS; ESSENCES FOR USE IN MAKING SOFT DRINKS; PREPARATIONS FOR MAKING SOFT DRINKS AND FRUIT DRINKS (U.S. CLS. 45, 46 AND 48).

ELIZABETH PIGNATELLO, EXAMINING ATTORNEY

CLASS 32—(Continued).

SN 76-615,867. FIREFIGHTER BEVERAGES, LLC, NORWALK, CT. FILED 10-8-2004.

FIRE ESCAPE

THE MARK CONSISTS OF STANDARD CHARACTERS WITHOUT CLAIM TO ANY PARTICULAR FONT, STYLE, SIZE, OR COLOR.

FOR BEVERAGES, NAMELY, SOFT DRINKS, POP, COLAS, FRUIT FLAVORED SOFT DRINKS, COFFEE-FLAVORED SOFT DRINKS, SOFT DRINKS FLAVORED WITH TEA, FRUIT DRINKS, FRUIT-FLAVORED DRINKS, FRUIT AND VEGETABLE JUICES; WATER BEVERAGES, NAMELY, MINERAL, SPRING, FLAVORED, SELTZER, AERATED, SODA, QUININE, TABLE, TONIC, AND DRINKING WATER; SYRUPS FOR MAKING SOFT DRINKS AND FRUIT DRINKS; CONCENTRATES, SYRUPS AND POWDERS USED IN THE PREPARATION OF SOFT DRINKS; ESSENCES FOR USE IN MAKING SOFT DRINKS; PREPARATIONS FOR MAKING SOFT DRINKS AND FRUIT DRINKS (U.S. CLS. 45, 46 AND 48).

ELIZABETH PIGNATELLO, EXAMINING ATTORNEY

SN 78-317,571. DISNEY ENTERPRISES, INC., BURBANK, CA. FILED 10-23-2003.

WALT DISNEY WORLD

OWNER OF U.S. REG. NOS. 980,995, 1,189,727 AND 2,189,177.

THE NAME IN THE MARK DOES NOT IDENTIFY A PARTICULAR LIVING INDIVIDUAL.

FOR NON-ALCOHOLIC BEVERAGES, NAMELY FRUIT DRINKS, FRUIT JUICES, FRUIT FLAVORED DRINKS, LIMEADE, LEMONADE, PUNCHES, SPORTS DRINKS AND SMOOTHIES; BOTTLED DRINKING WATER (U.S. CLS. 45, 46 AND 48).

PAUL F. GAST, EXAMINING ATTORNEY

SN 78-320,753. KIRIN BEER KABUSHIKI KAISHA, TA KIRIN BREWERY CO., LTD., TOKYO, JAPAN, FILED 10-30-2003.

極生 GOKUNAMA

NO CLAIM IS MADE TO THE EXCLUSIVE RIGHT TO USE THE NON-LATIN CHARACTER WHICH MEANS "DRAFT" IN ENGLISH, APART FROM THE MARK AS SHOWN.

THE NON-LATIN CHARACTERS IN THE MARK TRANSLITERATE TO GOKUNAMA AND THIS MEANS "DRAFT" IN ENGLISH.

FOR BEER, NON-ALCOHOLIC BEER, NON-ALCOHOLIC BEVERAGES, NAMELY, CARBONATED BEVERAGES, FRUIT JUICES, VEGETABLE JUICES, WHEY BEVERAGES; EXTRACTS OF HOPS FOR MAKING BEER (U.S. CLS. 45, 46 AND 48).

SUSAN STIGLITZ, EXAMINING ATTORNEY

CLASS 32—(Continued).

SN 78-344,601. MINERAL SMART INC., WARSAW, CANADA, FILED 12-23-2003.

CLASS 32—(Continued).

SN 78-362,773. ETHOS BRANDS LLC, LOS ANGELES, CA, FILED 2-4-2004.

CLEARLY SMART

THE MARK CONSISTS OF STANDARD CHARACTERS WITHOUT CLAIM TO ANY PARTICULAR FONT, STYLE, SIZE, OR COLOR.

NO CLAIM IS MADE TO THE EXCLUSIVE RIGHT TO USE "SMART", APART FROM THE MARK AS SHOWN.

THE MARK IS PRESENTED IN STANDARD CHARACTER WITHOUT CLAIM TO ANY PARTICULAR FONT, STYLE, SIZE OR COLOR

FOR BOTTLED DRINKING WATER; FLAVORED WATERS (U.S. CLS. 45, 46 AND 48).

FIRST USE 2-2-2004; IN COMMERCE 2-2-2004.

EVELYN BRADLEY, EXAMINING ATTORNEY



SN 78-354,998. DIAGEO NORTH AMERICA, INC., NORWALK, CT. FILED 1-21-2004.

ETHOS

THE MARK CONSISTS OF STANDARD CHARACTERS WITHOUT CLAIM TO ANY PARTICULAR FONT, STYLE, SIZE, OR COLOR.

FOR DRINKING WATER AND SODA WATER (U.S. CLS. 45, 46 AND 48).

BRENDAN MCCAULEY, EXAMINING ATTORNEY



SN 78-405,219. CAPE COD SPLASH, INC., HYANNIS, MA, FILED 4-20-2004.

SMIRNOFF

THE MARK CONSISTS OF STANDARD CHARACTERS WITHOUT CLAIM TO ANY PARTICULAR FONT, STYLE, SIZE, OR COLOR.

OWNER OF U.S. REG. NOS. 2,047,345, 2,686,697 AND OTHERS.

SEC. 2(F).

FOR FLAVORED MALT BEVERAGES (U.S. CLS. 45, 46 AND 48).

FIRST USE 5-19-2000; IN COMMERCE 5-19-2000.

RAUL CORDOVA, EXAMINING ATTORNEY

CAPE COD SPLASH

THE MARK CONSISTS OF STANDARD CHARACTERS WITHOUT CLAIM TO ANY PARTICULAR FONT, STYLE, SIZE, OR COLOR.

NO CLAIM IS MADE TO THE EXCLUSIVE RIGHT TO USE "CAPE COD", APART FROM THE MARK AS SHOWN. FOR DRINKING WATER (U.S. CLS. 45, 46 AND 48).

FIRST USE 5-18-2004; IN COMMERCE 5-18-2004.

MARY ROSSMAN, EXAMINING ATTORNEY

CLASS 32—(Continued).

SN 78-424,267. MAJEDO CORPORATION, KATY, TX. FILED 5-25-2004.

MISSION COLA

THE MARK CONSISTS OF STANDARD CHARACTERS WITHOUT CLAIM TO ANY PARTICULAR FONT, STYLE, SIZE, OR COLOR.

NO CLAIM IS MADE TO THE EXCLUSIVE RIGHT TO USE "COLA", APART FROM THE MARK AS SHOWN.

FOR MALTLESS NON-ALCOHOLIC BEVERAGES USED AS SOFT DRINKS AND BASES, CONCENTRATES, SYRUPS, POWDERS AND EXTRACTS FOR THE PREPARATION OF SOFT DRINKS, FLAVORED DRINKS, COLA DRINKS, PUNCH, LOW CALORIE AND FLAVORED CARBONATED DRINKS, SOFT DRINKS FLAVORED WITH TEA, FRUIT FLAVORED SOFT DRINKS (U.S. CLS. 45, 46 AND 48).

DOUGLAS LEE, EXAMINING ATTORNEY

SN 78-425,202. SOUTH BEACH BEVERAGE COMPANY, INC., NORWALK, CT. FILED 5-26-2004.

SOBE HYDRENALINE

THE MARK CONSISTS OF STANDARD CHARACTERS WITHOUT CLAIM TO ANY PARTICULAR FONT, STYLE, SIZE, OR COLOR.

OWNER OF U.S. REG. NOS. 2,153,152, 2,256,688 AND 2,345,815.

FOR ENERGY DRINKS, ISOTONIC SPORTS DRINKS, FRUIT DRINKS, JUICE DRINKS, SOFT DRINKS, AND SYRUPS AND CONCENTRATES FOR MAKING THE SAME (U.S. CLS. 45, 46 AND 48).

JOHN HWANG, EXAMINING ATTORNEY

CLASS 32—(Continued).

SN 78-425,585. PETE'S BREWING COMPANY, SAN ANTONIO, TX. FILED 5-26-2004.

WANDERLUST

THE MARK CONSISTS OF STANDARD CHARACTERS WITHOUT CLAIM TO ANY PARTICULAR FONT, STYLE, SIZE, OR COLOR.

FOR BEER AND ALE (U.S. CLS. 45, 46 AND 48).
MIDGE BUTLER, EXAMINING ATTORNEY

SN 78-435,495. THE GREAT ATLANTIC & PACIFIC TEA COMPANY, INC., MONTVALE, NJ. FILED 6-15-2004.

TORNADO SPLASH

THE MARK CONSISTS OF STANDARD CHARACTERS WITHOUT CLAIM TO ANY PARTICULAR FONT, STYLE, SIZE, OR COLOR.

FOR FRUIT JUICES (U.S. CLS. 45, 46 AND 48).
MATTHEW KLINE, EXAMINING ATTORNEY

SN 78-438,399. U.S. BEVERAGE, INC., NEWNAN, GA. FILED 6-21-2004.

H2OPIA

THE MARK CONSISTS OF STANDARD CHARACTERS WITHOUT CLAIM TO ANY PARTICULAR FONT, STYLE, SIZE, OR COLOR.

FOR NON-ALCOHOLIC BEVERAGES, NAMELY, BOTTLED DRINKING WATER, BOTTLED MINERAL WATER, FLAVORED DRINKING WATER, FLAVORED MINERAL WATER (U.S. CLS. 45, 46 AND 48).

WON TEAK OH, EXAMINING ATTORNEY

CLASS 32—(Continued).

SN 78-438,863. JOE SMOOTHIE, L.L.C., TULSA, OK. FILED 6-21-2004.

Joe Smoothie

THE MARK CONSISTS OF STANDARD CHARACTERS WITHOUT CLAIM TO ANY PARTICULAR FONT, STYLE, SIZE, OR COLOR.

NO CLAIM IS MADE TO THE EXCLUSIVE RIGHT TO USE SMOOTHIE, APART FROM THE MARK AS SHOWN. FOR FRUIT SMOOTHIES AND FRUIT JUICES (U.S. CLS. 45, 46 AND 48).

FIRST USE 6-1-2002; IN COMMERCE 6-1-2002.
STEVEN R. FINE, EXAMINING ATTORNEY

CLASS 33—WINES AND SPIRITS

SN 76-248,274. BODEGAS MONTECILLO, S.A., 26360 FUENMAYOR, LA RIOJA, SPAIN, FILED 5-1-2001.



SN 78-455,545. SOUTH BEACH BEVERAGE COMPANY, INC., NORWALK, CT. FILED 7-23-2004.

SOBE ADRENALINE SPORT

THE MARK CONSISTS OF STANDARD CHARACTERS WITHOUT CLAIM TO ANY PARTICULAR FONT, STYLE, SIZE, OR COLOR.

OWNER OF U.S. REG. NOS. 2,153,152, 2,345,815 AND OTHERS.

NO CLAIM IS MADE TO THE EXCLUSIVE RIGHT TO USE SPORT, APART FROM THE MARK AS SHOWN.

FOR ENERGY DRINKS, ISOTONIC SPORTS DRINKS, FRUIT DRINKS, FRUIT JUICE DRINKS, SOFT DRINKS AND SYRUPS, CONCENTRATES AND POWDERS FOR MAKING THE SAME (U.S. CLS. 45, 46 AND 48).

JOHN HWANG, EXAMINING ATTORNEY

NO CLAIM IS MADE TO THE EXCLUSIVE RIGHT TO USE BODEGAS, SOCIEDAD ANONIMA, RIOJA, DENOMINACION DE ORIGEN CALIFICADA, BOTTLED BY, FUENMAYOR ESPANA, ESTABLISHED IN 1874, PRODUCE OF SPAIN, CONSEJO, REGULADOS, AND 750 ML, APART FROM THE MARK AS SHOWN.

BODEGAS MEANS "WINE CELLARS;" SOCIEDAD ANONIMA MEANS "CORPORATION;" FUENMAYOR IS THE NAME OF A TOWN; ESPANA MEANS "SPAIN;" RIOJA DENOMINACION DE ORIGEN CALIFICADA MEANS "RIOJA QUALIFIED APPELLATION OF ORIGIN;" CONSEJO MEANS "COUNCIL;" REGULADOS MEANS "REGULATORS."

FOR WINES (U.S. CLS. 47 AND 49).

FIRST USE 0-0-1973; IN COMMERCE 0-0-1973.

ELIZABETH HUGHITT, EXAMINING ATTORNEY

SN 76-468,593. CANTINE CAPUTO S.P.A., TEVEROLA (CE), ITALY, FILED 11-8-2002.

SN 79-001,416. HEINEKEN IRELAND LIMITED, IRELAND, FILED 2-24-2004.

ARROW RIVER

THE MARK CONSISTS OF STANDARD CHARACTERS WITHOUT CLAIM TO ANY PARTICULAR FONT, STYLE, SIZE, OR COLOR.

PRIORITY DATE OF 11-25-2003 IS CLAIMED.

OWNER OF INTERNATIONAL REGISTRATION 0820699 DATED 2-24-2004, EXPIRES 2-24-2014.

FOR BEER, ALE, PORTER AND STOUT (U.S. CLS. 45, 46 AND 48).

DAVID TAYLOR, EXAMINING ATTORNEY

CAPUTO

SEC. 2(F).

FOR WINES (U.S. CLS. 47 AND 49).

FIRST USE 0-0-1997; IN COMMERCE 0-0-1997.

DAWN FELDMAN, EXAMINING ATTORNEY

CLASS 33—(Continued).

SN 76-522,656. HAKKAI-JYOZO SAKE BREWING CO., LTD., JAPAN, FILED 6-13-2003.



OWNER OF JAPAN REG. NO. 1641993, DATED 12-26-1983, RENEWED AS REG. NO. 1641993, DATED 8-5-2003, EXPIRES 12-26-2013.

THE MARK CONSISTS OF THE JAPANESE CHARACTERS MEANING HIGH GRADE SAKE AND PRONOUNCED KOKYU SEISYU (C) ATOP A DESIGN OF THE MUIKAINACHI MOUNTAINS; BELOW THE DESIGN IN LEFT CENTER ARE THE JAPANESE CHARACTERS MEANING WIDE SPREAD EXCELLENT REPUTATION (E) PRONOUNCED MIELSEL SHIKAL SHIRASHJU; IN THE CENTER SECOND LINE WITHIN THE CENTER DESIGN ARE THE JAPANESE CHARACTERS MEANING REGISTERED TRADEMARK AND PRONOUNCED TOHROKU SHOHO (D); IN THE CENTER OF THE DESIGN IN LARGE JAPANESE CHARACTERS IS THE NAME OF THE MOUNTAIN IN MUIKAMACHI WHERE THE APPLICANT'S OFFICE IS LOCATED, PRONOUNCED IHIAKKAISAN (A); IN THE UPPER RIGHT CORNER WITHIN A RECTANGLE APPEAR THE JAPANESE CHARACTERS MEANING SAKE MADE FROM RICE AND PRONOUNCED SEISHU (B); IN THE LOWER LEFT CORNER IN A CIRCLE THE JAPANESE CHARACTERS MEANING RESPECTFULLY AND BREWING APPEAR PRONOUNCED KINJYG (D); IN THE LOWER RIGHT CENTER WITHIN THE CENTER DESIGN ARE THE JAPANESE CHARACTERS AGAIN NAMING THE MOUNTAIN IN MUIKAMACHI WHERE THE APPLICANT'S OFFICE IS LOCATED AND PRONOUNCED HAKKAISAN (G); AND IN THE LOWER CENTER BORDER ARE SETS OF JAPANESE CHARACTERS WHICH ARE APPLICANT'S NAME AND ITS ADDRESS, PRONOUNCED MINAMLUONUMA-GUN NIIGATA-KEN HAKKAI-JYOZO KABUSHIKI KAISHA GAZA NAGAMORI MUIKAMACHI (H).-

FOR SAKE (U.S. CLS. 47 AND 49).
LAURA KOVAISKY, EXAMINING ATTORNEY

SN 76-583,445. DONATI ESTATE VINEYARDS, LLC, PAICINES, CA. FILED 3-29-2004.



NO CLAIM IS MADE TO THE EXCLUSIVE RIGHT TO USE "PAICINES", APART FROM THE MARK AS SHOWN. FOR WINES (U.S. CLS. 47 AND 49).
RICHARD WHITE, EXAMINING ATTORNEY

CLASS 33—(Continued).

SN 76-585,038. SPIRITS PRODUCT INTERNATIONAL INTELLECTUAL PROPERTY B.V., ORANJESTAD, ARUBA, FILED 4-5-2004.

KREMLYOVSKAYA

THE MARK CONSISTS OF STANDARD CHARACTERS WITHOUT CLAIM TO ANY PARTICULAR FONT, STYLE, SIZE, OR COLOR.

OWNER OF BENELUX REG. NO. 0749624, DATED 1-29-2004, EXPIRES 1-29-2014.

OWNER OF U.S. REG. NO. 1,943,768.

THE WORD IS AN ENGLISH TRANSLITERATION OF A RUSSIAN WORD THAT HAS NO SPECIFIC MEANING IN ANY LANGUAGE.

FOR ALCOHOLIC BEVERAGES, NAMELY VODKA, DISTILLED SPIRITS (U.S. CLS. 47 AND 49).
DAVID MURRAY, EXAMINING ATTORNEY

SN 76-585,039. SPIRITS PRODUCT INTERNATIONAL INTELLECTUAL PROPERTY B.V., ORANJESTAD, ARUBA, FILED 4-5-2004.



OWNER OF BENELUX REG. NO. 0749622, DATED 1-29-2004, EXPIRES 1-29-2014.

OWNER OF U.S. REG. NO. 1,943,768.

THE WORD IS AN ENGLISH TRANSLITERATION OF A RUSSIAN WORD THAT HAS NO SPECIFIC MEANING IN ANY LANGUAGE.

FOR ALCOHOLIC BEVERAGES, NAMELY, VODKA, DISTILLED SPIRITS (U.S. CLS. 47 AND 49).
DAVID MURRAY, EXAMINING ATTORNEY

SN 76-596,811. C3 BRANDS, INC., NEW YORK, NY. FILED 6-10-2004.

SIN-AMEN

THE MARK CONSISTS OF STANDARD CHARACTERS WITHOUT CLAIM TO ANY PARTICULAR FONT, STYLE, SIZE, OR COLOR.

FOR CINNAMON FLAVORED LIQUEUR (U.S. CLS. 47 AND 49).
JAMES A. RAUEN, EXAMINING ATTORNEY

CLASS 33—(Continued).

SN 76-597,945. JEANJEAN S.A., 34150 GIGNAC, FRANCE,
FILED 6-18-2004.

CATCH THE WAVE

THE MARK CONSISTS OF STANDARD CHARACTERS WITHOUT CLAIM TO ANY PARTICULAR FONT, STYLE, SIZE, OR COLOR.

FOR ALCOHOLIC BEVERAGES, NAMELY, WINES, LOCAL WINES, WINES WITH REGISTERED DESIGNATION OF ORIGIN, SPIRITS, APERITIFS, HARD CIDERS, LIQUEURS, BRANDY, PREPARED ALCOHOLIC COCKTAILS, GIN, RUM, VODKA AND WHISKY (U.S. CLS. 47 AND 49).

ARETHA SOMERVILLE, EXAMINING ATTORNEY

SN 78-150,258. ALLIED DOMEQ INTERNATIONAL HOLDINGS BV, ETTEN-LEUR, NETHERLANDS, FILED 8-2-2002.

STOLICHNAYA CRANBERI

OWNER OF U.S. REG. NOS. 865,462 AND 1,244,735.
NO CLAIM IS MADE TO THE EXCLUSIVE RIGHT TO USE "CRANBERRY", APART FROM THE MARK AS SHOWN.

THE FOREIGN WORDING IN THE MARK TRANSLATES INTO ENGLISH AS "CAPITAL" MEANING "MAIN CITY," FOR VODKA; PREPARED VODKA-BASED ALCOHOLIC COCKTAIL (U.S. CLS. 47 AND 49).

FIRST USE 5-5-2003; IN COMMERCE 5-5-2003.
MARIA-VICTORIA SUAREZ, EXAMINING ATTORNEY

SN 78-175,407. TEQUILA SAUZA S.A. DE C.V., GUADALAJARA, MEXICO, FILED 10-17-2002.

SAUZA HACIENDA

OWNER OF U.S. REG. NOS. 314,543, 2,665,796 AND OTHERS.

THE FOREIGN WORDING IN THE MARK TRANSLATES INTO ENGLISH AS ESTATE OR RANCH.

FOR TEQUILA (U.S. CLS. 47 AND 49).
MARLENE BELL, EXAMINING ATTORNEY

SN 78-208,211. ALTOS LAS HORMIGAS S.A., MENDOZA, ARGENTINA, FILED 1-29-2003.

ALTOS LAS HORMIGAS

THE FOREIGN WORDING IN THE MARK TRANSLATES INTO ENGLISH AS ANTS HEIGHT.

FOR WINES (U.S. CLS. 47 AND 49).
FIRST USE 12-31-2000; IN COMMERCE 12-31-2000.
JOHN KELLY, EXAMINING ATTORNEY

CLASS 33—(Continued).

SN 78-208,609. COTCHETT, JOSEPH W., HALF MOON BAY, CA. FILED 1-29-2003.

COASTAL FOG

FOR WINES (U.S. CLS. 47 AND 49).
BRETT J. GOLDEN, EXAMINING ATTORNEY

SN 78-274,601. MATTHEWS, DEBBIE, COLUMBIA, TN. FILED 7-15-2003.

WHISKEY IV

NO CLAIM IS MADE TO THE EXCLUSIVE RIGHT TO USE WHISKEY, APART FROM THE MARK AS SHOWN.

FOR ALCOHOLIC BEVERAGES; NAMELY, DISTILLED SPIRIT; PREPARED ALCOHOLIC COCKTAILS; WHISKEY (U.S. CLS. 47 AND 49).

MARY I. SPARROW, EXAMINING ATTORNEY

SN 78-280,388. DIAGEO BRANDS B.V., AMSTERDAM, NETHERLANDS, FILED 7-29-2003.

PIMM'S

SEC. 2(F).
FOR PREPARED ALCOHOLIC DRINKS CONTAINING GIN, WHISKEYS, BRANDY, RUM OR VODKA (U.S. CLS. 47 AND 49).

FIRST USE 0-0-1898; IN COMMERCE 10-12-1936.
ALICE SUE CARRUTHERS, EXAMINING ATTORNEY

SN 78-303,781. SUMMER HOUSE WINE COMPANY LIMITED, BLENHEIM, NEW ZEALAND, FILED 9-22-2003.

BALDY

PRIORITY CLAIMED UNDER SEC. 44(D) ON NEW ZEALAND APPLICATION NO. 701793, FILED 9-19-2003, REG. NO. 701793, DATED 9-19-2003, EXPIRES 9-19-2013.

OWNER OF NEW ZEALAND REG. NO. 701792, DATED 9-19-2003, EXPIRES 9-19-2023.
FOR WINES (U.S. CLS. 47 AND 49).
SUE LAWRENCE, EXAMINING ATTORNEY

CLASS 33—(Continued).

SN 78-313,703. WINGARA WINE GROUP PTY LTD, SOUTH MELBOURNE, AUSTRALIA, FILED 10-15-2003.

DEAKIN ESTATE WINE YOU CAN BELIEVE IN

OWNER OF AUSTRALIA REG. NO. 950616, DATED 4-14-2003, EXPIRES 4-14-2013.
 OWNER OF U.S. REG. NO. 2,118,205.
 NO CLAIM IS MADE TO THE EXCLUSIVE RIGHT TO USE "WINE", APART FROM THE MARK AS SHOWN.
 FOR WINE (U.S. CLS. 47 AND 49).
 HENRY S. ZAK, EXAMINING ATTORNEY

SN 78-317,573. DISNEY ENTERPRISES, INC., BURBANK, CA. FILED 10-23-2003.

WALT DISNEY WORLD

OWNER OF U.S. REG. NOS. 980,995, 1,189,727 AND 2,189,177.
 THE NAME IN THE MARK DOES NOT IDENTIFY A PARTICULAR LIVING INDIVIDUAL.
 FOR WINE; DISTILLED SPIRITS; BRANDY SPIRITS (U.S. CLS. 47 AND 49).
 PAUL F. GAST, EXAMINING ATTORNEY

SN 78-327,029. DIAGEO BRANDS B.V., AMSTERDAM, NETHERLANDS, FILED 11-12-2003.



PRIORITY CLAIMED UNDER SEC. 44(D) ON UNITED KINGDOM APPLICATION NO. 2339263, FILED 7-30-2003.
 FOR ALCOHOLIC BEVERAGES, NAMELY, GIN AND VODKA (U.S. CLS. 47 AND 49).
 FIRST USE 0-0-1951; IN COMMERCE 0-0-1951.
 JASON TURNER, EXAMINING ATTORNEY

CLASS 33—(Continued).

SN 78-331,159. BOZZINI, MARK F., NAPA, CA. FILED 11-20-2003.

TA-LA-HA-LU-SI

THE MARK CONSISTS OF STANDARD CHARACTERS WITHOUT CLAIM TO ANY PARTICULAR FONT, STYLE, SIZE, OR COLOR.
 THE ENGLISH TRANSLATION OF THE TERM TA-LA-HA-LU-SI IS "BEAUTIFUL LAND".
 FOR WINE (U.S. CLS. 47 AND 49).
 TRACY CROSS, EXAMINING ATTORNEY

SN 78-337,457. D.J. MARAGAS WINE CO., BEND, OR. FILED 12-7-2003.



THE COLOR RED IS CLAIMED AS A FEATURE OF THE MARK.
 THE COLOR RED APPEARS JUST LEFT OF CENTER AND FILLS THE CONTENT AREA OF THE GLASS SO THAT THE GLASS APPEARS FULL - WHICH IS DRAWN IN THREE PARTS OVERLAPPING ONE ANOTHER TO GIVE THE EFFECT OF MOVEMENT.
 THE MARK CONSISTS OF A CARICATURE DRAWING - CARICATURE IS HOLDING A PARTIALLY RED FILLED GLASS.
 FOR WINE (U.S. CLS. 47 AND 49).
 FIRST USE 7-16-2003; IN COMMERCE 9-19-2003.
 JIM RINGLE, EXAMINING ATTORNEY

CLASS 33—(Continued).

SN 78-337,458. D.J. MARAGAS WINE CO., BEND, OR. FILED 12-7-2003.



THE COLOR RED IS CLAIMED AS A FEATURE OF THE MARK.

THE COLOR RED APPEARS IN TWO AREAS OF THE MARK - FIRST, AT THE TOP OF THE MARK, FILLING THE CONTENTS OF THE HAT ATOP THE CARICATURE'S HEAD - SECOND, IN THE MIDSECTION OF THE MARK COLORING RED THE STRIPES ON THE CARICATURES SHIRT WHICH ALTERNATE WITH BLACK, AND COLORING RED THE JEWELS ON THE BRACELET OF THE CARICATURE'S RIGHT ARM THAT ALTERNATE WITH BLACK JEWELS ON THE SAME ARM.

THE MARK CONSISTS OF A CARICATURE DRAWING - HER HAT, PART OF SHIRT STRIPES, & PART OF BRACELET ARE RED.

FOR WINE (U.S. CLS. 47 AND 49).
FIRST USE 7-16-2003; IN COMMERCE 8-15-2003.
JIM RINGLE, EXAMINING ATTORNEY

CLASS 33—(Continued).

SN 78-344,446. PERRIN ET FILS, ORANGE, FRANCE, FILED 12-22-2003.

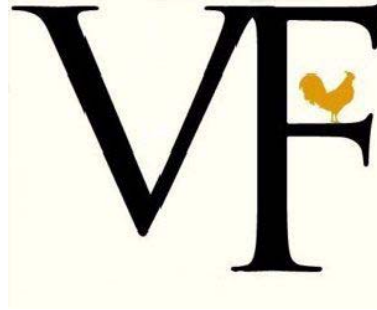

PRIORITY CLAIMED UNDER SEC. 44(D) ON FRANCE APPLICATION NO. 033232484, FILED 6-23-2003, REG. NO. 033232484, DATED 6-23-2003, EXPIRES 6-23-2013.

THE COLOR(S) YELLOW IS/ARE CLAIMED AS A FEATURE OF THE MARK.

THE COLOR YELLOW APPEARS AS THE COLOR OF THE ROOSTER STANDING ON THE LOWER ARM OF THE LETTER F.

FOR WINES (U.S. CLS. 47 AND 49).
JEFF DEFORD, EXAMINING ATTORNEY

SN 78-337,643. SOUTHERN COMFORT PROPERTIES, INC., SAN RAFAEL, CA. FILED 12-8-2003.

SO JUICY

THE MARK CONSISTS OF STANDARD CHARACTERS WITHOUT CLAIM TO ANY PARTICULAR FONT, STYLE, SIZE, OR COLOR.

NO CLAIM IS MADE TO THE EXCLUSIVE RIGHT TO USE "JUICY", APART FROM THE MARK AS SHOWN.

FOR ALCOHOLIC BEVERAGES, NAMELY, DISTILLED SPIRITS (U.S. CLS. 47 AND 49).

FIRST USE 3-31-2004; IN COMMERCE 3-31-2004.
KAREN BRACEY, EXAMINING ATTORNEY

SN 78-344,533. ROBERT MONDAVI WINERY, NAPA, CA. FILED 12-22-2003.

PRIVATE SELECTION

THE MARK CONSISTS OF STANDARD CHARACTERS WITHOUT CLAIM TO ANY PARTICULAR FONT, STYLE, SIZE, OR COLOR.

NO CLAIM IS MADE TO THE EXCLUSIVE RIGHT TO USE "SELECTION", APART FROM THE MARK AS SHOWN.

FOR WINE, NOT INCLUDING COOKING WINE (U.S. CLS. 47 AND 49).

FIRST USE 9-4-2001; IN COMMERCE 9-4-2001.
SUSAN HAYASH, EXAMINING ATTORNEY

CLASS 33—(Continued).

SN 78-346,381. JACOB THE JEWELER, INC., NEW YORK, NY. FILED 12-30-2003.

CLASS 33—(Continued).

SN 78-371,728. PRODUCTOS FINOS DE AGAVE SA DE CV, GUADALAJARA, MEXICO, FILED 2-20-2004.

BOCAJ

CUMBRES

THE MARK CONSISTS OF STANDARD CHARACTERS WITHOUT CLAIM TO ANY PARTICULAR FONT, STYLE, SIZE, OR COLOR.

FOR VODKA (U.S. CLS. 47 AND 49).
AMY GEARIN, EXAMINING ATTORNEY

THE MARK CONSISTS OF STANDARD CHARACTERS WITHOUT CLAIM TO ANY PARTICULAR FONT, STYLE, SIZE, OR COLOR.

THE FOREIGN WORDING IN THE MARK TRANSLATES INTO ENGLISH AS SUMMITS.
FOR ALCOHOLIC BEVERAGES NAMELY TEQUILA (U.S. CLS. 47 AND 49).
CYNTHIA SLOAN, EXAMINING ATTORNEY

SN 78-360,553. WESTLAKE, DAWN H, LOS ANGELES, CA. FILED 1-31-2004.

SN 78-379,862. WILSON, MICHAEL F., BOZEMAN, MT. FILED 3-6-2004.

Jesus Juice

PLONK

THE MARK CONSISTS OF STANDARD CHARACTERS WITHOUT CLAIM TO ANY PARTICULAR FONT, STYLE, SIZE, OR COLOR.

NO CLAIM IS MADE TO THE EXCLUSIVE RIGHT TO USE "JUICE", APART FROM THE MARK AS SHOWN.
FOR WINE (U.S. CLS. 47 AND 49).
KIMBERLY PERRY, EXAMINING ATTORNEY

THE MARK CONSISTS OF STANDARD CHARACTERS WITHOUT CLAIM TO ANY PARTICULAR FONT, STYLE, SIZE, OR COLOR.

FOR WINE (U.S. CLS. 47 AND 49).
STANLEY I. OSBORNE, EXAMINING ATTORNEY

CLASS 33—(Continued).

SN 78-388,823. TEQUILA EMBAJADOR, S.A. DE C.V., TEPATITLAN DE MORELOS, MEXICO, FILED 3-23-2004.



NO CLAIM IS MADE TO THE EXCLUSIVE RIGHT TO USE JALISCIENSE, APART FROM THE MARK AS SHOWN.

THE MARK CONSISTS OF AN OLD SHIELD, IN THE CONTOUR HAS EIGHT CROSSINGS, INSIDE OF THE SHIELD ON THE TOP, IT HAS TWO GEOMETRIC FIGURES, AND IN THE CENTER IT HAS A FIGURE REPRESENTING A CASTLE. ON THE TOP OF THE SHIELD IT HAS A MEDIEVAL HELMET, AND IN THE RIGHT SIDE AS IN THE LEFT, IT HAS A PAIR OF GRAPEVINE LEAVES OUT OF THE SHIELD.

THE FOREIGN WORDING IN THE MARK TRANSLATES INTO ENGLISH AS THE ENGLISH TRANSLATION OF "EMBAJADOR" IS "AMBASSADOR", THE ENGLISH TRANSLATION OF "JALISCIENSE" IS "ANY PERSON WHO LIVES IN JALISCO".

FOR DISTILLED ALCOHOL LIQUORS (U.S. CLS. 47 AND 49).

FIRST USE 4-2-1997; IN COMMERCE 4-2-1997.
ASMAT KHAN, EXAMINING ATTORNEY

CLASS 33—(Continued).

SN 78-401,572. SMOOTH SPIRITS, LLC, SAN FRANCISCO, CA. FILED 4-14-2004.

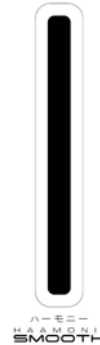

NO CLAIM IS MADE TO THE EXCLUSIVE RIGHT TO USE "SMOOTH", APART FROM THE MARK AS SHOWN.

THE ENGLISH TRANSLATION OF THE TERM HAAMONII IN THE MARK IS HARMONY.

THE NON-LATIN CHARACTER(S) IN THE MARK TRANSLITERATES INTO HAAMONII, AND THIS MEANS HARMONY IN ENGLISH.

FOR DISTILLED SPIRITS (U.S. CLS. 47 AND 49).
LINDA ESTRADA, EXAMINING ATTORNEY

SN 78-401,322. KEYMOSABI INC., SANTA MONICA, CA. FILED 4-13-2004.



THE STIPPLING SHOWN IN THE DRAWING IS FOR SHADING PURPOSES ONLY.

THE MARK CONSISTS OF THE WORDS "LAUGHING KOOKABURRA" IN STYLIZED LETTERING. THE TWO WORDS PART OVERLAP EACH OTHER AND THEY CURVE AROUND (ABOVE) A CARICATURE OF A LAUGHING KOOKABURRA BIRD ON ITS BACK IN A JOVIAL MOOD.

FOR WINE (U.S. CLS. 47 AND 49).
FIRST USE 2-12-2004; IN COMMERCE 2-15-2004.
JENNIFER CHICOSKI, EXAMINING ATTORNEY

SN 78-401,754. MEREDITH MITCHELL VINEYARDS, LLC, MCMINNVILLE, OR. FILED 4-14-2004.

MEREDITH MITCHELL
VINEYARD

THE MARK CONSISTS OF STANDARD CHARACTERS WITHOUT CLAIM TO ANY PARTICULAR FONT, STYLE, SIZE, OR COLOR.

NO CLAIM IS MADE TO THE EXCLUSIVE RIGHT TO USE "VINEYARD", APART FROM THE MARK AS SHOWN.

THE NAME(S), PORTRAIT(S), AND/OR SIGNATURE(S) SHOWN IN THE MARK DOES NOT IDENTIFY A PARTICULAR LIVING INDIVIDUAL.

FOR WINE (U.S. CLS. 47 AND 49).
FIRST USE 2-0-2001; IN COMMERCE 2-0-2001.
ROBIN CHOSID, EXAMINING ATTORNEY

CLASS 33—(Continued).

SN 78-403,880. DIAGEO NORTH AMERICA, INC., NORWALK, CT. FILED 4-19-2004.

TATTOO YOUR NIGHT

THE MARK CONSISTS OF STANDARD CHARACTERS WITHOUT CLAIM TO ANY PARTICULAR FONT, STYLE, SIZE, OR COLOR.

FOR ALCOHOLIC BEVERAGES, NAMELY, RUM, AND FLAVORED RUMS (U.S. CLS. 47 AND 49).

LESLEY LAMOTHE, EXAMINING ATTORNEY

SN 78-405,676. WINGARA WINE GROUP PTY LTD, SOUTH MELBOURNE, VICTORIA, AUSTRALIA, FILED 4-21-2004.

SHEPHERD'S HUT

THE MARK CONSISTS OF STANDARD CHARACTERS WITHOUT CLAIM TO ANY PARTICULAR FONT, STYLE, SIZE, OR COLOR.

FOR WINES (U.S. CLS. 47 AND 49).

HOWARD B. LEVINE, EXAMINING ATTORNEY

SN 78-428,993. FOXES ISLAND WINES LTD, BLENHEIM, NEW ZEALAND, FILED 6-2-2004.

SEVEN TERRACES

THE MARK CONSISTS OF STANDARD CHARACTERS WITHOUT CLAIM TO ANY PARTICULAR FONT, STYLE, SIZE, OR COLOR.

FOR WINE (U.S. CLS. 47 AND 49).

NICHOLAS ALTREE, EXAMINING ATTORNEY

CLASS 33—(Continued).

SN 78-429,393. EAGLE EYE IMPORTS, L.L.C., BLOOMFIELD HILLS, MI. FILED 6-3-2004.

**DOMAINE DES
KARANTES**

THE MARK CONSISTS OF STANDARD CHARACTERS WITHOUT CLAIM TO ANY PARTICULAR FONT, STYLE, SIZE, OR COLOR.

NO CLAIM IS MADE TO THE EXCLUSIVE RIGHT TO USE "DOMAINE", APART FROM THE MARK AS SHOWN. THE ENGLISH TRANSLATION OF THE WORD DOMAINE IN THE MARK IS HOUSE.

FOR WINES (U.S. CLS. 47 AND 49).

MARK SPARACINO, EXAMINING ATTORNEY

SN 78-429,640. JAMIESON, RAY W., MEMPHIS, TN. FILED 6-3-2004.

SWEET LUCY LIQUEUR

THE MARK CONSISTS OF STANDARD CHARACTERS WITHOUT CLAIM TO ANY PARTICULAR FONT, STYLE, SIZE, OR COLOR.

NO CLAIM IS MADE TO THE EXCLUSIVE RIGHT TO USE SWEET AND LIQUEUR, APART FROM THE MARK AS SHOWN.

FOR ALCOHOLIC BEVERAGE, NAMELY A LIQUEUR (U.S. CLS. 47 AND 49).

JULIA HARDY COFIELD, EXAMINING ATTORNEY

SN 78-434,785. FETZER VINEYARDS, HOPLAND, CA. FILED 6-14-2004.

BOXING ROO

THE MARK CONSISTS OF STANDARD CHARACTERS WITHOUT CLAIM TO ANY PARTICULAR FONT, STYLE, SIZE, OR COLOR.

FOR ALCOHOLIC BEVERAGES, NAMELY, WINE (U.S. CLS. 47 AND 49).

FIRST USE 6-10-2004; IN COMMERCE 6-10-2004.

ROBIN CHOSID, EXAMINING ATTORNEY

CLASS 33—(Continued).

SN 78-434,989. JACK POUST & COMPANY, INC., NEW YORK, NY. FILED 6-14-2004.

THAI BLOSSOM

THE MARK CONSISTS OF STANDARD CHARACTERS WITHOUT CLAIM TO ANY PARTICULAR FONT, STYLE, SIZE, OR COLOR.

NO CLAIM IS MADE TO THE EXCLUSIVE RIGHT TO USE "THAI", APART FROM THE MARK AS SHOWN. FOR WINE (U.S. CLS. 47 AND 49). FIRST USE 9-1-2004; IN COMMERCE 9-1-2004. LINDA ESTRADA, EXAMINING ATTORNEY

CLASS 33—(Continued).

SN 78-435,959. ORANJERIVIER WYNKELDERS CO-OP LIMITED, UPINGTON, NORTHERN CAPE, SOUTH AFRICA, FILED 6-16-2004.



NO CLAIM IS MADE TO THE EXCLUSIVE RIGHT TO USE "CELLARS", APART FROM THE MARK AS SHOWN. FOR ALCOHOLIC BEVERAGES, NAMELY, WINES, DISTILLED SPIRITS DERIVED FROM GRAPES, LIQUEURS (U.S. CLS. 47 AND 49).

STEPHANIE DAVIS, EXAMINING ATTORNEY

SN 78-436,072. FETZER VINEYARDS, HOPLAND, CA. FILED 6-16-2004.

SO LOW MERLOT

THE MARK CONSISTS OF STANDARD CHARACTERS WITHOUT CLAIM TO ANY PARTICULAR FONT, STYLE, SIZE, OR COLOR.

NO CLAIM IS MADE TO THE EXCLUSIVE RIGHT TO USE "MERLOT", APART FROM THE MARK AS SHOWN. FOR ALCOHOLIC BEVERAGES, NAMELY, WINE (U.S. CLS. 47 AND 49). CURTIS FRENCH, EXAMINING ATTORNEY

SN 78-435,030. OVALLE, HERNAN, SANTIAGO, CHILE, FILED 6-14-2004.

Terrantai

SN 78-437,315. DOLAN & SONS, UKIAH, CA. FILED 6-17-2004.

STUMBLING GOAT

THE MARK CONSISTS OF STANDARD CHARACTERS WITHOUT CLAIM TO ANY PARTICULAR FONT, STYLE, SIZE, OR COLOR.

FOR WINE (U.S. CLS. 47 AND 49). BRETT J. GOLDEN, EXAMINING ATTORNEY

THE MARK CONSISTS OF STANDARD CHARACTERS WITHOUT CLAIM TO ANY PARTICULAR FONT, STYLE, SIZE, OR COLOR.

FOR WINE (U.S. CLS. 47 AND 49). SUSAN STIGLITZ, EXAMINING ATTORNEY

CLASS 33—(Continued).

SN 78-437,345. VINICON, INC., SAN RAFAEL, CA. FILED 6-17-2004.

BLIND DOG

THE MARK CONSISTS OF STANDARD CHARACTERS WITHOUT CLAIM TO ANY PARTICULAR FONT, STYLE, SIZE, OR COLOR.

FOR WINE (U.S. CLS. 47 AND 49).
BARBARA BROWN, EXAMINING ATTORNEY

SN 78-438,392. OLD MILL WINERY, MIDDLEBURG HEIGHTS, OH. FILED 6-21-2004.

GRINDSTONE PINK

THE MARK CONSISTS OF STANDARD CHARACTERS WITHOUT CLAIM TO ANY PARTICULAR FONT, STYLE, SIZE, OR COLOR.

NO CLAIM IS MADE TO THE EXCLUSIVE RIGHT TO USE "PINK", APART FROM THE MARK AS SHOWN.
FOR WINE (U.S. CLS. 47 AND 49).
RONALD MCMORROW, EXAMINING ATTORNEY

SN 78-438,403. OLD MILL WINERY, MIDDLEBURG HEIGHTS, OH. FILED 6-21-2004.

GRINDSTONE WHITE

THE MARK CONSISTS OF STANDARD CHARACTERS WITHOUT CLAIM TO ANY PARTICULAR FONT, STYLE, SIZE, OR COLOR.

NO CLAIM IS MADE TO THE EXCLUSIVE RIGHT TO USE "WHITE", APART FROM THE MARK AS SHOWN.
FOR WINE (U.S. CLS. 47 AND 49).
RONALD MCMORROW, EXAMINING ATTORNEY

CLASS 33—(Continued).

SN 78-438,414. OLD MILL WINERY, MIDDLEBURG HEIGHTS, OH. FILED 6-21-2004.

GRINDSTONE RED

THE MARK CONSISTS OF STANDARD CHARACTERS WITHOUT CLAIM TO ANY PARTICULAR FONT, STYLE, SIZE, OR COLOR.

NO CLAIM IS MADE TO THE EXCLUSIVE RIGHT TO USE "RED", APART FROM THE MARK AS SHOWN.
FOR WINE (U.S. CLS. 47 AND 49).
RONALD MCMORROW, EXAMINING ATTORNEY

SN 78-438,473. BLAVOD BLACK VODKA PLC, LONDON, UNITED KINGDOM, FILED 6-21-2004.

EXTREME BUMPY

THE MARK CONSISTS OF STANDARD CHARACTERS WITHOUT CLAIM TO ANY PARTICULAR FONT, STYLE, SIZE, OR COLOR.

FOR DISTILLED ALCHOLIC BEVERAGES, NAMELY, LIQUOR AND SPIRITS (U.S. CLS. 47 AND 49).
MARK RADEMACHER, EXAMINING ATTORNEY

SN 79-000,017. GROUPEMENT FONCIER AGRICOLE; DES CHATEAUX LANGOA; ET LEOVILLE BARTON.; GROUPEMENT FONCIER AGRICOLE, FRANCE, FILED 11-17-2003.

CHATEAU LANGOA

THE MARK CONSISTS OF STANDARD CHARACTERS WITHOUT CLAIM TO ANY PARTICULAR FONT, STYLE, SIZE, OR COLOR.

OWNER OF INTERNATIONAL REGISTRATION 0439248 DATED 8-8-1978, EXPIRES 8-8-2008.

NO CLAIM IS MADE TO THE EXCLUSIVE RIGHT TO USE CHATEAU, APART FROM THE MARK AS SHOWN.
FOR WINE (U.S. CLS. 47 AND 49).
SAMUEL E. SHARPER JR., EXAMINING ATTORNEY

CLASS 33—(Continued).

SN 79-001,303. LIDL STIFTUNG & CO. KG, FED REP GERMANY, FILED 12-3-2003.

PUTINOFF

THE MARK CONSISTS OF STANDARD CHARACTERS WITHOUT CLAIM TO ANY PARTICULAR FONT, STYLE, SIZE, OR COLOR.

PRIORITY DATE OF 6-13-2003 IS CLAIMED. OWNER OF INTERNATIONAL REGISTRATION 0820273 DATED 12-3-2003, EXPIRES 12-3-2013.

FOR ALCOHOLIC BEVERAGES, NAMELY, DISTILLED SPIRITS, VODKA SCHNAPS, LIQUEURS, BITTERS, WINE, SPARKLING WINE, WINE-CONTAINING BEVERAGES (U.S. CLS. 47 AND 49).

ROBERT LORENZO, EXAMINING ATTORNEY

SN 79-001,704. COOPERATIVA AGRICOLA DE; PAU I ROSES S.C.C.L., SPAIN, FILED 2-24-2004.

SINOLS

THE MARK CONSISTS OF STANDARD CHARACTERS WITHOUT CLAIM TO ANY PARTICULAR FONT, STYLE, SIZE, OR COLOR.

OWNER OF INTERNATIONAL REGISTRATION 0821774 DATED 2-24-2004, EXPIRES 2-24-2014.

FOR WINE (U.S. CLS. 47 AND 49).

LINDA E. BLOHM, EXAMINING ATTORNEY

CLASS 34—SMOKERS' ARTICLES

SN 76-593,404. AGROINDUSTRIAS LAEPE S.A., TEGUCIGALPA, HONDURAS, FILED 5-21-2004.

JERICHO

THE MARK CONSISTS OF STANDARD CHARACTERS WITHOUT CLAIM TO ANY PARTICULAR FONT, STYLE, SIZE, OR COLOR.

FOR CIGARS (U.S. CLS. 2, 8, 9 AND 17).

KATHLEEN M. VANSTON, EXAMINING ATTORNEY

CLASS 34—(Continued).

SN 76-598,196. TOP TOBACCO, L.P., GLENVIEW, IL. FILED 6-18-2004.



FOR CIGARETTE TOBACCO (U.S. CLS. 2, 8, 9 AND 17).

ALICE BENMAMAN, EXAMINING ATTORNEY

SN 78-202,428. BRECO INTERNATIONAL LIMITED, SUNNINGDALE, UNITED KINGDOM, FILED 1-13-2003.

ROXTON

FOR CIGARETTES. (U.S. CLS. 2, 8, 9 AND 17).

SUSAN HAYASH, EXAMINING ATTORNEY

SN 78-232,275. RBJ SALES, INC., DRESDEN, TN. FILED 4-1-2003.

Fred's Choice

OWNER OF U.S. REG. NO. 2,740,903. FOR SMOKELESS AND SMOKING TOBACCOS (U.S. CLS. 2, 8, 9 AND 17).

PRISCILLA MILTON, EXAMINING ATTORNEY

SN 78-432,979. CEE KING ENTERPRISES INC., SKOKIE, IL. FILED 6-10-2004.

NICARAGUAN HEIRLOOM

THE MARK CONSISTS OF STANDARD CHARACTERS WITHOUT CLAIM TO ANY PARTICULAR FONT, STYLE, SIZE, OR COLOR.

OWNER OF U.S. REG. NO. 2,890,135.

NO CLAIM IS MADE TO THE EXCLUSIVE RIGHT TO USE "NICARAGUAN", APART FROM THE MARK AS SHOWN.

FOR CIGARS (U.S. CLS. 2, 8, 9 AND 17).

FIRST USE 6-10-2004; IN COMMERCE 6-10-2004.

JENNIFER KRISP, EXAMINING ATTORNEY

CLASS 34—(Continued).

SN 78-435,952. ACEVEDO, URIEL FERNANDO, MIAMI, FL. FILED 6-16-2004.

MILLER

THE MARK CONSISTS OF STANDARD CHARACTERS WITHOUT CLAIM TO ANY PARTICULAR FONT, STYLE, SIZE, OR COLOR.

FOR CIGARETTES (U.S. CLS. 2, 8, 9 AND 17).
MARGERY A. TIERNEY, EXAMINING ATTORNEY

CLASS 34—(Continued).

ING AND STRIPE FRAMES THE RIM OF THE BLUE FOND; AND THE LABEL IS THE COLOR CREAM. POSITIONED AT THE LEFT HAND SIDE OF THE BORDER. WITH A RED RIM ON THE OUTSIDE AND GRAY AND OLD PINK COLORING ON THE INSIDE OF THE LABEL, THE UPPER PART OF THE LABEL CONTAINS TOBACCO LEAVES IN OLD PINK COLOR WITH GOLDEN VEINS AND AGAINST A GOLDEN BACKGROUND THERE APPEARS THE FIVE MEDAL AND SCROLL CONFIGURATION AND THE WORD AGIO FLOR FINA. ALL IN BROWN.

THE ENGLISH TRANSLATION OF THE WORD AGLO IS "PREMIUM ON SHARES." IT IS A TERM USED IN THE STOCK MARKET. THE ENGLISH TRANSLATION OF THE WORD TOBACOS IS TOBACCOS; THE ENGLISH TRANSLATION OF THE WORD PRIMEROS IS SUPERIOR; THE ENGLISH TRANSLATION OF THE WORD FLOR IS FLOWER; AND THE ENGLISH TRANSLATION OF THE WORD FINA IS FINE.

FOR CIGARS (U.S. CLS. 2, 8, 9 AND 17).
APRIL L. RADEMACHER, EXAMINING ATTORNEY

SN 79-000,495. AGIO SIGARENFABRIEKEN N.V., NETHERLANDS, FILED 11-25-2003.



OWNER OF INTERNATIONAL REGISTRATION 0557508 DATED 7-13-1990, EXPIRES 7-13-2010.

OWNER OF U.S. REG. NOS. 790,926, 848,887 AND 1,743,452.

THE COLOR(S) RED, FADED PINK, BLUE, BROWN, GREY, CREAM, AND GOLD IS/ARE CLAIMED AS A FEATURE OF THE MARK.

THE DRAWING OF THE MARK IS LINED FOR THE COLORS BLUE, GOLD, RED, GRAY, BROWN AND PINK. THE MARK CONSISTS OF THE STYLIZED WORD ELEGANT, A MEDAL AND SCROLL DEVICE, A BORDER AND A LABEL; WHEREIN THE BACKGROUND IS DARK BLUE AT THE RIM AND GROWING LIGHTER TO THE CENTER; THE WORD ELEGANT APPEARS ABOVE IN RED WITH A GOLDEN BORDER AND BLACK LINING; FIVE MEDALS AND A SCROLL DEVICE CONTAINING THE WORDS AGIO FLOR FINA, TABACOS PRIMEROS, ALL IN GOLD AGAINST THE BLUE BACKGROUND APPEAR BENEATH THE WORD ELEGANT; A BORDER OF GOLDEN LETTER-

SERVICE MARKS

CLASS 35—ADVERTISING AND BUSINESS

SN 75-673,770. ESQUIRE SEARCH, LTD., MINNEAPOLIS, MN. FILED 4-1-1999.



OWNER OF U.S. REG. NO. 2,112,360.
NO CLAIM IS MADE TO THE EXCLUSIVE RIGHT TO USE "GROUP", APART FROM THE MARK AS SHOWN.
SEC. 2(F).

FOR TEMPORARY AND PERMANENT LEGAL STAFFING AND OUT PLACEMENT SERVICES (U.S. CLS. 100, 101 AND 102).

FIRST USE 12-31-1993; IN COMMERCE 12-31-1993.
EDWARD NELSON, EXAMINING ATTORNEY

CLASS 35—(Continued).

SN 75-710,963. KEPNER-TREGOE, INC., PRINCETON, NJ. FILED 5-21-1999.

BREAKAWAY ORGANIZATION

NO CLAIM IS MADE TO THE EXCLUSIVE RIGHT TO USE "ORGANIZATION", APART FROM THE MARK AS SHOWN.

FOR BUSINESS CONSULTATION, NAMELY, PROVIDING PROBLEM SOLVING AND DECISION MAKING CONSULTATION SERVICES BY DISTRIBUTING PRINTED AND AUDIO AND VISUAL MATERIALS AND SOFTWARE TO OTHER (U.S. CLS. 100, 101 AND 102).

JASON TURNER, EXAMINING ATTORNEY

SN 76-018,064. FUNMAIL, INC., LIVERMORE, CA. FILED 4-6-2000.

FUNMAIL.COM

OWNER OF U.S. REG. NO. 2,760,195. FOR ADVERTISING AND MARKETING SERVICES, NAMELY, PROMOTING THE GOODS AND SERVICES OF OTHERS BY PLACING ADVERTISEMENTS VIA AN ON LINE ELECTRONIC COMMUNICATIONS NETWORK (U.S. CLS. 100, 101 AND 102).

FIRST USE 4-28-1998; IN COMMERCE 5-17-1998. EDWARD NELSON, EXAMINING ATTORNEY

SN 76-034,826. FL RETAIL OPERATIONS, LLC, NEW YORK, NY. FILED 4-26-2000.

1 SPOT

FOR RETAIL STORE SERVICES SPECIALIZING IN ATHLETIC AND LEISURE CLOTHING AND FOOTWEAR (U.S. CLS. 100, 101 AND 102).

FIRST USE 4-0-2000; IN COMMERCE 4-0-2000. WON TEAK OH, EXAMINING ATTORNEY

SN 76-288,610. MELALEUCA, INC., IDAHO FALLS, ID. FILED 7-23-2001.

MELALEUCA: THE WELLNESS COMPANY

OWNER OF U.S. REG. NOS. 1,917,517, 2,538,961 AND OTHERS.

NO CLAIM IS MADE TO THE EXCLUSIVE RIGHT TO USE "WELLNESS COMPANY", APART FROM THE MARK AS SHOWN.

FOR MAIL ORDER CATALOG SERVICES FEATURING HEALTH CARE PRODUCTS, NUTRITIONALS, DIETARY SUPPLEMENTS, VITAMINS AND MINERAL SUPPLEMENTS, NUTRITIOUS FOODS, SNACKS AND BEVERAGES, COSMETICS, TOILETRIES, LAUNDRY CARE PRODUCTS, CLEANERS, SOAPS, DISHWASHER DETERGENTS, AIR FRESHENERS, DETERGENTS AND DISINFECTANTS (U.S. CLS. 100, 101 AND 102).

DAWN FELDMAN, EXAMINING ATTORNEY

CLASS 35—(Continued).

SN 76-374,751. HIGH ADVENTURE TREKS FOR DADS AND DAUGHTERS, DALLAS, TX. FILED 2-25-2002.

High Adventure Treks



for Dads & Daughters

NO CLAIM IS MADE TO THE EXCLUSIVE RIGHT TO USE "ADVENTURE TREKS" AND "FOR DADS & DAUGHTERS", APART FROM THE MARK AS SHOWN.

FOR PROMOTING INTERACTION BETWEEN DADS AND DAUGHTERS THROUGH THE ORGANIZATION OF OUTDOOR ADVENTURE ACTIVITIES (U.S. CLS. 100, 101 AND 102).

FIRST USE 4-9-2003; IN COMMERCE 4-9-2003. SHAUNIA WALLACE, EXAMINING ATTORNEY

SN 76-496,734. MSW GROUP, PLC, FARMINGTON HILLS, MI. FILED 3-12-2003.



FOR BUSINESS CONSULTATION SERVICES, ACCOUNTING SERVICES, AND BUSINESS MANAGEMENT SERVICES (U.S. CLS. 100, 101 AND 102).

FIRST USE 12-31-2002; IN COMMERCE 12-31-2002. DARRYL SPRUILL, EXAMINING ATTORNEY

SN 76-504,022. BBM CANADA, TORONTO, ONTARIO, CANADA, FILED 4-4-2003.



PRIORITY CLAIMED UNDER SEC. 44(D) ON CANADA APPLICATION NO. 1159777, FILED 11-21-2002, REG. NO. TMA615499, DATED 7-22-2004, EXPIRES 7-22-2019.

NO CLAIM IS MADE TO THE EXCLUSIVE RIGHT TO USE "CANADA", APART FROM THE MARK AS SHOWN.

FOR IMPARTIAL MEASUREMENT OF CIRCULATION, COVERAGE AND AUDIENCE OF ALL TYPES OF ADVERTISING MEDIA (U.S. CLS. 100, 101 AND 102).

FIRST USE 3-7-2002; IN COMMERCE 3-7-2002.

THEODORE MCBRIDE, EXAMINING ATTORNEY

CLASS 35—(Continued).

SN 76-506,931. GAGLIARDI, EUGENE D., ATGLEN, PA.
FILED 4-4-2003.

CREATIVATORS

THE MARK CONSISTS OF STANDARD CHARACTERS WITHOUT CLAIM TO ANY PARTICULAR FONT, STYLE, SIZE, OR COLOR.

NO CLAIM IS MADE TO THE EXCLUSIVE RIGHT TO USE LLC, APART FROM THE MARK AS SHOWN.

FOR BUSINESS CONSULTING SERVICES IN THE FIELD OF FOOD PRODUCTS AND FOOD PACKAGING, IN THE FOOD INDUSTRY (U.S. CLS. 100, 101 AND 102).

FIRST USE 0-0-1983; IN COMMERCE 0-0-1983.
ODESSA BIBBINS, EXAMINING ATTORNEY

SN 76-515,516. LOVER'S LANE, WESTLAND, MI. FILED 5-19-2003.

FREQUENT LOVER CARD

NO CLAIM IS MADE TO THE EXCLUSIVE RIGHT TO USE CARD, APART FROM THE MARK AS SHOWN.

FOR RETAIL STORE SERVICES IN THE FIELD OF LINGERIE, SWIM WEAR, LEATHER WEAR, MEN'S UNDERWEAR, ADULT GAMES, GAG GIFTS AND NOVELTIES, BATH ACCESSORIES, PRE-RECORDED VIDEO TAPES, BOOKS AND GREETING CARDS (U.S. CLS. 100, 101 AND 102).

FIRST USE 4-1-2003; IN COMMERCE 4-1-2003.
TRACY WHITAKER-BOWN, EXAMINING ATTORNEY

SN 76-518,996. THE DWYER GROUP, INC., WACO, TX.
FILED 6-2-2003.

THE DWYER GROUP

NO CLAIM IS MADE TO THE EXCLUSIVE RIGHT TO USE "GROUP", APART FROM THE MARK AS SHOWN.
SEC. 2(F).

FOR PROVIDING A WIDE VARIETY OF SUPPORT SERVICES TO FRANCHISE COMPANIES, NAMELY, ACCOUNTING SERVICES, PERSONNEL MANAGEMENT SERVICES AND BUSINESS MANAGEMENT AND BUSINESS CONSULTATION SERVICES (U.S. CLS. 100, 101 AND 102).

FIRST USE 5-1-1993; IN COMMERCE 5-1-1993.
ODESSA BIBBINS, EXAMINING ATTORNEY

CLASS 35—(Continued).

SN 76-542,539. GOODBAR, LESLIE, DBA ZIPPER, LOS ANGELES, CA. FILED 9-5-2003.



FOR ADVERTISING SERVICES NAMELY BUSINESS AND CREATIVE COMMERCIAL ADVERTISING CONSULTING; CREATION OF CORPORATE LOGOS AND BRAND IDENTITY FOR OTHERS; DIRECT EMAIL ADVERTISING; CREATION OF PUBLICITY TEXTS INCLUDING PRESS RELEASES AND PRESS KITS AND ADVERTISING BIOS; PREPARING AUDIO-VISUAL PRESENTATIONS FOR USE IN ADVERTISING IN THE MEDIA OF THE INTERNET, MULTIMEDIA PRESENTATIONS AND BROADCAST MEDIA; DISSEMINATION OF ADVERTISING MATTER; CONDUCTING STRATEGIC MARKETING RESEARCH; PUBLIC RELATIONS (U.S. CLS. 100, 101 AND 102).

FIRST USE 12-31-2001; IN COMMERCE 12-31-2001.
HENRY S. ZAK, EXAMINING ATTORNEY

SN 76-546,614. U. S. TOY CO., INC., GRANDVIEW, MO.
FILED 9-24-2003.

U. S. TOY MAGIC

OWNER OF U.S. REG. NO. 1,943,799.

NO CLAIM IS MADE TO THE EXCLUSIVE RIGHT TO USE "TOY MAGIC", APART FROM THE MARK AS SHOWN.

SEC. 2(F).

FOR RETAIL STORE SERVICES FEATURING PRODUCTS IN THE FIELD OF MAGIC, NAMELY, MAGICAL TRICK DEVICES, BOOKS ON MAGIC AND MAGIC ACCESSORIES (U.S. CLS. 100, 101 AND 102).

FIRST USE 8-0-1980; IN COMMERCE 8-0-1980.
RAUL CORDOVA, EXAMINING ATTORNEY

SN 76-553,378. THE SPORTS HOUSE, INC., HOUSTON, TX.
FILED 10-3-2003.



NO CLAIM IS MADE TO THE EXCLUSIVE RIGHT TO USE "SPORTS" AND "PERFORMANCE TRAINING", APART FROM THE MARK AS SHOWN.

FOR RETAIL STORES SERVICES FEATURING ATHLETIC AND SPORTS EQUIPMENT AND APPAREL; ATHLETIC RETAIL STORE SERVICES; APPAREL STORE SERVICES; SPORTS EQUIPMENT STORE SERVICES (U.S. CLS. 100, 101 AND 102).

FIRST USE 9-0-2002; IN COMMERCE 9-0-2002.
STACY WAHLBERG, EXAMINING ATTORNEY

CLASS 35—(Continued).

SN 76-558,596. WALGREEN CO., DEERFIELD, IL. FILED 10-28-2003.



FOR RETAIL DRUG STORE AND GENERAL CONSUMER MERCHANDISE STORE SERVICES (U.S. CLS. 100, 101 AND 102).
AMOS T. MATTHEWS, JR., EXAMINING ATTORNEY

CLASS 35—(Continued).

SN 76-561,052. THE KRYSTAL COMPANY, CHATTANOOGA, TN. FILED 11-19-2003.

SQUARE WEAR

THE MARK CONSISTS OF STANDARD CHARACTERS WITHOUT CLAIM TO ANY PARTICULAR FONT, STYLE, SIZE, OR COLOR.

NO CLAIM IS MADE TO THE EXCLUSIVE RIGHT TO USE "WEAR", APART FROM THE MARK AS SHOWN.

FOR MAIL ORDER SERVICES AND ONLINE RETAIL STORE SERVICES FEATURING CLOTHING (U.S. CLS. 100, 101 AND 102).

FIRST USE 10-14-2003; IN COMMERCE 10-14-2003.
BARBARA A. LOUGHRAN, EXAMINING ATTORNEY

SN 76-558,951. HOTEL GUEST SERVICES CORP., HONOLULU, HI. FILED 11-10-2003.



HOTEL GUEST SERVICES

NO CLAIM IS MADE TO THE EXCLUSIVE RIGHT TO USE "HOTEL GUEST SERVICES", APART FROM THE MARK AS SHOWN.

THE MARK CONSISTS IN PART OF A STYLIZED REPRESENTATION OF THE LETTERS HGS.

FOR ADVERTISING SERVICES, NAMELY, PRODUCING VIDEO ADVERTISEMENT SEGMENTS FOR ADVERTISER CUSTOMERS, PROGRAMMING SUCH VIDEO ADVERTISEMENT SEGMENTS FOR DISPLAY ON HOTEL IN-ROOM TVS, AND OFFERING HOTELS TO SUBSCRIBE TO SUCH PROGRAMMING FOR DISPLAY ON HOTEL IN-ROOM TVS (U.S. CLS. 100, 101 AND 102).

FIRST USE 4-7-1999; IN COMMERCE 4-7-1999.
STEVEN R. FINE, EXAMINING ATTORNEY

SN 76-562,041. ELECTROLUX HOME PRODUCTS, INC., CLEVELAND, OH. FILED 11-26-2003.

EHP DIRECT

THE MARK CONSISTS OF STANDARD CHARACTERS WITHOUT CLAIM TO ANY PARTICULAR FONT, STYLE, SIZE, OR COLOR.

NO CLAIM IS MADE TO THE EXCLUSIVE RIGHT TO USE "DIRECT", APART FROM THE MARK AS SHOWN.

FOR DISTRIBUTORSHIPS AND WHOLESALE DISTRIBUTORSHIPS IN THE FIELD OF MAJOR APPLIANCES, NAMELY HOUSEHOLD AND COMMERCIAL CLOTHES WASHING MACHINES, CLOTHES DRYING MACHINES, DISHWASHING MACHINES, REFRIGERATORS, FREEZERS, WINE COOLERS, ICE MAKERS, GAS AND ELECTRIC RANGES, OVENS, STOVES AND COOKTOPS, MICROWAVE OVENS, RANGE HOODS, ROOM AIR CONDITIONERS AND WATER PURIFYING APPARATUS (U.S. CLS. 100, 101 AND 102).

PAUL F. GAST, EXAMINING ATTORNEY

SN 76-559,175. MANDALAY RESORT GROUP, LAS VEGAS, NV. FILED 11-12-2003.



FOR RETAIL STORE SERVICES FEATURING WINES IN GENERAL, WINE ACCESSORIES, BEVERAGES AND GOURMET FOODS (U.S. CLS. 100, 101 AND 102).
DARRYL SPRUILL, EXAMINING ATTORNEY

CLASS 35—(Continued).

SN 76-564,097. STRATEGANCE, INC., WESTBOROUGH, MA. FILED 12-8-2003.

STRATEGANCE

THE MARK CONSISTS OF STANDARD CHARACTERS WITHOUT CLAIM TO ANY PARTICULAR FONT, STYLE, SIZE, OR COLOR.

FOR BUSINESS RESEARCH SERVICES RELATING TO CORPORATE COMPLIANCE WITH LEGISLATIVE MANDATES; BUSINESS CONSULTATION SERVICES RELATING TO CORPORATE COMPLIANCE WITH LEGISLATIVE MANDATES (U.S. CLS. 100, 101 AND 102).
ELISSA GARBER KON, EXAMINING ATTORNEY

SN 76-564,305. CABRILLO GROUP, INC., DEL MAR, CA. FILED 11-28-2003.

EMERGENCY OPTIONS

THE MARK CONSISTS OF STANDARD CHARACTERS WITHOUT CLAIM TO ANY PARTICULAR FONT, STYLE, SIZE, OR COLOR.

NO CLAIM IS MADE TO THE EXCLUSIVE RIGHT TO USE "EMERGENCY", APART FROM THE MARK AS SHOWN.

FOR ONLINE RETAIL STORE, RETAIL STORE AND MAIL ORDER SERVICES IN THE FIELDS OF PERSONAL AND CONSUMER SAFETY AND ELECTRONIC PRODUCTS, GIFTS AND PERSONAL ACCESSORIES, HOME AND OFFICE SAFETY PRODUCTS, FLASHLIGHTS, RESPIRATORY PROTECTION, GAS MASKS, PREPAREDNESS KITS, HELMETS, HARNESSSES, FIRST AID, TRAUMA AND SURVIVAL KITS, RADIOS AND COMMUNICATION DEVICES, HOME FIRE PROTECTION, LADDERS, EYEWEAR AND GLOVES, EMERGENCY BLANKETS, COMPASSES, LIGHTSTICKS, LIGHTERS, RADIATION ALERT DEVICES, RADIATION PROTECTION DEVICES AND COMPOSITIONS, KEY CHAINS, PARACHUTES, LOCATION DEVICES, TRAVEL ACCESSORIES, LUGGAGE AND TRAVEL BAGS, VITAMINS, OVER THE COUNTER DRUGS AND FOOD SUPPLEMENTS, HEALTH AND BEAUTY PRODUCTS, ATHLETIC AND EXERCISE EQUIPMENT, AIR FILTERS, PURIFIERS AND CONDITIONERS, LAMPS AND NIGHT LIGHTS, LED FLASHLIGHTS, CUTLERY AND TOOLS, HOME AND OFFICE CLEANING EQUIPMENT, MOTION, CARBON DIOXIDE AND SMOKE DETECTORS, VIDEOS, MANUALS AND OTHER WRITTEN SAFETY MATERIALS, PET PROTECTION EQUIPMENT AND GIFT CERTIFICATES (U.S. CLS. 100, 101 AND 102).
FIRST USE 5-1-2003; IN COMMERCE 5-1-2003.

MARLENE BELL, EXAMINING ATTORNEY

CLASS 35—(Continued).

SN 76-565,505. SOUTHEAST TOYOTA DISTRIBUTORS, LLC, DEERFIELD BEACH, FL. FILED 12-16-2003.

LIVE IT. LOVE IT. DRIVE IT.

THE MARK CONSISTS OF STANDARD CHARACTERS WITHOUT CLAIM TO ANY PARTICULAR FONT, STYLE, SIZE, OR COLOR.

FOR DISTRIBUTORSHIP SERVICES FEATURING VEHICLE ACCESSORIES FOR AUTOMOBILE AND TRUCK DEALERSHIPS (U.S. CLS. 100, 101 AND 102).

FIRST USE 9-10-2003; IN COMMERCE 9-10-2003.

KAREN BRACEY, EXAMINING ATTORNEY

SN 76-566,280. CODING & COMPLIANCE SOLUTIONS, INC., OLATHE, KS. FILED 12-1-2003.



CODING & COMPLIANCE INITIATIVES, INC.

NO CLAIM IS MADE TO THE EXCLUSIVE RIGHT TO USE "CODING & COMPLIANCE INITIATIVES, INC"., APART FROM THE MARK AS SHOWN.

FOR CONSULTING IN THE FIELD OF HEALTH CARE UTILIZATION AND REVIEW SERVICES, NAMELY, HEALTH CARE CODING, BILLING, THIRD PARTY PAYOR, REVIEWING MEDICAL RECORDS, RISK ASSESSMENT, REGULATORY INSURANCE COMPLIANCE, HUMAN RESOURCES, OPERATIONS EFFICIENCIES, RESOURCE UTILIZATION AND PHYSICIAN REVENUE ANALYSIS (U.S. CLS. 100, 101 AND 102).

ELIZABETH PIGNATELLO, EXAMINING ATTORNEY

SN 76-566,627. RUSSACK, HARVEY, YONKERS, NY. FILED 12-22-2003.

UCW UNIQUE CLOTHING WAREHOUSE

THE MARK CONSISTS OF STANDARD CHARACTERS WITHOUT CLAIM TO ANY PARTICULAR FONT, STYLE, SIZE, OR COLOR.

NO CLAIM IS MADE TO THE EXCLUSIVE RIGHT TO USE "CLOTHING WAREHOUSE", APART FROM THE MARK AS SHOWN.

FOR RETAIL STORE SERVICES AND ONLINE RETAIL STORE SERVICES FEATURING CLOTHING, CLOTHING ACCESSORIES AND SHOES (U.S. CLS. 100, 101 AND 102).

REBECCA SMITH, EXAMINING ATTORNEY

CLASS 35—(Continued).

SN 76-567,024. SQUARE M CO., MERRIAM, KS. FILED 12-15-2003.

SQUARE M

THE MARK CONSISTS OF STANDARD CHARACTERS WITHOUT CLAIM TO ANY PARTICULAR FONT, STYLE, SIZE, OR COLOR.

FOR MAIL ORDER CATALOG SERVICES AND DISTRIBUTORSHIP SERVICES FEATURING CRANES, HOISTS, TOOL BOXES, AIR COMPRESSORS AND WELDING TABLES (U.S. CLS. 100, 101 AND 102).

FIRST USE 5-0-2001; IN COMMERCE 9-0-2001.
BARBARA BROWN, EXAMINING ATTORNEY



SN 76-567,433. SQUARE M CO., MERRIAM, KS. FILED 12-15-2003.



FOR MAIL ORDER CATALOG SERVICES AND DISTRIBUTORSHIP SERVICES FEATURING CRANES, HOISTS, TOOL BOXES, AIR COMPRESSORS AND WELDING TABLES (U.S. CLS. 100, 101 AND 102).

FIRST USE 5-0-2001; IN COMMERCE 9-0-2001.
BARBARA BROWN, EXAMINING ATTORNEY



SN 76-568,979. AUTONATION HOLDING CORP., FT. LAUDERDALE, FL. FILED 1-9-2004.

LUXURNATION

THE MARK CONSISTS OF STANDARD CHARACTERS WITHOUT CLAIM TO ANY PARTICULAR FONT, STYLE, SIZE, OR COLOR.

FOR ON-LINE AUTOMOBILE DEALERSHIP SERVICES (U.S. CLS. 100, 101 AND 102).

FIRST USE 2-1-1994; IN COMMERCE 2-1-1994.
ANDREA K. NADELMAN, EXAMINING ATTORNEY

CLASS 35—(Continued).

SN 76-568,984. BIOPROCESS TECHNOLOGY CONSULTANTS INC., ACTON, MA. FILED 1-9-2004.

FROM CLONE TO CLINIC

THE MARK CONSISTS OF STANDARD CHARACTERS WITHOUT CLAIM TO ANY PARTICULAR FONT, STYLE, SIZE, OR COLOR.

FOR BUSINESS CONSULTATION RELATED TO ECONOMIC EVALUATIONS OF GMP MANUFACTURING FACILITIES; BUSINESS DEVELOPMENT SERVICES, NAMELY, PROVIDING START-UP SUPPORT FOR BIOPHARMACEUTICAL BUSINESSES; PROCESS ENGINEERING SERVICES FOR BIOPHARMACEUTICAL BUSINESSES; BUSINESS EVALUATION OF BIOPHARMACEUTICAL JOINT VENTURES (U.S. CLS. 100, 101 AND 102).

FIRST USE 7-0-2002; IN COMMERCE 7-0-2002.
ROBERT COGGINS, EXAMINING ATTORNEY



SN 76-569,357. JOBPACK TEC, INC., ELGIN, IL. FILED 1-12-2004.

JobPack

THE MARK CONSISTS OF STANDARD CHARACTERS WITHOUT CLAIM TO ANY PARTICULAR FONT, STYLE, SIZE, OR COLOR.

OWNER OF U.S. REG. NO. 2,000,876.
FOR COMPUTERIZED DATABASE MANAGEMENT IN THE FIELD OF METAL CUTTING AND MANUFACTURING (U.S. CLS. 100, 101 AND 102).

FIRST USE 2-2-1984; IN COMMERCE 2-2-1984.
BRIDGETT SMITH, EXAMINING ATTORNEY

CLASS 35—(Continued).

SN 76-570,693. FINEJEWELERS.COM, INC., NEW YORK, NY. FILED 1-20-2004.



NO CLAIM IS MADE TO THE EXCLUSIVE RIGHT TO USE "FINEJEWELERS.COM", APART FROM THE MARK AS SHOWN.

THE COLORS SILVER, GREY AND GOLD ARE CLAIMED AS A FEATURE OF THE MARK.

THE COLOR SILVER APPEARS IN THE PORTION OF THE MARK FORMING THE WORD PORTIONS "FINE" AND "COM"; THE COLOR GOLD APPEARS IN THE PORTION OF THE MARK FORMING THE WORD PORTION "JEWELERS"; AN IMAGE OF THE ROUND FACE OF A FACETED DIAMOND FORMS THE "DOT" IN "FINEJEWELERS.COM"; THE COLOR GREY APPEARS IN THE PORTION OF THE MARK FORMING A SHADOW BEHIND EACH CHARACTER IN "FINEJEWELERS.COM".

SEC. 2(F).

FOR RETAIL JEWELRY STORES; COMPUTERIZED ON-LINE RETAIL SERVICES IN THE FIELD OF JEWELRY (U.S. CLS. 100, 101 AND 102).

FIRST USE 4-1-1999; IN COMMERCE 4-1-1999.

PAUL F. GAST, EXAMINING ATTORNEY

SN 76-572,259. HELMES CONSULTING LLC, BOSTON, MA. FILED 1-26-2004.

CRITICAL BAND ACTIVITIES

NO CLAIM IS MADE TO THE EXCLUSIVE RIGHT TO USE "ACTIVITIES", APART FROM THE MARK AS SHOWN.

FOR BUSINESS PROJECT SCHEDULE ANALYSIS SERVICES (U.S. CLS. 100, 101 AND 102).

SHAUNIA WALLACE, EXAMINING ATTORNEY

SN 76-573,539. O'NEILL LIFTON HUFFSTETLER FEENEY & BARRY LLC, POUND RIDGE, NY. FILED 2-2-2004.

TUESDAY TEAM

THE MARK CONSISTS OF STANDARD CHARACTERS WITHOUT CLAIM TO ANY PARTICULAR FONT, STYLE, SIZE, OR COLOR.

FOR ADVERTISING SERVICES, NAMELY CONDUCTING MARKET RESEARCH AND MARKET ANALYSIS; CONDUCTING MARKETING STUDIES; CONDUCTING MARKET RESEARCH SURVEYS; DIRECT MAIL ADVERTISING; PUBLIC RELATIONS; CORPORATE BRANDING AND DEVELOPMENT OF BRAND STRATEGIES FOR OTHERS FOR USE IN PRINT, TELEVISION, RADIO, BILLBOARDS AND WEB SITES IN CONNECTION WITH ISSUES OF INTEREST TO THE PUBLIC INCLUDING POLITICAL ISSUES, PUBLIC POLICY ISSUES AND CORPORATE ISSUES (U.S. CLS. 100, 101 AND 102).

PAUL F. GAST, EXAMINING ATTORNEY

CLASS 35—(Continued).

SN 76-574,102. FARM EMPLOYERS LABOR SERVICE, SACRAMENTO, CA. FILED 2-4-2004.

OWNER OF U.S. REG. NO. 1,922,344.

FOR CONSULTING SERVICES PERTAINING TO PERSONNEL MANAGEMENT AND LABOR MANAGEMENT RELATIONS FOR AGRICULTURAL EMPLOYERS (U.S. CLS. 100, 101 AND 102).

FIRST USE 12-1-1979; IN COMMERCE 12-1-1979.

ELIZABETH PIGNATELLO, EXAMINING ATTORNEY

SN 76-574,150. NEW SHOES MEDIA, LLC, NASHVILLE, TN. FILED 2-4-2004.

THE RISK AND REWARD NETWORK

THE MARK CONSISTS OF STANDARD CHARACTERS WITHOUT CLAIM TO ANY PARTICULAR FONT, STYLE, SIZE, OR COLOR.

FOR RETAIL GAME AND CLOTHING STORES (U.S. CLS. 100, 101 AND 102).

PAUL F. GAST, EXAMINING ATTORNEY

SN 76-575,283. PASSANG, TENZIN, BOULDER, CO. FILED 2-12-2004.

SILK ROAD INTERIORS

THE MARK CONSISTS OF STANDARD CHARACTERS WITHOUT CLAIM TO ANY PARTICULAR FONT, STYLE, SIZE, OR COLOR.

NO CLAIM IS MADE TO THE EXCLUSIVE RIGHT TO USE "INTERIORS", APART FROM THE MARK AS SHOWN.

FOR RETAIL STORE SERVICES AND WHOLESALE DISTRIBUTORSHIP SERVICES OF RUGS, CARPETS, ARTS AND CRAFTS, AND HOME DECOR (U.S. CLS. 100, 101 AND 102).

FIRST USE 12-1-2003; IN COMMERCE 12-1-2003.

SOPHIA S. KIM, EXAMINING ATTORNEY

CLASS 35—(Continued).

SN 76-575,784. NESTLE WATERS NORTH AMERICA INC., GREENWICH, CT. FILED 2-17-2004.

PRIVATE STOCKROOM

THE MARK CONSISTS OF STANDARD CHARACTERS WITHOUT CLAIM TO ANY PARTICULAR FONT, STYLE, SIZE, OR COLOR.

FOR RETAIL MAIL ORDER AND INTERNET CATALOG SERVICES FEATURING HOME DECOR, TRAVEL AND GARDEN ITEMS (U.S. CLS. 100, 101 AND 102).

FIRST USE 6-0-2002; IN COMMERCE 6-0-2002.
ROBERT COGGINS, EXAMINING ATTORNEY

SN 76-575,985. DEUTSCHE TELEKOM AG, BONN, 53113, FED REP GERMANY, FILED 2-17-2004.

T-M3

THE MARK CONSISTS OF STANDARD CHARACTERS WITHOUT CLAIM TO ANY PARTICULAR FONT, STYLE, SIZE, OR COLOR.

OWNER OF FED REP GERMANY REG. NO. 30341456, DATED 9-22-2003, EXPIRES 8-31-2013.

FOR TELEPHONE DIRECTORY ASSISTANCE SERVICES; ADVERTISING SERVICES, NAMELY, PREPARING AND PLACING ADVERTISEMENTS FOR OTHERS; PROMOTING THE GOODS AND SERVICES OF OTHERS THROUGH THE DISTRIBUTION OF PRINTED ADVERTISING MATERIALS, PRINTED DIRECTORIES; AND ENCODED MEDIA, AND THROUGH THE DISSEMINATION OF PROMOTIONAL MATERIALS, THROUGH DIRECT MAIL ADVERTISING, THROUGH ELECTRONIC BILLBOARD ADVERTISING, AND PREPARING AUDIO-VISUAL PRESENTATIONS FOR USE IN ADVERTISING; BUSINESS SERVICES, NAMELY, BUSINESS APPRAISALS, BUSINESS AUDITING, PROVIDING BUSINESS INFORMATION, NAMELY, PREPARING BUSINESS REPORTS AND CONDUCTING BUSINESS RESEARCH, ANALYSIS AND SURVEYS, BUSINESS MANAGEMENT PLANNING, BUSINESS MANAGEMENT CONSULTATION, BUSINESS MANAGEMENT SUPERVISION, CONDUCTING BUSINESS NETWORKING FOR OTHERS; BUSINESS MANAGEMENT AND CONSULTING SERVICES, EXCLUDING AGRICULTURAL BUSINESS MANAGEMENT AND CONSULTING SERVICES; BUSINESS INFORMATION SERVICES IN THE FIELD OF ADVERTISING, AND MARKETING; PROVIDING INFORMATION VIA THE TELEPHONE AND THE GLOBAL COMMUNICATION NETWORKS IN THE FIELD OF BUSINESS MARKETING; PROFESSIONAL CONSULTANCY IN THE FIELD OF DATA PROCESSING; RENTAL OF DATA PROCESSING EQUIPMENT (U.S. CLS. 100, 101 AND 102).

JEFFERY COWARD, EXAMINING ATTORNEY

CLASS 35—(Continued).

SN 76-577,577. PEPKOM INC., BOYNTON BEACH, FL. FILED 2-20-2004.

PEPKOM

THE MARK CONSISTS OF STANDARD CHARACTERS WITHOUT CLAIM TO ANY PARTICULAR FONT, STYLE, SIZE, OR COLOR.

FOR ARRANGING, CONDUCTING AND PROMOTING TRADE SHOW EXHIBITIONS IN THE FIELD OF PORTABLE AND WIRELESS TECHNOLOGY; PROMOTING THE SALE OF GOODS AND SERVICES OF OTHERS THROUGH THE DISTRIBUTION OF PRINTED MATERIAL AND PROMOTIONAL EVENTS (U.S. CLS. 100, 101 AND 102).

FIRST USE 1-0-1997; IN COMMERCE 1-0-1997.
PAUL F. GAST, EXAMINING ATTORNEY

SN 76-578,089. COSE DEL MONDO, INC., HATBORO, PA. FILED 2-27-2004.

BCP VIP CLUB

THE MARK CONSISTS OF STANDARD CHARACTERS WITHOUT CLAIM TO ANY PARTICULAR FONT, STYLE, SIZE, OR COLOR.

NO CLAIM IS MADE TO THE EXCLUSIVE RIGHT TO USE "CLUB", APART FROM THE MARK AS SHOWN.

FOR DISSEMINATION OF ADVERTISING, ADVERTISING MATTER AND ADVERTISING MATERIALS FOR OTHERS; PROMOTING THE GOODS AND SERVICES OF OTHERS THROUGH THE DISTRIBUTION OF DISCOUNT CARDS; COOPERATIVE ADVERTISING AND MARKETING SERVICES; PROVIDING BUSINESS MARKETING INFORMATION; BUSINESS MARKETING CONSULTING SERVICES, AND ORGANIZING EXHIBITIONS FOR BUSINESS MARKETING, BUSINESS OPERATIONS, AND LEGAL ISSUES (U.S. CLS. 100, 101 AND 102).

MARK T. MULLEN, EXAMINING ATTORNEY

SN 76-579,422. INTELLIM RESEARCH, INC., BOCA RATON, FL. FILED 3-3-2004.

INTELLISAVINGS

THE MARK CONSISTS OF STANDARD CHARACTERS WITHOUT CLAIM TO ANY PARTICULAR FONT, STYLE, SIZE, OR COLOR.

FOR PROVIDING AN ON-LINE WEBSITE FEATURING SAVINGS COUPONS VIA A GLOBAL COMPUTER NETWORK (U.S. CLS. 100, 101 AND 102).

FIRST USE 2-21-2004; IN COMMERCE 2-21-2004.
SUSAN LESLIE DUBOIS, EXAMINING ATTORNEY

CLASS 35—(Continued).

SN 76-579,823. RL & ASSOCIATES, MCMINNVILLE, OR.
FILED 3-8-2004.

BY NEIGHBOR

THE MARK CONSISTS OF STANDARD CHARACTERS WITHOUT CLAIM TO ANY PARTICULAR FONT, STYLE, SIZE, OR COLOR.

FOR MARKETING AND ADVERTISING (U.S. CLS. 100, 101 AND 102).

STEVEN R. FINE, EXAMINING ATTORNEY

SN 76-582,295. THE COLLABORATIVE LAW ASSOCIATION,
CLAYTON, MO. FILED 3-22-2004.



NO CLAIM IS MADE TO THE EXCLUSIVE RIGHT TO USE COLLABORATIVE FAMILY LAW ASSOCIATION, APART FROM THE MARK AS SHOWN.

THE COLOR(S) BLUE, YELLOW, GREEN, RED, BLACK AND WHITE IS/ARE CLAIMED AS A FEATURE OF THE MARK.

THE COLOR(S) BLUE, YELLOW, GREEN, RED, BLACK AND WHITE IS/ARE CLAIMED AS A FEATURE OF THE MARK.

BLACK SQUARE OVERLYING A MOSAIC OF COLORED SHAPES FORMING A LARGER SQUARE

FOR PROMOTING PUBLIC AWARENESS OF THE NEED FOR THE USE OF LEGAL DISPUTE RESOLUTION SERVICES THROUGH EDUCATION, RESEARCH, AND TRAINING SERVICES PROVIDED TO LAWYERS AND THE PUBLIC (U.S. CLS. 100, 101 AND 102).

FIRST USE 10-31-2003; IN COMMERCE 10-31-2003.
STANLEY I. OSBORNE, EXAMINING ATTORNEY

CLASS 35—(Continued).

SN 76-582,847. SRI/SURGICAL EXPRESS, INC., TAMPA, FL.
FILED 3-24-2004.

ECOSENSE

THE MARK CONSISTS OF STANDARD CHARACTERS WITHOUT CLAIM TO ANY PARTICULAR FONT, STYLE, SIZE, OR COLOR.

FOR INCENTIVE AWARD PROGRAMS TO RECOGNIZE AND PROMOTE ENVIRONMENTAL AWARENESS AND SAVINGS BY HOSPITALS AND OTHER SURGICAL AND HEALTHCARE FACILITIES (U.S. CLS. 100, 101 AND 102).

NANCY CLARKE, EXAMINING ATTORNEY

SN 76-584,734. KTM NORTH AMERICA, INC., AMHERST,
OH. FILED 4-5-2004.

HARDEQUIPMENT

THE MARK CONSISTS OF STANDARD CHARACTERS WITHOUT CLAIM TO ANY PARTICULAR FONT, STYLE, SIZE, OR COLOR.

FOR CATALOG SERVICES FEATURING MOTORCYCLE PARTS AND ACCESSORIES (U.S. CLS. 100, 101 AND 102).

FIRST USE 0-0-1997; IN COMMERCE 0-0-1997.

ARETHA SOMERVILLE, EXAMINING ATTORNEY

SN 76-585,440. AMERICAN SIGNATURE, INC., COLUMBUS,
OH. FILED 4-7-2004.

YOUR TOTAL HOME SOLUTION

THE MARK CONSISTS OF STANDARD CHARACTERS WITHOUT CLAIM TO ANY PARTICULAR FONT, STYLE, SIZE, OR COLOR.

NO CLAIM IS MADE TO THE EXCLUSIVE RIGHT TO USE "HOME SOLUTION", APART FROM THE MARK AS SHOWN.

FOR RETAIL FURNITURE STORE SERVICES AND ELECTRONIC RETAIL FURNITURE STORE SERVICES OVER THE INTERNET (U.S. CLS. 100, 101 AND 102).

FIRST USE 5-24-2004; IN COMMERCE 5-24-2004.

ALLISON HOLTZ, EXAMINING ATTORNEY

CLASS 35—(Continued).

SN 76-586,727. KANNER, MARSHALL, MIAMI, FL. FILED 4-15-2004.

DMES OF AMERICA

THE MARK CONSISTS OF STANDARD CHARACTERS WITHOUT CLAIM TO ANY PARTICULAR FONT, STYLE, SIZE, OR COLOR.

NO CLAIM IS MADE TO THE EXCLUSIVE RIGHT TO USE "AMERICA", APART FROM THE MARK AS SHOWN.

FOR OPERATION OF BUSINESS FOR OTHERS IN THE FIELD OF MEDICAL EQUIPMENT SUPPLY, NAMELY, PROVIDING BILLING SERVICES, ACTING AS PURCHASING AGENTS FOR MEDICAL EQUIPMENT AND PHARMACEUTICALS AND BUSINESS PROMOTION IN THE NATURE OF BRAND DEVELOPMENT, ADVERTISING AND MARKETING (U.S. CLS. 100, 101 AND 102).

FIRST USE 3-15-2004; IN COMMERCE 3-15-2004.
WENDY GOODMAN, EXAMINING ATTORNEY

SN 76-586,763. IHMA TECHNOLOGIES, INC., HOUSTON, TX. FILED 4-14-2004.

IHMA TECHNOLOGIES

THE MARK CONSISTS OF STANDARD CHARACTERS WITHOUT CLAIM TO ANY PARTICULAR FONT, STYLE, SIZE, OR COLOR.

NO CLAIM IS MADE TO THE EXCLUSIVE RIGHT TO USE TECHNOLOGIES, APART FROM THE MARK AS SHOWN.

FOR BUSINESS MANAGEMENT CONSULTATION FOR THE HEALTH CARE INDUSTRY, NAMELY PROVIDING HEALTHCARE DATA ANALYSIS, RESEARCH AND INFORMATION TO EMPLOYERS, EMPLOYEES AND CUSTOMERS UTILIZING DATA RECEIVED THROUGH SUBMISSIONS FROM EMPLOYERS (U.S. CLS. 100, 101 AND 102).

STACY WAHLBERG, EXAMINING ATTORNEY

CLASS 35—(Continued).

SN 76-587,308. CRAZY GRAZER LLC, LAS VEGAS, NV. FILED 4-19-2004.

2 WAZE 2 GRAZE

THE MARK CONSISTS OF STANDARD CHARACTERS WITHOUT CLAIM TO ANY PARTICULAR FONT, STYLE, SIZE, OR COLOR.

FOR RETAIL STORE SERVICES FEATURING GENERAL CONSUMER MERCHANDISE, ELECTRONICS, BOOKS, COMPUTER HARDWARE AND SOFTWARE, PRE-RECORDED AUDIO AND VIDEO TAPES AND DISCS, HEALTH AND BEAUTY PRODUCTS, FURNITURE, OFFICE SUPPLIES, SPORTING GOODS, PHOTOGRAPHIC, AUDIO AND VIDEO GOODS, CONSUMER APPLIANCES, AND GAMES (U.S. CLS. 100, 101 AND 102).

FIRST USE 12-0-2002; IN COMMERCE 10-0-2003.
GLENN CLARK, EXAMINING ATTORNEY

SN 76-588,177. BEL-AQUA POOL SUPPLY, INC., NEW ROCHELLE, NY. FILED 4-22-2004.

**DISTRIBUTORS OF EVERYTHING FOR A POOL OR SPA
EXCEPT THE WATER AND THE WORRIES**

THE MARK CONSISTS OF STANDARD CHARACTERS WITHOUT CLAIM TO ANY PARTICULAR FONT, STYLE, SIZE, OR COLOR.

FOR WHOLESALE DISTRIBUTORSHIPS FEATURING SWIMMING POOL AND SPA SUPPLIES, PARTS AND CHEMICALS (U.S. CLS. 100, 101 AND 102).

FIRST USE 0-0-2003; IN COMMERCE 0-0-2003.
ROBERT COGGINS, EXAMINING ATTORNEY

SN 76-589,851. MOTHERS AGAINST SCHOOL HAZING, INC. (MASH), ST. AMANT, LA. FILED 4-30-2004.



NO CLAIM IS MADE TO THE EXCLUSIVE RIGHT TO USE "MOTHERS AGAINST SCHOOL HAZING", APART FROM THE MARK AS SHOWN.

FOR CHARITABLE SERVICES, NAMELY PROMOTING THE INTERESTS OF INDIVIDUALS OPPOSED TO HAZING, BULLYING, AND ANY ABUSIVE ACT TOWARDS CHILDREN (U.S. CLS. 100, 101 AND 102).

FIRST USE 1-6-2004; IN COMMERCE 1-6-2004.
TRACY WHITAKER-BOWN, EXAMINING ATTORNEY

CLASS 35—(Continued).

SN 76-590,397. TOTALMOVE INC., SHELTON, CT. FILED 5-4-2004.

TotalMove

THE MARK CONSISTS OF STANDARD CHARACTERS WITHOUT CLAIM TO ANY PARTICULAR FONT, STYLE, SIZE, OR COLOR.

OWNER OF U.S. REG. NOS. 2,176,182 AND 2,210,042.
FOR REFERRALS IN THE FIELD OF HOME SALES, MOVING, MORTGAGE PLACEMENT, HOME INSPECTION, INSURANCE, VAN LINE OR TRUCK RENTAL, HOME CLEANING AND HOME REPAIR; PROVIDING NEIGHBORHOOD DEMOGRAPHIC INFORMATION; AND NOTIFYING THIRD PARTIES OF ADDRESS CHANGES FOR OTHERS (U.S. CLS. 100, 101 AND 102).

FIRST USE 1-15-2004; IN COMMERCE 1-15-2004.
SUE LAWRENCE, EXAMINING ATTORNEY

SN 76-590,849. DUTY FREE AMERICAS, INC., HOLLYWOOD, FL. FILED 5-6-2004.



NO CLAIM IS MADE TO THE EXCLUSIVE RIGHT TO USE DUTY FREE AND AMERICAS, APART FROM THE MARK AS SHOWN.

FOR RETAIL STORE SERVICES FEATURING DUTY FREE GOODS, NAMELY, FRAGRANCES, COSMETICS, AND BATH AND BODY PRODUCTS, NAMELY PERFUMES, COLOGNES, FACIAL TREATMENTS, MAKE-UP, LOTIONS, POWDERS, OILS, SOAPS, DEODORANTS, AND HAIR, NAIL AND SKINCARE PRODUCTS; TOBACCO PRODUCTS, INCLUDING BUT NOT LIMITED TO IMPORTED AND DOMESTIC CIGARETTES, CIGARS, PIPES, PIPE TOBACCO, CHEWING TOBACCO, AND SMOKERS' ARTICLES, NAMELY, LIGHTERS, MATCHES, CIGAR UTENSILS, NAMELY, HUMIDORS, CLIPPERS, CIGAR CASES AND ASHTRAYS; ALCOHOLIC BEVERAGES, NAMELY, IMPORTED AND DOMESTIC LIQUORS, MIXERS, BEER, WINE, CHAMPAGNE, LIQUEURS, AND PRE-MIXED LIQUOR DRINKS; FOOD, CONFECTION AND BEVERAGE PRODUCTS, NAMELY CHIPS, COOKIES, ASSORTED NUTS, CHOCOLATES, HARD CANDY, CHEWING GUM, ASSORTED SNACK SEEDS, SOFT DRINKS, JUICES,

CLASS 35—(Continued).

WATER, HYDRATION DRINKS AND ENERGY DRINKS; GOURMET AND SPECIALTY PACKAGED FOOD PRODUCTS, INCLUDING BUT NOT LIMITED TO SMOKED FISH, CAVIAR, MUSSELS, SARDINES AND EEL; APPAREL ACCESSORIES, NAMELY, BELTS, SCARVES, TIES, HATS AND GLOVES; FASHION EYEWEAR, SUNGLASSES AND ATHLETIC-ORIENTED EYEWEAR; PURSES AND HANDBAGS; SMALL LEATHER GOODS, NAMELY, WALLETS AND BRIEF-CASES; WATCHES AND CLOCKS; JEWELRY; WRITING INSTRUMENTS; CRYSTAL GIFT ITEMS; NOVELTY GIFTS AND SOUVENIRS, NAMELY, PLUSH TOYS, PLAYING CARDS, MAGIC TRICKS, KEY CHAINS, DRINKING MUGS, POSTCARDS, T-SHIRTS AND SWEATSHIRTS; ELECTRONICS, CAMERAS, CALCULATORS, COMPUTERS, BATTERIES AND MUSIC; AND TRAVEL-RELATED PRODUCTS, NAMELY, LUGGAGE, BACKPACKS, DUFFEL BAGS, SHOULDER BAGS, WAIST PACKS, MONEY BELTS, TOILETRY KITS, LOCKS, TAGS, STRAPS, CONVERTERS AND INFLIGHT COMFORT ITEMS (U.S. CLS. 100, 101 AND 102).

FIRST USE 2-28-2002; IN COMMERCE 2-28-2002.
RON FAIRBANKS, EXAMINING ATTORNEY

SN 76-591,831. DESIGNER FURNITURE WAREHOUSE, INC., COLUMBUS, OH. FILED 5-12-2004.



NO CLAIM IS MADE TO THE EXCLUSIVE RIGHT TO USE FURNITURE WAREHOUSE, APART FROM THE MARK AS SHOWN.

FOR RETAIL STORE SERVICES AND COMPUTERIZED ON-LINE ORDERING SERVICES ALL FEATURING FURNITURE (U.S. CLS. 100, 101 AND 102).

FIRST USE 12-1-2003; IN COMMERCE 12-1-2003.
TARAH HARDY, EXAMINING ATTORNEY

SN 76-593,846. T&M, INC., NORTH MYRTLE BEACH, SC. FILED 5-24-2004.

ORIGINAL PAINTER'S HOMEMADE ICE CREAM

THE MARK CONSISTS OF STANDARD CHARACTERS WITHOUT CLAIM TO ANY PARTICULAR FONT, STYLE, SIZE, OR COLOR.

NO CLAIM IS MADE TO THE EXCLUSIVE RIGHT TO USE "ORIGINAL" AND "HOMEMADE ICE CREAM", APART FROM THE MARK AS SHOWN.

FOR RETAIL ICE CREAM SHOP SERVICES (U.S. CLS. 100, 101 AND 102).

FIRST USE 3-3-1999; IN COMMERCE 3-3-1999.
MARLENE BELL, EXAMINING ATTORNEY

CLASS 35—(Continued).

SN 76-595,557. MEATBALL MOMENTS PRODUCTIONS, INC., SAN ANTONIO, TX. FILED 6-4-2004.

MEATBALL MOMENTS

THE MARK CONSISTS OF STANDARD CHARACTERS WITHOUT CLAIM TO ANY PARTICULAR FONT, STYLE, SIZE, OR COLOR.

FOR ADVERTISING AGENCY, NAMELY, PROMOTING THE GOODS AND SERVICES OF OTHERS THROUGH PROMOTIONAL CONSULTATION; THE PREPARATION OF RADIO ADVERTISING MATERIALS; RENDERING ADVERTISING, MARKETING, AND SALES PROMOTIONS ADVICE; AND BY PROMOTING THE GOODS AND SERVICES OF OTHERS ON RADIO PROGRAMS (U.S. CLS. 100, 101 AND 102).

FIRST USE 6-1-2004; IN COMMERCE 6-1-2004.
JERI J. FICKES, EXAMINING ATTORNEY

CLASS 35—(Continued).

SN 76-597,073. CHICO'S RETAIL SERVICES, INC., FT. MYERS, FL. FILED 6-10-2004.

WHITE LIST

THE MARK CONSISTS OF STANDARD CHARACTERS WITHOUT CLAIM TO ANY PARTICULAR FONT, STYLE, SIZE, OR COLOR.

FOR RETAIL STORE SERVICES IN THE FIELD OF CLOTHING AND PERSONAL CARE PRODUCTS FEATURING A BONUS INCENTIVE PROGRAM FOR CUSTOMERS (U.S. CLS. 100, 101 AND 102).

BARBARA BROWN, EXAMINING ATTORNEY

SN 76-596,675. FASHION EXCHANGE CONSIGNMENT INC., MCLEAN, VA. FILED 6-10-2004.



FOR RETAIL CONSIGNMENT STORE SERVICES FEATURING WOMEN'S CLOTHING AND ACCESSORIES (U.S. CLS. 100, 101 AND 102).

FIRST USE 10-17-1995; IN COMMERCE 10-17-1995.
MARGERY A. TIERNEY, EXAMINING ATTORNEY

SN 76-597,306. BAER SUPPLY COMPANY, VERNON HILLS, IL. FILED 6-15-2004.



FOR DISTRIBUTORSHIP SERVICES IN THE FIELDS OF WOODWORKING SUPPLIES, FITTINGS AND PARTS, HARDWARE AND TOOLS, AND WOODWORKING SHOP SUPPLIES, SURFACING MATERIALS, BOARD AND PANEL PRODUCTS, AND MACHINERY; INVENTORY CONTROL AND MANAGEMENT IN THE FIELDS OF WOODWORKING SUPPLIES, FITTINGS AND PARTS, HARDWARE AND TOOLS, AND WOODWORKING SHOP SUPPLIES, SURFACING MATERIALS, BOARD AND PANEL PRODUCTS, AND MACHINERY; AND BUSINESS CONSULTATION RELATED THERETO (U.S. CLS. 100, 101 AND 102).

FIRST USE 0-0-1976; IN COMMERCE 0-0-1976.
KELLY BOULTON, EXAMINING ATTORNEY

SN 76-597,038. R.F. TECHNOLOGIES, INC., BETHALTO, IL. FILED 6-7-2004.

REALLY FAST ◦ REALLY FRIENDLY ◦ REALLY FOCUSED .

THE MARK CONSISTS OF STANDARD CHARACTERS WITHOUT CLAIM TO ANY PARTICULAR FONT, STYLE, SIZE, OR COLOR.

FOR ADVERTISING AND ADVERTISING SERVICES (U.S. CLS. 100, 101 AND 102).

DEZMONA MIZELLE, EXAMINING ATTORNEY

CLASS 35—(Continued).

SN 76-597,715. IGLOO'S FROZEN DRINKS, DALLAS, TX.
FILED 6-17-2004.

DAQ SHACK

THE MARK CONSISTS OF STANDARD CHARACTERS WITHOUT CLAIM TO ANY PARTICULAR FONT, STYLE, SIZE, OR COLOR.

NO CLAIM IS MADE TO THE EXCLUSIVE RIGHT TO USE DAQ, APART FROM THE MARK AS SHOWN.

FOR RETAIL DISTRIBUTORSHIPS SERVICES FEATURING FROZEN ALCOHOLIC BEVERAGES PREPARED FOR OFF-SITE CONSUMPTION (U.S. CLS. 100, 101 AND 102).

ALICE BENMAMAN, EXAMINING ATTORNEY

SN 76-597,779. SYBIL HARMON, INC., GREENSBORO, NC.
FILED 6-15-2004.

ART OF WELLBEING EXPO

THE MARK CONSISTS OF STANDARD CHARACTERS WITHOUT CLAIM TO ANY PARTICULAR FONT, STYLE, SIZE, OR COLOR.

NO CLAIM IS MADE TO THE EXCLUSIVE RIGHT TO USE "EXPO", APART FROM THE MARK AS SHOWN.

FOR ARRANGING AND CONDUCTING TRADE SHOW EXHIBITIONS IN THE FIELD OF HOLISTIC HEALTH CARE AND ALTERNATIVE MEDICINE (U.S. CLS. 100, 101 AND 102).

FIRST USE 10-19-2002; IN COMMERCE 10-19-2002.
CHARLES JOYNER, EXAMINING ATTORNEY

SN 76-597,857. ASD SPECIALTY HEALTHCARE, INC.,
ADDISON, TX. FILED 6-17-2004.

POINT2POINT

THE MARK CONSISTS OF STANDARD CHARACTERS WITHOUT CLAIM TO ANY PARTICULAR FONT, STYLE, SIZE, OR COLOR.

FOR WHOLESALE DISTRIBUTORSHIP SERVICES IN THE FIELD OF SPECIALTY PHARMACEUTICALS AND HEALTHCARE PRODUCTS (U.S. CLS. 100, 101 AND 102).

MICHAEL KEATING, EXAMINING ATTORNEY

CLASS 35—(Continued).

SN 76-597,949. CFS MEDIACOM, LLC., BOCA RATON, FL.
FILED 6-18-2004.

AUTOEMPLOY

THE MARK CONSISTS OF STANDARD CHARACTERS WITHOUT CLAIM TO ANY PARTICULAR FONT, STYLE, SIZE, OR COLOR.

FOR EMPLOYMENT HIRING, RECRUITING, PLACEMENT, STAFFING AND CAREER NETWORKING SERVICES (U.S. CLS. 100, 101 AND 102).

FIRST USE 10-4-1999; IN COMMERCE 10-4-1999.

ARETHA SOMERVILLE, EXAMINING ATTORNEY

SN 76-598,088. ECOLIVING, INC., AUSTIN, TX. FILED 6-18-2004.



FOR RETAIL STORE SERVICES FEATURING A VARIETY OF APPLIANCES, BUILDING MATERIALS, PLUMBING SUPPLIES, ROOFING MATERIALS, HOME FURNISHINGS AND ITEMS USED IN HOME IMPROVEMENT (U.S. CLS. 100, 101 AND 102).

FIRST USE 2-11-2004; IN COMMERCE 3-1-2004.

RONALD AIKENS, EXAMINING ATTORNEY

CLASS 35—(Continued).

SN 76-598,089. ECOLIVING, INC., AUSTIN, TX. FILED 6-18-2004.

ECOLIVING

THE MARK CONSISTS OF STANDARD CHARACTERS WITHOUT CLAIM TO ANY PARTICULAR FONT, STYLE, SIZE, OR COLOR.

FOR RETAIL STORE SERVICES FEATURING A VARIETY OF APPLIANCES, BUILDING MATERIALS, PLUMBING SUPPLIES, ROOFING MATERIALS, HOME FURNISHINGS AND ITEMS USED IN HOME IMPROVEMENT (U.S. CLS. 100, 101 AND 102).

FIRST USE 2-11-2004; IN COMMERCE 3-1-2004.
RONALD AIKENS, EXAMINING ATTORNEY

CLASS 35—(Continued).

SN 76-598,329. PHOENIX MARKETING SOLUTIONS, L.L.C., WARREN, NJ. FILED 6-17-2004.



NO CLAIM IS MADE TO THE EXCLUSIVE RIGHT TO USE "AUDIENCE GENERATION", APART FROM THE MARK AS SHOWN.

FOR BUSINESS MARKETING SERVICES, NAMELY, AUDIENCE GENERATION FOR MEDICAL SEMINARS AND PROGRAMS (U.S. CLS. 100, 101 AND 102).

FIRST USE 4-27-2004; IN COMMERCE 4-27-2004.
WINSTON FOLMAR, EXAMINING ATTORNEY

SN 76-598,408. JCC ASSOCIATION OF NORTH AMERICA, NEW YORK CITY, NY. FILED 6-21-2004.

INSPIRING JEWISH JOURNEYS

THE MARK CONSISTS OF STANDARD CHARACTERS WITHOUT CLAIM TO ANY PARTICULAR FONT, STYLE, SIZE, OR COLOR.

NO CLAIM IS MADE TO THE EXCLUSIVE RIGHT TO USE "JEWISH", APART FROM THE MARK AS SHOWN.

FOR ASSOCIATION SERVICES, NAMELY PROMOTING THE INTERESTS OF LOCAL, NATIONAL AND INTERNATIONAL JEWISH COMMUNITIES (U.S. CLS. 100, 101 AND 102).

FIRST USE 5-2-2004; IN COMMERCE 5-2-2004.
JOANNA DUKOVIC, EXAMINING ATTORNEY

SN 76-598,101. CASTER CITY, INC., LAS VEGAS, NV. FILED 6-18-2004.



OWNER OF U.S. REG. NO. 1,287,917.
NO CLAIM IS MADE TO THE EXCLUSIVE RIGHT TO USE "CASTER", APART FROM THE MARK AS SHOWN.

FOR DISTRIBUTORSHIP SERVICES IN THE FIELD OF WHEELS AND CASTERS (U.S. CLS. 100, 101 AND 102).

FIRST USE 4-8-1983; IN COMMERCE 4-8-1983.
ESTHER BELENKER, EXAMINING ATTORNEY

SN 76-598,463. PREMIER BPO INC., CLARKSVILLE, TN. FILED 6-22-2004.

ARE YOU READY TO TAKE THE NEXT STEP?

THE MARK CONSISTS OF STANDARD CHARACTERS WITHOUT CLAIM TO ANY PARTICULAR FONT, STYLE, SIZE, OR COLOR.

FOR OUTSOURCING SERVICES FOR OTHERS IN THE FIELDS OF HUMAN RESOURCES, BUSINESS PAYROLL, ACCOUNTING, BOOKKEEPING, CUSTOMER SERVICE, PURCHASING, CLAIMS PROCESSING, ORDER AND PAPER PROCESSING, APPLICATION PROCESSING, INFORMATION TECHNOLOGY HELP DESK AND SUPPORT, AND BACK OFFICE OPERATIONS (U.S. CLS. 100, 101 AND 102).

ALLISON HOLTZ, EXAMINING ATTORNEY

CLASS 35—(Continued).

SN 76-598,613. BAR NAPKIN CONCEPTS, L.L.C., ALEXANDRIA, VA. FILED 6-22-2004.

BAR NAPKIN CONCEPTS

THE MARK CONSISTS OF STANDARD CHARACTERS WITHOUT CLAIM TO ANY PARTICULAR FONT, STYLE, SIZE, OR COLOR.

FOR MARKETING SERVICES IN THE FIELD OF BRAND NAME MANAGEMENT; AND SERVICES IN THE FIELD OF PUBLIC RELATIONS (U.S. CLS. 100, 101 AND 102).

FIRST USE 12-4-2003; IN COMMERCE 12-4-2003.
WILLIAM VERHOSEK, EXAMINING ATTORNEY

SN 76-598,718. JJR VENTURES, INC., JENKINTOWN, PA. FILED 6-23-2004.

INTERVIEWING FOR SUCCESS

THE MARK CONSISTS OF STANDARD CHARACTERS WITHOUT CLAIM TO ANY PARTICULAR FONT, STYLE, SIZE, OR COLOR.

FOR COUNSELING IN THE FIELD OF RESUME AND COVER LETTER DEVELOPMENT, JOB INTERVIEW PREPARATION; CONSULTATION AND RESEARCH IN THE FIELD OF CAREER PLACEMENT (U.S. CLS. 100, 101 AND 102).

DANIEL BRODY, EXAMINING ATTORNEY

SN 76-598,829. FACE CONSTRUCTION TECHNOLOGIES, INC., NORFOLK, VA. FILED 6-23-2004.

GOLDEN TROWEL

THE MARK CONSISTS OF STANDARD CHARACTERS WITHOUT CLAIM TO ANY PARTICULAR FONT, STYLE, SIZE, OR COLOR.

FOR CONDUCTING AWARD PROGRAMS TO PROMOTE ON-THE-JOB QUALITY, SAFETY AND PRODUCTIVITY IN THE CONCRETE INDUSTRY (U.S. CLS. 100, 101 AND 102).

FIRST USE 1-30-1990; IN COMMERCE 1-30-1990.
AISHA CLARKE, EXAMINING ATTORNEY

SN 76-599,005. ELLIOTT, STEWART E., JR., DALLAS, TX. FILED 6-24-2004.

BOTTLED POETRY

THE MARK CONSISTS OF STANDARD CHARACTERS WITHOUT CLAIM TO ANY PARTICULAR FONT, STYLE, SIZE, OR COLOR.

FOR IMPORT AND EXPORT SERVICES (U.S. CLS. 100, 101 AND 102).

RONALD MCMORROW, EXAMINING ATTORNEY

CLASS 35—(Continued).

SN 78-079,180. HSI IP, INC., GEORGE TOWN, GRAND CAYMAN, CAYMAN ISLANDS, FILED 8-14-2001.



OWNER OF U.S. REG. NOS. 2,064,591, 2,307,278 AND OTHERS.

SEC. 2(F).

FOR WHOLESALE DISTRIBUTORSHIP SERVICES FEATURING ELECTRICAL, ELECTRIC UTILITY, PLUMBING, PIPES-VALVES-FITTINGS, BUILDING MATERIALS, TOOLS, AIR CONDITIONING/HEATING, VENTILATION, CONCRETE FABRICATION, PUMP, REFRIGERATION AND WATER AND SEWER SUPPLIES (U.S. CLS. 100, 101 AND 102).

FIRST USE 9-7-2001; IN COMMERCE 9-7-2001.

WANDA KAY PRICE, EXAMINING ATTORNEY

SN 78-104,707. WEBMAGIC VENTURES LLC, PASADENA, CA. FILED 1-24-2002.

POLAR

FOR PROVIDING INFORMATION ON SHOPPING OPPORTUNITIES PROVIDED BY OTHERS; PROVIDING A GUIDE TO A WIDE VARIETY OF WEB SITES IN THE FIELDS OF RECREATION, BUSINESS, LIVING, SHOPPING, THE HOME, AND THE INTERNET; MARKETING A VARIETY OF SERVICES PROVIDED BY OTHERS BY DISSEMINATING INFORMATION ON A GLOBAL COMPUTER NETWORK (U.S. CLS. 100, 101 AND 102).

FIRST USE 4-26-1998; IN COMMERCE 4-26-1998.

REBECCA SMITH, EXAMINING ATTORNEY

SN 78-162,448. LIFE ED, DENVER, CO. FILED 9-10-2002.



P R O - K N O W L E D G E .

NO CLAIM IS MADE TO THE EXCLUSIVE RIGHT TO USE LIFE ED, APART FROM THE MARK AS SHOWN.

FOR PROMOTING PUBLIC AWARENESS OF THE NEED FOR SOCIAL AWARENESS OF AND RESPONSIBILITY FOR HUMAN LIFE, AND PROMOTING SEXUAL EDUCATION, BOTH OF THE FOREGOING THROUGH THE DISTRIBUTION OF AUDIO, VIDEO AND PRINTED MATERIALS (U.S. CLS. 100, 101 AND 102).

FIRST USE 8-27-2002; IN COMMERCE 8-27-2002.

NANCY CLARKE, EXAMINING ATTORNEY

CLASS 35—(Continued).

SN 78-195,903. WHITEHALL REPRODUCTIONS CANADA LTD., VICTORIA, BRITISH COLUMBIA, CANADA, FILED 12-18-2002.

WHITEHALL ROWING AND SAIL

PRIORITY CLAIMED UNDER SEC. 44(D) ON CANADA APPLICATION NO. 1145096, FILED 7-3-2002, REG. NO. TMA607980, DATED 4-19-2004, EXPIRES 4-19-2019.

NO CLAIM IS MADE TO THE EXCLUSIVE RIGHT TO USE "WHITEHAL"L, APART FROM THE MARK AS SHOWN.

SEC. 2(F).

FOR CATALOG MAIL ORDER SERVICES AND ON-LINE RETAIL SERVICES IN THE FIELD OF BOATS AND MARINE ORIENTED PRODUCTS (U.S. CLS. 100, 101 AND 102).

FIRST USE 0-0-1993; IN COMMERCE 0-0-1993.

DAVID ELTON, EXAMINING ATTORNEY

SN 78-211,994. DONATE FOR CHARITY, INC., SAN RAMON, CA. FILED 2-6-2003.

"HELPING CHARITIES HELP THEMSELVES"

FOR CHARITABLE SERVICES, NAMELY, PROVIDING RETAIL SERVICES FEATURING DONATED VEHICLES WHEREIN THE REVENUES ARE USED FOR DONOR DIRECTED CHARITABLE PURPOSES (U.S. CLS. 100, 101 AND 102).

FIRST USE 12-27-2002; IN COMMERCE 12-27-2002.

ALICIA COLLINS, EXAMINING ATTORNEY

SN 78-225,729. J & C NATIONWIDE, INC., ATLANTA, GA. FILED 3-14-2003.

JACKSON & COKER

FOR PHYSICIAN, CERTIFIED REGISTERED NURSE ANESTHETIST AND CERTIFIED MIDWIFE STAFFING AND PLACEMENT SERVICES (U.S. CLS. 100, 101 AND 102).

FIRST USE 1-1-1979; IN COMMERCE 1-1-1979.

TONI HICKEY, EXAMINING ATTORNEY

CLASS 35—(Continued).

SN 78-228,761. AMERICAN CENTER FOR LAW AND JUSTICE, INC., VIRGINIA BEACH, VA. FILED 3-21-2003.



FOR COMPUTERIZED ON-LINE RETAIL SERVICES IN THE FIELD OF GOODS, NAMELY BOOKS, MAGAZINES, NEWSLETTERS, BROCHURES, PAMPHLETS, OUTLINES, FLYERS, LETTERS, LEAFLETS, PRINTED LECTURES, TRANSCRIPTS, PRE-RECORDED VIDEO TAPES AND CASSETTES, COMPACT DISCS AND DIGITAL VIDEO DISKS, AUDIO TAPES AND CASSETTES CLOTHING, FOOTWEAR, BAGS AND ACCESSORIES RELATED TO PUBLIC INTEREST LAW, CONSTITUTIONAL LAW, CONSTITUTIONAL FREEDOMS WITH EMPHASIS ON THE FIRST AMENDMENT RIGHTS, NATIONAL SECURITY, HOMELAND SECURITY, PRINCIPLES OF JUSTICE, THE PROTECTION OF LIFE AND RELIGIOUS LIBERTY, CIVIL LIBERTIES, PRO-FAMILY AND PRO-LIFE ISSUES AND ON THE SUBJECTS OF THE RENDERING OF LEGAL SERVICES, ADVICE AND COUNSELING OTHERS (U.S. CLS. 100, 101 AND 102).

APRIL L. RADEMACHER, EXAMINING ATTORNEY

SN 78-232,068. AMERICAN SOCIETY OF INTERIOR DESIGNERS, WASHINGTON, DC. FILED 3-31-2003.

AMERICAN SOCIETY OF INTERIOR DESIGNERS

OWNER OF U.S. REG. NOS. 1,035,060, 1,037,723 AND 2,577,425.

NO CLAIM IS MADE TO THE EXCLUSIVE RIGHT TO USE SOCIETY OF INTERIOR DESIGNERS, APART FROM THE MARK AS SHOWN.

SEC. 2(F).

FOR PROMOTING THE INTERESTS OF MEMBERS OF THE INTERIOR DESIGN FIELD (U.S. CLS. 100, 101 AND 102).

FIRST USE 4-1-1974; IN COMMERCE 4-1-1974.

KIM SAITO, EXAMINING ATTORNEY

SN 78-236,834. RUGGED SHARK LLC, LIGHTHOUSE POINT, FL. FILED 4-11-2003.

THE SHOE SHARKS

NO CLAIM IS MADE TO THE EXCLUSIVE RIGHT TO USE SHOE, APART FROM THE MARK AS SHOWN.

FOR RETAIL STORE SERVICES AND ON-LINE RETAIL SERVICES FEATURING FOOTWEAR AND CLOTHING. (U.S. CLS. 100, 101 AND 102).

DANIEL CAPSHAW, EXAMINING ATTORNEY

CLASS 35—(Continued).

SN 78-261,516. MISSIONCRITICAL, LLC, SALT LAKE CITY, UT. FILED 6-12-2003.



FOR PROVIDING CONSULTATIVE SERVICES TO NEW AND ESTABLISHED BUSINESS FOR IMPROVING BUSINESS OPERATIONS (U.S. CLS. 100, 101 AND 102).
FIRST USE 5-1-2003; IN COMMERCE 5-1-2003.
GINA HAYES, EXAMINING ATTORNEY

CLASS 35—(Continued).

SN 78-269,357. MEDIA FINANCE, LTD., INGLESIDE, IL. FILED 7-1-2003.

MY OLIVE TREE

FOR MAIL ORDER, TELEPHONE AND ON-LINE RETAIL STORE SERVICES, FEATURING THE GUARANTEED RIGHT TO LIMITED QUANTITIES OF OLIVE OIL PROCESSED FROM SPECIFIED SOURCES AND PROVIDING DOCUMENTATION RELATED THERETO (U.S. CLS. 100, 101 AND 102).

DAVID TAYLOR, EXAMINING ATTORNEY

SN 78-262,957. CONVERGENT GROUP CORP., GREENWOOD VILLAGE, CO. FILED 6-16-2003.



NO CLAIM IS MADE TO THE EXCLUSIVE RIGHT TO USE "INTEGRATED DELIVERY METHODOLOGY", APART FROM THE MARK AS SHOWN.

THE COLOR(S) YELLOW, BLUE AND RED IS/ARE CLAIMED AS A FEATURE OF THE MARK.

THE COLORS RED AND YELLOW APPEAR ON THE "I". THE COLOR BLUE APPEARS ON THE "D" AND THE COLOR YELLOW APPEARS ON THE "M".

FOR BUSINESS CONSULTING SERVICES IN THE FIELD OF COMPUTER HARDWARE AND SOFTWARE INTEGRATION AND BUSINESS PROCESS AND CHANGE MANAGEMENT (U.S. CLS. 100, 101 AND 102).
CHARLES L. JENKINS, EXAMINING ATTORNEY

SN 78-270,778. AENZI LLC, ATLANTA, GA. FILED 7-6-2003.

AENZI

THE FOREIGN WORDING IN THE MARK TRANSLATES INTO ENGLISH AS POWER.

FOR RETAIL DEPARTMENT STORE FEATURING BOOKS, MAGAZINES, COMPACT DISCS, AUDIO, VIDEO CASSETTES, TOYS, DIGITAL VIDEO DISCS, POSTERS, GREETING CARDS, CANDLES, COSMETICS, COMPUTERS, ELECTRONIC APPLIANCES, PERFUME, FOOD, BEVERAGES, APPAREL, HOME DECOR AND GIFTWARE ITEMS; GIFT REGISTRY SERVICES; ON-LINE RETAIL STORE FEATURING BOOKS, MAGAZINES, COMPACT DISCS, AUDIO, VIDEO CASSETTES, TOYS, DIGITAL VIDEO DISCS, POSTERS, GREETING CARDS, CANDLES, COSMETICS, PERFUME, COMPUTERS, ELECTRONIC APPLIANCES, FOOD, BEVERAGES, APPAREL, HOME DECOR AND GIFTWARE ITEMS; MAIL ORDER RETAIL SERVICES FEATURING BOOKS, MAGAZINES, COMPACT DISCS, AUDIO, VIDEO CASSETTES, TOYS, DIGITAL VIDEO DISCS, POSTERS, GREETING CARDS, CANDLES, COSMETICS, PERFUME, COMPUTERS, ELECTRONIC APPLIANCES, FOOD, BEVERAGES, APPAREL, HOME DECOR, AND GIFTWARE ITEMS; MAIL ORDER BOOK-CLUBS; RETAIL STORE SERVICES AVAILABLE THROUGH COMPUTER COMMUNICATIONS AND INTERACTIVE TELEVISION FEATURING BOOKS, MAGAZINES, COMPACT DISCS, AUDIO, VIDEO CASSETTES, TOYS, COMPUTERS, ELECTRONIC APPLIANCES DIGITAL VIDEO DISCS, POSTERS, GREETING CARDS, CANDLES, COSMETICS, PERFUME, FOOD, BEVERAGES, APPAREL, HOME DECOR AND GIFTWARE ITEMS; BUSINESS CONSULTATION; BUSINESS MANAGEMENT; BUSINESS PLANNING AND BUSINESS ORGANIZATIONAL CONSULTATION; ARRANGING AND CONDUCTING BUSINESS CONFERENCES; BUSINESS MARKETING CONSULTING SERVICES; ADVERTISING SERVICES, NAMELY, DIRECT MARKETING ADVERTISING FOR OTHERS, CREATING CORPORATE AND BRAND IDENTITY FOR OTHERS AND PREPARING AND PLACING ADVERTISEMENTS FOR OTHERS; PROVIDING SPACE AT A WEB SITE FOR THE ADVERTISEMENT OF THE GOODS AND SERVICES OF OTHERS (U.S. CLS. 100, 101 AND 102).

FIRST USE 12-6-2002; IN COMMERCE 12-6-2002.

STANLEY I. OSBORNE, EXAMINING ATTORNEY

SN 78-266,688. INTERNEXT MEDIA CORP., ENCINO, CA. FILED 6-24-2003.

BUILDING E-BUSINESS

FOR RENTAL OF ADVERTISING SPACE ON WEB SITES (U.S. CLS. 100, 101 AND 102).

MICHAEL ENGEL, EXAMINING ATTORNEY

CLASS 35—(Continued).

SN 78-303,690. DISNEY ENTERPRISES, INC., BURBANK, CA. FILED 9-22-2003.

BRING ON THE MOVIES

FOR BUSINESS SERVICES, NAMELY, PROVIDING INFORMATION ON BILLING FOR TELEVISION AND AUDIO-VISUAL PROGRAMMING SERVICES, AND CUSTOMER SERVICE FOR TELEVISION AND AUDIO-VISUAL PROGRAMMING SERVICES VIA A WEB SITE ON THE INTERNET (U.S. CLS. 100, 101 AND 102).

JEFFERY COWARD, EXAMINING ATTORNEY

SN 78-308,392. DENVER METRO CHAMBER OF COMMERCE, DENVER, CO. FILED 10-2-2003.

DENVER METRO CHAMBER OF COMMERCE

NO CLAIM IS MADE TO THE EXCLUSIVE RIGHT TO USE "METRO CHAMBER OF COMMERCE", APART FROM THE MARK AS SHOWN.

SEC. 2(F).

FOR CHAMBER OF COMMERCE SERVICES, NAMELY, PROMOTION OF BUSINESS AND TOURISM IN THE DENVER, COLORADO METROPOLITAN AREA (U.S. CLS. 100, 101 AND 102).

FIRST USE 11-2-1993; IN COMMERCE 11-2-1993.
EDWARD NELSON, EXAMINING ATTORNEY

SN 78-311,705. B&F CAPITAL MARKETS, INC., CLEVELAND, OH. FILED 10-9-2003.



THE MARK CONSISTS OF A STYLIZED B&F LOCATED IN THE CAPITAL OF A STYLIZED GREEK COLUMN.

FOR BUSINESS CONSULTATION FOR BANKS; BUSINESS MARKETING CONSULTATION IN THE FIELD OF FINANCIAL PRODUCTS INCLUDING DERIVATIVES FOR BANKS (U.S. CLS. 100, 101 AND 102).

FIRST USE 6-30-2003; IN COMMERCE 6-30-2003.
CHRISIE B. KING, EXAMINING ATTORNEY

CLASS 35—(Continued).

SN 78-316,605. DISNEY ENTERPRISES, INC., BURBANK, CA. FILED 10-21-2003.

WALT DISNEY WORLD

OWNER OF U.S. REG. NOS. 980,995, 1,189,727 AND 2,189,177.

THE NAME IN THE MARK DOES NOT IDENTIFY A PARTICULAR LIVING INDIVIDUAL.

FOR RETAIL STORE SERVICES AND COMPUTERIZED ON-LINE RETAIL STORES, BOTH IN THE FIELDS OF VIDEOS, DVD'S, COMPACT DISCS, AUDIO CASSETTES, SUNGLASSES, DECORATIVE REFRIGERATOR MAGNETS, CONSUMER ELECTRONICS, CLOTHING, HATS, SHOES, SOUVENIRS, BOOKS, KEYCHAINS, STATIONERY, COSMETICS, PERSONAL CARE, HOUSEHOLD STORAGE CONTAINERS, DISHES, MUGS, DRINKING GLASSES, HOUSEHOLD LINENS, GLASSWARE, PURSES, WALLETS, TOTE BAGS, UMBRELLAS, DIAPER BAGS, BABY CLOTHING, POSTCARDS, PACKAGED FOOD AND DRINK, PREPARED FOOD AND DRINK, TOYS, GAMES, SPORTING ITEMS, PICTURE FRAMES, PILLOWS, BACKPACKS, FIGURINES, WATCHES, CLOCKS, JEWELRY, DECORATIVE PINS AND SOUVENIR BUTTONS (U.S. CLS. 100, 101 AND 102).

PAUL F. GAST, EXAMINING ATTORNEY

SN 78-320,022. MESSE FRANKFURT GMBH, FRANKFURT AM MAIN, FED REP GERMANY, FILED 10-29-2003.

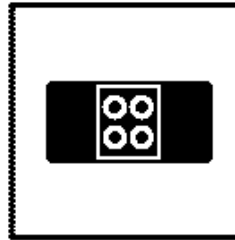
**Medtech**

PRIORITY CLAIMED UNDER SEC. 44(D) ON FED REP GERMANY APPLICATION NO. 002388916, FILED 9-26-2001, REG. NO. 002388916, DATED 9-26-2003, EXPIRES 9-26-2011.

THE MARK CONSISTS OF A RECTANGULAR FRAME SURROUNDING A REPRESENTATION OF AN ADHESIVE BANDAGE WITH THE DESIGNATION "MEDTECH" CENTERED BELOW THE RECTANGULAR FRAME.

FOR PREPARING ADVERTISEMENTS FOR OTHERS IN CONJUNCTION WITH ORGANIZING FAIRS AND EXHIBITIONS; PREPARING TRADE SHOW DISPLAYS AND EXHIBITS FOR OTHERS; COOPERATIVE ADVERTISING AND MARKETING; BUSINESS MANAGEMENT; PERSONNEL MANAGEMENT CONSULTATION; ADMINISTRATION OF BUSINESS PAYROLL FOR OTHERS; OFFICE SERVICES, NAMELY, SECRETARIAL AND CLERICAL SERVICES; RENTAL OF ADVERTISING SPACE; RENTAL OF ADVERTISING DISPLAYS; ORGANIZING AND ARRANGING FAIRS AND EXHIBITIONS FOR COMMERCIAL AND ADVERTISING PURPOSES IN THE FIELD OF TECHNICAL TEXTILES; ORGANIZING AND ARRANGING MEETINGS, CONFERENCES, CONGRESSES, AND SYMPOSIA FOR BUSINESS AND COMMERCIAL PURPOSES, EXCEPT IN THE FIELD OF MEDICAL PRODUCTS, MEDICAL PRODUCT DESIGN OR MANUFACTURING, OR MEDICAL SERVICES (U.S. CLS. 100, 101 AND 102).

GINA HAYES, EXAMINING ATTORNEY

CLASS 35—(Continued).

SN 78-321,438. E.F. ALVAREZ & COMPANY, P.A., MIAMI, FL. FILED 10-31-2003.



THE MARK CONSISTS OF THE LETTER "A" IN AN ABSTRACT FORM.

FOR BUSINESS CONSULTATION AND ACCOUNTING SERVICES (U.S. CLS. 100, 101 AND 102).

FIRST USE 9-20-1988; IN COMMERCE 10-6-1988.

PAUL F. GAST, EXAMINING ATTORNEY

SN 78-321,980. STEFFENSEN, NILS P., BROOKFIELD, CT. FILED 11-2-2003.

THREADSMITH

THE MARK CONSISTS OF STANDARD CHARACTERS WITHOUT CLAIM TO ANY PARTICULAR FONT, STYLE, SIZE, OR COLOR.

FOR ONLINE EMBROIDERY RETAIL STORES FEATURING EMBROIDERY DESIGNS (U.S. CLS. 100, 101 AND 102).

BRIAN PINO, EXAMINING ATTORNEY

CLASS 35—(Continued).

SN 78-323,730. CRAIGSLIST, INC., SAN FRANCISCO, CA. FILED 11-5-2003.

CRAIGSLIST

THE MARK CONSISTS OF STANDARD CHARACTERS WITHOUT CLAIM TO ANY PARTICULAR FONT, STYLE, SIZE, OR COLOR.

OWNER OF U.S. REG. NOS. 2,395,628 AND 2,707,749.

FOR ADVERTISING AND INFORMATION DISTRIBUTION SERVICES, NAMELY, PROVIDING CLASSIFIED ADVERTISING SPACE VIA THE GLOBAL COMPUTER NETWORK; PROVIDING CONSUMER PRODUCT AND SERVICE INFORMATION VIA THE INTERNET; PROMOTING THE GOODS AND SERVICES OF OTHERS OVER THE INTERNET; PROVIDING AN ONLINE BUSINESS INFORMATION DIRECTORY ON THE INTERNET; COMPUTERIZED DATABASE MANAGEMENT; PROMOTING AND ADVERTISING INFORMATION ABOUT THE PROFESSIONAL SERVICES OF OTHERS; PROVIDING ON-LINE COMPUTER DATABASES AND ON-LINE SEARCHABLE DATABASES FEATURING CLASSIFIED LISTINGS AND WANT ADS; PROVIDING ON-LINE COMPUTER DATABASES AND ON-LINE SEARCHABLE DATABASES FEATURING INFORMATION, CLASSIFIED LISTINGS AND ANNOUNCEMENTS ABOUT EMPLOYMENT INFORMATION AND RESUMES, JOB OPENINGS, VOLUNTEER INFORMATION AND VOLUNTEER OPPORTUNITIES THROUGH COMMUNITY AND CHARITABLE ORGANIZATIONS AND BUSINESSES, INFORMATION ABOUT COMMUNITY SERVICE PROGRAMS, INFORMATION ABOUT POLITICS, BUSINESS EVENTS, AND BUSINESS MEETINGS; CLASSIFIED LISTINGS FOR RENTALS OF A WIDE-VARIETY OF CONSUMER AND BUSINESS GOODS; COMPUTER SERVICES, NAMELY, PROVIDING ON-LINE COMPUTER DATABASES AND ON-LINE SEARCHABLE DATABASES FEATURING CONSUMER INFORMATION ON A WIDE VARIETY OF TOPICS OF GENERAL INTEREST TO THE CONSUMING PUBLIC (U.S. CLS. 100, 101 AND 102).

FIRST USE 7-1-1995; IN COMMERCE 7-1-1995.

KELLEY WELLS, EXAMINING ATTORNEY

CLASS 35—(Continued).

SN 78-323,767. PICOPORTO CORPORATION, BELLEVUE, WA. FILED 11-5-2003.

PICOPORTO

THE MARK CONSISTS OF STANDARD CHARACTERS WITHOUT CLAIM TO ANY PARTICULAR FONT, STYLE, SIZE, OR COLOR.
FOR ACCOUNTS RECEIVABLE SERVICES (U.S. CLS. 100, 101 AND 102).
TONI HICKEY, EXAMINING ATTORNEY

CLASS 35—(Continued).

SN 78-328,919. SEAN HEALY PRESENTS, INC., HOLLYWOOD, CA. FILED 11-17-2003.



THE NAME(S), PORTRAIT(S), AND/OR SIGNATURE(S) SHOWN IN THE MARK IDENTIFIES SEAN HEALY, WHO IS THE PRESIDENT OF THE CORPORATION, WHOSE CONSENT(S) TO REGISTER IS SUBMITTED.
FOR PROMOTING THE SHOWS AND CONCERTS OF OTHERS (U.S. CLS. 100, 101 AND 102).
FIRST USE 5-14-1999; IN COMMERCE 5-14-1999.
GINNY ISAACSON, EXAMINING ATTORNEY

SN 78-325,641. SIEMENS ENERGY & AUTOMATION, INC., ALPHARETTA, GA. FILED 11-10-2003.



NO CLAIM IS MADE TO THE EXCLUSIVE RIGHT TO USE "CHANNEL PARTNER PROGRAM", APART FROM THE MARK AS SHOWN.
THE MARK CONSISTS OF THE WORDS MARKET BUILDER CHANNEL PARTNER PROGRAM IN SPECIAL FORM WITH AN ARBITRARY DESIGN.
FOR BUSINESS CONSULTATION; BUSINESS MANAGEMENT ASSISTANCE, ADVISORY SERVICES AND CONSULTANCY WITH REGARD TO BUSINESS PLANNING AND ANALYSIS; CHANNEL PARTNER AND INCENTIVE AWARD PROGRAMS TO PROMOTE THE SALE OF PRODUCTS IN THE RESIDENTIAL AND COMMERCIAL CONSTRUCTION INDUSTRIES, NATIONAL ELECTRICAL MANUFACTURERS ASSOCIATION MOTOR MARKET, INDUSTRIAL DISTRIBUTION AND INDUSTRIAL AUTOMATION INDUSTRIES (U.S. CLS. 100, 101 AND 102).
ANN E. SAPPENFIELD, EXAMINING ATTORNEY

SN 78-330,767. ANVERS, LOS ANGELES, CA. FILED 11-20-2003.

POM POM

THE MARK CONSISTS OF STANDARD CHARACTERS WITHOUT CLAIM TO ANY PARTICULAR FONT, STYLE, SIZE, OR COLOR.
FOR RETAIL STORE SERVICES FEATURING ANTIQUE FURNISHINGS AND HOMEDÉCOR (U.S. CLS. 100, 101 AND 102).
FIRST USE 1-1-1989; IN COMMERCE 1-1-1991.
KELLY BOULTON, EXAMINING ATTORNEY

CLASS 35—(Continued).

SN 78-331,349. TRADER PUBLISHING COMPANY, NORFOLK, VA. FILED 11-21-2003.

123MOVERS.COM

THE MARK CONSISTS OF STANDARD CHARACTERS WITHOUT CLAIM TO ANY PARTICULAR FONT, STYLE, SIZE, OR COLOR.

FOR PROVIDING INFORMATION BY MEANS OF A GLOBAL COMPUTER NETWORK ALLOWING WEBSITE USERS TO COLLECT INFORMATION ABOUT MOVING COMPANIES, TO PLACE USER MOVING NEEDS INTO THE WEBSITE AND RECEIVE COMPETITIVE BIDS FROM COMPETING MOVING COMPANIES (U.S. CLS. 100, 101 AND 102).

FIRST USE 7-24-1999; IN COMMERCE 7-24-1999.
BRIAN NEVILLE, EXAMINING ATTORNEY

CLASS 35—(Continued).

SN 78-336,157. MARS ADVERTISING COMPANY, INC., SOUTHFIELD, MI. FILED 12-4-2003.



FOR ADVERTISING AND MARKETING SERVICES, NAMELY, IN-STORE PRODUCT DEMONSTRATIONS, SAMPLING DISTRIBUTION EVENTS, MOBILE MARKETING, NAMELY, PROVIDING DIRECT MARKETING ADVERTISING FOR OTHERS, AND IN-STORE PROMOTIONAL EVENTS FOR OTHERS IN THE NATURE OF PROMOTIONAL CONTESTS, DISSEMINATION OF PROMOTIONAL MATERIALS AND PROMOTIONAL GAMES (U.S. CLS. 100, 101 AND 102).

ANN E. SAPPENFIELD, EXAMINING ATTORNEY

SN 78-332,264. SMART BUCKS, INC., TROY, MI. FILED 11-24-2003.

SMART BUCKS

THE MARK CONSISTS OF STANDARD CHARACTERS WITHOUT CLAIM TO ANY PARTICULAR FONT, STYLE, SIZE, OR COLOR.

FOR RETAIL VARIETY STORES (U.S. CLS. 100, 101 AND 102).

SUE LAWRENCE, EXAMINING ATTORNEY

SN 78-337,876. THE INDIGO MARKET, INC., DBA INDIGO, PERRYSBURG, OH. FILED 12-8-2003.

LES IDEES MARKET

THE MARK CONSISTS OF STANDARD CHARACTERS WITHOUT CLAIM TO ANY PARTICULAR FONT, STYLE, SIZE, OR COLOR.

NO CLAIM IS MADE TO THE EXCLUSIVE RIGHT TO USE "MARKET", APART FROM THE MARK AS SHOWN.

THE PHRASE "LES IDEES" TRANSLATES TO "THE IDEAS" OR "THE THOUGHTS" IN FRENCH.

FOR RETAIL SERVICES, NAMELY, IN-STORE BOUTIQUES FEATURING THEMATIC COLLECTIONS OF FURNITURE AND ACCESSORIES (U.S. CLS. 100, 101 AND 102).

MICHAEL KEATING, EXAMINING ATTORNEY

CLASS 35—(Continued).

SN 78-338,928. MATERIAL MANAGEMENT GROUP, INC., APPLETON, WI. FILED 12-10-2003.



NO CLAIM IS MADE TO THE EXCLUSIVE RIGHT TO USE "MATERIAL MANAGEMENT GROUP, INC.", APART FROM THE MARK AS SHOWN.

THE COLOR(S) BLUE AND GRAY IS/ARE CLAIMED AS A FEATURE OF THE MARK

THE MARK CONSISTS OF A BLUE DESIGN, 3-DIMENSIONAL IN APPEARANCE, RESEMBLING A STACK OF PAPER-LIKE MATERIAL SEPARATED INTO 3 UNEQUAL PARTS, FOLLOWED BY THE STYLIZED WORDS "MATERIAL MANAGEMENT GROUP, INC." WITH THE WORDS "GROUP, INC." IN GRAY.

FOR INVENTORY MANAGEMENT SERVICES PROVIDED TO CUSTOMERS IN THE MANAGEMENT PURCHASING FIELD TO ASSIST IN MANAGING THEIR INVENTORY (U.S. CLS. 100, 101 AND 102).

FIRST USE 10-1-1989; IN COMMERCE 10-1-1989.
DARRYL SPRUILL, EXAMINING ATTORNEY

SN 78-339,192. INTERNATIONAL DATA GROUP, INC., FRAMINGHAM, MA. FILED 12-11-2003.

CIO MAGAZINE TECH POLL

THE MARK CONSISTS OF STANDARD CHARACTERS WITHOUT CLAIM TO ANY PARTICULAR FONT, STYLE, SIZE, OR COLOR.

NO CLAIM IS MADE TO THE EXCLUSIVE RIGHT TO USE "MAGAZINE TECH POLL", APART FROM THE MARK AS SHOWN.

FOR CONDUCTING BUSINESS RESEARCH AND SURVEYS; CONDUCTING BUSINESS AND MARKETING OPINION POLLING, NAMELY, COMPUTER ASSISTED POLLING; PROVIDING STATISTICAL INFORMATION FOR BUSINESS PURPOSES (U.S. CLS. 100, 101 AND 102).

FIRST USE 8-31-2000; IN COMMERCE 8-31-2000.
INGA ERVIN, EXAMINING ATTORNEY

CLASS 35—(Continued).

SN 78-344,686. OBSERVANT LLC, LEXINGTON, MA. FILED 12-23-2003.



FOR BUSINESS MARKETING CONSULTING SERVICES (U.S. CLS. 100, 101 AND 102).

FIRST USE 12-14-2003; IN COMMERCE 12-18-2003.
KATHERINE STOIDES, EXAMINING ATTORNEY

SN 78-345,190. RONALD ALAN GOCH, SOUTH JORDAN, UT. FILED 12-23-2003.

The Telios Group

THE MARK CONSISTS OF STANDARD CHARACTERS WITHOUT CLAIM TO ANY PARTICULAR FONT, STYLE, SIZE, OR COLOR.

NO CLAIM IS MADE TO THE EXCLUSIVE RIGHT TO USE "GROUP", APART FROM THE MARK AS SHOWN.

FOR BUSINESS CONSULTATION SERVICES. (U.S. CLS. 100, 101 AND 102).

DEZMONA MIZELLE, EXAMINING ATTORNEY

SN 78-345,454. SMITHKLINE BEECHAM CORPORATION, PHILADELPHIA, PA. FILED 12-24-2003.



NO CLAIM IS MADE TO THE EXCLUSIVE RIGHT TO USE "CARE", APART FROM THE MARK AS SHOWN.

FOR CONSULTATION SERVICES PROVIDED TO THE MANAGED HEALTH CARE INDUSTRY REGARDING HEALTH CARE COST CONTAINMENT (U.S. CLS. 100, 101 AND 102).

DORITT L. CARROLL, EXAMINING ATTORNEY

CLASS 35—(Continued).

SN 78-352,732. GLOBE MEDIA INTERNATIONAL CORPORATION, TORONTO, CANADA, FILED 1-15-2004.

**Globe Media
International
Corporation**

THE MARK CONSISTS OF STANDARD CHARACTERS WITHOUT CLAIM TO ANY PARTICULAR FONT, STYLE, SIZE, OR COLOR.

NO CLAIM IS MADE TO THE EXCLUSIVE RIGHT TO USE "MEDIA INTERNATIONAL CORPORATION", APART FROM THE MARK AS SHOWN.

FOR PROVIDING ADVERTISING SPACE FOR OTHERS IN NEWSPAPERS, MAGAZINES, RADIO, INTERNET AND TELEVISION (U.S. CLS. 100, 101 AND 102).

PAUL F. GAST, EXAMINING ATTORNEY

CLASS 35—(Continued).

SN 78-354,374. EDELSBACHER DESIGN GROUP INC., SARASOTA, FL. FILED 1-20-2004.

The Wild Things

THE MARK CONSISTS OF STANDARD CHARACTERS WITHOUT CLAIM TO ANY PARTICULAR FONT, STYLE, SIZE, OR COLOR.

FOR ADVERTISING AGENCY (U.S. CLS. 100, 101 AND 102).

ELLEN PERKINS, EXAMINING ATTORNEY

SN 78-354,292. SHARABY, YIGAL, ARIEH, HOLLYWOOD, FL. FILED 1-20-2004.

JNC

THE MARK CONSISTS OF STANDARD CHARACTERS WITHOUT CLAIM TO ANY PARTICULAR FONT, STYLE, SIZE, OR COLOR.

FOR WHOLESALE STORES AND WHOLESALE ORDERING SERVICES IN THE FIELD OF JEWELRY, RINGS, EARRINGS, PENDANTS, BRACELETS AND NECKLACES (U.S. CLS. 100, 101 AND 102).

FIRST USE 1-1-2004; IN COMMERCE 1-20-2004.

PAUL F. GAST, EXAMINING ATTORNEY

SN 78-356,705. POWELL, PRECIOUS E, LITHONIA, GA. FILED 1-23-2004.

MAYLOR'S *M* FURNITURE
Where you'll find affordable quality furniture

NO CLAIM IS MADE TO THE EXCLUSIVE RIGHT TO USE "FURNITURE" AND "WHERE YOU'LL FIND AFFORDABLE QUALITY FURNITURE", APART FROM THE MARK AS SHOWN.

THE COLOR(S) GREEN AND RED IS/ARE CLAIMED AS A DISTINCTIVE FEATURE OF THE MARK.

THE MARK CONSISTS OF MAYLOR'S FURNITURE (GREEN) M (RED) WHERE YOU'LL FIND AFFORDABLE FURNITURE (RED).

FOR FURNITURE IMPORT AND RETAIL STORES FEATURING FURNITURE (U.S. CLS. 100, 101 AND 102).

FIRST USE 1-23-2004; IN COMMERCE 1-23-2004.

KAREN K. BUSH, EXAMINING ATTORNEY

CLASS 35—(Continued).

SN 78-356,871. FURTHER MEDIA, INC., SUFFERN, NY.
FILED 1-23-2004.

CLASS 35—(Continued).

SN 78-363,230. D.V.D. EXPLOSION, INC., NEW YORK, NY.
FILED 2-5-2004.

MIO

THE MARK CONSISTS OF STANDARD CHARACTERS WITHOUT CLAIM TO ANY PARTICULAR FONT, STYLE, SIZE, OR COLOR.

FOR ON-LINE RETAIL STORE SERVICES FEATURING CLOTHING AND PRERECORDED COMPACT DISCS AND PRERECORDED VIDEO CASSETTES (U.S. CLS. 100, 101 AND 102).
CURTIS FRENCH, EXAMINING ATTORNEY

DVD EXPLOSION

THE MARK CONSISTS OF STANDARD CHARACTERS WITHOUT CLAIM TO ANY PARTICULAR FONT, STYLE, SIZE, OR COLOR.

NO CLAIM IS MADE TO THE EXCLUSIVE RIGHT TO USE "DVD", APART FROM THE MARK AS SHOWN.

FOR RETAIL STORE SERVICES FEATURING BLANK AND PRE-RECORDED AUDIO AND VIDEO TAPES, DVD'S, CD'S, PLAYERS FOR AUDIO TAPES, VIDEO TAPES, DVD'S AND CD'S, HEAD CLEANING CASSETTES FOR AUDIO TAPE PLAYERS, AUDIO CABLES, MICROPHONES, CHEMICALS FOR CLEANING AUDIO CASSETTE PLAYER HEADS, CHEMICALS FOR CLEANING DVD'S AND CD'S, AND DVD CLEANING AND POLISHING APPARATUS (U.S. CLS. 100, 101 AND 102).
FIRST USE 8-16-2001; IN COMMERCE 8-16-2001.
JENNIFER KRISP, EXAMINING ATTORNEY

SN 78-359,245. SRL, INC., LEXINGTON, MA. FILED 1-29-2004.

SN 78-364,695. CMP PRINCETON, INC., PRINCETON, NJ.
FILED 2-9-2004.

STRIDE RITE E-FIT

THE MARK CONSISTS OF STANDARD CHARACTERS WITHOUT CLAIM TO ANY PARTICULAR FONT, STYLE, SIZE, OR COLOR.

OWNER OF U.S. REG. NOS. 1,236,944, 2,386,293 AND OTHERS.

NO CLAIM IS MADE TO THE EXCLUSIVE RIGHT TO USE "E-FIT", APART FROM THE MARK AS SHOWN.

FOR COMPUTERIZED ON-LINE ORDERING SERVICES IN THE FIELD OF CHILDREN'S FOOTWEAR FEATURING A PROCESS TO MEASURE THE FOOT FOR LENGTH AND WIDTH AND TO INDICATE THE PROPER SIZE AND WIDTH OF THE SHOE (U.S. CLS. 100, 101 AND 102).
PAUL F. GAST, EXAMINING ATTORNEY

BEAUTYWEEK

THE MARK CONSISTS OF STANDARD CHARACTERS WITHOUT CLAIM TO ANY PARTICULAR FONT, STYLE, SIZE, OR COLOR.

FOR CONDUCTING AND PROMOTING TRADE SHOWS, EXPOSITIONS AND CONFERENCES IN THE FIELDS OF COSMETICS, HAIR CARE, SKIN CARE, AND RELATED TECHNOLOGIES, AND THE DISTRIBUTION OF PRINTED MATERIALS IN CONNECTION THEREWITH; PROMOTING EDUCATIONAL SEMINARS IN THE FIELDS OF COSMETICS, HAIR CARE, SKIN CARE, AND RELATED TECHNOLOGIES (U.S. CLS. 100, 101 AND 102).
PAUL F. GAST, EXAMINING ATTORNEY

CLASS 35—(Continued).

SN 78-368,409. DONALD A. GARDNER INTERACTIVE, LLC, GREENVILLE, SC. FILED 2-16-2004.

DONALD A. GARDNER
INTERACTIVE, LLC

THE MARK CONSISTS OF STANDARD CHARACTERS WITHOUT CLAIM TO ANY PARTICULAR FONT, STYLE, SIZE, OR COLOR.

OWNER OF U.S. REG. NO. 2,768,922.

NO CLAIM IS MADE TO THE EXCLUSIVE RIGHT TO USE INTERACTIVE, LLC, APART FROM THE MARK AS SHOWN.

THE NAME DONALD A. GARDNER IDENTIFIES A LIVING INDIVIDUAL WHOSE CONSENT IS OF RECORD.

FOR PROMOTING THE GOODS AND SERVICES OF OTHERS BY ARRANGING FOR SPONSORS TO AFFILIATE THEIR GOODS AND SERVICES WITH VARIOUS AFFILIATED WEB SITES (U.S. CLS. 100, 101 AND 102).

FIRST USE 11-1-2001; IN COMMERCE 11-1-2001.

TRACY CROSS, EXAMINING ATTORNEY

CLASS 35—(Continued).

SN 78-374,978. NAPA VALLEY VINTNERS ASSOCIATION, ST. HELENA, CA. FILED 2-26-2004.



THE MARK CONSISTS OF THE LETTER "N" EMBEDDED WITHIN FOUR CONTIGUOUS CIRCLES.

FOR ASSOCIATION SERVICES, NAMELY PROMOTING THE INTEREST OF NAPA VALLEY VINTNERS INCLUDING THE PROMOTION OF THE APPELLATION OF ORIGIN (U.S. CLS. 100, 101 AND 102).

FIRST USE 2-3-2004; IN COMMERCE 2-3-2004.

AMY HELLA, EXAMINING ATTORNEY

SN 78-373,168. HIEROGRAPHICS, INC., LOUISVILLE, KY. FILED 2-24-2004.



NO CLAIM IS MADE TO THE EXCLUSIVE RIGHT TO USE "IMAGERS SUPPLY", APART FROM THE MARK AS SHOWN.

THE COLORS PURPLE, BLUE, YELLOW AND BLACK ARE CLAIMED AS A FEATURE OF THE MARK.

THE MARK CONSISTS OF FOUR VERTICAL CIRCLES WITH THE TOP CIRCLE APPEARING IN MAGENTA, THE NEXT CIRCLE APPEARING IN CYAN BLUE, THE NEXT CIRCLE APPEARING IN YELLOW, AND THE BOTTOM CIRCLE APPEARING IN BLACK. THE WORDING IMAGERS SUPPLY IS COLORED IN CYAN BLUE WITH A BLACK OUTLINE.

FOR RETAIL AND ONLINE RETAIL STORE SERVICES FEATURING PRINTERS, PRINTING EQUIPMENT, PRINTER INK, PAPER, SCANNERS, AND SOFTWARE (U.S. CLS. 100, 101 AND 102).

FIRST USE 2-27-2003; IN COMMERCE 2-27-2003.

STEVEN R. FINE, EXAMINING ATTORNEY

SN 78-381,828. CONTINUOUS LEARNING GROUP, INC., MORGANTOWN, WV. FILED 3-10-2004.

PERFORMANCE
CATALYST

THE MARK CONSISTS OF STANDARD CHARACTERS WITHOUT CLAIM TO ANY PARTICULAR FONT, STYLE, SIZE, OR COLOR.

FOR BUSINESS CONSULTATION SERVICES LEVERAGING THE SCIENCE OF APPLIED BEHAVIOR ANALYSIS (U.S. CLS. 100, 101 AND 102).

FIRST USE 3-23-2004; IN COMMERCE 3-23-2004.

ELISSA GARBER KON, EXAMINING ATTORNEY

CLASS 35—(Continued).

SN 78-384,916. SILVER CERTIFICATES INC., BUFFALO, NY.
FILED 3-16-2004.



NO CLAIM IS MADE TO THE EXCLUSIVE RIGHT TO USE "CERTIFICATE", APART FROM THE MARK AS SHOWN.

THE COLOR GRAY IS CLAIMED AS A FEATURE OF THE MARK.

THE MARK CONSISTS OF AN EAGLE, WITH WINGS EXTENDED, PORTIONS OF WHICH ARE GRAY, AND HOLDING A BRANCH, PORTIONS OF WHICH ARE GRAY, WITHIN ITS TALONS, WITHIN A CIRCLE. THE ENTIRE CIRCLE IS ENCLOSED WITHIN A SECOND LARGER CIRCLE AND THE WORDS "SILVER CERTIFICATE" APPEAR IN BETWEEN THE TWO CIRCLES ALONG WITH TWO FIVE POINTED STARS.

FOR ON-LINE GIFT CERTIFICATE ORDER FULFILLMENT SERVICES FOR RESTAURANTS AND OTHER RETAIL BUSINESSES (U.S. CLS. 100, 101 AND 102).

TRACY CROSS, EXAMINING ATTORNEY

SN 78-395,799. KIETRA CORPORATION, PORTLAND, OR.
FILED 4-2-2004.

XPR

THE MARK CONSISTS OF STANDARD CHARACTERS WITHOUT CLAIM TO ANY PARTICULAR FONT, STYLE, SIZE, OR COLOR.

FOR BUSINESS INFORMATION MANAGEMENT, NAMELY, ACQUISITION, STORAGE, REVIEW, AND TRACKING OF HEALTH INFORMATION FOR PATIENT CARE, MEDICAL BILLING, AND HEALTH CARE TRANSACTIONS FOR PHYSICIANS, MEDICAL PRACTICE GROUPS AND MEDICAL INSURANCE ENTITIES (U.S. CLS. 100, 101 AND 102).

KATHY DE JONGE, EXAMINING ATTORNEY

CLASS 35—(Continued).

SN 78-398,796. ADEXELITE MEDICAL STAFFING, LLC,
NEW YORK, NY. FILED 4-8-2004.

**MEMBERSHIP HAS ITS
PRIVILEGES**

THE MARK CONSISTS OF STANDARD CHARACTERS WITHOUT CLAIM TO ANY PARTICULAR FONT, STYLE, SIZE, OR COLOR.

FOR TEMPORARY EMPLOYMENT AND STAFFING SERVICES IN THE HEALTHCARE FIELD (U.S. CLS. 100, 101 AND 102).

BARBARA GAYNOR, EXAMINING ATTORNEY

SN 78-400,864. KEYMEDIA, INC., LOS GATOS, CA. FILED 4-13-2004.

SonicSwap

THE MARK CONSISTS OF STANDARD CHARACTERS WITHOUT CLAIM TO ANY PARTICULAR FONT, STYLE, SIZE, OR COLOR.

FOR OPERATING AN ON-LINE MARKETPLACE FOR BUYERS AND SELLERS OF GOODS AND SERVICES (U.S. CLS. 100, 101 AND 102).

FIRST USE 8-1-2003; IN COMMERCE 8-31-2004.

DAWN FELDMAN, EXAMINING ATTORNEY

SN 78-403,555. IBG ENTERPRISES, INC., BAKERSFIELD, CA. FILED 4-16-2004.

**STOPCREDITOFFERS.
COM**

THE MARK CONSISTS OF STANDARD CHARACTERS WITHOUT CLAIM TO ANY PARTICULAR FONT, STYLE, SIZE, OR COLOR.

FOR SERVICES FOR REMOVING NAMES FROM MAILING LISTS FOR PRE-APPROVED CREDIT CARDS (U.S. CLS. 100, 101 AND 102).

SALLY SHIN, EXAMINING ATTORNEY

CLASS 35—(Continued).

SN 78-403,981. HALL, CHESTON L., TALLAHASSEE, FL. FILED 4-19-2004.

HIREMART

THE MARK CONSISTS OF STANDARD CHARACTERS WITHOUT CLAIM TO ANY PARTICULAR FONT, STYLE, SIZE, OR COLOR.

FOR SERVING AS A HUMAN RESOURCES DEPARTMENT FOR OTHERS (U.S. CLS. 100, 101 AND 102). FIRST USE 1-1-2003; IN COMMERCE 1-1-2003. MONIQUE MILLER, EXAMINING ATTORNEY

CLASS 35—(Continued).

SN 78-410,089. PETLAND, INC., CHILlicothe, OH. FILED 4-29-2004.

PETS MAKE LIFE BETTER

THE MARK CONSISTS OF STANDARD CHARACTERS WITHOUT CLAIM TO ANY PARTICULAR FONT, STYLE, SIZE, OR COLOR.

OWNER OF U.S. REG. NOS. 1,060,290, 1,061,413 AND 1,113,136.

FOR RETAIL STORE SERVICES FEATURING PET RELATED SUPPLIES AND LIVE PETS (U.S. CLS. 100, 101 AND 102).

BRIDGETT SMITH, EXAMINING ATTORNEY

SN 78-411,723. SKILLED HEALTHCARE, LLC, FOOTHILL RANCH, CA. FILED 4-30-2004.

SN 78-406,547. COMBS, JOHN, IRVINE, CA. FILED 4-22-2004.

Synergy Sourcing



THE MARK CONSISTS OF STANDARD CHARACTERS WITHOUT CLAIM TO ANY PARTICULAR FONT, STYLE, SIZE, OR COLOR.

FOR CREATION AND DEVELOPMENT OF STRATEGIC PARTNERSHIPS BETWEEN BUSINESSES THAT ARE INVOLVED IN THE FIELD OF REAL ESTATE AND REAL ESTATE SUPPORT, SUCH AS PROPERTY MANAGEMENT BUSINESSES, CONSTRUCTION MANAGEMENT BUSINESSES, REAL ESTATE BROKERAGES, COMMERCIAL PROPERTY OWNERS, REAL PROPERTY OWNERS AND OWNER AND LEASING FUNDING SOURCES (U.S. CLS. 100, 101 AND 102). ALLISON HOLTZ, EXAMINING ATTORNEY

FOR BUSINESS MANAGEMENT SERVICES FOR HEALTH SERVICES PROVIDERS (U.S. CLS. 100, 101 AND 102).

FIRST USE 8-31-2003; IN COMMERCE 8-31-2003. RAMONA ORTIGA, EXAMINING ATTORNEY

CLASS 35—(Continued).

SN 78-420,005. CANINE & ABLE, LLC, ALAMEDA, CA.
FILED 5-17-2004.

DOG BONE ALLEY

THE MARK CONSISTS OF STANDARD CHARACTERS WITHOUT CLAIM TO ANY PARTICULAR FONT, STYLE, SIZE, OR COLOR.

NO CLAIM IS MADE TO THE EXCLUSIVE RIGHT TO USE "DOG BONE", APART FROM THE MARK AS SHOWN. FOR RETAIL PET SUPPLY STORE SERVICES (U.S. CLS. 100, 101 AND 102).

FIRST USE 5-15-2004; IN COMMERCE 7-26-2004.
NANCY CLARKE, EXAMINING ATTORNEY

CLASS 35—(Continued).

SN 78-422,305. HENDON PUBLISHING CO., DEERFIELD, IL.
FILED 5-20-2004.



NO CLAIM IS MADE TO THE EXCLUSIVE RIGHT TO USE "POLICE FLEET EXPO", APART FROM THE MARK AS SHOWN.

THE MARK CONSISTS OF A PARTIAL OUTLINE SKETCH OF A LAW ENFORCEMENT VEHICLE AND THE WORDS POLICE FLEET EXPO.

FOR ORGANIZING, PROMOTING AND CONDUCTING TRADE SHOW EXHIBITIONS AND CONFERENCES RELATING TO LAW ENFORCEMENT, NAMELY POLICE FLEET MANAGEMENT AND OPERATIONS (U.S. CLS. 100, 101 AND 102).

FIRST USE 3-7-2003; IN COMMERCE 3-7-2003.
KEVON CHISOLM, EXAMINING ATTORNEY

SN 78-422,163. HENDON PUBLISHING CO., DEERFIELD, IL.
FILED 5-20-2004.

Tactical Pro Expo

THE MARK CONSISTS OF STANDARD CHARACTERS WITHOUT CLAIM TO ANY PARTICULAR FONT, STYLE, SIZE, OR COLOR.

NO CLAIM IS MADE TO THE EXCLUSIVE RIGHT TO USE "TACTICAL" AND "EXPO", APART FROM THE MARK AS SHOWN.

FOR ORGANIZING, PROMOTING AND CONDUCTING TRADE SHOW EXHIBITIONS AND CONFERENCES RELATING TO TACTICAL UNIT LAW ENFORCEMENT (U.S. CLS. 100, 101 AND 102).

FIRST USE 9-0-2003; IN COMMERCE 9-0-2003.
ROBERT LORENZO, EXAMINING ATTORNEY

SN 78-423,604. RACH ENTERPRISES, NEW YORK, NY.
FILED 5-24-2004.

Business Simple.

THE MARK CONSISTS OF STANDARD CHARACTERS WITHOUT CLAIM TO ANY PARTICULAR FONT, STYLE, SIZE, OR COLOR.

NO CLAIM IS MADE TO THE EXCLUSIVE RIGHT TO USE BUSINESS, APART FROM THE MARK AS SHOWN.

FOR BUSINESS MARKETING CONSULTING SERVICES (U.S. CLS. 100, 101 AND 102).

ASMAT KHAN, EXAMINING ATTORNEY

CLASS 35—(Continued).

SN 78-423,701. CHRISTMAS TREE HILL, INC., YORK, PA.
FILED 5-24-2004.

CLASS 35—(Continued).

SN 78-423,735. CALENDARS.COM, L.L.C., AUSTIN, TX.
FILED 5-24-2004.

CHRISTMAS TREE
HILL

Nothing But the
Breed

THE MARK CONSISTS OF STANDARD CHARACTERS WITHOUT CLAIM TO ANY PARTICULAR FONT, STYLE, SIZE, OR COLOR.

FOR RETAIL AND ON-LINE RETAIL STORE SERVICES FEATURING BEDDING, CLOTHING, COLLECTIBLES, WALL HANGINGS, TOYS, PLUSH TOYS, DOLLS, FIGURINES AND ACCESSORIES FOR USE THEREWITH, POTTERY, TABLEWARE, GLASSWARE, DECORATIVE PLATES, ART PRINTS, MIRRORS, DECORATIVE SIGNS, ELECTRIC LAMPS, LAMP SHADES AND LIGHT BULBS, HOUSEWARES, PICTURE FRAMES, LUGGAGE, FURNITURE, RUGS, LINENS, CURTAINS AND WINDOW TREATMENTS, TABLE RUNNERS, TABLE CLOTHS, DOILIES, COASTERS AND PLACEMATS, CANDLES, CANDLESTICKS, CANDLE HOLDERS, CANDLE RINGS AND CANDLE ACCESSORIES, MUSIC AND JEWELRY BOXES, JEWELRY, CASSETTE TAPES AND COMPACT DISCS, CLOCKS, BIRD FEEDERS, BIRD HOUSES AND BIRD BATHS, WATER FOUNTAINS, MAIL BOXES, SUN DIALS, STATIONERY, POSTCARDS, NOTECARDS, CHRISTMAS CARDS, HOLIDAY CARDS AND EVERYDAY CARDS, CALENDARS, BOOKS, RIBBONS, BOWS, FLAGS, WIND-SOCKS AND WIND CHIMES, NON-MEDICATED SOAPS, COLOGNES AND SKIN LOTIONS, ARTIFICIAL CHRISTMAS TREES, HOLIDAY LIGHTS AND CHRISTMAS TREE ORNAMENTS, CHRISTMAS, HOLIDAY AND SEASONAL DECORATIONS, CANDY, POTPOURRI, HOME FRAGRANCE PRODUCTS, BASKETS, LIVE PLANTS, GARDEN DECORATIONS, GARDEN FURNITURE AND GARDEN TOOLS (U.S. CLS. 100, 101 AND 102).

FIRST USE 10-15-1971; IN COMMERCE 10-15-1971.
ANGELA M. MICHELI, EXAMINING ATTORNEY

THE MARK CONSISTS OF STANDARD CHARACTERS WITHOUT CLAIM TO ANY PARTICULAR FONT, STYLE, SIZE, OR COLOR.

FOR PROMOTING THE GOODS AND SERVICES OF OTHERS BY PROVIDING A WEB SITE AT WHICH USERS CAN PURCHASE SPECIALITY CALENDERS FEATURING INDIVIDUAL DOG BREEDS, REFERENCE AND GUIDE BOOKS ON THE TOPIC OF DOGS AND DOG BREEDS; ON-LINE RETAIL STORE SERVICES FEATURING BOOKS, GUIDE BOOKS, BOOK COVERS, BOOK HOLDERS, BOOK RESTS, BOOK STANDS, CALENDARS, SPECIALITY CALENDERS FEATURING DOGS, CALENDAR DESK PADS, CALENDAR DESK STANDS, CALENDAR STANDS, LEASH HOOKS, DOG LEASHES, DOG COLLARS, DOG CLOTHING AND APPAREL, DOG PARKAS, BOOK MARKERS, DOG BOWLS, NON-METAL PIGGY BANKS, ELECTRIC NIGHT LIGHTS, PICTURE FRAMES, SALT AND PEPPER SHAKERS, NON-LUMINOUS, NON-MECHANICAL SIGNS NOT OF METAL, HOUSEHOLD UTENSILS, COOKIE JARS, SOAP DISHES, TOOTH ELECTRIC AND NON-ELECTRIC BRUSHES, CUPS, DOOR MATS, BATH MATS, FLOOR MATS FOR VEHICLES, PLASTIC PLACE MATS FOR PET BOWLS, MUGS, BEER MUGS, EARTHENWARE MUGS, GLASS MUGS, PORCELAIN MUGS, NOTE PADS, NON-METAL AND NON-LEATHER KEY CHAINS, KEY FOBs NOT OF METAL, POSTCARDS, BLANK OR PARTIALLY PRINTED POSTCARDS, PICTURE POSTCARDS, COLD CAST RESIN FIGURINES, FABRIC FIGURINES, FIGURINES, CERAMIC FIGURINES, CLAY DOUGH FIGURINES, GLASS FIGURINES, PORCELAIN FIGURINES, SHIRTS, T-SHIRTS, SWEAT SHIRTS AND PANTS, SPORT AND GOLF SHIRTS, KNIT SHIRTS, NIGHT AND SLEEP SHIRTS, POLO SHIRTS, WIND SHIRTS, PET TOYS, DOG TOYS, PLUSH TOYS, AND SOFT SCULPTURE PLUSH TOYS; PROVIDING A WEB SITE WHICH FEATURES ADVERTISEMENTS FOR THE GOODS AND SERVICES OF OTHERS ON A GLOBAL COMPUTER NETWORK (U.S. CLS. 100, 101 AND 102).

MONIQUE MILLER, EXAMINING ATTORNEY

CLASS 35—(Continued).

SN 78-423,915. DAVIS, KEITH J, SR., HOUSTON, TX. FILED 5-24-2004.

D-MARS

THE MARK CONSISTS OF STANDARD CHARACTERS WITHOUT CLAIM TO ANY PARTICULAR FONT, STYLE, SIZE, OR COLOR.
FOR BUSINESS MARKETING AND DIRECT MAIL ADVERTISING (U.S. CLS. 100, 101 AND 102).
FIRST USE 10-0-1999; IN COMMERCE 10-0-1999.
ASMAT KHAN, EXAMINING ATTORNEY

SN 78-424,005. GENERAL MILLS, INC., MINNEAPOLIS, MN. FILED 5-24-2004.

**KIDS BAKE AMERICA
BETTER**

THE MARK CONSISTS OF STANDARD CHARACTERS WITHOUT CLAIM TO ANY PARTICULAR FONT, STYLE, SIZE, OR COLOR.
FOR PROMOTING AWARENESS OF CHILDHOOD HUNGER AND PROVIDING INFORMATION TO CHARITABLE ORGANIZATIONS, FAMILIES AND CHILDREN REGARDING CHILDHOOD HUNGER AND BAKE SALES (U.S. CLS. 100, 101 AND 102).
BRIAN NEVILLE, EXAMINING ATTORNEY

SN 78-424,072. PLATT, KENNETH, DBA PLATT/FORM ART COMPANY, BIRMINGHAM, MI. FILED 5-24-2004.

LET THEM PLAY TOO

THE MARK CONSISTS OF STANDARD CHARACTERS WITHOUT CLAIM TO ANY PARTICULAR FONT, STYLE, SIZE, OR COLOR.
FOR PROMOTING PUBLIC AWARENESS OF THE NEED TO PROTECT ENDANGERED SPECIES (U.S. CLS. 100, 101 AND 102).
MARY ROSSMAN, EXAMINING ATTORNEY

CLASS 35—(Continued).

SN 78-424,712. SIMMONS MARKET RESEARCH BUREAU, INC., DEERFIELD BEACH, FL. FILED 5-25-2004.

**THE FUTURE OF
INFORMATION**

THE MARK CONSISTS OF STANDARD CHARACTERS WITHOUT CLAIM TO ANY PARTICULAR FONT, STYLE, SIZE, OR COLOR.
FOR MARKET RESEARCH SERVICES (U.S. CLS. 100, 101 AND 102).
FIRST USE 2-1-2003; IN COMMERCE 2-1-2003.
HOWARD B. LEVINE, EXAMINING ATTORNEY

SN 78-424,998. COKEM INTERNATIONAL, LTD., PLYMOUTH, MN. FILED 5-25-2004.

WAREHOUSE190

THE MARK CONSISTS OF STANDARD CHARACTERS WITHOUT CLAIM TO ANY PARTICULAR FONT, STYLE, SIZE, OR COLOR.
FOR ONLINE RETAIL STORE AND ORDER FULFILLMENT SERVICES FEATURING VIDEO GAMES, COMPUTER SOFTWARE AND ACCESSORIES (U.S. CLS. 100, 101 AND 102).
WINSTON FOLMAR, EXAMINING ATTORNEY

SN 78-425,201. MIDWEST MOUNTAINEERING INCORPORATED, MINNEAPOLIS, MN. FILED 5-26-2004.

**Ask us. We've been
there.**

THE MARK CONSISTS OF STANDARD CHARACTERS WITHOUT CLAIM TO ANY PARTICULAR FONT, STYLE, SIZE, OR COLOR.
FOR RETAIL STORE SERVICES, MAIL ORDER RETAIL SERVICES, AND ON-LINE RETAIL SERVICES, ALL FEATURING OUTDOOR AND TRAVEL GEAR, EQUIPMENT, APPAREL, FOOTWEAR, ACCESSORIES AND PUBLICATIONS (U.S. CLS. 100, 101 AND 102).
FIRST USE 0-0-1980; IN COMMERCE 0-0-1980.
JOHN HWANG, EXAMINING ATTORNEY

CLASS 35—(Continued).

SN 78-425,647. MOMENTUM MARKETING SERVICES CORP., ALEXANDRIA, VA. FILED 5-26-2004.

CLASS 35—(Continued).

SN 78-427,465. DIEBOLD, INCORPORATED, NORTH CANTON, OH. FILED 5-30-2004.

Avidxperiential

THE MARK CONSISTS OF STANDARD CHARACTERS WITHOUT CLAIM TO ANY PARTICULAR FONT, STYLE, SIZE, OR COLOR.

FOR ARRANGING AND CONDUCTING MARKETING PROMOTIONAL EVENTS FOR OTHERS (U.S. CLS. 100, 101 AND 102).

MIDGE BUTLER, EXAMINING ATTORNEY

POINTRAC

THE MARK CONSISTS OF STANDARD CHARACTERS WITHOUT CLAIM TO ANY PARTICULAR FONT, STYLE, SIZE, OR COLOR.

FOR PROVIDING MARKET RESEARCH INFORMATION TO FINANCIAL INSTITUTIONS VIA WEBSITES ON GLOBAL COMPUTER NETWORKS (U.S. CLS. 100, 101 AND 102).

STEVEN R. FOSTER, EXAMINING ATTORNEY

SN 78-425,892. SHELL TRADEMARK MANAGEMENT BV, THE HAGUE, NETHERLANDS, FILED 5-27-2004.

SN 78-427,953. LEE HECHT HARRISON LLC, WOODCLIFF LAKE, NJ. FILED 6-1-2004.

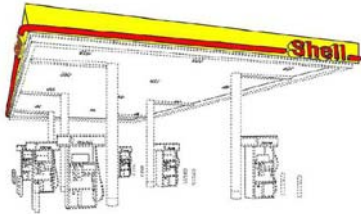

OWNER OF U.S. REG. NO. 2,745,401.
THE COLOR(S) YELLOW AND RED IS/ARE CLAIMED AS A FEATURE OF THE MARK.

THE MARK CONSISTS OF THE COLORS YELLOW AND RED AND THE WORD SHELL USED ON A CANOPY. THE CANOPY IS YELLOW AND THE STRIPE ALONG THE BOTTOM OF THE CANOPY IS RED. THE WORD "SHELL" IS RED ON THE CANOPY. THE OTHER MATTER SHOWN IN THE DRAWING SHOWS POSITIONING OF THE MARK ONLY AND IS NOT CLAIMED AS A FEATURE OF THE MARK.

FOR RETAIL STORE SERVICES FEATURING CONVENIENCE STORE ITEMS AND GASOLINE (U.S. CLS. 100, 101 AND 102).

FIRST USE 5-31-2000; IN COMMERCE 5-31-2000.
TARAH HARDY, EXAMINING ATTORNEY

THE MARK CONSISTS OF STANDARD CHARACTERS WITHOUT CLAIM TO ANY PARTICULAR FONT, STYLE, SIZE, OR COLOR.

FOR EMPLOYMENT SERVICES IN THE FIELD OF JOB PLACEMENT, NAMELY PROVIDING AN ONLINE COMPUTER DATABASE OF RESUMES AND JOB LISTINGS (U.S. CLS. 100, 101 AND 102).

TIMOTHY FINNEGAN, EXAMINING ATTORNEY

LHH CONNECT2JOBS

CLASS 35—(Continued).

SN 78-428,129. PROKARMA, INC., TIGARD, OR. FILED 6-1-2004.

PROKARMA

THE MARK CONSISTS OF STANDARD CHARACTERS WITHOUT CLAIM TO ANY PARTICULAR FONT, STYLE, SIZE, OR COLOR.

FOR BUSINESS PROCESS OUTSOURCING, OUTSOURCING IN THE FIELD OF PROCUREMENT, HUMAN RESOURCES, FINANCE AND MANUFACTURING; EMPLOYMENT CONTRACTING AND TEMPORARY HELP SERVICES; RECRUITMENT AND PLACEMENT OF PERSONNEL ON A TEMPORARY, CONTRACT OR PERMANENT BASIS; BUSINESS CONSULTING SERVICES IN THE FIELD OF PROCUREMENT, HUMAN RESOURCES, FINANCE AND MANUFACTURING (U.S. CLS. 100, 101 AND 102).

JENNIFER KRISP, EXAMINING ATTORNEY

SN 78-428,467. MPS IP SERVICES CORP., JACKSONVILLE, FL. FILED 6-2-2004.

SUNBELT

THE MARK CONSISTS OF STANDARD CHARACTERS WITHOUT CLAIM TO ANY PARTICULAR FONT, STYLE, SIZE, OR COLOR.

FOR EMPLOYMENT HIRING, RECRUITING, PLACEMENT, STAFFING AND CAREER NETWORKING SERVICES (U.S. CLS. 100, 101 AND 102).

FIRST USE 3-17-1998; IN COMMERCE 3-17-1998.

MICHAEL ENGEL, EXAMINING ATTORNEY

CLASS 35—(Continued).

SN 78-429,924. TRUE DOLLAR STORE, INC., ODESSA, TX. FILED 6-4-2004.

TRUE DOLLAR

THE MARK CONSISTS OF STANDARD CHARACTERS WITHOUT CLAIM TO ANY PARTICULAR FONT, STYLE, SIZE, OR COLOR.

NO CLAIM IS MADE TO THE EXCLUSIVE RIGHT TO USE "DOLLAR", APART FROM THE MARK AS SHOWN.

FOR RETAIL STORE SERVICES FEATURING GENERAL MERCHANDISE (U.S. CLS. 100, 101 AND 102).

FIRST USE 12-9-2003; IN COMMERCE 12-9-2003.

JENNIFER KRISP, EXAMINING ATTORNEY

SN 78-430,325. WALZ, MARK F., HOUSTON, TX. FILED 6-4-2004.

EXXPRESSNEWS

THE MARK CONSISTS OF STANDARD CHARACTERS WITHOUT CLAIM TO ANY PARTICULAR FONT, STYLE, SIZE, OR COLOR.

FOR RETAIL STORES AND COMPUTERIZED ONLINE RETAIL STORE SERVICES IN THE FIELDS OF NEWSPAPERS, PERIODICALS, SUBSCRIPTIONS, COFFEE BEVERAGES AND RELATED COFFEE PARAPHERNALIA (U.S. CLS. 100, 101 AND 102).

MIDGE BUTLER, EXAMINING ATTORNEY

SN 78-430,410. SPLATBROTHERS PAINTBALL, CHESTERFIELD, VA. FILED 6-4-2004.

**SPLATBROTHERS
PAINTBALL**

THE MARK CONSISTS OF STANDARD CHARACTERS WITHOUT CLAIM TO ANY PARTICULAR FONT, STYLE, SIZE, OR COLOR.

NO CLAIM IS MADE TO THE EXCLUSIVE RIGHT TO USE "PAINTBALL", APART FROM THE MARK AS SHOWN.

FOR RETAIL STORE SERVICES FEATURING PAINTBALL PRODUCTS (U.S. CLS. 100, 101 AND 102).

FIRST USE 2-8-2002; IN COMMERCE 2-1-2004.

AMY ALFIERI, EXAMINING ATTORNEY

CLASS 35—(Continued).

SN 78-431,130. THE FOOTBALL SPECTACULAR, INC., LAS VEGAS, NV. FILED 6-7-2004.

**THE FOOTBALL
SPECTACULAR**

THE MARK CONSISTS OF STANDARD CHARACTERS WITHOUT CLAIM TO ANY PARTICULAR FONT, STYLE, SIZE, OR COLOR.

NO CLAIM IS MADE TO THE EXCLUSIVE RIGHT TO USE "FOOTBALL", APART FROM THE MARK AS SHOWN. SEC. 2(F).

FOR ORGANIZING AND CONDUCTING TRADE SHOWS IN THE FIELD OF SPORTS MEMORABILIA COLLECTING (U.S. CLS. 100, 101 AND 102).

FIRST USE 2-25-1995; IN COMMERCE 2-25-1995.
WANDA KAY PRICE, EXAMINING ATTORNEY

SN 78-431,218. HOWARD J. WILK, PHILADELPHIA, PA. FILED 6-7-2004.

Viz

THE MARK CONSISTS OF STANDARD CHARACTERS WITHOUT CLAIM TO ANY PARTICULAR FONT, STYLE, SIZE, OR COLOR.

FOR BUSINESS MARKETING SERVICES, NAMELY, NAMING AND BRANDING OF PRODUCTS AND SERVICES OF OTHERS AND CREATING CORPORATE IDENTITY FOR OTHERS (U.S. CLS. 100, 101 AND 102).
CIMMERIAN COLEMAN, EXAMINING ATTORNEY

CLASS 35—(Continued).

SN 78-431,600. DAP BRANDS COMPANY, MEDINA, OH. FILED 6-8-2004.



THE MARK CONSISTS OF THE WORD INSIGHT WITH A \$ SIGN IN AN EYEBALL SHAPE OVER THE LETTERS.

FOR TRACKING SALES OF PRODUCTS OFF SHELVES AND, BASED ON THE DATA SO COLLECTED, PROVIDING REPORTS AND ADVICE ON IMPROVING SALES, PLANOGRAMS AND FINANCIAL PROGRAMS (U.S. CLS. 100, 101 AND 102).

FIRST USE 6-30-2002; IN COMMERCE 6-30-2002.
ARETHA SOMERVILLE, EXAMINING ATTORNEY

SN 78-432,631. GUARDIAN BUILDING PRODUCTS, INC., GREER, SC. FILED 6-9-2004.

SOLUTIONS2

THE MARK CONSISTS OF STANDARD CHARACTERS WITHOUT CLAIM TO ANY PARTICULAR FONT, STYLE, SIZE, OR COLOR.

FOR DISTRIBUTORSHIP SERVICES IN THE FIELD OF BUILDING PRODUCTS (U.S. CLS. 100, 101 AND 102).
FIRST USE 4-15-2004; IN COMMERCE 4-15-2004.
C. DIONNE CLYBURN, EXAMINING ATTORNEY

CLASS 35—(Continued).

SN 78-432,980. ATHENIAN REAL ESTATE DEVELOPMENT, INC., SCARBOROUGH, ME. FILED 6-10-2004.



OWNER OF U.S. REG. NOS. 2,130,179 AND 2,218,522.
NO CLAIM IS MADE TO THE EXCLUSIVE RIGHT TO USE "SUPERMARKET", APART FROM THE MARK AS SHOWN.

THE COLOR(S) PURPLE, GREEN, RED, BROWN AND WHITE IS/ARE CLAIMED AS A FEATURE OF THE MARK.

THE MARK CONSISTS OF A GREEN PEPPER, GREEN LEAVES, GREEN GRAPES WITH A BROWN STEM, A LOAF OF BROWN AND WHITE BREAD, A RED APPLE WITH GREEN LEAVES, AND CHERRIES WITH GREEN STEMS ALL ON A PURPLE BACKGROUND, WITH THE WORDING SWEETBAY IN PURPLE, AND THE WORDING SUPERMARKET IN GREEN.

THE MARK CONSISTS OF A PEPPER, LEAVES, GRAPES WITH A STEM, A LOAF OF BREAD, AN APPLE WITH LEAVES, AND CHERRIES WITH STEMS ALL ON A BACKGROUND, WITH THE WORDING SWEETBAY AND THE WORDING SUPERMARKET.

FOR RETAIL SUPERMARKET SERVICES (U.S. CLS. 100, 101 AND 102).

FIRST USE 5-12-2004; IN COMMERCE 5-12-2004.
JENNIFER KRISP, EXAMINING ATTORNEY

SN 78-433,084. BUILD-A-BEAR RETAIL MANAGEMENT, INC., ST. LOUIS, MO. FILED 6-10-2004.

THINGS 2 SAY

THE MARK CONSISTS OF STANDARD CHARACTERS WITHOUT CLAIM TO ANY PARTICULAR FONT, STYLE, SIZE, OR COLOR.

FOR RETAIL STORE SERVICES AND RETAIL SERVICES VIA A GLOBAL COMPUTER NETWORK ALL IN THE FIELD OF DOLLS AND ACCESSORIES THEREFOR (U.S. CLS. 100, 101 AND 102).

ALEXANDER L. POWERS, EXAMINING ATTORNEY

CLASS 35—(Continued).

SN 78-433,719. BLUE, DANIEL S., BLANDINSVILLE, IL. FILED 6-11-2004.

Backyardstuff

THE MARK CONSISTS OF STANDARD CHARACTERS WITHOUT CLAIM TO ANY PARTICULAR FONT, STYLE, SIZE, OR COLOR.

FOR ONLINE RETAIL STORE SERVICES FEATURING OUTDOOR AND BACKYARD LEISURE PRODUCTS (U.S. CLS. 100, 101 AND 102).

FIRST USE 1-15-2002; IN COMMERCE 1-15-2002.
PATRICIA EVANKO, EXAMINING ATTORNEY

SN 78-433,740. TECHNICON SYSTEMS, INC., OMAHA, NE. FILED 6-11-2004.



THE LINING AND STIPLING ARE FEATURES OF THE MARK.

THE MARK CONSISTS OF A DESIGN OF A HOG'S HEAD AND A DOG'S HEAD.

FOR BUSINESS MANAGEMENT CONSULTATION (U.S. CLS. 100, 101 AND 102).

FIRST USE 4-23-2004; IN COMMERCE 4-23-2004.
BRIAN PINO, EXAMINING ATTORNEY

SN 78-433,778. FUEL MANAGERS, INCORPORATED, TULSA, OK. FILED 6-11-2004.



FOR FUEL MANAGEMENT SERVICES FOR OTHERS, NAMELY, INVENTORY MANAGEMENT, PROVIDING DATA FOR COMPLIANCE WITH ENVIRONMENTAL LAWS AND REGULATIONS, AND FUEL TRANSPORTATION LOGISTICS MANAGEMENT SERVICES IN THE NATURE OF DELIVERY SCHEDULING, PURCHASE TIMING OPTIMIZATION AND FUEL REPORTING, PROVIDED OVER A GLOBAL COMMUNICATION INFORMATION NETWORK (U.S. CLS. 100, 101 AND 102).

FIRST USE 1-31-2003; IN COMMERCE 1-31-2003.
LAURA KOVAISKY, EXAMINING ATTORNEY

CLASS 35—(Continued).

SN 78-434,046. BUNN-O-MATIC CORPORATION, SPRINGFIELD, IL. FILED 6-11-2004.

**BUNN FAMILY
GOURMET**

THE MARK CONSISTS OF STANDARD CHARACTERS WITHOUT CLAIM TO ANY PARTICULAR FONT, STYLE, SIZE, OR COLOR.

OWNER OF U.S. REG. NOS. 694,904, 2,581,498 AND OTHERS.

NO CLAIM IS MADE TO THE EXCLUSIVE RIGHT TO USE GOURMET, APART FROM THE MARK AS SHOWN.

FOR ON-LINE RETAIL STORE SERVICES FEATURING FOOD AND FOOD PREPARATION GOODS (U.S. CLS. 100, 101 AND 102).

FIRST USE 6-1-2004; IN COMMERCE 6-1-2004.
LINDA POWELL, EXAMINING ATTORNEY

CLASS 35—(Continued).

SN 78-434,362. NU-LIFE INC., TORONTO, ONTARIO, CANADA, FILED 6-13-2004.

DSMAX

THE MARK CONSISTS OF STANDARD CHARACTERS WITHOUT CLAIM TO ANY PARTICULAR FONT, STYLE, SIZE, OR COLOR.

FOR RETAIL VARIETY STORE SERVICES; RETAIL STORE SERVICES FEATURING GENERAL MERCHANDISE (U.S. CLS. 100, 101 AND 102).

BRIAN PINO, EXAMINING ATTORNEY

SN 78-434,231. ROGAN, MARCUS R., COLORADO SPRINGS, CO. FILED 6-11-2004.

Hercules Condoms

THE MARK CONSISTS OF STANDARD CHARACTERS WITHOUT CLAIM TO ANY PARTICULAR FONT, STYLE, SIZE, OR COLOR.

OWNER OF U.S. REG. NO. 2,841,651.

NO CLAIM IS MADE TO THE EXCLUSIVE RIGHT TO USE "CONDOMS", APART FROM THE MARK AS SHOWN.

FOR RETAIL STORE AND MAIL ORDER SERVICES FEATURING CONDOMS, ADULT SEXUAL PRODUCTS, ADULT MOVIES, PERSONAL LUBRICANTS AND NOVELTY ITEMS (U.S. CLS. 100, 101 AND 102).

FIRST USE 6-11-2004; IN COMMERCE 6-11-2004.
ROBERT LORENZO, EXAMINING ATTORNEY

SN 78-434,801. MASTERCARD INTERNATIONAL INCORPORATED, PURCHASE, NY. FILED 6-14-2004.

PURCHASELOGIC

THE MARK CONSISTS OF STANDARD CHARACTERS WITHOUT CLAIM TO ANY PARTICULAR FONT, STYLE, SIZE, OR COLOR.

FOR CONSULTING SERVICES REGARDING BUSINESS PROCUREMENT PRACTICES; BUSINESS MANAGEMENT SERVICES REGARDING IDENTIFYING, ANALYZING, DEVELOPING, MONITORING AND IMPLEMENTING PROCUREMENT PRACTICES; PROVIDING A WEB SITE FOR USE BY OTHERS IN IDENTIFYING, ANALYZING, DEVELOPING, MONITORING AND OPTIMIZING BUSINESS PROCUREMENT PRACTICES (U.S. CLS. 100, 101 AND 102).

FIRST USE 4-19-2004; IN COMMERCE 4-19-2004.
YSA DEJESUS, EXAMINING ATTORNEY

CLASS 35—(Continued).

SN 78-434,872. NEWGISTICS, INC., AUSTIN, TX. FILED 6-14-2004.

Returns aren't just
boxes. They're
customers.

THE MARK CONSISTS OF STANDARD CHARACTERS WITHOUT CLAIM TO ANY PARTICULAR FONT, STYLE, SIZE, OR COLOR.

FOR RETURN SHIPPING MANAGEMENT OF MERCHANDISE BY ENABLING EASY RETURNS, STREAMLINING RETURN PROCESS, AND PROVIDING ADVANCED SHIPPING NOTIFICATION FOR COMPANIES PROVIDING PRODUCTS OR MERCHANDISE IN COMMERCE, TO RETAILERS, WHOLESALERS, FULFILLMENT COMPANIES, DISTRIBUTION COMPANIES, AND MANUFACTURERS (U.S. CLS. 100, 101 AND 102).

FIRST USE 6-1-2003; IN COMMERCE 1-15-2004.
YSA DEJESUS, EXAMINING ATTORNEY

SN 78-434,934. GUESTKEY MEDIA, LLC, SHERMAN OAKS, CA. FILED 6-14-2004.

GUESTKEY

THE MARK CONSISTS OF STANDARD CHARACTERS WITHOUT CLAIM TO ANY PARTICULAR FONT, STYLE, SIZE, OR COLOR.

FOR ADVERTISING, MARKETING AND PROMOTIONAL SERVICES AND CONSULTATION (U.S. CLS. 100, 101 AND 102).

JAMES GRIFFIN, EXAMINING ATTORNEY

CLASS 35—(Continued).

SN 78-434,994. WILLIAMS, BETSY ANN, LONG BEACH, CA. FILED 6-14-2004.

flypepper

FOR WHOLESALE DISTRIBUTORSHIPS FEATURING CLOTHING (U.S. CLS. 100, 101 AND 102).
LINDA ESTRADA, EXAMINING ATTORNEY

SN 78-435,897. WIEMERSLAGE, DONNA, CHICAGO, IL. FILED 6-16-2004.

JUST BE COZ!

THE MARK CONSISTS OF STANDARD CHARACTERS WITHOUT CLAIM TO ANY PARTICULAR FONT, STYLE, SIZE, OR COLOR.

FOR RETAIL STORE SERVICES, MAIL ORDER RETAIL CATALOG SERVICES AND ON-LINE RETAIL SERVICES FEATURING SOUVENIRS FOR PETS (U.S. CLS. 100, 101 AND 102).

ALICE BENMAMAN, EXAMINING ATTORNEY

CLASS 35—(Continued).

SN 78-435,946. SOCIETY FOR MAINTENANCE & RELIABILITY PROFESSIONALS, KNOXVILLE, TN. FILED 6-16-2004.



OWNER OF U.S. REG. NO. 1,985,400.
 NO CLAIM IS MADE TO THE EXCLUSIVE RIGHT TO USE "SOCIETY FOR MAINTENANCE & RELIABILITY PROFESSIONALS CERTIFYING ORGANIZATION", APART FROM THE MARK AS SHOWN.
 THE MARK CONSISTS OF THE NUMERAL "6" AND THE GREEK LETTER "SIGMA".
 FOR ASSOCIATION SERVICES, NAMELY PROMOTING THE INTERESTS OF INDIVIDUALS IN THE ENGINEERING, MAINTENANCE, PURCHASING, AND DISTRIBUTION FIELDS (U.S. CLS. 100, 101 AND 102).
 FIRST USE 8-0-2003, THE MARK WAS FIRST USED ANYWHERE IN A DIFFERENT FORM OTHER THAN THAT SOUGHT TO BE REGISTERED ON 12/00/1992.; IN COMMERCE 8-0-2003, THE MARK WAS FIRST USED IN COMMERCE IN A DIFFERENT FORM OTHER THAN THAT SOUGHT TO BE REGISTERED ON 12/00/1992..
 MARGERY A. TIERNEY, EXAMINING ATTORNEY

SN 78-436,009. OVERSTOCK.COM, INC., SALT LAKE CITY, UT. FILED 6-16-2004.

CLUB O GOLD

THE MARK CONSISTS OF STANDARD CHARACTERS WITHOUT CLAIM TO ANY PARTICULAR FONT, STYLE, SIZE, OR COLOR.
 FOR PROMOTING THE GOODS AND SERVICES OF OTHERS THROUGH A DISCOUNT AND LOYALTY CARD MEMBERSHIP PROGRAM FOR USE IN CONNECTION WITH ONLINE PURCHASES (U.S. CLS. 100, 101 AND 102).
 KEVON CHISOLM, EXAMINING ATTORNEY

CLASS 35—(Continued).

SN 78-436,038. VIRGINIA BEACH CONVENTION AND VISITORS BUREAU, VIRGINIA BEACH, VA. FILED 6-16-2004.

LIVE THE LIFE

THE MARK CONSISTS OF STANDARD CHARACTERS WITHOUT CLAIM TO ANY PARTICULAR FONT, STYLE, SIZE, OR COLOR.
 FOR CONVENTION AND VISITOR'S BUREAU SERVICES, NAMELY PROMOTING BUSINESS AND TOURISM IN THE VIRGINIA BEACH, VIRGINIA AREA (U.S. CLS. 100, 101 AND 102).
 FIRST USE 12-15-2003; IN COMMERCE 12-15-2003.
 SUSAN STIGLITZ, EXAMINING ATTORNEY

SN 78-436,054. VIRGINIA BEACH CONVENTION AND VISITORS BUREAU, VIRGINIA BEACH, VA. FILED 6-16-2004.



FOR CONVENTION AND VISITOR'S BUREAU SERVICES, NAMELY PROMOTING BUSINESS AND TOURISM IN THE VIRGINIA BEACH, VIRGINIA AREA (U.S. CLS. 100, 101 AND 102).
 FIRST USE 9-15-2003; IN COMMERCE 9-15-2003.
 KATHERINE STOIDES, EXAMINING ATTORNEY

CLASS 35—(Continued).

SN 78-436,088. TOTEM BRAND STRATEGY, INC., LOS ALTOS HILLS, CA. FILED 6-16-2004.

CLASS 35—(Continued).

SN 78-436,717. R & L HOBBIES INC., PORTAGE, MI. FILED 6-17-2004.

TOTEM

THE MARK CONSISTS OF STANDARD CHARACTERS WITHOUT CLAIM TO ANY PARTICULAR FONT, STYLE, SIZE, OR COLOR.

FOR CONSULTING SERVICES IN THE FIELD OF MARKETING STRATEGY INCLUDING TARGET AUDIENCE DEFINITION, COMPETITIVE POSITIONING, MESSAGING, NEW PRODUCTS AND BUSINESS PLANING (U.S. CLS. 100, 101 AND 102).
ALICE BENMAMAN, EXAMINING ATTORNEY

HOBBY-SPORTS.COM

THE MARK CONSISTS OF STANDARD CHARACTERS WITHOUT CLAIM TO ANY PARTICULAR FONT, STYLE, SIZE, OR COLOR.

FOR ONLINE AND RETAIL STORE SERVICES FEATURING HOBBY-RELATED PRODUCTS, CRAFTS AND CRAFT SUPPLIES, COLLECTIBLES, RADIO-CONTROLLED TOYS AND PARTS THEREFOR, FUELS, LUBRICANTS, TOYS, TOOLS, PAINTS, ADHESIVES, BOOKS, VIDEOS, EDUCATIONAL MATERIAL AND LITERATURE, ROCKETS AND PARTS THEREFOR, MODELS, RADIOS AND PARTS THEREFOR, SLOT CARS, TRAINS AND APPAREL (U.S. CLS. 100, 101 AND 102).
ARETHA SOMERVILLE, EXAMINING ATTORNEY

SN 78-436,530. NORDSTROM, INC., SEATTLE, WA. FILED 6-16-2004.

NPLUS

THE MARK CONSISTS OF STANDARD CHARACTERS WITHOUT CLAIM TO ANY PARTICULAR FONT, STYLE, SIZE, OR COLOR.

FOR RETAIL STORE SERVICES IN THE FIELDS OF CLOTHING, APPAREL ACCESSORIES, FOOTWEAR, GIFTS, TAILORED CLOTHING, PROSTHETIC DEVICES, AND SPECIALIZED BRAS (U.S. CLS. 100, 101 AND 102).
TARAH HARDY, EXAMINING ATTORNEY

SN 78-436,877. VQ GROUP INTERNATIONAL INCORPORATED, PORTLAND, OR. FILED 6-17-2004.

SOLESTRUCK

THE MARK CONSISTS OF STANDARD CHARACTERS WITHOUT CLAIM TO ANY PARTICULAR FONT, STYLE, SIZE, OR COLOR.

FOR RETAIL CLOTHING STORE SERVICES; ONLINE RETAIL STORE SERVICES FEATURING CLOTHING, SHOES AND ACCESSORIES (U.S. CLS. 100, 101 AND 102).
MAUREEN DALL, EXAMINING ATTORNEY

CLASS 35—(Continued).

SN 78-436,903. AUDIT SOLUTIONS, INC., E. MOLINE, IL.
FILED 6-17-2004.

Vistabon

THE COLOR(S) BLUE (128) IS/ARE CLAIMED AS A FEATURE OF THE MARK.

THE MARK CONSISTS OF LETTERS IN CENTURY GOTHIC FONT AND THE COLOR BLUE, WITH A DOUBLE LINE BELOW THE LETTERS.

FOR BUSINESS SERVICES IN THE NATURE OF ACCOUNTING, BUSINESS AUDITING, BUSINESS CONSULTATION, FISCAL VALUATION AND TAXATION PLANNING, ADVICE, INFORMATION AND CONSULTANCY SERVICES (U.S. CLS. 100, 101 AND 102).

Laura Kovaisky, Examining Attorney

SN 78-437,133. QUALUUM CORPORATION, DENVER, CO.
FILED 6-17-2004.

Qualuum

THE MARK CONSISTS OF STANDARD CHARACTERS WITHOUT CLAIM TO ANY PARTICULAR FONT, STYLE, SIZE, OR COLOR.

FOR HEALTH CARE BUSINESS MANAGEMENT AND BUSINESS CONSULTATION IN THE FIELDS OF HOME AND AMBULATORY CARE (U.S. CLS. 100, 101 AND 102).

FIRST USE 5-28-2004; IN COMMERCE 5-28-2004.
Dawn Feldman, Examining Attorney

CLASS 35—(Continued).

SN 78-437,491. ONEIDA INDIAN NATION, ONEIDA, NY.
FILED 6-18-2004.

**FOUR DIRECTIONS
TALENT**

THE MARK CONSISTS OF STANDARD CHARACTERS WITHOUT CLAIM TO ANY PARTICULAR FONT, STYLE, SIZE, OR COLOR.

OWNER OF U.S. REG. NO. 2,892,930.

NO CLAIM IS MADE TO THE EXCLUSIVE RIGHT TO USE TALENT, APART FROM THE MARK AS SHOWN.

FOR TALENT AGENCY SERVICES IN THE NATURE OF CONDUCTING TALENT SEARCHES AND PROVIDING TALENT DIRECTORIES FOR EMPLOYMENT PLACEMENT (U.S. CLS. 100, 101 AND 102).

Amos T. Matthews, Jr., Examining Attorney

SN 78-437,535. SPECTOR, KINDRA, WESTON, MA. FILED 6-18-2004.

KIDS FOR HEROES

THE MARK CONSISTS OF STANDARD CHARACTERS WITHOUT CLAIM TO ANY PARTICULAR FONT, STYLE, SIZE, OR COLOR.

FOR PROVIDING INFORMATION AND RESOURCES FOR FUNDRAISING ACTIVITIES FOR OTHERS (U.S. CLS. 100, 101 AND 102).

Aretha Somerville, Examining Attorney

SN 78-437,631. BELREWMOND INC., RANCHO CUCAMONGA, CA. FILED 6-18-2004.

TIME DEPOT

THE MARK CONSISTS OF STANDARD CHARACTERS WITHOUT CLAIM TO ANY PARTICULAR FONT, STYLE, SIZE, OR COLOR.

FOR RETAIL, WHOLESALE AND ON-LINE RETAIL STORE SERVICES ALL FEATURING WATCHES, WRIST WATCHES, SPORTS WATCHES AND FASHION WATCHES (U.S. CLS. 100, 101 AND 102).

Tracy Fletcher, Examining Attorney

CLASS 35—(Continued).

SN 78-437,705. OFFICE FURNITURE TODAY, YORK, PA. FILED 6-18-2004.

**BANKERS QUALITY AT
WELFARE PRICES**

THE MARK CONSISTS OF STANDARD CHARACTERS WITHOUT CLAIM TO ANY PARTICULAR FONT, STYLE, SIZE, OR COLOR.

FOR RETAIL STORE SERVICES FEATURING NEW AND USED OFFICE FURNITURE (U.S. CLS. 100, 101 AND 102).

FIRST USE 4-0-2002; IN COMMERCE 4-0-2002.
MICHAEL WEBSTER, EXAMINING ATTORNEY

SN 78-437,808. CAFE RAZZI, LLC, PALM BEACH, FL. FILED 6-18-2004.

CLUB-RAZZI

THE MARK CONSISTS OF STANDARD CHARACTERS WITHOUT CLAIM TO ANY PARTICULAR FONT, STYLE, SIZE, OR COLOR.

FOR ADMINISTRATION OF AN ONLINE DISCOUNT PROGRAM FOR PROVIDING PROMOTIONS TO PARTICIPANTS FOR DISCOUNTS ON COFFEE AND COFFEE RELATED PRODUCTS (U.S. CLS. 100, 101 AND 102).

CAROLYN GRAY, EXAMINING ATTORNEY

SN 78-438,135. MOUNDS EAST, INC., MIDDLETON, WI. FILED 6-19-2004.



FOR RETAIL STORE SERVICES FEATURING PET FOOD, PET SUPPLIES, AND PET TOYS; HORSE TACK SHOP (U.S. CLS. 100, 101 AND 102).

FIRST USE 2-0-1993; IN COMMERCE 2-0-1993.
LAURA KOVAISKY, EXAMINING ATTORNEY

CLASS 35—(Continued).

SN 78-438,334. TEXAS DEPARTMENT OF AGRICULTURE, AUSTIN, TX. FILED 6-21-2004.



FOR PROMOTING PUBLIC AWARENESS OF THE NEED FOR PROPER NUTRITION AND HEALTHY EATING HABITS FOR CHILDREN (U.S. CLS. 100, 101 AND 102).

FIRST USE 3-1-2004; IN COMMERCE 3-1-2004.
ALEX KEAM, EXAMINING ATTORNEY

SN 78-438,514. ALPINE SURGICAL EQUIPMENT, INC., EL DORADO HILLS, CA. FILED 6-21-2004.

**ALPINE SURGICAL
EQUIPMENT, INC.**

THE MARK CONSISTS OF STANDARD CHARACTERS WITHOUT CLAIM TO ANY PARTICULAR FONT, STYLE, SIZE, OR COLOR.

NO CLAIM IS MADE TO THE EXCLUSIVE RIGHT TO USE "SURGICAL EQUIPMENT, INC.", APART FROM THE MARK AS SHOWN.

FOR DISTRIBUTORSHIPS IN THE FIELD OF SURGICAL EQUIPMENT (U.S. CLS. 100, 101 AND 102).
JENNIFER CHICOSKI, EXAMINING ATTORNEY

CLASS 35—(Continued).

SN 78-438,739. LEIPZIG, KIRK R., BRENTWOOD, TN. FILED 6-21-2004.

**J L Kirk
Associates**

THE MARK CONSISTS OF STANDARD CHARACTERS WITHOUT CLAIM TO ANY PARTICULAR FONT, STYLE, SIZE, OR COLOR.

NO CLAIM IS MADE TO THE EXCLUSIVE RIGHT TO USE "ASSOCIATES", APART FROM THE MARK AS SHOWN.

FOR EMPLOYMENT COUNSELING AND PERSONNEL PLACEMENT, AND RECRUITING (U.S. CLS. 100, 101 AND 102).

DAVID TAYLOR, EXAMINING ATTORNEY

SN 78-438,774. WRITERS-IN-MOTION, LLC, CANDLER, NC. FILED 6-21-2004.

WRITERS-IN-MOTION

THE MARK CONSISTS OF STANDARD CHARACTERS WITHOUT CLAIM TO ANY PARTICULAR FONT, STYLE, SIZE, OR COLOR.

FOR PROMOTIONAL SERVICES, NAMELY, PRODUCTION OF DVD'S FOR PUBLISHERS AND AUTHORS TO HELP THEM PROMOTE THEIR BOOKS (U.S. CLS. 100, 101 AND 102).

FIRST USE 6-2-2004; IN COMMERCE 6-2-2004.
AMY HELLA, EXAMINING ATTORNEY

SN 78-439,265. DREAM TEAM CONSULTING, INC., MELVILLE, NY. FILED 6-22-2004.

Cossential
what your business needs

FOR PAYROLL PREPARATION SERVICES (U.S. CLS. 100, 101 AND 102).
GEORGE LORENZO, EXAMINING ATTORNEY

CLASS 35—(Continued).

SN 78-439,328. WINDWARD PRINT STAR, INC., DBA ADPLEX-RHODES, HOUSTON, TX. FILED 6-22-2004.

ADPIX

THE MARK CONSISTS OF STANDARD CHARACTERS WITHOUT CLAIM TO ANY PARTICULAR FONT, STYLE, SIZE, OR COLOR.

FOR PROVIDING ON-LINE LIBRARY OF DIGITAL ART FOR USE IN ADVERTISING BY SUBSCRIBING CLIENTS (U.S. CLS. 100, 101 AND 102).

FIRST USE 6-13-1994; IN COMMERCE 6-13-1994.
KEVON CHISOLM, EXAMINING ATTORNEY

SN 78-439,664. DIVAS AND PRINCESSES, EASTON, MA. FILED 6-22-2004.

**DIVAS AND
PRINCESSES**

THE MARK CONSISTS OF STANDARD CHARACTERS WITHOUT CLAIM TO ANY PARTICULAR FONT, STYLE, SIZE, OR COLOR.

FOR RETAIL STORE SERVICES SELLING CHILDREN'S NOVELTIES AND ACCESSORIES (U.S. CLS. 100, 101 AND 102).

FIRST USE 1-1-2004; IN COMMERCE 1-1-2004.
SUSAN STIGLITZ, EXAMINING ATTORNEY

CLASS 35—(Continued).

SN 78-456,446. KMART OF MICHIGAN, INC., TROY, MI. FILED 7-26-2004.



FOR RETAIL DEPARTMENT STORE AND GROCERY STORE SERVICES (U.S. CLS. 100, 101 AND 102). JOHN HWANG, EXAMINING ATTORNEY

SN 78-459,033. HEWLETT-PACKARD DEVELOPMENT COMPANY, L.P., HOUSTON, TX. FILED 7-29-2004.



OWNER OF U.S. REG. NOS. 614,803, 862,308 AND OTHERS. FOR BUSINESS MANAGEMENT CONSULTING AND PLANNING SERVICES; BUSINESS CONSULTING SERVICES; BUSINESS MARKETING CONSULTING SERVICES; CUSTOMER RELATIONSHIP MANAGEMENT SERVICES; BUSINESS CONSULTING SERVICES RELATING TO PRODUCT DISTRIBUTION, OPERATIONS MANAGEMENT SERVICES, LOGISTICS, REVERSE LOGISTICS, SUPPLY CHAIN, AND PRODUCTION SYSTEMS AND DISTRIBUTION SOLUTIONS. (U.S. CLS. 100, 101 AND 102). ELISSA GARBER KON, EXAMINING ATTORNEY

SN 78-459,322. KMART OF MICHIGAN, INC., TROY, MI. FILED 7-30-2004.



OWNER OF U.S. REG. NOS. 743,912 AND 1,710,545. FOR RETAIL DEPARTMENT STORE AND GROCERY STORE SERVICES (U.S. CLS. 100, 101 AND 102). JOHN HWANG, EXAMINING ATTORNEY

CLASS 35—(Continued).

SN 78-462,013. GAMESTOP, INC., GRAPEVINE, TX. FILED 8-4-2004.



NO CLAIM IS MADE TO THE EXCLUSIVE RIGHT TO USE "BUY", "SELL" AND "TRADE", APART FROM THE MARK AS SHOWN.

THE COLOR(S) RED, WHITE AND BLACK IS/ARE CLAIMED AS A FEATURE OF THE MARK.

THE MARK CONSISTS OF THE WORDS MOVIE, BUY, SELL AND TRADE IN WHITE, THE WORD STOP IN BLACK SURROUNDED BY A RED BORDER IN A FILM-STRIP DESIGN.

FOR RETAIL STORE SERVICES AND ONLINE RETAIL STORE SERVICES PROVIDED VIA A GLOBAL COMPUTER NETWORK FEATURING DVDS, VIDEO-CASSETTES AND OTHER DIGITAL MEDIA FEATURING FILMS, MOVIES, VIDEOS, TELEVISION SHOWS, MUSIC, CARTOONS, DOCUMENTARIES, SPORTS, COMEDY AND ENTERTAINMENT, CDS, BOOKS, MAGAZINES, COMPUTER, VIDEO AND ELECTRONIC GAMES, STRATEGY GUIDES, DVD PLAYERS AND RECORDERS, COMPUTER HARDWARE AND ACCESSORIES, COMPUTER CONSOLE GAME HARDWARE AND ACCESSORIES, TOYS, TRADING CARDS AND ACTION FIGURES (U.S. CLS. 100, 101 AND 102).

MATTHEW PAPPAS, EXAMINING ATTORNEY

SN 78-465,927. MOMENTUM MARKETING SERVICES CORP., ALEXANDRIA, VA. FILED 8-11-2004.



THE MARK CONSISTS OF STANDARD CHARACTERS WITHOUT CLAIM TO ANY PARTICULAR FONT, STYLE, SIZE, OR COLOR.

FOR ARRANGING AND CONDUCTING MARKETING PROMOTIONAL EVENTS FOR OTHERS (U.S. CLS. 100, 101 AND 102).

MIDGE BUTLER, EXAMINING ATTORNEY

CLASS 35—(Continued).

SN 78-465,967. MOMENTUM MARKETING SERVICES CORP., ALEXANDRIA, VA. FILED 8-11-2004.

RED PEG

THE MARK CONSISTS OF STANDARD CHARACTERS WITHOUT CLAIM TO ANY PARTICULAR FONT, STYLE, SIZE, OR COLOR.

FOR ARRANGING AND CONDUCTING MARKETING PROMOTIONAL EVENTS FOR OTHERS (U.S. CLS. 100, 101 AND 102).

MIDGE BUTLER, EXAMINING ATTORNEY

SN 78-475,083. WYNN RESORTS HOLDINGS, LLC, LAS VEGAS, NV. FILED 8-27-2004.

B

Bags Belts & Baubles

THE MARK CONSISTS OF THE STYLIZED LETTER B ON TOP OF THE STYLIZED WORDS BAGS BELTS & BAUBLES.

FOR RETAIL STORE SERVICES FEATURING A WIDE VARIETY OF CONSUMER GOODS OF OTHERS (U.S. CLS. 100, 101 AND 102).

SOPHIA S. KIM, EXAMINING ATTORNEY

SN 78-496,792. SEARS BRANDS, LLC, HOFFMAN ESTATES, IL. FILED 10-8-2004.



OWNER OF U.S. REG. NOS. 1,529,006, 1,556,039 AND 2,621,139.

FOR RETAIL DEPARTMENT STORE SERVICES (U.S. CLS. 100, 101 AND 102).

FIRST USE 9-12-2004; IN COMMERCE 9-12-2004.

KIM SAITO, EXAMINING ATTORNEY

CLASS 35—(Continued).

SN 78-504,405. SEARS BRANDS, LLC, HOFFMAN ESTATES, IL. FILED 10-22-2004.



OWNER OF U.S. REG. NOS. 1,529,006, 1,556,039 AND 2,621,139.

FOR RETAIL DEPARTMENT STORE SERVICES (U.S. CLS. 100, 101 AND 102).

FIRST USE 9-12-2004; IN COMMERCE 9-12-2004.

KIM SAITO, EXAMINING ATTORNEY

SN 79-000,052. BCMG LIMITED, LONDON WC2H 0AU, UNITED KINGDOM, FILED 11-14-2003.



OWNER OF INTERNATIONAL REGISTRATION 0796815 DATED 2-6-2003, EXPIRES 2-6-2013.

FOR ADVERTISING AND PROMOTIONAL SERVICES, NAMELY, THE CREATION OF MARKETING TOOLS DESIGNED TO INCREASE A CLIENT COMPANY'S KNOWLEDGE OF MEDIA TRENDS, ITS CUSTOMERS' NEEDS AND ITS COMPETITORS' PRODUCTS, SERVICES, PRICING, ADVERTISING STRATEGY AND SALES STRATEGY; PLACING ADVERTISEMENTS FOR OTHERS; CONSULTATION SERVICES IN THE FIELD OF ADVERTISING; MARKET RESEARCH AND CONDUCTING MARKET STUDIES; PROVIDING BUSINESS AND MARKETING ANALYSIS OF ADVERTISING RESPONSE AND MARKET RESEARCH; BUSINESS ADVISORY SERVICES IN THE NATURE OF BUSINESS CONSULTATION, COMMERCIAL INFORMATION AND ADVICE FOR CONSUMERS; COMPUTERIZED DATABASE MANAGEMENT SERVICES; DATA PROCESSING SERVICES (U.S. CLS. 100, 101 AND 102).

GINA FINK, EXAMINING ATTORNEY

CLASS 36—INSURANCE AND FINANCIAL

SN 75-640,214. THE ST. JOE COMPANY, JACKSONVILLE, FL. FILED 2-12-1999.

ADVANTIS

FOR LAND ACQUISITION, NAMELY, REAL ESTATE BROKERAGE; REAL ESTATE LISTING SERVICES; AND REAL ESTATE MANAGEMENT SERVICES (U.S. CLS. 100, 101 AND 102).

FIRST USE 4-13-1999; IN COMMERCE 4-13-1999.

CIMMERIAN COLEMAN, EXAMINING ATTORNEY

CLASS 36—(Continued).

SN 76-170,452. SHELTER MORTGAGE COMPANY, L.L.C., MILWAUKEE, WI. FILED 11-24-2000.

GUARANTY MORTGAGE

NO CLAIM IS MADE TO THE EXCLUSIVE RIGHT TO USE MORTGAGE, APART FROM THE MARK AS SHOWN. SEC. 2(F).
FOR MORTGAGE BANKING SERVICES (U.S. CLS. 100, 101 AND 102).
FIRST USE 0-0-1982; IN COMMERCE 0-0-1982.
BRENDAN MCCAULEY, EXAMINING ATTORNEY

SN 76-356,253. PEOPLES BANCORP., INC., MARIETTA, OH. FILED 1-9-2002.

CONNECT CARD

NO CLAIM IS MADE TO THE EXCLUSIVE RIGHT TO USE "CARD", APART FROM THE MARK AS SHOWN.
FOR FINANCIAL SERVICES, NAMELY, DEBITING A BANK ACCOUNT AT A REMOTE LOCATION BY THE USE OF A DEBIT CARD (U.S. CLS. 100, 101 AND 102).
FIRST USE 9-1-1995; IN COMMERCE 9-1-1995.
SHARI SHEFFIELD, EXAMINING ATTORNEY

SN 76-481,954. SEA PINES COMPANY, INC., HILTON HEAD ISLAND, SC. FILED 1-13-2003.

**CERTIFIED SEA PINES
RESORT PROPERTY**

OWNER OF U.S. REG. NOS. 1,239,738 AND 1,649,014.
NO CLAIM IS MADE TO THE EXCLUSIVE RIGHT TO USE "CERTIFIED" AND "RESORT PROPERTY", APART FROM THE MARK AS SHOWN.
FOR RENTAL OF VACATION APARTMENTS AND CONDOMINIUMS (U.S. CLS. 100, 101 AND 102).
SOPHIA S. KIM, EXAMINING ATTORNEY

SN 76-512,547. MONTGOMERYVILLE ASSOCIATES, KING OF PRUSSIA, PA. FILED 5-8-2003.

MONTGOMERY MALL

NO CLAIM IS MADE TO THE EXCLUSIVE RIGHT TO USE MALL, APART FROM THE MARK AS SHOWN. SEC. 2(F).
FOR SHOPPING CENTER SERVICES; REAL ESTATE MANAGEMENT AND LEASING OF RETAIL STORE SPACE (U.S. CLS. 100, 101 AND 102).
FIRST USE 2-0-1977; IN COMMERCE 2-0-1977.
TONJA GASKINS, EXAMINING ATTORNEY

CLASS 36—(Continued).

SN 76-519,255. LUMINENT MORTGAGE CAPITAL, INC., SAN FRANCISCO, CA. FILED 6-3-2003.

**LUMINENT MORTGAGE
CAPITAL, INC.**

NO CLAIM IS MADE TO THE EXCLUSIVE RIGHT TO USE "MORTGAGE CAPITAL, INC.", APART FROM THE MARK AS SHOWN.
FOR FINANCIAL INVESTMENTS IN THE FIELD OF MORTGAGE-BACKED SECURITIES (U.S. CLS. 100, 101 AND 102).
ROBERT LORENZO, EXAMINING ATTORNEY

SN 76-538,788. PRIMETRICA, INC., CARLSBAD, CA. FILED 8-21-2003.

PRIMETRICA

FOR FINANCIAL VALUATION OF BUSINESSES IN THE COMMUNICATIONS, MEDIA, AND BUSINESS MANAGEMENT FIELDS (U.S. CLS. 100, 101 AND 102).
FIRST USE 4-4-2002; IN COMMERCE 6-1-2002.
CURTIS FRENCH, EXAMINING ATTORNEY

SN 76-548,114. HARRIS TRUST AND SAVINGS BANK, CHICAGO, IL. FILED 9-12-2003.

THE QUALIFIED SOLUTION

NO CLAIM IS MADE TO THE EXCLUSIVE RIGHT TO USE SOLUTION, APART FROM THE MARK AS SHOWN.
FOR INVESTMENT PLANNING SERVICES FEATURING INDIVIDUAL RETIREMENT ACCOUNT SOLUTIONS (U.S. CLS. 100, 101 AND 102).
GIANCARLO CASTRO, EXAMINING ATTORNEY

SN 76-554,435. INSCO INSURANCE SERVICES, INC., IRVINE, CA. FILED 10-27-2003.

**THE
INSCO
DICO
GROUP**

NO CLAIM IS MADE TO THE EXCLUSIVE RIGHT TO USE GROUP, APART FROM THE MARK AS SHOWN.
THE COLOR(S) WHITE, BLACK AND BURGUNDY IS/ARE CLAIMED AS A FEATURE OF THE MARK.
THE COLOR WHITE WITH BLACK OUTLINE/BORDER APPEAR IN THE WORDS "THE" AND "GROUP"; THE COLOR BURGUNDY APPEARS IN THE WORD "INSCO" AND THE COLOR BLACK APPEARS IN THE WORD "DICO." IS/ARE CLAIMED AS A FEATURE OF THE MARK.
FOR INSURANCE UNDERWRITING IN THE FIELD OF SURETY BONDS; FINANCIAL SERVICES; NAMELY, SURETY SERVICES (U.S. CLS. 100, 101 AND 102).
FIRST USE 3-12-1984; IN COMMERCE 3-12-1984.
JENNIFER KRISP, EXAMINING ATTORNEY

CLASS 36—(Continued).

SN 76-556,919. COSTAR REALTY INFORMATION, INC.,
BETHESDA, MD. FILED 11-5-2003.

PROPERTY EXPRESS

THE MARK CONSISTS OF STANDARD CHARACTERS WITHOUT CLAIM TO ANY PARTICULAR FONT, STYLE, SIZE, OR COLOR.

NO CLAIM IS MADE TO THE EXCLUSIVE RIGHT TO USE PROPERTY, APART FROM THE MARK AS SHOWN.

FOR REAL ESTATE INFORMATION SERVICES, NAMELY, PROVIDING SEARCH, ANALYSIS, TRACKING, REPORTING AND PRESENTATION CAPABILITIES VIA A DATABASE OF CURRENT AND HISTORICAL INFORMATION, PHOTOGRAPHS, GRAPHICS, IMAGES, NEWS STORIES AND ADVERTISEMENTS REGARDING THE COMMERCIAL, INDUSTRIAL, RETAIL AND HOSPITALITY ORIENTED REAL ESTATE INDUSTRY AND TENANTS OF COMMERCIAL, INDUSTRIAL, RETAIL AND HOSPITALITY ORIENTED REAL ESTATE PROPERTIES (U.S. CLS. 100, 101 AND 102).

FIRST USE 11-1-2003; IN COMMERCE 11-1-2003.
AISHA CLARKE, EXAMINING ATTORNEY

SN 76-557,943. OLD HARBOR BANK, CLEARWATER, FL.
FILED 11-5-2003.

Old Harbor
BANK

NO CLAIM IS MADE TO THE EXCLUSIVE RIGHT TO USE "BANK", APART FROM THE MARK AS SHOWN.

FOR PERSONAL AND BUSINESS BANKING (U.S. CLS. 100, 101 AND 102).

FIRST USE 8-1-2003; IN COMMERCE 8-1-2003.
IRENE D. WILLIAMS, EXAMINING ATTORNEY

SN 76-558,829. LASALLE BANK CORPORATION, CHICAGO,
IL. FILED 11-10-2003.

INTERFIRSTLINK

THE MARK CONSISTS OF STANDARD CHARACTERS WITHOUT CLAIM TO ANY PARTICULAR FONT, STYLE, SIZE, OR COLOR.

FOR MORTGAGE BANKING SERVICES OFFERED VIA A GLOBAL COMPUTER NETWORK (U.S. CLS. 100, 101 AND 102).

FIRST USE 10-0-2000; IN COMMERCE 10-0-2000.
ROBERT LORENZO, EXAMINING ATTORNEY

CLASS 36—(Continued).

SN 76-558,830. LASALLE BANK CORPORATION, CHICAGO,
IL. FILED 11-10-2003.

InterFirstlink

FOR MORTGAGE BANKING SERVICES OFFERED VIA A GLOBAL COMPUTER NETWORK (U.S. CLS. 100, 101 AND 102).

FIRST USE 10-6-2003; IN COMMERCE 10-6-2003.
ROBERT LORENZO, EXAMINING ATTORNEY

SN 76-559,172. INTEGRITY MEDIA, INC., MOBILE, AL.
FILED 11-10-2003.



OWNER OF U.S. REG. NOS. 2,205,115 AND 2,210,359.
NO CLAIM IS MADE TO THE EXCLUSIVE RIGHT TO USE "FUNDRAISING", APART FROM THE MARK AS SHOWN.

FOR CHARITABLE FUNDRAISING SERVICES, NAMELY, SHARING PROFITS FROM THE SALE OF MERCHANDISE (U.S. CLS. 100, 101 AND 102).

ROBERT LORENZO, EXAMINING ATTORNEY

SN 76-565,415. COMERICA INCORPORATED, DETROIT, MI.
FILED 12-3-2003.

**COMERICA
CHARITABLE FOCUS
FUND**

THE MARK CONSISTS OF STANDARD CHARACTERS WITHOUT CLAIM TO ANY PARTICULAR FONT, STYLE, SIZE, OR COLOR.

OWNER OF U.S. REG. NOS. 1,251,846, 2,852,429 AND OTHERS.

NO CLAIM IS MADE TO THE EXCLUSIVE RIGHT TO USE CHARITABLE FOCUS FUND, APART FROM THE MARK AS SHOWN.

FOR FINANCIAL SERVICES, NAMELY, FUND BROKERAGE SERVICES IN THE FIELD OF COLLECTIVE FUNDS (U.S. CLS. 100, 101 AND 102).

FIRST USE 9-1-2002; IN COMMERCE 9-1-2002.
LINDA ESTRADA, EXAMINING ATTORNEY

CLASS 36—(Continued).

SN 76-565,419. COMERICA INCORPORATED, DETROIT, MI. FILED 12-3-2003.

COMERICA SECURITIES LIMITED DURATION ACCOUNT

THE MARK CONSISTS OF STANDARD CHARACTERS WITHOUT CLAIM TO ANY PARTICULAR FONT, STYLE, SIZE, OR COLOR.

OWNER OF U.S. REG. NOS. 1,251,846, 2,852,429 AND OTHERS.

NO CLAIM IS MADE TO THE EXCLUSIVE RIGHT TO USE SECURITIES LIMITED DURATION ACCOUNT, APART FROM THE MARK AS SHOWN.

FOR FINANCIAL SERVICES IN THE NATURE OF A FIXED INCOME, SEPARATELY MANAGED ACCOUNT (U.S. CLS. 100, 101 AND 102).

FIRST USE 2-1-2003; IN COMMERCE 2-1-2003. MICHAEL HALL, EXAMINING ATTORNEY

CLASS 36—(Continued).

SN 76-572,872. ENGEMANN ASSET MANAGEMENT, PASADENA, CA. FILED 1-30-2004.

ENGEMANN

THE MARK CONSISTS OF STANDARD CHARACTERS WITHOUT CLAIM TO ANY PARTICULAR FONT, STYLE, SIZE, OR COLOR.

SEC. 2(F).

FOR INVESTMENT MANAGEMENT AND ADVISORY SERVICES; MUTUAL FUND INVESTMENT SERVICES (U.S. CLS. 100, 101 AND 102).

FIRST USE 0-0-1969; IN COMMERCE 1-5-1972. ROBERT COGGINS, EXAMINING ATTORNEY

SN 76-569,295. CENTURY BUSINESS SERVICES, INC., CLEVELAND, OH. FILED 1-12-2004.

CBIZ WEALTHCENTER

THE MARK CONSISTS OF STANDARD CHARACTERS WITHOUT CLAIM TO ANY PARTICULAR FONT, STYLE, SIZE, OR COLOR.

OWNER OF U.S. REG. NOS. 2,376,672, 2,396,894 AND 2,608,976.

FOR FINANCIAL SERVICES, NAMELY, PROVIDING INFORMATION VIA THE INTERNET FOR CUSTOMER TO TRACK AND MANAGE THEIR FINANCIAL INVESTMENTS (U.S. CLS. 100, 101 AND 102).

BARNEY CHARLON, EXAMINING ATTORNEY

SN 76-573,260. ASSIST-2-SELL, INC., RENO, NV. FILED 2-2-2004.

FRIENDS DON'T LET FRIENDS PAY 6%

THE MARK CONSISTS OF STANDARD CHARACTERS WITHOUT CLAIM TO ANY PARTICULAR FONT, STYLE, SIZE, OR COLOR.

FOR REAL ESTATE CONSULTING AND BROKERAGE SERVICES (U.S. CLS. 100, 101 AND 102).

FIRST USE 9-30-2001; IN COMMERCE 9-30-2001. PAUL F. GAST, EXAMINING ATTORNEY

SN 76-571,178. GLENN COMPUTER CORPORATION, SOUTHFIELD, MI. FILED 1-21-2004.

GCC SERVICING SYSTEMS

THE MARK CONSISTS OF STANDARD CHARACTERS WITHOUT CLAIM TO ANY PARTICULAR FONT, STYLE, SIZE, OR COLOR.

NO CLAIM IS MADE TO THE EXCLUSIVE RIGHT TO USE "SERVICING SYSTEMS", APART FROM THE MARK AS SHOWN.

FOR ADMINISTRATION OF MORTGAGES AND LOANS (U.S. CLS. 100, 101 AND 102).

FIRST USE 12-1-2003; IN COMMERCE 12-1-2003. ELLEN PERKINS, EXAMINING ATTORNEY

SN 76-573,334. LIBERTY TREE FINANCIAL SERVICES, INC., OMAHA, NE. FILED 2-2-2004.

LIBERTY TREE

THE MARK CONSISTS OF STANDARD CHARACTERS WITHOUT CLAIM TO ANY PARTICULAR FONT, STYLE, SIZE, OR COLOR.

FOR BROKERAGE OF FIXED AND VARIABLE LIFE/ ANNUITY THIRD-PARTY INSURANCE PRODUCTS (U.S. CLS. 100, 101 AND 102).

PAUL F. GAST, EXAMINING ATTORNEY

CLASS 36—(Continued).

SN 76-574,570. FIDELITY & GUARANTY LIFE INSURANCE COMPANY, BALTIMORE, MD. FILED 2-9-2004.

PAIR

THE MARK CONSISTS OF STANDARD CHARACTERS WITHOUT CLAIM TO ANY PARTICULAR FONT, STYLE, SIZE, OR COLOR.

FOR PROVISION AND ADMINISTRATION OF DEFERRED COMPENSATION PLANS (U.S. CLS. 100, 101 AND 102).

ELISSA GARBER KON, EXAMINING ATTORNEY

CLASS 36—(Continued).

SN 76-581,772. BRISTOL HOME MORTGAGE LENDING, LLC, BOCA RATON, FL. FILED 3-18-2004.

BRISTOL

THE MARK CONSISTS OF STANDARD CHARACTERS WITHOUT CLAIM TO ANY PARTICULAR FONT, STYLE, SIZE, OR COLOR.

FOR FINANCIAL SERVICES, NAMELY, MORTGAGE LENDING SERVICES TO INVESTORS WHO PURCHASE AND REHABILITATE RESIDENTIAL PROPERTIES; PROVIDING PERMANENT FINANCING SERVICES FOR RESIDENTIAL PROPERTIES; AND NEW CONSTRUCTION FINANCING SERVICES FOR RESIDENTIAL PROPERTIES (U.S. CLS. 100, 101 AND 102).

FIRST USE 11-1-2001; IN COMMERCE 11-1-2001.
EDWARD NELSON, EXAMINING ATTORNEY

SN 76-576,620. GAW REALTY SERVICES, CELEBRATION, FL. FILED 2-20-2004.



NO CLAIM IS MADE TO THE EXCLUSIVE RIGHT TO USE REALTY SERVICES CELEBRATION FLORIDA USA, APART FROM THE MARK AS SHOWN.

THE COLORS YELLOW AND BLUE ARE CLAIMED AS A FEATURE OF THE MARK.

THE MARK CONSISTS OF A ROUND GOLDEN COLORED SUN WITH A FACE IN IT PLACED ABOVE A ROUNDED BLUE VIEW OF THE PLANET EARTH.

FOR REAL ESTATE BROKERAGE SERVICES (U.S. CLS. 100, 101 AND 102).

H. M. FISHER, EXAMINING ATTORNEY

SN 76-583,173. FIDELITY & GUARANTY LIFE INSURANCE COMPANY, BALTIMORE, MD. FILED 3-26-2004.

LIBERTY NY

THE MARK CONSISTS OF STANDARD CHARACTERS WITHOUT CLAIM TO ANY PARTICULAR FONT, STYLE, SIZE, OR COLOR.

NO CLAIM IS MADE TO THE EXCLUSIVE RIGHT TO USE "NY", APART FROM THE MARK AS SHOWN.

FOR ANNUITY UNDERWRITING SERVICES (U.S. CLS. 100, 101 AND 102).

ESTHER A. BORSUK, EXAMINING ATTORNEY

SN 76-578,191. MASSACHUSETTS FINANCIAL SERVICES COMPANY, BOSTON, MA. FILED 2-26-2004.

A DISCIPLINED APPROACH TO DIVERSIFICATION

THE MARK CONSISTS OF STANDARD CHARACTERS WITHOUT CLAIM TO ANY PARTICULAR FONT, STYLE, SIZE, OR COLOR.

FOR FINANCIAL SERVICES; NAMELY, FINANCIAL INVESTMENT, FINANCIAL ADVICE, AND THE MANAGEMENT, ADMINISTRATIVE AND DISTRIBUTION SERVICES FOR INVESTMENT COMPANIES, MUTUAL FUNDS AND OTHER INVESTMENT FUNDS FOR INVESTMENT COMPANIES AND OTHERS (U.S. CLS. 100, 101 AND 102).

FIRST USE 8-0-2003; IN COMMERCE 8-0-2003.
KAREN BRACEY, EXAMINING ATTORNEY

SN 76-586,656. GMAC MORTGAGE CORPORATION, HORSHAM, PA. FILED 4-14-2004.

CUOTA FIJA DITECH

THE MARK CONSISTS OF STANDARD CHARACTERS WITHOUT CLAIM TO ANY PARTICULAR FONT, STYLE, SIZE, OR COLOR.

OWNER OF U.S. REG. NOS. 2,158,800, 2,861,149 AND OTHERS.

NO CLAIM IS MADE TO THE EXCLUSIVE RIGHT TO USE "CUOTA FIJA", APART FROM THE MARK AS SHOWN.

THE ENGLISH TRANSLATION OF THE MARK IS—"DITECH FIXED FEE".

FOR REAL ESTATE MORTGAGE BANKING, MORTGAGE LENDING (U.S. CLS. 100, 101 AND 102).

BERYL GARDNER, EXAMINING ATTORNEY

CLASS 36—(Continued).

SN 76-593,665. TEE CAPE COD FIVE CENTS SAVINGS BANK, ORLEANS, MA. FILED 5-20-2004.

Business Port

THE MARK CONSISTS OF STANDARD CHARACTERS WITHOUT CLAIM TO ANY PARTICULAR FONT, STYLE, SIZE, OR COLOR.

NO CLAIM IS MADE TO THE EXCLUSIVE RIGHT TO USE "BUSINESS", APART FROM THE MARK AS SHOWN. FOR ONLINE BANKING SERVICES (U.S. CLS. 100, 101 AND 102).

FIRST USE 3-1-2002; IN COMMERCE 3-1-2002.
INGA ERVIN, EXAMINING ATTORNEY

SN 76-593,949. INVENTUM SERVICES CORP., BURLINGTON, MA. FILED 5-19-2004.

INVENTUM

THE MARK CONSISTS OF STANDARD CHARACTERS WITHOUT CLAIM TO ANY PARTICULAR FONT, STYLE, SIZE, OR COLOR.

FOR INSURANCE BROKERAGE (U.S. CLS. 100, 101 AND 102).

JENNIFER MARTIN, EXAMINING ATTORNEY

SN 76-594,127. MINERS AND MERCHANTS BANK AND TRUST COMPANY, GRUNDY, VA. FILED 5-25-2004.

TRUPOINT BANK

THE MARK CONSISTS OF STANDARD CHARACTERS WITHOUT CLAIM TO ANY PARTICULAR FONT, STYLE, SIZE, OR COLOR.

NO CLAIM IS MADE TO THE EXCLUSIVE RIGHT TO USE "BANK", APART FROM THE MARK AS SHOWN.

FOR INDIVIDUAL, COMMERCIAL AND SMALL BUSINESS BANKING AND FINANCIAL SERVICES, NAMELY CHECKING ACCOUNTS, SAVINGS ACCOUNTS, ISSUING CERTIFICATES OF DEPOSIT, PROVIDING UNSECURED PERSONAL LINES OF CREDIT, CONSUMER LOANS, MORTGAGE LOANS AND HOME EQUITY LOANS, AND BILL PAYMENT SERVICES, AND PROVIDING SUCH SERVICES BY TRADITIONAL METHODS, BY TELEPHONE, AND BY A GLOBAL COMPUTER NETWORK, AND SAFE DEPOSIT BOX RENTAL (U.S. CLS. 100, 101 AND 102).

THEODORE MCBRIDE, EXAMINING ATTORNEY

CLASS 36—(Continued).

SN 76-595,155. LEDERMAN, STEVEN L., SACRAMENTO, CA. FILED 5-28-2004.

NO SACRIFICE SERVICE WITH MAXIMUM RETURN

THE MARK CONSISTS OF STANDARD CHARACTERS WITHOUT CLAIM TO ANY PARTICULAR FONT, STYLE, SIZE, OR COLOR.

FOR PROVIDING INFORMATION TO REAL ESTATE CUSTOMERS ABOUT REDUCING THE COST OF COMMISSIONS FOR REAL ESTATE TRANSACTIONS (U.S. CLS. 100, 101 AND 102).

LEIGH LOWRY, EXAMINING ATTORNEY

SN 76-595,716. NEC FINANCIAL SERVICES, INC., TEANECK, NJ. FILED 6-4-2004.

BLUEPOINT LEASING

THE MARK CONSISTS OF STANDARD CHARACTERS WITHOUT CLAIM TO ANY PARTICULAR FONT, STYLE, SIZE, OR COLOR.

NO CLAIM IS MADE TO THE EXCLUSIVE RIGHT TO USE "LEASING", APART FROM THE MARK AS SHOWN. FOR FINANCIAL LEASING SERVICES FOR TELECOMMUNICATIONS EQUIPMENT (U.S. CLS. 100, 101 AND 102).

BRIAN NEVILLE, EXAMINING ATTORNEY

SN 76-595,717. NEC FINANCIAL SERVICES, INC., TEANECK, NJ. FILED 6-4-2004.

BLUEPOINT FINANCIAL

THE MARK CONSISTS OF STANDARD CHARACTERS WITHOUT CLAIM TO ANY PARTICULAR FONT, STYLE, SIZE, OR COLOR.

NO CLAIM IS MADE TO THE EXCLUSIVE RIGHT TO USE "FINANCIAL", APART FROM THE MARK AS SHOWN.

FOR FINANCIAL LEASING SERVICES FOR TELECOMMUNICATIONS EQUIPMENT (U.S. CLS. 100, 101 AND 102).

BRIAN NEVILLE, EXAMINING ATTORNEY

CLASS 36—(Continued).

SN 76-596,196. THE LENNY FUND, INC., BOSTON, MA.
FILED 6-7-2004.

THE LENNY FUND

THE MARK CONSISTS OF STANDARD CHARACTERS WITHOUT CLAIM TO ANY PARTICULAR FONT, STYLE, SIZE, OR COLOR.

NO CLAIM IS MADE TO THE EXCLUSIVE RIGHT TO USE FUND, APART FROM THE MARK AS SHOWN.

THE MARK DOES NOT IDENTIFY A LIVING INDIVIDUAL.

FOR CHARITABLE FUND RAISING SERVICES, PHILANTHROPIC SERVICES, NAMELY MONETARY DONATIONS (U.S. CLS. 100, 101 AND 102).

FIRST USE 0-0-1995; IN COMMERCE 0-0-1995.
BRIDGETT SMITH, EXAMINING ATTORNEY

SN 76-596,909. MUNCIE INSURANCE & FINANCIAL SERVICES, SEAFORD, DE. FILED 6-14-2004.

SPEND IT ON SOMETHING YOU DESERVE

THE MARK CONSISTS OF STANDARD CHARACTERS WITHOUT CLAIM TO ANY PARTICULAR FONT, STYLE, SIZE, OR COLOR.

FOR INSURANCE AGENCY SERVICES (U.S. CLS. 100, 101 AND 102).

FIRST USE 3-26-2003; IN COMMERCE 3-26-2003.
WARREN L. OLANDRIA, EXAMINING ATTORNEY

SN 76-597,915. FORTIS INSURANCE COMPANY, INC., MILWAUKEE, WI. FILED 6-17-2004.

VOLUNTARYMART

THE MARK CONSISTS OF STANDARD CHARACTERS WITHOUT CLAIM TO ANY PARTICULAR FONT, STYLE, SIZE, OR COLOR.

FOR INSURANCE SERVICES, NAMELY, HEALTH INSURANCE UNDERWRITING (U.S. CLS. 100, 101 AND 102).

KATHERINE STOIDES, EXAMINING ATTORNEY

SN 76-598,580. GOLDENTREE ASSET MANAGEMENT LP, NEW YORK, NY. FILED 6-21-2004.

GOLDENTREE CAPITAL SOLUTIONS

THE MARK CONSISTS OF STANDARD CHARACTERS WITHOUT CLAIM TO ANY PARTICULAR FONT, STYLE, SIZE, OR COLOR.

OWNER OF U.S. REG. NOS. 2,872,016 AND 2,889,490.

NO CLAIM IS MADE TO THE EXCLUSIVE RIGHT TO USE CAPITAL, APART FROM THE MARK AS SHOWN.

FOR FINANCIAL SERVICES, NAMELY, INVESTMENT ADVISORY SERVICES, INVESTMENT MANAGEMENT SERVICES AND ASSET MANAGEMENT SERVICES (U.S. CLS. 100, 101 AND 102).

FIRST USE 1-0-2004; IN COMMERCE 1-0-2004.
LEIGH CAROLINE CASE, EXAMINING ATTORNEY

CLASS 36—(Continued).

SN 76-599,085. MARES INC., HILTON HEAD ISLAND, SC.
FILED 6-24-2004.

MARS INC.
The Real Estate Store

NO CLAIM IS MADE TO THE EXCLUSIVE RIGHT TO USE INC. AND THE REAL ESTATE STORE, APART FROM THE MARK AS SHOWN.

FOR REAL ESTATE BROKERAGE SERVICES AND CONSULTING IN THE FIELD OF REAL ESTATE AND HOME PROCUREMENT (U.S. CLS. 100, 101 AND 102).

FIRST USE 4-1-2004; IN COMMERCE 4-1-2004.
ESTHER BELENKER, EXAMINING ATTORNEY

SN 76-599,820. PRIMECAP MANAGEMENT COMPANY, PASADENA, CA. FILED 6-28-2004.

PRIMECAP ODYSSEY

THE MARK CONSISTS OF STANDARD CHARACTERS WITHOUT CLAIM TO ANY PARTICULAR FONT, STYLE, SIZE, OR COLOR.

FOR FINANCIAL SERVICES, NAMELY, MUTUAL FUND INVESTMENT SERVICES, FINANCIAL MANAGEMENT SERVICES, FINANCIAL PORTFOLIO MANAGEMENT SERVICES AND INVESTMENT MANAGEMENT AND ADVISORY SERVICES (U.S. CLS. 100, 101 AND 102).

ELLEN PERKINS, EXAMINING ATTORNEY

SN 76-627,561. PRIMECAP MANAGEMENT COMPANY, PASADENA, CA. FILED 1-10-2005.



NO CLAIM IS MADE TO THE EXCLUSIVE RIGHT TO USE "FUND", APART FROM THE MARK AS SHOWN.

FOR FINANCIAL SERVICES, NAMELY, MUTUAL FUND INVESTMENT SERVICES, FINANCIAL MANAGEMENT SERVICES, FINANCIAL PORTFOLIO MANAGEMENT SERVICES AND INVESTMENT MANAGEMENT AND ADVISORY SERVICES (U.S. CLS. 100, 101 AND 102).

FIRST USE 12-17-2004; IN COMMERCE 12-17-2004.
ELLEN PERKINS, EXAMINING ATTORNEY

CLASS 36—(Continued).

SN 78-209,531. SECURED MARINE TRUST, LLC, NEW HAVEN, CT. FILED 1-31-2003.



NO CLAIM IS MADE TO THE EXCLUSIVE RIGHT TO USE "SECURED MARINE TRUST", APART FROM THE MARK AS SHOWN.

FOR FINANCIAL SERVICES, NAMELY, BUSINESS BROKERAGE, MAINTAINING ESCROW ACCOUNTS FOR SALES TRANSACTIONS, AND MONITORING ACTIVITIES AND COMPLETING DOCUMENTS FOR SALES TRANSACTIONS IN THE FIELD OF YACHTS, BOATS, SHIPS, MARINE VESSELS, AIRCRAFT, MOTOR VEHICLES AND OTHER TRANSPORTATION VEHICLES (U.S. CLS. 100, 101 AND 102).

STEVEN BERK, EXAMINING ATTORNEY

SN 78-215,370. MOORE, DONALD PIERCE, MIAMI, FL. FILED 2-15-2003.

REBELYON

FOR CAPITAL INVESTMENT CONSULTATION (U.S. CLS. 100, 101 AND 102).

FIRST USE 4-30-2001; IN COMMERCE 4-30-2001.
JOHN KELLY, EXAMINING ATTORNEY

SN 78-230,754. WACHOVIA CORPORATION, CHARLOTTE, NC. FILED 3-27-2003.

MACROTRACK

OWNER OF U.S. REG. NOS. 2,262,077, 2,337,067 AND 2,591,731.

FOR FINANCIAL MARKET INFORMATION SERVICES PROVIDED VIA A GLOBAL COMPUTER NETWORK, NAMELY, PROVIDING DYNAMIC INTRADAY UPDATES OF QUOTES, CHARTS, NEWS, AND PORTFOLIOS FOR OPERATORS OF ONLINE BROKERAGE AND GENERAL WEB SITES (U.S. CLS. 100, 101 AND 102).

MONIQUE MILLER, EXAMINING ATTORNEY

SN 78-230,759. WACHOVIA CORPORATION, CHARLOTTE, NC. FILED 3-27-2003.

MACRO*TRACK

OWNER OF U.S. REG. NOS. 2,262,077, 2,337,067 AND 2,591,731.

FOR FINANCIAL MARKET INFORMATION SERVICES PROVIDED VIA A GLOBAL COMPUTER NETWORK, NAMELY, PROVIDING DYNAMIC INTRADAY UPDATES OF QUOTES, CHARTS, NEWS, AND PORTFOLIOS FOR OPERATORS OF ONLINE BROKERAGE AND GENERAL WEB SITES (U.S. CLS. 100, 101 AND 102).

MONIQUE MILLER, EXAMINING ATTORNEY

CLASS 36—(Continued).

SN 78-234,951. INTERNATIONAL TRADINGCHARTS.COM, INC., NORTH BATTLEFORD, SASKATCHEWAN, CANADA, FILED 4-8-2003.

TFC COMMODITY CHARTS

NO CLAIM IS MADE TO THE EXCLUSIVE RIGHT TO USE "COMMODITY CHARTS", APART FROM THE MARK AS SHOWN.

FOR FINANCIAL INFORMATION PROVIDED BY ELECTRONIC MEANS, NAMELY, COMMODITY AND FUTURES PRICE CHARTS, QUOTATIONS AND RELATED FINANCIAL NEWS INFORMATION (U.S. CLS. 100, 101 AND 102).

FIRST USE 7-0-1995; IN COMMERCE 12-0-1995.
ROBERT LORENZO, EXAMINING ATTORNEY

SN 78-242,689. TRANSAMERICA CATALYST FINANCIAL SERVICES, L.L.C., HOFFMAN ESTATE, IL. FILED 4-28-2003.



NO CLAIM IS MADE TO THE EXCLUSIVE RIGHT TO USE "FINANCIAL SERVICES", APART FROM THE MARK AS SHOWN.

FOR RETAIL FINANCING, NAMELY CONSUMER CREDIT PROGRAMS FOR RETAILERS (U.S. CLS. 100, 101 AND 102).

FIRST USE 10-31-2002; IN COMMERCE 10-31-2002.
REBECCA GILBERT, EXAMINING ATTORNEY

CLASS 36—(Continued).

SN 78-242,727. MASTERCARD INTERNATIONAL INCORPORATED, PURCHASE, NY. FILED 4-28-2003.

MC2

THE MARK CONSISTS OF STANDARD CHARACTERS WITHOUT CLAIM TO ANY PARTICULAR FONT, STYLE, SIZE, OR COLOR.

OWNER OF U.S. REG. NOS. 1,365,900, 1,365,901 AND 1,365,902.

FOR FINANCIAL SERVICES RELATED TO PAYMENT CARDS, NAMELY CREDIT CARD SERVICES AND DEBIT CARD SERVICES; BANKING SERVICES; CHARGE CARD AND STORED VALUE PREPAID CARD SERVICES; STORED VALUE ELECTRONIC PURSE SERVICES, PROVIDING ELECTRONIC FUNDS AND CURRENCY TRANSFER SERVICES, ELECTRONIC PAYMENTS SERVICES, PREPAID TELEPHONE CALLING CARD SERVICES, CASH DISBURSEMENT SERVICES, AND TRANSACTION AUTHORIZATION AND SETTLEMENT SERVICES; PAYMENT SERVICES UTILIZING A RADIO FREQUENCY DEVICE TO ALLOW PAYMENT TO BE CHARGED TO A PREVIOUSLY SPECIFIED PAYMENT MECHANISM, SUCH AS A DEBIT CARD OR CREDIT CARD; CHEQUE VERIFICATION SERVICES, ISSUING AND REDEMPTION SERVICES ALL RELATING TO TRAVELLERS' CHEQUES AND TRAVEL VOUCHERS; ADVISORY SERVICES RELATING TO ALL THE AFORESAID SERVICES (U.S. CLS. 100, 101 AND 102).

JOHN KELLY, EXAMINING ATTORNEY

SN 78-250,178. WELLS FARGO & COMPANY, MINNEAPOLIS, MN. FILED 5-15-2003.

GOLD PACKAGE

FOR BANKING SERVICES; FINANCIAL SERVICES, NAMELY, CREDIT CARD AND DEBIT CARD SERVICES; INVESTMENT CONSULTATION SERVICES, INVESTMENT BROKERAGE SERVICES; INVESTMENT MANAGEMENT SERVICES; FINANCIAL INVESTMENT SERVICES IN THE FIELDS OF SECURITIES, MUTUAL FUNDS, CERTIFICATES OF DEPOSIT, AND PORTFOLIO MANAGEMENT; MORTGAGE BANKING AND LENDING SERVICES; CONSUMER LENDING SERVICES; ELECTRONIC PROCESSING AND TRANSMISSION OF BILL PAYMENT DATA; FINANCIAL CONSULTATION FOR EDUCATIONAL FINANCIAL ASSISTANCE; AND STUDENT LOAN SERVICES (U.S. CLS. 100, 101 AND 102).

JASON TURNER, EXAMINING ATTORNEY

CLASS 36—(Continued).

SN 78-275,959. FIDUCIARY TRUST COMPANY, BOSTON, MA. FILED 7-18-2003.

COMMON SENSE UNCOMMON INDEPENDENCE

FOR FINANCIAL PLANNING AND ADVISORY SERVICES, NAMELY, INVESTMENT ADVISORY, CUSTODY AND CORPORATE TRUSTEE SERVICES, ESTATE ADMINISTRATION, FINANCIAL AND TAX PLANNING, AND CHARITABLE GIFT PLANNING (U.S. CLS. 100, 101 AND 102).

FIRST USE 5-14-2003; IN COMMERCE 5-14-2003.
RAUL CORDOVA, EXAMINING ATTORNEY

SN 78-296,253. DIMENSIONAL FUND ADVISORS INC., SANTA MONICA, CA. FILED 9-4-2003.



OWNER OF U.S. REG. NOS. 1,746,066 AND 2,374,664.
FOR INVESTMENT MANAGEMENT SERVICES (U.S. CLS. 100, 101 AND 102).
FIRST USE 4-0-2002; IN COMMERCE 4-0-2002.
STEVEN R. FOSTER, EXAMINING ATTORNEY

SN 78-299,050. DEVENIR, LLC, MINNEAPOLIS, MN. FILED 9-11-2003.

DEVENIR

THE ENGLISH TRANSLATION OF THE WORD DEVENIR IS TO BECOME.

FOR FINANCIAL SERVICES, NAMELY, FINANCIAL MANAGEMENT SERVICES, FINANCIAL ADVISORY SERVICES, FINANCIAL CONSULTING SERVICES, INVESTMENT BANKING SERVICES, FINANCIAL PLANNING, FINANCIAL PORTFOLIO MANAGEMENT, FINANCIAL RESEARCH, INVESTMENT ADVICE, CAPITAL INVESTMENT CONSULTATION, STOCK BROKERAGE, VENTURE CAPITAL SERVICES, NAMELY, PROVIDING FINANCING TO EMERGING AND START-UP COMPANIES (U.S. CLS. 100, 101 AND 102).

PAUL F. GAST, EXAMINING ATTORNEY

CLASS 36—(Continued).

SN 78-299,168. DEVENIR, LLC, MINNEAPOLIS, MN. FILED 9-11-2003.



THE ENGLISH TRANSLATION OF THE WORD DEVENIR IS TO BECOME.

FOR FINANCIAL SERVICES, NAMELY, FINANCIAL MANAGEMENT SERVICES, FINANCIAL ADVISORY SERVICES, FINANCIAL CONSULTING SERVICES, INVESTMENT BANKING SERVICES, FINANCIAL PLANNING, FINANCIAL PORTFOLIO MANAGEMENT, FINANCIAL RESEARCH, INVESTMENT ADVICE, CAPITAL INVESTMENT CONSULTATION, STOCK BROKERAGE, VENTURE CAPITAL SERVICES, NAMELY, PROVIDING FINANCING TO EMERGING AND START-UP COMPANIES (U.S. CLS. 100, 101 AND 102).
PAUL F. GAST, EXAMINING ATTORNEY

SN 78-316,656. BCS INSURANCE COMPANY, CHICAGO, IL. FILED 10-21-2003.



FOR HEALTH CARE INSURANCE UNDERWRITING SERVICES (U.S. CLS. 100, 101 AND 102).
LESLEY LAMOTHE, EXAMINING ATTORNEY

SN 78-320,139. CHS SERVICES, INC., WILMINGTON, DE. FILED 10-29-2003.

CURATIVE PHARMACY SERVICES

NO CLAIM IS MADE TO THE EXCLUSIVE RIGHT TO USE "PHARMACY SERVICES", APART FROM THE MARK AS SHOWN.

FOR ADMINISTRATION OF PATIENT REIMBURSEMENT PROGRAMS; INSURANCE CONSULTATION; PROVIDING INFORMATION IN INSURANCE MATTERS; INSURANCE CLAIMS ASSISTANCE, NAMELY, FILING INSURANCE CLAIMS FOR OTHERS (U.S. CLS. 100, 101 AND 102).

FIRST USE 1-31-2003; IN COMMERCE 1-31-2003.
LEIGH CAROLINE CASE, EXAMINING ATTORNEY

SN 78-320,700. PROTECTED TOMORROWS, INC., VERNON HILLS, IL. FILED 10-30-2003.

PROTECTED TOMORROWS

FOR FINANCIAL PLANNING SERVICES FOR INDIVIDUALS WITH SPECIAL NEEDS (U.S. CLS. 100, 101 AND 102).

KATHRYN COWARD, EXAMINING ATTORNEY

CLASS 36—(Continued).

SN 78-334,118. O.R.E.P.INC, SANTA ANA, CA. FILED 11-29-2003.

casapueblo realty

THE MARK CONSISTS OF STANDARD CHARACTERS WITHOUT CLAIM TO ANY PARTICULAR FONT, STYLE, SIZE, OR COLOR.

NO CLAIM IS MADE TO THE EXCLUSIVE RIGHT TO USE "REALTY", APART FROM THE MARK AS SHOWN.

THE FOREIGN WORDING IN THE MARK TRANSLATES INTO ENGLISH AS HOUSE TOWN.

SEC. 2(F) AS TO "CASAPUEBLO".

FOR REAL ESTATE BROKERAGE (U.S. CLS. 100, 101 AND 102).

FIRST USE 2-2-1998; IN COMMERCE 2-2-1998.
MITCHELL FRONT, EXAMINING ATTORNEY

SN 78-336,646. FLEXPOINT FUNDING CORPORATION, IRVINE, CA. FILED 12-4-2003.

FLEXPOINT

THE MARK CONSISTS OF STANDARD CHARACTERS WITHOUT CLAIM TO ANY PARTICULAR FONT, STYLE, SIZE, OR COLOR.

FOR MORTGAGE BANKING SERVICES; BROKER SERVICES, NAMELY, MORTGAGE BROKERAGE; MORTGAGE LENDING AND FINANCIAL SERVICES, NAMELY, LOAN PROCESSING, AND MORTGAGE BROKERAGE; RETAIL MORTGAGE SERVICES, NAMELY BROKERING OF MORTGAGE LOANS TO SECONDARY MORTGAGE LENDERS; CONSUMER MORTGAGE BANKING AND LOAN FINANCING SERVICES. (U.S. CLS. 100, 101 AND 102).

KATHERINE STOIDES, EXAMINING ATTORNEY

CLASS 36—(Continued).

SN 78-337,263. THE HUMAN DEVELOPMENT FOUNDATION OF NORTH AMERICA, SCHAUMBURG, IL. FILED 12-5-2003.

HDF Canada

THE MARK CONSISTS OF STANDARD CHARACTERS WITHOUT CLAIM TO ANY PARTICULAR FONT, STYLE, SIZE, OR COLOR.

NO CLAIM IS MADE TO THE EXCLUSIVE RIGHT TO USE "CANADA", APART FROM THE MARK AS SHOWN.

FOR COMMUNITY DEVELOPMENT SERVICES, NAMELY, FINANCING SERVICES TO SUPPORT COMMUNITY DEVELOPMENT PROJECTS IN THE NATURE OF LITERACY PROGRAMS, EDUCATIONAL PROGRAMS, HEALTH CARE PROGRAMS, ECONOMIC DEVELOPMENT PROGRAMS BASED ON MICRO-CREDITS, AND PROJECTS FOR DEVELOPING COMMUNITY-BASED ORGANIZATIONS (U.S. CLS. 100, 101 AND 102).

FIRST USE 10-1-2003; IN COMMERCE 10-1-2003.
KIMBERLY FRYE, EXAMINING ATTORNEY

SN 78-337,288. THE HUMAN DEVELOPMENT FOUNDATION OF NORTH AMERICA, SCHAUMBURG, IL. FILED 12-5-2003.

HDF International

THE MARK CONSISTS OF STANDARD CHARACTERS WITHOUT CLAIM TO ANY PARTICULAR FONT, STYLE, SIZE, OR COLOR.

NO CLAIM IS MADE TO THE EXCLUSIVE RIGHT TO USE "INTERNATIONAL", APART FROM THE MARK AS SHOWN.

FOR COMMUNITY DEVELOPMENT SERVICES, NAMELY, FINANCING SERVICES TO SUPPORT COMMUNITY DEVELOPMENT PROJECTS IN THE NATURE OF LITERACY PROGRAMS, EDUCATIONAL PROGRAMS, HEALTH CARE PROGRAMS, ECONOMIC DEVELOPMENT PROGRAMS BASED ON MICRO-CREDITS, AND PROJECTS FOR DEVELOPING COMMUNITY-BASED ORGANIZATIONS (U.S. CLS. 100, 101 AND 102).

FIRST USE 10-1-2003; IN COMMERCE 10-1-2003.
KIMBERLY FRYE, EXAMINING ATTORNEY

CLASS 36—(Continued).

SN 78-339,414. CHARLES SCHWAB & CO., INC., SAN FRANCISCO, CA. FILED S.R. 12-11-2003; AM. P.R. 1-13-2005.

SCHWAB ADVISOR CASH RESERVES

THE MARK CONSISTS OF STANDARD CHARACTERS WITHOUT CLAIM TO ANY PARTICULAR FONT, STYLE, SIZE, OR COLOR.

OWNER OF U.S. REG. NOS. 2,393,766, 2,758,271 AND OTHERS.

NO CLAIM IS MADE TO THE EXCLUSIVE RIGHT TO USE "CASH RESERVES", APART FROM THE MARK AS SHOWN.

SEC. 2(F) AS TO "ADVISOR".

FOR SECURITIES BROKERAGE AND INVESTMENT SERVICES, NAMELY, MONEY MARKET FUNDS; INVESTMENT ADVICE AND MANAGEMENT SERVICES IN THE FIELD OF MONEY MARKET FUNDS (U.S. CLS. 100, 101 AND 102).

FIRST USE 8-19-2004; IN COMMERCE 8-19-2004.
EVELYN BRADLEY, EXAMINING ATTORNEY

SN 78-343,417. AFFINITY BANK, VENTURA, CA. FILED 12-19-2003.

AFFINITY BANK

THE MARK CONSISTS OF STANDARD CHARACTERS WITHOUT CLAIM TO ANY PARTICULAR FONT, STYLE, SIZE, OR COLOR.

FOR BANKING SERVICES AND FINANCIAL SERVICES, NAMELY, SAVINGS ACCOUNT SERVICES AND MONEY LENDING SERVICES (U.S. CLS. 100, 101 AND 102).

FIRST USE 8-31-1997; IN COMMERCE 8-31-1997.
NANCY CLARKE, EXAMINING ATTORNEY

CLASS 36—(Continued).

SN 78-344,722. DIRECT TECHNOLOGIES, LLC, POMPANO BEACH, FL. FILED 12-23-2003.

Swipe N' Go

THE MARK CONSISTS OF STANDARD CHARACTERS WITHOUT CLAIM TO ANY PARTICULAR FONT, STYLE, SIZE, OR COLOR.

OWNER OF U.S. REG. NOS. 2,777,562 AND 2,779,225. FOR CREDIT CARD SERVICES, NAMELY, SIGNATURE-FREE CREDIT CARD TRANSACTION AND PROCESSING SERVICES (U.S. CLS. 100, 101 AND 102). FIRST USE 8-21-2001; IN COMMERCE 8-21-2001. KATHERINE STOIDES, EXAMINING ATTORNEY

SN 78-348,471. DAILY JOURNAL CORPORATION, LOS ANGELES, CA. FILED 1-6-2004.

INSITES

THE MARK CONSISTS OF STANDARD CHARACTERS WITHOUT CLAIM TO ANY PARTICULAR FONT, STYLE, SIZE, OR COLOR.

FOR PROVIDING INFORMATION IN THE FIELD OF REAL ESTATE OVER A WORLDWIDE COMPUTER NETWORK (U.S. CLS. 100, 101 AND 102). FIRST USE 11-1-2000; IN COMMERCE 11-1-2000. JENNIFER CHICOSKI, EXAMINING ATTORNEY

CLASS 36—(Continued).

SN 78-350,803. BERWIND PROPERTY GROUP, LTD., YARDELEY, PA. FILED 1-12-2004.

MADISON APARTMENT GROUP, L.P.

THE MARK CONSISTS OF STANDARD CHARACTERS WITHOUT CLAIM TO ANY PARTICULAR FONT, STYLE, SIZE, OR COLOR.

NO CLAIM IS MADE TO THE EXCLUSIVE RIGHT TO USE "APARTMENT GROUP, L.P.", APART FROM THE MARK AS SHOWN.

FOR COMMERCIAL AND RESIDENTIAL REAL ESTATE INVESTMENT AND MANAGEMENT SERVICES (U.S. CLS. 100, 101 AND 102).

PAUL F. GAST, EXAMINING ATTORNEY

SN 78-360,166. CAPTRAN HOLDING LLC, PINEHURST, NC. FILED 1-30-2004.

"Let Us Help Level The Playing Field"

THE MARK CONSISTS OF STANDARD CHARACTERS WITHOUT CLAIM TO ANY PARTICULAR FONT, STYLE, SIZE, OR COLOR.

FOR FINANCIAL SERVICES IN THE NATURE OF ADVANCING FUNDS TO PERSONS WHO ARE SUING FOR DAMAGES FOR PERSONAL INJURY OR OTHER DAMAGES (U.S. CLS. 100, 101 AND 102).

FIRST USE 1-30-2004; IN COMMERCE 1-30-2004.

DAVID TAYLOR, EXAMINING ATTORNEY

SN 78-363,826. NATIONAL ASSET RECOVERY, INC., ATLANTA, GA. FILED 2-6-2004.

NATIONAL ASSET RECOVERY, INC.

THE MARK CONSISTS OF STANDARD CHARACTERS WITHOUT CLAIM TO ANY PARTICULAR FONT, STYLE, SIZE, OR COLOR.

NO CLAIM IS MADE TO THE EXCLUSIVE RIGHT TO USE "ASSET RECOVERY, INC.", APART FROM THE MARK AS SHOWN.

SEC. 2(F).

FOR DEBT RECOVERY AND COLLECTION AGENCIES (U.S. CLS. 100, 101 AND 102).

FIRST USE 8-15-1994; IN COMMERCE 8-15-1994.

MICHAEL KEATING, EXAMINING ATTORNEY

CLASS 36—(Continued).

SN 78-366,379. PERSHING INVESTMENTS LLC, NEWARK, DE. FILED 2-11-2004.

net exchange | CLIENT

OWNER OF U.S. REG. NOS. 2,369,648, 2,753,684 AND OTHERS.

NO CLAIM IS MADE TO THE EXCLUSIVE RIGHT TO USE CLIENT, APART FROM THE MARK AS SHOWN.

FOR OFFERING A WEBSITE OF INVESTMENT RELATED INFORMATION AND LINKS, OFFERED TO LOCAL BROKERS AND THEIR CUSTOMERS, IN THE FIELD OF AUTOMATED SECURITY BROKERAGE AND PROVIDING ON-LINE SECURITIES BROKERAGE (U.S. CLS. 100, 101 AND 102).

BRIDGETT SMITH, EXAMINING ATTORNEY

SN 78-366,842. US EXPRESS LEASING, INC., PARSIPPANY, NJ. FILED 2-12-2004.

USXL

THE MARK CONSISTS OF STANDARD CHARACTERS WITHOUT CLAIM TO ANY PARTICULAR FONT, STYLE, SIZE, OR COLOR.

FOR FINANCIAL SERVICES IN CONNECTION WITH EQUIPMENT LEASING, NAMELY PROVIDING SALES ASSISTANCE FINANCING THROUGH DEALERS, DISTRIBUTORS AND VENDORS TO CUSTOMERS FOR CAPITAL EQUIPMENT ACQUISITIONS BY ORIGINATING, FUNDING AND ADMINISTERING EQUIPMENT LEASES (U.S. CLS. 100, 101 AND 102).

FIRST USE 8-31-2003; IN COMMERCE 2-10-2004.

STEVEN JACKSON, EXAMINING ATTORNEY

CLASS 36—(Continued).

SN 78-366,946. CIACCI, FURIO, SANDY, UT. FILED 2-12-2004.

**INDEX VENTURES
PARTNER IN IDEA AND
VALUE REALIZATION**

THE MARK CONSISTS OF STANDARD CHARACTERS WITHOUT CLAIM TO ANY PARTICULAR FONT, STYLE, SIZE, OR COLOR.

NO CLAIM IS MADE TO THE EXCLUSIVE RIGHT TO USE INDEX VENTURES AND VALUE REALIZATION, APART FROM THE MARK AS SHOWN.

FOR VENTURE CAPITAL FUNDING SERVICES TO EMERGING AND START-UP COMPANIES; VENTURE CAPITAL SERVICES, NAMELY, PROVIDING FINANCING TO EMERGING AND START-UP COMPANIES (U.S. CLS. 100, 101 AND 102).

LESLEY LAMOTHE, EXAMINING ATTORNEY

SN 78-368,418. WELLS FARGO & COMPANY, MINNEAPOLIS, MN. FILED 2-16-2004.

SPECTRUM PRICING

THE MARK CONSISTS OF STANDARD CHARACTERS WITHOUT CLAIM TO ANY PARTICULAR FONT, STYLE, SIZE, OR COLOR.

NO CLAIM IS MADE TO THE EXCLUSIVE RIGHT TO USE "PRICING", APART FROM THE MARK AS SHOWN.

FOR LOAN FINANCING (U.S. CLS. 100, 101 AND 102). FIRST USE 2-2-2004; IN COMMERCE 2-2-2004.

TRACY CROSS, EXAMINING ATTORNEY

CLASS 36—(Continued).

SN 78-368,486. DIRECT BENEFITS, INC., ST. PAUL, MN. FILED 2-16-2004.

CLASS 36—(Continued).

SN 78-383,106. DARWIN PROFESSIONAL UNDERWRITERS, INC., FARMINGTON, CT. FILED 3-12-2004.

SPIRIT DENTAL

DARWIN SELECT INSURANCE COMPANY

THE MARK CONSISTS OF STANDARD CHARACTERS WITHOUT CLAIM TO ANY PARTICULAR FONT, STYLE, SIZE, OR COLOR.

NO CLAIM IS MADE TO THE EXCLUSIVE RIGHT TO USE "DENTAL", APART FROM THE MARK AS SHOWN.

FOR DENTAL HEALTH INSURANCE ADMINISTRATION (U.S. CLS. 100, 101 AND 102).

FIRST USE 1-28-2004; IN COMMERCE 1-28-2004.
MICHAEL TANNER, EXAMINING ATTORNEY

THE MARK CONSISTS OF STANDARD CHARACTERS WITHOUT CLAIM TO ANY PARTICULAR FONT, STYLE, SIZE, OR COLOR.

NO CLAIM IS MADE TO THE EXCLUSIVE RIGHT TO USE SELECT INSURANCE COMPANY, APART FROM THE MARK AS SHOWN.

FOR INSURANCE SERVICES, NAMELY UNDERWRITING PROFESSIONAL LIABILITY INSURANCE, UNDERWRITING FIDUCIARY INSURANCE, UNDERWRITING FIDELITY INSURANCE, UNDERWRITING PROPERTY AND CASUALTY INSURANCE, UNDERWRITING EMPLOYMENT PRACTICES INSURANCE, AND INSURANCE ADMINISTRATION SERVICES (U.S. CLS. 100, 101 AND 102).

BARBARA A. LOUGHRAN, EXAMINING ATTORNEY

SN 78-374,313. GIRESI, MARGARET J., NAPLES, FL. FILED 2-26-2004.

SN 78-385,355. TITAN TOOL, INC., OAKLAND, NJ. FILED 3-16-2004.

Kastle Realty

WEARGUARD

THE MARK CONSISTS OF STANDARD CHARACTERS WITHOUT CLAIM TO ANY PARTICULAR FONT, STYLE, SIZE, OR COLOR.

NO CLAIM IS MADE TO THE EXCLUSIVE RIGHT TO USE REALTY, APART FROM THE MARK AS SHOWN.

FOR REAL ESTATE BROKERAGE SERVICES (U.S. CLS. 100, 101 AND 102).

FIRST USE 10-1-2002; IN COMMERCE 10-1-2002.
KENNETH D. BATTLE, EXAMINING ATTORNEY

THE MARK CONSISTS OF STANDARD CHARACTERS WITHOUT CLAIM TO ANY PARTICULAR FONT, STYLE, SIZE, OR COLOR.

FOR PROVIDING WARRANTIES ON PAINTING EQUIPMENT (U.S. CLS. 100, 101 AND 102).

DOMINIC J. FERRAIUOLO, EXAMINING ATTORNEY

CLASS 36—(Continued).

SN 78-392,252. AMERICAN INTERNATIONAL GROUP, INC., NEW YORK, NY. FILED 3-29-2004.

EPL PROFESSIONAL ENTITY SELECT

THE MARK CONSISTS OF STANDARD CHARACTERS WITHOUT CLAIM TO ANY PARTICULAR FONT, STYLE, SIZE, OR COLOR.

OWNER OF U.S. REG. NOS. 2,180,677, 2,646,903 AND OTHERS.

NO CLAIM IS MADE TO THE EXCLUSIVE RIGHT TO USE EPL PROFESSIONAL ENTITY, APART FROM THE MARK AS SHOWN.

FOR INSURANCE UNDERWRITING SERVICES, NAMELY EMPLOYMENT PRACTICES LIABILITY (U.S. CLS. 100, 101 AND 102).

FIRST USE 1-1-2001; IN COMMERCE 1-1-2001.
TRACY CROSS, EXAMINING ATTORNEY

CLASS 36—(Continued).

SN 78-397,600. METUCHEN SAVINGS BANK, METUCHEN, NJ. FILED 4-7-2004.

METUCHEN SAVINGS BANK

THE MARK CONSISTS OF STANDARD CHARACTERS WITHOUT CLAIM TO ANY PARTICULAR FONT, STYLE, SIZE, OR COLOR.

NO CLAIM IS MADE TO THE EXCLUSIVE RIGHT TO USE "SAVINGS BANK", APART FROM THE MARK AS SHOWN.

SEC. 2(F).

FOR BANKING SERVICES (U.S. CLS. 100, 101 AND 102).

FIRST USE 0-0-1993. THE MARK WAS FIRST USED ANYWHERE IN A DIFFERENT FORM OTHER THAN THAT SOUGHT TO BE REGISTERED ON 00/00/1879. ; IN COMMERCE 0-0-1993, THE MARK WAS FIRST USED IN COMMERCE IN A DIFFERENT FORM OTHER THAN THAT SOUGHT TO BE REGISTERED ON 00/00/1879..

PAUL F. GAST, EXAMINING ATTORNEY

SN 78-393,591. BENARTZI, SCHLOMO, LOS ANGELES, CA. FILED 3-30-2004.

SAVE MORE TOMORROW

THE MARK CONSISTS OF STANDARD CHARACTERS WITHOUT CLAIM TO ANY PARTICULAR FONT, STYLE, SIZE, OR COLOR.

NO CLAIM IS MADE TO THE EXCLUSIVE RIGHT TO USE "SAVE", APART FROM THE MARK AS SHOWN.

FOR FINANCIAL SERVICES, NAMELY, PROVIDING A SAVINGS PLAN (U.S. CLS. 100, 101 AND 102).

FIRST USE 1-15-2000; IN COMMERCE 1-15-2000.
ARETHA SOMERVILLE, EXAMINING ATTORNEY

SN 78-398,120. TRAVEL GUARD GROUP, INC., STEVENS POINT, WI. FILED 4-7-2004.

CRUISEGUARD

THE MARK CONSISTS OF STANDARD CHARACTERS WITHOUT CLAIM TO ANY PARTICULAR FONT, STYLE, SIZE, OR COLOR.

OWNER OF U.S. REG. NO. 1,280,126.

FOR UNDERWRITING TRAVEL, ACCIDENT AND HEALTH INSURANCE SERVICES FOR OTHERS (U.S. CLS. 100, 101 AND 102).

WON TEAK OH, EXAMINING ATTORNEY

CLASS 36—(Continued).

SN 78-402,224. RELIABLE FINANCIAL GROUP, LLC, BALTIMORE, MD. FILED 4-15-2004.

For All Your
Mortgage Needs

THE MARK CONSISTS OF STANDARD CHARACTERS WITHOUT CLAIM TO ANY PARTICULAR FONT, STYLE, SIZE, OR COLOR.
FOR RESIDENTIAL MORTGAGE LENDING (U.S. CLS. 100, 101 AND 102).
ANN E. SAPPENFIELD, EXAMINING ATTORNEY

SN 78-403,460. BUNGER, CHANCE, INDIANAPOLIS, IN. FILED 4-16-2004.

Quality Indy
Living

THE MARK CONSISTS OF STANDARD CHARACTERS WITHOUT CLAIM TO ANY PARTICULAR FONT, STYLE, SIZE, OR COLOR.
NO CLAIM IS MADE TO THE EXCLUSIVE RIGHT TO USE "INDY", APART FROM THE MARK AS SHOWN.
FOR RENTAL REAL ESTATE MANAGEMENT SERVICES (U.S. CLS. 100, 101 AND 102).
FIRST USE 6-1-2003; IN COMMERCE 6-1-2003.
TRACY WHITAKER-BOWN, EXAMINING ATTORNEY

CLASS 36—(Continued).

SN 78-405,823. TRUSTMARK NATIONAL BANK, JACKSON, MS. FILED 4-21-2004.

TRUSTMARK MORTGAGE
SERVICES

THE MARK CONSISTS OF STANDARD CHARACTERS WITHOUT CLAIM TO ANY PARTICULAR FONT, STYLE, SIZE, OR COLOR.

OWNER OF U.S. REG. NOS. 2,433,197, 2,880,332 AND OTHERS.

NO CLAIM IS MADE TO THE EXCLUSIVE RIGHT TO USE "MORTGAGE SERVICES", APART FROM THE MARK AS SHOWN.

FOR BANKING AND FINANCIAL SERVICES, NAMELY, MORTGAGE LENDING, MORTGAGE BANKING, AND MORTGAGE BROKERING, NAMELY, THE RECEIPT OF MORTGAGE PAYMENTS, CUSTOMER SERVICE RELATING TO MORTGAGE SERVICES, ESCROW ADMINISTRATION OF MORTGAGES, MORTGAGE INVESTOR ACCOUNTING, MORTGAGE COLLECTIONS AND FORECLOSURES, PURCHASES AND SALES OF MORTGAGE BACKED SECURITIES, PRIVATE AND PUBLIC SALES OF MORTGAGE LOANS AND MORTGAGE LOAN PORTFOLIOS, SERVICING OF MORTGAGE LOAN PORTFOLIOS, AND BROKERING OF MORTGAGING LOAN SERVICING RIGHTS (U.S. CLS. 100, 101 AND 102).

FIRST USE 9-30-1985; IN COMMERCE 9-30-1985.
ERNEST SHOSHO, EXAMINING ATTORNEY

SN 78-424,697. LIFE SETTLEMENT INSIGHTS LLC, SOLON, OH. FILED 5-25-2004.

A NEW LOOK AT LIFE

THE MARK CONSISTS OF STANDARD CHARACTERS WITHOUT CLAIM TO ANY PARTICULAR FONT, STYLE, SIZE, OR COLOR.

FOR BROKERAGE SERVICES IN THE FIELD OF THE SALE OF LIFE-INSURANCE POLICIES (U.S. CLS. 100, 101 AND 102).

HOWARD B. LEVINE, EXAMINING ATTORNEY

CLASS 36—(Continued).

SN 78-424,855. BC INTERNATIONAL COSMETIC & IMAGE SERVICES, INC., ORLANDO, FL. FILED 5-25-2004.

W.H.O. LAND

THE MARK CONSISTS OF STANDARD CHARACTERS WITHOUT CLAIM TO ANY PARTICULAR FONT, STYLE, SIZE, OR COLOR.

OWNER OF U.S. REG. NOS. 1,847,461 AND 2,201,540. FOR CHARITABLE SERVICES, NAMELY, PROVIDING FUNDS TO ECONOMICALLY DEPRIVED CHILDREN FOR SHOPPING AND PURCHASING HOLIDAY GIFTS (U.S. CLS. 100, 101 AND 102).

RONALD MCMORROW, EXAMINING ATTORNEY

SN 78-425,152. WACHOVIA CORPORATION, CHARLOTTE, NC. FILED 5-26-2004.



OWNER OF U.S. REG. NOS. 2,744,554, 2,744,626 AND 2,805,546.

THE MARK CONSISTS OF A STYLIZED RENDERING OF A FEMALE GOLFER SWINGING A GOLF CLUB IMPOSED OVER THREE CURVED SECTIONS..

FOR FINANCIAL SPONSORSHIP OF GOLF TOURNAMENTS (U.S. CLS. 100, 101 AND 102).

FIRST USE 3-5-2003; IN COMMERCE 3-5-2003.

JULIA HARDY COFIELD, EXAMINING ATTORNEY

CLASS 36—(Continued).

SN 78-425,175. WACHOVIA CORPORATION, CHARLOTTE, NC. FILED 5-26-2004.



THE COLOR(S) GREEN AND BLUE IS/ARE CLAIMED AS A FEATURE OF THE MARK.

THE MARK CONSISTS OF A STYLIZED RENDERING OF A FEMALE GOLFER SWINGING A GOLF CLUB IMPOSED OVER THREE CURVING COLOR BLOCKS SECTIONS. THE COLORS CLAIMED FOR THOSE SECTIONS ARE: GREEN FOR THE TOP TWO SECTIONS, AND BLUE FOR THE BOTTOM SECTION.

THE MARK CONSISTS OF A STYLIZED RENDERING OF A FEMALE GOLFER SWINGING A GOLF CLUB IMPOSED OVER THREE CURVING COLOR BLOCKS SECTIONS. THE COLORS CLAIMED FOR THOSE SECTIONS ARE: GREEN FOR THE TOP TWO SECTIONS, AND BLUE FOR THE BOTTOM SECTION.

FOR FINANCIAL SPONSORSHIP OF GOLF TOURNAMENTS (U.S. CLS. 100, 101 AND 102).

FIRST USE 3-5-2003; IN COMMERCE 3-5-2003.

TIMOTHY FINNEGAN, EXAMINING ATTORNEY

SN 78-425,254. CANTOR MARKET DATA, NEW YORK, NY. FILED 5-26-2004.

TOMORROW'S
HEADLINES

THE MARK CONSISTS OF STANDARD CHARACTERS WITHOUT CLAIM TO ANY PARTICULAR FONT, STYLE, SIZE, OR COLOR.

FOR FINANCIAL SERVICES, NAMELY, PROVIDING REAL TIME FINANCIAL AND INVESTMENT INFORMATION, ADVICE AND ANALYSIS (U.S. CLS. 100, 101 AND 102).

DAVID MURRAY, EXAMINING ATTORNEY

CLASS 36—(Continued).

SN 78-428,750. BGC PARTNERS, L.P., NEW YORK, NY. FILED 6-2-2004.



FOR FINANCIAL SERVICES, NAMELY, BROKERAGE FOR TRANSACTING AND TRADING OF FINANCIAL INSTRUMENTS; PROVIDING INFORMATION IN THE FIELD OF FUTURES, COMMODITIES, SECURITIES, CURRENCIES, FINANCIAL INSTRUMENTS, BROKERAGE, TRADING, INVESTMENTS, COMPANIES, FINANCIAL MARKETS AND STOCK PRICING AND INDICES; PROVIDING FINANCIAL MARKET INFORMATION RELATING TO MARKET TRADING QUOTATIONS, TRADING STOCKS, FUTURES, CURRENCIES, COMMODITIES AND SECURITIES AND RELATED TRADE EXECUTION, CONFIRMATION, CLEARING AND SETTLEMENT SERVICES AND PROVIDING INFORMATION RELATED TO SUCH TRADES; PROVIDING ONLINE FINANCIAL INFORMATION RELATING TO MARKET QUOTATIONS, TRADING IN FINANCIAL INSTRUMENTS, INCLUDING BIDS, OFFERS, TRADE AND SIZES, EXECUTION, CONFIRMATION AND SUPERVISION OF CLEARING AND SETTLEMENT OF FINANCIAL INSTRUMENTS AND FINANCIAL INFORMATION RELATING THERETO (U.S. CLS. 100, 101 AND 102).

ROBIN CHOSID, EXAMINING ATTORNEY

SN 78-429,835. FMR CORP., BOSTON, MA. FILED 6-4-2004.

**GO-TO-MARKET
CAPITAL**

THE MARK CONSISTS OF STANDARD CHARACTERS WITHOUT CLAIM TO ANY PARTICULAR FONT, STYLE, SIZE, OR COLOR.

NO CLAIM IS MADE TO THE EXCLUSIVE RIGHT TO USE "CAPITAL", APART FROM THE MARK AS SHOWN.

FOR VENTURE CAPITAL AND PRIVATE EQUITY INVESTMENT SERVICES; MANAGEMENT OF VENTURE CAPITAL INVESTMENTS AND VENTURE CAPITAL PARTNERSHIPS (U.S. CLS. 100, 101 AND 102).

FLORENTINA BLANDU, EXAMINING ATTORNEY

CLASS 36—(Continued).

SN 78-429,923. HOME SWEET HOME REALTY, INC., ALBUQUERQUE, NM. FILED 6-4-2004.

**HOME SWEET HOME
REALTY**

THE MARK CONSISTS OF STANDARD CHARACTERS WITHOUT CLAIM TO ANY PARTICULAR FONT, STYLE, SIZE, OR COLOR.

NO CLAIM IS MADE TO THE EXCLUSIVE RIGHT TO USE "REALTY", APART FROM THE MARK AS SHOWN.

FOR REAL ESTATE BROKERAGE SERVICES (U.S. CLS. 100, 101 AND 102).

FIRST USE 3-14-1988; IN COMMERCE 2-1-2004.

JENNIFER KRISP, EXAMINING ATTORNEY

SN 78-430,203. BAIL BOND FRANCHISORS, INC., MOHNTON, PA. FILED 6-4-2004.

**PRESERVING
AMERICA'S 8TH
AMENDMENT RIGHTS**

THE MARK CONSISTS OF STANDARD CHARACTERS WITHOUT CLAIM TO ANY PARTICULAR FONT, STYLE, SIZE, OR COLOR.

FOR BAIL BOND SERVICES (U.S. CLS. 100, 101 AND 102).

GINA HAYES, EXAMINING ATTORNEY

SN 78-430,428. GRAND PACIFIC DEVELOPMENT, INC., CARLSBAD, CA. FILED 6-4-2004.

**GRAND PACIFIC
VACATION CLUB**

THE MARK CONSISTS OF STANDARD CHARACTERS WITHOUT CLAIM TO ANY PARTICULAR FONT, STYLE, SIZE, OR COLOR.

NO CLAIM IS MADE TO THE EXCLUSIVE RIGHT TO USE "VACATION CLUB", APART FROM THE MARK AS SHOWN.

FOR REAL ESTATE OWNERSHIP EXCHANGE SERVICES, NAMELY VACATION REAL ESTATE TIME-SHARING; REAL ESTATE MANAGEMENT AND LEASING SERVICES (U.S. CLS. 100, 101 AND 102).

MIDGE BUTLER, EXAMINING ATTORNEY

CLASS 36—(Continued).

SN 78-431,201. JENSEN, GEORGE R., WEST CHESTER, PA.
FILED 6-7-2004.

CURE WITHIN WALKING DISTANCE

THE MARK CONSISTS OF STANDARD CHARACTERS
WITHOUT CLAIM TO ANY PARTICULAR FONT, STYLE,
SIZE, OR COLOR.
FOR CHARITABLE FUND RAISING (U.S. CLS. 100,
101 AND 102).
TRACY CROSS, EXAMINING ATTORNEY

SN 78-432,681. 360 DEGREES MODERN, LLC, BELLEVUE,
WA. FILED 6-9-2004.

360°MODERN

THE MARK CONSISTS OF STANDARD CHARACTERS
WITHOUT CLAIM TO ANY PARTICULAR FONT, STYLE,
SIZE, OR COLOR.
FOR PROVIDING INFORMATION IN THE FIELD OF
REAL ESTATE VIA A WEB SITE FEATURING MODERN
ARCHITECTURE AND INFORMATION ON THE SALE
OF REAL ESTATE IN MODERN STYLES (U.S. CLS. 100,
101 AND 102).
FIRST USE 4-15-2004; IN COMMERCE 4-15-2004.
C. DIONNE CLYBURN, EXAMINING ATTORNEY

SN 78-432,974. PEMCO MUTUAL INSURANCE COMPANY,
SEATTLE, WA. FILED 6-10-2004.

SAFE DRIVERS GET IT

THE MARK CONSISTS OF STANDARD CHARACTERS
WITHOUT CLAIM TO ANY PARTICULAR FONT, STYLE,
SIZE, OR COLOR.
FOR OFFERING FOR SALE, UNDERWRITING, AND
ADMINISTRATION OF AUTOMOBILE INSURANCE
(U.S. CLS. 100, 101 AND 102).
JENNIFER KRISP, EXAMINING ATTORNEY

CLASS 36—(Continued).

SN 78-432,978. PEMCO MUTUAL INSURANCE COMPANY,
SEATTLE, WA. FILED 6-10-2004.

REWARDING RESPONSIBILITY

THE MARK CONSISTS OF STANDARD CHARACTERS
WITHOUT CLAIM TO ANY PARTICULAR FONT, STYLE,
SIZE, OR COLOR.
FOR OFFERING FOR SALE, UNDERWRITING, AND
ADMINISTRATION OF PERSONAL LINES OF INSUR-
ANCE (U.S. CLS. 100, 101 AND 102).
JENNIFER KRISP, EXAMINING ATTORNEY

SN 78-433,076. THE MEGA LIFE AND HEALTH INSUR-
ANCE COMPANY, PHOENIX, AZ. FILED 6-10-2004.

STARBRIDGE SELECT

THE MARK CONSISTS OF STANDARD CHARACTERS
WITHOUT CLAIM TO ANY PARTICULAR FONT, STYLE,
SIZE, OR COLOR.
OWNER OF U.S. REG. NOS. 1,674,514 AND 1,678,803.
NO CLAIM IS MADE TO THE EXCLUSIVE RIGHT TO
USE "SELECT", APART FROM THE MARK AS SHOWN.
FOR INSURANCE SERVICES, NAMELY, MEDICAL,
DENTAL, PRESCRIPTION AND ACCIDENT UNDER-
WRITING SERVICES (U.S. CLS. 100, 101 AND 102).
FIRST USE 1-1-2004; IN COMMERCE 1-1-2004.
EUGENIA MARTIN, EXAMINING ATTORNEY

SN 78-433,193. BANK OF AMERICA CORPORATION,
CHARLOTTE, NC. FILED 6-10-2004.

RELATIONSHIP EDGE

THE MARK CONSISTS OF STANDARD CHARACTERS
WITHOUT CLAIM TO ANY PARTICULAR FONT, STYLE,
SIZE, OR COLOR.
FOR BANKING AND RELATED FINANCIAL SER-
VICES (U.S. CLS. 100, 101 AND 102).
CAROLINE WOOD, EXAMINING ATTORNEY

CLASS 36—(Continued).

SN 78-434,522. EQUITY RISK PARTNERS, INC., WALNUT CREEK, CA. FILED 6-14-2004.

YOUR EQUITY, YOUR RISK, YOUR PARTNER

THE MARK CONSISTS OF STANDARD CHARACTERS WITHOUT CLAIM TO ANY PARTICULAR FONT, STYLE, SIZE, OR COLOR.
FOR INSURANCE BROKERAGE; CONSULTING SERVICES IN THE FIELD OF INSURANCE AND RISK MANAGEMENT (U.S. CLS. 100, 101 AND 102).
FIRST USE 7-18-2001; IN COMMERCE 7-18-2001.
RONALD MCMORROW, EXAMINING ATTORNEY

SN 78-434,765. AUTO ADVISOR SERVICES, LLC, WIND-EMERE, FL. FILED 6-14-2004.



"Why Go It Alone?"

NO CLAIM IS MADE TO THE EXCLUSIVE RIGHT TO USE "AUTO ADVISORS", APART FROM THE MARK AS SHOWN.
THE COLOR(S) LETTERS IN BLUE; ROAD IN BLACK WITH YELLOW STRIPE IS/ARE CLAIMED AS A FEATURE OF THE MARK.
THE MARK CONSISTS, IN PART, OF THE WORDS, AUTO ADVISORS "WHY GO IT ALONE?" AND THE FANCIFUL DESIGN OF A ROAD. THE LETTERS OF THE WORDS ARE IN BLUE, AND THE ROAD IS IN BLACK WITH A YELLOW STRIPE.
FOR FINANCING RELATING TO AUTOMOBILES (U.S. CLS. 100, 101 AND 102).
BARBARA A. GOLD, EXAMINING ATTORNEY

CLASS 36—(Continued).

SN 78-434,924. SCI MANAGEMENT L.P., HOUSTON, TX. FILED 6-14-2004.

DIGNITY MEMORIAL DIRECT

THE MARK CONSISTS OF STANDARD CHARACTERS WITHOUT CLAIM TO ANY PARTICULAR FONT, STYLE, SIZE, OR COLOR.
OWNER OF U.S. REG. NOS. 2,445,392, 2,629,718 AND OTHERS.
NO CLAIM IS MADE TO THE EXCLUSIVE RIGHT TO USE MEMORIAL, APART FROM THE MARK AS SHOWN.
FOR PREPAID, PRE-NEED AND PRE-ARRANGEMENT CREMATION, FUNERAL AND CEMETERY EXPENSES FUNDED THROUGH FINANCIAL AND INSURANCE SERVICES (U.S. CLS. 100, 101 AND 102).
JAMES GRIFFIN, EXAMINING ATTORNEY

SN 78-435,176. NOVARTIS AG, BASEL, SWITZERLAND, FILED 6-15-2004.

TUITIONSECURE

THE MARK CONSISTS OF STANDARD CHARACTERS WITHOUT CLAIM TO ANY PARTICULAR FONT, STYLE, SIZE, OR COLOR.
FOR LIFE INSURANCE UNDERWRITING SERVICES (U.S. CLS. 100, 101 AND 102).
KARANENDRA S. CHHINA, EXAMINING ATTORNEY

CLASS 36—(Continued).

SN 78-435,180. PUTNAM RETAIL MANAGEMENT, LP, BOSTON, MA. FILED 6-15-2004.

CLASS 36—(Continued).

SN 78-435,207. NOVARTIS AG, BASEL, SWITZERLAND, FILED 6-15-2004.

SMART GOAL

THE MARK CONSISTS OF STANDARD CHARACTERS WITHOUT CLAIM TO ANY PARTICULAR FONT, STYLE, SIZE, OR COLOR.

FOR MUTUAL FUND INVESTMENT, BROKERAGE AND DISTRIBUTION SERVICES; MUTUAL FUND ADMINISTRATION SERVICES AND INVESTMENT ADVICE AND CONSULTATION SERVICES; FINANCIAL SERVICES, NAMELY, INVESTMENT MANAGEMENT, FINANCIAL MANAGEMENT, FINANCIAL ANALYSIS, CONSULTATION, MANAGEMENT AND PLANNING SERVICES; PROVIDING FINANCIAL NEWS AND INFORMATION, INFORMATION ABOUT RETIREMENT PLANNING, INVESTMENT ACCOUNT INFORMATION, RESEARCH IN THE FIELDS OF INVESTMENT AND FINANCE, AND INFORMATION ABOUT MUTUAL FUND PERFORMANCE (U.S. CLS. 100, 101 AND 102).

FIRST USE 1-0-2004; IN COMMERCE 1-0-2004.

KARANENDRA S. CHHINA, EXAMINING ATTORNEY

**ADVANTAGES FOR
LIFE**

THE MARK CONSISTS OF STANDARD CHARACTERS WITHOUT CLAIM TO ANY PARTICULAR FONT, STYLE, SIZE, OR COLOR.

FOR LIFE INSURANCE UNDERWRITING SERVICES (U.S. CLS. 100, 101 AND 102).

KARANENDRA S. CHHINA, EXAMINING ATTORNEY

SN 78-435,184. METROPOLITAN LIFE INSURANCE COMPANY, NEW YORK, NY. FILED 6-15-2004.

SN 78-435,550. DATAPATH, INC., LITTLE ROCK, AR. FILED 6-15-2004.

FLEXPROTECT PLAN

THE MARK CONSISTS OF STANDARD CHARACTERS WITHOUT CLAIM TO ANY PARTICULAR FONT, STYLE, SIZE, OR COLOR.

NO CLAIM IS MADE TO THE EXCLUSIVE RIGHT TO USE "PLAN", APART FROM THE MARK AS SHOWN.

FOR INSURANCE AND FINANCIAL SERVICES, NAMELY THE UNDERWRITING AND ADMINISTRATION OF LONG-TERM CARE INSURANCE; UNDERWRITING, BROKERAGE, MANAGEMENT AND ADMINISTRATION OF PENSION, RETIREMENT, AND ANNUITY PLANS; ASSET MANAGEMENT, NAMELY CASH MANAGEMENT, FINANCIAL MANAGEMENT, AND FINANCIAL PORTFOLIO MANAGEMENT; AND ADMINISTRATION OF INSURANCE MATTERS ON AN ONLINE COMPUTER NETWORK (U.S. CLS. 100, 101 AND 102).

FIRST USE 6-1-2004; IN COMMERCE 6-1-2004.

KARANENDRA S. CHHINA, EXAMINING ATTORNEY

MYSOURCECARD

THE MARK CONSISTS OF STANDARD CHARACTERS WITHOUT CLAIM TO ANY PARTICULAR FONT, STYLE, SIZE, OR COLOR.

FOR DEBIT CARD SERVICES (U.S. CLS. 100, 101 AND 102).

TIMOTHY FINNEGAN, EXAMINING ATTORNEY

CLASS 36—(Continued).

SN 78-435,603. FIRST MIDWEST FINANCIAL, INC., STORM LAKE, IA. FILED 6-15-2004.

META

THE MARK CONSISTS OF STANDARD CHARACTERS WITHOUT CLAIM TO ANY PARTICULAR FONT, STYLE, SIZE, OR COLOR.

FOR FINANCIAL SERVICES, NAMELY, BANKING SERVICES; ONLINE BANKING SERVICES; TRUST SERVICES, NAMELY, INVESTMENT ADVICE AND MANAGEMENT SERVICES; PREPAID PURCHASE CARD SERVICES, NAMELY, PROCESSING ELECTRONIC PAYMENTS MADE THROUGH PREPAID CARDS (U.S. CLS. 100, 101 AND 102).

LAURA KOVAISKY, EXAMINING ATTORNEY

SN 78-436,070. WILMINGTON FINANCE, INC., PLYMOUTH MEETING, PA. FILED 6-16-2004.

WilQual

THE MARK CONSISTS OF STANDARD CHARACTERS WITHOUT CLAIM TO ANY PARTICULAR FONT, STYLE, SIZE, OR COLOR.

FOR MORTGAGE BANKING SERVICES; PROVIDING MORTGAGE BANKING SERVICES AND INFORMATION REGARDING MORTGAGE BANKING SERVICES THROUGH ELECTRONIC, CONVENTIONAL AND PRINTED MEDIA (U.S. CLS. 100, 101 AND 102).

FIRST USE 6-30-2004; IN COMMERCE 6-30-2004.
KATHERINE STOIDES, EXAMINING ATTORNEY

CLASS 36—(Continued).

SN 78-436,262. SETTLERS LIFE INSURANCE COMPANY, BRISTOL, VA. FILED 6-16-2004.



OWNER OF U.S. REG. NOS. 1,555,077 AND 1,798,154.
NO CLAIM IS MADE TO THE EXCLUSIVE RIGHT TO USE LIFE, APART FROM THE MARK AS SHOWN.

THE MARK CONSISTS, IN PART, OF THE GRAPHICAL DESIGN OF A COVERED WAGON.

FOR LIFE INSURANCE UNDERWRITING SERVICES (U.S. CLS. 100, 101 AND 102).

FIRST USE 2-28-2002, THE MARK WAS FIRST USED ANYWHERE IN A DIFFERENT FORM OTHER THAN THAT SOUGHT TO BE REGISTERED ON 04/01/1990.; IN COMMERCE 2-28-2002, THE MARK WAS FIRST USED IN COMMERCE IN A DIFFERENT FORM OTHER THAN THAT SOUGHT TO BE REGISTERED ON 04/01/1990..

TRICIA SONNEBORN, EXAMINING ATTORNEY

SN 78-436,904. BUREAU OF THE PUBLIC DEBT, WASHINGTON, DC. FILED 6-17-2004.

MANAGEDIRECT

THE MARK CONSISTS OF STANDARD CHARACTERS WITHOUT CLAIM TO ANY PARTICULAR FONT, STYLE, SIZE, OR COLOR.

OWNER OF U.S. REG. NO. 2,544,914.
FOR FINANCIAL SERVICES, NAMELY, PROVIDING ADMINISTRATION OF U S TREASURY SECURITIES ACCOUNTS BY MEANS OF THE INTERNET AND OTHER COMMUNICATION DEVICES (U.S. CLS. 100, 101 AND 102).

LAURA KOVAISKY, EXAMINING ATTORNEY

CLASS 36—(Continued).

SN 78-437,041. NEWPORT R&D, INC., PORTSMOUTH, RI.
FILED 6-17-2004.

THE PRETTIEST GIRL
AT THE DANCE

THE MARK CONSISTS OF STANDARD CHARACTERS
WITHOUT CLAIM TO ANY PARTICULAR FONT, STYLE,
SIZE, OR COLOR.
FOR YACHT BROKERAGE SERVICES (U.S. CLS. 100,
101 AND 102).
FIRST USE 6-1-2004; IN COMMERCE 6-1-2004.
ALICIA COLLINS, EXAMINING ATTORNEY

SN 78-437,629. LEGACY TITLE, LLC, HACKENSACK, NJ.
FILED 6-18-2004.

LEGACY TITLE, LLC

THE MARK CONSISTS OF STANDARD CHARACTERS
WITHOUT CLAIM TO ANY PARTICULAR FONT, STYLE,
SIZE, OR COLOR.
NO CLAIM IS MADE TO THE EXCLUSIVE RIGHT TO
USE TITLE, LLC, APART FROM THE MARK AS SHOWN.
FOR TITLE INSURANCE SERVICES (U.S. CLS. 100, 101
AND 102).
FIRST USE 4-1-2003; IN COMMERCE 7-1-2003.
TRACY FLETCHER, EXAMINING ATTORNEY

CLASS 36—(Continued).

SN 78-438,193. SIMPLEX MORTGAGE, INC., SAN JOSE, CA.
FILED 6-20-2004.



THE COLOR(S) RED IS/ARE CLAIMED AS A FEATURE
OF THE MARK.
THE MARK CONSISTS OF A STYLIZED LETTER "S" IN
RED.
FOR MORTGAGE BROKERAGE (U.S. CLS. 100, 101
AND 102).
GINNY ISAACSON, EXAMINING ATTORNEY

SN 78-438,304. PREMISYS ENTERPRISES, INC., ATLANTA,
GA. FILED 6-21-2004.

PREMISYS

THE MARK CONSISTS OF STANDARD CHARACTERS
WITHOUT CLAIM TO ANY PARTICULAR FONT, STYLE,
SIZE, OR COLOR.
FOR REAL ESTATE INVESTMENT SERVICES (U.S.
CLS. 100, 101 AND 102).
WILLIAM VERHOSEK, EXAMINING ATTORNEY

CLASS 36—(Continued).

SN 78-438,928. CLIF BAR, INC., BERKELEY, CA. FILED 6-21-2004.

RRIPL3

THE MARK CONSISTS OF STANDARD CHARACTERS WITHOUT CLAIM TO ANY PARTICULAR FONT, STYLE, SIZE, OR COLOR.
FOR CHARITABLE FUND RAISING SERVICES (U.S. CLS. 100, 101 AND 102).
FIRST USE 6-0-2002; IN COMMERCE 6-0-2002.
JILL C. ALT, EXAMINING ATTORNEY

CLASS 36—(Continued).

SN 78-444,809. AMERICAN INTERNATIONAL GROUP, INC., NEW YORK, NY. FILED 7-1-2004.

**STARR EXCESS
LIABILITY
INSURANCE
COMPANY, LTD.**

THE MARK CONSISTS OF STANDARD CHARACTERS WITHOUT CLAIM TO ANY PARTICULAR FONT, STYLE, SIZE, OR COLOR.
NO CLAIM IS MADE TO THE EXCLUSIVE RIGHT TO USE "EXCESS LIABILITY INSURANCE COMPANY LTD", APART FROM THE MARK AS SHOWN.
FOR INSURANCE UNDERWRITING SERVICES, NAMELY, PROPERTY AND CASUALTY INSURANCE, DIRECTORS' AND OFFICERS' LIABILITY INSURANCE, ERRORS AND OMISSIONS LIABILITY, FIDUCIARY LIABILITY, EMPLOYEE PRACTICES LIABILITY, AND PROFESSIONAL LIABILITY INSURANCE (U.S. CLS. 100, 101 AND 102).
FIRST USE 6-30-1993; IN COMMERCE 6-30-1993.
WENDY GOODMAN, EXAMINING ATTORNEY

SN 78-444,790. AMERICAN INTERNATIONAL GROUP, INC., NEW YORK, NY. FILED 7-1-2004.

STARR EXCESS

THE MARK CONSISTS OF STANDARD CHARACTERS WITHOUT CLAIM TO ANY PARTICULAR FONT, STYLE, SIZE, OR COLOR.
NO CLAIM IS MADE TO THE EXCLUSIVE RIGHT TO USE "EXCESS", APART FROM THE MARK AS SHOWN.
FOR INSURANCE UNDERWRITING SERVICES, NAMELY, PROPERTY AND CASUALTY INSURANCE, DIRECTORS' AND OFFICERS' LIABILITY INSURANCE, ERRORS AND OMISSIONS LIABILITY, FIDUCIARY LIABILITY, EMPLOYEE PRACTICES LIABILITY, AND PROFESSIONAL LIABILITY INSURANCE (U.S. CLS. 100, 101 AND 102).
FIRST USE 6-30-1993; IN COMMERCE 6-30-1993.
WENDY GOODMAN, EXAMINING ATTORNEY

SN 78-446,387. AMERICAN INTERNATIONAL GROUP, INC., NEW YORK, NY. FILED 7-6-2004.

**STARR EXCESS
SERVICES**

THE MARK CONSISTS OF STANDARD CHARACTERS WITHOUT CLAIM TO ANY PARTICULAR FONT, STYLE, SIZE, OR COLOR.
NO CLAIM IS MADE TO THE EXCLUSIVE RIGHT TO USE "EXCESS SERVICES", APART FROM THE MARK AS SHOWN.
FOR INSURANCE UNDERWRITING SERVICES, NAMELY, PROPERTY AND CASUALTY INSURANCE, DIRECTORS' AND OFFICERS' LIABILITY INSURANCE, ERRORS AND OMISSIONS LIABILITY, FIDUCIARY LIABILITY, EMPLOYEE PRACTICES LIABILITY, AND PROFESSIONAL LIABILITY INSURANCE (U.S. CLS. 100, 101 AND 102).
FIRST USE 9-1-1999; IN COMMERCE 9-1-1999.
WENDY GOODMAN, EXAMINING ATTORNEY

CLASS 36—(Continued).

SN 78-473,363. THE LENNY FUND, INC., BOSTON, MA.
FILED 8-25-2004.

**THE LENNY ZAKIM
FUND**

THE MARK CONSISTS OF STANDARD CHARACTERS WITHOUT CLAIM TO ANY PARTICULAR FONT, STYLE, SIZE, OR COLOR.

NO CLAIM IS MADE TO THE EXCLUSIVE RIGHT TO USE FUND, APART FROM THE MARK AS SHOWN.

THE MARK DOES NOT IDENTIFY A LIVING INDIVIDUAL.

FOR CHARITABLE FUNDRAISING SERVICES AND PHILANTHROPIC SERVICES, NAMELY MONETARY DONATIONS (U.S. CLS. 100, 101 AND 102).

BRIDGETT SMITH, EXAMINING ATTORNEY

SN 78-486,951. SCHAEFFER'S INVESTMENT RESEARCH, INC., CINCINNATI, OH. FILED 9-21-2004.

**S+ SCHAEFFER'S
GOLD**

THE MARK CONSISTS OF STANDARD CHARACTERS WITHOUT CLAIM TO ANY PARTICULAR FONT, STYLE, SIZE, OR COLOR.

FOR FINANCIAL SERVICES, NAMELY, PROVIDING FINANCIAL ANALYSIS AND PROVIDING FINANCIAL INVESTMENT INFORMATION AND FINANCIAL INVESTMENT DATA INFORMATION TO OTHERS; AND FINANCIAL INVESTMENT INFORMATION PROVIDED BY ELECTRONIC MEANS (U.S. CLS. 100, 101 AND 102).

FIRST USE 9-7-2004; IN COMMERCE 9-7-2004.

KIMBERLY PERRY, EXAMINING ATTORNEY

CLASS 36—(Continued).

SN 78-495,789. BEST WESTERN INTERNATIONAL, INC., PHOENIX, AZ. FILED 10-6-2004.

**BEST WESTERN
TRAVEL CARD**

THE MARK CONSISTS OF STANDARD CHARACTERS WITHOUT CLAIM TO ANY PARTICULAR FONT, STYLE, SIZE, OR COLOR.

OWNER OF U.S. REG. NOS. 1,072,360, 2,826,386 AND OTHERS.

NO CLAIM IS MADE TO THE EXCLUSIVE RIGHT TO USE TRAVEL CARD, APART FROM THE MARK AS SHOWN.

FOR ISSUING STORED VALUE CARDS (U.S. CLS. 100, 101 AND 102).

FIRST USE 11-1-2002; IN COMMERCE 11-1-2002.

GWEN STOKOLS, EXAMINING ATTORNEY

CLASS 37—CONSTRUCTION AND REPAIR

SN 75-336,616. E-CAPITAL, INC., MENLO PARK, CA. FILED 8-6-1997.

E-CAPITAL

FOR REAL ESTATE DEVELOPMENT SERVICES (U.S. CLS. 100, 103 AND 106).

FIRST USE 8-30-1996; IN COMMERCE 8-30-1996.

ALICE SUE CARRUTHERS, EXAMINING ATTORNEY

CLASS 37—(Continued).

SN 76-557,376. TIDY CLEANING CORP, DBA TARGET CLEANING SYSTEMS, HAVERSTRAW, NY. FILED 11-6-2003.



NO CLAIM IS MADE TO THE EXCLUSIVE RIGHT TO USE "CLEAN", APART FROM THE MARK AS SHOWN.

THE COLOR(S) ORANGE IS/ARE CLAIMED AS A FEATURE OF THE MARK.

THE MARK CONSISTS OF THE WORDS "CLICK & CLEAN" IN BLACK LETTERING WITH AN AMPERSAND IN WHITE LETTERING ENCLOSED WITHIN AN ORANGE CIRCLE BETWEEN THE TWO WORDS. AN ARROW APPEARS TO THE LOWER RIGHT OF THE AMPERSAND AND OVERLAPS THE ORANGE CIRCLE AND THE AMPERSAND.

FOR CLEANING, REPAIR, AND PREVENTIVE MAINTENANCE SERVICES FOR COMMERCIAL BUSINESSES, NAMELY SUPERMARKETS, RETAIL STORES, HOTELS, RESTAURANTS, HOSPITALS AND AIRPORTS (U.S. CLS. 100, 103 AND 106).

FIRST USE 10-1-2003; IN COMMERCE 10-1-2003.
REBECCA SMITH, EXAMINING ATTORNEY

CLASS 37—(Continued).

SN 76-576,402. MAXIMUS, INC., RESTON, VA. FILED 2-17-2004.

FUELFOCUS

THE MARK CONSISTS OF STANDARD CHARACTERS WITHOUT CLAIM TO ANY PARTICULAR FONT, STYLE, SIZE, OR COLOR.

FOR CONSULTING AND TECHNICAL SUPPORT SERVICES RELATED TO FUEL AND FLUID USE AND CONSUMPTION BY FLEETS OF CARS, TRUCKS, SHIPS, AIRCRAFT, VEHICLES AND THE LIKE (U.S. CLS. 100, 103 AND 106).

FIRST USE 8-0-2001; IN COMMERCE 8-0-2001.

MICHELLE S. WISEMAN, EXAMINING ATTORNEY

SN 76-594,865. JLG INDUSTRIES, INC., MCCONNELLSBURG, PA. FILED 6-1-2004.

SN 76-576,400. MAXIMUS, INC., RESTON, VA. FILED 2-17-2004.

FLEETFOCUS

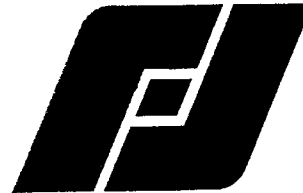

THE MARK CONSISTS OF STANDARD CHARACTERS WITHOUT CLAIM TO ANY PARTICULAR FONT, STYLE, SIZE, OR COLOR.

FOR CONSULTING AND TECHNICAL SUPPORT SERVICES RELATED TO THE MANAGEMENT AND MAINTENANCE OF FLEETS OF CARS, TRUCKS, SHIPS, AIRCRAFT, VEHICLES AND THE LIKE (U.S. CLS. 100, 103 AND 106).

FIRST USE 1-4-2001; IN COMMERCE 1-4-2001.

MICHELLE S. WISEMAN, EXAMINING ATTORNEY

FOR REPAIR AND MAINTENANCE OF CONSTRUCTION AND INDUSTRIAL EQUIPMENT, SUCH AS AERIAL WORK PLATFORMS, ARTICULATING BOOM LIFTS, TELESCOPIC BOOM LIFTS, SCISSOR LIFTS, VERTICAL PERSONNEL LIFTS AND TELESCOPIC MATERIAL HANDLERS (U.S. CLS. 100, 103 AND 106).

DOMINICK J. SALEMI, EXAMINING ATTORNEY

CLASS 37—(Continued).

SN 76-594,866. JLG INDUSTRIES, INC., MCCONNELLSBURG, PA. FILED 6-1-2004.



GRAY, DARK GRAY AND ORANGE
THE DESIGN ELEMENT TO THE LEFT OF THE PARALLELOGRAM IS GRAY; THE PARALLELOGRAM IS DARK GRAY, AND THE DESIGN ELEMENT TO THE RIGHT OF THE PARALLELOGRAM IS ORANGE.

FOR REPAIR AND MAINTENANCE OF CONSTRUCTION AND INDUSTRIAL EQUIPMENT, SUCH AS AERIAL WORK PLATFORMS, ARTICULATING BOOM LIFTS, TELESCOPIC BOOM LIFTS, SCISSOR LIFTS, VERTICAL PERSONNEL LIFTS AND TELESCOPIC MATERIAL HANDLERS (U.S. CLS. 100, 103 AND 106).

DOMINICK J. SALEMI, EXAMINING ATTORNEY

CLASS 37—(Continued).

SN 78-312,360. TERASEN INC., FORMERLY BC GAS INC., VANCOUVER, BRITISH COLUMBIA, CANADA, FILED 10-10-2003.



SN 78-201,079. GUTTZ CORPORATION OF AMERICA, IRVINGTON, NY. FILED 1-8-2003.

GUTTZ

FOR MAINTENANCE AND REPAIR SERVICES FOR PRINTERS (U.S. CLS. 100, 103 AND 106).

TONI HICKEY, EXAMINING ATTORNEY

SN 78-291,010. LMC INTERNATIONAL TRADE, INC., ALLENTOWN, PA. FILED 8-22-2003.

DESIGNER GARAGE

NO CLAIM IS MADE TO THE EXCLUSIVE RIGHT TO USE "GARAGE", APART FROM THE MARK AS SHOWN.

FOR RESIDENTIAL GARAGE ORGANIZING, NAMELY, INSTALLING PVC WALL PANELS, HOOKS, SHELVES, RACKS AND CABINETS (U.S. CLS. 100, 103 AND 106).

FIRST USE 8-1-2002; IN COMMERCE 3-1-2003.

TRACY WHITAKER-BOWN, EXAMINING ATTORNEY

PRIORITY CLAIMED UNDER SEC. 44(D) ON CANADA APPLICATION NO. 1,173,585, FILED 4-11-2003, REG. NO. TMA627436, DATED 12-3-2004, EXPIRES 12-3-2019.

FOR PIPELINE INSTALLATION AND REPAIR, NAMELY, INSTALLATION, OPERATION, AND SERVICING OF PIPES, VALVES, METERS, AND COMPRESSORS USED TO SUPPLY NATURAL GAS AND PROPANE GAS TO RESIDENTIAL, COMMERCIAL AND INDUSTRIAL USERS; INSTALLATION REPAIR AND MAINTENANCE OF NATURAL GAS, PROPANE GAS, OIL AND/OR ELECTRIC APPLIANCES AND EQUIPMENT, NAMELY BOILERS, BURNERS, CLOTHES DRYERS, DEEP FAT FRYERS, FURNACES, FIREPLACES, SPACE HEATERS, POOL HEATERS, PATIO HEATERS, SPA HEATERS, WATER HEATERS, HOT PLATES AND GRIDDLES, INCINERATORS, OVENS, RANGES, GAS BARBECUES AND LIGHTS AND REPAIR SERVICES FOR THE ABOVE LISTED PRODUCTS COVERED BY WARRANTY; INSTALLATION AND REPAIR OF ACCESSORIES FOR GAS FIRED APPLIANCES AND EQUIPMENT, NAMELY AUTOMATIC BURNER IGNITION AND SAFETY SHUT-OFF DEVICES, COMBINATION CONTROLS, CONNECTORS, DRIP TUBES, DRAFT HOODS, PRESSURE REGULATORS, QUICK-DISCONNECT DEVICES, THERMOSTATS, AND VALVES; INSTALLATION OF EMERGENCY SAFETY EQUIPMENT AND DEVICES; REPAIR SERVICES FOR GAS AND FLUID METERS; METER MAINTENANCE SERVICES; HOME ENERGY RETROFITTING SERVICES, NAMELY INSTALLING THERMAL WINDOWS AND INSULATION; HOME RENOVATION SERVICES, NAMELY PERFORMING STRUCTURAL RENOVATIONS FOR THE HOME; NATURAL GAS, PROPANE GAS, AND WATER PUMP MAINTENANCE; FIRE HYDRANT MAINTENANCE; GAS LEAK REPAIR SERVICES (U.S. CLS. 100, 103 AND 106).

KIMBERLY FRYE, EXAMINING ATTORNEY

CLASS 37—(Continued).

SN 78-316,725. SHIEL-SEXTON COMPANY INC., INDIANA-POLIS, IN. FILED 10-21-2003.

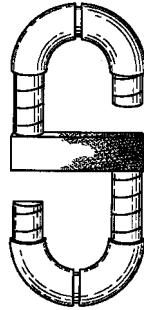

THE LINING SHOWN IN THE DRAWING IS FOR SHADING ONLY AND IS NOT A FEATURE OF THE MARK.

FOR BUILDING CONSTRUCTION AND REAL ESTATE DEVELOPMENT SERVICES (U.S. CLS. 100, 103 AND 106).

FIRST USE 3-0-2000; IN COMMERCE 3-0-2000.
KATHY DE JONGE, EXAMINING ATTORNEY

CLASS 37—(Continued).

SN 78-336,456. SCHERER BROS. LUMBER CO., BROOKLYN PARK, MN. FILED 12-4-2003.

HARMONY MELAMINE CREATIONS

THE MARK CONSISTS OF STANDARD CHARACTERS WITHOUT CLAIM TO ANY PARTICULAR FONT, STYLE, SIZE, OR COLOR.

NO CLAIM IS MADE TO THE EXCLUSIVE RIGHT TO USE MELAMINE CREATIONS, APART FROM THE MARK AS SHOWN.

FOR DESIGN, CONSTRUCTION AND INSTALLATION OF STORAGE SYSTEMS FOR NEW HOME, REMODELING AND COMMERCIAL CONSTRUCTION (U.S. CLS. 100, 103 AND 106).

MICHELE SWAIN, EXAMINING ATTORNEY

SN 78-316,726. SHIEL-SEXTON COMPANY INC., INDIANA-POLIS, IN. FILED 10-21-2003.

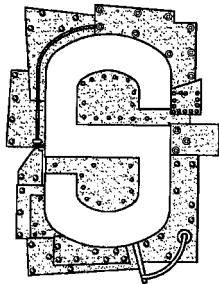

THE STIPPLING IS FOR SHADING PURPOSES ONLY AND IS NOT A FEATURE OF THE MARK.

FOR BUILDING CONSTRUCTION AND REAL ESTATE DEVELOPMENT SERVICES (U.S. CLS. 100, 103 AND 106).

FIRST USE 3-0-2000; IN COMMERCE 3-0-2000.
KATHY DE JONGE, EXAMINING ATTORNEY

SN 78-347,117. NORSTAR RESIDENTIAL LLLP, DENVER, CO. FILED 12-31-2003.

NORSTAR RESIDENTIAL

THE MARK CONSISTS OF STANDARD CHARACTERS WITHOUT CLAIM TO ANY PARTICULAR FONT, STYLE, SIZE, OR COLOR.

NO CLAIM IS MADE TO THE EXCLUSIVE RIGHT TO USE "RESIDENTIAL", APART FROM THE MARK AS SHOWN.

FOR CONSTRUCTION SERVICES, NAMELY, CONSTRUCTION MANAGEMENT, CONSTRUCTION SUPERVISION, RESIDENTIAL AND COMMERCIAL CONSTRUCTION SERVICES; PLANNING, LAYING OUT AND CONSTRUCTION OF RESIDENTIAL AND COMMERCIAL COMMUNITIES; RENOVATION OF HOMES AND BUILDINGS, INSPECTION SERVICES RENDERED IN CONNECTION WITH SAME (U.S. CLS. 100, 103 AND 106).

RICHARD A. STRASER, EXAMINING ATTORNEY

CLASS 37—(Continued).

SN 78-359,620. HORNE, ALAN R., FORT COLLINS, CO.
FILED 1-29-2004.

Yard Elves Inc.

THE MARK CONSISTS OF STANDARD CHARACTERS WITHOUT CLAIM TO ANY PARTICULAR FONT, STYLE, SIZE, OR COLOR.

NO CLAIM IS MADE TO THE EXCLUSIVE RIGHT TO USE "YARD" OR "INC", APART FROM THE MARK AS SHOWN.

FOR LANDSCAPE CONSTRUCTION SERVICES (U.S. CLS. 100, 103 AND 106).

FIRST USE 12-1-1997; IN COMMERCE 4-1-1998.

JOHN KELLY, EXAMINING ATTORNEY

CLASS 37—(Continued).

SN 78-384,053. APPLIED MATERIALS, INC., SANTA CLARA, CA. FILED 3-14-2004.

POLYGUARD

THE MARK CONSISTS OF STANDARD CHARACTERS WITHOUT CLAIM TO ANY PARTICULAR FONT, STYLE, SIZE, OR COLOR.

FOR MAINTENANCE AND REPAIR OF SEMICONDUCTOR PROCESSING AND PRODUCTION EQUIPMENT (U.S. CLS. 100, 103 AND 106).

EUGENIA MARTIN, EXAMINING ATTORNEY

SN 78-368,998. HOLT SERVICES CORPORATION, INC., PENSACOLA, FL. FILED 2-17-2004.

TWO MAIDS & A MOP

THE MARK CONSISTS OF STANDARD CHARACTERS WITHOUT CLAIM TO ANY PARTICULAR FONT, STYLE, SIZE, OR COLOR.

FOR CLEANING OF RESIDENTIAL AND COMMERCIAL PREMISES (U.S. CLS. 100, 103 AND 106).

FIRST USE 8-1-2003; IN COMMERCE 8-1-2003.

THEODORE MCBRIDE, EXAMINING ATTORNEY

SN 78-393,319. DRYVIT SYSTEMS, INC., WEST WARWICK, RI. FILED 3-30-2004.

SN 78-382,556. SASSMAN MASONRY CONSTRUCTION CO., KINGSTON, NJ. FILED 3-11-2004.

Sassman Masonry Construction

THE MARK CONSISTS OF STANDARD CHARACTERS WITHOUT CLAIM TO ANY PARTICULAR FONT, STYLE, SIZE, OR COLOR.

NO CLAIM IS MADE TO THE EXCLUSIVE RIGHT TO USE "MASONRY CONSTRUCTION", APART FROM THE MARK AS SHOWN.

SEC. 2(F).

FOR MASONRY SERVICES; CONSTRUCTION AND RESTORATION OF BUILDINGS (U.S. CLS. 100, 103 AND 106).

FIRST USE 12-1-1975; IN COMMERCE 12-1-1975.

PAULA MAYS, EXAMINING ATTORNEY

WALL WIZARD

THE MARK CONSISTS OF STANDARD CHARACTERS WITHOUT CLAIM TO ANY PARTICULAR FONT, STYLE, SIZE, OR COLOR.

NO CLAIM IS MADE TO THE EXCLUSIVE RIGHT TO USE WALL, APART FROM THE MARK AS SHOWN.

FOR CONSULTING SERVICES THE FIELD OF WALL CLADDING SYSTEM SELECTION AND APPLICATION RENDERED VIA THE INTERNET (U.S. CLS. 100, 103 AND 106).

MELVIN AXILBUND, EXAMINING ATTORNEY

CLASS 37—(Continued).

SN 78-424,175. KRISTOFKO, JOE, RALEIGH, NC. FILED 5-24-2004.



FOR RESIDENTIAL HOUSE REPAINTING (U.S. CLS. 100, 103 AND 106).
RUDY R. SINGLETON, EXAMINING ATTORNEY

SN 78-425,612. CARPENTRY COLLABORATIVE, INC., ROSEMONT, IL. FILED 5-26-2004.



NO CLAIM IS MADE TO THE EXCLUSIVE RIGHT TO USE "CARPENTRY" AND "INC"., APART FROM THE MARK AS SHOWN.

THE COLOR(S) RED AND WHITE IS/ARE CLAIMED AS A FEATURE OF THE MARK.

THE COLOR RED APPEARS IN THE SQUARE BOX SURROUNDING THE LETTERS CCI

FOR RESIDENTIAL AND COMMERCIAL BUILDING INSTALLATION AND RENOVATION OF DRYWALL, INSULATION, PAINTING, STUCCO, EXTERIOR INSULATION AND FINISH SYSTEMS, PLASTER, CARPENTRY, METAL FRAMING, WOODWORK, ACOUSTIC CEILINGS (U.S. CLS. 100, 103 AND 106).

MIDGE BUTLER, EXAMINING ATTORNEY

SN 78-427,754. MOTOSPA, LLC, DENVER, CO. FILED 6-1-2004.



NO CLAIM IS MADE TO THE EXCLUSIVE RIGHT TO USE "CAR", APART FROM THE MARK AS SHOWN.

FOR CAR WASHING, DETAILING, AND LUBRICATION SERVICES (U.S. CLS. 100, 103 AND 106).

JENNIFER CHICOSKI, EXAMINING ATTORNEY

CLASS 37—(Continued).

SN 78-432,207. MTJ ENTERPRISES, INC., HOUSTON, TX. FILED 6-9-2004.

Tom Tynan Homes

THE MARK CONSISTS OF STANDARD CHARACTERS WITHOUT CLAIM TO ANY PARTICULAR FONT, STYLE, SIZE, OR COLOR.

NO CLAIM IS MADE TO THE EXCLUSIVE RIGHT TO USE "HOMES", APART FROM THE MARK AS SHOWN.

FOR CUSTOM CONSTRUCTION OF HOMES (U.S. CLS. 100, 103 AND 106).

CHERYL CLAYTON, EXAMINING ATTORNEY

SN 78-434,241. ALL CLEAR POOL & SPA, ELK GROVE, CA. FILED 6-11-2004.

All Clear Pool & Spa

THE MARK CONSISTS OF STANDARD CHARACTERS WITHOUT CLAIM TO ANY PARTICULAR FONT, STYLE, SIZE, OR COLOR.

NO CLAIM IS MADE TO THE EXCLUSIVE RIGHT TO USE "POOL & SPA", APART FROM THE MARK AS SHOWN.

FOR POOL CONSTRUCTION AND MAINTENANCE (U.S. CLS. 100, 103 AND 106).

FIRST USE 5-1-2004; IN COMMERCE 5-1-2004.

CURTIS FRENCH, EXAMINING ATTORNEY

SN 78-434,487. RAGGHIANI, GABRIEL J., III, EADS, TN. FILED 6-14-2004.

A Home's Medic

THE MARK CONSISTS OF STANDARD CHARACTERS WITHOUT CLAIM TO ANY PARTICULAR FONT, STYLE, SIZE, OR COLOR.

FOR HOUSE BUILDING AND REPAIR (U.S. CLS. 100, 103 AND 106).

INGRID C. EULIN, EXAMINING ATTORNEY

CLASS 37—(Continued).

SN 78-435,899. KAIS, JOSEPH J., FAIRFIELD, CT. FILED 6-16-2004.

**The Mark of
Mastery**

THE MARK CONSISTS OF STANDARD CHARACTERS WITHOUT CLAIM TO ANY PARTICULAR FONT, STYLE, SIZE, OR COLOR.

FOR CONSTRUCTION MANAGEMENT, BUILDING CONSTRUCTION AND REPAIR (U.S. CLS. 100, 103 AND 106).

ALICE BENMAMAN, EXAMINING ATTORNEY

CLASS 38—COMMUNICATION

SN 76-256,508. ADVANCED TELCOM, INC., SANTA ROSA, CA. FILED 5-15-2001.

TFIRE

FOR PROVIDING TELECOMMUNICATIONS CONNECTIONS TO A GLOBAL COMPUTER NETWORK (U.S. CLS. 100, 101 AND 104).

HEATHER THOMPSON, EXAMINING ATTORNEY

SN 76-347,859. PREFERRED VOICE, INC., DALLAS, TX. FILED 12-12-2001.

BUSINESSCONNECT

FOR TELECOMMUNICATION SERVICES, NAMELY, AUTOMATED DIALING SERVICE OF TELEPHONE NUMBERS LOCATED THROUGH DIRECTORY ASSISTANCE (U.S. CLS. 100, 101 AND 104).

LEIGH LOWRY, EXAMINING ATTORNEY

CLASS 38—(Continued).

SN 76-587,688. COMCAST CORPORATION, PHILADELPHIA, PA. FILED 4-16-2004.

THAT WAS THEN. THIS IS COMCAST.

THE MARK CONSISTS OF STANDARD CHARACTERS WITHOUT CLAIM TO ANY PARTICULAR FONT, STYLE, SIZE, OR COLOR.

OWNER OF U.S. REG. NOS. 1,421,433, 2,480,809 AND OTHERS.

FOR CABLE TELEVISION TRANSMISSION SERVICES; TELECOMMUNICATIONS SERVICES, NAMELY, VOICE, VIDEO AND DATA TRANSMISSIONS PROVIDED THROUGH THE USE OF CABLE TELEVISION DISTRIBUTION FACILITIES; HIGH SPEED ELECTRONIC DATA INTERCHANGE SERVICES PROVIDED VIA MODEMS, HYBRID FIBER COAXIAL CABLE NETWORKS, ROUTERS AND SERVERS; TELEPHONE COMMUNICATION SERVICES (U.S. CLS. 100, 101 AND 104).

STEVEN JACKSON, EXAMINING ATTORNEY

SN 76-589,364. STARBUCKS U.S. BRANDS, LLC, MINDEN, NV. FILED 4-29-2004.

STARBUCKS

THE MARK CONSISTS OF STANDARD CHARACTERS WITHOUT CLAIM TO ANY PARTICULAR FONT, STYLE, SIZE, OR COLOR.

OWNER OF U.S. REG. NOS. 2,035,005, 2,325,182 AND OTHERS.

FOR PROVIDING MULTIPLE USER DIAL-UP AND DEDICATED ACCESS TO THE INTERNET (U.S. CLS. 100, 101 AND 104).

FIRST USE 8-21-2002; IN COMMERCE 8-21-2002.

BARBARA RUTLAND, EXAMINING ATTORNEY

SN 76-595,907. SWITCH & DATA HOLDINGS, INC., TAMPA, FL. FILED 6-4-2004.

SWITCH AND DATA

THE MARK CONSISTS OF STANDARD CHARACTERS WITHOUT CLAIM TO ANY PARTICULAR FONT, STYLE, SIZE, OR COLOR.

FOR TELECOMMUNICATIONS SERVICES, NAMELY, PROVIDING THIRD PARTY USERS WITH ACCESS TO TELECOMMUNICATION INFRASTRUCTURE, NAMELY PROVIDING INTERCONNECTIVITY BY ALLOWING BUYERS AND SELLERS TO EXCHANGE OR PURCHASE MULTIPLE USER ACCESS TO A GLOBAL COMMUNICATION NETWORK FROM THIRD PARTIES AND FEATURING DIRECT, UNLIMITED AND UNRESTRICTED INTERCONNECTION AMONG INTERNET SERVICE PROVIDERS, CONTENT PROVIDERS, DATA SERVICE PROVIDERS, CARRIERS AND COMPONENT SERVICES PROVIDERS (U.S. CLS. 100, 101 AND 104).

FIRST USE 3-1-2003; IN COMMERCE 3-1-2003.

LA TONIA FISHER, EXAMINING ATTORNEY

CLASS 38—(Continued).

SN 76-597,849. UNIVERSITY OF SOUTHERN CALIFORNIA, LOS ANGELES, CA. FILED 6-17-2004.

IN CONCERT WITH YOUR LIFE

THE MARK CONSISTS OF STANDARD CHARACTERS WITHOUT CLAIM TO ANY PARTICULAR FONT, STYLE, SIZE, OR COLOR.

FOR RADIO BROADCASTING SERVICES (U.S. CLS. 100, 101 AND 104).

FIRST USE 6-1-2004; IN COMMERCE 6-1-2004.
HOWARD SMIGA, EXAMINING ATTORNEY

SN 76-617,156. WHOLE FOODS MARKET IP, L.P., AUSTIN, TX. FILED 10-21-2004.

WFM-U

THE MARK CONSISTS OF STANDARD CHARACTERS WITHOUT CLAIM TO ANY PARTICULAR FONT, STYLE, SIZE, OR COLOR.

FOR STREAMING OF AUDIO AND VIDEO MATERIAL ON THE INTERNET (U.S. CLS. 100, 101 AND 104).

JOHN DALIER, EXAMINING ATTORNEY

SN 78-218,643. AKLUVIS, OCEANSIDE, CA. FILED 2-25-2003.

STUPIDVIDEOS

FOR STREAMING OF VIDEO MATERIAL ON THE INTERNET (U.S. CLS. 100, 101 AND 104).

FIRST USE 6-20-2001; IN COMMERCE 10-20-2002.
JOHN GARTNER, EXAMINING ATTORNEY

SN 78-252,416. ROCHESTER TELECONNECT CORPORATION, AKA ROCHESTER TEL, ROCHESTER, NY. FILED 5-21-2003.

TELETRACK

FOR VOICE MAIL SERVICES (U.S. CLS. 100, 101 AND 104).

RUSS HERMAN, EXAMINING ATTORNEY

CLASS 38—(Continued).

SN 78-252,421. ROCHESTER TELECONNECT CORPORATION, AKA ROCHESTER TEL, ROCHESTER, NY. FILED 5-21-2003.

STARTRACK

FOR VOICE MAIL SERVICES (U.S. CLS. 100, 101 AND 104).

RUSS HERMAN, EXAMINING ATTORNEY

SN 78-260,473. AT&T CORP., NEW YORK, NY. FILED 6-10-2003.

**ANYTHING TO ANYWHERE
BUSINESS
COMMUNICATIONS**

NO CLAIM IS MADE TO THE EXCLUSIVE RIGHT TO USE "BUSINESS COMMUNICATIONS", APART FROM THE MARK AS SHOWN.

FOR INTERNET ACCESS SERVICES (U.S. CLS. 100, 101 AND 104).

APRIL L. RADEMACHER, EXAMINING ATTORNEY

SN 78-260,484. AT&T CORP., NEW YORK, NY. FILED 6-10-2003.

**ANYTHING TO ANYWHERE
COMMUNICATIONS**

NO CLAIM IS MADE TO THE EXCLUSIVE RIGHT TO USE "COMMUNICATIONS", APART FROM THE MARK AS SHOWN.

FOR INTERNET ACCESS SERVICES (U.S. CLS. 100, 101 AND 104).

APRIL L. RADEMACHER, EXAMINING ATTORNEY

SN 78-303,703. DISNEY ENTERPRISES, INC., BURBANK, CA. FILED 9-22-2003.

BRING ON THE MOVIES

FOR TELECOMMUNICATION SERVICES, NAMELY, ELECTRONIC DATA, MAIL AND MESSAGING SERVICES, INCLUDING CUSTOMER SERVICE DELIVERY USING A WIDE VARIETY OF ELECTRONIC AND TELEPHONIC MEANS; TELEVISION BROADCASTING SERVICES; CABLE TELEVISION BROADCASTING SERVICES; INTERACTIVE TELEVISION TRANSMISSION SERVICES; INTERACTIVE ELECTRONIC COMMUNICATIONS SERVICES INCORPORATING VIDEO AND AUDIO TRANSMISSION BROADCASTING PROGRAMS VIA THE INTERNET; PAY-PER-VIEW TELEVISION TRANSMISSION SERVICES; AND VIDEO-ON-DEMAND TRANSMISSION SERVICES (U.S. CLS. 100, 101 AND 104).

JEFFERY COWARD, EXAMINING ATTORNEY

CLASS 38—(Continued).

SN 78-317,052. CONVOQ, INC., LEXINGTON, MA. FILED 10-22-2003.

CONVOQ

FOR COMPUTER AND TELECOMMUNICATIONS-RELATED SERVICES, NAMELY, FACILITATING THE SENDING AND RECEIVING OF DATA, MESSAGES, VOICE AND TELEPHONY OVER COMPUTER NETWORKS AND THE INTERNET, VIA PERSONAL COMPUTERS, COMPUTER SERVERS, WIRELESS AND OTHER MOBILE TECHNOLOGIES AND DEVICES (U.S. CLS. 100, 101 AND 104).

GWEN STOKOLS, EXAMINING ATTORNEY

CLASS 38—(Continued).

SN 78-345,366. LAWNET, INC., AUSTIN, TX. FILED 12-24-2003.

DOCPOSIT

SN 78-320,289. WINTERS, JAMES T., NEW YORK, NY. FILED 10-29-2003.

BLISSTV

FOR CABLE TELEVISION BROADCASTING SERVICES (U.S. CLS. 100, 101 AND 104).

JOHN KELLY, EXAMINING ATTORNEY

THE MARK CONSISTS OF STANDARD CHARACTERS WITHOUT CLAIM TO ANY PARTICULAR FONT, STYLE, SIZE, OR COLOR.

FOR PROVIDING ACCESS TO DOCUMENTS STORED ELECTRONICALLY IN CENTRAL FILES FOR REMOTE CONSULTATION, (U.S. CLS. 100, 101 AND 104).

GWEN STOKOLS, EXAMINING ATTORNEY

SN 78-329,041. WOOLERY, REGINALD, EAST HAMPTON, NY. FILED 11-17-2003.

radio free hamptons - online

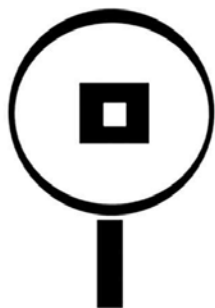

NO CLAIM IS MADE TO THE EXCLUSIVE RIGHT TO USE RADIO, HAMPTONS, ONLINE, APART FROM THE MARK AS SHOWN.

FOR WEB RADIO BROADCASTING AND COMMUNICATION SERVICES, NAMELY, TRANSMITTING STREAMING SOUND AND AUDIO-VISUAL RECORDINGS VIA THE INTERNET (U.S. CLS. 100, 101 AND 104).

MIDGE BUTLER, EXAMINING ATTORNEY

SN 78-383,167. VIRGIN MOBILE USA, LLC, WARREN, NJ. FILED 3-12-2004.

**SUPERPHONIC
RINGTONES**

THE MARK CONSISTS OF STANDARD CHARACTERS WITHOUT CLAIM TO ANY PARTICULAR FONT, STYLE, SIZE, OR COLOR.

NO CLAIM IS MADE TO THE EXCLUSIVE RIGHT TO USE "RINGTONES", APART FROM THE MARK AS SHOWN.

FOR TELECOMMUNICATION SERVICES, NAMELY PROVIDING PERSONAL RINGTONE WIRELESS TELEPHONE COMMUNICATION SERVICES AND TRANSMISSION OF INFORMATION AND IMAGES TO MOBILE TELEPHONES (U.S. CLS. 100, 101 AND 104).

SOPHIA S. KIM, EXAMINING ATTORNEY

CLASS 38—(Continued).

SN 78-391,167. ONE WORLD TELECOMMUNICATIONS HOLDINGS LTD, HONG KONG, HONG KONG, FILED 3-26-2004.

CLASS 38—(Continued).

SN 78-429,523. EPANA NETWORKS, INC., NEW YORK, NY, FILED 6-3-2004.



BON JOUR AFRICA

FOR (BASED ON USE) TELECOMMUNICATIONS SERVICES, NAMELY, LONG DISTANCE TRANSMISSION OF VOICE BY TELEPHONE; (BASED ON INTENT-TO-USE) INTERNET TELEPHONY SERVICES; PROVIDING MULTIPLE-USER ACCESS TO A GLOBAL COMPUTER INFORMATION NETWORK (U.S. CLS. 100, 101 AND 104).

FIRST USE 7-1-2003; IN COMMERCE 7-1-2003.
MARCIE MILONE, EXAMINING ATTORNEY

THE MARK CONSISTS OF STANDARD CHARACTERS WITHOUT CLAIM TO ANY PARTICULAR FONT, STYLE, SIZE, OR COLOR.

NO CLAIM IS MADE TO THE EXCLUSIVE RIGHT TO USE "AFRICA", APART FROM THE MARK AS SHOWN.

THE FOREIGN WORDING IN THE MARK TRANSLATES INTO ENGLISH AS HELLO AFRICA.

FOR LONG DISTANCE TELEPHONE TELECOMMUNICATIONS SERVICES PROVIDED VIA PREPAID TELEPHONE CALLING CARDS (U.S. CLS. 100, 101 AND 104).

BRIAN PINO, EXAMINING ATTORNEY

SN 78-423,742. PRACTICAL DATABASE SOLUTIONS, INC., OKLAHOMA CITY, OK. FILED 5-24-2004.

SN 78-430,275. US LEC ACQUISITION CO., CHARLOTTE, NC. FILED 6-4-2004.

INTELLIPLUG

VOICEECLIPSE

THE MARK CONSISTS OF STANDARD CHARACTERS WITHOUT CLAIM TO ANY PARTICULAR FONT, STYLE, SIZE, OR COLOR.

FOR TELECOMMUNICATION SERVICES, NAMELY, LOCAL AND LONG DISTANCE TRANSMISSION OF VOICE, DATA, AUDIO AND VIDEO DATA VIA THE ELECTRICAL POWER GRID (U.S. CLS. 100, 101 AND 104).

FIRST USE 5-4-2004; IN COMMERCE 5-4-2004.
MONIQUE MILLER, EXAMINING ATTORNEY

THE MARK CONSISTS OF STANDARD CHARACTERS WITHOUT CLAIM TO ANY PARTICULAR FONT, STYLE, SIZE, OR COLOR.

FOR COMMUNICATION SERVICES, NAMELY, PROVIDING VOICE OVER INTERNET PROTOCOL (U.S. CLS. 100, 101 AND 104).

MONIQUE MILLER, EXAMINING ATTORNEY

CLASS 38—(Continued).

SN 78-431,333. EPANA NETWORKS, INC., NEW YORK, NY.
FILED 6-7-2004.

ASIATEL

THE MARK CONSISTS OF STANDARD CHARACTERS WITHOUT CLAIM TO ANY PARTICULAR FONT, STYLE, SIZE, OR COLOR.

FOR TELEPHONE TELECOMMUNICATIONS SERVICES PROVIDED VIA PREPAID TELEPHONE CALLING CARDS (U.S. CLS. 100, 101 AND 104).
JASON LOTT, EXAMINING ATTORNEY

SN 78-431,336. EPANA NETWORKS, INC., NEW YORK, NY.
FILED 6-7-2004.

AFRICATEL

THE MARK CONSISTS OF STANDARD CHARACTERS WITHOUT CLAIM TO ANY PARTICULAR FONT, STYLE, SIZE, OR COLOR.

FOR TELEPHONE TELECOMMUNICATIONS SERVICES PROVIDED VIA PREPAID TELEPHONE CALLING CARDS (U.S. CLS. 100, 101 AND 104).
JASON LOTT, EXAMINING ATTORNEY

CLASS 38—(Continued).

SN 78-432,509. SDGI HOLDINGS, INC., WILMINGTON, DE.
FILED 6-9-2004.

RECOVERYCARE

THE MARK CONSISTS OF STANDARD CHARACTERS WITHOUT CLAIM TO ANY PARTICULAR FONT, STYLE, SIZE, OR COLOR.

OWNER OF U.S. REG. NO. 2,728,285.
SEC. 2(F).

FOR PROVIDING ONLINE CHAT ROOMS AND BULLETIN BOARDS FOR POSTING AND SHARING HEALTH AND MEDICAL INFORMATION AND MESSAGES AMONG USERS; PROVIDING MULTIPLE USER ACCESS TO A GLOBAL COMPUTER INFORMATION NETWORK FOR THE SHARING OF INFORMATION BETWEEN PATIENTS AND HEALTH PROFESSIONALS (U.S. CLS. 100, 101 AND 104).

FIRST USE 5-31-1999; IN COMMERCE 5-31-1999.
MAUREEN DALL, EXAMINING ATTORNEY

SN 78-435,072. NOTIFICATION TECHNOLOGIES, INC.,
SHERMAN OAKS, CA. FILED 6-14-2004.



THE MARK CONSISTS OF THE CAPITAL LETTERS "NTI" WITH A SINGLE RAINBOW ARCH SET ABOVE THE THREE LETTERS.

FOR ELECTRONIC TRANSMISSION OF MESSAGES, USED BY COMMERCIAL, NON-PROFIT, EDUCATIONAL, AND HEALTH INDUSTRIES, FOR THE PURPOSES OF AUTODIALING MEMBERS' TELEPHONE NUMBERS FOR THE DISSEMINATION OF RECORDED MESSAGES REGARDING GENERAL AND EMERGENCY INFORMATION (U.S. CLS. 100, 101 AND 104).

FIRST USE 6-11-2004; IN COMMERCE 6-11-2004.
TIMOTHY FINNEGAN, EXAMINING ATTORNEY

CLASS 38—(Continued).

SN 78-435,850. DAVIS-REUSS, INC., WOODLAND HILLS, CA. FILED 6-16-2004.

MoneyPie

THE MARK CONSISTS OF STANDARD CHARACTERS WITHOUT CLAIM TO ANY PARTICULAR FONT, STYLE, SIZE, OR COLOR.

FOR ELECTRONIC TRANSMISSION OF DIGITAL MEDIA, DATA, AND DIGITAL INFORMATION VIA A GLOBAL COMPUTER NETWORK (U.S. CLS. 100, 101 AND 104).

BARNEY CHARLON, EXAMINING ATTORNEY

CLASS 38—(Continued).

SN 78-438,509. CBeyond COMMUNICATIONS, LLC, ATLANTA, GA. FILED 6-21-2004.

BEYONDVOICE LITE

THE MARK CONSISTS OF STANDARD CHARACTERS WITHOUT CLAIM TO ANY PARTICULAR FONT, STYLE, SIZE, OR COLOR.

OWNER OF U.S. REG. NOS. 2,761,638, 2,763,714 AND OTHERS.

FOR TELECOMMUNICATION SERVICES, NAMELY ELECTRONIC TRANSMISSION OF VOICE, DATA, VIDEO, FACSIMILE AND INFORMATION; LOCAL, LONG DISTANCE, TOLL-FREE AND INTERNATIONAL VOICE, DATA AND FACSIMILE TELEPHONE SERVICES; PROVIDING MULTIPLE USER DIAL-UP AND DEDICATED ACCESS TO INTERNAL COMPUTER NETWORKS AND GLOBAL COMPUTER NETWORKS; ELECTRONIC VOICE MESSAGING TRANSMISSION OF VOICE MESSAGES BY TELEPHONE; VIDEO CONFERENCE TRANSMISSION; ELECTRONIC MAIL SERVICES AND HIGH SPEED INTERNET ACCESS (U.S. CLS. 100, 101 AND 104).

LA TONIA FISHER, EXAMINING ATTORNEY

SN 78-439,180. WCLR, INC., CHICAGO, IL. FILED 6-22-2004.

SN 78-436,335. SHOWTIME NETWORKS INC., NEW YORK, NY. FILED 6-16-2004.

**SHOWTIME ON DEMAND
HD**

THE MARK CONSISTS OF STANDARD CHARACTERS WITHOUT CLAIM TO ANY PARTICULAR FONT, STYLE, SIZE, OR COLOR.

OWNER OF U.S. REG. NOS. 2,483,680, 2,580,328 AND OTHERS.

NO CLAIM IS MADE TO THE EXCLUSIVE RIGHT TO USE "ON DEMAND HD", APART FROM THE MARK AS SHOWN.

FOR COMMUNICATION SERVICES, NAMELY, TRANSMITTING PRE-RECORDED STREAMED AUDIO AND VIDEO MATERIAL THROUGH MEDIA OF TELEVISION, CABLE AND SATELLITE SYSTEMS AND THE INTERNET, ALL IN HIGH DEFINITION FORMAT (U.S. CLS. 100, 101 AND 104).

DARRYL SPRUILL, EXAMINING ATTORNEY

WE PLAY ANYTHING

THE MARK CONSISTS OF STANDARD CHARACTERS WITHOUT CLAIM TO ANY PARTICULAR FONT, STYLE, SIZE, OR COLOR.

FOR RADIO BROADCASTING (U.S. CLS. 100, 101 AND 104).

FIRST USE 6-15-2004; IN COMMERCE 6-15-2004.
GEOFFREY FOSDICK, EXAMINING ATTORNEY

SN 78-439,187. WCLR, INC., CHICAGO, IL. FILED 6-22-2004.

WHATEVER WE WANT

THE MARK CONSISTS OF STANDARD CHARACTERS WITHOUT CLAIM TO ANY PARTICULAR FONT, STYLE, SIZE, OR COLOR.

FOR RADIO BROADCASTING (U.S. CLS. 100, 101 AND 104).

CHERYL STEPLIGHT, EXAMINING ATTORNEY

CLASS 39—TRANSPORTATION AND STORAGE

SN 76-530,058. BROOKSHIRE, NANCY, DBA MAGIC MOVING COMPANY, WALNUT CREEK, CA. FILED 6-25-2003.

MAGIC MOVING CO.

THE MARK CONSISTS OF STANDARD CHARACTERS WITHOUT CLAIM TO ANY PARTICULAR FONT, STYLE, SIZE, OR COLOR.

NO CLAIM IS MADE TO THE EXCLUSIVE RIGHT TO USE MOVING CO., APART FROM THE MARK AS SHOWN.

FOR RESIDENTIAL AND OFFICE SERVICES, NAMELY PACKING ARTICLES FOR TRANSPORTATION AND TRANSPORTATION OF ARTICLES VIA TRUCK, AIR, BOAT, OR RAIL; MOVING VAN SERVICES AND TRANSPORT; MOVING PROVIDER SERVICES, NAMELY, DELIVERY OF GOODS BY TRUCK; DOMESTIC AND INTERNATIONAL WAREHOUSING SERVICES, NAMELY, STORAGE, DISTRIBUTION, AND PACKING FOR SHIPMENT OF FREIGHT FOR OTHERS; PACKAGING ARTICLES TO THE ORDER AND SPECIFICATION OF OTHERS; WAREHOUSE STORAGE OF FURNITURE (U.S. CLS. 100 AND 105).

FIRST USE 12-1-1997; IN COMMERCE 12-1-1997.
GINA FINK, EXAMINING ATTORNEY

SN 76-536,281. THOMSON INFORMATION LICENSING CORPORATION, CLAYMONT, DE. FILED 8-11-2003.

PRIMARY SOURCE MICROFILM

NO CLAIM IS MADE TO THE EXCLUSIVE RIGHT TO USE "MICROFILM", APART FROM THE MARK AS SHOWN.

FOR STORAGE SERVICES FOR ARCHIVING MICROFILM CONTAINING RESEARCH AND LEARNING INFORMATION OF INTEREST TO ACADEMIC AND SPECIAL LIBRARIES (U.S. CLS. 100 AND 105).

FIRST USE 1-0-2001; IN COMMERCE 1-0-2001.
RICHARD WHITE, EXAMINING ATTORNEY

SN 76-560,645. NOLAN LLC, FORT WORTH, TX. FILED 11-18-2003.



OWNER OF U.S. REG. NOS. 2,803,153 AND 2,811,390.
FOR PROVIDING SELF STORAGE IN A WAREHOUSE; AND RENTAL OF MOVING VANS AND MOVING EQUIPMENT, NAMELY, TRAILERS, TOW DOLLIES, TRAILER HITCHES, VEHICLE TOP BAGGAGE CARRIERS, DOLLIES, AND FURNITURE PADS (U.S. CLS. 100 AND 105).

FIRST USE 8-0-2002; IN COMMERCE 8-0-2002.
EUGENIA MARTIN, EXAMINING ATTORNEY

CLASS 39—(Continued).

SN 76-574,151. NEW SHOES MEDIA, LLC, NASHVILLE, TN. FILED 2-4-2004.

THE RISK AND REWARD NETWORK

THE MARK CONSISTS OF STANDARD CHARACTERS WITHOUT CLAIM TO ANY PARTICULAR FONT, STYLE, SIZE, OR COLOR.

FOR ARRANGING TRAVEL TOURS; TRAVEL GUIDE SERVICES (U.S. CLS. 100 AND 105).

PAUL F. GAST, EXAMINING ATTORNEY

SN 76-597,847. THREE IN ONE CONCEPTS, INC., BURBANK, CA. FILED 6-17-2004.

TOOLS OF THE TRADE

THE MARK CONSISTS OF STANDARD CHARACTERS WITHOUT CLAIM TO ANY PARTICULAR FONT, STYLE, SIZE, OR COLOR.

FOR EDUCATION SERVICES, NAMELY CONDUCTING CLASSES AND WORKSHOPS IN THE FIELD OF PERSONAL GROWTH AND DEVELOPMENT FOR INDIVIDUALS AND GROUPS (U.S. CLS. 100 AND 105).

FIRST USE 0-0-1991; IN COMMERCE 0-0-1991.
HOWARD SMIGA, EXAMINING ATTORNEY

SN 76-598,099. MAYDEN, CHRISTOPHER, CHICAGO, IL. FILED 6-18-2004.

MOTIONS IN MOTION

THE MARK CONSISTS OF STANDARD CHARACTERS WITHOUT CLAIM TO ANY PARTICULAR FONT, STYLE, SIZE, OR COLOR.

FOR MESSENGER SERVICES (U.S. CLS. 100 AND 105).

FIRST USE 6-22-1998; IN COMMERCE 1-20-2003.
SCOTT BALDWIN, EXAMINING ATTORNEY

SN 76-598,573. BWIA WEST INDIES AIRWAYS LIMITED, PIARCO, TRINIDAD/TOBAGO, FILED 6-21-2004.

WHEN THE NEED IS SPEED

THE MARK CONSISTS OF STANDARD CHARACTERS WITHOUT CLAIM TO ANY PARTICULAR FONT, STYLE, SIZE, OR COLOR.

FOR AIRLINE TRANSPORTATION SERVICES; TRANSPORTATION OF PASSENGERS AND THEIR LUGGAGE AND CARGO BY AIR; LUGGAGE STORAGE SERVICES; TOURIST AGENCY SERVICES AND TRAVEL AGENCY SERVICES FOR ARRANGING TRAVEL, NAMELY, MAKING RESERVATIONS AND BOOKINGS FOR TRANSPORTATION (U.S. CLS. 100 AND 105).

FIRST USE 5-0-1999; IN COMMERCE 5-0-1999.
WINSTON FOLMAR, EXAMINING ATTORNEY

CLASS 39—(Continued).

SN 78-154,454. CARGOJET CANADA LTD., MISSISSAUGA ONTARIO, CANADA, FILED 8-15-2002.



PRIORITY CLAIMED UNDER SEC. 44(D) ON CANADA APPLICATION NO. 1,131,863, FILED 2-19-2002, REG. NO. TMA609755, DATED 5-7-2004, EXPIRES 5-7-2019.

THE MARK CONSISTS OF A DRAWING OF A MAPLE LEAF SUPERIMPOSED ON A GLOBE.

FOR AIRPORT SERVICES; AIR TRANSPORTATION SERVICES; FREIGHT TRANSPORTATION BY AIR; FREIGHT FORWARDING (U.S. CLS. 100 AND 105).

TONJA GASKINS, EXAMINING ATTORNEY

SN 78-154,455. CARGOJET CANADA LTD., MISSISSAUGA, ONTARIO, FILED 8-15-2002.



PRIORITY CLAIMED UNDER SEC. 44(D) ON CANADA APPLICATION NO. 1,131,862, FILED 2-19-2002, REG. NO. TMA609782, DATED 5-10-2004, EXPIRES 5-10-2019.

THE MARK CONSISTS OF A MAPLE LEAF SUPERIMPOSED ON A GLOBE AS APPLIED TO AN AIRCRAFT'S CERTICAL STABILIZER.

FOR AIRPORT SERVICES; AIR TRANSPORTATION SERVICES; FREIGHT TRANSPORTATION BY AIR; FREIGHT FORWARDING (U.S. CLS. 100 AND 105).

TONJA GASKINS, EXAMINING ATTORNEY

SN 78-308,349. PIEDMONT NATURAL GAS COMPANY, INC., CHARLOTTE, NC. FILED 10-2-2003.

NORTH CAROLINA NATURAL GAS

NO CLAIM IS MADE TO THE EXCLUSIVE RIGHT TO USE "NATURAL GAS", APART FROM THE MARK AS SHOWN.

SEC. 2(F).

FOR PUBLIC UTILITY SERVICES IN THE NATURE OF NATURAL GAS DISTRIBUTION, TRANSMISSION BY PIPELINE AND STORAGE OF NATURAL GAS (U.S. CLS. 100 AND 105).

FIRST USE 10-15-1955; IN COMMERCE 10-15-1955.

TONI HICKEY, EXAMINING ATTORNEY

CLASS 39—(Continued).

SN 78-357,351. OMNIMED INTERNATIONAL, INC., NEW YORK, NY. FILED 1-26-2004.

Omnimed International

THE MARK CONSISTS OF STANDARD CHARACTERS WITHOUT CLAIM TO ANY PARTICULAR FONT, STYLE, SIZE, OR COLOR.

NO CLAIM IS MADE TO THE EXCLUSIVE RIGHT TO USE "INTERNATIONAL", APART FROM THE MARK AS SHOWN.

FOR ARCHIVING COMPLETE FILES OF PATIENT MEDICAL RECORDS (U.S. CLS. 100 AND 105).

FIRST USE 10-17-2003; IN COMMERCE 10-17-2003.

ANDREW BENZMILLER, EXAMINING ATTORNEY

SN 78-364,657. MAGELLAN MIDSTREAM PARTNERS, L.P., TULSA, OK. FILED 2-9-2004.



NO CLAIM IS MADE TO THE EXCLUSIVE RIGHT TO USE "MIDSTREAM PARTNERS, L.P.", APART FROM THE MARK AS SHOWN.

FOR STORAGE, TRANSPORTATION AND DISTRIBUTION OF PETROLEUM PRODUCTS AND AMMONIA (U.S. CLS. 100 AND 105).

DANIELLE MATTESSICH, EXAMINING ATTORNEY

CLASS 39—(Continued).

SN 78-382,649. SOUTH FLORIDA COURIER SYSTEMS, INC., FORT LAUDERDALE, FL. FILED 3-11-2004.



THE STIPPLING IS NOT A FEATURE OF THE MARK. THE MARK CONSISTS OF A SILHOUETTE-LIKE FIGURE OF AN INDIVIDUAL IN ACTION CARRYING A LETTER.

FOR COURIER SERVICES, DOCUMENT DELIVERY, SHIP CARGO DELIVERY, MESSAGE DELIVERY, DELIVERY OF GOODS BY SHIP CARGO, TRUCK, AND AIR; TRANSPORTATION AND DELIVERY SERVICES NAMELY, SAME DAY SHIPMENT, OVERNIGHT DELIVERY, INTERNATIONAL, AND MULTIPLE DAY SHIPMENT (U.S. CLS. 100 AND 105).

PAULA MAYS, EXAMINING ATTORNEY

SN 78-430,888. STEHLIN, KARL JAMES, LARGO, FL. FILED 6-7-2004.



NO CLAIM IS MADE TO THE EXCLUSIVE RIGHT TO USE "TRANSPORT, INC"., APART FROM THE MARK AS SHOWN.

FOR INTRASTATE AND INTERSTATE TRANSPORTATION OF GOODS BY MEANS OF TRUCK (U.S. CLS. 100 AND 105).

FIRST USE 10-11-2000; IN COMMERCE 10-11-2000. GIANCARLO CASTRO, EXAMINING ATTORNEY

CLASS 39—(Continued).

SN 78-432,374. 4 CONCEPTS, SIMI VALLEY, CA. FILED 6-9-2004.

BIDS4RIDES.COM

THE MARK CONSISTS OF STANDARD CHARACTERS WITHOUT CLAIM TO ANY PARTICULAR FONT, STYLE, SIZE, OR COLOR.

FOR TRANSPORTATION SERVICES, NAMELY, ARRANGING LIMOUSINE SERVICES FOR OTHERS VIA THE INTERNET (U.S. CLS. 100 AND 105).

GWEN STOKOLS, EXAMINING ATTORNEY

SN 78-437,823. AMERICAN AIRLINES, INC., FORT WORTH, TX. FILED 6-18-2004.



OWNER OF U.S. REG. NOS. 514,292, 2,339,639 AND OTHERS.

FOR TRANSPORTATION OF PASSENGERS AND CARGO BY AIR (U.S. CLS. 100 AND 105).

FIRST USE 2-5-1998; IN COMMERCE 2-5-1998. ROBERT COGGINS, EXAMINING ATTORNEY

CLASS 40—MATERIAL TREATMENT

SN 76-571,510. MILLER'S INC., PITTSBURG, KS. FILED 1-21-2004.

MPIX

THE MARK CONSISTS OF STANDARD CHARACTERS WITHOUT CLAIM TO ANY PARTICULAR FONT, STYLE, SIZE, OR COLOR.

FOR PROCESSING OF PHOTOGRAPHIC FILM (U.S. CLS. 100, 103 AND 106).

PAUL F. GAST, EXAMINING ATTORNEY

CLASS 40—(Continued).

SN 76-594,808. H.S. CROCKER CO., INC., HUNTLEY, IL.
FILED 6-1-2004.

CROCKERBRITE

THE MARK CONSISTS OF STANDARD CHARACTERS
WITHOUT CLAIM TO ANY PARTICULAR FONT, STYLE,
SIZE, OR COLOR.

OWNER OF U.S. REG. NOS. 2,639,155 AND 2,848,155.
FOR CUSTOMIZED PRINTING SERVICES FOR
OTHERS (U.S. CLS. 100, 103 AND 106).
FIRST USE 5-26-2004; IN COMMERCE 5-26-2004.
ANDREA SAUNDERS, EXAMINING ATTORNEY

SN 78-194,376. LES TECHNOLOGIES SENSORIELLES (TEG)
INC., MONTREAL, QUEBEC, CANADA, FILED 12-13-
2002.

SENSIO

PRIORITY CLAIMED UNDER SEC. 44(D) ON CANADA
APPLICATION NO. 1143951, FILED 6-14-2002.
FOR ENCODING OF STEREOSCOPIC FILM AND
VIDEO AND MIXING OF STEREOSCOPIC FILM AND
VIDEO (U.S. CLS. 100, 103 AND 106).
FIRST USE 4-0-2002; IN COMMERCE 4-0-2002.
TRACY CROSS, EXAMINING ATTORNEY

SN 78-303,016. PIXPERT INSTA-PHOTO INC., EDMONTON,
ALBERTA, CANADA, FILED 9-19-2003.

PIXPERT

PRIORITY CLAIMED UNDER SEC. 44(D) ON CANADA
APPLICATION NO. 1189664, FILED 9-18-2003.
FOR DOCUMENTED DATA TRANSFER AND PHYSI-
CAL CONVERSION SERVICES FROM ONE MEDIA TO
ANOTHER CONDUCTED VIA SELF SERVICE KIOSKS
(U.S. CLS. 100, 103 AND 106).
MICHAEL SOUDERS, EXAMINING ATTORNEY

SN 78-310,190. JÜRGENS FINE JEWELRY, INC., NORTH
BEND, OR. FILED 10-7-2003.

JÜRGENS

SEC. 2(F).
FOR CUSTOM MANUFACTURING OF JEWELRY
FOR OTHERS (U.S. CLS. 100, 103 AND 106).
FIRST USE 1-0-1990; IN COMMERCE 1-0-1990.
AMY GEARIN, EXAMINING ATTORNEY

CLASS 40—(Continued).

SN 78-335,125. BARTLETT CORPORATION, MUNCIE, IN.
FILED 12-2-2003.



SEC. 2(F).
FOR CUSTOM MANUFACTURE OF SEAT COVERS,
INTERIOR TRIM, AND OTHER COMPONENTS FOR
THE AUTOMOTIVE INDUSTRY (U.S. CLS. 100, 103
AND 106).
CAROLYN CATALDO, EXAMINING ATTORNEY

SN 78-335,135. BARTLETT CORPORATION, MUNCIE, IN.
FILED 12-2-2003.

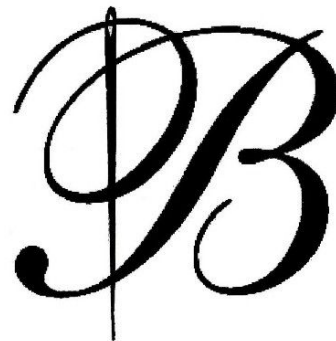

FOR CUSTOM MANUFACTURE OF SEAT COVERS,
INTERIOR TRIM, AND OTHER COMPONENTS FOR
THE AUTOMOTIVE INDUSTRY (U.S. CLS. 100, 103
AND 106).
CAROLYN CATALDO, EXAMINING ATTORNEY

CLASS 40—(Continued).

SN 78-373,224. CLOBUS PRINTING, INC., NEW CASTLE, PA. FILED 2-24-2004.



THE COLOR(S) RED, BLUE, YELLOW AND BLACK IS/ ARE CLAIMED AS A FEATURE OF THE MARK.

LETTER "C" AT LEAST PARTIALLY ENCOMPASSING A COLOR WHEEL HAVING COLOR QUADRANTS, CLOCKWISE FROM UPPER RIGHT, YELLOW, BLUE, BLACK AND CYAN.

THE MARK CONSISTS OF LETTER "C" AT LEAST PARTIALLY ENCOMPASSING A COLOR WHEEL.

FOR PRINTING, DESIGN PRINTING, LITHOGRAPHIC PRINTING, OFFSET PRINTING, PATTERN PRINTING (U.S. CLS. 100, 103 AND 106).

FIRST USE 4-15-1987; IN COMMERCE 4-15-1987.

MICHELE SWAIN, EXAMINING ATTORNEY

CLASS 40—(Continued).

SN 78-425,379. ZEROTOUCHDIGITAL, INC., SAN FRANCISCO, CA. FILED 5-26-2004.

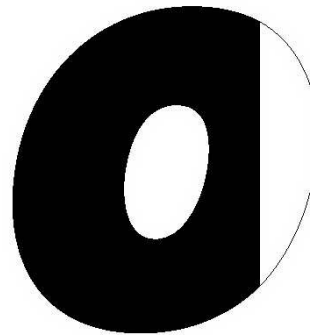

FOR DIGITAL IMAGE FINISHING SERVICES; DIGITAL IMAGE ENHANCEMENT; DIGITAL IMAGE PROCESSING; FILM DEVELOPING; FILM PROCESSING; PHOTOFINISHING (U.S. CLS. 100, 103 AND 106).

DAVID MURRAY, EXAMINING ATTORNEY

SN 78-394,082. TAILORED LABEL PRODUCTS, INC., MEMONONEE FALLS, WI. FILED 3-31-2004.



THE LINING AND STIPPLING SHOWN IN THE DRAWING ARE FEATURES OF THE MARK.

FOR CUSTOM MANUFACTURE OF LABELS, PRINTED MATTER AND STATIONERY (U.S. CLS. 100, 103 AND 106).

FIRST USE 8-0-2003; IN COMMERCE 8-0-2003.

RICHARD WHITE, EXAMINING ATTORNEY

SN 78-432,375. DEPARTMENT OF THE ARMY, ARLINGTON, VA. FILED 6-9-2004.

**CREATING A SAFER
TOMORROW**

THE MARK CONSISTS OF STANDARD CHARACTERS WITHOUT CLAIM TO ANY PARTICULAR FONT, STYLE, SIZE, OR COLOR.

FOR TREATMENT OF MATERIALS, NAMELY, TREATMENT AND TOXIC WASTE DISPOSAL OF CHEMICAL WEAPONS AND CHEMICAL WEAPONS AGENTS (U.S. CLS. 100, 103 AND 106).

FIRST USE 4-0-2004; IN COMMERCE 6-7-2004.

GWEN STOKOLS, EXAMINING ATTORNEY

CLASS 40—(Continued).

SN 78-434,427. WELDON ENTERPRISES LLC, NORTH-BROOK, IL. FILED 6-13-2004.

Reclaimed Memories

THE MARK CONSISTS OF STANDARD CHARACTERS WITHOUT CLAIM TO ANY PARTICULAR FONT, STYLE, SIZE, OR COLOR.

FOR ELECTRONIC IMAGING, SCANNING, DIGITIZING AND PRINTING; ALTERATION AND/OR RETOUCHING OF PHOTOGRAPHIC IMAGES AND ARTWORK (U.S. CLS. 100, 103 AND 106).

FIRST USE 10-10-2003; IN COMMERCE 4-7-2004.
CHRIS WELLS, EXAMINING ATTORNEY

SN 78-438,988. CAMPBELL, JOI N., WEST HILLS, CA. FILED 6-22-2004.

Little Faces

THE MARK CONSISTS OF STANDARD CHARACTERS WITHOUT CLAIM TO ANY PARTICULAR FONT, STYLE, SIZE, OR COLOR.

FOR IMPRINTING MESSAGES ON T- SHIRTS (U.S. CLS. 100, 103 AND 106).

TRICIA SONNEBORN, EXAMINING ATTORNEY

CLASS 41—EDUCATION AND ENTERTAINMENT

SN 75-761,457. INTERNATIONAL SURFING ASSOCIATION, LA JOLLA, CA. FILED 7-27-1999.

BIG WAVE WORLD TOUR

NO CLAIM IS MADE TO THE EXCLUSIVE RIGHT TO USE "BIG WAVE" AND "TOUR", APART FROM THE MARK AS SHOWN.

FOR ARRANGING AND CONDUCTING ATHLETIC EVENTS RELATING TO SURFING (U.S. CLS. 100, 101 AND 107).

AMOS T. MATTHEWS, JR., EXAMINING ATTORNEY

CLASS 41—(Continued).

SN 76-286,287. POPCORN MUSIC, LLC, LOS ANGELES, CA. FILED 7-12-2001.



NO CLAIM IS MADE TO THE EXCLUSIVE RIGHT TO USE "MUSIC", APART FROM THE MARK AS SHOWN.

FOR MUSIC PUBLISHING SERVICES; MUSIC PRODUCTION SERVICES, NAMELY AUDIO RECORDING AND PRODUCTION AND RECORD PRODUCTION; SONG-WRITING SERVICES; MUSIC COMPOSITION AND TRANSCRIPTION FOR OTHERS; MOTION PICTURE SONG PRODUCTION (U.S. CLS. 100, 101 AND 107).

ALICE SUE CARRUTHERS, EXAMINING ATTORNEY

SN 76-485,204. RTM PRODUCTIONS, INC., BRENTWOOD, TN. FILED 1-27-2003.

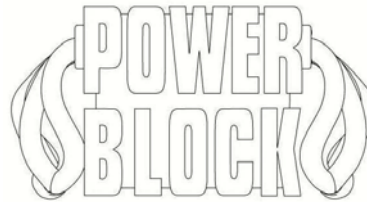

THE STIPPLING IN THE MARK INDICATES SHADING, AND IS NOT INTENDED TO INDICATE COLOR.

FOR PRODUCTION OF TELEVISION SHOWS AND DISTRIBUTION OF TELEVISION PROGRAMS FOR OTHERS, ALL FEATURING EDUCATION AND ENTERTAINMENT IN THE FIELD OF AUTOMOBILES (U.S. CLS. 100, 101 AND 107).

FIRST USE 1-4-2003; IN COMMERCE 1-4-2003.
FRED MANDIR, EXAMINING ATTORNEY

SN 76-523,833. AMERICAN WATER WORKS ASSOCIATION, DENVER, CO. FILED 6-20-2003.

WATER QUALITY TECHNOLOGY CONFERENCE

NO CLAIM IS MADE TO THE EXCLUSIVE RIGHT TO USE CONFERENCE, APART FROM THE MARK AS SHOWN.

SEC. 2(F).
FOR EDUCATIONAL SERVICES, NAMELY, ORGANIZING AND CONDUCTING CONFERENCES FOR WATER QUALITY PROFESSIONALS FOR PROMOTING TECHNICAL INFORMATION RELATED TO WATER QUALITY (U.S. CLS. 100, 101 AND 107).

FIRST USE 10-1-1977; IN COMMERCE 12-4-1977.
STEVEN BERK, EXAMINING ATTORNEY

CLASS 41—(Continued).

SN 76-537,576. UNIVERSITY OF MASSACHUSETTS, WORCESTER, MA. FILED 7-31-2003.



OWNER OF U.S. REG. NO. 2,655,544.
NO CLAIM IS MADE TO THE EXCLUSIVE RIGHT TO USE "CENTER FOR ADOPTION RESEARCH", APART FROM THE MARK AS SHOWN.

FOR EDUCATIONAL SERVICES, NAMELY, CONDUCTING CLASSES, WORKSHOPS, AND CONFERENCES IN THE FIELD OF ADOPTION AND FOSTER CARE (U.S. CLS. 100, 101 AND 107).

FIRST USE 3-18-2003; IN COMMERCE 3-18-2003.
MARY BOAGNI, EXAMINING ATTORNEY

SN 76-538,787. PRIMETRICA, INC., CARLSBAD, CA. FILED 8-21-2003.

PRIMETRICA

FOR PROVIDING ON-LINE NEWSLETTERS AND DATA BOOKS IN THE FIELDS OF COMMUNICATIONS, MEDIA, AND BUSINESS MANAGEMENT (U.S. CLS. 100, 101 AND 107).

FIRST USE 4-4-2002; IN COMMERCE 6-1-2002.
CURTIS FRENCH, EXAMINING ATTORNEY

SN 76-538,921. DRIZEN-DOHS CORPORATE COMMUNICATIONS, INC., CHATSWORTH, CA. FILED 8-8-2003.

TwoWork.com

THE MARK CONSISTS OF STANDARD CHARACTERS WITHOUT CLAIM TO ANY PARTICULAR FONT, STYLE, SIZE, OR COLOR.

FOR ONLINE MAGAZINE IN THE FIELD OF WORKING COUPLES (U.S. CLS. 100, 101 AND 107).

FIRST USE 5-15-2002; IN COMMERCE 5-15-2002.
PAUL F. GAST, EXAMINING ATTORNEY

CLASS 41—(Continued).

SN 76-541,789. DIANE DOWNEY ASSOCIATES, NEW YORK, NY. FILED 9-2-2003.

MANAGING IN A GLOBAL MATRIX

FOR PROVIDING TRAINING IN THE FIELD OF BUSINESS LEADERSHIP, MANAGEMENT, AND TEAM SKILLS IN A GLOBAL ORGANIZATIONAL STRUCTURE, AND DISTRIBUTING COURSE MATERIALS IN CONNECTION THEREWITH (U.S. CLS. 100, 101 AND 107).

FIRST USE 5-1-2001; IN COMMERCE 5-1-2001.
SOPHIA S. KIM, EXAMINING ATTORNEY

SN 76-555,987. DUMPY, LLC, BEVERLY HILLS, CA. FILED 11-3-2003.

DUMPY THE DUMP TRUCK

THE MARK CONSISTS OF STANDARD CHARACTERS WITHOUT CLAIM TO ANY PARTICULAR FONT, STYLE, SIZE, OR COLOR.

NO CLAIM IS MADE TO THE EXCLUSIVE RIGHT TO USE DUMP TRUCK, APART FROM THE MARK AS SHOWN.

FOR ENTERTAINMENT IN THE NATURE OF ONGOING CHILDREN'S TELEVISION PROGRAMS, MOTION PICTURE FILM PRODUCTION AND MOTION PICTURE FILM RENTAL FOR CHILDREN'S FILMS, LIVE VISUAL AND AUDIO PERFORMANCES BY CHARACTERS AND ACTORS, AND ONGOING LIVE MUSICAL, VARIETY, NEWS AND COMEDY SHOWS, AND LIVE SHOWS FOR CHILDREN FEATURING ANIMATION (U.S. CLS. 100, 101 AND 107).

PAUL F. GAST, EXAMINING ATTORNEY

SN 76-557,077. LEE HECHT HARRISON LLC, WOODCLIFF LAKE, NJ. FILED 10-6-2003.

SIGNATURE SUCCESS

FOR CAREER COUNSELING IN THE FIELD OF CAREER TRANSITION, NAMELY PROVIDING CAREER ASSESSMENT AND CONSULTATION SERVICES TO SENIOR EXECUTIVES, AND PROVIDING TRAINING AND COUNSELING TO SENIOR EXECUTIVES IN LEADERSHIP DEVELOPMENT AND ENTREPRENEURIAL CAREER OPTIONS (U.S. CLS. 100, 101 AND 107).

FIRST USE 7-31-2003; IN COMMERCE 7-31-2003.
ANN E. SAPPENFIELD, EXAMINING ATTORNEY

CLASS 41—(Continued).

SN 76-559,066. GLAZER, BENOIT, ORLANDO, FL. FILED 11-13-2003.



THE MARK CONSISTS OF THE WORD MARK "B G" AS A DESIGN.

FOR MUSIC EDUCATION AND ENTERTAINMENT SERVICES, NAMELY MUSIC INSTRUCTION, MUSIC COMPOSITION FOR OTHERS, MUSIC TRANSCRIPTION FOR OTHERS, MUSIC PRODUCTION, MUSIC PUBLISHING, AND PROVIDING A WEB SITE FEATURING PRE-RECORDED AND LIVE MUSICAL PERFORMANCES (U.S. CLS. 100, 101 AND 107).

FIRST USE 1-1-1989; IN COMMERCE 1-1-1999.
DOUGLAS LEE, EXAMINING ATTORNEY

CLASS 41—(Continued).

SN 76-562,660. SUNSTONE YOGA, L.L.C., DALLAS, TX. FILED 12-2-2003.



NO CLAIM IS MADE TO THE EXCLUSIVE RIGHT TO USE YOGA, APART FROM THE MARK AS SHOWN.

FOR EDUCATION AND TRAINING SERVICES, NAMELY CONDUCTING CLASSES, SEMINARS, CONFERENCES AND WORKSHOPS IN THE FIELD OF YOGA, FITNESS, HEALTH, AND MASSAGE THERAPY, INCLUDING EDUCATIONAL AND TRAINING PRE-CERTIFICATION COURSES FOR YOGA INSTRUCTORS, AND DISTRIBUTING COURSE MATERIALS IN CONNECTION THEREWITH (U.S. CLS. 100, 101 AND 107).

FIRST USE 6-0-2003; IN COMMERCE 6-0-2003.
JACQUELINE A. LAVINE, EXAMINING ATTORNEY

SN 76-560,088. COLUMBINE-LAKEWOOD COLORADO SOCCER ASSOCIATION, LAKEWOOD, CO. FILED 9-17-2003.

RUSH SOCCER

THE MARK CONSISTS OF STANDARD CHARACTERS WITHOUT CLAIM TO ANY PARTICULAR FONT, STYLE, SIZE, OR COLOR.

NO CLAIM IS MADE TO THE EXCLUSIVE RIGHT TO USE "SOCCER", APART FROM THE MARK AS SHOWN.

FOR EDUCATION AND ENTERTAINMENT SERVICES, NAMELY A SOCCER CLUB (U.S. CLS. 100, 101 AND 107).

FIRST USE 5-5-1997; IN COMMERCE 5-5-1997.
ALEXANDER L. POWERS, EXAMINING ATTORNEY

SN 76-563,453. FINDING PURPOSE, RALEIGH, NC. FILED 12-5-2003.

FINDING PURPOSE

THE MARK CONSISTS OF STANDARD CHARACTERS WITHOUT CLAIM TO ANY PARTICULAR FONT, STYLE, SIZE, OR COLOR.

FOR EDUCATIONAL SERVICES, NAMELY, CHRISTIAN BIBLICAL INSTRUCTION; DISCIPLESHIP TRAINING; AND EDUCATIONAL OUTREACH SERVICES, NAMELY, IN THE FIELD OF CHRISTIAN TEACHING; RELIGIOUS INSTRUCTION SERVICES; EDUCATIONAL SERVICES, NAMELY, CONDUCTING CLASSES, SEMINARS, CONFERENCES, AND WORKSHOPS IN THE FIELD OF RELIGION AND RELIGIOUS OUTREACH; INSTRUCTION IN THE FIELD OF RELIGION AND RELIGIOUS OUTREACH (U.S. CLS. 100, 101 AND 107).

FIRST USE 11-7-2003; IN COMMERCE 11-7-2003.
VIVIAN MICZNIK FIRST, EXAMINING ATTORNEY

CLASS 41—(Continued).

SN 76-564,503. COOKE CONSULTING GROUP, LLC, HADDON HEIGHTS, NJ. FILED 12-10-2003.



NO CLAIM IS MADE TO THE EXCLUSIVE RIGHT TO USE "CONSULTING", APART FROM THE MARK AS SHOWN.

FOR EDUCATIONAL SERVICES, NAMELY, PROVIDING TRAINING AND SEMINARS IN THE FIELD OF ORGANIZATIONAL BUSINESS DEVELOPMENT, AND DISTRIBUTING COURSE MATERIALS IN CONNECTION THEREWITH (U.S. CLS. 100, 101 AND 107).

FIRST USE 10-1-2003; IN COMMERCE 10-1-2003.
EVELYN BRADLEY, EXAMINING ATTORNEY

CLASS 41—(Continued).

SN 76-566,572. ZEPHIRIN, HENRIOT, SUNNYSIDE, NY. FILED 12-23-2003.



NO CLAIM IS MADE TO THE EXCLUSIVE RIGHT TO USE NORTH AMERICAN KYOKUSHIN ORGANIZATION, APART FROM THE MARK AS SHOWN.

FOR EDUCATIONAL AND ENTERTAINMENT SERVICES, NAMELY CLINICS, CAMPS, SEMINARS, TOURNAMENTS AND CLASSES IN THE FIELD OF MARTIAL ARTS, SELF-DEFENSE, KICKBOXING AND AEROBICS (U.S. CLS. 100, 101 AND 107).

FIRST USE 9-8-1996; IN COMMERCE 9-8-1996.
KELLY BOULTON, EXAMINING ATTORNEY

SN 76-564,759. KRCA TELEVISION, INC., BURBANK, CA. FILED 12-11-2003.

LOS ANGELES AL DIA

THE MARK CONSISTS OF STANDARD CHARACTERS WITHOUT CLAIM TO ANY PARTICULAR FONT, STYLE, SIZE, OR COLOR.

NO CLAIM IS MADE TO THE EXCLUSIVE RIGHT TO USE LOS ANGELES, APART FROM THE MARK AS SHOWN.

THE WORDS "LOS ANGELES AL DIA" TRANSLATES INTO ENGLISH AS "LOS ANGELES TODAY".

FOR ENTERTAINMENT, NAMELY A CONTINUING SPANISH LANGUAGE TELEVISION SHOW FEATURING NEWS AND GENERAL INFORMATION, BROADCAST OVER TELEVISION, SATELLITE, CABLE, AUDIO, AND VIDEO MEDIA (U.S. CLS. 100, 101 AND 107).

FIRST USE 10-13-2003; IN COMMERCE 10-13-2003.
BRIAN NEVILLE, EXAMINING ATTORNEY

SN 76-568,538. HYPERSTRIKE, LLC, COLUMBUS, OH. FILED 12-22-2003.



THE MARK CONSISTS OF THE HIGHLY STYLIZED LETTER H.

FOR SPORTS PERFORMANCE TRAINING SERVICES, NAMELY, PERSONAL FITNESS INSTRUCTION, TEAM FITNESS INSTRUCTION AND INTERNET FITNESS SERVICES, NAMELY, PROVIDING WEB-BASED, SPORT-SPECIFIC INFORMATION REGARDING PERSONALIZED STRENGTH, CONDITIONING AND PERFORMANCE REGIMES BASED UPON THE UNIQUE CHARACTERISTICS AND NEEDS OF EACH INDIVIDUAL AND TEAM USER (U.S. CLS. 100, 101 AND 107).

LINDA E. BLOHM, EXAMINING ATTORNEY

CLASS 41—(Continued).

SN 76-569,351. THE FOREST HIGHLANDS ASSOCIATION, FLAGSTAFF, AZ. FILED 1-12-2004.

FOREST HIGHLANDS

THE MARK CONSISTS OF STANDARD CHARACTERS WITHOUT CLAIM TO ANY PARTICULAR FONT, STYLE, SIZE, OR COLOR.

FOR RECREATIONAL SERVICES, NAMELY, GOLF COURSE FACILITIES (U.S. CLS. 100, 101 AND 107).

FIRST USE 1-1-1985; IN COMMERCE 1-1-1988.
BRIDGETT SMITH, EXAMINING ATTORNEY

CLASS 41—(Continued).

SN 76-571,241. DEJA VU CONSULTING, INC., LANSING, MI. FILED 1-7-2004.

SHOWGIRLS

OWNER OF U.S. REG. NOS. 1,718,866, 2,297,828 AND OTHERS.

SEC. 2(F).
FOR ENTERTAINMENT SERVICES, NAMELY, PROVIDING LIVE VARIETY AND BURLESQUE SHOWS (U.S. CLS. 100, 101 AND 107).

FIRST USE 9-1-1979; IN COMMERCE 9-1-1979.
KELLY BOULTON, EXAMINING ATTORNEY

SN 76-570,903. ST. ANDREWS EVANGELICAL LUTHERAN CHURCH, MAHTOMEDI, MN. FILED 1-15-2004.



NO CLAIM IS MADE TO THE EXCLUSIVE RIGHT TO USE "ACADEMY", APART FROM THE MARK AS SHOWN.

THE MARK CONSISTS OF THE WORDS "ST. ANDREW'S ACADEMY" OVER A SILHOUETTE OF A SHALLOW LAUREL OF LEAVES THAT IN TURN SUPPORTS A RECTANGULAR BLOCK CONTAINING THE REVERSED-OUT LETTERS "SAA".

FOR PROVIDING RELIGIOUS AND SECULAR COURSES OF INSTRUCTION AT THE PRIMARY THROUGH SECONDARY GRADES (U.S. CLS. 100, 101 AND 107).

FIRST USE 9-1-2003; IN COMMERCE 9-1-2003.
SHARI SHEFFIELD, EXAMINING ATTORNEY

SN 76-571,693. GEISINGER COMMUNITY HEALTH SERVICES, DANVILLE, PA. FILED 1-23-2004.



FOR PROVIDING VOCATIONAL REHABILITATION SERVICES IN THE NATURE OF TRAINING IN THE FIELDS OF EMPLOYMENT, JOB SKILLS, AND LIFE SKILLS, AND PROVIDING GUIDANCE IN THE AREA OF COMMUNITY INTEGRATION FOR PERSONS WITH COGNITIVE OR PHYSICAL IMPAIRMENTS OR ISSUES OF MENTAL HEALTH (U.S. CLS. 100, 101 AND 107).

FIRST USE 0-0-2001; IN COMMERCE 0-0-2001.
KIMBERLY PERRY, EXAMINING ATTORNEY

SN 76-570,998. LEADERTREKS, CAROL STREAM, IL. FILED 1-20-2004.

LEADERTREKS

FOR EDUCATIONAL SERVICES, NAMELY LEADERSHIP DEVELOPMENT PROGRAMS. (U.S. CLS. 100, 101 AND 107).

FIRST USE 1-1-2003; IN COMMERCE 1-1-2003.
JACQUELINE A. LAVINE, EXAMINING ATTORNEY

SN 76-574,504. REFERRAL INSTITUTE, LLC, ATTLEBORO FALLS, MA. FILED 2-9-2004.



NO CLAIM IS MADE TO THE EXCLUSIVE RIGHT TO USE "REFERRAL INSTITUTE", APART FROM THE MARK AS SHOWN.

FOR TEACHING BUSINESS TRAINERS AND COACHES ON HOW TO DELIVER REFERRAL TRAINING PROGRAMS AND REFERRAL TRAINING PROGRAMS DELIVERED BY BUSINESS TRAINERS AND COACHES TO THE GENERAL PUBLIC (U.S. CLS. 100, 101 AND 107).

FIRST USE 8-1-2003; IN COMMERCE 8-1-2003.
SUSAN HAYASH, EXAMINING ATTORNEY

CLASS 41—(Continued).

SN 76-575,842. BOOTCAMP FOR YOUR MIND, INC., VALLEY VILLAGE, CA. FILED 2-17-2004.



THE COLOR(S) RED IS/ARE CLAIMED AS A FEATURE OF THE MARK.

A RED BOXED STAMP READING "BOOTCAMP FOR YOUR MIND".

A RED BOXED STAMP READING "BOOTCAMP FOR YOUR MIND".

FOR PERSONAL COACHING SERVICES IN THE FIELD OF PERSONAL RELATIONSHIPS, CAREERS, AND HEALTH; EDUCATIONAL SERVICES, NAMELY, WORKSHOPS AND SEMINARS IN THE FIELD OF PERSONAL RELATIONSHIPS, CAREERS, AND HEALTH (U.S. CLS. 100, 101 AND 107).

FIRST USE 9-0-2003; IN COMMERCE 9-0-2003.

KELLY BOULTON, EXAMINING ATTORNEY

SN 76-575,955. STYLETONE HEARING CARE, L.L.C., WHIPPANY, NJ. FILED 2-18-2004.

STYLETONE

THE MARK CONSISTS OF STANDARD CHARACTERS WITHOUT CLAIM TO ANY PARTICULAR FONT, STYLE, SIZE, OR COLOR.

FOR EDUCATIONAL SERVICES, NAMELY - CONDUCTING TRAINING CONCERNING HEARING ASSESSMENT, DIAGNOSIS AND DETECTION OF AUDITORY DEFICIENCIES, SELECTION, FITTING, ADJUSTMENT AND READJUSTMENT OF HEARING AIDS AND HEARING PROTECTION, AND HEARING REHABILITATION (U.S. CLS. 100, 101 AND 107).

PAUL F. GAST, EXAMINING ATTORNEY

CLASS 41—(Continued).

SN 76-576,171. BANAFSHE, SAIED, STERLING, VA. AND BANAFSHE, ALALEH, STERLING, VA. FILED 2-19-2004.

PLAY 'N' EXPLORE

THE MARK CONSISTS OF STANDARD CHARACTERS WITHOUT CLAIM TO ANY PARTICULAR FONT, STYLE, SIZE, OR COLOR.

NO CLAIM IS MADE TO THE EXCLUSIVE RIGHT TO USE "PLAY", APART FROM THE MARK AS SHOWN.

FOR EDUTAINMENT SERVICES IN THE NATURE OF CHILDREN'S ENTERTAINMENT AND AMUSEMENT CENTERS, NAMELY, INTERACTIVE PLAY AND LEARNING AREAS (U.S. CLS. 100, 101 AND 107).

PAUL F. GAST, EXAMINING ATTORNEY

SN 76-578,314. HIGHLIGHTS FOR CHILDREN, INC., COLUMBUS, OH. FILED 2-27-2004.

ELP

THE MARK CONSISTS OF STANDARD CHARACTERS WITHOUT CLAIM TO ANY PARTICULAR FONT, STYLE, SIZE, OR COLOR.

FOR PUBLICATION OF EDUCATIONAL WORKBOOKS FOR STUDENTS FROM KINDERGARTEN THROUGH GRADE 12 (U.S. CLS. 100, 101 AND 107).

FIRST USE 2-15-1994; IN COMMERCE 2-15-1994.

TARAH HARDY, EXAMINING ATTORNEY

SN 76-585,755. CASTLE WORLDWIDE, INC., RESEARCH TRIANGLE PARK, NC. FILED 4-8-2004.

I-PASS

THE MARK CONSISTS OF STANDARD CHARACTERS WITHOUT CLAIM TO ANY PARTICULAR FONT, STYLE, SIZE, OR COLOR.

FOR EDUCATIONAL TESTING SERVICES, NAMELY, PREPARING ADMINISTERING, AND SCORING NON-PROCTORED AND PROCTORED ASSESSMENTS AND EXAMINATIONS IN A CONTROLLED OR MONITORED SETTING VIA A WORLDWIDE COMPUTER NETWORK FOR USE IN EDUCATIONAL PROFESSIONAL, GOVERNMENTAL, AND VOCATIONAL OCCUPATIONS (U.S. CLS. 100, 101 AND 107).

STANLEY I. OSBORNE, EXAMINING ATTORNEY

CLASS 41—(Continued).

SN 76-586,570. AWPT, INC., FALLS CHURCH, VA. FILED 4-12-2004.

PAL

FOR PROVIDING TRAINING COURSES FOR OPERATORS OF MOBILE ELEVATING WORK PLATFORMS, MECHANICAL VEHICLES, AND TOW MOTORS AND PROVIDING TRAINING MATERIALS, IDENTIFICATION CARDS, SAFETY MATERIALS, TESTS AND OPERATING MANUALS IN CONNECTION THEREWITH (U.S. CLS. 100, 101 AND 107).

FIRST USE 0-0-1993; IN COMMERCE 0-0-1993.
MARGERY A. TIERNEY, EXAMINING ATTORNEY

SN 76-592,622. SEVADA DESIGN INC., DBA ETHOS DESIGN, GLENDALE, CA. FILED 5-17-2004.

LOUNGE 22

THE MARK CONSISTS OF STANDARD CHARACTERS WITHOUT CLAIM TO ANY PARTICULAR FONT, STYLE, SIZE, OR COLOR.

FOR BUSINESS AND NON-BUSINESS EVENT PLANNING, NAMELY, CONSULTATION, ORGANIZATION AND PRODUCTION (U.S. CLS. 100, 101 AND 107).

KARANENDRA S. CHHINA, EXAMINING ATTORNEY

SN 76-593,579. MURPHY, CARLENE U., AUGUSTA, GA. FILED 5-24-2004.

WHOLE-FACULTY STUDY GROUPS

THE MARK CONSISTS OF STANDARD CHARACTERS WITHOUT CLAIM TO ANY PARTICULAR FONT, STYLE, SIZE, OR COLOR.

NO CLAIM IS MADE TO THE EXCLUSIVE RIGHT TO USE STUDY GROUPS, APART FROM THE MARK AS SHOWN.

FOR EDUCATIONAL SERVICES, NAMELY CONDUCTING WORKSHOPS IN THE FIELD OF TRAINING EDUCATORS AND DISTRIBUTING COURSE MATERIALS IN CONNECTION THEREWITH (U.S. CLS. 100, 101 AND 107).

FIRST USE 2-28-1994; IN COMMERCE 2-28-1994.
NICHOLAS ALTREE, EXAMINING ATTORNEY

CLASS 41—(Continued).

SN 76-593,880. BAILES, STEPHANIE D., WALDORF, MD. FILED 5-25-2004.

AMAZING ENTERTAINMENT

THE MARK CONSISTS OF STANDARD CHARACTERS WITHOUT CLAIM TO ANY PARTICULAR FONT, STYLE, SIZE, OR COLOR.

NO CLAIM IS MADE TO THE EXCLUSIVE RIGHT TO USE "ENTERTAINMENT", APART FROM THE MARK AS SHOWN.

FOR PROVIDING ENTERTAINMENT SERVICES IN THE NATURE OF LIVE DANCE PERFORMANCES BY A PERFORMER OR PERFORMERS (U.S. CLS. 100, 101 AND 107).

FIRST USE 4-19-1993; IN COMMERCE 4-19-1993.
FRED MANDIR, EXAMINING ATTORNEY

SN 76-594,018. DIVINITY TO INFINITY UNLIMITED, LOS ANGELES, CA. FILED 5-26-2004.

ACTORPRENEUR ATTITUDE

THE MARK CONSISTS OF STANDARD CHARACTERS WITHOUT CLAIM TO ANY PARTICULAR FONT, STYLE, SIZE, OR COLOR.

FOR EDUCATIONAL AND ENTERTAINMENT SERVICES, NAMELY, CONDUCTING WORKSHOPS, LECTURES AND SEMINARS IN THE FIELDS OF SELF AWARENESS; CREATIVITY; SPIRITUAL, PERSONAL AND PROFESSIONAL GROWTH; CAREER COUNSELING AND NETWORKING; AND MONEY MANAGEMENT; AND DISTRIBUTING COURSE MATERIALS IN CONNECTION THEREWITH (U.S. CLS. 100, 101 AND 107).

FIRST USE 7-15-2003; IN COMMERCE 7-15-2003.
ALICE SUE CARRUTHERS, EXAMINING ATTORNEY

SN 76-595,963. MUSHIN, INC., HARRISBURG, PA. FILED 6-7-2004.

C⁵ FITNESS

NO CLAIM IS MADE TO THE EXCLUSIVE RIGHT TO USE "FITNESS", APART FROM THE MARK AS SHOWN.

FOR HEALTH CLUB SERVICES, NAMELY, PROVIDING INSTRUCTION AND EQUIPMENT IN THE FIELD OF PHYSICAL EXERCISE; PROVIDING FITNESS AND EXERCISE FACILITIES (U.S. CLS. 100, 101 AND 107).

TARAH HARDY, EXAMINING ATTORNEY

CLASS 41—(Continued).

SN 76-596,971. SPANISH BROADCASTING SYSTEM, INC., COCONUT GROVE, FL. FILED 6-14-2004.

BACHATAZOL

THE MARK CONSISTS OF STANDARD CHARACTERS WITHOUT CLAIM TO ANY PARTICULAR FONT, STYLE, SIZE, OR COLOR.

OWNER OF U.S. REG. NO. 2,708,927.
FOR ENTERTAINMENT, NAMELY LIVE MUSIC CONCERTS (U.S. CLS. 100, 101 AND 107).
FIRST USE 6-0-2003; IN COMMERCE 6-0-2003.
GRETTA YAO, EXAMINING ATTORNEY

SN 76-597,017. THE PRESIDENTIAL PRAYER TEAM, SCOTTSDALE, AZ. FILED 6-15-2004.

PRAY THE VOTE

THE MARK CONSISTS OF STANDARD CHARACTERS WITHOUT CLAIM TO ANY PARTICULAR FONT, STYLE, SIZE, OR COLOR.

FOR INSTRUCTION SERVICES, NAMELY, TEACHING PROSPECTIVE VOTERS HOW TO VOTE, EXPLAINING THE NATURE OF POLITICAL ISSUES, TEACHING ABOUT COMMUNITY AND NATIONAL ELECTION PROCESSES, AND PROVIDING RELIGIOUS INSTRUCTION IN THE FIELD OF LEADING AND ORGANIZING PRAYER GATHERINGS RELATED TO ELECTIONS (U.S. CLS. 100, 101 AND 107).

FIRST USE 4-20-2004; IN COMMERCE 4-20-2004.
JOHN DWYER, EXAMINING ATTORNEY

SN 76-597,290. HICKS, DAN, MILL VALLEY, CA. FILED 6-14-2004.

DAN HICKS AND THE HOT LICKS

THE MARK CONSISTS OF STANDARD CHARACTERS WITHOUT CLAIM TO ANY PARTICULAR FONT, STYLE, SIZE, OR COLOR.

THE NAME "DAN HICKS" IDENTIFIES A LIVING INDIVIDUAL WHOSE CONSENT IS OF RECORD.

FOR ENTERTAINMENT SERVICES IN THE NAME OF LIVE MUSICAL PERFORMANCES AND CONCERTS (U.S. CLS. 100, 101 AND 107).

FIRST USE 1-1-1968; IN COMMERCE 1-1-1968.
MELVIN AXILBUND, EXAMINING ATTORNEY

CLASS 41—(Continued).

SN 76-597,434. PEOPLES NATION INC., JENISON, MI. FILED 6-16-2004.

PEOPLES NATION

THE MARK CONSISTS OF STANDARD CHARACTERS WITHOUT CLAIM TO ANY PARTICULAR FONT, STYLE, SIZE, OR COLOR.

FOR PROVIDING NEWS AND COMMENTARY IN THE NATURE OF CURRENT EVENT REPORTING VIA THE INTERNET (U.S. CLS. 100, 101 AND 107).
DOMINIC J. FERRAIUOLO, EXAMINING ATTORNEY

SN 76-597,984. JOHNSON & WALES UNIVERSITY, PROVIDENCE, RI. FILED 6-18-2004.

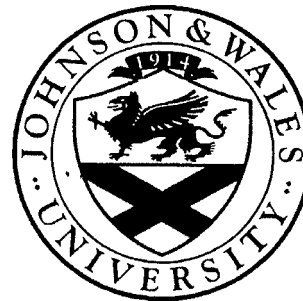

OWNER OF U.S. REG. NOS. 1,173,673, 2,221,615 AND OTHERS.

NO CLAIM IS MADE TO THE EXCLUSIVE RIGHT TO USE UNIVERSITY AND 1914, APART FROM THE MARK AS SHOWN.

FOR EDUCATIONAL SERVICES, NAMELY, PROVIDING COURSES OF INSTRUCTION AT THE COLLEGE LEVEL (U.S. CLS. 100, 101 AND 107).

FIRST USE 9-0-1988; IN COMMERCE 9-0-1988.
STEVEN R. FINE, EXAMINING ATTORNEY

SN 76-597,992. ANDERSON, LEON, DBA HARLAN PUBLISHING COMPANY, LEAWOOD, KS. FILED 6-17-2004.

HARLAN PUBLISHING

THE MARK CONSISTS OF STANDARD CHARACTERS WITHOUT CLAIM TO ANY PARTICULAR FONT, STYLE, SIZE, OR COLOR.

NO CLAIM IS MADE TO THE EXCLUSIVE RIGHT TO USE "PUBLISHING", APART FROM THE MARK AS SHOWN.

FOR EDUCATIONAL SERVICES RENDERED BY PUBLISHING A SERIES OF TEXTBOOKS IN THE INSURANCE FIELD (U.S. CLS. 100, 101 AND 107).

H. M. FISHER, EXAMINING ATTORNEY

CLASS 41—(Continued).

SN 76-598,123. CREATIVE SOCCER GROUP, INC., PLANTATION, FL. FILED 6-18-2004.

SOCCER SENSE

THE MARK CONSISTS OF STANDARD CHARACTERS WITHOUT CLAIM TO ANY PARTICULAR FONT, STYLE, SIZE, OR COLOR.

NO CLAIM IS MADE TO THE EXCLUSIVE RIGHT TO USE "SOCCER", APART FROM THE MARK AS SHOWN.

FOR ENTERTAINMENT AND EDUCATIONAL SERVICES, NAMELY, CONDUCTING AND ORGANIZING CLINICS, TRAINING, CAMPS, COACHING SESSIONS, EXHIBITIONS, TOURNAMENTS AND MATCHES IN THE FIELD OF SOCCER, AND DISTRIBUTING TRAINING VIDEOS MANUALS AND OTHER INSTRUCTIONAL MATERIALS IN THE FIELD OF SOCCER FOR USE IN CONNECTION THEREWITH (U.S. CLS. 100, 101 AND 107).

FIRST USE 4-8-1993; IN COMMERCE 4-8-1993.

CIMMERIAN COLEMAN, EXAMINING ATTORNEY

SN 76-598,162. MCVEIGH, DANIEL P., SCARSDALE, NY. FILED 6-18-2004.

OCEAN OF KNOW

THE MARK CONSISTS OF STANDARD CHARACTERS WITHOUT CLAIM TO ANY PARTICULAR FONT, STYLE, SIZE, OR COLOR.

FOR PROVIDING INTERACTIVE COURSES OF INSTRUCTION IN MARINE BIOLOGY VIA A WEBSITE ON A GLOBAL COMPUTER NETWORK VIA VIDEO TELECONFERENCING (U.S. CLS. 100, 101 AND 107).

FIRST USE 11-8-1994; IN COMMERCE 11-8-1994.

KAREN K. BUSH, EXAMINING ATTORNEY

SN 76-598,310. BRIDGE RECORDS, INC., NEW ROCHELLE, NY. FILED 6-21-2004.

BRIDGE RECORDS, INC.

THE MARK CONSISTS OF STANDARD CHARACTERS WITHOUT CLAIM TO ANY PARTICULAR FONT, STYLE, SIZE, OR COLOR.

OWNER OF U.S. REG. NO. 1,243,461.

NO CLAIM IS MADE TO THE EXCLUSIVE RIGHT TO USE "RECORDS, INC.", APART FROM THE MARK AS SHOWN.

FOR RECORD PRODUCTION SERVICES (U.S. CLS. 100, 101 AND 107).

FIRST USE 4-1-1981; IN COMMERCE 4-1-1981.

GEOFFREY FOSDICK, EXAMINING ATTORNEY

CLASS 41—(Continued).

SN 76-598,816. CHILDREN'S ACADEMY, LLC, THE, MT. PLEASANT, SC. FILED 6-23-2004.



FOR EDUCATIONAL SERVICES, NAMELY, PROVIDING COURSES OF INSTRUCTION, CLASSES, TUTORING AND WORKSHOPS FOR INFANT, TODDLER, PRE-SCHOOL, PRE-KINDERGARTEN AND ELEMENTARY SCHOOL AGE LEVELS (U.S. CLS. 100, 101 AND 107).

FIRST USE 2-0-2004; IN COMMERCE 2-0-2004.

CHRIS WELLS, EXAMINING ATTORNEY

SN 76-598,817. GINSBURG, JEFFREY R., BOSTON, MA. FILED 6-23-2004.

JONES ONE

THE MARK CONSISTS OF STANDARD CHARACTERS WITHOUT CLAIM TO ANY PARTICULAR FONT, STYLE, SIZE, OR COLOR.

FOR ENTERTAINMENT SERVICES - NAMELY LIVE PERFORMANCES BY A MUSICAL GROUP (U.S. CLS. 100, 101 AND 107).

FIRST USE 5-1-1998; IN COMMERCE 5-1-1998.

DANIEL CAPSHAW, EXAMINING ATTORNEY

SN 76-598,979. MORRIS, JOHN C., DBA YOW-ZAH! PRODUCTIONS, BELTON, MO. FILED 6-23-2004.

NEON BEAT

THE MARK CONSISTS OF STANDARD CHARACTERS WITHOUT CLAIM TO ANY PARTICULAR FONT, STYLE, SIZE, OR COLOR.

FOR RADIO SHOW FEATURING ADULT STANDARDS FROM THE 40'S, 50'S AND 60'S (U.S. CLS. 100, 101 AND 107).

ELIZABETH PIGNATELLO, EXAMINING ATTORNEY

CLASS 41—(Continued).

SN 76-599,082. LE CABARET DE PARIS, PARIS, FRANCE, FILED 6-24-2004.

CABARET DE PARIS

THE MARK CONSISTS OF STANDARD CHARACTERS WITHOUT CLAIM TO ANY PARTICULAR FONT, STYLE, SIZE, OR COLOR.

OWNER OF U.S. REG. NO. 1,286,494.

NO CLAIM IS MADE TO THE EXCLUSIVE RIGHT TO USE "CABARET", APART FROM THE MARK AS SHOWN. SEC. 2(F) AS TO "PARIS".

FOR ENTERTAINMENT SERVICES, NAMELY, STAGING LIVE VARIETY SHOWS, PRODUCTION OF TELEVISION FILMS AND RADIO AND TELEVISION PROGRAMS (U.S. CLS. 100, 101 AND 107).

ESTHER BELENKER, EXAMINING ATTORNEY

SN 76-599,582. COVEY/LINK, LLC, ALPINE, UT. FILED 6-25-2004.

THE SPEED OF TRUST

THE MARK CONSISTS OF STANDARD CHARACTERS WITHOUT CLAIM TO ANY PARTICULAR FONT, STYLE, SIZE, OR COLOR.

FOR EDUCATIONAL SERVICES, NAMELY SEMINARS, WORKSHOPS, CONFERENCES, SPEECHES, TRAINING, CONSULTING AND PERSONAL COACHING, ALL IN THE FIELDS OF IMPROVING PERSONAL, TEAM, ORGANIZATIONAL AND BUSINESS SKILLS, ABILITIES AND PERFORMANCE (U.S. CLS. 100, 101 AND 107).

FIRST USE 5-24-2004; IN COMMERCE 5-24-2004.

SUSAN HAYASH, EXAMINING ATTORNEY

SN 76-600,215. AMATO, ANTHONY, JR., WHITE PLAINS, NY. FILED 6-23-2004.

ANTHONY'S ANIMATED ANIMALS

THE MARK CONSISTS OF STANDARD CHARACTERS WITHOUT CLAIM TO ANY PARTICULAR FONT, STYLE, SIZE, OR COLOR.

NO CLAIM IS MADE TO THE EXCLUSIVE RIGHT TO USE "ANIMATED ANIMALS", APART FROM THE MARK AS SHOWN.

FOR ENTERTAINMENT IN THE NATURE OF THEATER PRODUCTIONS FOR CHILDREN (U.S. CLS. 100, 101 AND 107).

LA TONIA FISHER, EXAMINING ATTORNEY

CLASS 41—(Continued).

SN 76-617,520. WHOLE FOODS MARKET IP, L.P., AUSTIN, TX. FILED 10-21-2004.

WFM-U

THE MARK CONSISTS OF STANDARD CHARACTERS WITHOUT CLAIM TO ANY PARTICULAR FONT, STYLE, SIZE, OR COLOR.

FOR EDUCATIONAL SERVICES, NAMELY, CONDUCTING CLASSES, SEMINARS, CONFERENCES, AND WORKSHOPS IN THE FIELD OF LEADERSHIP, MANAGEMENT, CUSTOMER SERVICE, RETAILING, PROFESSIONAL DEVELOPMENT, FOOD, NUTRITION, DIET, COOKING, HEALTH, FITNESS, LIFESTYLE AND PERSONAL IMPROVEMENT; PROVIDING INFORMATION IN THE FIELD OF LEADERSHIP, MANAGEMENT, CUSTOMER SERVICE, RETAILING, PROFESSIONAL DEVELOPMENT, FOOD, NUTRITION, DIET, COOKING, HEALTH, FITNESS, LIFESTYLE AND PERSONAL IMPROVEMENT VIA COMPUTER NETWORKS, INTRANETS, AND THE INTERNET (U.S. CLS. 100, 101 AND 107).

JOHN DALIER, EXAMINING ATTORNEY

SN 76-619,407. SPANISH BROADCASTING SYSTEM, INC., COCONUT GROVE, FL. FILED 11-4-2004.

MEGATON

THE MARK CONSISTS OF STANDARD CHARACTERS WITHOUT CLAIM TO ANY PARTICULAR FONT, STYLE, SIZE, OR COLOR.

FOR ENTERTAINMENT, NAMELY LIVE MUSIC CONCERTS (U.S. CLS. 100, 101 AND 107).

FIRST USE 10-26-2004; IN COMMERCE 10-26-2004.

GRETTA YAO, EXAMINING ATTORNEY

SN 76-621,483. SPANISH BROADCASTING SYSTEM, INC., COCONUT GROVE, FL. FILED 11-19-2004.

EL VACILON

THE MARK CONSISTS OF STANDARD CHARACTERS WITHOUT CLAIM TO ANY PARTICULAR FONT, STYLE, SIZE, OR COLOR.

OWNER OF U.S. REG. NO. 2,084,891.

THE SPANISH WORDS IN THE MARK TRANSLATE TO "THE PARTY".

FOR ENTERTAINMENT SERVICES IN THE NATURE OF ONGOING RADIO PROGRAMS IN THE FIELD OF MUSIC, COMEDY AND VARIETY (U.S. CLS. 100, 101 AND 107).

FIRST USE 7-13-1995; IN COMMERCE 7-13-1995.

GRETTA YAO, EXAMINING ATTORNEY

CLASS 41—(Continued).

SN 76-621,659. SPANISH BROADCASTING SYSTEM, INC.,
COCONUT GROVE, FL. FILED 11-22-2004.

FAMA DULCE HOGAR

THE MARK CONSISTS OF STANDARD CHARACTERS WITHOUT CLAIM TO ANY PARTICULAR FONT, STYLE, SIZE, OR COLOR.

THE SPANISH WORDS IN THE MARK TRANSLATES TO "FAME SWEET HOME".

FOR ENTERTAINMENT SERVICES IN THE NATURE OF ONGOING TELEVISION PROGRAMS IN THE FIELDS OF MUSIC AND VARIETY (U.S. CLS. 100, 101 AND 107).

GRETTA YAO, EXAMINING ATTORNEY

SN 76-621,660. SPANISH BROADCASTING SYSTEM, INC.,
COCONUT GROVE, FL. FILED 11-22-2004.

MAS ALLA DE LA FAMA

THE MARK CONSISTS OF STANDARD CHARACTERS WITHOUT CLAIM TO ANY PARTICULAR FONT, STYLE, SIZE, OR COLOR.

THE SPANISH WORDS IN THE MARK TRANSLATES TO "BEYOND THE FAME".

FOR ENTERTAINMENT SERVICES IN THE NATURE OF ONGOING DOCUMENTARY TELEVISION PROGRAMS RELATED TO MUSIC AND ENTERTAINMENT CELEBRITIES (U.S. CLS. 100, 101 AND 107).

GRETTA YAO, EXAMINING ATTORNEY

SN 76-621,661. SPANISH BROADCASTING SYSTEM, INC.,
COCONUT GROVE, FL. FILED 11-22-2004.

CINEMA TICKET

THE MARK CONSISTS OF STANDARD CHARACTERS WITHOUT CLAIM TO ANY PARTICULAR FONT, STYLE, SIZE, OR COLOR.

FOR ENTERTAINMENT SERVICES IN THE NATURE OF ONGOING TELEVISION PROGRAMS IN THE FIELDS OF FILM AND ANIMATION (U.S. CLS. 100, 101 AND 107).

GRETTA YAO, EXAMINING ATTORNEY

CLASS 41—(Continued).

SN 76-621,665. SPANISH BROADCASTING SYSTEM, INC.,
COCONUT GROVE, FL. FILED 11-22-2004.

RETO A LA MODA

THE MARK CONSISTS OF STANDARD CHARACTERS WITHOUT CLAIM TO ANY PARTICULAR FONT, STYLE, SIZE, OR COLOR.

THE SPANISH WORDS IN THE MARK TRANSLATES TO "STYLE CHALLENGE".

FOR ENTERTAINMENT SERVICES IN THE NATURE OF ONGOING TELEVISION PROGRAMS IN THE FIELDS OF FASHION AND COSMETICS (U.S. CLS. 100, 101 AND 107).

GRETTA YAO, EXAMINING ATTORNEY

SN 76-623,540. SPANISH BROADCASTING SYSTEM, INC.,
COCONUT GROVE, FL. FILED 12-7-2004.

LO MEJOR DE . . . EL VACION

THE MARK CONSISTS OF STANDARD CHARACTERS WITHOUT CLAIM TO ANY PARTICULAR FONT, STYLE, SIZE, OR COLOR.

OWNER OF U.S. REG. NO. 2,084,891.

THE SPANISH WORDS IN THE MARK TRANSLATES TO "THE BEST OF... THE PARTY".

FOR ENTERTAINMENT SERVICES IN THE NATURE OF ONGOING TELEVISION PROGRAMS IN THE FIELDS OF MUSIC, COMEDY AND VARIETY (U.S. CLS. 100, 101 AND 107).

GRETTA YAO, EXAMINING ATTORNEY

SN 78-117,632. 9096-2788 QUEBEC INC., ST-JOSEPH-DU-LAC,
QUEBEC, CANADA, FILED 3-26-2002.

CASINO PROPHET

PRIORITY CLAIMED UNDER SEC. 44(D) ON CANADA APPLICATION NO. 1135020, FILED 3-26-2002, REG. NO. TMA603627, DATED 3-1-2004, EXPIRES 3-1-2019.

NO CLAIM IS MADE TO THE EXCLUSIVE RIGHT TO USE "CASINO", APART FROM THE MARK AS SHOWN.

FOR PROVIDING AN INTERACTIVE COMPUTER DATABASE IN THE FIELD OF COMPUTERIZED ON-LINE GAMING AND CASINOS; ELECTRONIC PUBLISHING SERVICES, NAMELY, PUBLICATION OF INFORMATION ON CD, DVD, ON-LINE OF OTHERS FEATURING RATINGS AND OPINIONS CONCERNING ONLINE CASINOS AND GAMING SITES; ELECTRONIC PUBLICATION SERVICES, NAMELY, PUBLISHING RATINGS AND OPINIONS OF THE ANALYSIS, CONSENSUS AND OPINIONS OF OTHERS ON CD, DVD, ON-LINE FEATURING INTERNET GAMING AND CASINO SITES VIA LOCAL, REGIONAL AND GLOBAL COMPUTER NETWORKS; ELECTRONIC PUBLISHING CD, DVD, ON-LINE OF OTHERS FEATURING RESEARCH STATISTICS FEATURING ON-LINE GAMING AND CASINOS; ENTERTAINMENT SERVICES IN THE NATURE OF ON-LINE GAMES, CONTESTS, SWEEPSTAKES AND WAGERING, ALL BY MEANS OF LOCAL AND GLOBAL COMMUNICATION NETWORKS (U.S. CLS. 100, 101 AND 107).

FIRST USE 1-31-2000; IN COMMERCE 1-31-2000.

GEORGIA CARTY, EXAMINING ATTORNEY

CLASS 41—(Continued).

SN 78-201,112. THE RANDOM ACTS OF KINDNESS FOUNDATION, DENVER, CO. FILED 1-8-2003.

DO KINDNESS

FOR EDUCATION SERVICES, NAMELY CONDUCTING SEMINARS, CLASSES, AND CULTURAL AND EDUCATIONAL EVENTS IN THE FIELD OF ENCOURAGING THE DOING OF KIND ACTS FOR OTHERS; AND ENTERTAINMENT SERVICES, NAMELY, MUSIC CONCERTS AND PUBLIC FESTIVALS IN THE FIELD OF ENCOURAGING THE DOING OF KIND ACTS FOR OTHERS (U.S. CLS. 100, 101 AND 107).

FIRST USE 11-1-2002; IN COMMERCE 11-1-2002.
HOWARD B. LEVINE, EXAMINING ATTORNEY

SN 78-206,828. AMERICAN CHRISTIAN TOURS, INC., RICE LAKE, WI. FILED 1-24-2003.

LIBERTY CENTER

NO CLAIM IS MADE TO THE EXCLUSIVE RIGHT TO USE "CENTER", APART FROM THE MARK AS SHOWN.

FOR EDUCATIONAL SERVICES, NAMELY, PROVIDING EDUCATIONAL INTERACTIVE EXHIBITIONS, DISPLAYS, AND EXHIBITS, ALL IN THE FIELD OF AMERICAN HISTORY; AND PROVIDING FACILITIES FOR EDUCATIONAL CONFERENCES RELATED TO AMERICAN HISTORY FOR GROUPS AND SCHOOLS (U.S. CLS. 100, 101 AND 107).

PAUL F. GAST, EXAMINING ATTORNEY

SN 78-225,630. ANAND, SANJAY, CLIFTON, NJ. FILED 3-14-2003.

CMP

FOR CERTIFIED MANAGEMENT PROFESSIONAL TRAINING SERVICES FOR BUSINESS MANAGEMENT PROFESSIONALS, MANAGERS, DIRECTORS AND LEADERS (U.S. CLS. 100, 101 AND 107).

FIRST USE 1-1-2003; IN COMMERCE 3-1-2003.
DOMINIC J. FERRAIUOLO, EXAMINING ATTORNEY

SN 78-226,845. GOSPEL MUSIC ASSOCIATION, NASHVILLE, TN. FILED 3-18-2003.

GMA GOSPEL MUSIC HALL OF FAME

OWNER OF U.S. REG. NO. 2,734,234.
NO CLAIM IS MADE TO THE EXCLUSIVE RIGHT TO USE "GOSPEL MUSIC HALL OF FAME", APART FROM THE MARK AS SHOWN.

FOR EDUCATIONAL AND ENTERTAINMENT SERVICES, NAMELY, OPERATION OF A GOSPEL MUSIC MUSEUM; HALL OF FAME SERVICES, NAMELY, CONDUCTING INDUCTIONS AND RELATED CEREMONIES IN CONNECTION WITH THE FIELD OF GOSPEL MUSIC AND PERSONS AND GROUPS ASSOCIATED WITH SUCH MUSIC (U.S. CLS. 100, 101 AND 107).

HENRY S. ZAK, EXAMINING ATTORNEY

CLASS 41—(Continued).

SN 78-235,226. HANOVER COLLEGE, HANOVER, IN. FILED 4-8-2003.

POWERED BY THOUGHT

FOR EDUCATIONAL SERVICES, NAMELY PROVIDING COURSES OF INSTRUCTION AT THE COLLEGE LEVEL; DISTRIBUTION OF COURSE MATERIAL IN CONNECTION THEREWITH (U.S. CLS. 100, 101 AND 107).

SHARI SHEFFIELD, EXAMINING ATTORNEY

SN 78-237,189. FAZIO, GENE S., TEMPE, AZ. FILED 4-13-2003.

YOU PRACTICE. I COACH. YOU LEARN.

FOR EDUCATIONAL SERVICES, NAMELY, CONDUCTING CLASSES, SEMINARS AND WORKSHOPS FEATURING WRITING COMPOSITIONS (U.S. CLS. 100, 101 AND 107).

AMOS T. MATTHEWS, JR., EXAMINING ATTORNEY

SN 78-241,153. MOSS, TIMOTHY, R, HOUSTON, TX. FILED 4-23-2003.

SIXGUN

FOR ENTERTAINMENT SERVICES, NAMELY, LIVE MUSICAL PERFORMANCE BY A BAND (U.S. CLS. 100, 101 AND 107).

FIRST USE 6-1-1993; IN COMMERCE 6-1-1993.
DAVID TAYLOR, EXAMINING ATTORNEY

SN 78-249,162. AMERICAN YOUTH HOSTELS, INC., SILVER SPRING, MD. FILED 5-13-2003.

OPENING DOORS, OPENING MINDS

FOR EDUCATIONAL SERVICES, NAMELY CONDUCTING PROGRAMS IN THE FIELDS OF INTERCULTURAL EXCHANGE, COMMUNITY SERVICE, TRAVEL, AND GLOBAL CITIZENSHIP THROUGH HOSTELLING TO FOSTER GREATER TOLERANCE AND UNDERSTANDING BETWEEN PEOPLE OF DIFFERENT HERITAGES (U.S. CLS. 100, 101 AND 107).

FIRST USE 1-1-2003; IN COMMERCE 1-1-2003.
STEVEN BERK, EXAMINING ATTORNEY

CLASS 41—(Continued).

SN 78-257,168. PASTERNAK, MICHAEL J, SHERMAN OAKS, CA. FILED S.R. 6-2-2003; AM. P.R. 5-3-2004.

THE AMAZING BOTTLE DANCERS

NO CLAIM IS MADE TO THE EXCLUSIVE RIGHT TO USE "BOTTLE DANCERS", APART FROM THE MARK AS SHOWN.

SEC. 2(F).
FOR ENTERTAINMENT SERVICES, NAMELY LIVE PERFORMANCES BY A DANCE TROUPE (U.S. CLS. 100, 101 AND 107).

FIRST USE 9-1-2001; IN COMMERCE 9-1-2001.
JENNIFER CHICOSKI, EXAMINING ATTORNEY

SN 78-260,632. JARVIS, WILL, VAN NUYS, CA. FILED 6-10-2003.

TALIESIN THE BARD

THE NAME TALIESIN THE BARD IS A PSEUDONYM OF THE PERSON APPLYING TO REGISTER, WHOSE CONSENT IS OF RECORD.

FOR ENTERTAINMENT IN THE NATURE OF PROVIDING ADULT-ORIENTED EDUCATIONAL OR MOTIVATIONAL SPEAKERS AND CUSTOM WRITING SERVICES (U.S. CLS. 100, 101 AND 107).

HENRY S. ZAK, EXAMINING ATTORNEY

SN 78-288,147. KLITZKY, DAVID, LONG GROVE, IL. FILED 8-15-2003.

LIFE IS SIMPLY ART

FOR ARRANGING AND CONDUCTING EXHIBITIONS AND COMPETITIONS IN THE FIELD OF ART (U.S. CLS. 100, 101 AND 107).

FIRST USE 2-0-2003; IN COMMERCE 2-0-2003.
STEVEN R. FOSTER, EXAMINING ATTORNEY

SN 78-303,691. DISNEY ENTERPRISES, INC., BURBANK, CA. FILED 9-22-2003.

BRING ON THE MOVIES

FOR ENTERTAINMENT SERVICES, NAMELY, INTERACTIVE TELEVISION AND AUDIO-VISUAL PROGRAMMING AND COMPUTER GAME SERVICES; TELEVISION AND AUDIO-VISUAL PRODUCTION SERVICES; TELEVISION PROGRAMMING ON A GLOBAL COMPUTER NETWORK; DISTRIBUTION OF TELEVISION AND AUDIO-VISUAL PROGRAMS FOR OTHERS; PROVIDING ONLINE INTERACTIVE COMPUTER DATABASES OF INFORMATION IN THE FIELDS OF ENTERTAINMENT, NEWS AND SPORTS PROVIDING ONLINE INTERACTIVE COMPUTER DATABASES OF INFORMATION ON PROGRAMMING SCHEDULES (U.S. CLS. 100, 101 AND 107).

JEFFERY COWARD, EXAMINING ATTORNEY

CLASS 41—(Continued).

SN 78-304,469. BACICH, NANCY, NEW YORK, NY. FILED 9-23-2003.

EVE KITTEN

NO CLAIM IS MADE TO THE EXCLUSIVE RIGHT TO USE NO CLAIM IS MADE TO THE EXCLUSIVE RIGHT TO USE "KITTEN" APART FROM THE MARK AS SHOWN, APART FROM THE MARK AS SHOWN.

FOR PROVIDING ONLINE CARTOON FEATURES; PROVIDING ONLINE MAGAZINES, NEWSPAPERS, PAMPHLETS, AND BOOKS FEATURING CARTOONS (U.S. CLS. 100, 101 AND 107).

KEVON CHISOLM, EXAMINING ATTORNEY

SN 78-309,455. CLE-EZ LLC, ALBANY, NY. FILED 10-4-2003.

CLE - EZ

NO CLAIM IS MADE TO THE EXCLUSIVE RIGHT TO USE "CLE", APART FROM THE MARK AS SHOWN.

FOR EDUCATIONAL SERVICES, NAMELY, PROVIDING CONTINUING LEGAL EDUCATIONAL SERVICES (U.S. CLS. 100, 101 AND 107).

MICHAEL HALL, EXAMINING ATTORNEY

SN 78-312,146. TERASEN INC., FORMERLY BC GAS INC., VANCOUVER, BRITISH COLUMBIA, CANADA, FILED 10-10-2003.



PRIORITY CLAIMED UNDER SEC. 44(D) ON CANADA APPLICATION NO. 1,173,586, FILED 4-11-2003, REG. NO. TMA627593, DATED 12-6-2004, EXPIRES 12-6-2019.

FOR ENTERTAINMENT AND EDUCATION SERVICES IN THE NATURE OF COOKING SHOWS FOR TELEVISION BROADCASTS AND BROADCAST VIA A GLOBAL COMMUNICATIONS NETWORK (U.S. CLS. 100, 101 AND 107).

ODESSA BIBBINS, EXAMINING ATTORNEY

CLASS 41—(Continued).

SN 78-325,034. DUB PUBLISHING, INC., CITY OF INDUSTRY, CA. FILED 11-7-2003.

DUB TV

THE MARK CONSISTS OF STANDARD CHARACTERS WITHOUT CLAIM TO ANY PARTICULAR FONT, STYLE, SIZE, OR COLOR.

OWNER OF U.S. REG. NO. 2,408,405.
NO CLAIM IS MADE TO THE EXCLUSIVE RIGHT TO USE "TV", APART FROM THE MARK AS SHOWN.
FOR ENTERTAINMENT SERVICES IN THE NATURE OF ONGOING TELEVISION PROGRAMS IN THE FIELDS OF AUTOMOBILES, AUTOMOBILE-RELATED ISSUES, AUTOMOTIVE LIFESTYLES, NEWS, COMEDY, VARIETY AND ACTION (U.S. CLS. 100, 101 AND 107).
PAUL F. GAST, EXAMINING ATTORNEY

SN 78-325,039. DUB PUBLISHING, INC., CITY OF INDUSTRY, CA. FILED 11-7-2003.

DUB HD

THE MARK CONSISTS OF STANDARD CHARACTERS WITHOUT CLAIM TO ANY PARTICULAR FONT, STYLE, SIZE, OR COLOR.

OWNER OF U.S. REG. NO. 2,408,405.
NO CLAIM IS MADE TO THE EXCLUSIVE RIGHT TO USE "HD", APART FROM THE MARK AS SHOWN.
FOR ENTERTAINMENT SERVICES IN THE NATURE OF ONGOING TELEVISION PROGRAMS IN THE FIELDS OF AUTOMOBILES, AUTOMOBILE-RELATED ISSUES, AUTOMOTIVE LIFESTYLES, NEWS, COMEDY, VARIETY AND ACTION (U.S. CLS. 100, 101 AND 107).
PAUL F. GAST, EXAMINING ATTORNEY

CLASS 41—(Continued).

SN 78-325,040. DUB PUBLISHING, INC., CITY OF INDUSTRY, CA. FILED 11-7-2003.

DUB

THE MARK CONSISTS OF STANDARD CHARACTERS WITHOUT CLAIM TO ANY PARTICULAR FONT, STYLE, SIZE, OR COLOR.

OWNER OF U.S. REG. NO. 2,408,405.
FOR ENTERTAINMENT SERVICES IN THE NATURE OF ONGOING TELEVISION PROGRAMS IN THE FIELDS OF AUTOMOBILES, AUTOMOBILE-RELATED ISSUES, AUTOMOTIVE LIFESTYLES, NEWS, COMEDY, VARIETY AND ACTION (U.S. CLS. 100, 101 AND 107).
PAUL F. GAST, EXAMINING ATTORNEY

SN 78-325,043. DUB PUBLISHING, INC., CITY OF INDUSTRY, CA. FILED 11-7-2003.

DUBS

THE MARK CONSISTS OF STANDARD CHARACTERS WITHOUT CLAIM TO ANY PARTICULAR FONT, STYLE, SIZE, OR COLOR.

OWNER OF U.S. REG. NO. 2,408,405.
FOR ENTERTAINMENT SERVICES IN THE NATURE OF ONGOING TELEVISION PROGRAMS IN THE FIELDS OF AUTOMOBILES, AUTOMOBILE-RELATED ISSUES, AUTOMOTIVE LIFESTYLES, NEWS, COMEDY, VARIETY AND ACTION (U.S. CLS. 100, 101 AND 107).
PAUL F. GAST, EXAMINING ATTORNEY

CLASS 41—(Continued).

SN 78-325,863. CASEY, KEN, NOVATO, CA. FILED 11-11-2003.

SANTA POWER

THE MARK CONSISTS OF STANDARD CHARACTERS WITHOUT CLAIM TO ANY PARTICULAR FONT, STYLE, SIZE, OR COLOR.

NO CLAIM IS MADE TO THE EXCLUSIVE RIGHT TO USE "PRESS", APART FROM THE MARK AS SHOWN.

FOR PUBLICATION OF BOOKS, CATALOGS, BROCHURES (U.S. CLS. 100, 101 AND 107).

GENE MACIOL, EXAMINING ATTORNEY

SN 78-328,119. CHAPEL HILL-CARRBORO CITY SCHOOLS, CHAPEL HILL, NC. FILED 11-14-2003.



FOR EDUCATIONAL SERVICES, NAMELY, CONDUCTING PRIMARY AND SECONDARY EDUCATIONAL CLASSES IN ALL PRIMARY AND SECONDARY SCHOOL SUBJECTS IN THE FIELD OF PUBLIC EDUCATION AND THE ON-LINE DISTRIBUTION OF COURSE MATERIALS, ASSIGNMENTS AND OTHER IMPORTANT INFORMATION RELATED TO THOSE CLASSES FOR ACCESS BY STUDENTS, TEACHERS AND PARENTS (U.S. CLS. 100, 101 AND 107).

FIRST USE 1-1-2002; IN COMMERCE 7-1-2002.
BARNEY CHARLON, EXAMINING ATTORNEY

CLASS 41—(Continued).

SN 78-329,524. PRL USA HOLDINGS, INC., WILMINGTON, DE. FILED 11-18-2003.

**G.I.V.E. GET
INVOLVED.
VOLUNTEER.
EXCEED.**

THE MARK CONSISTS OF STANDARD CHARACTERS WITHOUT CLAIM TO ANY PARTICULAR FONT, STYLE, SIZE, OR COLOR.

NO CLAIM IS MADE TO THE EXCLUSIVE RIGHT TO USE "VOLUNTEER", APART FROM THE MARK AS SHOWN.

FOR ENTERTAINMENT, NAMELY A CONTINUING NEWS SHOW FEATURING INFORMATION ON VOLUNTEERISM, FASHION, MUSIC, FILM, CULTURE, POLITICS AND CELEBRITIES BROADCAST OVER TELEVISION; ENTERTAINMENT SERVICES, NAMELY PROVIDING A RADIO PROGRAM IN THE FIELDS OF VOLUNTEERISM, FASHION, MUSIC, FILM, CULTURE, POLITICS AND CELEBRITIES BROADCAST OVER THE RADIO AND VIA A GLOBAL COMPUTER NETWORK. (U.S. CLS. 100, 101 AND 107).

JEFF DEFORD, EXAMINING ATTORNEY

SN 78-335,282. TALO ANALYTIC INTERNATIONAL, INC., DULUTH, GA. FILED 12-2-2003.

Nip Impressions

THE MARK CONSISTS OF STANDARD CHARACTERS WITHOUT CLAIM TO ANY PARTICULAR FONT, STYLE, SIZE, OR COLOR.

FOR PROVIDING AN EDITORIAL COLUMN, IN AN ONLINE WEEKLY ELECTRONIC NEWSLETTER, FEATURING EDITORIAL COMMENTARY ON VARIOUS FINANCIAL, PERSONAL, AND BUSINESS ISSUES (U.S. CLS. 100, 101 AND 107).

FIRST USE 1-2-2003; IN COMMERCE 1-2-2003.
KIMBERLY FRYE, EXAMINING ATTORNEY

CLASS 41—(Continued).

SN 78-336,512. VIACOM INTERNATIONAL INC., NEW YORK, NY. FILED 12-4-2003.

**AMERICA'S MOST
USELESS TEEN**

THE MARK CONSISTS OF STANDARD CHARACTERS WITHOUT CLAIM TO ANY PARTICULAR FONT, STYLE, SIZE, OR COLOR.

NO CLAIM IS MADE TO THE EXCLUSIVE RIGHT TO USE "AMERICA'S", APART FROM THE MARK AS SHOWN. FOR ENTERTAINMENT SERVICES IN THE NATURE OF AN ON-GOING REALITY-BASED TELEVISION SERIES; PROVIDING INFORMATION IN THE FIELD OF ENTERTAINMENT BY MEANS OF A GLOBAL COMPUTER NETWORK (U.S. CLS. 100, 101 AND 107).
ODESSA BIBBINS, EXAMINING ATTORNEY

CLASS 41—(Continued).

SN 78-337,826. COHN, SALOMON, SAN FRANCISCO, CA. FILED 12-8-2003.

**visionary quantum
healing**

THE MARK CONSISTS OF STANDARD CHARACTERS WITHOUT CLAIM TO ANY PARTICULAR FONT, STYLE, SIZE, OR COLOR.

NO CLAIM IS MADE TO THE EXCLUSIVE RIGHT TO USE "QUANTUM HEALING", APART FROM THE MARK AS SHOWN.
FOR EDUCATIONAL SERVICES, NAMELY, TEACHING CLASSES AND SEMINARS IN THE FIELD OF PHYSICAL HEALING UTILIZING A PROCESS OF NATURAL AIR AND LIGHT ENERGY (U.S. CLS. 100, 101 AND 107).
ELISSA GARBER KON, EXAMINING ATTORNEY

SN 78-336,828. SISTEMA UNIVERSITARIO ANA G. MÉNDEZ, SAN JUAN, UNITED STATES, FILED 12-5-2003.



NO CLAIM IS MADE TO THE EXCLUSIVE RIGHT TO USE "UNIVERSIDAD DEL ESTE", APART FROM THE MARK AS SHOWN.

THE COLOR(S) TEAL AND BLACK IS/ARE CLAIMED AS A FEATURE OF THE MARK.

THE TERM "UNE" IS PRESENTED IN THE COLOR TEAL AND HAS A BLACK ELLIPTICAL LINE CROSSING THE TERM. THE WORDINGS "UNIVERSIDAD DEL ESTE" IS PRESENTED IN THE COLOR BLACK AND IS UNDERLINE AND OVER LINED WITH TEAL BARS.

THE FOREIGN WORDING IN THE MARK TRANSLATES INTO ENGLISH AS UNIVERSITY OF THE EAST.

FOR EDUCATIONAL SERVICES IN THE NATURE OF COURSES AT THE UNIVERSITY LEVEL (U.S. CLS. 100, 101 AND 107).

FIRST USE 0-0-2001; IN COMMERCE 0-0-2001.
KAREN BRACEY, EXAMINING ATTORNEY

SN 78-353,265. H.A.LO.H. LLC, WASHINGTON, DC. FILED 1-16-2004.

H.A.LO.H.

THE MARK CONSISTS OF STANDARD CHARACTERS WITHOUT CLAIM TO ANY PARTICULAR FONT, STYLE, SIZE, OR COLOR.

FOR EDUCATIONAL SERVICES IN THE NATURE OF MARTIAL ARTS INSTRUCTION (U.S. CLS. 100, 101 AND 107).

FIRST USE 9-1-2003; IN COMMERCE 11-1-2003.
MICHAEL HALL, EXAMINING ATTORNEY

CLASS 41—(Continued).

SN 78-354,014. UNITED STATIONS RADIO NETWORKS, INC., NEW YORK, NY. FILED 1-20-2004.

THE PULSE OF RADIO

THE MARK CONSISTS OF STANDARD CHARACTERS WITHOUT CLAIM TO ANY PARTICULAR FONT, STYLE, SIZE, OR COLOR.

NO CLAIM IS MADE TO THE EXCLUSIVE RIGHT TO USE "RADIO", APART FROM THE MARK AS SHOWN.

FOR RADIO STATION SERVICES, NAMELY, PRODUCTION AND DISTRIBUTION OF MUSIC NEWS, ENTERTAINMENT NEWS AND RADIO SHOW PREPARATION FEATURES FOR RADIO STATIONS (U.S. CLS. 100, 101 AND 107).

FIRST USE 2-0-2004; IN COMMERCE 2-0-2004.
MATTHEW KLINE, EXAMINING ATTORNEY

SN 78-354,298. ISLE OF CAPRI CASINOS, INC., BILOXI, MS. FILED 1-20-2004.

ISLEONE GAMEFUNDS

THE MARK CONSISTS OF STANDARD CHARACTERS WITHOUT CLAIM TO ANY PARTICULAR FONT, STYLE, SIZE, OR COLOR.

OWNER OF U.S. REG. NO. 2,846,790.

FOR ENTERTAINMENT SERVICES, NAMELY CASINO SERVICES (U.S. CLS. 100, 101 AND 107).

PAUL F. GAST, EXAMINING ATTORNEY

SN 78-354,524. KATHY CASEY, INC., SEATTLE, WA. FILED 1-20-2004.

SHAKE, SWIZZLE & STIR

THE MARK CONSISTS OF STANDARD CHARACTERS WITHOUT CLAIM TO ANY PARTICULAR FONT, STYLE, SIZE, OR COLOR.

FOR ENTERTAINMENT SERVICES IN THE NATURE OF AN ON-GOING TELEVISION PROGRAM IN THE FIELD OF COOKING; ENTERTAINMENT SERVICES IN THE NATURE OF AN ON-GOING REALITY BASED TELEVISION PROGRAM; PRODUCTION AND DISTRIBUTION OF COOKING AND REALITY-BASED SHOWS FOR TELEVISION BROADCASTING (U.S. CLS. 100, 101 AND 107).

PAUL F. GAST, EXAMINING ATTORNEY

CLASS 41—(Continued).

SN 78-355,876. CASCADIA COMMUNITY COLLEGE, BOTHELL, WA. FILED 1-22-2004.



NO CLAIM IS MADE TO THE EXCLUSIVE RIGHT TO USE "COMMUNITY COLLEGE", APART FROM THE MARK AS SHOWN.

FOR EDUCATIONAL SERVICES NAMELY PROVIDING COURSES OF INSTRUCTION AT THE UNDERGRADUATE LEVEL (U.S. CLS. 100, 101 AND 107).

FIRST USE 9-25-2000; IN COMMERCE 9-25-2000.
RON FAIRBANKS, EXAMINING ATTORNEY

SN 78-358,292. METROPOLITAN PIER AND EXPOSITION AUTHORITY, CHICAGO, IL. FILED 1-27-2004.



OWNER OF U.S. REG. NOS. 1,943,338 AND 2,399,323.
THE COLOR(S) BLACK AND MAGENTA IS/ARE CLAIMED AS A FEATURE OF THE MARK.

THE COLOR BLACK APPEARS IN NAVY FEAR & AND MAGENTA APPEARS IN FEAR.

FOR ENTERTAINMENT SERVICES, NAMELY, A HALLOWEEN AND HALLOWEEN-THEMED FESTIVAL OF EVENTS FOR FAMILIES (U.S. CLS. 100, 101 AND 107).

FIRST USE 7-0-2003; IN COMMERCE 9-0-2003.
SHARI SHEFFIELD, EXAMINING ATTORNEY

CLASS 41—(Continued).

SN 78-363,865. JEFFREY AND CARLETTE ANDERSON, EL CAJON, CA. FILED 2-6-2004.

SAVE-A-HEART

THE MARK CONSISTS OF STANDARD CHARACTERS WITHOUT CLAIM TO ANY PARTICULAR FONT, STYLE, SIZE, OR COLOR.

FOR EDUCATIONAL SERVICES, NAMELY, CONDUCTING CLASSES AND SEMINARS IN THE FIELD OF CARDIOPULMONARY RESUSCITATION AND EMERGENCY CARDIAC CARE (U.S. CLS. 100, 101 AND 107).

FIRST USE 3-0-1988; IN COMMERCE 4-0-1988.
JEFF DEFORD, EXAMINING ATTORNEY

SN 78-364,263. FULL SPEED PRODUCTIONS INC., LAS VEGAS, NV. FILED 2-6-2004.



NO CLAIM IS MADE TO THE EXCLUSIVE RIGHT TO USE "NAKED WOMEN WRESTLING LEAGUE", APART FROM THE MARK AS SHOWN.

THE STIPLING IS A FEATURE OF THE MARK.
FOR ENTERTAINMENT IN THE NATURE OF WRESTLING SHOWS (U.S. CLS. 100, 101 AND 107).
FIRST USE 2-6-2004; IN COMMERCE 2-6-2004.
LINDA MICKLEBURGH, EXAMINING ATTORNEY

SN 78-368,981. MATINEE PICTURES, LLC, SANTA MONICA, CA. FILED 2-17-2004.

MATINEE PICTURES

THE MARK CONSISTS OF STANDARD CHARACTERS WITHOUT CLAIM TO ANY PARTICULAR FONT, STYLE, SIZE, OR COLOR.

NO CLAIM IS MADE TO THE EXCLUSIVE RIGHT TO USE "PICTURES", APART FROM THE MARK AS SHOWN.

FOR ENTERTAINMENT SERVICES, NAMELY PRODUCTION AND DISTRIBUTION OF MOTION PICTURES AND TELEVISION PROGRAMS; PUBLICATIONS OF BOOKS (U.S. CLS. 100, 101 AND 107).

THEODORE MCBRIDE, EXAMINING ATTORNEY

CLASS 41—(Continued).

SN 78-383,595. REED, JAMES FRANKLIN, SPRING VALLEY, CA. FILED 3-12-2004.

Christian Life Tools

THE MARK CONSISTS OF STANDARD CHARACTERS WITHOUT CLAIM TO ANY PARTICULAR FONT, STYLE, SIZE, OR COLOR.

NO CLAIM IS MADE TO THE EXCLUSIVE RIGHT TO USE "CHRISTIAN", APART FROM THE MARK AS SHOWN.
FOR EDUCATIONAL SERVICES NAMELY PROVIDING ONLY BIBLE INSTRUCTION AND DISTRIBUTION OF COURSE MATERIALS THEREWITH. (U.S. CLS. 100, 101 AND 107).

LESLEY LAMOTHE, EXAMINING ATTORNEY

SN 78-384,138. COMPASS SETTINGS LTD., AUSTIN, TX. FILED 3-15-2004.



THE COLOR(S) RED, GREEN, BLUE, AND YELLOW IS/ ARE CLAIMED AS A FEATURE OF THE MARK.

THE MARK CONSISTS OF THREE (3) MULTI-COLORED CIRCLES ARRANGED IN A "V" FORMATION. EACH CIRCLE IS DIVIDED INTO QUADRANTS ALONG IMAGINARY "EAST TO WEST" AND "NORTH TO SOUTH" LINES. CIRCLE 1 HAS THE COLOR RED IN ITS "SOUTHWEST" QUADRANT, THE COLOR GREEN IN ITS "NORTHWEST" QUADRANT, THE COLOR BLUE IN ITS "NORTHEAST" QUADRANT, AND THE COLOR YELLOW IN ITS "SOUTHEAST" QUADRANT. CIRCLE 2 IS SITUATED ABOVE AND TO THE LEFT OF CIRCLE 1, OVERLAPPING THE "NORTHWEST" QUADRANT OF CIRCLE 1, AND HAS THE COLOR GREEN IN ITS "SOUTHWEST" QUADRANT, THE COLOR BLUE IN ITS "NORTHWEST" QUADRANT, THE COLOR RED IN ITS "NORTHEAST" QUADRANT, AND THE COLOR YELLOW IN ITS "SOUTHEAST" QUADRANT. CIRCLE 3 IS SITUATED ABOVE AND TO THE RIGHT OF CIRCLE 1, OVERLAPPING THE "NORTHEAST" AND "SOUTHEAST" QUADRANTS OF CIRCLE 2 AND THE "NORTHEAST" QUADRANT OF CIRCLE 1, AND HAS THE COLOR YELLOW IN ITS "SOUTHWEST" QUADRANT, THE COLOR RED IN ITS "NORTHWEST" QUADRANT, THE COLOR GREEN IN ITS "NORTHEAST" QUADRANT, AND THE COLOR BLUE IN ITS "SOUTHEAST" QUADRANT. THE WORD COMPONENT "ABOUT U THE UNIQUE YOU ANSWERED AND EXPLAINED" APPEARS TO THE RIGHT OF THE DESIGN ELEMENT, THE WORDS "ABOUT U" CENTERED ABOVE THE WORDS "THE UNIQUE YOU ANSWERED AND EXPLAINED" IN A SMALLER TYPE SIZE.

FOR CAREER COUNSELING SERVICES (U.S. CLS. 100, 101 AND 107).

JIM RINGLE, EXAMINING ATTORNEY

CLASS 41—(Continued).

SN 78-384,285. STRUCTURED INTERACTIONAL FITNESS TECHNIQUE, LLC, OCEANSIDE, CA. FILED 3-15-2004.



NO CLAIM IS MADE TO THE EXCLUSIVE RIGHT TO USE WORKOUT, APART FROM THE MARK AS SHOWN.

THE COLOR(S) BLUE AND GOLD IS/ARE CLAIMED AS A FEATURE OF THE MARK.

THE MARK CONSISTS OF STYLIZED "S" SURROUNDED BY TWO CRESCENTS ALL IN BLUE AND SHADOWED IN GOLD.

FOR PROVIDING FITNESS AND EXERCISE FACILITY (U.S. CLS. 100, 101 AND 107).

FIRST USE 8-1-2003; IN COMMERCE 8-1-2003.

CAROLINE WEIMER, EXAMINING ATTORNEY

CLASS 41—(Continued).

SN 78-395,788. STACK, LAURA M., HIGHLANDS RANCH, CO. FILED 4-2-2004.

Leave the office
earlier

THE MARK CONSISTS OF STANDARD CHARACTERS WITHOUT CLAIM TO ANY PARTICULAR FONT, STYLE, SIZE, OR COLOR.

FOR EDUCATIONAL SERVICES, NAMELY, CONDUCTING CLASSES, LECTURES, SEMINARS, CONFERENCES, WORKSHOPS IN THE FIELD OF SOCIAL AND BUSINESS INTERACTION AND DISTRIBUTING COURSE MATERIALS IN CONNECTION THEREWITH (U.S. CLS. 100, 101 AND 107).

FIRST USE 6-1-1998; IN COMMERCE 6-1-1998.

AMOS T. MATTHEWS, JR., EXAMINING ATTORNEY

SN 78-393,328. VASTI, ELIZABETH A., WESLEY CHAPEL, FL. FILED 3-30-2004.

360 Degree
Retirement

THE MARK CONSISTS OF STANDARD CHARACTERS WITHOUT CLAIM TO ANY PARTICULAR FONT, STYLE, SIZE, OR COLOR.

NO CLAIM IS MADE TO THE EXCLUSIVE RIGHT TO USE "RETIREMENT", APART FROM THE MARK AS SHOWN.

FOR PROVIDING EDUCATIONAL AND TRAINING SERVICES IN THE FIELD OF RETIREMENT PLANNING AND CONSULTATION SERVICES THERETO (U.S. CLS. 100, 101 AND 107).

FIRST USE 3-20-2004; IN COMMERCE 3-20-2004.

SKYE YOUNG, EXAMINING ATTORNEY

SN 78-400,512. VASTI, ELIZABETH A., WESLEY CHAPEL, FL. FILED 4-12-2004.

Retirement 360

THE MARK CONSISTS OF STANDARD CHARACTERS WITHOUT CLAIM TO ANY PARTICULAR FONT, STYLE, SIZE, OR COLOR.

NO CLAIM IS MADE TO THE EXCLUSIVE RIGHT TO USE "RETIREMENT", APART FROM THE MARK AS SHOWN.

FOR PROVIDING EDUCATIONAL AND TRAINING SERVICES IN THE FIELD OF RETIREMENT PLANNING AND CONSULTATION SERVICES THERETO (U.S. CLS. 100, 101 AND 107).

FIRST USE 3-20-2004; IN COMMERCE 3-20-2004.

SKYE YOUNG, EXAMINING ATTORNEY

CLASS 41—(Continued).

SN 78-401,816. ANIPLEX, INC., TOKYO, 102-8353, JAPAN,
FILED 4-14-2004.

SPIRAL

THE MARK CONSISTS OF STANDARD CHARACTERS
WITHOUT CLAIM TO ANY PARTICULAR FONT, STYLE,
SIZE, OR COLOR.

FOR ENTERTAINMENT SERVICES IN THE NATURE
OF AN ANIMATED TELEVISION SERIES (U.S. CLS. 100,
101 AND 107).

MITCHELL FRONT, EXAMINING ATTORNEY

CLASS 41—(Continued).

SN 78-403,670. SHARYN SCHEYD, INC, KENNER, LA.
FILED 4-17-2004.

Love the Life you Live

THE MARK CONSISTS OF STANDARD CHARACTERS
WITHOUT CLAIM TO ANY PARTICULAR FONT, STYLE,
SIZE, OR COLOR.

FOR TRAINING SERVICES IN THE FIELD OF AL-
TERNATIVE HEALTH/PEOPLE WITH DISABILITY/PER-
SONAL GROWTH (U.S. CLS. 100, 101 AND 107).

FIRST USE 7-1-2003; IN COMMERCE 8-1-2003.

SUSAN LESLIE DUBOIS, EXAMINING ATTORNEY

SN 78-403,173. CALLAHAN, MARTA, HAMILTON, OH.
FILED 4-16-2004.



NO CLAIM IS MADE TO THE EXCLUSIVE RIGHT TO
USE "FITNESS CENTER", APART FROM THE MARK AS
SHOWN.

FOR PHYSICAL FITNESS INSTRUCTION, TRAINING
AND CONSULTATION AND PROVIDING FITNESS AND
EXERCISE EQUIPMENT AND FACILITIES (U.S. CLS.
100, 101 AND 107).

GEORGIA CARTY, EXAMINING ATTORNEY

SN 78-403,942. MERRICK, STEPHEN CLAY., DBA ELE-
PHANTMAN MUSIC PRODUCTIONS, CLAREMONT,
CA. FILED 4-19-2004.

Elephantman Music Productions

THE MARK CONSISTS OF STANDARD CHARACTERS
WITHOUT CLAIM TO ANY PARTICULAR FONT, STYLE,
SIZE, OR COLOR.

NO CLAIM IS MADE TO THE EXCLUSIVE RIGHT TO
USE "MUSIC PRODUCTIONS", APART FROM THE MARK
AS SHOWN.

FOR MUSIC PRODUCTIONS SERVICES AND MUSIC
PUBLISHING SERVICES (U.S. CLS. 100, 101 AND 107).

CAROL SPILS, EXAMINING ATTORNEY

CLASS 41—(Continued).

SN 78-408,158. BLUMENBERG, TINA, CALUMET CITY, IL. FILED 4-26-2004.

ToMBoy

THE MARK CONSISTS OF STANDARD CHARACTERS WITHOUT CLAIM TO ANY PARTICULAR FONT, STYLE, SIZE, OR COLOR.

FOR ENTERTAINMENT SERVICES, NAMELY, LIVE MUSICAL PERFORMANCES BY AN ARTIST; ENTERTAINMENT SERVICES, NAMELY, LIVE CONCERTS BY A MUSICAL ARTIST AND A GROUP; MUSIC PRODUCTION SERVICES (U.S. CLS. 100, 101 AND 107).

FIRST USE 11-1-1998; IN COMMERCE 2-1-1999.
BERYL GARDNER, EXAMINING ATTORNEY

CLASS 41—(Continued).

SN 78-420,708. HEAVYGUNZ ENTERPRISES INC., GREENDALE, WI. FILED 5-18-2004.

R
R & R
ROCKIT RECORDS
& RECORDING

THE MARK CONSISTS OF STANDARD CHARACTERS WITHOUT CLAIM TO ANY PARTICULAR FONT, STYLE, SIZE, OR COLOR.

NO CLAIM IS MADE TO THE EXCLUSIVE RIGHT TO USE "RECORDS AND RECORDING", APART FROM THE MARK AS SHOWN.

FOR MUSIC PRODUCTION SERVICES (U.S. CLS. 100, 101 AND 107).

FIRST USE 6-1-1998; IN COMMERCE 6-1-1998.
GINA HAYES, EXAMINING ATTORNEY

SN 78-414,197. LONDON PEDIATRIC FOUNDATION, VENTURA, CA. FILED 5-6-2004.

Get Moving!

THE MARK CONSISTS OF STANDARD CHARACTERS WITHOUT CLAIM TO ANY PARTICULAR FONT, STYLE, SIZE, OR COLOR.

FOR EDUCATIONAL SERVICES, NAMELY CONDUCTING PROGRAMS IN THE FIELD OF COMMUNITY-BASED NUTRITION AND FITNESS PROGRAMS, LINKED WITH ELEMENTARY SCHOOLS, AND AIMED AT PREVENTING TYPE 2 DIABETES IN CHILDREN (U.S. CLS. 100, 101 AND 107).

TIMOTHY FINNEGAN, EXAMINING ATTORNEY

SN 78-421,893. TERRY, JOHN, NEPHI, UT. FILED 5-19-2004.

ReSPITE

THE MARK CONSISTS OF STANDARD CHARACTERS WITHOUT CLAIM TO ANY PARTICULAR FONT, STYLE, SIZE, OR COLOR.

FOR EDUCATIONAL SERVICES NAMELY CONDUCTING CLASSES AND WORKSHOPS IN THE FIELD OF RELAXATION TECHNIQUES (U.S. CLS. 100, 101 AND 107).

FIRST USE 1-19-2001; IN COMMERCE 7-3-2003.
LESLEY LAMOTHE, EXAMINING ATTORNEY

CLASS 41—(Continued).

SN 78-422,063. EMUSICQUEST, LANSDALE, PA. FILED 5-20-2004.

THE MUSIC-IN-PRINT SERIES

THE MARK CONSISTS OF STANDARD CHARACTERS WITHOUT CLAIM TO ANY PARTICULAR FONT, STYLE, SIZE, OR COLOR.

OWNER OF U.S. REG. NO. 2,909,593.

NO CLAIM IS MADE TO THE EXCLUSIVE RIGHT TO USE "SERIES", APART FROM THE MARK AS SHOWN.

SEC. 2(F).

FOR PROVIDING AN ON-LINE COMPUTER DATABASE IN THE FIELD OF MUSIC (U.S. CLS. 100, 101 AND 107).

FIRST USE 7-24-1973; IN COMMERCE 8-1-2000.

TRACY CROSS, EXAMINING ATTORNEY

SN 78-422,425. REDSTONE CONSULTING, LLC, EAST LONGMEADOW, MA. FILED 5-20-2004.



FOR TRAINING SERVICES IN THE FIELD OF TEACHING SALES SKILLS TO NEW AND CURRENT SALES ASSOCIATES IN THE FINANCIAL INDUSTRY (U.S. CLS. 100, 101 AND 107).

FIRST USE 10-3-2003; IN COMMERCE 10-3-2003.

MARK SPARACINO, EXAMINING ATTORNEY

SN 78-423,634. REIMAN MEDIA GROUP, INC., GREENDALE, WI. FILED 5-24-2004.



OWNER OF U.S. REG. NO. 2,721,370.

NO CLAIM IS MADE TO THE EXCLUSIVE RIGHT TO USE "QUICK COOKING", APART FROM THE MARK AS SHOWN.

THE MARK CONSISTS OF THE STYLIZED WORDS QUICK COOKING ON STAGE! WITH A DEPICTION OF A SPOTLIGHT BEGINNING ABOVE THE WORDS QUICK COOKING AND AIMING DOWN ON THE WORDS ON STAGE!.

FOR EDUCATIONAL SERVICES, NAMELY CONDUCTING CULINARY COURSES AND DISTRIBUTING COURSE MATERIALS THEREWITH (U.S. CLS. 100, 101 AND 107).

RICHARD A. STRASER, EXAMINING ATTORNEY

CLASS 41—(Continued).

SN 78-424,623. ANHEUSER-BUSCH INCORPORATED, ST. LOUIS, MO. FILED 5-25-2004.

ANHEUSER-BUSCH ADVENTURE PARKS

THE MARK CONSISTS OF STANDARD CHARACTERS WITHOUT CLAIM TO ANY PARTICULAR FONT, STYLE, SIZE, OR COLOR.

OWNER OF U.S. REG. NOS. 925,302, 1,832,461 AND 2,040,031.

NO CLAIM IS MADE TO THE EXCLUSIVE RIGHT TO USE "ADVENTURE PARKS", APART FROM THE MARK AS SHOWN.

FOR AMUSEMENT PARKS; ZOOLOGICAL PARKS AND EXHIBITIONS; RECREATIONAL/EDUCATIONAL DAY AND NIGHT CAMPS, AND EDUCATIONAL SERVICES NAMELY, CONDUCTING SEMINARS AND CLASSES IN THE FIELDS OF ZOOLOGY AND ECOLOGY (U.S. CLS. 100, 101 AND 107).

FIRST USE 3-11-1998; IN COMMERCE 3-11-1998.

ELIZABETH J. WINTER, EXAMINING ATTORNEY

SN 78-425,153. COMPUTER QUEST LTD., PARMA HEIGHTS, OH. FILED 5-26-2004.

BRIGHTER FUTURES BEGIN HERE

THE MARK CONSISTS OF STANDARD CHARACTERS WITHOUT CLAIM TO ANY PARTICULAR FONT, STYLE, SIZE, OR COLOR.

FOR EDUCATIONAL SERVICES, NAMELY, CONDUCTING CLASSES, TRAINING AND VOCATIONAL EDUCATION IN THE FIELDS OF COMPUTER HARDWARE TECHNOLOGY, COMPUTER SOFTWARE, ENVIRONMENTAL TECHNOLOGY, LABORATORY TECHNOLOGY, DESKTOP PUBLISHING, WEB DESIGN, VISUAL MEDIA, AND BUSINESS THEORY AND PRACTICE; VOCATIONAL GUIDANCE SERVICES (U.S. CLS. 100, 101 AND 107).

FIRST USE 4-15-2004; IN COMMERCE 4-15-2004.

JULIA HARDY COFIELD, EXAMINING ATTORNEY

CLASS 41—(Continued).

SN 78-425,526. HEARTLAND LAW ENFORCEMENT TRAINING INSTITUTE, L.L.C., LEE'S SUMMIT, MO. FILED 5-26-2004.

**HEARTLAND LAW
ENFORCEMENT
TRAINING INSTITUTE**

THE MARK CONSISTS OF STANDARD CHARACTERS WITHOUT CLAIM TO ANY PARTICULAR FONT, STYLE, SIZE, OR COLOR.

NO CLAIM IS MADE TO THE EXCLUSIVE RIGHT TO USE "LAW ENFORCEMENT TRAINING INSTITUTE", APART FROM THE MARK AS SHOWN.

FOR EDUCATIONAL SERVICES, NAMELY CONDUCTING TRAINING IN THE NATURE OF CLASSES, SEMINARS, AND WORKSHOPS IN THE FIELD OF LAW ENFORCEMENT (U.S. CLS. 100, 101 AND 107).

FIRST USE 2-19-2002; IN COMMERCE 8-19-2002.
JENNIFER KRISP, EXAMINING ATTORNEY

CLASS 41—(Continued).

SN 78-426,097. ASA ACADEMIC STUDY ASSOCIATES, WHITE PLAINS, NY. FILED 5-27-2004.

SUMMERSSION

THE MARK CONSISTS OF STANDARD CHARACTERS WITHOUT CLAIM TO ANY PARTICULAR FONT, STYLE, SIZE, OR COLOR.

FOR INTERNATIONAL EDUCATIONAL SERVICES, NAMELY, ARRANGING AND CONDUCTING STUDY ABROAD PROGRAMS FOR LANGUAGE AND CULTURAL EDUCATION FOR SECONDARY SCHOOL STUDENTS (U.S. CLS. 100, 101 AND 107).

FIRST USE 11-0-2003; IN COMMERCE 11-0-2003.
MONIQUE MILLER, EXAMINING ATTORNEY

SN 78-425,603. HEARTLAND LAW ENFORCEMENT TRAINING INSTITUTE, L.L.C., LEE'S SUMMIT, MO. FILED 5-26-2004.



NO CLAIM IS MADE TO THE EXCLUSIVE RIGHT TO USE "LAW ENFORCEMENT TRAINING INSTITUTE", APART FROM THE MARK AS SHOWN.

THE MARK CONSISTS OF THE WORDS HEARTLAND LAW ENFORCEMENT TRAINING INSTITUTE ACCOMPANIED BY THE STYLIZED IMAGE OF AN EAGLE IN FLIGHT.

FOR EDUCATIONAL SERVICES, NAMELY CONDUCTING TRAINING IN THE NATURE OF CLASSES, SEMINARS, AND WORKSHOPS IN THE FIELD OF LAW ENFORCEMENT (U.S. CLS. 100, 101 AND 107).

FIRST USE 2-19-2002; IN COMMERCE 11-14-2003.
JENNIFER KRISP, EXAMINING ATTORNEY

SN 78-426,578. EYEPLAY GAMES LLC, FAYVILLE, MA. FILED 5-27-2004.

EyePlay Games

THE MARK CONSISTS OF STANDARD CHARACTERS WITHOUT CLAIM TO ANY PARTICULAR FONT, STYLE, SIZE, OR COLOR.

NO CLAIM IS MADE TO THE EXCLUSIVE RIGHT TO USE GAMES, APART FROM THE MARK AS SHOWN.

FOR ENTERTAINMENT SERVICES, NAMELY, PROVIDING AN ONLINE COMPUTER GAME (U.S. CLS. 100, 101 AND 107).

FIRST USE 4-16-2001; IN COMMERCE 4-16-2001.
JILL C. ALT, EXAMINING ATTORNEY

CLASS 41—(Continued).

SN 78-426,956. BESSELLIEU, LINDA, FREEPORT, NY. FILED 5-28-2004.

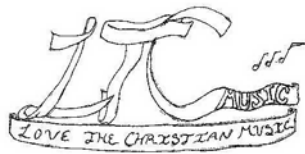

NO CLAIM IS MADE TO THE EXCLUSIVE RIGHT TO USE "CHRISTIAN MUSIC", APART FROM THE MARK AS SHOWN.
 FOR RECORD PRODUCTION SERVICES (U.S. CLS. 100, 101 AND 107).
 KAREN BRACEY, EXAMINING ATTORNEY

SN 78-427,219. AMFM BROADCASTING, INC., CHICAGO, IL. FILED 5-28-2004.

THE CHILL

THE MARK CONSISTS OF STANDARD CHARACTERS WITHOUT CLAIM TO ANY PARTICULAR FONT, STYLE, SIZE, OR COLOR.
 FOR ENTERTAINMENT SERVICES, NAMELY, LIVE PERFORMANCES FEATURING MUSIC AND/OR SPOKEN WORD (U.S. CLS. 100, 101 AND 107).
 FIRST USE 5-21-2004; IN COMMERCE 5-21-2004.
 CAROLYN CATALDO, EXAMINING ATTORNEY

CLASS 41—(Continued).

SN 78-428,948. CITY OF SAN ANTONIO, SAN ANTONIO, TX. FILED 6-2-2004.



NO CLAIM IS MADE TO THE EXCLUSIVE RIGHT TO USE "FALL ART FESTIVALS", APART FROM THE MARK AS SHOWN.
 FOR ENTERTAINMENT SERVICES, NAMELY, ARRANGING AND CONDUCTING EVENTS FEATURING ART EXHIBITIONS, ART DISPLAYS, ARTS AND CRAFTS, TOURS OF ART STUDIOS, DANCING, FOOD AND PERFORMING ARTS (U.S. CLS. 100, 101 AND 107).
 FIRST USE 6-2-2004; IN COMMERCE 6-2-2004.
 BRIAN NEVILLE, EXAMINING ATTORNEY

SN 78-428,950. HARE, DANIEL, ENCINITAS, CA. FILED 6-2-2004.

THE PEOPLE STUDIO

THE MARK CONSISTS OF STANDARD CHARACTERS WITHOUT CLAIM TO ANY PARTICULAR FONT, STYLE, SIZE, OR COLOR.
 NO CLAIM IS MADE TO THE EXCLUSIVE RIGHT TO USE "STUDIO", APART FROM THE MARK AS SHOWN.
 FOR ENTERTAINMENT SERVICES IN THE FIELD OF INDEPENDENT FILM DISTRIBUTION AND EXHIBITION; EDUCATIONAL SERVICES, NAMELY PROVIDING CLASSES, WORKSHOPS AND SEMINARS IN THE FIELD OF INDEPENDENT FILM PRODUCTION, DISTRIBUTION, MARKETING AND EXHIBITION (U.S. CLS. 100, 101 AND 107).
 FIRST USE 6-1-2004; IN COMMERCE 6-2-2004.
 BRIAN NEVILLE, EXAMINING ATTORNEY

CLASS 41—(Continued).

SN 78-429,273. OPERATION RESPECT, INC., NEW YORK, NY. FILED 6-3-2004.

OPERATION RESPECT

THE MARK CONSISTS OF STANDARD CHARACTERS WITHOUT CLAIM TO ANY PARTICULAR FONT, STYLE, SIZE, OR COLOR.

FOR EDUCATIONAL SERVICES, NAMELY CONDUCTING WORKSHOPS AND PROGRAMS IN THE FIELDS OF CHARACTER EDUCATION AND SOCIAL AND EMOTIONAL LEARNING FOR CHILDREN, AND DEVELOPING AND DISTRIBUTING COURSE MATERIAL IN CONNECTION THEREWITH; DEVELOPING AND PROVIDING EDUCATIONAL MATERIAL FOR OTHERS IN THE FIELDS OF CHARACTER EDUCATION AND SOCIAL AND EMOTIONAL LEARNING FOR CHILDREN (U.S. CLS. 100, 101 AND 107).

FIRST USE 9-0-2000; IN COMMERCE 9-0-2000.
INGA ERVIN, EXAMINING ATTORNEY

CLASS 41—(Continued).

SN 78-429,549. ALL STAR MIDWEST, INC., MANHATTAN, KS. FILED 6-3-2004.

BARPOKER

THE MARK CONSISTS OF STANDARD CHARACTERS WITHOUT CLAIM TO ANY PARTICULAR FONT, STYLE, SIZE, OR COLOR.

FOR ENTERTAINMENT IN THE NATURE OF POKER TOURNAMENTS (U.S. CLS. 100, 101 AND 107).

FIRST USE 11-11-2003; IN COMMERCE 5-24-2004.
SAMUEL E. SHARPER JR., EXAMINING ATTORNEY

SN 78-429,510. BREWER, ROY E., FULTONDALE, AL. FILED 6-3-2004.



THE COLOR(S) BLUE AND GOLD IS/ARE CLAIMED AS A FEATURE OF THE MARK.

THE MARK CONSISTS OF THREE INTERCONNECTED TRIANGLES COMBINED TO CREATE ONE TRIANGLE, COMPRISED OF A GOLD TRIANGLE ON THE BOTTOM LEFT, A ROYAL BLUE TRIANGLE ON THE BOTTOM RIGHT AND A NON-COLOR SPECIFIC OUTLINE OF A TRIANGLE ON TOP.

FOR TRAINING SERVICES IN THE FIELD OF BUSINESS PROJECT MANAGEMENT, NAMELY BUSINESS CONSULTATION SERVICES; TRAINING SERVICES IN THE FIELD OF BUSINESS PROJECT DEVELOPMENT SERVICES, NAMELY PROVIDING START-UP AND CONTINUED PROFESSIONAL DEVELOPMENT SUPPORT FOR BUSINESSES OF OTHERS (U.S. CLS. 100, 101 AND 107).

FIRST USE 9-7-2001; IN COMMERCE 9-25-2001.
INGA ERVIN, EXAMINING ATTORNEY

SN 78-429,576. BIRDZERK!, INC., LOUISVILLE, KY. FILED 6-3-2004.

BIRDZERK!

THE MARK CONSISTS OF STANDARD CHARACTERS WITHOUT CLAIM TO ANY PARTICULAR FONT, STYLE, SIZE, OR COLOR.

FOR ENTERTAINMENT SERVICES, NAMELY, COMIC PERFORMANCES BY COSTUMED CHARACTERS (U.S. CLS. 100, 101 AND 107).

FIRST USE 1-17-1995; IN COMMERCE 1-17-1995.
BRENDAN REGAN, EXAMINING ATTORNEY

CLASS 41—(Continued).

SN 78-429,593. SACCA, TONY J., LAS VEGAS, NV. FILED 6-3-2004.

**Entertainment
Ambassador of Las
Vegas**

THE MARK CONSISTS OF STANDARD CHARACTERS WITHOUT CLAIM TO ANY PARTICULAR FONT, STYLE, SIZE, OR COLOR.

FOR ENTERTAINMENT IN THE NATURE OF VISUAL AND AUDIO PERFORMANCES AND MUSICAL VARIETY, NEWS AND COMEDY SHOWS (U.S. CLS. 100, 101 AND 107).

BRENDAN REGAN, EXAMINING ATTORNEY

SN 78-429,907. MARRION, JACK H., MARYLAND HEIGHTS, MO. FILED 6-4-2004.

SAFE MONEY PLACES

THE MARK CONSISTS OF STANDARD CHARACTERS WITHOUT CLAIM TO ANY PARTICULAR FONT, STYLE, SIZE, OR COLOR.

FOR EDUCATION SERVICES, NAMELY, PROVIDING TUTORIAL SESSIONS IN THE FIELD OF PERSONAL FINANCIAL MANAGEMENT (U.S. CLS. 100, 101 AND 107).

JENNIFER KRISP, EXAMINING ATTORNEY

CLASS 41—(Continued).

SN 78-430,250. THOROUGHbred LEGENDS, LLC, ATLANTA, GA. FILED 6-4-2004.

WHIRLAWAY

THE MARK CONSISTS OF STANDARD CHARACTERS WITHOUT CLAIM TO ANY PARTICULAR FONT, STYLE, SIZE, OR COLOR.

FOR ENTERTAINMENT SERVICES, NAMELY, PRODUCTION OF THEATRICAL PLAYS, MOTION PICTURE FILMS, TELEVISION SHOWS, AND DOCUMENTARIES (U.S. CLS. 100, 101 AND 107).

GINA HAYES, EXAMINING ATTORNEY

SN 78-430,922. STANWORTH DEVELOPMENT LIMITED, TORTOLA, BR.VIRGIN ISLANDS, FILED 6-7-2004.



NO CLAIM IS MADE TO THE EXCLUSIVE RIGHT TO USE "GAMING", APART FROM THE MARK AS SHOWN.

FOR ENTERTAINMENT SERVICES, NAMELY, GAMING SERVICES IN THE NATURE OF GAMES OF CHANCE, GAMES OF SKILL AND CASINO STYLE GAMES (U.S. CLS. 100, 101 AND 107).

FIRST USE 5-31-2004; IN COMMERCE 5-31-2004.

C. DIONNE CLYBURN, EXAMINING ATTORNEY

SN 78-432,022. ABRAHAMSON, TERRY, CHICAGO, IL. FILED 6-8-2004.

WRITE ME SOMETHING

THE MARK CONSISTS OF STANDARD CHARACTERS WITHOUT CLAIM TO ANY PARTICULAR FONT, STYLE, SIZE, OR COLOR.

FOR MUSIC PRODUCTION SERVICES; THEATER PRODUCTION SERVICES; FILM PRODUCTION SERVICES; CUSTOM WRITING SERVICES, NAMELY, SPEECHES, MUSIC, ADVERTISING, WEBSITES, THEATER AND FILM, MARKETING PROJECTS, GREETING CARDS, STORYBOOKS (U.S. CLS. 100, 101 AND 107).

FIRST USE 3-31-2004; IN COMMERCE 3-31-2004.

WILLIAM BRECKENFELD, EXAMINING ATTORNEY

CLASS 41—(Continued).

SN 78-432,858. DAVIS, ROBERT KENT, ANNA MARIA, FL. FILED 6-10-2004.

CLASS 41—(Continued).

SN 78-434,057. WARD, ALLISON L.P., DEXTER, MI. FILED 6-11-2004.

MVM

Pretty Nifty Art

THE MARK CONSISTS OF STANDARD CHARACTERS WITHOUT CLAIM TO ANY PARTICULAR FONT, STYLE, SIZE, OR COLOR.

FOR ENTERTAINMENT SERVICES, NAMELY, THE PRODUCTION OF DEMONSTRATIONS AND SHOWS FEATURING FIGHTS BETWEEN HUMAN AND ROBOT PERFORMERS RENDERED LIVE AND THROUGH THE MEDIA OF TELEVISION (U.S. CLS. 100, 101 AND 107).

DAVID MURRAY, EXAMINING ATTORNEY

THE MARK CONSISTS OF STANDARD CHARACTERS WITHOUT CLAIM TO ANY PARTICULAR FONT, STYLE, SIZE, OR COLOR.

NO CLAIM IS MADE TO THE EXCLUSIVE RIGHT TO USE "ART", APART FROM THE MARK AS SHOWN.

FOR PROVIDING CREATIVE ART PARTIES FOR IN HOME AND OFFICES FOR THE PURPOSE OF CREATING ART (U.S. CLS. 100, 101 AND 107).

FIRST USE 5-25-2004; IN COMMERCE 5-25-2004. LINDA POWELL, EXAMINING ATTORNEY

SN 78-433,444. WIDOWMAKER, L.L.C., CHENEY, WA. FILED 6-10-2004.

SN 78-434,632. MUSICALLY SPEAKING, GLENVIEW, IL. FILED 6-14-2004.

WidowMaker

MUSICALLY SPEAKING

THE MARK CONSISTS OF STANDARD CHARACTERS WITHOUT CLAIM TO ANY PARTICULAR FONT, STYLE, SIZE, OR COLOR.

FOR ENTERTAINMENT SERVICES, NAMELY, PARTICIPATION IN MONSTER TRUCK RACES, SHOWS, EXHIBITIONS, AND DEMONSTRATIONS (U.S. CLS. 100, 101 AND 107).

FIRST USE 1-2-2004; IN COMMERCE 1-2-2004. STEVEN BERK, EXAMINING ATTORNEY

THE MARK CONSISTS OF STANDARD CHARACTERS WITHOUT CLAIM TO ANY PARTICULAR FONT, STYLE, SIZE, OR COLOR.

FOR SPEECH AND LANGUAGE MUSIC CLASSES FOR CHILDREN (U.S. CLS. 100, 101 AND 107).

GENE MACIOL, EXAMINING ATTORNEY

CLASS 41—(Continued).

SN 78-434,748. ALL ART MEDIA INC., SOUTH PORTLAND, ME. FILED 6-14-2004.

CLASS 41—(Continued).

SN 78-434,873. PERRY MEDIA, INCORPORATED, ELLISVILLE, MO. FILED 6-14-2004.

Delicious TV

PERAZIM

THE MARK CONSISTS OF STANDARD CHARACTERS WITHOUT CLAIM TO ANY PARTICULAR FONT, STYLE, SIZE, OR COLOR.

NO CLAIM IS MADE TO THE EXCLUSIVE RIGHT TO USE "TV", APART FROM THE MARK AS SHOWN.

FOR VEGETARIAN COOKING AND LIFESTYLE TELEVISION SERIES (U.S. CLS. 100, 101 AND 107).

MICHAEL HALL, EXAMINING ATTORNEY

THE MARK CONSISTS OF STANDARD CHARACTERS WITHOUT CLAIM TO ANY PARTICULAR FONT, STYLE, SIZE, OR COLOR.

FOR AUDIO AND VIDEO RECORDING AND PRODUCTION (U.S. CLS. 100, 101 AND 107).

YSA DEJESUS, EXAMINING ATTORNEY

SN 78-434,817. MASTERCARD INTERNATIONAL INCORPORATED, PURCHASE, NY. FILED 6-14-2004.

SN 78-434,982. MORTON, VICTORIA M., CLEARWATER, FL. FILED 6-14-2004.

PURCHASELOGIC

BEAUTIFUL AT ANY AGE

THE MARK CONSISTS OF STANDARD CHARACTERS WITHOUT CLAIM TO ANY PARTICULAR FONT, STYLE, SIZE, OR COLOR.

FOR PROVIDING TRAINING TO OTHERS REGARDING PROCUREMENT SERVICES (U.S. CLS. 100, 101 AND 107).

FIRST USE 4-19-2004; IN COMMERCE 4-19-2004.

ANDREW BENZMILLER, EXAMINING ATTORNEY

THE MARK CONSISTS OF STANDARD CHARACTERS WITHOUT CLAIM TO ANY PARTICULAR FONT, STYLE, SIZE, OR COLOR.

FOR RADIO ENTERTAINMENT SERVICES, NAMELY RADIO PROGRAMS FEATURING PERFORMANCES BY A VICTORIA MORTON (U.S. CLS. 100, 101 AND 107).

FIRST USE 5-15-2004; IN COMMERCE 5-15-2004.

ALEX KEAM, EXAMINING ATTORNEY

CLASS 41—(Continued).

SN 78-435,061. TWENTIETH CENTURY FOX FILM CORPORATION, LOS ANGELES, CA. FILED 6-14-2004.

CLASS 41—(Continued).

SN 78-436,156. DONOVAN, GWEN PATRICE, COCOA, FL. FILED 6-16-2004.

FLEET STREET

GOT CORE?

THE MARK CONSISTS OF STANDARD CHARACTERS WITHOUT CLAIM TO ANY PARTICULAR FONT, STYLE, SIZE, OR COLOR.

FOR ENTERTAINMENT SERVICES IN THE NATURE OF A TELEVISION SERIES FEATURING DRAMA (U.S. CLS. 100, 101 AND 107).

CHERYL CLAYTON, EXAMINING ATTORNEY

THE MARK CONSISTS OF STANDARD CHARACTERS WITHOUT CLAIM TO ANY PARTICULAR FONT, STYLE, SIZE, OR COLOR.

FOR EDUCATIONAL SERVICES, NAMELY PROVIDING HEALTH, EXERCISE AND FITNESS PROGRAMS FEATURING PILATES TO INSTRUCTORS AND STUDENTS IN FITNESS CLUBS, HEALTH, AND EXERCISE CENTERS; FITNESS CENTERS PROVIDING HEALTH, FITNESS AND EXERCISE PROGRAMS (U.S. CLS. 100, 101 AND 107).

BRIDGETT SMITH, EXAMINING ATTORNEY

SN 78-435,234. SHARIF, MARYAM, NEW YORK, NY. FILED 6-15-2004.

SN 78-436,297. UNIVERSITY OF CENTRAL FLORIDA, ORLANDO, FL. FILED 6-16-2004.

MaitriYoga

FROM PROMISE TO PROMINENCE

THE MARK CONSISTS OF STANDARD CHARACTERS WITHOUT CLAIM TO ANY PARTICULAR FONT, STYLE, SIZE, OR COLOR.

FOR YOGA CLASSES, YOGA WORKSHOPS AND YOGA RETREATS IN THE NATURE OF YOGA WORKSHOPS AND CLASSES (U.S. CLS. 100, 101 AND 107).

JOHN SCHUYLER YARD, EXAMINING ATTORNEY

THE MARK CONSISTS OF STANDARD CHARACTERS WITHOUT CLAIM TO ANY PARTICULAR FONT, STYLE, SIZE, OR COLOR.

FOR EDUCATIONAL SERVICES, NAMELY, PROVIDING COURSES OF INSTRUCTION FOR OTHERS AT THE UNDERGRADUATE, GRADUATE AND POST-GRADUATE UNIVERSITY LEVEL; EDUCATIONAL RESEARCH; ENTERTAINMENT SERVICES, NAMELY, ORGANIZING AND CONDUCTING COLLEGE SPORTS COMPETITIONS, ATHLETIC EVENTS AND TOURNAMENTS, EXHIBITIONS, CONFERENCES, LECTURES, CONCERTS, LIVE PERFORMANCES, FESTIVALS AND THEATER AND DANCE PRODUCTIONS (U.S. CLS. 100, 101 AND 107).

FIRST USE 10-0-2003; IN COMMERCE 10-0-2003.
PRISCILLA MILTON, EXAMINING ATTORNEY

CLASS 41—(Continued).

SN 78-436,568. FUEL TV, INC., LOS ANGELES, CA. FILED 6-16-2004.

CLASS 41—(Continued).

SN 78-436,675. SAWYER, DAWN, FLOWER MOUND, TX. FILED 6-17-2004.

PRO-FILES

**Choose To Be
Exceptional!**

THE MARK CONSISTS OF STANDARD CHARACTERS WITHOUT CLAIM TO ANY PARTICULAR FONT, STYLE, SIZE, OR COLOR.

NO CLAIM IS MADE TO THE EXCLUSIVE RIGHT TO USE "PROFILES", APART FROM THE MARK AS SHOWN.

FOR ENTERTAINMENT SERVICES IN THE NATURE OF A TELEVISION SERIES FEATURING ATHLETES (U.S. CLS. 100, 101 AND 107).

ELLEN PERKINS, EXAMINING ATTORNEY

THE MARK CONSISTS OF STANDARD CHARACTERS WITHOUT CLAIM TO ANY PARTICULAR FONT, STYLE, SIZE, OR COLOR.

FOR TRAINING SERVICES IN THE FIELD OF LEADERSHIP TRAINING (U.S. CLS. 100, 101 AND 107).

JOANNA DUKOVIC, EXAMINING ATTORNEY

SN 78-436,646. DAVIS HOLDINGS OF NORTH CAROLINA, DBA C. A. SHORT COMPANY, CHARLOTTE, NC. FILED 6-17-2004.

SN 78-436,863. INTERNATIONAL TRADE EVENTS MANAGEMENT, LLC, WASHINGTON, DC. FILED 6-17-2004.

UROCK

Swizzle

THE MARK CONSISTS OF STANDARD CHARACTERS WITHOUT CLAIM TO ANY PARTICULAR FONT, STYLE, SIZE, OR COLOR.

FOR EDUCATIONAL SERVICES, NAMELY- CONDUCTING INSTRUCTIONAL PROGRAMS DESIGNED TO INCREASE EMPLOYEE MORALE THROUGH PEER-TO-PEER RECOGNITION (U.S. CLS. 100, 101 AND 107).

KATHY DE JONGE, EXAMINING ATTORNEY

FOR ENTERTAINMENT SERVICES, NAMELY, NIGHTCLUB SERVICES FEATURING LIVE MUSIC PERFORMANCE (U.S. CLS. 100, 101 AND 107).

FIRST USE 4-1-2004; IN COMMERCE 4-1-2004.

RONALD AIKENS, EXAMINING ATTORNEY

CLASS 41—(Continued).

SN 78-437,359. TELEVISION EVENTS AND MARKETING, INC., HONOLULU, HI. FILED 6-17-2004.

CLASS 41—(Continued).

SN 78-437,501. TRANSITIONERS, LLC, BECKET, MA. FILED 6-18-2004.

XTERRA

THE MARK CONSISTS OF STANDARD CHARACTERS WITHOUT CLAIM TO ANY PARTICULAR FONT, STYLE, SIZE, OR COLOR.

FOR ENTERTAINMENT IN THE NATURE OF ATHLETIC COMPETITIONS, NAMELY, ORGANIZING AND CONDUCTING SPORTING EVENTS (U.S. CLS. 100, 101 AND 107).

FIRST USE 10-11-1998; IN COMMERCE 10-11-1998.
BARBARA BROWN, EXAMINING ATTORNEY

THE MARK CONSISTS OF STANDARD CHARACTERS WITHOUT CLAIM TO ANY PARTICULAR FONT, STYLE, SIZE, OR COLOR.

FOR EDUCATIONAL SERVICES, NAMELY CONDUCTING CONFERENCES, SEMINARS AND WORKSHOPS IN THE FIELD OF HUMAN RIGHTS, THE ENVIRONMENT, SOCIALLY RESPONSIBLE BUSINESS, AND SPIRITUAL ACTIVISM, INCLUDING DISTRIBUTION OF COURSE MATERIALS IN ASSOCIATION THEREWITH (U.S. CLS. 100, 101 AND 107).

FIRST USE 4-15-2003; IN COMMERCE 4-15-2003.
MARY CRAWFORD, EXAMINING ATTORNEY

SN 78-437,812. FELLOWSHIP CHURCH, GRAPEVINE, TX. FILED 6-18-2004.

SN 78-437,385. MYERS, DAVID S., SLIDELL, LA. AND MYERS, JOANNE B., SLIDELL, LA. FILED 6-17-2004.

Treasured Images

FOR PORTRAIT PHOTOGRAPHY IN SCHOOLS, CHILD CARE CENTERS AND CORPORATE VENUES (U.S. CLS. 100, 101 AND 107).

ALLISON HOLTZ, EXAMINING ATTORNEY

CREATIVE CONNECTION

THE MARK CONSISTS OF STANDARD CHARACTERS WITHOUT CLAIM TO ANY PARTICULAR FONT, STYLE, SIZE, OR COLOR.

FOR ENTERTAINMENT SERVICES IN THE NATURE OF ONGOING RADIO AND TELEVISION PROGRAMS IN THE FIELD OF RELIGION (U.S. CLS. 100, 101 AND 107).

FIRST USE 4-1-2002; IN COMMERCE 4-1-2002.
BARNEY CHARLON, EXAMINING ATTORNEY

CLASS 41—(Continued).

SN 78-438,041. FREYA PRODUCTIONS, SPOKANE, WA.
FILED 6-18-2004.

CLASS 41—(Continued).

SN 78-438,584. UNIVERSAL TECHNICAL INSTITUTE, INC.,
PHOENIX, AZ. FILED 6-21-2004.

FREYA PRODUCTIONS



THE MARK CONSISTS OF STANDARD CHARACTERS WITHOUT CLAIM TO ANY PARTICULAR FONT, STYLE, SIZE, OR COLOR.

NO CLAIM IS MADE TO THE EXCLUSIVE RIGHT TO USE "PRODUCTIONS", APART FROM THE MARK AS SHOWN.

THE NAME(S), PORTRAIT(S), AND/OR SIGNATURE(S) SHOWN IN THE MARK DOES NOT IDENTIFY A PARTICULAR LIVING INDIVIDUAL.

FOR MOTION PICTURE FILM PRODUCTION; DOCUMENTARY FILM PRODUCTION; PUBLICATION OF BOOKS (U.S. CLS. 100, 101 AND 107).

WINSTON FOLMAR, EXAMINING ATTORNEY

THE MARK CONSISTS OF STANDARD CHARACTERS WITHOUT CLAIM TO ANY PARTICULAR FONT, STYLE, SIZE, OR COLOR.

FOR EDUCATIONAL SERVICES, NAMELY, CONDUCTING PROGRAMS IN THE FIELD OF MOTORCYCLE TECHNOLOGY (U.S. CLS. 100, 101 AND 107).

FIRST USE 0-0-1973; IN COMMERCE 0-0-1973.

NANCY CLARKE, EXAMINING ATTORNEY

SN 78-438,567. UNIVERSAL TECHNICAL INSTITUTE, INC.,
PHOENIX, AZ. FILED 6-21-2004.

SN 78-438,612. UNIVERSAL TECHNICAL INSTITUTE, INC.,
PHOENIX, AZ. FILED 6-21-2004.

**UNIVERSAL
TECHNICAL INSTITUTE**



THE MARK CONSISTS OF STANDARD CHARACTERS WITHOUT CLAIM TO ANY PARTICULAR FONT, STYLE, SIZE, OR COLOR.

NO CLAIM IS MADE TO THE EXCLUSIVE RIGHT TO USE TECHNICAL INSTITUTE, APART FROM THE MARK AS SHOWN.

FOR EDUCATIONAL SERVICES, NAMELY, CONDUCTING PROGRAMS IN THE FIELDS OF- AUTOMOTIVE TECHNOLOGY; DIESEL TECHNOLOGY; MOTORCYCLE TECHNOLOGY; MARINE AND WATERCRAFT TECHNOLOGY; COLLISION REPAIR AND REFINISHING TECHNOLOGY; AND HEATING, VENTILATION, AIR CONDITIONING, AND REFRIGERATION TECHNOLOGY (U.S. CLS. 100, 101 AND 107).

FIRST USE 0-0-1965; IN COMMERCE 0-0-1965.

TRACY FLETCHER, EXAMINING ATTORNEY

THE MARK CONSISTS OF STANDARD CHARACTERS WITHOUT CLAIM TO ANY PARTICULAR FONT, STYLE, SIZE, OR COLOR.

FOR EDUCATIONAL SERVICES, NAMELY, CONDUCTING PROGRAMS IN THE FIELD OF MARINE AND WATERCRAFT TECHNOLOGY (U.S. CLS. 100, 101 AND 107).

FIRST USE 0-0-1991; IN COMMERCE 0-0-1991.

NANCY CLARKE, EXAMINING ATTORNEY

CLASS 41—(Continued).

SN 78-438,789. MGI PHARMA, INC., BLOOMINGTON, MN. FILED 6-21-2004.

YES TO CONTROL

THE MARK CONSISTS OF STANDARD CHARACTERS WITHOUT CLAIM TO ANY PARTICULAR FONT, STYLE, SIZE, OR COLOR.

FOR EDUCATIONAL SERVICES, NAMELY, PROGRAMS FOR CHEMOTHERAPY PATIENTS (U.S. CLS. 100, 101 AND 107).

AMY HELLA, EXAMINING ATTORNEY

CLASS 41—(Continued).

SN 78-438,924. WOMEN'S SPORTS FOUNDATION, EAST MEADOW, NY. FILED 6-21-2004.

FITWOMAN AWARD

THE MARK CONSISTS OF STANDARD CHARACTERS WITHOUT CLAIM TO ANY PARTICULAR FONT, STYLE, SIZE, OR COLOR.

OWNER OF U.S. REG. NO. 2,143,709.

NO CLAIM IS MADE TO THE EXCLUSIVE RIGHT TO USE "AWARD", APART FROM THE MARK AS SHOWN. SEC. 2(F).

FOR PROVIDING RECOGNITION AND INCENTIVES BY THE WAY OF AWARDS TO DEMONSTRATE EXCELLENCE IN THE FIELD OF SPORTS (U.S. CLS. 100, 101 AND 107).

FIRST USE 6-1-1994; IN COMMERCE 6-1-1994.

JILL C. ALT, EXAMINING ATTORNEY

SN 78-438,838. THE KUGLER COMPANY, LLC, LOS ANGELES, CA. FILED 6-21-2004.

**Constructive
Candor**

THE MARK CONSISTS OF STANDARD CHARACTERS WITHOUT CLAIM TO ANY PARTICULAR FONT, STYLE, SIZE, OR COLOR.

FOR PERSONAL COACHING SERVICES IN THE FIELDS OF COMMUNICATION AND LEADERSHIP (U.S. CLS. 100, 101 AND 107).

IRA J. GOODSaid, EXAMINING ATTORNEY

SN 78-439,294. BODY OF CHRIST CHURCH INTERNATIONAL, USA, INC., THE, COLLEGE PARK, GA. FILED 6-22-2004.

LIVING IN VICTORY

THE MARK CONSISTS OF STANDARD CHARACTERS WITHOUT CLAIM TO ANY PARTICULAR FONT, STYLE, SIZE, OR COLOR.

FOR ENTERTAINMENT AND EDUCATIONAL SERVICES, NAMELY CONTINUING TELEVISION AND RADIO SHOWS FEATURING RELIGIOUS MINISTRY, PRODUCTION OF TELEVISION AND RADIO SHOWS FEATURING RELIGIOUS MINISTRY, LIVE RELIGIOUS MINISTRY SERVICES, RELIGIOUS INSTRUCTION SERVICES, AND PROVIDING A WEB SITE FEATURING RELIGIOUS CONTENT (U.S. CLS. 100, 101 AND 107).

FIRST USE 3-0-1996; IN COMMERCE 3-0-1996.

CAROLYN CATALDO, EXAMINING ATTORNEY

CLASS 41—(Continued).

SN 78-439,313. VIACOM HA! HOLDING COMPANY, NEW YORK, NY. FILED 6-22-2004.

MIDNIGHT SPIKE

THE MARK CONSISTS OF STANDARD CHARACTERS WITHOUT CLAIM TO ANY PARTICULAR FONT, STYLE, SIZE, OR COLOR.

FOR ENTERTAINMENT SERVICES IN THE NATURE OF AN ON-GOING MAGAZINE-STYLE TELEVISION SERIES FEATURING LIVE ACTION, MUSIC, COMEDY AND DRAMA; PROVIDING ONLINE INFORMATION IN THE FIELD OF ENTERTAINMENT CONCERNING A MAGAZINE-STYLE TELEVISION SERIES (U.S. CLS. 100, 101 AND 107).

KARANENDRA S. CHHINA, EXAMINING ATTORNEY

CLASS 41—(Continued).

SN 78-442,086. PFIZER INC., NEW YORK, NY. FILED 6-28-2004.

PROTECTION, LIKE NO OTHER.

THE MARK CONSISTS OF STANDARD CHARACTERS WITHOUT CLAIM TO ANY PARTICULAR FONT, STYLE, SIZE, OR COLOR.

FOR EDUCATIONAL SERVICES, NAMELY, PROVIDING INFORMATIONAL WORKSHOPS, CONFERENCES AND SEMINARS IN THE FIELD OF LIVESTOCK ANIMAL HEALTH (U.S. CLS. 100, 101 AND 107).

ZACHARY BELLO, EXAMINING ATTORNEY

SN 78-440,085. THE DRIVER TRAINING GROUP, INC., REDMOND, WA. FILED 6-23-2004.

SWERVE

THE MARK CONSISTS OF STANDARD CHARACTERS WITHOUT CLAIM TO ANY PARTICULAR FONT, STYLE, SIZE, OR COLOR.

FOR VEHICLE DRIVING INSTRUCTION, NAMELY, ADVANCED AUTOMOBILE DRIVER TRAINING; DRIVING SCHOOLS (U.S. CLS. 100, 101 AND 107).

SKYE YOUNG, EXAMINING ATTORNEY

SN 78-490,738. THE CARTOON NETWORK LP, LLLP, ATLANTA, GA. FILED 9-28-2004.

TOM GOES TO THE MAYOR

THE MARK CONSISTS OF STANDARD CHARACTERS WITHOUT CLAIM TO ANY PARTICULAR FONT, STYLE, SIZE, OR COLOR.

FOR ENTERTAINMENT AND EDUCATION SERVICES IN THE NATURE OF A CONTINUING COMEDY, DRAMA, ACTION, ADVENTURE AND/OR ANIMATION PROGRAM SERIES AND MOTION PICTURE FILM PRODUCTION, PROVIDED THROUGH CABLE TELEVISION, BROADCAST TELEVISION, BROADCAST RADIO AND THE GLOBAL COMPUTER INFORMATION NETWORK (U.S. CLS. 100, 101 AND 107).

DEZMONA MIZELLE, EXAMINING ATTORNEY

CLASS 41—(Continued).

SN 79-000,289. WORLD BET EXCHANGE LIMITED, LONDON, WC2E 7RS, UNITED KINGDOM, FILED 12-19-2003.



OWNER OF INTERNATIONAL REGISTRATION 0798007 DATED 2-12-2003, EXPIRES 2-12-2013.

LIGHT BLUE, DARK BLUE, BLACK, BLACK, DARK YELLOW, LIGHT YELLOW

THE COLOR(S) FROM LEFT TO RIGHT IS LIGHT BLUE, DARK BLUE, BLACK, BLACK, DARK YELLOW, LIGHT YELLOW IS/ARE CLAIMED AS A FEATURE OF THE MARK.

FOR BETTING SERVICES PROVIDED ON THE INTERNET (U.S. CLS. 100, 101 AND 107).

MIDGE BUTLER, EXAMINING ATTORNEY

CLASS 41—(Continued).

SN 79-005,627. DEVELOPMENT CENTER FOR TEACHING; CHINESE AS A FOREIGN LANGUAGE OF; THE MINISTRY OF EDUCATION P.R.C., CHINA, FILED 6-3-2004.



OWNER OF INTERNATIONAL REGISTRATION 0834069 DATED 6-3-2004, EXPIRES 6-3-2014.

FOR EDUCATIONAL EXAMINATION (U.S. CLS. 100, 101 AND 107).

MIDGE BUTLER, EXAMINING ATTORNEY

SN 79-001,365. FASHIONTV.COM GMBH, FED REP GERMANY, FILED 2-5-2004.



OWNER OF INTERNATIONAL REGISTRATION 0811683 DATED 9-3-2003, EXPIRES 9-3-2013.

FOR FILM PRODUCTION, MOTION PICTURE RENTAL, PROJECTION OF FILMS NAMELY MOTION PICTURE THEATERS, BROADCAST AND TELEVISION ENTERTAINMENT NAMELY ON-GOING TELEVISION AND RADIO PROGRAMS IN THE FIELD OF NEWS, COMEDY, VARIETY (U.S. CLS. 100, 101 AND 107).

BRIAN NEVILLE, EXAMINING ATTORNEY

CLASS 42—SCIENTIFIC, COMPUTER AND LEGAL SERVICES

SN 75-730,116. BROWN, KAREN STEVENSON, NORMAL, IL. FILED 7-9-1999.

ELDERWEB

SEC. 2(F). FOR HEALTH INFORMATION (U.S. CLS. 100 AND 101).

FIRST USE 0-0-1994; IN COMMERCE 0-0-1994.

AMY HELLA, EXAMINING ATTORNEY

CLASS 42—(Continued).

SN 76-121,656. ACTV ENTERTAINMENT, INC., NEW YORK, NY. FILED 8-30-2000.



NO CLAIM IS MADE TO THE EXCLUSIVE RIGHT TO USE "TV", APART FROM THE MARK AS SHOWN.

FOR FACILITATING THE CUSTOMIZATION OR INDIVIDUALIZATION OF TELEVISION OR VIDEO PROGRAMMING, NAMELY, PROVIDING TECHNOLOGY THAT ENABLES THE VIEWER TO ACCESS, SELECT, UTILIZE OR OTHERWISE INTERFACE WITH LIVE OR PRERECORDED INSTRUCTIONAL, EDUCATIONAL AND/OR ENTERTAINMENT TELEVISION OR VIDEO PROGRAMMING BY UTILIZING DATA CODES IMBEDDED THEREIN OR ASSOCIATED THEREWITH TO RESPOND TO VIEWER INPUTS AND THAT ENABLES THE PROGRAMMER TO DELIVER CUSTOMIZED OR INDIVIDUALIZED TELEVISION OR VIDEO PROGRAMMING IN RESPONSE TO THOSE VIEWER INPUTS OR ANY RECORD THEREOF (U.S. CLS. 100 AND 101).

MELVIN AXILBUND, EXAMINING ATTORNEY

SN 76-443,278. KELLTECH INTERNATIONAL, INC., DBA PCS ISERVICES GROUP, INC., INDEPENDENCE, OH. FILED 8-23-2002.

EMPOWERLAB

FOR CONSULTING SERVICES, NAMELY ASSISTANCE AND EVALUATION OF MEDICAL OF HEALTH-CARE RESEARCH AND DEVELOPMENT, ANALYSIS OF DATA AND TEST RESULTS, AND COMPUTER SIMULATION (U.S. CLS. 100 AND 101).

FIRST USE 6-26-2002; IN COMMERCE 6-26-2002.

AMOS T. MATTHEWS, JR., EXAMINING ATTORNEY

SN 76-498,673. ATLANTIC ASSURANCE, LLC, CHARLOTTE, NC. FILED 3-19-2003.

THE LINING IS A FEATURE OF THE MARK AND DOES NOT INDICATE COLOR.

FOR PUBLIC DOCUMENT SEARCHING AND RETRIEVAL FOR THE PURPOSE OF CANCELING LIENS FROM THE PUBLIC RECORD (U.S. CLS. 100 AND 101).

FIRST USE 12-2-2002; IN COMMERCE 12-2-2002.

CIMMERIAN COLEMAN, EXAMINING ATTORNEY

CLASS 42—(Continued).

SN 76-528,557. CYBERSOFT, INC., CONSHOHOCKEN, PA. FILED 7-9-2003.

CYBERSOFT

OWNER OF U.S. REG. NOS. 2,422,687 AND 2,620,317.

FOR COMPUTER CONSULTATION SERVICES IN THE FIELD OF SECURITY AND UTILITY APPLICATIONS; COMPUTER SOFTWARE CONSULTATION SERVICES IN THE FIELD OF SECURITY AND UTILITY SOFTWARE; CONSULTING SERVICES IN THE FIELD OF DESIGN, SELECTION, IMPLEMENTATION AND USE OF COMPUTER SOFTWARE SYSTEMS FOR OTHERS IN THE FIELD OF SECURITY AND UTILITY SOFTWARE; TECHNICAL SUPPORT SERVICES, NAMELY, TROUBLESHOOTING OF COMPUTER SOFTWARE PROBLEMS IN THE FIELD OF SECURITY, FORENSICS AND UTILITY SOFTWARE (U.S. CLS. 100 AND 101).

FIRST USE 0-0-1990; IN COMMERCE 0-0-1990.

VERNA BETH RIRIE, EXAMINING ATTORNEY

SN 76-528,891. CYBERSOFT, INC., CONSHOHOCKEN, PA. FILED 7-11-2003.

**CYBERSOFT
INTERNATIONAL**

OWNER OF U.S. REG. NOS. 2,422,687 AND 2,620,317.

NO CLAIM IS MADE TO THE EXCLUSIVE RIGHT TO USE "INTERNATIONAL", APART FROM THE MARK AS SHOWN.

FOR COMPUTER CONSULTATION SERVICES IN THE FIELD OF SECURITY AND UTILITY APPLICATIONS; COMPUTER SOFTWARE CONSULTATION SERVICES IN THE FIELD OF SECURITY AND UTILITY SOFTWARE; CONSULTING SERVICES IN THE FIELD OF DESIGN, SELECTION, IMPLEMENTATION AND USE OF COMPUTER SOFTWARE SYSTEMS FOR OTHERS IN THE FIELD OF SECURITY AND UTILITY SOFTWARE; TECHNICAL SUPPORT SERVICES, NAMELY, TROUBLESHOOTING OF COMPUTER SOFTWARE PROBLEMS IN THE FIELD OF SECURITY, FORENSICS AND UTILITY SOFTWARE (U.S. CLS. 100 AND 101).

FIRST USE 4-0-2003; IN COMMERCE 4-0-2003.

VERNA BETH RIRIE, EXAMINING ATTORNEY

SN 76-552,259. ESTECH, LLC, COLUMBUS, OH. FILED 10-17-2003.



NO CLAIM IS MADE TO THE EXCLUSIVE RIGHT TO USE RECYCLING SYMBOL, APART FROM THE MARK AS SHOWN.

FOR ENGINEERING SERVICES FOR WASTE TREATMENT PLANTS (U.S. CLS. 100 AND 101).

PAUL F. GAST, EXAMINING ATTORNEY

CLASS 42—(Continued).

SN 76-556,652. BSI PROPERTIES, LP, PITTSBURGH, PA.
FILED 11-3-2003.

PROPERTYSCOUT

FOR PROVIDING TEMPORARY USE OF NONDOWN-
LOADABLE COMPUTER SOFTWARE VIA THE INTER-
NET USED FOR REAL ESTATE MORTGAGE SERVICES,
NAMELY ORDER ENTRY, ASSET MANAGEMENT,
STATUS REPORTING AND RECORD KEEPING (U.S.
CLS. 100 AND 101).

KEVON CHISOLM, EXAMINING ATTORNEY

SN 76-560,888. AMERICAN TRANSPORTATION EX-
CHANGE, INC., IRVINE, CA. FILED 11-19-2003.

HALO

THE MARK CONSISTS OF STANDARD CHARACTERS
WITHOUT CLAIM TO ANY PARTICULAR FONT, STYLE,
SIZE, OR COLOR.

FOR PROVIDING NON-DOWNLOADABLE SOFT-
WARE FOR USE IN VISIBLE SUPPLY CHAIN MANE-
GEMENT AND SCHEDULING AND TRACKING OF
FREIGHT SHIPMENTS (U.S. CLS. 100 AND 101).

FIRST USE 6-0-2002; IN COMMERCE 6-0-2002.

ROBIN CHOSID, EXAMINING ATTORNEY

SN 76-566,967. BAY REPROGRAPHICS, INC., TAMPA, FL.
FILED 12-12-2003.

NATIONAL GRAPHIC IMAGING

THE MARK CONSISTS OF STANDARD CHARACTERS
WITHOUT CLAIM TO ANY PARTICULAR FONT, STYLE,
SIZE, OR COLOR.

NO CLAIM IS MADE TO THE EXCLUSIVE RIGHT TO
USE "GRAPHIC IMAGING", APART FROM THE MARK AS
SHOWN.

SEC. 2(F).

FOR GRAPHIC ART DESIGN AND COMPUTER GRA-
PHIC SERVICES (U.S. CLS. 100 AND 101).

FIRST USE 2-10-1998; IN COMMERCE 2-10-1998.

JOANNA DUKOVIC, EXAMINING ATTORNEY

CLASS 42—(Continued).

SN 76-568,179. LITT, STEVEN JAY, DBA AMERICAN
TROUBLEBUSTERS, LONGWOOD, FL. FILED 1-2-2004.

TROUBLESHOOTERS.COM

THE MARK CONSISTS OF STANDARD CHARACTERS
WITHOUT CLAIM TO ANY PARTICULAR FONT, STYLE,
SIZE, OR COLOR.

OWNER OF U.S. REG. NOS. 2,164,874 AND 2,210,851.

SEC. 2(F).

FOR COMPUTER SERVICES, NAMELY, PROVIDING
INFORMATION REGARDING THE DIAGNOSIS OF
PROBLEMS IN COMPUTERS, COMPUTER PROGRAMS,
COMPUTER OPERATING SYSTEMS, AND COMPUTER
NETWORKS, AS WELL AS INFORMATION ON COM-
PUTER PROGRAM DESIGN AND COMPUTER NET-
WORK DESIGN (U.S. CLS. 100 AND 101).

FIRST USE 7-26-1996; IN COMMERCE 7-26-1996.

MITCHELL FRONT, EXAMINING ATTORNEY

SN 76-591,482. CHAN, THOMAS T., LOS ANGELES, CA.
FILED 5-10-2004.

CHAN LAW GROUP

THE MARK CONSISTS OF STANDARD CHARACTERS
WITHOUT CLAIM TO ANY PARTICULAR FONT, STYLE,
SIZE, OR COLOR.

OWNER OF U.S. REG. NO. 2,166,674.

NO CLAIM IS MADE TO THE EXCLUSIVE RIGHT TO
USE "LAW GROUP", APART FROM THE MARK AS
SHOWN.

SEC. 2(F) CHAN.

FOR LEGAL SERVICES (U.S. CLS. 100 AND 101).

FIRST USE 8-1-1996; IN COMMERCE 8-1-1996.

CHRISTOPHER ADKINS, EXAMINING ATTORNEY

SN 76-594,292. PERKINS & WILL, INC., ATLANTA, GA.
FILED 5-25-2004.

P&W

OWNER OF U.S. REG. NO. 2,909,607.

FOR ARCHITECTURAL SERVICES; NAMELY BUILD-
ING DESIGN, SCHOOL DESIGN, SCIENCE AND TECHNOLOGY CENTER DESIGN, HEALTHCARE FACILITY DESIGN, GENERAL BUSINESS BUILDING DESIGN, INTERIOR DESIGN, AND ENGINEERING DESIGN (U.S. CLS. 100 AND 101).

FIRST USE 5-25-1993; IN COMMERCE 5-25-1993.

RON FAIRBANKS, EXAMINING ATTORNEY

CLASS 42—(Continued).

SN 76-597,509. GRANT & EISENHOFER, P.A., WILMINGTON, DE. FILED 6-14-2004.

FIGHTING FOR INSTITUTIONAL INVESTORS

THE MARK CONSISTS OF STANDARD CHARACTERS WITHOUT CLAIM TO ANY PARTICULAR FONT, STYLE, SIZE, OR COLOR.

FOR LEGAL SERVICES; LEGAL CONSULTING SERVICES IN THE FIELD OF CORPORATE GOVERNANCE (U.S. CLS. 100 AND 101).

FIRST USE 5-23-2004; IN COMMERCE 5-23-2004, EVELYN BRADLEY, EXAMINING ATTORNEY

SN 76-597,986. SWIFT, CURRIE, MCGHEE & HIERS, LLP, ATLANTA, GA. FILED 6-18-2004.

TIMELESS VALUES. PROGRESSIVE SOLUTIONS.

THE MARK CONSISTS OF STANDARD CHARACTERS WITHOUT CLAIM TO ANY PARTICULAR FONT, STYLE, SIZE, OR COLOR.

FOR LEGAL SERVICES (U.S. CLS. 100 AND 101). STEVEN R. FINE, EXAMINING ATTORNEY

SN 76-598,172. NATIONAL AUTO INSPECTIONS, LLC, BALTIMORE, MD. FILED 6-18-2004.

CARCHEX

THE MARK CONSISTS OF STANDARD CHARACTERS WITHOUT CLAIM TO ANY PARTICULAR FONT, STYLE, SIZE, OR COLOR.

FOR MOTOR VEHICLE INSPECTION SERVICES (U.S. CLS. 100 AND 101).

FIRST USE 10-31-2001; IN COMMERCE 10-31-2001, WILLIAM BRECKENFELD, EXAMINING ATTORNEY

SN 76-598,173. NATIONAL AUTO INSPECTIONS, LLC, BALTIMORE, MD. FILED 6-18-2004.



FOR MOTOR VEHICLE INSPECTION SERVICES (U.S. CLS. 100 AND 101).

FIRST USE 10-31-2001; IN COMMERCE 10-31-2001, WILLIAM BRECKENFELD, EXAMINING ATTORNEY

CLASS 42—(Continued).

SN 76-599,456. SEIKO COMPUTER SYSTEMS OF NEVADA, DBA CONNECTING POINT TECHNOLOGY CENTER, LAS VEGAS, NV. FILED 6-28-2004.



NO CLAIM IS MADE TO THE EXCLUSIVE RIGHT TO USE CIO, APART FROM THE MARK AS SHOWN.

FOR COMPUTER SUPPORT SERVICES, NAMELY, TROUBLESHOOTING OF COMPUTER HARDWARE AND SOFTWARE PROBLEMS (U.S. CLS. 100 AND 101).

FIRST USE 12-0-2003; IN COMMERCE 12-0-2003, TARAH HARDY, EXAMINING ATTORNEY

SN 78-084,009. RETX ENERGY SERVICES, INC., CONYERS, GA. FILED 9-14-2001.

CCM

FOR TEMPORARY USE OF ONLINE NON-DOWNLOADABLE SOFTWARE FOR ENERGY COMPANIES MANAGEMENT OF CUSTOMER ACCOUNTS INCLUDING ENROLLMENT, METERING, SETTLEMENT, AND BILLING. (U.S. CLS. 100 AND 101).

FIRST USE 8-6-2000; IN COMMERCE 8-6-2000, TRICIA SONNEBORN, EXAMINING ATTORNEY

SN 78-153,083. EIRICH, PHILIPP, T., GURNEE, IL. FILED 8-11-2002.

ANIREX

FOR COMPUTER SERVICES, NAMELY, CREATING AND MAINTAINING WEB SITES FOR OTHERS, COMPUTER WEB SITE CONSULTING; GRAPHIC ART DESIGN; REGISTRATION OF DOMAIN NAMES FOR IDENTIFICATION OF USERS ON A GLOBAL COMPUTER NETWORK; ANIMATION AND SPECIAL-EFFECTS DESIGNS FOR OTHERS (U.S. CLS. 100 AND 101).

PRISCILLA MILTON, EXAMINING ATTORNEY

CLASS 42—(Continued).

SN 78-178,185. MARKETRON INTERNATIONAL, INC., BURLINGAME, CA. FILED 10-24-2002.



FOR APPLICATION SERVICE PROVIDER (ASP) SERVICES, NAMELY, PROVIDING TEMPORARY USE OF ONLINE NON-DOWNLOADABLE SOFTWARE FOR USE IN WORD PROCESSING, IN DATABASE MANAGEMENT AND AS A SPREADSHEET FOR RESEARCHING, NEGOTIATING AND SCHEDULING ADVERTISING SPOTS; FOR MANAGING STATION AD SCHEDULING, INVENTORY MANAGEMENT AND BILLING, AND FOR PROVIDING ACCESS TO SALES AND TRAFFIC DATA, ALL IN THE FIELD OF BROADCASTING (U.S. CLS. 100 AND 101).

FIRST USE 9-23-2002; IN COMMERCE 9-23-2002.
MARY I. SPARROW, EXAMINING ATTORNEY

SN 78-191,291. ZENGEN, INC., WOODLAND HILLS, CA. FILED 12-4-2002.

FOR TECHNICAL CONSULTATION AND RESEARCH AND DEVELOPMENT IN THE FIELDS OF PHARMACEUTICAL AND CHEMICAL PRODUCTS AND DRUG THERAPIES; PHARMACEUTICAL AND CHEMICAL DRUG DEVELOPMENT; PHARMACEUTICAL AND CHEMICAL ANALYSIS; DESIGN AND TESTING FOR NEW PRODUCT DEVELOPMENT; PRODUCT DEVELOPMENT CONSULTATION TO PHARMACEUTICAL AND CHEMICAL COMPANIES; AND PRODUCT RESEARCH AND DEVELOPMENT (U.S. CLS. 100 AND 101).

FIRST USE 5-18-1999; IN COMMERCE 5-18-1999.
KHANH LE, EXAMINING ATTORNEY

SN 78-196,360. QWEST COMMUNICATIONS INTERNATIONAL INC., DENVER, CO. FILED 12-19-2002.

Q-CONTRACTOR

FOR APPLICATION SERVICE PROVIDER FOR BUSINESSES, THEIR EMPLOYEES, AND CONTRACTORS, FEATURING SOFTWARE IN THE FIELDS OF PROCUREMENT, TIMEKEEPING, PROJECT MANAGEMENT, RECORD KEEPING, WORK SCHEDULING, AND ACCOUNTS RECEIVABLE (U.S. CLS. 100 AND 101).

FIRST USE 9-6-2002; IN COMMERCE 2-24-2003.
ROBERT COGGINS, EXAMINING ATTORNEY

CLASS 42—(Continued).

SN 78-213,011. LOW, MICHAEL, BROOKLYN, NY. FILED 2-10-2003.

LOWCO. LABS

FOR GRAPHIC DESIGN SERVICES; AND COMPUTER WEB SITE DESIGN SERVICES (U.S. CLS. 100 AND 101).
MITCHELL FRONT, EXAMINING ATTORNEY

SN 78-220,125. PORTELLIGENT, INC., AUSTIN, TX. FILED 2-28-2003.

TEARDOWN.COM

FOR PRODUCT RESEARCH; MEASUREMENT EVALUATIONS IN THE CONSUMER ELECTRONICS PRODUCT FIELD (U.S. CLS. 100 AND 101).
MICHAEL SOUDERS, EXAMINING ATTORNEY

SN 78-245,020. ESPEED, INC., NEW YORK, NY. FILED 5-2-2003.

KLEOS

FOR MANAGED NETWORK SERVICES, NAMELY, PROVIDING CONSULTING SERVICES IN THE FIELD OF MONITORING AND MAINTAINING OF COMPUTER NETWORKS, DESIGN OF COMPUTER NETWORKS FOR OTHERS, MANAGEMENT OF COMPUTER NETWORKS FOR OTHERS, HOSTING THE WEB SITES OF OTHERS ON A COMPUTER SERVER FOR A GLOBAL COMPUTER NETWORK (U.S. CLS. 100 AND 101).
SOPHIA S. KIM, EXAMINING ATTORNEY

SN 78-254,978. SOFTSERVE, INC., WALTHAM, MA. FILED 5-28-2003.

NO CLAIM IS MADE TO THE EXCLUSIVE RIGHT TO USE THE WORLD CLASS SOFTWARE FACTORY, APART FROM THE MARK AS SHOWN.

THE MARK CONSISTS OF TWO STYLIZED LETTER "S" INSET INTO EACH OTHER TOGETHER WITH THE WORDS SOFTSERVE THE WORLD CLASS SOFTWARE FACTORY.

FOR COMPUTER SOFTWARE DEVELOPMENT SERVICES, NAMELY GRAPHICAL USER INTERFACE DEVELOPMENT, MANAGEMENT INFORMATION SYSTEM (MIS) DEVELOPMENT, DATABASE DEVELOPMENT, AND COMPUTER SOFTWARE MAINTENANCE (U.S. CLS. 100 AND 101).

FIRST USE 4-1-2002; IN COMMERCE 4-1-2002.
BARBARA BROWN, EXAMINING ATTORNEY

CLASS 42—(Continued).

SN 78-262,863. POLYCOMMERCE.COM, INC., SAN JOSE, CA. FILED 6-16-2003.

POLYCOMMERCE

FOR COMPUTER CONSULTING IN THE FIELD OF COMPUTER SECURITY, NAMELY, PRIVACY LAWS AND REGULATIONS, AND REQUIREMENTS FOR BUSINESSES (U.S. CLS. 100 AND 101).

FIRST USE 7-2-1999; IN COMMERCE 7-2-1999.
ROBERT COGGINS, EXAMINING ATTORNEY

CLASS 42—(Continued).

SN 78-312,151. TERASEN INC., FORMERLY BC GAS INC., VANCOUVER, BRITISH COLUMBIA, CANADA, FILED 10-10-2003.



PRIORITY CLAIMED UNDER SEC. 44(D) ON CANADA APPLICATION NO. 1,173,586, FILED 4-11-2003, REG. NO. TMA627593, DATED 12-6-2004, EXPIRES 12-6-2019.

FOR ELECTRICITY, WATER AND GAS METER READING SERVICES, NAMELY, REMOTE READING OF ELECTRIC, WATER AND GAS METERS TRANSMITTED USING TWO WAY PAGER DEVICES; TECHNICAL SUPPORT SERVICES AND TECHNICAL SUPPORT CONSULTATION SERVICES, NAMELY, TROUBLESHOOTING OF FUNCTIONALITY PROBLEMS AND COMPUTER HARDWARE PROBLEMS RELATING TO ENERGY METERING EQUIPMENT AND MEASUREMENT TECHNOLOGIES; CONSUMER PRODUCT SAFETY TESTING, NAMELY, PRESSURE BACKFLOW TESTING (U.S. CLS. 100 AND 101).

ODESSA BIBBINS, EXAMINING ATTORNEY

SN 78-295,605. VIRTUALCOUNTRIES, INC., SEATTLE, WA. FILED 9-3-2003.

LINKA.COM

FOR DATA MINING BY MEANS OF GLOBAL COMPUTER NETWORKS (U.S. CLS. 100 AND 101).
FIRST USE 8-21-2003; IN COMMERCE 8-21-2003.
JOHN LINCOSKI, EXAMINING ATTORNEY

SN 78-318,510. FORMAN, GEORGE, MARTIN JR, ORLANDO, FL. FILED 10-24-2003.

SN 78-303,705. DISNEY ENTERPRISES, INC., BURBANK, CA. FILED 9-22-2003.

BRING ON THE MOVIES

FOR COMPUTER SERVICES, NAMELY PROVIDING SEARCH ENGINES FOR OBTAINING DATA ON A GLOBAL COMPUTER NETWORK; AND CREATING INDEXES OF INFORMATION, SITES AND OTHER RESOURCES AVAILABLE ON COMPUTER NETWORKS (U.S. CLS. 100 AND 101).

JEFFERY COWARD, EXAMINING ATTORNEY



FOR CAR COLLISION REPAIR INSPECTIONS; EXPERT WITNESS SERVICES IN THE FIELD OF CAR COLLISION REPAIRS (U.S. CLS. 100 AND 101).

FIRST USE 10-24-2003; IN COMMERCE 10-24-2003.
JILL C. ALT, EXAMINING ATTORNEY

CLASS 42—(Continued).

SN 78-329,439. WEBHEADS INC., HILTON HEAD ISLAND, SC. FILED 11-18-2003.

CLASS 42—(Continued).

SN 78-336,096. PRIVACY INNOVATIONS INC., CHICAGO, IL. FILED 12-3-2003.

Webheads

Privacy Innovations

THE MARK CONSISTS OF STANDARD CHARACTERS WITHOUT CLAIM TO ANY PARTICULAR FONT, STYLE, SIZE, OR COLOR.

FOR WEBSITE DESIGN (U.S. CLS. 100 AND 101).
FIRST USE 7-1-2001; IN COMMERCE 7-1-2001.
ALICE SUE CARRUTHERS, EXAMINING ATTORNEY

THE MARK CONSISTS OF STANDARD CHARACTERS WITHOUT CLAIM TO ANY PARTICULAR FONT, STYLE, SIZE, OR COLOR.

NO CLAIM IS MADE TO THE EXCLUSIVE RIGHT TO USE "PRIVACY", APART FROM THE MARK AS SHOWN.

FOR PROVIDING COMPUTER CONSULTING SERVICES, PARTICULARLY WITH RESPECT TO PRIVACY AND SECURITY RELATED ISSUES INCLUDING INTERNET WEBSITES, TECHNOLOGICAL INNOVATIONS, SECURITY PRODUCTS, PRIVACY PRODUCTS, AND EMERGING TECHNOLOGIES (U.S. CLS. 100 AND 101).

FIRST USE 3-8-2002; IN COMMERCE 3-8-2002.
BRIDGETT SMITH, EXAMINING ATTORNEY

SN 78-329,740. ORMAZA, MANUEL, MIAMI, FL. FILED 11-18-2003.

SN 78-337,049. TRIANGLE ASSOCIATES, INC., HIALEAH, FL. FILED 12-5-2003.



THE COLOR(S) RED AND GREEN AND BLUE IS/ARE CLAIMED AS A FEATURE OF THE MARK.

THE MARK CONSISTS OF THE FIRST LETTER OF THE FIRST WORD, "A" SYMBOLIZES A CLOCK WITH THE HOURS AND MINUTES HANDS IN RED. THE GREEN HAND OVER THE "A" IS THAT OF A MOUSE CURSER WHEN IT SWITCHES TO THE "HAND" WHEN IT HOVERS OVER A LINK.

FOR COMPUTER SOFTWARE DEVELOPMENT (U.S. CLS. 100 AND 101).
INGA ERVIN, EXAMINING ATTORNEY

FOR CIVIL, STRUCTURAL AND ENVIRONMENTAL CONSULTING ENGINEERS (U.S. CLS. 100 AND 101).

FIRST USE 5-8-1996; IN COMMERCE 5-8-1996.
ELIZABETH J. WINTER, EXAMINING ATTORNEY

CLASS 42—(Continued).

SN 78-341,449. ARENT FOX PLLC, WASHINGTON, DC.
FILED 12-16-2003.



OWNER OF U.S. REG. NOS. 2,845,046 AND 2,856,103.
NO CLAIM IS MADE TO THE EXCLUSIVE RIGHT TO
USE "ATTORNEYS AT LAW", APART FROM THE MARK
AS SHOWN.

FOR LEGAL SERVICES (U.S. CLS. 100 AND 101).
MARIA-VICTORIA SUAREZ, EXAMINING ATTORNEY

SN 78-343,850. LIQUASOFT, INC., HAVRE DE GRACE, MD.
FILED 12-19-2003.

LiquaSoft

THE MARK CONSISTS OF STANDARD CHARACTERS
WITHOUT CLAIM TO ANY PARTICULAR FONT, STYLE,
SIZE, OR COLOR.

FOR COMPUTER SERVICES, NAMELY, DESIGNING,
IMPLEMENTING AND MAINTAINING SOFTWARE
AND NETWORKS INTERNAL AND INTERNET NET-
WORKS; COMPUTER CONSULTATION AND MAINTEN-
ANCE OF SOFTWARE AND SOFTWARE DESIGN FOR
OTHERS (U.S. CLS. 100 AND 101).

FIRST USE 2-21-2001; IN COMMERCE 2-21-2001.
ZACHARY BELLO, EXAMINING ATTORNEY

CLASS 42—(Continued).

SN 78-348,693. MID-ATLANTIC TECHNOLOGY, RESEARCH
& INNOVATION CENTER, INC., CHARLESTON, WV.
FILED 1-7-2004.



THE COLOR(S) BLUE IS/ARE CLAIMED AS A FEATURE
OF THE MARK.

THE COLOR BLUE APPEARS IN THE CRESCENT
SHAPES OF THE LOGO AS SHOWN.

FOR SCIENTIFIC RESEARCH; PRODUCT DEVELOP-
MENT IN THE FIELDS OF CHEMISTRY, POLYMER
SCIENCE, BIOCHEMISTRY, MEDICINE, CHEMICAL
AND MECHANICAL ENGINEERING, STATISTICAL
ANALYSIS AND RELATED FIELDS (U.S. CLS. 100
AND 101).

FIRST USE 8-14-2003; IN COMMERCE 8-14-2003.
ANN E. SAPPENFIELD, EXAMINING ATTORNEY

SN 78-352,055. LADAS & PARRY LLP, NEW YORK, NY.
FILED 1-14-2004.

L@dasDomains
Domain Names Are Intellectual Property

NO CLAIM IS MADE TO THE EXCLUSIVE RIGHT TO
USE "DOMAIN NAMES ARE INTELLECTUAL PROP-
ERTY", APART FROM THE MARK AS SHOWN.

FOR REGISTRATION OF DOMAIN NAMES FOR
OTHERS (U.S. CLS. 100 AND 101).

HENRY S. ZAK, EXAMINING ATTORNEY

CLASS 42—(Continued).

SN 78-354,184. THE MEDIA KITCHEN, INC., ATLANTA, GA.
FILED 1-20-2004.

The Media Kitchen

THE MARK CONSISTS OF STANDARD CHARACTERS WITHOUT CLAIM TO ANY PARTICULAR FONT, STYLE, SIZE, OR COLOR.

NO CLAIM IS MADE TO THE EXCLUSIVE RIGHT TO USE "MEDIA", APART FROM THE MARK AS SHOWN.

FOR GRAPHIC ART DESIGN; COMPUTER SERVICES, NAMELY, DESIGNING AND IMPLEMENTING WEB SITES, INTRANET SITES, INTERACTIVE CD-ROM'S AND DVD'S FOR OTHERS AND CONSULTING SERVICES RELATED THERETO (U.S. CLS. 100 AND 101).

FIRST USE 8-6-1998; IN COMMERCE 8-13-1998.
EVELYN BRADLEY, EXAMINING ATTORNEY

CLASS 42—(Continued).

SN 78-364,420. ITUITY, INCORPORATED, ALDIE, VA.
FILED 2-8-2004.



THE COLOR(S) BLUE AND PURPLE IS/ARE CLAIMED AS A FEATURE OF THE MARK.

THE MARK CONSISTS OF THE WORDING IN THE MARK IS BLUE AND THE DESIGN ELEMENT IS PURPLE.

FOR CONSULTING AND SOFTWARE DEVELOPMENT SERVICES IN THE FIELD OF INFORMATION TECHNOLOGY, NAMELY, PROVIDING TECHNOLOGICAL ASSESSMENTS AND REQUIREMENTS ANALYSIS AND COMPUTER SOFTWARE DESIGN, DEVELOPMENT AND IMPLEMENTATION (U.S. CLS. 100 AND 101).

FIRST USE 1-1-2004; IN COMMERCE 2-5-2004.
KIMBERLY FRYE, EXAMINING ATTORNEY

SN 78-362,907. ANTIG TECHNOLOGY CO., LTD., TAIPEI, TAIWAN, FILED 2-5-2004.

Antig

OWNER OF CHINA REG. NO. 1126454, DATED 11-1-2004, EXPIRES 10-31-2014.

THE MARK CONSISTS OF A CIRCULAR DISK SUPERIMPOSED ON THE LETTER A IN THE WORD ELEMENT ANTIG.

FOR TECHNICAL CONSULTATION AND RESEARCH IN RESPECT OF THE MANUFACTURE OF BATTERIES/CELLS FOR USE IN NOTEBOOK COMPUTERS, DIGITAL CAMERAS, PERSONAL COMPUTERS, AUTOMOBILES, MEDICAL DEVICES, POWER GENERATORS, CELLULAR PHONES, UNINTERRUPTED POWER SUPPLIES; DESIGN AND TESTING FOR NEW PRODUCT DEVELOPMENT; MATERIAL TESTING; PRODUCT SAFETY TESTING (U.S. CLS. 100 AND 101).

DAVID TAYLOR, EXAMINING ATTORNEY

SN 78-367,794. NATIONAL LAW CENTER FOR CHILDREN AND FAMILIES, FAIRFAX, VA. FILED 2-13-2004.

NATIONAL LAW
CENTER FOR
CHILDREN AND
FAMILIES

THE MARK CONSISTS OF STANDARD CHARACTERS WITHOUT CLAIM TO ANY PARTICULAR FONT, STYLE, SIZE, OR COLOR.

NO CLAIM IS MADE TO THE EXCLUSIVE RIGHT TO USE "LAW CENTER", APART FROM THE MARK AS SHOWN.

SEC. 2(F).
FOR PUBLIC INTEREST LEGAL SERVICES (U.S. CLS. 100 AND 101).

FIRST USE 4-9-1991; IN COMMERCE 4-9-1991.
PAUL F. GAST, EXAMINING ATTORNEY

CLASS 42—(Continued).

SN 78-380,505. Q2 LEARNING, LLC, FALLS CHURCH, VA.
FILED 3-8-2004.

**Q2Learning When
Mastery Matters**

THE MARK CONSISTS OF STANDARD CHARACTERS WITHOUT CLAIM TO ANY PARTICULAR FONT, STYLE, SIZE, OR COLOR.

FOR DESIGN, INSTALLATION AND MAINTENANCE OF ONLINE WEB-BASED COMPUTER SOFTWARE; PROVIDING TEMPORARY USE OF NON-DOWNLOADABLE COMPUTER SOFTWARE PLATFORMS FOR FORMAL AND INFORMAL COMPANY TRAINING AND INFORMATION REFERENCE UTILIZING COLLABORATION TOOLS IN THE NATURE OF DISCUSSION FORUMS, INSTANT MESSAGING, EMAIL NOTIFICATION AND SUBSCRIPTION AND DOCUMENTATION (U.S. CLS. 100 AND 101).

FIRST USE 1-1-2004; IN COMMERCE 1-1-2004.
WON TEAK OH, EXAMINING ATTORNEY

SN 78-384,355. XENCOR, INC., MONROVIA, CA. FILED 3-15-2004.

PROTEINS BY DESIGN

THE MARK CONSISTS OF STANDARD CHARACTERS WITHOUT CLAIM TO ANY PARTICULAR FONT, STYLE, SIZE, OR COLOR.

NO CLAIM IS MADE TO THE EXCLUSIVE RIGHT TO USE "PROTEINS", APART FROM THE MARK AS SHOWN. THE MARK IS PRESENTED IN STANDARD CHARACTER WITHOUT CLAIM TO ANY PARTICULAR FONT, STYLE, SIZE, OR COLOR.

FOR MEDICAL AND SCIENTIFIC RESEARCH AND DEVELOPMENT SERVICES FOR THIRD PARTIES IN THE FIELD OF PHARMACEUTICALS; SCIENTIFIC CONSULTING SERVICES FOR THIRD PARTIES IN THE FIELD OF PHARMACEUTICALS (U.S. CLS. 100 AND 101).

MATTHEW PAPPAS, EXAMINING ATTORNEY

CLASS 42—(Continued).

SN 78-402,822. PXE INTERNATIONAL, WASHINGTON, DC.
FILED 4-15-2004.



NO CLAIM IS MADE TO THE EXCLUSIVE RIGHT TO USE "PXE INTERNATIONAL", APART FROM THE MARK AS SHOWN.

FOR MEDICAL AND SCIENTIFIC RESEARCH SERVICES IN THE FIELD OF PSEUDOXANTHOMA ELASTICUM TREATMENT AND DIAGNOSIS (U.S. CLS. 100 AND 101).

ALEXANDER L. POWERS, EXAMINING ATTORNEY

SN 78-402,927. VECNA TECHNOLOGIES, INC., COLLEGE PARK, MD. FILED 4-16-2004.

Vecna

THE MARK CONSISTS OF STANDARD CHARACTERS WITHOUT CLAIM TO ANY PARTICULAR FONT, STYLE, SIZE, OR COLOR.

OWNER OF U.S. REG. NO. 2,726,475. FOR PROVIDES CONSULTING SERVICES IN THE FIELD OF COMPUTER PROGRAMMING AND ROBOTIC DESIGNS FOR OTHERS, AND SCIENTIFIC RESEARCH IN THE FIELD OF ARTIFICIAL INTELLIGENCE (U.S. CLS. 100 AND 101).

FIRST USE 1-1-2000; IN COMMERCE 1-1-2000.

MICHELLE S. WISEMAN, EXAMINING ATTORNEY

CLASS 42—(Continued).

SN 78-409,698. KINETIC PIXELS, INC., TARPON SPRINGS, FL. FILED 4-28-2004.

ART THROUGH TECHNOLOGY

THE MARK CONSISTS OF STANDARD CHARACTERS WITHOUT CLAIM TO ANY PARTICULAR FONT, STYLE, SIZE, OR COLOR.

FOR COMPUTER SOFTWARE DESIGN, COMPUTER PROGRAMMING, AND MAINTENANCE OF COMPUTER SOFTWARE FOR CREATING, UTILIZING, AND TRANSFORMING IMAGES, AUDIO, VIDEO, SPATIAL, AND TEXTUAL CONTENT IN DIGITAL FORM FROM OTHER DIGITAL OR ANALOG FORMS IN THE FIELDS OF GRAPHIC ILLUSTRATION, ANIMATION AND SPECIAL-EFFECTS (U.S. CLS. 100 AND 101).

FIRST USE 7-9-2001; IN COMMERCE 7-9-2001.
DANIEL BRODY, EXAMINING ATTORNEY

SN 78-413,627. THOMPSON, STEPHANIE, ANNE, LEESBURG, VA. FILED 5-5-2004.



NO CLAIM IS MADE TO THE EXCLUSIVE RIGHT TO USE "GRAPHICS", APART FROM THE MARK AS SHOWN. THE COLORS GREY AND BLUE ARE CLAIMED AS A FEATURE OF THE MARK.

THE MARK CONSISTS OF THE WORD AGILE IN GREY, THE WORD GRAPHICS IN BLUE, AND A SILHOUETTE OF A WOMAN DOING A FLIP IN BLUE.

FOR GRAPHIC DESIGN SERVICES AND WEB DESIGN SERVICES INCLUDING THE DESIGN AND PRODUCTION OF NEWSLETTERS, BROCHURES, BOOKLETS, POSTCARDS, FLYERS, LOGOS, LETTERHEAD, ADVERTISEMENTS, CONFERENCE MATERIALS, WEBSITES, HTML EMAIL, AND COMPUTER ANIMATION (U.S. CLS. 100 AND 101).

FIRST USE 1-1-2004; IN COMMERCE 1-12-2004.
LEIGH CAROLINE CASE, EXAMINING ATTORNEY

CLASS 42—(Continued).

SN 78-421,288. GEOTRUST, INC., WELLESLEY HILLS, MA. FILED 5-19-2004.

RAPIDSSL

THE MARK CONSISTS OF STANDARD CHARACTERS WITHOUT CLAIM TO ANY PARTICULAR FONT, STYLE, SIZE, OR COLOR.

FOR COMPUTER SERVICES, NAMELY, PROVIDING INFORMATION AND DATA BASES FOR SECURITY AND MONITORING OF DATA IN THE FIELDS OF AUTHENTICATION, PRIVACY, AND CONFIDENTIALITY OF DATA ON A GLOBAL COMMUNICATION NETWORK; COMPUTER SOFTWARE DEVELOPMENT SERVICES FOR OTHERS; COMPUTER CONSULTATION SERVICES; RATING OF WEB SITES, BUSINESSES AND INDIVIDUALS FOR THE SECURITY OF DATA AND MONITORING THE PRIVACY, AUTHENTICITY AND CONFIDENTIALITY OF DATA ON A COMPUTER WEB SITE (U.S. CLS. 100 AND 101).

FIRST USE 5-20-2004; IN COMMERCE 5-20-2004.
SKYE YOUNG, EXAMINING ATTORNEY

SN 78-422,211. VALENTIS, INC., BURLINGAME, CA. FILED 5-20-2004.

CLIC

THE MARK CONSISTS OF STANDARD CHARACTERS WITHOUT CLAIM TO ANY PARTICULAR FONT, STYLE, SIZE, OR COLOR.

FOR MEDICAL AND SCIENTIFIC RESEARCH IN THE FIELD OF SYNTHETIC GENE DELIVERY SYSTEMS; DEVELOPMENT AND TESTING OF PRODUCTS FOR GENE DELIVERY; LICENSING OF INTELLECTUAL PROPERTY RIGHTS IN THE FIELD OF GENE DELIVERY; PROVISION OF TECHNICAL KNOW-HOW, NAMELY CONSULTATION AND TECHNICAL ADVICE IN THE FIELD OF CONDENSING FORMULATIONS FOR GENE DELIVERY (U.S. CLS. 100 AND 101).

IRA J. GOODSaid, EXAMINING ATTORNEY

CLASS 42—(Continued).

SN 78-423,411. MICROSEISMIC, INC., HOUSTON, TX. FILED 5-22-2004.

PSET

THE MARK CONSISTS OF STANDARD CHARACTERS WITHOUT CLAIM TO ANY PARTICULAR FONT, STYLE, SIZE, OR COLOR.

FOR COLLECTION, RECORDING AND ANALYSIS OF SEISMIC EMISSIONS, EARTHQUAKE PATTERNS USING A PROCESSING METHODOLOGY; IMAGING AND MAPPING SERVICES RELATED TO SEISMIC EMISSIONS AND EARTHQUAKE PATTERNS (U.S. CLS. 100 AND 101).

FIRST USE 2-17-2003; IN COMMERCE 2-17-2003.
MATTHEW KLINE, EXAMINING ATTORNEY

SN 78-423,468. GRAHAM, MARTIN A., DOWNINGTOWN, PA. FILED 5-23-2004.

PKPD

THE MARK CONSISTS OF STANDARD CHARACTERS WITHOUT CLAIM TO ANY PARTICULAR FONT, STYLE, SIZE, OR COLOR.

FOR RESEARCH IN THE FIELD OF PHARMACOKINETIC AND PHARMACODYNAMIC ANALYSIS (U.S. CLS. 100 AND 101).

MICHAEL WEBSTER, EXAMINING ATTORNEY

CLASS 42—(Continued).

SN 78-424,871. GENAISSANCE PHARMACEUTICALS, INC., NEW HAVEN, CT. FILED 5-25-2004.



THE MARK CONSISTS OF THE WORD "LARK" ADJACENT TO TWO INCOMPLETE ELLIPTICAL ORBITS THAT CROSS EACH OTHER AT A CENTRAL AXIS.

FOR MOLECULAR BIOLOGY AND GENOMICS SERVICES, NAMELY NUCLEIC ACID ISOLATION AND PURIFICATION, DNA SEQUENCING, GENOTYPING, GENETIC STABILITY TESTING, AND QUANTITATIVE POLYMERASE CHAIN REACTION ANALYSIS (U.S. CLS. 100 AND 101).

FIRST USE 1-1-2001; IN COMMERCE 1-1-2001.
ASMAT KHAN, EXAMINING ATTORNEY

SN 78-425,191. THE TRIZETTO GROUP, INC., NEWPORT BEACH, CA. FILED 5-26-2004.

**TRIZETTO
CAREADVANCE
ENTERPRISE**

THE MARK CONSISTS OF STANDARD CHARACTERS WITHOUT CLAIM TO ANY PARTICULAR FONT, STYLE, SIZE, OR COLOR.

OWNER OF U.S. REG. NO. 2,428,698.

NO CLAIM IS MADE TO THE EXCLUSIVE RIGHT TO USE "ENTERPRISE", APART FROM THE MARK AS SHOWN.

FOR COMPUTER CONSULTATION SERVICES AND APPLICATION SERVICE PROVIDER (ASP) FEATURING SOFTWARE THAT ENABLES FINANCIAL MANAGEMENT, FINANCIAL PLANNING, FINANCIAL REPORTING, FINANCIAL BUDGETING, FINANCIAL FORECASTING, AND THAT ENABLES FINANCIAL RISK ASSESSMENT, CLINICAL RISK ASSESSMENT AND OPERATIONAL RISK ASSESSMENT, FINANCIAL EXCEPTION REPORTING, FINANCIAL TREND IDENTIFICATION, FINANCIAL QUALITY MEASUREMENT, FINANCIAL QUALITY EVALUATION, FINANCIAL QUALITY MANAGEMENT, FINANCIAL QUALITY ASSESSMENT, CRITICAL PERFORMANCE DRIVER FINANCIAL EVALUATIONS; AND PROVIDING RENTAL OF SOFTWARE FOR ALL OF THE SAME (U.S. CLS. 100 AND 101).

FIRST USE 4-23-2004; IN COMMERCE 4-23-2004.
MELVIN AXILBUND, EXAMINING ATTORNEY

CLASS 42—(Continued).

SN 78-425,200. THE TRIZETTO GROUP, INC., NEWPORT BEACH, CA. FILED 5-26-2004.

**TRIZETTO PERSONAL
CAREADVANCE**

THE MARK CONSISTS OF STANDARD CHARACTERS WITHOUT CLAIM TO ANY PARTICULAR FONT, STYLE, SIZE, OR COLOR.

OWNER OF U.S. REG. NO. 2,428,698.
NO CLAIM IS MADE TO THE EXCLUSIVE RIGHT TO USE "PERSONAL", APART FROM THE MARK AS SHOWN.

FOR COMPUTER CONSULTATION SERVICES AND APPLICATION SERVICE PROVIDER (ASP) FEATURING SOFTWARE THAT ENABLES FINANCIAL MANAGEMENT, FINANCIAL PLANNING, FINANCIAL REPORTING, FINANCIAL BUDGETING, FINANCIAL FORECASTING, AND THAT ENABLES FINANCIAL RISK ASSESSMENT, CLINICAL RISK ASSESSMENT AND OPERATIONAL RISK ASSESSMENT, FINANCIAL EXCEPTION REPORTING, FINANCIAL TREND IDENTIFICATION, FINANCIAL QUALITY MEASUREMENT, FINANCIAL QUALITY EVALUATION, FINANCIAL QUALITY MANAGEMENT, FINANCIAL QUALITY ASSESSMENT, CRITICAL PERFORMANCE DRIVER FINANCIAL EVALUATIONS; AND PROVIDING RENTAL OF SOFTWARE FOR ALL OF THE SAME (U.S. CLS. 100 AND 101).

FIRST USE 4-23-2004; IN COMMERCE 4-23-2004.
MELVIN AXILBUND, EXAMINING ATTORNEY

SN 78-425,277. THE TRIZETTO GROUP, INC., NEWPORT BEACH, CA. FILED 5-26-2004.

**TRIZETTO CLINICAL
CAREADVANCE**

THE MARK CONSISTS OF STANDARD CHARACTERS WITHOUT CLAIM TO ANY PARTICULAR FONT, STYLE, SIZE, OR COLOR.

OWNER OF U.S. REG. NO. 2,428,698.
NO CLAIM IS MADE TO THE EXCLUSIVE RIGHT TO USE "CLINICAL", APART FROM THE MARK AS SHOWN.

FOR COMPUTER CONSULTATION SERVICES AND APPLICATION SERVICE PROVIDER (ASP) FEATURING SOFTWARE THAT ENABLES FINANCIAL MANAGEMENT, FINANCIAL PLANNING, FINANCIAL REPORTING, FINANCIAL BUDGETING, FINANCIAL FORECASTING, AND THAT ENABLES FINANCIAL RISK ASSESSMENT, CLINICAL RISK ASSESSMENT AND OPERATIONAL RISK ASSESSMENT, FINANCIAL EXCEPTION REPORTING, FINANCIAL TREND IDENTIFICATION, FINANCIAL QUALITY MEASUREMENT, FINANCIAL QUALITY EVALUATION, FINANCIAL QUALITY MANAGEMENT, FINANCIAL QUALITY ASSESSMENT, CRITICAL PERFORMANCE DRIVER FINANCIAL EVALUATIONS; AND PROVIDING RENTAL OF SOFTWARE FOR ALL OF THE SAME (U.S. CLS. 100 AND 101).

MELVIN AXILBUND, EXAMINING ATTORNEY

CLASS 42—(Continued).

SN 78-425,588. CEMINES, INC., EVERGREEN, CO. FILED 5-26-2004.

CEMINES

THE MARK CONSISTS OF STANDARD CHARACTERS WITHOUT CLAIM TO ANY PARTICULAR FONT, STYLE, SIZE, OR COLOR.

FOR RESEARCH AND PRODUCT DEVELOPMENT SERVICES IN THE FIELDS OF MOLECULAR SCREENING, AND DEVELOPMENT OF DIAGNOSTIC TEST METHODS AND THERAPEUTICS FOR HUMAN AND ANIMAL DISEASES (U.S. CLS. 100 AND 101).

FIRST USE 10-0-2002; IN COMMERCE 10-0-2002.
BRIAN NEVILLE, EXAMINING ATTORNEY

SN 78-428,124. PROKARMA, INC., TIGARD, OR. FILED 6-1-2004.

PROKARMA

THE MARK CONSISTS OF STANDARD CHARACTERS WITHOUT CLAIM TO ANY PARTICULAR FONT, STYLE, SIZE, OR COLOR.

FOR DEVELOPMENT AND CUSTOMIZATION OF COMPUTER SOFTWARE IN THE FIELD OF PROCUREMENT, HUMAN RESOURCES, FINANCE AND MANUFACTURING (U.S. CLS. 100 AND 101).

JENNIFER KRISP, EXAMINING ATTORNEY

CLASS 42—(Continued).

SN 78-428,128. THE FRANK LLOYD WRIGHT FOUNDATION, SCOTTSDALE, AZ. FILED 6-1-2004.

**FRANK LLOYD WRIGHT
STUDIO**

THE MARK CONSISTS OF STANDARD CHARACTERS WITHOUT CLAIM TO ANY PARTICULAR FONT, STYLE, SIZE, OR COLOR.

OWNER OF U.S. REG. NOS. 1,022,648, 1,871,719 AND 1,901,709.

NO CLAIM IS MADE TO THE EXCLUSIVE RIGHT TO USE "STUDIO", APART FROM THE MARK AS SHOWN.

THE NAME(S), PORTRAIT(S), AND/OR SIGNATURE(S) SHOWN IN THE MARK DOES NOT IDENTIFY A PARTICULAR LIVING INDIVIDUAL.

FOR ARCHITECTURAL DESIGN AND CONSULTATION SERVICES (U.S. CLS. 100 AND 101).

JENNIFER KRISP, EXAMINING ATTORNEY

CLASS 42—(Continued).

SN 78-430,754. SYNIVERSE TECHNOLOGIES, INC., TAMPA, FL. FILED 6-7-2004.

VISWISE

THE MARK CONSISTS OF STANDARD CHARACTERS WITHOUT CLAIM TO ANY PARTICULAR FONT, STYLE, SIZE, OR COLOR.

FOR TELECOMMUNICATIONS NETWORK MONITORING SERVICES (U.S. CLS. 100 AND 101).

WON TEAK OH, EXAMINING ATTORNEY

SN 78-428,783. ALDAPE LAW FIRM PLLC, SAN ANTONIO, TX. FILED 6-2-2004.

**I FIGHT FOR THE
RIGHTS OF THE
INJURED.**

THE MARK CONSISTS OF STANDARD CHARACTERS WITHOUT CLAIM TO ANY PARTICULAR FONT, STYLE, SIZE, OR COLOR.

FOR ATTORNEY SERVICES (U.S. CLS. 100 AND 101).
MARK SPARACINO, EXAMINING ATTORNEY

SN 78-431,168. WEATHERWAVE, INC., RESTON, VA. FILED 6-7-2004.

WeatherWave

THE MARK CONSISTS OF STANDARD CHARACTERS WITHOUT CLAIM TO ANY PARTICULAR FONT, STYLE, SIZE, OR COLOR.

FOR WEATHER REPORTING (U.S. CLS. 100 AND 101).
WANDA KAY PRICE, EXAMINING ATTORNEY

CLASS 42—(Continued).

SN 78-432,462. FOCUS DIAGNOSTICS, INC., HERNDON, VA. FILED 6-9-2004.

CLASS 42—(Continued).

SN 78-434,089. ANALYSTS INTERNATIONAL CORPORATION, MINNEAPOLIS, MN. FILED 6-11-2004.

FOCUS BIO-INOVA

NEW EQUITIES

THE MARK CONSISTS OF STANDARD CHARACTERS WITHOUT CLAIM TO ANY PARTICULAR FONT, STYLE, SIZE, OR COLOR.

OWNER OF U.S. REG. NOS. 2,681,849, 2,774,504 AND 2,816,040.

FOR CLINICAL LABORATORY TESTING SERVICES, DATA MANAGEMENT OF LABORATORY TEST RESULTS AND LOGISTICAL MANAGEMENT OF HUMAN SPECIMENS AND ISOLATES OF MICROORGANISMS; CENTRAL MEDICAL SERVICES, NAMELY, MONITORING SERVICES, DIAGNOSTIC SERVICES, AND IMAGING SERVICES FOR ALL PHASES OF CLINICAL TRIALS; AND EPIDEMIOLOGICAL STUDIES FOR LATE PHASE CLINICAL TRIALS AND POST-MARKETING SURVEILLANCE (U.S. CLS. 100 AND 101).

FIRST USE 12-15-2003; IN COMMERCE 12-15-2003.
SHARON MEIER, EXAMINING ATTORNEY

THE MARK CONSISTS OF STANDARD CHARACTERS WITHOUT CLAIM TO ANY PARTICULAR FONT, STYLE, SIZE, OR COLOR.

FOR CUSTOM SOFTWARE CONSULTING SERVICES PERFORMED FOR OTHERS (U.S. CLS. 100 AND 101).
JULIE WATSON, EXAMINING ATTORNEY

SN 78-434,271. SECURGEN L.L.C., SPOKANE, WA. FILED 6-11-2004.

SN 78-433,239. ULTRABOOKING SOLUTIONS, INC., WESTON, FL. FILED 6-10-2004.

SECURGEN

ULTRABOOKING

THE MARK CONSISTS OF STANDARD CHARACTERS WITHOUT CLAIM TO ANY PARTICULAR FONT, STYLE, SIZE, OR COLOR.

FOR APPLICATION SERVICE PROVIDER(ASP), FEATURING SOFTWARE IN THE FIELD OF TRAVEL RESERVATIONS AND BOOKING (U.S. CLS. 100 AND 101).

SUELLEN HICKEY, EXAMINING ATTORNEY

THE MARK CONSISTS OF STANDARD CHARACTERS WITHOUT CLAIM TO ANY PARTICULAR FONT, STYLE, SIZE, OR COLOR.

FOR DESIGN AND DEVELOPMENT OF EXTERNAL STORAGE AND SPECIAL APPLICATION SERVERS TO THE ORDER AND SPECIFICATION OF OTHERS (U.S. CLS. 100 AND 101).

DORITT L. CARROLL, EXAMINING ATTORNEY

CLASS 42—(Continued).

SN 78-434,816. KEYDESIGN, INC., NASHVILLE, TN. FILED 6-14-2004.

keydesign

THE MARK CONSISTS OF STANDARD CHARACTERS WITHOUT CLAIM TO ANY PARTICULAR FONT, STYLE, SIZE, OR COLOR.

FOR PRODUCT DESIGN AND PRODUCT DEVELOPMENT SERVICES (U.S. CLS. 100 AND 101). FIRST USE 10-15-2001; IN COMMERCE 10-15-2001. ANDREW BENZMILLER, EXAMINING ATTORNEY

CLASS 42—(Continued).

SN 78-435,094. LITIGATION MEDIA GROUP, LLC, SANTA CLARA, CA. FILED 6-14-2004.



NO CLAIM IS MADE TO THE EXCLUSIVE RIGHT TO USE "LITIGATION MEDIA GROUP", APART FROM THE MARK AS SHOWN.

THE COLOR(S) BLUE, WHITE AND GRAY IS/ARE CLAIMED AS A FEATURE OF THE MARK.

THE BACKGROUND COLOR IS WHITE. THE STYLIZED SCALES OF JUSTICE ARE BLUE. THE TERM LITIGATION IS GRAY. THE TERMS MEDIA GROUP ARE BLUE.

FOR LEGAL SERVICES (U.S. CLS. 100 AND 101). BERYL GARDNER, EXAMINING ATTORNEY

SN 78-435,182. HUNT, JASON W, GLENDALE, AZ. FILED 6-15-2004.

SN 78-434,979. DAHM & ELVIN, LLP, FORT WAYNE, IN. FILED 6-14-2004.

THE UCMJ!-THE
UNIFORM CENTER
FOR MILITARY
JUSTICE!

Hunt Healthcare
Solutions

THE MARK CONSISTS OF STANDARD CHARACTERS WITHOUT CLAIM TO ANY PARTICULAR FONT, STYLE, SIZE, OR COLOR.

NO CLAIM IS MADE TO THE EXCLUSIVE RIGHT TO USE "HEALTHCARE", APART FROM THE MARK AS SHOWN.

FOR CONSULTING SERVICES IN THE FIELD OF DESIGN, SELECTION, IMPLEMENTATION AND USE OF COMPUTER HARDWARE AND SOFTWARE SYSTEMS FOR OTHERS (U.S. CLS. 100 AND 101).

KARANENDRA S. CHHINA, EXAMINING ATTORNEY

THE MARK CONSISTS OF STANDARD CHARACTERS WITHOUT CLAIM TO ANY PARTICULAR FONT, STYLE, SIZE, OR COLOR.

NO CLAIM IS MADE TO THE EXCLUSIVE RIGHT TO USE "CENTER FOR MILITARY JUSTICE!", APART FROM THE MARK AS SHOWN.

FOR LEGAL SERVICES (U.S. CLS. 100 AND 101). JIM RINGLE, EXAMINING ATTORNEY

CLASS 42—(Continued).

SN 78-435,662. TAKENET, LLC, NEW YORK, NY. FILED 6-15-2004.

CLASS 42—(Continued).

SN 78-436,873. PANZARELLA, ROSARIO M., CARTERET, NJ. FILED 6-17-2004.

LokoMix

SevTel

THE MARK CONSISTS OF STANDARD CHARACTERS WITHOUT CLAIM TO ANY PARTICULAR FONT, STYLE, SIZE, OR COLOR.

FOR APPLICATION SERVICE PROVIDER (ASP) FEATURING SOFTWARE FOR DOWNLOAD TO MOBILE DEVICES IN THE FIELD OF MUSICAL SOUND RECORDINGS, VIDEO RECORDINGS AND IMAGES (U.S. CLS. 100 AND 101).

ASMAT KHAN, EXAMINING ATTORNEY

THE MARK CONSISTS OF STANDARD CHARACTERS WITHOUT CLAIM TO ANY PARTICULAR FONT, STYLE, SIZE, OR COLOR.

FOR CONSULTING SERVICES IN THE FIELD OF DESIGN, SELECTION, IMPLEMENTATION AND USE OF COMPUTER HARDWARE AND SOFTWARE SYSTEMS AND NETWORKS FOR OTHERS AS WELL AS COMPUTER SOFTWARE DEVELOPMENT (U.S. CLS. 100 AND 101).

RONALD AIKENS, EXAMINING ATTORNEY

SN 78-436,195. PULEO, KYLE V, STEAMBOAT SPRINGS, CO. FILED 6-16-2004.

SN 78-437,964. UNITEDHEALTH GROUP INCORPORATED, MINNETONKA, MN. FILED 6-18-2004.

AnalyzePlus

UNITEDHEALTH
ADVISOR

THE MARK CONSISTS OF STANDARD CHARACTERS WITHOUT CLAIM TO ANY PARTICULAR FONT, STYLE, SIZE, OR COLOR.

FOR ANALYSIS OF SPA, HOT TUB AND SWIMMING POOL WATER FOR THE PURPOSE OF ACHIEVING PROPER WATER CHEMISTRY (U.S. CLS. 100 AND 101).

JOHN DALIER, EXAMINING ATTORNEY

THE MARK CONSISTS OF STANDARD CHARACTERS WITHOUT CLAIM TO ANY PARTICULAR FONT, STYLE, SIZE, OR COLOR.

OWNER OF U.S. REG. NOS. 2,248,887 AND 2,635,728. FOR PROVIDING TEMPORARY USE OF NON-DOWNLOADABLE ONLINE SOFTWARE AND SOFTWARE TOOLS THAT ALLOW INSURANCE BROKERS, INSURANCE AGENTS AND EMPLOYERS TO DESIGN HEALTH BENEFIT PLANS FOR CLIENTS AND EMPLOYEES (U.S. CLS. 100 AND 101).

STEPHANIE DAVIS, EXAMINING ATTORNEY

CLASS 42—(Continued).

SN 78-438,528. CBeyond COMMUNICATIONS, LLC,
ATLANTA, GA. FILED 6-21-2004.

BEYONDVOICE LITE

THE MARK CONSISTS OF STANDARD CHARACTERS
WITHOUT CLAIM TO ANY PARTICULAR FONT, STYLE,
SIZE, OR COLOR.

OWNER OF U.S. REG. NOS. 2,761,638, 2,763,714 AND
OTHERS.

FOR APPLICATION SERVICE PROVIDER, NAMELY,
HOSTING COMPUTER SOFTWARE APPLICATIONS OF
OTHERS (U.S. CLS. 100 AND 101).

LA TONIA FISHER, EXAMINING ATTORNEY

SN 78-439,190. ANDERSON, LEON G, FALLSTON, MD.
FILED 6-22-2004.

Delineation

THE MARK CONSISTS OF STANDARD CHARACTERS
WITHOUT CLAIM TO ANY PARTICULAR FONT, STYLE,
SIZE, OR COLOR.

FOR COMPUTER SOFTWARE CONSULTATION (U.S.
CLS. 100 AND 101).

KATHLEEN M. VANSTON, EXAMINING ATTORNEY

SN 79-000,643. MESSE MÜNCHEN GMBH, FED REP GER-
MANY, FILED 12-27-2003.

inhorgenta

OWNER OF INTERNATIONAL REGISTRATION 0468112
DATED 3-9-1982, EXPIRES 3-9-2012.

FOR CONDUCTING TRADE FAIRS AND TRADE
EXHIBITIONS IN THE FIELD OF JEWELRY (U.S. CLS.
100 AND 101).

JENNIFER KRISP, EXAMINING ATTORNEY

**CLASS 43—HOTEL AND RESTAURANT SER-
VICES**

SN 76-481,902. SEA PINES COMPANY, INC., HILTON HEAD
ISLAND, SC. FILED 1-13-2003.

**CERTIFIED SEA PINES
RESORT PARTNER**

OWNER OF U.S. REG. NOS. 1,239,738 AND 1,649,014.
NO CLAIM IS MADE TO THE EXCLUSIVE RIGHT TO
USE "CERTIFIED" AND "RESORT PARTNER", APART
FROM THE MARK AS SHOWN.

FOR RESTAURANT SERVICES (U.S. CLS. 100 AND
101).

SOPHIA S. KIM, EXAMINING ATTORNEY

SN 76-505,012. MCDONALD'S CORPORATION, OAK
BROOK, IL. FILED 4-7-2003.

**BOSTON MARKET'S
ROTISSERIE GRILL**

OWNER OF U.S. REG. NOS. 1,517,660, 2,551,400 AND
OTHERS.

NO CLAIM IS MADE TO THE EXCLUSIVE RIGHT TO
USE "ROTISSERIE GRILL", APART FROM THE MARK AS
SHOWN.

SEC. 2(F) AS TO "BOSTON".
FOR RESTAURANT SERVICES (U.S. CLS. 100 AND
101).

DAVID TAYLOR, EXAMINING ATTORNEY

SN 76-505,013. MCDONALD'S CORPORATION, OAK
BROOK, IL. FILED 4-7-2003.



OWNER OF U.S. REG. NOS. 1,517,660, 2,551,400 AND
OTHERS.

NO CLAIM IS MADE TO THE EXCLUSIVE RIGHT TO
USE "ROTISSERIE GRILL", APART FROM THE MARK AS
SHOWN.

SEC. 2(F) AS TO "BOSTON".
FOR RESTAURANT SERVICES (U.S. CLS. 100 AND
101).

DAVID TAYLOR, EXAMINING ATTORNEY

CLASS 43—(Continued).

SN 76-511,591. WALTER'S HOT DOGS, INC., MAMARONECK, NY. FILED 4-28-2003.

WALTER'S

FOR ROADSIDE FOOD STANDS WHICH SERVE HOT DOGS AND HOT DOG ACCOUTREMENTS AS CARRY-OUT RESTAURANT SERVICES (U.S. CLS. 100 AND 101).
FIRST USE 12-31-1931; IN COMMERCE 12-31-1931.
DOUGLAS LEE, EXAMINING ATTORNEY

CLASS 43—(Continued).

SN 76-550,544. HENRY J. BEANS GROUP, PLC, LONDON SW3 5ED, ENGLAND, FILED 9-22-2003.



SN 76-512,011. MCPHERSON, GINA, LUBBOCK, TX. FILED 5-5-2003.



OWNER OF UNITED KINGDOM REG. NO. 1488661, DATED 1-28-1994, EXPIRES 1-22-2009.

NO CLAIM IS MADE TO THE EXCLUSIVE RIGHT TO USE "BAR AND GRILL", APART FROM THE MARK AS SHOWN.

HENRY J. BEAN DOES NOT IDENTIFY A LIVING INDIVIDUAL.

FOR RESTAURANT, BAR AND CATERING SERVICES (U.S. CLS. 100 AND 101).

DANIEL CAPSHAW, EXAMINING ATTORNEY

NO CLAIM IS MADE TO THE EXCLUSIVE RIGHT TO USE "KID", APART FROM THE MARK AS SHOWN.

THE COLOR(S) PINK AND GREEN IS/ARE CLAIMED AS A FEATURE OF THE MARK.

THE MARK CONSISTS OF A PICTURE OF A CHILD PLAYING WITH BLOCKS, WITH THE WORDS "KID CENTRAL" IN BLACK UNDERNEATH THE CHILD, ALL SUPERPOSED OVER A BACKGROUND OF VERTICAL ALTERNATING GREEN AND WHITE STRIPES.

FOR NURSERY AND CHILD DAY CARE CENTERS AND ASSOCIATED CHILD CARE SERVICES (U.S. CLS. 100 AND 101).

FIRST USE 1-25-2001; IN COMMERCE 3-10-2001.
SCOTT BALDWIN, EXAMINING ATTORNEY

SN 76-556,058. CORE-MARK INTERNATIONAL, INC., SAN FRANCISCO, CA. FILED 11-3-2003.

SN 76-516,143. FAMOUS INVESTMENTS, LLC, EDINA, MN. FILED 4-29-2003.

**KOKOMOS ISLAND CAFÉ**

NO CLAIM IS MADE TO THE EXCLUSIVE RIGHT TO USE CAFE, APART FROM THE MARK AS SHOWN.

FOR RESTAURANT AND BAR SERVICES (U.S. CLS. 100 AND 101).

YSA DEJESUS, EXAMINING ATTORNEY

OWNER OF U.S. REG. NOS. 2,752,187 AND 2,758,506. FOR FOOD AND BEVERAGE SERVICES, NAMELY, RESTAURANT SERVICES, CARRYOUT RESTAURANTS (U.S. CLS. 100 AND 101).

FIRST USE 11-14-2002; IN COMMERCE 11-19-2002.
ALICE SUE CARRUTHERS, EXAMINING ATTORNEY

CLASS 43—(Continued).

SN 76-566,217. L.G. FAMILY GROUP, INC., RICHMOND HILL, GA. FILED 12-8-2003.

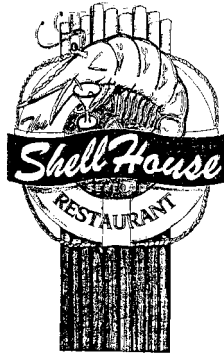

NO CLAIM IS MADE TO THE EXCLUSIVE RIGHT TO USE "HOUSE" AND "RESTAURANT", APART FROM THE MARK AS SHOWN.

THE COLOR GRAY IS A FEATURE OF THE MARK. THE COLOR GRAY APPEARS IN THE POLE DESIGN AND THE LIFE PRESERVER DESIGN.

FOR RESTAURANT SERVICES FEATURING EAT-IN, CARRY-OUT, AND DELIVERY, AND CATERING SERVICES (U.S. CLS. 100 AND 101).

FIRST USE 9-0-1990; IN COMMERCE 9-0-1990. ROBERT LORENZO, EXAMINING ATTORNEY

CLASS 43—(Continued).

SN 76-567,487. 1458255 ONTARIO LIMITED, TORONTO, ONTARIO, M2J 4E9, CANADA, FILED 12-18-2003.

THE SYMPOSIUM CAFÉ

THE MARK CONSISTS OF STANDARD CHARACTERS WITHOUT CLAIM TO ANY PARTICULAR FONT, STYLE, SIZE, OR COLOR.

NO CLAIM IS MADE TO THE EXCLUSIVE RIGHT TO USE CAFÉ, APART FROM THE MARK AS SHOWN.

FOR RESTAURANT SERVICES SPECIALIZING IN GOURMET COFFEE, DESSERTS, SPECIALTY BEVERAGES AND ALCOHOLIC BEVERAGES (U.S. CLS. 100 AND 101).

MARGERY A. TIERNEY, EXAMINING ATTORNEY

SN 76-566,721. SEATTLE'S BEST COFFEE LLC, SEATTLE, WA. FILED 12-23-2003.



OWNER OF U.S. REG. NOS. 1,557,057, 2,647,322 AND OTHERS.

FOR RESTAURANTS; SELF-SERVICE RESTAURANTS; CAFES AND COFFEE BARS (U.S. CLS. 100 AND 101).

DORITT L. CARROLL, EXAMINING ATTORNEY

SN 76-567,561. BLASÉ, INC., SCOTTSDALE, AZ. FILED 12-18-2003.



NO CLAIM IS MADE TO THE EXCLUSIVE RIGHT TO USE "CAFÉ", APART FROM THE MARK AS SHOWN.

FOR CAFÉ-RESTAURANT SERVING FOOD AND DRINK, INCLUDING NON-ALCOHOLIC AND ALCOHOLIC DRINK (U.S. CLS. 100 AND 101).

FIRST USE 5-0-1974; IN COMMERCE 5-0-1974. ALICIA COLLINS, EXAMINING ATTORNEY

CLASS 43—(Continued).

SN 76-570,625. STEAMROLLERS RESTAURANTS INTERNATIONAL INC., VANCOUVER, BRITISH COLUMBIA, CANADA, FILED 1-7-2004.



THE MARK CONSISTS OF DESIGN OF A STEAMROLLER.

FOR PROVIDING FOOD AND DRINK; CARRY OUT RESTAURANTS, TAKE OUT RESTAURANTS, CATERING, CONTRACT FOOD SERVICES, FOOD PREPARATION, PREPARATION OF CARRY OUT FOODS AND BEVERAGES, PROVIDING FOOD AND DRINK FOR CARRY OUT; RESTAURANTS AND SNACK BARS (U.S. CLS. 100 AND 101).

FIRST USE 10-8-1998; IN COMMERCE 10-8-1998.
MICHELE SWAIN, EXAMINING ATTORNEY

SN 76-571,342. PINONS, LLC, ASPEN, CO. FILED 1-22-2004.

PIÑONS

THE MARK CONSISTS OF STANDARD CHARACTERS WITHOUT CLAIM TO ANY PARTICULAR FONT, STYLE, SIZE, OR COLOR.

OWNER OF U.S. REG. NO. 1,830,694.
FOR RESTAURANT SERVICES SPECIALIZING IN AMERICAN FOODS (U.S. CLS. 100 AND 101).
FIRST USE 2-0-1990; IN COMMERCE 2-0-1990.
RONALD AIKENS, EXAMINING ATTORNEY

SN 76-585,762. MORSELS LP, AUSTIN, TX. FILED 4-6-2004.

MORSELS

THE MARK CONSISTS OF STANDARD CHARACTERS WITHOUT CLAIM TO ANY PARTICULAR FONT, STYLE, SIZE, OR COLOR.

FOR RESTAURANT AND CATERING SERVICES (U.S. CLS. 100 AND 101).
GRETTA YAO, EXAMINING ATTORNEY

CLASS 43—(Continued).

SN 76-589,300. WHAT ABOUT A BAGEL LLC, DANBURY, CT. FILED 4-29-2004.



THE STIPPLING IS A FEATURE OF THE MARK.
FOR EAT IN AND TAKE OUT RESTAURANT SERVICES; RESTAURANTS FEATURING BAGELS AND BAKERY GOODS; DELICATESSENS; CATERING SERVICES (U.S. CLS. 100 AND 101).

FIRST USE 3-0-1999; IN COMMERCE 3-0-1999.
DANIELLE MATTESSICH, EXAMINING ATTORNEY

SN 76-589,759. WHAT ABOUT A BAGEL LLC, DANBURY, CT. FILED 4-29-2004.

WHAT ABOUT A BAGEL?

THE MARK CONSISTS OF STANDARD CHARACTERS WITHOUT CLAIM TO ANY PARTICULAR FONT, STYLE, SIZE, OR COLOR.

FOR EAT IN AND TAKE OUT RESTAURANT SERVICES; RESTAURANTS FEATURING BAGELS AND BAKERY GOODS; DELICATESSENS; CATERING SERVICES (U.S. CLS. 100 AND 101).

FIRST USE 3-0-1999; IN COMMERCE 3-0-1999.
DANIELLE MATTESSICH, EXAMINING ATTORNEY

CLASS 43—(Continued).

SN 76-589,760. WHAT ABOUT A BAGEL LLC, DANBURY, CT. FILED 4-29-2004.



THE STIPPLING IS A FEATURE OF THE MARK. FOR EAT IN AND TAKE OUT RESTAURANT SERVICES; RESTAURANTS FEATURING BAGELS AND BAKERY GOODS; DELICATESSENS; CATERING SERVICES (U.S. CLS. 100 AND 101). FIRST USE 3-0-1999; IN COMMERCE 3-0-1999. DANIELLE MATTESSICH, EXAMINING ATTORNEY

SN 76-595,227. WILD FIG INC., MIDDLE ISLAND, NY. FILED 6-3-2004.

WILD FIG

FOR RESTAURANT (U.S. CLS. 100 AND 101). FIRST USE 8-9-2001; IN COMMERCE 8-9-2001. ANGELA M. MICHELI, EXAMINING ATTORNEY

SN 76-597,037. COSTON, TIMOTHY, CHESTER, PA. FILED 6-7-2004.

Peninsula Hospitality Company

NO CLAIM IS MADE TO THE EXCLUSIVE RIGHT TO USE HOSPITALITY COMPANY, APART FROM THE MARK AS SHOWN. FOR RESTAURANTS AND PROVIDING TEMPORARY HOUSING ACCOMMODATIONS (U.S. CLS. 100 AND 101). DEZMONA MIZELLE, EXAMINING ATTORNEY

CLASS 43—(Continued).

SN 76-597,839. WYNN RESORTS HOLDINGS, LLC, LAS VEGAS, NV. FILED 6-15-2004.

SUGAR & ICE

THE MARK CONSISTS OF STANDARD CHARACTERS WITHOUT CLAIM TO ANY PARTICULAR FONT, STYLE, SIZE, OR COLOR. FOR RESTAURANT SERVICES; TAKE-OUT RESTAURANT SERVICES (U.S. CLS. 100 AND 101). DOMINICK J. SALEMI, EXAMINING ATTORNEY

SN 76-598,029. MOE'S SOUTHWEST GRILL, LLC, ATLANTA, GA. FILED 6-18-2004.

HOMEWRECKER...IT'S A FOOD, NOT A PHILOSOPHY

THE MARK CONSISTS OF STANDARD CHARACTERS WITHOUT CLAIM TO ANY PARTICULAR FONT, STYLE, SIZE, OR COLOR. FOR RESTAURANT SERVICES (U.S. CLS. 100 AND 101). LINDA E. BLOHM, EXAMINING ATTORNEY

SN 76-598,104. HI LIMITED PARTNERSHIP, CLEARWATER, FL. FILED 6-18-2004.

WEAPONS OF MASS DISTRACTION

THE MARK CONSISTS OF STANDARD CHARACTERS WITHOUT CLAIM TO ANY PARTICULAR FONT, STYLE, SIZE, OR COLOR. FOR RESTAURANT SERVICES (U.S. CLS. 100 AND 101). SCOTT BALDWIN, EXAMINING ATTORNEY

SN 76-599,466. HALDIRAM INDIA (PVT.) LTD., NEW DELHI - 110004, INDIA, FILED 6-28-2004.



OWNER OF U.S. REG. NOS. 1,963,956 AND 2,357,883. FOR HOTEL, RESTAURANT AND BAR SERVICES (U.S. CLS. 100 AND 101). TARAH HARDY, EXAMINING ATTORNEY

CLASS 43—(Continued).

SN 78-262,250. THE TRUSTEES OF THE ARBY'S IP HOLDER TRUST, A DELAWARE BUSINESS TRUST, COMPRISING: THE CORPORATE TRUST ADMINISTRATOR, WILMINGTON TRUST COMPANY, A DELAWARE CORPORATION, FT. LAUDERDALE, FL. FILED 6-13-2003.



OWNER OF U.S. REG. NOS. 842,177, 2,720,357 AND OTHERS.
FOR RESTAURANT SERVICES (U.S. CLS. 100 AND 101).
JOHN GARTNER, EXAMINING ATTORNEY

SN 78-267,285. SHIRK, JOSEPH A., LBTS, FL. FILED 6-26-2003.

PEYOTE JOE'S

THE MARK DOES NOT IDENTIFY A LIVING INDIVIDUAL.
FOR RESTAURANT (U.S. CLS. 100 AND 101).
TRACY FLETCHER, EXAMINING ATTORNEY

SN 78-284,316. D.J. ARDORE, INC., BOONTON, NJ. FILED 8-7-2003.

RESTAURANTPASSION

THE MARK CONSISTS OF STANDARD CHARACTERS WITHOUT CLAIM TO ANY PARTICULAR FONT, STYLE, SIZE, OR COLOR.

OWNER OF U.S. REG. NO. 2,759,257.
FOR PROVIDING INFORMATION ABOUT RESTAURANTS AND HOTELS VIA A GLOBAL COMPUTER NETWORK (U.S. CLS. 100 AND 101).
FIRST USE 6-0-2003; IN COMMERCE 6-0-2003.
BARBARA A. GOLD, EXAMINING ATTORNEY

CLASS 43—(Continued).

SN 78-288,674. JOHN SKIDMORE DEVELOPMENT, INC., SUTTON, WV. FILED 8-18-2003.



NO CLAIM IS MADE TO THE EXCLUSIVE RIGHT TO USE INN, APART FROM THE MARK AS SHOWN.
FOR MOTELS (U.S. CLS. 100 AND 101).
FIRST USE 8-12-2003; IN COMMERCE 8-12-2003.
JENNIFER CHICOSKI, EXAMINING ATTORNEY

SN 78-295,262. D'ANGELO'S SANDWICH SHOPS, INC., DEDHAM, MA. FILED 9-3-2003.

D'ANGELO

OWNER OF U.S. REG. NOS. 1,673,737, 2,107,484 AND 2,440,957.
SEC. 2(F).
FOR RESTAURANT SERVICES (U.S. CLS. 100 AND 101).
FIRST USE 1-1-1990; IN COMMERCE 1-1-1990.
PAUL F. GAST, EXAMINING ATTORNEY

SN 78-322,987. SHAHANDANA Z. ULLAH, POMONA, CA. FILED 11-4-2003.

**MEXI-BURGER, USA.
THE FIRST
MEXICAN-
AMERICAN BURGER.**

THE MARK CONSISTS OF STANDARD CHARACTERS WITHOUT CLAIM TO ANY PARTICULAR FONT, STYLE, SIZE, OR COLOR.

NO CLAIM IS MADE TO THE EXCLUSIVE RIGHT TO USE "MEXI-BURGER, USA" AND "MEXICAN-AMERICAN BURGER", APART FROM THE MARK AS SHOWN.
FOR FAST FOOD RESTAURANT (U.S. CLS. 100 AND 101).
JENNIFER KRISP, EXAMINING ATTORNEY

CLASS 43—(Continued).

SN 78-330,300. GUEST SERVICES COMPANY OF VIRGINIA, FAIRFAX, VA. FILED 11-19-2003.

PALACE DRAGON

THE MARK CONSISTS OF STANDARD CHARACTERS WITHOUT CLAIM TO ANY PARTICULAR FONT, STYLE, SIZE, OR COLOR.

FOR RESTAURANT AND CARRY-OUT SERVICES (U.S. CLS. 100 AND 101).

FIRST USE 7-0-1998; IN COMMERCE 7-0-1998.
JASON TURNER, EXAMINING ATTORNEY

SN 78-331,927. BIANCHI, JOSEPHINE, SPOTSYLVANIA, VA. FILED 11-23-2003.



NO CLAIM IS MADE TO THE EXCLUSIVE RIGHT TO USE "ITALIAN RESTAURANT & PIZZERIA", APART FROM THE MARK AS SHOWN.

THE MARK CONSISTS OF STYLIZED LETTERS FOR THE WORDS "BIVIO LUCIANO" AND A FORM OF BOLD ARIEL FONT FOR THE WORDS "ITALIAN RESTAURANT & PIZZERIA" WITH AN ARCH AND TABLE SETTING

THE FOREIGN WORDING IN THE MARK TRANSLATES INTO ENGLISH AS FORK IN THE ROAD.

FOR RESTAURANT SERVICES (U.S. CLS. 100 AND 101).

FIRST USE 12-15-2002; IN COMMERCE 3-23-2003.
ANNE MADDEN, EXAMINING ATTORNEY

SN 78-334,861. CP2, L.P., LOS ANGELES, CA. FILED 12-1-2003.

LINCOLN SM

THE MARK CONSISTS OF STANDARD CHARACTERS WITHOUT CLAIM TO ANY PARTICULAR FONT, STYLE, SIZE, OR COLOR.

FOR RESTAURANT SERVICES; EXCLUDING HOTEL AND HOTEL RELATED RESTAURANT SERVICES. (U.S. CLS. 100 AND 101).

LINDA ESTRADA, EXAMINING ATTORNEY

CLASS 43—(Continued).

SN 78-336,906. AYOUB, PETER J., CHANTILLY, VA. AND AYOUB, JOHN P., CHANTILLY, VA. FILED 12-5-2003.

PIZZARAMA

THE MARK CONSISTS OF STANDARD CHARACTERS WITHOUT CLAIM TO ANY PARTICULAR FONT, STYLE, SIZE, OR COLOR.

FOR RESTAURANT SERVICES (U.S. CLS. 100 AND 101).

FIRST USE 5-0-1981; IN COMMERCE 9-0-1984.
TONI HICKEY, EXAMINING ATTORNEY

SN 78-337,610. KONITZER, REMY C., JANESVILLE, WI. FILED 12-8-2003.

**Wild Bill's Saloon
& Steakhouse**

THE MARK CONSISTS OF STANDARD CHARACTERS WITHOUT CLAIM TO ANY PARTICULAR FONT, STYLE, SIZE, OR COLOR.

NO CLAIM IS MADE TO THE EXCLUSIVE RIGHT TO USE "SALOON & STEAKHOUSE", APART FROM THE MARK AS SHOWN.

THE NAME(S), PORTRAIT(S), AND/OR SIGNATURE(S) SHOWN IN THE MARK DOES NOT IDENTIFY A PARTICULAR LIVING INDIVIDUAL.

FOR BAR AND RESTAURANT SERVICES (U.S. CLS. 100 AND 101).

LESLEY LAMOTHE, EXAMINING ATTORNEY

CLASS 43—(Continued).

SN 78-338,874. ASCENDING GLORY OUTREACH, INC., FENTON, MO. FILED 12-10-2003.



NO CLAIM IS MADE TO THE EXCLUSIVE RIGHT TO USE "CAFE", APART FROM THE MARK AS SHOWN.

THE MARK CONSISTS OF THE WORDS ASCENDING GLORY CAFE SURROUNDED BY A BORDER AND ABOVE THE WORDS APPEARS THE IMAGE OF A CUP, SAUCER AND SPOON WITH STEAM AND MUSICAL NOTES EMANATING FROM THE CUP.

FOR CAFE AND RESTAURANT SERVICES (U.S. CLS. 100 AND 101).

FIRST USE 11-15-2001; IN COMMERCE 11-15-2001.
KIM SAITO, EXAMINING ATTORNEY

SN 78-342,463. MRS. FIELDS' BRAND, INC., THE, SALT LAKE, UT. FILED 12-17-2003.

DEBBI FIELDS

THE MARK CONSISTS OF STANDARD CHARACTERS WITHOUT CLAIM TO ANY PARTICULAR FONT, STYLE, SIZE, OR COLOR.

OWNER OF U.S. REG. NOS. 1,241,619, 2,680,419 AND OTHERS.

THE NAME DEBBI FIELDS IDENTIFIES A LIVING INDIVIDUAL WHOSE CONSENT IS OF RECORD.

FOR RESTAURANT SERVICES (U.S. CLS. 100 AND 101).

GINA HAYES, EXAMINING ATTORNEY

CLASS 43—(Continued).

SN 78-345,872. MALLARD COVE INCORPORATED, OLYMPIA, WA. FILED 12-29-2003.

**The Inn at Mallard
Cove**

THE MARK CONSISTS OF STANDARD CHARACTERS WITHOUT CLAIM TO ANY PARTICULAR FONT, STYLE, SIZE, OR COLOR.

FOR BED AND BREAKFAST INN (U.S. CLS. 100 AND 101).

FIRST USE 5-1-2000; IN COMMERCE 10-1-2000.
DARRYL SPRUILL, EXAMINING ATTORNEY

SN 78-366,267. AMERICAN INSTITUTE FOR FOREIGN STUDY, INC., STAMFORD, CT. FILED 2-11-2004.

**Au Pair
Extraordinaire**

OWNER OF U.S. REG. NOS. 2,066,044, 2,092,712 AND 2,877,225.

THE FOREIGN WORDING IN THE MARK TRANSLATES INTO ENGLISH AS EXTRAORDINARY.

FOR PROVIDING IN-HOME CHILD CARE (U.S. CLS. 100 AND 101).

FIRST USE 2-9-2004; IN COMMERCE 2-9-2004.
HENRY S. ZAK, EXAMINING ATTORNEY

SN 78-380,469. THE KESSLER ENTERPRISE, INC., ORLANDO, FL. FILED 3-8-2004.

THE BOHEMIAN CAFE

THE MARK CONSISTS OF STANDARD CHARACTERS WITHOUT CLAIM TO ANY PARTICULAR FONT, STYLE, SIZE, OR COLOR.

OWNER OF U.S. REG. NO. 2,324,739.

NO CLAIM IS MADE TO THE EXCLUSIVE RIGHT TO USE "CAFE", APART FROM THE MARK AS SHOWN.

FOR RESTAURANT SERVICES (U.S. CLS. 100 AND 101).

JENNIFER MARTIN, EXAMINING ATTORNEY

CLASS 43—(Continued).

SN 78-395,867. ROBINSON, MARK A., CELEBRATION, FL.
FILED 4-2-2004.

CK Jerk

THE MARK CONSISTS OF STANDARD CHARACTERS WITHOUT CLAIM TO ANY PARTICULAR FONT, STYLE, SIZE, OR COLOR.

NO CLAIM IS MADE TO THE EXCLUSIVE RIGHT TO USE "JERK", APART FROM THE MARK AS SHOWN.

THE NAME(S), PORTRAIT(S), AND/OR SIGNATURE(S) SHOWN IN THE MARK DOES NOT IDENTIFY A PARTICULAR LIVING INDIVIDUAL.

FOR RESTAURANT SERVICES, NAMELY DINE-IN, TAKE-OUT, DELIVERY, AND CATERING (U.S. CLS. 100 AND 101).

FIRST USE 1-1-2004; IN COMMERCE 2-1-2004.

DOMINICK J. SALEMI, EXAMINING ATTORNEY

SN 78-400,515. TOYOTA JIDOSHA KABUSHIKI KAISHA, TA TOYOTA MOTOR CORPORATION, TOYOTA-SHI, AICHIKEN, JAPAN, FILED 4-12-2004.



NO CLAIM IS MADE TO THE EXCLUSIVE RIGHT TO USE "CENTER", APART FROM THE MARK AS SHOWN.

THE MARK CONSISTS OF T DESIGN & TOYOTA CENTER.

THE JAPANESE WORD "TOYOTA" IN THE MARK MAY BE TRANSLATED AS "RICHFIELD".

FOR ARENA SERVICES, NAMELY, PROVIDING FACILITIES FOR ATHLETIC COMPETITIONS, THEATRICAL AND MUSICAL SHOWS, CONCERTS, ICE SHOWS, CIRCUS PERFORMANCES, AND COMMUNITY EVENTS (U.S. CLS. 100 AND 101).

FIRST USE 10-6-2003; IN COMMERCE 10-6-2003.

ODESSA BIBBINS, EXAMINING ATTORNEY

CLASS 43—(Continued).

SN 78-413,781. MADISON HOLDINGS, INC., SEATTLE, WA.
FILED 5-5-2004.

Goodness in Motion

THE MARK CONSISTS OF STANDARD CHARACTERS WITHOUT CLAIM TO ANY PARTICULAR FONT, STYLE, SIZE, OR COLOR.

FOR RESTAURANT SERVICES IN THE NATURE OF A CONVEYOR BELT RESTAURANT (U.S. CLS. 100 AND 101).

KELLY BOULTON, EXAMINING ATTORNEY

SN 78-415,356. MURRAY, STEVEN A., BAKERSFIELD, CA.
FILED 5-7-2004.

ORCHARD KITCHEN

THE MARK CONSISTS OF STANDARD CHARACTERS WITHOUT CLAIM TO ANY PARTICULAR FONT, STYLE, SIZE, OR COLOR.

NO CLAIM IS MADE TO THE EXCLUSIVE RIGHT TO USE KITCHEN, APART FROM THE MARK AS SHOWN.

FOR RESTAURANT SERVICES (U.S. CLS. 100 AND 101).

GEORGE LORENZO, EXAMINING ATTORNEY

SN 78-419,200. COLONY REEF CLUB CONDOMINIUM ASSOCIATION, INC., ST. AUGUSTINE, FL. FILED 5-14-2004.



NO CLAIM IS MADE TO THE EXCLUSIVE RIGHT TO USE CLUB, APART FROM THE MARK AS SHOWN.

THE COLOR(S) RED AND BLUE IS/ARE CLAIMED AS A FEATURE OF THE MARK.

THE MARK CONSISTS OF A JUMPING BLUE DOLPHIN AND STYLIZED BLUE WAVES SURROUNDING THE LITERAL ELEMENT PRESENTED IN RED LETTERS.

FOR RESORT LODGING SERVICES (U.S. CLS. 100 AND 101).

KARLA PERKINS, EXAMINING ATTORNEY

CLASS 43—(Continued).

SN 78-423,296. FLORENCEIN, INC., TIGARD, OR. FILED 5-21-2004.

**BRIARWOOD BAR &
GRILL**

THE MARK CONSISTS OF STANDARD CHARACTERS WITHOUT CLAIM TO ANY PARTICULAR FONT, STYLE, SIZE, OR COLOR.

NO CLAIM IS MADE TO THE EXCLUSIVE RIGHT TO USE "BAR & GRILL", APART FROM THE MARK AS SHOWN.

FOR RESTAURANT SERVICES (U.S. CLS. 100 AND 101).

KAREN BRACEY, EXAMINING ATTORNEY

CLASS 43—(Continued).

SN 78-427,517. FAMOUS UNCLE AL'S HOT DOGS, INC., KATONAH, NY. FILED 5-31-2004.

**Famous Uncle Al's
Hot Dogs**

THE MARK CONSISTS OF STANDARD CHARACTERS WITHOUT CLAIM TO ANY PARTICULAR FONT, STYLE, SIZE, OR COLOR.

NO CLAIM IS MADE TO THE EXCLUSIVE RIGHT TO USE "HOT DOGS", APART FROM THE MARK AS SHOWN. FOR RESTAURANTS SERVING PRIMARILY HOT DOGS, SAUSAGES, HAMBURGERS AND SOFT DRINKS (U.S. CLS. 100 AND 101).

FIRST USE 1-1-1990; IN COMMERCE 1-1-1990.
KEVON CHISOLM, EXAMINING ATTORNEY

SN 78-430,939. SOUTHBOURNE INC., SAN FRANCISCO, CA. FILED 6-7-2004.

CAMPTON PLACE

SN 78-426,274. ROSEN HOTELS & RESORTS, INC., ORLANDO, FL. FILED 5-27-2004.

THE MARK CONSISTS OF STANDARD CHARACTERS WITHOUT CLAIM TO ANY PARTICULAR FONT, STYLE, SIZE, OR COLOR.

OWNER OF U.S. REG. NO. 1,317,424. FOR HOTEL, RESTAURANT AND BAR SERVICES (U.S. CLS. 100 AND 101).

FIRST USE 10-6-1983; IN COMMERCE 10-6-1983.
VERNA BETH RIRIE, EXAMINING ATTORNEY

PAR-TAKE

SN 78-433,998. CROWLEY, JOHN T., FRANKLIN LAKES, NJ. FILED 6-11-2004.

**DIAL N' DELIVER
PIZZA**

THE MARK CONSISTS OF STANDARD CHARACTERS WITHOUT CLAIM TO ANY PARTICULAR FONT, STYLE, SIZE, OR COLOR.

FOR RESTAURANT SERVICES, SNACK BAR SERVICES, AND TAKE-OUT RESTAURANT SERVICES (U.S. CLS. 100 AND 101).

FIRST USE 5-25-2004; IN COMMERCE 5-25-2004.
ALICE SUE CARRUTHERS, EXAMINING ATTORNEY

THE MARK CONSISTS OF STANDARD CHARACTERS WITHOUT CLAIM TO ANY PARTICULAR FONT, STYLE, SIZE, OR COLOR.

NO CLAIM IS MADE TO THE EXCLUSIVE RIGHT TO USE PIZZA, APART FROM THE MARK AS SHOWN. FOR PIZZERIA (U.S. CLS. 100 AND 101).

ANDREW BENZMILLER, EXAMINING ATTORNEY

CLASS 43—(Continued).

SN 78-434,177. BEST WESTERN INTERNATIONAL, INC., PHOENIX, AZ. FILED 6-11-2004.

BESTWESTERN.COM

THE MARK CONSISTS OF STANDARD CHARACTERS WITHOUT CLAIM TO ANY PARTICULAR FONT, STYLE, SIZE, OR COLOR.

OWNER OF U.S. REG. NOS. 1,072,360, 2,826,386 AND OTHERS.

FOR PROVIDING HOTEL, MOTEL AND RESORT RESERVATION SERVICES VIA A GLOBAL COMPUTER NETWORK (U.S. CLS. 100 AND 101).

GWEN STOKOLS, EXAMINING ATTORNEY

SN 78-434,756. LAKE CARE SYSTEMS, INC., MT. DORA, FL. FILED 6-14-2004.

**LIVING YOUR BEST
LIFE**

THE MARK CONSISTS OF STANDARD CHARACTERS WITHOUT CLAIM TO ANY PARTICULAR FONT, STYLE, SIZE, OR COLOR.

FOR RESIDENTIAL ELDER CARE SERVICES, NAMELY PROVIDING INDEPENDENT LIVING FACILITIES; ASSISTED LIVING FACILITIES (U.S. CLS. 100 AND 101).

CHARLES JOYNER, EXAMINING ATTORNEY

SN 78-435,387. AUSTIN, DALLAS, ATLANTA, GA. FILED 6-15-2004.

OM

THE MARK CONSISTS OF STANDARD CHARACTERS WITHOUT CLAIM TO ANY PARTICULAR FONT, STYLE, SIZE, OR COLOR.

FOR HOTEL SERVICES (U.S. CLS. 100 AND 101).

GRETTA YAO, EXAMINING ATTORNEY

CLASS 43—(Continued).

SN 78-435,388. RE ARENA, INC., GRAND FORKS, ND. FILED 6-15-2004.

**BETTY ENGELSTAD
SIOUX CENTER**

THE MARK CONSISTS OF STANDARD CHARACTERS WITHOUT CLAIM TO ANY PARTICULAR FONT, STYLE, SIZE, OR COLOR.

NO CLAIM IS MADE TO THE EXCLUSIVE RIGHT TO USE "CENTER", APART FROM THE MARK AS SHOWN.

THE NAME(S), PORTRAIT(S), AND/OR SIGNATURE(S) SHOWN IN THE MARK IDENTIFIES BETTY ENGELSTAD, WHOSE CONSENT(S) TO REGISTER IS SUBMITTED.

FOR ARENA SERVICES, NAMELY PROVIDING FACILITIES FOR SPORTS, CONCERTS, CONVENTIONS, CONFERENCES AND EXHIBITIONS (U.S. CLS. 100 AND 101).

GRETTA YAO, EXAMINING ATTORNEY

SN 78-435,531. CROMWELL CORP., AURORA, CO. FILED 6-15-2004.

NOT JUAN'S

THE MARK CONSISTS OF STANDARD CHARACTERS WITHOUT CLAIM TO ANY PARTICULAR FONT, STYLE, SIZE, OR COLOR.

FOR RESTAURANT SERVICES (U.S. CLS. 100 AND 101).

KIMBERLY PERRY, EXAMINING ATTORNEY

CLASS 43—(Continued).

SN 78-435,562. SABOR DE MINAS, NATICK, MA. FILED 6-15-2004.

CLASS 43—(Continued).

SN 78-438,027. SUNSHINE COFFEE, INC., DENVER, CO. FILED 6-18-2004.

SABOR DE MINAS



THE MARK CONSISTS OF STANDARD CHARACTERS WITHOUT CLAIM TO ANY PARTICULAR FONT, STYLE, SIZE, OR COLOR.

NO CLAIM IS MADE TO THE EXCLUSIVE RIGHT TO USE "DE MINAS", APART FROM THE MARK AS SHOWN. THE ENGLISH TRANSLATION OF SABOR DE MINAS IS FLAVOR OF MINAS.

FOR RESTAURANT SERVICES FEATURING FOOD FROM MINAS (U.S. CLS. 100 AND 101).

ELLEN B. AWRICH, EXAMINING ATTORNEY

NO CLAIM IS MADE TO THE EXCLUSIVE RIGHT TO USE "COFFEE" & "CHAI", APART FROM THE MARK AS SHOWN.

FOR RESTAURANT, CAFE AND TAKE-OUT SERVICES FEATURING COFFEE, CHAI, TEA, SNACKS, AND OTHER BEVERAGES (U.S. CLS. 100 AND 101).

FIRST USE 6-3-2004; IN COMMERCE 6-3-2004.

WINSTON FOLMAR, EXAMINING ATTORNEY

SN 78-438,026. CALIFORNIA FISH GRILL, INC., COVINA, CA. FILED 6-18-2004.

SN 78-438,431. CELEBRATIONS MANAGEMENT, INC., HIGHLAND VILLAGE, TX. FILED 6-21-2004.

**CALIFORNIA FISH
GRILL HAS YOU
HOOKED**

DELLA VITA

THE MARK CONSISTS OF STANDARD CHARACTERS WITHOUT CLAIM TO ANY PARTICULAR FONT, STYLE, SIZE, OR COLOR.

OWNER OF U.S. REG. NO. 2,864,201.

FOR RESTAURANT SERVICES (U.S. CLS. 100 AND 101).

ANN E. SAPPENFIELD, EXAMINING ATTORNEY

THE MARK CONSISTS OF STANDARD CHARACTERS WITHOUT CLAIM TO ANY PARTICULAR FONT, STYLE, SIZE, OR COLOR.

THE ENGLISH TRANSLATION OF THE ITALIAN WORDING "DELLA VITA" IS "OF THE LIFE".

FOR RESTAURANT SERVICES (U.S. CLS. 100 AND 101).

CHRISTOPHER ADKINS, EXAMINING ATTORNEY

CLASS 43—(Continued).

SN 78-439,326. CORSUN, HILARY A., SCARSDALE, NY.
FILED 6-22-2004.

CLASS 43—(Continued).

SN 78-475,452. OLIVER, ROBERT, NEW YORK, NY. FILED
8-30-2004.

Bone 'n Bark

THE MARK CONSISTS OF STANDARD CHARACTERS
WITHOUT CLAIM TO ANY PARTICULAR FONT, STYLE,
SIZE, OR COLOR.
FOR BOARDING CAMP FOR DOGS (U.S. CLS. 100
AND 101).
FIRST USE 4-1-2000; IN COMMERCE 4-1-2000.
KEVON CHISOLM, EXAMINING ATTORNEY

SUVA

THE MARK CONSISTS OF STANDARD CHARACTERS
WITHOUT CLAIM TO ANY PARTICULAR FONT, STYLE,
SIZE, OR COLOR.
FOR RESTAURANT SERVICES (U.S. CLS. 100 AND
101).
ALLISON SCHRODY, EXAMINING ATTORNEY

SN 78-441,568. GIOVANNI'S PIZZA, INC., ASHLAND, KY.
FILED 6-25-2004.

SN 78-495,805. BEST WESTERN INTERNATIONAL, INC.,
PHOENIX, AZ. FILED 10-6-2004.



BEST WESTERN BESTRATES

FOR RESTAURANT SERVICES (U.S. CLS. 100 AND
101).
FIRST USE 4-1-2004; IN COMMERCE 4-1-2004.
DANIEL BRODY, EXAMINING ATTORNEY

THE MARK CONSISTS OF STANDARD CHARACTERS
WITHOUT CLAIM TO ANY PARTICULAR FONT, STYLE,
SIZE, OR COLOR.
OWNER OF U.S. REG. NOS. 1,072,360, 2,826,386 AND
OTHERS.
FOR HOTEL, MOTEL AND RESORT HOTEL SER-
VICES (U.S. CLS. 100 AND 101).
FIRST USE 9-1-1994; IN COMMERCE 9-1-1994.
GWEN STOKOLS, EXAMINING ATTORNEY

CLASS 44—MEDICAL, BEAUTY AND AGRICULTURAL SERVICES

SN 76-542,343. EL PASO FIRST HEALTH PLANS, INC., EL PASO, TX. FILED 9-3-2003.

EL PASO CHOICE

NO CLAIM IS MADE TO THE EXCLUSIVE RIGHT TO USE "EL PASO", APART FROM THE MARK AS SHOWN. FOR HEALTH CARE IN THE NATURE OF HEALTH MAINTENANCE ORGANIZATIONS (U.S. CLS. 100 AND 101).

SOPHIA S. KIM, EXAMINING ATTORNEY

SN 76-563,656. SSM HEALTH CARE OF OKLAHOMA, INC., OKLAHOMA CITY, OK. FILED 11-24-2003.

Bone & Joint Hospital



NO CLAIM IS MADE TO THE EXCLUSIVE RIGHT TO USE "HOSPITAL", APART FROM THE MARK AS SHOWN. SEC. 2(F) AS TO "BONE & JOINT HOSPITAL" AND THE CROSS DESIGN.

FOR HEALTHCARE AND HOSPITAL CARE SERVICES (U.S. CLS. 100 AND 101).

FIRST USE 5-1-1995; IN COMMERCE 5-1-1995.

KATHY DE JONGE, EXAMINING ATTORNEY

SN 76-567,075. GALANTE, GUSTAVO E., MUNSTER, IN. FILED 12-24-2003.

THE CONFIDENCE NO BODY CAN RESIST

THE MARK CONSISTS OF STANDARD CHARACTERS WITHOUT CLAIM TO ANY PARTICULAR FONT, STYLE, SIZE, OR COLOR.

FOR COSMETIC AND PLASTIC SURGERY (U.S. CLS. 100 AND 101).

FIRST USE 11-15-1998; IN COMMERCE 11-15-1998.

JASON TURNER, EXAMINING ATTORNEY

SN 76-568,126. GILLIAN, BRANDON JAMESON, HILLSIDE, NJ. FILED 12-29-2003.

ENDURING BEAUTY

THE MARK CONSISTS OF STANDARD CHARACTERS WITHOUT CLAIM TO ANY PARTICULAR FONT, STYLE, SIZE, OR COLOR.

FOR SERVICES IN THE NATURE OF MICROPIGMENTATION, NAMELY, TATTOOING SERVICES (U.S. CLS. 100 AND 101).

FIRST USE 6-30-2002; IN COMMERCE 6-30-2002.

IRA J. GOODSAD, EXAMINING ATTORNEY

CLASS 44—(Continued).

SN 76-570,086. BAYLOR UNIVERSITY, WACO, MCLENNAN COUNTY, TX. FILED 1-15-2004.

BAYLOR HEART SCAN

THE MARK CONSISTS OF STANDARD CHARACTERS WITHOUT CLAIM TO ANY PARTICULAR FONT, STYLE, SIZE, OR COLOR.

OWNER OF U.S. REG. NOS. 751,683, 1,936,714 AND OTHERS.

NO CLAIM IS MADE TO THE EXCLUSIVE RIGHT TO USE "HEART SCAN", APART FROM THE MARK AS SHOWN.

SEC. 2(F) AS TO "BAYLOR".

FOR DIAGNOSTIC MEDICAL SERVICES, NAMELY, PERFORMING NON-INVASIVE DIAGNOSTIC TESTS ON THE HEART AND CORONARY ARTERIES (U.S. CLS. 100 AND 101).

PAUL F. GAST, EXAMINING ATTORNEY

SN 76-579,017. INFERTILITY AND GYNECOLOGIC MEDICINE, INC., ST. LOUIS, MO. FILED 3-2-2004.



OWNER OF U.S. REG. NO. 1,831,714. FOR MEDICAL SERVICES IN THE FIELD OF INFERTILITY AND ADVANCE AND ASSISTED REPRODUCTIVE TECHNOLOGIES (U.S. CLS. 100 AND 101).

FIRST USE 0-0-1993; IN COMMERCE 0-0-1993.

ALLISON HOLTZ, EXAMINING ATTORNEY

SN 76-593,222. CHADWICK, ANNE, MESA, AZ. FILED 5-10-2004.

METACARPAL MOTIONS

THE MARK CONSISTS OF STANDARD CHARACTERS WITHOUT CLAIM TO ANY PARTICULAR FONT, STYLE, SIZE, OR COLOR.

NO CLAIM IS MADE TO THE EXCLUSIVE RIGHT TO USE "METACARPAL", APART FROM THE MARK AS SHOWN.

FOR MASSAGE, AND REFLEXOLOGY (U.S. CLS. 100 AND 101).

FIRST USE 11-9-1995; IN COMMERCE 11-11-1995.

JOHN LINCOSKI, EXAMINING ATTORNEY

CLASS 44—(Continued).

SN 76-597,591. ABLON, GLYNIS, MANHATTAN BEACH, CA. FILED 6-16-2004.

ThermaPhoto.

THE MARK CONSISTS OF STANDARD CHARACTERS WITHOUT CLAIM TO ANY PARTICULAR FONT, STYLE, SIZE, OR COLOR.

FOR LASER LIGHT AND RADIO FREQUENCY TREATMENT FOR DESTRUCTION OF WRINKLES, SUN DAMAGE, VESSEL FORMATION, ACNE SEARS, AND FOR SKIN TIGHTENING (U.S. CLS. 100 AND 101). FIRST USE 6-4-2004; IN COMMERCE 6-4-2004.

DOMINIC J. FERRAIUOLO, EXAMINING ATTORNEY

SN 76-597,963. COLLIER, ANTHONY W., FORSYTH, MO. FILED 6-18-2004.

LIGHTWORKS

FOR NUTRITION CLINICS AND NUTRITION COUNSELING (U.S. CLS. 100 AND 101).

DORITT L. CARROLL, EXAMINING ATTORNEY

SN 76-599,275. SPAMEDICA INTERNATIONAL SRL, WHITEHALL ST. MICHAEL, BARBADOS, FILED 6-25-2004.

LOOPLIFT

THE MARK CONSISTS OF STANDARD CHARACTERS WITHOUT CLAIM TO ANY PARTICULAR FONT, STYLE, SIZE, OR COLOR.

FOR COSMETIC AND THERAPEUTIC SERVICES, NAMELY, A NON-SURGICAL PROCEDURE USING INTENSE PULSED LIGHT, LASER AND RADIOFREQUENCY ENERGY TO NON-INVASIVELY AND NON-ABLATIVELY FIRM, LIFT, TIGHTEN, REJUVENATE AND ENHANCE THE SOFT TISSUE OF THE FACE, BROW, NECK, BREASTS, BUTTOCKS AND ABDOMEN, AND A NON-SURGICAL REJUVENATION PROCEDURE WHEREIN THE SOFT-TISSUE OF THE BROWS, CHEEKS, NECK, BREASTS, BUTTOCKS OR BODY ARE RESUSPENDED USING MODIFIED PROLENE SUTURES INSERTED WITH A NEEDLE (U.S. CLS. 100 AND 101).

FIRST USE 12-0-2003; IN COMMERCE 12-0-2003.
GEOFFREY FOSDICK, EXAMINING ATTORNEY

CLASS 44—(Continued).

SN 78-247,018. ENTREPRENEURIAL MEDICAL CONSULTING, LLC, LOS ANGELES, CA. FILED 5-7-2003.



The logo features a stylized letter 'G' on the left, which is a thick, black, curved line that forms a partial circle. To the right of the 'G' is the word 'SPOT' in a bold, sans-serif font. Below 'SPOT' is the word 'AMPLIFICATION' in a smaller, all-caps, sans-serif font. A small dot is positioned between the 'G' and 'SPOT'.

NO CLAIM IS MADE TO THE EXCLUSIVE RIGHT TO USE G-SPOT AMPLIFICATION, APART FROM THE MARK AS SHOWN.

THE MARK CONSISTS IN PART OF A STYLIZED LETTER G.

FOR MEDICAL SERVICES, NAMELY GYNECOLOGIC SURGERY (U.S. CLS. 100 AND 101).

FIRST USE 6-1-2002; IN COMMERCE 6-1-2002.

STEVEN R. FOSTER, EXAMINING ATTORNEY

SN 78-271,936. COTITA, TIMOTHY C., MONROE, LA. FILED 7-9-2003.

HEALTHCARE AT HOME, WE MAKE IT POSSIBLE!

FOR HOME HEALTHCARE SERVICES, NURSING CARE, PHYSICAL THERAPY, AND HEALTHCARE SERVICES (U.S. CLS. 100 AND 101).

FIRST USE 2-17-2003; IN COMMERCE 2-17-2003.

DANIELLE MATTESSICH, EXAMINING ATTORNEY

SN 78-274,923. AMERICAN HOMES OF WESTERN COLORADO, DELTA, CO. FILED 7-16-2003.

TANDEM FAMILIES

NO CLAIM IS MADE TO THE EXCLUSIVE RIGHT TO USE FAMILIES, APART FROM THE MARK AS SHOWN.

FOR MENTAL HEALTH SERVICES FOR AT-RISK CHILDREN AND THEIR FAMILIES VIA THE ONLINE RESPONSE FORM (U.S. CLS. 100 AND 101).

FIRST USE 3-1-2000; IN COMMERCE 3-1-2000.

DOMINIC J. FERRAIUOLO, EXAMINING ATTORNEY

CLASS 44—(Continued).

SN 78-338,903. KINDRED HEALTHCARE, INC., LOUISVILLE, KY. FILED 12-10-2003.



NO CLAIM IS MADE TO THE EXCLUSIVE RIGHT TO USE REHABILITATION, APART FROM THE MARK AS SHOWN.

FOR PHYSICAL AND OCCUPATIONAL REHABILITATION AND THERAPY SERVICES (U.S. CLS. 100 AND 101).

GINA FINK, EXAMINING ATTORNEY

CLASS 44—(Continued).

SN 78-354,353. GUSS, AVA, NEW YORK, NY. FILED 1-20-2004.

DIMENSIONAL ENERGY WEAVING

THE MARK CONSISTS OF STANDARD CHARACTERS WITHOUT CLAIM TO ANY PARTICULAR FONT, STYLE, SIZE, OR COLOR.

NO CLAIM IS MADE TO THE EXCLUSIVE RIGHT TO USE "DIMENSIONAL ENERGY", APART FROM THE MARK AS SHOWN.

FOR STRESS MANAGEMENT THERAPY BASED ON HYPNOTHERAPY, BODYWORK, SHIATSU-ACUPRESSURE, MOVEMENT AND BREATH THERAPY, CHAKRA AND AURA AND ENERGY WORK, SONAR AND VOICE THERAPY, COLOR AND MUSIC THERAPY, VERBAL PROCESSING, METAPHYSICAL AND SPIRITUAL TECHNIQUES (U.S. CLS. 100 AND 101).

PAUL F. GAST, EXAMINING ATTORNEY

SN 78-346,323. EL REY SALON, LP, AUSTIN, TX. FILED 12-29-2003.

EL REY

THE MARK CONSISTS OF STANDARD CHARACTERS WITHOUT CLAIM TO ANY PARTICULAR FONT, STYLE, SIZE, OR COLOR.

THE FOREIGN WORDING IN THE MARK TRANSLATES INTO ENGLISH AS THE KING.

FOR BEAUTY SALONS AND HEALTH SPA SERVICES, NAMELY, COSMETIC BODY CARE SERVICES (U.S. CLS. 100 AND 101).

STANLEY I. OSBORNE, EXAMINING ATTORNEY

SN 78-359,056. HAZELWOOD-SAVAGE, NANCY, MALIN, OR. FILED 1-28-2004.

Farceur

THE MARK CONSISTS OF STANDARD CHARACTERS WITHOUT CLAIM TO ANY PARTICULAR FONT, STYLE, SIZE, OR COLOR.

FOR HORSE BREEDING AND STUD SERVICES (U.S. CLS. 100 AND 101).

FIRST USE 1-1-1963; IN COMMERCE 1-1-1963.

MARK SPARACINO, EXAMINING ATTORNEY

CLASS 44—(Continued).

SN 78-382,277. STRAUSS, FRED L., MODESTO, CA. AND ROMANDER, ALLAN H., MODESTO, CA. FILED 3-11-2004.

CLASS 44—(Continued).

SN 78-396,344. KREIGER, ALLISON, ORLANDO, FL. FILED 4-5-2004.

Doctor Grape

H.O.P.E. Helping Other People Eat

THE MARK CONSISTS OF STANDARD CHARACTERS WITHOUT CLAIM TO ANY PARTICULAR FONT, STYLE, SIZE, OR COLOR.

FOR PROVIDING ON-LINE AGRICULTURAL INFORMATION FOR GROWERS OF GRAPES (U.S. CLS. 100 AND 101).

SUELLEN HICKEY, EXAMINING ATTORNEY

THE MARK CONSISTS OF STANDARD CHARACTERS WITHOUT CLAIM TO ANY PARTICULAR FONT, STYLE, SIZE, OR COLOR.

FOR PROVIDING HEALTH INFORMATION AND ON-LINE HEALTH INFORMATION IN THE FIELD OF EATING DISORDERS (U.S. CLS. 100 AND 101).

FIRST USE 11-1-2001; IN COMMERCE 12-31-2001.
ARETHA SOMERVILLE, EXAMINING ATTORNEY

SN 78-393,146. GRUBB, LARRY K., SILVER SPRING, MD. FILED 3-30-2004.

SN 78-402,391. BENT OAK FARM INC, OCALA, FL. FILED 4-15-2004.

DOC GRUBB



THE MARK CONSISTS OF STANDARD CHARACTERS WITHOUT CLAIM TO ANY PARTICULAR FONT, STYLE, SIZE, OR COLOR.

THE NAME DOC GRUBB IDENTIFIES A LIVING INDIVIDUAL WHOSE CONSENT IS OF RECORD.

FOR CONDUCTING MEDICALLY SUPERVISED WEIGHT NORMALIZATION PROGRAMS, NAMELY, WEIGHT REDUCTION DIET PLANNING AND SUPERVISION FOR CHILDREN AND ADOLESCENTS THAT PROVIDES INFORMATION ABOUT HEALTH, NUTRITION, AND DIET AND PSYCHOLOGICAL CONSULTATION DEALING WITH ISSUES ASSOCIATED WITH OBESITY. (U.S. CLS. 100 AND 101).

MARY CRAWFORD, EXAMINING ATTORNEY

THE COLOR(S) BLUE, GREEN, BROWN IS/ARE CLAIMED AS A FEATURE OF THE MARK.

THE MARK CONSISTS OF TWO BROWN HANDS SHAKING. THE LEFT BROWN HAND MAKES INTO BROWN ROOTS, THE RIGHT BROWN HAND MAKES INTO GREEN LEAVES. BLUE AND BROWN BACKGROUND BEHIND HANDS.

THE MARK CONSISTS OF TWO BROWN HANDS SHAKING. THE LEFT BROWN HAND MAKES INTO BROWN ROOTS, THE RIGHT BROWN HAND MAKES INTO GREEN LEAVES. BLUE AND BROWN BACKGROUND BEHIND HANDS.

FOR TREE NURSERIES (U.S. CLS. 100 AND 101).
MICHAEL SOUDERS, EXAMINING ATTORNEY

CLASS 44—(Continued).

SN 78-410,450. SELECTMARK, INC., WILMINGTON, DE. FILED 4-29-2004.



OWNER OF U.S. REG. NOS. 2,300,405, 2,304,858 AND 2,708,695.

NO CLAIM IS MADE TO THE EXCLUSIVE RIGHT TO USE "SPECIALTY HOSPITAL", APART FROM THE MARK AS SHOWN.

THE MARK CONSISTS OF A REPRESENTATION OF A TREE DIVIDED INTO FOUR PARTS BY A WHITE CROSS, THE LOWER RIGHT-HAND QUADRANT OF THE TREE IS REPLACED WITH THE TEXT "SELECT SPECIALTY HOSPITAL."

FOR INPATIENT AND OUTPATIENT LONG-TERM ACUTE HEALTH CARE SERVICES (U.S. CLS. 100 AND 101).

FIRST USE 6-1-1998; IN COMMERCE 6-1-1998. CAROL SPILS, EXAMINING ATTORNEY

CLASS 44—(Continued).

SN 78-420,736. MAY, MICHELLE L, PHOENIX, AZ. FILED 5-18-2004.



FOR COMPREHENSIVE WEIGHT MANAGEMENT SERVICES, NAMELY, WEIGHT REDUCTION PLANNING AND SUPERVISION (U.S. CLS. 100 AND 101). WON TEAK OH, EXAMINING ATTORNEY

SN 78-425,590. CURASCRIPT PHARMACY, INC., ORLANDO, FL. FILED 5-26-2004.

PSORIASISLOGIC

THE MARK CONSISTS OF STANDARD CHARACTERS WITHOUT CLAIM TO ANY PARTICULAR FONT, STYLE, SIZE, OR COLOR.

FOR HEALTH CARE SERVICES, NAMELY TO PROVIDE INTENSE CARE MANAGEMENT FOR PATIENTS CURRENTLY IN THERAPY FOR PSORIASIS (U.S. CLS. 100 AND 101).

FIRST USE 12-1-2003; IN COMMERCE 12-1-2003. BRIAN NEVILLE, EXAMINING ATTORNEY

SN 78-413,040. INFLEXXION, INC., NEWTON, MA. FILED 5-4-2004.



THE COLOR(S) GOLD, RED, WHITE AND GRAY IS/ARE CLAIMED AS A FEATURE OF THE MARK.

THE COLORS WHITE APPEARS IN THE LETTERS, THE COLORS GRAY AND RED APPEAR IN THE HORIZONTAL BAND, AND THE COLOR GOLD APPEARS IN THE REST OF THE CIRCLE.

FOR PROVIDING A WEB SITE FEATURING INFORMATION IN THE FIELD OF HEALTH, NAMELY, AN INTERACTIVE WEBSITE ON THE GLOBAL INFORMATION NETWORK CONTAINING CLINICAL INFORMATION ON HEALTH AND DRUG ISSUES FOR COLLEGE STUDENTS (U.S. CLS. 100 AND 101).

FIRST USE 1-0-2004; IN COMMERCE 2-0-2004. RON FAIRBANKS, EXAMINING ATTORNEY

SN 78-430,945. CANTON, JOHN, SAN DIEGO, CA. FILED 6-7-2004.



FOR HAIR SALON SERVICES (U.S. CLS. 100 AND 101). LINDA ESTRADA, EXAMINING ATTORNEY

CLASS 44—(Continued).

SN 78-433,756. ABC PEDIATRIC REHAB, INC., MIAMI, FL. FILED 6-11-2004.



NO CLAIM IS MADE TO THE EXCLUSIVE RIGHT TO USE "PEDIATRIC REHAB INC.", APART FROM THE MARK AS SHOWN.

THE COLOR(S) A-YELLOW, B-MAGENTA, C-CYAN IS/ ARE CLAIMED AS A FEATURE OF THE MARK.

THE MARK CONSISTS OF THE WORD ABC PEDIATRIC REHAB INC. IN BLACK AND IN CENTURY GOTHIC FONT. THE LETTERS ABC ARE IN CAPITAL LETTERS, AND THE FIRST LETTER OF THE WORDS PEDIATRIC, REHAB, AND INC. ARE IN CAPITAL LETTERS. ADDITIONAL LETTERS ABC ARE ON THREE TOY BLOCKS. THE BLOCK A IS IN YELLOW, THE BLOCK B IS IN MAGENTA, AND THE BLOCK C IS IN CYAN.

FOR OCCUPATIONAL, PHYSICAL, AND SPEECH THERAPY PROVIDED TO KIDS AT THEIR HOMES OR DAYCARE FACILITIES (U.S. CLS. 100 AND 101).

JENNIFER KRISP, EXAMINING ATTORNEY

SN 78-434,679. WONG, VIRGIL C, NEW YORK, NY. FILED 6-14-2004.

**The best of nature
before you nurture**

THE MARK CONSISTS OF STANDARD CHARACTERS WITHOUT CLAIM TO ANY PARTICULAR FONT, STYLE, SIZE, OR COLOR.

FOR GENETIC SCREENING AND TREATMENT FOR EMBRYOS, FETUSES, AND BABIES (U.S. CLS. 100 AND 101).

RONALD MCMORROW, EXAMINING ATTORNEY

CLASS 44—(Continued).

SN 78-434,750. LAKE CARE SYSTEMS, INC., MT. DORA, FL. FILED 6-14-2004.

**LIVING YOUR BEST
LIFE**

THE MARK CONSISTS OF STANDARD CHARACTERS WITHOUT CLAIM TO ANY PARTICULAR FONT, STYLE, SIZE, OR COLOR.

FOR ELDER CARE MEDICAL AND HEALTH SERVICES, NAMELY MEDICAL SERVICES AND NURSING HOME SERVICES (U.S. CLS. 100 AND 101).

CHARLES JOYNER, EXAMINING ATTORNEY

SN 78-437,253. CLARIGOMED, LLC, ARLINGTON HEIGHTS, IL. FILED 6-17-2004.



FOR HEALTH CARE SERVICES, NAMELY PROVIDING PHYSICAL THERAPY AND DIAGNOSTIC TESTING SERVICES (U.S. CLS. 100 AND 101).

FIRST USE 3-8-2004; IN COMMERCE 3-8-2004.

BRIDGETT SMITH, EXAMINING ATTORNEY

SN 78-437,257. CLARIGOMED, LLC, ARLINGTON HEIGHTS, IL. FILED 6-17-2004.

CLARIGOMED

THE MARK CONSISTS OF STANDARD CHARACTERS WITHOUT CLAIM TO ANY PARTICULAR FONT, STYLE, SIZE, OR COLOR.

FOR HEALTH CARE SERVICES, NAMELY PROVIDING PHYSICAL THERAPY AND DIAGNOSTIC TESTING SERVICES (U.S. CLS. 100 AND 101).

FIRST USE 3-8-2004; IN COMMERCE 3-8-2004.

BRIDGETT SMITH, EXAMINING ATTORNEY

CLASS 44—(Continued).

SN 78-437,430. MICHIGAN OPEN MRI, LLC, ROYAL OAK, MI. FILED 6-17-2004.

**CMI CENTRAL
MEDICAL IMAGING**

THE MARK CONSISTS OF STANDARD CHARACTERS WITHOUT CLAIM TO ANY PARTICULAR FONT, STYLE, SIZE, OR COLOR.

NO CLAIM IS MADE TO THE EXCLUSIVE RIGHT TO USE "MEDICAL IMAGING", APART FROM THE MARK AS SHOWN.

FOR MEDICAL SERVICES, NAMELY MEDICAL IMAGING SERVICES (U.S. CLS. 100 AND 101).
MARK T. MULLEN, EXAMINING ATTORNEY

CLASS 44—(Continued).

SN 78-483,946. DAYHAWK RADIOLOGY SERVICES, LLC, LAFAYETTE, LA. FILED 9-15-2004.



NO CLAIM IS MADE TO THE EXCLUSIVE RIGHT TO USE RADIOLOGY SERVICES, APART FROM THE MARK AS SHOWN.

FOR TELERADIOLOGY HEALTHCARE SERVICES IN THE NATURE OF READING SCANS VIA THE INTERNET FOR HOSPITALS, IMAGING CLINICS, AND RADIOLOGY GROUPS (U.S. CLS. 100 AND 101).
BRIDGETT SMITH, EXAMINING ATTORNEY

SN 78-438,301. CHILDREN'S HOSPITAL MEDICAL CENTER, CINCINNATI, OH. FILED 6-21-2004.

CHANGE THE OUTCOME

THE MARK CONSISTS OF STANDARD CHARACTERS WITHOUT CLAIM TO ANY PARTICULAR FONT, STYLE, SIZE, OR COLOR.

FOR PEDIATRIC AND ADOLESCENT INPATIENT AND OUTPATIENT HOSPITAL SERVICES (U.S. CLS. 100 AND 101).

FIRST USE 12-5-2003; IN COMMERCE 4-12-2004.
INGRID C. EULIN, EXAMINING ATTORNEY

CLASS 45—PERSONAL SERVICES

SN 76-538,441. MAURER'S TEXTILE RENTAL SERVICES, INC., DEWITT, MI. FILED 8-19-2003.

**MAURER'S YOUR IMAGE
PARTNER**

FOR TEXTILE RENTAL SERVICES, NAMELY, RENTAL OF LINENS, MATS, UNIFORMS AND SHIRTS (U.S. CLS. 100 AND 101).

FIRST USE 5-1-2003; IN COMMERCE 5-1-2003.
KIMBERLY PERRY, EXAMINING ATTORNEY

SN 78-438,864. D-AGE NAIL & SPA, INC., NEW YORK, NY. FILED 6-21-2004.

D-AGE NAIL & SPA

THE MARK CONSISTS OF STANDARD CHARACTERS WITHOUT CLAIM TO ANY PARTICULAR FONT, STYLE, SIZE, OR COLOR.

NO CLAIM IS MADE TO THE EXCLUSIVE RIGHT TO USE NAIL & SPA, APART FROM THE MARK AS SHOWN.

FOR BEAUTY SPA SERVICES, NAMELY, MANICURES, PEDICURES, FACIAL AND BODY TREATMENTS, HAIR CARE SERVICES; AND HEALTH SPA SERVICES, NAMELY, BATH, SAUNA, AROMATHERAPY, RELAXATION THERAPY, BODY MASSAGE AND BODY WAXING (U.S. CLS. 100 AND 101).
STEVEN R. FINE, EXAMINING ATTORNEY

SN 76-545,012. D W A COMMUNICATIONS, INCORPORATED, POMPANO BEACH, FL. FILED 9-3-2003.

**FLAWLESS SERVICE
DISTINCTION**

FOR CONCIERGE SERVICES FOR OTHERS PROVIDED EITHER BY TELEPHONE OR ON-LINE, NAMELY, HOTEL, TRAVEL AND ENTERTAINMENT RESERVATIONS, AND PROVIDING CUSTOMER SPECIFIC INFORMATION REGARDING LUXURY GOODS AND ENTERTAINMENT PRODUCTS AND SERVICES (U.S. CLS. 100 AND 101).
SOPHIA S. KIM, EXAMINING ATTORNEY

CLASS 45—(Continued).

SN 76-595,760. WILKIRSON-HATCH-BAILEY FUNERAL HOME INCORPORATED, WACO, TX. FILED 6-2-2004.

Lifewalk 

FOR FUNERAL HOME SERVICES, MORTUARY SERVICES, EMBALMING, CREMATION, INTERMENT SERVICES (U.S. CLS. 100 AND 101).
FIRST USE 10-1-2003; IN COMMERCE 10-1-2003.
RUSS HERMAN, EXAMINING ATTORNEY

SN 76-598,304. DEPARTING SHOT, INC., THE, KANSAS CITY, MO. FILED 6-21-2004.

THE DEPARTING SHOT

THE MARK CONSISTS OF STANDARD CHARACTERS WITHOUT CLAIM TO ANY PARTICULAR FONT, STYLE, SIZE, OR COLOR.

FOR PROVIDING PACKAGING AND SCATTERING SERVICES FOR THE REMAINS OF DOGS (U.S. CLS. 100 AND 101).

RONALD MCMORROW, EXAMINING ATTORNEY

SN 78-234,501. B.L. BARBOUR, FOLEY, AL. FILED 4-7-2003.

Adorable  *Gift Baskets*

NO CLAIM IS MADE TO THE EXCLUSIVE RIGHT TO USE ADORABLE GIFT BASKETS, APART FROM THE MARK AS SHOWN.

FOR PREPARATION OF CUSTOMIZED GIFT BASKETS WITH SELECTED ITEMS REGARDING A PARTICULAR OCCASION OR THEME (U.S. CLS. 100 AND 101).

HEATHER THOMPSON, EXAMINING ATTORNEY

SN 78-304,408. GREENE, HAL, NUTLEY, NJ. FILED 9-23-2003.

MEET.COM

FOR INTERNET DATING SERVICE (U.S. CLS. 100 AND 101).

LINDA E. BLOHM, EXAMINING ATTORNEY

CLASS 45—(Continued).

SN 78-319,706. HARRIS, JENNIFER, CLEVELAND, OH. FILED 10-28-2003.

Long After the Funeral

NO CLAIM IS MADE TO THE EXCLUSIVE RIGHT TO USE "AFTER THE FUNERAL", APART FROM THE MARK AS SHOWN.

FOR FUNERAL HOME SERVICES (U.S. CLS. 100 AND 101).

JOHN KELLY, EXAMINING ATTORNEY

SN 78-331,393. MARKUS, BEYR, WELS, AUSTRIA, FILED 11-21-2003.

**JIC Junior
International Club**

THE MARK CONSISTS OF STANDARD CHARACTERS WITHOUT CLAIM TO ANY PARTICULAR FONT, STYLE, SIZE, OR COLOR.

NO CLAIM IS MADE TO THE EXCLUSIVE RIGHT TO USE "JUNIOR INTERNATIONAL CLUB", APART FROM THE MARK AS SHOWN.

FOR SOCIAL CLUBS; DATING SERVICES; LIFESTYLE MANAGEMENT/CONCIERGE SERVICES FOR OTHERS COMPRISING MAKING REQUESTED PERSONAL ARRANGEMENTS, RESERVATIONS AND PROVIDING CUSTOMER SPECIFIC INFORMATION TO MEET INDIVIDUAL NEEDS IN THE FIELDS OF DINING, SHOPPING, ENTERTAINMENT, NETWORKING, TRAVEL, CULTURE, NIGHTCLUBS AND BUSINESS LIFE (U.S. CLS. 100 AND 101).

CHERYL STEPLIGHT, EXAMINING ATTORNEY

SN 78-360,250. MY COMPANION MANAGEMENT GROUP, LLC., WASHINGTONVILLE, NY. FILED 1-30-2004.

**My Companion
Dating**

THE MARK CONSISTS OF STANDARD CHARACTERS WITHOUT CLAIM TO ANY PARTICULAR FONT, STYLE, SIZE, OR COLOR.

NO CLAIM IS MADE TO THE EXCLUSIVE RIGHT TO USE "DATING", APART FROM THE MARK AS SHOWN.

FOR COMPUTER DATING SERVICES (U.S. CLS. 100 AND 101).

PAUL F. GAST, EXAMINING ATTORNEY

CLASS 45—(Continued).

SN 78-360,323. MY COMPANION MANAGEMENT GROUP, LLC., WASHINGTONVILLE, NY. FILED 1-30-2004.

MyCompanionDating.com

THE MARK CONSISTS OF STANDARD CHARACTERS WITHOUT CLAIM TO ANY PARTICULAR FONT, STYLE, SIZE, OR COLOR.
FOR COMPUTER DATING SERVICES (U.S. CLS. 100 AND 101).
PAUL F. GAST, EXAMINING ATTORNEY

CLASS 45—(Continued).

SN 78-425,601. MORTGAGERAMP, INC., HORSHAM, PA. FILED 5-26-2004.

THE WATERFALL GROUP

THE MARK CONSISTS OF STANDARD CHARACTERS WITHOUT CLAIM TO ANY PARTICULAR FONT, STYLE, SIZE, OR COLOR.
NO CLAIM IS MADE TO THE EXCLUSIVE RIGHT TO USE "GROUP", APART FROM THE MARK AS SHOWN.
FOR RESIDENTIAL SURVEILLANCE SERVICES, CONSULTING SERVICES IN THE FIELD OF RESIDENTIAL SURVEILLANCE (U.S. CLS. 100 AND 101).
JENNIFER KRISP, EXAMINING ATTORNEY

SN 78-423,103. THORNTON, MARK, AUSTIN, TX. FILED 5-21-2004.

PetStar

THE MARK CONSISTS OF STANDARD CHARACTERS WITHOUT CLAIM TO ANY PARTICULAR FONT, STYLE, SIZE, OR COLOR.
FOR PROVIDING A CLEARINGHOUSE OF INFORMATION FOR PERSONS WHO HAVE LOST OR FOUND A HOUSEHOLD PET (U.S. CLS. 100 AND 101).
MICHAEL KEATING, EXAMINING ATTORNEY

SN 78-429,906. REED, G. PETER, JR., PALM BEACH, FL. FILED 6-4-2004.

Ident

SN 78-425,584. MORTGAGERAMP, INC., HORSHAM, PA. FILED 5-26-2004.

WATERFALL ADVISORS

THE MARK CONSISTS OF STANDARD CHARACTERS WITHOUT CLAIM TO ANY PARTICULAR FONT, STYLE, SIZE, OR COLOR.
NO CLAIM IS MADE TO THE EXCLUSIVE RIGHT TO USE "ADVISORS", APART FROM THE MARK AS SHOWN.
FOR RESIDENTIAL SURVEILLANCE SERVICES, CONSULTING SERVICES IN THE FIELD OF RESIDENTIAL SURVEILLANCE (U.S. CLS. 100 AND 101).
JENNIFER KRISP, EXAMINING ATTORNEY

THE MARK CONSISTS OF STANDARD CHARACTERS WITHOUT CLAIM TO ANY PARTICULAR FONT, STYLE, SIZE, OR COLOR.
FOR SECURITY PRINTING, NAMELY, ENCODING IDENTIFICATION INFORMATION ON VALUABLE DOCUMENTS AND PRODUCTS (U.S. CLS. 100 AND 101).
JENNIFER KRISP, EXAMINING ATTORNEY

CLASS 45—(Continued).

SN 78-432,025. KOSKIMAKI, JASON MICHAEL, CARROLLTON, TX. FILED 6-8-2004.

Active Friends

THE MARK CONSISTS OF STANDARD CHARACTERS WITHOUT CLAIM TO ANY PARTICULAR FONT, STYLE, SIZE, OR COLOR.

FOR SOCIAL CLUB SERVICES AND SOCIAL INTRODUCTION AGENCY SERVICES FEATURING A WEB SITE THAT PROVIDES ACCESS TO A WIDE VARIETY OF SOCIAL ACTIVITIES AND FACILITATES THE INTERACTION OF PEOPLE WITH COMMON INTERESTS (U.S. CLS. 100 AND 101).

WILLIAM BRECKENFELD, EXAMINING ATTORNEY

CLASS 45—(Continued).

SN 78-432,987. DEBLOIS, LINDA K., BRYN MAWR, PA. FILED 6-10-2004.

MommyMatcher.com

THE MARK CONSISTS OF STANDARD CHARACTERS WITHOUT CLAIM TO ANY PARTICULAR FONT, STYLE, SIZE, OR COLOR.

FOR COMPUTER SERVICES, NAMELY, PROVIDING AN ONLINE INTRODUCTION SERVICE FOR MOTHERS OF YOUNG CHILDREN AND PROVIDING INFORMATION REGARDING PERSONS PARTICIPATING IN SUCH SERVICES (U.S. CLS. 100 AND 101).

JENNIFER KRISP, EXAMINING ATTORNEY

SN 78-435,847. MOCHA MOMS, INC., STATEN ISLAND, NY. FILED 6-16-2004.

SN 78-432,680. SOMERS SHOEMAKER, TERANCE GILBERT, SAN JOSE DEL CABO, MEXICO, FILED 6-9-2004.

GUARDIAN ANGEL CONCIERGE

THE MARK CONSISTS OF STANDARD CHARACTERS WITHOUT CLAIM TO ANY PARTICULAR FONT, STYLE, SIZE, OR COLOR.

NO CLAIM IS MADE TO THE EXCLUSIVE RIGHT TO USE "CONCIERGE", APART FROM THE MARK AS SHOWN.

FOR CONCIERGE SERVICES FOR OTHERS COMPRISING MAKING REQUESTED PERSONAL ARRANGEMENTS AND RESERVATIONS AND PROVIDING CUSTOMER SPECIFIC INFORMATION AND ASSISTANCE TO MEET INDIVIDUAL AND GROUP NEEDS RENDERED TOGETHER IN TOURIST DESTINATION CITIES (U.S. CLS. 100 AND 101).

C. DIONNE CLYBURN, EXAMINING ATTORNEY

Mocha Kids

THE MARK CONSISTS OF STANDARD CHARACTERS WITHOUT CLAIM TO ANY PARTICULAR FONT, STYLE, SIZE, OR COLOR.

OWNER OF U.S. REG. NO. 2,232,102. NO CLAIM IS MADE TO THE EXCLUSIVE RIGHT TO USE "KIDS", APART FROM THE MARK AS SHOWN.

FOR COUNSELING SERVICES IN THE NATURE OF PROVIDING SUPPORT GROUP SERVICES FOR WOMEN AND CHILDREN OF COLOR WHOSE MOTHERS ARE STAYING HOME TO RAISE THEIR CHILDREN (U.S. CLS. 100 AND 101).

BARNEY CHARLON, EXAMINING ATTORNEY

CLASS 45—(Continued).

SN 78-435,849. MOCHA MOMS, INC., STATEN ISLAND, NY. FILED 6-16-2004.

CLASS 45—(Continued).

SN 78-437,806. DOUGLAS, JOEL S, GROTON, CT. FILED 6-18-2004.

Mocha Dads

Intellimark

THE MARK CONSISTS OF STANDARD CHARACTERS WITHOUT CLAIM TO ANY PARTICULAR FONT, STYLE, SIZE, OR COLOR.

OWNER OF U.S. REG. NO. 2,232,102.
NO CLAIM IS MADE TO THE EXCLUSIVE RIGHT TO USE "DADS", APART FROM THE MARK AS SHOWN.
FOR COUNSELING SERVICES IN THE NATURE OF PROVIDING SUPPORT GROUP SERVICES FOR FATHERS OF COLOR (U.S. CLS. 100 AND 101).
BARNEY CHARLON, EXAMINING ATTORNEY

THE MARK CONSISTS OF STANDARD CHARACTERS WITHOUT CLAIM TO ANY PARTICULAR FONT, STYLE, SIZE, OR COLOR.

FOR SECURITY PRINTING, NAMELY, ENCODING IDENTIFICATION INFORMATION ON VALUABLE DOCUMENTS AND PRODUCTS (U.S. CLS. 100 AND 101).
KATHLEEN M. VANSTON, EXAMINING ATTORNEY

SN 78-436,148. TREJO, JULIO, HOUSTON, TX. FILED 6-16-2004.

SN 78-439,295. BODY OF CHRIST CHURCH INTERNATIONAL, USA, INC., THE, COLLEGE PARK, GA. FILED 6-22-2004.

USA Training Partners

LIVING IN VICTORY

NO CLAIM IS MADE TO THE EXCLUSIVE RIGHT TO USE "TRAINING PARTNERS", APART FROM THE MARK AS SHOWN.

FOR TRAINING PARTNER MATCHMAKING SERVICE (U.S. CLS. 100 AND 101).
FIRST USE 5-1-2003; IN COMMERCE 5-1-2004.
MICHAEL HALL, EXAMINING ATTORNEY

THE MARK CONSISTS OF STANDARD CHARACTERS WITHOUT CLAIM TO ANY PARTICULAR FONT, STYLE, SIZE, OR COLOR.

FOR MINISTERIAL SERVICES; RELIGIOUS CRUSADES; SPIRITUAL GUIDANCE AND COUNSELING (U.S. CLS. 100 AND 101).
FIRST USE 3-0-1996; IN COMMERCE 3-0-1996.
CAROLYN CATALDO, EXAMINING ATTORNEY

* * * * *

SECTION 4.—PRIOR UNITED STATES CLASSIFICATION

APPLICATION IN ONE CLASS

COLLECTIVE MEMBERSHIP MARKS

CLASS 200—COLLECTIVE MEMBERSHIP
SN 76-514,980. THETA NU XI MULTICULTURAL SORORITY, INC., CHARLOTTE, NC. FILED 5-16-2003.

Θ N E

FOR INDICATING MEMBERSHIP IN A MULTICULTURAL SORORITY DEDICATED TO PROMOTE LEADERSHIP, MULTICULTURALISM, AND SELF-IMPROVEMENT THROUGH ACADEMIC EXCELLENCE, INVOLVEMENT IN AND SERVICE TO THE CAMPUS AND COMMUNITY, AS WELL AS BEING LIVING EXAMPLES OF SISTERHOOD ACROSS DIFFERENT RACES, CULTURES, RELIGIONS, BACKGROUNDS, AND LIFESTYLES.

FIRST USE 4-11-1997; IN COMMERCE 4-11-1997.
KHANH LE, EXAMINING ATTORNEY

SN 78-301,553. HENCHMEN MOTORCYCLE CLUB INC., LIVERMORE, CA. FILED 9-17-2003.



FOR INDICATING MEMBERSHIP OF AN ASSOCIATION OF MOTORCYCLE RIDERS.
FIRST USE 10-15-1997; IN COMMERCE 3-1-2000.
LINDA E. BLOHM, EXAMINING ATTORNEY

SN 78-438,679. NATIONAL WILD TURKEY FEDERATION, INC., EDGEFIELD, SC. FILED 6-21-2004.

SN 78-276,879. PAPER, ALLIED-INDUSTRIAL, CHEMICAL AND ENERGY WORKERS INTERNATIONAL UNION, AFL-CIO, CLC, NASHVILLE, TN. FILED 7-21-2003.

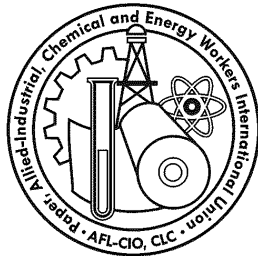

NO CLAIM IS MADE TO THE EXCLUSIVE RIGHT TO USE PAPER, ALLIED-INDUSTRIAL, CHEMICAL AND ENERGY WORKERS INTERNATIONAL UNION AND AFL-CIO, CLC, APART FROM THE MARK AS SHOWN.

FOR INDICATING MEMBERSHIP IN A LABOR UNION.
FIRST USE 1-4-1999; IN COMMERCE 1-4-1999.
BARBARA GAYNOR, EXAMINING ATTORNEY



THE MARK CONSISTS OF THE HEAD OF A TURKEY.
FOR INDICATING MEMBERSHIP IN AN ORGANIZATION OF WILD TURKEY ENTHUSIASTS.
DAWN FELDMAN, EXAMINING ATTORNEY

CERTIFICATION MARKS

CLASS A—GOODS

SN 76-467,643. ASTHMA FRIENDLY PRODUCTS LTD., DUBLIN 3, IRELAND, FILED 11-18-2002.

SN 76-560,910. AACSB INTERNATIONAL, ST. LOUIS, MO. FILED 11-18-2003.



NO CLAIM IS MADE TO THE EXCLUSIVE RIGHT TO USE ASTHMA FRIENDLY, APART FROM THE MARK AS SHOWN.

THE CERTIFICATION MARK, AS INTENDED TO BE USED BY AUTHORIZED PERSONS, IS INTENDED TO CERTIFY PILLOWS, SOFT FURNISHINGS AND ACCESSORIES THEREFOR, WINDOW TREATMENTS, BEDDING AND ACCESSORIES THEREFOR, FLOOR COVERING; TOYS, AND BUILDINGS, AND ROOMS AND AREAS OF A BUILDING THAT MEET PRESCRIBED STANDARDS.

FOR PILLOWS; SOFT FURNISHINGS AND ACCESSORIES THEREFOR; WINDOW TREATMENTS; BEDDING AND ACCESSORIES THEREFOR; WINDOW TREATMENTS; FLOOR COVERINGS; TOYS; BUILDINGS; AND ROOM AND AREAS OF A BUILDING THAT MEET PRESCRIBED STANDARDS.

KEVON CHISOLM, EXAMINING ATTORNEY

OWNER OF U.S. REG. NO. 2,245,561.

NO CLAIM IS MADE TO THE EXCLUSIVE RIGHT TO USE ACCREDITED OR INTERNATIONAL, APART FROM THE MARK AS SHOWN.

THE CERTIFICATION MARK, AS USED BY AUTHORIZED PERSONS, CERTIFIES THAT THE ACCREDITED INSTITUTION MAINTAINS COMMITMENT TO QUALITY AND CONTINUOUS IMPROVEMENT THROUGH RIGOROUS AND COMPREHENSIVE PEER REVIEW AND THAT THE INSTITUTION MAINTAINS AND PERIODICALLY REVIEWS STRATEGIC MANAGEMENT STANDARDS, PARTICIPANT STANDARDS AND ASSURANCE OF LEARNING STANDARDS, ALL IN THE FIELDS OF BUSINESS EDUCATION, BUSINESS ADMINISTRATION EDUCATION AND EDUCATION IN RELATED FIELDS.

FOR PROVIDE EDUCATIONAL SERVICES, NAMELY PROVIDING COURSES OF INSTRUCTION IN BUSINESS, BUSINESS ADMINISTRATION AND RELATED FIELDS AT THE COLLEGE LEVEL.

FIRST USE 8-1-2001; IN COMMERCE 8-1-2001.

MICHAEL TANNER, EXAMINING ATTORNEY

SN 78-371,075. UNIONE INDUSTRIALE BIELLESE, BIELLA, ITALY, FILED 2-20-2004.

SN 76-580,129. NATIONAL ASSOCIATION OF CERTIFIED HOME INSPECTORS, INC., VALLEY FORGE, PA. FILED 3-10-2004.



THE CERTIFICATION MARK AS INTENDED TO BE USED BY AUTHORIZED PERSONS IS INTENDED TO CERTIFY THAT THE GOODS OR SERVICES ORIGINATE FROM THE REGION OF BIELLA AND MEET SPECIFIC REQUIREMENTS

FOR LACE AND EMBROIDERY, RIBBONS AND BRAID; BUTTONS, HOOKS AND EYES, PINS AND NEEDLES; ARTIFICIAL FLOWERS.

YSA DEJESUS, EXAMINING ATTORNEY

THIS MARK WILL BE USED AS A CERTIFICATION MARK TO CERTIFY THE COMPETENCE OF THOSE HOME INSPECTORS WHO HAVE SATISFACTORILY COMPLETED THE CERTIFICATION REQUIREMENTS OF THE NATIONAL ASSOCIATION OF CERTIFIED HOME INSPECTORS

FOR CERTIFICATION OF HOME INSPECTORS.

FIRST USE 10-1-1996; IN COMMERCE 10-1-1996.

ANN E. SAPPENFIELD, EXAMINING ATTORNEY

CLASS B—SERVICES

SN 76-596,603. AMERICAN ACADEMY OF HIV MEDICINE, INC., LOS ANGELES, CA. FILED 6-4-2004.

SN 78-366,814. SERVICE RATINGS LLC, CHEVY CHASE, MD. FILED 2-12-2004.

AAHIVS

THE MARK CONSISTS OF STANDARD CHARACTERS WITHOUT CLAIM TO ANY PARTICULAR FONT, STYLE, SIZE, OR COLOR.

THE AAHIVS MARK IS AN ABBREVIATION OF THE APPLICANT'S AAHIVM HIV SPECIALIST CERTIFICATION AND CREDENTIAL. THE CERTIFICATION MARK, AS USED BY PERSONS AUTHORIZED BY THE CERTIFIER IN ADVERTISING AND INFORMATIONAL MATERIALS, CERTIFIES THAT THESE PERSONS, WHO ARE PROVIDERS OF HIV/AIDS RELATED MEDICAL TREATMENT AND SERVICES, MEET THE CERTIFIER'S STANDARDS OF EXPERIENCE, EDUCATION, AND KNOWLEDGE IN SAID FIELD, IN ACCORDANCE WITH THE REQUIREMENTS AS ESTABLISHED BY THE CERTIFIER. A COPY OF THE CERTIFIER'S ELIGIBILITY STANDARDS IS SUBMITTED WITH THIS APPLICATION.

FOR MEDICAL PRACTICE AND TREATMENT SERVICES RELATED TO HUMAN IMMUNODEFICIENCY VIRUS/ACQUIRED IMMUNE DEFICIENCY SYNDROME (HIV/AIDS).

FIRST USE 4-0-2004; IN COMMERCE 4-0-2004.
JIM RINGLE, EXAMINING ATTORNEY



OWNER OF U.S. REG. NOS. 1,830,735 AND 1,972,567.
NO CLAIM IS MADE TO THE EXCLUSIVE RIGHT TO USE CUSTOMER RATED, APART FROM THE MARK AS SHOWN.

APPLICANT MAKES NO CLAIM TO COLOR.
THE MARK CONSISTS OF CIRCLE WITH A "V" AND A STAR.

THE MARK CERTIFIES THAT THE SERVICES ARE BEING PERFORMED BY A PERSON OR BUSINESS THAT MEETS CERTAIN CUSTOMER SATISFACTION STANDARDS SET BY THE CERTIFIER SUCH AS HAVING ADEQUATE INSURANCE AND PROPER LICENSES

FOR HOME CONSTRUCTION, REPAIR, MAINTENANCE, AND FURNISHINGS SERVICES; PERSONAL CARE SERVICES; HEALTH CARE SERVICES; AUTOMOBILE MAINTENANCE, REPAIR AND PARTS SUPPLY SERVICES; CAR AND TRUCK RENTAL AND LEASING SERVICES; TRANSPORTATION SERVICES; TRAVEL SERVICES; CRUISES; FINANCIAL SERVICES, NAMELY BANKING, FINANCIAL PLANNING, AND STOCK BROKERAGE, REAL ESTATE LOAN SERVICES, REAL ESTATE INSPECTION, REAL ESTATE APPRAISERS, INSURANCE; TAX PREPARATION, SAVINGS AND LOAN SERVICES, RESUME PREPARATION SERVICES; EXECUTIVE SEARCH AND CONSULTING SERVICES, EMPLOYMENT AGENCIES, EMPLOYMENT AGENCY SERVICES, PROFESSIONAL SERVICES, NAMELY ACCOUNTING, ARCHITECTURAL, AND LEGAL SERVICES, NOTARIES PUBLIC, APPLIANCE REPAIR SERVICES, CARPET AND DRAPERY CLEANING SERVICES, EQUIPMENT RENTAL SERVICES, CATERING SERVICES, PARTY PLANNING SERVICES, PARTY SUPPLIES AND RENTAL, DATING SERVICES; DAY CARE SERVICES, DIAPER SERVICES; CEMETERIES, FUNERAL DIRECTOR SERVICES; PAYROLL PREPARATION SERVICES; ADVERTISING AGENCIES AND CONSULTANTS; PACKAGING SERVICES, MAIL AND SHIPPING SERVICES; COURIER AND DELIVERY SERVICES, PROPERTY MAINTENANCE SERVICES, MANUFACTURE, MAINTENANCE, REPAIR, AND INSTALLATION OF SIGNS, COLLECTION AGENCIES, UNIFORM RENTAL SERVICES, DISPLAY DESIGNERS AND PRODUCERS, INVESTIGATORS, TRAINING PROGRAMS AND SERVICES, TRANSLATORS AND INTERPRETERS, INSTALLATION, RENTAL AND REPAIR OF AUDIO-VISUAL EQUIPMENT, AUDIO-VISUAL PRODUCTION SERVICES, COPYING MACHINE SERVICE AND REPAIR, ANSWERING SERVICES, VOICEMAIL AND PAGING SYSTEMS AND SERVICE, JANITORIAL SERVICES, GRAPHIC DESIGNERS, SECURITY GUARD AND PATROL SERVICES, ALARM AND MONITORING SYSTEMS, ENVIRONMENTAL AND ECOLOGICAL SERVICES, GIFT BASKETS AND PARCELS, RECORDS STORAGE, COMPUTER RENTING AND LEASING SERVICES, COMPUTER SERVICES AND REPAIR, COMPUTER TRAINING, COMPUTER CONSULTANTS, WEB SITE DESIGN SERVICES, FLORISTS, BEAUTY SALONS,

SN 78-307,921. AMERICAN FARRIER'S ASSOCIATION, INC., LEXINGTON, KY. FILED 10-1-2003.

AMERICAN FARRIER'S ASSOCIATION CERTIFIED JOURNEYMAN FARRIER

OWNER OF U.S. REG. NOS. 2,761,230 AND 2,783,838.
NO CLAIM IS MADE TO THE EXCLUSIVE RIGHT TO USE "ASSOCIATION CERTIFIED JOURNEYMAN FARRIER", APART FROM THE MARK AS SHOWN.

THIS CERTIFICATION MARK, AS USED BY AUTHORIZED PERSONS, CERTIFIES THAT THE USER HAS SUCCESSFULLY MET THE ASSOCIATION'S STANDARDS OF HORSESHOEING SKILL AND KNOWLEDGE TO ACHIEVE THE STATUS OF CERTIFIED JOURNEYMAN FARRIER.

SEC. 2(F).
FOR CERTIFICATION OF PERSONS WHO HAVE SUCCESSFULLY COMPLETED THE CERTIFIED JOURNEYMAN FARRIER TESTING PROGRAM OF THE ASSOCIATION.

FIRST USE 0-0-1976; IN COMMERCE 0-0-1976.
HOWARD SMIGA, EXAMINING ATTORNEY

FACIAL AND SKIN CARE, NAIL CARE, JEWELRY DESIGN AND REPAIR, DRY CLEANING AND LAUNDRY, HEALTH CLUBS, STUDIOS AND GYMNASIUMS, HEALTH AND FITNESS PROGRAM CONSULTANTS, DRIVING INSTRUCTION, BOAT DEALERS, BOAT REPAIRING, BOATS RENTAL AND CHARTER, ENGRAVERS, SHOE CARE SERVICES, RETIREMENT COMMUNITIES AND HOMES, WEIGHT CONTROL SERVICES, APPRAISERS, DANCE INSTRUCTION, GOLF INSTRUCTION, DIVING INSTRUCTION, MARTIAL ARTS INSTRUCTION, BUSINESS AND VOCATIONAL SCHOOLS, AUCTIONEERS, BICYCLE AND BICYCLE REPAIR, VETERINARIANS, PET BOARDING; ANIMAL HOSPITALS, PET SITTING SERVICES, PET WASHING AND GROOMING, PHOTOGRAPHERS, PHOTOGRAPHIC EQUIPMENT AND REPAIR SERVICES, PRINTERS, COPYING AND DUPLICATING SERVICES, SCREEN PRINTING, COMMERCIAL PRINTING, MOVERS, AND RELOCATION SERVICES; RESTAURANTS, HOTELS AND ACCOMMODATIONS, BARS AND DRINKING ESTABLISHMENTS.

BARBARA RUTLAND, EXAMINING ATTORNE

* * * * *

TRADEMARK REGISTRATIONS ISSUED

PRINCIPAL REGISTER

SECTION 1.— INTERNATIONAL CLASSIFICATION

The short titles associated below with the international class numbers are terms designed merely for quick identification and are not an official part of the international classification. The full names of international classes are given in section 6.1 of the trademark rules of practice.

The designation "U.S. Cl." appearing in this section refers to the U.S. class in effect prior to Sep. 1, 1973 rather than the international class which applies to applications filed on or after that date. For adoption of international classification see notice in the OFFICIAL GAZETTE of Jun. 26, 1973 (911 O.G. TM 210).

CLASS 1—CHEMICALS

- 2,954,009. **PROLYSIS**. PROLYSIS LIMITED, MULTIPLE CLASS, (INT. CLS. 1, 5, 35 AND 42), (U.S. CLS. 1, 5, 6, 10, 18, 26, 44, 46, 51, 52, 100, 101 AND 102). SN 75-808,223. PUB. 3-1-2005. FILED 9-27-1999.
- 2,954,070. **INVOLIN**. CELLECTIS S.A., MULTIPLE CLASS, (INT. CLS. 1, 5 AND 42), (U.S. CLS. 1, 5, 6, 10, 18, 26, 44, 46, 51, 52, 100 AND 101). SN 76-307,432. PUB. 5-4-2004. FILED 8-30-2001.
- 2,954,084. **SPIESS URANIA AND DESIGN**. SPIESS-URANIA CHEMICALS GMBH, MULTIPLE CLASS, (INT. CLS. 1, 2, 3, 4, 5, 16, 17, 35, 37, 38, 39, 40, 41 AND 42), (U.S. CLS. 1, 2, 4, 5, 6, 10, 11, 12, 13, 15, 16, 18, 22, 23, 26, 29, 35, 37, 38, 44, 46, 50, 51, 52, 100, 101, 102, 103, 104, 105, 106 AND 107). SN 76-345,159. PUB. 10-26-2004. FILED 12-5-2001.
- 2,954,099. **SAFRON**. BROMINE COMPOUNDS LTD., (U.S. CLS. 1, 5, 6, 10, 26 AND 46). SN 76-393,554. PUB. 3-1-2005. FILED 4-10-2002.
- 2,954,137. **ECOFORM**. NORSK HYDRO ASA, (U.S. CLS. 1, 5, 6, 10, 26 AND 46). SN 76-468,595. PUB. 3-1-2005. FILED 11-8-2002.
- 2,954,145. **DAKO**. DAKOCYTOMATION DENMARK A/S, MULTIPLE CLASS, (INT. CLS. 1, 5, 9, 10, 42 AND 44), (U.S. CLS. 1, 5, 6, 10, 18, 21, 23, 26, 36, 38, 39, 44, 46, 51, 52, 100 AND 101). SN 76-478,367. PUB. 3-1-2005. FILED 12-26-2002.
- 2,954,147. **FLAME STOP**. FLAME STOP INC., (U.S. CLS. 1, 5, 6, 10, 26 AND 46). SN 76-478,660. PUB. 3-1-2005. FILED 12-27-2002.
- 2,954,203. **RADSPIN**. HARWELL DOSIMETERS LTD, (U.S. CLS. 1, 5, 6, 10, 26 AND 46). SN 76-506,600. PUB. 7-27-2004. FILED 4-15-2003.
- 2,954,205. **HEALTHY PONDS**. BIOVERSE, INC., MULTIPLE CLASS, (INT. CLS. 1, 16 AND 40), (U.S. CLS. 1, 2, 5, 6, 10, 22, 23, 26, 29, 37, 38, 46, 50, 100, 103 AND 106). SN 76-507,279. PUB. 3-1-2005. FILED 4-3-2003.
- 2,954,235. **QUADSIL**. QUADSIL, INC., (U.S. CLS. 1, 5, 6, 10, 26 AND 46). SN 76-522,124. PUB. 9-7-2004. FILED 6-11-2003.
- 2,954,279. **PHYTOSAN**. CHEMISCHES LABORATORIUM DR. KURT RICHTER GMBH, (U.S. CLS. 1, 5, 6, 10, 26 AND 46). SN 76-543,674. PUB. 3-1-2005. FILED 8-28-2003.
- 2,954,346. **SUPRADEL (BLOCK FORM)**. SOLVAY (SOCIÉTÉ ANONYME), MULTIPLE CLASS, (INT. CLS. 1 AND 17), (U.S. CLS. 1, 5, 6, 10, 12, 13, 26, 35, 46 AND 50). SN 76-558,728. PUB. 3-1-2005. FILED 11-13-2003.
- 2,954,378. **AVENTINE RENEWABLE ENERGY, INC. AND DESIGN**. AVENTINE RENEWABLE ENERGY, INC., MULTIPLE CLASS, (INT. CLS. 1 AND 31), (U.S. CLS. 1, 5, 6, 10, 26 AND 46). SN 76-564,750. PUB. 3-1-2005. FILED 12-11-2003.
- 2,954,381. **PHYDRION (BLOCK FORM)**. MICRO ESSENTIAL LABORATORY, INC., (U.S. CLS. 1, 5, 6, 10, 26 AND 46). SN 76-565,447. PUB. 3-1-2005. FILED 12-3-2003.
- 2,954,400. **ADEG (BLOCK FORM)**. BASF AKTIENGESELLSCHAFT, (U.S. CLS. 1, 5, 6, 10, 26 AND 46). SN 76-568,771. PUB. 3-1-2005. FILED 1-7-2004.
- 2,954,404. **VOLTAIX, INC. (BLOCK FORM)**. VOLTAIX, INC., (U.S. CLS. 1, 5, 6, 10, 26 AND 46). SN 76-569,570. PUB. 3-1-2005. FILED 1-8-2004.
- 2,954,409. **INVISICON (BLOCK FORM)**. EIKOS INC., MULTIPLE CLASS, (INT. CLS. 1 AND 2), (U.S. CLS. 1, 5, 6, 10, 11, 16, 26 AND 46). SN 76-570,224. PUB. 3-1-2005. FILED 1-16-2004.
- 2,954,413. **GREAT LAKES PULP & FIBRE AND DESIGN**. GREAT LAKES PULP COMPANY, (U.S. CLS. 1, 5, 6, 10, 26 AND 46). SN 76-571,123. PUB. 3-1-2005. FILED 1-21-2004.
- 2,954,450. **ABZOL (BLOCK FORM)**. ABLEMARLE CORPORATION, MULTIPLE CLASS, (INT. CLS. 1 AND 3), (U.S. CLS. 1, 4, 5, 6, 10, 26, 46, 50, 51 AND 52). SN 76-580,264. PUB. 3-1-2005. FILED 3-9-2004.
- 2,954,467. **AQUASALINA (BLOCK FORM)**. DUCK CREEK RESOURCES, INC., (U.S. CLS. 1, 5, 6, 10, 26 AND 46). SN 76-584,191. PUB. 3-1-2005. FILED 3-31-2004.
- 2,954,487. **CAST-O-MAGIC (BLOCK FORM)**. THE TRUSTEE OF THE WILLIAM A. ROSTINE REVOCABLE TRUST UNDER AGREEMENT DATED NOVEMBER 9, 2001, (U.S. CLS. 1, 5, 6, 10, 26 AND 46). SN 76-585,935. PUB. 3-1-2005. FILED 4-9-2004.
- 2,954,514. **B/C/B (BLOCK FORM)**. J & M APPLIED TECHNOLOGY, INC., DBA APTEK LABORATORIES, INC., (U.S. CLS. 1, 5, 6, 10, 26 AND 46). SN 76-588,489. PUB. 3-1-2005. FILED 4-23-2004.
- 2,954,526. **ENGINEERED WITH PRIDE (BLOCK FORM)**. DAVISON OIL COMPANY, INC., MULTIPLE CLASS, (INT. CLS. 1 AND 4), (U.S. CLS. 1, 5, 6, 10, 15, 26 AND 46). SN 76-588,984. PUB. 3-1-2005. FILED 4-26-2004.
- 2,954,610. **VTA**. ADVANCED COMPOSITES GROUP LIMITED, MULTIPLE CLASS, (INT. CLS. 1 AND 17), (U.S. CLS. 1, 5, 6, 10, 12, 13, 26, 35, 46 AND 50). SN 78-106,215. PUB. 3-1-2005. FILED 2-1-2002.
- 2,954,618. **FOSS4ME**. FOSS A/S, MULTIPLE CLASS, (INT. CLS. 1, 5, 9, 10 AND 42), (U.S. CLS. 1, 5, 6, 10, 18, 21, 23, 26, 36, 38, 39, 44, 46, 51, 52, 100 AND 101). SN 78-138,080. PUB. 3-1-2005. FILED 6-24-2002.
- 2,954,632. **COATEX**. COATEX S.A.S., MULTIPLE CLASS, (INT. CLS. 1 AND 42), (U.S. CLS. 1, 5, 6, 10, 26, 46, 100 AND 101). SN 78-178,290. PUB. 5-25-2004. FILED 10-25-2002.
- 2,954,665. **P-PLUS**. MERCK KGAA, (U.S. CLS. 1, 5, 6, 10, 26 AND 46). SN 78-217,422. PUB. 3-1-2005. FILED 2-21-2003.
- 2,954,678. **NANOFLAT**. JSR CORPORATION, MULTIPLE CLASS, (INT. CLS. 1 AND 7), (U.S. CLS. 1, 5, 6, 10, 13, 19, 21, 23, 26, 31, 34, 35 AND 46). SN 78-224,103. PUB. 1-6-2004. FILED 3-11-2003.
- 2,954,698. **INNOVATION ONE-ON-ONE**. JSR CORPORATION, MULTIPLE CLASS, (INT. CLS. 1 AND 7), (U.S. CLS. 1, 5, 6, 10, 13, 19, 21, 23, 26, 31, 34, 35 AND 46). SN 78-236,296. PUB. 6-1-2004. FILED 4-10-2003.
- 2,954,793. **MEYCO**. CONSTRUCTION RESEARCH & TECHNOLOGY GMBH, MULTIPLE CLASS, (INT. CLS. 1 AND 19), (U.S. CLS. 1, 5, 6, 10, 12, 26, 33, 46 AND 50). SN 78-299,901. PUB. 3-1-2005. FILED 9-12-2003.
- 2,954,917. **BOATLIFE AND DESIGN**. LIFE INDUSTRIES CORPORATION, MULTIPLE CLASS, (INT. CLS. 1, 2, 3 AND 17), (U.S. CLS. 1, 4, 5, 6, 10, 11, 12, 13, 16, 26, 35, 46, 50, 51 AND 52). SN 78-354,355. PUB. 3-1-2005. FILED 1-20-2004.
- 2,954,970. **RENLAM (BLOCK FORM)**. HUNTSMAN ADVANCED MATERIALS AMERICAS INC., (U.S. CLS. 1, 5, 6, 10, 26 AND 46). SN 78-381,471. PUB. 3-1-2005. FILED 3-10-2004.

- 2,955,070. **RIDI-CAL (BLOCK FORM)**. INDOPCO, INC., DBA NATIONAL STARCH AND CHEMICAL COMPANY, (U.S. CLS. 1, 5, 6, 10, 26 AND 46). SN 78-409,302. PUB. 3-1-2005. FILED 4-28-2004.
- 2,955,090. **CHEMIGLOW (BLOCK FORM)**. ALPHA INNOTECH CORPORATION, (U.S. CLS. 1, 5, 6, 10, 26 AND 46). SN 78-413,790. PUB. 3-1-2005. FILED 5-5-2004.
- 2,955,091. **SAPPHIRE (BLOCK FORM)**. ANSUL, INCORPORATED, MULTIPLE CLASS, (INT. CLS. 1 AND 9), (U.S. CLS. 1, 5, 6, 10, 21, 23, 26, 36, 38 AND 46). SN 78-414,940. PUB. 3-1-2005. FILED 5-7-2004.
- 2,955,134. **HYDROTECH (BLOCK FORM)**. BIOLAB SERVICES, INC., (U.S. CLS. 1, 5, 6, 10, 26 AND 46). SN 78-420,132. PUB. 3-1-2005. FILED 5-17-2004.
- 2,955,168. **ENA (BLOCK FORM)**. SANKYO LIFETECH COMPANY, LIMITED, MULTIPLE CLASS, (INT. CLS. 1 AND 5), (U.S. CLS. 1, 5, 6, 10, 18, 26, 44, 46, 51 AND 52). SN 79-000,607. PUB. 3-1-2005. FILED 11-27-2003.
- 2,955,184. **ADGREEN (BLOCK FORM)**. AMI AGROLINZ MELAMINE INTERNATIONAL, GMBH, MULTIPLE CLASS, (INT. CLS. 1 AND 4), (U.S. CLS. 1, 5, 6, 10, 15, 26 AND 46). SN 79-002,701. PUB. 3-1-2005. FILED 3-23-2004.

CLASS 2—PAINTS

- 2,954,084 (*See Class 1 for this trademark*).
- 2,954,138. **MILLS PAINT SINCE 1930 AND DESIGN**. MILLS PAINT SALES LTD., (U.S. CLS. 6, 11 AND 16). SN 76-470,628. PUB. 6-29-2004. FILED 11-29-2002.
- 2,954,187. **MORPHOTONE**. TEIJIN KABUSHIKI KAISHA (TEIJIN LIMITED), AND NISSAN JIDOSHA KABUSHIKI KAISHA, TA NISSAN MOTOR CO., LTD., AND TANAKA KINKINZOKU KOGYO K.K., (U.S. CLS. 6, 11 AND 16). SN 76-501,826. PUB. 3-1-2005. FILED 3-27-2003.
- 2,954,403. **THE COLOR AUTHORITY (BLOCK FORM)**. BENJAMIN MOORE & CO., (U.S. CLS. 6, 11 AND 16). SN 76-569,119. PUB. 3-1-2005. FILED 12-3-2003.
- 2,954,409 (*See Class 1 for this trademark*).
- 2,954,590. **COURTLINES (STYLIZED)**. BONAKEMI USA, INC., (U.S. CLS. 6, 11 AND 16). SN 76-592,527. PUB. 3-1-2005. FILED 5-17-2004.
- 2,954,902. **COOL COVERINGS (BLOCK FORM)**. DURA-LOC ROOFING SYSTEMS LIMITED, (U.S. CLS. 6, 11 AND 16). SN 78-345,525. PUB. 3-1-2005. FILED 12-24-2003.
- 2,954,917 (*See Class 1 for this trademark*).
- 2,954,942. **GAMSOL (BLOCK FORM)**. GAMBLIN ARTISTS COLORS CO., (U.S. CLS. 6, 11 AND 16). SN 78-368,564. PUB. 3-1-2005. FILED 2-16-2004.

CLASS 3—COSMETICS AND CLEANING PREPARATIONS

- 2,954,040. **DERMOCOSMETICS SYNCHROLINE THE FUTURE IS OPEN AND DESIGN**. GIANFRANCO, DE PAOLI AMBROSI, (U.S. CLS. 1, 4, 6, 50, 51 AND 52). SN 76-160,423. PUB. 7-6-2004. FILED 11-6-2000.
- 2,954,043. **ANDAMIRO AND DESIGN**. ANDAMIRO CO., LTD., MULTIPLE CLASS, (INT. CLS. 3, 8, 9, 14, 15, 16, 18, 20, 21, 24, 25, 28 AND 41), (U.S. CLS. 1, 2, 3, 4, 5, 6, 13, 21, 22, 23, 25, 26, 27, 28, 29, 30, 32, 33, 36, 37, 38, 39, 40, 41, 42, 44, 50, 51, 52, 100, 101 AND 107). SN 76-180,652. PUB. 6-29-2004. FILED 12-13-2000.
- 2,954,084 (*See Class 1 for this trademark*).
- 2,954,090. **ROGER VIVIER**. DORINT HOLDING S.A., (U.S. CLS. 1, 4, 6, 50, 51 AND 52). SN 76-364,532. PUB. 11-19-2002. FILED 1-28-2002.
- 2,954,122. **SOAPOPULAR**. DOWTY, MICHAEL SCOTT, (U.S. CLS. 1, 4, 6, 50, 51 AND 52). SN 76-451,491. PUB. 8-10-2004. FILED 9-20-2002.
- 2,954,153. **MENOFILAVON**. IDEE & GESTALT SA, (U.S. CLS. 1, 4, 6, 50, 51 AND 52). SN 76-484,247. PUB. 6-1-2004. FILED 1-23-2003.
- 2,954,255. **EZ GRIP SOAP**. JOHNSON & JOHNSON, (U.S. CLS. 1, 4, 6, 50, 51 AND 52). SN 76-535,430. PUB. 3-1-2005. FILED 7-25-2003.
- 2,954,263. **SPORTSFUSION AND DESIGN**. SMITH, JOSEPH, (U.S. CLS. 1, 4, 6, 50, 51 AND 52). SN 76-539,329. PUB. 3-1-2005. FILED 7-28-2003.
- 2,954,282. **XXL VOLUME (STYLIZED)**. LABORATOIRE GARNIER & CIE, (U.S. CLS. 1, 4, 6, 50, 51 AND 52). SN 76-545,003. PUB. 3-1-2005. FILED 9-3-2003.
- 2,954,288. **NEONLIGHT**. LANCOME PARFUMS ET BEAUTE & CIE, (U.S. CLS. 1, 4, 6, 50, 51 AND 52). SN 76-546,367. PUB. 3-1-2005. FILED 9-8-2003.
- 2,954,289. **LE DIX BALENCIAGA**. BALENCIAGA, (U.S. CLS. 1, 4, 6, 50, 51 AND 52). SN 76-546,689. PUB. 3-1-2005. FILED 9-23-2003.
- 2,954,333. **BODYVITAL (STYLIZED)**. BORLIND GSELLSCHAFT FUR KOSMETISCHE ERZEUGNISSE MBH, (U.S. CLS. 1, 4, 6, 50, 51 AND 52). SN 76-556,950. PUB. 8-17-2004. FILED 11-5-2003.
- 2,954,340. **BROTHER KAHNIYAH**. HOOKS, LEROY, DBA BROTHER KAHNIYAH PEDICURE AND REFLEXOLOGY, (U.S. CLS. 1, 4, 6, 50, 51 AND 52). SN 76-557,746. PUB. 3-1-2005. FILED 10-16-2003.
- 2,954,450 (*See Class 1 for this trademark*).
- 2,954,481. **EGO TRIP (BLOCK FORM)**. TODD CHRISTOPHER INTERNATIONAL, INC., DBA VOGUE INTERNATIONAL, INC., (U.S. CLS. 1, 4, 6, 50, 51 AND 52). SN 76-585,652. PUB. 3-1-2005. FILED 4-7-2004.
- 2,954,483. **ALOE ESSENTIALS (BLOCK FORM)**. TANKE, WILLIAM B., MULTIPLE CLASS, (INT. CLS. 3 AND 5), (U.S. CLS. 1, 4, 6, 18, 44, 46, 50, 51 AND 52). SN 76-585,705. PUB. 3-1-2005. FILED 4-7-2004.
- 2,954,485. **SOUND & SCENT (BLOCK FORM)**. NEERUAM, INCORPORATED, (U.S. CLS. 1, 4, 6, 50, 51 AND 52). SN 76-585,760. PUB. 3-1-2005. FILED 4-6-2004.
- 2,954,591. **ASANA (BLOCK FORM)**. ASANA ENTERPRISES, LLC, (U.S. CLS. 1, 4, 6, 50, 51 AND 52). SN 76-592,556. PUB. 3-1-2005. FILED 5-17-2004.
- 2,954,595. **E AND DESIGN**. TANKE, WILLIAM B., (U.S. CLS. 1, 4, 6, 50, 51 AND 52). SN 76-593,128. PUB. 3-1-2005. FILED 5-18-2004.
- 2,954,608. **VOLUME MIRACLE**. MEDICAL EXPRESS (UK) LIMITED, (U.S. CLS. 1, 4, 6, 50, 51 AND 52). SN 78-091,393. PUB. 3-1-2005. FILED 11-2-2001.
- 2,954,663. **WHITEPRO**. BIOLITEC, INC., (U.S. CLS. 1, 4, 6, 50, 51 AND 52). SN 78-216,836. PUB. 3-1-2005. FILED 2-20-2003.
- 2,954,666. **EVER-FRESH SYSTEM**. PRINCE LIONHEART, INC., MULTIPLE CLASS, (INT. CLS. 3 AND 11), (U.S. CLS. 1, 4, 6, 13, 21, 23, 31, 34, 50, 51 AND 52). SN 78-218,523. PUB. 3-1-2005. FILED 2-25-2003.
- 2,954,670. **AGNES B. SPORT (STYLIZED)**. TROUBLE, AGNES, MULTIPLE CLASS, (INT. CLS. 3, 14, 18, 24 AND 25), (U.S. CLS. 1, 2, 3, 4, 6, 22, 27, 28, 39, 41, 42, 50, 51 AND 52). SN 78-219,616. PUB. 12-14-2004. FILED 2-27-2003.
- 2,954,714. **DESTELLO**. QUIMI ROMAR, S.L., (U.S. CLS. 1, 4, 6, 50, 51 AND 52). SN 78-251,839. PUB. 8-31-2004. FILED 5-19-2003.
- 2,954,720. **TWEEZE-FREE**. AMERICAN INTERNATIONAL INDUSTRIES, (U.S. CLS. 1, 4, 6, 50, 51 AND 52). SN 78-255,238. PUB. 12-9-2003. FILED 5-28-2003.
- 2,954,743. **OCTAROME**. FIRMENICH S.A., MULTIPLE CLASS, (INT. CLS. 3 AND 30), (U.S. CLS. 1, 4, 6, 46, 50, 51 AND 52). SN 78-270,848. PUB. 8-3-2004. FILED 7-7-2003.
- 2,954,797. **STAIN GUARD PROTECTANT AND DESIGN**. RECKITT & COLMAN SUBSIDIARY CORPORATION, (U.S. CLS. 1, 4, 6, 50, 51 AND 52). SN 78-301,718. PUB. 3-1-2005. FILED 9-17-2003.
- 2,954,912. **SPOT SHOT AND DESIGN**. HEARTLAND CORPORATION, (U.S. CLS. 1, 4, 6, 50, 51 AND 52). SN 78-352,690. PUB. 10-19-2004. FILED 1-15-2004.
- 2,954,917 (*See Class 1 for this trademark*).
- 2,954,921. **TRILASTIN AND DESIGN**. EC RESEARCH CORP., (U.S. CLS. 1, 4, 6, 50, 51 AND 52). SN 78-357,440. PUB. 10-19-2004. FILED 1-26-2004.
- 2,954,925. **HYPER-VITALIZER (BLOCK FORM)**. RENATURE SKIN CARE INC., (U.S. CLS. 1, 4, 6, 50, 51 AND 52). SN 78-360,092. PUB. 3-1-2005. FILED 1-30-2004.
- 2,954,932. **MISCELLANEOUS DESIGN**. INFINITY INTERNATIONAL HEALTH & BEAUTY, INC., (U.S. CLS. 1, 4, 6,

- 50, 51 AND 52). SN 78-364,727. PUB. 3-1-2005. FILED 2-9-2004.
- 2,954,939. **FRUITY LIP JUICE (BLOCK FORM)**. AVON PRODUCTS, INC., (U.S. CLS. 1, 4, 6, 50, 51 AND 52). SN 78-367,502. PUB. 3-1-2005. FILED 2-13-2004.
- 2,954,982. **CELLEX-C AND DESIGN**. CELLEX-C INTERNATIONAL INC., (U.S. CLS. 1, 4, 6, 50, 51 AND 52). SN 78-386,908. PUB. 3-1-2005. FILED 3-18-2004.
- 2,955,075. **TRICOMIN (BLOCK FORM)**. PROCYTE CORPORATION, (U.S. CLS. 1, 4, 6, 50, 51 AND 52). SN 78-410,536. PUB. 3-1-2005. FILED 4-29-2004.
- 2,955,085. **OBAGI-C (BLOCK FORM)**. OMP, INC., MULTIPLE CLASS, (INT. CLS. 3 AND 5), (U.S. CLS. 1, 4, 6, 18, 44, 46, 50, 51 AND 52). SN 78-413,318. PUB. 3-1-2005. FILED 5-5-2004.
- 2,955,104. **ORGANIC BRIDE (BLOCK FORM)**. DAVEWORLD INC., (U.S. CLS. 1, 4, 6, 50, 51 AND 52). SN 78-416,190. PUB. 3-1-2005. FILED 5-10-2004.
- 2,955,110. **GEMSMETICS (BLOCK FORM)**. GEMSMETICS, INC., (U.S. CLS. 1, 4, 6, 50, 51 AND 52). SN 78-417,034. PUB. 3-1-2005. FILED 5-11-2004.
- 2,955,136. **HYDROTECH (BLOCK FORM)**. BIOLAB SERVICES, INC., (U.S. CLS. 1, 4, 6, 50, 51 AND 52). SN 78-420,141. PUB. 3-1-2005. FILED 5-17-2004.
- 2,955,139. **HYDROTECH AND DESIGN**. BIOLAB SERVICES, INC., (U.S. CLS. 1, 4, 6, 50, 51 AND 52). SN 78-420,641. PUB. 3-1-2005. FILED 5-18-2004.
- 2,955,170. **ÉRUPTION (STYLIZED)**. LIDL STIFTUNG & CO. KG, (U.S. CLS. 1, 4, 6, 50, 51 AND 52). SN 79-000,651. PUB. 3-1-2005. FILED 12-18-2003.
- 2,955,185. **PAPERSMILE (BLOCK FORM)**. WERNER KAUFMANN, MULTIPLE CLASS, (INT. CLS. 3, 16 AND 21), (U.S. CLS. 1, 2, 4, 5, 6, 13, 22, 23, 29, 30, 33, 37, 38, 40, 50, 51 AND 52). SN 79-004,247. PUB. 3-1-2005. FILED 2-16-2004.

CLASS 4—LUBRICANTS AND FUELS

- 2,953,996. **MISCELLANEOUS DESIGN**. ROYAL PURPLE, INC., (U.S. CLS. 1, 6 AND 15). SN 75-005,969. PUB. 2-4-2003. FILED 10-16-1995.
- 2,954,084 (*See Class 1 for this trademark*).
- 2,954,525. **OMNILUBE (STYLIZED)**. ULTRACHEM, INC., (U.S. CLS. 1, 6 AND 15). SN 76-588,983. PUB. 3-1-2005. FILED 4-26-2004.
- 2,954,526 (*See Class 1 for this trademark*).
- 2,954,821. **SOY TO THE WORLD CANDLE COMPANY AND DESIGN**. PANIKOWSKI, LINDA M., (U.S. CLS. 1, 6 AND 15). SN 78-313,068. PUB. 3-1-2005. FILED 10-14-2003.
- 2,954,877. **EZE-SLIDE OS (BLOCK FORM)**. SUN DRILLING PRODUCTS CORPORATION, (U.S. CLS. 1, 6 AND 15). SN 78-331,696. PUB. 3-1-2005. FILED 11-21-2003.
- 2,954,878. **EZE-SLIDE XLT (BLOCK FORM)**. SUN DRILLING PRODUCTS CORPORATION, (U.S. CLS. 1, 6 AND 15). SN 78-331,698. PUB. 3-1-2005. FILED 11-21-2003.
- 2,954,879. **EZE-SLIDE D (BLOCK FORM)**. SUN DRILLING PRODUCTS CORPORATION, (U.S. CLS. 1, 6 AND 15). SN 78-331,704. PUB. 3-1-2005. FILED 11-21-2003.
- 2,954,900. **BIO LUBE AND DESIGN**. LUCKEY, WARREN LLOYD, (U.S. CLS. 1, 6 AND 15). SN 78-344,959. PUB. 11-30-2004. FILED 12-23-2003.
- 2,955,089. **KLEEN-KOOL (BLOCK FORM)**. DOALL COMPANY, (U.S. CLS. 1, 6 AND 15). SN 78-413,638. PUB. 3-1-2005. FILED 5-5-2004.
- 2,955,123. **SUPERFILM (BLOCK FORM)**. AMREP, INC., (U.S. CLS. 1, 6 AND 15). SN 78-418,858. PUB. 3-1-2005. FILED 5-14-2004.
- 2,955,130. **THE CANDLEMEISTER (BLOCK FORM)**. MCLELLAN PRODUCTS & SERVICES, INC., DBA THE CANDLEMEISTER, (U.S. CLS. 1, 6 AND 15). SN 78-419,489. PUB. 3-1-2005. FILED 5-15-2004.
- 2,955,167. **RVS TECHNOLOGY AND DESIGN**. RVS-TEC OY, MULTIPLE CLASS, (INT. CLS. 4, 40 AND 42), (U.S. CLS. 1, 6, 15, 100, 101, 103 AND 106). SN 79-000,370. PUB. 3-1-2005. FILED 12-11-2003.
- 2,955,184 (*See Class 1 for this trademark*).

CLASS 5—PHARMACEUTICALS

- 2,954,009 (*See Class 1 for this trademark*).
- 2,954,018. **INSULOGEN**. MUSCLETECH RESEARCH AND DEVELOPMENT INC., (U.S. CLS. 6, 18, 44, 46, 51 AND 52). SN 76-029,450. PUB. 3-1-2005. FILED 4-19-2000.
- 2,954,067. **XCELODOSE**. MERIDICA LTD., MULTIPLE CLASS, (INT. CLS. 5, 9, 42 AND 44), (U.S. CLS. 6, 18, 21, 23, 26, 36, 38, 44, 46, 51, 52, 100 AND 101). SN 76-295,158. PUB. 3-23-2004. FILED 8-3-2001.
- 2,954,070 (*See Class 1 for this trademark*).
- 2,954,084 (*See Class 1 for this trademark*).
- 2,954,102. **ARIZONA**. AURUM CERAMIC DENTAL LABORATORIES LTD., MULTIPLE CLASS, (INT. CLS. 5 AND 10), (U.S. CLS. 6, 18, 26, 39, 44, 46, 51 AND 52). SN 76-400,658. PUB. 9-21-2004. FILED 4-26-2002.
- 2,954,109. **4 A BETTER LIFE**. 4 EVER PETS NATURAL PRODUCTS LTD., (U.S. CLS. 6, 18, 44, 46, 51 AND 52). SN 76-422,770. PUB. 9-21-2004. FILED 6-20-2002.
- 2,954,145 (*See Class 1 for this trademark*).
- 2,954,164. **SILVER SOFT**. LASAL LABORATORIES, LLC, (U.S. CLS. 6, 18, 44, 46, 51 AND 52). SN 76-494,135. PUB. 3-1-2005. FILED 3-3-2003.
- 2,954,165. **IM1**. VITA ZAHNFABRIK H. RAUTER GMBH & CO. KG, MULTIPLE CLASS, (INT. CLS. 5 AND 10), (U.S. CLS. 6, 18, 26, 39, 44, 46, 51 AND 52). SN 76-494,252. PUB. 3-1-2005. FILED 3-3-2003.
- 2,954,166. **3L2.5**. VITA ZAHNFABRIK H. RAUTER GMBH & CO. KG, MULTIPLE CLASS, (INT. CLS. 5 AND 10), (U.S. CLS. 6, 18, 26, 39, 44, 46, 51 AND 52). SN 76-494,254. PUB. 3-1-2005. FILED 3-3-2003.
- 2,954,167. **5M2**. VITA ZAHNFABRIK H. RAUTER GMBH & CO. KG, MULTIPLE CLASS, (INT. CLS. 5 AND 10), (U.S. CLS. 6, 18, 26, 39, 44, 46, 51 AND 52). SN 76-494,255. PUB. 3-1-2005. FILED 3-3-2003.
- 2,954,168. **0M1**. VITA ZAHNFABRIK H. RAUTER GMBH & CO. KG, (U.S. CLS. 6, 18, 44, 46, 51 AND 52). SN 76-494,303. PUB. 3-1-2005. FILED 3-3-2003.
- 2,954,169. **4R1.5**. VITA ZAHNFABRIK H. RAUTER GMBH & CO. KG, MULTIPLE CLASS, (INT. CLS. 5 AND 10), (U.S. CLS. 6, 18, 26, 39, 44, 46, 51 AND 52). SN 76-494,304. PUB. 3-1-2005. FILED 3-3-2003.
- 2,954,170. **2M3**. VITA ZAHNFABRIK H. RAUTER GMBH & CO. KG, MULTIPLE CLASS, (INT. CLS. 5 AND 10), (U.S. CLS. 6, 18, 26, 39, 44, 46, 51 AND 52). SN 76-494,552. PUB. 3-1-2005. FILED 3-3-2003.
- 2,954,201. **NATREL NUTRITION 24**. AGROPUR COOPERATIVE, MULTIPLE CLASS, (INT. CLS. 5 AND 32), (U.S. CLS. 6, 18, 44, 45, 46, 48, 51 AND 52). SN 76-506,367. PUB. 9-28-2004. FILED 4-15-2003.
- 2,954,251. **INTEREX AND DESIGN**. UPTIN, INC., DBA BENSON-PENDANT, (U.S. CLS. 6, 18, 44, 46, 51 AND 52). SN 76-533,467. PUB. 3-1-2005. FILED 7-30-2003.
- 2,954,252. **LOVE LIQUID**. KAMSUT, INC., (U.S. CLS. 6, 18, 44, 46, 51 AND 52). SN 76-534,071. PUB. 5-18-2004. FILED 8-1-2003.
- 2,954,256. **FIDENCIA**. SCHERING AKTIENGESELLSCHAFT, (U.S. CLS. 6, 18, 44, 46, 51 AND 52). SN 76-536,190. PUB. 8-17-2004. FILED 8-12-2003.
- 2,954,257. **ON YOUR BODY. OFF YOUR MIND.** JOHNSON & JOHNSON, MULTIPLE CLASS, (INT. CLS. 5 AND 16), (U.S. CLS. 2, 5, 6, 18, 22, 23, 29, 37, 38, 44, 46, 50, 51 AND 52). SN 76-536,393. PUB. 3-1-2005. FILED 8-13-2003.
- 2,954,262. **VISCONTOUR**. AVENTIS (IRELAND) LIMITED, (U.S. CLS. 6, 18, 44, 46, 51 AND 52). SN 76-538,206. PUB. 3-1-2005. FILED 8-18-2003.
- 2,954,281. **ADVANTAN**. SCHERING AKTIENGESELLSCHAFT, (U.S. CLS. 6, 18, 44, 46, 51 AND 52). SN 76-544,978. PUB. 10-26-2004. FILED 9-2-2003.
- 2,954,405. **SUMIMET (BLOCK FORM)**. SUMITOMO CHEMICAL CO., LTD., (U.S. CLS. 6, 18, 44, 46, 51 AND 52). SN 76-569,590. PUB. 3-1-2005. FILED 1-8-2004.
- 2,954,406. **SUMIVITA (BLOCK FORM)**. SUMITOMO CHEMICAL CO., LTD., (U.S. CLS. 6, 18, 44, 46, 51 AND 52). SN 76-569,591. PUB. 3-1-2005. FILED 1-8-2004.
- 2,954,469. **DR. STINK (BLOCK FORM)**. NO STINK, INC., (U.S. CLS. 6, 18, 44, 46, 51 AND 52). SN 76-584,394. PUB. 3-1-2005. FILED 4-1-2004.
- 2,954,483 (*See Class 3 for this trademark*).

- 2,954,495. **STING ZAPPER (BLOCK FORM)**. THE TRUSTEES OF FOREMOST LABS, COMPRISING LAWRENCE M. LOGSDON AND NORMA JO LOGSDON BOTH U.S. CITIZEN, (U.S. CLS. 6, 18, 44, 46, 51 AND 52). SN 76-586,825. PUB. 3-1-2005. FILED 4-15-2004.
- 2,954,527. **ANDRO STACK AND DESIGN**. BIOENERGIMED, L.L.C., (U.S. CLS. 6, 18, 44, 46, 51 AND 52). SN 76-589,008. PUB. 3-1-2005. FILED 4-26-2004.
- 2,954,587. **RIGHT AGE (BLOCK FORM)**. SWANSON HEALTH PRODUCTS, INCORPORATED, (U.S. CLS. 6, 18, 44, 46, 51 AND 52). SN 76-592,342. PUB. 3-1-2005. FILED 5-17-2004.
- 2,954,598. **SUMMER'S EVE (BLOCK FORM)**. C.B. FLEET COMPANY, INCORPORATED, (U.S. CLS. 6, 18, 44, 46, 51 AND 52). SN 76-605,448. PUB. 3-1-2005. FILED 8-2-2004.
- 2,954,618 (*See Class 1 for this trademark*).
- 2,954,650. **TEVA-TECH**. TEVA PHARMACEUTICAL INDUSTRIES LTD., (U.S. CLS. 6, 18, 44, 46, 51 AND 52). SN 78-206,871. PUB. 3-1-2005. FILED 1-24-2003.
- 2,954,695. **PHALLOFIT (STYLIZED)**. KOICHEM, HANS-GUENTER, (U.S. CLS. 6, 18, 44, 46, 51 AND 52). SN 78-233,950. PUB. 3-1-2005. FILED 4-4-2003.
- 2,954,731. **CALC-I-CAGE**. BIEDERMANN MOTECH GMBH, MULTIPLE CLASS, (INT. CLS. 5 AND 10), (U.S. CLS. 6, 18, 26, 39, 44, 46, 51 AND 52). SN 78-263,387. PUB. 3-1-2005. FILED 6-17-2003.
- 2,954,739. **VENTANA AND DESIGN**. VENTANA MEDICAL SYSTEMS, INC., (U.S. CLS. 6, 18, 44, 46, 51 AND 52). SN 78-268,801. PUB. 3-23-2004. FILED 6-30-2003.
- 2,954,783. **DROP DOSE**. KING PHARMACEUTICALS, INC., (U.S. CLS. 6, 18, 44, 46, 51 AND 52). SN 78-293,892. PUB. 3-1-2005. FILED 8-29-2003.
- 2,954,791. **STEMIEL**. INVERSIONES HOSPITALARIAS SOCIEDAD ANONIMA DE CAPITAL VARIABLE, (U.S. CLS. 6, 18, 44, 46, 51 AND 52). SN 78-299,082. PUB. 8-31-2004. FILED 9-11-2003.
- 2,954,800. **NUTRISYSTEM NOURISH (STYLIZED)**. NUTRI/SYSTEM IPHC, INC., (U.S. CLS. 6, 18, 44, 46, 51 AND 52). SN 78-304,743. PUB. 3-1-2005. FILED 9-24-2003.
- 2,954,823. **GARDIVES**. AVENTIS PHARMA S.A., (U.S. CLS. 6, 18, 44, 46, 51 AND 52). SN 78-313,684. PUB. 3-1-2005. FILED 10-15-2003.
- 2,954,845. **PIZZAZZ**. BENGAL PRODUCTS INC., (U.S. CLS. 6, 18, 44, 46, 51 AND 52). SN 78-320,421. PUB. 8-3-2004. FILED 10-29-2003.
- 2,954,868. **HEALTHCO (BLOCK FORM)**. SCHELLING, CHRISTIANNE, (U.S. CLS. 6, 18, 44, 46, 51 AND 52). SN 78-327,687. PUB. 3-1-2005. FILED 11-13-2003.
- 2,954,893. **SEAPRO (BLOCK FORM)**. BIO-OREGON, INC., (U.S. CLS. 6, 18, 44, 46, 51 AND 52). SN 78-341,101. PUB. 3-1-2005. FILED 12-15-2003.
- 2,954,904. **PERCY'S POWDER (BLOCK FORM)**. HEALTH RESEARCH PTY LTD, (U.S. CLS. 6, 18, 44, 46, 51 AND 52). SN 78-347,598. PUB. 3-1-2005. FILED 1-5-2004.
- 2,954,913. **NO MORE FUNGUS (BLOCK FORM)**. DEL LABORATORIES, INC., (U.S. CLS. 6, 18, 44, 46, 51 AND 52). SN 78-352,764. PUB. 10-19-2004. FILED 1-16-2004.
- 2,954,934. **DREAM DIET REST EXERCISE ALTERNATIVE CARE MOTIVATION (BLOCK FORM)**. DREAM HEALTH L.L.C., MULTIPLE CLASS, (INT. CLS. 5 AND 35), (U.S. CLS. 6, 18, 44, 46, 51, 52, 100, 101 AND 102). SN 78-365,674. PUB. 3-1-2005. FILED 2-10-2004.
- 2,954,941. **ESPATAL (BLOCK FORM)**. FARMACEUTICA RODIM S. A. DE C.V., (U.S. CLS. 6, 18, 44, 46, 51 AND 52). SN 78-368,475. PUB. 11-9-2004. FILED 2-16-2004.
- 2,954,957. **MAXIMOL SOLUTIONS (BLOCK FORM)**. NEWAYS, INC., (U.S. CLS. 6, 18, 44, 46, 51 AND 52). SN 78-376,152. PUB. 3-1-2005. FILED 3-1-2004.
- 2,954,958. **ORACHEL (BLOCK FORM)**. NEWAYS, INC., (U.S. CLS. 6, 18, 44, 46, 51 AND 52). SN 78-376,154. PUB. 3-1-2005. FILED 3-1-2004.
- 2,954,959. **VMM (BLOCK FORM)**. NEWAYS, INC., (U.S. CLS. 6, 18, 44, 46, 51 AND 52). SN 78-376,158. PUB. 3-1-2005. FILED 3-1-2004.
- 2,954,960. **REVENOL (BLOCK FORM)**. NEWAYS, INC., (U.S. CLS. 6, 18, 44, 46, 51 AND 52). SN 78-376,171. PUB. 3-1-2005. FILED 3-1-2004.
- 2,954,961. **BIOGIVITY (BLOCK FORM)**. NEWAYS, INC., (U.S. CLS. 6, 18, 44, 46, 51 AND 52). SN 78-376,191. PUB. 3-1-2005. FILED 3-1-2004.
- 2,954,980. **AGELESS BEAUTY (BLOCK FORM)**. AGRIGENIC FOOD CORPORATION, (U.S. CLS. 6, 18, 44, 46, 51 AND 52). SN 78-386,195. PUB. 3-1-2005. FILED 3-17-2004.
- 2,955,011. **LEGACY BALANCE FOR LIFE AND DESIGN**. LEGACY FOR LIFE, LLC, (U.S. CLS. 6, 18, 44, 46, 51 AND 52). SN 78-395,367. PUB. 3-1-2005. FILED 4-2-2004.
- 2,955,085 (*See Class 3 for this trademark*).
- 2,955,168 (*See Class 1 for this trademark*).
- 2,955,172. **NETURYA (BLOCK FORM)**. NOVARTIS AG, (U.S. CLS. 6, 18, 44, 46, 51 AND 52). SN 79-000,823. PUB. 3-1-2005. FILED 1-8-2004.
- 2,955,179. **SANKOM SWITZERLAND (BLOCK FORM)**. SANKOM SARL, (U.S. CLS. 6, 18, 44, 46, 51 AND 52). SN 79-001,628. PUB. 3-1-2005. FILED 2-3-2004.
- 2,955,181. **CLEVOR (BLOCK FORM)**. ORION CORPORATION, (U.S. CLS. 6, 18, 44, 46, 51 AND 52). SN 79-001,721. PUB. 3-1-2005. FILED 3-5-2004.

CLASS 6—METAL GOODS

- 2,954,059. **MINUTE MAN PRODUCTS**. MINUTE MAN PRODUCTS, INC., (U.S. CLS. 2, 12, 13, 14, 23, 25 AND 50). SN 76-272,491. PUB. 3-1-2005. FILED 6-15-2001.
- 2,954,103. **KAMAX FASTENER SOLUTIONS WORLDWIDE**. KAMAX-WERKE RUDOLF KELLENNANN GMBH & CO. KG, MULTIPLE CLASS, (INT. CLS. 6 AND 7), (U.S. CLS. 2, 12, 13, 14, 19, 21, 23, 25, 31, 34, 35 AND 50). SN 76-402,791. PUB. 8-31-2004. FILED 5-1-2002.
- 2,954,143. **REFLECT SUCCESS**. ANOMET INC., MULTIPLE CLASS, (INT. CLS. 6 AND 35), (U.S. CLS. 2, 12, 13, 14, 23, 25, 50, 100, 101 AND 102). SN 76-475,401. PUB. 9-21-2004. FILED 11-25-2002.
- 2,954,172. **S AND DESIGN**. SIMONSWERK, GESELLSCHAFT MIT BESCHRANKTER HAFTUNG, (U.S. CLS. 2, 12, 13, 14, 23, 25 AND 50). SN 76-494,629. PUB. 3-1-2005. FILED 2-28-2003.
- 2,954,278. **GIGGLE-LINGS**. BELSNICKEL ENTERPRISES, INC., (U.S. CLS. 2, 12, 13, 14, 23, 25 AND 50). SN 76-543,546. PUB. 3-1-2005. FILED 8-27-2003.
- 2,954,305. **X+CELL FASTENERS A STANDARD OF "EXCELL-ENCE" IN QUALITY HARDWARE AND DESIGN**. XM INTERNATIONAL INC., (U.S. CLS. 2, 12, 13, 14, 23, 25 AND 50). SN 76-550,828. PUB. 3-1-2005. FILED 10-10-2003.
- 2,954,313. **ALEF STANDARD PACKAGING**. ALEF STANDARD PACKAGING COMPANY, MULTIPLE CLASS, (INT. CLS. 6, 9, 14, 16, 20, 21 AND 22), (U.S. CLS. 1, 2, 5, 7, 12, 13, 14, 19, 21, 22, 23, 25, 26, 27, 28, 29, 30, 32, 33, 36, 37, 38, 40, 42 AND 50). SN 76-552,410. PUB. 3-1-2005. FILED 10-17-2003.
- 2,954,392. **PALMAIR (BLOCK FORM)**. BREEZWAY AUSTRALIA PTY LTD, (U.S. CLS. 2, 12, 13, 14, 23, 25 AND 50). SN 76-567,305. PUB. 3-1-2005. FILED 12-29-2003.
- 2,954,442. **EDH PUSHBOARD (STYLIZED)**. EXCLUSIVE DOOR HANDLES, INC., (U.S. CLS. 2, 12, 13, 14, 23, 25 AND 50). SN 76-579,013. PUB. 3-1-2005. FILED 3-2-2004.
- 2,954,531. **EASY START (STYLIZED)**. GAME TRACKER, INC., (U.S. CLS. 2, 12, 13, 14, 23, 25 AND 50). SN 76-590,100. PUB. 3-1-2005. FILED 5-3-2004.
- 2,954,625. **ASSA ABLOY**. ASSA ABLOY AB, MULTIPLE CLASS, (INT. CLS. 6, 9 AND 45), (U.S. CLS. 2, 12, 13, 14, 21, 23, 25, 26, 36, 38, 50, 100 AND 101). SN 78-162,349. PUB. 3-1-2005. FILED 9-10-2002.
- 2,954,645. **U.S. FDRY (BLOCK FORM)**. UNITED STATES FOUNDRY & MANUFACTURING CORPORATION, (U.S. CLS. 2, 12, 13, 14, 23, 25 AND 50). SN 78-200,736. PUB. 4-27-2004. FILED 1-7-2003.
- 2,954,707. **APFCT AND DESIGN**. ASIA PACIFIC FUEL CELL TECHNOLOGIES, LTD., MULTIPLE CLASS, (INT. CLS. 6, 7, 9, 12 AND 42), (U.S. CLS. 2, 12, 13, 14, 19, 21, 23, 25, 26, 31, 34, 35, 36, 38, 44, 50, 100 AND 101). SN 78-244,101. PUB. 11-2-2004. FILED 4-30-2003.
- 2,954,899. **NORAM AND DESIGN**. NORAM, INC., (U.S. CLS. 2, 12, 13, 14, 23, 25 AND 50). SN 78-344,475. PUB. 3-1-2005. FILED 12-22-2003.
- 2,954,971. **CANTSINK (BLOCK FORM)**. HUTCHINSON &

GEBHARDT, INC., (U.S. CLS. 2, 12, 13, 14, 23, 25 AND 50). SN 78-381,705. PUB. 3-1-2005. FILED 3-10-2004.
 2,955,162. **VIVARA (STYLIZED)**. C J WILDBIRD FOODS LIMITED, MULTIPLE CLASS, (INT. CLS. 6, 9, 16, 19, 20, 21 AND 31), (U.S. CLS. 1, 2, 5, 12, 13, 14, 21, 22, 23, 25, 26, 29, 30, 32, 33, 36, 37, 38, 40, 46 AND 50). SN 79-000,006. PUB. 3-1-2005. FILED 11-2-2003.

CLASS 7—MACHINERY

2,954,007. **YELLO**. YELLO STROM VERWALTUNGSGESELLSCHAFT MBH, MULTIPLE CLASS, (INT. CLS. 7, 9, 11, 12, 21, 28, 35, 39 AND 42), (U.S. CLS. 2, 13, 19, 21, 22, 23, 26, 29, 30, 31, 33, 34, 35, 36, 38, 40, 44, 50, 100, 101, 102 AND 105). SN 75-776,613. PUB. 3-1-2005. FILED 8-16-1999.
 2,954,055. **HYELECTRIC AND DESIGN**. HUSKY INJECTION MOLDING SYSTEMS LTD., (U.S. CLS. 13, 19, 21, 23, 31, 34 AND 35). SN 76-250,342. PUB. 3-1-2005. FILED 5-2-2001.
 2,954,074. **BRUSH AND DESIGN**. FKI PLC, (U.S. CLS. 13, 19, 21, 23, 31, 34 AND 35). SN 76-320,512. PUB. 3-1-2005. FILED 10-2-2001.
 2,954,078. **LARKIN AND DESIGN**. LARKIN INDUSTRIES, INC., MULTIPLE CLASS, (INT. CLS. 7, 9 AND 11), (U.S. CLS. 13, 19, 21, 23, 26, 31, 34, 35, 36 AND 38). SN 76-333,781. PUB. 3-1-2005. FILED 11-5-2001.
 2,954,103 (*See Class 6 for this trademark*).
 2,954,129. **ROTO-MAX**. ROTOBEC INC., (U.S. CLS. 13, 19, 21, 23, 31, 34 AND 35). SN 76-458,697. PUB. 11-9-2004. FILED 10-8-2002.
 2,954,222. **PROFILO AND DESIGN**. BSH PROFILO ELEKTRIKLI GERECLER SANAYI A.S., MULTIPLE CLASS, (INT. CLS. 7 AND 11), (U.S. CLS. 13, 19, 21, 23, 31, 34 AND 35). SN 76-514,113. PUB. 3-1-2005. FILED 5-14-2003.
 2,954,227. **S@A AND DESIGN**. KOOPNAUTIC HOLLAND B.V., MULTIPLE CLASS, (INT. CLS. 7, 9 AND 12), (U.S. CLS. 13, 19, 21, 23, 26, 31, 34, 35, 36, 38 AND 44). SN 76-515,989. PUB. 3-1-2005. FILED 5-21-2003.
 2,954,260. **S SIMPOWER (STYLIZED)**. COLLICUTT ENERGY SERVICES, LTD., (U.S. CLS. 13, 19, 21, 23, 31, 34 AND 35). SN 76-537,886. PUB. 3-1-2005. FILED 8-15-2003.
 2,954,267. **MAX-PAK**. WASTE PROCESSING EQUIPMENT, INC., (U.S. CLS. 13, 19, 21, 23, 31, 34 AND 35). SN 76-540,223. PUB. 3-1-2005. FILED 8-26-2003.
 2,954,345. **BIOSTEP**. BIO-MICROBICS INCORPORATED, (U.S. CLS. 13, 19, 21, 23, 31, 34 AND 35). SN 76-558,556. PUB. 3-1-2005. FILED 10-27-2003.
 2,954,353. **SCOTT (BLOCK FORM)**. TAFCO EQUIPMENT CO., INC., MULTIPLE CLASS, (INT. CLS. 7 AND 12), (U.S. CLS. 13, 19, 21, 23, 31, 34, 35 AND 44). SN 76-560,628. PUB. 3-1-2005. FILED 11-18-2003.
 2,954,431. **AS-U-ROLL (BLOCK FORM)**. MAGNUM INTEGRATED TECHNOLOGIES INC., (U.S. CLS. 13, 19, 21, 23, 31, 34 AND 35). SN 76-576,374. PUB. 3-1-2005. FILED 2-19-2004.
 2,954,593. **CHROMEBOSS (STYLIZED)**. ECKEL MANUFACTURING CO., INC., (U.S. CLS. 13, 19, 21, 23, 31, 34 AND 35). SN 76-592,801. PUB. 3-1-2005. FILED 5-12-2004.
 2,954,616. **KG AND DESIGN**. KG INTERNATIONAL FZCO, (U.S. CLS. 13, 19, 21, 23, 31, 34 AND 35). SN 78-122,973. PUB. 3-1-2005. FILED 4-19-2002.
 2,954,629. **XWIN**. MAGOTTEAUX INTERNATIONAL, (U.S. CLS. 13, 19, 21, 23, 31, 34 AND 35). SN 78-169,177. PUB. 9-21-2004. FILED 9-30-2002.
 2,954,644. **TAZMO**. TAZMO CO., LTD., MULTIPLE CLASS, (INT. CLS. 7, 9 AND 42), (U.S. CLS. 13, 19, 21, 23, 26, 31, 34, 35, 36, 38, 100 AND 101). SN 78-200,644. PUB. 10-26-2004. FILED 1-7-2003.
 2,954,651. **VIBROFLOW**. GEA BUCK VALVE GMBH, (U.S. CLS. 13, 19, 21, 23, 31, 34 AND 35). SN 78-207,051. PUB. 8-10-2004. FILED 1-24-2003.
 2,954,678 (*See Class 1 for this trademark*).
 2,954,698 (*See Class 1 for this trademark*).
 2,954,707 (*See Class 6 for this trademark*).
 2,954,755. **HSMC**. ENERGY CRANES LLC, (U.S. CLS. 13, 19, 21, 23, 31, 34 AND 35). SN 78-278,664. PUB. 3-1-2005. FILED 7-24-2003.

2,954,756. **HOUSTON SYSTEMS MARINE PRODUCTS**. ENERGY CRANES LLC, (U.S. CLS. 13, 19, 21, 23, 31, 34 AND 35). SN 78-278,672. PUB. 3-1-2005. FILED 7-24-2003.
 2,954,757. **HERCULES MARINE PRODUCTS**. ENERGY CRANES LLC, (U.S. CLS. 13, 19, 21, 23, 31, 34 AND 35). SN 78-278,679. PUB. 3-1-2005. FILED 7-24-2003.
 2,954,787. **DOUBLE-TUBE**. COTTING, STEVEN R., (U.S. CLS. 13, 19, 21, 23, 31, 34 AND 35). SN 78-297,842. PUB. 3-1-2005. FILED 9-9-2003.
 2,954,834. **HAYDEN SUPERVAC CENTRAL VACUUM SYSTEMS AND DESIGN**. HAYDEN INDUSTRIES INC., (U.S. CLS. 13, 19, 21, 23, 31, 34 AND 35). SN 78-316,750. PUB. 3-1-2005. FILED 10-21-2003.
 2,954,837. **STOUT TOOL CORP.**. STOUT TOOL CORP., (U.S. CLS. 13, 19, 21, 23, 31, 34 AND 35). SN 78-318,093. PUB. 3-1-2005. FILED 10-24-2003.
 2,954,846. **TREX**. REEDHYCALOG, L.P., (U.S. CLS. 13, 19, 21, 23, 31, 34 AND 35). SN 78-320,473. PUB. 3-1-2005. FILED 10-29-2003.
 2,954,874. **ZACH & DAN'S AND DESIGN**. ZACH & DAN'S, LLC, (U.S. CLS. 13, 19, 21, 23, 31, 34 AND 35). SN 78-330,414. PUB. 3-1-2005. FILED 11-19-2003.
 2,954,943. **QWIK-PURE (BLOCK FORM)**. BEKO CONDENSATE SYSTEMS CORPORATION, DBA BEKO TECHNOLOGIES CORPORATION, (U.S. CLS. 13, 19, 21, 23, 31, 34 AND 35). SN 78-368,687. PUB. 3-1-2005. FILED 2-16-2004.
 2,955,060. **QCIMEG (BLOCK FORM)**. SPRAYING SYSTEMS COMPANY, (U.S. CLS. 13, 19, 21, 23, 31, 34 AND 35). SN 78-406,296. PUB. 3-1-2005. FILED 4-22-2004.
 2,955,069. **QCZMEG (BLOCK FORM)**. SPRAYING SYSTEMS COMPANY, (U.S. CLS. 13, 19, 21, 23, 31, 34 AND 35). SN 78-408,760. PUB. 3-1-2005. FILED 4-27-2004.
 2,955,166. **FRESH X PRESS (BLOCK FORM)**. SEB, (U.S. CLS. 13, 19, 21, 23, 31, 34 AND 35). SN 79-000,251. PUB. 3-1-2005. FILED 11-26-2003.

CLASS 8—HAND TOOLS

2,954,043 (*See Class 3 for this trademark*).
 2,954,350. **ZATOICHI**. C.A.S. IBERIA, INC., (U.S. CLS. 23, 28 AND 44). SN 76-559,706. PUB. 3-1-2005. FILED 10-30-2003.
 2,954,482. **ROYAL NORFOLK (BLOCK FORM)**. DOLLAR TREE STORES, INC., MULTIPLE CLASS, (INT. CLS. 8, 21 AND 24), (U.S. CLS. 2, 13, 23, 28, 29, 30, 33, 40, 42, 44 AND 50). SN 76-585,654. PUB. 3-1-2005. FILED 4-7-2004.
 2,954,512. **STOPSA-DROP (BLOCK FORM)**. SOUTHEASTERN DEVELOPMENT, INC., (U.S. CLS. 23, 28 AND 44). SN 76-588,326. PUB. 3-1-2005. FILED 4-20-2004.
 2,954,719. **MC STEEL AND DESIGN**. "JAGUAR" STAHLWARENFABRIK GMBH & CO. KG, (U.S. CLS. 23, 28 AND 44). SN 78-255,004. PUB. 3-1-2005. FILED 5-28-2003.
 2,954,733. **CAPTAIN SABERTOOTH AND DESIGN**. FORMOE, TERJE, MULTIPLE CLASS, (INT. CLS. 8, 9, 14, 16, 18, 21, 24, 25, 26, 28 AND 41), (U.S. CLS. 1, 2, 3, 5, 13, 21, 22, 23, 26, 27, 28, 29, 30, 33, 36, 37, 38, 39, 40, 41, 42, 44, 50, 100, 101 AND 107). SN 78-265,078. PUB. 10-26-2004. FILED 6-20-2003.
 2,954,883. **THE STRAW WIZARD (BLOCK FORM)**. LOIK, JAMES B, (U.S. CLS. 23, 28 AND 44). SN 78-334,315. PUB. 3-1-2005. FILED 12-1-2003.
 2,954,920. **FLEXLOK (BLOCK FORM)**. HI-FIVE PRODUCTS DEVELOPING CO., LTD., (U.S. CLS. 23, 28 AND 44). SN 78-356,979. PUB. 10-19-2004. FILED 1-23-2004.
 2,955,051. **GERBER (BLOCK FORM)**. FISKARS BRANDS, INC., MULTIPLE CLASS, (INT. CLS. 8 AND 11), (U.S. CLS. 13, 21, 23, 28, 31, 34 AND 44). SN 78-400,766. PUB. 3-1-2005. FILED 4-13-2004.

CLASS 9—ELECTRICAL AND SCIENTIFIC APPARATUS

2,953,999. **MISCELLANEOUS DESIGN**. COSMODA CONCEPT CORPORATION, (U.S. CLS. 21, 23, 26, 36 AND 38). SN 75-324,968. PUB. 7-27-2004. FILED 7-15-1997.

- 2,954,005. **COUNTERPOINT**. POINT BLANK BODY ARMOR, INC. (U.S. CLS. 21, 23, 26, 36 AND 38). SN 75-690,679. PUB. 10-19-2004. FILED 4-22-1999.
- 2,954,007 (*See Class 7 for this trademark*).
- 2,954,016. **CACTUS COMPUTATIONAL TOOLKIT**. MAX-PLANCK-GESELLSCHAFT, MULTIPLE CLASS, (INT. CLS. 9, 16 AND 42), (U.S. CLS. 2, 5, 21, 22, 23, 26, 29, 36, 37, 38, 50, 100 AND 101). SN 76-007,970. PUB. 3-1-2005. FILED 3-23-2000.
- 2,954,017. **PHASEO**. SCHNEIDER ELECTRIC INDUSTRIES SAS, (U.S. CLS. 21, 23, 26, 36 AND 38). SN 76-019,661. PUB. 7-27-2004. FILED 4-6-2000.
- 2,954,023. **BOSS**. BOSS & CO. LIMITED, MULTIPLE CLASS, (INT. CLS. 9, 13 AND 37), (U.S. CLS. 2, 9, 21, 23, 26, 36, 38, 100, 103 AND 106). SN 76-072,106. PUB. 3-2-2004. FILED 6-16-2000.
- 2,954,024. **BOSS & CO**. BOSS & CO. LIMITED, MULTIPLE CLASS, (INT. CLS. 9, 13 AND 37), (U.S. CLS. 2, 9, 21, 23, 26, 36, 38, 100, 103 AND 106). SN 76-072,724. PUB. 3-16-2004. FILED 6-16-2000.
- 2,954,025. **T INFO AND DESIGN**. DEUTSCHE TELEKOM AG, MULTIPLE CLASS, (INT. CLS. 9, 16, 35, 38 AND 42), (U.S. CLS. 2, 5, 21, 22, 23, 26, 29, 36, 37, 38, 50, 100, 101, 102 AND 104). SN 76-083,601. PUB. 9-21-2004. FILED 7-6-2000.
- 2,954,026. **CASHFAC**. CASHFAC LIMITED, MULTIPLE CLASS, (INT. CLS. 9, 16, 35, 36, 38, 41 AND 42), (U.S. CLS. 2, 5, 21, 22, 23, 26, 29, 36, 37, 38, 50, 100, 101, 102, 104 AND 107). SN 76-091,773. PUB. 3-1-2005. FILED 7-17-2000.
- 2,954,028. **IVIEW STUDIO**. SAP PORTALS, INC., (U.S. CLS. 21, 23, 26, 36 AND 38). SN 76-102,434. PUB. 10-19-2004. FILED 8-2-2000.
- 2,954,029. **NEMISYS**. EADS DEUTSCHLAND GMBH, MULTIPLE CLASS, (INT. CLS. 9, 13, 37 AND 42), (U.S. CLS. 2, 9, 21, 23, 26, 36, 38, 100, 101, 103 AND 106). SN 76-108,316. PUB. 3-1-2005. FILED 8-11-2000.
- 2,954,030. **MTAS**. MITSUBISHI MATERIALS CORPORATION, MULTIPLE CLASS, (INT. CLS. 9, 16 AND 40), (U.S. CLS. 2, 5, 21, 22, 23, 26, 29, 36, 37, 38, 50, 100, 103 AND 106). SN 76-109,123. PUB. 8-3-2004. FILED 8-14-2000.
- 2,954,037. **DEUTSCHE TELEKOM GROUP**. DEUTSCHE TELEKOM AG, MULTIPLE CLASS, (INT. CLS. 9, 14, 16, 18, 25, 28, 35, 36, 37, 38, 39, 41 AND 42), (U.S. CLS. 1, 2, 3, 5, 21, 22, 23, 26, 27, 28, 29, 36, 37, 38, 39, 41, 50, 100, 101, 102, 103, 104, 105, 106 AND 107). SN 76-142,269. PUB. 9-14-2004. FILED 10-6-2000.
- 2,954,043 (*See Class 3 for this trademark*).
- 2,954,044. **TIREBOSS**. TIRE PRESSURE CONTROL INTERNATIONAL LTD., (U.S. CLS. 21, 23, 26, 36 AND 38). SN 76-183,486. PUB. 3-1-2005. FILED 12-20-2000.
- 2,954,045. **M AND DESIGN**. GEOMETRIE CONCERN VERWALTUNGS-UND BETEILIGUNGSGESELLSCHAFT MBH, MULTIPLE CLASS, (INT. CLS. 9, 12, 35, 36, 38, 40, 41 AND 42), (U.S. CLS. 19, 21, 23, 26, 31, 35, 36, 38, 44, 100, 101, 102, 103, 104, 106 AND 107). SN 76-186,960. PUB. 9-21-2004. FILED 12-27-2000.
- 2,954,046. **EURONET WORLDWIDE**. EURONET WORLDWIDE, INC., MULTIPLE CLASS, (INT. CLS. 9, 36 AND 38), (U.S. CLS. 21, 23, 26, 36, 38, 100, 101, 102 AND 104). SN 76-202,672. PUB. 12-2-2003. FILED 1-29-2001.
- 2,954,047. **SOLO AND DESIGN**. NORDEA BANK FINLAND ABP, MULTIPLE CLASS, (INT. CLS. 9, 35, 36 AND 38), (U.S. CLS. 21, 23, 26, 36, 38, 100, 101, 102 AND 104). SN 76-210,012. PUB. 3-1-2005. FILED 2-12-2001.
- 2,954,050. **KESTREL**. KESTREL TECHNOLOGIES, INC., MULTIPLE CLASS, (INT. CLS. 9 AND 42), (U.S. CLS. 21, 23, 26, 36, 38, 100 AND 101). SN 76-220,048. PUB. 5-21-2002. FILED 3-5-2001.
- 2,954,061. **LIPPER LEADER AND DESIGN**. REUTERS S.A., MULTIPLE CLASS, (INT. CLS. 9, 35 AND 36), (U.S. CLS. 21, 23, 26, 36, 38, 100, 101 AND 102). SN 76-283,207. PUB. 3-1-2005. FILED 7-3-2001.
- 2,954,063. **SOLARBIRD**. MITSUBISHI ELECTRIC CORPORATION, (U.S. CLS. 21, 23, 26, 36 AND 38). SN 76-286,751. PUB. 3-1-2005. FILED 7-17-2001.
- 2,954,064. **MONTERNET**. CHINA MOBILE (HONG KONG) LIMITED, MULTIPLE CLASS, (INT. CLS. 9, 16, 35, 38 AND 42), (U.S. CLS. 2, 5, 21, 22, 23, 26, 29, 36, 37, 38, 50, 100, 101, 102 AND 104). SN 76-286,951. PUB. 3-1-2005. FILED 7-18-2001.
- 2,954,067 (*See Class 5 for this trademark*).
- 2,954,071. **GOOGLE**. GOOGLE INC., MULTIPLE CLASS, (INT. CLS. 9, 11, 12, 16, 18, 21, 25, 28 AND 35), (U.S. CLS. 1, 2, 3, 5, 13, 19, 21, 22, 23, 26, 29, 30, 31, 33, 34, 35, 36, 37, 38, 39, 40, 41, 44, 50, 100, 101 AND 102). SN 76-314,783. PUB. 7-6-2004. FILED 9-18-2001.
- 2,954,072. **DECISIONWARE**. MIS AG, MULTIPLE CLASS, (INT. CLS. 9, 35 AND 42), (U.S. CLS. 21, 23, 26, 36, 38, 100, 101 AND 102). SN 76-317,018. PUB. 7-13-2004. FILED 9-25-2001.
- 2,954,077. **TRANSPARENT READY**. SCHNEIDER ELECTRIC INDUSTRIES SA, MULTIPLE CLASS, (INT. CLS. 9, 37, 38 AND 42), (U.S. CLS. 21, 23, 26, 36, 38, 100, 101, 103, 104 AND 106). SN 76-332,734. PUB. 3-1-2005. FILED 11-2-2001.
- 2,954,078 (*See Class 7 for this trademark*).
- 2,954,080. **RISKOUTLOOK**. QUANTITATIVE DECISION SUPPORT INC., MULTIPLE CLASS, (INT. CLS. 9 AND 36), (U.S. CLS. 21, 23, 26, 36, 38, 100, 101 AND 102). SN 76-337,445. PUB. 10-26-2004. FILED 11-13-2001.
- 2,954,081. **CEEFA CAT! AND DESIGN**. WEBSTER, GLENN DAVID, MULTIPLE CLASS, (INT. CLS. 9, 16, 25, 28, 31 AND 41), (U.S. CLS. 1, 2, 5, 21, 22, 23, 26, 29, 36, 37, 38, 39, 46, 50, 100, 101 AND 107). SN 76-339,088. PUB. 3-1-2005. FILED 11-17-2001.
- 2,954,082. **DEEFA DOG! AND DESIGN**. WEBSTER, GLENN DAVID, MULTIPLE CLASS, (INT. CLS. 9, 16, 25, 28, 31 AND 41), (U.S. CLS. 1, 2, 5, 21, 22, 23, 26, 29, 36, 37, 38, 39, 46, 50, 100, 101 AND 107). SN 76-339,089. PUB. 3-1-2005. FILED 11-17-2001.
- 2,954,087. **PENBASE**. PENBASE, MULTIPLE CLASS, (INT. CLS. 9 AND 42), (U.S. CLS. 21, 23, 26, 36, 38, 100 AND 101). SN 76-350,096. PUB. 6-15-2004. FILED 12-19-2001.
- 2,954,088. **UNITE2HELP (STYLIZED)**. UNITE2HELP HOLDING A/S, MULTIPLE CLASS, (INT. CLS. 9, 28, 35, 36, 41 AND 42), (U.S. CLS. 21, 22, 23, 26, 36, 38, 50, 100, 101, 102 AND 107). SN 76-350,239. PUB. 8-31-2004. FILED 12-19-2001.
- 2,954,089. **VTT**. TECHNICAL RESEARCH CENTRE OF FINLAND, MULTIPLE CLASS, (INT. CLS. 9, 16, 35, 41 AND 42), (U.S. CLS. 2, 5, 21, 22, 23, 26, 29, 36, 37, 38, 50, 100, 101, 102 AND 107). SN 76-350,468. PUB. 3-1-2005. FILED 12-18-2001.
- 2,954,100. **GEMINI**. BOHLIN INSTRUMENTS LIMITED, (U.S. CLS. 21, 23, 26, 36 AND 38). SN 76-394,280. PUB. 3-1-2005. FILED 4-12-2002.
- 2,954,111. **HAMILTON**. HAMILTON COMPANY, MULTIPLE CLASS, (INT. CLS. 9 AND 42), (U.S. CLS. 21, 23, 26, 36, 38, 100 AND 101). SN 76-427,875. PUB. 8-24-2004. FILED 7-1-2002.
- 2,954,112. **DRAGSTER AND DESIGN**. DRAGSTER S.R.L., (U.S. CLS. 21, 23, 26, 36 AND 38). SN 76-428,549. PUB. 12-30-2003. FILED 7-3-2002.
- 2,954,118. **ORI - WORLD AND DESIGN**. KARL STORZ GMBH & CO. KG, MULTIPLE CLASS, (INT. CLS. 9 AND 10), (U.S. CLS. 21, 23, 26, 36, 38, 39 AND 44). SN 76-438,810. PUB. 9-21-2004. FILED 8-7-2002.
- 2,954,119. **NANO FOCUS AND DESIGN**. PHOENIX X-RAY SYSTEMS + SERVICES GMBH, MULTIPLE CLASS, (INT. CLS. 9 AND 10), (U.S. CLS. 21, 23, 26, 36, 38, 39 AND 44). SN 76-440,180. PUB. 3-1-2005. FILED 8-14-2002.
- 2,954,126. **4LIFE**. 4LIFE RESEARCH, L.C., (U.S. CLS. 21, 23, 26, 36 AND 38). SN 76-456,704. PUB. 3-1-2005. FILED 10-3-2002.
- 2,954,127. **MISCELLANEOUS DESIGN**. PAYKEY USA, INC., (U.S. CLS. 21, 23, 26, 36 AND 38). SN 76-457,241. PUB. 3-1-2005. FILED 10-9-2002.
- 2,954,131. **DIGITAL FIRST**. KARL STORZ GMBH & CO. KG, MULTIPLE CLASS, (INT. CLS. 9 AND 10), (U.S. CLS. 21, 23, 26, 36, 38, 39 AND 44). SN 76-459,270. PUB. 10-5-2004. FILED 10-11-2002.
- 2,954,144. **THE SOURCE OF IMAGING**. KARL STORZ GMBH & CO. KG, MULTIPLE CLASS, (INT. CLS. 9 AND 10), (U.S. CLS. 21, 23, 26, 36, 38, 39 AND 44). SN 76-476,305. PUB. 11-9-2004. FILED 12-17-2002.
- 2,954,145 (*See Class 1 for this trademark*).
- 2,954,146. **VIBXPERT**. PRUFTECHNIK DIETER BUSCH AG, (U.S. CLS. 21, 23, 26, 36 AND 38). SN 76-478,369. PUB. 3-1-2005. FILED 12-26-2002.

- 2,954,149. **THE PROGRAM FOR BETTER VISION.** CAMBRIDGE INSTITUTE FOR BETTER VISION, INC., MULTIPLE CLASS, (INT. CLS. 9 AND 16), (U.S. CLS. 2, 5, 21, 22, 23, 26, 29, 36, 37, 38 AND 50). SN 76-478,735. PUB. 3-1-2005. FILED 12-20-2002.
- 2,954,151. **PDT.** IDELIX SOFTWARE INC., MULTIPLE CLASS, (INT. CLS. 9 AND 42), (U.S. CLS. 21, 23, 26, 36, 38, 100 AND 101). SN 76-483,258. PUB. 11-23-2004. FILED 1-17-2003.
- 2,954,152. **REALTREE ROADTRIPS WITH MICHAEL WADDELL AND DESIGN.** JORDAN OUTDOOR ENTERPRISES, LTD., MULTIPLE CLASS, (INT. CLS. 9 AND 41), (U.S. CLS. 21, 23, 26, 36, 38, 100, 101 AND 107). SN 76-483,354. PUB. 3-1-2005. FILED 1-21-2003.
- 2,954,155. **AD-AWARE.** NICOLAS STARK COMPUTING, AB, (U.S. CLS. 21, 23, 26, 36 AND 38). SN 76-485,376. PUB. 5-18-2004. FILED 1-28-2003.
- 2,954,162. **KINGDOM QUEST AND DESIGN.** KING OF KINGS LUTHERAN CHURCH, U.A.C., (U.S. CLS. 21, 23, 26, 36 AND 38). SN 76-493,060. PUB. 3-1-2005. FILED 2-25-2003.
- 2,954,163. **MISCELLANEOUS DESIGN.** KABUSHIKI KAISHA VILLAGE RECORD, MULTIPLE CLASS, (INT. CLS. 9, 16, 41 AND 43), (U.S. CLS. 2, 5, 21, 22, 23, 26, 29, 36, 37, 38, 50, 100, 101 AND 107). SN 76-493,394. PUB. 12-28-2004. FILED 2-26-2003.
- 2,954,171. **DUB STUDIO AND DESIGN.** RYSHCO MEDIA INC., (U.S. CLS. 21, 23, 26, 36 AND 38). SN 76-494,614. PUB. 3-1-2005. FILED 2-28-2003.
- 2,954,173. **CAPSTONE.** PARK LI MANAGEMENT SIMULATIONS, INC., DBA MANAGEMENT SIMULATIONS, MULTIPLE CLASS, (INT. CLS. 9, 41 AND 42), (U.S. CLS. 21, 23, 26, 36, 38, 100, 101 AND 107). SN 76-495,148. PUB. 3-1-2005. FILED 3-6-2003.
- 2,954,174. **CAPSTONE AND DESIGN.** PARK LI MANAGEMENT SIMULATIONS, INC., DBA MANAGEMENT SIMULATIONS, MULTIPLE CLASS, (INT. CLS. 9, 41 AND 42), (U.S. CLS. 21, 23, 26, 36, 38, 100, 101 AND 107). SN 76-495,149. PUB. 3-1-2005. FILED 3-6-2003.
- 2,954,178. **WISARD.** WESTERN INVENTORY SERVICE LTD., (U.S. CLS. 21, 23, 26, 36 AND 38). SN 76-498,110. PUB. 3-1-2005. FILED 2-19-2003.
- 2,954,184. **SNOW MONSTERS.** SIRDAR, LLC, MULTIPLE CLASS, (INT. CLS. 9, 16, 25 AND 41), (U.S. CLS. 2, 5, 21, 22, 23, 26, 29, 36, 37, 38, 39, 50, 100, 101 AND 107). SN 76-500,847. PUB. 4-27-2004. FILED 3-14-2003.
- 2,954,198. **PCM.** CERVITECH, INC., MULTIPLE CLASS, (INT. CLS. 9, 10, 16, 42 AND 44), (U.S. CLS. 2, 5, 21, 22, 23, 26, 29, 36, 37, 38, 39, 44, 50, 100 AND 101). SN 76-505,334. PUB. 8-17-2004. FILED 4-9-2003.
- 2,954,199. **AEROSMITH.** RAG DOLL MERCHANDISING, INC., (U.S. CLS. 21, 23, 26, 36 AND 38). SN 76-505,679. PUB. 3-1-2005. FILED 4-11-2003.
- 2,954,204. **TUGAL.** INDUSTRIAS TUGAL, S.A. DE C.V., (U.S. CLS. 21, 23, 26, 36 AND 38). SN 76-506,636. PUB. 9-7-2004. FILED 4-16-2003.
- 2,954,214. **FURNERVE INNOVATIVE SOFTWARE & SERVICES AND DESIGN.** FURNERVE, INC., MULTIPLE CLASS, (INT. CLS. 9 AND 35), (U.S. CLS. 21, 23, 26, 36, 38, 100, 101 AND 102). SN 76-512,345. PUB. 3-1-2005. FILED 5-6-2003.
- 2,954,215. **FURNERVE.** FURNERVE, INC., MULTIPLE CLASS, (INT. CLS. 9 AND 35), (U.S. CLS. 21, 23, 26, 36, 38, 100, 101 AND 102). SN 76-512,346. PUB. 3-1-2005. FILED 5-6-2003.
- 2,954,227 (*See Class 7 for this trademark*).
- 2,954,237. **BRITENING.** RAFAEL ARMAMENT DEVELOPMENT AUTHORITY LTD., (U.S. CLS. 21, 23, 26, 36 AND 38). SN 76-523,754. PUB. 3-1-2005. FILED 6-16-2003.
- 2,954,240. **MITUS.** WALDEMAR LINK GMBH & CO. KG, MULTIPLE CLASS, (INT. CLS. 9, 10, 16, 42 AND 44), (U.S. CLS. 2, 5, 21, 22, 23, 26, 29, 36, 37, 38, 39, 44, 50, 100 AND 101). SN 76-526,778. PUB. 8-24-2004. FILED 7-1-2003.
- 2,954,246. **FACCS.** CARL-ZEISS-STIFTUNG, DBA CARL ZEISS, (U.S. CLS. 21, 23, 26, 36 AND 38). SN 76-529,704. PUB. 3-1-2005. FILED 7-17-2003.
- 2,954,253. **PEERPLACE.** FREY, ERIC, (U.S. CLS. 21, 23, 26, 36 AND 38). SN 76-534,677. PUB. 3-1-2005. FILED 8-4-2003.
- 2,954,261. **EPSONNET SERVICEPLATFORM (BLOCK FORM).** SEIKO EPSON KABUSHIKI KAISHA, DBA SEIKO EPSON CORPORATION, (U.S. CLS. 21, 23, 26, 36 AND 38). SN 76-537,969. PUB. 3-1-2005. FILED 8-18-2003.
- 2,954,292. **JOYMASTER AND DESIGN.** JOYMASTER, INC., (U.S. CLS. 21, 23, 26, 36 AND 38). SN 76-546,993. PUB. 3-1-2005. FILED 9-25-2003.
- 2,954,308. **MEMORY GENIE (STYLIZED).** HSU LI, HSIU CHU, (U.S. CLS. 21, 23, 26, 36 AND 38). SN 76-551,546. PUB. 12-28-2004. FILED 10-16-2003.
- 2,954,313 (*See Class 6 for this trademark*).
- 2,954,314. **SURECAL.** NORTHROP GRUMMAN CORPORATION, (U.S. CLS. 21, 23, 26, 36 AND 38). SN 76-552,502. PUB. 3-1-2005. FILED 10-1-2003.
- 2,954,318. **SOUNDLINE.** SOUNDLINE, LLC, MULTIPLE CLASS, (INT. CLS. 9, 16, 35 AND 41), (U.S. CLS. 2, 5, 21, 22, 23, 26, 29, 36, 37, 38, 50, 100, 101, 102 AND 107). SN 76-553,286. PUB. 3-1-2005. FILED 9-22-2003.
- 2,954,331. **MISCELLANEOUS DESIGN.** ANDIGILOG, INC., (U.S. CLS. 21, 23, 26, 36 AND 38). SN 76-556,454. PUB. 3-1-2005. FILED 11-4-2003.
- 2,954,334. **CIP-CHECK (STYLIZED).** TYSON, JAMES, (U.S. CLS. 21, 23, 26, 36 AND 38). SN 76-557,337. PUB. 3-1-2005. FILED 11-6-2003.
- 2,954,351. **DAP/DNA AND DESIGN.** IPFLEX INC., (U.S. CLS. 21, 23, 26, 36 AND 38). SN 76-560,466. PUB. 3-1-2005. FILED 11-17-2003.
- 2,954,372. **MYFAMILYCD (BLOCK FORM).** HUTCHINS, CORRINE C., (U.S. CLS. 21, 23, 26, 36 AND 38). SN 76-563,217. PUB. 3-1-2005. FILED 11-20-2003.
- 2,954,373. **RIDEPRO (BLOCK FORM).** AIR RIDE TECHNOLOGIES, INC., (U.S. CLS. 21, 23, 26, 36 AND 38). SN 76-563,314. PUB. 3-1-2005. FILED 12-4-2003.
- 2,954,377. **WISDOM OF THE ANCIENT FORESTS (BLOCK FORM).** QUEST FOUNDATION, INC., (U.S. CLS. 21, 23, 26, 36 AND 38). SN 76-564,442. PUB. 3-1-2005. FILED 12-10-2003.
- 2,954,383. **F.I.S.T. (BLOCK FORM).** NATIONAL INSTITUTE FOR TRUTH VERIFICATION LLC, (U.S. CLS. 21, 23, 26, 36 AND 38). SN 76-565,677. PUB. 3-1-2005. FILED 12-8-2003.
- 2,954,387. **MARINA GUARD (BLOCK FORM).** SHAFER, JAMES, (U.S. CLS. 21, 23, 26, 36 AND 38). SN 76-566,465. PUB. 3-1-2005. FILED 12-22-2003.
- 2,954,394. **MAMAC SYSTEMS AND DESIGN.** MAMAC SYSTEMS, INC., (U.S. CLS. 21, 23, 26, 36 AND 38). SN 76-567,842. PUB. 3-1-2005. FILED 12-31-2003.
- 2,954,397. **ULTRAVUE (BLOCK FORM).** MINE SAFETY APPLIANCES COMPANY, (U.S. CLS. 21, 23, 26, 36 AND 38). SN 76-568,555. PUB. 3-1-2005. FILED 1-7-2004.
- 2,954,401. **COIN MAGIC (BLOCK FORM).** ELLSWORTH SYSTEMS, LLC, (U.S. CLS. 21, 23, 26, 36 AND 38). SN 76-568,961. PUB. 3-1-2005. FILED 1-8-2004.
- 2,954,407. **NEXXIM (BLOCK FORM).** ANSOFT CORPORATION, (U.S. CLS. 21, 23, 26, 36 AND 38). SN 76-569,712. PUB. 10-19-2004. FILED 1-13-2004.
- 2,954,417. **ADDAIR (BLOCK FORM).** ADDA CORP., MULTIPLE CLASS, (INT. CLS. 9 AND 11), (U.S. CLS. 13, 21, 23, 26, 31, 34, 36 AND 38). SN 76-571,875. PUB. 10-26-2004. FILED 1-26-2004.
- 2,954,422. **BROKER VILLAGE (BLOCK FORM).** BLACK CAT DECISIONS, LLC, (U.S. CLS. 21, 23, 26, 36 AND 38). SN 76-573,298. PUB. 3-1-2005. FILED 2-2-2004.
- 2,954,425. **LAYOFFSHIELD (BLOCK FORM).** HENSON, CHRISTOPHER, (U.S. CLS. 21, 23, 26, 36 AND 38). SN 76-574,983. PUB. 3-1-2005. FILED 2-10-2004.
- 2,954,436. **VELOCITY SERIES (BLOCK FORM).** CMS PRODUCTS, INC., (U.S. CLS. 21, 23, 26, 36 AND 38). SN 76-578,215. PUB. 12-21-2004. FILED 2-26-2004.
- 2,954,477. **SET & MATCH (BLOCK FORM).** KAPRO INDUSTRIES LTD., (U.S. CLS. 21, 23, 26, 36 AND 38). SN 76-585,327. PUB. 3-1-2005. FILED 4-6-2004.
- 2,954,478. **OPENSOUND (STYLIZED).** PHONAK HOLDING AG, MULTIPLE CLASS, (INT. CLS. 9 AND 10), (U.S. CLS. 21, 23, 26, 36, 38, 39 AND 44). SN 76-585,334. PUB. 3-1-2005. FILED 4-6-2004.
- 2,954,484. **GAGE-CHEK (BLOCK FORM).** METRONICS, INC., (U.S. CLS. 21, 23, 26, 36 AND 38). SN 76-585,754. PUB. 3-1-2005. FILED 4-8-2004.
- 2,954,505. **BORDERGUARD (BLOCK FORM).** BLUE RIDGE

- NETWORKS, INC., (U.S. CLS. 21, 23, 26, 36 AND 38). SN 76-587,898. PUB. 3-1-2005. FILED 4-21-2004.
- 2,954,509. **POWERCOAT (BLOCK FORM)**. PERFECT FIT GLOVE CO., LLC, (U.S. CLS. 21, 23, 26, 36 AND 38). SN 76-588,028. PUB. 3-1-2005. FILED 4-22-2004.
- 2,954,545. **TECH-DESIGN (STYLIZED)**. LAB-VOLT SYSTEMS, INC., (U.S. CLS. 21, 23, 26, 36 AND 38). SN 76-590,852. PUB. 3-1-2005. FILED 5-6-2004.
- 2,954,550. **AUTOMAX PRECISION V 2 PINPOINTER (STYLIZED)**. LORD'S COMPANY OF ORLANDO, THE, DBA KELLYCO, (U.S. CLS. 21, 23, 26, 36 AND 38). SN 76-591,138. PUB. 3-1-2005. FILED 5-10-2004.
- 2,954,565. **UNITED (BLOCK FORM)**. BRAND DESIGN COMPANY, INC., DBA HOUSE INDUSTRIES, (U.S. CLS. 21, 23, 26, 36 AND 38). SN 76-591,615. PUB. 3-1-2005. FILED 5-11-2004.
- 2,954,568. **AOSAFETY (BLOCK FORM)**. AMERICAN OPTICAL IP CORPORATION, (U.S. CLS. 21, 23, 26, 36 AND 38). SN 76-591,682. PUB. 3-1-2005. FILED 5-12-2004.
- 2,954,570. **C-CURE WARE (BLOCK FORM)**. YORK TELECOM CORPORATION, (U.S. CLS. 21, 23, 26, 36 AND 38). SN 76-591,779. PUB. 3-1-2005. FILED 5-12-2004.
- 2,954,574. **POWEREXCHANGE (BLOCK FORM)**. INFORMATICA CORPORATION, (U.S. CLS. 21, 23, 26, 36 AND 38). SN 76-591,869. PUB. 3-1-2005. FILED 5-12-2004.
- 2,954,580. **MISCELLANEOUS DESIGN**. DEROSIER, MELISSA, MULTIPLE CLASS, (INT. CLS. 9, 16 AND 45), (U.S. CLS. 2, 5, 21, 22, 23, 26, 29, 36, 37, 38, 50, 100 AND 101). SN 76-592,066. PUB. 3-1-2005. FILED 5-13-2004.
- 2,954,589. **MISCELLANEOUS DESIGN**. GLOBAL SPAN PRODUCTS, INC., (U.S. CLS. 21, 23, 26, 36 AND 38). SN 76-592,523. PUB. 3-1-2005. FILED 5-17-2004.
- 2,954,599. **IGO EVERYWHEREPOWER (BLOCK FORM)**. MOBILITY ELECTRONICS, INC., (U.S. CLS. 21, 23, 26, 36 AND 38). SN 76-615,411. PUB. 3-1-2005. FILED 10-5-2004.
- 2,954,600. **IGO DUALPOWER (BLOCK FORM)**. MOBILITY ELECTRONICS, INC., (U.S. CLS. 21, 23, 26, 36 AND 38). SN 76-615,412. PUB. 3-1-2005. FILED 10-5-2004.
- 2,954,601. **IGO AUTOPOWER (BLOCK FORM)**. MOBILITY ELECTRONICS, INC., (U.S. CLS. 21, 23, 26, 36 AND 38). SN 76-615,413. PUB. 3-1-2005. FILED 10-5-2004.
- 2,954,602. **IGO WALLPOWER (BLOCK FORM)**. MOBILITY ELECTRONICS, INC., (U.S. CLS. 21, 23, 26, 36 AND 38). SN 76-615,414. PUB. 3-1-2005. FILED 10-5-2004.
- 2,954,614. **SPMTECHNOLOGIES THE EXPERT FACTORY (STYLIZED)**. SPM TECHNOLOGIES DEUTSCHLAND GMBH, MULTIPLE CLASS, (INT. CLS. 9, 35, 36, 38 AND 42), (U.S. CLS. 21, 23, 26, 36, 38, 100, 101, 102 AND 104). SN 78-118,258. PUB. 12-30-2003. FILED 3-28-2002.
- 2,954,617. **BUI. VIRTTOOLS**, MULTIPLE CLASS, (INT. CLS. 9, 35, 38 AND 42), (U.S. CLS. 21, 23, 26, 36, 38, 100, 101, 102 AND 104). SN 78-127,241. PUB. 6-22-2004. FILED 5-8-2002.
- 2,954,618 (*See Class 1 for this trademark*).
- 2,954,619. **TRIFORCE**. NINTENDO CO., LTD., MULTIPLE CLASS, (INT. CLS. 9 AND 41), (U.S. CLS. 21, 23, 26, 36, 38, 100, 101 AND 107). SN 78-146,773. PUB. 4-20-2004. FILED 7-23-2002.
- 2,954,623. **LIFECYCLE**. IMS SOFTWARE SERVICES, LTD., MULTIPLE CLASS, (INT. CLS. 9, 35 AND 42), (U.S. CLS. 21, 23, 26, 36, 38, 100, 101 AND 102). SN 78-160,589. PUB. 3-1-2005. FILED 9-4-2002.
- 2,954,625 (*See Class 6 for this trademark*).
- 2,954,626. **SENSITIVITY**. SENSITIVITY LIMITED, MULTIPLE CLASS, (INT. CLS. 9, 11 AND 35), (U.S. CLS. 13, 21, 23, 26, 31, 34, 36, 38, 100, 101 AND 102). SN 78-164,814. PUB. 8-31-2004. FILED 9-17-2002.
- 2,954,627. **LINEGUARD**. THE BETTIS CORPORATION, (U.S. CLS. 21, 23, 26, 36 AND 38). SN 78-165,219. PUB. 8-3-2004. FILED 9-18-2002.
- 2,954,634. **MAGNA-WEDGE**. RAMPAGE VENTURES INC., (U.S. CLS. 21, 23, 26, 36 AND 38). SN 78-181,025. PUB. 3-1-2005. FILED 11-1-2002.
- 2,954,644 (*See Class 7 for this trademark*).
- 2,954,648. **INET ACCESS AND DESIGN**. INET ACCESS, (U.S. CLS. 21, 23, 26, 36 AND 38). SN 78-204,978. PUB. 3-1-2005. FILED 1-20-2003.
- 2,954,659. **KEDU AND DESIGN**. YUEQING PUQI ELECTRICAL PLASTIC FACTORY, (U.S. CLS. 21, 23, 26, 36 AND 38). SN 78-214,590. PUB. 3-1-2005. FILED 2-13-2003.
- 2,954,669. **PIEZO LEGS**. PIEZOMOTOR UPPSALA AB, (U.S. CLS. 21, 23, 26, 36 AND 38). SN 78-219,186. PUB. 3-1-2005. FILED 2-26-2003.
- 2,954,672. **ZITEMAN**. SITEMAN A/S, MULTIPLE CLASS, (INT. CLS. 9, 35 AND 42), (U.S. CLS. 21, 23, 26, 36, 38, 100, 101 AND 102). SN 78-220,598. PUB. 6-1-2004. FILED 3-2-2003.
- 2,954,675. **MISCELLANEOUS DESIGN**. LINDEN RESEARCH, INC., MULTIPLE CLASS, (INT. CLS. 9, 38 AND 41), (U.S. CLS. 21, 23, 26, 36, 38, 100, 101, 104 AND 107). SN 78-223,132. PUB. 5-25-2004. FILED 3-7-2003.
- 2,954,677. **BIOSOMNIA**. OXFORD BIOSIGNALS LIMITED, MULTIPLE CLASS, (INT. CLS. 9 AND 10), (U.S. CLS. 21, 23, 26, 36, 38, 39 AND 44). SN 78-223,665. PUB. 6-1-2004. FILED 3-10-2003.
- 2,954,679. **PAPEETE**. THALES, SOCIÉTÉ ANONYME, (U.S. CLS. 21, 23, 26, 36 AND 38). SN 78-224,236. PUB. 10-19-2004. FILED 3-11-2003.
- 2,954,691. **EASYTELECOM**. EASYGROUP IP LICENSING LIMITED, MULTIPLE CLASS, (INT. CLS. 9, 37, 38 AND 42), (U.S. CLS. 21, 23, 26, 36, 38, 100, 101, 103, 104 AND 106). SN 78-229,194. PUB. 10-26-2004. FILED 3-24-2003.
- 2,954,694. **D J ROCKBAG BY WARWICK AND DESIGN**. WILFER, HANS-PETER, MULTIPLE CLASS, (INT. CLS. 9 AND 15), (U.S. CLS. 2, 21, 23, 26, 36 AND 38). SN 78-233,003. PUB. 11-9-2004. FILED 4-2-2003.
- 2,954,707 (*See Class 6 for this trademark*).
- 2,954,708. **BAREBACK RECORDS AND DESIGN**. BUTTE, FAWN CHANETTE, (U.S. CLS. 21, 23, 26, 36 AND 38). SN 78-245,322. PUB. 3-1-2005. FILED 5-2-2003.
- 2,954,710. **HELIXIR**. THE AUTOMATION PARTNERSHIP (CAMBRIDGE) LIMITED, (U.S. CLS. 21, 23, 26, 36 AND 38). SN 78-248,429. PUB. 9-14-2004. FILED 5-12-2003.
- 2,954,725. **2ND CHAPTER OF ACTS**. HERRING, DEXTER R., DBA BUCK HERRING PRODUCTIONS, (U.S. CLS. 21, 23, 26, 36 AND 38). SN 78-258,818. PUB. 3-1-2005. FILED 6-5-2003.
- 2,954,733 (*See Class 8 for this trademark*).
- 2,954,734. **PYROTECT**. BELL MOTORSPORTS, (U.S. CLS. 21, 23, 26, 36 AND 38). SN 78-265,269. PUB. 3-1-2005. FILED 6-20-2003.
- 2,954,735. **CONVERGATE (STYLIZED)**. INFINEON TECHNOLOGIES AG, MULTIPLE CLASS, (INT. CLS. 9 AND 38), (U.S. CLS. 21, 23, 26, 36, 38, 100, 101 AND 104). SN 78-266,481. PUB. 3-1-2005. FILED 6-24-2003.
- 2,954,750. **METRIX**. OUTBACK SOFTWARE PTY LIMITED, A.C.N., (U.S. CLS. 21, 23, 26, 36 AND 38). SN 78-278,090. PUB. 3-1-2005. FILED 7-24-2003.
- 2,954,753. **HERCULOG**. ENERGY CRANES LLC, (U.S. CLS. 21, 23, 26, 36 AND 38). SN 78-278,640. PUB. 3-1-2005. FILED 7-24-2003.
- 2,954,760. **REVIZE WEBSITE**. IDETIX, INC., (U.S. CLS. 21, 23, 26, 36 AND 38). SN 78-281,808. PUB. 3-1-2005. FILED 8-1-2003.
- 2,954,770. **SOUND SCENERIES**. SOUND SCENERIES CORPORATION, (U.S. CLS. 21, 23, 26, 36 AND 38). SN 78-286,116. PUB. 9-28-2004. FILED 8-12-2003.
- 2,954,771. **PROGRES AND DESIGN**. JENOPTIK LASER, OPTIK, SYSTEME GMBH, (U.S. CLS. 21, 23, 26, 36 AND 38). SN 78-286,394. PUB. 3-1-2005. FILED 8-12-2003.
- 2,954,779. **QOVIA**. QOVIA, INC., (U.S. CLS. 21, 23, 26, 36 AND 38). SN 78-292,989. PUB. 3-1-2005. FILED 8-27-2003.
- 2,954,785. **REMY BATTERY**. REMY BATTERY COMPANY, MULTIPLE CLASS, (INT. CLS. 9 AND 35), (U.S. CLS. 21, 23, 26, 36, 38, 100, 101 AND 102). SN 78-294,958. PUB. 7-6-2004. FILED 9-2-2003.
- 2,954,795. **MISCELLANEOUS DESIGN**. BIRD TECHNOLOGIES GROUP INC., (U.S. CLS. 21, 23, 26, 36 AND 38). SN 78-300,245. PUB. 3-1-2005. FILED 9-15-2003.
- 2,954,802. **VISUAL FITNESS PLANNER AND DESIGN**. INTER-IMAGES PARTNERS, LP, (U.S. CLS. 21, 23, 26, 36 AND 38). SN 78-305,416. PUB. 3-1-2005. FILED 9-25-2003.
- 2,954,804. **HIPAA INTERPRETR**. AVARUA SYSTEMS AND SERVICES, INC., (U.S. CLS. 21, 23, 26, 36 AND 38). SN 78-305,639. PUB. 3-1-2005. FILED 9-25-2003.
- 2,954,809. **MISCELLANEOUS DESIGN**. OFF-CAMPUS DINING NETWORK, MULTIPLE CLASS, (INT. CLS. 9, 16 AND 36), (U.S. CLS. 2, 5, 21, 22, 23, 26, 29, 36, 37, 38, 50, 100, 101

AND 102). SN 78-307,825. PUB. 3-1-2005. FILED 10-1-2003.

2,954,822. **SOFTGUARD. NUCLETRON B.V.**, (U.S. CLS. 21, 23, 26, 36 AND 38). SN 78-313,280. PUB. 3-1-2005. FILED 10-14-2003.

2,954,841. **IMLOGIC. IMLOGIC INC.**, (U.S. CLS. 21, 23, 26, 36 AND 38). SN 78-319,094. PUB. 3-1-2005. FILED 10-27-2003.

2,954,856. **SITCORE AND DESIGN. SITCORE**, (U.S. CLS. 21, 23, 26, 36 AND 38). SN 78-323,871. PUB. 3-1-2005. FILED 11-6-2003.

2,954,857. **BRIGHTSTATION (BLOCK FORM). BRIGHT STATION LIMITED, MULTIPLE CLASS**, (INT. CLS. 9, 35, 36, 38 AND 42), (U.S. CLS. 21, 23, 26, 36, 38, 100, 101, 102 AND 104). SN 78-324,507. PUB. 3-1-2005. FILED 11-7-2003.

2,954,860. **BROKERFORCE (BLOCK FORM). BREMERS, ROBERT C.**, (U.S. CLS. 21, 23, 26, 36 AND 38). SN 78-324,817. PUB. 3-1-2005. FILED 11-7-2003.

2,954,884. **NEXTRANSIT (BLOCK FORM). TRANSNEXUS, INC.**, (U.S. CLS. 21, 23, 26, 36 AND 38). SN 78-334,991. PUB. 10-26-2004. FILED 12-2-2003.

2,954,891. **CHEMTATTOO (BLOCK FORM). MESA ANALYTICS & COMPUTING, LLC**, (U.S. CLS. 21, 23, 26, 36 AND 38). SN 78-340,452. PUB. 3-1-2005. FILED 12-12-2003.

2,954,898. **WINTOX (STYLIZED). INTEGRATED MANAGEMENT SOLUTIONS, INC.**, (U.S. CLS. 21, 23, 26, 36 AND 38). SN 78-343,633. PUB. 3-1-2005. FILED 12-19-2003.

2,954,901. **ZYDAS (STYLIZED). ZYDAS TECHNOLOGY CORPORATION, MULTIPLE CLASS**, (INT. CLS. 9 AND 42), (U.S. CLS. 21, 23, 26, 36, 38, 100 AND 101). SN 78-345,511. PUB. 3-1-2005. FILED 12-24-2003.

2,954,910. **PROFILE (BLOCK FORM). SYNBIOTICS CORPORATION**, (U.S. CLS. 21, 23, 26, 36 AND 38). SN 78-349,914. PUB. 10-5-2004. FILED 1-9-2004.

2,954,928. **HELINOX AND DESIGN. DONGAH ALUMINUM CORPORATION**, (U.S. CLS. 21, 23, 26, 36 AND 38). SN 78-361,278. PUB. 3-1-2005. FILED 2-2-2004.

2,954,929. **FOXFALES AND DESIGN. FOXFALES, INC.**, (U.S. CLS. 21, 23, 26, 36 AND 38). SN 78-362,265. PUB. 3-1-2005. FILED 2-4-2004.

2,954,937. **BAR BOY (BLOCK FORM). MASTER HOUSEHOLD, INC.**, (U.S. CLS. 21, 23, 26, 36 AND 38). SN 78-366,523. PUB. 3-1-2005. FILED 2-11-2004.

2,954,949. **LABJACK (BLOCK FORM). LABJACK CORPORATION**, (U.S. CLS. 21, 23, 26, 36 AND 38). SN 78-373,048. PUB. 1-18-2005. FILED 2-24-2004.

2,954,951. **COSMIC BLOBS (BLOCK FORM). SOLIDWORKS CORPORATION**, (U.S. CLS. 21, 23, 26, 36 AND 38). SN 78-373,963. PUB. 3-1-2005. FILED 2-25-2004.

2,954,964. **CLARITY (BLOCK FORM). PLANTRONICS, INC.**, (U.S. CLS. 21, 23, 26, 36 AND 38). SN 78-378,101. PUB. 3-1-2005. FILED 3-3-2004.

2,954,977. **CADRE HR AND DESIGN. ARTEMIS CONSULTING SERVICES, INC.**, (U.S. CLS. 21, 23, 26, 36 AND 38). SN 78-385,261. PUB. 3-1-2005. FILED 3-16-2004.

2,955,012. **SOUNDGATE AND DESIGN. THE PUTMAN GROUP, INCORPORATED**, (U.S. CLS. 21, 23, 26, 36 AND 38). SN 78-395,427. PUB. 3-1-2005. FILED S.R. 4-2-2004; AM. P.R. 10-25-2004.

2,955,046. **ORANGEHAUS AND DESIGN. ANDERSON UNIVERSITY, INC.**, (U.S. CLS. 21, 23, 26, 36 AND 38). SN 78-400,273. PUB. 3-1-2005. FILED 4-12-2004.

2,955,053. **RAPITEST (BLOCK FORM). LUSTER LEAF PRODUCTS, INC.**, (U.S. CLS. 21, 23, 26, 36 AND 38). SN 78-401,207. PUB. 3-1-2005. FILED 4-13-2004.

2,955,064. **USBXPRESS (BLOCK FORM). SILICON LABORATORIES, INC.**, (U.S. CLS. 21, 23, 26, 36 AND 38). SN 78-406,762. PUB. 3-1-2005. FILED 4-22-2004.

2,955,073. **ULTRACART (BLOCK FORM). BPS INFO SOLUTIONS, INC.**, (U.S. CLS. 21, 23, 26, 36 AND 38). SN 78-410,273. PUB. 3-1-2005. FILED 4-29-2004.

2,955,076. **SCRAPBOSS (BLOCK FORM). SYNERGISTIC SOFTWARE SYSTEMS, INC.**, (U.S. CLS. 21, 23, 26, 36 AND 38). SN 78-411,472. PUB. 3-1-2005. FILED 4-30-2004.

2,955,088. **ARIS/SMARTBUS (BLOCK FORM). ASCENT TECHNOLOGY, INC.**, (U.S. CLS. 21, 23, 26, 36 AND 38). SN 78-413,558. PUB. 3-1-2005. FILED 5-5-2004.

2,955,091 (*See Class 1 for this trademark*).

2,955,107. **WORLD MARKET (BLOCK FORM). COST PLUS MARKETING SERVICES, INC.**, (U.S. CLS. 21, 23, 26, 36

AND 38). SN 78-416,846. PUB. 3-1-2005. FILED 5-11-2004.

2,955,109. **IBUYPOWER AND DESIGN. AMERICAN FUTURE TECHNOLOGY CORP., DBA IBUYPOWER**, (U.S. CLS. 21, 23, 26, 36 AND 38). SN 78-417,001. PUB. 3-1-2005. FILED 5-11-2004.

2,955,112. **KEYPOLLER (BLOCK FORM). KEY-TRAK, INC.**, (U.S. CLS. 21, 23, 26, 36 AND 38). SN 78-417,731. PUB. 3-1-2005. FILED 5-12-2004.

2,955,117. **DS15 INTEGRATED MARKETING SOLUTION (BLOCK FORM). PLANAR SYSTEMS, INC.**, (U.S. CLS. 21, 23, 26, 36 AND 38). SN 78-418,045. PUB. 3-1-2005. FILED 5-13-2004.

2,955,124. **STRIKESHIELD (BLOCK FORM). SOUTHWIRE COMPANY**, (U.S. CLS. 21, 23, 26, 36 AND 38). SN 78-418,872. PUB. 3-1-2005. FILED 5-14-2004.

2,955,129. **ROOTENNA (BLOCK FORM). PACIFIC WIRELESS MANUFACTURING INC**, (U.S. CLS. 21, 23, 26, 36 AND 38). SN 78-419,245. PUB. 3-1-2005. FILED 5-14-2004.

2,955,161. **KINEESY. CENTER FOR DANCE EDUCATION, LLC**, (U.S. CLS. 21, 23, 26, 36 AND 38). SN 78-975,245. PUB. 6-1-2004. FILED 2-24-2003.

2,955,162 (*See Class 6 for this trademark*).

2,955,163. **SERVOPT (BLOCK FORM). SIEMENS AKTIENGESELLSCHAFT, MULTIPLE CLASS**, (INT. CLS. 9, 35 AND 42), (U.S. CLS. 21, 23, 26, 36, 38, 100, 101 AND 102). SN 79-000,081. PUB. 3-1-2005. FILED 11-5-2003.

2,955,169. **GROUP SWX (BLOCK FORM). SWX SWISS EXCHANGE, MULTIPLE CLASS**, (INT. CLS. 9, 16, 35, 36, 41 AND 42), (U.S. CLS. 2, 5, 21, 22, 23, 26, 29, 36, 37, 38, 50, 100, 101, 102 AND 107). SN 79-000,621. PUB. 3-1-2005. FILED 11-2-2003.

2,955,177. **TAKEMS AND DESIGN. MEMORY SOLUTION GMBH**, (U.S. CLS. 21, 23, 26, 36 AND 38). SN 79-001,512. PUB. 3-1-2005. FILED 2-18-2004.

CLASS 10—MEDICAL APPARATUS

2,954,102 (*See Class 5 for this trademark*).

2,954,104. **UNISON AND DESIGN. UNITRON INDUSTRIES LTD.**, (U.S. CLS. 26, 39 AND 44). SN 76-411,689. PUB. 10-26-2004. FILED 5-22-2002.

2,954,118 (*See Class 9 for this trademark*).

2,954,119 (*See Class 9 for this trademark*).

2,954,131 (*See Class 9 for this trademark*).

2,954,142. **DYNALINE. INTERCO GESELLSCHAFT FUR DIE PLANUNG UND DEN VERTRIEB VON REHA HILFEN MBH, MULTIPLE CLASS**, (INT. CLS. 10 AND 12), (U.S. CLS. 19, 21, 23, 26, 31, 35, 39 AND 44). SN 76-472,428. PUB. 6-1-2004. FILED 12-3-2002.

2,954,144 (*See Class 9 for this trademark*).

2,954,145 (*See Class 1 for this trademark*).

2,954,161. **SANDALEX. TATAMI SCHUH GMBH, MULTIPLE CLASS**, (INT. CLS. 10, 18 AND 25), (U.S. CLS. 1, 2, 3, 22, 26, 39, 41 AND 44). SN 76-490,779. PUB. 6-8-2004. FILED 2-12-2003.

2,954,165 (*See Class 5 for this trademark*).

2,954,166 (*See Class 5 for this trademark*).

2,954,167 (*See Class 5 for this trademark*).

2,954,169 (*See Class 5 for this trademark*).

2,954,170 (*See Class 5 for this trademark*).

2,954,198 (*See Class 9 for this trademark*).

2,954,240 (*See Class 9 for this trademark*).

2,954,338. **COOLTOUCH CT3 AND DESIGN. COOLTOUCH INCORPORATED**, (U.S. CLS. 26, 39 AND 44). SN 76-557,733. PUB. 3-1-2005. FILED 10-16-2003.

2,954,339. **COOLTOUCH CTHI (STYLIZED). COOLTOUCH INCORPORATED**, (U.S. CLS. 26, 39 AND 44). SN 76-557,734. PUB. 3-1-2005. FILED 10-16-2003.

2,954,384. **THERMABUMP HEAT & COLD THERAPY PRODUCTS FOR HOME USE & HEALTHCARE PROFESSIONALS AND DESIGN. THERMABOOT**, (U.S. CLS. 26, 39 AND 44). SN 76-565,794. PUB. 3-1-2005. FILED 12-4-2003.

2,954,410. **WRAPPEL (BLOCK FORM). STANDARD TEXTILE CO., INC.**, (U.S. CLS. 26, 39 AND 44). SN 76-570,354. PUB. 3-1-2005. FILED 1-12-2004.

2,954,412. **PLUS IQ (STYLIZED). TP ORTHODONTICS, INC.**,

- (U.S. CLS. 26, 39 AND 44). SN 76-571,103. PUB. 3-1-2005. FILED 1-21-2004.
- 2,954,424. **AT.SMART AND DESIGN**. ACRI.TEC GESELLSCHAFT FUER OPHTHALMOLOGISCHE PRODUKTE, (U.S. CLS. 26, 39 AND 44). SN 76-574,256. PUB. 3-1-2005. FILED 2-6-2004.
- 2,954,429. **PK SYSTEM SEAL (BLOCK FORM)**. GYRUS GROUP PLC, (U.S. CLS. 26, 39 AND 44). SN 76-575,817. PUB. 3-1-2005. FILED 2-17-2004.
- 2,954,440. **FAMIO (BLOCK FORM)**. TOSHIBA MEDICAL SYSTEMS CORPORATION, (U.S. CLS. 26, 39 AND 44). SN 76-578,866. PUB. 3-1-2005. FILED 3-3-2004.
- 2,954,478 (*See Class 9 for this trademark*).
- 2,954,502. **ALLRAP (BLOCK FORM)**. DENTAL DISPOSABLES INTERNATIONAL, INC., (U.S. CLS. 26, 39 AND 44). SN 76-587,417. PUB. 3-1-2005. FILED 4-19-2004.
- 2,954,503. **INSORB SUBCUTICULAR SKIN STAPLER (BLOCK FORM)**. INCISIVE SURGICAL, INC., (U.S. CLS. 26, 39 AND 44). SN 76-587,495. PUB. 3-1-2005. FILED 4-19-2004.
- 2,954,618 (*See Class 1 for this trademark*).
- 2,954,677 (*See Class 9 for this trademark*).
- 2,954,683. **OPSERVERI**. KARL STORZ GMBH & CO. KG, (U.S. CLS. 26, 39 AND 44). SN 78-226,726. PUB. 5-25-2004. FILED 3-18-2003.
- 2,954,690. **MAGIC CUP**. CANNON RUBBER LIMITED, (U.S. CLS. 26, 39 AND 44). SN 78-229,178. PUB. 3-1-2005. FILED 3-24-2003.
- 2,954,699. **SPRINGBOARD ORTHOPAEDICS**. SPRINGBOARD ORTHOPAEDICS LLC, (U.S. CLS. 26, 39 AND 44). SN 78-236,529. PUB. 3-1-2005. FILED 4-11-2003.
- 2,954,731 (*See Class 5 for this trademark*).
- 2,954,914. **RELIABILITY SENSITIVITY COMFORT PLEASURE ZONE AND DESIGN**. ANSELL HEALTHCARE PRODUCTS, LLC, DBA ANSELL HEALTHCARE, (U.S. CLS. 26, 39 AND 44). SN 78-353,113. PUB. 3-1-2005. FILED 1-16-2004.
- 2,954,986. **EZ STENT (BLOCK FORM)**. TANG, BRIAN, (U.S. CLS. 26, 39 AND 44). SN 78-388,119. PUB. 3-1-2005. FILED 3-21-2004.
- 2,954,995. **PAPETTE (BLOCK FORM)**. WALLACH SURGICAL DEVICES, INC., (U.S. CLS. 26, 39 AND 44). SN 78-391,186. PUB. 3-1-2005. FILED 3-26-2004.
- 2,955,009. **BIRDBEAK (BLOCK FORM)**. ARTHREX, INC., (U.S. CLS. 26, 39 AND 44). SN 78-394,686. PUB. 3-1-2005. FILED 4-1-2004.
- 2,955,049. **ARRAY (BLOCK FORM)**. EBI, L.P., (U.S. CLS. 26, 39 AND 44). SN 78-400,357. PUB. 3-1-2005. FILED 4-12-2004.
- 2,955,138. **SUN SIGNALS (BLOCK FORM)**. SUNHEALTH SOLUTIONS, LLC, (U.S. CLS. 26, 39 AND 44). SN 78-420,493. PUB. 3-1-2005. FILED 5-18-2004.
- 2,955,173. **SERVOS (STYLIZED)**. MAQUET CRITICAL CARE AB, (U.S. CLS. 26, 39 AND 44). SN 79-000,911. PUB. 3-1-2005. FILED 11-24-2003.
- (INT. CLS. 11, 16, 20, 21 AND 34), (U.S. CLS. 2, 5, 8, 9, 13, 17, 21, 22, 23, 25, 29, 30, 31, 32, 33, 34, 37, 38, 40 AND 50). SN 76-440,396. PUB. 6-1-2004. FILED 8-8-2002.
- 2,954,135. **SOFTWARE FOR YOUR EYES**. ENVIRONMENTAL LIGHTING CONCEPTS, INC., (U.S. CLS. 13, 21, 23, 31 AND 34). SN 76-467,053. PUB. 3-1-2005. FILED 11-14-2002.
- 2,954,156. **CLABER OASIS AND DESIGN**. CLABER S.P.A., (U.S. CLS. 13, 21, 23, 31 AND 34). SN 76-485,992. PUB. 9-7-2004. FILED 1-29-2003.
- 2,954,189. **PWI**. RG DELAWARE, INC., (U.S. CLS. 13, 21, 23, 31 AND 34). SN 76-504,066. PUB. 3-1-2005. FILED 4-3-2003.
- 2,954,222 (*See Class 7 for this trademark*).
- 2,954,294. **PLANTEC (STYLIZED)**. PLANTEC INC., (U.S. CLS. 13, 21, 23, 31 AND 34). SN 76-547,892. PUB. 3-1-2005. FILED 9-29-2003.
- 2,954,348. **DUALFLUSH (BLOCK FORM)**. ADVANCED MODERN TECHNOLOGIES CORPORATION, (U.S. CLS. 13, 21, 23, 31 AND 34). SN 76-559,109. PUB. 3-1-2005. FILED 11-10-2003.
- 2,954,356. **DONVIER (BLOCK FORM)**. BROWNE & CO. LTD., MULTIPLE CLASS, (INT. CLS. 11 AND 21), (U.S. CLS. 2, 13, 21, 23, 29, 30, 31, 33, 34, 40 AND 50). SN 76-561,200. PUB. 3-1-2005. FILED 11-21-2003.
- 2,954,376. **SO HOT IT'S COOL AND DESIGN**. NEW ERA LIFESTYLE SYSTEMS, LLC, (U.S. CLS. 13, 21, 23, 31 AND 34). SN 76-564,344. PUB. 3-1-2005. FILED 12-9-2003.
- 2,954,411. **SERIES 2 (BLOCK FORM)**. BURNHAM SERVICES, INC., (U.S. CLS. 13, 21, 23, 31 AND 34). SN 76-570,473. PUB. 3-1-2005. FILED 1-16-2004.
- 2,954,417 (*See Class 9 for this trademark*).
- 2,954,449. **DUALBRITE AND DESIGN**. DESA IP, LLC, (U.S. CLS. 13, 21, 23, 31 AND 34). SN 76-579,856. PUB. 3-1-2005. FILED 3-8-2004.
- 2,954,532. **BUOY BOY (BLOCK FORM)**. CLEVELAND PROCESS CORPORATION, (U.S. CLS. 13, 21, 23, 31 AND 34). SN 76-590,162. PUB. 3-1-2005. FILED 5-3-2004.
- 2,954,626 (*See Class 9 for this trademark*).
- 2,954,636. **GIFTS 4U**. CAUDWELL HOLDINGS LIMITED, MULTIPLE CLASS, (INT. CLS. 11, 28 AND 35), (U.S. CLS. 13, 21, 22, 23, 31, 34, 38, 50, 100, 101 AND 102). SN 78-185,525. PUB. 8-10-2004. FILED 11-15-2002.
- 2,954,666 (*See Class 3 for this trademark*).
- 2,954,713. **SUBWAY**. VILLEROY & BOCH AG, (U.S. CLS. 13, 21, 23, 31 AND 34). SN 78-251,456. PUB. 3-1-2005. FILED 5-19-2003.
- 2,954,722. **DISCOVER**. INTERBATH, INC., (U.S. CLS. 13, 21, 23, 31 AND 34). SN 78-256,505. PUB. 3-1-2005. FILED 5-30-2003.
- 2,954,737. **TVEL CORPORATION AND DESIGN**. OPEN JOINT-STOCK COMPANY "TVEL", (U.S. CLS. 13, 21, 23, 31 AND 34). SN 78-267,188. PUB. 9-21-2004. FILED 6-25-2003.
- 2,954,763. **PASSO (STYLIZED)**. INAX CORPORATION, (U.S. CLS. 13, 21, 23, 31 AND 34). SN 78-282,118. PUB. 9-28-2004. FILED 8-1-2003.
- 2,954,887. **DCS AND DESIGN**. DYNAMIC COOKING SYSTEMS, INC., (U.S. CLS. 13, 21, 23, 31 AND 34). SN 78-338,279. PUB. 3-1-2005. FILED 12-9-2003.
- 2,954,974. **SWINGBURNER.COM (BLOCK FORM)**. KEN-CO INDUSTRIES, INC., (U.S. CLS. 13, 21, 23, 31 AND 34). SN 78-383,031. PUB. 3-1-2005. FILED 3-12-2004.
- 2,954,990. **SANISINK (BLOCK FORM)**. ON SITE SANITATION, INC., (U.S. CLS. 13, 21, 23, 31 AND 34). SN 78-389,267. PUB. 3-1-2005. FILED 3-23-2004.
- 2,955,051 (*See Class 8 for this trademark*).
- 2,955,146. **PLEXINEON (BLOCK FORM)**. ILIGHT TECHNOLOGIES, INC., (U.S. CLS. 13, 21, 23, 31 AND 34). SN 78-421,551. PUB. 3-1-2005. FILED 5-19-2004.

CLASS 11—ENVIRONMENTAL CONTROL APPARATUS

- 2,954,007 (*See Class 7 for this trademark*).
- 2,954,020. **HPX**. PHILIPS ELECTRONICS HONG KONG LIMITED, (U.S. CLS. 13, 21, 23, 31 AND 34). SN 76-053,293. PUB. 4-16-2002. FILED 5-22-2000.
- 2,954,071 (*See Class 9 for this trademark*).
- 2,954,073. **SMOKEPORT**. SOMANTEC GMBH, MULTIPLE CLASS, (INT. CLS. 11 AND 20), (U.S. CLS. 2, 13, 21, 22, 23, 25, 31, 32, 34 AND 50). SN 76-317,416. PUB. 6-1-2004. FILED 9-26-2001.
- 2,954,078 (*See Class 7 for this trademark*).
- 2,954,091. **AQUATECTURE AND DESIGN**. EMPEX PRODUCTIONS LIMITED, MULTIPLE CLASS, (INT. CLS. 11 AND 28), (U.S. CLS. 13, 21, 22, 23, 31, 34, 38 AND 50). SN 76-380,088. PUB. 6-15-2004. FILED 3-11-2002.
- 2,954,097. **ALL AIR**. L2B ENVIRONMENTAL SYSTEMS INC., (U.S. CLS. 13, 21, 23, 31 AND 34). SN 76-388,580. PUB. 3-1-2005. FILED 3-29-2002.
- 2,954,120. **WYETH**. BIRCH, JOHN N. JR., MULTIPLE CLASS,

CLASS 12—VEHICLES

- 2,954,007 (*See Class 7 for this trademark*).
- 2,954,022. **OKTOPUS**. WIRTH MASCHINENBAU GMBH, (U.S. CLS. 19, 21, 23, 31, 35 AND 44). SN 76-070,500. PUB. 3-1-2005. FILED 6-15-2000.
- 2,954,045 (*See Class 9 for this trademark*).
- 2,954,060. **SPYKER**. SPYKER CARS N.V., (U.S. CLS. 19, 21, 23,

- 31, 35 AND 44). SN 76-279,391. PUB. 8-24-2004. FILED 7-2-2001.
- 2,954,071 (*See Class 9 for this trademark*).
- 2,954,136. **DETECH**. TECHNOLOGY DEVELOPMENT SUPPORTING COMPANY, DBA DETECH CO., (U.S. CLS. 19, 21, 23, 31, 35 AND 44). SN 76-467,110. PUB. 5-11-2004. FILED 11-6-2002.
- 2,954,142 (*See Class 10 for this trademark*).
- 2,954,227 (*See Class 7 for this trademark*).
- 2,954,269. **KUSTOMWERKS**. KUSTOMWERKS, INC., (U.S. CLS. 19, 21, 23, 31, 35 AND 44). SN 76-540,341. PUB. 7-27-2004. FILED 8-14-2003.
- 2,954,311. **KARR SECURITY SYSTEMS**. ALDERSON, STEPHEN J., MULTIPLE CLASS, (INT. CLS. 12 AND 36), (U.S. CLS. 19, 21, 23, 31, 35, 44, 100, 101 AND 102). SN 76-551,990. PUB. 3-1-2005. FILED 10-14-2003.
- 2,954,336. **X CLEAT (STYLIZED)**. SPEEDPLAY, INC., (U.S. CLS. 19, 21, 23, 31, 35 AND 44). SN 76-557,526. PUB. 3-1-2005. FILED 11-6-2003.
- 2,954,341. **EL PLACER DE CONDUCIR (BLOCK FORM)**. BAYERISCHE MOTOREN WERKE AKTIENGESELLSCHAFT, (U.S. CLS. 19, 21, 23, 31, 35 AND 44). SN 76-558,045. PUB. 3-1-2005. FILED 11-7-2003.
- 2,954,353 (*See Class 7 for this trademark*).
- 2,954,460. **BOXTOP (BLOCK FORM)**. TRUCK ACCESSORIES GROUP, INC., (U.S. CLS. 19, 21, 23, 31, 35 AND 44). SN 76-583,281. PUB. 3-1-2005. FILED 3-25-2004.
- 2,954,620. **VITUS ACCESS (STYLIZED)**. ETABLISSEMENTS JOSE ALVAREZ S.A., MULTIPLE CLASS, (INT. CLS. 12, 25 AND 28), (U.S. CLS. 19, 21, 22, 23, 31, 35, 38, 39, 44 AND 50). SN 78-148,040. PUB. 8-10-2004. FILED 7-26-2002.
- 2,954,707 (*See Class 6 for this trademark*).
- 2,954,730. **ICC BIG IRON AND DESIGN**. WALLINGFORD'S, INC., (U.S. CLS. 19, 21, 23, 31, 35 AND 44). SN 78-262,537. PUB. 8-24-2004. FILED 6-14-2003.
- 2,954,744. **DEFLECTOP**. GROUPE HENRI HEULIEZ, (U.S. CLS. 19, 21, 23, 31, 35 AND 44). SN 78-273,379. PUB. 3-1-2005. FILED 7-11-2003.
- 2,954,854. **ROMANI (BLOCK FORM)**. LEHMAN TRIKES, INC., (U.S. CLS. 19, 21, 23, 31, 35 AND 44). SN 78-323,440. PUB. 3-1-2005. FILED 11-5-2003.
- 2,955,010. **FENDERLIMITATOR (BLOCK FORM)**. FENDERLIMITATORS, INC., (U.S. CLS. 19, 21, 23, 31, 35 AND 44). SN 78-394,789. PUB. 3-1-2005. FILED 4-1-2004.
- 2,955,014. **ASP AND DESIGN**. PORTMAN SECURITY SYSTEM (USA) LTD., (U.S. CLS. 19, 21, 23, 31, 35 AND 44). SN 78-395,489. PUB. 3-1-2005. FILED 4-2-2004.
- 2,955,025. **HARDROCK (BLOCK FORM)**. SPECIALIZED BICYCLE COMPONENTS, INC., (U.S. CLS. 19, 21, 23, 31, 35 AND 44). SN 78-397,471. PUB. 3-1-2005. FILED 4-6-2004.
- 2,955,028. **TRANSITION (BLOCK FORM)**. AIRO-SERIES, INC., (U.S. CLS. 19, 21, 23, 31, 35 AND 44). SN 78-397,824. PUB. 3-1-2005. FILED 4-7-2004.
- 2,955,098. **SUNCUTTERS (BLOCK FORM)**. PENNZOIL-QUAKER STATE COMPANY, (U.S. CLS. 19, 21, 23, 31, 35 AND 44). SN 78-415,678. PUB. 3-1-2005. FILED 5-10-2004.
- 2,955,126. **WORLDWIDE TRANSMISSION GROUP AND DESIGN**. WORLDWIDE TRANSMISSION CORE SUPPLY, INCORPORATED, (U.S. CLS. 19, 21, 23, 31, 35 AND 44). SN 78-418,946. PUB. 3-1-2005. FILED 5-14-2004.
- 2,955,142. **AD-IS (BLOCK FORM)**. BENDIX COMMERCIAL VEHICLE SYSTEMS LLC, (U.S. CLS. 19, 21, 23, 31, 35 AND 44). SN 78-421,040. PUB. 3-1-2005. FILED 5-18-2004.
- SA, (U.S. CLS. 2, 27, 28 AND 50). SN 75-552,651. PUB. 3-1-2005. FILED 9-14-1998.
- 2,954,011. **HW HARRY WINSTON THE AVENUE COLLECTION**. HARRY WINSTON ULTIMATE TIMEPIECE S.A., (U.S. CLS. 2, 27, 28 AND 50). SN 75-860,668. PUB. 7-27-2004. FILED 11-30-1999.
- 2,954,037 (*See Class 9 for this trademark*).
- 2,954,043 (*See Class 3 for this trademark*).
- 2,954,105. **DOY**. SISON-JONES, DOY, (U.S. CLS. 2, 27, 28 AND 50). SN 76-416,640. PUB. 6-1-2004. FILED 5-31-2002.
- 2,954,179. **SISLEY AND DESIGN**. BENCOM S.R.L., (U.S. CLS. 2, 27, 28 AND 50). SN 76-498,494. PUB. 6-22-2004. FILED 3-19-2003.
- 2,954,244. **LUMINIS STAR**. WOLF, OLLECH, (U.S. CLS. 2, 27, 28 AND 50). SN 76-528,398. PUB. 3-1-2005. FILED 7-10-2003.
- 2,954,309. **CH CHRISTINA HAN (STYLIZED)**. CHRISTINA HAN, INC., MULTIPLE CLASS, (INT. CLS. 14, 18, 24 AND 25), (U.S. CLS. 1, 2, 3, 22, 27, 28, 39, 41, 42 AND 50). SN 76-551,743. PUB. 3-1-2005. FILED 10-10-2003.
- 2,954,313 (*See Class 6 for this trademark*).
- 2,954,370. **MISCELLANEOUS DESIGN**. CESPA S.R.L., (U.S. CLS. 2, 27, 28 AND 50). SN 76-562,204. PUB. 10-26-2004. FILED 11-14-2003.
- 2,954,396. **DUNAY (STYLIZED)**. HENRY DUNAY DESIGNS, INC., (U.S. CLS. 2, 27, 28 AND 50). SN 76-567,951. PUB. 3-1-2005. FILED 1-2-2004.
- 2,954,524. **IDEAL WOMAN (STYLIZED)**. K.L.H. DIAMONDS INC., (U.S. CLS. 2, 27, 28 AND 50). SN 76-588,975. PUB. 3-1-2005. FILED 4-26-2004.
- 2,954,539. **CH (STYLIZED)**. CHROME HEARTS, INC., (U.S. CLS. 2, 27, 28 AND 50). SN 76-590,713. PUB. 3-1-2005. FILED 5-6-2004.
- 2,954,583. **CHARMED EXPRESSIONS (BLOCK FORM)**. ASI IMPORTS, INC., (U.S. CLS. 2, 27, 28 AND 50). SN 76-592,078. PUB. 3-1-2005. FILED 5-13-2004.
- 2,954,649. **RSE**. HANNAH ROSE CORPORATION, (U.S. CLS. 2, 27, 28 AND 50). SN 78-206,378. PUB. 3-1-2005. FILED 1-23-2003.
- 2,954,670 (*See Class 3 for this trademark*).
- 2,954,733 (*See Class 8 for this trademark*).
- 2,954,814. **JÜRGENS**. JÜRGENS FINE JEWELRY, INC., (U.S. CLS. 2, 27, 28 AND 50). SN 78-310,241. PUB. 3-1-2005. FILED 10-7-2003.
- 2,954,924. **STERLING ELEGANCE (BLOCK FORM)**. COUSIN CORPORATION OF AMERICA, (U.S. CLS. 2, 27, 28 AND 50). SN 78-359,884. PUB. 3-1-2005. FILED 1-30-2004.
- 2,954,996. **SIS AND DESIGN**. SIS DESIGNS, LLC, (U.S. CLS. 2, 27, 28 AND 50). SN 78-391,401. PUB. 3-1-2005. FILED 3-26-2004.
- 2,955,034. **LYTHA STUDIOS (BLOCK FORM)**. ERIN H. WEIK, (U.S. CLS. 2, 27, 28 AND 50). SN 78-398,136. PUB. 3-1-2005. FILED 4-7-2004.
- 2,955,186. **BOBBY FINDER (BLOCK FORM)**. ALFRED DUNHILL LIMITED, (U.S. CLS. 2, 27, 28 AND 50). SN 79-005,191. PUB. 3-1-2005. FILED 5-14-2004.

CLASS 15—MUSICAL INSTRUMENTS

CLASS 13—FIREARMS

- 2,954,023 (*See Class 9 for this trademark*).
- 2,954,024 (*See Class 9 for this trademark*).
- 2,954,029 (*See Class 9 for this trademark*).

CLASS 14—JEWELRY

- 2,954,001. **SALTARELLO**. RICHEMONT INTERNATIONAL

- 2,954,043 (*See Class 3 for this trademark*).
- 2,954,226. **MISCELLANEOUS DESIGN**. FENDER MUSICAL INSTRUMENTS CORPORATION, (U.S. CLS. 2, 21 AND 36). SN 76-515,928. PUB. 3-16-2004. FILED 4-25-2003.
- 2,954,228. **MISCELLANEOUS DESIGN**. FENDER MUSICAL INSTRUMENTS CORPORATION, (U.S. CLS. 2, 21 AND 36). SN 76-516,126. PUB. 3-16-2004. FILED 4-25-2003.
- 2,954,229. **MISCELLANEOUS DESIGN**. FENDER MUSICAL INSTRUMENTS CORPORATION, (U.S. CLS. 2, 21 AND 36). SN 76-516,127. PUB. 3-16-2004. FILED 4-25-2003.
- 2,954,328. **CALATO**. J.D. CALATO MANUFACTURING CO., INC., (U.S. CLS. 2, 21 AND 36). SN 76-554,804. PUB. 3-1-2005. FILED 10-14-2003.
- 2,954,562. **ANTIGUA (BLOCK FORM)**. ANTIGUA WINDS, INC., (U.S. CLS. 2, 21 AND 36). SN 76-591,518. PUB. 3-1-2005. FILED 5-10-2004.
- 2,954,694 (*See Class 9 for this trademark*).

CLASS 16—PAPER GOODS AND PRINTED MATTER

- 2,954,006. **HOUSE & HOME (STYLIZED)**. CANADIAN HOME PUBLISHERS, MULTIPLE CLASS, (INT. CLS. 16 AND 41), (U.S. CLS. 2, 5, 22, 23, 29, 37, 38, 50, 100, 101 AND 107). SN 75-729,669. PUB. 3-1-2005. FILED 6-15-1999.
- 2,954,016 (*See Class 9 for this trademark*).
- 2,954,025 (*See Class 9 for this trademark*).
- 2,954,026 (*See Class 9 for this trademark*).
- 2,954,030 (*See Class 9 for this trademark*).
- 2,954,037 (*See Class 9 for this trademark*).
- 2,954,039. **GENTE**. HACHETTE RUSCONI S.P.A., MULTIPLE CLASS, (INT. CLS. 16 AND 41), (U.S. CLS. 2, 5, 22, 23, 29, 37, 38, 50, 100, 101 AND 107). SN 76-145,505. PUB. 12-30-2003. FILED 10-12-2000.
- 2,954,043 (*See Class 3 for this trademark*).
- 2,954,064 (*See Class 9 for this trademark*).
- 2,954,071 (*See Class 9 for this trademark*).
- 2,954,081 (*See Class 9 for this trademark*).
- 2,954,082 (*See Class 9 for this trademark*).
- 2,954,084 (*See Class 1 for this trademark*).
- 2,954,089 (*See Class 9 for this trademark*).
- 2,954,093. **KOELNmesse AND DESIGN**. KÖLNmesse GMBH, MULTIPLE CLASS, (INT. CLS. 16, 35, 37, 38, 41 AND 42), (U.S. CLS. 2, 5, 22, 23, 29, 37, 38, 50, 100, 101, 102, 103, 104, 106 AND 107). SN 76-384,236. PUB. 3-1-2005. FILED 3-19-2002.
- 2,954,120 (*See Class 11 for this trademark*).
- 2,954,134. **MEDIATECH (STYLIZED)**. MEDIA-TECH E.V., MULTIPLE CLASS, (INT. CLS. 16, 35 AND 41), (U.S. CLS. 2, 5, 22, 23, 29, 37, 38, 50, 100, 101, 102 AND 107). SN 76-464,701. PUB. 11-2-2004. FILED 11-6-2002.
- 2,954,139. **CULTURA TRIPS AND DESIGN**. THOMAS COOK UK LIMITED, MULTIPLE CLASS, (INT. CLS. 16, 35, 36, 39 AND 43), (U.S. CLS. 2, 5, 22, 23, 29, 37, 38, 50, 100, 101, 102 AND 105). SN 76-471,810. PUB. 3-1-2005. FILED 12-3-2002.
- 2,954,149 (*See Class 9 for this trademark*).
- 2,954,150. **DARK ENERGY-DRINK AND DESIGN**. FIB GMBH, MULTIPLE CLASS, (INT. CLS. 16, 25, 32, 35 AND 43), (U.S. CLS. 2, 5, 22, 23, 29, 37, 38, 39, 45, 46, 48, 50, 100, 101 AND 102). SN 76-480,243. PUB. 6-22-2004. FILED 1-3-2003.
- 2,954,160. **SMART FOR LIFE**. CANADIAN CENTRE FOR HIGH PERFORMANCE INC., MULTIPLE CLASS, (INT. CLS. 16 AND 41), (U.S. CLS. 2, 5, 22, 23, 29, 37, 38, 50, 100, 101 AND 107). SN 76-490,356. PUB. 5-25-2004. FILED 2-12-2003.
- 2,954,163 (*See Class 9 for this trademark*).
- 2,954,184 (*See Class 9 for this trademark*).
- 2,954,188. **SJ BERWIN**. SJ BERWIN, MULTIPLE CLASS, (INT. CLS. 16 AND 42), (U.S. CLS. 2, 5, 22, 23, 29, 37, 38, 50, 100 AND 101). SN 76-503,592. PUB. 3-1-2005. FILED 4-2-2003.
- 2,954,198 (*See Class 9 for this trademark*).
- 2,954,205 (*See Class 1 for this trademark*).
- 2,954,207. **JOBSITE**. TRADES PUBLISHING, INC., (U.S. CLS. 2, 5, 22, 23, 29, 37, 38 AND 50). SN 76-508,525. PUB. 3-1-2005. FILED 4-21-2003.
- 2,954,208. **ASCP STAR AND DESIGN**. AMERICAN SOCIETY FOR CLINICAL PATHOLOGY, INC., (U.S. CLS. 2, 5, 22, 23, 29, 37, 38 AND 50). SN 76-509,095. PUB. 3-1-2005. FILED 4-23-2003.
- 2,954,233. **FAU AND DESIGN**. FLORIDA ATLANTIC UNIVERSITY, MULTIPLE CLASS, (INT. CLS. 16, 18, 25 AND 28), (U.S. CLS. 1, 2, 3, 5, 22, 23, 29, 37, 38, 39, 41 AND 50). SN 76-521,444. PUB. 3-1-2005. FILED 6-11-2003.
- 2,954,240 (*See Class 9 for this trademark*).
- 2,954,249. **SWAP**. NATIONAL PORK BOARD, MULTIPLE CLASS, (INT. CLS. 16, 35 AND 41), (U.S. CLS. 2, 5, 22, 23, 29, 37, 38, 50, 100, 101, 102 AND 107). SN 76-531,852. PUB. 3-1-2005. FILED 7-24-2003.
- 2,954,250. **SWINE WELFARE ASSURANCE PROGRAM AND DESIGN**. NATIONAL PORK BOARD, MULTIPLE CLASS, (INT. CLS. 16, 35 AND 41), (U.S. CLS. 2, 5, 22, 23, 29, 37, 38, 50, 100, 101, 102 AND 107). SN 76-531,854. PUB. 3-1-2005. FILED 7-24-2003.
- 2,954,257 (*See Class 5 for this trademark*).
- 2,954,276. **ACK! AMERICAN CAREERS FOR KIDS**. CAREER COMMUNICATIONS, (U.S. CLS. 2, 5, 22, 23, 29, 37, 38 AND 50). SN 76-543,014. PUB. 3-1-2005. FILED 8-25-2003.
- 2,954,310. **ANIMAL TIMES**. FOUNDATION TO SUPPORT ANIMAL PROTECTION, MULTIPLE CLASS, (INT. CLS. 16, 35 AND 41), (U.S. CLS. 2, 5, 22, 23, 29, 37, 38, 50, 100, 101, 102 AND 107). SN 76-551,913. PUB. 3-1-2005. FILED 10-10-2003.
- 2,954,313 (*See Class 6 for this trademark*).
- 2,954,318 (*See Class 9 for this trademark*).
- 2,954,326. **TINY TURTLES**. TUB PRODUCTIONS, LLC, (U.S. CLS. 2, 5, 22, 23, 29, 37, 38 AND 50). SN 76-554,521. PUB. 3-1-2005. FILED 10-27-2003.
- 2,954,335. **SW AND DESIGN**. VANDERSHACK ENTERPRISES, LLC, (U.S. CLS. 2, 5, 22, 23, 29, 37, 38 AND 50). SN 76-557,457. PUB. 3-1-2005. FILED 10-23-2003.
- 2,954,343. **TSS PHOTOGRAPHY AND DESIGN**. THE SPORTS SECTION, INC., MULTIPLE CLASS, (INT. CLS. 16 AND 41), (U.S. CLS. 2, 5, 22, 23, 29, 37, 38, 50, 100, 101 AND 107). SN 76-558,332. PUB. 7-27-2004. FILED 11-12-2003.
- 2,954,390. **CEO SEE-YA (BLOCK FORM)**. GRUNER + JAHR PRINTING & PUBLISHING CO., (U.S. CLS. 2, 5, 22, 23, 29, 37, 38 AND 50). SN 76-567,099. PUB. 3-1-2005. FILED 12-24-2003.
- 2,954,432. **LIVES THEY LIVED (BLOCK FORM)**. THE NEW YORK TIMES COMPANY, MULTIPLE CLASS, (INT. CLS. 16 AND 41), (U.S. CLS. 2, 5, 22, 23, 29, 37, 38, 50, 100, 101 AND 107). SN 76-577,215. PUB. 3-1-2005. FILED 2-18-2004.
- 2,954,443. **HONDA (STYLIZED)**. HONDA MOTOR CO., LTD., (U.S. CLS. 2, 5, 22, 23, 29, 37, 38 AND 50). SN 76-579,146. PUB. 3-1-2005. FILED 3-4-2004.
- 2,954,445. **HOMELAND SECURITY TODAY (BLOCK FORM)**. KMD MEDIA, L.L.C., (U.S. CLS. 2, 5, 22, 23, 29, 37, 38 AND 50). SN 76-579,438. PUB. 3-1-2005. FILED 2-26-2004.
- 2,954,466. **THRIFTY NICKEL (BLOCK FORM)**. SENTEN, INC., (U.S. CLS. 2, 5, 22, 23, 29, 37, 38 AND 50). SN 76-584,091. PUB. 3-1-2005. FILED 3-29-2004.
- 2,954,494. **HARMONY QUILL (STYLIZED)**. GOLDSTEIN, IRA, AND GOLDSTEIN, DAVID, (U.S. CLS. 2, 5, 22, 23, 29, 37, 38 AND 50). SN 76-586,431. PUB. 3-1-2005. FILED 4-1-2004.
- 2,954,536. **THE TULIP BOX (BLOCK FORM)**. HOFFER, PETER, (U.S. CLS. 2, 5, 22, 23, 29, 37, 38 AND 50). SN 76-590,550. PUB. 3-1-2005. FILED 5-5-2004.
- 2,954,552. **GIFT SHAKER (BLOCK FORM)**. CLAMPIT, SHELLEY A., DBA THE GIFT SHAKER, (U.S. CLS. 2, 5, 22, 23, 29, 37, 38 AND 50). SN 76-591,172. PUB. 3-1-2005. FILED 5-10-2004.
- 2,954,575. **TRUE BLUE NOTES (BLOCK FORM)**. SOUTHSTAR ENERGY SERVICES LLC, DBA GEORGIA NATURAL GAS AND GEORGIA NATURAL GAS SERVICES, (U.S. CLS. 2, 5, 22, 23, 29, 37, 38 AND 50). SN 76-591,877. PUB. 3-1-2005. FILED 5-12-2004.
- 2,954,580 (*See Class 9 for this trademark*).
- 2,954,596. **BASIC MAINTENANCE FOR THE AMERICAN DREAM (STYLIZED)**. PITTS, JIM, MULTIPLE CLASS, (INT. CLS. 16 AND 41), (U.S. CLS. 2, 5, 22, 23, 29, 37, 38, 50, 100, 101 AND 107). SN 76-593,915. PUB. 3-1-2005. FILED 5-17-2004.
- 2,954,622. **HOCKEY IT PAYS AND DESIGN**. IT PAYS, INC., (U.S. CLS. 2, 5, 22, 23, 29, 37, 38 AND 50). SN 78-155,366. PUB. 3-1-2005. FILED 8-19-2002.
- 2,954,630. **THE FLATIRON REPORT**. FLATIRON INFORMATION SERVICES INC., MULTIPLE CLASS, (INT. CLS. 16 AND 35), (U.S. CLS. 2, 5, 22, 23, 29, 37, 38, 50, 100, 101 AND 102). SN 78-176,419. PUB. 3-1-2005. FILED 10-21-2002.
- 2,954,631. **FLATIRON INFORMATION SERVICES**. FLATIRON INFORMATION SERVICES INC., MULTIPLE CLASS, (INT. CLS. 16 AND 35), (U.S. CLS. 2, 5, 22, 23, 29, 37, 38, 50, 100, 101 AND 102). SN 78-176,420. PUB. 3-1-2005. FILED 10-21-2002.
- 2,954,671. **GOOD NEWZ TATTOOZ**. ANGEL TOES, INC., (U.S. CLS. 2, 5, 22, 23, 29, 37, 38 AND 50). SN 78-220,323. PUB. 3-1-2005. FILED 2-28-2003.
- 2,954,688. **HAPPY FACES (STYLIZED)**. PAPER CONVERTING OF AMERICA, INC., (U.S. CLS. 2, 5, 22, 23, 29, 37, 38 AND 50). SN 78-228,112. PUB. 3-1-2005. FILED 3-20-2003.
- 2,954,701. **WING YIP**. W WING YIP AND BROTHERS (HOLDINGS) LIMITED, MULTIPLE CLASS, (INT. CLS. 16, 21, 29, 30, 31, 32, 33, 35, 36, 37, 39 AND 43), (U.S. CLS. 1, 2, 5, 13, 22, 23, 29, 30, 33, 37, 38, 40, 45, 46, 47, 48, 49, 50, 100, 101, 102, 103, 105 AND 106). SN 78-237,838. PUB. 3-1-2005. FILED

4-15-2003.
 2,954,733 (*See Class 8 for this trademark*).
 2,954,738. **ULTRA GLOSS**. INTERNATIONAL PAPER TRADEMARK COMPANY, (U.S. CLS. 2, 5, 22, 23, 29, 37, 38 AND 50). SN 78-268,634. PUB. 10-26-2004. FILED 6-30-2003.
 2,954,759. **ELECTRAPRIME**. NORSKE SKOG CANADA LIMITED, (U.S. CLS. 2, 5, 22, 23, 29, 37, 38 AND 50). SN 78-280,938. PUB. 9-28-2004. FILED 7-30-2003.
 2,954,784. **ANONYMOUSLY YOURS**. JOSS PRODUCTIONS, INC., (U.S. CLS. 2, 5, 22, 23, 29, 37, 38 AND 50). SN 78-294,629. PUB. 3-1-2005. FILED 9-1-2003.
 2,954,789. **MISCELLANEOUS DESIGN**. VOLVO CAR CORPORATION, AKA VOLVO PERSONVAGNAR AB, (U.S. CLS. 2, 5, 22, 23, 29, 37, 38 AND 50). SN 78-298,135. PUB. 3-1-2005. FILED 9-9-2003.
 2,954,809 (*See Class 9 for this trademark*).
 2,954,818. **SEXYMAUREN.COM**. HOANG, MAUREEN DAO, (U.S. CLS. 2, 5, 22, 23, 29, 37, 38 AND 50). SN 78-311,906. PUB. 8-10-2004. FILED 10-10-2003.
 2,954,829. **R AND DESIGN**. ROCKHURST UNIVERSITY, MULTIPLE CLASS, (INT. CLS. 16, 25 AND 41), (U.S. CLS. 2, 5, 22, 23, 29, 37, 38, 39, 50, 100, 101 AND 107). SN 78-314,746. PUB. 3-1-2005. FILED 10-16-2003.
 2,954,875. **MASTER OF COMPETENCE (BLOCK FORM)**. INFORMATION ET DEVELOPPEMENT SOCIAL, MULTIPLE CLASS, (INT. CLS. 16, 35 AND 41), (U.S. CLS. 2, 5, 22, 23, 29, 37, 38, 50, 100, 101, 102 AND 107). SN 78-330,874. PUB. 3-1-2005. FILED 11-20-2003.
 2,954,876. **WALK OFF WEIGHT (BLOCK FORM)**. RODALE INC., (U.S. CLS. 2, 5, 22, 23, 29, 37, 38 AND 50). SN 78-331,489. PUB. 3-1-2005. FILED 11-21-2003.
 2,954,903. **THE REGULATOR'S CHOICE (BLOCK FORM)**. NEHA TRAINING LLC, MULTIPLE CLASS, (INT. CLS. 16 AND 41), (U.S. CLS. 2, 5, 22, 23, 29, 37, 38, 50, 100, 101 AND 107). SN 78-346,453. PUB. 3-1-2005. FILED 12-30-2003.
 2,954,936. **DIANE (BLOCK FORM)**. CURVES INTERNATIONAL, (U.S. CLS. 2, 5, 22, 23, 29, 37, 38 AND 50). SN 78-366,132. PUB. 3-1-2005. FILED 2-11-2004.
 2,954,945. **BABY TANG AND DESIGN**. TANGS DEPARTMENT LIMITED, MULTIPLE CLASS, (INT. CLS. 16, 20, 21, 24, 25 AND 28), (U.S. CLS. 2, 5, 13, 22, 23, 25, 29, 30, 32, 33, 37, 38, 39, 40, 42 AND 50). SN 78-369,242. PUB. 12-28-2004. FILED 2-17-2004.
 2,954,963. **TEWARI AND DESIGN**. TEWARI DE-OX SYSTEMS, INC., AND TEWARI, GAURAV, (U.S. CLS. 2, 5, 22, 23, 29, 37, 38 AND 50). SN 78-378,035. PUB. 3-1-2005. FILED 3-3-2004.
 2,954,968. **MOM FRIENDLY PUBLICATIONS MOMFRIENDLY.COM AND DESIGN**. NODINE, SAMANTHA L., (U.S. CLS. 2, 5, 22, 23, 29, 37, 38 AND 50). SN 78-380,256. PUB. 3-1-2005. FILED 3-8-2004.
 2,954,997. **VAPORPRINT (BLOCK FORM)**. ELECTRONIC SENSOR TECHNOLOGY LP, (U.S. CLS. 2, 5, 22, 23, 29, 37, 38 AND 50). SN 78-391,798. PUB. 3-1-2005. FILED 3-26-2004.
 2,955,004. **KEY-PAK (BLOCK FORM)**. HARTMAN, WADE, (U.S. CLS. 2, 5, 22, 23, 29, 37, 38 AND 50). SN 78-393,348. PUB. 3-1-2005. FILED 3-30-2004.
 2,955,023. **AT THE YARD (BLOCK FORM)**. STAR STRUCK, INC., MULTIPLE CLASS, (INT. CLS. 16 AND 35), (U.S. CLS. 2, 5, 22, 23, 29, 37, 38, 50, 100, 101 AND 102). SN 78-397,096. PUB. 3-1-2005. FILED 4-6-2004.
 2,955,030. **TACTICAL TR RESPONSE AND DESIGN**. HENDON PUBLISHING CO., MULTIPLE CLASS, (INT. CLS. 16 AND 41), (U.S. CLS. 2, 5, 22, 23, 29, 37, 38, 50, 100, 101 AND 107). SN 78-397,979. PUB. 3-1-2005. FILED 4-7-2004.
 2,955,031. **DELILAH POCKET FULL OF POSIEZ AND DESIGN**. GRAVNING, PATRICIA M., (U.S. CLS. 2, 5, 22, 23, 29, 37, 38 AND 50). SN 78-397,990. PUB. 3-1-2005. FILED 4-7-2004.
 2,955,032. **BELLADONNA, POCKET FULL OF POSIEZ AND DESIGN**. GRAVNING, PATRICIA M., (U.S. CLS. 2, 5, 22, 23, 29, 37, 38 AND 50). SN 78-397,994. PUB. 3-1-2005. FILED 4-7-2004.
 2,955,045. **LOOKY-LOO (STYLIZED)**. REZAI, LAILA, (U.S. CLS. 2, 5, 22, 23, 29, 37, 38 AND 50). SN 78-399,900. PUB. 3-1-2005. FILED 4-11-2004.
 2,955,050. **GOT THE PICTURE? (BLOCK FORM)**. ABELL, MARTHA S., (U.S. CLS. 2, 5, 22, 23, 29, 37, 38 AND 50). SN

78-400,574. PUB. 3-1-2005. FILED 4-12-2004.
 2,955,071. **FUN WITH PHOTOS MEMORIES & MORE (BLOCK FORM)**. INTERNATIONAL MASTERS PUBLISHERS AB, (U.S. CLS. 2, 5, 22, 23, 29, 37, 38 AND 50). SN 78-410,112. PUB. 3-1-2005. FILED 4-29-2004.
 2,955,087. **GIRLFRIENDS IN GRACE (STYLIZED)**. RIVERWOOD CHURCH, (U.S. CLS. 2, 5, 22, 23, 29, 37, 38 AND 50). SN 78-413,447. PUB. 3-1-2005. FILED 5-5-2004.
 2,955,094. **BAD DRUNK GIRL (BLOCK FORM)**. GIRLS & SPORTS, LLC, MULTIPLE CLASS, (INT. CLS. 16 AND 25), (U.S. CLS. 2, 5, 22, 23, 29, 37, 38, 39 AND 50). SN 78-415,202. PUB. 3-1-2005. FILED 5-7-2004.
 2,955,102. **THE ROOMS CHRONICLE (BLOCK FORM)**. NITSCHKE, ALETA A., (U.S. CLS. 2, 5, 22, 23, 29, 37, 38 AND 50). SN 78-416,076. PUB. 3-1-2005. FILED 5-10-2004.
 2,955,140. **T AND DESIGN**. THE NEW YORK TIMES COMPANY, (U.S. CLS. 2, 5, 22, 23, 29, 37, 38 AND 50). SN 78-420,781. PUB. 3-1-2005. FILED 5-18-2004.
 2,955,162 (*See Class 6 for this trademark*).
 2,955,169 (*See Class 9 for this trademark*).
 2,955,175. **ALIPROT (STYLIZED)**. CROCCO S.P.A., (U.S. CLS. 2, 5, 22, 23, 29, 37, 38 AND 50). SN 79-001,337. PUB. 3-1-2005. FILED 12-17-2003.
 2,955,185 (*See Class 3 for this trademark*).

CLASS 17—RUBBER GOODS

2,954,084 (*See Class 1 for this trademark*).
 2,954,346 (*See Class 1 for this trademark*).
 2,954,479. **CLEARGRIPZ (BLOCK FORM)**. WEINGARDEN, MARSHALL L., (U.S. CLS. 1, 5, 12, 13, 35 AND 50). SN 76-585,379. PUB. 3-1-2005. FILED 4-2-2004.
 2,954,610 (*See Class 1 for this trademark*).
 2,954,729. **ACE SECURITY LAMINATES AND DESIGN**. PLACEMENTS CONTEMPORAINS, INC., (U.S. CLS. 1, 5, 12, 13, 35 AND 50). SN 78-260,495. PUB. 3-1-2005. FILED 6-10-2003.
 2,954,853. **PROPYLUX HS (BLOCK FORM)**. WESTLAKE PLASTICS COMPANY, (U.S. CLS. 1, 5, 12, 13, 35 AND 50). SN 78-323,343. PUB. 3-1-2005. FILED 11-5-2003.
 2,954,917 (*See Class 1 for this trademark*).

CLASS 18—LEATHER GOODS

2,954,037 (*See Class 9 for this trademark*).
 2,954,043 (*See Class 3 for this trademark*).
 2,954,071 (*See Class 9 for this trademark*).
 2,954,161 (*See Class 10 for this trademark*).
 2,954,233 (*See Class 16 for this trademark*).
 2,954,309 (*See Class 14 for this trademark*).
 2,954,393. **TRUNKS BATHING AND DESIGN**. TRUNKS BATHING, INC., MULTIPLE CLASS, (INT. CLS. 18, 24 AND 25), (U.S. CLS. 1, 2, 3, 22, 39, 41, 42 AND 50). SN 76-567,703. PUB. 10-26-2004. FILED 12-19-2003.
 2,954,451. **ABBYSON U.S.A. (BLOCK FORM)**. ABBYSON CORPORATION, (U.S. CLS. 1, 2, 3, 22 AND 41). SN 76-580,764. PUB. 3-1-2005. FILED 3-12-2004.
 2,954,544. **CCC AND DESIGN**. THREE C'S DESIGN, LLC, (U.S. CLS. 1, 2, 3, 22 AND 41). SN 76-590,768. PUB. 3-1-2005. FILED 5-6-2004.
 2,954,670 (*See Class 3 for this trademark*).
 2,954,733 (*See Class 8 for this trademark*).
 2,954,790. **EXO**. EXO INC., (U.S. CLS. 1, 2, 3, 22 AND 41). SN 78-298,555. PUB. 3-1-2005. FILED 9-10-2003.
 2,954,801. **ICE & COZY AND DESIGN**. JT INTERNATIONAL DISTRIBUTORS, INC., (U.S. CLS. 1, 2, 3, 22 AND 41). SN 78-304,997. PUB. 3-1-2005. FILED 9-24-2003.
 2,954,803. **AMINA RUBINACCI**. AMINA RUBINACCI S.R.L., MULTIPLE CLASS, (INT. CLS. 18, 24 AND 25), (U.S. CLS. 1, 2, 3, 22, 39, 41, 42 AND 50). SN 78-305,608. PUB. 3-1-2005. FILED 9-25-2003.
 2,954,862. **REDBACK (BLOCK FORM)**. REBACK BOOTS USA, MULTIPLE CLASS, (INT. CLS. 18 AND 25), (U.S. CLS. 1, 2,

- 3, 22, 39 AND 41). SN 78-326,291. PUB. 3-1-2005. FILED 11-11-2003.
 2,955,059. **YASMENA (BLOCK FORM)**. YASMENA INC., (U.S. CLS. 1, 2, 3, 22 AND 41). SN 78-406,246. PUB. 3-1-2005. FILED 4-22-2004.
 2,955,133. **THIRTYTHREE (BLOCK FORM)**. HARDMAN, KIM A., (U.S. CLS. 1, 2, 3, 22 AND 41). SN 78-420,023. PUB. 3-1-2005. FILED 5-17-2004.

CLASS 19—NON-METALLIC BUILDING MATERIALS

- 2,954,036. **FLOORSFIRST.COM AND DESIGN**. GESCO INDUSTRIES INC., MULTIPLE CLASS, (INT. CLS. 19, 27 AND 35), (U.S. CLS. 1, 12, 19, 20, 33, 37, 42, 50, 100, 101 AND 102). SN 76-136,393. PUB. 3-1-2005. FILED 9-28-2000.
 2,954,098. **JOIST AND DESIGN**. ALPA LUMBER INC., (U.S. CLS. 1, 12, 33 AND 50). SN 76-388,985. PUB. 9-7-2004. FILED 3-28-2002.
 2,954,128. **COMCORK**. AUTOMOTIVE COMPONENTS LIMITED, MULTIPLE CLASS, (INT. CLS. 19 AND 27), (U.S. CLS. 1, 12, 19, 20, 33, 37, 42 AND 50). SN 76-458,368. PUB. 11-9-2004. FILED 10-7-2002.
 2,954,130. **FAST-N-WELD**. IKO INDUSTRIES LTD., (U.S. CLS. 1, 12, 33 AND 50). SN 76-459,052. PUB. 6-29-2004. FILED 10-15-2002.
 2,954,243. **REDIPAK**. OUTDOOR TECHNOLOGIES INC., (U.S. CLS. 1, 12, 33 AND 50). SN 76-528,282. PUB. 3-1-2005. FILED 7-7-2003.
 2,954,247. **PERMA-GREEN ROOFING SYSTEMS**. PERMA-QUIK CORPORATION, (U.S. CLS. 1, 12, 33 AND 50). SN 76-530,817. PUB. 11-9-2004. FILED 7-18-2003.
 2,954,327. **NO BRAINER SIDING**. CHURCHILL COATINGS CORPORATION, (U.S. CLS. 1, 12, 33 AND 50). SN 76-554,644. PUB. 3-1-2005. FILED 10-10-2003.
 2,954,342. **ECOLO-CLIP (BLOCK FORM)**. MATERIAUX A BAS PRIX LTEE/ BARGAIN BUILDING MATERIALS LTD., MULTIPLE CLASS, (INT. CLS. 19 AND 35), (U.S. CLS. 1, 12, 33, 50, 100, 101 AND 102). SN 76-558,047. PUB. 10-12-2004. FILED 11-7-2003.
 2,954,455. **SILHOUETTE TRIMS (BLOCK FORM)**. KEMLITE COMPANY, INC., (U.S. CLS. 1, 12, 33 AND 50). SN 76-581,855. PUB. 3-1-2005. FILED 3-18-2004.
 2,954,673. **MISCELLANEOUS DESIGN**. NIKE, INC., MULTIPLE CLASS, (INT. CLS. 19 AND 27), (U.S. CLS. 1, 12, 19, 20, 33, 37, 42 AND 50). SN 78-222,467. PUB. 3-1-2005. FILED 3-6-2003.
 2,954,793 (See Class 1 for this trademark).
 2,955,013. **SPECCOLORI (BLOCK FORM)**. SPECCERAMICS, INC., (U.S. CLS. 1, 12, 33 AND 50). SN 78-395,481. PUB. 3-1-2005. FILED 4-2-2004.
 2,955,018. **SPECCERAMICS (BLOCK FORM)**. SPECCERAMICS, INC., (U.S. CLS. 1, 12, 33 AND 50). SN 78-395,751. PUB. 3-1-2005. FILED 4-2-2004.
 2,955,084. **BRACE E-Z (BLOCK FORM)**. ORTON, MARK B., (U.S. CLS. 1, 12, 33 AND 50). SN 78-413,300. PUB. 3-1-2005. FILED 5-5-2004.
 2,955,162 (See Class 6 for this trademark).

CLASS 20—FURNITURE AND ARTICLES NOT OTHERWISE CLASSIFIED

- 2,954,043 (See Class 3 for this trademark).
 2,954,073 (See Class 11 for this trademark).
 2,954,117. **GERVASONI**. GERVASONI S.P.A., (U.S. CLS. 2, 13, 22, 25, 32 AND 50). SN 76-438,503. PUB. 5-25-2004. FILED 8-7-2002.
 2,954,120 (See Class 11 for this trademark).
 2,954,297. **KING E-BOARD**. KING PLASTIC CORPORATION, (U.S. CLS. 2, 13, 22, 25, 32 AND 50). SN 76-548,129. PUB. 3-1-2005. FILED 9-15-2003.
 2,954,313 (See Class 6 for this trademark).
 2,954,472. **M.D.S AND DESIGN**. MODULAR DISPLAY SYS-

- TEMS, INC., (U.S. CLS. 2, 13, 22, 25, 32 AND 50). SN 76-584,927. PUB. 3-1-2005. FILED 4-1-2004.
 2,954,656. **NINASUN**. NINACLIP, PLC, MULTIPLE CLASS, (INT. CLS. 20 AND 22), (U.S. CLS. 1, 2, 7, 13, 19, 22, 25, 32, 42 AND 50). SN 78-208,209. PUB. 3-1-2005. FILED 1-29-2003.
 2,954,685. **CHATEAU DESIGN**. WESTPORT BAY LLC, (U.S. CLS. 2, 13, 22, 25, 32 AND 50). SN 78-227,246. PUB. 3-1-2005. FILED 3-19-2003.
 2,954,686. **TRADITIONELLE**. WESTPORT BAY LLC, (U.S. CLS. 2, 13, 22, 25, 32 AND 50). SN 78-227,258. PUB. 3-1-2005. FILED 3-19-2003.
 2,954,700. **CUISINES DE CHATEAU**. LA CORNUE SA, (U.S. CLS. 2, 13, 22, 25, 32 AND 50). SN 78-237,553. PUB. 3-1-2005. FILED 4-14-2003.
 2,954,745. **QUINETTE GALLAY PARIS**. QUINETTE GALLAY, MULTIPLE CLASS, (INT. CLS. 20 AND 37), (U.S. CLS. 2, 13, 22, 25, 32, 50, 100, 103 AND 106). SN 78-273,713. PUB. 9-21-2004. FILED 7-14-2003.
 2,954,864. **MINT JULEP ROCKER (BLOCK FORM)**. OLD CHARLESTON JOGGING BOARD CO., INC., (U.S. CLS. 2, 13, 22, 25, 32 AND 50). SN 78-326,590. PUB. 3-1-2005. FILED 11-12-2003.
 2,954,867. **A LIFETIME OF CHOICES (BLOCK FORM)**. OMEGA IP CO., (U.S. CLS. 2, 13, 22, 25, 32 AND 50). SN 78-327,461. PUB. 3-1-2005. FILED 11-13-2003.
 2,954,923. **MY PILA' (BLOCK FORM)**. WASHINGTON-TONEY, GLENDA FAYE, (U.S. CLS. 2, 13, 22, 25, 32 AND 50). SN 78-359,040. PUB. 3-1-2005. FILED 1-28-2004.
 2,954,945 (See Class 16 for this trademark).
 2,955,162 (See Class 6 for this trademark).

CLASS 21—HOUSEWARES AND GLASS

- 2,954,007 (See Class 7 for this trademark).
 2,954,032. **THE WILD BEAN**. BP PRODUCTS NORTH AMERICA INC., MULTIPLE CLASS, (INT. CLS. 21, 30 AND 35), (U.S. CLS. 2, 13, 23, 29, 30, 33, 40, 46, 50, 100, 101 AND 102). SN 76-120,125. PUB. 4-23-2002. FILED 9-1-2000.
 2,954,043 (See Class 3 for this trademark).
 2,954,066. **DON'T JUST MOVE DUST...REMOVE IT!**. ORIGINAL CALIFORNIA CAR DUSTER COMPANY, INC., (U.S. CLS. 2, 13, 23, 29, 30, 33, 40 AND 50). SN 76-291,292. PUB. 10-26-2004. FILED 7-26-2001.
 2,954,071 (See Class 9 for this trademark).
 2,954,120 (See Class 11 for this trademark).
 2,954,125. **GABBY'S BBQ GRID**. CARIME LTD., (U.S. CLS. 2, 13, 23, 29, 30, 33, 40 AND 50). SN 76-456,252. PUB. 10-26-2004. FILED 9-25-2002.
 2,954,202. **EARTHWARE BIODEGRADABLES**. RUBIN, JEROME M., (U.S. CLS. 2, 13, 23, 29, 30, 33, 40 AND 50). SN 76-506,379. PUB. 3-1-2005. FILED 4-14-2003.
 2,954,303. **INTELLIJET**. TVI CORPORATION, (U.S. CLS. 2, 13, 23, 29, 30, 33, 40 AND 50). SN 76-550,406. PUB. 3-1-2005. FILED 10-8-2003.
 2,954,313 (See Class 6 for this trademark).
 2,954,349. **EDGELESS MOP (BLOCK FORM)**. CONTEC, INC., (U.S. CLS. 2, 13, 23, 29, 30, 33, 40 AND 50). SN 76-559,330. PUB. 3-1-2005. FILED 11-14-2003.
 2,954,356 (See Class 11 for this trademark).
 2,954,482 (See Class 8 for this trademark).
 2,954,606. **ART FOR THE BATH**. ALCHEMY GLASS & LIGHT, INC., (U.S. CLS. 2, 13, 23, 29, 30, 33, 40 AND 50). SN 78-052,292. PUB. 3-1-2005. FILED 3-9-2001.
 2,954,680. **MOONWALKER**. MAJOR TOM HOLDING B.V., (U.S. CLS. 2, 13, 23, 29, 30, 33, 40 AND 50). SN 78-224,565. PUB. 8-24-2004. FILED 3-12-2003.
 2,954,701 (See Class 16 for this trademark).
 2,954,733 (See Class 8 for this trademark).
 2,954,882. **CHEF'S REVIEW SMART & FINAL AND DESIGN**. SMART & FINAL STORES CORPORATION, (U.S. CLS. 2, 13, 23, 29, 30, 33, 40 AND 50). SN 78-332,904. PUB. 3-1-2005. FILED 11-25-2003.
 2,954,905. **SOFT TOP (BLOCK FORM)**. ORBIT IRRIGATION PRODUCTS, INC., (U.S. CLS. 2, 13, 23, 29, 30, 33, 40 AND 50). SN 78-347,912. PUB. 3-1-2005. FILED 1-5-2004.
 2,954,945 (See Class 16 for this trademark).

2,955,056. **PORTA-FILLET (BLOCK FORM)**. NESTLER, CARLOS W., JR., AND KLEIN, TERRILL, (U.S. CLS. 2, 13, 23, 29, 30, 33, 40 AND 50). SN 78-401,782. PUB. 3-1-2005. FILED 4-14-2004.

2,955,162 (*See Class 6 for this trademark*).

2,955,165. **DIVA (BLOCK FORM)**. SCHOTT ZWIESEL AG, (U.S. CLS. 2, 13, 23, 29, 30, 33, 40 AND 50). SN 79-000,186. PUB. 3-1-2005. FILED 11-11-2003.

2,955,185 (*See Class 3 for this trademark*).

CLASS 22—CORDAGE AND FIBERS

2,954,313 (*See Class 6 for this trademark*).

2,954,321. **WALKISOFT**. BKI HOLDING CORPORATION, (U.S. CLS. 1, 2, 7, 19, 22, 42 AND 50). SN 76-554,031. PUB. 3-1-2005. FILED 10-24-2003.

2,954,656 (*See Class 20 for this trademark*).

2,954,774. **BEST TENT MADE IN AMERICA**. AAA TENT & AWNING COMPANY, (U.S. CLS. 1, 2, 7, 19, 22, 42 AND 50). SN 78-288,052. PUB. 3-1-2005. FILED 8-15-2003.

CLASS 23—YARNS AND THREADS

2,954,095. **DALE BABY ULL**. DALE OF NORWAY AS, (U.S. CL. 43). SN 76-384,982. PUB. 3-1-2005. FILED 3-20-2002.

CLASS 24—FABRICS

2,954,043 (*See Class 3 for this trademark*).

2,954,309 (*See Class 14 for this trademark*).

2,954,393 (*See Class 18 for this trademark*).

2,954,482 (*See Class 8 for this trademark*).

2,954,628. **DORMEO**. STUDIO MODERNA SA, MULTIPLE CLASS, (INT. CLS. 24 AND 25), (U.S. CLS. 22, 39, 42 AND 50). SN 78-166,558. PUB. 12-16-2003. FILED 9-20-2002.

2,954,670 (*See Class 3 for this trademark*).

2,954,733 (*See Class 8 for this trademark*).

2,954,786. **KOMATSU AND DESIGN**. KOMATSU SEIREN KABUSHIKI KAISHA (KOMATSU SEIREN CO., LTD.), (U.S. CLS. 42 AND 50). SN 78-297,825. PUB. 3-1-2005. FILED 9-9-2003.

2,954,803 (*See Class 18 for this trademark*).

2,954,827. **CECCHI E CECCHI AND DESIGN**. CECCHI E CECCHI TESSITURE S.R.L., MULTIPLE CLASS, (INT. CLS. 24 AND 25), (U.S. CLS. 22, 39, 42 AND 50). SN 78-314,376. PUB. 3-1-2005. FILED 10-16-2003.

2,954,945 (*See Class 16 for this trademark*).

2,955,147. **STARSETTA (BLOCK FORM)**. INTERNATIONAL WOMEN'S APPAREL, INC., (U.S. CLS. 42 AND 50). SN 78-421,660. PUB. 3-1-2005. FILED 5-19-2004.

CLASS 25—CLOTHING

2,953,997. **FUNKYTOWN SPORTSWEAR AND DESIGN**. U.S. GRAPHICS, INC., (U.S. CLS. 22 AND 39). SN 75-062,041. PUB. 10-22-1996. FILED 2-23-1996.

2,954,002. **JOOS AND DESIGN**. PROTOMASTRO, MICHAEL, AND JOOP! GMBH, (U.S. CLS. 22 AND 39). SN 75-562,321. PUB. 2-1-2000. FILED 9-30-1998.

2,954,037 (*See Class 9 for this trademark*).

2,954,043 (*See Class 3 for this trademark*).

2,954,062. **RED ROCKER**. RED HEAD, INC., DBA CABO WABO ENTERPRISES, (U.S. CLS. 22 AND 39). SN 76-284,033. PUB. 3-1-2005. FILED 7-13-2001.

2,954,071 (*See Class 9 for this trademark*).

2,954,081 (*See Class 9 for this trademark*).

2,954,082 (*See Class 9 for this trademark*).

2,954,083. **MISCELLANEOUS DESIGN**. MORETZ, INC., (U.S. CLS. 22 AND 39). SN 76-339,324. PUB. 5-4-2004. FILED 11-

19-2001.

2,954,101. **DRYSTAR**. ALPINESTARS RESEARCH SRL, (U.S. CLS. 22 AND 39). SN 76-398,749. PUB. 8-24-2004. FILED 4-22-2002.

2,954,106. **BC SEYCHELLES IMPORTS, LLC**, (U.S. CLS. 22 AND 39). SN 76-416,801. PUB. 3-1-2005. FILED 6-4-2002.

2,954,114. **FUNKÉ FLOPZ (STYLIZED)**. MANNING, DIANE, (U.S. CLS. 22 AND 39). SN 76-432,243. PUB. 5-25-2004. FILED 7-17-2002.

2,954,150 (*See Class 16 for this trademark*).

2,954,161 (*See Class 10 for this trademark*).

2,954,184 (*See Class 9 for this trademark*).

2,954,213. **WORKFORCE AND DESIGN**. IRONCLAD PERFORMANCE WEAR CORP., (U.S. CLS. 22 AND 39). SN 76-511,090. PUB. 8-24-2004. FILED 5-2-2003.

2,954,231. **MISCELLANEOUS DESIGN**. CANNA B.V., (U.S. CLS. 22 AND 39). SN 76-519,890. PUB. 9-14-2004. FILED 6-5-2003.

2,954,233 (*See Class 16 for this trademark*).

2,954,236. **LMDC LOWER MANHATTAN DEVELOPMENT CORPORATION AND DESIGN**. LOWER MANHATTAN DEVELOPMENT CORPORATION, MULTIPLE CLASS, (INT. CLS. 25, 35 AND 37), (U.S. CLS. 22, 39, 100, 101, 102, 103 AND 106). SN 76-522,417. PUB. 3-1-2005. FILED 6-13-2003.

2,954,264. **MISCELLANEOUS DESIGN**. NBA PROPERTIES, INC., (U.S. CLS. 22 AND 39). SN 76-539,417. PUB. 3-1-2005. FILED 8-11-2003.

2,954,280. **AMERICAN APPAREL**. AMERICAN APPAREL, INC., (U.S. CLS. 22 AND 39). SN 76-544,549. PUB. 3-1-2005. FILED 9-15-2003.

2,954,287. **USA AND DESIGN**. UNITED STATES ROWING ASSOCIATION, (U.S. CLS. 22 AND 39). SN 76-546,255. PUB. 3-1-2005. FILED 9-22-2003.

2,954,299. **20 AND DESIGN**. BARRY SANDERS, INC., (U.S. CLS. 22 AND 39). SN 76-549,066. PUB. 7-6-2004. FILED 10-6-2003.

2,954,300. **RABBI'S DAUGHTERS (BLOCK FORM)**. RABBI'S DAUGHTERS, (U.S. CLS. 22 AND 39). SN 76-549,287. PUB. 3-1-2005. FILED 10-6-2003.

2,954,309 (*See Class 14 for this trademark*).

2,954,323. **ADLER COLLECTION**. ADLER LEATHER SPORTSWEAR MANUFACTURING CO., INC., (U.S. CLS. 22 AND 39). SN 76-554,269. PUB. 3-1-2005. FILED 10-27-2003.

2,954,330. **T AND DESIGN**. TENNESSEE EDUCATION LOTTERY CORPORATION, MULTIPLE CLASS, (INT. CLS. 25 AND 28), (U.S. CLS. 22, 23, 38, 39 AND 50). SN 76-556,161. PUB. 3-1-2005. FILED 11-3-2003.

2,954,359. **GEL-GUTS (BLOCK FORM)**. ASICS CORPORATION, (U.S. CLS. 22 AND 39). SN 76-561,305. PUB. 3-1-2005. FILED 11-12-2003.

2,954,369. **UNDER ARMOUR AND DESIGN**. KP SPORTS, INC., (U.S. CLS. 22 AND 39). SN 76-561,993. PUB. 3-1-2005. FILED 11-26-2003.

2,954,393 (*See Class 18 for this trademark*).

2,954,402. **FINAL 4 (BLOCK FORM)**. NATIONAL COLLEGIATE ATHLETIC ASSOCIATION, THE, (U.S. CLS. 22 AND 39). SN 76-569,078. PUB. 3-1-2005. FILED 1-9-2004.

2,954,420. **SUPER BOWL (BLOCK FORM)**. NATIONAL FOOTBALL LEAGUE, (U.S. CLS. 22 AND 39). SN 76-572,704. PUB. 3-1-2005. FILED 1-29-2004.

2,954,426. **PHYL CASUAL COUTURE (BLOCK FORM)**. LEWIN, JAMIE P., (U.S. CLS. 22 AND 39). SN 76-575,689. PUB. 3-1-2005. FILED 2-3-2004.

2,954,430. **RJR ROBIN JOY RIGGSBEE AND DESIGN**. JOY-RIGGS CORPORATION, (U.S. CLS. 22 AND 39). SN 76-576,197. PUB. 3-1-2005. FILED 2-13-2004.

2,954,433. **WOLFBALL (BLOCK FORM)**. GIBSON, GREGORY R., (U.S. CLS. 22 AND 39). SN 76-577,271. PUB. 3-1-2005. FILED 2-17-2004.

2,954,446. **BALANCE STREETWEAR (BLOCK FORM)**. KLEINMAN, KELLY, (U.S. CLS. 22 AND 39). SN 76-579,456. PUB. 3-1-2005. FILED 3-5-2004.

2,954,458. **SMART DOGS AND DESIGN**. GRANDOE CORPORATION, THE, (U.S. CLS. 22 AND 39). SN 76-582,651. PUB. 12-21-2004. FILED 3-23-2004.

2,954,459. **BVLGARI (BLOCK FORM)**. BULGARI S.P.A., (U.S. CLS. 22 AND 39). SN 76-583,076. PUB. 3-1-2005. FILED 3-23-

2004.
 2,954,488. **PLPA PROFESSIONAL LACROSSE PLAYERS' ASSOCIATION AND DESIGN**. PROFESSIONAL LACROSSE PLAYERS' ASSOCIATION, (U.S. CLS. 22 AND 39). SN 76-586,042. PUB. 3-1-2005. FILED 4-8-2004.
 2,954,489. **ORIGINAL FOXWORTHY REDNECK WEAR AND DESIGN**. FOXWORTHY, JEFF, (U.S. CLS. 22 AND 39). SN 76-586,147. PUB. 3-1-2005. FILED 4-12-2004.
 2,954,490. **GIT-R-DONE (BLOCK FORM)**. WHITNEY, DANIEL D., (U.S. CLS. 22 AND 39). SN 76-586,149. PUB. 3-1-2005. FILED 4-12-2004.
 2,954,513. **ADIXION CLOTHING AND DESIGN**. FAT KAT LLC, (U.S. CLS. 22 AND 39). SN 76-588,336. PUB. 3-1-2005. FILED 4-22-2004.
 2,954,555. **CULTURED PEARL (BLOCK FORM)**. BEARD, TODD, (U.S. CLS. 22 AND 39). SN 76-591,198. PUB. 3-1-2005. FILED 5-10-2004.
 2,954,584. **SLICKEXOTICA AND DESIGN**. DHARMA LEATHER CORP., (U.S. CLS. 22 AND 39). SN 76-592,304. PUB. 3-1-2005. FILED 5-13-2004.
 2,954,605. **HUMMER (STYLIZED)**. GENERAL MOTORS CORPORATION, (U.S. CLS. 22 AND 39). SN 78-051,723. PUB. 10-2-2001. FILED 3-7-2001.
 2,954,613. **ALOHA.CALM**. JLB CORPORATION, (U.S. CLS. 22 AND 39). SN 78-111,189. PUB. 3-1-2005. FILED 2-26-2002.
 2,954,620 (*See Class 12 for this trademark*).
 2,954,628 (*See Class 24 for this trademark*).
 2,954,643. **MASIME AND DESIGN**. MEME, MASIFA, (U.S. CLS. 22 AND 39). SN 78-199,114. PUB. 3-1-2005. FILED 12-31-2002.
 2,954,670 (*See Class 3 for this trademark*).
 2,954,709. **STORM CHASER**. L. L. BEAN, INC., (U.S. CLS. 22 AND 39). SN 78-248,351. PUB. 3-1-2005. FILED 5-12-2003.
 2,954,723. **MISCELLANEOUS DESIGN**. KEDA, LLC, (U.S. CLS. 22 AND 39). SN 78-256,883. PUB. 9-28-2004. FILED 6-2-2003.
 2,954,724. **INDIGO BY CLARKS (STYLIZED)**. C. & J. CLARK INTERNATIONAL LIMITED, (U.S. CLS. 22 AND 39). SN 78-257,447. PUB. 11-30-2004. FILED 6-3-2003.
 2,954,733 (*See Class 8 for this trademark*).
 2,954,741. **NO LABEL DENIM COMPANY**. DIAMANTE, ALEX, (U.S. CLS. 22 AND 39). SN 78-268,969. PUB. 3-1-2005. FILED 7-1-2003.
 2,954,758. **BANGDANA (BLOCK FORM)**. SHARP, GLORIA A., (U.S. CLS. 22 AND 39). SN 78-278,745. PUB. 3-1-2005. FILED 7-24-2003.
 2,954,803 (*See Class 18 for this trademark*).
 2,954,811. **ALL-PURPOSE WINDOWS AND DOORS**. ALL PURPOSE, INC., (U.S. CLS. 22 AND 39). SN 78-308,733. PUB. 3-1-2005. FILED 10-2-2003.
 2,954,827 (*See Class 24 for this trademark*).
 2,954,828. **SARA BERMAN**. CHARLES GRAY LONDON LIMITED, (U.S. CLS. 22 AND 39). SN 78-314,682. PUB. 3-1-2005. FILED 10-16-2003.
 2,954,829 (*See Class 16 for this trademark*).
 2,954,862 (*See Class 18 for this trademark*).
 2,954,911. **BIG DUDE (BLOCK FORM)**. TANU U.S.A., INC., (U.S. CLS. 22 AND 39). SN 78-352,028. PUB. 10-19-2004. FILED 1-14-2004.
 2,954,945 (*See Class 16 for this trademark*).
 2,954,947. **PRAYA AND DESIGN**. SIMMONS, HERBERT D., (U.S. CLS. 22 AND 39). SN 78-369,931. PUB. 11-16-2004. FILED 2-18-2004.
 2,954,976. **MISCELLANEOUS DESIGN**. WOLPA, STEVE, (U.S. CLS. 22 AND 39). SN 78-383,993. PUB. 3-1-2005. FILED 3-14-2004.
 2,954,988. **OURS (BLOCK FORM)**. ALVARADO DYE & KNITTING MILLS, (U.S. CLS. 22 AND 39). SN 78-389,048. PUB. 3-1-2005. FILED 3-23-2004.
 2,955,027. **C AND DESIGN**. ROUND ROCK BASEBALL, INC, (U.S. CLS. 22 AND 39). SN 78-397,798. PUB. 3-1-2005. FILED 4-7-2004.
 2,955,048. **WORMY DOG SALOON (BLOCK FORM)**. WD VENTURES, INC., (U.S. CLS. 22 AND 39). SN 78-400,355. PUB. 3-1-2005. FILED 4-12-2004.
 2,955,052. **FAVOLOSA (BLOCK FORM)**. FAVOLOSA, AND CHRISTOPHER TONE STORER AND DONNA ANN GAMBARDELLA PARTNERSHIP, THE, (U.S. CLS. 22

AND 39). SN 78-401,115. PUB. 3-1-2005. FILED 4-13-2004.
 2,955,055. **BOBBY JONES STROKE OF GENIUS (BLOCK FORM)**. JONESHEIRS, INC., (U.S. CLS. 22 AND 39). SN 78-401,522. PUB. 3-1-2005. FILED 4-14-2004.
 2,955,065. **TRADE MARK MITCHELL & NESS AND DESIGN**. MITCHELL & NESS NOSTALGIA COMPANY, (U.S. CLS. 22 AND 39). SN 78-406,930. PUB. 2-15-2005. FILED 4-23-2004.
 2,955,083. **W AND DESIGN**. MOOSEJAW MOUNTAINEERING AND BACKCOUNTRY TRAVEL, INC., (U.S. CLS. 22 AND 39). SN 78-412,793. PUB. 3-1-2005. FILED 5-4-2004.
 2,955,094 (*See Class 16 for this trademark*).
 2,955,095. **SIMPLY SHAPERS (BLOCK FORM)**. TRISTAR PRODUCTS, INC., (U.S. CLS. 22 AND 39). SN 78-415,289. PUB. 3-1-2005. FILED 5-7-2004.
 2,955,152. **SAERA (BLOCK FORM)**. SAERA CO., LTD., (U.S. CLS. 22 AND 39). SN 78-422,313. PUB. 3-1-2005. FILED 5-20-2004.
 2,955,178. **GOOR (STYLIZED)**. WENZHOU CHENGBO GOOR SHOES CO., LTD., (U.S. CLS. 22 AND 39). SN 79-001,524. PUB. 3-1-2005. FILED 3-16-2004.

CLASS 26—FANCY GOODS

2,954,501. **SOHO FASHION (BLOCK FORM)**. SOHO FASHION, INC., (U.S. CLS. 37, 39, 40, 42 AND 50). SN 76-587,265. PUB. 3-1-2005. FILED 4-19-2004.
 2,954,511. **BLUE NOTE (BLOCK FORM)**. BENSUSAN RESTAURANT CORPORATION, (U.S. CLS. 37, 39, 40, 42 AND 50). SN 76-588,200. PUB. 3-1-2005. FILED 4-23-2004.
 2,954,733 (*See Class 8 for this trademark*).
 2,955,078. **ELVIS PRESLEY (BLOCK FORM)**. ELVIS PRESLEY ENTERPRISES, INC., (U.S. CLS. 37, 39, 40, 42 AND 50). SN 78-411,506. PUB. 3-1-2005. FILED 4-30-2004.
 2,955,099. **EASHAIR (BLOCK FORM)**. REYNOLDS, PAUL, (U.S. CLS. 37, 39, 40, 42 AND 50). SN 78-416,019. PUB. 3-1-2005. FILED 5-10-2004.

CLASS 27—FLOOR COVERINGS

2,954,036 (*See Class 19 for this trademark*).
 2,954,128 (*See Class 19 for this trademark*).
 2,954,234. **HOLD PLUS, L & P PROPERTY MANAGEMENT COMPANY**, (U.S. CLS. 19, 20, 37, 42 AND 50). SN 76-521,732. PUB. 3-1-2005. FILED 6-10-2003.
 2,954,673 (*See Class 19 for this trademark*).

CLASS 28—TOYS AND SPORTING GOODS

2,953,998. **JERSEY DEVIL**. ARTIFICIAL MIND AND MOVEMENT/PENSEE ET MOUVEMENT ARTIFICIEL INC., (U.S. CLS. 22, 23, 38 AND 50). SN 75-101,405. PUB. 8-24-2004. FILED 5-9-1996.
 2,954,007 (*See Class 7 for this trademark*).
 2,954,037 (*See Class 9 for this trademark*).
 2,954,043 (*See Class 3 for this trademark*).
 2,954,057. **RAPTOR (STYLIZED)**. THUNDER TIGER CORPORATION, (U.S. CLS. 22, 23, 38 AND 50). SN 76-260,512. PUB. 12-23-2003. FILED 5-21-2001.
 2,954,071 (*See Class 9 for this trademark*).
 2,954,081 (*See Class 9 for this trademark*).
 2,954,082 (*See Class 9 for this trademark*).
 2,954,088 (*See Class 9 for this trademark*).
 2,954,091 (*See Class 11 for this trademark*).
 2,954,108. **GLOBTER**. MAYER, LUDOVIC, (U.S. CLS. 22, 23, 38 AND 50). SN 76-422,429. PUB. 6-1-2004. FILED 6-19-2002.
 2,954,233 (*See Class 16 for this trademark*).
 2,954,248. **BATS BASEBALL DICE GAME AND DESIGN**. WASN'T THAT A PARTY INC., (U.S. CLS. 22, 23, 38 AND 50). SN 76-531,843. PUB. 3-1-2005. FILED 7-24-2003.
 2,954,270. **TRAVEL PLAY**. BE'COZZ INTERNATIONAL, INC., (U.S. CLS. 22, 23, 38 AND 50). SN 76-541,420. PUB. 3-

- 1-2005. FILED 8-20-2003.
2,954,330 (*See Class 25 for this trademark*).
2,954,461. **LPL BUSY BOX (BLOCK FORM)**. HASBRO, INC., (U.S. CLS. 22, 23, 38 AND 50). SN 76-583,464. PUB. 3-1-2005. FILED 3-29-2004.
2,954,547. **CATALYST (STYLIZED)**. TYR SPORT, INC., (U.S. CLS. 22, 23, 38 AND 50). SN 76-591,090. PUB. 3-1-2005. FILED 5-7-2004.
2,954,551. **THE TRANSISTOR SISTERS (BLOCK FORM)**. DIFRANCESCO, JOSEPH, AND DIFRANCESCO, BERNADETTE, MULTIPLE CLASS, (INT. CLS. 28 AND 41), (U.S. CLS. 22, 23, 38, 50, 100, 101 AND 107). SN 76-591,139. PUB. 3-1-2005. FILED 5-10-2004.
2,954,573. **NEGATIVE ONE (STYLIZED)**. WOOSTER PRODUCTS, INC, (U.S. CLS. 22, 23, 38 AND 50). SN 76-591,848. PUB. 3-1-2005. FILED 5-12-2004.
2,954,620 (*See Class 12 for this trademark*).
2,954,635. **TOT TOWN**. SPORTSPLAY EQUIPMENT, INC., (U.S. CLS. 22, 23, 38 AND 50). SN 78-182,049. PUB. 3-1-2005. FILED 11-5-2002.
2,954,636 (*See Class 11 for this trademark*).
2,954,733 (*See Class 8 for this trademark*).
2,954,769. **CYCLONE**. JAS. D. EASTON, INC., (U.S. CLS. 22, 23, 38 AND 50). SN 78-284,458. PUB. 5-4-2004. FILED 8-7-2003.
2,954,849. **ANIMAL NATION**. P. C. WOO, INC., DBA MEGATOYS, (U.S. CLS. 22, 23, 38 AND 50). SN 78-321,238. PUB. 3-1-2005. FILED 10-30-2003.
2,954,945 (*See Class 16 for this trademark*).
2,955,005. **Q 4 (STYLIZED)**. SILL & SONS SERVICES, (U.S. CLS. 22, 23, 38 AND 50). SN 78-394,106. PUB. 3-1-2005. FILED 3-31-2004.
2,955,017. **LUCILLE (BLOCK FORM)**. SILSTAR CORPORATION OF AMERICA, INC., (U.S. CLS. 22, 23, 38 AND 50). SN 78-395,743. PUB. 3-1-2005. FILED 4-2-2004.
2,955,061. **HOIST (BLOCK FORM)**. HOIST FITNESS SYSTEMS, INC., (U.S. CLS. 22, 23, 38 AND 50). SN 78-406,483. PUB. 3-1-2005. FILED 4-22-2004.
2,955,067. **CRAWBUG (BLOCK FORM)**. EBSO INDUSTRIES INC., (U.S. CLS. 22, 23, 38 AND 50). SN 78-408,081. PUB. 3-1-2005. FILED 4-26-2004.
2,955,119. **SOFT BITE FLOPPY DISC (BLOCK FORM)**. FLOPPY DISC ROYALTY CORP., (U.S. CLS. 22, 23, 38 AND 50). SN 78-418,598. PUB. 3-1-2005. FILED 5-14-2004.
2,955,120. **SOFT BITE (BLOCK FORM)**. FLOPPY DISC ROYALTY CORP., (U.S. CLS. 22, 23, 38 AND 50). SN 78-418,603. PUB. 3-1-2005. FILED 5-14-2004.
2,955,128. **FLOPPY DISC (BLOCK FORM)**. FLOPPY DISC ROYALTY CORP., (U.S. CLS. 22, 23, 38 AND 50). SN 78-419,010. PUB. 3-1-2005. FILED 5-14-2004.
-
- CLASS 29—MEATS AND PROCESSED FOODS**
- 2,954,033. **FOUR SEASONS AND DESIGN**. MILKY WAY INTERNATIONAL TRADING CORPORATION, (U.S. CL. 46). SN 76-120,754. PUB. 9-21-2004. FILED 8-31-2000.
2,954,034. **FOUR SEASONS**. MILKY WAY INTERNATIONAL TRADING CORPORATION, (U.S. CL. 46). SN 76-120,769. PUB. 9-21-2004. FILED 8-31-2000.
2,954,076. **SENSATIONAL SOY**. PARMALAT DAIRY & BAKERY INC., (U.S. CL. 46). SN 76-327,168. PUB. 10-26-2004. FILED 10-19-2001.
2,954,094. **CALIFORNIA STYLE**. BORGES USA, INC., DBA STAR FINE FOODS, (U.S. CL. 46). SN 76-384,528. PUB. 1-13-2004. FILED 3-12-2002.
2,954,140. **VIVACE**. NUTRAVITAL INC., MULTIPLE CLASS, (INT. CLS. 29 AND 30), (U.S. CL. 46). SN 76-472,092. PUB. 11-16-2004. FILED 12-2-2002.
2,954,200. **ARCHER FARMS**. TARGET BRANDS, INC., MULTIPLE CLASS, (INT. CLS. 29, 30 AND 32), (U.S. CLS. 45, 46 AND 48). SN 76-506,359. PUB. 3-1-2005. FILED 4-15-2003.
2,954,209. **POWER SNACKS**. FRANKLIN CONNECTIONS, L.P., (U.S. CL. 46). SN 76-509,105. PUB. 3-1-2005. FILED 4-24-2003.
2,954,230. **PLUNDERED BOOTY**. ROBERT'S AMERICAN GOURMET, (U.S. CL. 46). SN 76-517,870. PUB. 3-1-2005. FILED 5-5-2003.
2,954,275. **BULL HEAD**. HAW-DI-I FOODS CO., LTD., MULTIPLE CLASS, (INT. CLS. 29 AND 30), (U.S. CL. 46). SN 76-542,804. PUB. 3-1-2005. FILED 9-5-2003.
2,954,277. **JENNIE-O TURKEY STORE AND DESIGN**. JENNIE-O TURKEY STORE, LLC, (U.S. CL. 46). SN 76-543,390. PUB. 3-1-2005. FILED 9-8-2003.
2,954,284. **RUBY DRAGON**. TOWNSENDS, INC., (U.S. CL. 46). SN 76-545,572. PUB. 3-1-2005. FILED 9-17-2003.
2,954,301. **OMELET STARTERS AND DESIGN**. INTERNATIONAL FROZEN FOODS, LLC., (U.S. CL. 46). SN 76-549,641. PUB. 3-1-2005. FILED 9-22-2003.
2,954,382. **M AND DESIGN**. LA MONTERRATINA C.A., (U.S. CL. 46). SN 76-565,644. PUB. 3-1-2005. FILED 12-17-2003.
2,954,492. **OCEAN MAJESTY (BLOCK FORM)**. RUGGIERO SEAFOOD, INC., (U.S. CL. 46). SN 76-586,331. PUB. 3-1-2005. FILED 4-2-2004.
2,954,493. **BUTTE VIEW (BLOCK FORM)**. JOHNSON, LEWIS WALLACE, (U.S. CL. 46). SN 76-586,387. PUB. 3-1-2005. FILED 4-8-2004.
2,954,500. **NORTHWEST FINEST AND DESIGN**. INTERSTATE MEAT DIST., INC., (U.S. CL. 46). SN 76-587,065. PUB. 3-1-2005. FILED 4-16-2004.
2,954,578. **YOGONEZ (BLOCK FORM)**. CZINGULA, JOHN, (U.S. CL. 46). SN 76-592,052. PUB. 3-1-2005. FILED 5-13-2004.
2,954,592. **DR. GEORGE WASHINGTON CARVER (STYLIZED)**. WASHINGTON, LENDA P., (U.S. CL. 46). SN 76-592,670. PUB. 3-1-2005. FILED 5-14-2004.
2,954,609. **CONCHITA**. CONCHITA FOODS, INC., MULTIPLE CLASS, (INT. CLS. 29, 30, 32 AND 33), (U.S. CLS. 45, 46, 47, 48 AND 49). SN 78-101,624. PUB. 3-1-2005. FILED 1-9-2002.
2,954,687. **FRICO BALANCE**. FRIESLAND BRANDS B.V., (U.S. CL. 46). SN 78-227,614. PUB. 6-15-2004. FILED 3-19-2003.
2,954,701 (*See Class 16 for this trademark*).
2,954,721. **SALUMI 1 2 3 4 5 6 AND DESIGN**. ARMANDINO'S SALUMI, INC., (U.S. CL. 46). SN 78-255,967. PUB. 3-1-2005. FILED 5-29-2003.
2,954,765. **DEER**. BEST FOODS INC., MULTIPLE CLASS, (INT. CLS. 29 AND 30), (U.S. CL. 46). SN 78-283,129. PUB. 3-1-2005. FILED 8-5-2003.
2,954,766. **O DEER**. BEST FOODS INC., MULTIPLE CLASS, (INT. CLS. 29 AND 30), (U.S. CL. 46). SN 78-283,137. PUB. 3-1-2005. FILED 8-5-2003.
2,954,775. **SMOKIE GRILL**. PIERRE FOODS, INC., (U.S. CL. 46). SN 78-290,290. PUB. 3-1-2005. FILED 8-21-2003.
2,954,806. **BUFFALO DOUBLE DIPPIN' FINGERS**. ARBY'S IP HOLDER TRUST, A DELAWARE BUSINESS TRUST, THE TRUSTEES COMPRISING THE CORPORATE TRUST ADMINISTRATOR, WILMINGTON TRUST COMPANY, A DELAWARE CORPORATION, THE, (U.S. CL. 46). SN 78-306,561. PUB. 3-1-2005. FILED 9-29-2003.
2,954,807. **LAFOOCO AND DESIGN**. LONG AN FOOD PROCESSING EXPORT JOINT STOCK COMPANY (LAFOOCO), (U.S. CL. 46). SN 78-307,044. PUB. 3-1-2005. FILED 9-30-2003.
2,954,820. **FRUIX**. COMPAGNIE GERVAIS DANONE, (U.S. CL. 46). SN 78-312,693. PUB. 3-1-2005. FILED 10-13-2003.
2,954,885. **AMY'S KITCHEN (BLOCK FORM)**. AMY'S KITCHEN, INC., MULTIPLE CLASS, (INT. CLS. 29 AND 30), (U.S. CL. 46). SN 78-337,338. PUB. 3-1-2005. FILED 12-5-2003.
2,954,919. **BUTTER IT'S NOT (BLOCK FORM)**. THE KROGER CO. OF MICHIGAN, (U.S. CL. 46). SN 78-356,044. PUB. 10-26-2004. FILED 1-22-2004.
2,954,933. **DALLOYAU (BLOCK FORM)**. DALLOYAU, MULTIPLE CLASS, (INT. CLS. 29, 30 AND 43), (U.S. CLS. 46, 100 AND 101). SN 78-365,478. PUB. 12-14-2004. FILED 2-10-2004.
2,955,016. **FIGARO AND DESIGN**. KOIPE CORPORACION, S.L., (U.S. CL. 46). SN 78-395,619. PUB. 3-1-2005. FILED 4-2-2004.
2,955,125. **ROYAL SCARLET (BLOCK FORM)**. SUPREME OIL COMPANY, (U.S. CL. 46). SN 78-418,889. PUB. 3-1-2005. FILED 5-14-2004.
2,955,141. **HAND-PICKED GOODNESS MOTT'S AND DESIGN**. MOTT'S INC., MULTIPLE CLASS, (INT. CLS. 29 AND 32), (U.S. CLS. 45, 46 AND 48). SN 78-420,815. PUB. 3-1-

2005. FILED 5-18-2004.
 2,955,164. **GUT FRIELINGSHOF AND DESIGN. LIDL STIFTUNG & CO. KG.** (U.S. CL. 46). SN 79-000,161. PUB. 3-1-2005. FILED 11-6-2003.

2,955,182. **CREAMERO (BLOCK FORM).** INTERCOOKIES GEBÄCK-; UND KUCHENSPEZIALITÄTEN GMBH. (U.S. CL. 46). SN 79-001,931. PUB. 3-1-2005. FILED 3-9-2004.

CLASS 30—STAPLE FOODS

2,954,032 (*See Class 21 for this trademark*).
 2,954,041. **BANANA FLIP.** INTERSTATE BAKERIES CORPORATION, (U.S. CL. 46). SN 76-163,860. PUB. 3-1-2005. FILED 11-13-2000.
 2,954,110. **BORGHETTI SPECIALITA ITALIANA DAL 1860 LIQUORE DI VERO CAFFE ESPRESSO AND DESIGN.** FRATELLI BRANCA-DISTILLERIE S.R.L., MULTIPLE CLASS, (INT. CLS. 30, 32 AND 33), (U.S. CLS. 45, 46, 47, 48 AND 49). SN 76-424,814. PUB. 8-24-2004. FILED 6-24-2002.
 2,954,140 (*See Class 29 for this trademark*).
 2,954,177. **CIT AND DESIGN. COLOSSUS INT'L TRADING(USA), INC.,** (U.S. CL. 46). SN 76-497,706. PUB. 3-1-2005. FILED 3-17-2003.
 2,954,200 (*See Class 29 for this trademark*).
 2,954,254. **THINKING FOOD AND DESIGN. BRISCIANI, ROBERTO,** (U.S. CL. 46). SN 76-535,290. PUB. 3-1-2005. FILED 8-7-2003.
 2,954,275 (*See Class 29 for this trademark*).
 2,954,306. **BOONDOCK BAY GOURMET COFFEE AND DESIGN.** BAY AREA COFFEE, INC., (U.S. CL. 46). SN 76-550,865. PUB. 3-1-2005. FILED 10-14-2003.
 2,954,375. **SUNNY BROOK FARMS, INC. (BLOCK FORM).** SUNNY BROOK FARMS, INC., (U.S. CL. 46). SN 76-563,930. PUB. 3-1-2005. FILED 12-5-2003.
 2,954,388. **CEREAL AND FLUID-MILK WITHOUT THE BOWL AND SPOON (BLOCK FORM).** HEALTHY GRAIN-FOODS LLC, (U.S. CL. 46). SN 76-566,749. PUB. 9-28-2004. FILED 12-16-2003.
 2,954,415. **YOU CAN'T BUY HAPPINESS BUT YOU CAN BUY BLISS (BLOCK FORM).** TROPHY NUT CORPORATION, (U.S. CL. 46). SN 76-571,430. PUB. 10-26-2004. FILED 1-16-2004.
 2,954,609 (*See Class 29 for this trademark*).
 2,954,701 (*See Class 16 for this trademark*).
 2,954,742. **GH BRANDS CALIFORNIA ALMOND BAR.** GAUGHEN HOLDINGS LLC, (U.S. CL. 46). SN 78-270,672. PUB. 3-1-2005. FILED 7-4-2003.
 2,954,743 (*See Class 3 for this trademark*).
 2,954,751. **KOON CHUN HOISIN SAUCE AND DESIGN.** KOON CHUN HING KEE SOY & SAUCE FACTORY LIMITED, (U.S. CL. 46). SN 78-278,201. PUB. 3-1-2005. FILED 7-24-2003.
 2,954,752. **KOON CHUN CHILI SAUCE AND DESIGN.** KOON CHUN HING KEE SOY & SAUCE FACTORY LIMITED, (U.S. CL. 46). SN 78-278,212. PUB. 3-1-2005. FILED 7-24-2003.
 2,954,765 (*See Class 29 for this trademark*).
 2,954,766 (*See Class 29 for this trademark*).
 2,954,788. **KINGCOOK.** ACECOOK VIETNAM COMPANY LIMITED, (U.S. CL. 46). SN 78-298,128. PUB. 3-1-2005. FILED 9-9-2003.
 2,954,852. **ROYAL DANSK DANISH BUTTER COOKIES AND DESIGN.** KELSENBISCA A/S, (U.S. CL. 46). SN 78-323,335. PUB. 3-1-2005. FILED 11-5-2003.
 2,954,885 (*See Class 29 for this trademark*).
 2,954,906. **BIGOTES (BLOCK FORM).** GRUPO BIMBO, S.A. DE C.V., (U.S. CL. 46). SN 78-348,836. PUB. 10-19-2004. FILED 1-7-2004.
 2,954,933 (*See Class 29 for this trademark*).
 2,954,938. **SALT WORKS (BLOCK FORM).** DANIEL COHEN, (U.S. CL. 46). SN 78-367,032. PUB. 3-1-2005. FILED 2-12-2004.
 2,954,944. **THE GINGERBREAD CONSTRUCTION CO. AND DESIGN.** GINGERBREAD CONSTRUCTION CO., INC., (U.S. CL. 46). SN 78-369,215. PUB. 3-1-2005. FILED 2-17-2004.
 2,955,007. **M.Y. SAN SKYFLAKES CRACKERS AND DESIGN.** MONDE M.Y. SAN CORPORATION, (U.S. CL. 46). SN 78-394,332. PUB. 3-1-2005. FILED 3-31-2004.
 2,955,108. **SHULTZ (BLOCK FORM).** TODD'S SNAX, INC., DBA SHULTZ FOODS COMPANY, (U.S. CL. 46). SN 78-416,869. PUB. 3-1-2005. FILED 5-11-2004.

CLASS 31—NATURAL AGRICULTURAL PRODUCTS

2,954,081 (*See Class 9 for this trademark*).
 2,954,082 (*See Class 9 for this trademark*).
 2,954,206. **CAT SASS.** EURO-CAN MANUFACTURING INC., (U.S. CLS. 1 AND 46). SN 76-508,222. PUB. 7-27-2004. FILED 4-22-2003.
 2,954,378 (*See Class 1 for this trademark*).
 2,954,474. **SLT (BLOCK FORM).** TURF-SEED, INC., (U.S. CLS. 1 AND 46). SN 76-585,257. PUB. 3-1-2005. FILED 4-6-2004.
 2,954,535. **WINGMASTER (BLOCK FORM).** PENNINGTON SEED, INC. OF NEBRASKA, (U.S. CLS. 1 AND 46). SN 76-590,380. PUB. 3-1-2005. FILED 5-4-2004.
 2,954,546. **BLACKYORK (BLOCK FORM).** CORNELL RESEARCH FOUNDATION, INC., (U.S. CLS. 1 AND 46). SN 76-590,944. PUB. 3-1-2005. FILED 5-7-2004.
 2,954,567. **TOM MATT OTTO AND DESIGN.** PROCACCI BROTHERS SALES CORP., (U.S. CLS. 1 AND 46). SN 76-591,645. PUB. 3-1-2005. FILED 5-11-2004.
 2,954,701 (*See Class 16 for this trademark*).
 2,954,978. **BARCELONA (BLOCK FORM).** JOHN BODGER & SONS COMPANY, (U.S. CLS. 1 AND 46). SN 78-385,333. PUB. 3-1-2005. FILED 3-16-2004.
 2,954,979. **PARIS (BLOCK FORM).** JOHN BODGER & SONS COMPANY, (U.S. CLS. 1 AND 46). SN 78-385,340. PUB. 3-1-2005. FILED 3-16-2004.
 2,955,024. **FROM THE SEED TO YOUR TABLE (BLOCK FORM).** MARTIN, WILLIAM, (U.S. CLS. 1 AND 46). SN 78-397,361. PUB. 3-1-2005. FILED 4-6-2004.
 2,955,103. **LICK A LOTS (BLOCK FORM).** COOMES, NANCY, (U.S. CLS. 1 AND 46). SN 78-416,097. PUB. 3-1-2005. FILED 5-10-2004.
 2,955,162 (*See Class 6 for this trademark*).

CLASS 32—LIGHT BEVERAGES

2,954,110 (*See Class 30 for this trademark*).
 2,954,150 (*See Class 16 for this trademark*).
 2,954,175. **MISSION ALE DOUBLE HAPPY VALLEY BREWING CO. AND DESIGN.** ROMANCO LLC, DBA HAPPY VALLEY BREWING CO., (U.S. CLS. 45, 46 AND 48). SN 76-496,038. PUB. 3-1-2005. FILED 3-10-2003.
 2,954,200 (*See Class 29 for this trademark*).
 2,954,201 (*See Class 5 for this trademark*).
 2,954,586. **LET IT SUN. LET IT SUN. LET IT SUN. (BLOCK FORM).** CERVECERIA MODELO, S.A. DE C.V., (U.S. CLS. 45, 46 AND 48). SN 76-592,335. PUB. 3-1-2005. FILED 5-17-2004.
 2,954,609 (*See Class 29 for this trademark*).
 2,954,633. **HAWAIIAN PUNCH GREEN BERRY RUSH. DR PEPPER/SEVEN UP, INC.,** (U.S. CLS. 45, 46 AND 48). SN 78-178,405. PUB. 2-10-2004. FILED 10-25-2002.
 2,954,701 (*See Class 16 for this trademark*).
 2,954,776. **BERRY LIME SUBLIME.** JAMBA JUICE COMPANY, (U.S. CLS. 45, 46 AND 48). SN 78-291,372. PUB. 3-1-2005. FILED 8-22-2003.
 2,954,808. **MOTHER EARTH MINERALS.** OTT, A. TRUE, DBA MOTHER EARTH MINERALS, (U.S. CLS. 45, 46 AND 48). SN 78-307,749. PUB. 3-1-2005. FILED 9-30-2003.
 2,954,881. **PIGS ASS PORTER (BLOCK FORM).** HARVEST MOON BREWING, (U.S. CLS. 45, 46 AND 48). SN 78-331,964. PUB. 3-1-2005. FILED 11-23-2003.
 2,955,057. **ALOE FARMS (BLOCK FORM).** ALOE FARMS, INC., (U.S. CLS. 45, 46 AND 48). SN 78-404,780. PUB. 3-1-2005. FILED 4-20-2004.
 2,955,141 (*See Class 29 for this trademark*).

CLASS 33—WINES AND SPIRITS

- 2,954,008. **BULL. RED BULL GMBH**, MULTIPLE CLASS, (INT. CLS. 33 AND 42), (U.S. CLS. 47, 49, 100 AND 101). SN 75-788,831. PUB. 10-5-2004. FILED 8-30-1999.
- 2,954,014. **BAYWOOD CELLARS (STYLIZED)**, LAS VINAS WINERY, INC., (U.S. CLS. 47 AND 49). SN 75-918,451. PUB. 11-21-2000. FILED 2-16-2000.
- 2,954,053. **SPEND TONIGHT WITH CRISTALL**, CRISTALL U.S.A., INC., (U.S. CLS. 47 AND 49). SN 76-228,408. PUB. 3-4-2003. FILED 3-22-2001.
- 2,954,110 (*See Class 30 for this trademark*).
- 2,954,121. **MACKMYRA AND DESIGN**, MACKMYRA SVENSK WHISKY AB, (U.S. CLS. 47 AND 49). SN 76-449,392. PUB. 5-11-2004. FILED 9-9-2002.
- 2,954,196. **KANELILLA**, TARRE, FRANCISCO GUILLERMO MENDOZA, (U.S. CLS. 47 AND 49). SN 76-504,763. PUB. 7-27-2004. FILED 4-7-2003.
- 2,954,220. **MISCELLANEOUS DESIGN**, HAKKAI-JYOZO SAKE BREWING CO., LTD., (U.S. CLS. 47 AND 49). SN 76-513,577. PUB. 3-1-2005. FILED 5-13-2003.
- 2,954,221. **MISCELLANEOUS DESIGN**, HAKKAI-JYOZO SAKE BREWING CO., LTD., (U.S. CLS. 47 AND 49). SN 76-513,817. PUB. 3-1-2005. FILED 5-13-2003.
- 2,954,454. **HESS SELECT AND DESIGN**, THE HESS COLLECTION WINERY, (U.S. CLS. 47 AND 49). SN 76-581,809. PUB. 3-1-2005. FILED 3-18-2004.
- 2,954,528. **PIO CESARE (BLOCK FORM)**, PIO CESARE S.R.L., (U.S. CLS. 47 AND 49). SN 76-589,209. PUB. 3-1-2005. FILED 4-27-2004.
- 2,954,609 (*See Class 29 for this trademark*).
- 2,954,615. **RINCON PRIVADO CABERNET SAUVIGNON AND DESIGN**, GAUCHO IMPORTS LLC, (U.S. CLS. 47 AND 49). SN 78-122,069. PUB. 8-3-2004. FILED 4-16-2002.
- 2,954,621. **DESTINY BAY**, DESTINY BAY VINEYARDS LIMITED, (U.S. CLS. 47 AND 49). SN 78-154,260. PUB. 3-1-2005. FILED 8-14-2002.
- 2,954,662. **DELLA SERENISSIMA**, GANCIA S.P.A., (U.S. CLS. 47 AND 49). SN 78-216,299. PUB. 8-17-2004. FILED 2-19-2003.
- 2,954,701 (*See Class 16 for this trademark*).
- 2,954,736. **BERENTZEN AND DESIGN**, BERENTZEN BRENNEREIEN GMBH + CO. KG, (U.S. CLS. 47 AND 49). SN 78-266,639. PUB. 9-28-2004. FILED 6-24-2003.
- 2,954,792. **MORANDÉ (STYLIZED)**, VINA MORANDÉ S.A., (U.S. CLS. 47 AND 49). SN 78-299,889. PUB. 3-1-2005. FILED 9-12-2003.
- 2,954,843. **VISTA MONTONE**, SUTTER HOME WINERY, INC., (U.S. CLS. 47 AND 49). SN 78-319,931. PUB. 3-1-2005. FILED 10-28-2003.
- 2,954,844. **MISCELLANEOUS DESIGN**, OZEKI CORPORATION, (U.S. CLS. 47 AND 49). SN 78-320,040. PUB. 3-1-2005. FILED 10-29-2003.
- 2,955,036. **APAN (BLOCK FORM)**, APAN WINE COMPANY LLC, (U.S. CLS. 47 AND 49). SN 78-398,259. PUB. 3-1-2005. FILED 4-7-2004.
- 2,955,047. **ENSEMBLE (BLOCK FORM)**, DIAGEO NORTH AMERICA, INC., (U.S. CLS. 47 AND 49). SN 78-400,310. PUB. 3-1-2005. FILED 4-12-2004.
- 2,955,092. **NATURE TRADITION INNOVATION (BLOCK FORM)**, LEMELSON WINERY LLC, (U.S. CLS. 47 AND 49). SN 78-414,958. PUB. 3-1-2005. FILED 5-7-2004.
- 2,955,143. **SPRUCE MOUNTAIN MEADERY (BLOCK FORM)**, FORTRESS GROUP LIMITED, (U.S. CLS. 47 AND 49). SN 78-421,120. PUB. 3-1-2005. FILED 5-18-2004.
- 2,955,160. **FRIENDS.ZIN (BLOCK FORM)**, WINERY ASSOCIATES OF SONOMA COUNTY, INC., (U.S. CLS. 47 AND 49). SN 78-481,982. PUB. 3-1-2005. FILED 9-10-2004.
- 2,955,171. **VIÑA TONDONIA AND DESIGN**, R. LOPEZ DE HEREDIA; VIÑA TONDONIA, S.A., (U.S. CLS. 47 AND 49). SN 79-000,677. PUB. 3-1-2005. FILED 12-10-2003.
- 2,955,180. **L'IMPERTINENTE (BLOCK FORM)**, LES VIGNERONS DU SIEUR D'ARQUES; SOCIETE COOPERATIVE AGRICOLE, (U.S. CLS. 47 AND 49). SN 79-001,647. PUB. 3-1-2005. FILED 2-17-2004.
- 2,955,183. **OGGA (BLOCK FORM)**, SANTIAGO IJALBA, S.A., (U.S. CLS. 47 AND 49). SN 79-002,559. PUB. 3-1-2005. FILED 4-6-2004.

CLASS 34—SMOKERS' ARTICLES

- 2,954,120 (*See Class 11 for this trademark*).
- 2,954,361. **EXOTIC TOBACCO DELICIOSO HAND MADE AND DESIGN**, LEVY CAFE, INC., (U.S. CLS. 2, 8, 9 AND 17). SN 76-561,355. PUB. 9-21-2004. FILED 11-21-2003.
- 2,955,174. **BALMORAL (BLOCK FORM)**, AGIO SIGAREN-FABRIEKEN N.V., (U.S. CLS. 2, 8, 9 AND 17). SN 79-001,327. PUB. 3-1-2005. FILED 12-29-2003.

SERVICE MARKS**CLASS 35—ADVERTISING AND BUSINESS**

- 2,953,994. **THE ACCU GROUP PERSONNEL COMPANIES AND DESIGN**, ACCU PERSONNEL, INC., (U.S. CL. 101). SN 74-475,613. PUB. 3-1-2005. FILED 12-30-1993.
- 2,953,995. **DISTRIBUTION SOLUTIONS**, UNITED JERSEY BANK, MULTIPLE CLASS, (INT. CLS. 35 AND 39), (U.S. CLS. 100, 101, 102 AND 105). SN 74-733,396. PUB. 3-23-2004. FILED 9-22-1995.
- 2,954,007 (*See Class 7 for this trademark*).
- 2,954,009 (*See Class 1 for this trademark*).
- 2,954,025 (*See Class 9 for this trademark*).
- 2,954,026 (*See Class 9 for this trademark*).
- 2,954,032 (*See Class 21 for this trademark*).
- 2,954,036 (*See Class 19 for this trademark*).
- 2,954,037 (*See Class 9 for this trademark*).
- 2,954,042. **MISCELLANEOUS DESIGN**, ALLIANCE OF CANADIAN CINEMA TELEVISION AND RADIO ARTISTS, MULTIPLE CLASS, (INT. CLS. 35, 36, 41 AND 42), (U.S. CLS. 100, 101, 102 AND 107). SN 76-171,477. PUB. 6-8-2004. FILED 11-28-2000.
- 2,954,045 (*See Class 9 for this trademark*).
- 2,954,047 (*See Class 9 for this trademark*).
- 2,954,048. **MARKETFIRST AND DESIGN**, MARKETFIRST SOFTWARE, INC., MULTIPLE CLASS, (INT. CLS. 35, 41 AND 42), (U.S. CLS. 100, 101, 102 AND 107). SN 76-210,324. PUB. 3-1-2005. FILED 2-12-2001.
- 2,954,051. **TEKGRAF**, TEKGRAF CORPORATION, (U.S. CLS. 100, 101 AND 102). SN 76-223,868. PUB. 3-1-2005. FILED 3-9-2001.
- 2,954,058. **RESILIEEN AND DESIGN**, RESILIEEN WORLDWIDE LLC, (U.S. CLS. 100, 101 AND 102). SN 76-264,316. PUB. 3-1-2005. FILED 5-29-2001.
- 2,954,061 (*See Class 9 for this trademark*).
- 2,954,064 (*See Class 9 for this trademark*).
- 2,954,071 (*See Class 9 for this trademark*).
- 2,954,072 (*See Class 9 for this trademark*).
- 2,954,075. **PRODUCTLAB**, PRODUCTLAB, INC., (U.S. CLS. 100, 101 AND 102). SN 76-323,948. PUB. 3-1-2005. FILED S.R. 10-11-2001; AM. P.R. 12-13-2004.
- 2,954,079. **YOUR JOB IS YOUR CREDIT**, RDA INC., (U.S. CLS. 100, 101 AND 102). SN 76-335,401. PUB. 7-8-2003. FILED 11-8-2001.
- 2,954,084 (*See Class 1 for this trademark*).
- 2,954,085. **TOTAL FITNESS - THE RIGHT EQUIPMENT. THE RIGHT PEOPLE.**, TOTAL FITNESS, INC., (U.S. CLS. 100, 101 AND 102). SN 76-346,627. PUB. 3-1-2005. FILED 12-6-2001.
- 2,954,086. **CASH FLOW AND DESIGN**, AMERICAN CASH FLOW ASSOCIATION, INC., (U.S. CLS. 100, 101 AND 102). SN 76-349,542. PUB. 1-28-2003. FILED 12-17-2001.
- 2,954,088 (*See Class 9 for this trademark*).
- 2,954,089 (*See Class 9 for this trademark*).
- 2,954,092. **RESONANCE CRM FROM COSSETTE**, GROUPE COSSETTE COMMUNICATION INC., (U.S. CLS. 100, 101 AND 102). SN 76-381,551. PUB. 9-7-2004. FILED 3-12-2002.
- 2,954,093 (*See Class 16 for this trademark*).
- 2,954,113. **TIDEWATER CONSULTING**, TIDEWATER PHYSICAL THERAPY AND REHABILITATION ASSOCIATION, P.A., (U.S. CLS. 100, 101 AND 102). SN 76-430,464. PUB. 3-1-2005. FILED 7-11-2002.
- 2,954,124. **AD TABS MONEY**, ADAMS ENTERPRISES, INC., (U.S. CLS. 100, 101 AND 102). SN 76-454,357. PUB. 3-1-2005.

- FILED 10-1-2002.
 2,954,134 (*See Class 16 for this trademark*).
 2,954,139 (*See Class 16 for this trademark*).
 2,954,141. **MISCELLANEOUS DESIGN**. CARING AMBASSADORS PROGRAM, INC., MULTIPLE CLASS, (INT. CLS. 35 AND 42), (U.S. CLS. 100, 101 AND 102). SN 76-472,400. PUB. 3-1-2005. FILED 12-3-2002.
 2,954,143 (*See Class 6 for this trademark*).
 2,954,150 (*See Class 16 for this trademark*).
 2,954,158. **FOUNTAIN PARK ACADEMY**. FOUNTAIN PARK ACADEMY, INC., (U.S. CLS. 100, 101 AND 102). SN 76-486,627. PUB. 3-1-2005. FILED 2-3-2003.
 2,954,181. **PCAOB**. PUBLIC COMPANY ACCOUNTING OVERSIGHT BOARD, MULTIPLE CLASS, (INT. CLS. 35 AND 42), (U.S. CLS. 100, 101 AND 102). SN 76-499,544. PUB. 1-13-2004. FILED 3-21-2003.
 2,954,185. **THE EXCITEMENT AGENCY**. RPMC, INC., (U.S. CLS. 100, 101 AND 102). SN 76-501,227. PUB. 3-1-2005. FILED 3-19-2003.
 2,954,197. **FPS**. HET FRIESCH PAARDEN-STAMBOEK, MULTIPLE CLASS, (INT. CLS. 35, 41 AND 42), (U.S. CLS. 100, 101, 102 AND 107). SN 76-505,186. PUB. 3-1-2005. FILED 4-9-2003.
 2,954,214 (*See Class 9 for this trademark*).
 2,954,215 (*See Class 9 for this trademark*).
 2,954,218. **ART: ASAP KIDS AND DESIGN**. ART A. S. A. P. KIDS INC., (U.S. CLS. 100, 101 AND 102). SN 76-513,273. PUB. 3-1-2005. FILED 5-12-2003.
 2,954,232. **MISCELLANEOUS DESIGN**. NATURAL ENERGY LABORATORY OF HAWAII AUTHORITY (NELHA), (U.S. CLS. 100, 101 AND 102). SN 76-520,364. PUB. 3-1-2005. FILED 5-29-2003.
 2,954,236 (*See Class 25 for this trademark*).
 2,954,239. **MISCELLANEOUS DESIGN**. GEORGIA BREAST CANCER COALITION FUND, (U.S. CLS. 100, 101 AND 102). SN 76-525,836. PUB. 3-1-2005. FILED 6-5-2003.
 2,954,241. **DENTALWORKERS WWW.DENTALWORKERS.COM AND DESIGN**. PRICE, CATHY, (U.S. CLS. 100, 101 AND 102). SN 76-526,927. PUB. 3-1-2005. FILED 6-30-2003.
 2,954,245. **THE OPEN ENVELOPE**. THE OPEN ENVELOPE, LLC, (U.S. CLS. 100, 101 AND 102). SN 76-528,709. PUB. 3-1-2005. FILED 7-9-2003.
 2,954,249 (*See Class 16 for this trademark*).
 2,954,250 (*See Class 16 for this trademark*).
 2,954,265. **A S A P TEMPORARIES AND DESIGN**. A.S.A.P. PERSONNEL SERVICES, INC., (U.S. CLS. 100, 101 AND 102). SN 76-539,902. PUB. 3-1-2005. FILED 8-12-2003.
 2,954,266. **PARK PLACE DEALERSHIPS**. PARK PLACE MOTORCARS OF TEXAS, INC., (U.S. CLS. 100, 101 AND 102). SN 76-540,191. PUB. 8-10-2004. FILED 8-13-2003.
 2,954,268. **PARK PLACE**. PARK PLACE MOTORCARS OF TEXAS, INC., MULTIPLE CLASS, (INT. CLS. 35, 36, 37 AND 39), (U.S. CLS. 100, 101, 102, 103, 105 AND 106). SN 76-540,299. PUB. 8-10-2004. FILED 8-13-2003.
 2,954,285. **IT'S WORTH THE DRIVE! (BLOCK FORM)**. HUSKER AUTO GROUP, INC., (U.S. CLS. 100, 101 AND 102). SN 76-545,680. PUB. 3-1-2005. FILED 9-22-2003.
 2,954,286. **E CONNECT (BLOCK FORM)**. COLONIAL REALTY LIMITED PARTNERSHIP, MULTIPLE CLASS, (INT. CLS. 35 AND 36), (U.S. CLS. 100, 101 AND 102). SN 76-546,042. PUB. 3-1-2005. FILED 9-18-2003.
 2,954,290. **KNOWLEDGE-COLOR-BEAUTY-POWER**. ZETA SIGMA PHI SORORITY, (U.S. CLS. 100, 101 AND 102). SN 76-546,838. PUB. 3-1-2005. FILED 9-8-2003.
 2,954,291. **SOME GIRLS DEFINE THEIR LIVES BY A SORORITY, BUT THIS SORORITY IS DEFINED BY OUR LIVES**. ZETA SIGMA PHI SORORITY, (U.S. CLS. 100, 101 AND 102). SN 76-546,840. PUB. 3-1-2005. FILED 9-8-2003.
 2,954,293. **TIBA SOLUTIONS**. TIBA SOLUTIONS, LLC, MULTIPLE CLASS, (INT. CLS. 35 AND 42), (U.S. CLS. 100, 101 AND 102). SN 76-547,191. PUB. 3-1-2005. FILED 9-26-2003.
 2,954,302. **INTERACTION STYLE**. TIMMERMAN, WARREN M., DBA LOCKWOOD LEADERSHIP INTERNATIONAL, AND BLECHA, DIANE L., DBA LOCKWOOD LEADERSHIP INTERNATIONAL, (U.S. CLS. 100, 101 AND 102). SN 76-549,876. PUB. 3-1-2005. FILED 10-8-2003.
 2,954,310 (*See Class 16 for this trademark*).
 2,954,312. **SEX.XXX**. GRANT MEDIA, LLC, MULTIPLE CLASS, (INT. CLS. 35 AND 42), (U.S. CLS. 100, 101 AND 102). SN 76-552,233. PUB. 3-1-2005. FILED 9-29-2003.
 2,954,318 (*See Class 9 for this trademark*).
 2,954,325. **TRUCKS 4 U**. HUDGINS, GARY A., (U.S. CLS. 100, 101 AND 102). SN 76-554,440. PUB. 3-1-2005. FILED 10-27-2003.
 2,954,329. **MOORE WALLACE MAILTRACKER**. MOORE NORTH AMERICA, INC., (U.S. CLS. 100, 101 AND 102). SN 76-555,045. PUB. 3-1-2005. FILED 10-29-2003.
 2,954,342 (*See Class 19 for this trademark*).
 2,954,354. **SOLUTIENCE (BLOCK FORM)**. FOWLER, JULIA S., MULTIPLE CLASS, (INT. CLS. 35 AND 42), (U.S. CLS. 100, 101 AND 102). SN 76-561,050. PUB. 3-1-2005. FILED 11-19-2003.
 2,954,355. **FABULOUS JEWELRY OF THE STARS (BLOCK FORM)**. INTERNATIONAL GEM & JEWELRY SHOW, INC., (U.S. CLS. 100, 101 AND 102). SN 76-561,162. PUB. 3-1-2005. FILED 11-20-2003.
 2,954,363. **CITITRAVEL (STYLIZED)**. CITICORP, MULTIPLE CLASS, (INT. CLS. 35, 39 AND 43), (U.S. CLS. 100, 101, 102 AND 105). SN 76-561,633. PUB. 3-1-2005. FILED 11-7-2003.
 2,954,371. **THE INDIVIDUAL AND ORGANIZATIONAL PATH TO DISCOVERY (BLOCK FORM)**. PROJECT INNOVATIONS, INC., (U.S. CLS. 100, 101 AND 102). SN 76-562,709. PUB. 3-1-2005. FILED 11-17-2003.
 2,954,374. **SAY IT WITH A STORY (BLOCK FORM)**. SILVERMAN, LORI L., (U.S. CLS. 100, 101 AND 102). SN 76-563,605. PUB. 3-1-2005. FILED 11-21-2003.
 2,954,379. **GTSC (BLOCK FORM)**. GENERAL THORACIC SURGICAL CLUB, MULTIPLE CLASS, (INT. CLS. 35 AND 41), (U.S. CLS. 100, 101, 102 AND 107). SN 76-564,877. PUB. 3-1-2005. FILED 12-12-2003.
 2,954,380. **GTSC AND DESIGN**. GENERAL THORACIC SURGICAL CLUB, MULTIPLE CLASS, (INT. CLS. 35 AND 41), (U.S. CLS. 100, 101, 102 AND 107). SN 76-564,883. PUB. 3-1-2005. FILED 12-12-2003.
 2,954,386. **JUST THE THING (BLOCK FORM)**. JUST THE THING, INC., (U.S. CLS. 100, 101 AND 102). SN 76-566,308. PUB. 3-1-2005. FILED 12-22-2003.
 2,954,389. **ROX-SAN PHARMACY (BLOCK FORM)**. MELAMED, SHANA, (U.S. CLS. 100, 101 AND 102). SN 76-566,858. PUB. 3-1-2005. FILED 12-5-2003.
 2,954,398. **PHARMED (BLOCK FORM)**. PHARMED STAFFING, LLC, (U.S. CLS. 100, 101 AND 102). SN 76-568,660. PUB. 3-1-2005. FILED 12-24-2003.
 2,954,399. **PHARMED AND DESIGN**. PHARMED STAFFING, LLC, (U.S. CLS. 100, 101 AND 102). SN 76-568,661. PUB. 3-1-2005. FILED 12-24-2003.
 2,954,414. **W AND DESIGN**. DEE CEE LABORATORIES, INC., (U.S. CLS. 100, 101 AND 102). SN 76-571,410. PUB. 3-1-2005. FILED 1-22-2004.
 2,954,421. **LIVING WHAT YOU'RE SELLING (BLOCK FORM)**. GEEHAN ADVISORY GROUP, INC., (U.S. CLS. 100, 101 AND 102). SN 76-572,918. PUB. 3-1-2005. FILED 1-28-2004.
 2,954,427. **SNAP AND DESIGN**. SNAP AUCTIONS, INC., (U.S. CLS. 100, 101 AND 102). SN 76-575,796. PUB. 3-1-2005. FILED 2-17-2004.
 2,954,428. **SNAP (STYLIZED)**. SNAP AUCTIONS, INC., (U.S. CLS. 100, 101 AND 102). SN 76-575,797. PUB. 3-1-2005. FILED 2-17-2004.
 2,954,437. **GPO (BLOCK FORM)**. GOTTBETTER & PARTNERS, LLP, MULTIPLE CLASS, (INT. CLS. 35, 36 AND 42), (U.S. CLS. 100, 101 AND 102). SN 76-578,491. PUB. 3-1-2005. FILED 3-1-2004.
 2,954,439. **A ALAMO GROUP AND DESIGN**. ALAMO GROUP INC., (U.S. CLS. 100, 101 AND 102). SN 76-578,823. PUB. 3-1-2005. FILED 3-1-2004.
 2,954,441. **NETLINK (BLOCK FORM)**. NETLINK REALTY ONLINE MAGAZINE, LLC, (U.S. CLS. 100, 101 AND 102). SN 76-578,967. PUB. 3-1-2005. FILED 3-3-2004.
 2,954,456. **NATIONAL PET WEEK (BLOCK FORM)**. AMERICAN VETERINARY MEDICAL ASSOCIATION, (U.S. CLS. 100, 101 AND 102). SN 76-581,994. PUB. 3-1-2005. FILED 3-17-2004.
 2,954,457. **THE MOST TRUSTED NAME IN SERVICED APARTMENTS WORLDWIDE (BLOCK FORM)**. R & B

- REALTY GROUP, DBA OAKWOOD WORLDWIDE, (U.S. CLS. 100, 101 AND 102). SN 76-582,570. PUB. 3-1-2005. FILED 3-19-2004.
- 2,954,463. **VIAMEDIC (BLOCK FORM)**. VIAMEDIC, INC., (U.S. CLS. 100, 101 AND 102). SN 76-583,605. PUB. 3-1-2005. FILED 3-29-2004.
- 2,954,468. **GET CUSTOMIZED (BLOCK FORM)**. EXTREME AUTO & TRUCK INC, (U.S. CLS. 100, 101 AND 102). SN 76-584,261. PUB. 3-1-2005. FILED 3-29-2004.
- 2,954,475. **YOUR HR LIFELINE (BLOCK FORM)**. BANNER ASSOCIATES, INC., (U.S. CLS. 100, 101 AND 102). SN 76-585,323. PUB. 3-1-2005. FILED 4-6-2004.
- 2,954,476. **BANNER ASSOCIATES YOUR HR LIFELINE (BLOCK FORM)**. BANNER ASSOCIATES, INC., (U.S. CLS. 100, 101 AND 102). SN 76-585,324. PUB. 3-1-2005. FILED 4-6-2004.
- 2,954,486. **THE REAL ESTATE SUPPORT SOLUTION (BLOCK FORM)**. HMS NATIONAL, INC., (U.S. CLS. 100, 101 AND 102). SN 76-585,909. PUB. 3-1-2005. FILED 4-9-2004.
- 2,954,499. **PROFOODS RESTAURANT SUPPLY (BLOCK FORM)**. STRATHMORE PARTNERS LP, (U.S. CLS. 100, 101 AND 102). SN 76-586,934. PUB. 3-1-2005. FILED 4-13-2004.
- 2,954,519. **DUMANEE (BLOCK FORM)**. DUMANEE, LLC, (U.S. CLS. 100, 101 AND 102). SN 76-588,770. PUB. 3-1-2005. FILED 4-26-2004.
- 2,954,520. **WE DRESS THE WORLD! (STYLIZED)**. AMERICAN APPAREL & FOOTWEAR ASSOCIATION, (U.S. CLS. 100, 101 AND 102). SN 76-588,779. PUB. 3-1-2005. FILED 4-26-2004.
- 2,954,521. **WE DRESS THE WORLD! (BLOCK FORM)**. AMERICAN APPAREL & FOOTWEAR ASSOCIATION, (U.S. CLS. 100, 101 AND 102). SN 76-588,780. PUB. 3-1-2005. FILED 4-26-2004.
- 2,954,537. **THE OKLAHOMAN DIRECT (BLOCK FORM)**. OKLAHOMA PUBLISHING COMPANY, THE, (U.S. CLS. 100, 101 AND 102). SN 76-590,569. PUB. 3-1-2005. FILED 5-5-2004.
- 2,954,558. **TICKETSAGE (BLOCK FORM)**. TICKETSAGE, INC., (U.S. CLS. 100, 101 AND 102). SN 76-591,276. PUB. 3-1-2005. FILED 5-10-2004.
- 2,954,563. **DESTINATION DALLAS HERO AND DESIGN**. THE DALLAS CONVENTION & VISITORS BUREAU, (U.S. CLS. 100, 101 AND 102). SN 76-591,534. PUB. 3-1-2005. FILED 4-30-2004.
- 2,954,564. **DECISIONCODER (BLOCK FORM)**. UNITED COMMUNICATIONS GROUP LIMITED PARTNERSHIP, (U.S. CLS. 100, 101 AND 102). SN 76-591,595. PUB. 3-1-2005. FILED 5-11-2004.
- 2,954,566. **STRATAMED (BLOCK FORM)**. STRATAMED, LLC, (U.S. CLS. 100, 101 AND 102). SN 76-591,640. PUB. 3-1-2005. FILED 5-11-2004.
- 2,954,576. **EXTRASERVE (STYLIZED)**. PAGOSA TECHNOLOGIES, INC., (U.S. CLS. 100, 101 AND 102). SN 76-591,991. PUB. 3-1-2005. FILED 5-13-2004.
- 2,954,581. **MI WHEELSHUNT POWERED BY THE DETROIT NEWS AND FREE PRESS AND DESIGN**. DETROIT NEWSPAPER AGENCY, (U.S. CLS. 100, 101 AND 102). SN 76-592,072. PUB. 3-1-2005. FILED 5-13-2004.
- 2,954,582. **MISTUFFHUNT POWERED BY THE DETROIT NEWS AND FREE PRESS AND DESIGN**. DETROIT NEWSPAPER AGENCY, (U.S. CLS. 100, 101 AND 102). SN 76-592,073. PUB. 3-1-2005. FILED 5-13-2004.
- 2,954,611. **MISCELLANEOUS DESIGN**. CANADIAN EGG MARKETING AGENCY, (U.S. CLS. 100, 101 AND 102). SN 78-110,473. PUB. 7-6-2004. FILED 2-22-2002.
- 2,954,614 (*See Class 9 for this trademark*).
- 2,954,617 (*See Class 9 for this trademark*).
- 2,954,623 (*See Class 9 for this trademark*).
- 2,954,626 (*See Class 9 for this trademark*).
- 2,954,630 (*See Class 16 for this trademark*).
- 2,954,631 (*See Class 16 for this trademark*).
- 2,954,636 (*See Class 11 for this trademark*).
- 2,954,638. **MIZUNO DIRECT.CONNECT**. MIZUNO USA, INC., (U.S. CLS. 100, 101 AND 102). SN 78-196,428. PUB. 3-1-2005. FILED 12-19-2002.
- 2,954,640. **BORON**. BORON MANAGEMENT B.V., MULTIPLE CLASS, (INT. CLS. 35 AND 36), (U.S. CLS. 100, 101 AND 102). SN 78-198,471. PUB. 10-5-2004. FILED 12-30-2002.
- 2,954,641. **BORON AND DESIGN**. BORON MANAGEMENT B.V., MULTIPLE CLASS, (INT. CLS. 35 AND 36), (U.S. CLS. 100, 101 AND 102). SN 78-198,472. PUB. 10-5-2004. FILED 12-30-2002.
- 2,954,642. **NPS AND DESIGN**. NATIONAL PREARRANGED SERVICES, INC., MULTIPLE CLASS, (INT. CLS. 35, 36, 41 AND 45), (U.S. CLS. 100, 101, 102 AND 107). SN 78-199,047. PUB. 3-1-2005. FILED 12-31-2002.
- 2,954,647. **ADVAGO**. HOCHTIEF AKTIENGESELLSCHAFT, MULTIPLE CLASS, (INT. CLS. 35, 36, 38 AND 39), (U.S. CLS. 100, 101, 102, 104 AND 105). SN 78-203,105. PUB. 6-8-2004. FILED 1-14-2003.
- 2,954,657. **FINE WINES. BE SEDUCED.**. CONSEIL INTER-PROFESSIONNEL DU VIN DE BORDEAUX, (U.S. CLS. 100, 101 AND 102). SN 78-209,471. PUB. 1-6-2004. FILED 1-31-2003.
- 2,954,661. **INCOWEB**. C.R.A.C. LTD., (U.S. CLS. 100, 101 AND 102). SN 78-215,804. PUB. 9-21-2004. FILED 2-18-2003.
- 2,954,664. **SUN HUNG KAI**. UNITED WAY INVESTMENTS LIMITED, MULTIPLE CLASS, (INT. CLS. 35 AND 36), (U.S. CLS. 100, 101 AND 102). SN 78-217,295. PUB. 12-14-2004. FILED 2-21-2003.
- 2,954,672 (*See Class 9 for this trademark*).
- 2,954,689. **THE PERGE! SOCIETY**. PHI GAMMA DELTA EDUCATIONAL FOUNDATION, INC., (U.S. CLS. 100, 101 AND 102). SN 78-229,048. PUB. 3-1-2005. FILED 3-24-2003.
- 2,954,692. **QUEBIT (STYLIZED)**. QUEBIT CONSULTING LLC, (U.S. CLS. 100, 101 AND 102). SN 78-230,658. PUB. 3-1-2005. FILED 3-27-2003.
- 2,954,701 (*See Class 16 for this trademark*).
- 2,954,705. **GOOD LEADS AND DESIGN**. ROBERT GOOD ASSOCIATES, LLC, (U.S. CLS. 100, 101 AND 102). SN 78-240,006. PUB. 9-21-2004. FILED 4-21-2003.
- 2,954,711. **THE FAMILY AISLE**. THE COLUMBIA HOUSE COMPANY, (U.S. CLS. 100, 101 AND 102). SN 78-249,326. PUB. 3-1-2005. FILED 5-13-2003.
- 2,954,712. **PERFORMANCE-DRIVEN MARKETING**. FIND-WHAT.COM, INC., MULTIPLE CLASS, (INT. CLS. 35 AND 38), (U.S. CLS. 100, 101, 102 AND 104). SN 78-249,655. PUB. 3-1-2005. FILED 5-14-2003.
- 2,954,748. **CUBIC**. ILLINOIS INSTITUTE OF TECHNOLOGY, (U.S. CLS. 100, 101 AND 102). SN 78-275,654. PUB. 3-1-2005. FILED 7-17-2003.
- 2,954,764. **TREE CARE INDUSTRY ASSOCIATION**. TREE CARE INDUSTRY ASSOCIATION, INC., (U.S. CLS. 100, 101 AND 102). SN 78-282,886. PUB. 3-1-2005. FILED 8-4-2003.
- 2,954,772. **THE AGENCY GROUP LTD (STYLIZED)**. THE AGENCY GROUP LIMITED, (U.S. CLS. 100, 101 AND 102). SN 78-286,888. PUB. 3-1-2005. FILED 8-13-2003.
- 2,954,773. **KIRKHAM'S**. AAA TENT & AWNING COMPANY, (U.S. CLS. 100, 101 AND 102). SN 78-288,041. PUB. 3-1-2005. FILED 8-15-2003.
- 2,954,777. **AHOLA PAYROLL SERVICES AND DESIGN**. AHOLA CORPORATION, (U.S. CLS. 100, 101 AND 102). SN 78-291,602. PUB. 3-1-2005. FILED 8-25-2003.
- 2,954,780. **THE ST. LOUIS TRUST COMPANY AND DESIGN**. THE ST. LOUIS TRUST COMPANY, MULTIPLE CLASS, (INT. CLS. 35 AND 36), (U.S. CLS. 100, 101 AND 102). SN 78-293,075. PUB. 3-1-2005. FILED 8-27-2003.
- 2,954,785 (*See Class 9 for this trademark*).
- 2,954,794. **VISION YOUTH**. WORLD VISION, INC., MULTIPLE CLASS, (INT. CLS. 35, 36 AND 41), (U.S. CLS. 100, 101, 102 AND 107). SN 78-299,930. PUB. 3-1-2005. FILED 9-12-2003.
- 2,954,824. **MCKESSON MAX REWARDS AND DESIGN**. MCKESSON CORPORATION, (U.S. CLS. 100, 101 AND 102). SN 78-314,181. PUB. 3-1-2005. FILED 10-15-2003.
- 2,954,833. **NEW YORK SUB NEW YORK SUB SINCE 1974 AND DESIGN**. NEW YORK SUB, INC., MULTIPLE CLASS, (INT. CLS. 35 AND 43), (U.S. CLS. 100, 101 AND 102). SN 78-316,276. PUB. 3-1-2005. FILED 10-21-2003.
- 2,954,836. **AUTOBYTEL CONNECT**. AUTOBYTEL INC., (U.S. CLS. 100, 101 AND 102). SN 78-317,855. PUB. 3-1-2005. FILED 10-23-2003.
- 2,954,839. **COMING SOON TO A MAILBOX NEAR YOU**. TCC, LLC, (U.S. CLS. 100, 101 AND 102). SN 78-318,471. PUB. 3-1-2005. FILED 10-24-2003.

- 2,954,840. **SHEPLEY AND DESIGN**. SHEPLEY WOOD PRODUCTS, INC., MULTIPLE CLASS, (INT. CLS. 35 AND 37), (U.S. CLS. 100, 101, 102, 103 AND 106). SN 78-319,025. PUB. 3-1-2005. FILED 10-27-2003.
- 2,954,850. + **ADJUNCT (BLOCK FORM)**. ADJUNCT LLC, (U.S. CLS. 100, 101 AND 102). SN 78-322,936. PUB. 3-1-2005. FILED 11-4-2003.
- 2,954,851. **ARNIE ADJUNCT RISK NUMBER (BLOCK FORM)**. ADJUNCT LLC, (U.S. CLS. 100, 101 AND 102). SN 78-322,958. PUB. 3-1-2005. FILED 11-4-2003.
- 2,954,857 (*See Class 9 for this trademark*).
- 2,954,858. **CAM (BLOCK FORM)**. INTERNATIONAL DATA GROUP, INC., (U.S. CLS. 100, 101 AND 102). SN 78-324,570. PUB. 3-1-2005. FILED 11-7-2003.
- 2,954,869. **PIVOT DESIGN (STYLIZED)**. PIVOT DESIGN, INC., MULTIPLE CLASS, (INT. CLS. 35 AND 42), (U.S. CLS. 100, 101 AND 102). SN 78-328,124. PUB. 3-1-2005. FILED 11-14-2003.
- 2,954,873. **BLAKE BROTHERS (BLOCK FORM)**. BLAKE BROS. INTERNATIONAL, INC., (U.S. CLS. 100, 101 AND 102). SN 78-330,324. PUB. 3-1-2005. FILED 11-19-2003.
- 2,954,875 (*See Class 16 for this trademark*).
- 2,954,886. **REGENT STONE PRODUCTS EQUIPMENT SUPPLIES SERVICE AND DESIGN**. REGENT PRODUCTS, INC., (U.S. CLS. 100, 101 AND 102). SN 78-338,148. PUB. 3-1-2005. FILED 12-9-2003.
- 2,954,908. **A AMERICAN RENTAL AND DESIGN**. FULL-OPEN APPLIANCES, INC., (U.S. CLS. 100, 101 AND 102). SN 78-349,346. PUB. 3-1-2005. FILED 1-8-2004.
- 2,954,909. **BISON.COM (BLOCK FORM)**. BISON ADVERTISING, INC., (U.S. CLS. 100, 101 AND 102). SN 78-349,779. PUB. 3-1-2005. FILED 1-9-2004.
- 2,954,930. **MSEC AND DESIGN**. MOUNTAIN STATES EMPLOYERS COUNCIL, INC., MULTIPLE CLASS, (INT. CLS. 35, 41 AND 42), (U.S. CLS. 100, 101, 102 AND 107). SN 78-363,991. PUB. 3-1-2005. FILED 2-6-2004.
- 2,954,934 (*See Class 5 for this trademark*).
- 2,954,935. **BRANDPULSE (BLOCK FORM)**. INTELLISEEK, INC., (U.S. CLS. 100, 101 AND 102). SN 78-366,128. PUB. 3-1-2005. FILED 2-11-2004.
- 2,954,955. **KINDERTRAINS (BLOCK FORM)**. SYNERGY COMPUTING BUSINESS GROUP, INC., (U.S. CLS. 100, 101 AND 102). SN 78-376,042. PUB. 3-1-2005. FILED 3-1-2004.
- 2,954,969. **THE MORE PAPERLESS (BLOCK FORM)**. ECOMPEX, INC., (U.S. CLS. 100, 101 AND 102). SN 78-380,612. PUB. 3-1-2005. FILED 3-8-2004.
- 2,954,983. **THERE'S NO PLACE LIKE HOM (BLOCK FORM)**. HOM FURNITURE, INC., (U.S. CLS. 100, 101 AND 102). SN 78-387,222. PUB. 12-21-2004. FILED 3-19-2004.
- 2,954,989. **FOCUS ON MAKING PEOPLE HAPPY! AND DESIGN**. CARVEL CORPORATION, (U.S. CLS. 100, 101 AND 102). SN 78-389,221. PUB. 3-1-2005. FILED 3-23-2004.
- 2,954,992. **AUTM ASSOCIATION OF UNIVERSITY TECHNOLOGY MANAGERS, INC. AND DESIGN**. ASSOCIATION OF UNIVERSITY TECHNOLOGY MANAGERS, (U.S. CLS. 100, 101 AND 102). SN 78-389,295. PUB. 3-1-2005. FILED 3-23-2004.
- 2,954,993. **RSPA RETAIL SOLUTIONS PROVIDERS ASSOCIATION AND DESIGN**. RETAIL SOLUTIONS PROVIDERS ASSOCIATION, INC., (U.S. CLS. 100, 101 AND 102). SN 78-389,735. PUB. 3-1-2005. FILED 3-24-2004.
- 2,955,001. **REDEEM THE VOTE (BLOCK FORM)**. REDEEM THE VOTE, INC., (U.S. CLS. 100, 101 AND 102). SN 78-392,952. PUB. 3-1-2005. FILED 3-30-2004.
- 2,955,002. **DOTSTAFF AND DESIGN**. GUIDESOFT, INC., DBA KNOWLEDGE SERVICES, (U.S. CLS. 100, 101 AND 102). SN 78-392,963. PUB. 3-1-2005. FILED 3-30-2004.
- 2,955,003. **AMBRION (BLOCK FORM)**. AMBRION, INC., (U.S. CLS. 100, 101 AND 102). SN 78-393,120. PUB. 3-1-2005. FILED 3-30-2004.
- 2,955,022. **RFD INSIGHT (BLOCK FORM)**. RFD INSIGHT, INC., (U.S. CLS. 100, 101 AND 102). SN 78-397,018. PUB. 3-1-2005. FILED 4-6-2004.
- 2,955,023 (*See Class 16 for this trademark*).
- 2,955,039. **@CONTENT.COM (BLOCK FORM)**. DATA CONTROL CORPORATION, MULTIPLE CLASS, (INT. CLS. 35, 36, 37 AND 42), (U.S. CLS. 100, 101, 102, 103 AND 106). SN 78-399,009. PUB. 3-1-2005. FILED 4-8-2004.
- 2,955,043. **GET IT TOGETHER (BLOCK FORM)**. SHAKER ADVERTISING AGENCY, INC., (U.S. CLS. 100, 101 AND 102). SN 78-399,658. PUB. 3-1-2005. FILED 4-9-2004.
- 2,955,072. **OIS ORIGINAL ITALIAN SLATE AND DESIGN**. ITALIAN TRADE COMMISSION, (U.S. CLS. 100, 101 AND 102). SN 78-410,236. PUB. 3-1-2005. FILED 4-29-2004.
- 2,955,082. **STRETCH MINDS, NOT BUDGETS (BLOCK FORM)**. RED APPLE SCHOOL SUPPLY, INC., (U.S. CLS. 100, 101 AND 102). SN 78-412,790. PUB. 3-1-2005. FILED 5-4-2004.
- 2,955,096. **GROSS TO NET (BLOCK FORM)**. VALENTINE HORSE FARM INC., (U.S. CLS. 100, 101 AND 102). SN 78-415,309. PUB. 3-1-2005. FILED 5-7-2004.
- 2,955,100. **SIMPLY STATED (BLOCK FORM)**. TRUSERV CORPORATION, (U.S. CLS. 100, 101 AND 102). SN 78-416,028. PUB. 3-1-2005. FILED 5-10-2004.
- 2,955,101. **MARC Z (BLOCK FORM)**. LONGFELLOW STAFFING, INC., (U.S. CLS. 100, 101 AND 102). SN 78-416,029. PUB. 3-1-2005. FILED 5-10-2004.
- 2,955,106. **DCWW (BLOCK FORM)**. DC WEB WOMEN, MULTIPLE CLASS, (INT. CLS. 35 AND 41), (U.S. CLS. 100, 101, 102 AND 107). SN 78-416,799. PUB. 3-1-2005. FILED 5-11-2004.
- 2,955,115. **SWEET CONCESSIONS (BLOCK FORM)**. SWEET COCESSIONS, INC., (U.S. CLS. 100, 101 AND 102). SN 78-417,847. PUB. 3-1-2005. FILED 5-13-2004.
- 2,955,131. **MASTERSVISIONS (BLOCK FORM)**. GALLERY ONE, LTD., COMPANY, (U.S. CLS. 100, 101 AND 102). SN 78-419,518. PUB. 3-1-2005. FILED 5-16-2004.
- 2,955,159. **THE AIG EDGE (BLOCK FORM)**. AMERICAN INTERNATIONAL GROUP, INC., (U.S. CLS. 100, 101 AND 102). SN 78-476,570. PUB. 3-1-2005. FILED 8-31-2004.
- 2,955,163 (*See Class 9 for this trademark*).
- 2,955,169 (*See Class 9 for this trademark*).

CLASS 36—INSURANCE AND FINANCIAL

- 2,954,003. **LIBRA**. LIBRA SECURITIES HOLDINGS, LLC, (U.S. CLS. 100, 101 AND 102). SN 75-631,649. PUB. 1-20-2004. FILED 2-2-1999.
- 2,954,012. **METROPOLITAN**. F.N.B. CORPORATION, (U.S. CLS. 100, 101 AND 102). SN 75-876,493. PUB. 6-8-2004. FILED 12-17-1999.
- 2,954,013. **HIGHLAND CAPITAL PARTNERS AND DESIGN**. HIGHLAND CAPITAL PARTNERS, INC., (U.S. CLS. 100, 101 AND 102). SN 75-912,442. PUB. 3-1-2005. FILED 2-8-2000.
- 2,954,019. **MISCELLANEOUS DESIGN**. HANDELSBANKEN VARUMARKES AB, MULTIPLE CLASS, (INT. CLS. 36, 41 AND 42), (U.S. CLS. 100, 101, 102 AND 107). SN 76-050,666. PUB. 3-1-2005. FILED 5-17-2000.
- 2,954,021. **RESOURCEBANK A NATIONAL BANK AND DESIGN**. RESOURCE BANK, NATIONAL ASSOCIATION (N. A.), (U.S. CLS. 100, 101 AND 102). SN 76-063,361. PUB. 10-30-2001. FILED 6-5-2000.
- 2,954,026 (*See Class 9 for this trademark*).
- 2,954,027. **INDIGO CAPITAL**. INDIGO CAPITAL, LLC, (U.S. CLS. 100, 101 AND 102). SN 76-095,747. PUB. 3-1-2005. FILED 7-24-2000.
- 2,954,035. **GOLDRINGS**. AGF MANAGEMENT LIMITED, (U.S. CLS. 100, 101 AND 102). SN 76-124,582. PUB. 9-7-2004. FILED 9-7-2000.
- 2,954,037 (*See Class 9 for this trademark*).
- 2,954,042 (*See Class 35 for this trademark*).
- 2,954,045 (*See Class 9 for this trademark*).
- 2,954,046 (*See Class 9 for this trademark*).
- 2,954,047 (*See Class 9 for this trademark*).
- 2,954,052. **SUNCASH**. MIPS DATALINE TECHNOLOGIES, GMBH, (U.S. CLS. 100, 101 AND 102). SN 76-227,825. PUB. 12-24-2002. FILED 3-21-2001.
- 2,954,054. **MITSUI SUMITOMO INSURANCE**. MITSUI SUMITOMO KAIJO KASAI HOKEN KABUSHIKI KAISHA, (U.S. CLS. 100, 101 AND 102). SN 76-247,829. PUB. 11-9-2004. FILED 4-27-2001.
- 2,954,061 (*See Class 9 for this trademark*).
- 2,954,065. **CIPHER**. CIPHER INVESTMENT MANAGEMENT COMPANY, INC., (U.S. CLS. 100, 101 AND 102). SN 76-

- 289,983. PUB. 3-1-2005. FILED 7-25-2001.
 2,954,080 (*See Class 9 for this trademark*).
 2,954,088 (*See Class 9 for this trademark*).
 2,954,133. **RADIAN EXPRESS (STYLIZED)**. RADIAN GROUP INC., MULTIPLE CLASS, (INT. CLS. 36 AND 42), (U.S. CLS. 100, 101 AND 102). SN 76-463,237. PUB. 7-20-2004. FILED 10-31-2002.
 2,954,139 (*See Class 16 for this trademark*).
 2,954,180. **LIVINGCHOICES**. NETWORK COMMUNICATIONS, INC., (U.S. CLS. 100, 101 AND 102). SN 76-499,362. PUB. 3-1-2005. FILED 3-11-2003.
 2,954,182. **F&C AMETHYST FUND**. F&C MANAGEMENT LIMITED, (U.S. CLS. 100, 101 AND 102). SN 76-499,789. PUB. 7-20-2004. FILED 3-24-2003.
 2,954,186. **THE TICKETRESERVE AND DESIGN**. THE TICKET RESERVE, INC., (U.S. CLS. 100, 101 AND 102). SN 76-501,462. PUB. 3-1-2005. FILED 3-27-2003.
 2,954,212. **SUNSHINEMLS AND DESIGN**. SUNSHINEMLS, LLC, MULTIPLE CLASS, (INT. CLS. 36 AND 41), (U.S. CLS. 100, 101, 102 AND 107). SN 76-510,246. PUB. 9-21-2004. FILED 4-28-2003.
 2,954,238. **MISCELLANEOUS DESIGN**. GEORGIA BREAST CANCER COALITION FUND, (U.S. CLS. 100, 101 AND 102). SN 76-525,835. PUB. 3-1-2005. FILED 6-5-2003.
 2,954,258. **HORICON STATE BANK AND DESIGN**. HORICON BANK, (U.S. CLS. 100, 101 AND 102). SN 76-537,276. PUB. 3-1-2005. FILED 8-13-2003.
 2,954,268 (*See Class 35 for this trademark*).
 2,954,286 (*See Class 35 for this trademark*).
 2,954,311 (*See Class 12 for this trademark*).
 2,954,319. **BLUE VISTA**. BLUE VISTA CAPITAL PARTNERS, LLC, (U.S. CLS. 100, 101 AND 102). SN 76-553,497. PUB. 3-1-2005. FILED 10-23-2003.
 2,954,320. **TINY TOWN USA AND DESIGN**. ROUSE IP, LLC, MULTIPLE CLASS, (INT. CLS. 36 AND 41), (U.S. CLS. 100, 101, 102 AND 107). SN 76-553,931. PUB. 3-1-2005. FILED 10-22-2003.
 2,954,332. **HIWAY CU SERVICES (BLOCK FORM)**. HIWAY FEDERAL CREDIT UNION, (U.S. CLS. 100, 101 AND 102). SN 76-556,566. PUB. 3-1-2005. FILED 11-3-2003.
 2,954,347. **HOME DISCOVERE (BLOCK FORM)**. HOME DISCOVERE REAL ESTATE SERVICES CORPORATION, (U.S. CLS. 100, 101 AND 102). SN 76-559,015. PUB. 3-1-2005. FILED 11-13-2003.
 2,954,352. **GE PRE-AUTHORIZATION SYSTEM (BLOCK FORM)**. GENERAL ELECTRIC COMPANY, (U.S. CLS. 100, 101 AND 102). SN 76-560,588. PUB. 3-1-2005. FILED 11-17-2003.
 2,954,357. **GC AND DESIGN**. GC SERVICES, LP, (U.S. CLS. 100, 101 AND 102). SN 76-561,215. PUB. 3-1-2005. FILED 11-24-2003.
 2,954,360. **PLAN ON US (BLOCK FORM)**. SECURIAN FINANCIAL GROUP, INC., (U.S. CLS. 100, 101 AND 102). SN 76-561,342. PUB. 3-1-2005. FILED 11-21-2003.
 2,954,362. **MAX CASH (BLOCK FORM)**. CAMCO, INC., (U.S. CLS. 100, 101 AND 102). SN 76-561,516. PUB. 3-1-2005. FILED 11-10-2003.
 2,954,437 (*See Class 35 for this trademark*).
 2,954,438. **PROPELS (STYLIZED)**. MORGAN STANLEY, (U.S. CLS. 100, 101 AND 102). SN 76-578,786. PUB. 3-1-2005. FILED 3-1-2004.
 2,954,448. **CIGNATURE - YOUR PLAN. YOUR CHOICE. (BLOCK FORM)**. CIGNA INTELLECTUAL PROPERTY, INC., (U.S. CLS. 100, 101 AND 102). SN 76-579,472. PUB. 3-1-2005. FILED 3-5-2004.
 2,954,464. **BROADWAY BANK (BLOCK FORM)**. BROADWAY BANCSHARES, INC., (U.S. CLS. 100, 101 AND 102). SN 76-583,855. PUB. 3-1-2005. FILED 3-26-2004.
 2,954,471. **HYCUS (BLOCK FORM)**. THE BEAR STEARNS COMPANIES INC., (U.S. CLS. 100, 101 AND 102). SN 76-584,769. PUB. 3-1-2005. FILED 4-5-2004.
 2,954,497. **CFO STRATEGIC PARTNERS (BLOCK FORM)**. CORPORATE FINANCIAL VENTURES, INC., (U.S. CLS. 100, 101 AND 102). SN 76-586,914. PUB. 3-1-2005. FILED 4-15-2004.
 2,954,498. **CFO STRATEGIC PARTNERS AND DESIGN**. CORPORATE FINANCIAL VENTURES, INC., (U.S. CLS. 100, 101 AND 102). SN 76-586,916. PUB. 3-1-2005. FILED 4-15-2004.
 2,954,518. **CHILDREN'S MIRACLE NETWORK AND DESIGN**. OSMOND FOUNDATION, FOR THE CHILDREN OF THE WORLD, DBA CHILDREN'S MIRACLE NETWORK, (U.S. CLS. 100, 101 AND 102). SN 76-588,741. PUB. 3-1-2005. FILED 4-26-2004.
 2,954,530. **PROSERVICES AND DESIGN**. PASSPORT HEALTH COMMUNICATIONS, INC., (U.S. CLS. 100, 101 AND 102). SN 76-589,417. PUB. 3-1-2005. FILED 4-29-2004.
 2,954,540. **LNB (BLOCK FORM)**. THE LAREDO NATIONAL BANK, (U.S. CLS. 100, 101 AND 102). SN 76-590,727. PUB. 3-1-2005. FILED 5-6-2004.
 2,954,541. **FREEDOM TO GROW (BLOCK FORM)**. ANHEUSER-BUSCH EMPLOYEES' CREDIT UNION, (U.S. CLS. 100, 101 AND 102). SN 76-590,730. PUB. 3-1-2005. FILED 5-6-2004.
 2,954,542. **MISCELLANEOUS DESIGN**. ANHEUSER-BUSCH EMPLOYEES' CREDIT UNION, (U.S. CLS. 100, 101 AND 102). SN 76-590,731. PUB. 3-1-2005. FILED 5-6-2004.
 2,954,543. **WORK LIVE JOIN (BLOCK FORM)**. KEYS FEDERAL CREDIT UNION, (U.S. CLS. 100, 101 AND 102). SN 76-590,761. PUB. 3-1-2005. FILED 5-6-2004.
 2,954,548. **1ST C AND DESIGN**. 1ST COMMUNITY FEDERAL CREDIT UNION, (U.S. CLS. 100, 101 AND 102). SN 76-591,127. PUB. 3-1-2005. FILED 5-10-2004.
 2,954,554. **WELDON AND DESIGN**. WELDON CAPITAL FUNDS, INC., (U.S. CLS. 100, 101 AND 102). SN 76-591,192. PUB. 3-1-2005. FILED 5-10-2004.
 2,954,571. **CONNECTING GREAT BRANDS WITH GREAT LOCATIONS (BLOCK FORM)**. PRIME SITES, INC., (U.S. CLS. 100, 101 AND 102). SN 76-591,792. PUB. 3-1-2005. FILED 5-12-2004.
 2,954,585. **DISCOVER YOUR POTENTIAL (BLOCK FORM)**. DISCOVERY COLLEGIATE ADVISORS, INC., (U.S. CLS. 100, 101 AND 102). SN 76-592,330. PUB. 3-1-2005. FILED 5-17-2004.
 2,954,597. **GUIDESTONE AND DESIGN**. ANNUITY BOARD OF THE SOUTHERN BAPTIST CONVENTION, (U.S. CLS. 100, 101 AND 102). SN 76-594,457. PUB. 3-1-2005. FILED 5-28-2004.
 2,954,604. **MISCELLANEOUS DESIGN**. PCCW-HKT DATA-COM SERVICES LIMITED, (U.S. CLS. 100, 101 AND 102). SN 78-037,006. PUB. 3-1-2005. FILED 11-29-2000.
 2,954,614 (*See Class 9 for this trademark*).
 2,954,640 (*See Class 35 for this trademark*).
 2,954,641 (*See Class 35 for this trademark*).
 2,954,642 (*See Class 35 for this trademark*).
 2,954,647 (*See Class 35 for this trademark*).
 2,954,664 (*See Class 35 for this trademark*).
 2,954,674. **BRINK'S AND DESIGN**. BRINK'S NETWORK, INC., (U.S. CLS. 100, 101 AND 102). SN 78-222,631. PUB. 3-1-2005. FILED 3-6-2003.
 2,954,693. **UNITED AMERICAN MORTGAGE**. UNITED AMERICAN MORTGAGE CORPORATION, (U.S. CLS. 100, 101 AND 102). SN 78-232,898. PUB. 3-1-2005. FILED 4-2-2003.
 2,954,696. **PROJECT RENEWAL**. PROJECT RENEWAL, INC., MULTIPLE CLASS, (INT. CLS. 36, 41, 43 AND 44), (U.S. CLS. 100, 101, 102 AND 107). SN 78-234,019. PUB. 3-1-2005. FILED 4-4-2003.
 2,954,701 (*See Class 16 for this trademark*).
 2,954,716. **WIRB WESTERN INTERNATIONAL RECOVERY BUREAU AND DESIGN**. WIRB, INC., (U.S. CLS. 100, 101 AND 102). SN 78-252,868. PUB. 3-1-2005. FILED 5-21-2003.
 2,954,717. **MARINERS ESCROW AND DESIGN**. MARINERS ESCROW CORPORATION, (U.S. CLS. 100, 101 AND 102). SN 78-253,966. PUB. 5-25-2004. FILED 5-23-2003.
 2,954,718. **AMERIVEST PARTNERS, LLC**. AMERIVEST PARTNERS, LLC, (U.S. CLS. 100, 101 AND 102). SN 78-254,497. PUB. 8-17-2004. FILED 5-27-2003.
 2,954,726. **LEASECOMM AND DESIGN**. LEASECOMM CORPORATION, (U.S. CLS. 100, 101 AND 102). SN 78-259,294. PUB. 3-1-2005. FILED 6-6-2003.
 2,954,727. **LEASECOMM**. LEASECOMM CORPORATION, (U.S. CLS. 100, 101 AND 102). SN 78-259,295. PUB. 3-1-2005. FILED 6-6-2003.
 2,954,728. **BIDV AND DESIGN**. BANK FOR INVESTMENT AND DEVELOPMENT OF VIETNAM (BIDV), DBA VIE-

TINDEBANK, (U.S. CLS. 100, 101 AND 102). SN 78-260,243. PUB. 3-1-2005. FILED 6-10-2003.

2,954,740. **E CHEX AND DESIGN**. NATIONAL E COMMERCE, DBA E CHEX. MULTIPLE CLASS, (INT. CLS. 36 AND 40), (U.S. CLS. 100, 101, 102, 103 AND 106). SN 78-268,867. PUB. 3-1-2005. FILED 6-30-2003.

2,954,746. **OPTION PLAN TRUST**. OPTCAPITAL, LLC, (U.S. CLS. 100, 101 AND 102). SN 78-274,204. PUB. 3-1-2005. FILED 7-15-2003.

2,954,761. **BANIF**. BANIF - SGPS, S.A., (U.S. CLS. 100, 101 AND 102). SN 78-282,079. PUB. 3-1-2005. FILED 8-1-2003.

2,954,762. **MISCELLANEOUS DESIGN**. BANIF - SGPS, S.A., (U.S. CLS. 100, 101 AND 102). SN 78-282,100. PUB. 3-1-2005. FILED 8-1-2003.

2,954,778. **WSS SELECT FUNDS**. METROPOLITAN LIFE INSURANCE COMPANY, (U.S. CLS. 100, 101 AND 102). SN 78-291,613. PUB. 3-1-2005. FILED 8-25-2003.

2,954,780 (*See Class 35 for this trademark*).

2,954,794 (*See Class 35 for this trademark*).

2,954,805. **SALDOMINIUM**. MCMULLEN, MICHAEL, (U.S. CLS. 100, 101 AND 102). SN 78-306,414. PUB. 3-1-2005. FILED 9-28-2003.

2,954,809 (*See Class 9 for this trademark*).

2,954,812. **MY OPENCHECK WWW.MYOPENCHECK.COM (STYLIZED)**. NORTH AMERICAN ACCEPTANCE CORPORATION, (U.S. CLS. 100, 101 AND 102). SN 78-308,857. PUB. 3-1-2005. FILED 10-2-2003.

2,954,813. **WALTER'S**. WALTER'S PUBLISHING, MULTIPLE CLASS, (INT. CLS. 36 AND 41), (U.S. CLS. 100, 101, 102 AND 107). SN 78-309,692. PUB. 3-1-2005. FILED 10-6-2003.

2,954,847. **ALPHA OMICRON PI STRIKE OUT ARTHRITIS!**. ALPHA OMICRON PI FOUNDATION, (U.S. CLS. 100, 101 AND 102). SN 78-321,021. PUB. 3-1-2005. FILED 10-30-2003.

2,954,848. **HUDSON CASTLE**. HUDSON CASTLE GROUP INC., (U.S. CLS. 100, 101 AND 102). SN 78-321,079. PUB. 3-1-2005. FILED 10-30-2003.

2,954,855. **LONGSHIP (BLOCK FORM)**. LONGSHIP ALTERNATIVE ASSET MANAGEMENT LLC, (U.S. CLS. 100, 101 AND 102). SN 78-323,456. PUB. 3-1-2005. FILED 11-5-2003.

2,954,857 (*See Class 9 for this trademark*).

2,954,889. **SMART-LOCKS (STYLIZED)**. FIRST-CITIZENS BANK & TRUST COMPANY, (U.S. CLS. 100, 101 AND 102). SN 78-339,684. PUB. 3-1-2005. FILED 12-11-2003.

2,954,987. **DSG DEWITT STERN GROUP (BLOCK FORM)**. DEWITT STERN GROUP, INC., (U.S. CLS. 100, 101 AND 102). SN 78-388,435. PUB. 3-1-2005. FILED 3-22-2004.

2,954,998. **AURARIAN (BLOCK FORM)**. AURARIAN CAPITAL MANAGEMENT, LLC, (U.S. CLS. 100, 101 AND 102). SN 78-391,890. PUB. 3-1-2005. FILED 3-26-2004.

2,955,039 (*See Class 35 for this trademark*).

2,955,041. **FEDERATED DIRECT (BLOCK FORM)**. FEDERATED MUTUAL INSURANCE COMPANY, (U.S. CLS. 100, 101 AND 102). SN 78-399,244. PUB. 3-1-2005. FILED 4-9-2004.

2,955,062. **VENUE LIABILITY PROTECTOR (BLOCK FORM)**. AMERICAN INTERNATIONAL GROUP, INC., (U.S. CLS. 100, 101 AND 102). SN 78-406,538. PUB. 3-1-2005. FILED 4-22-2004.

2,955,063. **EPL HOSPITALITY SELECT (BLOCK FORM)**. AMERICAN INTERNATIONAL GROUP, INC., (U.S. CLS. 100, 101 AND 102). SN 78-406,556. PUB. 3-1-2005. FILED 4-22-2004.

2,955,074. **LATIN POWER (BLOCK FORM)**. CONDUIT CAPITAL PARTNERS, LLC, (U.S. CLS. 100, 101 AND 102). SN 78-410,463. PUB. 3-1-2005. FILED 4-29-2004.

2,955,093. **PB AND DESIGN**. PREMIER BANCSHARES, INC., (U.S. CLS. 100, 101 AND 102). SN 78-415,024. PUB. 3-1-2005. FILED 5-7-2004.

2,955,105. **DPI UNDERWRITING (BLOCK FORM)**. UNITED GUARANTY CORPORATION, (U.S. CLS. 100, 101 AND 102). SN 78-416,199. PUB. 3-1-2005. FILED 5-10-2004.

2,955,113. **RELAX...YOUR CLIENT IS INSURED WITH CHUBB. (BLOCK FORM)**. THE CHUBB CORPORATION, (U.S. CLS. 100, 101 AND 102). SN 78-417,842. PUB. 3-1-2005. FILED 5-13-2004.

2,955,114. **RELAX. YOU'RE INSURED WITH CHUBB. (BLOCK FORM)**. THE CHUBB CORPORATION, (U.S. CLS. 100, 101 AND 102). SN 78-417,843. PUB. 3-1-2005. FILED 5-13-2004.

2,955,145. **MISCELLANEOUS DESIGN**. WACHOVIA CORPORATION, (U.S. CLS. 100, 101 AND 102). SN 78-421,511. PUB. 3-1-2005. FILED 5-19-2004.

2,955,149. **MISCELLANEOUS DESIGN**. THE COASTAL BANK, (U.S. CLS. 100, 101 AND 102). SN 78-421,672. PUB. 3-1-2005. FILED 5-19-2004.

2,955,156. **WORLDRISK TRAVELPAK (BLOCK FORM)**. AMERICAN INTERNATIONAL GROUP, INC., (U.S. CLS. 100, 101 AND 102). SN 78-463,248. PUB. 3-1-2005. FILED 8-6-2004.

2,955,157. **AIG WORLDRISK (BLOCK FORM)**. AMERICAN INTERNATIONAL GROUP, INC., (U.S. CLS. 100, 101 AND 102). SN 78-463,315. PUB. 3-1-2005. FILED 8-6-2004.

2,955,158. **WORLDRISK (BLOCK FORM)**. AMERICAN INTERNATIONAL GROUP, INC., (U.S. CLS. 100, 101 AND 102). SN 78-463,631. PUB. 3-1-2005. FILED 8-6-2004.

2,955,169 (*See Class 9 for this trademark*).

2,955,176. **JCB J/SECURE AND DESIGN**. JCB CO., LTD., (U.S. CLS. 100, 101 AND 102). SN 79-001,431. PUB. 3-1-2005. FILED 1-16-2004.

CLASS 37—CONSTRUCTION AND REPAIR

2,954,015. **3NET AND DESIGN**. 3NET COMMUNICATIONS CORPORATION, MULTIPLE CLASS, (INT. CLS. 37 AND 42), (U.S. CLS. 100, 101, 103 AND 106). SN 75-977,831. PUB. 7-25-2000. FILED 3-4-1998.

2,954,023 (*See Class 9 for this trademark*).

2,954,024 (*See Class 9 for this trademark*).

2,954,029 (*See Class 9 for this trademark*).

2,954,037 (*See Class 9 for this trademark*).

2,954,077 (*See Class 9 for this trademark*).

2,954,084 (*See Class 1 for this trademark*).

2,954,093 (*See Class 16 for this trademark*).

2,954,107. **GENERAL FIBER COMMUNICATIONS**. GENERAL FIBER COMMUNICATIONS, INC., MULTIPLE CLASS, (INT. CLS. 37 AND 42), (U.S. CLS. 100, 101, 103 AND 106). SN 76-418,381. PUB. 9-2-2003. FILED 6-7-2002.

2,954,123. **CAT MBX**. CAT MBX, (U.S. CLS. 100, 103 AND 106). SN 76-452,598. PUB. 3-1-2005. FILED 9-17-2002.

2,954,236 (*See Class 25 for this trademark*).

2,954,268 (*See Class 35 for this trademark*).

2,954,273. **JERRY GREER'S ENGINEERING AND DESIGN**. CUSTOM FABRICATORS, INC., MULTIPLE CLASS, (INT. CLS. 37 AND 40), (U.S. CLS. 100, 103 AND 106). SN 76-542,020. PUB. 3-1-2005. FILED 9-3-2003.

2,954,295. **EI (STYLIZED)**. EPOCH CORPORATION, THE, (U.S. CLS. 100, 103 AND 106). SN 76-547,959. PUB. 3-1-2005. FILED 9-29-2003.

2,954,358. **BOLAND SERVICES (BLOCK FORM)**. BOLAND TRANE SERVICES, INC., DBA BOLAND SERVICES, (U.S. CLS. 100, 103 AND 106). SN 76-561,297. PUB. 3-1-2005. FILED 11-24-2003.

2,954,391. **ESSENTIAL ELEMENTS FOR THE IDEAL WORKPLACE (BLOCK FORM)**. WORKPLACE ESSENTIALS, INC., (U.S. CLS. 100, 103 AND 106). SN 76-567,242. PUB. 3-1-2005. FILED 12-24-2003.

2,954,395. **D R HORTON AMERICA'S BUILDER AND DESIGN**. D.R. HORTON MANAGEMENT COMPANY, LTD., (U.S. CLS. 100, 103 AND 106). SN 76-567,926. PUB. 3-1-2005. FILED 1-2-2004.

2,954,435. **VICTORY HEATING & AIR CONDITIONING (BLOCK FORM)**. VICTORY HEATING & AIR CONDITIONING, INC., (U.S. CLS. 100, 103 AND 106). SN 76-578,006. PUB. 3-1-2005. FILED 2-25-2004.

2,954,453. **FACILITIES TO PERFECTION (BLOCK FORM)**. MAID TO PERFECTION CORPORATION, (U.S. CLS. 100, 103 AND 106). SN 76-581,423. PUB. 3-1-2005. FILED 3-15-2004.

2,954,491. **BARRY PLUMBING AND HEATING AND DESIGN**. JOHN E. BARRY PLUMBING & HEATING CORP., (U.S. CLS. 100, 103 AND 106). SN 76-586,167. PUB. 3-1-2005. FILED 4-12-2004.

2,954,522. **YOUR HOMETOWN ALARM COMPANY (BLOCK FORM)**. SECURITY ASSOCIATES, INC., MULTIPLE CLASS, (INT. CLS. 37 AND 45), (U.S. CLS. 100, 101, 103

AND 106). SN 76-588,867. PUB. 3-1-2005. FILED 4-23-2004.
 2,954,577. **PURSUIT (BLOCK FORM)**. PURSUIT REAL ESTATE SERVICE, INC., (U.S. CLS. 100, 103 AND 106). SN 76-592,002. PUB. 3-1-2005. FILED 5-11-2004.
 2,954,624. **EMPIRE GLASS**. EMPIRE GLASS COMPANIES, INC., (U.S. CLS. 100, 103 AND 106). SN 78-161,357. PUB. 3-1-2005. FILED 9-6-2002.
 2,954,652. **SUN HUNG KAI**. UNITED WAY INVESTMENTS LIMITED, (U.S. CLS. 100, 103 AND 106). SN 78-207,869. PUB. 9-7-2004. FILED 1-28-2003.
 2,954,691 (*See Class 9 for this trademark*).
 2,954,701 (*See Class 16 for this trademark*).
 2,954,745 (*See Class 20 for this trademark*).
 2,954,754. **MSI AND DESIGN**. ENERGY CRANES LLC, (U.S. CLS. 100, 103 AND 106). SN 78-278,660. PUB. 3-1-2005. FILED 7-24-2003.
 2,954,830. **XENERGY**. XENERGY, (U.S. CLS. 100, 103 AND 106). SN 78-315,164. PUB. 3-1-2005. FILED 10-17-2003.
 2,954,840 (*See Class 35 for this trademark*).
 2,954,863. **CLIMATE CARE AND DESIGN**. CLIMATE CARE, (U.S. CLS. 100, 103 AND 106). SN 78-326,537. PUB. 3-1-2005. FILED 11-12-2003.
 2,954,950. **RV TECH ADVANTAGE (BLOCK FORM)**. COACHNET SERVICES GROUP, INC., MULTIPLE CLASS, (INT. CLS. 37 AND 39), (U.S. CLS. 100, 103, 105 AND 106). SN 78-373,862. PUB. 3-1-2005. FILED 2-25-2004.
 2,954,956. **ARBORWOOD HOMES (BLOCK FORM)**. ARBORWOOD HOMES, INC., (U.S. CLS. 100, 103 AND 106). SN 78-376,127. PUB. 3-1-2005. FILED 3-1-2004.
 2,954,975. **LW AND DESIGN**. WISCONSIN LIFT TRUCK CORP., (U.S. CLS. 100, 103 AND 106). SN 78-383,126. PUB. 3-1-2005. FILED 3-12-2004.
 2,954,984. **MISCELLANEOUS DESIGN**. GAMBRO LUNDIA AB, (U.S. CLS. 100, 103 AND 106). SN 78-387,812. PUB. 3-1-2005. FILED 3-19-2004.
 2,955,039 (*See Class 35 for this trademark*).

CLASS 38—COMMUNICATION

2,954,010. **GOAMERICA WIRELESS E-MAIL AND INTERNET TO GO**. GOAMERICA COMMUNICATIONS CORPORATION, (U.S. CLS. 100, 101 AND 104). SN 75-812,876. PUB. 3-1-2005. FILED 10-1-1999.
 2,954,025 (*See Class 9 for this trademark*).
 2,954,026 (*See Class 9 for this trademark*).
 2,954,037 (*See Class 9 for this trademark*).
 2,954,045 (*See Class 9 for this trademark*).
 2,954,046 (*See Class 9 for this trademark*).
 2,954,047 (*See Class 9 for this trademark*).
 2,954,049. **M-TOURISME**. ASSOCIATION TELECOM VALLEY, MULTIPLE CLASS, (INT. CLS. 38, 39, 41 AND 42), (U.S. CLS. 100, 101, 104, 105 AND 107). SN 76-214,409. PUB. 6-8-2004. FILED 2-22-2001.
 2,954,064 (*See Class 9 for this trademark*).
 2,954,077 (*See Class 9 for this trademark*).
 2,954,084 (*See Class 1 for this trademark*).
 2,954,093 (*See Class 16 for this trademark*).
 2,954,159. **SPINALNET**. COLOPLAST A/S, MULTIPLE CLASS, (INT. CLS. 38 AND 44), (U.S. CLS. 100, 101 AND 104). SN 76-486,713. PUB. 9-21-2004. FILED 2-3-2003.
 2,954,219. **TECHNOLOGY OF TOMORROW, SERVICE OF YESTERDAY**. FTTH COMMUNICATIONS, L.L.C., (U.S. CLS. 100, 101 AND 104). SN 76-513,425. PUB. 3-1-2005. FILED 5-8-2003.
 2,954,517. **CHILDREN'S MIRACLE NETWORK AND DESIGN**. OSMOND FOUNDATION, FOR THE CHILDREN OF THE WORLD, DBA CHILDREN'S MIRACLE NETWORK, (U.S. CLS. 100, 101 AND 104). SN 76-588,740. PUB. 3-1-2005. FILED 4-26-2004.
 2,954,614 (*See Class 9 for this trademark*).
 2,954,617 (*See Class 9 for this trademark*).
 2,954,647 (*See Class 35 for this trademark*).
 2,954,653. **SUN HUNG KAI**. UNITED WAY INVESTMENTS LIMITED, (U.S. CLS. 100, 101 AND 104). SN 78-207,893. PUB. 12-14-2004. FILED 1-28-2003.
 2,954,675 (*See Class 9 for this trademark*).

2,954,676. **MISCELLANEOUS DESIGN**. T-MOBILE USA, INC., (U.S. CLS. 100, 101 AND 104). SN 78-223,239. PUB. 7-6-2004. FILED 3-7-2003.
 2,954,691 (*See Class 9 for this trademark*).
 2,954,712 (*See Class 35 for this trademark*).
 2,954,735 (*See Class 9 for this trademark*).
 2,954,799. **BUREAUCAM**. MEDIA 3 LTD., (U.S. CLS. 100, 101 AND 104). SN 78-304,361. PUB. 3-1-2005. FILED 9-23-2003.
 2,954,842. **CENTRA**. CENTRA SOFTWARE, INC., MULTIPLE CLASS, (INT. CLS. 38, 41 AND 42), (U.S. CLS. 100, 101, 104 AND 107). SN 78-319,560. PUB. 10-26-2004. FILED 10-28-2003.
 2,954,857 (*See Class 9 for this trademark*).
 2,954,870. **HELLO (STYLIZED)**. WESTERN WIRELESS CORPORATION, (U.S. CLS. 100, 101 AND 104). SN 78-328,950. PUB. 3-1-2005. FILED 11-17-2003.
 2,954,895. **OSCARLINK (BLOCK FORM)**. HANOUN MEDICAL, (II) U.S., INC., (U.S. CLS. 100, 101 AND 104). SN 78-343,011. PUB. 3-1-2005. FILED 12-18-2003.
 2,954,916. **XONDEMAND (BLOCK FORM)**. XOD, LLC, (U.S. CLS. 100, 101 AND 104). SN 78-353,703. PUB. 3-1-2005. FILED 1-19-2004.
 2,954,922. **FITZEN (BLOCK FORM)**. AGL, (U.S. CLS. 100, 101 AND 104). SN 78-357,471. PUB. 3-1-2005. FILED 1-26-2004.
 2,955,042. **HIGHWAY RADIO (BLOCK FORM)**. KHVY, INC., (U.S. CLS. 100, 101 AND 104). SN 78-399,534. PUB. 3-1-2005. FILED 4-9-2004.
 2,955,127. **NIGHT CALLS (BLOCK FORM)**. PLAYBOY ENTERPRISES INTERNATIONAL, INC., MULTIPLE CLASS, (INT. CLS. 38 AND 41), (U.S. CLS. 100, 101, 104 AND 107). SN 78-418,992. PUB. 3-1-2005. FILED 5-14-2004.

CLASS 39—TRANSPORTATION AND STORAGE

2,953,995 (*See Class 35 for this trademark*).
 2,954,004. **EEXPRESS (BLOCK FORM)**. CNF INC., (U.S. CLS. 100 AND 105). SN 75-648,955. PUB. 7-31-2001. FILED 2-26-1999.
 2,954,007 (*See Class 7 for this trademark*).
 2,954,037 (*See Class 9 for this trademark*).
 2,954,049 (*See Class 38 for this trademark*).
 2,954,084 (*See Class 1 for this trademark*).
 2,954,132. **DOWNUNDER (STYLIZED)**. GOWAY TRAVEL LIMITED, (U.S. CLS. 100 AND 105). SN 76-460,728. PUB. 7-20-2004. FILED 10-22-2002.
 2,954,139 (*See Class 16 for this trademark*).
 2,954,268 (*See Class 35 for this trademark*).
 2,954,298. **HOLIDAZE SKI TOURS (STYLIZED)**. FIVE STAR, INC., MULTIPLE CLASS, (INT. CLS. 39 AND 43), (U.S. CLS. 100, 101 AND 105). SN 76-548,681. PUB. 3-1-2005. FILED 9-16-2003.
 2,954,363 (*See Class 35 for this trademark*).
 2,954,447. **CP CHAMPION PARKING AND DESIGN**. CHAMPION PARKING CORP., (U.S. CLS. 100 AND 105). SN 76-579,464. PUB. 3-1-2005. FILED 3-5-2004.
 2,954,560. **CLUB NAUTICO (BLOCK FORM)**. NAUTICO VENTURES, L.L.C., (U.S. CLS. 100 AND 105). SN 76-591,425. PUB. 3-1-2005. FILED 5-10-2004.
 2,954,637. **ASAP MOVERS**. FREY, MARK, J, (U.S. CLS. 100 AND 105). SN 78-186,254. PUB. 3-1-2005. FILED 11-18-2002.
 2,954,647 (*See Class 35 for this trademark*).
 2,954,654. **SUN HUNG KAI**. UNITED WAY INVESTMENTS LIMITED, (U.S. CLS. 100 AND 105). SN 78-207,913. PUB. 12-14-2004. FILED 1-28-2003.
 2,954,701 (*See Class 16 for this trademark*).
 2,954,702. **BEYOND YOUR DREAMS. WITHIN YOUR REACH.** ALASKA TRAVEL INDUSTRY ASSOCIATION, (U.S. CLS. 100 AND 105). SN 78-238,152. PUB. 3-1-2005. FILED 4-15-2003.
 2,954,704. **TCONS**. TONS CONSOLIDATORS, INC., (U.S. CLS. 100 AND 105). SN 78-239,690. PUB. 3-1-2005. FILED 4-18-2003.
 2,954,817. **SECURE FLIGHT AND DESIGN**. SECUREFLIGHT, INC., (U.S. CLS. 100 AND 105). SN 78-311,383. PUB. 3-1-2005. FILED 10-9-2003.

2,954,950 (*See Class 37 for this trademark.*)
 2,955,066. **STARS AT SEA (BLOCK FORM)**. EVANS, STEVEN W., (U.S. CLS. 100 AND 105). SN 78-407,217. PUB. 3-1-2005. FILED 4-23-2004.

CLASS 40—MATERIAL TREATMENT

2,954,030 (*See Class 9 for this trademark.*)
 2,954,045 (*See Class 9 for this trademark.*)
 2,954,084 (*See Class 1 for this trademark.*)
 2,954,154. **INTERACTIVE ILLUSION**. PHOENIX COLOR CORP., (U.S. CLS. 100, 103 AND 106). SN 76-484,882. PUB. 3-1-2005. FILED 1-24-2003.
 2,954,205 (*See Class 1 for this trademark.*)
 2,954,273 (*See Class 37 for this trademark.*)
 2,954,529. **ENXMEDIA (BLOCK FORM)**. ENXNET, INC., (U.S. CLS. 100, 103 AND 106). SN 76-589,269. PUB. 3-1-2005. FILED 4-29-2004.
 2,954,594. **CREATIVE HEARTS (BLOCK FORM)**. R AND K SALES, INC., (U.S. CLS. 100, 103 AND 106). SN 76-593,060. PUB. 3-1-2005. FILED 5-17-2004.
 2,954,703. **CUSTOM DOORS IN DAYS**. LTL WHOLESALE, INC., DBA LTL HOME PRODUCTS, INC., (U.S. CLS. 100, 103 AND 106). SN 78-238,468. PUB. 3-1-2005. FILED 4-16-2003.
 2,954,740 (*See Class 36 for this trademark.*)
 2,954,872. **W AND DESIGN**. WALDWICK PLASTICS CORPORATION, (U.S. CLS. 100, 103 AND 106). SN 78-329,500. PUB. 3-1-2005. FILED 11-18-2003.
 2,955,155. **THE WORKING GROUP'S CHOICE (BLOCK FORM)**. IMAGEMASTER, INC., (U.S. CLS. 100, 103 AND 106). SN 78-450,175. PUB. 3-1-2005. FILED 7-13-2004.
 2,955,167 (*See Class 4 for this trademark.*)

CLASS 41—EDUCATION AND ENTERTAINMENT

2,954,000. **TIVOLI**. TIVOLI A/S, (U.S. CLS. 100, 101 AND 107). SN 75-529,073. PUB. 3-1-2005. FILED 7-29-1998.
 2,954,006 (*See Class 16 for this trademark.*)
 2,954,019 (*See Class 36 for this trademark.*)
 2,954,026 (*See Class 9 for this trademark.*)
 2,954,037 (*See Class 9 for this trademark.*)
 2,954,038. **WOW WOMEN OF WRESTLING AND DESIGN**. WOMEN OF WRESTLING, INC., (U.S. CLS. 100, 101 AND 107). SN 76-144,172. PUB. 9-2-2003. FILED 10-10-2000.
 2,954,039 (*See Class 16 for this trademark.*)
 2,954,042 (*See Class 35 for this trademark.*)
 2,954,043 (*See Class 3 for this trademark.*)
 2,954,045 (*See Class 9 for this trademark.*)
 2,954,048 (*See Class 35 for this trademark.*)
 2,954,049 (*See Class 38 for this trademark.*)
 2,954,081 (*See Class 9 for this trademark.*)
 2,954,082 (*See Class 9 for this trademark.*)
 2,954,084 (*See Class 1 for this trademark.*)
 2,954,088 (*See Class 9 for this trademark.*)
 2,954,089 (*See Class 9 for this trademark.*)
 2,954,093 (*See Class 16 for this trademark.*)
 2,954,134 (*See Class 16 for this trademark.*)
 2,954,148. **WHERE YOU WANT TO BE**. ROOSEVELT UNIVERSITY, (U.S. CLS. 100, 101 AND 107). SN 76-478,695. PUB. 10-26-2004. FILED 12-27-2002.
 2,954,152 (*See Class 9 for this trademark.*)
 2,954,160 (*See Class 16 for this trademark.*)
 2,954,163 (*See Class 9 for this trademark.*)
 2,954,173 (*See Class 9 for this trademark.*)
 2,954,174 (*See Class 9 for this trademark.*)
 2,954,184 (*See Class 9 for this trademark.*)
 2,954,197 (*See Class 35 for this trademark.*)
 2,954,210. **SUPER GRUPO COLOMBIA**. ISLAS, AARON PEDRAZA, (U.S. CLS. 100, 101 AND 107). SN 76-509,688. PUB. 3-1-2005. FILED 4-28-2003.
 2,954,211. **SHOCK TRIP**. RISTANO, MICHAEL A., SR., (U.S.

CLS. 100, 101 AND 107). SN 76-510,223. PUB. 3-1-2005. FILED 4-28-2003.
 2,954,212 (*See Class 36 for this trademark.*)
 2,954,217. **PAINT N' POTTERY AND DESIGN**. PAINT N POTTERY, INC., (U.S. CLS. 100, 101 AND 107). SN 76-513,131. PUB. 3-1-2005. FILED 4-22-2003.
 2,954,223. **CJ. SPICE ENTERTAINMENT, INC.**, (U.S. CLS. 100, 101 AND 107). SN 76-514,338. PUB. 3-1-2005. FILED 5-15-2003.
 2,954,225. **MCAT AAMC MEDICAL COLLEGE ADMISSION TEST AND DESIGN**. ASSOCIATION OF AMERICAN MEDICAL COLLEGES, (U.S. CLS. 100, 101 AND 107). SN 76-515,729. PUB. 3-1-2005. FILED 5-20-2003.
 2,954,242. **NO LIMIT LACROSSE**. NO LIMIT LACROSSE, INC., (U.S. CLS. 100, 101 AND 107). SN 76-527,257. PUB. 3-16-2004. FILED 6-30-2003.
 2,954,249 (*See Class 16 for this trademark.*)
 2,954,250 (*See Class 16 for this trademark.*)
 2,954,259. **R.E.A.R. RIDE**. HOUSE OF HARLEY-DAVIDSON, INC., (U.S. CLS. 100, 101 AND 107). SN 76-537,416. PUB. 10-26-2004. FILED 8-14-2003.
 2,954,271. **COLUMBIA ATHLETIC CLUBS AND DESIGN**. COLUMBIA ATHLETIC CLUBS, INC., (U.S. CLS. 100, 101 AND 107). SN 76-541,967. PUB. 3-1-2005. FILED 8-22-2003.
 2,954,272. **COLUMBIA FITNESS AND DESIGN**. COLUMBIA ATHLETIC CLUBS, INC., (U.S. CLS. 100, 101 AND 107). SN 76-541,988. PUB. 3-1-2005. FILED 8-22-2003.
 2,954,274. **LIGHTEN UP! FREE YOURSELF FROM CLUTTER**. PASSOFF, MICHELLE, MULTIPLE CLASS, (INT. CLS. 41 AND 45), (U.S. CLS. 100, 101 AND 107). SN 76-542,159. PUB. 3-1-2005. FILED 9-2-2003.
 2,954,296. **CULTURE CLASH**. CULTURE CLASH, (U.S. CLS. 100, 101 AND 107). SN 76-547,962. PUB. 3-1-2005. FILED 9-29-2003.
 2,954,310 (*See Class 16 for this trademark.*)
 2,954,315. **KUDZU YOGA**. CARROLL, TRACI, (U.S. CLS. 100, 101 AND 107). SN 76-552,811. PUB. 3-1-2005. FILED 10-20-2003.
 2,954,318 (*See Class 9 for this trademark.*)
 2,954,320 (*See Class 36 for this trademark.*)
 2,954,324. **ATLANTA RHYTHM SECTION**. ATLANTA RHYTHM SECTION, (U.S. CLS. 100, 101 AND 107). SN 76-554,433. PUB. 3-1-2005. FILED 10-27-2003.
 2,954,343 (*See Class 16 for this trademark.*)
 2,954,367. **AUTUMN HOUSE (BLOCK FORM)**. REVIEW AND HERALD PUBLISHING ASSOCIATION, (U.S. CLS. 100, 101 AND 107). SN 76-561,773. PUB. 3-1-2005. FILED 11-25-2003.
 2,954,379 (*See Class 35 for this trademark.*)
 2,954,380 (*See Class 35 for this trademark.*)
 2,954,408. **MEDS (STYLIZED)**. MEDICAL EDUCATION DEVELOPMENT SERVICES, INC., (U.S. CLS. 100, 101 AND 107). SN 76-569,907. PUB. 3-1-2005. FILED 12-31-2003.
 2,954,416. **UNIVERSITY OF HARTFORD (BLOCK FORM)**. THE UNIVERSITY OF HARTFORD, (U.S. CLS. 100, 101 AND 107). SN 76-571,658. PUB. 3-1-2005. FILED 1-23-2004.
 2,954,418. **THE FEDERALIST PATRIOT (BLOCK FORM)**. PUBLIUS PRESS, INC., (U.S. CLS. 100, 101 AND 107). SN 76-572,636. PUB. 3-1-2005. FILED 1-26-2004.
 2,954,423. **CAL FARLEY'S (BLOCK FORM)**. CAL FARLEY'S BOYS RANCH, DBA CAL FARLEY'S, MULTIPLE CLASS, (INT. CLS. 41, 43 AND 44), (U.S. CLS. 100, 101 AND 107). SN 76-573,584. PUB. 3-1-2005. FILED 2-2-2004.
 2,954,432 (*See Class 16 for this trademark.*)
 2,954,434. **CHEX KNOWLEDGE EXCHANGE (BLOCK FORM)**. CHILD HEALTH CORPORATION OF AMERICA, (U.S. CLS. 100, 101 AND 107). SN 76-577,916. PUB. 3-1-2005. FILED 2-23-2004.
 2,954,452. **PROSPECT AND PROSPER (BLOCK FORM)**. SCHUMAN, JESSICA, (U.S. CLS. 100, 101 AND 107). SN 76-581,033. PUB. 3-1-2005. FILED 3-12-2004.
 2,954,465. **LIFESCRIPTS (BLOCK FORM)**. POLLAN, STEPHEN M., (U.S. CLS. 100, 101 AND 107). SN 76-584,090. PUB. 3-1-2005. FILED 3-29-2004.
 2,954,473. **EPHESIANS 4 NETWORK (BLOCK FORM)**. EPHESIANS 4 NETWORK, INC., (U.S. CLS. 100, 101 AND 107). SN 76-585,151. PUB. 3-1-2005. FILED 4-6-2004.
 2,954,504. **JOFFREY BALLET (BLOCK FORM)**. THE JOFFREY BALLET OF CHICAGO, INC., (U.S. CLS. 100, 101

- AND 107). SN 76-587,748. PUB. 3-1-2005. FILED 4-21-2004.
- 2,954,516. **CHILDREN'S MIRACLE NETWORK AND DESIGN**. OSMOND FOUNDATION, FOR THE CHILDREN OF THE WORLD, DBA CHILDREN'S MIRACLE NETWORK, (U.S. CLS. 100, 101 AND 107). SN 76-588,739. PUB. 3-1-2005. FILED 4-26-2004.
- 2,954,534. **CITYLIT PROJECT, INC. (BLOCK FORM)**. CITYLIT PROJECT, INC., (U.S. CLS. 100, 101 AND 107). SN 76-590,307. PUB. 3-1-2005. FILED 5-3-2004.
- 2,954,538. **NEWSOK.COM (BLOCK FORM)**. THE OKLAHOMA PUBLISHING COMPANY, (U.S. CLS. 100, 101 AND 107). SN 76-590,570. PUB. 3-1-2005. FILED 5-5-2004.
- 2,954,549. **MONSTER TRUCK SHOOTOUT (BLOCK FORM)**. WESTERN CAROLINA PRODUCTIONS, INCORPORATED, (U.S. CLS. 100, 101 AND 107). SN 76-591,134. PUB. 3-1-2005. FILED 5-10-2004.
- 2,954,551 (*See Class 28 for this trademark*).
- 2,954,553. **1000'S OF BEAUTIFUL GIRLS AND 3 UGLY ONES (STYLIZED)**. DEJA VU CONSULTING, INC., (U.S. CLS. 100, 101 AND 107). SN 76-591,190. PUB. 3-1-2005. FILED 5-10-2004.
- 2,954,557. **DIGITIMES DOT-COM AND DESIGN**. DIGITIMES PUBLICATION INC., (U.S. CLS. 100, 101 AND 107). SN 76-591,255. PUB. 3-1-2005. FILED 5-10-2004.
- 2,954,559. **GOLDEN ARM (BLOCK FORM)**. BOYD GAMING CORPORATION, (U.S. CLS. 100, 101 AND 107). SN 76-591,315. PUB. 3-1-2005. FILED 5-6-2004.
- 2,954,561. **CARDIOLATES (BLOCK FORM)**. PILATES CENTER OF NEW YORK, INC., (U.S. CLS. 100, 101 AND 107). SN 76-591,433. PUB. 3-1-2005. FILED 5-10-2004.
- 2,954,569. **THE PROSEN CENTER FOR BUSINESS ADVANCEMENT (BLOCK FORM)**. BUSINESS RESULTS, INC., (U.S. CLS. 100, 101 AND 107). SN 76-591,737. PUB. 3-1-2005. FILED 5-11-2004.
- 2,954,572. **RIDE OF THE PATRIOTS (BLOCK FORM)**. PATRIOT HARLEY-DAVIDSON, INC., (U.S. CLS. 100, 101 AND 107). SN 76-591,828. PUB. 3-1-2005. FILED 5-12-2004.
- 2,954,588. **IMPACT PLUS (BLOCK FORM)**. NATIONAL COUNCIL OF YOUNG MEN'S CHRISTIAN ASSOCIATIONS OF THE UNITED STATES OF AMERICA, (U.S. CLS. 100, 101 AND 107). SN 76-592,486. PUB. 3-1-2005. FILED 5-17-2004.
- 2,954,596 (*See Class 16 for this trademark*).
- 2,954,603. **PS AND DESIGN**. JASPER PRODUCTIONS, INC., (U.S. CLS. 100, 101 AND 107). SN 76-975,860. PUB. 10-5-2004. FILED 7-31-2002.
- 2,954,612. **ULTIMATE FITNESS AND DESIGN**. CARPENTER, DALE F., (U.S. CLS. 100, 101 AND 107). SN 78-111,133. PUB. 7-13-2004. FILED 2-26-2002.
- 2,954,619 (*See Class 9 for this trademark*).
- 2,954,642 (*See Class 35 for this trademark*).
- 2,954,658. **LEWISTON ROUNDUP**. LEWISTON ROUNDUP ASSOCIATION, INC., (U.S. CLS. 100, 101 AND 107). SN 78-210,342. PUB. 3-1-2005. FILED 2-3-2003.
- 2,954,667. **MISCELLANEOUS DESIGN**. AVID CENTER, (U.S. CLS. 100, 101 AND 107). SN 78-218,829. PUB. 6-1-2004. FILED 2-25-2003.
- 2,954,668. **DECADES OF COLLEGE DREAMS**. AVID CENTER, (U.S. CLS. 100, 101 AND 107). SN 78-218,835. PUB. 6-1-2004. FILED 2-25-2003.
- 2,954,675 (*See Class 9 for this trademark*).
- 2,954,684. **EDUCATION IS THE BEST MEDICINE**. IMEDEX, INC., (U.S. CLS. 100, 101 AND 107). SN 78-227,124. PUB. 3-1-2005. FILED 3-18-2003.
- 2,954,696 (*See Class 36 for this trademark*).
- 2,954,706. **CIELO**. CIELO LTD., MULTIPLE CLASS, (INT. CLS. 41 AND 43), (U.S. CLS. 100, 101 AND 107). SN 78-242,711. PUB. 10-26-2004. FILED 4-28-2003.
- 2,954,732. **RHEUMANATIONS**. CONCEPTIS TECHNOLOGIES INC., (U.S. CLS. 100, 101 AND 107). SN 78-264,069. PUB. 3-1-2005. FILED 6-18-2003.
- 2,954,733 (*See Class 8 for this trademark*).
- 2,954,749. **STREIGHT POOL (STYLIZED)**. ADDISON, GARY L., (U.S. CLS. 100, 101 AND 107). SN 78-277,558. PUB. 3-1-2005. FILED 7-22-2003.
- 2,954,767. **YOUTH SALUTE**. NATIONAL COUNCIL ON YOUTH LEADERSHIP, (U.S. CLS. 100, 101 AND 107). SN 78-283,254. PUB. 3-1-2005. FILED 8-5-2003.
- 2,954,794 (*See Class 35 for this trademark*).
- 2,954,810. **PERFORMANCE TRAINING ASSOCIATES, INC.**. NATIONAL TECHNOLOGY TRANSFER, INC., (U.S. CLS. 100, 101 AND 107). SN 78-307,994. PUB. 3-1-2005. FILED 10-1-2003.
- 2,954,813 (*See Class 36 for this trademark*).
- 2,954,815. **WOW DELICIOUS**. MAYONE, KIMBERLY A., (U.S. CLS. 100, 101 AND 107). SN 78-310,683. PUB. 10-26-2004. FILED 10-7-2003.
- 2,954,816. **IQ INSIGHTS QUARTERLY AND DESIGN**. LIPSON ASSOCIATES, INC., DBA LIPSON-ALPORT-GLASS & ASSOCIATES, (U.S. CLS. 100, 101 AND 107). SN 78-311,304. PUB. 3-1-2005. FILED 10-9-2003.
- 2,954,819. **DYNAMIC PRODUCER**. BOOKER, FELISHA A., DBA DYNAMIC PRODUCER, (U.S. CLS. 100, 101 AND 107). SN 78-311,919. PUB. 3-1-2005. FILED 10-10-2003.
- 2,954,826. **WWW.CONTRACTORORIENTATION.COM**. BITTERLICH, R/TERRY, AND BITTERLICH, KRISTINE, (U.S. CLS. 100, 101 AND 107). SN 78-314,237. PUB. 3-1-2005. FILED 10-15-2003.
- 2,954,829 (*See Class 16 for this trademark*).
- 2,954,831. **KIP MCGRATH EDUCATION CENTERS**. KIP MCGRATH EDUCATION CENTRES CORPORATION, (U.S. CLS. 100, 101 AND 107). SN 78-315,171. PUB. 3-1-2005. FILED 10-17-2003.
- 2,954,842 (*See Class 38 for this trademark*).
- 2,954,859. **MASTER STRINGS MUSIC CAMP AND DESIGN**. ORCHESTRA PARENTS/PATRONS' UNITED SUPPORT ASSOCIATION, (U.S. CLS. 100, 101 AND 107). SN 78-324,790. PUB. 3-1-2005. FILED 11-7-2003.
- 2,954,871. **STRIKING POWER AND DESIGN**. PALMER, DIANE L., (U.S. CLS. 100, 101 AND 107). SN 78-329,227. PUB. 3-1-2005. FILED 11-17-2003.
- 2,954,875 (*See Class 16 for this trademark*).
- 2,954,880. **THE SENDING PLACE (BLOCK FORM)**. LUTHERANS AT MISSION BODY AND SOUL (LAMBS), INC., (U.S. CLS. 100, 101 AND 107). SN 78-331,813. PUB. 3-1-2005. FILED 11-22-2003.
- 2,954,888. **CONTOGRAPHER (BLOCK FORM)**. GEIGER, KRAIG, (U.S. CLS. 100, 101 AND 107). SN 78-339,405. PUB. 3-1-2005. FILED 12-11-2003.
- 2,954,892. **JUMPNASTICS! (BLOCK FORM)**. JUMPNASTICS, LLC, (U.S. CLS. 100, 101 AND 107). SN 78-340,590. PUB. 3-1-2005. FILED 12-14-2003.
- 2,954,896. **MEDIARAZZI AND DESIGN**. MEDIARAZZI, INC., (U.S. CLS. 100, 101 AND 107). SN 78-343,205. PUB. 3-1-2005. FILED 12-19-2003.
- 2,954,897. **CENTER FOR LEADERSHIP IN SCHOOL REFORM (BLOCK FORM)**. CENTER FOR LEADERSHIP IN SCHOOL REFORM INC., (U.S. CLS. 100, 101 AND 107). SN 78-343,495. PUB. 3-1-2005. FILED 12-19-2003.
- 2,954,903 (*See Class 16 for this trademark*).
- 2,954,907. **PILATES BY THE SEA (BLOCK FORM)**. PILATES BY THE SEA, (U.S. CLS. 100, 101 AND 107). SN 78-348,917. PUB. 3-1-2005. FILED 1-7-2004.
- 2,954,918. **ROCKIN' AMERICA (BLOCK FORM)**. WALKER ENTERTAINMENT GROUP, (U.S. CLS. 100, 101 AND 107). SN 78-354,562. PUB. 3-1-2005. FILED 1-20-2004.
- 2,954,927. **SIMUNIVERSITY (BLOCK FORM)**. FERLAND, DONALD F., (U.S. CLS. 100, 101 AND 107). SN 78-361,161. PUB. 3-1-2005. FILED 2-2-2004.
- 2,954,930 (*See Class 35 for this trademark*).
- 2,954,940. **ON CALL AND DESIGN**. SOUTH DAKOTA STATE UNIVERSITY, (U.S. CLS. 100, 101 AND 107). SN 78-368,312. PUB. 3-1-2005. FILED 2-15-2004.
- 2,954,948. **SPIRIT OF EXCELLENCE AWARDS (BLOCK FORM)**. SODEXHO OPERATIONS, LLC, (U.S. CLS. 100, 101 AND 107). SN 78-371,925. PUB. 3-1-2005. FILED 2-22-2004.
- 2,954,952. **AMS ENTERTAINMENT (BLOCK FORM)**. AMS FRANCHISE CORPORATION, (U.S. CLS. 100, 101 AND 107). SN 78-374,170. PUB. 3-1-2005. FILED 2-25-2004.
- 2,954,953. **MISCELLANEOUS DESIGN**. DEPARTMENT OF VETERANS AFFAIRS, (U.S. CLS. 100, 101 AND 107). SN 78-374,351. PUB. 3-1-2005. FILED 2-26-2004.
- 2,954,954. **ALS ANGELS (BLOCK FORM)**. ALS SCAN, INC., (U.S. CLS. 100, 101 AND 107). SN 78-375,191. PUB. 3-1-2005. FILED 2-27-2004.

2,954,966. **ALL MEN ARE NOT CREATED EQUAL (BLOCK FORM)**. ZIZZO, THOMAS F., (U.S. CLS. 100, 101 AND 107). SN 78-379,631. PUB. 3-1-2005. FILED 3-5-2004.

2,954,967. **MARIC COLLEGE (BLOCK FORM)**. KAPLAN HIGHER EDUCATION CORPORATION, (U.S. CLS. 100, 101 AND 107). SN 78-380,138. PUB. 3-1-2005. FILED 3-8-2004.

2,954,985. **HURLY BURLY (BLOCK FORM)**. HURLY BURLY PARTNERSHIP, (U.S. CLS. 100, 101 AND 107). SN 78-388,000. PUB. 3-1-2005. FILED 3-20-2004.

2,955,006. **BRINGING YOUR RESUME ALIVE (BLOCK FORM)**. CAREER IMAGING, (U.S. CLS. 100, 101 AND 107). SN 78-394,142. PUB. 3-1-2005. FILED 3-31-2004.

2,955,008. **FEEL THE DIFFERENCE (BLOCK FORM)**. CORDAIRE & PARTNERS COMPANY INC., (U.S. CLS. 100, 101 AND 107). SN 78-394,538. PUB. 3-1-2005. FILED 4-1-2004.

2,955,019. **KINDERFOALS AND DESIGN**. DIETERLE, NANETTE, (U.S. CLS. 100, 101 AND 107). SN 78-396,057. PUB. 3-1-2005. FILED 4-5-2004.

2,955,029. **HOFU (BLOCK FORM)**. HEARTS ON FIRE COMPANY LLC, (U.S. CLS. 100, 101 AND 107). SN 78-397,859. PUB. 3-1-2005. FILED 4-7-2004.

2,955,030 (See Class 16 for this trademark).

2,955,037. **HEARTS ON FIRE UNIVERSITY HOFU EST. 1997 AND DESIGN**. HEARTS ON FIRE COMPANY LLC, (U.S. CLS. 100, 101 AND 107). SN 78-398,452. PUB. 3-1-2005. FILED 4-8-2004.

2,955,040. **JOIN IN (BLOCK FORM)**. STARMARK HOLDINGS, LLC, (U.S. CLS. 100, 101 AND 107). SN 78-399,149. PUB. 3-1-2005. FILED 4-9-2004.

2,955,044. **EDHELPER (BLOCK FORM)**. FREY, RUSSELL E., DBA EDHELPER, (U.S. CLS. 100, 101 AND 107). SN 78-399,898. PUB. 3-1-2005. FILED 4-11-2004.

2,955,054. **TALOSSA (BLOCK FORM)**. MADISON, ROBERT B., (U.S. CLS. 100, 101 AND 107). SN 78-401,395. PUB. 3-1-2005. FILED 4-14-2004.

2,955,058. **FORKLIFSAFETY.COM AND DESIGN**. FORKLIFT SAFETY TRAINING SERVICES, INC., (U.S. CLS. 100, 101 AND 107). SN 78-406,034. PUB. 3-1-2005. FILED 4-21-2004.

2,955,077. **AMERICAN IDOL AND DESIGN**. FREMANTLE-MEDIA NORTH AMERICA, INC., (U.S. CLS. 100, 101 AND 107). SN 78-411,475. PUB. 3-1-2005. FILED 4-30-2004.

2,955,079. **THE EDIBLE SCHOOLYARD AND DESIGN**. THE EDIBLE SCHOOLYARD, (U.S. CLS. 100, 101 AND 107). SN 78-411,601. PUB. 3-1-2005. FILED 4-30-2004.

2,955,081. **THE WISE INVESTOR (BLOCK FORM)**. MALONE, RICHARD W., (U.S. CLS. 100, 101 AND 107). SN 78-412,073. PUB. 3-1-2005. FILED 5-3-2004.

2,955,086. **DONDE TUCSON JUEGA (BLOCK FORM)**. PASCUA YAQUI TRIBE, (U.S. CLS. 100, 101 AND 107). SN 78-413,414. PUB. 3-1-2005. FILED 5-5-2004.

2,955,106 (See Class 35 for this trademark).

2,955,118. **STYLE YOUR OWN SUCCESS. (BLOCK FORM)**. EMPIRE BEAUTY SCHOOL, INC., (U.S. CLS. 100, 101 AND 107). SN 78-418,450. PUB. 3-1-2005. FILED 5-13-2004.

2,955,127 (See Class 38 for this trademark).

2,955,132. **SUBMURSED AND DESIGN**. YOUNG, JAMES, AARON, (U.S. CLS. 100, 101 AND 107). SN 78-419,549. PUB. 3-1-2005. FILED 5-16-2004.

2,955,135. **ALLISON & BUSBY (BLOCK FORM)**. EDITORIAL PRENSA IBERICA, S.A., (U.S. CLS. 100, 101 AND 107). SN 78-420,133. PUB. 3-1-2005. FILED 5-17-2004.

2,955,137. **ABSOLUTE EVIL EAST COAST INDOOR 5 MAN CHAMPIONSHIPS (BLOCK FORM)**. DELMARVA PAINTBALL, (U.S. CLS. 100, 101 AND 107). SN 78-420,184. PUB. 3-1-2005. FILED 5-17-2004.

2,955,153. **MISS IDAHO TEEN USA (BLOCK FORM)**. MISS UNIVERSE L.P., LLLP, (U.S. CLS. 100, 101 AND 107). SN 78-443,714. PUB. 3-1-2005. FILED 6-30-2004.

2,955,154. **MISS IDAHO USA (BLOCK FORM)**. MISS UNIVERSE L.P., LLLP, (U.S. CLS. 100, 101 AND 107). SN 78-443,729. PUB. 3-1-2005. FILED 6-30-2004.

2,955,169 (See Class 9 for this trademark).

CLASS 42—SCIENTIFIC, COMPUTER AND LEGAL SERVICES

2,954,007 (See Class 7 for this trademark).

2,954,008 (See Class 33 for this trademark).

2,954,009 (See Class 1 for this trademark).

2,954,015 (See Class 37 for this trademark).

2,954,016 (See Class 9 for this trademark).

2,954,019 (See Class 36 for this trademark).

2,954,025 (See Class 9 for this trademark).

2,954,026 (See Class 9 for this trademark).

2,954,029 (See Class 9 for this trademark).

2,954,031. **CELERA AND DESIGN**. APPLERA CORPORATION, (U.S. CLS. 100 AND 101). SN 76-118,476. PUB. 9-24-2002. FILED 8-29-2000.

2,954,037 (See Class 9 for this trademark).

2,954,042 (See Class 35 for this trademark).

2,954,045 (See Class 9 for this trademark).

2,954,048 (See Class 35 for this trademark).

2,954,049 (See Class 38 for this trademark).

2,954,050 (See Class 9 for this trademark).

2,954,056. **UPSIDE SOFTWARE**. UPSIDE SOFTWARE INC., (U.S. CLS. 100 AND 101). SN 76-257,660. PUB. 10-28-2003. FILED 5-15-2001.

2,954,064 (See Class 9 for this trademark).

2,954,067 (See Class 5 for this trademark).

2,954,068. **NANOCARRIER**. NANOCARRIER CO., LTD., (U.S. CLS. 100 AND 101). SN 76-300,555. PUB. 3-1-2005. FILED 8-15-2001.

2,954,069. **INDUSTRYSUITE CHANGE WHERE YOU DO BUSINESS, NOT HOW. AND DESIGN**. INDUSTRYSUITE, INC., (U.S. CLS. 100 AND 101). SN 76-300,699. PUB. 3-4-2003. FILED 8-17-2001.

2,954,070 (See Class 1 for this trademark).

2,954,072 (See Class 9 for this trademark).

2,954,077 (See Class 9 for this trademark).

2,954,084 (See Class 1 for this trademark).

2,954,087 (See Class 9 for this trademark).

2,954,088 (See Class 9 for this trademark).

2,954,089 (See Class 9 for this trademark).

2,954,093 (See Class 16 for this trademark).

2,954,096. **LINK TO AMERICA AND DESIGN**. MERLIN DATA PUBLISHING CORPORATION, DBA MERLIN INFORMATION SERVICES, (U.S. CLS. 100 AND 101). SN 76-386,610. PUB. 11-12-2002. FILED 3-25-2002.

2,954,107 (See Class 37 for this trademark).

2,954,111 (See Class 9 for this trademark).

2,954,133 (See Class 36 for this trademark).

2,954,145 (See Class 1 for this trademark).

2,954,151 (See Class 9 for this trademark).

2,954,157. **SOFTOPT AND DESIGN**. PATTERSON, PILAR, (U.S. CLS. 100 AND 101). SN 76-486,078. PUB. 3-1-2005. FILED 1-27-2003.

2,954,173 (See Class 9 for this trademark).

2,954,174 (See Class 9 for this trademark).

2,954,181 (See Class 35 for this trademark).

2,954,183. **HOSTGO (BLOCK FORM)**. FRITSCHNET, INC., DBA HOSTGO.COM, (U.S. CLS. 100 AND 101). SN 76-500,150. PUB. 8-3-2004. FILED 3-14-2003.

2,954,188 (See Class 16 for this trademark).

2,954,197 (See Class 35 for this trademark).

2,954,198 (See Class 9 for this trademark).

2,954,216. **EXHIBIT A VISUAL AIDS FOR THE LEGAL PROFESSION (STYLIZED)**. CARDONI, JOE, (U.S. CLS. 100 AND 101). SN 76-512,826. PUB. 3-1-2005. FILED 5-8-2003.

2,954,240 (See Class 9 for this trademark).

2,954,283. **AIS MEDIA AND DESIGN**. AIS MEDIA, INC., (U.S. CLS. 100 AND 101). SN 76-545,427. PUB. 3-1-2005. FILED 9-17-2003.

2,954,293 (See Class 35 for this trademark).

2,954,304. **REVISION**. REVISION EYEWEAR INC., (U.S. CLS. 100 AND 101). SN 76-550,450. PUB. 3-1-2005. FILED 10-9-2003.

2,954,312 (See Class 35 for this trademark).

2,954,322. **CIRRUS**. CIRRUS TECHNOLOGY, INC., (U.S. CLS. 100 AND 101). SN 76-554,216. PUB. 3-1-2005. FILED 10-27-2003.

2,954,337. **BYTESIZENEWS**. BYTE SIZE TOOLS LLC, (U.S. CLS. 100 AND 101). SN 76-557,659. PUB. 3-1-2005. FILED 10-

- 27-2003.
 2,954,344. **ONE GREAT ANSWER AFTER ANOTHER (BLOCK FORM)**, THE GCRH CORPORATION, (U.S. CLS. 100 AND 101). SN 76-558,371. PUB. 3-1-2005. FILED 11-12-2003.
 2,954,354 (*See Class 35 for this trademark*).
 2,954,385. **RJ LEE GROUP (BLOCK FORM)**, RJ LEE GROUP, INCORPORATED, (U.S. CLS. 100 AND 101). SN 76-565,836. PUB. 3-1-2005. FILED 12-18-2003.
 2,954,419. **CHILD LAB AND DESIGN**, CHILDREN'S HOSPITAL, (U.S. CLS. 100 AND 101). SN 76-572,680. PUB. 3-1-2005. FILED 1-26-2004.
 2,954,437 (*See Class 35 for this trademark*).
 2,954,470. **THE LEADER IN GEOSPATIAL INTELLIGENCE (BLOCK FORM)**, SPATIAL DATA ANALYTICS CORPORATION, (U.S. CLS. 100 AND 101). SN 76-584,549. PUB. 3-1-2005. FILED 3-30-2004.
 2,954,480. **TECHREF (BLOCK FORM)**, SEMCO ENTERPRISES, INC., (U.S. CLS. 100 AND 101). SN 76-585,409. PUB. 3-1-2005. FILED 4-7-2004.
 2,954,496. **DEVICEIQ (STYLIZED)**, DEVICEIQ, INC., (U.S. CLS. 100 AND 101). SN 76-586,912. PUB. 3-1-2005. FILED 4-15-2004.
 2,954,506. **BORDERGUARD (BLOCK FORM)**, BLUE RIDGE NETWORKS, INC., (U.S. CLS. 100 AND 101). SN 76-587,899. PUB. 3-1-2005. FILED 4-21-2004.
 2,954,507. **PORTICOS (BLOCK FORM)**, PORTICOS, INC., (U.S. CLS. 100 AND 101). SN 76-588,025. PUB. 3-1-2005. FILED 4-22-2004.
 2,954,508. **WE TURN GOOD IDEAS INTO GREAT PRODUCTS (BLOCK FORM)**, PORTICOS, INC., (U.S. CLS. 100 AND 101). SN 76-588,026. PUB. 3-1-2005. FILED 4-22-2004.
 2,954,510. **FLIGHTLINE AMERICA AND DESIGN**, COONEY, MICHAEL J., (U.S. CLS. 100 AND 101). SN 76-588,051. PUB. 3-1-2005. FILED 4-19-2004.
 2,954,607. **IP DOX AND DESIGN**, HALO MANAGEMENT, LLC, (U.S. CLS. 100 AND 101). SN 78-079,056. PUB. 2-17-2004. FILED 8-14-2001.
 2,954,614 (*See Class 9 for this trademark*).
 2,954,617 (*See Class 9 for this trademark*).
 2,954,618 (*See Class 1 for this trademark*).
 2,954,623 (*See Class 9 for this trademark*).
 2,954,632 (*See Class 1 for this trademark*).
 2,954,644 (*See Class 7 for this trademark*).
 2,954,655. **SUN HUNG KAI**, UNITED WAY INVESTMENTS LIMITED, (U.S. CLS. 100 AND 101). SN 78-207,933. PUB. 12-14-2004. FILED 1-28-2003.
 2,954,660. **POINTGUARD**, CATERPILLAR INC., (U.S. CLS. 100 AND 101). SN 78-215,626. PUB. 7-6-2004. FILED 2-17-2003.
 2,954,672 (*See Class 9 for this trademark*).
 2,954,691 (*See Class 9 for this trademark*).
 2,954,697. **F&B (STYLIZED)**, FEES & BURGESS, P. C., (U.S. CLS. 100 AND 101). SN 78-236,044. PUB. 1-13-2004. FILED 4-10-2003.
 2,954,707 (*See Class 6 for this trademark*).
 2,954,715. **HELIXLAW**, LUDBROOK, TIMOTHY VIVIAN, (U.S. CLS. 100 AND 101). SN 78-251,982. PUB. 10-26-2004. FILED 5-20-2003.
 2,954,747. **PATTON BOGGS LLP ATTORNEYS AT LAW WWW.PATTONBOGGS.COM AND DESIGN**, PATTON BOGGS LLP, (U.S. CLS. 100 AND 101). SN 78-275,232. PUB. 3-1-2005. FILED 7-16-2003.
 2,954,781. **PHENOMENOME DISCOVERIES**, PHENOMENOME DISCOVERIES, INC., (U.S. CLS. 100 AND 101). SN 78-293,507. PUB. 3-1-2005. FILED 8-28-2003.
 2,954,782. **PD AND DESIGN**, PHENOMENOME DISCOVERIES INC., (U.S. CLS. 100 AND 101). SN 78-293,578. PUB. 3-1-2005. FILED 8-28-2003.
 2,954,798. **ABN MANAGER PRO**, CODECORRECT, (U.S. CLS. 100 AND 101). SN 78-303,436. PUB. 3-1-2005. FILED 9-22-2003.
 2,954,825. **AXONWAVE**, AXONWAVE SOFTWARE, INC., (U.S. CLS. 100 AND 101). SN 78-314,197. PUB. 3-1-2005. FILED 10-15-2003.
 2,954,832. **SCIENTEUR**, SCIENTEUR CORPORATION, MULTIPLE CLASS, (INT. CLS. 42 AND 44), (U.S. CLS. 100 AND 101). SN 78-316,188. PUB. 3-1-2005. FILED 10-21-2003.
 2,954,842 (*See Class 38 for this trademark*).
 2,954,857 (*See Class 9 for this trademark*).
 2,954,869 (*See Class 35 for this trademark*).
 2,954,894. **CLINICAL LOOKING GLASS (BLOCK FORM)**, MONTEFIORE MEDICAL CENTER, (U.S. CLS. 100 AND 101). SN 78-341,403. PUB. 3-1-2005. FILED 12-16-2003.
 2,954,901 (*See Class 9 for this trademark*).
 2,954,915. **COMMUNICATION BEYOND DESIGN (BLOCK FORM)**, TRILLIUM CREATIVE LLC, (U.S. CLS. 100 AND 101). SN 78-353,303. PUB. 3-1-2005. FILED 1-16-2004.
 2,954,930 (*See Class 35 for this trademark*).
 2,954,962. **EZ PUBLISHING (BLOCK FORM)**, EZ PUBLISHING, INC., (U.S. CLS. 100 AND 101). SN 78-376,835. PUB. 3-1-2005. FILED 3-2-2004.
 2,954,972. **QTRAC AND DESIGN**, AUSTRALIA MEAT HOLDINGS PTY LIMITED, (U.S. CLS. 100 AND 101). SN 78-381,882. PUB. 3-1-2005. FILED 3-10-2004.
 2,954,991. **CORNERSTONE LOGIC INC. (STYLIZED)**, CORNERSTONE LOGIC, INC., (U.S. CLS. 100 AND 101). SN 78-389,269. PUB. 3-1-2005. FILED 3-23-2004.
 2,955,020. **LEVANT TECHNOLOGIES (BLOCK FORM)**, LEVANT TECHNOLOGIES, LLC., (U.S. CLS. 100 AND 101). SN 78-396,385. PUB. 3-1-2005. FILED 4-5-2004.
 2,955,033. **Z AND DESIGN**, ZELESKEY, CORNELIUS, HALLMARK, ROPER & HICKS, L.L.P., (U.S. CLS. 100 AND 101). SN 78-397,995. PUB. 3-1-2005. FILED 4-7-2004.
 2,955,035. **HUCKABEE (BLOCK FORM)**, HUCKABEE & ASSOCIATES, INC., (U.S. CLS. 100 AND 101). SN 78-398,139. PUB. 3-1-2005. FILED 4-7-2004.
 2,955,039 (*See Class 35 for this trademark*).
 2,955,080. **STRUCTSOURCE (BLOCK FORM)**, MATTHEWS, ROBERT C., (U.S. CLS. 100 AND 101). SN 78-411,881. PUB. 3-1-2005. FILED 5-2-2004.
 2,955,097. **SHARP IMPACT (BLOCK FORM)**, SHARP IMPACT, INC., (U.S. CLS. 100 AND 101). SN 78-415,618. PUB. 3-1-2005. FILED 5-10-2004.
 2,955,144. **CONJUGON (BLOCK FORM)**, CONJUGON, INC., (U.S. CLS. 100 AND 101). SN 78-421,443. PUB. 3-1-2005. FILED 5-19-2004.
 2,955,150. **C CEPHALON DELIVER MORE AND DESIGN**, CEPHALON, INC., (U.S. CLS. 100 AND 101). SN 78-421,794. PUB. 3-1-2005. FILED 5-19-2004.
 2,955,151. **C AND DESIGN**, CEPHALON, INC., (U.S. CLS. 100 AND 101). SN 78-421,809. PUB. 3-1-2005. FILED 5-19-2004.
 2,955,163 (*See Class 9 for this trademark*).
 2,955,167 (*See Class 4 for this trademark*).
 2,955,169 (*See Class 9 for this trademark*).
-
- CLASS 43—HOTEL AND RESTAURANT SERVICES**
- 2,954,116. **MANGANARO'S HERO BOY**, MANGANARO'S HERO BOY INC., (U.S. CLS. 100 AND 101). SN 76-437,488. PUB. 3-1-2005. FILED 8-5-2002.
 2,954,139 (*See Class 16 for this trademark*).
 2,954,150 (*See Class 16 for this trademark*).
 2,954,163 (*See Class 9 for this trademark*).
 2,954,176. **MISCELLANEOUS DESIGN**, RRI FINANCIAL, INC., (U.S. CLS. 100 AND 101). SN 76-496,818. PUB. 3-1-2005. FILED 3-13-2003.
 2,954,224. **COFFEE BOX AND DESIGN**, CAFE CUMBRE, S.A. DE C. V., (U.S. CLS. 100 AND 101). SN 76-515,314. PUB. 7-27-2004. FILED 5-19-2003.
 2,954,298 (*See Class 39 for this trademark*).
 2,954,317. **FOOD FOR FAMILIES**, HEARST-ARGYLE STATIONS, INC., (U.S. CLS. 100 AND 101). SN 76-553,269. PUB. 3-1-2005. FILED 10-2-2003.
 2,954,363 (*See Class 35 for this trademark*).
 2,954,368. **CRAFTBAR (BLOCK FORM)**, FOODCRAFT, LLC, (U.S. CLS. 100 AND 101). SN 76-561,950. PUB. 3-1-2005. FILED 11-25-2003.
 2,954,423 (*See Class 41 for this trademark*).
 2,954,556. **BUONGIORNO PIZZA & PASTA (BLOCK FORM)**, BUONGIORNO PIZZA AND PASTA, INC., (U.S. CLS. 100 AND 101). SN 76-591,221. PUB. 3-1-2005. FILED 5-10-2004.
 2,954,639. **D DIMILLE'S ITALIAN DELI & PIZZA GROTTO AND DESIGN**, DIMILLE'S, INC., (U.S. CLS. 100 AND 101).

SN 78-198,245. PUB. 9-28-2004. FILED 12-27-2002.
 2,954,646. **CAMP BOW WOW**. FLAMMANG, HEIDI A., (U.S. CLS. 100 AND 101). SN 78-202,868. PUB. 6-8-2004. FILED 1-14-2003.
 2,954,696 (*See Class 36 for this trademark*).
 2,954,701 (*See Class 16 for this trademark*).
 2,954,706 (*See Class 41 for this trademark*).
 2,954,768. **RED CAT JAZZ CAFÉ AND DESIGN**. MPF MANAGEMENT, LLC., (U.S. CLS. 100 AND 101). SN 78-283,420. PUB. 3-1-2005. FILED 8-5-2003.
 2,954,833 (*See Class 35 for this trademark*).
 2,954,838. **SAN FRANCISCO BREAD CO. BAKERY CAFÉ AND DESIGN**. SUKAN INVESTMENTS, INC., (U.S. CLS. 100 AND 101). SN 78-318,313. PUB. 3-1-2005. FILED 10-24-2003.
 2,954,931. **GRAND LODGE AT THE PRESERVE (BLOCK FORM)**. THE GRAND LODGE RETIREMENT COMMUNITY, INC., (U.S. CLS. 100 AND 101). SN 78-364,154. PUB. 3-1-2005. FILED 2-6-2004.
 2,954,933 (*See Class 29 for this trademark*).
 2,954,994. **HOMEWOOD FOR THE HOLIDAYS (BLOCK FORM)**. HILTON HOSPITALITY, INC., (U.S. CLS. 100 AND 101). SN 78-389,996. PUB. 3-1-2005. FILED 3-24-2004.
 2,955,000. **COOL DOWN. DRINK UP. (BLOCK FORM)**. AMERICA'S DRIVE-IN CORP., (U.S. CLS. 100 AND 101). SN 78-392,759. PUB. 3-1-2005. FILED 3-29-2004.
 2,955,015. **SEÑOR TEQUILA'S (BLOCK FORM)**. GRILL, SARA, (U.S. CLS. 100 AND 101). SN 78-395,510. PUB. 3-1-2005. FILED 4-2-2004.
 2,955,026. **FROZEN 2 PERFECTION (BLOCK FORM)**. MCCUBBIN, STACEY L., DBA FROZEN 2 PERFECTION, (U.S. CLS. 100 AND 101). SN 78-397,736. PUB. 3-1-2005. FILED 4-7-2004.
 2,955,068. **MESO (BLOCK FORM)**. EL MESON DE FELIPE INC., (U.S. CLS. 100 AND 101). SN 78-408,483. PUB. 3-1-2005. FILED 4-27-2004.
 2,955,121. **THE MOUNTAIN ROSE INN (BLOCK FORM)**. POGUE, MELODIE, (U.S. CLS. 100 AND 101). SN 78-418,675. PUB. 3-1-2005. FILED 5-14-2004.
 2,955,122. **BANG ON (BLOCK FORM)**. ELEPHANT & CASTLE GROUP, INC., (U.S. CLS. 100 AND 101). SN 78-418,823. PUB. 3-1-2005. FILED 5-14-2004.

CLASS 44—MEDICAL, BEAUTY AND AGRICULTURAL SERVICES

2,954,067 (*See Class 5 for this trademark*).
 2,954,115. **JULIEN FAREL**. JULIEN FAREL LLC, (U.S. CLS. 100 AND 101). SN 76-433,424. PUB. 3-1-2005. FILED 7-16-2002.
 2,954,141 (*See Class 35 for this trademark*).
 2,954,145 (*See Class 1 for this trademark*).
 2,954,159 (*See Class 38 for this trademark*).
 2,954,190. **MISCELLANEOUS DESIGN**. HOUSTON RADIOLOGY, AND RMI PHYSICIAN SERVICES CORPORATION, (U.S. CLS. 100 AND 101). SN 76-504,201. PUB. 3-1-2005. FILED 4-4-2003.
 2,954,191. **MISCELLANEOUS DESIGN**. HOUSTON RADIOLOGY, AND RMI PHYSICIAN SERVICES CORPORATION, (U.S. CLS. 100 AND 101). SN 76-504,202. PUB. 3-1-2005. FILED 4-4-2003.
 2,954,192. **MISCELLANEOUS DESIGN**. HOUSTON RADIOLOGY, AND RMI PHYSICIAN SERVICES CORPORATION, (U.S. CLS. 100 AND 101). SN 76-504,203. PUB. 3-1-2005. FILED 4-4-2003.
 2,954,193. **MISCELLANEOUS DESIGN**. HOUSTON RADIOLOGY, AND RMI PHYSICIAN SERVICES CORPORATION, (U.S. CLS. 100 AND 101). SN 76-504,204. PUB. 3-1-2005. FILED 4-4-2003.
 2,954,194. **MISCELLANEOUS DESIGN**. HOUSTON RADIOLOGY, AND RMI PHYSICIAN SERVICES CORPORATION, (U.S. CLS. 100 AND 101). SN 76-504,205. PUB. 3-1-2005. FILED 4-4-2003.
 2,954,195. **MISCELLANEOUS DESIGN**. HOUSTON RADIOLOGY, AND RMI PHYSICIAN SERVICES CORPORATION, (U.S. CLS. 100 AND 101). SN 76-504,206. PUB. 3-1-2005. FILED 4-4-2003.

2,954,198 (*See Class 9 for this trademark*).
 2,954,240 (*See Class 9 for this trademark*).
 2,954,307. **BEACON SPECIALTY HOSPITAL**. NEXUS HEALTH SYSTEMS, LTD., (U.S. CLS. 100 AND 101). SN 76-551,217. PUB. 3-1-2005. FILED 9-22-2003.
 2,954,364. **UNITED SITE SERVICES AND DESIGN**. UNITED SITE SERVICES, INC., (U.S. CLS. 100 AND 101). SN 76-561,651. PUB. 3-1-2005. FILED 11-12-2003.
 2,954,365. **UNITED SITE SERVICES AND DESIGN**. UNITED SITE SERVICES, INC., (U.S. CLS. 100 AND 101). SN 76-561,652. PUB. 3-1-2005. FILED 11-12-2003.
 2,954,366. **UNITED SITE SERVICES AND DESIGN**. UNITED SITE SERVICES, INC., (U.S. CLS. 100 AND 101). SN 76-561,657. PUB. 3-1-2005. FILED 11-12-2003.
 2,954,423 (*See Class 41 for this trademark*).
 2,954,444. **AQUAHAB REHABILITATION (BLOCK FORM)**. AQUAHAB, L.P., (U.S. CLS. 100 AND 101). SN 76-579,299. PUB. 3-1-2005. FILED 3-5-2004.
 2,954,515. **CARON NEW YORK RECOVERY CENTER (BLOCK FORM)**. CARON FOUNDATION OF NEW YORK, INC., (U.S. CLS. 100 AND 101). SN 76-588,687. PUB. 3-1-2005. FILED 4-26-2004.
 2,954,523. **HANSEN'S AND DESIGN**. HANSEN'S TREE, LAWN AND LANDSCAPING SERVICES, INC., (U.S. CLS. 100 AND 101). SN 76-588,942. PUB. 3-1-2005. FILED 4-27-2004.
 2,954,533. **MISCELLANEOUS DESIGN**. ALAN I. ROSENBLATT, MD, SC, (U.S. CLS. 100 AND 101). SN 76-590,284. PUB. 3-1-2005. FILED 5-3-2004.
 2,954,579. **ACU-GLOW (BLOCK FORM)**. PERI, CHARLES E., (U.S. CLS. 100 AND 101). SN 76-592,057. PUB. 3-1-2005. FILED 5-13-2004.
 2,954,696 (*See Class 36 for this trademark*).
 2,954,796. **BETTER TAN AND DESIGN**. VIDEO TREATS INC., (U.S. CLS. 100 AND 101). SN 78-300,306. PUB. 3-1-2005. FILED 9-15-2003.
 2,954,832 (*See Class 42 for this trademark*).
 2,954,835. **ANKONY**. ANKONY LAND, INC., (U.S. CLS. 100 AND 101). SN 78-317,842. PUB. 3-1-2005. FILED 10-23-2003.
 2,954,865. **LOYOLA UNIVERSITY MEDICAL CENTER (BLOCK FORM)**. LOYOLA UNIVERSITY OF CHICAGO, (U.S. CLS. 100 AND 101). SN 78-327,291. PUB. 3-1-2005. FILED 11-13-2003.
 2,954,866. **LOYOLA UNIVERSITY HEALTH SYSTEM (BLOCK FORM)**. LOYOLA UNIVERSITY OF CHICAGO, (U.S. CLS. 100 AND 101). SN 78-327,298. PUB. 3-1-2005. FILED 11-13-2003.
 2,954,926. **ASPIRE CHANGE UNDERSTAND BORIS THOMAS LCSW, MSW, JD PSYCHOTHERAPY AND CONSULTATION AND DESIGN**. THOMAS, BORIS, (U.S. CLS. 100 AND 101). SN 78-360,918. PUB. 3-1-2005. FILED 2-2-2004.
 2,954,946. **RESPIRA MEDICAL RESPIRATORY & HOME MEDICAL SPECIALISTS (STYLIZED)**. MARIA, WELCH, Y., (U.S. CLS. 100 AND 101). SN 78-369,324. PUB. 3-1-2005. FILED 2-17-2004.
 2,954,981. **REACH BEYOND THE BOX AND DESIGN**. SABINE GRANDKE-BAYER, (U.S. CLS. 100 AND 101). SN 78-386,277. PUB. 3-1-2005. FILED 3-17-2004.
 2,954,999. **AESTHETIC CONCEPTS AND DESIGN**. RICHARD A. GANGNES M.D., INC., (U.S. CLS. 100 AND 101). SN 78-391,925. PUB. 3-1-2005. FILED 3-26-2004.
 2,955,021. **INTERNATIONAL CENTER FOR VASECTOMY REVERSAL (BLOCK FORM)**. MARKS, SHELDON H., (U.S. CLS. 100 AND 101). SN 78-396,626. PUB. 3-1-2005. FILED 4-5-2004.
 2,955,148. **CROPX (BLOCK FORM)**. TARALAN CORPORATION, (U.S. CLS. 100 AND 101). SN 78-421,665. PUB. 3-1-2005. FILED 5-19-2004.

CLASS 45—PERSONAL SERVICES

2,954,274 (*See Class 41 for this trademark*).
 2,954,462. **THE SENTINEL GROUP (BLOCK FORM)**. TRUSTMARK INSURANCE COMPANY, (U.S. CLS. 100 AND 101). SN 76-583,473. PUB. 3-1-2005. FILED 3-29-2004.
 2,954,522 (*See Class 37 for this trademark*).

- 2,954,580 (*See Class 9 for this trademark*).
- 2,954,625 (*See Class 6 for this trademark*).
- 2,954,642 (*See Class 35 for this trademark*).
- 2,954,861. **US ONESEARCH (BLOCK FORM)**. KESSLER, CRAIG, (U.S. CLS. 100 AND 101). SN 78-325,361. PUB. 3-1-2005. FILED 11-10-2003.
- 2,954,890. **CELEBRATION OF LIGHT CHURCH (BLOCK FORM)**. CELEBRATION OF LIGHT CHURCH, INC., (U.S. CLS. 100 AND 101). SN 78-339,751. PUB. 3-1-2005. FILED 12-11-2003.
- 2,954,965. **MATCHING YOUR POTENTIAL TO GOD'S PASSION (BLOCK FORM)**. CENTER FOR GLOBAL MINISTRIES, (U.S. CLS. 100 AND 101). SN 78-378,241. PUB. 3-1-2005. FILED 3-4-2004.
- 2,954,973. **PINCHECK (BLOCK FORM)**. PINCHECK, L.C., (U.S. CLS. 100 AND 101). SN 78-382,220. PUB. 3-1-2005. FILED 3-11-2004.
- 2,955,038. **COMPLYCHEK (BLOCK FORM)**. FDS, INC., (U.S. CLS. 100 AND 101). SN 78-398,859. PUB. 3-1-2005. FILED 4-8-2004.
- 2,955,116. **MISCELLANEOUS DESIGN**. CHURCH AND CHAPEL FUNERAL SERVICES, INC., (U.S. CLS. 100 AND 101). SN 78-417,972. PUB. 3-1-2005. FILED 5-13-2004.

* * * * *

SECTION 2.—PRIOR UNITED STATES CLASSIFICATION

COLLECTIVE MEMBERSHIP MARKS

CLASS 200—COLLECTIVE MEMBERSHIP

2,955,111. **RSPA RETAIL SOLUTIONS PROVIDERS ASSOCIATION AND DESIGN.** RETAIL SOLUTIONS PROVIDERS ASSOCIATION, INC., SN 78-417,273. PUB. 3-1-2005. FILED 5-12-2004.

CERTIFICATION MARKS

CLASS A—GOODS

2,954,316. **OTCO AND DESIGN.** OREGON TILTH, INC., SN 76-552,937. PUB. 3-1-2005. FILED 10-2-2003.

2,954,681. **TPC-C.** TRANSACTION PROCESSING PERFORMANCE COUNCIL, SN 78-225,159. PUB. 3-1-2005. FILED 3-13-2003.

2,954,682. **TPC BENCHMARK.** TRANSACTION PROCESSING PERFORMANCE COUNCIL, SN 78-225,177. PUB. 3-1-2005. FILED 3-13-2003.

* * * * *

TRADEMARK REGISTRATIONS ISSUED UNDER SECTION 1(d)

The following marks have registered on the Principal Register pursuant to the intent-to-use provisions of Section 1(d) of the Trademark Act of 1946, as amended.

SECTION 1.— INTERNATIONAL CLASSIFICATION

The short titles associated below with the international class numbers are terms designed merely for quick identification and are not an official part of the international classification. The full names of international classes are given in section 6.1 of the trademark rules of practice.

The designation "U.S. Cl." appearing in this section refers to the U.S. class in effect prior to Sep. 1, 1973 rather than the international class which applies to applications filed on or after that date. For adoption of international classification see notice in the OFFICIAL GAZETTE of Jun. 26, 1973 (911 O.G. TM 210).

Application in more than one class

2,955,194. MATTEL, INC., EL SEGUNDO, CA. SN 75-756,895.
PUB. 6-19-2001, FILED 7-21-1999.

BARBIE AVENUE

OWNER OF U.S. REG. NOS. 689,055, 772,298, AND OTHERS.

CLASS 9—ELECTRICAL AND SCIENTIFIC APPARATUS

FOR SUNGLASSES (U.S. CLS. 21, 23, 26, 36 AND 38).
FIRST USE 3-11-2003; IN COMMERCE 3-11-2003.

CLASS 14—JEWELRY

FOR CLOCKS; ANKLE BRACELETS; COSTUME JEWELRY; RINGS BEING JEWELRY; EARRINGS; BRACELETS; NECKLACES AND CHARMS; LOCKETS (U.S. CLS. 2, 27, 28 AND 50).
FIRST USE 2-11-2004; IN COMMERCE 2-11-2004.

CLASS 16—PAPER GOODS AND PRINTED MATTER

FOR PAPER BOXES (U.S. CLS. 2, 5, 22, 23, 29, 37, 38 AND 50).
FIRST USE 3-11-2003; IN COMMERCE 3-11-2003.

CLASS 18—LEATHER GOODS

FOR BACKPACKS; HANDBAGS; PURSES; COSMETIC CASES (U.S. CLS. 1, 2, 3, 22 AND 41).
FIRST USE 3-11-2003; IN COMMERCE 3-11-2003.

CLASS 20—FURNITURE AND ARTICLES NOT OTHERWISE CLASSIFIED

FOR JEWELRY BOXES NOT OF METAL; SNOW GLOBES (U.S. CLS. 2, 13, 22, 25, 32 AND 50).
FIRST USE 7-17-2003; IN COMMERCE 7-17-2003.

CLASS 21—HOUSEWARES AND GLASS

FOR NON-METAL PLATES, CUPS AND BOWLS; PORCELAIN FIGURINES; PLASTIC CUPS; DRINKING GLASSES; MUGS; TEA SETS FEATURING PLATES, SAUCERS, CUPS, POTS AND PITCHERS; NON-METAL DECORATIVE BOXES; FITTED PICNIC BASKETS (U.S. CLS. 2, 13, 23, 29, 30, 33, 40 AND 50).
FIRST USE 7-13-2003; IN COMMERCE 7-17-2003.

CLASS 24—FABRICS

FOR BED BLANKETS (U.S. CLS. 42 AND 50).
FIRST USE 3-31-2001; IN COMMERCE 3-31-2001.

CLASS 25—CLOTHING

FOR BATHING SUITS; BERETS; HATS; HEADWEAR; CAPS; SWIMSUITS (U.S. CLS. 22 AND 39).
FIRST USE 1-17-2003; IN COMMERCE 1-17-2003.

2,955,197. AVCJ HOLDINGS LIMITED, WANCHAI, HONG KONG. SN 75-840,638. PUB. 11-18-2003, FILED 11-3-1999.

QIOSK.COM

CLASS 9—ELECTRICAL AND SCIENTIFIC APPARATUS

FOR DOWNLOADABLE ELECTRONIC PUBLICATIONS IN THE NATURE OF JOURNALS IN A WIDE RANGE OF FIELDS (U.S. CLS. 21, 23, 26, 36 AND 38).
FIRST USE 3-0-1999; IN COMMERCE 10-0-1999.

CLASS 41—EDUCATION AND ENTERTAINMENT

FOR ELECTRONIC PUBLISHING SERVICES, NAMELY PUBLICATION OF TEXT AND GRAPHIC WORKS OF OTHERS ON A GLOBAL COMPUTER NETWORK (U.S. CLS. 100, 101 AND 107).
FIRST USE 3-0-1999; IN COMMERCE 10-0-1999.

CLASS 42—SCIENTIFIC, COMPUTER AND LEGAL SERVICES

FOR PROVIDING ON-LINE JOURNALS IN A WIDE RANGE OF FIELDS (U.S. CLS. 100 AND 101).
FIRST USE 3-0-1999; IN COMMERCE 10-0-1999.

2,955,199. KABUSHIKI KAISHA RED ENTERTAINMENT, TOKYO, JAPAN. SN 75-859,359. PUB. 6-12-2001, FILED 11-29-1999.

ROBOPON**CLASS 9—ELECTRICAL AND SCIENTIFIC APPARATUS**

FOR COMPUTER VIDEO GAMES SOFTWARE STORED ON CARTRIDGES, CASSETTES AND COMPUTER DISCS (U.S. CLS. 21, 23, 26, 36 AND 38).
FIRST USE 12-11-2000; IN COMMERCE 12-11-2000.

CLASS 16—PAPER GOODS AND PRINTED MATTER

FOR BOOKLETS FOR COMPUTER VIDEO GAMES (U.S. CLS. 2, 5, 22, 23, 29, 37, 38 AND 50).
FIRST USE 12-11-2000; IN COMMERCE 12-11-2000.

2,955,203. SHOW OF THE MONTH CLUB, LLC, BOSTON, MA. SN 75-906,079. PUB. 9-4-2001, FILED 1-28-2000.

SHOW OF THE MONTH CLUB**CLASS 35—ADVERTISING AND BUSINESS**

FOR THEATRICAL TICKET AGENCIES (U.S. CLS. 100, 101 AND 102).
FIRST USE 1-20-2000; IN COMMERCE 1-20-2000.

CLASS 41—EDUCATION AND ENTERTAINMENT

FOR ARRANGING FOR TICKET RESERVATIONS FOR SHOWS AND OTHER ENTERTAINMENT EVENTS (U.S. CLS. 100, 101 AND 107).
FIRST USE 1-20-2000; IN COMMERCE 1-20-2000.

2,955,205. BADER, SHAWN EDWARD, WACCABUC, NY. SN 75-930,284. PUB. 12-11-2001, FILED 2-13-2000.

ALPHAPET**CLASS 35—ADVERTISING AND BUSINESS**

FOR ON-LINE RETAIL MAIL ORDER SERVICES, ON-LINE RETAIL STORE SERVICES PROVIDED VIA A GLOBAL COMMUNICATION INFORMATION NETWORK, RETAIL MAIL ORDER SERVICES AND RETAIL STORE SERVICES ALL FEATURING PET TRAINING APPARATUS, PET CARE AIDS AND PET FURNISHINGS, AND PROVIDING PRODUCT INFORMATION ABOUT THE AFOREMENTIONED GOODS (U.S. CLS. 100, 101 AND 102).
FIRST USE 6-18-1996; IN COMMERCE 8-15-2004.

CLASS 42—SCIENTIFIC, COMPUTER AND LEGAL SERVICES

FOR PROVIDING INFORMATION AND ADVICE, VIA A GLOBAL COMPUTER NETWORK, REGARDING PET CARE, PET TRAINING; PET BREEDING; IDENTIFICATION AND LOCATION OF PET BREEDERS OF DOGS, CATS, BIRDS, HORSES, AND OTHER EXOTIC PETS; AND PET HEALTH; AND LEGAL AND CARE ISSUES PERTAINING TO PETS (U.S. CLS. 100 AND 101).
FIRST USE 6-18-1996; IN COMMERCE 8-15-2004.

2,955,210. INSPIRATIONAL NETWORK, INC., THE, CHARLOTTE, NC. SN 76-013,396. PUB. 12-18-2001, FILED 3-30-2000.

THE DJ CLUB

NO CLAIM IS MADE TO THE EXCLUSIVE RIGHT TO USE "CLUB", APART FROM THE MARK AS SHOWN.

CLASS 16—PAPER GOODS AND PRINTED MATTER

FOR PUBLICATIONS, NAMELY, BOOKS, PAMPHLETS, BOOKS FEATURING BIBLE STUDY (U.S. CLS. 2, 5, 22, 23, 29, 37, 38 AND 50).
FIRST USE 1-1-2002; IN COMMERCE 1-1-2002.

CLASS 41—EDUCATION AND ENTERTAINMENT

FOR FAN CLUB SERVICES (U.S. CLS. 100, 101 AND 107).
FIRST USE 8-6-2000; IN COMMERCE 8-6-2000.

2,955,213. ON TOP OF THE WORLD COMMUNITIES, INC., OCALA, FL. SN 76-021,536. PUB. 10-30-2001, FILED 4-10-2000.

CIRCLE SQUARE RANCH

NO CLAIM IS MADE TO THE EXCLUSIVE RIGHT TO USE "RANCH", APART FROM THE MARK AS SHOWN.

CLASS 36—INSURANCE AND FINANCIAL

FOR REAL ESTATE BROKERAGE AND MANAGEMENT SERVICES (U.S. CLS. 100, 101 AND 102).
FIRST USE 8-4-2004; IN COMMERCE 8-4-2004.

CLASS 37—CONSTRUCTION AND REPAIR

FOR LAND DEVELOPMENT SERVICE, NAMELY, PLANNING AND LAYING OUT OF RESIDENTIAL AND/OR COMMERCIAL COMMUNITIES (U.S. CLS. 100, 103 AND 106).
FIRST USE 8-4-2004; IN COMMERCE 8-4-2004.

2,955,217. INSPIRATIONAL NETWORK, INC., THE, CHARLOTTE, NC. SN 76-038,798. PUB. 2-19-2002, FILED 5-2-2000.



OWNER OF U.S. REG. NO. 2,234,359.

CLASS 16—PAPER GOODS AND PRINTED MATTER

FOR PUBLICATIONS, NAMELY, BOOKS, PAMPHLETS, BOOKS FEATURING BIBLE STUDY TOPICS (U.S. CLS. 2, 5, 22, 23, 29, 37, 38 AND 50).
FIRST USE 1-31-2002; IN COMMERCE 1-31-2002.

CLASS 38—COMMUNICATION

FOR ELECTRONIC MAIL SERVICES; TELEVISION BROADCASTING (U.S. CLS. 100, 101 AND 104).
FIRST USE 12-4-2000; IN COMMERCE 12-4-2000.

CLASS 41—EDUCATION AND ENTERTAINMENT

FOR FAN CLUB SERVICES (U.S. CLS. 100, 101 AND 107).
FIRST USE 12-4-2000; IN COMMERCE 12-4-2000.

2,955,231. INTERMIX MEDIA, INC., LOS ANGELES, CA. SN 76-091,908. PUB. 9-10-2002, FILED 7-19-2000.

SUPERNATING SUPERDUDES

CLASS 9—ELECTRICAL AND SCIENTIFIC APPARATUS

FOR DOWNLOADABLE ELECTRONIC PUBLICATIONS IN THE NATURE OF FICTIONAL BACKGROUND OR GAMING TIPS IN THE FIELD OF ENTERTAINMENT OR SCIENCE FICTION; DOWNLOADABLE COMPUTER GAME SOFTWARE (U.S. CLS. 21, 23, 26, 36 AND 38).
FIRST USE 1-1-2000; IN COMMERCE 1-1-2000.

CLASS 41—EDUCATION AND ENTERTAINMENT

FOR PROVIDING ON-LINE INFORMATION IN THE FIELD OF ENTERTAINMENT, NAMELY, FICTIONAL STORIES, TIPS AND INFORMATION ON ON-LINE GAMING AND CELEBRITY INTERVIEWS; ENTERTAINMENT SERVICES, NAMELY, PROVIDING ON-LINE COMPUTER GAMES VIA THE INTERNET (U.S. CLS. 100, 101 AND 107).
FIRST USE 1-1-2000; IN COMMERCE 1-1-2000.

2,955,233. ARCHIPELAGO HOLDINGS, LLC, CHICAGO, IL. SN 76-118,673. PUB. 9-17-2002, FILED 8-29-2000.

WAVE SECURITIES

NO CLAIM IS MADE TO THE EXCLUSIVE RIGHT TO USE "SECURITIES", APART FROM THE MARK AS SHOWN.

CLASS 16—PAPER GOODS AND PRINTED MATTER

FOR NEWSLETTERS, BROCHURES, AND PAMPHLETS, LEAFLETS AND FLYERS IN THE FIELDS OF SECURITIES, OPTIONS, BONDS AND OTHER FINANCIAL INSTRUMENTS (U.S. CLS. 2, 5, 22, 23, 29, 37, 38 AND 50).
FIRST USE 5-0-2002; IN COMMERCE 5-0-2002.

CLASS 36—INSURANCE AND FINANCIAL

FOR BROKER-DEALER SERVICES IN THE FIELDS OF SECURITIES, OPTIONS, BONDS, AND OTHER FINANCIAL INSTRUMENTS; RESEARCH SERVICES FOR OTHERS IN THE FIELD OF SECURITIES, OPTIONS, BONDS, AND OTHER FINANCIAL INSTRUMENTS (U.S. CLS. 100, 101 AND 102).
FIRST USE 10-0-2002; IN COMMERCE 10-0-2002.

2,955,235. CONTACTMUSIC.COM.LIMITED, ILKLEY, WEST YORKSHIRE, ENGLAND. SN 76-137,362. PUB. 9-24-2002, FILED 9-28-2000.

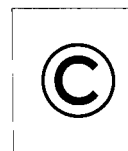

contactmusic.com

CLASS 9—ELECTRICAL AND SCIENTIFIC APPARATUS

FOR DOWNLOADABLE ELECTRONIC PUBLICATIONS IN THE NATURE OF MAGAZINES AND NEWSLETTERS CONCERNING MUSIC AND PERFORMERS; DOWNLOADABLE MUSICAL SOUND AND VIDEO RECORDINGS (U.S. CLS. 21, 23, 26, 36 AND 38).
FIRST USE 0-0-2002; IN COMMERCE 0-0-2002.

CLASS 35—ADVERTISING AND BUSINESS

FOR PUBLICITY AGENTS; MUSICAL TALENT AND THEATRICAL AGENCIES; OPINION POLLING OF THE POPULARITY OF MUSICIANS AND MUSIC FOR BUSINESS OR ADVERTISING PURPOSES (U.S. CLS. 100, 101 AND 102).
FIRST USE 0-0-2002; IN COMMERCE 0-0-2002.

CLASS 41—EDUCATION AND ENTERTAINMENT

FOR PROVIDING AN ON-LINE COMPUTER DATABASE IN THE FIELD OF MUSIC AND PERFORMERS; ENTERTAINMENT SERVICES, NAMELY, PROVIDING RADIO MUSIC PROGRAMMING VIA A GLOBAL COMPUTER NETWORK; ENTERTAINMENT IN THE NATURE OF LIVE MUSICAL PERFORMANCES; MUSIC COMPOSITION AND TRANSCRIPTION FOR OTHERS; MUSIC PUBLISHING SERVICES (U.S. CLS. 100, 101 AND 107).

FIRST USE 0-0-2002; IN COMMERCE 0-0-2002.

2,955,242. BACON PRODUCTS CORPORATION, CHATTANOOGA, TN. SN 76-196,825. PUB. 7-16-2002, FILED 1-22-2001.

MY BUDDY

OWNER OF U.S. REG. NO. 1,533,112.

CLASS 3—COSMETICS AND CLEANING PREPARATIONS

FOR NON-MEDICATED GROOMING PREPARATIONS FOR PETS, NAMELY NON-MEDICATED SHAMPOOS AND NON-MEDICATED CONDITIONERS (U.S. CLS. 1, 4, 6, 50, 51 AND 52).

FIRST USE 9-5-2004; IN COMMERCE 9-5-2004.

CLASS 5—PHARMACEUTICALS

FOR MEDICATED GROOMING PREPARATIONS FOR PETS FOR THE TREATMENT OF EAR MITES AND IRRITATED SKIN, NAMELY, SALVES, MEDICATED TOPICAL PET SHAMPOOS, CONDITIONERS, SPRAYS, CREAMS, BALM, OINTMENTS; FLEA COLLARS; FLEA AND TICK POWDERS; SPRAY PREPARATIONS FOR PETS TO REPEL FLEAS AND TICKS (U.S. CLS. 6, 18, 44, 46, 51 AND 52).

FIRST USE 9-5-2004; IN COMMERCE 9-5-2004.

2,955,243. SURFACE SCIENCES, INC., CHICAGO, IL. SN 76-205,673. PUB. 11-27-2001, FILED 2-6-2001.

DYNACRON**CLASS 4—LUBRICANTS AND FUELS**

FOR INDUSTRIAL DRY LUBRICANTS (U.S. CLS. 1, 6 AND 15).

FIRST USE 1-5-2005; IN COMMERCE 1-31-2005.

CLASS 37—CONSTRUCTION AND REPAIR

FOR LUBRICATION SERVICES, NAMELY, LUBRICATION OF METAL SURFACES (U.S. CLS. 100, 103 AND 106).

FIRST USE 1-5-2005; IN COMMERCE 1-31-2005.

2,955,256. PROTIVERIS, INC., ROCKVILLE, MD. SN 76-261,499. PUB. 10-8-2002, FILED 5-23-2001.

PROTIVERIS**CLASS 9—ELECTRICAL AND SCIENTIFIC APPARATUS**

FOR SENSING APPARATUS, NAMELY, A MICRO-CANTILEVER SENSOR FOR DETECTING ORGANIC AND INORGANIC SUBSTANCES FOR MEDICAL RESEARCH, SCIENTIFIC RESEARCH AND DEVELOPMENT USE, LABORATORY USE AND INDUSTRIAL USE; AND A MICROFLUIDICS CARTRIDGE COMPRISING AN ARRAY OF MICROCANTILEVER SENSORS FOR DETECTING ORGANIC AND INORGANIC SUBSTANCES FOR SCIENTIFIC RESEARCH AND DEVELOPMENT USE, LABORATORY USE AND INDUSTRIAL USE (U.S. CLS. 21, 23, 26, 36 AND 38).

FIRST USE 1-4-2005; IN COMMERCE 1-4-2005.

CLASS 10—MEDICAL APPARATUS

FOR SENSING APPARATUS, NAMELY, A MICRO-CANTILEVER SENSOR FOR DETECTING ORGANIC AND INORGANIC SUBSTANCES FOR DIAGNOSTIC AND CLINICAL USE; AND A MICROFLUIDICS CARTRIDGE COMPRISING AN ARRAY OF MICROCANTILEVER SENSORS FOR DETECTING ORGANIC AND INORGANIC SUBSTANCES FOR MEDICAL RESEARCH, AND DIAGNOSTIC AND CLINICAL USE (U.S. CLS. 26, 39 AND 44).

FIRST USE 1-4-2005; IN COMMERCE 1-4-2005.

2,955,259. NOVANARY, INC., STANTON, NJ. SN 76-280,613. PUB. 4-8-2003, FILED 7-5-2001.

**CLASS 9—ELECTRICAL AND SCIENTIFIC APPARATUS**

FOR WEB BASED COMMUNICATIONS SOFTWARE, NAMELY, DOWNLOADABLE COMMUNICATIONS SOFTWARE FOR USE WITHIN AN INSTITUTION FOR SENDING AND RECEIVING INTERNAL COMMUNICATIONS AMONG MEMBER EMPLOYEES (U.S. CLS. 21, 23, 26, 36 AND 38).

FIRST USE 6-18-2003; IN COMMERCE 6-18-2003.

CLASS 42—SCIENTIFIC, COMPUTER AND LEGAL SERVICES

FOR PROVIDING TEMPORARY USE OF NON-DOWNLOADABLE WEB-BASED SOFTWARE FOR USE WITHIN AN INSTITUTION FOR SENDING AND RECEIVING INTERNAL COMMUNICATIONS AMONG MEMBER EMPLOYEES (U.S. CLS. 100 AND 101).

FIRST USE 6-18-2003; IN COMMERCE 6-18-2003.

2,955,270. CHAFFEE, ROBERT B., BOSTON, MA. SN 76-342,608. PUB. 6-10-2003, FILED 11-28-2001.

COMFORT WITH THE TOUCH OF A BUTTON

CLASS 20—FURNITURE AND ARTICLES NOT OTHERWISE CLASSIFIED

FOR INFLATABLE FURNITURE DEVICES, NAMELY CUSHIONS, PILLOWS AND MATTRESSES (U.S. CLS. 2, 13, 22, 25, 32 AND 50).

FIRST USE 2-0-2002; IN COMMERCE 2-0-2002.

CLASS 28—TOYS AND SPORTING GOODS

FOR INFLATABLE RECREATIONAL DEVICES, NAMELY, FLOAT CUSHIONS, PILLOWS AND MATTRESSES FOR RECREATIONAL USE (U.S. CLS. 22, 23, 38 AND 50).

FIRST USE 2-0-2002; IN COMMERCE 2-0-2002.

2,955,272. CHANNEL VANTAGE, INC., DETROIT, MI. SN 76-349,137. PUB. 11-18-2003, FILED 12-14-2001.



THE LINING SHOWN IN THE DRAWING IS A FEATURE OF THE MARK AND NOT INTENDED TO INDICATE COLOR.

CLASS 9—ELECTRICAL AND SCIENTIFIC APPARATUS

FOR COMPUTER SOFTWARE AND INSTRUCTIONAL MANUALS SOLD AS A UNIT FOR MARKET RESEARCH AND ANALYSIS (U.S. CLS. 21, 23, 26, 36 AND 38).

FIRST USE 9-30-2001; IN COMMERCE 9-30-2001.

CLASS 16—PAPER GOODS AND PRINTED MATTER

FOR PRINTED MATTER IN THE NATURE OF INFORMATIONAL REPORTS, TECHNICAL INSTRUCTIONAL AND OPERATIONAL MATERIALS, AND NEWSLETTERS IN THE FIELD OF MARKET RESEARCH AND ANALYSIS (U.S. CLS. 2, 5, 22, 23, 29, 37, 38 AND 50).

FIRST USE 9-30-2001; IN COMMERCE 9-30-2001.

CLASS 35—ADVERTISING AND BUSINESS

FOR BUSINESS CONSULTATION SERVICES, NAMELY, MARKET RESEARCH AND ANALYSIS, STATISTICAL AND QUANTITATIVE ANALYSIS, DATABASE MANAGEMENT, AND DIRECT MARKETING (U.S. CLS. 100, 101 AND 102).

FIRST USE 9-30-2001; IN COMMERCE 9-30-2001.

CLASS 42—SCIENTIFIC, COMPUTER AND LEGAL SERVICES

FOR COMPUTER NETWORK CONSULTATION SERVICES, DATA AND TECHNICAL CONSULTATION SERVICES FOR SOFTWARE APPLICATIONS, COMPUTER SOFTWARE PROGRAMMING AND DESIGN FOR OTHERS, GRAPHIC ART DESIGN FOR DIRECT MARKETING, AND ARBITRATION SUPPORT SERVICES (U.S. CLS. 100 AND 101).

FIRST USE 9-30-2001; IN COMMERCE 9-30-2001.

2,955,274. CHAPA, TATIANA PALACIOS, GARZA GARCIA, N.L. CP 66256, MEXICO. SN 76-363,513. PUB. 11-11-2003, FILED 1-28-2002.

TATIANA

CLASS 9—ELECTRICAL AND SCIENTIFIC APPARATUS

FOR COMPUTER SOFTWARE AND PRE-RECORDED AUDIO AND VIDEO CASSETTES, COMPACT DISCS, AND DIGITAL DISCS FOR EDUCATION OF CHILDREN BY PROVIDING VERBAL AND VISUAL MATERIAL, NAMELY, LYRICS, SONGS, STORIES, AND ASSOCIATED IMAGES TO CONTRIBUTE TO THE CHILD'S UNDERSTANDING AND COMPREHENSION OF FAMILY VALUES AND MORAL AWARENESS, AND FOR ENTERTAINMENT BOTH TYPES FEATURING ENTERTAINER PERFORMANCES, NAMELY, MUSICAL, BAND PERFORMANCE, DANCE, SINGING, ACTING, AND ASSOCIATED ANIMATION, AND VARIETY SHOWS FEATURING, MUSIC, BAND PERFORMANCE, DANCE, SINGING, ACTING, GUEST INTERVIEWS, AND TRAVEL, CALCULATORS (U.S. CLS. 21, 23, 26, 36 AND 38).

FIRST USE 12-31-1995; IN COMMERCE 12-31-1995.

CLASS 41—EDUCATION AND ENTERTAINMENT

FOR EDUCATIONAL AND ENTERTAINMENT SERVICES, NAMELY, PROVIDING EDUCATION OF CHILDREN BY PROVIDING VERBAL AND VISUAL MATERIAL, NAMELY, LYRICS, SONGS, STORIES, AND ASSOCIATED IMAGES TO CONTRIBUTE TO THE CHILD'S UNDERSTANDING AND COMPREHENSION OF FAMILY VALUES AND MORAL AWARENESS, AND PROVIDING ENTERTAINMENT PERFORMANCES AND APPEARANCES NAMELY, MUSICAL, BAND PERFORMANCE, DANCE, SINGING, ACTING, AND ASSOCIATED ANIMATION BOTH VIA LIVE PERFORMANCES, RADIO, TELEVISION, AND GLOBAL COMPUTER NETWORKS (U.S. CLS. 100, 101 AND 107).

FIRST USE 12-31-2003; IN COMMERCE 12-31-2003.

2,955,275. CHAPA, TATIANA PALACIOS, GARZA GARCIA, N.L. CP 66256, MEXICO. SN 76-363,698. PUB. 12-9-2003, FILED 1-28-2002.

TATIANA LA REINA DE LOS NINOS

THE ENGLISH TRANSLATION OF "TATIANA LA REINA DE LOS NINOS" IS "TATIANA THE QUEEN OF THE CHILDREN".

CLASS 9—ELECTRICAL AND SCIENTIFIC APPARATUS

FOR COMPUTER SOFTWARE AND PRE-RECORDED AUDIO AND VIDEO CASSETTES, COMPACT DISCS, AND DIGITAL DISCS FOR EDUCATION OF CHILDREN BY PROVIDING VERBAL AND VISUAL MATERIAL, NAMELY, LYRICS, SONGS, STORIES, AND ASSOCIATED IMAGES TO CONTRIBUTE TO THE CHILD'S UNDERSTANDING AND COMPREHENSION OF FAMILY VALUES AND MORAL AWARENESS, AND FOR ENTERTAINMENT BOTH TYPES FEATURING ENTERTAINER PERFORMANCES, NAMELY, MUSICAL, BAND PERFORMANCE, DANCE, SINGING, ACTING, AND ASSOCIATED ANIMATION, AND VARIETY SHOWS FEATURING MUSIC, BAND PERFORMANCE, DANCE, SINGING, ACTING, GUEST INTERVIEWS, AND TRAVEL; CALCULATORS (U.S. CLS. 21, 23, 26, 36 AND 38).
FIRST USE 0-0-2000; IN COMMERCE 0-0-2000.

CLASS 41—EDUCATION AND ENTERTAINMENT

FOR EDUCATIONAL AND ENTERTAINMENT SERVICES, NAMELY, PROVIDING EDUCATION OF CHILDREN BY PROVIDING VERBAL AND VISUAL MATERIAL, NAMELY, LYRICS, SONGS, STORIES, AND ASSOCIATED IMAGES TO CONTRIBUTE TO THE CHILD'S UNDERSTANDING AND COMPREHENSION OF FAMILY VALUES AND MORAL AWARENESS, AND PROVIDING ENTERTAINMENT PERFORMANCES AND APPEARANCES NAMELY, MUSICAL, BAND PERFORMANCE, DANCE, SINGING, ACTING, AND ASSOCIATED ANIMATION BOTH VIA LIVE PERFORMANCES, RADIO, TELEVISION, AND GLOBAL COMPUTER NETWORKS (U.S. CLS. 100, 101 AND 107).
FIRST USE 0-0-2002; IN COMMERCE 0-0-2002.

2,955,276. DEFENDERS OF WILDLIFE, WASHINGTON, DC, DC. SN 76-363,854. PUB. 4-6-2004, FILED 1-28-2002.

JAVA FOREST

NO CLAIM IS MADE TO THE EXCLUSIVE RIGHT TO USE "JAVA", APART FROM THE MARK AS SHOWN.

CLASS 30—STAPLE FOODS

FOR ORGANIC, FAIR TRADE CERTIFIED AND SHADE GROWN COFFEE BEANS; BREWED COFFEE; CHOCOLATE COVERED COFFEE BEANS MADE FROM ORGANIC, FAIR TRADE CERTIFIED AND SHADE GROWN COFFEE BEANS AND ORGANIC, SHADE GROWN SUSTAINABLE COCOA BEANS (U.S. CL. 46).
FIRST USE 2-28-2002; IN COMMERCE 2-28-2002.

CLASS 35—ADVERTISING AND BUSINESS

FOR PROMOTING PUBLIC AWARENESS OF THE NEED FOR PROTECTION OF WILDLIFE AND HABITATS (U.S. CLS. 100, 101 AND 102).
FIRST USE 2-28-2002; IN COMMERCE 2-28-2002.

CLASS 36—INSURANCE AND FINANCIAL

FOR CHARITABLE FUND RAISING SERVICES, NAMELY, FUNDING THE PROTECTION OF WILDLIFE AND HABITATS VIA THE SALE OF ORGANIC, FAIR TRADE CERTIFIED AND SHADE GROWN COFFEE BEANS, BREWED COFFEE, CHOCOLATE COVERED COFFEE BEANS MADE FROM ORGANIC, FAIR TRADE CERTIFIED AND SHADE GROWN COFFEE BEANS AND ORGANIC, SHADE GROWN SUSTAINABLE COCOA BEANS, COFFEE CUPS, COFFEE MUGS, MOUSE PADS, T-SHIRTS, GIFT BASKETS CONTAINING ORGANIC, FAIR TRADE CERTIFIED AND SHADE GROWN COFFEE BEANS, CHOCOLATE COVERED COFFEE BEANS MADE FROM ORGANIC, FAIR TRADE CERTIFIED AND SHADE GROWN COFFEE BEANS AND ORGANIC, SHADE GROWN SUSTAINABLE COCOA BEANS (U.S. CLS. 100, 101 AND 102).
FIRST USE 2-28-2002; IN COMMERCE 2-28-2002.

2,955,277. MEDAIRE, INC., TEMPE, AZ. SN 76-369,277. PUB. 11-4-2003, FILED 2-11-2002.

GLOBALIFELINE**CLASS 44—MEDICAL, BEAUTY AND AGRICULTURAL SERVICES**

FOR PROVIDING HEALTH INFORMATION AND ADVICE TO TRAVELERS (U.S. CLS. 100 AND 101).
FIRST USE 4-15-2002; IN COMMERCE 4-15-2002.

CLASS 45—PERSONAL SERVICES

FOR PROVIDING PERSONAL SECURITY INFORMATION AND ADVICE TO TRAVELERS (U.S. CLS. 100 AND 101).
FIRST USE 4-15-2002; IN COMMERCE 4-15-2002.

2,955,280. AGRILINK HOLDINGS PTY LTD., HILTON, SOUTH AUSTRALIA 5033, AUSTRALIA. SN 76-380,050. PUB. 9-16-2003, FILED 3-8-2002.

AGWISE**CLASS 35—ADVERTISING AND BUSINESS**

FOR BUSINESS MANAGEMENT AND BUSINESS CONSULTATION, INCLUDING THE GENERATION, COMPILATION AND MANAGEMENT OF INFORMATION, DOCUMENTS AND DATA; STRATEGIC BUSINESS PLANNING (U.S. CLS. 100, 101 AND 102).
FIRST USE 8-23-2001; IN COMMERCE 8-23-2001.

CLASS 36—INSURANCE AND FINANCIAL

FOR AGRICULTURAL RISK MANAGEMENT (U.S. CLS. 100, 101 AND 102).
FIRST USE 8-23-2001; IN COMMERCE 8-23-2001.

CLASS 44—MEDICAL, BEAUTY AND AGRICULTURAL SERVICES

FOR AGRICULTURAL MANAGEMENT AND CONSULTATION IN CONNECTION THEREWITH, INCLUDING THE GENERATION, COMPILATION AND MANAGEMENT OF AGRICULTURAL INFORMATION, DOCUMENTS AND DATA, INCLUDING ALL ASPECTS OF THE MANAGEMENT OF IRRIGATION AND SOIL CONDITIONING ACTIVITIES; ENVIRONMENTAL MANAGEMENT; FARM MANAGEMENT; LAND MANAGEMENT; AND STRATEGIC AGRICULTURAL AND ENVIRONMENTAL PLANNING (U.S. CLS. 100 AND 101).

FIRST USE 8-23-2001; IN COMMERCE 8-23-2001.

2,955,281. AGRILINK HOLDINGS PTY LTD., HILTON, SOUTH AUSTRALIA 5033, AUSTRALIA. SN 76-380,051. PUB. 9-16-2003, FILED 3-8-2002.

**CLASS 35—ADVERTISING AND BUSINESS**

FOR BUSINESS MANAGEMENT AND BUSINESS CONSULTATION, INCLUDING THE GENERATION, COMPILATION AND MANAGEMENT OF INFORMATION, DOCUMENTS AND DATA; STRATEGIC BUSINESS PLANNING (U.S. CLS. 100, 101 AND 102).

FIRST USE 8-23-2001; IN COMMERCE 8-23-2001.

CLASS 36—INSURANCE AND FINANCIAL

FOR AGRICULTURAL RISK MANAGEMENT (U.S. CLS. 100, 101 AND 102).

FIRST USE 8-23-2001; IN COMMERCE 8-23-2001.

CLASS 44—MEDICAL, BEAUTY AND AGRICULTURAL SERVICES

FOR AGRICULTURAL MANAGEMENT AND CONSULTATION IN CONNECTION THEREWITH, INCLUDING THE GENERATION, COMPILATION AND MANAGEMENT OF AGRICULTURAL INFORMATION, DOCUMENTS AND DATA, INCLUDING ALL ASPECTS OF THE MANAGEMENT OF IRRIGATION AND SOIL CONDITIONING ACTIVITIES; ENVIRONMENTAL MANAGEMENT; FARM MANAGEMENT; LAND MANAGEMENT; AND STRATEGIC AGRICULTURAL AND ENVIRONMENTAL PLANNING (U.S. CLS. 100 AND 101).

FIRST USE 8-23-2001; IN COMMERCE 8-23-2001.

2,955,293. YANNI PARTNERS, INC., PITTSBURGH, PA. SN 76-422,079. PUB. 2-25-2003, FILED 6-19-2002.

MEASURING UP**CLASS 16—PAPER GOODS AND PRINTED MATTER**

FOR NEWSLETTERS IN THE FIELD OF FINANCIAL, BUSINESS AND INVESTMENT INFORMATION (U.S. CLS. 2, 5, 22, 23, 29, 37, 38 AND 50).

FIRST USE 12-0-1988; IN COMMERCE 12-0-1988.

CLASS 36—INSURANCE AND FINANCIAL

FOR PROVIDING FINANCIAL AND INVESTMENT INFORMATION VIA ELECTRONIC MEANS (U.S. CLS. 100, 101 AND 102).

FIRST USE 12-0-1988; IN COMMERCE 12-0-1988.

2,955,304. BAD NEWS TRAVELS FAST, INC., FRANKLIN, NC. SN 76-452,165. PUB. 11-18-2003, FILED 9-18-2002.

BAD NEWS TRAVELS FAST**CLASS 25—CLOTHING**

FOR CLOTHING, NAMELY, SHIRTS, JERSEYS AND HATS (U.S. CLS. 22 AND 39).

FIRST USE 2-23-2001; IN COMMERCE 2-23-2001.

CLASS 28—TOYS AND SPORTING GOODS

FOR TOYS, NAMELY REPLICA TOY TRUCKS, REPLICA TOY MODEL TRUCKS AND REPLICA TOY DIE CAST COLLECTIBLE TRUCKS FOR USE IN CONNECTION WITH THE PROMOTION OF MONSTER TRUCK EVENTS (U.S. CLS. 22, 23, 38 AND 50).

FIRST USE 6-1-2004; IN COMMERCE 6-1-2004.

2,955,326. UNITED STATES LUGE ASSOCIATION, LAKE PLACID, NY. SN 76-466,761. PUB. 9-16-2003, FILED 11-14-2002.

THE FASTEST SPORT ON ICE**CLASS 16—PAPER GOODS AND PRINTED MATTER**

FOR POSTERS AND BROCHURES ABOUT THE SPORT OF LUGE (U.S. CLS. 2, 5, 22, 23, 29, 37, 38 AND 50).

FIRST USE 7-1-2002; IN COMMERCE 7-1-2002.

CLASS 25—CLOTHING

FOR CLOTHING, NAMELY, T-SHIRTS, POLO SHIRTS, GOLF SHIRTS, SWEATSHIRTS, SWEATPANTS, SWEATERS, FLEECE PULLOVERS, FLEECE VESTS, JACKETS, CAPS, VISORS, AND FLEECE HATS (U.S. CLS. 22 AND 39).

FIRST USE 7-1-2002; IN COMMERCE 7-1-2002.

2,955,346. THE BLONDER COMPANY, CLEVELAND, OH. SN 76-479,344. PUB. 1-13-2004, FILED 12-31-2002.

EXPRESSIONS**CLASS 9—ELECTRICAL AND SCIENTIFIC APPARATUS**

FOR SWITCHPLATES (U.S. CLS. 21, 23, 26, 36 AND 38).

FIRST USE 11-14-1995; IN COMMERCE 11-14-1995.

CLASS 11—ENVIRONMENTAL CONTROL APPARATUS

FOR ELECTRIC NIGHT LIGHTS (U.S. CLS. 13, 21, 23, 31 AND 34).
FIRST USE 11-14-1995; IN COMMERCE 11-14-1995.

CLASS 20—FURNITURE AND ARTICLES NOT OTHERWISE CLASSIFIED

FOR NON-METAL SHOWER CURTAIN RINGS; DRAPERY HARDWARE, NAMELY, SHOWER CURTAIN HOOKS; AND LAUNDRY HAMPERS (U.S. CLS. 2, 13, 22, 25, 32 AND 50).
FIRST USE 11-14-1995; IN COMMERCE 11-14-1995.

CLASS 21—HOUSEWARES AND GLASS

FOR TOOTHBRUSH HOLDERS; SOAP DISPENSERS; SOAP DISHES; TOILET BRUSHES; TISSUE BOX HOLDERS; CUPS; TRASH BASKETS; LOTION PUMPS; COTTON BALL HOLDERS (U.S. CLS. 2, 13, 23, 29, 30, 33, 40 AND 50).
FIRST USE 11-14-1995; IN COMMERCE 11-14-1995.

CLASS 24—FABRICS

FOR SHOWER CURTAINS AND TOWELS, FITTED TOILET LIDCOVERS MADE OF FABRIC AND FITTED TRASH BASKET COVERS MADE OF FABRIC (U.S. CLS. 42 AND 50).
FIRST USE 11-14-1995; IN COMMERCE 11-14-1995.

CLASS 27—FLOOR COVERINGS

FOR BATH MATS, RUGS, WALLPAPER, WALLPAPER BOARDERS, AND WALLPAPER APPLIQUES (U.S. CLS. 19, 20, 37, 42 AND 50).
FIRST USE 11-14-1995; IN COMMERCE 11-14-1995.

2,955,355. BONFIGLIO, BARBARA, WASHINGTON, DC. SN 76-484,007. PUB. 5-4-2004, FILED 1-17-2003.

ITURNEM**CLASS 9—ELECTRICAL AND SCIENTIFIC APPARATUS**

FOR SERIES OF MUSICAL SOUND RECORDINGS, PRE-RECORDED COMPACT DISCS, AUDIO CASSETTES, DIGITAL VIDEO DISCS, PHONOGRAPH RECORDS AND DIGITAL AUDIO FILES FEATURING MUSIC (U.S. CLS. 21, 23, 26, 36 AND 38).
FIRST USE 8-1-2003; IN COMMERCE 9-1-2004.

CLASS 25—CLOTHING

FOR CLOTHING, NAMELY SHIRTS, PANTS, SHORTS, SKIRTS, JACKETS, SWEATSHIRTS, SWEATERS, T-SHIRTS, HATS, FOOTWEAR, AND HEADWEAR (U.S. CLS. 22 AND 39).
FIRST USE 8-1-2003; IN COMMERCE 9-1-2004.

2,955,356. AMERICAN MEGACOM, INC., LIVONIA, MI. SN 76-484,496. PUB. 9-7-2004, FILED 1-22-2003.

EAMI**CLASS 35—ADVERTISING AND BUSINESS**

FOR WEB BASED INVENTORY MANAGEMENT SERVICES IN THE FIELD OF INFORMATION TECHNOLOGY FOR BUSINESS, INDUSTRY AND GOVERNMENT; WEB BASED VENDOR MANAGEMENT SERVICES IN THE FIELD OF INFORMATION TECHNOLOGY FOR BUSINESS, INDUSTRY AND GOVERNMENT (U.S. CLS. 100, 101 AND 102).
FIRST USE 3-1-2003; IN COMMERCE 3-1-2003.

CLASS 42—SCIENTIFIC, COMPUTER AND LEGAL SERVICES

FOR PROVIDING TEMPORARY USE OF ON-LINE NON-DOWNLOADABLE SOFTWARE IN THE FIELD OF INFORMATION TECHNOLOGY FOR USE IN VENDOR AND INVENTORY MANAGEMENT, NAMELY, INFORMATION TECHNOLOGY VENDOR RELATIONSHIP MANAGEMENT, MANAGING COSTS, ALLOCATING COSTS, AUDITING OF INVOICES AND COSTS AND CONTRACT MANAGEMENT; DESIGN AND MAINTENANCE OF WEB BASED VENDOR MANAGEMENT AND INVENTORY MANAGEMENT SOFTWARE FOR OTHERS (U.S. CLS. 100 AND 101).
FIRST USE 3-1-2003; IN COMMERCE 3-1-2003.

2,955,363. ALLTECH ASSOCIATES, INC., COLUMBIA, MD. SN 76-489,435. PUB. 11-18-2003, FILED 2-12-2003.

EXPEDITION**CLASS 1—CHEMICALS**

FOR CHEMICALS FOR USE IN CHROMATOGRAPHY (U.S. CLS. 1, 5, 6, 10, 26 AND 46).
FIRST USE 3-4-2004; IN COMMERCE 3-4-2004.

CLASS 9—ELECTRICAL AND SCIENTIFIC APPARATUS

FOR CHROMATOGRAPHY COLUMNS (U.S. CLS. 21, 23, 26, 36 AND 38).
FIRST USE 3-4-2004; IN COMMERCE 3-4-2004.

2,955,374. LICO BRANDS, INC., STOCKTON, CA. SN 76-491,935. PUB. 11-4-2003, FILED 2-21-2003.

DOLCE VITA

THE WORDS "DOLCE VITA" MAY BE TRANSLATED INTO ENGLISH AS "SWEET LIFE".

CLASS 29—MEATS AND PROCESSED FOODS

FOR CANNED GOODS, NAMELY, CANNED TOMATOES (U.S. CL. 46).
FIRST USE 11-24-2004; IN COMMERCE 11-24-2004.

CLASS 30—STAPLE FOODS

FOR TOMATO-BASED FOOD SAUCES (U.S. CL. 46).
FIRST USE 11-9-2004; IN COMMERCE 11-9-2004.

2,955,396. ZIEBART INTERNATIONAL CORPORATION, TROY, MI. SN 76-499,436. PUB. 1-27-2004, FILED 3-13-2003.

AUTO APPEARANCE EXPERTS BY ZIEBART

OWNER OF U.S. REG. NOS. 1,125,370, 1,799,658, AND OTHERS.

NO CLAIM IS MADE TO THE EXCLUSIVE RIGHT TO USE "AUTO APPEARANCE EXPERTS", APART FROM THE MARK AS SHOWN.

CLASS 37—CONSTRUCTION AND REPAIR

FOR VEHICLE REPAIR, MAINTENANCE, AND CLEANING SERVICES, NAMELY PRESERVATION AND RECONDITIONING SERVICES FOR VEHICLES, RUST PROOFING SERVICES FOR VEHICLES, SOUND-PROOFING OF VEHICLES, INTERIOR VACUUMING, INTERIOR CLEANING OF SEATS, CARPETS, HEADLINERS, DOOR PANELS, DASHBOARDS, DECKS, EXTERIOR CLEANING, POLISHING, CLEANING ENGINES, APPLICATION OF GRAPHICS TO VEHICLE BODY; AFTER MARKET INSTALLATION ON VEHICLES OF SPRAY-ON OR MOLDED TRUCK BEDLINERS, SUNROOFS, SPLASH GUARDS, PROTECTIVE MOLDINGS, RUNNING BOARDS, TRUCK PASS-THROUGH WINDOWS, BUG DEFLECTORS, VAN RACKS, DECK/ROOF RACKS, CAB EXTENDERS, SPLASH GUARDS, GRILL GUARDS, LUGGAGE RACKS, BURGLAR ALARMS, INSTALLATION OF REMOTE CAR STARTERS, REPAIR AND REPLACEMENT OF AUTOMOTIVE GLASS, AUTOMOBILE SCRATCH AND DENT REPAIR, AND CARPET CLEANING, NAMELY, CARPET RESTORATION (U.S. CLS. 100, 103 AND 106).

FIRST USE 10-1-2001; IN COMMERCE 10-1-2001.

CLASS 40—MATERIAL TREATMENT

FOR APPLICATION OF PROTECTIVE COATING TO PREVENT ROAD ABRASIONS, APPLICATION OF PROTECTIVE COATINGS TO INTERIOR SURFACES, APPLICATION OF PROTECTIVE SEALANTS TO EXTERIOR PAINTED AND NON-PAINTED SURFACES, WINDOW GLASS TINTING SERVICES (U.S. CLS. 100, 103 AND 106).

FIRST USE 10-1-2001; IN COMMERCE 10-1-2001.

2,955,431. LAVELLE INDUSTRIES, INC., BURLINGTON, WI. SN 76-529,760. PUB. 5-18-2004, FILED 7-14-2003.

KORKY

OWNER OF U.S. REG. NO. 769,398.

CLASS 11—ENVIRONMENTAL CONTROL APPARATUS

FOR TOILET FILL VALVES AND TOILET FLUSH VALVES (U.S. CLS. 13, 21, 23, 31 AND 34).

FIRST USE 9-0-2000; IN COMMERCE 12-0-2000.

CLASS 21—HOUSEWARES AND GLASS

FOR TOILET PLUNGERS (U.S. CLS. 2, 13, 23, 29, 30, 33, 40 AND 50).

FIRST USE 0-0-1996; IN COMMERCE 0-0-1996.

2,955,449. OCHS, MICHAEL, NASHVILLE, TN. SN 76-541,447. PUB. 9-21-2004, FILED 8-20-2003.

GESHER

THE FOREIGN WORDING IN THE MARK TRANSLATES INTO ENGLISH AS BRIDGE.

CLASS 9—ELECTRICAL AND SCIENTIFIC APPARATUS

FOR MUSICAL SOUND RECORDINGS, MUSICAL VIDEO RECORDINGS, VIDEO CASSETTES AND MUSIC CASSETTES, COMPACT DISCS FEATURING MUSIC (U.S. CLS. 21, 23, 26, 36 AND 38).

FIRST USE 4-0-2002; IN COMMERCE 7-30-2004.

CLASS 41—EDUCATION AND ENTERTAINMENT

FOR ENTERTAINMENT SERVICES, NAMELY, LIVE PERFORMANCES BY A MUSICAL GROUP; PROVIDING ENTERTAINMENT SERVICES IN THE NATURE OF LIVE PERFORMANCES FOR CAMPS; EDUCATION SERVICES, NAMELY, CONDUCTING CLASSES OF INSTRUCTION AND SEMINARS IN THE FIELD OF RELIGION; PROVIDING LIVE RELIGIOUS AND INSTRUMENTAL MUSICAL PERFORMANCES; CONCERT BOOKING SERVICES, SONG WRITING SERVICES AND COMPOSING MUSIC FOR USE BY OTHERS; MUSIC PUBLISHING SERVICES (U.S. CLS. 100, 101 AND 107).

FIRST USE 4-0-2002; IN COMMERCE 7-30-2004.

2,955,476. KAPPA KAPPA GAMMA FRATERNITY, COLUMBUS, OH. SN 76-977,408. PUB. 11-19-2002, FILED 11-14-2001.

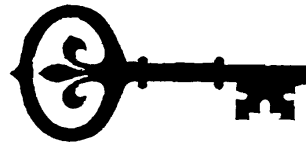

CLASS 14—JEWELRY

FOR JEWELRY; NAMELY, RINGS, PENDANTS, DECORATIVE PINS IN THE NATURE OF JEWELRY FOR VISIBLE ATTACHMENT TO CLOTHING, CHARMS, LAVALIERS, WATCHES, BRACELETS, AND MEMBERSHIP BADGES MADE OF PRECIOUS METAL (U.S. CLS. 2, 27, 28 AND 50).

FIRST USE 6-20-2002; IN COMMERCE 6-20-2002.

CLASS 16—PAPER GOODS AND PRINTED MATTER

FOR MANUALS ON SUBJECTS OF INTEREST TO COLLEGIATE FRATERNAL CHAPTERS; NAMELY, MANAGEMENT, FINANCES, MEMBERSHIP AND PHYSICAL AND PSYCHOLOGICAL WELL-BEING; NOTEBOOKS; PRINTED MEMBERSHIP DIRECTORIES; PAMPHLETS AND NEWSLETTERS PERTAINING TO SORORITY AFFAIRS; PENS AND PENCILS; POSTERS; STATIONERY, PAPER NAPKINS; MEMBERSHIP CERTIFICATES; AND PLASTIC CHECKBOOK COVERS (U.S. CLS. 2, 5, 22, 23, 29, 37, 38 AND 50).

FIRST USE 6-20-2002; IN COMMERCE 6-20-2002.

CLASS 25—CLOTHING

FOR SHIRTS, PANTS, JACKETS, HATS, SOCKS, SWEATERS, CLOTH SUN VISORS AND PLASTIC SUN VISORS (U.S. CLS. 22 AND 39).

FIRST USE 6-20-2002; IN COMMERCE 6-20-2002.

CLASS 41—EDUCATION AND ENTERTAINMENT

FOR EDUCATIONAL SERVICES; NAMELY, CONDUCTING SEMINARS AND EDUCATIONAL PROGRAMS IN THE NATURE OF WORKSHOPS ON TOPICS OF INTEREST TO FRATERNITY MEMBERS; NAMELY, MANAGEMENT, FINANCES, AND MEMBERSHIP PHYSICAL AND PSYCHOLOGICAL WELL-BEING (U.S. CLS. 100, 101 AND 107).

FIRST USE 6-20-2002; IN COMMERCE 6-20-2002.

CLASS 42—SCIENTIFIC, COMPUTER AND LEGAL SERVICES

FOR FRATERNITY SERVICES—NAMELY, PROMOTING AND FOSTERING GOOD WILL, FRIENDSHIP AND SOCIAL AND ACADEMIC ACHIEVEMENT AMONG AND BY MEMBERS AND PROSPECTIVE MEMBERS OF APPLICANT ORGANIZATION (U.S. CLS. 100 AND 101).

FIRST USE 6-20-2002; IN COMMERCE 6-20-2002.

2,955,481. SYSTEM SCHULTHEIS AG, RAPPERSWIL, SWITZERLAND. SN 78-051,520. PUB. 11-4-2003, FILED 3-6-2001.

MULTI TOWER**CLASS 6—METAL GOODS**

FOR STORAGE RACKS OF METAL (U.S. CLS. 2, 12, 13, 14, 23, 25 AND 50).

FIRST USE 11-18-2000; IN COMMERCE 11-18-2000.

CLASS 20—FURNITURE AND ARTICLES NOT OTHERWISE CLASSIFIED

FOR SHELVES, STORAGE RACKS NOT OF METAL (U.S. CLS. 2, 13, 22, 25, 32 AND 50).

FIRST USE 11-18-2000; IN COMMERCE 11-18-2000.

2,955,497. Z "K" CONCEPT, PARIS, FRANCE. SN 78-139,742. PUB. 11-4-2003, FILED 6-28-2002.

POP UP KUKURUDZ**CLASS 16—PAPER GOODS AND PRINTED MATTER**

FOR PRINTED MATTER, NAMELY MAPS, GRAPH PAPER, NOTE PAPER AND LOOSE LEAF PAPER, POSTERS, FOLDERS, PHOTOGRAPHS, DECALS, IRON-ON AND PLASTIC TRANSFERS, BUMPER STICKERS, NOTE CARDS AND GREETING CARDS, CALENDARS, TRADING CARDS, THREE DIMENSIONAL MODELS FOR EDUCATIONAL PURPOSES, FOOD WRAPPERS AND ENVELOPES OF PAPER AND CARDBOARD AND BAGS OF PAPER AND PLASTIC FOR PACKAGING (U.S. CLS. 2, 5, 22, 23, 29, 37, 38 AND 50).

FIRST USE 9-0-2002; IN COMMERCE 9-0-2002.

CLASS 35—ADVERTISING AND BUSINESS

FOR DISSEMINATION OF ADVERTISING MATTER FOR OTHERS AND PREPARATION OF CUSTOM ADVERTISEMENTS AND CUSTOM PROMOTIONAL PRODUCTS FOR OTHERS IN THE NATURE OF LEAFLETS, BROCHURES, PAMPHLETS, PROSPECTUSES, CATALOGUES, AND THREE-DIMENSIONAL MODELS MADE OF PAPER AND/OR CARDBOARD (U.S. CLS. 100, 101 AND 102).

FIRST USE 9-0-2002; IN COMMERCE 9-0-2002.

2,955,506. INSTAGARDEN CORPORATION, FORT COLLINS, CO. SN 78-149,689. PUB. 12-2-2003, FILED 8-1-2002.

INSTAGARDEN**CLASS 19—NON-METALLIC BUILDING MATERIALS**

FOR NON-METAL RAISED BEDS FOR HOLDING SOIL IN WHICH PLANTS MAY BE GROWN AND PREFABRICATED NON-METAL HOT FRAMES FOR GROWING PLANTS (U.S. CLS. 1, 12, 33 AND 50).

FIRST USE 7-23-2003; IN COMMERCE 1-4-2005.

CLASS 21—HOUSEWARES AND GLASS

FOR NON-METAL CONTAINERS IN THE NATURE OF RAISED BEDS AND HOT FRAMES IN WHICH PLANTS MAY BE GROWN (U.S. CLS. 2, 13, 23, 29, 30, 33, 40 AND 50).

FIRST USE 7-23-2003; IN COMMERCE 1-10-2005.

2,955,509. ACCELA COMMUNICATIONS INC, SOUTHBOROUGH, MA. SN 78-153,173. PUB. 4-27-2004, FILED 8-12-2002.

ACCELACAST**CLASS 35—ADVERTISING AND BUSINESS**

FOR PROVIDING ON-LINE REGISTRATION SERVICES FOR ON-LINE PRESENTATIONS, DEMONSTRATIONS, TRAINING, AND SEMINARS; CONDUCTING AND PROVIDING THE RESULTS OF BUSINESS RESEARCH AND SURVEYS OVER THE INTERNET; AND BUSINESS MARKETING CONSULTING SERVICES IN THE FIELD OF ON-LINE PRESENTATIONS, DEMONSTRATIONS, TRAINING, AND COMMUNICATION; DATABASE MANAGEMENT SERVICES IN THE FIELD OF ON-LINE PRESENTATIONS, DEMONSTRATIONS, TRAINING, AND COMMUNICATION (U.S. CLS. 100, 101 AND 102).

FIRST USE 9-0-2002; IN COMMERCE 9-0-2002.

CLASS 38—COMMUNICATION

FOR STREAMING OF AUDIO AND VIDEO MATERIAL ON THE INTERNET; BROADCASTING PROGRAMS VIA A GLOBAL COMPUTER NETWORK; WEBCASTING SERVICES; COMMUNICATIONS SERVICES, NAMELY, ELECTRONIC TRANSMISSION OF DATA AND DOCUMENTS AMONG USERS OF COMPUTERS; COMMUNICATIONS SERVICES, NAMELY, TRANSMITTING STREAMED SOUND AND AUDIO-VISUAL RECORDS VIA THE INTERNET; ELECTRONIC AND DIGITAL TRANSMISSION OF VOICE, DATA, IMAGES, SIGNALS, AND MESSAGES OVER THE INTERNET (U.S. CLS. 100, 101 AND 104).

FIRST USE 9-0-2002; IN COMMERCE 9-0-2002.

CLASS 41—EDUCATION AND ENTERTAINMENT

FOR ARRANGING AND CONDUCTING BUSINESS CONFERENCES AND SEMINARS (U.S. CLS. 100, 101 AND 107).

FIRST USE 9-0-2002; IN COMMERCE 9-0-2002.

CLASS 42—SCIENTIFIC, COMPUTER AND LEGAL SERVICES

FOR HOSTING OF DIGITAL CONTENT OVER THE INTERNET; COMPUTER SERVICES, NAMELY, HOSTING ON-LINE DEMONSTRATIONS, TRAINING, COMMUNICATIONS AND INTERACTIVE DISCUSSIONS TO EVALUATE, ANALYZE AND COLLECT SERVICE DATA FOR OTHERS (U.S. CLS. 100 AND 101).

FIRST USE 9-0-2002; IN COMMERCE 9-0-2002.

2,955,525. FIRMENICH S.A., GENEVE 8, SWITZERLAND. SN 78-167,147. PUB. 5-13-2003, FILED 9-24-2002.

NATUREINTACT

THE MARK CONSISTS OF STANDARD CHARACTERS WITHOUT CLAIM TO ANY PARTICULAR FONT, STYLE, SIZE, OR COLOR.

CLASS 1—CHEMICALS

FOR CHEMICALS INTENDED FOR USE IN THE MANUFACTURE OF PERFUMES, FRAGRANCES, FLAVORS, COSMETICS, AND SOAPS (U.S. CLS. 1, 5, 6, 10, 26 AND 46).

FIRST USE 2-28-2003; IN COMMERCE 2-28-2003.

CLASS 3—COSMETICS AND CLEANING PREPARATIONS

FOR NATURAL AND ARTIFICIAL PERFUMES AND COLOGNES; COSMETICS, NAMELY MAKEUP FOUNDATIONS, POWDERS, EYELINERS, EYESHADOWS, BLUSH, LIP LINERS, LIPSTICKS, AND DEODORANTS FOR PERSONAL USE; FRAGRANCE PREPARATIONS FOR SKIN CARE AND BODY CARE, NAMELY FACE AND BODY CREAMS, LOTIONS, SHOWER AND BATH MILKS, GELS, SALTS, AND LOTIONS; HAIR CARE PREPARATIONS, NAMELY SHAMPOOS, CONDITIONERS, HAIR SPRAYS AND LOTIONS; SOAPS, ALL-PURPOSE CLEANING PRODUCTS FOR HOUSEHOLD OR INDUSTRIAL USE, FABRIC SOFTENERS; AND ESSENTIAL OILS, ALL BEING RAW MATERIALS OR INTERMEDIATES INTENDED FOR INCORPORATION INTO END-PRODUCT PREPARATIONS FOR CONSUMERS (U.S. CLS. 1, 4, 6, 50, 51 AND 52).

FIRST USE 2-28-2003; IN COMMERCE 2-28-2003.

CLASS 30—STAPLE FOODS

FOR FOOD ADDITIVES FOR NON-NUTRITIONAL PURPOSES FOR USE AS FLAVORINGS AND INGREDIENTS IN FOODSTUFFS, BEVERAGES, PHARMACEUTICAL PRODUCTS AND ORAL CARE PRODUCTS (U.S. CL. 46).

FIRST USE 2-28-2003; IN COMMERCE 2-28-2003.

2,955,527. TURBINE END-USER SERVICES, INC., SEABROOK, TX. SN 78-168,344. PUB. 5-25-2004, FILED 9-26-2002.

**CLASS 37—CONSTRUCTION AND REPAIR**

FOR CLEANING OF TURBINE EQUIPMENT AND PARTS (U.S. CLS. 100, 103 AND 106).

FIRST USE 9-10-2004; IN COMMERCE 9-10-2004.

CLASS 40—MATERIAL TREATMENT

FOR APPLICATION OF PROTECTIVE COATINGS, FINISHES, METALLIZING, METAL CASTING, METAL TREATMENT SERVICES TO TURBINE EQUIPMENT AND PARTS (U.S. CLS. 100, 103 AND 106).

FIRST USE 9-10-2004; IN COMMERCE 9-10-2004.

2,955,538. LEGACY MULTIMEDIA, LLC, KATY, TX. SN 78-174,488. PUB. 1-27-2004, FILED 10-15-2002.

LEGACY MULTIMEDIA

NO CLAIM IS MADE TO THE EXCLUSIVE RIGHT TO USE "MULTIMEDIA", APART FROM THE MARK AS SHOWN.

CLASS 40—MATERIAL TREATMENT

FOR DOCUMENT DATA TRANSFER AND PHYSICAL CONVERSION SERVICES FROM ONE MEDIA TO ANOTHER, NAMELY, CONVERSION OF PHOTOGRAPHS INTO DIGITAL FILES (U.S. CLS. 100, 103 AND 106).

FIRST USE 10-6-2002; IN COMMERCE 10-6-2002.

CLASS 42—SCIENTIFIC, COMPUTER AND LEGAL SERVICES

FOR COMPUTER SERVICES, NAMELY, CREATION OF ELECTRONIC AND COMPUTER PRESENTATIONS (U.S. CLS. 100 AND 101).

FIRST USE 10-6-2002; IN COMMERCE 10-6-2002.

2,955,539. FUTURE MEDIA ARCHITECTS, INC, ROAD TOWN, TORTOLA, BR.VIRGIN ISLANDS. SN 78-174,909. PUB. 5-18-2004, FILED 10-16-2002.

FUTURE MEDIA ARCHITECTS

NO CLAIM IS MADE TO THE EXCLUSIVE RIGHT TO USE "MEDIA", APART FROM THE MARK AS SHOWN.

CLASS 35—ADVERTISING AND BUSINESS

FOR DISSEMINATION OF ADVERTISING MATERIAL FOR OTHERS, NAMELY, BROCHURES, CATALOGS, INTERNATIONAL SHEETS, FLYERS; DISSEMINATION OF ADVERTISING FOR OTHERS THROUGH THE INTERNET; RENTAL OF ADVERTISING SPACE; COMPUTER SERVICES, NAMELY ADDRESS CHANGE NOTIFICATION SERVICES VIA THE INTERNET; ON-LINE TRADING SERVICES IN WHICH SELLER POSTS PRODUCTS TO BE AUCTIONED AND BIDDING IS DONE VIA THE INTERNET; ADVERTISING AGENCY SERVICES; FACILITATING THE EXCHANGE OF NEEDED INFORMATION FOR FINANCIAL COMPENSATION VIA THE INTERNET; PROMOTING THE MUSIC OF OTHERS BY PLACING SAID MUSIC ON THE INTERNET, DISTRIBUTING PRINTED AND AUDIO PROMOTIONAL MATERIAL; ON-LINE RETAIL AND WHOLESALE STORE SERVICES, FEATURING BOOKS, MOVIES, PRE-RECORDED VIDEO DISCS, VIDEO CASSETTES, VIDEO TAPES AND DOWNLOADABLE MEDIA, AND OTHER ELECTRONIC PRODUCTS (U.S. CLS. 100, 101 AND 102).

FIRST USE 11-6-1999; IN COMMERCE 11-6-1999.

CLASS 38—COMMUNICATION

FOR ELECTRONIC MAIL SERVICES; ON-LINE CHAT ROOM SERVICES FOR TRANSMISSION OF MESSAGES AMONG COMPUTER USERS ON A WIDE VARIETY OF TOPICS TRANSMITTING STREAMING AUDIO AND OR VIDEO VIA THE INTERNET (U.S. CLS. 100, 101 AND 104).

FIRST USE 11-6-1999; IN COMMERCE 11-6-1999.

CLASS 41—EDUCATION AND ENTERTAINMENT

FOR ENTERTAINMENT, NAMELY, A CONTINUING NEWS SHOW BROADCAST OVER TELEVISION, AND THE INTERNET; PROVIDING INFORMATION IN THE FIELD OF MUSIC AND VIDEO PRODUCTION VIA THE INTERNET (U.S. CLS. 100, 101 AND 107).

FIRST USE 11-6-1999; IN COMMERCE 11-6-1999.

CLASS 42—SCIENTIFIC, COMPUTER AND LEGAL SERVICES

FOR COMPUTER SERVICES, NAMELY PROVIDING SEARCH ENGINE AND ONLINE WEB LINK SERVICES ON A GLOBAL COMPUTER NETWORK; DOMAIN NAME REGISTRATION SERVICES ON A GLOBAL COMPUTER NETWORK (U.S. CLS. 100 AND 101).

FIRST USE 11-6-1999; IN COMMERCE 11-6-1999.

2,955,550. SESECURITY.COM, LLC, WEST ISLIP, NY. SN 78-181,939. PUB. 12-23-2003, FILED 11-5-2002.

SEELITLIVE.COM

CLASS 38—COMMUNICATION

FOR ELECTRONIC TRANSMISSION OF SOUND AND IMAGES FROM A DIGITAL RECORDER (U.S. CLS. 100, 101 AND 104).

FIRST USE 8-4-2004; IN COMMERCE 8-4-2004.

CLASS 40—MATERIAL TREATMENT

FOR REPRODUCTION OF SOUND AND IMAGES FROM A DIGITAL RECORDER (U.S. CLS. 100, 103 AND 106).

FIRST USE 8-4-2004; IN COMMERCE 8-4-2004.

2,955,561. KENDAL INTERNATIONAL COMPANY, MASPETH, NY. SN 78-196,334. PUB. 1-6-2004, FILED 12-19-2002.

**CLASS 7—MACHINERY**

FOR VACUUM CLEANERS AND STEAM CLEANERS (U.S. CLS. 13, 19, 21, 23, 31, 34 AND 35).

FIRST USE 11-1-2002; IN COMMERCE 11-1-2002.

CLASS 11—ENVIRONMENTAL CONTROL APPARATUS

FOR HOUSEHOLD AIR CLEANERS, AIR CONDITIONERS, AIR FILTERS FOR AIR CONDITIONING UNITS, AIR FILTERS FOR DOMESTIC USE, AIR FILTERS FOR INDUSTRIAL INSTALLATIONS, DISPENSING UNITS FOR ROOM AIR FRESHENERS, AIR PURIFYING UNITS FOR COMMERCIAL, DOMESTIC AND INDUSTRIAL USES, ELECTRIC HEATERS FOR BABY BOTTLES, BARBECUE GRILLS, CEILING FANS, CLEAN ROOMS, CLOTHES DRYERS, ELECTRIC COFFEE MAKERS FOR DOMESTIC AND COMMERCIAL USES, ELECTRIC COFFEE PERCOLATORS, ELECTRIC COFFEE POTS, COFFEE ROASTING OVENS, COMMERCIAL COOKING OVENS, ELECTRIC DEEP FRYERS, DEHUMIDIFIERS, ELECTRIC HAIR HAND DRYERS, HAND HELD ELECTRIC HAIR DRYERS, STATIONARY HAIR DRYERS FOR COMMERCIAL USE, FACIAL SAUNAS, ELECTRIC FANS, PORTABLE ELECTRIC FANS, AIR FILTERS FOR AIR CONDITIONING UNITS, AIR FILTERS FOR DOMESTIC USE, FREEZERS; DOMESTIC ELECTRIC APPLIANCES, NAMELY, FRY PANS, ELECTRIC GRIDDLES, AQUARIUM HEATERS, HOT WATER HEATERS, KEROSENE HEATERS, PORTABLE ELECTRIC HEATERS, ELECTRIC HEATERS FOR BABY BOTTLES, ELECTRIC HOT PLATES, HOT WATER BOTTLES, HOT WATER TANKS, HUMIDIFIERS, ELECTRIC WAFFLE IRONS, ELECTRIC KETTLES, ELECTRIC CHINESE LANTERNS, OIL LANTERNS, MICROWAVE OVENS FOR COOKING, OVEN GAS IGNITERS, OVEN VENTILATOR HOODS, CERAMIC PLATES SOLD AS PARTS OF OVENS, COFFEE ROASTING OVEN, COMMERCIAL COOKING OVENS, DOMESTIC COOKING OVENS, ELECTRIC TOASTER OVENS, GLASS PLATES SOLD AS PARTS OF OVENS, ELECTRIC FOOD STEAMERS, ELECTRIC WARMING PANS FOR BEDS, ELECTRIC COFFEE PERCOLATORS, ELECTRIC HOT PLATES, ELECTRIC COFFEE POTS, ELECTRIC PRESSURE COOKERS, ELECTRIC RICE COOKERS, ELECTRIC TOASTER OVENS, ELECTRIC TOASTERS, AUTOMATIC BREAD-MAKING MACHINES FOR DOMESTIC USE, SPAS IN THE NATURE OF HEATED POOLS, WATER FILTERING UNITS FOR DOMESTIC USE, HOT WATERS HEATERS, WATER PURIFICATION UNITS, WASTE WATER PURIFICATION UNITS, WATER PURIFYING UNITS FOR POTABLE WATER FOR DOMESTIC USE (U.S. CLS. 13, 21, 23, 31 AND 34).

FIRST USE 11-1-2002; IN COMMERCE 11-1-2002.

2,955,562. 2NDEDISON, INC., REDWOOD CITY, CA. SN 78-196,433. PUB. 4-27-2004, FILED 12-19-2002.

SIKKO

CLASS 16—PAPER GOODS AND PRINTED MATTER

FOR SNOWBOARD ACCESSORIES, NAMELY, SNOWBOARD SKINS IN THE NATURE OF VINYL LAMINATES THAT ADHERE TO THE TOP OF THE BOARD AND DECORATIVE SNOWBOARD STICKERS (U.S. CLS. 2, 5, 22, 23, 29, 37, 38 AND 50).

FIRST USE 1-1-2003; IN COMMERCE 1-1-2003.

CLASS 25—CLOTHING

FOR CLOTHING, NAMELY, SHORT-SLEEVED T-SHIRTS, LONG-SLEEVED T-SHIRTS, SWEATSHIRTS, UNDERWEAR IN THE NATURE OF BOXERS AND THONGS (U.S. CLS. 22 AND 39).

FIRST USE 1-1-2003; IN COMMERCE 1-1-2003.

CLASS 28—TOYS AND SPORTING GOODS

FOR SNOWBOARDS AND SNOWBOARD PARTS AND ACCESSORIES, NAMELY, SNOWBOARD BINDINGS, SNOWBOARD STOMP PADS, AND SNOWBOARD LEASHES (U.S. CLS. 22, 23, 38 AND 50).

FIRST USE 1-1-2003; IN COMMERCE 1-1-2003.

2,955,578. BUDDHIST COMPASSION RELIEF TZU-CHI FOUNDATION, HUALIEN COUNTY, TAIWAN. SN 78-205,426. PUB. 1-27-2004, FILED 1-21-2003.

TZU CHI

OWNER OF U.S. REG. NOS. 1,988,214, 2,303,651, AND 2,303,652.

THE FOREIGN WORDING IN THE MARK TRANSLATES INTO ENGLISH AS "COMPASSION" AND "RELIEF".

CLASS 36—INSURANCE AND FINANCIAL

FOR GLOBAL MISSION OF CHARITY BEING CHARITABLE FUND-RAISING; CHARITY COLLECTIONS; AND ARRANGING OF FUNDING FOR OVERSEAS CHARITABLE AID PROJECTS (U.S. CLS. 100, 101 AND 102).

FIRST USE 3-24-1966; IN COMMERCE 11-20-1989.

CLASS 38—COMMUNICATION

FOR CABLE RADIO/TELEVISION BROADCASTING SERVICES; CABLE TELEVISION TRANSMISSION; RADIO AND COMPUTER ON-LINE BROADCASTING SERVICE; MASS AUDIO AND VIDEO BROADCASTING SERVICE; VISUAL BROADCASTING SERVICE; VIDEO TRANSMISSION SERVICE OFFERED VIA THE INTERNET (U.S. CLS. 100, 101 AND 104).

FIRST USE 3-24-1966; IN COMMERCE 11-20-1989.

CLASS 41—EDUCATION AND ENTERTAINMENT

FOR EDUCATIONAL SERVICES, NAMELY, CONDUCTING CLASSES, SEMINARS, CONFERENCES, AND WORKSHOPS IN THE FIELD OF NURSING, MEDICINE, PUBLIC HEALTH, MEDICAL TECHNOLOGY, RELIGION, CULTURE, PERSONAL DEVELOPMENT, BUSINESS MANAGEMENT, THE ARTS AND THE ENVIRONMENT; LIBRARY SERVICES; EDUCATIONAL SERVICES, NAMELY, ESTABLISHING SCHOOLS, DEVELOPING EDUCATIONAL MATERIALS AND TEACHING METHODS; PRODUCTION OF RADIO AND TELEVISION PROGRAMS; PROGRAMMING, NAMELY, SCHEDULING FOR CABLE TELEVISION; PUBLICATION OF TEXT BOOKS AND MAGAZINES (U.S. CLS. 100, 101 AND 107).

FIRST USE 3-24-1966; IN COMMERCE 11-20-1989.

CLASS 44—MEDICAL, BEAUTY AND AGRICULTURAL SERVICES

FOR NURSING HOMES; MEDICAL SERVICES; HOSPITAL SERVICES; PROVIDING MEDICAL INFORMATION REGARDING BONE MARROW DATA CENTERS AND USE THEREOF FOR MEDICAL PURPOSES AND INTERNATIONAL RELIEF (U.S. CLS. 100 AND 101).

FIRST USE 3-24-1966; IN COMMERCE 11-20-1989.

2,955,608. CORE NAP, L.P., AUSTIN, TX. SN 78-223,671. PUB. 8-3-2004, FILED 3-10-2003.

CORE NAP

CLASS 38—COMMUNICATION

FOR PROVIDING MULTIPLE-USER ACCESS TO A GLOBAL COMPUTER INFORMATION NETWORK THROUGH DEDICATED LINES (U.S. CLS. 100, 101 AND 104).

FIRST USE 3-1-2003; IN COMMERCE 4-15-2003.

CLASS 42—SCIENTIFIC, COMPUTER AND LEGAL SERVICES

FOR OPERATING OF DATA CENTERS, NAMELY MONITORING SERVICES FOR INTERNET AND COMPUTER SYSTEMS FOR PURPOSE OF DETECTION OUTAGES AND OTHER PERFORMANCE DEGRADING AND PROVIDING TECHNICAL SUPPORT (U.S. CLS. 100 AND 101).

FIRST USE 3-1-2003; IN COMMERCE 4-15-2003.

2,955,622. GOLDBRICK GAMES, LLC, MASON, NH. SN 78-226,308. PUB. 11-4-2003, FILED 3-17-2003.

PERPETUAL COMMOTION

CLASS 25—CLOTHING

FOR CLOTHING, NAMELY, SHIRTS, T-SHIRTS, GOLF SHIRTS, KNIT SHIRTS, POLO SHIRTS, SPORTS SHIRTS, SWEAT SHIRTS, JERSEYS, BASEBALL CAPS AND HATS (U.S. CLS. 22 AND 39).

FIRST USE 5-7-2004; IN COMMERCE 5-22-2004.

CLASS 28—TOYS AND SPORTING GOODS

FOR GAMES, NAMELY, CARD GAMES, BOARD GAMES AND PARLOR GAMES (U.S. CLS. 22, 23, 38 AND 50).

FIRST USE 4-28-2004; IN COMMERCE 5-22-2004.

CLASS 41—EDUCATION AND ENTERTAINMENT

FOR ENTERTAINMENT IN THE NATURE OF CARD GAME TOURNAMENTS; PROVIDING AN ONLINE COMPUTER GAME (U.S. CLS. 100, 101 AND 107).
FIRST USE 4-28-2004; IN COMMERCE 4-28-2004.

2,955,629. DESTINATION IMAGINATION, INC., GLASSBORO, NJ. SN 78-227,304. PUB. 1-13-2004, FILED 3-19-2003.

**CLASS 9—ELECTRICAL AND SCIENTIFIC APPARATUS**

FOR PRE-RECORDED VIDEO TAPES FEATURING CREATIVE PROBLEM SOLVING FOR STUDENTS FROM KINDERGARTEN THROUGH COLLEGE; COMPUTER SOFTWARE FOR THE USE OF SCORING IN THE FIELD OF TEAM-BASED CREATIVE PROBLEM SOLVING FOR STUDENTS FROM KINDERGARTEN THROUGH COLLEGE AND USER MANUALS SOLD AS A UNIT (U.S. CLS. 21, 23, 26, 36 AND 38).
FIRST USE 9-30-2003; IN COMMERCE 9-30-2003.

CLASS 14—JEWELRY

FOR MEDALS AND BADGES OF PRECIOUS METAL; LAPEL PINS; BRACELETS; EARRINGS; TIE FASTENERS; JEWELRY (U.S. CLS. 2, 27, 28 AND 50).
FIRST USE 9-30-2003; IN COMMERCE 9-30-2003.

CLASS 16—PAPER GOODS AND PRINTED MATTER

FOR PAPER AND PRINTED MATERIAL, NAMELY GUIDEBOOKS ABOUT TEAM-BASED CREATIVE PROBLEM SOLVING FOR STUDENTS FROM KINDERGARTEN THROUGH COLLEGE, CURRICULUM GUIDES FOR TEAM-BASED CREATIVE PROBLEM SOLVING FOR STUDENTS FROM KINDERGARTEN THROUGH COLLEGE, STATIONERY, BROCHURES ABOUT TEAM-BASED CREATIVE PROBLEM SOLVING FOR STUDENTS FROM KINDERGARTEN THROUGH COLLEGE, BUMPER STICKERS, BOOKS IN THE FIELD OF TEAM-BASED CREATIVE PROBLEM SOLVING FOR STUDENTS FROM KINDERGARTEN THROUGH COLLEGE, GREETING CARDS AND BUSINESS FORMS (U.S. CLS. 2, 5, 22, 23, 29, 37, 38 AND 50).
FIRST USE 9-30-2003; IN COMMERCE 9-30-2003.

CLASS 18—LEATHER GOODS

FOR LEATHER SOLD IN BULK; LEATHER BAGS (U.S. CLS. 1, 2, 3, 22 AND 41).
FIRST USE 9-30-2003; IN COMMERCE 9-30-2003.

CLASS 20—FURNITURE AND ARTICLES NOT OTHERWISE CLASSIFIED

FOR WOODEN AWARDS, NAMELY PLAQUES; WOODEN BOXES (U.S. CLS. 2, 13, 22, 25, 32 AND 50).
FIRST USE 9-30-2003; IN COMMERCE 9-30-2003.

CLASS 24—FABRICS

FOR FABRICS FOR THE MANUFACTURE OF CLOTHING, CLOTH FLAGS, TOWELS, CLOTH BANNERS (U.S. CLS. 42 AND 50).
FIRST USE 9-30-2003; IN COMMERCE 9-30-2003.

CLASS 25—CLOTHING

FOR CLOTHING, NAMELY T-SHIRTS, SWEATSHIRTS, HATS AND JACKETS (U.S. CLS. 22 AND 39).
FIRST USE 9-30-2003; IN COMMERCE 9-30-2003.

CLASS 41—EDUCATION AND ENTERTAINMENT

FOR EDUCATIONAL AND ENTERTAINMENT SERVICES, NAMELY INFORMATIONAL PROGRAMS, SEMINARS AND COMPETITIONS IN THE FIELD OF TEAM-BASED CREATIVE PROBLEM SOLVING FOR STUDENTS FROM KINDERGARTEN THROUGH COLLEGE (U.S. CLS. 100, 101 AND 107).
FIRST USE 9-30-2003; IN COMMERCE 9-30-2003.

2,955,630. SENS FURNITURE, INC., SAN FRANCISCO, CA. SN 78-227,479. PUB. 12-9-2003, FILED 3-19-2003.

SENS

THE FOREIGN WORDING IN THE MARK TRANSLATES INTO ENGLISH AS "SENSES".

CLASS 11—ENVIRONMENTAL CONTROL APPARATUS

FOR LAMPS, LAMPSHADES AND OTHER ELECTRIC LIGHTING FIXTURES (U.S. CLS. 13, 21, 23, 31 AND 34).
FIRST USE 10-1-2002; IN COMMERCE 5-12-2004.

CLASS 20—FURNITURE AND ARTICLES NOT OTHERWISE CLASSIFIED

FOR FURNITURE AND FURNITURE MIRRORS (U.S. CLS. 2, 13, 22, 25, 32 AND 50).
FIRST USE 10-1-2002; IN COMMERCE 5-12-2004.

2,955,649. UPPER SKAGIT INDIAN TRIBE, THE, DBA SKAGIT VALLEY CASINO RESORT, BOW, WA. SN 78-236,290. PUB. 1-27-2004, FILED 4-10-2003.

STARS OF SUMMER AT THE SKAGIT

OWNER OF U.S. REG. NOS. 2,605,444, 2,735,419, AND 2,756,484.

CLASS 41—EDUCATION AND ENTERTAINMENT

FOR CASINOS; ENTERTAINMENT IN THE NATURE OF VISUAL AND AUDIO PERFORMANCES, NAMELY, MUSICAL BAND, ROCK GROUP, DANCE, AND SOLO MUSICAL PERFORMANCES (U.S. CLS. 100, 101 AND 107).
FIRST USE 5-31-2003; IN COMMERCE 5-31-2003.

CLASS 43—HOTEL AND RESTAURANT SERVICES

FOR RESORT LODGING AND HOTEL SERVICES (U.S. CLS. 100 AND 101).
FIRST USE 5-31-2003; IN COMMERCE 5-31-2003.

2,955,666. LOWERY, BOYCE F., DRAPER, UT. SN 78-244,601.
PUB. 7-6-2004, FILED 5-1-2003.

SUNCREST STRATEGIC ADVISORS

NO CLAIM IS MADE TO THE EXCLUSIVE RIGHT TO USE STRATEGIC ADVISORS, APART FROM THE MARK AS SHOWN.

CLASS 35—ADVERTISING AND BUSINESS

FOR INCOME TAX PLANNING (U.S. CLS. 100, 101 AND 102).
FIRST USE 5-12-2003; IN COMMERCE 5-12-2003.

CLASS 36—INSURANCE AND FINANCIAL

FOR FINANCIAL COUNSELING AND CONSULTING SERVICE, NAMELY ASSET PROTECTION PLANNING, WEALTH AND ASSET TRANSFER PLANNING, RETIREMENT PLANNING SERVICES, AND ESTATE PLANNING (U.S. CLS. 100, 101 AND 102).
FIRST USE 5-12-2003; IN COMMERCE 5-12-2003.

2,955,667. MARTIN, CHRISTOPHER, BRONX, NY. SN 78-245,682. PUB. 5-4-2004, FILED 5-5-2003.

YEAR ROUND RECORDS

NO CLAIM IS MADE TO THE EXCLUSIVE RIGHT TO USE "RECORDS", APART FROM THE MARK AS SHOWN.

CLASS 9—ELECTRICAL AND SCIENTIFIC APPARATUS

FOR SERIES OF CDS AND AUDIO CASSETTES FEATURING MUSIC, MUSICAL SOUND RECORDINGS, MUSICAL VIDEO RECORDINGS, DOWNLOADABLE MUSICAL SOUND RECORDINGS AND DOWNLOADABLE MUSICAL VIDEO RECORDINGS (U.S. CLS. 21, 23, 26, 36 AND 38).
FIRST USE 9-30-2002; IN COMMERCE 9-30-2002.

CLASS 25—CLOTHING

FOR CLOTHING, NAMELY, T-SHIRTS, SHIRTS, JACKETS, HATS, VISORS, HEADWEAR, BOXER SHORTS AND BANDANNAS (U.S. CLS. 22 AND 39).
FIRST USE 11-30-2004; IN COMMERCE 11-30-2004.

CLASS 35—ADVERTISING AND BUSINESS

FOR ONLINE RETAIL STORE SERVICES FEATURING MUSICAL SOUND RECORDINGS, MUSICAL VIDEO RECORDINGS, DOWNLOADABLE MUSICAL SOUND RECORDINGS, DOWNLOADABLE MUSICAL VIDEO RECORDINGS AND CLOTHING (U.S. CLS. 100, 101 AND 102).
FIRST USE 11-30-2004; IN COMMERCE 11-30-2004.

CLASS 38—COMMUNICATION

FOR COMMUNICATIONS SERVICES, NAMELY, PROVIDING TRANSMISSION SERVICES IN THE NATURE OF STREAMING OF AUDIO AND VIDEO MATERIALS, NAMELY, MUSICAL RECORDINGS, MUSIC VIDEOS, CONCERT FOOTAGE AND INTERVIEWS REGARDING A MUSICAL GROUP (U.S. CLS. 100, 101 AND 104).
FIRST USE 9-30-2003; IN COMMERCE 9-30-2003.

CLASS 41—EDUCATION AND ENTERTAINMENT

FOR ENTERTAINMENT SERVICES, NAMELY, LIVE MUSICAL PERFORMANCES, MUSICAL TOURS, PROVIDING A WEBSITE OF INFORMATION ON MUSIC, PERFORMANCES, SOUND AND VIDEO RECORDINGS, APPEARANCES, THE BIOGRAPHY, AND OTHER INFORMATION ON A MUSIC GROUP VIA A WEBSITE ON A GLOBAL COMPUTER NETWORK (U.S. CLS. 100, 101 AND 107).
FIRST USE 9-30-2003; IN COMMERCE 9-30-2003.

2,955,681. OCHS, BEVERLY, CENTERVILLE, OH. SN 78-252,532. PUB. 2-10-2004, FILED 5-21-2003.

SHOE BUDDIES

NO CLAIM IS MADE TO THE EXCLUSIVE RIGHT TO USE "SHOE", APART FROM THE MARK AS SHOWN.

CLASS 21—HOUSEWARES AND GLASS

FOR HOUSEWARES AND GLASS, NAMELY, COFFEE CUPS (U.S. CLS. 2, 13, 23, 29, 30, 33, 40 AND 50).
FIRST USE 5-15-2004; IN COMMERCE 6-1-2004.

CLASS 25—CLOTHING

FOR CLOTHING, NAMELY, T-SHIRTS (U.S. CLS. 22 AND 39).
FIRST USE 5-15-2004; IN COMMERCE 6-1-2004.

2,955,690. THE KENNA GROUP, LLC, DALY CITY, CA. SN 78-262,475. PUB. 5-11-2004, FILED 6-13-2003.

REMITHOME

CLASS 35—ADVERTISING AND BUSINESS

FOR INTEGRATED TRACKING AND MANAGEMENT OF COMMERCIAL TRANSACTIONS ON A GLOBAL COMPUTER NETWORK; DIRECT MARKETING ADVERTISING FOR OTHERS, PRIMARILY, FINANCIAL COMPANIES (U.S. CLS. 100, 101 AND 102).
FIRST USE 9-23-2003; IN COMMERCE 9-23-2003.

CLASS 36—INSURANCE AND FINANCIAL

FOR ELECTRONIC CASH TRANSACTIONS; ELECTRONIC CREDIT CARD TRANSACTIONS; PROVIDING FINANCIAL INFORMATION RELATED TO ON-LINE FINANCIAL TRANSACTIONS (U.S. CLS. 100, 101 AND 102).
FIRST USE 10-1-2004; IN COMMERCE 10-1-2004.

2,955,691. FARLAN ENTERTAINMENT, PORT LOUIS, MAURITIUS. SN 78-262,953. PUB. 8-31-2004, FILED 6-16-2003.

DARK AND LIGHT

CLASS 9—ELECTRICAL AND SCIENTIFIC APPARATUS

FOR COMPUTER AND VIDEO GAME SOFTWARE (U.S. CLS. 21, 23, 26, 36 AND 38).
FIRST USE 9-21-2004; IN COMMERCE 9-21-2004.

CLASS 41—EDUCATION AND ENTERTAINMENT

FOR ENTERTAINMENT SERVICES, NAMELY OPERATING AN INTERACTIVE GAME PLAYED BY OTHERS OVER A GLOBAL COMMUNICATIONS NETWORK (U.S. CLS. 100, 101 AND 107).
FIRST USE 9-21-2004; IN COMMERCE 9-21-2004.

2,955,697. CNS VITAL SIGNS, LLC, CHAPEL HILL, NC. SN 78-266,348. PUB. 6-8-2004, FILED 6-24-2003.

CNS VITAL SIGNS

NO CLAIM IS MADE TO THE EXCLUSIVE RIGHT TO USE CNS, APART FROM THE MARK AS SHOWN.

CLASS 9—ELECTRICAL AND SCIENTIFIC APPARATUS

FOR COMPUTER SOFTWARE FOR (A) TESTING AND SCREENING FOR A VARIETY OF NEUROCOGNITIVE DISORDERS AND METAL ILLNESSES, INCLUDING LEARNING DISABILITIES, ATTENTION DEFICIT DISORDER, DEMENTIA, AND ALZHEIMER'S DISEASE, AND (B) AGGREGATING, ANALYZING, AND REPORTING ON THE RESULTS OF SUCH NEUROCOGNITIVE TESTS (U.S. CLS. 21, 23, 26, 36 AND 38).
FIRST USE 5-26-2003; IN COMMERCE 12-23-2003.

CLASS 44—MEDICAL, BEAUTY AND AGRICULTURAL SERVICES

FOR PROVIDING CONSULTING SERVICES TO HEALTH CARE PRACTITIONERS AND PHARMACEUTICAL/BIOTECH COMPANIES IN THE FIELD OF NEUROCOGNITIVE TESTING AND ANALYSIS; PROVIDING ON-LINE DATABASES CONTAINING RESULTS OF NEUROCOGNITIVE TESTING (U.S. CLS. 100 AND 101).
FIRST USE 5-26-2003; IN COMMERCE 5-26-2003.

2,955,701. SLEEP COUNTRY USA, INC., KENT, WA. SN 78-269,240. PUB. 10-12-2004, FILED 7-1-2003.

SLEEP COUNTRY PLUS

NO CLAIM IS MADE TO THE EXCLUSIVE RIGHT TO USE "SLEEP", APART FROM THE MARK AS SHOWN.

CLASS 35—ADVERTISING AND BUSINESS

FOR RETAIL FURNITURE STORES; RETAIL MATTRESS AND BEDDING FURNITURE STORES (U.S. CLS. 100, 101 AND 102).
FIRST USE 7-10-2003; IN COMMERCE 7-10-2003.

CLASS 39—TRANSPORTATION AND STORAGE

FOR DELIVERY AND PICKUP OF MATTRESSES AND BEDDING PRODUCTS FOR OTHERS (U.S. CLS. 100 AND 105).
FIRST USE 7-10-2003; IN COMMERCE 7-10-2003.

CLASS 42—SCIENTIFIC, COMPUTER AND LEGAL SERVICES

FOR INSPECTION OF MATTRESSES AND BEDDING PRODUCTS FOR OTHERS (U.S. CLS. 100 AND 101).
FIRST USE 7-10-2003; IN COMMERCE 7-10-2003.

2,955,713. SMITHKLINE BEECHAM CORPORATION, PHILADELPHIA, PA. SN 78-277,195. PUB. 12-9-2003, FILED 7-22-2003.

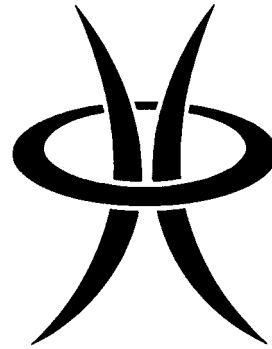

THE MARK CONSISTS OF TWO CURVED LINES IN A CIRCLE.

CLASS 16—PAPER GOODS AND PRINTED MATTER

FOR PRINTED EDUCATIONAL MATERIALS, NAMELY BROCHURES, PAMPHLETS AND BOOKLETS, CONCERNING THE TREATMENT AND PREVENTION OF PROSTATE CANCER AND CLINICAL TRIALS THEREFOR (U.S. CLS. 2, 5, 22, 23, 29, 37, 38 AND 50).
FIRST USE 3-31-2004; IN COMMERCE 3-31-2004.

CLASS 44—MEDICAL, BEAUTY AND AGRICULTURAL SERVICES

FOR HEALTHCARE SERVICES RELATING TO THE TREATMENT AND PREVENTION OF PROSTATE CANCER (U.S. CLS. 100 AND 101).
FIRST USE 3-31-2004; IN COMMERCE 3-31-2004.

2,955,721. STARKIE, MICHAEL CHARLES, MORRISTOWN, NJ. SN 78-285,940. PUB. 10-5-2004, FILED 8-11-2003.

GLOBAL FORGE

NO CLAIM IS MADE TO THE EXCLUSIVE RIGHT TO USE "GLOBAL", APART FROM THE MARK AS SHOWN.

CLASS 41—EDUCATION AND ENTERTAINMENT

FOR EDUCATIONAL SERVICES NAMELY CONDUCTING PROGRAMS IN THE FIELD OF COMPUTER SOFTWARE TECHNOLOGY (U.S. CLS. 100, 101 AND 107).

FIRST USE 1-1-2005; IN COMMERCE 1-1-2005.

CLASS 42—SCIENTIFIC, COMPUTER AND LEGAL SERVICES

FOR COMPUTER SOFTWARE CONSULTATION SERVICES, COMPUTER SOFTWARE DESIGN FOR OTHERS AND CREATION OF COMPUTER PROGRAM CODE BY CONTRACT FOR PURPOSES DESCRIBED BY CONTRACT (U.S. CLS. 100 AND 101).

FIRST USE 1-1-2005; IN COMMERCE 1-1-2005.

2,955,754. NORCRAFT COMPANIES, L.L.C., EAGAN, MN. SN 78-310,494. PUB. 5-18-2004, FILED 10-7-2003.

NORCRAFT COMPANIES

OWNER OF U.S. REG. NOS. 1,705,039, 2,263,022, AND 2,267,039.

NO CLAIM IS MADE TO THE EXCLUSIVE RIGHT TO USE COMPANIES, APART FROM THE MARK AS SHOWN.

CLASS 20—FURNITURE AND ARTICLES NOT OTHERWISE CLASSIFIED

FOR KITCHEN, BATH AND OFFICE CABINETS (U.S. CLS. 2, 13, 22, 25, 32 AND 50).

FIRST USE 12-1-2003; IN COMMERCE 1-1-2004.

CLASS 40—MATERIAL TREATMENT

FOR CUSTOM MANUFACTURE OF CABINETS TO THE ORDER AND SPECIFICATION OF OTHERS (U.S. CLS. 100, 103 AND 106).

FIRST USE 12-1-2003; IN COMMERCE 1-1-2004.

2,955,760. ICON IP, INC., LOGAN, UT. SN 78-317,679. PUB. 5-4-2004, FILED 10-23-2003.



CLASS 5—PHARMACEUTICALS

FOR FOOD SUPPLEMENTS AND VITAMINS (U.S. CLS. 6, 18, 44, 46, 51 AND 52).

FIRST USE 10-14-2003; IN COMMERCE 10-14-2003.

CLASS 9—ELECTRICAL AND SCIENTIFIC APPARATUS

FOR PRERECORDED VIDEO CASSETTES AND COMPACT DISCS FEATURING INFORMATION REGARDING NUTRITION, EXERCISE AND WEIGHT LOSS (U.S. CLS. 21, 23, 26, 36 AND 38).

FIRST USE 10-14-2003; IN COMMERCE 10-14-2003.

CLASS 16—PAPER GOODS AND PRINTED MATTER

FOR PRINTED MATERIAL IN THE FORM OF BOOKLETS AND BROCHURES DIRECTED TO NUTRITION, EXERCISE AND WEIGHT LOSS (U.S. CLS. 2, 5, 22, 23, 29, 37, 38 AND 50).

FIRST USE 10-14-2003; IN COMMERCE 10-14-2003.

2,955,762. HANOVER TOOL, INC., ASHLAND, VA. SN 78-319,051. PUB. 9-7-2004, FILED 10-27-2003.

EXTREME TORQUE CORP

NO CLAIM IS MADE TO THE EXCLUSIVE RIGHT TO USE "CORP", APART FROM THE MARK AS SHOWN.

CLASS 7—MACHINERY

FOR AIR POWERED HAND TOOLS, NAMELY, DRILLS, SCREWDRIVERS, RIVET HAMMERS, SAWS, IMPACT WRENCHES, DRILLS, GRINDERS, AND ORBITAL SANDERS (U.S. CLS. 13, 19, 21, 23, 31, 34 AND 35).

FIRST USE 12-15-2004; IN COMMERCE 12-15-2004.

CLASS 8—HAND TOOLS

FOR HAND TOOLS, NAMELY, PLANERS, DRILLS, SHOVELS, HAMMERS, SOCKET SETS, WRENCHES, CLAMPS, DIES, FILES, HAND JACKS, MANUALLY-OPERATED GRINDSTONES, MANUALLY-OPERATED SHARPENING WHEELS, PICKS, PUNCHES, RASPS, RATCHET WRENCHES, REAMERS, SAWS, SCRAPERS, SCREW DRIVERS, SQUARES, TONGS, NIPPERS, HEX KEYS WRENCHES, NUT DRIVERS, RIPPING BARS, SANDERS, PUTTY KNIVES, ENGRAVERS, BOLT CUTTERS, WIRE CUTTERS, WIRE NIPPERS, WIRE STRIPPERS, PUNCHES, MAULS, HATCHETS, SOCKET WRENCHES, VICES, PAINT SCRAPERS, CHISELS (U.S. CLS. 23, 28 AND 44).

FIRST USE 12-15-2004; IN COMMERCE 12-15-2004.

2,955,772. BURLWOOD FINANCIAL GROUP, INC., MINNEAPOLIS, MN. SN 78-330,977. PUB. 10-19-2004, FILED 11-20-2003.

BURLWOOD

THE MARK CONSISTS OF STANDARD CHARACTERS WITHOUT CLAIM TO ANY PARTICULAR FONT, STYLE,

MAY 24, 2005

U.S. PATENT AND TRADEMARK OFFICE

TM 709

SIZE, OR COLOR.

CLASS 35—ADVERTISING AND BUSINESS

FOR TAX CONSULTATION AND PREPARATION
(U.S. CLS. 100, 101 AND 102).
FIRST USE 12-1-2003; IN COMMERCE 12-1-2003.

CLASS 36—INSURANCE AND FINANCIAL

FOR FINANCIAL CONSULTING, INVESTMENT AD-
VISING, AND ESTATE PLANNING (U.S. CLS. 100, 101
AND 102).
FIRST USE 12-1-2003; IN COMMERCE 12-1-2003.

* * * * *

SECTION 2.— INTERNATIONAL CLASSIFICATION

The short titles associated below with the international class numbers are terms designed merely for quick identification and are not an official part of the international classification. The full names of international classes are given in section 6.1 of the trademark rules of practice.

The designation "U.S. Cl." appearing in this section refers to the U.S. class in effect prior to Sep. 1, 1973 rather than the international class which applies to applications filed on or after that date. For adoption of international classification see notice in the OFFICIAL GAZETTE of Jun. 26, 1973 (911 O.G. TM 210).

Application in one class

CLASS 1—CHEMICALS

2,955,211. ORION GENOMICS, LLC, ST. LOUIS, MO. SN 76-015,001. PUB. 12-11-2001, FILED 3-31-2000.

GENETHRESHER

OWNER OF U.S. REG. NOS. 2,651,059 AND 2,737,322.
FOR AGRICULTURAL, PHARMACEUTICAL AND BIOTECHNOLOGY GENETIC AND GNOMIC PREPARATIONS, NAMELY, REAGENTS CONSISTING OF DNA, DNA BY-PRODUCTS, NAMELY, CLONES, DNA SEQUENCE INFORMATION, AND THERAPEUTIC PROTEINS FOR SCIENTIFIC USE IN AGRICULTURAL AND DRUG DISCOVERY; A MICRO ARRAY CONSISTING OF A SUBSTRATE ON WHICH NUCLEIC ACID SEQUENCES OR GNOMIC CLONES ARE AFFIXED, FOR USE IN THE FIELDS OF GNOMIC, SCIENTIFIC AND RESEARCH DIAGNOSTICS AND BIOTECHNOLOGY (U.S. CLS. 1, 5, 6, 10, 26 AND 46).
FIRST USE 7-12-1999; IN COMMERCE 7-12-1999.

2,955,244. MILLENNIUM PHARMACEUTICALS, INC., CAMBRIDGE, MA. SN 76-210,512. PUB. 10-14-2003, FILED 2-14-2001.



OWNER OF U.S. REG. NO. 2,257,174.
FOR DIAGNOSTIC ASSAYS FOR RESEARCH, TO DIAGNOSE, PROGNOSE, PREDICT OR TREAT DISEASES AND FOR PROVIDING GENOMIC AND PROTEOMIC PROFILES USEFUL IN THE SELECTION OF THERAPEUTICS (U.S. CLS. 1, 5, 6, 10, 26 AND 46).
FIRST USE 7-7-2003; IN COMMERCE 7-7-2003.

CLASS 1—(Continued).

2,955,267. PHARMOS CORPORATION, ISELIN, NJ. SN 76-323,512. PUB. 1-14-2003, FILED 10-4-2001.

EMULSOME

FOR CHEMICAL SUBSTANCES, NAMELY, EMULSION OF NANOPARTICLES USED AS A VEHICLE FOR DELIVERING DRUG OR COSMETIC COMPONENTS TO A USER (U.S. CLS. 1, 5, 6, 10, 26 AND 46).
FIRST USE 3-24-2003; IN COMMERCE 3-24-2003.

2,955,313. A. SCHULMAN, INC., AKRON, OH. SN 76-456,915. PUB. 4-1-2003, FILED 10-8-2002.

CLARIX

FOR IONOMER POLYMERS CONTAINING LESS THAN TEN (10) PERCENT OF AT LEAST ONE ADDITIONAL FUNCTIONAL CHEMICAL CONSTITUENT, INCLUDING, BUT NOT LIMITED TO, COLORANTS AND ADDITIVES, SUCH IONOMERS OPTIONALLY CONTAINING UP TO FIFTY (50) PERCENT FLEXIBILIZERS AND/OR OTHER POLYMERS FOR FURTHER PROCESSING IN MOLDING OR EXTRUSION APPARATUS (U.S. CLS. 1, 5, 6, 10, 26 AND 46).
FIRST USE 2-1-2003; IN COMMERCE 4-1-2004.

2,955,581. DEUTREL INDUSTRIES, INC., LANCASTER, CA. SN 78-209,731. PUB. 11-18-2003, FILED 1-31-2003.

SCIENTIFIC NATURAL

NO CLAIM IS MADE TO THE EXCLUSIVE RIGHT TO USE "NATURAL", APART FROM THE MARK AS SHOWN.
FOR WATER TREATMENT CHEMICALS FOR USE IN SWIMMING POOLS AND SPAS (U.S. CLS. 1, 5, 6, 10, 26 AND 46).
FIRST USE 1-15-2005; IN COMMERCE 1-15-2005.

CLASS 1—(Continued).

2,955,614. HIKARI SALES USA, INC., HAYWARD, CA. SN 78-225,126. PUB. 12-2-2003, FILED 3-13-2003.

REPTILE SOLUTIONS

NO CLAIM IS MADE TO THE EXCLUSIVE RIGHT TO USE "REPTILE", APART FROM THE MARK AS SHOWN. FOR WATER CONDITIONERS FOR USE WITH REPTILES AND HERPTILES (U.S. CLS. 1, 5, 6, 10, 26 AND 46).

FIRST USE 12-14-2004; IN COMMERCE 12-14-2004.

2,955,687. APPLIED SPECIALTIES, INC., AVON LAKE, OH. SN 78-261,401. PUB. 12-23-2003, FILED 6-12-2003.

ALUMER

FOR WATER TREATMENT CHEMICALS, NAMELY, COAGULANTS (U.S. CLS. 1, 5, 6, 10, 26 AND 46). FIRST USE 2-21-2005; IN COMMERCE 2-21-2005.

2,955,693. INTERNATIONAL COMMERCIAL TELEVISION, INC., BAINBRIDGE ISLAND, WA. SN 78-264,548. PUB. 3-23-2004, FILED 6-19-2003.

TWINTTECH

FOR CHEMICAL FUEL ADDITIVE FOR COMBUSTION ENGINES (U.S. CLS. 1, 5, 6, 10, 26 AND 46). FIRST USE 11-5-2004; IN COMMERCE 11-5-2004.

2,955,702. HESS, JOHN E., TULSA, OK. SN 78-269,620. PUB. 9-21-2004, FILED 7-2-2003.

SPA DOC

NO CLAIM IS MADE TO THE EXCLUSIVE RIGHT TO USE "SPA", APART FROM THE MARK AS SHOWN. FOR WATER TREATMENT CHEMICALS FOR POOL AND SPA USE (U.S. CLS. 1, 5, 6, 10, 26 AND 46). FIRST USE 1-10-2005; IN COMMERCE 1-10-2005.

2,955,703. OMG AMERICAS, INC., CLEVELAND, OH. SN 78-270,179. PUB. 4-6-2004, FILED 7-3-2003.

FRIC-SHUN

FOR OVERBASED METAL CARBOXYLATES FOR USE IN LUBRICANTS AND GREASES (U.S. CLS. 1, 5, 6, 10, 26 AND 46). FIRST USE 7-29-2004; IN COMMERCE 7-29-2004.

CLASS 1—(Continued).

2,955,727. ILLINOIS TOOL WORKS INC., GLENVIEW, IL. SN 78-288,700. PUB. 5-25-2004, FILED 8-18-2003.

FLOW-MIX

FOR EPOXY FOR AUTOMOTIVE, HOUSEHOLD AND GENERAL PURPOSE BONDING (U.S. CLS. 1, 5, 6, 10, 26 AND 46).

FIRST USE 9-0-2003; IN COMMERCE 9-0-2003.

CLASS 2—PAINTS

2,955,390. SUNBELT CORPORATION, ROCK HILL, SC. SN 76-498,670. PUB. 11-18-2003, FILED 3-19-2003.

NAVISURF

FOR WATER-BASED PIGMENT DISPERSION FOR USE IN THE MANUFACTURE OF INKS (U.S. CLS. 6, 11 AND 16).

FIRST USE 3-19-2003; IN COMMERCE 3-19-2003.

2,955,457. INSL-X PRODUCTS CORPORATION, STONY POINT, NY. SN 76-546,894. PUB. 6-1-2004, FILED 9-10-2003.

ULTRAMAX

FOR COATINGS IN THE NATURE OF CLEAR AND PIGMENTED FINISHES FOR USE ON INTERIOR AND EXTERIOR SURFACES OF WOOD, PARTICLE BOARD, AND PLYWOOD (U.S. CLS. 6, 11 AND 16).

FIRST USE 4-10-2004; IN COMMERCE 4-10-2004.

2,955,475. LIBERTY BELL EQUIPMENT CORPORATION, TA MEDCO, PHILADELPHIA, PA. SN 76-977,399. PUB. 11-4-2003, FILED 2-22-2002.

FINISH PRO

NO CLAIM IS MADE TO THE EXCLUSIVE RIGHT TO USE "FINISH", APART FROM THE MARK AS SHOWN.

FOR AUTOMOTIVE PAINT, NAMELY, AEROSOL SPRAY PAINT; PAINT-RELATED PRODUCTS, NAMELY, AUTOMOTIVE FINISHING COATINGS IN THE NATURE OF CLEAR COATS, PRIMERS, SURFACERS, REDUCERS, HARDENERS, ACTIVATORS, AND PAINT THINNERS (U.S. CLS. 6, 11 AND 16).

FIRST USE 4-10-2002; IN COMMERCE 4-10-2002.

CLASS 2—(Continued).

2,955,528. WATTYL (US) LIMITED, EDGEWATER, FL. SN 78-168,517. PUB. 5-13-2003, FILED 9-27-2002.

GRIPS-ALL

FOR PRIMER AND SEALER COATINGS WITH OR WITHOUT STAIN-KILLING PROPERTIES, FOR APPLICATION TO WALLS, CEILINGS, AND FLOORS ON VARIOUS SUBSTRATES, PRIOR TO THE APPLICATION OF WALL COVERINGS OR PAINTS; INTERIOR AND EXTERIOR PAINTS; AND WALLPAPER STRIPPING PREPARATION (U.S. CLS. 6, 11 AND 16).

FIRST USE 9-23-2002; IN COMMERCE 9-23-2002.

2,955,563. GRINBERG, JULIO GERARDO, BUENOS AIRES, ARGENTINA. AND GRINBERG, ALEJANDRO JAVIER, BUENOS AIRES, ARGENTINA. SN 78-196,481. PUB. 12-2-2003, FILED 12-19-2002.

DOSICOLOR

FOR PIGMENTS AND COLOR DISPERSIONS IN THE NATURE OF COLORINGS FOR USE IN THE MANUFACTURING OF PLASTICS (U.S. CLS. 6, 11 AND 16).

FIRST USE 4-30-1989; IN COMMERCE 1-13-2005.

CLASS 3—COSMETICS AND CLEANING PREPARATIONS

2,955,200. FAITHFUL FRIENDS HOMEOPATHIC COMPANY, BRYN MAWR, PA. SN 75-871,874. PUB. 9-25-2001, FILED 12-14-1999.

OUCHY!

FOR SKIN CARE PRODUCTS, NAMELY, LOTIONS, GELS AND CREAMS; BODY CARE PRODUCTS, NAMELY, BUBBLE BATH, BATH GEL, SHOWER GEL, MILK BATH SOAK, MOISTURIZING BODY LOTION; SKIN SOAPS; MASSAGE OILS (U.S. CLS. 1, 4, 6, 50, 51 AND 52).

FIRST USE 11-17-2004; IN COMMERCE 11-17-2004.

2,955,216. FDN ENTERPRISES, INC., OPA LOCKA, FL. SN 76-036,671. PUB. 7-1-2003, FILED 4-28-2000.

CLASSIC CARE BY FDN

NO CLAIM IS MADE TO THE EXCLUSIVE RIGHT TO USE "CARE", APART FROM THE MARK AS SHOWN.

FOR HAIR CARE PREPARATIONS, NAMELY SHAMPOO, BODY WASH, NAIL CARE PREPARATIONS, SHOWER AND BATH POWDER, HAND AND BODY CREAM, COLD CREAM, HAND AND BODY LOTION AND MOUTHWASH (U.S. CLS. 1, 4, 6, 50, 51 AND 52).

FIRST USE 7-31-2000; IN COMMERCE 7-31-2000.

CLASS 3—(Continued).

2,955,252. CITRA-SOLV LLC, RIDGEFIELD, CT. SN 76-246,011. PUB. 8-6-2002, FILED 4-25-2001.

CITRA-BRITE

OWNER OF U.S. REG. NOS. 1,675,655, 1,919,148, AND 2,376,134.

FOR LAUNDRY BLEACH (U.S. CLS. 1, 4, 6, 50, 51 AND 52).

FIRST USE 5-6-2004; IN COMMERCE 5-6-2004.

2,955,273. MARKETING SYSTEMS OF AMERICA INC., WEST PALM BEACH, FL. SN 76-350,584. PUB. 4-20-2004, FILED 12-18-2001.

MEDI-CELL

FOR NON-MEDICATED SKIN CARE PREPARATIONS (U.S. CLS. 1, 4, 6, 50, 51 AND 52).

FIRST USE 1-1-2000; IN COMMERCE 1-1-2000.

2,955,284. WINTER, DEBORAH A., WASHINGTON, DC. SN 76-400,059. PUB. 7-6-2004, FILED 4-25-2002.

ALBISSA

FOR COSMETICS; SKIN CARE PRODUCTS NAMELY CLEANSERS, TONERS, LOTIONS; SUN BLOCKS OR SUN SCREENS; AFTER SUN PRODUCTS NAMELY MOISTURIZERS, SKIN CREAMS; SKIN AND FACIAL MASKS; SKIN SOAPS, FACE SOAPS; EXFOLIANTS FOR USE ON THE SKIN; HAND CREAMS, BODY CREAMS, AND SKIN CREAMS; NON-MEDICATED SKIN TREATMENTS AND NON-MEDICATED SKIN SERUMS; EYE TREATMENTS, NAMELY EYE CREAMS, EYE GELS, AND EYE MAKE UP REMOVERS; SKIN CLARIFIERS; SKIN CONDITIONERS; SKIN EMOLLIENTS; AND BODY LOTIONS (U.S. CLS. 1, 4, 6, 50, 51 AND 52).

FIRST USE 5-0-2001; IN COMMERCE 5-0-2001.

2,955,294. LANCOME PARFUMS ET BEAUTE & CIE, PARIS, FRANCE. SN 76-425,484. PUB. 7-1-2003, FILED 6-25-2002.

MIRACLE INTENSE

FOR PERFUMERY PRODUCTS, NAMELY, PERFUMES, PERFUMED WATER (U.S. CLS. 1, 4, 6, 50, 51 AND 52).

FIRST USE 10-0-2002; IN COMMERCE 10-0-2002.

CLASS 3—(Continued).

2,955,332. HELEN OF TROY LIMITED, BRIDGETOWN, BARBADOS. SN 76-471,262. PUB. 2-17-2004, FILED 11-18-2002.

EPIL-STOP SPRAY AND WIPE

OWNER OF U.S. REG. NO. 2,162,229.
NO CLAIM IS MADE TO THE EXCLUSIVE RIGHT TO USE "SPRAY AND WIPE", APART FROM THE MARK AS SHOWN.

FOR HAIR REMOVER; DEPILATORY LOTIONS, CREAMS, SPRAYS AND WIPES (U.S. CLS. 1, 4, 6, 50, 51 AND 52).

FIRST USE 10-14-2004; IN COMMERCE 10-14-2004.

2,955,339. HELEN OF TROY LIMITED, BRIDGETOWN, BARBADOS. SN 76-476,657. PUB. 2-24-2004, FILED 12-17-2002.

HAIR B GONE

NO CLAIM IS MADE TO THE EXCLUSIVE RIGHT TO USE HAIR, APART FROM THE MARK AS SHOWN.

FOR HAIR REMOVER; DEPILATORY CREAMS (U.S. CLS. 1, 4, 6, 50, 51 AND 52).

FIRST USE 10-14-2004; IN COMMERCE 10-14-2004.

2,955,369. AMOREPACIFIC CORPORATION, SEOUL, REPUBLIC OF KOREA. SN 76-490,967. PUB. 4-20-2004, FILED 2-12-2003.

HAPPY STYLE PACT

NO CLAIM IS MADE TO THE EXCLUSIVE RIGHT TO USE "STYLE PACT", APART FROM THE MARK AS SHOWN.

FOR POWDER FOUNDATIONS, COMPACT POWDERS, FACE POWDERS (U.S. CLS. 1, 4, 6, 50, 51 AND 52).

FIRST USE 6-30-2004; IN COMMERCE 7-31-2004.

2,955,387. SOAP GARDEN, THE, BERKELEY, CA. SN 76-497,724. PUB. 1-6-2004, FILED 3-17-2003.

THE SOAP GARDEN

NO CLAIM IS MADE TO THE EXCLUSIVE RIGHT TO USE "SOAP", APART FROM THE MARK AS SHOWN.

FOR SKIN SOAP (U.S. CLS. 1, 4, 6, 50, 51 AND 52).

FIRST USE 4-1-2003; IN COMMERCE 4-1-2003.

CLASS 3—(Continued).

2,955,472. L'OREAL, PARIS, FRANCE. SN 76-573,677. PUB. 5-25-2004, FILED 1-28-2004.

COLOR OF HOPE

THE MARK CONSISTS OF STANDARD CHARACTERS WITHOUT CLAIM TO ANY PARTICULAR FONT, STYLE, SIZE, OR COLOR.

FOR LIPSTICK, NAIL COLOR, BLUSH, AND EYE SHADOW (U.S. CLS. 1, 4, 6, 50, 51 AND 52).

FIRST USE 10-1-2004; IN COMMERCE 10-1-2004.

2,955,477. C.B. FLEET INVESTMENT CORPORATION, WILMINGTON, DE. SN 76-977,417. PUB. 4-15-2003, FILED 6-25-2002.

ISLAND SPLASH

FOR NON-MEDICATED DOUCHES AND FEMININE DEODORANT SPRAY (U.S. CLS. 1, 4, 6, 50, 51 AND 52).

FIRST USE 11-0-2002; IN COMMERCE 11-0-2002.

2,955,480. HALL, KATHLEEN, EAST PROVIDENCE, RI. SN 78-049,522. PUB. 4-16-2002, FILED 2-21-2001.

EDUCATED PALATE

FOR ESSENTIAL OILS USED FOR TEACHING THE FLAVORS OF HERBS AND SPICES (U.S. CLS. 1, 4, 6, 50, 51 AND 52).

FIRST USE 2-27-2005; IN COMMERCE 2-27-2005.

2,955,487. SCHWARTZ, JOLENE, MT. LAUREL, NJ. SN 78-077,834. PUB. 7-2-2002, FILED 8-6-2001.

FACE TOOLS

FOR PERSONAL CARE PRODUCTS, NAMELY, FACIAL CLEANSER, SHAVING GEL, AND FACIAL MOISTURIZER, WITH DISPENSER/APPLICATORS SOLD AS A UNIT WITH EACH OF THE AFOREMENTIONED GOODS (U.S. CLS. 1, 4, 6, 50, 51 AND 52).

FIRST USE 11-15-2001; IN COMMERCE 2-14-2005.

CLASS 3—(Continued).

2,955,504. HART, DANIELLE, REDONDO BEACH, CA. AND PUGH, SONJA, REDONDO BEACH, CA. AND GUTH, SHYANNE, REDONDO BEACH, CA. SN 78-149,077. PUB. 1-20-2004, FILED 7-31-2002.



THIS MARK CONSISTS OF THE USE OF A PINEAPPLE IMAGE WITHIN THE NAME "PINEAPPLE PRINCESS" IN PLACE OF THE "A".

FOR BODY AND BATH PRODUCTS, NAMELY, SOAP, SALT BODY SCRUB, SALT FACIAL SCRUB, HAND CREAM, SCENTED BATH SALTS, BATH OIL, BATH GEL, POTPOURRI, AND SCENTED LINEN SPRAY (U.S. CLS. 1, 4, 6, 50, 51 AND 52).

FIRST USE 9-0-2002; IN COMMERCE 9-0-2002.

2,955,523. PALANZA, FRANCIS E., PALM BEACH GARDENS, FL. AND SAVARESE, CAROLYN J., PALM BEACH GARDENS, FL. SN 78-164,023. PUB. 12-16-2003, FILED 9-13-2002.

"EXTRA ADVANTAGE"

FOR PERFUME, COSMETICS AND TOILETRIES, NAMELY COLOGNE, BODY LOTIONS, BODY OILS, BODY POWDERS, SHOWER GELS, MASSAGE OILS AND LIQUID PHEROMONES FOR PERSONAL COSMETIC USE (U.S. CLS. 1, 4, 6, 50, 51 AND 52).

FIRST USE 1-0-2003; IN COMMERCE 1-0-2003.

2,955,534. COLGATE-PALMOLIVE COMPANY, NEW YORK, NY. SN 78-170,771. PUB. 11-18-2003, FILED 10-3-2002.

FRESH RUSH

NO CLAIM IS MADE TO THE EXCLUSIVE RIGHT TO USE "FRESH", APART FROM THE MARK AS SHOWN.

FOR PERSONAL CARE PRODUCTS, NAMELY, DEODORANTS AND ANTIPERSPIRANTS (U.S. CLS. 1, 4, 6, 50, 51 AND 52).

FIRST USE 12-17-2002; IN COMMERCE 12-17-2002.

CLASS 3—(Continued).

2,955,599. CONAIR CORPORATION, STAMFORD, CT. SN 78-218,749. PUB. 6-8-2004, FILED 2-25-2003.

CALENDULA GOLD

NO CLAIM IS MADE TO THE EXCLUSIVE RIGHT TO USE "CALENDULA", APART FROM THE MARK AS SHOWN.

FOR DEPILATORY WAX HAIR REMOVER AND DEPILATORY KIT; COMPRISED OF, A DEPILATORY WAX FOR APPLICATION AND ADHESION TO HAIR AND REMOVAL STRIPS, AN ELECTRICAL APPARATUS FOR HEATING THE DEPILATORY WAX, HAIR REMOVAL STRIPS, APPLICATORS FOR APPLYING THE DEPILATORY WAX TO THE HAIR AND TO THE HAIR REMOVAL STRIPS, AND PROTECTIVE COLLARS FOR USE WITH THE CONTAINERS IN WHICH THE DEPILATORY MATERIAL IS CONTAINED (U.S. CLS. 1, 4, 6, 50, 51 AND 52).

FIRST USE 4-0-2003; IN COMMERCE 4-0-2003.

2,955,612. PLAYTEX PRODUCTS, INC., WESTPORT, CT. SN 78-224,894. PUB. 11-11-2003, FILED 3-12-2003.



THE MARK CONSISTS OF THE REPRESENTATION OF A LAMB IN A TUB.

FOR CLEANSING AND MOISTURIZING PRODUCTS FOR BABIES, NAMELY HAIR AND BODY WASH, BABY BATH, HAIR SHAMPOO AND CONDITIONER, AND MOISTURIZING SKIN LOTIONS (U.S. CLS. 1, 4, 6, 50, 51 AND 52).

FIRST USE 7-0-2003; IN COMMERCE 7-0-2003.

2,955,617. AMOREPACIFIC CORPORATION, SEOUL, REPUBLIC OF KOREA. SN 78-225,362. PUB. 10-21-2003, FILED 3-13-2003.

TURN & TURN

FOR SKIN MILK LOTIONS, PERFUMES, LAVENDER OILS, TISSUES IMPREGNATED WITH COSMETIC LOTIONS, COSMETIC SOAPS, SHAMPOOS, TOOTH PASTE, LIPSTICKS, NON-MEDICATED SKIN MOISTURIZING SERUMS, NOURISHING CREAMS (U.S. CLS. 1, 4, 6, 50, 51 AND 52).

FIRST USE 4-0-2003; IN COMMERCE 2-0-2004.

CLASS 3—(Continued).

2,955,634. BOOTS COMPANY USA HOLDINGS INC., THE, WILMINGTON, DE. SN 78-228,967. PUB. 12-2-2003, FILED 3-24-2003.

INTELLIGENT BALANCE

FOR COSMETIC PREPARATIONS, NAMELY BLUSHER, BODY CREAMS, SKIN FOUNDATIONS, SKIN MOISTURISERS AND MAKE-UP (U.S. CLS. 1, 4, 6, 50, 51 AND 52).

FIRST USE 2-14-2004; IN COMMERCE 2-14-2004.

2,955,688. ALBERTO-CULVER COMPANY, MELROSE PARK, IL. SN 78-261,449. PUB. 2-3-2004, FILED 6-12-2003.

HYDRATEIN

FOR PROTEIN MOISTURIZING COMPLEX USED AS AN INGREDIENT IN SKIN CARE PREPARATIONS (U.S. CLS. 1, 4, 6, 50, 51 AND 52).

FIRST USE 6-0-2003; IN COMMERCE 6-0-2003.

2,955,695. AJR BEAUTY INDUSTRY SERVICES, LLC, NEW YORK, NY. SN 78-265,803. PUB. 1-13-2004, FILED 6-23-2003.

**ETHEREAL COSMETICS
DESIGNED BY FUNERAL
DIRECTORS FOR FUNERAL
DIRECTORS**

NO CLAIM IS MADE TO THE EXCLUSIVE RIGHT TO USE "COSMETICS DESIGNED BY FUNERAL DIRECTORS FOR FUNERAL DIRECTORS", APART FROM THE MARK AS SHOWN.

FOR COSMETICS, NAMELY MAKE-UP FOR MORTUARY USE (U.S. CLS. 1, 4, 6, 50, 51 AND 52).

FIRST USE 9-0-2003; IN COMMERCE 9-0-2003.

2,955,704. CURRY, AUDREY, DBA BARE KISS LTD., SANTA FE, NM. SN 78-271,246. PUB. 4-6-2004, FILED 7-7-2003.

BARE KISS

FOR COSMETICS, MAKE-UP, LIPSTICK, NON-MEDICATED LIP BALM AND TOILETRIES, NAMELY DEODORANTS, FRAGRANCES FOR PERSONAL USE, BATH AND BODY POWDER, NON-MEDICATED FOOT POWDER, FACE POWDER, TALCUM POWDER, FACIAL LOTION, BODY LOTION, FACIAL AND BODY LOTIONS IN SOLID BAR FORM, SKIN TONERS, NON-MEDICATED BATH SALTS, INCLUDING FRAGRANT AND SCENTED BATH SALTS, FACIAL AND BODY SUGAR SCRUBS, SKIN SOAP, HAND SOAP AND SHAVING SOAP (U.S. CLS. 1, 4, 6, 50, 51 AND 52).

FIRST USE 7-1-2004; IN COMMERCE 7-29-2004.

CLASS 3—(Continued).

2,955,736. BEARDOG PRODUCTS INC., SCOTTSDALE, AZ. SN 78-293,366. PUB. 2-3-2004, FILED 8-28-2003.

LIPTOPIA

FOR LIP AND SKIN CARE PRODUCTS NAMELY, LIP BALM, OINTMENTS, LOTION, AND SUN SCREEN (U.S. CLS. 1, 4, 6, 50, 51 AND 52).

FIRST USE 6-1-2003; IN COMMERCE 12-1-2004.

2,955,769. WESTRIDGE LABORATORIES, INC., SANTA, CA. SN 78-326,043. PUB. 8-31-2004, FILED 11-11-2003.

ID SENSATION

THE MARK CONSISTS OF STANDARD CHARACTERS WITHOUT CLAIM TO ANY PARTICULAR FONT, STYLE, SIZE, OR COLOR.

OWNER OF U.S. REG. NOS. 2,515,606 AND 2,573,871. FOR MASSAGE OILS AND LOTIONS, AND SKIN MOISTURIZERS AND CONDITIONERS (U.S. CLS. 1, 4, 6, 50, 51 AND 52).

FIRST USE 8-6-2004; IN COMMERCE 8-6-2004.

CLASS 4—LUBRICANTS AND FUELS

2,955,335. FRIEDMAN, NEIL, WESTPORT, CT. SN 76-474,661. PUB. 5-20-2003, FILED 12-10-2002.

LIGHT OF HOPE

FOR CANDLES, SCENTED CANDLES (U.S. CLS. 1, 6 AND 15).

FIRST USE 12-10-2004; IN COMMERCE 12-10-2004.

CLASS 4—(Continued).

2,955,768. CITGO PETROLEUM CORPORATION, TULSA, OK. SN 78-325,676. PUB. 6-22-2004, FILED 11-10-2003.

SYNBAR

THE MARK CONSISTS OF STANDARD CHARACTERS WITHOUT CLAIM TO ANY PARTICULAR FONT, STYLE, SIZE, OR COLOR.

FOR GENERAL PURPOSE LUBRICATING OILS AND GREASES (U.S. CLS. 1, 6 AND 15).

FIRST USE 2-0-2004; IN COMMERCE 2-0-2004.

2,955,802. SOY BASICS, LLC, NEW HAMPTON, IA. SN 78-975,944. PUB. 12-2-2003, FILED 4-10-2003.

SOY INSPIRATIONS

NO CLAIM IS MADE TO THE EXCLUSIVE RIGHT TO USE "SOY", APART FROM THE MARK AS SHOWN. FOR CANDLES (U.S. CLS. 1, 6 AND 15).

FIRST USE 10-14-2004; IN COMMERCE 10-14-2004.

CLASS 5—PHARMACEUTICALS**CLASS 5—(Continued).**

2,955,232. OKASAWARA, MAURICIO SUSSUMU, SAO JOSE DO RIO PRETO, SAO PAULO, BRAZIL. SN 76-101,641. PUB. 10-29-2002, FILED 8-3-2000.

BIONATUS

FOR NATURAL FOOD AND VITAMIN SUPPLEMENTS; PHARMACEUTICAL COMPOUNDS, NAMELY PROPELS, PROPELS WITH HONEY AND PROPOLIS WITH HONEY PENNYROYAL AS A NUTRITIONAL AND ENERGY SUPPLEMENT AND FOR TREATMENT OF COLDS AND RESPIRATORY CONDITIONS; NATURAL AND ARTIFICIAL PHYTOTHERAPIC PRODUCTS AND COMPOUNDS, NAMELY BETA CAROTENE, WEIGHT REDUCERS, DIGESTIVES, EXPECTORANTS, SEDATIVES, CELLULITE COMBATANTS, URINARY DIURETICS AND ANTISEPTICS, LAXATIVES, ANTI-RHEUMATICS, ANTI-INFLAMMATORIES, MILD STIMULANTS, APHRODISIACS, AND ANTIPIRETTICS; GUARANA PRODUCTS, NAMELY GUARANA CAPSULES TAKEN AS A MILD STIMULANT; AMINO ACID SUPPLEMENTS; WHEAT GERM FOR USE AS A DIETARY SUPPLEMENT; POLLEN AND HONEY DERIVATIVES FOR USE AS A DIETARY FOOD SUPPLEMENT (U.S. CLS. 6, 18, 44, 46, 51 AND 52).

FIRST USE 10-2-2004; IN COMMERCE 10-2-2004.

2,955,345. NOVAMEDICS HEALTH PRODUCTS, INC., SANTA MONICA, CA. SN 76-478,686. PUB. 5-6-2003, FILED 12-23-2002.

NOVAMEDICS

FOR DIETARY SUPPLEMENTS (U.S. CLS. 6, 18, 44, 46, 51 AND 52).

FIRST USE 1-8-2005; IN COMMERCE 1-8-2005.

2,955,360. WITNESS MEDCO, LLC, KINGMAN, KS. SN 76-486,672. PUB. 4-6-2004, FILED 2-3-2003.

WITNESS

FOR DRUG TESTING APPARATUS COMPRISED PRIMARILY OF CHEMICALS FOR USE IN TESTING FOR THE PRESENCE OR ABSENCE OF CONTROLLED SUBSTANCES AND FOR USE IN WASTING OF CONTROLLED SUBSTANCES (U.S. CLS. 6, 18, 44, 46, 51 AND 52).

FIRST USE 12-6-2003; IN COMMERCE 12-6-2003.

CLASS 5—(Continued).

2,955,384. SANRIO COMPANY, LTD., TOKYO 141, JAPAN.
SN 76-495,707. PUB. 11-4-2003, FILED 3-7-2003.

CINNAMOROLL

FOR ADHESIVE BANDAGES (U.S. CLS. 6, 18, 44, 46, 51 AND 52).
FIRST USE 1-15-2004; IN COMMERCE 1-15-2004.

2,955,413. ALL NATURAL FMG, INC., NORTH PALM BEACH, FL. SN 76-512,094. PUB. 12-2-2003, FILED 4-21-2003.

VIADERM FMG

FOR ALCOHOL-FREE ANALGESIC COMPOSITION EFFECTIVE FOR TRANSDERMAL DELIVERY (U.S. CLS. 6, 18, 44, 46, 51 AND 52).
FIRST USE 4-1-2004; IN COMMERCE 4-1-2004.

2,955,421. OLD MOTHER HUBBARD, INC., LOWELL, MA. SN 76-519,032. PUB. 12-2-2003, FILED 5-14-2003.

WELLCOAT

FOR VITAMINS FOR PETS, DIETARY SUPPLEMENTS FOR PETS AND NUTRACEUTICALS FOR USE AS DIETARY SUPPLEMENTS FOR PETS (U.S. CLS. 6, 18, 44, 46, 51 AND 52).
FIRST USE 4-0-2003; IN COMMERCE 6-3-2003.

2,955,422. OLD MOTHER HUBBARD, INC., LOWELL, MA. SN 76-519,034. PUB. 12-2-2003, FILED 5-14-2003.

WELLTABS

FOR VITAMINS FOR PETS, DIETARY SUPPLEMENTS FOR PETS AND NUTRACEUTICALS FOR USE AS DIETARY SUPPLEMENTS FOR PETS (U.S. CLS. 6, 18, 44, 46, 51 AND 52).
FIRST USE 1-1-2003; IN COMMERCE 6-1-2003.

2,955,465. SPLASHES INC., NORWALK, CT. SN 76-559,578. PUB. 4-13-2004, FILED 6-19-2003.

SPLASHES

FOR DISINFECTANT AND BACTERICIDAL PREPARATIONS FOR USE AS POOL AND SPA SANITIZERS (U.S. CLS. 6, 18, 44, 46, 51 AND 52).
FIRST USE 11-1-2003; IN COMMERCE 3-17-2004.

CLASS 5—(Continued).

2,955,489. ALTICOR INC., ADA, MI. SN 78-089,883. PUB. 6-4-2002, FILED 10-24-2001.

READY TO GO

FOR NUTRITIONALLY FORTIFIED PROTEIN DRINK (U.S. CLS. 6, 18, 44, 46, 51 AND 52).
FIRST USE 9-1-2003; IN COMMERCE 9-1-2003.

2,955,564. TARO PHARMACEUTICALS NORTH AMERICA, INC., GRAND CAYMAN, CAYMAN ISLANDS. SN 78-196,822. PUB. 2-10-2004, FILED 12-20-2002.

IT'S EVERYTHING YOUR FEET NEED

FOR MEDICATED LOTIONS AND OINTMENTS FOR SOFTENING SKIN (U.S. CLS. 6, 18, 44, 46, 51 AND 52).
FIRST USE 2-9-2003; IN COMMERCE 2-9-2003.

2,955,646. MANN, DOUGLAS G, VENICE, FL. SN 78-234,473. PUB. 9-30-2003, FILED 4-7-2003.

ANTI MAX

FOR NUTRITIONAL, DIETARY, AND VITAMIN SUPPLEMENTS; NUTRACEUTICALS FOR USE AS NUTRITIONAL, VITAMIN, AND DIETARY SUPPLEMENTS (U.S. CLS. 6, 18, 44, 46, 51 AND 52).
FIRST USE 5-0-2003; IN COMMERCE 5-0-2003.

2,955,685. GLUSTITCH INC., DELTA, BC V4G 1M6, CANADA. SN 78-255,682. PUB. 1-27-2004, FILED 5-29-2003.

GLUSHIELD

FOR TISSUE ADHESIVE FOR MEDICAL USE, NAMELY, A SKIN PROTECTANT USED OVER UNBROKEN SKIN (U.S. CLS. 6, 18, 44, 46, 51 AND 52).
FIRST USE 9-0-2003; IN COMMERCE 9-0-2003.

2,955,744. LESCO TECHNOLOGIES, LLC, CLEVELAND, OH. SN 78-300,610. PUB. 6-8-2004, FILED 9-15-2003.

LIFEGUARD

FOR HERBICIDE FOR USE ON TURF GRASS AND ORNAMENTAL PLANTINGS (U.S. CLS. 6, 18, 44, 46, 51 AND 52).
FIRST USE 2-13-2004; IN COMMERCE 2-13-2004.

CLASS 6—METAL GOODS

CLASS 6—(Continued).

2,955,254. WOLFCRAFT, INC., ADDISON, IL. SN 76-254,922.
PUB. 4-2-2002, FILED 5-11-2001.

AccUGRIP

FOR METAL CLAMPS (U.S. CLS. 2, 12, 13, 14, 23, 25
AND 50).
FIRST USE 4-0-2003; IN COMMERCE 1-15-2004.

2,955,376. LORD & SONS, INC., SAN JOSE, CA. SN 76-493,098.
PUB. 7-6-2004, FILED 2-24-2003.

SERIES SPF200

FOR METAL SEISMIC FITTINGS USED TO RE-
STRAIN UTILITIES IN BUILDING STRUCTURES (U.S.
CLS. 2, 12, 13, 14, 23, 25 AND 50).
FIRST USE 2-5-2003; IN COMMERCE 10-29-2004.

2,955,383. SANRIO COMPANY, LTD., TOKYO 141, JAPAN.
SN 76-495,706. PUB. 11-4-2003, FILED 3-7-2003.

CINNAMOROLL

FOR METAL CASES BOTH FOR HOUSEHOLD AND
PERSONAL STORAGE, METAL BOXES, METAL COIN
BANKS, METAL KEY CHAINS, METAL PAGER
CHAINS, METAL KEY RINGS, METAL PAGER RINGS
(U.S. CLS. 2, 12, 13, 14, 23, 25 AND 50).
FIRST USE 11-14-2004; IN COMMERCE 11-14-2004.

2,955,607. LOCKHEED MARTIN CORPORATION, BETHES-
DA, MD. SN 78-223,408. PUB. 11-18-2003, FILED 3-10-2003.

F-22

FOR METAL KEY CHAINS (U.S. CLS. 2, 12, 13, 14, 23,
25 AND 50).
FIRST USE 6-7-2004; IN COMMERCE 6-7-2004.

CLASS 6—(Continued).

2,955,644. GARCO BUILDING SYSTEMS, INC., AIRWAY
HEIGHTS, WA. SN 78-234,221. PUB. 2-3-2004, FILED 4-4-
2003.

ISS SYSTEMS

NO CLAIM IS MADE TO THE EXCLUSIVE RIGHT TO
USE "SYSTEMS", APART FROM THE MARK AS SHOWN.
FOR BUILT-UP WELDED PRIMARY REINFORCE-
MENT PLATES MADE OF STEEL AND FORGED INTO
VARIOUS SHAPES FOR USE IN COMBINATION WITH
COLD-FORMED GALVANIZED SECONDARY FRAM-
ING AND METAL ROOFING BEAMS (U.S. CLS. 2, 12,
13, 14, 23, 25 AND 50).
FIRST USE 10-1-2003; IN COMMERCE 10-1-2003.

2,955,757. LAWSON INDUSTRIES, INC., MEDLEY, FL. SN
78-314,968. PUB. 8-10-2004, FILED 10-17-2003.

HURRICANE GUARD

NO CLAIM IS MADE TO THE EXCLUSIVE RIGHT TO
USE "HURRICANE", APART FROM THE MARK AS
SHOWN.
FOR METAL FRAMED IMPACT RESISTANT SAFETY
GLASS WINDOWS AND DOORS (U.S. CLS. 2, 12, 13, 14,
23, 25 AND 50).
FIRST USE 12-27-2003; IN COMMERCE 12-27-2003.

CLASS 7—MACHINERY

2,955,262. AERATION INDUSTRIES INTERNATIONAL,
INC., CHASKA, MN. SN 76-301,898. PUB. 4-16-2002, FILED
8-20-2001.

TRI-OVAL

FOR ACTIVATED SLUDGE WASTE WATER TREAT-
MENT SYSTEM COMPRISED OF AERATORS AND
CLARIFIERS (U.S. CLS. 13, 19, 21, 23, 31, 34 AND 35).
FIRST USE 11-15-2004; IN COMMERCE 11-15-2004.

CLASS 7—(Continued).

2,955,305. PORTER-CABLE CORPORATION, JACKSON, TN. SN 76-452,996. PUB. 12-2-2003, FILED 9-26-2002.

GTF

FOR POWER TOOLS AND PARTS AND ACCESSORIES THEREFORE; NAMELY POWER DRILLS; HAMMER DRILLS; POWER SCREW DRIVERS; DRYWALL DRIVERS; ROTARY HAMMERS; POWER DRILLS; POWER FILERS; POWER POLISHERS; POWER FINISHERS; POWER GRINDERS; POWER SANDERS; BELT SAWS; HALF SHEET FINISHING SANDERS; PALM SANDERS; GRINDERS; PAINT REMOVERS; PLATE JOINERS; PLANES; SHEARS; PNEUMATIC NAILERS; PNEUMATIC STAPLERS; AIR POWERED TOOLS NAMELY, ANGLE ROTARY TOOL, CUT-OFF TOOL FOR CUTTING SHEET METAL, BOLTS AND FIBERGLASS, GRINDERS, RECIPROCATING SAWS, SHEARS, IMPACT WRENCHES, HAMMERS, SANDERS, DRILLS, WRENCHES, RATCHETS, ROUTERS; D-HANDLED ROUTERS; POWER SAWS; RECIPROCATING SAWS, CIRCULAR SAWS; JIG SAWS; AND PORTABLE BAND SAWS (U.S. CLS. 13, 19, 21, 23, 31, 34 AND 35).
FIRST USE 10-1-2002; IN COMMERCE 10-1-2002.

2,955,402. ROGER A. FARRARA & KENNETH E. JONES PARTNERSHIP, THE, CHICO, CA. SN 76-502,153. PUB. 3-30-2004, FILED 3-28-2003.

HEAD BUMPERS

NO CLAIM IS MADE TO THE EXCLUSIVE RIGHT TO USE "BUMPER", APART FROM THE MARK AS SHOWN.
FOR PADDED END CAP FOR VEHICLE HOIST LIFTING ARM (U.S. CLS. 13, 19, 21, 23, 31, 34 AND 35).
FIRST USE 0-0-2001; IN COMMERCE 3-28-2003.

2,955,414. KUHN KNIGHT INCORPORATED, BRODHEAD, WI. SN 76-513,267. PUB. 12-9-2003, FILED 5-12-2003.

PROPUSH

FOR AGRICULTURAL MACHINES, NAMELY MANURE SPREADERS, FERTILIZER SPREADERS, BEDDING SPREADERS, AND MATERIAL HANDLING EQUIPMENT, NAMELY, SPREADERS FOR HANDLING VARIOUS MATERIALS (U.S. CLS. 13, 19, 21, 23, 31, 34 AND 35).
FIRST USE 11-19-2004; IN COMMERCE 11-19-2004.

CLASS 7—(Continued).

2,955,448. ELECTROLUX HOME CARE PRODUCTS LTD., CLEVELAND, OH. SN 76-540,487. PUB. 5-18-2004, FILED 8-27-2003.

AFUERA

THE FOREIGN WORDING IN THE MARK TRANSLATES INTO ENGLISH AS OUTSIDE.

FOR DOMESTIC AND COMMERCIAL CENTRAL VACUUM CLEANERS AND PARTS AND FITTINGS THEREFOR, NAMELY POWER UNITS, NOZZLES, BRUSHES, WANDS, HOSES, ADAPTORS, BRACKETS, INLET PLATES, INLET VALVES AND PIPE FITTINGS SOLD INDIVIDUALLY OR IN KITS (U.S. CLS. 13, 19, 21, 23, 31, 34 AND 35).

FIRST USE 10-31-2003; IN COMMERCE 10-31-2003.

2,955,460. LAKE RESTORATION, INC., ROGERS, MN. SN 76-552,900. PUB. 6-29-2004, FILED 10-20-2003.

LAKEMAID

FOR AUTOMATIC WEED DEVICE DESIGNED FOR THE REMOVAL OF WEEDS FROM LAKES AND RIVERS (U.S. CLS. 13, 19, 21, 23, 31, 34 AND 35).
FIRST USE 2-15-2004; IN COMMERCE 2-15-2004.

2,955,517. PRESTOLITE WIRE CORPORATION, SOUTHFIELD, MI. SN 78-159,799. PUB. 10-14-2003, FILED 8-30-2002.

PRESTOLITE

OWNER OF U.S. REG. NOS. 742,943, 743,332, AND 1,134,022.
FOR SPARK PLUGS; SPARK PLUG WIRES; AND RELATED PARTS AND ACCESSORIES (U.S. CLS. 13, 19, 21, 23, 31, 34 AND 35).
FIRST USE 0-0-1963; IN COMMERCE 0-0-1963.

2,955,572. PERFORMANCE MOTORSPORTS, INC., DBA JE PISTONS, INC., HUNTINGTON BEACH, CA. SN 78-202,262. PUB. 10-21-2003, FILED 1-10-2003.

PRO STEEL

NO CLAIM IS MADE TO THE EXCLUSIVE RIGHT TO USE "STEEL", APART FROM THE MARK AS SHOWN.
FOR INTERNAL COMBUSTION ENGINE PISTON SEALING RINGS (U.S. CLS. 13, 19, 21, 23, 31, 34 AND 35).
FIRST USE 12-13-2004; IN COMMERCE 12-13-2004.

CLASS 7—(Continued).

2,955,575. NTI AG, ZURICH, SWITZERLAND. SN 78-204,061. PUB. 4-13-2004, FILED 1-16-2003.

MAGSPRING

PRIORITY CLAIMED UNDER SEC. 44(D) ON SWITZERLAND APPLICATION NO. 07684/2002, FILED 9-5-2002, REG. NO. 509796, DATED 4-30-2003, EXPIRES 9-5-2012.

FOR MACHINE TOOLS, NAMELY PACKAGING TOOLS, HANDLING TOOLS, SORTING TOOLS, PRINTING TOOLS, LABELING TOOLS, TESTING TOOLS, ASSEMBLING TOOLS, SEMICONDUCTOR TOOLS, STAMPING TOOLS, TEXTILE TOOLS; INDUSTRIAL ROBOTS; ELECTRIC MOTORS AND COMBUSTION ENGINES; COUPLINGS FOR MACHINES; FITTINGS FOR MACHINES, NAMELY DAMPER SHOCK ABSORBER, WEIGHT BALANCER, DOOR AND WINDOW LIFTING EQUIPMENT, PRELOAD FORCER; TRANSMISSION GEARS FOR MACHINES; STRUCTURAL OR REPLACEMENT COMPONENTS FOR PACKAGING MACHINES, HANDLING MACHINES, SORTING MACHINES, PRINTING MACHINES, LABELING MACHINES, TESTING MACHINES, ASSEMBLING MACHINES, PRODUCTION MACHINES, STAMPING MACHINES, TEXTILE MACHINES; MECHANIZED AGRICULTURAL IMPLEMENTS, NAMELY DAMPER, SHOCK ABSORBER, WEIGHT BALANCER, DOOR AND WINDOW LIFTING EQUIPMENT (U.S. CLS. 13, 19, 21, 23, 31, 34 AND 35).
FIRST USE 2-28-2004; IN COMMERCE 2-28-2004.

2,955,645. THE GATES CORPORATION, DENVER, CO. SN 78-234,236. PUB. 12-9-2003, FILED 4-4-2003.

TECHPRO

FOR POWER TRANSMISSION BELTS; AUTOMOTIVE TIMING BELTS (U.S. CLS. 13, 19, 21, 23, 31, 34 AND 35).
FIRST USE 9-1-2004; IN COMMERCE 9-1-2004.

2,955,684. HALLIBURTON ENERGY SERVICES, INC., CARROLLTON, TX. SN 78-255,052. PUB. 2-10-2004, FILED 5-28-2003.

TOPO

FOR OIL AND GAS WELL DRILLING PACKER (U.S. CLS. 13, 19, 21, 23, 31, 34 AND 35).
FIRST USE 8-15-2004; IN COMMERCE 9-30-2004.

CLASS 7—(Continued).

2,955,692. ONE WORLD TECHNOLOGIES LIMITED, HAMILTON, BERMUDA. SN 78-264,329. PUB. 3-9-2004, FILED 6-19-2003.



FOR POWER TOOLS, NAMELY, CORDLESS DRILLS (U.S. CLS. 13, 19, 21, 23, 31, 34 AND 35).
FIRST USE 9-0-2003; IN COMMERCE 9-0-2003.

CLASS 8—HAND TOOLS

2,955,434. IZUMI PRODUCTS COMPANY, MATSUMOTO, NAGANO, JAPAN. SN 76-531,957. PUB. 5-4-2004, FILED 7-14-2003.



NO CLAIM IS MADE TO THE EXCLUSIVE RIGHT TO USE "SHAVE", APART FROM THE MARK AS SHOWN.
FOR ELECTRIC SHAVERS, AND PARTS THEREOF (U.S. CLS. 23, 28 AND 44).
FIRST USE 8-6-2003; IN COMMERCE 8-6-2003.

2,955,435. IZUMI PRODUCTS COMPANY, MATSUMOTO, NAGANO, JAPAN. SN 76-531,958. PUB. 5-4-2004, FILED 7-14-2003.



NO CLAIM IS MADE TO THE EXCLUSIVE RIGHT TO USE "SHAVE", APART FROM THE MARK AS SHOWN.
FOR ELECTRIC SHAVERS, AND PARTS THEREOF (U.S. CLS. 23, 28 AND 44).
FIRST USE 8-6-2003; IN COMMERCE 8-6-2003.

CLASS 8—(Continued).

2,955,569. DIVERSIFIED DYNAMICS CORPORATION, MINNEAPOLIS, MN. SN 78-201,198. PUB. 11-4-2003, FILED 1-8-2003.

DECK-PRO

NO CLAIM IS MADE TO THE EXCLUSIVE RIGHT TO USE "DECK", APART FROM THE MARK AS SHOWN.

FOR PORTABLE HAND PUMPED SPRAYER FOR SPRAYING AND APPLYING CHEMICALS, NAMELY FERTILIZERS, HERBICIDES, PESTICIDES, STAINS AND SEALERS (U.S. CLS. 23, 28 AND 44).

FIRST USE 3-31-2003; IN COMMERCE 3-31-2003.

2,955,775. AMES TRUE TEMPER PROPERTIES, INC., WILMINGTON, DE. SN 78-335,553. PUB. 9-7-2004, FILED 12-3-2003.

**TRUE TEMPER SILVER
MAX**

THE MARK CONSISTS OF STANDARD CHARACTERS WITHOUT CLAIM TO ANY PARTICULAR FONT, STYLE, SIZE, OR COLOR.

FOR LONG-HANDLED TOOLS, NAMELY, EDGERS; FORKS; HOES; RAKES; POST-HOLE DIGGERS; SCOOPS; SHOVELS; SPADES; AND WEEDERS (U.S. CLS. 23, 28 AND 44).

FIRST USE 2-0-2004; IN COMMERCE 2-0-2004.

**CLASS 9—ELECTRICAL AND SCIENTIFIC
APPARATUS**

2,955,188. AUTUMN LIGHT ENTERTAINMENT, INC., ALBUQUERQUE, NM. SN 75-278,256. PUB. 2-10-2004, FILED 4-21-1997.

MYTV

FOR COMPUTER HARDWARE AND COMPUTER SOFTWARE FOR AUTOMATED TELEVISION PROGRAM GENERATION THAT AUTOMATICALLY CREATES A PROFESSIONALLY EDITED PRESENTATION FROM THE USER'S RAW IMAGE CONTENT WHERE THE USER NEEDS ONLY TO ANSWER A FEW SIMPLE QUESTIONS (U.S. CLS. 21, 23, 26, 36 AND 38).

FIRST USE 6-1-2004; IN COMMERCE 6-1-2004.

CLASS 9—(Continued).

2,955,190. ACCESS INC., CARROLLTON, TX. SN 75-496,994. PUB. 9-11-2001, FILED 6-5-1998.

ACCESS INC.

FOR INTEGRATED ELECTRONIC HARDWARE AND SOFTWARE SYSTEMS AND APPLICATIONS, NAMELY, DATA PROCESSORS, RADIO TRANSMITTERS, READERS, RECEIVERS, AND ANTENNAS, AND RESOURCE MANAGEMENT SOFTWARE, FOR IDENTIFYING AND TRACKING VEHICLES, PEOPLE, AND THINGS, USED IN IMPLEMENTING, CONTROLLING, MANAGING, AND MONITORING SECURITY CONTROL AND LOGISTICS SYSTEMS (U.S. CLS. 21, 23, 26, 36 AND 38).

FIRST USE 5-5-1998; IN COMMERCE 5-15-2000.

2,955,192. VALIDY, INC., SHERWOOD, OR. SN 75-650,727. PUB. 9-25-2001, FILED 3-7-1999.

VALIDY

FOR COMPUTER SOFTWARE AND HARDWARE RESTRICTING ACCESS ON A COMPUTER, ON A LOCAL COMPUTER NETWORK, OR ON THE GLOBAL COMPUTER NETWORK TO SPECIFIC USERS; COMPUTER SOFTWARE AND HARDWARE PERSONALIZING INFORMATION COMING FROM A COMPUTER, A LOCAL COMPUTER NETWORK, OR THE GLOBAL COMPUTER NETWORK FOR SPECIFIC USERS; COMPUTER SOFTWARE AND HARDWARE ALLOWING EASIER OR QUICKER ACCESS TO INFORMATION LOCATED ON A COMPUTER, A LOCAL COMPUTER NETWORK, OR THE GLOBAL COMPUTER NETWORK FOR SPECIFIC USERS; COMPUTER SOFTWARE AND HARDWARE USED TO ENCRYPT FILES FOR SPECIFIC USERS; COMPUTER SOFTWARE AND HARDWARE ALLOWING EXCHANGE OF INFORMATION BETWEEN SELECTED USERS ON A COMPUTER, A LOCAL COMPUTER NETWORK, OR THE GLOBAL COMPUTER NETWORK; COMPUTER SOFTWARE AND HARDWARE USED TO IDENTIFY HARDWARE AND SOFTWARE USERS WITHOUT THE USE OF PASSWORDS; COMPUTER SOFTWARE FOR USE IN THE FIELD OF COMPUTER SOFTWARE AND HARDWARE PROTECTION AND SECURITY USED TO DEVELOP, WRITE, EDIT OR RESTRICT THE USE OF OTHER COMPUTER SOFTWARE; COMPUTER HARDWARE FOR USE IN THE FIELD OF COMPUTER SOFTWARE PROTECTION; MAGNETICALLY ENCODED CARDS AND COMPUTER SOFTWARE FOR USE AS OPERATING SYSTEMS IN SMART CARDS AND SMART CARD READERS; SMART CARD READERS, COMPUTER KEYBOARDS WHICH INCLUDE SMART CARD READERS, COMPUTER HARDWARE WITH INTERNAL SMART CARD READERS; ALL THE FOREGOING COMPUTER SOFTWARE AND HARDWARE ARE FOR SECURITY PURPOSES (U.S. CLS. 21, 23, 26, 36 AND 38).

FIRST USE 4-20-1999; IN COMMERCE 5-23-2004.

2,955,202. BAE SYSTEMS INFORMATION AND ELECTRONIC SYSTEMS INTEGRATION INC., NASHUA, NH. SN 75-894,623. PUB. 11-2-2004, FILED 1-11-2000.

RAD6000

OWNER OF U.S. REG. NO. 2,279,942.
FOR INTEGRATED CIRCUITS WITH A TOLERANCE FOR RADIATION SOLD TO THE DEFENSE, AVIONICS AND SPACE MARKETS (U.S. CLS. 21, 23, 26, 36 AND 38).

FIRST USE 10-20-2004; IN COMMERCE 10-20-2004.

CLASS 9—(Continued).

2,955,214. IZ TECHNOLOGY CORPORATION, NEW WESTMINSTER, BRITISH COLUMBIA, CANADA. SN 76-021,824. PUB. 12-30-2003, FILED 4-7-2000.

ADRENALINE

FOR PROFESSIONAL DIGITAL AUDIO RECORDING DEVICES (U.S. CLS. 21, 23, 26, 36 AND 38).
FIRST USE 11-5-2004; IN COMMERCE 11-5-2004.

2,955,218. IMMTEC, INC., GOLDEN, CO. SN 76-039,862. PUB. 9-25-2001, FILED 5-3-2000.

MEWALLET

FOR COMPUTER SOFTWARE FOR PROVIDING ELECTRONIC EXCHANGE OF INFORMATION; COMPUTER SOFTWARE FOR PROVIDING WIRELESS EXCHANGE OF ELECTRONIC INFORMATION (U.S. CLS. 21, 23, 26, 36 AND 38).

FIRST USE 12-17-2004; IN COMMERCE 12-17-2004.

2,955,224. WREN ASSOCIATES, LTD., JEFFERSON CITY, MO. SN 76-064,582. PUB. 10-23-2001, FILED 6-6-2000.

WREN

FOR COMPONENTS FOR CLOSED CIRCUIT TELEVISION SYSTEMS, NAMELY, HOUSINGS, MOUNTS, INTEGRATED DOME SYSTEMS, DIGITAL VIDEO RECORDERS, CAMERAS, AND LENSES; COMPONENTS FOR VIDEO SURVEILLANCE SYSTEMS, NAMELY, HOUSINGS, MOUNTS, INTEGRATED DOME SYSTEMS, DIGITAL VIDEO RECORDERS, CAMERAS, AND LENSES (U.S. CLS. 21, 23, 26, 36 AND 38).

FIRST USE 12-22-1983; IN COMMERCE 12-22-1983.

CLASS 9—(Continued).

2,955,225. WREN ASSOCIATES, LTD., JEFFERSON CITY, MO. SN 76-064,583. PUB. 10-30-2001, FILED 6-6-2000.



FOR COMPONENTS FOR CLOSED CIRCUIT TELEVISION SYSTEMS, NAMELY, HOUSINGS, MOUNTS, INTEGRATED DOME SYSTEMS, CONTROLS, SWITCHES, VIDEO MANIPULATORS, QUADS, MULTIPLEXERS, DATE/TIME/TEXT GENERATORS, INTERFACES FOR CASH REGISTERS/AUTOMATIC TELLER MACHINES, VIDEO AMPLIFIERS, VIDEO STORAGE, VIDEO CASSETTE RECORDERS, TIME-LAPSE VIDEO CASSETTE RECORDERS, DIGITAL VIDEO RECORDERS, VIDEO TRANSMITTERS, LOCAL AREA NETWORK/WIDE AREA NETWORK VIDEO TRANSMITTERS, INTEGRATED SERVICES DIGITAL NETWORK VIDEO TRANSMITTERS, PUBLIC SWITCHED TELEPHONE NETWORK VIDEO TRANSMITTERS, TRANSMISSION CONTROL PROTOCOL/INTERNET PROTOCOL VIDEO TRANSMITTERS, RADIO FREQUENCY VIDEO TRANSMITTERS, CELLULAR VIDEO TRANSMITTERS, FIBER OPTIC CABLE VIDEO TRANSMITTERS, TWISTED PAIR CABLE VIDEO TRANSMITTERS, COAXIAL CABLE VIDEO TRANSMITTERS, CAMERAS, LENSES, MONITORS, CAMERA POSITION ADJUSTERS, RECEIVERS, DRIVERS, AND INFRARED ILLUMINATORS; COMPONENTS FOR VIDEO SURVEILLANCE SYSTEMS, NAMELY, HOUSINGS, MOUNTS, INTEGRATED DOME SYSTEMS, CONTROLS, SWITCHES, VIDEO MANIPULATORS, QUADS, MULTIPLEXERS, DATE/TIME/TEXT GENERATORS, INTERFACES FOR CASH REGISTERS/AUTOMATIC TELLER MACHINES, VIDEO AMPLIFIERS, VIDEO STORAGE, VIDEO CASSETTE RECORDERS, TIME-LAPSE VIDEO CASSETTE RECORDERS, DIGITAL VIDEO RECORDERS, VIDEO TRANSMITTERS, LOCAL AREA NETWORK/WIDE AREA NETWORK VIDEO TRANSMITTERS, INTEGRATED SERVICES DIGITAL NETWORK VIDEO TRANSMITTERS, PUBLIC SWITCHED TELEPHONE NETWORK VIDEO TRANSMITTERS, TRANSMISSION CONTROL PROTOCOL/INTERNET PROTOCOL VIDEO TRANSMITTERS, RADIO FREQUENCY VIDEO TRANSMITTERS, CELLULAR VIDEO TRANSMITTERS, FIBER OPTIC CABLE VIDEO TRANSMITTERS, TWISTED PAIR CABLE VIDEO TRANSMITTERS, COAXIAL CABLE VIDEO TRANSMITTERS, CAMERAS, LENSES, MONITORS, CAMERA POSITION ADJUSTERS, RECEIVERS, DRIVERS, AND INFRARED ILLUMINATORS (U.S. CLS. 21, 23, 26, 36 AND 38).

FIRST USE 7-21-1999; IN COMMERCE 7-21-1999.

2,955,227. MYRIAD SOFTWARE, LLC, SAN DIEGO, CA. SN 76-080,670. PUB. 2-10-2004, FILED 6-30-2000.

ECLICKTIC

FOR COMPUTER SOFTWARE FOR USE IN CONNECTION WITH MANAGEMENT OF RETAIL TRANSACTIONS FROM SALES ORDERING THRU PRODUCT DELIVERY AND BANKING THRU RECORDS BALANCING AND INVENTORY CONTROL FOR BUSINESSES (U.S. CLS. 21, 23, 26, 36 AND 38).

FIRST USE 10-29-2004; IN COMMERCE 10-29-2004.

CLASS 9—(Continued).

2,955,236. ADC TELECOMMUNICATIONS, INC., EDEN PRAIRIE, MN. SN 76-160,562. PUB. 5-7-2002, FILED 11-6-2000.

CLASS 9—(Continued).

2,955,250. CROWN FINANCIAL MINISTRIES, INC., GAINESVILLE, GA. SN 76-234,294. PUB. 9-10-2002, FILED 4-3-2001.

ENCASER

FOR HOUSINGS FOR STORAGE OF OUTSIDE PLANT TELECOMMUNICATIONS EQUIPMENT COMPRISING LOCAL LOOP ELECTRONICS AND OPTICS, REPEATERS, CABLES, CONNECTORS AND SUPPORTING MECHANICS (U.S. CLS. 21, 23, 26, 36 AND 38).
FIRST USE 11-0-2000; IN COMMERCE 10-31-2001.



2,955,245. OPTYS CORPORATION, TORONTO, ONTARIO, CANADA. SN 76-218,344. PUB. 10-28-2003, FILED 3-2-2001.

WIDE-ENVELOPE

PRIORITY CLAIMED UNDER SEC. 44(D) ON CANADA APPLICATION NO. 1083648, FILED 11-22-2000.
FOR ELECTRICAL EQUIPMENT, NAMELY, POWER SUPPLIES, AC/DC POWER SUPPLIES; LOCAL AND REMOTE POWER CONTROLLERS, ELECTRICAL POWER CONVERTERS, NAMELY, AC/DC POWER CONVERTERS (U.S. CLS. 21, 23, 26, 36 AND 38).
FIRST USE 7-1-2004; IN COMMERCE 7-1-2004.

OWNER OF U.S. REG. NOS. 1,503,264, 2,105,871, AND OTHERS.

FOR PRE-RECORDED AUDIO CASSETTES, COMPACT DISCS, PRERECORDED VIDEO CASSETTES AND MULTIMEDIA SOFTWARE RECORDED ON CD-ROM ALL FEATURING APPLYING BIBLICAL PRINCIPLES OF STEWARDSHIP TO ECONOMIC, FINANCIAL, AND SOCIAL ISSUES AND APPLYING BIBLICAL PRINCIPLES TO BUSINESS, PROVIDING INFORMATION IN THE FIELD OF FINANCES AND FINANCIAL ACCOUNTABILITY, AND DRAMATIZATIONS ABOUT MONEY MANAGEMENT ISSUES FOR EDUCATIONAL AND ENTERTAINMENT PURPOSES; DEBT-AMORTIZATION SOFTWARE PROGRAMS WITH FINANCIAL AND STEWARDSHIP APPLICATIONS BASED ON BIBLICAL PRINCIPLES; COMPUTER SOFTWARE PROGRAMS FOR USE IN CONDUCTING AN ASSESSMENT OF AN INDIVIDUAL'S SKILLS, CAREER ABILITIES AND INTERESTS, PERSONALITY QUALITIES AND QUALIFICATIONS, WORK PRIORITIES AND LIFE VALUES EVALUATION, AND FOR USE IN CAREER ASSESSMENT, VOCATION COUNSELING AND PSYCHOMETRIC RESEARCH; COMPUTER SOFTWARE FOR USE AS AN INTERACTIVE TUTORIAL, TEACHING BIBLICAL PRINCIPLES OF BUSINESS MANAGEMENT; COMPUTER SOFTWARE FOR SCREEN SAVING AND TOPICAL SEARCHING IN THE FIELD OF FINANCES AND FINANCIAL ACCOUNTABILITY; MULTIMEDIA CD-ROMS AND INTERACTIVE COMPUTER SOFTWARE IN THE FIELD OF CAREER PLANNING AND GUIDANCE; AND COMPUTER SOFTWARE IN THE FIELD OF FINANCES AND FINANCIAL ACCOUNTABILITY, NAMELY, FOR USE IN TRACKING, MANAGING AND CALCULATING INDIVIDUAL AND SMALL BUSINESS FINANCES, INCLUDING BUDGETING AND DEBT-REPAYMENT PRINCIPLES AND FINANCIAL CALCULATORS (U.S. CLS. 21, 23, 26, 36 AND 38).

FIRST USE 9-0-2000; IN COMMERCE 12-0-2000.

CLASS 9—(Continued).

2,955,257. ADC TELECOMMUNICATIONS, INC., EDEN PRAIRIE, MN. SN 76-269,242. PUB. 11-13-2001, FILED 6-8-2001.

DSXi

FOR TELECOMMUNICATION TERMINATION AND CABLE MANAGEMENT EQUIPMENT, NAMELY DIGITAL SIGNAL CROSS-CONNECT PANELS, JACKS, PATCH CORDS, CONNECTOR ASSEMBLIES, CHASSIS, FUSE PANELS, AND BAYS (U.S. CLS. 21, 23, 26, 36 AND 38).

FIRST USE 1-0-2002; IN COMMERCE 1-0-2002.

2,955,258. DOGSTAR RECORDS, INC., BETHESDA, MD. SN 76-273,033. PUB. 10-29-2002, FILED 6-18-2001.



THE MARK CONSISTS OF THE NAME - "FRESHLY TWISTED", REPEATED IN A CIRCLE AROUND A PURPLE "F" AND A GREEN "T" WITH A GLOWING YELLOW BALL BETWEEN THE LETTERS "F" AND "T".

FOR ENTERTAINMENT NAMELY, LIVE PERFORMANCES BY A MUSICAL BAND (U.S. CLS. 21, 23, 26, 36 AND 38).

FIRST USE 8-31-2001; IN COMMERCE 8-31-2001.

CLASS 9—(Continued).

2,955,264. FOUR J'S DEVELOPMENT TOOLS LTD., DUBLIN, IRELAND. SN 76-310,243. PUB. 12-9-2003, FILED 9-7-2001.

GENERO

PRIORITY CLAIMED UNDER SEC. 44(D) ON FED REP GERMANY APPLICATION NO. 30115364, FILED 3-8-2001.

FOR COMPUTER SOFTWARE FOR COMPILING OF OTHER COMPUTER PROGRAMS; COMPUTER SOFTWARE FOR DEVELOPING OTHER COMPUTER PROGRAMS; COMPUTER SOFTWARE FOR DESIGNING, CREATING, MAINTAINING AND ACCESSING CUSTOMIZED INTERNAL NETWORK SITES AND GLOBAL COMMUNICATIONS NETWORK SITES (U.S. CLS. 21, 23, 26, 36 AND 38).

FIRST USE 10-9-2003; IN COMMERCE 10-9-2003.

2,955,265. SHARP IMAGE GAMING, INC., CHATSWORTH, CA. SN 76-321,704. PUB. 3-18-2003, FILED 10-5-2001.

TIME LINE

FOR GAMING EQUIPMENT, NAMELY, SLOT MACHINES, WITH OR WITHOUT VIDEO OUTPUT (U.S. CLS. 21, 23, 26, 36 AND 38).

FIRST USE 12-6-2004; IN COMMERCE 12-6-2004.

2,955,283. HOOD, DREW D., PINE GROVE, CA. SN 76-389,104. PUB. 4-6-2004, FILED 3-29-2002.



NO CLAIM IS MADE TO THE EXCLUSIVE RIGHT TO USE "EMS DOCUMENTATION", APART FROM THE MARK AS SHOWN.

THE STIPPLING IN THE DRAWING IS A DESIGN FEATURE OF THE MARK AND IS FOR SHADING PURPOSES ONLY.

THE PORTION OF THE MARK COMPRISED OF A GREEK CROSS DESIGN IS NOT DISPLAYED IN THE COLOR RED OR A COLORABLE IMITATION THEREOF. APPLICANT DOES NOT USE AND WILL NOT USE THE GREEK CROSS DESIGN WHICH APPEARS IN ITS MARK IN THE COLOR RED OR A COLORABLE IMITATION THEREOF.

FOR COMPUTER SOFTWARE THAT FACILITATES THE RECORDING OF INFORMATION RELATED TO EMERGENCY MEDICAL PATIENTS INTO DIGITAL HANDHELD DEVICES, AND THAT ALSO ALLOWS FOR TRANSMITTING THE INFORMATION THROUGH REMOTE ELECTRONIC MEANS FROM ONE SUCH DEVICE TO THE OTHER (U.S. CLS. 21, 23, 26, 36 AND 38).

FIRST USE 6-18-2003; IN COMMERCE 6-18-2003.

CLASS 9—(Continued).

2,955,286. TOSHIBA TEC KABUSHIKI KAISHA, CHIYODA-KU, TOKYO 101-8442, JAPAN. SN 76-412,950. PUB. 7-15-2003, FILED 5-21-2002.

 The logo consists of a lowercase letter 'e' inside a square, followed by the word 'STUDIO' in a bold, sans-serif font.

THE MARK CONSISTS OF THE LETTER "E" IN LOWER CASE LETTERS WITHIN A SQUARE FOLLOWED BY THE STYLIZED LETTER "STUDIO".

FOR PARTS AND FITTINGS NAMELY, CHARGER UNITS, DEVELOPER UNITS, CLEANER/DRUM UNITS, TRANSFER BELT UNITS, FUSER UNITS, PRINTER CARTRIDGES AND DRUMS; DRUM CLEANING BLADES, DRUM SEPARATION SLAWS, HEAT ROLLER CLEANING ROLLERS, SCRAPERS FOR HEAT ROLLERS, CHARGER WIRES, OZONE FILTERS, DEVELOPERS, AND PAPER FEED ROLLERS FOR ELECTROSTATIC COPYING MACHINES, PHOTOSTATIC COPYING MACHINES, IMAGE AND DOCUMENT SCANNERS, LASER PRINTERS, AND FACSIMILE MACHINES AND MULTI-FUNCTIONAL COMBINATIONS OF SUCH MACHINES; MACHINE STANDS AND PARTS THEREFORE, NAMELY, CHARGER UNITS, DEVELOPER UNITS, CLEANER/DRUM UNITS, TRANSFER BELT UNITS, FUSER UNITS, PRINTER CARTRIDGES AND DRUMS; DRUM CLEANING BLADES, DRUM SEPARATION CLAWS, HEAT ROLLER CLEANING ROLLERS, SCRAPERS FOR HEAT ROLLERS, CHARGER WIRES, OZONE FILTERS, DEVELOPERS, AND PAPER FEED ROLLERS AND MULTI-FUNCTIONAL MACHINES COMBINING PHOTOCOPIERS AND SCANNERS AND FACSIMILE MACHINES AND LASER PRINTERS INTO ONE MACHINE (U.S. CLS. 21, 23, 26, 36 AND 38).

FIRST USE 12-0-2000; IN COMMERCE 1-0-2001.

2,955,296. EVERSPRING PRODUCTIONS, LLC, CITY OF INDUSTRY, CA. SN 76-442,832. PUB. 10-28-2003, FILED 8-16-2002.



 The logo consists of the word 'XNOLOGY' in a bold, sans-serif font.

FOR TELEPHONE PRODUCTS AND EQUIPMENT, NAMELY TELEPHONE HEADSETS, WIRELESS TELEPHONE HEADSETS AND COMPUTER HEADSETS (U.S. CLS. 21, 23, 26, 36 AND 38).

FIRST USE 8-0-2003; IN COMMERCE 8-0-2003.

CLASS 9—(Continued).

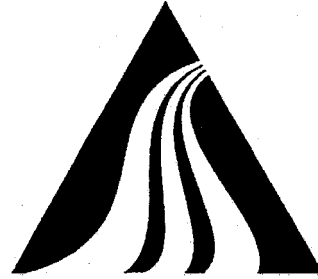
2,955,301. SAFE-TECH PRODUCTS, INC., PHOENIX, AZ. SN 76-447,919. PUB. 11-11-2003, FILED 9-9-2002.



FOR ELECTRICAL EQUIPMENT, NAMELY, ADAPTERS FOR ELECTRICAL PLUGS AND CONNECTORS, CONNECTORS, ELECTRICAL CONVERTERS, ELECTRICAL CIRCUIT CONNECTORS AND GROUNDING ATTACHMENTS; EQUIPMENT AND PROTECTIVE EYE WEAR FOR PROTECTION AGAINST HAZARDS AND ACCIDENTS, NAMELY PORTABLE GROUND FAULT CIRCUIT INTERRUPTERS, MULTIPLE SPARK INTERRUPTERS, EYE WEAR, LENSES AND LENSE INSERTS; AND A FUSIBLE LINK USED FOR FIRE RETARDING AND FIRE PREVENTION (U.S. CLS. 21, 23, 26, 36 AND 38).

FIRST USE 9-24-2004; IN COMMERCE 9-24-2004.

2,955,303. CANON KABUSHIKI KAISHA, OHTA-KU, TOKYO, JAPAN. SN 76-449,702. PUB. 12-30-2003, FILED 9-10-2002.

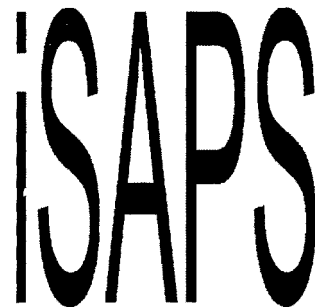
 The logo consists of the letters 'ISAPS' in a very large, bold, sans-serif font.

FOR DIGITAL CAMERAS; IMAGE PROCESSORS; IMAGE PROCESSING FIRMWARE AND IMAGE PROCESSING COMPUTER PROGRAMS FOR DIGITAL CAMERAS (U.S. CLS. 21, 23, 26, 36 AND 38).

FIRST USE 10-0-2004; IN COMMERCE 10-0-2004.

CLASS 9—(Continued).

2,955,307. YAMAHA CORPORATION, SHIZUOKA, JAPAN. SN 76-454,814. PUB. 12-9-2003, FILED 9-26-2002.

MUSICCAST

FOR MULTI-ROOM WIRELESS AUDIO SERVER SYSTEMS FOR NON-PROFESSIONAL HOME USE CONSISTING OF CD-R/RW DRIVES, HARD DISC DRIVES AND MP3 ENCODERS/PLAYERS, WIRELESS AUDIO RECEIVERS CONSISTING OF AMPLIFIERS AND SPEAKERS, RADIO BROADCASTING RECEIVERS, LOUDSPEAKERS, HEADPHONES, EARPHONES, MINI AUDIO SYSTEMS CONSISTING OF CD PLAYERS, CD RECORDERS, MP3 PLAYERS, AMPLIFIERS, HARD DISC DRIVES, AUDIO RECEIVERS AND SPEAKERS, ALL SOLD AS A UNIT, AUDIO/VIDEO AMPLIFIERS, RECORDERS/PLAYERS OF OPTICAL DISCS, COMPACT DISC PLAYERS/RECORDERS, DIGITAL VIDEO (VERSATILE) DISC PLAYERS, HARD DISC RECORDERS, VIDEO CONTROLLERS FOR AUDIO/VIDEO APPARATUS, ELECTRONIC SOUND EFFECT DEVICES, MP3 ENCODERS, MP3 PLAYERS, COMPUTER SOFTWARE FOR ENCODING/PLAYING MP3 MUSIC, COMPUTER SOFTWARE REPRODUCING, SOUND (U.S. CLS. 21, 23, 26, 36 AND 38).

FIRST USE 8-5-2003; IN COMMERCE 8-5-2003.

2,955,314. WIRE21, INC., LAS VEGAS, NV. SN 76-460,050. PUB. 4-27-2004, FILED 10-11-2002.

SATIUS

FOR TELECOMMUNICATIONS EQUIPMENT NAMELY, AUDIO VIDEO EXTENDER UNITS THAT TRANSMIT VIDEO OVER POWER LINES; UNITS FOR LOCAL AREA NETWORKING OVER POWER LINES INSIDE A BUILDING; UNITS FOR LAST MILE WIDE AREA NETWORKING OVER POWER LINES FROM A SUBSTATION THROUGH DISTRIBUTION TRANSFORMERS TO A HOUSE OR BUILDING; VIDEO SECURITY TRANSMITTERS THAT OPERATE OVER POWER LINES; AND VIDEO TRANSMITTERS THAT OPERATE OVER DC WIRE ON MOVING VEHICLES (U.S. CLS. 21, 23, 26, 36 AND 38).

FIRST USE 12-6-2002; IN COMMERCE 12-6-2002.

2,955,331. COASTAL TECHNOLOGIES GROUP, INC., BOCA RATON, FL. SN 76-470,961. PUB. 10-14-2003, FILED 11-29-2002.

SPEED SORT

NO CLAIM IS MADE TO THE EXCLUSIVE RIGHT TO USE SORT, APART FROM THE MARK AS SHOWN.

FOR FEATURE OF COMPUTER SOFTWARE CONSISTING OF A HIGH SPEED COMPUTER ALGORITHM, USED TO PROCESS CONNECTION DATA IN THE FIELD OF TELECOMMUNICATIONS (U.S. CLS. 21, 23, 26, 36 AND 38).

FIRST USE 2-0-2003; IN COMMERCE 9-0-2003.

CLASS 9—(Continued).

2,955,333. SODIM, 45490 FLEURY-LES-AUBRAIS, FRANCE. SN 76-473,225. PUB. 10-14-2003, FILED 12-2-2002.

CIGARLAB

FOR ELECTRONIC APPARATUS FOR MEASURING THE PULL AND DIAMETER OF CIGARS (U.S. CLS. 21, 23, 26, 36 AND 38).

FIRST USE 5-10-2004; IN COMMERCE 5-10-2004.

2,955,351. ARREDI TECNICI VILLA S.P.A., 21042 CARONNO PERTUSELLA (VA), ITALY. SN 76-479,833. PUB. 11-4-2003, FILED 12-26-2002.

SATELLITE

FOR MOBILE LABORATORY BENCHES WITH BUILT-IN UTILITIES SUPPLY LINES, WORKTOPS, DRAWERS, CABINETS, LABORATORY LIGHT FIXTURES, WORK TRAYS; LABORATORY SUPPORT FRAMES WITH BUILT-IN UTILITIES SUPPLY LINES AND FOR MOUNTING LABORATORY EQUIPMENT (U.S. CLS. 21, 23, 26, 36 AND 38).

FIRST USE 11-30-2001; IN COMMERCE 3-15-2004.

2,955,352. ISAACSON, RICH, TARRYTOWN, NY. AND COOKMAN, TOMAS, TARRYTOWN, NY. AND BLAIR, JERRY, TARRYTOWN, NY. SN 76-481,312. PUB. 5-18-2004, FILED 1-8-2003.

FUERTE RECORDS

NO CLAIM IS MADE TO THE EXCLUSIVE RIGHT TO USE RECORDS, APART FROM THE MARK AS SHOWN.

THE ENGLISH TRANSLATION OF "FUERTE" IS "STRONG".

FOR PRE-RECORDED MAGNETIC DATA CARRIERS FEATURING LATINO MUSIC (U.S. CLS. 21, 23, 26, 36 AND 38).

FIRST USE 7-1-2004; IN COMMERCE 7-1-2004.

CLASS 9—(Continued).

2,955,357. DRIVER, ANNIE, HOUSTON, TX. SN 76-485,476.
PUB. 10-21-2003, FILED 1-28-2003.

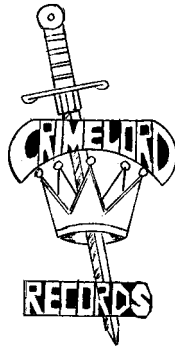

NO CLAIM IS MADE TO THE EXCLUSIVE RIGHT TO USE "RECORDS", APART FROM THE MARK AS SHOWN. FOR MUSICAL SOUND RECORDINGS (U.S. CLS. 21, 23, 26, 36 AND 38).
FIRST USE 3-12-1999; IN COMMERCE 3-12-1999.

2,955,367. DELIVERY TECHNOLOGIES, LLC, NORTH HAVEN, CT. SN 76-490,797. PUB. 10-21-2003, FILED 2-12-2003.

SOFTWARE FROM HERE TO THERE

NO CLAIM IS MADE TO THE EXCLUSIVE RIGHT TO USE "SOFTWARE", APART FROM THE MARK AS SHOWN. FOR COMPUTER SOFTWARE FOR TRACKING AND CONTROL OF DELIVERIES (U.S. CLS. 21, 23, 26, 36 AND 38).
FIRST USE 1-1-2003; IN COMMERCE 1-1-2003.

2,955,377. DELTA ENTERTAINMENT CORPORATION, LOS ANGELES, CA. SN 76-493,627. PUB. 10-21-2003, FILED 2-28-2003.

FOR PHONOGRAPH RECORDS AND COMPACT DISCS FEATURING MUSIC (U.S. CLS. 21, 23, 26, 36 AND 38).
FIRST USE 12-3-2002; IN COMMERCE 12-3-2002.

CLASS 9—(Continued).

2,955,379. COMPUWARE CORPORATION, DETROIT, MI. SN 76-493,978. PUB. 11-18-2003, FILED 3-3-2003.

COVISINT

OWNER OF U.S. REG. NO. 2,572,071.
FOR COMPUTER SOFTWARE TO FACILITATE ON-LINE COMMERCIAL AND PURCHASING TRANSACTIONS, NAMELY SOFTWARE TO PERFORM, ENCRYPTION AND AUTHENTICATION OF ELECTRONIC INFORMATION, SUPPLY CHAIN MANAGEMENT (U.S. CLS. 21, 23, 26, 36 AND 38).
FIRST USE 5-17-2000; IN COMMERCE 5-17-2000.

2,955,380. LUMITEX PTY LTD., SOUTH PERTH, WESTERN AUSTRALIA, AUSTRALIA. SN 76-494,967. PUB. 6-1-2004, FILED 2-28-2003.

EZY FLARE

FOR EMERGENCY LIGHTS (U.S. CLS. 21, 23, 26, 36 AND 38).
FIRST USE 2-0-2004; IN COMMERCE 2-0-2004.

2,955,381. ERGO CREATIVE, INC., AURORA, IL. SN 76-495,504. PUB. 11-4-2003, FILED 3-7-2003.

BRAND ACCESS

FOR WEB-BASED, DOWNLOADABLE COMPUTER PROGRAM AND INSTRUCTIONS THEREFOR, FOR USE IN THE FIELD OF BUSINESS, FOR THE PURPOSE OF INSTRUCTION, USE, MAINTENANCE AND MANAGEMENT OF THE INTELLECTUAL PROPERTY OF OTHERS, ACCESSIBLE THROUGH A GLOBAL COMPUTER INFORMATION AND COMMUNICATIONS NETWORK (U.S. CLS. 21, 23, 26, 36 AND 38).
FIRST USE 12-0-2002; IN COMMERCE 5-0-2004.

2,955,388. SUN CHEMICAL CORPORATION, PARSIPPANY, NJ. SN 76-498,042. PUB. 11-11-2003, FILED 3-10-2003.

DESIGNRITE

FOR COMPUTER SOFTWARE PROGRAM FOR COLOR PALETTE DEVELOPMENT AND COLOR MATCHING IN THE FIELD OF GRAPHIC ARTS (U.S. CLS. 21, 23, 26, 36 AND 38).
FIRST USE 6-30-2004; IN COMMERCE 6-30-2004.

CLASS 9—(Continued).

2,955,389. NOVA GAMING, LLC, GREENVILLE, SC. SN 76-498,575. PUB. 2-10-2004, FILED 3-19-2003.

FRUIT GONE WILD

FOR GAMING MACHINES AND COMPUTER GAMING SOFTWARE (U.S. CLS. 21, 23, 26, 36 AND 38).
FIRST USE 6-17-2003; IN COMMERCE 6-17-2003.

2,955,397. NOVA GAMING, LLC, GREENVILLE, SC. SN 76-499,479. PUB. 2-10-2004, FILED 3-21-2003.

ANCIENT TREASURES

FOR GAMING MACHINES AND COMPUTER SOFTWARE FOR USE IN GAMING MACHINES (U.S. CLS. 21, 23, 26, 36 AND 38).
FIRST USE 6-19-2003; IN COMMERCE 6-19-2003.

2,955,403. UNIVERSAL SECURITY INSTRUMENTS, INC., OWINGS MILLS, MD. SN 76-503,204. PUB. 11-11-2003, FILED 4-2-2003.

QUICK-DRAW

FOR SMOKE DETECTORS AND CARBON MONOXIDE DETECTORS (U.S. CLS. 21, 23, 26, 36 AND 38).
FIRST USE 12-1-2004; IN COMMERCE 2-2-2005.

2,955,405. HITEC GROUP INTERNATIONAL, INC., BURR RIDGE, IL. SN 76-506,432. PUB. 12-16-2003, FILED 4-14-2003.

CLEAROUNDS

FOR TELEPHONE EQUIPMENT, NAMELY TRANSMITTERS AND RECEIVERS (U.S. CLS. 21, 23, 26, 36 AND 38).
FIRST USE 1-30-2004; IN COMMERCE 1-30-2004.

CLASS 9—(Continued).

2,955,408. ARIO DATA NETWORKS, INC., SAN JOSE, CA. SN 76-507,465. PUB. 11-4-2003, FILED 4-17-2003.

ARIO @ WORK

THE MARK CONSISTS OF STANDARD CHARACTERS WITHOUT CLAIM TO ANY PARTICULAR FONT, STYLE, SIZE, OR COLOR.

NO CLAIM IS MADE TO THE EXCLUSIVE RIGHT TO USE WORK, APART FROM THE MARK AS SHOWN.

FOR COMPUTER HARDWARE, SOFTWARE AND APPLICATION SPECIFIC INTEGRATED CIRCUITS (ASIC) FOR STORAGE AREA NETWORKING CONTROLLERS FOR USE IN DEVELOPING NETWORK STORAGE DEVICES AND APPLICATIONS (U.S. CLS. 21, 23, 26, 36 AND 38).

FIRST USE 7-0-2003; IN COMMERCE 7-0-2003.

2,955,420. HARCOURT, INC., ORLANDO, FL. SN 76-518,562. PUB. 2-10-2004, FILED 6-2-2003.

CALL TO FAITH

FOR COMPUTER SOFTWARE, PRE RECORDED AUDIO AND VIDEO TAPES AND CD-ROM PRODUCTS FOR TEACHING RELIGION (U.S. CLS. 21, 23, 26, 36 AND 38).

FIRST USE 6-1-2004; IN COMMERCE 6-1-2004.

CLASS 9—(Continued).

2,955,427. PRO DESIGN ELECTRONIC & CAD-LAYOUT GMBH, BRUCKMUHL, FED REP GERMANY. SN 76-527,633. PUB. 9-21-2004, FILED 6-25-2003.

UMRBUS

FOR DATA PROCESSORS AND COMPUTERS; COMPUTER PERIPHERALS; COMPUTER SIMULATORS AND EMULATORS FOR THE DEVELOPMENT AND DESIGN OF INTEGRATED CIRCUITS AND PROCESSORS; COMPUTER SIMULATION AND EMULATION ACCELERATOR BOARDS FOR THE DEVELOPMENT AND DESIGN OF INTEGRATED CIRCUITS AND PROCESSORS; INTERFACES, NAMELY, UNIVERSAL PERIPHERAL INTERFACE HARDWARE AND UNIVERSAL PERIPHERAL INTERFACE SOFTWARE, SOLD AS AN INTEGRAL COMPONENT OF A COMPUTER OR A COMPUTER SIMULATOR OR EMULATOR FOR THE DEVELOPMENT AND DESIGN OF INTEGRATED CIRCUITS AND PROCESSORS; COMPUTER INTERFACE BOARDS, SOLD AS AN INTEGRAL COMPONENT OF A COMPUTER OR A COMPUTER SIMULATOR OR EMULATOR FOR THE DEVELOPMENT AND DESIGN OF INTEGRATED CIRCUITS AND PROCESSORS; ELECTRICAL CIRCUIT BOARDS, SOLD AS AN INTEGRAL COMPONENT OF A COMPUTER OR A COMPUTER SIMULATOR OR EMULATOR FOR THE DEVELOPMENT AND DESIGN OF INTEGRATED CIRCUITS AND PROCESSORS; INTEGRATED CIRCUITS; COMPUTER SOFTWARE FOR CONTROLLING, ROUTING AND HANDLING DATA FLOW WITHIN A COMPUTER, AN ELECTRIC CIRCUIT BOARD OR AN INTEGRATED CIRCUIT IN THE FIELD OF SIMULATION, EMULATION, DEVELOPMENT AND DESIGN OF INTEGRATED CIRCUITS AND PROCESSORS; DATA MEDIA, NAMELY, CDS, DVDS, OPTICAL DISCS, DISKETTES FEATURING COMPUTER PROGRAMS FOR USE IN THE SIMULATION, EMULATION, DEVELOPMENT AND DESIGN OF INTEGRATED CIRCUITS AND PROCESSORS (U.S. CLS. 21, 23, 26, 36 AND 38).

FIRST USE 2-27-2004; IN COMMERCE 2-27-2004.

2,955,436. ARISTOCRAT TECHNOLOGIES AUSTRALIA PTY LTD, NEW SOUTH WALES 2066, AUSTRALIA. SN 76-533,655. PUB. 4-20-2004, FILED 7-31-2003.

MARGARITA MAGIC

FOR GAMING DEVICES, NAMELY, GAMING MACHINES AND COMPUTER SOFTWARE USED THEREWITH TO ENABLE THE GAMING MACHINE TO RUN (U.S. CLS. 21, 23, 26, 36 AND 38).

FIRST USE 9-11-2003; IN COMMERCE 9-16-2003.

2,955,437. ARISTOCRAT TECHNOLOGIES AUSTRALIA PTY LTD, LANE COVE, NEW SOUTH WALES 2066, AUSTRALIA. SN 76-534,748. PUB. 4-13-2004, FILED 8-6-2003.

MAGIC EYES

FOR GAMING DEVICES, NAMELY, GAMING MACHINES AND COMPUTER SOFTWARE USED THEREWITH, TO ENABLE THE GAMING MACHINE TO RUN (U.S. CLS. 21, 23, 26, 36 AND 38).

FIRST USE 1-8-2004; IN COMMERCE 3-23-2004.

CLASS 9—(Continued).

2,955,442. WPI ACQUISITION LLC, BALTIMORE, MD. SN 76-536,613. PUB. 4-27-2004, FILED 8-13-2003.

ADMITRX

FOR COMPUTER SOFTWARE THAT PROVIDES LONG TERM CARE ADMISSIONS DIRECTORS AND HOSPITAL-BASED ASSESSMENT COORDINATORS THE ABILITY TO PRICE AND EVALUATE THE FINANCIAL IMPACT OF NEW RESIDENTS' DRUG THERAPIES PRIOR TO ADMISSION, PROVIDES IMMEDIATE ACCESS TO RESIDENTS' DRUG THERAPY INFORMATION, FEATURES A BUILT-IN THERAPEUTIC SUBSTITUTION FUNCTION, PROVIDES CLINICAL ADVISORIES WITH INFORMATION NECESSARY TO OPTIMIZE PHARMACEUTICAL REGIMENS PRIOR TO ADMISSION, AND PROVIDES A RAPID ASSESSMENT TOOL TO PROJECT REIMBURSEMENT UNDER THE MEDICARE PROSPECTIVE PAYMENT SYSTEM (PPS) (U.S. CLS. 21, 23, 26, 36 AND 38).

FIRST USE 5-0-2003; IN COMMERCE 5-0-2003.

2,955,444. BEST SOFTWARE, INC., IRVINE, CA. SN 76-538,035. PUB. 5-25-2004, FILED 8-14-2003.

FAS NONPROFIT ASSET INVENTORY

OWNER OF U.S. REG. NO. 2,735,768.
NO CLAIM IS MADE TO THE EXCLUSIVE RIGHT TO USE "NONPROFIT ASSET INVENTORY", APART FROM THE MARK AS SHOWN.

FOR COMPUTER SOFTWARE FOR ASSET INVENTORY MAINTENANCE, MANAGEMENT AND RECONCILIATION, IN THE FIELD OF ACCOUNTING AND FINANCE (U.S. CLS. 21, 23, 26, 36 AND 38).

FIRST USE 2-28-2004; IN COMMERCE 2-28-2004.

2,955,482. ICICI INFOTECH LTD., VASHI NAVI MUMBAI 400 705, INDIA. SN 78-059,818. PUB. 7-13-2004, FILED 4-23-2001.

PREMIA

FOR COMPUTER SOFTWARE FOR THE FORMATION, OPERATION AND MANAGEMENT OF INSURANCE ORGANIZATIONS; COMPUTER SOFTWARE FOR THE CREATION AND MANAGEMENT OF INSURANCE POLICIES (U.S. CLS. 21, 23, 26, 36 AND 38).

FIRST USE 1-31-1997; IN COMMERCE 12-31-2002.

CLASS 9—(Continued).

2,955,484. PROGRESS SOFTWARE CORPORATION, BEDFORD, MA. SN 78-064,465. PUB. 12-4-2001, FILED 5-18-2001.

FATHOM

FOR COMPUTER SOFTWARE IN THE FIELD OF INFORMATION TECHNOLOGY FOR USE BY INFORMATION TECHNOLOGY PROFESSIONALS FOR THE MANAGEMENT OF BUSINESS APPLICATION SOFTWARE DEPLOYED OVER LOCAL AREA, WIDE AREA, AND GLOBAL COMPUTER NETWORKS, AND INSTRUCTION MANUALS SOLD AS A UNIT THEREWITH (U.S. CLS. 21, 23, 26, 36 AND 38).
FIRST USE 10-29-2001; IN COMMERCE 10-29-2001.

2,955,486. OPDEX, INC., MOUNTAIN VIEW, CA. SN 78-072,041. PUB. 4-13-2004, FILED 7-2-2001.

POWERSAFE

FOR COMPUTER SOFTWARE FOR USE IN MANAGING UNINTERRUPTIBLE POWER SUPPLIES FOR A COMPUTER NETWORK (U.S. CLS. 21, 23, 26, 36 AND 38).
FIRST USE 6-23-2003; IN COMMERCE 6-23-2003.

2,955,507. DFA CAPITAL MANAGEMENT, INC., PURCHASE, NY. SN 78-151,716. PUB. 10-28-2003, FILED 8-7-2002.

ADVISE

PRIORITY CLAIMED UNDER SEC. 44(D) ON ERPNTY TM OFC APPLICATION NO. 002740892, FILED 6-20-2002.

FOR COMPUTER SOFTWARE USED TO MODEL FINANCIAL CONDITIONS IN THE INSURANCE INDUSTRY (U.S. CLS. 21, 23, 26, 36 AND 38).
FIRST USE 12-31-2002; IN COMMERCE 12-31-2002.

2,955,516. NOLAN, PHILIP, WAUPACA, WI. SN 78-159,523. PUB. 11-4-2003, FILED 8-30-2002.

MAG-FREE

FOR SCUBA DIVING MASKS AND CORRECTIVE AND NON-CORRECTIVE LENSES FOR USE THEREWITH (U.S. CLS. 21, 23, 26, 36 AND 38).
FIRST USE 1-1-2004; IN COMMERCE 1-1-2004.

CLASS 9—(Continued).

2,955,521. NORDSON CORPORATION, WESTLAKE, OH. SN 78-162,305. PUB. 5-25-2004, FILED 9-10-2002.

IFLOW

FOR DIGITAL AIR FLOW REGULATORS USED IN THE PAINTING AND COATING INDUSTRY (U.S. CLS. 21, 23, 26, 36 AND 38).
FIRST USE 10-15-2002; IN COMMERCE 10-15-2002.

2,955,533. PEAVEY ELECTRONICS CORPORATION, MERIDIAN, MS. SN 78-169,304. PUB. 1-13-2004, FILED 9-30-2002.

NION

FOR COMPUTERS, BREAKOUT BOXES, AND SOUND CARDS, NAMELY ANALOG AND DIGITAL AUDIO INPUT-OUTPUT CARDS (U.S. CLS. 21, 23, 26, 36 AND 38).
FIRST USE 3-19-2004; IN COMMERCE 3-19-2004.

2,955,549. EHEALTHCARE SYSTEMS, INC., TORRANCE, CA. SN 78-181,838. PUB. 6-10-2003, FILED 11-5-2002.

 **HEALTHCARE**
eHealthCare Systems, Inc.

NO CLAIM IS MADE TO THE EXCLUSIVE RIGHT TO USE "EHEALTHCARE EHEALTHCARE SYSTEMS, INC.", APART FROM THE MARK AS SHOWN.

FOR COMPUTER E-COMMERCE SOFTWARE TO ALLOW USERS TO PERFORM PATIENT HEALTHCARE-RELATED ELECTRONIC BUSINESS TRANSACTIONS VIA A GLOBAL COMPUTER NETWORK IN THE FIELDS OF MEDICINE, DENTISTRY, IPA/MANAGED CARE MANAGEMENT SERVICES; COMPUTER SOFTWARE - HEALTHCARE BILLING SOFTWARE FOR USE IN PATIENT HEALTH AND FINANCIAL RECORDS MANAGEMENT; AS WELL AS FOR MEDICAL, DENTAL, COMMUNITY-PUBLIC HEALTH AND IPA-MANAGED CARE HEALTHCARE-RELATED CLAIMS BILLING, CLAIMS ADJUDICATION, PATIENT CARE REFERRAL AUTHORIZATIONS, PATIENT CHART NOTING AND RECORDS MANAGEMENT, PATIENT APPOINTMENT SCHEDULING, AND FINANCIAL AND STATISTICAL REPORTING (U.S. CLS. 21, 23, 26, 36 AND 38).
FIRST USE 1-1-2001; IN COMMERCE 1-1-2001.

2,955,552. SCHNEDLER, DAVID E., PALO ALTO, CA. SN 78-184,868. PUB. 9-16-2003, FILED 11-13-2002.

METARI

FOR DISPENSERS THAT COUNT OR MEASURE OUTPUT FOR USE WITH FOODS (U.S. CLS. 21, 23, 26, 36 AND 38).
FIRST USE 8-4-2003; IN COMMERCE 8-4-2003.

CLASS 9—(Continued).

2,955,554. TECRA INTERNATIONAL PTY LTD, NEW SOUTH WALES, AUSTRALIA. SN 78-188,166. PUB. 3-2-2004, FILED 11-22-2002.

PROTOCOL CARD

FOR ENCODED INTEGRATED CIRCUIT CARDS CONTAINING PROGRAMMING USED TO CONTROL SCIENTIFIC APPARATUS; ENCODED SMART CARDS CONTAINING PROGRAMMING USED TO CONTROL SCIENTIFIC APPARATUS (U.S. CLS. 21, 23, 26, 36 AND 38).

FIRST USE 2-28-2002; IN COMMERCE 7-31-2002.

2,955,566. DYSTAR TEXTILFARBEN GMBH & CO. DEUTSCHLAND KG, FRANKFURT AM MAIN, FED REP GERMANY. SN 78-198,269. PUB. 4-27-2004, FILED 12-27-2002.

OPTIDYE

FOR COMPUTER PROGRAMS FOR USE IN THE FIELD OF TEXTILE DYEING TO CALCULATE DYE RECIPE DATA AND CONTROL THE OPERATION OF DYEING MACHINES (U.S. CLS. 21, 23, 26, 36 AND 38).

FIRST USE 0-0-1996; IN COMMERCE 1-0-1997.

2,955,567. BMAIL! CORP., MENLO PARK, CA. SN 78-198,983. PUB. 4-27-2004, FILED 12-31-2002.

SCALIX

FOR COMPUTER SOFTWARE, NAMELY ENTERPRISE SOFTWARE DESIGNED FOR USE AS AN ELECTRONIC MESSAGING AND CALENDARING INFRASTRUCTURE APPLICATION (U.S. CLS. 21, 23, 26, 36 AND 38).

FIRST USE 5-14-2003; IN COMMERCE 5-14-2003.

2,955,580. CIENA CORPORATION, LINTHICUM, MD. SN 78-209,326. PUB. 4-13-2004, FILED 1-31-2003.

ONLINE METRO DESIGNER

NO CLAIM IS MADE TO THE EXCLUSIVE RIGHT TO USE "ONLINE" AND "DESIGNER", APART FROM THE MARK AS SHOWN.

FOR SOFTWARE FOR CONFIGURING, SIMULATING, ANALYZING, PLANNING, MODELING AND OPTIMIZING WAVELENGTH DIVISION MULTIPLEXED (WDM) OPTICAL COMMUNICATION NETWORKS AND USER MANUALS SOLD TOGETHER AS A UNIT (U.S. CLS. 21, 23, 26, 36 AND 38).

FIRST USE 7-18-2003; IN COMMERCE 7-18-2003.

CLASS 9—(Continued).

2,955,587. SAMSUNG ELECTRO-MECHANICS CO., LTD., KYUNGKI-DO, REPUBLIC OF KOREA. SN 78-212,245. PUB. 10-7-2003, FILED 2-7-2003.

SEMICONLAMP

FOR LIGHT EMITTING DIODES (U.S. CLS. 21, 23, 26, 36 AND 38).

FIRST USE 1-0-2004; IN COMMERCE 1-0-2004.

2,955,589. TWENTIETH CENTURY FOX FILM CORPORATION, LOS ANGELES, CA. SN 78-214,220. PUB. 11-4-2003, FILED 2-12-2003.

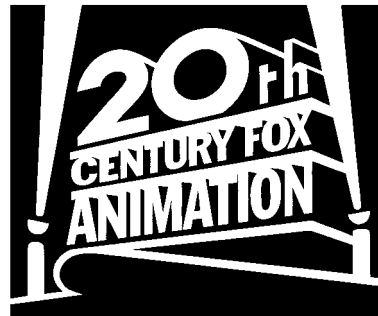

NO CLAIM IS MADE TO THE EXCLUSIVE RIGHT TO USE "ANIMATION", APART FROM THE MARK AS SHOWN.

FOR SERIES OF MOTION PICTURE FILMS FEATURING ANIMATED ENTERTAINMENT; PRE-RECORDED VIDEO TAPES, VIDEO CASSETTES AND DVDS ALL FEATURING ANIMATED MOTION PICTURE FILM ENTERTAINMENT (U.S. CLS. 21, 23, 26, 36 AND 38).

FIRST USE 11-16-1999; IN COMMERCE 11-16-1999.

2,955,601. AUTOMATION AND CONTROL TECHNOLOGY, INC., COLUMBUS, OH. SN 78-220,071. PUB. 12-9-2003, FILED 2-28-2003.

REMOTE ACT

OWNER OF U.S. REG. NO. 2,512,850.
NO CLAIM IS MADE TO THE EXCLUSIVE RIGHT TO USE "REMOTE", APART FROM THE MARK AS SHOWN.

FOR COMPUTER SOFTWARE, NAMELY SOFTWARE THAT ALLOWS AN ENGINEER TO CALL-IN TO A MEASUREMENT OR INDUSTRIAL CONTROL SYSTEM AND SEE WHAT AN ON-SITE OPERATOR SEES (U.S. CLS. 21, 23, 26, 36 AND 38).

FIRST USE 5-31-2002; IN COMMERCE 5-31-2002.

CLASS 9—(Continued).

2,955,602. AUTOMATION AND CONTROL TECHNOLOGY, INC., COLUMBUS, OH. SN 78-220,077. PUB. 12-9-2003, FILED 2-28-2003.

ACT DATAVISION

OWNER OF U.S. REG. NO. 2,512,850.
FOR COMPUTER SOFTWARE, NAMELY SOFTWARE THAT RECEIVES DIGITAL AND ANALOG INFORMATION, ACCUMULATES THAT DATA AND POSTS THE DATA FOR USE IN A MEASUREMENT OR INDUSTRIAL CONTROLS SYSTEM (U.S. CLS. 21, 23, 26, 36 AND 38).
FIRST USE 5-31-2002; IN COMMERCE 5-31-2002.

2,955,609. MARCHON EYEWEAR, INC., MELVILLE, NY. SN 78-223,674. PUB. 11-25-2003, FILED 3-10-2003.

TI-LIGHT

FOR EYEGLASSES, SUNGLASSES, EYEGLASS AND SUNGLASS FRAMES AND CASES FOR EYEGLASSES AND SUNGLASSES (U.S. CLS. 21, 23, 26, 36 AND 38).
FIRST USE 3-31-2004; IN COMMERCE 3-31-2004.

2,955,616. RICE LAKE WEIGHING SYSTEMS, INC., RICE LAKE, WI. SN 78-225,234. PUB. 6-8-2004, FILED 3-13-2003.

IQUBE

FOR DEVICE, NAMELY DIGITAL DIAGNOSTIC JUNCTION BOX USED IN THE WEIGHING INDUSTRY TO CALIBRATE INDIVIDUAL LOAD CELLS, TO SUM LOAD CELLS AND TO PROVIDE COMPLETE SCALE DIAGNOSTICS THROUGH LOCAL NETWORKS AND THE INTERNET (U.S. CLS. 21, 23, 26, 36 AND 38).
FIRST USE 11-0-2003; IN COMMERCE 11-0-2003.

2,955,621. IGT, RENO, NV. SN 78-225,983. PUB. 11-18-2003, FILED 3-14-2003.

EASEL MONEY

FOR GAMING MACHINES, NAMELY, SLOT MACHINES OR LOTTERY TERMINALS WITH OR WITHOUT VIDEO OUTPUT (U.S. CLS. 21, 23, 26, 36 AND 38).
FIRST USE 12-16-2004; IN COMMERCE 12-23-2004.

CLASS 9—(Continued).

2,955,636. WMS GAMING INC., WAUKEGAN, IL. SN 78-229,549. PUB. 11-11-2003, FILED 3-25-2003.

PREMIER NIGHT

FOR CURRENCY AND CREDIT OPERATED SLOT MACHINES AND GAMING DEVICES, NAMELY, GAMING MACHINES FOR USE IN GAMING ESTABLISHMENTS (U.S. CLS. 21, 23, 26, 36 AND 38).
FIRST USE 10-5-2004; IN COMMERCE 10-5-2004.

2,955,647. KEYTOUCH CORPORATION, WALNUT, CA. SN 78-234,601. PUB. 7-6-2004, FILED 4-7-2003.

KEYTOUCH

FOR SOFTWARE FOR CONTROLLING KEYPAD INPUT FOR USE IN THE MANUFACTURING OF ELECTRONIC DEVICES; COMPUTER HARDWARE FOR USE IN THE MANUFACTURING OF, AND AS ADD-ON DEVICES FOR ELECTRONIC DEVICES (U.S. CLS. 21, 23, 26, 36 AND 38).
FIRST USE 2-24-2000; IN COMMERCE 2-24-2000.

2,955,653. CAGAN, LEIGH D., SAN JOSE, CA. SN 78-236,755. PUB. 12-9-2003, FILED 4-11-2003.

FELONY

FOR GUITAR AMPLIFIERS (U.S. CLS. 21, 23, 26, 36 AND 38).
FIRST USE 4-13-2003; IN COMMERCE 1-9-2005.

2,955,675. BELKIN CORPORATION, COMPTON, CA. SN 78-249,611. PUB. 5-25-2004, FILED 5-14-2003.

TUNEPOWER

FOR ELECTRONIC ACCESSORIES, NAMELY, APPARATUS TO OPERATIVELY CONNECT AN MP3 PLAYER THROUGH A CAR OR HOME AUDIO OR STEREO SYSTEM (U.S. CLS. 21, 23, 26, 36 AND 38).
FIRST USE 11-0-2004; IN COMMERCE 11-0-2004.

2,955,676. GENERAL ELECTRIC COMPANY, SCHENECTADY, NY. SN 78-250,183. PUB. 12-23-2003, FILED 5-15-2003.

AUTOBONE

FOR SOFTWARE PACKAGE THAT ALLOWS FOR THE SEGMENTATION OF BONY STRUCTURES FROM ABDOMINAL AND EXTREMITY CT ANGIOGRAPHY DATA (U.S. CLS. 21, 23, 26, 36 AND 38).
FIRST USE 11-18-2003; IN COMMERCE 11-18-2003.

CLASS 9—(Continued).

2,955,683. LAPIDUS-SALTZ, WENDY, CHICAGO, IL. SN 78-253,956. PUB. 3-2-2004, FILED 5-23-2003.

HYPNO-ATTRACTION

FOR AUDIO CASSETTES, COMPACT DISCS AND DIGITAL VERSATILE DISCS FEATURING HYPNOSIS SERVICES (U.S. CLS. 21, 23, 26, 36 AND 38).
FIRST USE 9-1-2004; IN COMMERCE 9-1-2004.

2,955,686. MINE SAFETY APPLIANCES COMPANY, PITTSBURGH, PA. SN 78-259,373. PUB. 1-20-2004, FILED 6-6-2003.

SAFESITE

FOR HAZARDOUS AGENT MONITOR FOR DETECTING THE PRESENCE OF TOXIC GASES, VOLATILE ORGANIC COMPOUNDS AND CHEMICAL WARFARE AGENTS (U.S. CLS. 21, 23, 26, 36 AND 38).
FIRST USE 9-17-2004; IN COMMERCE 9-17-2004.

2,955,710. INFOCUS CORPORATION, WILSONVILLE, OR. SN 78-274,636. PUB. 6-1-2004, FILED 7-15-2003.

PROJECTABILITY

FOR PROJECTION DEVICES, NAMELY PRESENTATION PROJECTORS, HOME THEATRE PROJECTORS, MOBILE PROJECTORS, PROJECTION SCREENS; DISPLAYS FOR PROJECTION DEVICES, NAMELY LIQUID CRYSTAL DISPLAYS FOR PROJECTION DEVICES; ACCESSORIES AND COMPONENTS FOR PROJECTION DEVICES, NAMELY WIRELESS DEVICES FOR PROJECTION DEVICES, MULTIMEDIA ADAPTERS FOR PROJECTION DEVICES, NETWORK ADAPTERS FOR PROJECTION DEVICES, SOFTWARE FOR INSTALLATION, USE AND MANAGEMENT OF PROJECTION DEVICES (U.S. CLS. 21, 23, 26, 36 AND 38).
FIRST USE 1-13-2003; IN COMMERCE 1-13-2003.

2,955,714. IGT, RENO, NV. SN 78-277,939. PUB. 11-25-2003, FILED 7-23-2003.

DOUBLE DIAMOND STRIKE

OWNER OF U.S. REG. NOS. 1,854,535, 2,552,621, AND OTHERS.
FOR GAMING MACHINES, NAMELY, SLOT MACHINES WITH OR WITHOUT VIDEO OUTPUT OR VIDEO LOTTERY TERMINALS (U.S. CLS. 21, 23, 26, 36 AND 38).
FIRST USE 5-3-2004; IN COMMERCE 5-3-2004.

CLASS 9—(Continued).

2,955,717. IGT, RENO, NV. SN 78-281,329. PUB. 2-17-2004, FILED 7-31-2003.

CATS AND DOGS

OWNER OF U.S. REG. NO. 2,072,393.
FOR GAMING MACHINES, NAMELY, SLOT MACHINES WITH OR WITHOUT VIDEO OUTPUT OR VIDEO LOTTERY TERMINALS (U.S. CLS. 21, 23, 26, 36 AND 38).
FIRST USE 7-0-2003; IN COMMERCE 7-0-2003.

2,955,722. XEROX CORPORATION, STAMFORD, CT. SN 78-286,297. PUB. 4-27-2004, FILED 8-12-2003.

PHASERMATCH

FOR COMPUTER SOFTWARE FOR IMAGING, FOR PRINT MANAGEMENT, FOR NETWORK MANAGEMENT, FOR OCR (OPTICAL CHARACTER RECOGNITION) (U.S. CLS. 21, 23, 26, 36 AND 38).
FIRST USE 8-15-2003; IN COMMERCE 8-15-2003.

2,955,723. TRUWARIER RECORDS, LLC, CARMEL, IN. SN 78-286,357. PUB. 5-11-2004, FILED 8-12-2003.

TRUWARIER RECORDS

NO CLAIM IS MADE TO THE EXCLUSIVE RIGHT TO USE "RECORDS", APART FROM THE MARK AS SHOWN.
FOR SOUND RECORDINGS, NAMELY, COMPACT DISCS, RECORDS FEATURING MUSIC (U.S. CLS. 21, 23, 26, 36 AND 38).
FIRST USE 11-23-2004; IN COMMERCE 11-23-2004.

CLASS 9—(Continued).

2,955,730. THE BERGQUIST COMPANY, CHANHASSEN, MN. SN 78-291,188. PUB. 6-1-2004, FILED 8-22-2003.

HIGHROAD

THE MARK CONSISTS OF STANDARD CHARACTERS WITHOUT CLAIM TO ANY PARTICULAR FONT, STYLE, SIZE, OR COLOR.

FOR HEAT MANAGEMENT COMPONENTS FOR INCORPORATION IN ELECTRONIC ASSEMBLIES AND PRINTED CIRCUIT BOARDS, NAMELY, INSULATING HEAT SINK MOUNTS FITTED FOR ELECTRONIC COMPONENTS; SILICONE COATED ELECTRICAL INSULATIVE FILM FITTED FOR USE IN COMMERCIAL AND INDUSTRIAL ELECTRONIC INSTALLATIONS, SOLD IN THE FORM OF SHEETS AND SPECIAL SHAPES; MULTIFUNCTION ELECTRONIC MEMBRANE SWITCHES; MOUNTING PAD FITTED FOR SEMICONDUCTOR DEVICES; INSULATORY COATINGS OF PLASTIC RESIN SOLD AS A COMPONENT OF SEMICONDUCTORS FOR USE IN MANUFACTURING ELECTRONIC EQUIPMENT; MOUNTING SUBSTRATES FOR INCORPORATION IN ELECTRONIC COMPONENTS; ELECTRICAL MEMBRANE SWITCHES; ELECTRICAL INSULATIVE, THERMALLY CONDUCTIVE MOUNTING PADS FITTED FOR ELECTRONIC COMPONENTS; AND COMPUTER TOUCHSCREEN MONITORS (U.S. CLS. 21, 23, 26, 36 AND 38).

FIRST USE 11-17-2003; IN COMMERCE 11-17-2003.

2,955,731. CARRAWAY, RUSSELL D, RALEIGH, NC. SN 78-291,441. PUB. 5-11-2004, FILED 8-23-2003.

QUIXHIBIT

FOR COMPUTER SOFTWARE, NAMELY PROGRAM THAT GENERATES HTML IMAGE GALLERY (U.S. CLS. 21, 23, 26, 36 AND 38).

FIRST USE 2-1-2005; IN COMMERCE 2-1-2005.

2,955,734. INTERNATIONAL TRADING HOUSE, LLC, ALPHARETTA, GA. SN 78-292,438. PUB. 6-1-2004, FILED 8-26-2003.

SAMSTAR

FOR CONSUMER ELECTRONICS DEVICES AND HOME THEATER SYSTEMS, NAMELY, TELEVISIONS, LCD MONITORS, PLASMA MONITORS, VIDEO CASSETTE RECORDERS, DVD PLAYERS, CD PLAYERS; TELEPHONES, CORDLESS TELEPHONES, CALCULATORS, PERSONAL DIGITAL ASSISTANTS OR PDAS, MP3S, VOICE RECORDERS, CASSETTE RECORDERS, FRS TRANSCEIVER-RADIOS, AND MOBILE PHONE HANDS FREE KITS COMPRISING OF A TRANSMITTER AND A RECEIVER (U.S. CLS. 21, 23, 26, 36 AND 38).

FIRST USE 11-7-2003; IN COMMERCE 11-7-2003.

CLASS 9—(Continued).

2,955,764. CONOCOPHILLIPS COMPANY, HOUSTON, TX. SN 78-320,709. PUB. 5-25-2004, FILED 10-30-2003.



FOR MAGNETS; COMPACT DISC CASES; CALCULATORS; RADIOS (U.S. CLS. 21, 23, 26, 36 AND 38). FIRST USE 8-2-2004; IN COMMERCE 8-2-2004.

2,955,770. WANG, LIONEL, RIVERSIDE, CT. SN 78-328,600. PUB. 9-14-2004, FILED 11-16-2003.



THE COLOR(S) BLUE AND PURPLE IS/ARE CLAIMED AS A FEATURE OF THE MARK.

THE COLORS BLUE AND PURPLE APPEAR IN THE KEY DESIGN PORTION OF THE MARK.

THE MARK CONSISTS OF KEY IS BLUE AND PURPLE. FOR SOFTWARE FOR USE IN STATISTICAL ANALYSIS AND DATA COLLECTION IN THE FIELD OF MARKETING RESEARCH (U.S. CLS. 21, 23, 26, 36 AND 38).

FIRST USE 11-25-2004; IN COMMERCE 11-25-2004.

2,955,794. EHRREICH, GEORGE B., HUNTINGTON BEACH, CA. SN 78-366,984. PUB. 11-9-2004, FILED 2-12-2004.

InvestmentMaster

THE MARK CONSISTS OF STANDARD CHARACTERS WITHOUT CLAIM TO ANY PARTICULAR FONT, STYLE, SIZE, OR COLOR.

FOR COMPUTER SOFTWARE FOR COMMERCIAL REAL ESTATE INVESTMENT MANAGEMENT (U.S. CLS. 21, 23, 26, 36 AND 38).

FIRST USE 2-13-2004; IN COMMERCE 2-13-2004.

CLASS 10—MEDICAL APPARATUS

CLASS 10—(Continued).

2,955,266. MICROBRUSH CORPORATION, ORLANDO, FL.
SN 76-322,745. PUB. 2-19-2002, FILED 10-9-2001.



OWNER OF U.S. REG. NO. 2,219,003.
FOR APPLICATOR FOR DISPENSING AND SPREADING A MINUTE QUANTITY OF LIQUID IN THE FIELD OF DENTISTRY (U.S. CLS. 26, 39 AND 44).
FIRST USE 12-0-2004; IN COMMERCE 12-0-2004.

2,955,285. ELECTROMAGNETIC RESOURCES CORPORATION, HOUSTON, TX. SN 76-404,804. PUB. 1-6-2004, FILED 5-9-2002.

THERAMAG

FOR THERAPEUTIC TREATMENT MACHINES, NAMELY MACHINES FOR APPLICATION OF MAGNETIC FIELDS FOR MEDICAL THERAPY (U.S. CLS. 26, 39 AND 44).
FIRST USE 4-12-2002; IN COMMERCE 4-12-2002.

2,955,295. COLEMAN, CHARLES M., PITTSBURGH, PA. SN 76-433,656. PUB. 2-18-2003, FILED 7-23-2002.

PRIMASEP

FOR SERUM-PLASMA SEPARATOR DEVICE FOR USE WITH BLOOD COLLECTION TUBES AND BLOOD COLLECTION TUBES, FOR CLINICAL OR DIAGNOSTIC USE (U.S. CLS. 26, 39 AND 44).
FIRST USE 2-1-2004; IN COMMERCE 2-1-2004.

2,955,426. GALIL MEDICAL LTD., 20 692 YOKNEAM, ISRAEL. SN 76-524,678. PUB. 2-10-2004, FILED 6-19-2003.

ICEBULB

FOR MEDICAL DEVICE FOR FREEZING TUMORS (U.S. CLS. 26, 39 AND 44).
FIRST USE 4-30-2004; IN COMMERCE 4-30-2004.

CLASS 10—(Continued).

2,955,459. MAIN STREET INDUSTRIES, INC., MENOMONEE FALLS, WI. SN 76-547,086. PUB. 5-4-2004, FILED 9-10-2003.

ASSIST

FOR MEDICAL FURNITURE, NAMELY EXAMINATION TABLES (U.S. CLS. 26, 39 AND 44).
FIRST USE 10-3-2003; IN COMMERCE 10-3-2003.

2,955,491. ME & MY KIDS, LLC., HOLLAND, OH. SN 78-099,413. PUB. 7-2-2002, FILED 12-20-2001.

LILYPADZ

FOR BREAST SHIELDS (U.S. CLS. 26, 39 AND 44).
FIRST USE 12-4-2002; IN COMMERCE 12-4-2002.

2,955,513. MALLINCKRODT INC., ST. LOUIS, MO. SN 78-156,794. PUB. 10-14-2003, FILED 8-22-2002.

ZAP VAP

FOR ENDOTRACHEAL TUBES (U.S. CLS. 26, 39 AND 44).
FIRST USE 10-5-2002; IN COMMERCE 10-5-2002.

2,955,544. OSSUR HF, REYKJAVIK, ICELAND. SN 78-176,946. PUB. 5-27-2003, FILED 10-22-2002.

ELATION

FOR PROSTHETIC FEET (U.S. CLS. 26, 39 AND 44).
FIRST USE 1-2-2003; IN COMMERCE 1-13-2003.

2,955,570. SONOSITE, INC., BOTHELL, WA. SN 78-202,101. PUB. 12-30-2003, FILED 1-10-2003.

SONOSITE TITAN

OWNER OF U.S. REG. NOS. 2,414,562 AND 2,462,113.
FOR MEDICAL DIAGNOSTIC APPARATUS, NAMELY, MEDICAL ULTRASOUND DEVICE (U.S. CLS. 26, 39 AND 44).
FIRST USE 5-31-2003; IN COMMERCE 5-31-2003.

CLASS 10—(Continued).

2,955,618. SMITHS MEDICAL INTERNATIONAL LIMITED, LONDON NW11 8DS, UNITED KINGDOM. SN 78-225,514. PUB. 11-11-2003, FILED 3-14-2003.

BLUE LINE ULTRA

OWNER OF U.S. REG. NO. 1,193,558.
FOR TRACHEOSTOMY TUBES, TRACHEAL TUBES,
AND PARTS AND FITTINGS THEREFOR (U.S. CLS. 26,
39 AND 44).
FIRST USE 11-25-2004; IN COMMERCE 11-25-2004.

2,955,661. MICRUS CORPORATION, SUNNYVALE, CA. SN 78-242,004. PUB. 11-11-2003, FILED 4-25-2003.

CERECYTE

FOR MEDICAL AND SURGICAL DEVICES, NAMELY,
COILS FOR THE TREATMENT OF ANEURYSMS (U.S.
CLS. 26, 39 AND 44).
FIRST USE 6-3-2004; IN COMMERCE 6-11-2004.

2,955,699. MEDLINE INDUSTRIES, INC., MUNDELEIN, IL. SN 78-268,030. PUB. 10-21-2003, FILED 6-27-2003.

ALOETOUCH EASE

FOR GLOVES FOR SURGICAL AND MEDICAL USE
(U.S. CLS. 26, 39 AND 44).
FIRST USE 12-19-2003; IN COMMERCE 12-19-2003.

2,955,725. SENSORY ARTS & SCIENCE, LLC, LEDERACH, PA. SN 78-288,266. PUB. 7-20-2004, FILED 8-16-2003.

OTOVATION

FOR MEDICAL EQUIPMENT FOR USE IN DIAGNOSING
AND ASSESSING HEARING LOSS, NAMELY,
AUDIOMETERS, TYMPANOMETERS, AND OTOA-
COUSTIC EMISSIONS TESTING DEVICES (U.S. CLS.
26, 39 AND 44).
FIRST USE 1-2-2004; IN COMMERCE 1-2-2004.

CLASS 10—(Continued).

2,955,749. BYRNE SPECIALTY GASES, INC., SEATTLE, WA. SN 78-305,981. PUB. 10-5-2004, FILED 9-26-2003.



FOR CYLINDER CONTAINING COMPRESSED, MEDICAL
GRADE OXYGEN GAS, WITH AN INTEGRATED
VALVE ASSEMBLY INCLUDING REGULATOR, CON-
TENTS GAUGE, FLOW SELECTOR DIAL, SHUT-OFF
VALVE AND HANDLE (U.S. CLS. 26, 39 AND 44).
FIRST USE 9-1-2003; IN COMMERCE 9-1-2003.

2,955,780. ACTIVATOR METHODS INTERNATIONAL,
LTD., PHOENIX, AZ. SN 78-338,758. PUB. 10-19-2004,
FILED 12-10-2003.

**THE SITTING
SOLUTION**

THE MARK CONSISTS OF STANDARD CHARACTERS
WITHOUT CLAIM TO ANY PARTICULAR FONT, STYLE,
SIZE, OR COLOR.

NO CLAIM IS MADE TO THE EXCLUSIVE RIGHT TO
USE "SITTING", APART FROM THE MARK AS SHOWN.
FOR ORTHOPEDIC SEAT CUSHION (U.S. CLS. 26, 39
AND 44).

FIRST USE 1-17-2004; IN COMMERCE 1-17-2004.

**CLASS 11—ENVIRONMENTAL CONTROL AP-
PARATUS**

2,955,298. PARKER GAS SEPARATION B.V., AA 4878 ET-
TEN-LEUR, NETHERLANDS. SN 76-445,622. PUB. 12-2-
2003, FILED 8-30-2002.

NITROSOURCE

FOR GAS SEPARATION UNITS SERVING FOR THE
PRODUCTION OF DRY COMPRESSED AIR, OXYGEN
ENRICHED AIR AND NITROGEN (U.S. CLS. 13, 21, 23,
31 AND 34).

FIRST USE 6-1-2004; IN COMMERCE 6-1-2004.

CLASS 11—(Continued).

2,955,378. BERNER INTERNATIONAL CORPORATION, NEW CASTLE, PA. SN 76-493,680. PUB. 11-4-2003, FILED 2-28-2003.



FOR AIR CONTROL APPARATUS, NAMELY, AIR DOORS AND AIR CURTAINS FOR USE AT ENTRANCE DOORWAYS OF REFRIGERATED, AIR CONDITIONED OR HEATED ROOMS AND BUILDINGS (U.S. CLS. 13, 21, 23, 31 AND 34).

FIRST USE 4-23-2004; IN COMMERCE 4-23-2004.

2,955,393. SANRIO COMPANY, LTD., TOKYO 141, JAPAN. SN 76-499,075. PUB. 11-4-2003, FILED 3-20-2003.

CINNAMOROLL

FOR ELECTRIC NIGHT LIGHTS, CHRISTMAS TREE ELECTRIC LIGHTS, ELECTRIC FANS (U.S. CLS. 13, 21, 23, 31 AND 34).

FIRST USE 7-15-2004; IN COMMERCE 7-15-2004.

2,955,423. XCAD VALVE & IRRIGATION CORPORATION, PAUL, ID. SN 76-519,853. PUB. 2-10-2004, FILED 5-21-2003.

AQUA BURST

OWNER OF U.S. REG. NO. 2,447,894. FOR IRRIGATION SPRINKLERS AND PARTS THEREOF, FOR AGRICULTURE AND TURF USE (U.S. CLS. 13, 21, 23, 31 AND 34).

FIRST USE 11-15-2003; IN COMMERCE 11-15-2003.

2,955,458. URBAN ELECTRIC COMPANY, THE, CHARLESTON, SC. SN 76-546,950. PUB. 8-31-2004, FILED 9-25-2003.

THE URBAN ELECTRIC COMPANY

NO CLAIM IS MADE TO THE EXCLUSIVE RIGHT TO USE ELECTRIC COMPANY, APART FROM THE MARK AS SHOWN.

FOR ELECTRIC LIGHTING FIXTURES; GAS LAMPS (U.S. CLS. 13, 21, 23, 31 AND 34).

FIRST USE 1-1-2004; IN COMMERCE 1-1-2004.

CLASS 11—(Continued).

2,955,469. OSBORNE, ROBERT E., BRADLEY, WV. SN 76-565,675. PUB. 9-7-2004, FILED 12-8-2003.



FOR PORTABLE COOKING GRILLS (U.S. CLS. 13, 21, 23, 31 AND 34).

FIRST USE 8-14-2003; IN COMMERCE 8-14-2003.

2,955,540. POLARIS INDUSTRIES INC., MEDINA, MN. SN 78-175,227. PUB. 11-11-2003, FILED 10-16-2002.

VICTORY

FOR TIFFANY STYLE LAMPS (U.S. CLS. 13, 21, 23, 31 AND 34).

FIRST USE 12-31-2003; IN COMMERCE 12-31-2003.

2,955,632. CHALABI, RIFAT AL., FANWOOD, NJ. AND PERRY, OPHNEIL H., NOTTINGHAM, UNITED KINGDOM. SN 78-228,058. PUB. 1-20-2004, FILED 3-20-2003.

RODECS

FOR METAL RECYCLING AND HEAT TREATMENT OVENS (U.S. CLS. 13, 21, 23, 31 AND 34).

FIRST USE 4-0-2004; IN COMMERCE 4-0-2004.

2,955,654. BRADFORD WHITE CORPORATION, AMBLER, PA. SN 78-236,929. PUB. 6-22-2004, FILED 4-11-2003.

SCREENLOK

FOR WATER HEATERS FOR DOMESTIC, COMMERCIAL AND INDUSTRIAL USE, AND COMPONENTS THEREOF (U.S. CLS. 13, 21, 23, 31 AND 34).

FIRST USE 6-0-2003; IN COMMERCE 6-0-2003.

2,955,694. CONAIR CORPORATION, STAMFORD, CT. SN 78-265,742. PUB. 5-11-2004, FILED 6-23-2003.

WAFFLE DIPPERS

NO CLAIM IS MADE TO THE EXCLUSIVE RIGHT TO USE "WAFFLE", APART FROM THE MARK AS SHOWN.

FOR ELECTRIC WAFFLE IRONS (U.S. CLS. 13, 21, 23, 31 AND 34).

FIRST USE 9-15-2004; IN COMMERCE 9-15-2004.

CLASS 11—(Continued).

2,955,739. LINDSAY MANUFACTURING COMPANY, LINDSAY, NE. SN 78-295,681. PUB. 6-1-2004, FILED 9-3-2003.

Z CORNER

FOR AGRICULTURAL IRRIGATION UNITS (U.S. CLS. 13, 21, 23, 31 AND 34).
FIRST USE 9-19-2003; IN COMMERCE 9-19-2003.

2,955,746. MIRACLE SUN, INC., GOSHEN, IN. SN 78-302,331.
PUB. 5-4-2004, FILED 9-18-2003.

MAGIC 636

THE MARK CONSISTS OF STANDARD CHARACTERS WITHOUT CLAIM TO ANY PARTICULAR FONT, STYLE, SIZE, OR COLOR.

FOR TANNING EQUIPMENT, NAMELY, SUN TANNING BEDS WITH ULTRAVIOLET LAMPS; LIGHT BULBS FOR TANNING SKIN USING ULTRAVIOLET LIGHT (U.S. CLS. 13, 21, 23, 31 AND 34).
FIRST USE 2-28-2003; IN COMMERCE 2-28-2003.

2,955,751. WHIRLPOOL PROPERTIES, INC., ST. JOSEPH, MI.
SN 78-308,485. PUB. 6-8-2004, FILED 10-2-2003.

WHIRLPOOL

OWNER OF U.S. REG. NOS. 1,837,512, 2,548,168, AND OTHERS.

FOR WATER CONDITIONING UNITS, WATER SOFTENERS, WATER COOLERS, WATER CHILLERS, COUNTERTOP WATER FILTRATION DEVICES, HOME WATER FILTRATION DEVICES AND WATER FAUCET FILTERS (U.S. CLS. 13, 21, 23, 31 AND 34).
FIRST USE 5-10-2004; IN COMMERCE 5-10-2004.

2,955,752. CONAIR CORPORATION, STAMFORD, CT. SN 78-308,587. PUB. 6-29-2004, FILED 10-2-2003.

SPEED FREAK

FOR HAND-HELD ELECTRIC HAIR DRYERS (U.S. CLS. 13, 21, 23, 31 AND 34).
FIRST USE 2-1-2004; IN COMMERCE 2-1-2004.

CLASS 11—(Continued).

2,955,792. THEORY3, INC., ORLANDO, FL. SN 78-357,433.
PUB. 10-26-2004, FILED 1-26-2004.

MORPHSTICK

THE MARK CONSISTS OF STANDARD CHARACTERS WITHOUT CLAIM TO ANY PARTICULAR FONT, STYLE, SIZE, OR COLOR.

FOR LIGHTS FOR VEHICLES, NAMELY, COMPUTER CONTROLLED DECORATIVE LIGHT STRINGS (U.S. CLS. 13, 21, 23, 31 AND 34).

FIRST USE 11-2-2003; IN COMMERCE 11-2-2003.

CLASS 12—VEHICLES

2,955,238. WINPLUS COMPANY, LTD., SHATIN, HONG KONG. SN 76-190,201. PUB. 10-8-2002, FILED 1-5-2001.

**TOURING ITEMS
TYPES**

NO CLAIM IS MADE TO THE EXCLUSIVE RIGHT TO USE "TOURING ITEMS TYPE", APART FROM THE MARK AS SHOWN.

FOR AUTOMOTIVE ACCESSORIES, NAMELY, WINDSHIELD SUNSHADES, SIDE AND REAR WINDOW SUNSHADES, STEERING WHEEL COVERS, SEAT COVERS, SEAT CUSHIONS, SEAT POCKETS, TRUNK POCKETS, VISOR POCKETS AND SEAT BELT PADS (U.S. CLS. 19, 21, 23, 31, 35 AND 44).

FIRST USE 10-1-2001; IN COMMERCE 10-1-2001.

2,955,370. SPECIALIZED BICYCLE COMPONENTS, INC., MORGAN HILL, CA. SN 76-491,031. PUB. 10-7-2003, FILED 2-20-2003.

ROVAL

FOR BICYCLE PARTS, NAMELY, WHEELS (U.S. CLS. 19, 21, 23, 31, 35 AND 44).
FIRST USE 2-1-2005; IN COMMERCE 2-1-2005.

CLASS 12—(Continued).

2,955,418. VOLK, THOMAS, SANTA PAULA, CA. SN 76-518,001. PUB. 1-13-2004, FILED 5-9-2003.

WIND CHASER

NO CLAIM IS MADE TO THE EXCLUSIVE RIGHT TO USE "WIND", APART FROM THE MARK AS SHOWN.
FOR NON-MOTORIZED SPORT VEHICLES, NAMELY LANDSAILERS (U.S. CLS. 19, 21, 23, 31, 35 AND 44).
FIRST USE 9-7-2004; IN COMMERCE 9-7-2004.

2,955,594. AIRCRAFT GEAR CORPORATION, ROCKFORD, IL. SN 78-217,084. PUB. 12-2-2003, FILED 2-20-2003.



NO CLAIM IS MADE TO THE EXCLUSIVE RIGHT TO USE "MOTOR", APART FROM THE MARK AS SHOWN.
FOR VEHICLE PARTS, NAMELY, UNIVERSAL JOINTS AND PARTS THEREFOR (U.S. CLS. 19, 21, 23, 31, 35 AND 44).
FIRST USE 11-23-2004; IN COMMERCE 11-23-2004.

2,955,641. BRAUN CORPORATION, THE, WINAMAC, IN. SN 78-232,576. PUB. 11-11-2003, FILED 4-1-2003.

1-800-THE-LIFT

OWNER OF U.S. REG. NOS. 1,543,251, 1,814,579, AND 2,373,485.
FOR WHEELCHAIR LIFTS; BARRIER GATES; CONVERTED VEHICLES FOR WHEELCHAIR USERS; EXTENDING POWER SEATS; VEHICLE TOP WHEELCHAIR CARRIERS AND PARTS THEREOF (U.S. CLS. 19, 21, 23, 31, 35 AND 44).
FIRST USE 5-18-2004; IN COMMERCE 5-18-2004.

2,955,719. ROHO, INC., BELLEVILLE, IL. SN 78-281,963. PUB. 5-4-2004, FILED 8-1-2003.

HARMONY

FOR WHEELCHAIR CUSHION (U.S. CLS. 19, 21, 23, 31, 35 AND 44).
FIRST USE 10-0-2003; IN COMMERCE 10-0-2003.

CLASS 12—(Continued).

2,955,720. YAMAHA HATSUDOKI KABUSHIKI KAISHA, SHIZUOKA-KEN, JAPAN. SN 78-284,005. PUB. 4-27-2004, FILED 8-6-2003.

RS

FOR SNOWMOBILES AND STRUCTURAL PARTS THEREFOR (U.S. CLS. 19, 21, 23, 31, 35 AND 44).
FIRST USE 3-0-2004; IN COMMERCE 3-0-2004.

2,955,728. HYDRODYNAMICS USA, INC., WELLINGTON, FL. SN 78-289,238. PUB. 7-13-2004, FILED 8-19-2003.

ISHOCK

FOR SHOCK ABSORBERS AND RELATED SUSPENSION COMPONENTS, NAMELY, STRUTS AND COIL SPRINGS, FOR POWER SPORT VEHICLES, NAMELY, MOTORCYCLES, ALL-TERRAIN VEHICLES, MINI-CYCLES AND SNOWMOBILES (U.S. CLS. 19, 21, 23, 31, 35 AND 44).
FIRST USE 3-1-2003; IN COMMERCE 4-1-2003.

2,955,741. RIVOLTA ENGINEERING AND MARKETING, INC., SARASOTA, FL. SN 78-297,938. PUB. 6-15-2004, FILED 9-9-2003.

VOLTA

FOR VEHICLES, NAMELY ELECTRIC BICYCLES (U.S. CLS. 19, 21, 23, 31, 35 AND 44).
FIRST USE 7-15-2003; IN COMMERCE 7-15-2003.

2,955,767. FLEET ENGINEERS, INCORPORATED, MUSKEGON, MI. SN 78-323,966. PUB. 9-7-2004, FILED 11-6-2003.

SPRAY MASTER

THE MARK CONSISTS OF STANDARD CHARACTERS WITHOUT CLAIM TO ANY PARTICULAR FONT, STYLE, SIZE, OR COLOR.

OWNER OF U.S. REG. NO. 2,533,627.
FOR LAND MOTOR VEHICLE PARTS, NAMELY, PLASTIC FENDERS AND MOUNTING SYSTEMS COMPRISED OF MOLDED TEETH, GEARS AND CLAMPS (U.S. CLS. 19, 21, 23, 31, 35 AND 44).
FIRST USE 2-25-2004; IN COMMERCE 2-25-2004.

CLASS 12—(Continued).

2,955,796. THOR TECH, INC., SAGINAW, MI. SN 78-394,914.
PUB. 9-21-2004, FILED 4-1-2004.

PRESIDIO

THE MARK CONSISTS OF STANDARD CHARACTERS WITHOUT CLAIM TO ANY PARTICULAR FONT, STYLE, SIZE, OR COLOR.

THE ENGLISH TRANSLATION OF PRESIDIO IS GARRISON.

FOR RECREATIONAL VEHICLES, NAMELY MOTOR-HOMES (U.S. CLS. 19, 21, 23, 31, 35 AND 44).
FIRST USE 0-0-2004; IN COMMERCE 0-0-2004.

2,955,797. THOR TECH, INC., SAGINAW, MI. SN 78-395,631.
PUB. 9-21-2004, FILED 4-2-2004.

TUNDRA

THE MARK CONSISTS OF STANDARD CHARACTERS WITHOUT CLAIM TO ANY PARTICULAR FONT, STYLE, SIZE, OR COLOR.

FOR RVs, NAMELY, TRAVEL TRAILERS AND FIFTH WHEELS (U.S. CLS. 19, 21, 23, 31, 35 AND 44).
FIRST USE 6-0-2004; IN COMMERCE 6-0-2004.

CLASS 13—FIREARMS**CLASS 13—(Continued).**

2,955,593. POWER DECK COMPANY, LLC, STANTON, KY.
SN 78-215,994. PUB. 9-30-2003, FILED 2-18-2003.

POWER DECK

NO CLAIM IS MADE TO THE EXCLUSIVE RIGHT TO USE "DECK", APART FROM THE MARK AS SHOWN.

FOR EXPLOSIVE ACCESSORIES, NAMELY, BLASTING-HOLE DECKING USED TO ENHANCE BLASTING OPERATIONS (U.S. CLS. 2 AND 9).

FIRST USE 1-0-1999; IN COMMERCE 1-0-2000.

CLASS 14—JEWELRY

2,955,261. SCHACHTER, MICHAEL, SHORT HILLS, NJ. SN 76-298,787. PUB. 11-13-2001, FILED 8-13-2001.

PORTALS OF LIGHT

FOR DIAMONDS (U.S. CLS. 2, 27, 28 AND 50).
FIRST USE 9-15-2001; IN COMMERCE 9-15-2001.

2,955,385. CASSLAC, INC., MALIBU, CA. SN 76-495,965. PUB. 11-4-2003, FILED 3-11-2003.

LUCKY QUARTET

FOR JEWELRY (U.S. CLS. 2, 27, 28 AND 50).
FIRST USE 9-19-2003; IN COMMERCE 9-19-2003.

2,955,386. CASSLAC, INC., MALIBU, CA. SN 76-495,966. PUB. 11-4-2003, FILED 3-11-2003.

DISTINCTIVE EXPRESSIONS

FOR JEWELRY (U.S. CLS. 2, 27, 28 AND 50).
FIRST USE 9-19-2003; IN COMMERCE 9-19-2003.

2,955,392. SANRIO COMPANY, LTD., TOKYO 141, JAPAN.
SN 76-498,949. PUB. 11-4-2003, FILED 3-20-2003.

CINNAMOROLL

FOR CLOCKS, ALARM CLOCKS, WALL CLOCKS, JEWELRY, COSTUME WRIST WATCHES (U.S. CLS. 2, 27, 28 AND 50).
FIRST USE 11-14-2004; IN COMMERCE 11-14-2004.

CLASS 14—(Continued).

2,955,511. HARUN, KARA, LOS ANGELES, CA. SN 78-154,297. PUB. 11-4-2003, FILED 8-14-2002.

KARA SILVER INTERNATIONAL

NO CLAIM IS MADE TO THE EXCLUSIVE RIGHT TO USE "SILVER INTERNATIONAL", APART FROM THE MARK AS SHOWN.

FOR NON-ELECTRIC STERLING SILVER TEA SETS AND CANDELABRAS; CANDLESTICKS, CUPS, GOBLETs, SALT AND PEPPER SHAKERS, NAPKIN RINGS, COOLERS AND DECANTERS FOR WINE AND WATER ALL SOLD AS UNIT AND SEPARATELY AND ALL MADE OF STERLING SILVER; STERLING SILVER DRESS WARE COMPRISED OF BRUSHES AND HANDHELD MIRRORS ALL SOLD AS A UNIT AND SEPARATELY; STERLING SILVER AND SILVER-PLATED SERVING WARE, NAMELY, SALAD TONGS, PIE SERVERS, CAKE SERVERS, SERVING LADLES, BOWLS AND PITCHERS; STERLING SILVER AND SILVER-PLATED GIFTWARE, NAMELY, PICTURE FRAMES, DISPENSERS FOR PILLS OR CAPSULES, VASES, VANITY TRAYS AND DECORATIVE BOXES (U.S. CLS. 2, 27, 28 AND 50).

FIRST USE 1-1-2003; IN COMMERCE 1-1-2003.

2,955,536. JJI INTERNATIONAL, INC., WARWICK, RI. SN 78-171,699. PUB. 6-3-2003, FILED 10-7-2002.

JJI

FOR JEWELRY, NAMELY PRECIOUS METAL JEWELRY (U.S. CLS. 2, 27, 28 AND 50).

FIRST USE 1-1-1989; IN COMMERCE 1-1-1989.

2,955,555. SOMMER SOLSTICE DESIGNS, INC., NEW YORK, NY. SN 78-191,327. PUB. 1-27-2004, FILED 12-4-2002.

SOMMER SOLSTICE

THE MARK CONSISTS OF STANDARD CHARACTERS WITHOUT CLAIM TO ANY PARTICULAR FONT, STYLE, SIZE, OR COLOR.

FOR JEWELRY (U.S. CLS. 2, 27, 28 AND 50).
FIRST USE 12-1-2002; IN COMMERCE 12-1-2002.

CLASS 14—(Continued).

2,955,679. ANDERSON, JAMES D., LONGWOOD, FL. SN 78-251,273. PUB. 1-13-2004, FILED 5-18-2003.

JAVA JEWELS

NO CLAIM IS MADE TO THE EXCLUSIVE RIGHT TO USE "JEWELS", APART FROM THE MARK AS SHOWN.
FOR JEWELRY, BEADED JEWELRY, PRECIOUS GEMSTONES (U.S. CLS. 2, 27, 28 AND 50).

FIRST USE 11-1-2003; IN COMMERCE 1-1-2004.

2,955,700. FORD, KRISTEN C., PHOENIX, AZ. SN 78-268,786. PUB. 5-18-2004, FILED 6-30-2003.

SHAKALOCKET

THE MARK CONSISTS OF SHAKA LOCKET.
FOR JEWELRY, NAMELY, IDENTIFICATION LOCKETS FOR PETS (U.S. CLS. 2, 27, 28 AND 50).

FIRST USE 6-1-2004; IN COMMERCE 11-30-2004.

CLASS 16—PAPER GOODS AND PRINTED MATTER

2,955,208. BOWTIE, INC., LOS ANGELES, CA. SN 75-983,544. PUB. 5-14-2002, FILED 12-31-1998.

POPULAR PET LIBRARY

NO CLAIM IS MADE TO THE EXCLUSIVE RIGHT TO USE "PET LIBRARY", APART FROM THE MARK AS SHOWN.

FOR PRINTED MATTER, NAMELY, BOOKS, MAGAZINES, JOURNALS AND NEWSLETTERS IN THE FIELD OF ANIMAL, AQUATIC, REPTILE AND AVIAN SPECIES (U.S. CLS. 2, 5, 22, 23, 29, 37, 38 AND 50).

FIRST USE 1-13-2005; IN COMMERCE 1-13-2005.

2,955,215. NEW PRODUCTS INC., PORTLAND, OR. SN 76-035,847. PUB. 10-30-2001, FILED 4-26-2000.

KEEP TRAC

FOR REUSABLE WRITING SURFACES, NAMELY, ADHESIVE DISCS THAT INCLUDE AN ERASABLE WRITING SURFACE, ARE PRIMARILY USED ON TAPE MEASURES, AND ARE NOT FOR INDUSTRIAL USE (U.S. CLS. 2, 5, 22, 23, 29, 37, 38 AND 50).

FIRST USE 6-0-2004; IN COMMERCE 6-0-2004.

CLASS 16—(Continued).

2,955,237. CABLE TELEVISION LABORATORIES, INC., LOUISVILLE, CO. SN 76-182,660. PUB. 11-19-2002, FILED 12-19-2000.

CABLEHOME

FOR BOOKLETS, NEWSLETTERS, PAMPHLETS, BROCHURES, MONOGRAMS, BOOKS AND REPORTS IN THE FIELD OF TECHNOLOGIES IN THE CABLE TELEVISION INDUSTRY (U.S. CLS. 2, 5, 22, 23, 29, 37, 38 AND 50).

FIRST USE 12-19-2000; IN COMMERCE 7-16-2001.

2,955,241. RELIANT ENERGY, INC., HOUSTON, TX. SN 76-195,558. PUB. 9-18-2001, FILED 1-17-2001.

RELIANT STADIUM

FOR PAPER GOODS, PAPER MATERIALS AND PRINTED MATTER, NAMELY, POSTERS, MOUNTED PHOTOGRAPHS, POSTCARDS, PENNANTS, BOOKS IN THE FIELD OF FOOTBALL AND RELATED SPORTING EVENTS AND ACTIVITIES, YEARBOOKS, PAPER NAPKINS, BANNERS (U.S. CLS. 2, 5, 22, 23, 29, 37, 38 AND 50).

FIRST USE 8-0-2002; IN COMMERCE 8-0-2002.

2,955,248. VERITAS OPERATING CORPORATION, MOUNTAIN VIEW, CA. SN 76-222,385. PUB. 7-30-2002, FILED 3-8-2001.

VERITAS PUBLISHING

NO CLAIM IS MADE TO THE EXCLUSIVE RIGHT TO USE "PUBLISHING", APART FROM THE MARK AS SHOWN.

FOR PRINTED MATERIAL, NAMELY, BOOKS CONCERNING COMPUTER SOFTWARE AND HARDWARE, COMPUTER NETWORKS AND RELATED TOPICS (U.S. CLS. 2, 5, 22, 23, 29, 37, 38 AND 50).

FIRST USE 12-1-2003; IN COMMERCE 12-1-2003.

2,955,249. STATE OF OREGON ACTING BY AND THROUGH THE STATE BOARD OF HIGHER EDUCATION ON BEHALF OF OREGON STATE UNIVERSITY, CORVALLIS, OR. SN 76-225,374. PUB. 11-4-2003, FILED 3-14-2001.

DOTSPLUS

FOR READING MATERIALS, NAMELY MANUALS, THAT EXPLAIN THE USE OF ASSORTMENTS OF LETTERS, NUMERALS, FIGURES AND ILLUSTRATING ELEMENTS THAT CAN BE SENSED TACTILELY FOR THE VISUALLY IMPAIRED (U.S. CLS. 2, 5, 22, 23, 29, 37, 38 AND 50).

FIRST USE 4-0-2000; IN COMMERCE 6-0-2000.

CLASS 16—(Continued).

2,955,299. URBAN PUPPY INC., TORONTO, ONTARIO, CANADA. SN 76-447,220. PUB. 10-19-2004, FILED 9-6-2002.

URBAN PUPPY

PRIORITY CLAIMED UNDER SEC. 44(D) ON CANADA APPLICATION NO. 1,133,419, FILED 3-7-2002, REG. NO. TMA606936, DATED 4-2-2004, EXPIRES 4-2-2019.

NO CLAIM IS MADE TO THE EXCLUSIVE RIGHT TO USE "PUPPY", APART FROM THE MARK AS SHOWN.

FOR PRINTED PUPPY AND TRAINING MANUALS (U.S. CLS. 2, 5, 22, 23, 29, 37, 38 AND 50).

FIRST USE 9-26-2002; IN COMMERCE 9-26-2002.

2,955,340. ALPHA OMEGA PUBLICATIONS, INC., CHANDLER, AZ. SN 76-477,082. PUB. 4-27-2004, FILED 12-16-2002.

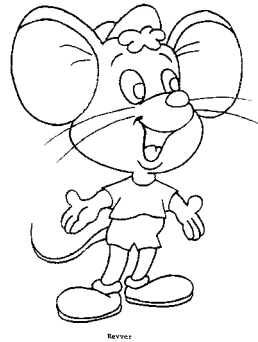

FOR COLORING BOOKS USED IN EDUCATIONAL MATERIALS FOR HOME SCHOOL AND CHRISTIAN SCHOOL USE (U.S. CLS. 2, 5, 22, 23, 29, 37, 38 AND 50).

FIRST USE 12-1-2003; IN COMMERCE 12-1-2003.

2,955,341. ALPHA OMEGA PUBLICATIONS, INC., CHANDLER, AZ. SN 76-477,083. PUB. 4-27-2004, FILED 12-16-2002.



FOR COLORING BOOKS USED IN EDUCATIONAL MATERIALS FOR HOME SCHOOL AND CHRISTIAN SCHOOL USE (U.S. CLS. 2, 5, 22, 23, 29, 37, 38 AND 50).

FIRST USE 12-1-2003; IN COMMERCE 12-1-2003.

CLASS 16—(Continued).

2,955,342. ALPHA OMEGA PUBLICATIONS, INC., CHANDLER, AZ. SN 76-477,084. PUB. 4-27-2004, FILED 12-16-2002.

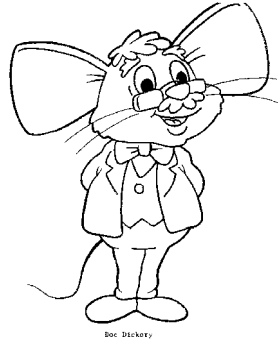

FOR COLORING BOOKS USED IN EDUCATIONAL MATERIALS FOR HOME SCHOOL AND CHRISTIAN SCHOOL USE (U.S. CLS. 2, 5, 22, 23, 29, 37, 38 AND 50). FIRST USE 12-1-2003; IN COMMERCE 12-1-2003.

CLASS 16—(Continued).

2,955,347. ALPHA OMEGA PUBLICATIONS, INC., CHANDLER, AZ. SN 76-479,708. PUB. 4-27-2004, FILED 12-31-2002.

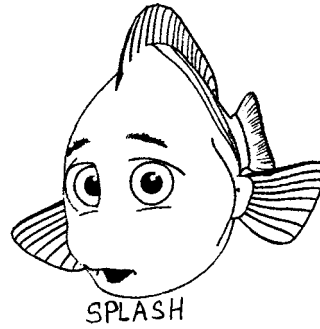

FOR COLORING BOOKS USED IN EDUCATIONAL MATERIALS FOR HOME SCHOOL AND CHRISTIAN SCHOOL USE (U.S. CLS. 2, 5, 22, 23, 29, 37, 38 AND 50). FIRST USE 12-1-2003; IN COMMERCE 12-1-2003.

2,955,343. ALPHA OMEGA PUBLICATIONS, INC., CHANDLER, AZ. SN 76-477,085. PUB. 4-27-2004, FILED 12-16-2002.



FOR COLORING BOOKS USED IN EDUCATIONAL MATERIALS FOR HOME SCHOOL AND CHRISTIAN SCHOOL USE (U.S. CLS. 2, 5, 22, 23, 29, 37, 38 AND 50). FIRST USE 12-1-2003; IN COMMERCE 12-1-2003.

2,955,348. ALPHA OMEGA PUBLICATIONS, INC., CHANDLER, AZ. SN 76-479,710. PUB. 4-27-2004, FILED 12-31-2002.

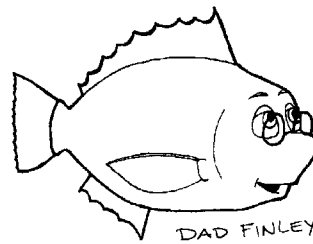

FOR COLORING BOOKS USED IN EDUCATIONAL MATERIALS FOR HOME SCHOOL AND CHRISTIAN SCHOOL USE (U.S. CLS. 2, 5, 22, 23, 29, 37, 38 AND 50). FIRST USE 12-1-2003; IN COMMERCE 12-1-2003.

CLASS 16—(Continued).

2,955,349. ALPHA OMEGA PUBLICATIONS, INC., CHANDLER, AZ. SN 76-479,711. PUB. 4-27-2004, FILED 12-31-2002.

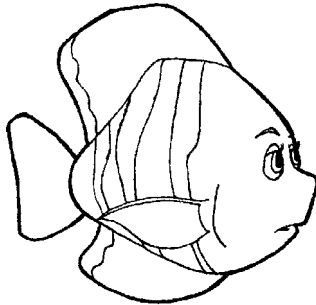

MOM FINLEY

FOR COLORING BOOKS USED IN EDUCATIONAL MATERIALS FOR HOME SCHOOL AND CHRISTIAN SCHOOL USE (U.S. CLS. 2, 5, 22, 23, 29, 37, 38 AND 50). FIRST USE 12-1-2003; IN COMMERCE 12-1-2003.

2,955,350. ALPHA OMEGA PUBLICATIONS, INC., CHANDLER, AZ. SN 76-479,712. PUB. 4-27-2004, FILED 12-31-2002.

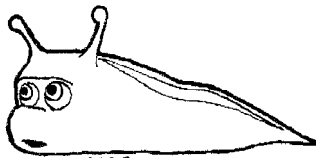

SLUGGER

FOR COLORING BOOKS USED IN EDUCATIONAL MATERIALS FOR HOME SCHOOL AND CHRISTIAN SCHOOL USE (U.S. CLS. 2, 5, 22, 23, 29, 37, 38 AND 50). FIRST USE 12-1-2003; IN COMMERCE 12-1-2003.

CLASS 16—(Continued).

2,955,391. SANRIO COMPANY, LTD., TOKYO 141, JAPAN. SN 76-498,932. PUB. 11-4-2003, FILED 3-20-2003.

CINNAMOROLL

FOR PENCILS, COLORED PENCILS, MECHANICAL PENCILS, PENS, FELT-TIPPED MARKERS, CRAYONS, LETTER PAPER, GREETING CARDS, SMALL ANNOUNCEMENT CARDS, SMALL BLANK ENCLOSURE CARDS, ENVELOPES, STATIONERY-TYPE PORTFOLIOS, STATIONERY SETS COMPRISED OF LETTER PAPER, ENVELOPES AND STICKERS IN A FOLDER, STICKERS, PAPER NAME TAGS, BOOKMARKS, AUTOGRAPH BOOKS, PHOTO ALBUMS, DIARIES, PERSONAL ORGANIZERS, LOOSE-LEAF BINDERS, ADDRESS BOOKS, NOTEBOOKS, MEMO PADS, TRACING PAPER BOOKS, SKETCH BOOKS, PENCIL CASES, PENCIL SHARPENERS, PLASTIC BINDER CLIPS, RUBBER STAMPS, DRAWING RULERS, ERASERS, PAPER STAPLERS, PAPER STAPLES, GLUE FOR STATIONERY OR HOUSEHOLD USE, DISPENSERS FOR ADHESIVE TAPES FOR STATIONERY OR HOUSEHOLD USE, PAPER SCHOOL BOXES FOR STORING SCHOOL SUPPLIES, CARD FILES, CALENDARS, GIFT WRAPPING PAPER, PLASTIC GIFT BAGS, PAPER GIFT BAGS, PAPER TOTE BAGS, PLASTIC PLACE MATS, PAPER PLACE MATS, FACIAL TISSUE, LETTER TRAYS (U.S. CLS. 2, 5, 22, 23, 29, 37, 38 AND 50).

FIRST USE 11-14-2003; IN COMMERCE 11-14-2003.

2,955,429. DIVIDELLA AG, 9472 GRABS, SWITZERLAND. SN 76-528,740. PUB. 6-1-2004, FILED 7-8-2003.

BOXWALLET

OWNER OF U.S. REG. NO. 2,377,896.
FOR PACKAGING MATERIAL IN THE NATURE OF PAPERBOARD OR CARDBOARD; PACKAGING AND PACKAGING INSERTS OF PAPER OR CARDBOARD (U.S. CLS. 2, 5, 22, 23, 29, 37, 38 AND 50).
FIRST USE 0-0-2001; IN COMMERCE 0-0-2001.

2,955,462. SCHOLASTIC INC., NEW YORK, NY. SN 76-554,809. PUB. 7-20-2004, FILED 10-14-2003.

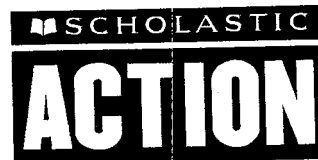

OWNER OF U.S. REG. NO. 1,264,901.
FOR SERIES OF CHILDREN'S BOOKS, TEACHING GUIDES AND STUDENT WORKBOOKS IN THE FIELD OF READING COMPREHENSION, READING IMPROVEMENT AND LANGUAGE ACQUISITION FOR ELEMENTARY SCHOOL AND JUNIOR HIGH SCHOOL STUDENTS (U.S. CLS. 2, 5, 22, 23, 29, 37, 38 AND 50).
FIRST USE 8-7-2003; IN COMMERCE 8-7-2003.

CLASS 16—(Continued).

2,955,510. TWENTY AND SEVEN, LLC, NEW YORK, NY. SN 78-154,287. PUB. 4-1-2003, FILED 8-14-2002.

TWENTY AND SEVEN

FOR STATIONERY MADE OF VARIOUS MATERIALS; PRINTED INVITATIONS; PRINTED INVITATIONS CONSISTING IN PART OF THREE DIMENSIONAL OBJECTS; PAPER BAGS FOR PACKAGING AND PLASTIC BAGS FOR PACKAGING (U.S. CLS. 2, 5, 22, 23, 29, 37, 38 AND 50).

FIRST USE 1-0-2002; IN COMMERCE 2-0-2002.

2,955,522. ATLANTIC PAPER & FOIL, LLC, HAUPPAUGE, NY. SN 78-163,804. PUB. 9-23-2003, FILED 9-13-2002.

COMPARE

FOR BATHROOM TISSUE; PAPER TOWELS; FACIAL TISSUES; PAPER NAPKINS (U.S. CLS. 2, 5, 22, 23, 29, 37, 38 AND 50).

FIRST USE 9-0-2002; IN COMMERCE 9-0-2002.

2,955,588. BIG BEAUTIFUL HOLDINGS INC., SHAWNIGAN LAKE, BRITISH COLUMBIA, CANADA. SN 78-213,638. PUB. 11-18-2003, FILED 2-11-2003.

Big Beautiful

PRIORITY CLAIMED UNDER SEC. 44(D) ON CANADA APPLICATION NO. 1163871, FILED 1-8-2003.

FOR NOTEBOOKS, WRITING JOURNALS, DIARIES, NOTE CARDS, MEMO PADS, ADDRESS BOOKS, MEMORY BOOKS, GUEST BOOKS, PHOTO ALBUMS, SKETCHBOOKS, KEEPSAKE ALBUMS, BINDERS, CALENDARS, BOOKMARKS, STATIONARY, STATIONARY BOXES AND FOLDERS, CARDBOARD OR PAPER BOXES AND CONTAINERS, ANNOUNCEMENT CARDS, PRINTED ART REPRODUCTIONS, POSTERS AND GREETING CARDS (U.S. CLS. 2, 5, 22, 23, 29, 37, 38 AND 50).

FIRST USE 1-8-2003; IN COMMERCE 8-4-2004.

CLASS 16—(Continued).

2,955,651. INTERNATIONAL MASTERS PUBLISHERS AB, MALMO, SWEDEN. SN 78-236,552. PUB. 1-13-2004, FILED 4-11-2003.



FOR PRINTED MATERIAL, NAMELY, A SERIES OF CONTINUITY CARDS ON THE SUBJECTS OF SPIRITUALITY, SPIRITUAL EXPERIENCES, SPIRITUAL SEXUALITY, HEALTH, HEALING, WORLD HEALING TRADITIONS, THE SUPERNATURAL, ASTROLOGY, CHARTING THE FUTURE, FORTUNE TELLING, PALMISTRY, MEDITATION, YOGA, STRESS RELIEF, HERBAL REMEDIES, GHOSTS, RUNES, FRIENDSHIPS, MASSAGES, DETOX, USING CRYSTALS, WICCAN TRADITIONS, MEDIUMS AND CLAIRVOYANTS, DREAMS, LOVE, SPIRITS, SPELLS, NATURE MAGIC, LUCKY CHARMS, CRYSTALS, AND TAROT CARDS, FOR INSERTION INTO A BINDER, AND A BINDER FOR USE IN CONNECTION THEREWITH; TAROT CARDS (U.S. CLS. 2, 5, 22, 23, 29, 37, 38 AND 50).

FIRST USE 6-30-2003; IN COMMERCE 6-30-2003.

2,955,709. XYRON INCORPORATED, SCOTTSDALE, AZ. SN 78-274,489. PUB. 7-27-2004, FILED 7-15-2003.

LEGACIES

FOR SCRAPBOOKS; SCRAPBOOKING KITS COMPRISED OF ONE OR MORE OF THE FOLLOWING— A SCRAP BOOK ALBUM, PAPER, ADHESIVES, WRITING INSTRUMENTS, PAPER TRIMMERS, DECORATIVE PAPER PUNCHES, INSTRUCTIONAL MANUALS AND A CARRYING BAG OR CASE; WRITING INSTRUMENTS, NAMELY, PENS, PENCILS AND MARKERS; INSTRUCTIONAL MANUALS IN THE FIELD OF SCRAPBOOKING; SCRAPBOOK ALBUMS; SCRAPBOOK ALBUM PAGES; PHOTOGRAPH ALBUMS; PHOTOGRAPH ALBUM PAGES; AND WEDDING ALBUMS (U.S. CLS. 2, 5, 22, 23, 29, 37, 38 AND 50).

FIRST USE 9-1-2003; IN COMMERCE 1-26-2004.

CLASS 16—(Continued).

2,955,732. LATINA MEDIA VENTURES LLC, NEW YORK, NY. SN 78-291,888. PUB. 10-12-2004, FILED 8-25-2003.

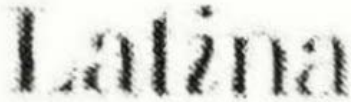

OWNER OF U.S. REG. NOS. 2,183,107, 2,839,474, AND OTHERS.

SEC. 2(F).
FOR PRINTED MAGAZINES WITH ARTICLES AND COMMENTARY CONCERNING FASHION, BEAUTY, CELEBRITIES, HEALTH ISSUES, PARENTING, FOOD AND RELATIONSHIPS (U.S. CLS. 2, 5, 22, 23, 29, 37, 38 AND 50).

FIRST USE 10-1-2003; IN COMMERCE 10-1-2003.



2,955,750. VIRTUAL REALITY MEDICAL CENTER, SAN DIEGO, CA. SN 78-306,867. PUB. 6-29-2004, FILED 9-29-2003.

EXPOSE YOURSELF!

FOR SERIES OF SELF-HELP BOOKS FOR GETTING OVER ONE'S PANICS, ANXIETIES AND PHOBIAS IN VARIOUS CITIES (U.S. CLS. 2, 5, 22, 23, 29, 37, 38 AND 50).

FIRST USE 2-0-2004; IN COMMERCE 2-0-2004.



2,955,756. TRAVEL AND SPORTS, INC., BOULDER, CO. SN 78-311,923. PUB. 10-26-2004, FILED 10-10-2003.

PUERTO RICO'S SIGNATURE MAGAZINE

NO CLAIM IS MADE TO THE EXCLUSIVE RIGHT TO USE "PUERTO RICO'S" AND "MAGAZINE", APART FROM THE MARK AS SHOWN.

FOR MAGAZINES FEATURING INFORMATION ABOUT PUERTO RICO (U.S. CLS. 2, 5, 22, 23, 29, 37, 38 AND 50).

FIRST USE 9-30-2003; IN COMMERCE 1-31-2004.

CLASS 16—(Continued).

2,955,765. MARSHALL HOUSE, SUNSET BEACH, CA. SN 78-320,789. PUB. 9-28-2004, FILED 10-30-2003.



FOR PAPER GOODS AND PRINTED MATTER, NAMELY, COMPUTER PRINTABLE PAPER TRANSPARENCIES AND COMPUTER PRINTABLE PLASTIC TRANSPARENCIES FOR PRINTING TWO-SIDED PICTURES (U.S. CLS. 2, 5, 22, 23, 29, 37, 38 AND 50).

FIRST USE 9-14-2003; IN COMMERCE 9-14-2003.



2,955,784. NUESTRA CASA, LLC, EVANSTON, IL. SN 78-341,191. PUB. 9-14-2004, FILED 12-15-2003.

Nuestra Casa

THE MARK CONSISTS OF STANDARD CHARACTERS WITHOUT CLAIM TO ANY PARTICULAR FONT, STYLE, SIZE, OR COLOR.

THE FOREIGN WORDING IN THE MARK TRANSLATES INTO ENGLISH AS OUR HOME.

FOR MAGAZINE/PUBLICATION LISTING RESIDENTIAL REAL ESTATE BY VARIOUS BROKERS (U.S. CLS. 2, 5, 22, 23, 29, 37, 38 AND 50).

FIRST USE 8-1-1999; IN COMMERCE 11-10-2001.

CLASS 16—(Continued).

2,955,788. FAT PAT PRODUCTIONS, LLC, TAMPA, FL. SN 78-348,096. PUB. 9-28-2004, FILED 1-6-2004.

Fat Pat

THE MARK CONSISTS OF STANDARD CHARACTERS WITHOUT CLAIM TO ANY PARTICULAR FONT, STYLE, SIZE, OR COLOR.

FOR GREETING CARDS AND STATIONERY (U.S. CLS. 2, 5, 22, 23, 29, 37, 38 AND 50).
FIRST USE 1-1-2003; IN COMMERCE 1-5-2004.

2,955,803. ESQUIBEL COMMUNICATIONS COMPANY, CORAL GABLES, FL. SN 78-975,960. PUB. 6-1-2004, FILED 6-5-2003.

THE BITTER SHREW

FOR NEWSLETTERS CONTAINING COMMENTARY AND SATIRE ABOUT PERSONAL EXPERIENCES WITH THE PRODUCTS, WORKS, SERVICES, PERFORMANCES OR CONDUCT OF OTHERS (U.S. CLS. 2, 5, 22, 23, 29, 37, 38 AND 50).
FIRST USE 1-31-2005; IN COMMERCE 1-31-2005.

CLASS 17—RUBBER GOODS

2,955,278. B & F PLASTICS, INC., RICHMOND, IN. SN 76-372,743. PUB. 1-27-2004, FILED 2-20-2002.

FIBERPLAST

FOR PLASTIC SHEETS, PLASTIC RODS, PLASTIC TUBES AND PLASTIC PELLETS FOR USE AS DECKING AND PACKING MATERIALS (U.S. CLS. 1, 5, 12, 13, 35 AND 50).
FIRST USE 6-16-2003; IN COMMERCE 1-15-2004.

CLASS 17—(Continued).

2,955,324. U.S. TSUBAKI, INC., WHEELING, IL. SN 76-464,825. PUB. 1-13-2004, FILED 10-29-2002.

PRO-GUARD

FOR POLYURETHANE LINERS FOR DRIVE CHAIN NOISE AND WEAR INSULATION AND MOISTURE BARRIERS USED IN THE AMUSEMENT PARK INDUSTRY (U.S. CLS. 1, 5, 12, 13, 35 AND 50).
FIRST USE 11-0-2002; IN COMMERCE 11-0-2002.

2,955,520. SKIMTECH, INCORPORATED, POLAND, OH. SN 78-160,848. PUB. 4-29-2003, FILED 9-5-2002.

TIGERTUBE

FOR PLASTIC TUBES, NAMELY, OIL COLLECTOR TUBES FOR USE WITH AN OIL SKIMMING SYSTEM (U.S. CLS. 1, 5, 12, 13, 35 AND 50).
FIRST USE 8-13-2003; IN COMMERCE 8-13-2003.

2,955,642. GOODYEAR TIRE & RUBBER COMPANY, THE, AKRON, OH. SN 78-232,586. PUB. 11-18-2003, FILED 4-1-2003.

PERMSHIELD

FOR NONMETALLIC FUEL FILL HOSE FOR LAND VEHICLES (U.S. CLS. 1, 5, 12, 13, 35 AND 50).
FIRST USE 9-2-2004; IN COMMERCE 9-2-2004.

CLASS 18—LEATHER GOODS

2,955,638. HERSHEY, CARA, PELICAN ISLAND, NJ. SN 78-231,587. PUB. 12-9-2003, FILED 3-28-2003.

FANCY GIRL

FOR HANDBAGS TOTE BAGS SHOULDER BAGS ALL PURPOSE CARRYING BAGS TRAVELING BAGS CLUTCH PURSES (U.S. CLS. 1, 2, 3, 22 AND 41).
FIRST USE 4-1-2004; IN COMMERCE 5-1-2004.

2,955,659. EZM, INC., NORWALK, CT. SN 78-238,909. PUB. 12-9-2003, FILED 4-17-2003.

MVISION

FOR LUGGAGE (U.S. CLS. 1, 2, 3, 22 AND 41).
FIRST USE 10-1-2004; IN COMMERCE 10-1-2004.

CLASS 18—(Continued).

2,955,740. LISA FRANK, INC., TUCSON, AZ. SN 78-296,262. PUB. 9-21-2004, FILED 9-4-2003.

PEEKABOO

FOR VANITY COSMETIC CASE MOLDED IN THE SHAPE OF A TURTLE SOLD EMPTY (U.S. CLS. 1, 2, 3, 22 AND 41).

FIRST USE 6-1-1998; IN COMMERCE 6-1-1998.

CLASS 19—NON-METALLIC BUILDING MATERIALS

2,955,361. STRUCTURAL GROUP, INC., HANOVER, MD. SN 76-487,951. PUB. 4-27-2004, FILED 2-6-2003.

VGROUT +

FOR HIGH PERFORMANCE ADMIXTURE OF STABILIZERS, HIGH-RANGE WATER REDUCERS AND EXPANSIVE ADMIXTURES FOR BLENDING WITH CEMENT AND WATER TO PRODUCE A HIGH STRENGTH GROUT FOR USE IN BUILDING AND CONSTRUCTION (U.S. CLS. 1, 12, 33 AND 50).

FIRST USE 11-20-2003; IN COMMERCE 11-20-2003.

2,955,456. UNITED STATES TILE CO., CORONA, CA. SN 76-546,684. PUB. 6-1-2004, FILED 9-24-2003.

PROSHAKE PLUS

OWNER OF U.S. REG. NO. 2,196,193. FOR CLAY ROOFING TILES (U.S. CLS. 1, 12, 33 AND 50).

FIRST USE 5-19-2004; IN COMMERCE 5-19-2004.

2,955,498. HOLLANDER GLASS TEXAS, INC., HOUSTON, TX. SN 78-144,405. PUB. 1-13-2004, FILED 7-16-2002.

OLD WORLD COLONIAL

FOR WINDOW GLASS MADE WITH IMPERFECTIONS AND DISTORTIONS FOR USE IN RESTORATION PROJECTS (U.S. CLS. 1, 12, 33 AND 50).

FIRST USE 9-14-2004; IN COMMERCE 10-12-2004.

CLASS 19—(Continued).

2,955,615. UNIVERSAL SUPPLY COMPANY, INC., HAMMONTON, NJ. SN 78-225,223. PUB. 10-21-2003, FILED 3-13-2003.

XTERIOR SOLUTIONS

NO CLAIM IS MADE TO THE EXCLUSIVE RIGHT TO USE EXTERIOR, APART FROM THE MARK AS SHOWN.

FOR EXTERIOR TRIM BOARDS AND FASCIA BOARDS MADE OF POLYVINYL CHLORIDE; BUILDING MATERIALS, NAMELY, WALL, AND POLYVINYL CHLORIDE BOARDS; BEAMS, COLUMNS, MOLDING, PANELING, POSTS, DOOR FRAMES, WINDOW FRAMES, SIDING, AND TRIM MADE OF POLYVINYL CHLORIDE (U.S. CLS. 1, 12, 33 AND 50).

FIRST USE 5-15-2003; IN COMMERCE 5-15-2003.

CLASS 20—FURNITURE AND ARTICLES NOT OTHERWISE CLASSIFIED

2,955,316. ARABELLA TEXTILES, LLC, NEW YORK, NY. SN 76-461,573. PUB. 11-11-2003, FILED 10-24-2002.

SAGE ISLAND SPA

NO CLAIM IS MADE TO THE EXCLUSIVE RIGHT TO USE "SPA", APART FROM THE MARK AS SHOWN.

FOR HOME FURNISHINGS, NAMELY PILLOWS, FLOOR CUSHIONS AND PET BEDS (U.S. CLS. 2, 13, 22, 25, 32 AND 50).

FIRST USE 11-3-2004; IN COMMERCE 11-3-2004.

2,955,318. DREAMWELL, LTD., LAS VEGAS, NV. SN 76-462,690. PUB. 2-10-2004, FILED 10-29-2002.

BACKCARE ADVANCED

OWNER OF U.S. REG. NOS. 813,001, 2,388,796, AND OTHERS.

SEC. 2(F). FOR MATTRESSES AND BOX SPRINGS (U.S. CLS. 2, 13, 22, 25, 32 AND 50).

FIRST USE 12-2-2002; IN COMMERCE 12-2-2002.

2,955,419. PICTURE THE CURE, INC., SAN FRANCISCO, CA. SN 76-518,132. PUB. 1-6-2004, FILED 5-30-2003.

PICTURE THE CURE

FOR PICTURE FRAMES (U.S. CLS. 2, 13, 22, 25, 32 AND 50).

FIRST USE 11-12-2004; IN COMMERCE 11-12-2004.

CLASS 20—(Continued).

2,955,432. TROPICOL LTD., GREENVILLE, MS. SN 76-531,095. PUB. 4-20-2004, FILED 7-21-2003.

BEACH OASIS

NO CLAIM IS MADE TO THE EXCLUSIVE RIGHT TO USE "BEACH", APART FROM THE MARK AS SHOWN.
FOR BEACH TABLES (U.S. CLS. 2, 13, 22, 25, 32 AND 50).
FIRST USE 4-0-2003; IN COMMERCE 4-0-2003.

2,955,451. WAL-MART STORES, INC., BENTONVILLE, AR. SN 76-545,519. PUB. 6-1-2004, FILED 9-17-2003.

COLONIAL ESTATE

FOR PATIO FURNITURE (U.S. CLS. 2, 13, 22, 25, 32 AND 50).
FIRST USE 12-0-2004; IN COMMERCE 12-0-2004.

2,955,452. WAL-MART STORES, INC., BENTONVILLE, AR. SN 76-545,521. PUB. 6-1-2004, FILED 9-17-2003.

STONEWATER

FOR PATIO FURNITURE (U.S. CLS. 2, 13, 22, 25, 32 AND 50).
FIRST USE 12-0-2004; IN COMMERCE 12-0-2004.

2,955,454. WAL-MART STORES, INC., BENTONVILLE, AR. SN 76-545,757. PUB. 6-1-2004, FILED 9-17-2003.

DELAHEY

FOR PATIO FURNITURE (U.S. CLS. 2, 13, 22, 25, 32 AND 50).
FIRST USE 12-0-2004; IN COMMERCE 12-0-2004.

2,955,455. WAL-MART STORES, INC., BENTONVILLE, AR. SN 76-545,759. PUB. 6-1-2004, FILED 9-17-2003.

HILLCREST

FOR PATIO FURNITURE (U.S. CLS. 2, 13, 22, 25, 32 AND 50).
FIRST USE 12-0-2004; IN COMMERCE 12-0-2004.

CLASS 20—(Continued).

2,955,650. WINDQUEST COMPANIES, INC., HOLLAND, MI. SN 78-236,524. PUB. 12-9-2003, FILED 4-11-2003.

GET ORG'D

FOR STORAGE AND ORGANIZATION SYSTEMS COMPRISED OF SHELVES, DRAWERS, CUPBOARDS, BASKETS AND CLOTHES RODS, SOLD INDIVIDUALLY OR AS A UNIT (U.S. CLS. 2, 13, 22, 25, 32 AND 50).
FIRST USE 12-15-2004; IN COMMERCE 12-15-2004.

2,955,665. LELAND INTERNATIONAL, ANN ARBOR, MI. SN 78-242,449. PUB. 1-20-2004, FILED 4-26-2003.

HI FI

FOR CHAIRS, TABLES, DESKS, SHELVES FOR STORAGE, STOOLS, CABINET WORK, CHESTS OF DRAWERS, BEDSTEADS, ARM CHAIRS, NON METAL BINS, CUPBOARDS, DIVANS, FOOTSTOOLS, SCHOOL FURNITURE, OFFICE FURNITURE, FURNITURE PARTITIONS, LECTERNS, LIBRARY SHELVES, SIDEBARDS, SOFAS, TABLE TOPS (U.S. CLS. 2, 13, 22, 25, 32 AND 50).
FIRST USE 6-15-2003; IN COMMERCE 6-15-2003.

2,955,677. FOAMEX L.P., LINWOOD, PA. SN 78-250,442. PUB. 6-1-2004, FILED 5-15-2003.

VP TECHNOLOGY

FOR MATTRESSES, MATTRESS TOPPERS, PILLOWS, CHAIRS (U.S. CLS. 2, 13, 22, 25, 32 AND 50).
FIRST USE 9-0-2003; IN COMMERCE 9-0-2003.

CLASS 21—HOUSEWARES AND GLASS

2,955,204. TONI & GUY (USA) LIMITED, LONDON, ENGLAND. SN 75-919,016. PUB. 7-16-2002, FILED 2-15-2000.

TONI&GUY

OWNER OF U.S. REG. NO. 1,525,304.
FOR HAIR ACCESSORIES, NAMELY, HAIR BRUSHES, HAIR COMBS, AND SHAVING CUPS (U.S. CLS. 2, 13, 23, 29, 30, 33, 40 AND 50).
FIRST USE 2-0-1986; IN COMMERCE 2-0-1986.

CLASS 21—(Continued).

2,955,330. HELEN OF TROY LIMITED, EL PASO, TX. SN 76-469,438. PUB. 6-3-2003, FILED 11-14-2002.

ION + CERAMIC

NO CLAIM IS MADE TO THE EXCLUSIVE RIGHT TO USE "ION", APART FROM THE MARK AS SHOWN.
FOR HAIR BRUSHES (U.S. CLS. 2, 13, 23, 29, 30, 33, 40 AND 50).

FIRST USE 1-0-2003; IN COMMERCE 1-0-2003.

CLASS 21—(Continued).

2,955,518. PAWS DOWN, VANCOUVER, WA. SN 78-159,840. PUB. 12-2-2003, FILED 8-30-2002.

PAWS DOWN

FOR PLASTIC WATER BOTTLES SOLD EMPTY; WATER BOTTLES FOR PETS SOLD EMPTY (U.S. CLS. 2, 13, 23, 29, 30, 33, 40 AND 50).

FIRST USE 2-11-2005; IN COMMERCE 2-5-2005.

2,955,415. JKA, INC. WOONSOCKET, RI. SN 76-514,076. PUB. 12-23-2003, FILED 5-12-2003.

SUPERIOR STYLE QUALITY CUT

NO CLAIM IS MADE TO THE EXCLUSIVE RIGHT TO USE "SUPERIOR" AND "QUALITY", APART FROM THE MARK AS SHOWN.

FOR BATH SPONGES MADE OF FOAM AND MESH; COSMETIC BRUSHES, FOAM SPONGES, COSMETIC FOAM SPONGE WEDGES AND COSMETIC APPLICATOR STICKS, ALL FOR APPLYING MAKE-UP; HAIR COMBS AND BRUSHES; AND BATH AND NAIL BRUSHES (U.S. CLS. 2, 13, 23, 29, 30, 33, 40 AND 50).

FIRST USE 1-1-2003; IN COMMERCE 1-1-2003.

2,955,519. PAWS DOWN, VANCOUVER, WA. SN 78-159,849. PUB. 12-16-2003, FILED 8-30-2002.



FOR PLASTIC WATER BOTTLES SOLD EMPTY; WATER BOTTLES FOR PETS SOLD EMPTY (U.S. CLS. 2, 13, 23, 29, 30, 33, 40 AND 50).

FIRST USE 2-11-2005; IN COMMERCE 2-11-2005.

2,955,446. ORBIT IRRIGATION PRODUCTS, INC., NORTH SALT LAKE, UT. SN 76-538,830. PUB. 12-2-2003, FILED 8-20-2003.

MIST 'R' SHOWER

FOR WAND TYPE SPRINKLER HEADS WITH SHOWER AND MIST SPRAYS FOR ATTACHMENT TO A GARDEN HOSE (U.S. CLS. 2, 13, 23, 29, 30, 33, 40 AND 50).

FIRST USE 5-30-2003; IN COMMERCE 5-30-2003.

2,955,600. ANTIOCH COMPANY, THE, YELLOW SPRINGS, OH. SN 78-219,333. PUB. 2-17-2004, FILED 2-26-2003.

OUR OWN IMAGE

FOR PAPER PLATES, PAPER CUPS, SERVING TRAYS, NOT OF PRECIOUS METAL; SERVING DISHES, NOT OF PRECIOUS METAL; CUTTING BOARDS, COASTERS, NOT MADE OF PAPER AND NOT BEING TABLE LINEN; SALAD BOWLS; FOOD CONTAINERS, NOT OF PRECIOUS METAL; CHAMPAGNE BUCKETS; TRIVETS; SPOON RESTS; TEA POTS, NOT OF PRECIOUS METAL; DINNERWARE IN GENERAL, NAMELY, DESSERT PLATES, TEA CUPS AND SAUCERS, COVERED SUGAR AND CREAMER SETS; CANISTERS AND SEALS, NOT OF PRECIOUS METAL; SWIZZLE STICKS; COCKTAIL PICKS; CHARMS FOR ATTACHMENT TO BEVERAGE GLASSWARE FOR IDENTIFICATION PURPOSES; PIE SERVERS; SERVING FORKS, SERVING TONGS, SERVING SPOONS; FITTED PICNIC BAG OR BASKET WITH DISHES (U.S. CLS. 2, 13, 23, 29, 30, 33, 40 AND 50).

FIRST USE 8-26-2003; IN COMMERCE 8-26-2003.

2,955,478. KENOVER MARKETING CORP., BROOKLYN, NY. SN 76-977,444. PUB. 2-10-2004, FILED 6-23-2003.

MERON

FOR CANDLE RINGS NOT OF PRECIOUS METAL (U.S. CLS. 2, 13, 23, 29, 30, 33, 40 AND 50).

FIRST USE 4-0-2004; IN COMMERCE 4-0-2004.

CLASS 21—(Continued).

2,955,627. INTEX DIY, INC., VILLA RICA, GA. SN 78-227,236.
PUB. 11-25-2003, FILED 3-19-2003.

ZERO WASTE

FOR WIPING CLOTHS (U.S. CLS. 2, 13, 23, 29, 30, 33, 40
AND 50).
FIRST USE 3-24-2004; IN COMMERCE 3-24-2004.

2,955,633. FREUDENBERG HOUSEHOLD PRODUCTS LP,
NORTHLAKE, IL. SN 78-228,457. PUB. 11-4-2003, FILED 3-
21-2003.

DERMO PLUS

FOR HOUSEHOLD GLOVES FOR GENERAL USE (U.S.
CLS. 2, 13, 23, 29, 30, 33, 40 AND 50).
FIRST USE 3-20-2004; IN COMMERCE 12-1-2004.

CLASS 24—FABRICS

2,955,409. SANRIO COMPANY, LTD., TOKYO 141, JAPAN.
SN 76-510,725. PUB. 11-4-2003, FILED 4-30-2003.

CINNAMOROLL

FOR BEACH TOWELS, BATH TOWELS, HAND TO-
WELS, HANDKERCHIEFS, BATH LINEN, TABLE
LINEN, STADIUM BLANKETS, CURTAINS, TEXTILE
WALL HANGINGS, TEXTILE PLACE MATS; BED BLAN-
KETS (U.S. CLS. 42 AND 50).
FIRST USE 11-14-2003; IN COMMERCE 11-14-2003.

2,955,541. POLARIS INDUSTRIES INC., MEDINA, MN. SN
78-175,238. PUB. 11-11-2003, FILED 10-16-2002.

VICTORY

FOR POLAR FLEECE BED OR THROW BLANKETS;
CLOTH AND FELT PENNANTS; TAPESTRIES OF TEX-
TILE (U.S. CLS. 42 AND 50).
FIRST USE 3-31-2000; IN COMMERCE 3-31-2000.

2,955,604. L. L. BEAN, INC., FREEPORT, ME. SN 78-222,765.
PUB. 5-11-2004, FILED 3-7-2003.

TEK2.5

FOR FABRICS TREATED WITH A COMBINATION OF
SHELL MATERIALS, COATING MATERIALS, AND
LAMINATE MATERIALS THAT INCREASE THE
BREATHABILITY, WATER-RESISTANT AND MOIST-
URE-WICKING PROPERTIES OF THE FABRICS, SOLD
AS COMPONENTS OF APPAREL (U.S. CLS. 42 AND 50).
FIRST USE 7-15-2003; IN COMMERCE 7-15-2003.

CLASS 24—(Continued).

2,955,637. QVC, INC., WEST CHESTER, PA. SN 78-230,939.
PUB. 11-11-2003, FILED 3-27-2003.

SURE-SHAPER

FOR FABRIC, NAMELY A SPANDEX/RAYON BLEND
USED AS A COMPONENT OF APPAREL (U.S. CLS. 42
AND 50).
FIRST USE 5-4-2003; IN COMMERCE 5-4-2003.

CLASS 25—CLOTHING

2,955,189. DOTS, LLC, SOLON, OH. SN 75-473,546. PUB. 9-14-
2004, FILED 4-24-1998.



FOR MEN'S, WOMEN'S AND CHILDREN'S CLOTH-
ING, NAMELY, DRESSES, SKIRTS, SHIRTS, BLOUSES,
PANTS, OVERALLS, JACKETS, COATS, VESTS,
SHORTS, T-SHIRTS, SWEATSHIRTS, SWEATERS, SWIM-
SUITS, HEADWEAR, SOCKS, HOSIERY, PAJAMAS,
UNDERWEAR, BELTS, SCARVES, TIES, GLOVES,
SHOES, BOOTS, SNEAKERS, SANDALS AND SLIPPERS
(U.S. CLS. 22 AND 39).
FIRST USE 1-1-1998; IN COMMERCE 1-1-1998.

2,955,198. GRAY MATTER HOLDINGS, LLC, BALTIMORE,
MD. SN 75-853,293. PUB. 2-18-2003, FILED 11-19-1999.

OWNER OF U.S. REG. NO. 2,143,509.
FOR EAR WARMERS AND INSULATED PERFORM-
ANCE GLOVES FOR COLD WEATHER (U.S. CLS. 22
AND 39).
FIRST USE 2-23-2000; IN COMMERCE 2-23-2000.

CLASS 25—(Continued).

2,955,201. JESSICA MCCLINTOCK, INC., SAN FRANCISCO, CA. SN 75-874,652. PUB. 11-7-2000, FILED 12-17-1999.

JESSICA MCCLINTOCK

OWNER OF U.S. REG. NOS. 1,164,724, 1,994,234, AND OTHERS.

THE NAME "JESSICA MCCLINTOCK" IDENTIFIES A LIVING INDIVIDUAL WHOSE CONSENT IS OF RECORD.

FOR LADIES APPAREL, NAMELY, SCARVES; AND GIRL'S APPAREL, NAMELY LOUNGEWEAR, SLEEPWEAR, PAJAMAS, AND NIGHT GOWNS (U.S. CLS. 22 AND 39).

FIRST USE 9-5-2003; IN COMMERCE 9-5-2003.

2,955,209. CORSER, TROY, MONTECARLO, MONACO. SN 76-000,043. PUB. 10-2-2001, FILED 3-14-2000.



THE NAME TROY CORSER IDENTIFIES A LIVING INDIVIDUAL WHOSE CONSENT IS OF RECORD.

FOR CLOTHING, NAMELY, COATS, MANTLES, RAINCOATS, DRESSES, SUITS, SKIRTS, JACKETS, TROUSERS, JEANS, WAISTCOATS, SHIRTS, T-SHIRTS, BLOUSES, JERSEYS, SWEATERS, BLAZERS, CARDIGANS, STOCKINGS, SOCKS, UNDERWEAR, CORSETS, NIGHT-GOWNS, PAJAMAS, BATHROBES, BATHING SUITS, SUN SUITS, SPORT JACKETS, WIND-RESISTANT JACKETS, ANORAKS, SWEATSUITS, TIES, NECKTIES, SCARVES, SHAWLS, FOULARDS, CAPS, HATS, GLOVES, SASHES, BELTS; FOOTWEAR, NAMELY, BOOTS, SHOES AND SLIPPERS (U.S. CLS. 22 AND 39).

FIRST USE 11-24-2004; IN COMMERCE 11-24-2004.

2,955,223. TANNER COMPANIES, LLC, RUTHERFORDTON, NC. SN 76-060,555. PUB. 9-17-2002, FILED 5-31-2000.



OWNER OF U.S. REG. NOS. 701,878, 1,491,236, AND OTHERS.

FOR WOMEN'S CLOTHING, NAMELY, SUITS, DRESSES, SKIRTS, BLOUSES, SLACKS, PANTS, JACKETS, COATS, RAINWEAR, SWEATERS, VESTS, SHORTS, CULOTTES, PLAYSUITS, BANDEAUX, HALTERS, SASHES, SCARVES, HATS, GLOVES, BELTS, HOSIERY, SOCKS, TIGHTS, PANTYHOSE, KNEE-HIGHS AND SHOES, ALL OF THE AFOREMENTIONED GOODS NOT FOR SPORTS PURPOSES (U.S. CLS. 22 AND 39).

FIRST USE 5-0-2000; IN COMMERCE 5-0-2000.

CLASS 25—(Continued).

2,955,240. STERLING METS, L.P., FLUSHING, NY. SN 76-192,513. PUB. 9-18-2001, FILED 1-11-2001.

AMAZIN' METS

FOR CLOTHING, NAMELY, CAPS, HATS, VISORS, KNITTED HEADWEAR, SHIRTS, T-SHIRTS, TANK TOPS, PULLOVERS, SHORTS, PANTS, SKIRTS, BASEBALL UNIFORMS, JERSEYS, WARM-UP SUITS, SWEATSHIRTS, JACKETS, CLOTH BIBS, INFANTWEAR, JUMPERS, ROMPERS, COVERALLS, BABY BOOTIES (U.S. CLS. 22 AND 39).

FIRST USE 10-1-2004; IN COMMERCE 10-1-2004.

2,955,247. DIVALICIOUS, INC., LOS ANGELES, CA. SN 76-221,434. PUB. 9-4-2001, FILED 3-8-2001.

DIVALICIOUS

FOR CLOTHING, NAMELY, SHIRTS, SWEATSHIRTS, PANTS, SWEATPANTS, SHORTS, DRESSES, TOPS, JUMPSUITS, ROMPERS, SKIRTS, SOCKS, UNDERWEAR, BATHING SUITS, JACKETS, VESTS; SHOES, BELTS, PANTYHOSE, GLOVES, SCARVES, HATS, HEADBANDS, COATS, NECKWEAR, CAPS, LEATHER COATS, LEATHER JACKETS, LEATHER PANTS (U.S. CLS. 22 AND 39).

FIRST USE 8-1-2001; IN COMMERCE 8-1-2001.

2,955,302. PEDERSEN, LISA M., HERMOSA BEACH, CA. SN 76-448,916. PUB. 12-16-2003, FILED 9-12-2002.

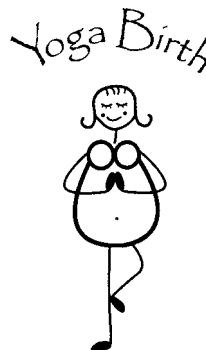

NO CLAIM IS MADE TO THE EXCLUSIVE RIGHT TO USE "YOGA", APART FROM THE MARK AS SHOWN.

FOR WOMEN'S CLOTHING AND MATERNITY WEAR, NAMELY, T-SHIRTS, TANK TOPS, PANTS (U.S. CLS. 22 AND 39).

FIRST USE 2-7-2003; IN COMMERCE 4-15-2003.

CLASS 25—(Continued).

2,955,323. CIBELLIS, MICHAEL J., PARSIPPANY, NJ. SN 76-464,075. PUB. 11-11-2003, FILED 11-4-2002.



FOR CLOTHING, NAMELY, SHORTS, HATS, CAPS, SWEATPANTS, SWEATSHIRTS, PANTS AND T-SHIRTS (U.S. CLS. 22 AND 39).
FIRST USE 2-0-2003; IN COMMERCE 2-0-2003.

2,955,329. NUCCI INTERNATIONAL CORP., NEW YORK, NY. SN 76-468,657. PUB. 1-27-2004, FILED 11-8-2002.

VESE

FOR CLOTHING, NAMELY, SKIRTS, SHORTS, PANTS AND JACKETS (U.S. CLS. 22 AND 39).
FIRST USE 4-30-2004; IN COMMERCE 4-30-2004.

2,955,334. C.P. INTERNATIONAL CORPORATION, ENGLEWOOD, NJ. SN 76-473,378. PUB. 3-23-2004, FILED 11-25-2002.

JONATHAN RUSSELL

THE NAME "JONATHAN RUSSELL" DOES NOT IDENTIFY A LIVING INDIVIDUAL.
FOR FOOTWEAR (U.S. CLS. 22 AND 39).
FIRST USE 1-25-2003; IN COMMERCE 1-25-2003.

2,955,358. PINNACLE TEXTILE INDUSTRIES LLC, KING OF PRUSSIA, PA. SN 76-486,192. PUB. 5-11-2004, FILED 1-30-2003.

chef trends

NO CLAIM IS MADE TO THE EXCLUSIVE RIGHT TO USE CHEF, APART FROM THE MARK AS SHOWN.
FOR UNIFORMS, CLOTHING, AND APPAREL FOR USE BY HOSPITALITY AND RESTAURANT STAFF, NAMELY, COATS, PANTS, SHIRTS, APRONS, AND HATS (U.S. CLS. 22 AND 39).
FIRST USE 4-0-2003; IN COMMERCE 4-0-2003.

CLASS 25—(Continued).

2,955,401. TRIPLE FIVE SOUL, INC., BROOKLYN, NY. SN 76-501,972. PUB. 12-2-2003, FILED 3-27-2003.

Triple Five Soul

OWNER OF U.S. REG. NOS. 2,223,449 AND 2,413,469.
FOR MEN'S, WOMEN'S AND CHILDREN'S FOOTWEAR (U.S. CLS. 22 AND 39).
FIRST USE 9-1-2004; IN COMMERCE 9-1-2004.

2,955,404. AMERICAN SPORTING GOODS CORPORATION, IRVINE, CA. SN 76-504,864. PUB. 1-6-2004, FILED 4-2-2003.

TRACTION TREDZ

NO CLAIM IS MADE TO THE EXCLUSIVE RIGHT TO USE "TREDZ", APART FROM THE MARK AS SHOWN.
FOR FOOTWEAR (U.S. CLS. 22 AND 39).
FIRST USE 5-0-2003; IN COMMERCE 5-0-2003.

2,955,406. BLAINE BROOKE PHOTOGRAPHY, INC., LOUISVILLE, KY. SN 76-507,158. PUB. 12-2-2003, FILED 4-17-2003.

**JUSTICE ISN'T ALWAYS
BLACK, AND WHITE
SOMETIMES IT'S RED,
WHITE, AND BLUE**

FOR CLOTHING, NAMELY, T-SHIRTS (U.S. CLS. 22 AND 39).
FIRST USE 8-1-2004; IN COMMERCE 8-1-2004.

2,955,438. APEMA S.R.L., MUGNANO DI NAPOLI (NA), ITALY. SN 76-535,022. PUB. 3-23-2004, FILED 8-6-2003.

LERRE

FOR CLOTHING, NAMELY, BELTS, BOOTS, SHOES AND SLIPPERS (U.S. CLS. 22 AND 39).
FIRST USE 7-0-1997; IN COMMERCE 7-0-1997.

CLASS 25—(Continued).

2,955,441. NAP, INC., NEW YORK, NY. SN 76-536,465. PUB. 8-24-2004, FILED 7-28-2003.

NEWPORT TERRY

NO CLAIM IS MADE TO THE EXCLUSIVE RIGHT TO USE "TERRY", APART FROM THE MARK AS SHOWN.

FOR WOMEN'S AND MEN'S CLOTHING, NAMELY, DRESSES, LOUNGE WEAR, BATHROBES, SLEEP WEAR, LINGERIE, NEGLIGÉES, UNDERWEAR, INTIMATE APPAREL, NAMELY, BRAS AND PANTIES AND NIGHTGOWNS (U.S. CLS. 22 AND 39).

FIRST USE 8-2-2004; IN COMMERCE 8-2-2004.

2,955,453. HODGMAN, INC., MONTGOMERY, IL. SN 76-545,541. PUB. 6-15-2004, FILED 9-17-2003.

FIELD-PAC

FOR HUNTING BOOTS (U.S. CLS. 22 AND 39).
FIRST USE 6-0-2003; IN COMMERCE 6-0-2003.

2,955,493. SARAMAR, L.L.C., CHICAGO, IL. SN 78-114,143. PUB. 6-22-2004, FILED 3-12-2002.

COMFORTABLE CURVES

FOR BRAS, PANTIES (U.S. CLS. 22 AND 39).
FIRST USE 2-15-2003; IN COMMERCE 2-15-2003.

2,955,494. TWENTIETH CENTURY FOX FILM CORPORATION, LOS ANGELES, CA. SN 78-115,901. PUB. 10-8-2002, FILED 3-19-2002.

THE FULL MONTY

FOR T-SHIRTS; SHIRTS (U.S. CLS. 22 AND 39).
FIRST USE 10-31-2000; IN COMMERCE 10-31-2000.

2,955,502. PRECISPORT, S.L., SANT QUIRZE DEL VALLÉS (BARCELONA), SPAIN. SN 78-147,393. PUB. 10-21-2003, FILED 7-25-2002.



FOR SPORTS RELATED GARMENTS, NAMELY, ATHLETIC UNIFORMS (U.S. CLS. 22 AND 39).
FIRST USE 2-0-2003; IN COMMERCE 2-0-2003.

CLASS 25—(Continued).

2,955,559. JEFFREY S. BROOKS, INC., CREVE COEUR, MO. SN 78-193,581. PUB. 7-1-2003, FILED 12-11-2002.

HOT 2 TROT

FOR FOOTWEAR, NAMELY, INSOLES (U.S. CLS. 22 AND 39).

FIRST USE 12-0-2004; IN COMMERCE 12-0-2004.

2,955,565. OVERSEAS DIRECT IMPORT CO., LTD., NEW YORK, NY. SN 78-198,110. PUB. 7-15-2003, FILED 12-27-2002.

RUGGED WILDERNESS

FOR MEN'S, WOMEN'S, CHILDREN'S AND INFANTS' APPAREL, NAMELY— SWIMWEAR, SHORTS, SHIRTS, TOPS, PANTS, JACKETS, UNDERWEAR, THERMAL UNDERWEAR, JOGGING SUITS AND JUMP SUITS (U.S. CLS. 22 AND 39).

FIRST USE 3-1-2004; IN COMMERCE 3-1-2004.

2,955,573. STRATTON CORPORATION, STRATTON MOUNTAIN, VT. SN 78-202,900. PUB. 4-20-2004, FILED 1-14-2003.



OWNER OF U.S. REG. NOS. 1,345,163, 1,536,463, AND 1,540,829.

NO CLAIM IS MADE TO THE EXCLUSIVE RIGHT TO USE "MOUNTAIN", APART FROM THE MARK AS SHOWN.

SEC. 2(F) AS TO "STRATTON".

FOR CLOTHING, NAMELY, UNIFORMS FOR CONCIERGE, WAIT STAFF, KITCHEN STAFF, MANAGEMENT, PARKING PERSONNEL, SKI VALET, CUSTODIAL STAFF, AND GUEST SERVICE ATTENDANTS; SKIWEAR, CLOTHING, NAMELY, SHIRTS, SWEATERS, HATS AND BELTS (U.S. CLS. 22 AND 39).
FIRST USE 2-0-2002; IN COMMERCE 2-0-2002.

CLASS 25—(Continued).

2,955,584. PRICE, KIM N., ALEXANDER CITY, AL. AND PRICE, TIM L., ALEXANDER CITY, AL. SN 78-210,930. PUB. 2-10-2004, FILED 2-4-2003.

COVEY RISE

FOR CLOTHING, NAMELY, SHIRTS, PANTS, CHAPS, HUNTING VESTS, GOLF SHIRTS, CAPS (U.S. CLS. 22 AND 39).

FIRST USE 7-30-2003; IN COMMERCE 8-15-2003.

2,955,603. VANITY FAIR, INC., WILMINGTON, DE. SN 78-222,752. PUB. 11-11-2003, FILED 3-7-2003.

COMFORT ESSENTIALS

OWNER OF U.S. REG. NOS. 818,301 AND 2,411,355. FOR LINGERIE, SLEEPWEAR AND HOSIERY (U.S. CLS. 22 AND 39).

FIRST USE 6-9-2003; IN COMMERCE 6-9-2003.

2,955,623. SARAMAR, L.L.C., CHICAGO, IL. SN 78-226,320. PUB. 11-18-2003, FILED 3-17-2003.

EASY ON

FOR SHAPEWEAR, NAMELY GIRDLES, THIGH SHAPERS, CONTROL PANTIES AND BRIEFS, BODY SHAPERS AND SLIPS WHICH SHAPE THE BODY (U.S. CLS. 22 AND 39).

FIRST USE 7-5-2004; IN COMMERCE 7-5-2004.

2,955,628. CARLBERG GRAFIX, INC., SPRINGFIELD, IL. SN 78-227,250. PUB. 2-10-2004, FILED 3-19-2003.

NICE BEAVER

FOR SCREEN PRINTED OR EMBROIDERED T-SHIRTS AND APPAREL (U.S. CLS. 22 AND 39).

FIRST USE 3-1-2003; IN COMMERCE 3-1-2003.

2,955,631. RECYCLING WORKS, LLC, DECATUR, GA. SN 78-227,958. PUB. 11-18-2003, FILED 3-20-2003.

JESSIE-THE-DEER

FOR CLOTHING, NAMELY PANTS, SHORTS, SHIRTS, SWEATERS, JACKETS, VESTS, HATS, CAPS, AND SOCKS (U.S. CLS. 22 AND 39).

FIRST USE 7-1-2004; IN COMMERCE 7-1-2004.

CLASS 25—(Continued).

2,955,643. SARAMAR, L.L.C., CHICAGO, IL. SN 78-233,911. PUB. 12-2-2003, FILED 4-4-2003.

COOL EFFECTS

FOR BRAS AND PANTIES (U.S. CLS. 22 AND 39).

FIRST USE 4-15-2004; IN COMMERCE 4-15-2004.

2,955,680. SAUCONY, INC., PEABODY, MA. SN 78-252,155. PUB. 1-20-2004, FILED 5-20-2003.

GRID ENERGY CRM

OWNER OF U.S. REG. NOS. 2,663,005 AND 2,683,189. FOR FOOTWEAR (U.S. CLS. 22 AND 39).

FIRST USE 12-1-2003; IN COMMERCE 12-1-2003.

2,955,698. COPPLEY APPAREL GROUP LIMITED, HAMILTON, CANADA. SN 78-267,837. PUB. 6-1-2004, FILED 6-27-2003.

STONEWOOL

PRIORITY CLAIMED UNDER SEC. 44(D) ON CANADA APPLICATION NO. 1167615, FILED 2-11-2003, REG. NO. 1167615, DATED 2-11-2003, EXPIRES 2-11-2013.

FOR CLOTHING, NAMELY- TROUSERS AND SPORTS COATS (U.S. CLS. 22 AND 39).

FIRST USE 1-1-2003; IN COMMERCE 2-1-2003.

2,955,753. SARAMAR, L.L.C., CHICAGO, IL. SN 78-310,368. PUB. 7-6-2004, FILED 10-7-2003.

FLAWLESS FIT

FOR CAMISOLES (U.S. CLS. 22 AND 39).

FIRST USE 11-15-2003; IN COMMERCE 11-15-2003.

CLASS 25—(Continued).

2,955,771. JAYSIX USA, FREDERICKSBURG, VA. SN 78-330,015. PUB. 9-14-2004, FILED 11-19-2003.

JAMES TATTERSALL

THE MARK CONSISTS OF STANDARD CHARACTERS WITHOUT CLAIM TO ANY PARTICULAR FONT, STYLE, SIZE, OR COLOR.

THE NAME IN THE MARK DOES NOT IDENTIFY A LIVING INDIVIDUAL.

FOR KNIT SHIRTS, WOVEN SHIRTS, JACKETS, LEATHER JACKETS, POLAR FLEECE JACKETS, TIES, COTTON PANTS, KNITTED SWEATERS, BOXER SHORTS, BRIEFS, WOMEN'S UNDERGARMENTS, BELTS, SOCKS, SHOES, CAPS, HATS, SCARVES, GLOVES (U.S. CLS. 22 AND 39).

FIRST USE 1-15-2004; IN COMMERCE 2-5-2004.

2,955,773. SUN ON INTERNATIONAL, LLC, NEW YORK, NY. SN 78-331,288. PUB. 8-31-2004, FILED 11-21-2003.

COLORAYON

THE MARK CONSISTS OF STANDARD CHARACTERS WITHOUT CLAIM TO ANY PARTICULAR FONT, STYLE, SIZE, OR COLOR.

FOR WOMEN'S CLOTHING, NAMELY, JACKETS, BLOUSES, SHIRTS, PANTS, SHORTS, SKIRTS, DRESSES AND SWEATERS (U.S. CLS. 22 AND 39).

FIRST USE 1-6-2004; IN COMMERCE 1-6-2004.

2,955,800. JONES, HARVEY N., SEATTLE, WA. SN 78-975,907. PUB. 5-25-2004, FILED 8-5-2003.

COOPER JONES

THE NAME "COPPER JONES" DOES NOT IDENTIFY A LIVING INDIVIDUAL.

FOR CLOTHING, NAMELY SHIRTS, SWEATERS, KNITWEAR, NAMELY, SHIRTS AND SWEATERS (U.S. CLS. 22 AND 39).

FIRST USE 2-17-2004; IN COMMERCE 4-30-2004.

CLASS 26—FANCY GOODS**CLASS 26—(Continued).**

2,955,412. SANRIO COMPANY, LTD., TOKYO 141, JAPAN. SN 76-510,874. PUB. 11-4-2003, FILED 4-30-2003.

CINNAMOROLL

FOR HAIR BANDS, HAIR ORNAMENTS, HAIR CLIPS, PONYTAIL HOLDERS, BARRETTES; SHOE ORNAMENTS NOT OF PRECIOUS METAL (U.S. CLS. 37, 39, 40, 42 AND 50).

FIRST USE 11-14-2004; IN COMMERCE 11-14-2004.

CLASS 27—FLOOR COVERINGS

2,955,410. SANRIO COMPANY, LTD., TOKYO 141, JAPAN. SN 76-510,863. PUB. 11-4-2003, FILED 4-30-2003.

CINNAMOROLL

FOR PLASTIC DOOR MATS, RUGS (U.S. CLS. 19, 20, 37, 42 AND 50).

FIRST USE 1-15-2004; IN COMMERCE 1-15-2004.

2,955,748. MOHAWK BRANDS, INC., WILMINGTON, DE. SN 78-304,279. PUB. 5-11-2004, FILED 9-23-2003.

MOHAWK SELECT

OWNER OF U.S. REG. NO. 1,099,660.

FOR CARPET (U.S. CLS. 19, 20, 37, 42 AND 50).

FIRST USE 1-2-2004; IN COMMERCE 1-2-2004.

CLASS 28—TOYS AND SPORTING GOODS

2,955,193. FLIGHT OF IDEAS, INC., WALTHAM, MA. SN 75-731,345. PUB. 5-9-2000, FILED 6-17-1999.

FLIGHT OF IDEAS

FOR EDUCATIONAL GAMES, NAMELY, PRINTED FOLDABLE SHEETS AND BOOKLETS SOLD AS A UNIT FOR PLAYING HAND-HELD PICTURE, WORD, NUMBER OR COLOR ASSOCIATION GAMES (U.S. CLS. 22, 23, 38 AND 50).

FIRST USE 12-7-2004; IN COMMERCE 12-7-2004.

CLASS 28—(Continued).

2,955,222. BEST PICTURE SHOW COMPANY PTY. LTD., THE, BRISBANE QUEENSLAND 4000, AUSTRALIA. SN 76-055,953. PUB. 12-25-2001, FILED 5-19-2000.



FOR PARTY FAVOURS IN THE NATURE OF SMALL TOYS; PLUSH TOYS; SOFT SCULPTURE TOYS; GAMES, NAMELY, BOARD GAMES, CARD GAMES, PARLOUR GAMES, ACTION SKILL GAMES, HAND HELD UNIT FOR PLAYING ELECTRONIC AND VIDEO GAMES; OUTDOOR ACTIVITY GAMES, MODELS, NAMELY, TOY MODEL VEHICLES AND RELATED ACCESSORIES SOLD AS UNITS, PUZZLES, NAMELY, JIGSAW PUZZLES, MANIPULATIVE PUZZLES, THREE-DIMENSIONAL PUZZLES; TOY ACTION FIGURES AND ACCESSORIES THEREFOR; PLAY FIGURES; WATER SQUIRTING TOYS; BATHTUB TOYS; DOLLS AND DOLL ACCESSORIES (U.S. CLS. 22, 23, 38 AND 50).
FIRST USE 10-0-2001; IN COMMERCE 10-0-2001.

2,955,234. THOMAS & THOMAS RODMAKERS, INC., TURNER FALLS, MA. SN 76-125,417. PUB. 1-27-2004, FILED 9-8-2000.

VECTOR

FOR FINE FLY FISHING RODS (U.S. CLS. 22, 23, 38 AND 50).
FIRST USE 0-0-1999; IN COMMERCE 0-0-1999.

2,955,239. STERLING METS, L.P., FLUSHING, NY. SN 76-192,504. PUB. 10-9-2001, FILED 1-11-2001.

AMAZIN' METS

FOR TOYS AND SPORTING GOODS, NAMELY STUFFED TOYS, PLUSH TOYS, TOY FIGURES, DOLLS NECK AND WRIST LANYARDS FOR MINI BATS, MINI BASEBALLS, TOY FIGURES, GOLF BALLS, GOLF CLUB COVERS, AND CHRISTMAS TREE ORNAMENTS (U.S. CLS. 22, 23, 38 AND 50).
FIRST USE 10-1-2004; IN COMMERCE 10-1-2004.

CLASS 28—(Continued).

2,955,287. BRUNSWICK BOWLING & BILLIARDS CORPORATION, MUSKEGON, MI. SN 76-416,344. PUB. 6-17-2003, FILED 6-3-2002.

V-FORCE

FOR GAME TABLES FOR USE WITH GLIDING SURFACE PROJECTILES, PROJECTILES FOR SAME AND PLAYING ACCESSORIES THEREFOR (U.S. CLS. 22, 23, 38 AND 50).
FIRST USE 9-0-2002; IN COMMERCE 9-0-2002.

2,955,364. SELLNER MANUFACTURING CO., INC., FARIBAULT, MN. SN 76-489,519. PUB. 10-21-2003, FILED 2-14-2003.

STAR COMMAND

FOR AMUSEMENT RIDES OF THE TYPE USED IN CARNIVALS, AMUSEMENT PARKS AND SIMILAR RECREATIONAL SETTINGS (U.S. CLS. 22, 23, 38 AND 50).
FIRST USE 3-17-2003; IN COMMERCE 3-17-2003.

2,955,371. SPIN MASTER LTD, TORONTO, ONTARIO M5V 1B6, CANADA. SN 76-491,060. PUB. 10-21-2003, FILED 2-20-2003.

CYBERHAWK

FOR FLYING TOYS, NAMELY ORNITHOPTERS (U.S. CLS. 22, 23, 38 AND 50).
FIRST USE 1-0-2002; IN COMMERCE 9-0-2002.

2,955,394. NEW BALANCE ATHLETIC SHOE, INC., BOSTON, MA. SN 76-499,092. PUB. 10-28-2003, FILED 3-20-2003.



FOR EXERCISE EQUIPMENT, NAMELY, TREADMILLS, ELLIPTICAL TRAINERS, AND STATIONARY PEDAL OPERATED TRAINING APPARATUS TO PROMOTE HEALTH AND FITNESS (U.S. CLS. 22, 23, 38 AND 50).
FIRST USE 5-1-2004; IN COMMERCE 5-1-2004.

CLASS 28—(Continued).

2,955,395. NEW BALANCE ATHLETIC SHOE, INC., BOSTON, MA. SN 76-499,093. PUB. 10-28-2003, FILED 3-20-2003.

NEW BALANCE

FOR EXERCISE EQUIPMENT, NAMELY, TREADMILLS, ELLIPTICAL TRAINERS, AND STATIONARY PEDAL OPERATED TRAINING APPARATUS TO PROMOTE HEALTH AND FITNESS (U.S. CLS. 22, 23, 38 AND 50).

FIRST USE 3-1-2004; IN COMMERCE 3-1-2004.

2,955,411. SANRIO COMPANY, LTD., TOKYO 141, JAPAN. SN 76-510,872. PUB. 3-2-2004, FILED 4-30-2003.

CINNAMOROLL

FOR STUFFED ANIMALS, PLUSH ANIMALS, SOFT SCULPTURE TOYS, TOY FIGURES, TOY WHISTLES, TOY STICK-ON JEWELRY, TOY RINGS, CASES FOR TOY ACCESSORIES, CHILDREN'S PLAY COSMETICS, CHRISTMAS TREE ORNAMENTS; PARTY FAVORS IN THE NATURE OF CRACKERS, NOISE MAKERS AND SMALL TOYS; SWIMMING AIDS, NAMELY, INFLATABLE TUBES AND BEACH BALLS; SNOW GLOBES (U.S. CLS. 22, 23, 38 AND 50).

FIRST USE 11-14-2003; IN COMMERCE 11-14-2003.

2,955,424. ZAK'S SPORTS PRODUCTS, LLC, NORTH-BROOK, IL. SN 76-521,630. PUB. 1-13-2004, FILED 6-11-2003.

SOCCIX

FOR SOCCER TRAINING EQUIPMENT, NAMELY, A DEVICE CONSISTING OF A SOCCER BALL ATTACHED TO CORDS AND STAKES FOR THE PURPOSE OF TRAINING AND ENTERTAINMENT (U.S. CLS. 22, 23, 38 AND 50).

FIRST USE 9-0-2003; IN COMMERCE 9-0-2003.

2,955,447. KABUSHIKI KAISHA SEGA, DBA SEGA CORPORATION, TOKYO, JAPAN. SN 76-539,228. PUB. 5-25-2004, FILED 8-22-2003.

OLLIE KING

THE MARK OLLIE KING DOES NOT IDENTIFY A LIVING INDIVIDUAL.

FOR STAND ALONE VIDEO GAME MACHINES; ARCADE GAME MACHINES WITH BUILT-IN SCREENS (U.S. CLS. 22, 23, 38 AND 50).

FIRST USE 5-12-2004; IN COMMERCE 5-12-2004.

CLASS 28—(Continued).

2,955,483. MATTEL, INC., EL SEGUNDO, CA. SN 78-062,907. PUB. 7-6-2004, FILED 5-10-2001.

ENCHANTED MERMAID

NO CLAIM IS MADE TO THE EXCLUSIVE RIGHT TO USE "MERMAID", APART FROM THE MARK AS SHOWN. FOR TOYS, GAMES, AND PLAYTHINGS, NAMELY, DOLLS, DOLL CLOTHING AND DOLL ACCESSORIES (U.S. CLS. 22, 23, 38 AND 50).

FIRST USE 10-31-2001; IN COMMERCE 10-31-2001.

2,955,499. MATTEL, INC., EL SEGUNDO, CA. SN 78-146,989. PUB. 12-2-2003, FILED 7-24-2002.

GROUND FX

FOR TOYS, GAMES AND PLAYTHINGS, NAMELY, TOY VEHICLES AND ACCESSORIES THEREFOR (U.S. CLS. 22, 23, 38 AND 50).

FIRST USE 4-30-2003; IN COMMERCE 4-30-2003.

2,955,500. MATTEL, INC., EL SEGUNDO, CA. SN 78-146,993. PUB. 12-2-2003, FILED 7-24-2002.

EMERALD FAIRY

FOR TOYS, GAMES AND PLAYTHINGS, NAMELY, DOLLS, DOLL CLOTHING AND DOLL ACCESSORIES (U.S. CLS. 22, 23, 38 AND 50).

FIRST USE 1-31-2003; IN COMMERCE 1-31-2003.

2,955,501. ODYSSEY PAINTBALL PRODUCTS, L.L.C., GARLAND, TX. SN 78-147,219. PUB. 5-11-2004, FILED 7-24-2002.

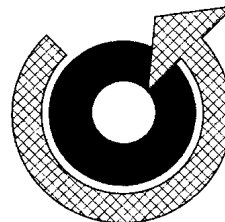

THE LINING IS FOR SHADING PURPOSES ONLY. FOR PAINTBALL GUNS AND COMPONENTS THEREOF; AND AUTOMATIC PAINTBALL FEEDERS (U.S. CLS. 22, 23, 38 AND 50).

FIRST USE 12-1-1999; IN COMMERCE 1-4-2000.

CLASS 28—(Continued).

2,955,503. SACRAMENTO KINGS LIMITED PARTNERSHIP, L.P., SACRAMENTO, CA. SN 78-147,621. PUB. 11-11-2003, FILED 7-25-2002.

SLAMSON

FOR TOYS, GAMES AND SPORTING GOODS, NAMELY BASKETBALLS, GOLF BALLS, PLAYGROUND BALLS, SPORTS BALLS, RUBBER ACTION BALLS AND FOAM ACTION BALLS, PLUSH BALLS, BASKETBALL NETS, BASKETBALL BACKBOARDS, PUMPS FOR INFLATING BASKETBALLS, AND NEEDLES THEREFOR, GOLF CLUBS, GOLF BAGS, GOLF PUTTERS, GOLF BALL GIFT SETS COMPRISING DIVOT REPAIR TOOLS, GOLF TEE MARKERS AND GOLF BALL MARKERS OR IN MIXED COMBINATION THEREOF, GOLF ACCESSORIES, NAMELY GOLF BAG COVERS, CLUB HEAD COVERS, GOLF GLOVES, GOLF BALL SLEEVES, ELECTRONIC BASKETBALL TABLE TOP GAMES, BASKETBALL TABLE TOP GAMES, BASKETBALL BOARD GAMES, ACTION SKILL GAMES, ADULT'S AND CHILDREN'S PARTY GAMES, TRIVIA INFORMATION GAMES AND ELECTRONIC VIDEO ARCADE GAME MACHINES, BASKETBALL KIT COMPRISED OF A BASKETBALL NET AND WHISTLE, DOLLS, TOY ACTION FIGURES, BOBBLEHEAD ACTION FIGURES, STUFFED TOYS, JIGSAW PUZZLES AND CHRISTMAS TREE ORNAMENTS, EXCEPT CONFECTIONARY AND ILLUMINATION ARTICLES, PLAYING CARDS (U.S. CLS. 22, 23, 38 AND 50).
FIRST USE 12-31-1998; IN COMMERCE 12-31-1998.

2,955,529. MATTEL, INC., EL SEGUNDO, CA. SN 78-168,644. PUB. 12-23-2003, FILED 9-27-2002.

JULY RUBY

OWNER OF U.S. REG. NOS. 1,994,182 AND 2,153,928.
FOR TOYS, GAMES AND PLAYTHINGS, NAMELY, DOLL, DOLL CLOTHING AND DOLL ACCESSORIES (U.S. CLS. 22, 23, 38 AND 50).
FIRST USE 3-6-2003; IN COMMERCE 3-6-2003.

2,955,530. MATTEL, INC., EL SEGUNDO, CA. SN 78-168,648. PUB. 12-23-2003, FILED 9-27-2002.

JUNE PEARL

OWNER OF U.S. REG. NOS. 2,010,987, 2,364,871, AND OTHERS.
FOR TOYS, GAMES AND PLAYTHINGS, DOLL, DOLL CLOTHING AND DOLL ACCESSORIES (U.S. CLS. 22, 23, 38 AND 50).
FIRST USE 3-6-2003; IN COMMERCE 3-6-2003.

CLASS 28—(Continued).

2,955,531. MATTEL, INC., EL SEGUNDO, CA. SN 78-168,657. PUB. 12-23-2003, FILED 9-27-2002.

NOVEMBER TOPAZ

FOR TOYS, GAMES AND PLAYTHINGS, NAMELY, DOLL, DOLL CLOTHING AND DOLL ACCESSORIES (U.S. CLS. 22, 23, 38 AND 50).
FIRST USE 3-6-2003; IN COMMERCE 3-6-2003.

2,955,532. MATTEL, INC., EL SEGUNDO, CA. SN 78-168,661. PUB. 12-23-2003, FILED 9-27-2002.

OCTOBER OPAL

FOR TOYS, GAMES AND PLAYTHINGS, NAMELY, DOLL, DOLL CLOTHING AND DOLL ACCESSORIES (U.S. CLS. 22, 23, 38 AND 50).
FIRST USE 3-6-2003; IN COMMERCE 3-6-2003.

2,955,543. MATTEL, INC., EL SEGUNDO, CA. SN 78-176,459. PUB. 12-23-2003, FILED 10-21-2002.

PICNIC FIESTA

OWNER OF U.S. REG. NOS. 2,041,445 AND 2,306,429.
NO CLAIM IS MADE TO THE EXCLUSIVE RIGHT TO USE "PICNIC", APART FROM THE MARK AS SHOWN.
FOR TOYS, NAMELY, BOARD GAMES (U.S. CLS. 22, 23, 38 AND 50).
FIRST USE 4-10-2003; IN COMMERCE 4-10-2003.

2,955,546. MATTEL, INC., EL SEGUNDO, CA. SN 78-179,410. PUB. 1-13-2004, FILED 10-29-2002.

AUDACIOUS

FOR TOYS, GAMES AND PLAYTHINGS, NAMELY, TOY VEHICLES AND ACCESSORIES THEREFOR (U.S. CLS. 22, 23, 38 AND 50).
FIRST USE 4-30-2002; IN COMMERCE 4-30-2002.

2,955,551. MATTEL, INC., EL SEGUNDO, CA. SN 78-182,664. PUB. 1-6-2004, FILED 11-7-2002.

BEAT STREET

FOR TOYS, GAMES AND PLAYTHINGS, NAMELY, DOLLS, DOLL CLOTHING AND DOLL ACCESSORIES (U.S. CLS. 22, 23, 38 AND 50).
FIRST USE 5-21-2003; IN COMMERCE 5-21-2003.

CLASS 28—(Continued).

2,955,586. NELOSTUOTE OY, PORI, FINLAND. SN 78-212,120. PUB. 5-4-2004, FILED 2-7-2003.



FOR BOARD GAMES, PUZZLES, JIG-SAW PUZZLES, YO-YOS, CARD GAMES, PLAYING CARDS, CHESS SETS, DOMINOES, BACKGAMMON SETS, MAH JONG SETS, AND MIKADO GAMES (U.S. CLS. 22, 23, 38 AND 50).

FIRST USE 11-3-2000; IN COMMERCE 11-3-2000.

2,955,592. HALE, JANE D., NEW YORK, NY. SN 78-215,933. PUB. 5-4-2004, FILED 2-18-2003.



NO CLAIM IS MADE TO THE EXCLUSIVE RIGHT TO USE "YOGA", APART FROM THE MARK AS SHOWN.

FOR EQUIPMENT USED FOR YOGA, NAMELY, RUBBER MATS, COTTON MATS, AND BLOCKS (U.S. CLS. 22, 23, 38 AND 50).

FIRST USE 3-0-2003; IN COMMERCE 3-0-2003.

2,955,610. KARSTEN MANUFACTURING CORPORATION, PHOENIX, AZ. SN 78-223,687. PUB. 11-4-2003, FILED 3-10-2003.

CT

FOR GOLF CLUBS (U.S. CLS. 22, 23, 38 AND 50).
FIRST USE 8-13-2003; IN COMMERCE 8-13-2003.

CLASS 28—(Continued).

2,955,613. LIQUIDMETAL TECHNOLOGIES, TAMPA, FL. SN 78-224,935. PUB. 1-6-2004, FILED 3-12-2003.

PURE ENERGY, PERFECT POWER

FOR SPORTING GOODS, NAMELY TENNIS RACKETS, SKIS, SKI POLES AND SNOW BOARDS (U.S. CLS. 22, 23, 38 AND 50).

FIRST USE 8-0-2003; IN COMMERCE 8-0-2003.

2,955,620. WARRIOR LACROSSE, INC., WARREN, MI. SN 78-225,866. PUB. 11-18-2003, FILED 3-14-2003.

PLAYERS CLUB

FOR LACROSSE EQUIPMENT, NAMELY LACROSSE STICKS, LACROSSE HANDLES, LACROSSE STICK HEADS, LACROSSE GLOVES, AND LACROSSE SHOULDER PADS (U.S. CLS. 22, 23, 38 AND 50).

FIRST USE 8-1-2003; IN COMMERCE 8-1-2003.

2,955,626. MATTEL, INC., EL SEGUNDO, CA. SN 78-227,088. PUB. 5-25-2004, FILED 3-18-2003.

QUICK FIRE

FOR TOYS, GAMES AND PLAYTHINGS NAMELY, TOY ACTION FIGURES AND ACCESSORIES THEREFOR (U.S. CLS. 22, 23, 38 AND 50).

FIRST USE 6-17-2003; IN COMMERCE 6-17-2003.

2,955,635. MATTEL, INC., EL SEGUNDO, CA. SN 78-229,342. PUB. 6-22-2004, FILED 3-24-2003.

PRINCESS OF ANCIENT GREECE

OWNER OF U.S. REG. NOS. 2,256,249 AND 2,566,249.
FOR TOYS, GAMES, AND PLAYTHINGS, NAMELY, DOLLS, DOLL CLOTHING AND DOLL ACCESSORIES (U.S. CLS. 22, 23, 38 AND 50).

FIRST USE 11-6-2003; IN COMMERCE 11-6-2003.

2,955,640. RALPH MALTBY ENTERPRISES, INC., NEWARK, OH. SN 78-232,292. PUB. 2-3-2004, FILED 4-1-2003.

FIBERSTEEL

FOR GOLF CLUB SHAFTS (U.S. CLS. 22, 23, 38 AND 50).
FIRST USE 7-0-2003; IN COMMERCE 7-0-2003.

CLASS 28—(Continued).

2,955,657. MATTEL, INC., EL SEGUNDO, CA. SN 78-237,397.
PUB. 6-8-2004, FILED 4-14-2003.

PADDLIN' PALS

FOR TOYS, GAMES, AND PLAYTHINGS, NAMELY,
TOY FIGURES, TOY PLAYSETS AND ACCESSORIES
FOR THE FOREGOING (U.S. CLS. 22, 23, 38 AND 50).
FIRST USE 6-23-2004; IN COMMERCE 6-23-2004.

2,955,658. MATTEL, INC., EL SEGUNDO, CA. SN 78-237,399.
PUB. 6-8-2004, FILED 4-14-2003.

POSH PETS

NO CLAIM IS MADE TO THE EXCLUSIVE RIGHT TO
USE "PETS", APART FROM THE MARK AS SHOWN.
FOR TOYS, GAMES AND PLAYTHINGS, NAMELY,
DOLLS, DOLL CLOTHING, TOY ANIMALS AND DOLL
ACCESSORIES (U.S. CLS. 22, 23, 38 AND 50).
FIRST USE 10-8-2003; IN COMMERCE 10-8-2003.

2,955,664. MATTEL, INC., EL SEGUNDO, CA. SN 78-242,285.
PUB. 6-8-2004, FILED 4-25-2003.

FORMULA FUELERS

FOR TOYS, GAMES, AND PLAYTHINGS, NAMELY,
TOY VEHICLES AND ACCESSORIES THEREFOR (U.S.
CLS. 22, 23, 38 AND 50).
FIRST USE 11-26-2003; IN COMMERCE 11-26-2003.

2,955,682. KABUSHIKI KAISHA SQUARE ENIX, TA
SQUARE ENIX CO., LTD., TOKYO, JAPAN. SN 78-
253,131. PUB. 12-30-2003, FILED 5-22-2003.

TRADING ARTS

FOR DOLLS AND TOY FIGURES (U.S. CLS. 22, 23, 38
AND 50).
FIRST USE 4-14-2004; IN COMMERCE 11-0-2004.

2,955,707. ROYAL PRECISION, INC., TORRINGTON, CT. SN
78-273,761. PUB. 3-30-2004, FILED 7-14-2003.

FLIGHTED

OWNER OF U.S. REG. NOS. 2,313,814 AND 2,378,888.
FOR GOLF CLUB SHAFTS (U.S. CLS. 22, 23, 38 AND
50).
FIRST USE 3-1-1998; IN COMMERCE 3-1-1998.

CLASS 28—(Continued).

2,955,726. MATTEL, INC., EL SEGUNDO, CA. SN 78-288,533.
PUB. 6-29-2004, FILED 8-18-2003.

POWER D-CRYPTOR

FOR TOYS, GAMES AND PLAYTHINGS, NAMELY,
BOARD GAMES, CARD GAMES, ROLE-PLAYING
GAMES AND ACCESSORIES SOLD IN CONNECTION
THEREWITH (U.S. CLS. 22, 23, 38 AND 50).
FIRST USE 1-16-2004; IN COMMERCE 1-16-2004.

2,955,742. TOY STATE INDUSTRIAL LTD., KOWLOON,
HONG KONG. SN 78-298,440. PUB. 6-15-2004, FILED 9-10-
2003.

COUNTDOWN RACE SET

NO CLAIM IS MADE TO THE EXCLUSIVE RIGHT TO
USE "RACE SET", APART FROM THE MARK AS SHOWN.
FOR TOY VEHICLES (U.S. CLS. 22, 23, 38 AND 50).
FIRST USE 10-4-2004; IN COMMERCE 10-4-2004.

2,955,745. MGA ENTERTAINMENT, INC., VAN NUYS, CA.
SN 78-302,299. PUB. 5-4-2004, FILED 9-18-2003.

LATE NIGHT CONCERT

FOR TOYS, GAMES AND PLAYTHINGS, NAMELY,
DOLLS AND DOLL CLOTHING, ACCESSORIES AND
PLAYSETS (U.S. CLS. 22, 23, 38 AND 50).
FIRST USE 12-15-2003; IN COMMERCE 12-15-2003.

2,955,763. MIELKE, LARRY, PORTAGE, MI. SN 78-319,744.
PUB. 6-8-2004, FILED 10-28-2003.

MARXRITE

FOR GOLF BALL MARKERS (U.S. CLS. 22, 23, 38 AND
50).
FIRST USE 12-0-2004; IN COMMERCE 12-0-2004.

CLASS 28—(Continued).

2,955,779. PRO FISH CO., BRIELLE, NJ. SN 78-338,620. PUB. 9-21-2004, FILED 12-9-2003.

Silhouettes

THE MARK CONSISTS OF STANDARD CHARACTERS WITHOUT CLAIM TO ANY PARTICULAR FONT, STYLE, SIZE, OR COLOR.

FOR ARTIFICIAL FISHING LURES; FISHING RODS AND REELS; OTHER FISHING TACKLE (U.S. CLS. 22, 23, 38 AND 50).

FIRST USE 1-2-2004; IN COMMERCE 1-2-2004.

CLASS 29—MEATS AND PROCESSED FOODS

2,955,246. SABATH, ANNA, GILROY, CA. AND REYNOLDS, CHARLES H., GILROY, CA. SN 76-219,388. PUB. 6-18-2002, FILED 3-5-2001.

THE PERFECT DATE

NO CLAIM IS MADE TO THE EXCLUSIVE RIGHT TO USE "DATE", APART FROM THE MARK AS SHOWN.

FOR PACKAGED DRIED DATES (U.S. CL. 46).
FIRST USE 11-3-2004; IN COMMERCE 11-3-2004.

2,955,322. PACIFIC RIM FOODS, INC., SCOTTSDALE, AZ. SN 76-463,937. PUB. 11-11-2003, FILED 10-31-2002.

ACCUSOY

THE MARK CONSISTS OF STANDARD CHARACTERS WITHOUT CLAIM TO ANY PARTICULAR FONT, STYLE, SIZE, OR COLOR.

FOR SOY BASED FOOD PRODUCTS, NAMELY SOY MILK, SOY SOUR CREAM, SOY CREAM CHEESE (U.S. CL. 46).

FIRST USE 11-0-2002; IN COMMERCE 11-0-2002.

CLASS 29—(Continued).

2,955,325. IGIA SPECIALTY IMPORTS, INC., WEST HILLS, CA. SN 76-465,397. PUB. 4-6-2004, FILED 10-31-2002.

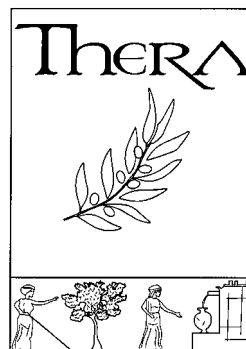

THE STIPLING IS A FEATURE OF THE MARK AND DOES NOT INDICATE COLOR.

FOR OLIVE OIL AND PROCESSED OLIVES (U.S. CL. 46).

FIRST USE 10-0-2003; IN COMMERCE 10-0-2003.

2,955,366. BEST SEA-PACK OF TEXAS, INC., DANBURY, TX. SN 76-490,593. PUB. 11-11-2003, FILED 2-19-2003.

GULF DELIGHT

FOR SEAFOOD, NAMELY, COOKED, FRESH OR FROZEN OR RAW FISH, SHRIMP CRABS OR OYSTER (U.S. CL. 46).

FIRST USE 9-25-2003; IN COMMERCE 9-25-2003.

2,955,398. DURAISAMY, PERUNDURAI CHENNIMALAI GOUNDER, DBA SAKTHI TRADING COMPANY, ERODE - 638 004, INDIA. SN 76-499,587. PUB. 6-1-2004, FILED 3-21-2003.

SAKTHI

OWNER OF U.S. REG. NO. 2,530,559.

THE MARK SAKTHI IS THE NAME OF A HINDU GODDESS.

FOR COCONUT OIL, PROCESSED DATES, FRUIT PULP, JAMS, MARMALADE, PRESERVED MUSHROOMS, PICKLES, POTATO CHIPS, SAUSAGES, SESAME OIL, PREPARATIONS FOR MAKING SOUP, PRESERVED SOYA BEANS FOR FOOD, SUNFLOWER OIL, TOMATO JUICE FOR COOKING, TOMATO PUREE, VEGETABLE JUICE FOR COOKING, DRIED VEGETABLES, BUTTER, GHEE, PRESERVED VEGETABLES, EDIBLE VEGETABLE FATS, COOKED VEGETABLES, ROASTED VEGETABLES, PREPARATIONS FOR MAKING VEGETABLE SOUP, FRUIT JELLIES, FRUIT JAMS (U.S. CL. 46).

FIRST USE 4-1-1985; IN COMMERCE 6-10-2002.

CLASS 29—(Continued).

2,955,624. DANA ALEXANDER, INC., MELVILLE, NY. SN 78-226,862. PUB. 11-11-2003, FILED 3-18-2003.

LIVE COLORFULLY

FOR VEGETABLE BASED SNACK FOODS (U.S. CL. 46).
FIRST USE 7-1-2003; IN COMMERCE 7-1-2003.

2,955,648. DANA ALEXANDER, INC., MELVILLE, NY. SN 78-235,835. PUB. 11-4-2003, FILED 4-9-2003.

TERRA LIVE COLORFULLY

OWNER OF U.S. REG. NOS. 1,652,524, 2,288,235, AND 2,352,461.
FOR VEGETABLE BASED SNACK FOODS (U.S. CL. 46).
FIRST USE 7-1-2003; IN COMMERCE 7-1-2003.

2,955,747. SONNE, INC., WAHPETON, ND. SN 78-302,951. PUB. 6-8-2004, FILED 9-19-2003.

SUN POPPERS

FOR RICE FLOUR COATED SUNFLOWER NUTS (U.S. CL. 46).
FIRST USE 2-27-2004; IN COMMERCE 2-27-2004.

2,955,799. CONSOLIDATED BISCUIT CO., MCCOMB, OH. SN 78-975,790. PUB. 1-13-2004, FILED 9-3-2002.



OWNER OF U.S. REG. NOS. 2,127,929, 2,127,930, AND 2,656,418.

NO CLAIM IS MADE TO THE EXCLUSIVE RIGHT TO USE "BACKING COMPANY", APART FROM THE MARK AS SHOWN.

FOR DRIED FRUIT SNACKS; PROCESSED NUTS; FRUIT-BASED BREAKFAST BARS; CANDIED NUTS; SNACK MIX CONSISTING MOSTLY OF NUTS AND DRIED FRUIT (U.S. CL. 46).

FIRST USE 5-20-2004; IN COMMERCE 5-20-2004.

CLASS 30—STAPLE FOODS**CLASS 30—(Continued).**

2,955,251. LIWAYWAY MARKETING CORPORATION, PASAY CITY, PHILIPPINES. SN 76-240,360. PUB. 6-29-2004, FILED 4-11-2001.



THE ENGLISH TRANSLATION OF "OISHI" IS BIG ROCK. FOR RICE FLOUR AND RICE STARCH BASED SNACK FOOD AND WHEAT FLOUR AND WHEAT STARCH BASE SNACK FOOD (U.S. CL. 46).
FIRST USE 4-11-2001; IN COMMERCE 11-23-2004.

2,955,271. VITECH AMERICA CORPORATION, INC., KENT, WA. SN 76-344,777. PUB. 3-9-2004, FILED 11-30-2001.

DROPZ

NO CLAIM IS MADE TO THE EXCLUSIVE RIGHT TO USE "DROPS", APART FROM THE MARK AS SHOWN. FOR CANDY, NAMELY, BREATH MINTS (U.S. CL. 46).

FIRST USE 10-21-2003; IN COMMERCE 10-21-2003.

2,955,311. MARS, INCORPORATED, MCLEAN, VA. SN 76-455,460. PUB. 5-6-2003, FILED 9-30-2002.

KUDOS NOW EVERYBODY'S HAPPY

FOR SNACK FOODS, NAMELY, A CHOCOLATE AND GRANOLA FOOD BAR AND A GRAIN-BASED SNACK WITH VARIOUS FLAVOR FILLINGS (U.S. CL. 46).
FIRST USE 1-1-2005; IN COMMERCE 1-1-2005.

CLASS 30—(Continued).

2,955,399. DURAISAMY, PERUNDURAI CHENNIMALAI GOUNDER, DBA SAKTHI TRADING COMPANY, ERODE - 638 004, INDIA. SN 76-499,590. PUB. 6-8-2004, FILED 3-21-2003.

SAKTHI

OWNER OF U.S. REG. NO. 2,530,559.
THE MARK SAKTHI IS THE NAME OF A HINDU GODDESS.

FOR SEASONINGS AND SPICES NAMELY MASALA POWDER, MURUKKU MIX FOR MAKING COOKIES; PAYASAM MIX FOR MAKING SWEET RICE DESSERTS; VADAI MIX MADE OUT OF CEREALS FOR MAKING VADAI; BADAM ALMOND MIX FOR MAKING CANDIES; RAGI VADAI MIX MADE OF CEREAL GRASS POWDER FOR MAKING VADAI; INSTANT WHEAT GRAIN PANCAKE MIX; FLOUR; WHEAT FLOUR; RAGI FLOUR; PROCESSED MAIZE, GRAHAM FLOUR; FOOD PRODUCTS MADE FROM FLOUR, NAMELY BREAD, BISCUITS, CAKES, PASTRIES; FLOUR MADE FROM PULSES AND DHALLS; SPICES AND SEASONINGS, NAMELY APPALAM, ASAFOETIDA, CARDAMON, TURMERIC, CUMIN, PEPPER AND SALT; CONDIMENTS, NAMELY KETCHUP, MUSTARD, CHUTNEY AND SAUCES; CHILI POWDER; SUGAR CANDIES, CHOCOLATES, AND TOFFEES; AROMATIC SPICE, NAMELY DRIED FENUGREEK LEAVES; VERMICELLI; RICE; COFFEE; TEA; SUGAR; HONEY; CORN FLAKES; PRESERVED DRIED CRISPY WAFERS; PRESERVED SEASONED RICE; AND PRESERVED AND DRIED CHILIES FOR USE AS A SEASONING (U.S. CL. 46).

FIRST USE 4-1-1995; IN COMMERCE 6-10-2002.

2,955,430. MARS, INCORPORATED, MCLEAN, VA. SN 76-528,883. PUB. 11-4-2003, FILED 7-11-2003.



OWNER OF U.S. REG. NOS. 2,068,516, 2,564,400, AND OTHERS.

NO CLAIM IS MADE TO THE EXCLUSIVE RIGHT TO USE "ALMOND", APART FROM THE MARK AS SHOWN.

THE MARK IS LINED FOR THE COLORS BLUE, BROWN, RED AND YELLOW.

THE MARK CONSISTS OF THE WORD "SNICKERS" IN STYLIZED BLUE LETTERS ON A WHITE BACKGROUND WITH A RED AND BLACK BORDER ATOP A TAN AND YELLOW FIELD OF ALMONDS WITH A YELLOW BORDER. THE WORD "ALMOND" APPEARS BELOW THE CANDY BAR ON THE LOWER RIGHT SIDE IN STYLIZED WHITE LETTERS. THESE ARE SITUATED ON AN OFF-WHITE BACKGROUND. THERE IS LIGHT BROWN SHADING IN THE UPPER LEFT HAND CORNER.

FOR FROZEN CONFECTIONS (U.S. CL. 46).
FIRST USE 7-0-2003; IN COMMERCE 7-0-2003.

CLASS 30—(Continued).

2,955,450. FRANKLIN CONNECTIONS, L.P., EL PASO, TX. SN 76-543,961. PUB. 5-25-2004, FILED 9-10-2003.

CARNIVAL CRUNCH

NO CLAIM IS MADE TO THE EXCLUSIVE RIGHT TO USE "CRUNCH", APART FROM THE MARK AS SHOWN.
FOR SNACK MIX (U.S. CL. 46).
FIRST USE 1-1-2004; IN COMMERCE 1-1-2004.

2,955,505. BROWN & HALEY, TACOMA, WA. SN 78-149,518. PUB. 12-23-2003, FILED 7-31-2002.

MOCHA ROCA

OWNER OF U.S. REG. NOS. 1,156,555, 2,196,160, AND OTHERS.

NO CLAIM IS MADE TO THE EXCLUSIVE RIGHT TO USE "MOCHA", APART FROM THE MARK AS SHOWN.
FOR CANDY (U.S. CL. 46).
FIRST USE 11-0-2002; IN COMMERCE 11-0-2002.

2,955,545. WINDSOR QUALITY FOOD COMPANY LTD., HOUSTON, TX. SN 78-177,373. PUB. 10-28-2003, FILED 10-23-2002.

GARDEN TRIO TORTELLINI

NO CLAIM IS MADE TO THE EXCLUSIVE RIGHT TO USE "TORTELLINI", APART FROM THE MARK AS SHOWN.
FOR TORTELLINI AND PASTA (U.S. CL. 46).
FIRST USE 8-13-2002; IN COMMERCE 8-13-2002.

2,955,557. CARGILL, INCORPORATED, WAYZATA, MN. SN 78-192,454. PUB. 10-14-2003, FILED 12-9-2002.

ASCEND

FOR FLAVORING ADDITIVES FOR NON-NUTRITIONAL PURPOSES (U.S. CL. 46).
FIRST USE 2-12-2003; IN COMMERCE 2-12-2003.

CLASS 30—(Continued).

2,955,568. LITTLE BEAR ORGANIC FOODS, INC., CARSON, CA. SN 78-199,100. PUB. 9-30-2003, FILED 12-31-2002.



OWNER OF U.S. REG. NOS. 1,307,322, 1,555,950, AND 2,337,071.

NO CLAIM IS MADE TO THE EXCLUSIVE RIGHT TO USE "SNACK FOODS", APART FROM THE MARK AS SHOWN.

FOR POPPED POPCORN, MICROWAVE POPCORN, TORTILLA CHIPS, CHEESE FLAVORED PUFFED CORN SNACKS, CORN CHIPS, TACO SHELLS, SEASONINGS (U.S. CL. 46).

FIRST USE 1-0-2003; IN COMMERCE 1-0-2003.

2,955,596. SARAMAR, L.L.C., CHICAGO, IL. SN 78-217,707. PUB. 10-14-2003, FILED 2-21-2003.

SEVEN LAYERS OF HEAVEN

FOR BAKERY GOODS (U.S. CL. 46).
FIRST USE 5-8-2003; IN COMMERCE 5-8-2003.

2,955,663. HAGGEN, INC., BELLINGHAM, WA. SN 78-242,160. PUB. 2-3-2004, FILED 4-25-2003.

TERRAVIDA COFFEE

NO CLAIM IS MADE TO THE EXCLUSIVE RIGHT TO USE "COFFEE", APART FROM THE MARK AS SHOWN.

FOR COFFEE, COFFEE BEANS, TEA, HOT CHOCOLATE, COCOA, CANDY MINTS, CANDY, CHOCOLATE AND PASTRIES (U.S. CL. 46).

FIRST USE 2-4-2004; IN COMMERCE 2-4-2004.

2,955,708. COOPER, BARRY, P. W., KINGSHILL, US VIRGIN ISLANDS. SN 78-274,129. PUB. 6-1-2004, FILED 7-14-2003.

COOPER'S

OWNER OF U.S. REG. NOS. 2,740,357 AND 2,774,022.
FOR TEA AND TEA BASED BEVERAGES; TEA EXTRACTS; TEA BAGS (U.S. CL. 46).
FIRST USE 7-0-2002; IN COMMERCE 7-0-2002.

CLASS 30—(Continued).

2,955,743. INTIMATE BEAUTY CORPORATION, DBA VICTORIA'S SECRET BEAUTY, NEW YORK, NY. SN 78-300,535. PUB. 6-8-2004, FILED 9-15-2003.

BITTEN BY LOVE

FOR CANDY, NAMELY, CHOCOLATE (U.S. CL. 46).
FIRST USE 2-1-2004; IN COMMERCE 2-1-2004.

2,955,774. KRAFT FOODS HOLDINGS, INC., NORTHFIELD, IL. SN 78-332,729. PUB. 9-21-2004, FILED 11-25-2003.

**GROOVALICIOUS
GRAPE**

THE MARK CONSISTS OF STANDARD CHARACTERS WITHOUT CLAIM TO ANY PARTICULAR FONT, STYLE, SIZE, OR COLOR.

NO CLAIM IS MADE TO THE EXCLUSIVE RIGHT TO USE "GRAPE", APART FROM THE MARK AS SHOWN.

FOR FLAVORED, SWEETENED GELATIN DESSERTS (U.S. CL. 46).

FIRST USE 3-1-2004; IN COMMERCE 3-1-2004.

2,955,801. BP INTERNATIONAL RIGHTS HOLDINGS INC., RICHMOND, BRITISH COLUMBIA, CANADA. SN 78-975,938. PUB. 6-8-2004, FILED 9-5-2003.

MAMA MEATA

FOR PIZZA (U.S. CL. 46).
FIRST USE 9-8-2003; IN COMMERCE 9-8-2003.

CLASS 31—NATURAL AGRICULTURAL PRODUCTS

2,955,309. DENTACLEAN, LLC, PALISADES PARK, NJ. SN 76-455,079. PUB. 12-2-2003, FILED 9-27-2002.

MEGA-BONE

FOR ORAL HYGIENE PRODUCTS FOR PETS, NAMELY, EDIBLE TREATS (U.S. CLS. 1 AND 46).
FIRST USE 1-17-2005; IN COMMERCE 1-17-2005.

CLASS 31—(Continued).

2,955,464. BOOTH RANCHES, ORANGE COVE, CA. SN 76-557,854. PUB. 9-21-2004, FILED 11-3-2003.

FLYING O

THE MARK CONSISTS OF STANDARD CHARACTERS WITHOUT CLAIM TO ANY PARTICULAR FONT, STYLE, SIZE, OR COLOR.

FOR FRESH ORANGES AND OTHER CITRUS PRODUCTS, NAMELY FRESH TANGERINES, FRESH TANGELOS, AND FRESH GRAPEFRUITS (U.S. CLS. 1 AND 46).

FIRST USE 2-12-2004; IN COMMERCE 2-12-2004.

2,955,466. J. FRANK SCHMIDT & SON CO., BORING, OR. SN 76-563,090. PUB. 9-21-2004, FILED 12-3-2003.

PRESIDENTIAL GOLD

THE MARK CONSISTS OF STANDARD CHARACTERS WITHOUT CLAIM TO ANY PARTICULAR FONT, STYLE, SIZE, OR COLOR.

NO CLAIM IS MADE TO THE EXCLUSIVE RIGHT TO USE "GOLD", APART FROM THE MARK AS SHOWN.

FOR LIVE PLANTS, INCLUDING LIVE TREES (U.S. CLS. 1 AND 46).

FIRST USE 2-19-2004; IN COMMERCE 2-19-2004.

2,955,512. DEL MONTE CORPORATION, PITTSBURGH, PA. SN 78-155,610. PUB. 9-30-2003, FILED 8-19-2002.

STUFFERS

FOR PET FOOD AND PET SNACKS (U.S. CLS. 1 AND 46).

FIRST USE 9-11-2003; IN COMMERCE 9-11-2003.

2,955,524. TONELERIA NACIONAL LTDA., SANTIAGO, CHILE. SN 78-164,429. PUB. 1-27-2004, FILED 9-16-2002.

TECH-STAVE

FOR WOODEN STAVES FOR WINE BARRELS AND WINE TANKS (U.S. CLS. 1 AND 46).

FIRST USE 8-20-2004; IN COMMERCE 8-20-2004.

CLASS 31—(Continued).

2,955,547. C-LITE INTERNATIONAL, INC., SAN ANTONIO, TX. SN 78-180,248. PUB. 11-18-2003, FILED 10-30-2002.

C-LITE

FOR NON-MEDICATED ADDITIVES FOR ANIMAL AND POULTRY FEED (U.S. CLS. 1 AND 46).

FIRST USE 7-13-2004; IN COMMERCE 7-13-2004.

2,955,558. RAGAN AND MASSEY, INC., PONCHATOULA, LA. SN 78-193,421. PUB. 6-8-2004, FILED 12-11-2002.

PLOT SPIKE ADDICTANT

OWNER OF U.S. REG. NO. 2,737,430. FOR PRODUCTS FOR WILDLIFE, NAMELY MINERALS TO ATTRACT WILDLIFE, NAMELY SODIUM AND CALCIUM (U.S. CLS. 1 AND 46).

FIRST USE 10-31-2003; IN COMMERCE 10-31-2003.

2,955,674. SOCIETE DES PRODUITS NESTLE S. A., VEVEY, SWITZERLAND. SN 78-249,108. PUB. 2-10-2004, FILED 5-13-2003.

PET PROMISE

THE MARK CONSISTS OF STANDARD CHARACTERS WITHOUT CLAIM TO ANY PARTICULAR FONT, STYLE, SIZE, OR COLOR.

NO CLAIM IS MADE TO THE EXCLUSIVE RIGHT TO USE "PET", APART FROM THE MARK AS SHOWN.

FOR PET FOOD; DOG FOOD; CAT FOOD (U.S. CLS. 1 AND 46).

FIRST USE 10-4-2004; IN COMMERCE 10-4-2004.

CLASS 32—LIGHT BEVERAGES

2,955,327. WAKEFERN FOOD CORP., ELIZABETH, NJ. SN 76-467,249. PUB. 10-14-2003, FILED 11-6-2002.

CLEAR DELIGHT

NO CLAIM IS MADE TO THE EXCLUSIVE RIGHT TO USE "CLEAR", APART FROM THE MARK AS SHOWN.

FOR NON-ALCOHOLIC BEVERAGES, NAMELY, SPARKLING WATER (U.S. CLS. 45, 46 AND 48).

FIRST USE 12-13-2004; IN COMMERCE 12-13-2004.

CLASS 32—(Continued).

2,955,467. THE COCA-COLA COMPANY, ATLANTA, GA. SN 76-563,650. PUB. 9-21-2004, FILED 11-24-2003.



NO CLAIM IS MADE TO THE EXCLUSIVE RIGHT TO USE "ENERGY DRINK", APART FROM THE MARK AS SHOWN.

FOR BEVERAGES, NAMELY ENERGY DRINKS (U.S. CLS. 45, 46 AND 48).

FIRST USE 11-22-2004; IN COMMERCE 11-22-2004.

2,955,537. SCHWAN'S IP, LLC, MARSHALL, MN. SN 78-174,366. PUB. 1-20-2004, FILED 10-15-2002.

ZERO LIMIT

FOR SMOOTHIES (U.S. CLS. 45, 46 AND 48).
FIRST USE 2-28-2003; IN COMMERCE 2-28-2003.

2,955,625. ETHOS INTERNATIONAL, NEW YORK, NY. SN 78-227,050. PUB. 11-11-2003, FILED 3-18-2003.

eth₂os

FOR DRINKING WATER (U.S. CLS. 45, 46 AND 48).
FIRST USE 6-0-2003; IN COMMERCE 12-0-2003.

CLASS 32—(Continued).

2,955,738. SATO PHARMACEUTICAL CO., LTD., TOKYO, JAPAN. SN 78-294,339. PUB. 5-25-2004, FILED 8-29-2003.

KOTEI

FOR HERBAL AND TONIC SOFT DRINKS (U.S. CLS. 45, 46 AND 48).
FIRST USE 1-1-1968; IN COMMERCE 12-1-2004.

2,955,776. SAVE-A-LOT FOOD STORES, LTD., EARTH CITY, MO. SN 78-335,594. PUB. 10-26-2004, FILED 12-3-2003.

VERY CHERRY BUBBA

THE MARK CONSISTS OF STANDARD CHARACTERS WITHOUT CLAIM TO ANY PARTICULAR FONT, STYLE, SIZE, OR COLOR.

OWNER OF U.S. REG. NO. 1,936,360.

NO CLAIM IS MADE TO THE EXCLUSIVE RIGHT TO USE "CHERRY". APART FROM THE MARK AS SHOWN.

FOR SOFT DRINKS (U.S. CLS. 45, 46 AND 48).

FIRST USE 5-15-2004; IN COMMERCE 5-15-2004.

CLASS 33—WINES AND SPIRITS

2,955,269. BODEGAS VALSACRO, SA, LA RIOJA, SPAIN. SN 76-331,526. PUB. 10-28-2003, FILED 9-11-2000.



NO CLAIM IS MADE TO THE EXCLUSIVE RIGHT TO USE "VINI", APART FROM THE MARK AS SHOWN.

THE MARK CONSISTS OF A TRIANGULAR DESIGN WITHIN WHICH RESIDES THE DEPICTION OF A SUNBURST PATTERN, THE FIGURE OF A CROSS, AN EYE AND FRUIT.

THE ENGLISH TRANSLATION OF "BIBI VINI", "BIBI VINCI", "VINI VALSACRO" IS "DRINK WINE", "DRINK AND WIN", "WINE VALSACRO."

FOR WINE (U.S. CLS. 47 AND 49).

FIRST USE 5-10-2000; IN COMMERCE 5-10-2000.

CLASS 33—(Continued).

2,955,279. MILL CREEK CELLARS LLC, WALLA WALLA, WA. SN 76-378,131. PUB. 12-3-2002, FILED 3-1-2002.

CLASS 33—(Continued).

2,955,440. ALPHONSE CAPONE ENTERPRISES, INC., ST. CHARLES, IL. SN 76-535,937. PUB. 7-6-2004, FILED 7-29-2003.

VIGNETTE

FOR WINES (U.S. CLS. 47 AND 49).
FIRST USE 2-22-2005; IN COMMERCE 2-22-2005.

2,955,336. TEQUILA TAPATIO, S.A., ARANDAS, JAILSCO, MEXICO. SN 76-475,570. PUB. 2-17-2004, FILED 12-16-2002.

EL TESORO PLATINUM

THE ENGLISH TRANSLATION OF THE SPANISH WORDING "EL TESORO" IS "THE TREASURE".
FOR TEQUILA (U.S. CLS. 47 AND 49).
FIRST USE 6-1-2003; IN COMMERCE 6-1-2003.

2,955,337. LA INVERSORA S.A., PROVINCIA DE NEUQUEN, ARGENTINA. SN 76-476,030. PUB. 3-9-2004, FILED 12-16-2002.

NEWEN

FOR WINES, DISTILLED SPIRITS, WHISKEY, BRANDY, COGNAC, CORDIALS, LIQUEURS AND APERITIFS WITH A WINE BASE (U.S. CLS. 47 AND 49).
FIRST USE 5-16-2002; IN COMMERCE 9-23-2004.

2,955,368. LEBANESE ARAK CORPORATION, GLENDALE, CA. SN 76-490,849. PUB. 5-18-2004, FILED 2-14-2003.

NOAH DABAN

THE NAME IN THE MARK IDENTIFIES A LIVING INDIVIDUAL WHOSE CONSENT IS OF RECORD.
FOR VODKA (U.S. CLS. 47 AND 49).
FIRST USE 11-16-2000; IN COMMERCE 11-16-2000.



THE MARK CONSISTS OF A THOMPSON SUBMACHINE GUN BOTTLE DESIGN CONFIGURATION OF THE PACKAGING FOR THE WINES AND DISTILLED SPIRITS WITH A BOTTLE OPENING AT A DISTAL END OF A BARREL.

FOR DISTILLED SPIRITS (U.S. CLS. 47 AND 49).
FIRST USE 1-0-2003; IN COMMERCE 12-15-2004.

2,955,468. STOLLER WHOLESALE WINES & SPIRITS, INC., DBA MARSALLE COMPANY, FRANKLIN PARK, IL. SN 76-565,088. PUB. 8-31-2004, FILED 12-4-2003.

LITTLE BROTHER

THE MARK CONSISTS OF STANDARD CHARACTERS WITHOUT CLAIM TO ANY PARTICULAR FONT, STYLE, SIZE, OR COLOR.

FOR GIN (U.S. CLS. 47 AND 49).
FIRST USE 7-8-2004; IN COMMERCE 7-8-2004.

CLASS 33—(Continued).

2,955,470. STRATO TRADING GROUP, INC., NEW YORK, NY. SN 76-569,606. PUB. 10-12-2004, FILED 1-8-2004.

SERAPHIN

THE MARK CONSISTS OF STANDARD CHARACTERS WITHOUT CLAIM TO ANY PARTICULAR FONT, STYLE, SIZE, OR COLOR.

FOR ALCOHOLIC BEVERAGES, NOT INCLUDING BEER, NAMELY BRANDY AND COGNAC (U.S. CLS. 47 AND 49).

FIRST USE 10-1-2004; IN COMMERCE 10-1-2004.

2,955,577. TCHOLAKOV, MIROSLAV, IVANOV, CLOVERDALE, CA. SN 78-204,901. PUB. 9-2-2003, FILED 1-19-2003.

MIRO

FOR WINE (U.S. CLS. 47 AND 49).
FIRST USE 3-15-2004; IN COMMERCE 2-4-2004.

2,955,598. LA RURAL VIÑEDOS Y BODEGAS S.A. LTDA, PROV. DE MENDOZA, ARGENTINA. SN 78-218,237. PUB. 5-4-2004, FILED 2-24-2003.

DULCINEA

FOR WINES AND SPIRITS (U.S. CLS. 47 AND 49).
FIRST USE 5-11-2004; IN COMMERCE 5-11-2004.

2,955,706. VIÑA DASSAULT-SAN PEDRO S.A., SANTIAGO, CHILE. SN 78-273,143. PUB. 6-1-2004, FILED 7-11-2003.

SIDERAL

FOR WINES AND LIQUORS (U.S. CLS. 47 AND 49).
FIRST USE 7-0-2004; IN COMMERCE 11-0-2004.

CLASS 33—(Continued).

2,955,716. SPAGNOL'S WINE & BEER MAKING SUPPLIES LTD., NIAGARA FALLS, ONTARIO, CANADA. SN 78-280,408. PUB. 5-11-2004, FILED 7-29-2003.

• O R C H A R D •
BREEZIN'

FOR KIT FOR MAKING WINE COMPOSED OF A MIXTURE CONTAINING YEASTS, ACIDS AND GRAPE CONCENTRATES, GLASS BOTTLES, BUCKETS, HOSES, BAGS AND CORKS SOLD AS A UNIT (U.S. CLS. 47 AND 49).

FIRST USE 5-31-2003; IN COMMERCE 5-31-2003.

CLASS 34—SMOKERS' ARTICLES

2,955,492. SOUTHERN SMOKE LLC, ATLANTA, GA. SN 78-111,035. PUB. 5-6-2003, FILED 2-26-2002.

CUBAN MISTAKES

NO CLAIM IS MADE TO THE EXCLUSIVE RIGHT TO USE "CUBAN", APART FROM THE MARK AS SHOWN.

FOR CIGARS CONTAINING TOBACCO FROM CUBAN TOBACCO SEEDS (U.S. CLS. 2, 8, 9 AND 17).

FIRST USE 1-1-2005; IN COMMERCE 1-1-2005.

2,955,655. BURLWOOD GROUP, INC., BURBANK, CA. SN 78-237,003. PUB. 11-18-2003, FILED 4-11-2003.

CONGA

FOR CIGARS (U.S. CLS. 2, 8, 9 AND 17).
FIRST USE 8-0-2003; IN COMMERCE 8-0-2003.

CLASS 34—(Continued).

2,955,705. H-D MICHIGAN, INC., ANN ARBOR, MI. SN 78-271,912. PUB. 9-28-2004, FILED 7-9-2003.



THE MARK CONSISTS OF A NUMBER ONE WITH RED AND WHITE STRIPES ON THE BOTTOM PART AND BLUE BACKGROUND WITH WHITE STARS ON THE TOP PART. FOR LIGHTERS NOT OF PRECIOUS METAL (U.S. CLS. 2, 8, 9 AND 17).
FIRST USE 7-0-2003; IN COMMERCE 7-0-2003.

SERVICE MARKS**CLASS 35—ADVERTISING AND BUSINESS**

2,955,187. GO SCORE, LLC, HARTFORD, CT. SN 75-268,046. PUB. 2-17-1998, FILED 4-2-1997.

GO SCORE

FOR SPORTS AGENCY SERVICES, NAMELY, SPORTS ASSET MANAGEMENT AND PROMOTION OF SPORTS FIGURES AND COMPETITIVE EVENTS (U.S. CLS. 100, 101 AND 102).
FIRST USE 10-2-1996; IN COMMERCE 10-2-1996.

2,955,212. KINGSLEY, TODD, STANTON ISLAND, NY. SN 76-016,796. PUB. 9-4-2001, FILED 4-4-2000.

ANYTOOL

FOR ON-LINE RETAIL STORE AND WHOLESALE SERVICES FEATURING LEARNING TOOLS USED IN THE COURSE OF INSTRUCTING IN THE FIELDS OF CONSTRUCTION AND MEDICINE (U.S. CLS. 100, 101 AND 102).
FIRST USE 11-21-2004; IN COMMERCE 11-21-2004.

CLASS 35—(Continued).

2,955,255. V. PATEL AND SONS, INC., DBA PATEL BROTHERS, AND RAJA FOODS, CHICAGO, IL. SN 76-255,687. PUB. 12-2-2003, FILED 5-11-2001.

PATEL BROTHERS CASH & CARRY

OWNER OF U.S. REG. NOS. 1,874,341, 2,043,986, AND OTHERS.

NO CLAIM IS MADE TO THE EXCLUSIVE RIGHT TO USE "CASH & CARRY", APART FROM THE MARK AS SHOWN.

SEC. 2(F) AS TO "PATEL BROTHERS".
FOR RETAIL AND WHOLESALE GROCERY STORE SERVICES (U.S. CLS. 100, 101 AND 102).
FIRST USE 0-0-1989; IN COMMERCE 0-0-1989.

2,955,282. NITRO ICE CREAM, LLC, BOONE, IA. SN 76-384,146. PUB. 5-4-2004, FILED 3-18-2002.

BLUE SKY CREAMERY

NO CLAIM IS MADE TO THE EXCLUSIVE RIGHT TO USE "CREAMERY", APART FROM THE MARK AS SHOWN.

FOR RETAIL OUTLETS FEATURING ICE CREAM AND FROZEN CONFECTIONS (U.S. CLS. 100, 101 AND 102).

FIRST USE 8-1-2002; IN COMMERCE 8-1-2002.

2,955,288. WILINK U.S. HOLDINGS INC., RICHMOND, VA. SN 76-417,752. PUB. 6-17-2003, FILED 6-5-2002.



NO CLAIM IS MADE TO THE EXCLUSIVE RIGHT TO USE "IR", APART FROM THE MARK AS SHOWN.

FOR DISTRIBUTION OF BUSINESS INFORMATION, NAMELY, ANNUAL, SHAREHOLDER AND OTHER BUSINESS AND COMPANY REPORTS AND FUND REPORTS AND PROSPECTUSES OF OTHERS; FACILITATION OF BUSINESS MEETINGS, NAMELY, ORGANIZING, CONDUCTING AND HOSTING MEETINGS BETWEEN BUSINESSES AND POTENTIAL INVESTORS CONDUCTED IN PERSON AND ELECTRONICALLY; COMPUTERIZED ON-LINE SEARCH AND ORDERING SERVICE FEATURING INVESTOR INFORMATION DIRECTED TO BUSINESSES (U.S. CLS. 100, 101 AND 102).
FIRST USE 6-0-2002; IN COMMERCE 6-0-2002.

CLASS 35—(Continued).

2,955,297. ETRAUMA.COM CORP., DEERFIELD BEACH, FL. SN 76-444,378. PUB. 10-28-2003, FILED 8-26-2002.

SCRIPTS

FOR ADVERTISING SERVICES FOR OTHERS, NAMELY BROADCASTING ADVERTISING FOR OTHERS ON SCREENSAVERS APPEARING ON COMPUTER MONITORS (U.S. CLS. 100, 101 AND 102).
FIRST USE 11-20-2003; IN COMMERCE 11-20-2003.

CLASS 35—(Continued).

2,955,353. BIKESTER INC., PACIFIC PALISADES, CA. SN 76-482,848. PUB. 11-4-2003, FILED 1-16-2003.

BIKESTER

FOR RETAIL STORE SERVICES AND ON-LINE RETAIL STORE SERVICES IN THE FIELD OF BICYCLES AND BICYCLES ACCESSORIES (U.S. CLS. 100, 101 AND 102).

FIRST USE 12-1-2003; IN COMMERCE 12-1-2003.

2,955,312. VENVEST, INC., ST. LOUIS, MO. SN 76-456,906. PUB. 1-13-2004, FILED 10-8-2002.

2,955,354. WPL GROUP, LLC, BIRMINGHAM, AL. SN 76-483,702. PUB. 6-8-2004, FILED 1-22-2003.



NO CLAIM IS MADE TO THE EXCLUSIVE RIGHT TO USE "CUSTOMER", APART FROM THE MARK AS SHOWN. FOR BUSINESS AND MARKETING CONSULTATION SERVICES (U.S. CLS. 100, 101 AND 102).
FIRST USE 8-16-2002; IN COMMERCE 8-16-2002.

**WEDDING POINTS
MARRIAGE HAS GREAT
REWARDS**

NO CLAIM IS MADE TO THE EXCLUSIVE RIGHT TO USE "POINTS", APART FROM THE MARK AS SHOWN.

FOR PROMOTING THE GOODS AND SERVICES OF OTHERS THROUGH THE ADMINISTRATION OF INCENTIVE REWARD PROGRAMS BY AWARDING POINTS TO PURCHASERS WHICH MAY BE REDEEMED FOR GOODS AND SERVICES, OR DONATED TO OTHERS WHO MAY REDEEM THEM FOR GOODS AND SERVICES (U.S. CLS. 100, 101 AND 102).

FIRST USE 7-26-2004; IN COMMERCE 7-26-2004.

2,955,321. WAREHOUSE HOME FURNISHING DISTRIBUTORS, INC., DUBLIN, GA. SN 76-463,665. PUB. 2-3-2004, FILED 11-1-2002.



OWNER OF U.S. REG. NOS. 1,589,486, 2,569,395, AND OTHERS.

NO CLAIM IS MADE TO THE EXCLUSIVE RIGHT TO USE "HOME FURNITURE", APART FROM THE MARK AS SHOWN.

THE COLOR(S) WHITE, YELLOW AND BLUE IS/ARE CLAIMED AS A FEATURE OF THE MARK.

COLOR IS CLAIMED AS A FEATURE OF THE MARK. THE WORDS "FARMERS" AND "FURNITURE" ARE WHITE AND THE WORD "HOME" IS YELLOW (COLOR NO. 1225) SITTING ON A BLUE (COLOR NO. 2718) BOX BACKGROUND.

FOR RETAIL STORE SERVICES FEATURING FURNITURE (U.S. CLS. 100, 101 AND 102).

FIRST USE 6-1-2003; IN COMMERCE 6-1-2003.

2,955,359. BROWN & COLE STORES, LLC, BELLINGHAM, WA. SN 76-486,220. PUB. 8-24-2004, FILED 1-30-2003.

GRASS ROOTS RETAILING

NO CLAIM IS MADE TO THE EXCLUSIVE RIGHT TO USE "RETAILING", APART FROM THE MARK AS SHOWN.

FOR RETAIL GROCERY STORES (U.S. CLS. 100, 101 AND 102).

FIRST USE 1-0-2003; IN COMMERCE 1-0-2003.

2,955,365. STREETSMART STRATEGIES, INC., CHICAGO, IL. SN 76-489,637. PUB. 11-4-2003, FILED 2-14-2003.

**WHERE WALL STREET
INTERSECTS MAIN STREET**

FOR BUSINESS MANAGEMENT CONSULTING SERVICES, NAMELY INVESTOR RELATIONS CONSULTING TO PUBLICLY TRADED COMPANIES (U.S. CLS. 100, 101 AND 102).

FIRST USE 7-0-2004; IN COMMERCE 7-0-2004.

CLASS 35—(Continued).

2,955,433. VENTIV HEALTH, INC., SOMERSET, NJ. SN 76-531,953. PUB. 7-27-2004, FILED 7-14-2003.

VENFEMME
The Ventiv Women's Health Group

NO CLAIM IS MADE TO THE EXCLUSIVE RIGHT TO USE WOMEN'S HEALTH GROUP, APART FROM THE MARK AS SHOWN.

THE COLOR(S) RED AND BLUE IS/ARE CLAIMED AS A FEATURE OF THE MARK.

THE MARK COMPRISES THE TERM "VENFEMME" RENDERED IN RED AND BLUE, UNDERLINED IN RED INK AND DISPLAYED WITH THE PHRASE "THE VENTIV WOMEN'S HEALTH GROUP" RENDERED IN BLUE INK.

FOR PROMOTING THE HEALTHCARE PRODUCTS AND SERVICES OF OTHERS RELATING TO WOMEN'S HEALTH BY DISTRIBUTING PRINTED MATERIAL; INDEPENDENT SALES REPRESENTATIVES IN THE FIELD OF HEALTHCARE PRODUCTS AND SERVICES RELATED TO WOMEN'S HEALTH; RETAIL SERVICES BY DIRECT SOLICITATION BY SALES AGENTS IN THE FIELD OF HEALTHCARE PRODUCTS AND SERVICES RELATING TO WOMEN'S HEALTH (U.S. CLS. 100, 101 AND 102).

FIRST USE 3-31-2003; IN COMMERCE 8-9-2003.

2,955,443. INCHORD COMMUNICATIONS, INC., WESTERVILLE, OH. SN 76-537,075. PUB. 5-4-2004, FILED 7-29-2003.

YQ INDEX

FOR BRANDING CONSULTING SERVICES TO THE PHARMACEUTICAL INDUSTRY, NAMELY PROVIDING MARKETING AND BRAND BUILDING RECOMMENDATIONS TO PHARMACEUTICAL COMPANIES TO HELP THEM GROW THEIR BUSINESS; AND MARKETING RESEARCH SERVICES (U.S. CLS. 100, 101 AND 102).

FIRST USE 1-1-2003; IN COMMERCE 1-1-2003.

CLASS 35—(Continued).

2,955,473. CLEAR CHANNEL IDENTITY, L.P., SAN ANTONIO, TX. SN 76-976,671. PUB. 8-3-2004, FILED 7-16-2001.

 **CLEAR CHANNEL**
ENTERTAINMENT

OWNER OF U.S. REG. NO. 2,361,253.

NO CLAIM IS MADE TO THE EXCLUSIVE RIGHT TO USE "ENTERTAINMENT", APART FROM THE MARK AS SHOWN.

FOR PROMOTING A VARIETY OF LIVE ENTERTAINMENT EVENTS FOR OTHERS AND MERCHANDISE RELATED THERETO; BUSINESS AND EVENT MANAGEMENT OF MUSICAL, THEATRICAL AND FAMILY/VARIETY TOURS AND PRESENTATIONS; OPERATION AND MANAGEMENT OF ENTERTAINMENT VENUES; MANAGEMENT OF PROFESSIONAL ATHLETES, PROFESSIONAL SPORTS GROUPS AND MEDIA TALENT; BUSINESS MANAGEMENT, EVENT MANAGEMENT SERVICES AND BUSINESS MARKETING AND CONSULTING SERVICES IN THE FIELDS OF SPORTS, NEWS, AND ENTERTAINMENT; BUSINESS MANAGEMENT IN THE NATURE OF SECURING NAMING RIGHTS SPONSORSHIP AGREEMENTS FOR PROFESSIONAL SPORTS AND COLLEGE ARENAS; RETAIL STORE SERVICES FEATURING ARTIST AND TOUR-RELATED MERCHANDISE AND COLLECTIBLES; BUSINESS DEVELOPMENT AND MANAGEMENT OF SPECIALIZED MOTOR SPORT EVENTS; PROMOTING TICKET SALES AND "VIP" PRIVILEGES FOR LIVE ENTERTAINMENT EVENTS; PROMOTING THE SALE OF FANTASY SPORTS AND ENTERTAINMENT PACKAGES; PROVIDING AUCTION SERVICES FOR FANTASY SPORTS AND ENTERTAINMENT PACKAGES (U.S. CLS. 100, 101 AND 102).

FIRST USE 5-31-2001; IN COMMERCE 5-31-2001.

2,955,488. KOPP, GUILLERMO ARTURO, DARIEN, CT. AND SORIA DE KOPP, GABRIELA MARIA, DARIEN, CT. SN 78-082,539. PUB. 2-4-2003, FILED 9-4-2001.

GUAU

THE ENGLISH TRANSLATION OF THE WORD "GUAU" IN THE MARK IS "WOOF" OR "BOW-WOW" IN SPANISH.

FOR BUSINESS MANAGEMENT CONSULTANCY SERVICES IN THE FIELD OF OVERALL BUSINESS PERFORMANCE AND CUSTOMER SATISFACTION, INCLUDING CONSULTANCY SERVICES WITH REGARD TO METHODS TO IDENTIFY FACTORS THAT LEAD TO CUSTOMER SATISFACTION, VALUE FACTORS, NAMELY, THE PERCEIVED WORTH IN TERMS OF THE USEFULNESS AND IMPORTANCE OF THE CLIENTS' PRODUCTS OR SERVICES INVOLVED, OF THE QUALITY OF THEIR DESIRABLE AND REQUIRED ATTRIBUTES, AND OF THEIR FITNESS FOR USE IN SPECIFIC BUSINESS OR ETHNICAL ENVIRONMENTS, AND THE UNDERLYING CAUSES OF CLIENTS' BUSINESS PROBLEMS (U.S. CLS. 100, 101 AND 102).

FIRST USE 9-26-2003; IN COMMERCE 9-26-2003.

CLASS 35—(Continued).

2,955,490. SPEEDWAY SUPERAMERICA LLC, ENON, OH. SN 78-093,286. PUB. 12-9-2003, FILED 11-14-2001.

BEER CAVE

NO CLAIM IS MADE TO THE EXCLUSIVE RIGHT TO USE "BEER", APART FROM THE MARK AS SHOWN.

FOR RETAIL STORE SERVICES FEATURING BEVERAGES (U.S. CLS. 100, 101 AND 102).

FIRST USE 10-31-2003; IN COMMERCE 10-31-2003.

2,955,495. DAVIS, SHEANA JUSTINE, SONOMA, CA. SN 78-132,923. PUB. 9-14-2004, FILED 6-3-2002.

SHEANA DAVIS THE EPICUREAN CONNECTION

THE NAME "SHEANA DAVIS" IDENTIFIES A LIVING INDIVIDUAL WHOSE CONSENT IS OF RECORD.

FOR INDEPENDENT SALES REPRESENTATIVE IN THE FIELD OF FOOD AND BEVERAGE (U.S. CLS. 100, 101 AND 102).

FIRST USE 3-6-2001; IN COMMERCE 3-6-2001.

2,955,508. PNEUMATIC TECHNOLOGY, INC., TROPHY CLUB, TX. SN 78-152,290. PUB. 10-21-2003, FILED 8-8-2002.

PNEUTECH TRAILER SALES

NO CLAIM IS MADE TO THE EXCLUSIVE RIGHT TO USE "TRAILER SALES", APART FROM THE MARK AS SHOWN.

FOR DISTRIBUTORSHIP SERVICES IN THE FIELD OF TANK TRAILERS AND PARTS AND ACCESSORIES THEREOF (U.S. CLS. 100, 101 AND 102).

FIRST USE 12-15-2004; IN COMMERCE 12-15-2004.

2,955,515. NICHOLS, DEBORAH L., CRESTWOOD, IL. SN 78-159,011. PUB. 5-20-2003, FILED 8-29-2002.



FOR RETAIL STORE SERVICES IN THE FIELD OF CLOTHING AND ACCESSORIES, NAMELY, SHIRTS, BLOUSES, PANTS, DRESSES, SHORTS, VESTS, SWEATERS, JACKETS, BANDANNAS, HEAD BANDS, SCARVES, CAPS, SOCKS, SHOES, HOSIERY, RAINWEAR, AND FOOTWEAR (U.S. CLS. 100, 101 AND 102). FIRST USE 8-1-1998; IN COMMERCE 10-14-2003.

CLASS 35—(Continued).

2,955,542. SANCHEZ, VINCENT F., LAKE ELSINORE, CA. SN 78-175,732. PUB. 10-28-2003, FILED 10-17-2002.

321DEAL.COM

FOR ADVERTISING SERVICES, NAMELY, DISSEMINATION OF ADVERTISING FOR OTHERS IN THE FIELD OF AUTOMOBILES VIA AN ON-LINE ELECTRONIC COMMUNICATIONS NETWORK; PROVIDING A SEARCHABLE ON-LINE ADVERTISING GUIDE FEATURING THE GOODS AND SERVICES OF OTHER ON-LINE VENDORS, NAMELY AUTOMOBILES; ELECTRONIC CLASSIFIED ADVERTISING SERVICES IN THE FIELD OF AUTOMOBILES; ON-LINE CLASSIFIED ADVERTISING SERVICES IN THE FIELD OF AUTOMOBILES; AND PROMOTING THE SERVICES OF AUTOMOBILE DEALERSHIPS THROUGH THE DISTRIBUTION OF PRINTED AND AUDIO PROMOTIONAL MATERIALS AND BY RENDERING SALES PROMOTION ADVICE (U.S. CLS. 100, 101 AND 102).

FIRST USE 12-0-2003; IN COMMERCE 12-0-2003.

2,955,548. LABOR SOLUTIONS INTERNATIONAL, INC., SANDY, UT. SN 78-180,661. PUB. 3-2-2004, FILED 10-31-2002.

LABORWISE

FOR LABOR MANAGEMENT CONSULTING SERVICES (U.S. CLS. 100, 101 AND 102).

FIRST USE 10-0-2003; IN COMMERCE 10-0-2003.

2,955,560. STONE MOUNTAIN CARPET MILLS, INC., EARTH CITY, MO. SN 78-193,951. PUB. 11-11-2003, FILED 12-12-2002.

STONE MOUNTAIN'S FLOORING OUTLET

OWNER OF U.S. REG. NO. 1,829,757.

NO CLAIM IS MADE TO THE EXCLUSIVE RIGHT TO USE "FLOORING OUTLET", APART FROM THE MARK AS SHOWN.

FOR RETAIL STORE SERVICES IN THE FIELD OF CARPETS AND OTHER FLOORCOVERINGS (U.S. CLS. 100, 101 AND 102).

FIRST USE 1-1-2001; IN COMMERCE 1-1-2001.

2,955,579. YEH, JOSEPH, OSPREY, FL. SN 78-205,497. PUB. 12-16-2003, FILED 1-21-2003.

VALUBOX

FOR WHOLESALE DISTRIBUTORSHIP FEATURING CORRUGATED BOXES AND SHEETS, CARDBOARD BOXES AND SHEETS, TAPES, SHIPPING AND MOVING SUPPLIES; RETAIL STORE SERVICES AND ON-LINE RETAIL STORE SERVICES FEATURING CORRUGATED BOXES AND SHEETS, CARDBOARD BOXES AND SHEETS, TAPES, SHIPPING AND MOVING SUPPLIES (U.S. CLS. 100, 101 AND 102).

FIRST USE 1-1-2003; IN COMMERCE 9-1-2003.

CLASS 35—(Continued).

2,955,582. LANCE MFG. LLC, DBA SOUTH STREET BAKERY CO., CHARLOTTE, NC. SN 78-210,207. PUB. 5-11-2004, FILED 2-3-2003.

SOUTH STREET BAKERY

NO CLAIM IS MADE TO THE EXCLUSIVE RIGHT TO USE "BAKERY", APART FROM THE MARK AS SHOWN. FOR WHOLESALE DISTRIBUTORSHIP FEATURING FOOD (U.S. CLS. 100, 101 AND 102).
FIRST USE 3-30-2003; IN COMMERCE 3-30-2003.

2,955,591. FRAKE PETEROLEUM COMPANY, INC., NORTH GROSVENORDALE, CT. SN 78-215,159. PUB. 2-10-2004, FILED 2-14-2003.

DIAMOND FUELS

NO CLAIM IS MADE TO THE EXCLUSIVE RIGHT TO USE "FUELS", APART FROM THE MARK AS SHOWN. FOR RETAIL STORE SERVICES FEATURING CONVENIENT STORE ITEMS, PRODUCTS, AND GASOLINE (U.S. CLS. 100, 101 AND 102).
FIRST USE 10-0-2003; IN COMMERCE 10-0-2003.

2,955,595. WILLIAM ALEXANDER'S, LLC, MCLEAN, VA. SN 78-217,101. PUB. 12-16-2003, FILED 2-20-2003.

William Alexander's

Making Your House A Home

THE NAME, "WILLIAM ALEXANDER", DOES NOT IDENTIFY A LIVING INDIVIDUAL. FOR ONLINE RETAIL STORE SERVICES FEATURING HOME DECOR (U.S. CLS. 100, 101 AND 102).
FIRST USE 1-1-2002; IN COMMERCE 1-1-2002.

2,955,611. ONE ECONOMY CORP., WASHINGTON, DC. SN 78-223,794. PUB. 5-25-2004, FILED 3-10-2003.

VOICES OF LOWER MANHATTAN

NO CLAIM IS MADE TO THE EXCLUSIVE RIGHT TO USE LOWER MANHATTAN, APART FROM THE MARK AS SHOWN. FOR PROMOTING THE ECONOMIC REDEVELOPMENT AND REJUVENATION OF LOWER MANHATTAN VIA AN ONLINE WEBSITE FEATURING INFORMATION AND NEWS ON A WIDE RANGE OF TOPICS ABOUT LOWER MANHATTAN FOR USE BY BUSINESSES, RESIDENTS AND VISITORS; PROMOTING BUSINESS AND TOURISM IN LOWER MANHATTAN VIA AN ONLINE WEBSITE FEATURING INFORMATION AND NEWS ON A WIDE RANGE OF TOPICS ABOUT LOWER MANHATTAN FOR USE BY BUSINESSES, RESIDENTS, AND VISITORS (U.S. CLS. 100, 101 AND 102).
FIRST USE 2-1-2004; IN COMMERCE 2-1-2004.

CLASS 35—(Continued).

2,955,669. WOODBURY, MARTHA, J., GLENS FALLS, NY. SN 78-246,006. PUB. 12-16-2003, FILED 5-6-2003.

THE PROSPECT GENERATOR

FOR ADVERTISING SERVICES, NAMELY CREATING CORPORATE AND BRAND IDENTITY FOR OTHERS (U.S. CLS. 100, 101 AND 102).
FIRST USE 5-25-2000; IN COMMERCE 5-25-2000.

2,955,670. MAPLE LEAF SPORTS & ENTERTAINMENT, LTD., TORONTO, CANADA. SN 78-247,382. PUB. 11-25-2003, FILED 5-8-2003.



FOR COMPUTERIZED ON-LINE RETAIL STORE, ORDERING, RETAIL, ELECTRONIC RETAILING, CATALOG AND MAIL ORDER CATALOG SERVICES FEATURING AN ARRAY OF BASKETBALL-THEMED MERCHANDISE; PROMOTING THE GOODS AND SERVICES OF OTHERS BY ALLOWING SPONSORS TO AFFILIATE THESE GOODS AND SERVICES WITH A BASKETBALL PROGRAM; PROMOTING THE SALE OF GOODS AND SERVICES OF OTHERS THROUGH THE DISTRIBUTION OF PROMOTIONAL CONTESTS PROVIDED OVER THE INTERNET; CONDUCTING PUBLIC OPINION POLL SURVEYS AND PUBLIC OPINION POLL SURVEYS IN THE FIELD OF BASKETBALL FOR NON-BUSINESS, NON-MARKETING PURPOSES OVER THE INTERNET; PROVIDING ACCESS TO INTERACTIVE POLLING IN THE FIELD OF BASKETBALL OVER THE INTERNET (U.S. CLS. 100, 101 AND 102).
FIRST USE 10-3-2003; IN COMMERCE 10-3-2003.

CLASS 35—(Continued).

2,955,712. LOCATION3 MEDIA, INC., DENVER, CO. SN 78-276,810. PUB. 7-20-2004, FILED 7-21-2003.



NO CLAIM IS MADE TO THE EXCLUSIVE RIGHT TO USE NETWORK, APART FROM THE MARK AS SHOWN. FOR PLACEMENT OF ADVERTISING FOR OTHERS VIA AN ONLINE GLOBAL COMPUTER NETWORK (U.S. CLS. 100, 101 AND 102).
FIRST USE 8-1-2003; IN COMMERCE 8-1-2003.

2,955,715. TM ACQUISITION CORP., LAS VEGAS, NV. SN 78-279,418. PUB. 5-11-2004, FILED 7-28-2003.

AMERISOURCE

FOR FRANCHISE SERVICES, NAMELY, PROVIDING TECHNICAL ASSISTANCE IN THE ORGANIZATION AND ESTABLISHMENT OF HOTEL, MOTEL AND RESTAURANT FRANCHISES; FRANCHISE SERVICES, NAMELY, PROVIDING BUSINESS INFORMATION FOR USE BY HOTEL, MOTEL AND RESTAURANT FRANCHISES VIA INTERNET, INTRANET AND EXTRANET WEB SITES (U.S. CLS. 100, 101 AND 102).
FIRST USE 4-1-2003; IN COMMERCE 4-1-2003.

2,955,729. RALPH D. SEABROOK, GREENWICH, CT. SN 78-290,209. PUB. 6-1-2004, FILED 8-21-2003.

LEARN TO PROFIT

NO CLAIM IS MADE TO THE EXCLUSIVE RIGHT TO USE "PROFIT", APART FROM THE MARK AS SHOWN. FOR BUSINESS CONSULTING SERVICES RELATED TO PROFIT IMPROVEMENT (U.S. CLS. 100, 101 AND 102).
FIRST USE 9-1-2004; IN COMMERCE 10-1-2004.

2,955,790. LEX SOLUTIO CORPORATION, PHOENIX, AZ. SN 78-350,675. PUB. 10-19-2004, FILED 1-12-2004.

ENCORE LEX SOLUTIO

THE MARK CONSISTS OF STANDARD CHARACTERS WITHOUT CLAIM TO ANY PARTICULAR FONT, STYLE, SIZE, OR COLOR.
THE FOREIGN WORDING IN THE MARK TRANSLATES

CLASS 35—(Continued).

INTO ENGLISH AS "LEX" IS "LAW, STATUTE/COVENANT, AGREEMENT" AND THE TERM "SOLUTIO" IS "LOOSENING/PAYMENT/SOLUTION/EXPLANATION".
FOR LEGAL DOCUMENT MANAGEMENT SERVICES; DEPOSITION DATABASE MANAGEMENT SERVICES; LICENSING OF COMPUTER SOFTWARE; VALUE-ADDED RESELLER SERVICES, NAMELY DISTRIBUTORSHIP SERVICES IN THE FIELD OF COMPUTER SOFTWARE (U.S. CLS. 100, 101 AND 102).
FIRST USE 12-0-2003; IN COMMERCE 12-0-2003.

2,955,795. NATIONAL ASSOCIATION FOR STOCK CAR AUTO RACING, INC., DAYTONA BEACH, FL. SN 78-367,536. PUB. 8-17-2004, FILED 2-13-2004.

**IT'S NASCAR, RIGHT
AROUND THE
CORNER**

THE MARK CONSISTS OF STANDARD CHARACTERS WITHOUT CLAIM TO ANY PARTICULAR FONT, STYLE, SIZE, OR COLOR.
OWNER OF U.S. REG. NOS. 990,987, 1,054,100, AND 1,974,069.
FOR PROMOTING STOCK CAR AUTOMOBILE RACING THROUGH THE MEANS OF ADVERTISEMENT IN MAGAZINES, TELEVISION BROADCAST AND THE INTERNET (U.S. CLS. 100, 101 AND 102).
FIRST USE 5-1-2004; IN COMMERCE 5-1-2004.

2,955,798. TACTIX LLC, MILL VALLEY, CA. SN 78-975,574. PUB. 2-10-2004, FILED 12-5-2002.



NO CLAIM IS MADE TO THE EXCLUSIVE RIGHT TO USE "ENGINEERED TOWELING", APART FROM THE MARK AS SHOWN.
FOR PREPARATION OF CUSTOM PROMOTIONAL PRODUCTS FOR OTHERS, NAMELY TOWELS, CLOTHS, THROWS, BATH TOWELS, GOLF TOWELS, HAND TOWELS AND HOODED TOWELS ALL MADE OF ENGINEERED POLYESTER FABRIC (U.S. CLS. 100, 101 AND 102).
FIRST USE 11-1-2003; IN COMMERCE 11-1-2003.

CLASS 36—INSURANCE AND FINANCIAL

2,955,191. CLASSNOTES, INC., SACRAMENTO, CA. SN 75-508,034. PUB. 6-15-1999, FILED 6-24-1998.

EDUSTAR SYSTEM

NO CLAIM IS MADE TO THE EXCLUSIVE RIGHT TO USE "SYSTEM", APART FROM THE MARK AS SHOWN.
FOR FINANCIAL SERVICES IN THE FIELD OF STUDENT LENDING, NAMELY, MONEY LENDING IN THE NATURE OF ASSET AND LOAN MANAGEMENT, LOAN SERVICING AND LOAN ORIGINATION (U.S. CLS. 100, 101 AND 102).

FIRST USE 4-7-2004; IN COMMERCE 4-7-2004.

2,955,196. METRIS DIRECT, INC., ST. LOUIS PARK, MN. SN 75-793,341. PUB. 5-7-2002, FILED 9-3-1999.

HOME SERVICEEDGE

OWNER OF U.S. REG. NO. 2,238,132.
NO CLAIM IS MADE TO THE EXCLUSIVE RIGHT TO USE "HOME", APART FROM THE MARK AS SHOWN.
FOR EXTENDED WARRANTY SERVICES ON A WIDE RANGE OF CONSUMER PRODUCTS AND CREDIT CARD SERVICES (U.S. CLS. 100, 101 AND 102).

FIRST USE 0-0-1999; IN COMMERCE 0-0-1999.

2,955,221. OLSON, A. WAYNE, DBA UNICACHE, LTD., LAS VEGAS, NV. SN 76-048,875. PUB. 7-16-2002, FILED 5-12-2000.

UNICARD

FOR DEBT RECOVERY AND COLLECTION SERVICES, NAMELY, PROVIDING A SETTLEMENT AND PROCEDURE FOR PAYMENT OF DEBT (U.S. CLS. 100, 101 AND 102).

FIRST USE 5-5-2001; IN COMMERCE 5-4-2002.

CLASS 36—(Continued).

2,955,226. AMERICAAT.COM, LLC, LAS VEGAS, NV. SN 76-072,579. PUB. 12-10-2002, FILED 6-16-2000.

BANKAT.COM

FOR PROVISION OF INFORMATION ON AND THROUGH A GLOBAL COMPUTER NETWORK IN THE FIELD OF ELECTRONIC BANKING SERVICES, DEPOSIT ACCOUNTS, CHECKING AND DRAFT ACCOUNTS, MONEY MARKET ACCOUNTS, CERTIFICATES OF DEPOSITS, FINANCING, LOAN, CREDIT AND MORTGAGE SERVICES, HOME EQUITY LOANS, MORTGAGE LENDING, CONSUMER AND COMMERCIAL LENDING, INVESTMENT BANKING SERVICES, FUND INVESTMENT CONSULTATION, INVESTMENT MANAGEMENT, FUND TRANSFER SERVICES, CURRENCY AND FOREIGN EXCHANGE DEALING AND FOREIGN EXCHANGE SERVICES, SERVICES OF INVESTMENT COMPANIES AND MUTUAL FUNDS, CAPITAL MANAGEMENT, FINANCIAL ADVISORY, CONSULTANCY AND INFORMATION SERVICES, FINANCIAL PLANNING, ANALYSIS, MANAGEMENT AND ORGANIZATION ASSISTANCE; FINANCIAL ADVICE AND CONSULTANCY, RESEARCH, PROVISION OF FINANCIAL INFORMATION, MARKET ANALYSIS, RESEARCH AND MONITORING SERVICES FOR FINANCIAL PURPOSES (U.S. CLS. 100, 101 AND 102).

FIRST USE 4-29-2004; IN COMMERCE 4-29-2004.

2,955,230. KABUSHIKI KAISHA HITACHI SEISAKUSHO, DBA HITACHI, LTD., TOKYO, JAPAN. SN 76-090,390. PUB. 7-29-2003, FILED 7-17-2000.

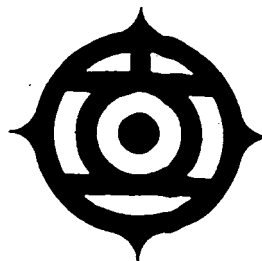

OWNER OF U.S. REG. NO. 1,934,706.

FOR INSURANCE SERVICES, NAMELY, INSURANCE BROKERAGE, INSURANCE CONSULTANCY, AND INSURANCE UNDERWRITING IN THE FIELDS OF COMMERCIAL AND RESIDENTIAL REAL ESTATE, HOME, ACCIDENT, LIFE, HEALTH, AUTOMOBILE, AND FIRE; PROVIDING INFORMATION IN THE FIELD OF INSURANCE VIA A GLOBAL COMPUTER NETWORK; FINANCIAL AND MONETARY SERVICES, NAMELY, BILL PAYMENT SERVICES, LOAN SERVICES, NAMELY, LOAN FINANCING, HOME EQUITY LOANS, LEASE-PURCHASE LOANS, INSTALLMENT LOANS, CREDIT CARD SERVICES AND CREDIT CONSULTATION; INSURANCE SERVICES, NAMELY, UNDERWRITING EXTENDED WARRANTY CONTRACTS IN THE FIELDS OF COMPUTERS, COMMERCIAL AND INDUSTRIAL APPLIANCES, CONSUMER ELECTRONICS, HEAVY MACHINERY, INDUSTRIAL MACHINERY, AND RAIL ROAD EQUIPMENT; ELECTRONIC COMMERCE FINANCIAL SERVICES, NAMELY, ELECTRONIC CREDIT AND DEBIT CARD TRANSACTION SERVICES, ELECTRONIC FUNDS TRANSFER, ELECTRONIC PAYMENTS, NAMELY, ELECTRONIC PROCESSING AND TRANSMISSION OF BILL PAYMENT DATA, REAL ESTATE INVESTMENT SERVICES, INVESTMENT BROKERAGE SERVICES AND INSURANCE UNDERWRITING SERVICES IN THE FIELDS OF COM-

CLASS 36—(Continued).

COMMERCIAL AND RESIDENTIAL REAL ESTATE, INSURANCE FOR PERSONAL PROPERTY, REAL ESTATE, HOME, ACCIDENT, LIFE, HEALTH, AUTOMOBILE, AND FIRE, ALL PROVIDED VIA A GLOBAL COMPUTER NETWORK OR BY ELECTRONIC MEANS; FINANCIAL ANALYSIS, FINANCIAL CONSULTATION, FINANCIAL INFORMATION, FINANCIAL MANAGEMENT AND FINANCIAL PLANNING, ALL PROVIDED VIA A GLOBAL COMPUTER NETWORK OR BY ELECTRONIC MEANS; LEASING OF COMMERCIAL AND RESIDENTIAL REAL ESTATE; LOAN SERVICES FOR THE ACQUISITION OF OFFICES, APARTMENTS, BUILDINGS, CONSTRUCTION FACILITIES, COMMERCIAL REAL ESTATE AND RESIDENTIAL REAL ESTATE; PROVIDING TEMPORARY LOANS AND INSTALLMENT LOANS TO HOTELS, HOSPITALS, RETAIL STORES, WHOLESALE STORES, POWER PLANTS, INDUSTRIAL PLANTS, MANUFACTURING PLANTS, AND COMMERCIAL, INDUSTRIAL AND RESIDENTIAL APARTMENT BUILDINGS IN CONNECTION WITH THE LEASING OF LAND; LEASE-PURCHASE LOAN SERVICES; BANKING SERVICES, NAMELY, SAFETY DEPOSIT BOX SERVICES, MONEY EXCHANGE SERVICES, FOREIGN CURRENCY EXCHANGE SERVICES AND ESTATE TRUST MANAGEMENT SERVICES; INVESTMENT SERVICES, NAMELY, SECURITIES BROKERAGE AND TRADING SERVICES; SECURITIES UNDERWRITING SERVICES; PROVIDING STOCK EXCHANGE PRICE QUOTATIONS; ACTUARIAL SERVICES; COMMERCIAL, INDUSTRIAL AND RESIDENTIAL APARTMENT BUILDING MANAGEMENT; REAL ESTATE AGENCY; REAL ESTATE MANAGEMENT; APPRAISAL SERVICES IN THE FIELDS OF ANTIQUES, ART AND JEWELRY; CHARITABLE FUNDRAISING SERVICES; CREDIT INVESTIGATION SERVICES (U.S. CLS. 100, 101 AND 102).
FIRST USE 3-23-1987; IN COMMERCE 3-23-1987.

CLASS 36—(Continued).

2,955,289. WILINK U.S. HOLDINGS INC., RICHMOND, VA. SN 76-417,938. PUB. 6-17-2003, FILED 6-5-2002.



NO CLAIM IS MADE TO THE EXCLUSIVE RIGHT TO USE "IR", APART FROM THE MARK AS SHOWN.

FOR PROVIDING FINANCIAL INVESTMENT INFORMATION TO BUSINESSES; INVESTMENT CONSULTATION AND INVESTMENT INFORMATION SERVICES TO BUSINESSES PROVIDED VIA A GLOBAL COMPUTER NETWORK, THE INTERNET, WIRELESS DEVICES AND TELEPHONE (U.S. CLS. 100, 101 AND 102).
FIRST USE 6-0-2002; IN COMMERCE 6-0-2002.

2,955,308. BRIDGER COMMERCIAL FUNDING LLC, MILL VALLEY, CA. SN 76-455,065. PUB. 3-30-2004, FILED 9-23-2002.

BANK EXCHANGE

FOR FINANCIAL SERVICES IN THE FIELD OF TRADING AND ORIGINATING COMMERCIAL DEBTS, ASSETS AND LOANS (U.S. CLS. 100, 101 AND 102).
FIRST USE 7-23-2004; IN COMMERCE 7-23-2004.

2,955,263. PREMERA BLUE CROSS, SEATTLE, WA. SN 76-307,804. PUB. 5-4-2004, FILED 8-31-2001.

MYPHARMACYPLUS

FOR PHARMACEUTICAL AND PRESCRIPTION DRUG INSURANCE UNDERWRITING; ADMINISTRATION AND ORGANIZING OF PREPAID PHARMACEUTICAL AND PRESCRIPTION DRUG PLANS, INCLUDING CLAIMS ADMINISTRATION FOR PHARMACEUTICAL AND PRESCRIPTION DRUG BENEFITS (U.S. CLS. 100, 101 AND 102).
FIRST USE 11-30-2002; IN COMMERCE 11-30-2002.

2,955,317. COVENANT RETIREMENT PLANNING, LLC, NASHVILLE, TN. SN 76-462,210. PUB. 10-14-2003, FILED 10-28-2002.

SENIOR MARKET SUCCESS SYSTEM

NO CLAIM IS MADE TO THE EXCLUSIVE RIGHT TO USE "SENIOR MARKET" OR "SYSTEM", APART FROM THE MARK AS SHOWN.

FOR INSURANCE BROKERAGE IN THE FIELD OF LIFE, HEALTH AND ANNUITIES (U.S. CLS. 100, 101 AND 102).
FIRST USE 1-15-2004; IN COMMERCE 1-15-2004.

CLASS 36—(Continued).

2,955,338. FIRST-CITIZENS BANK AND TRUST COMPANY OF SOUTH CAROLINA, COLUMBIA, SC. SN 76-476,079. PUB. 2-17-2004, FILED 12-11-2002.

WE'RE ON IT.

FOR BANKING AND RELATED FINANCIAL SERVICES, NAMELY, PERSONAL CHECKING AND SAVINGS ACCOUNTS, MONEY MARKET ACCOUNTS, ONLINE BANKING, LOANS AND MORTGAGES, CREDIT CARD SERVICES, RETIREMENT SERVICES, PERSONAL TRUST SERVICES AND BUSINESS BANKING SERVICES, NAMELY, MONEY MANAGEMENT AND CHECKING ACCOUNT SERVICES (U.S. CLS. 100, 101 AND 102).

FIRST USE 3-21-2004; IN COMMERCE 3-21-2004.

2,955,362. ROTHSCHILDS CONTINUATION HOLDINGS AG, ZUG, SWITZERLAND. SN 76-489,164. PUB. 7-27-2004, FILED 2-10-2003.

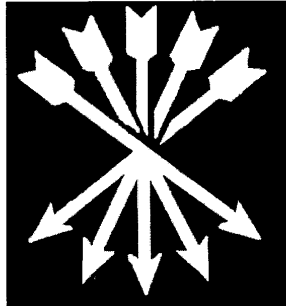

PRIORITY CLAIMED UNDER SEC. 44(D) ON UNITED KINGDOM APPLICATION NO. 2307707, FILED 8-9-2002.

FOR FINANCIAL SERVICES; NAMELY, ADVISING CORPORATIONS ON RESTRUCTURING, BANKRUPTCY, MERGERS AND ACQUISITIONS, DIVESTITURES, STRATEGIC PLANNING AND CAPITAL RAISING; PRIVATE EQUITY FUND SPONSORSHIP; MERCHANT BANKING; INVESTMENT BANKING; UNDERWRITING NAMELY, UNDERWRITING OFFERS OF SECURITIES AS MANAGER, CO-MANAGER OR SYNDICATE MEMBER, INCLUDING PRIVATE PLACEMENTS; INVESTMENT MANAGEMENT AND ADVICE; PROVIDING FINANCE, NAMELY, LENDING VIA PRIMARY AND SECONDARY LOAN PARTICIPATIONS; FACTORING AGENCIES; FINANCIAL CONSULTANCY, PLANNING, RESEARCH AND APPRAISAL; FINANCIAL EVALUATION AND OTHER WEALTH MANAGEMENT SERVICES; RISK MANAGEMENT SERVICES; TRADING AND DEALING IN STOCKS, SECURITIES, COMMODITIES, FOREIGN EXCHANGE, BULLION, PRECIOUS METALS AND OTHER FINANCIAL PRODUCTS AND ADVISORY SERVICES RELATING THERETO; BROKER-DEALER SERVICES; PROVIDING FINANCIAL NEWS AND INFORMATION VIA A GLOBAL COMMUNICATION NETWORK; FINANCIAL INVESTMENT AND ADVISORY SERVICES IN THE FIELD OF REAL ESTATE; LEASING OF REAL ESTATE; REAL ESTATE ACQUISITION SERVICES; REAL ESTATE APPRAISAL; REAL ESTATE EQUITY SHARING, NAMELY, MANAGING AND ARRANGING FOR CO-OWNERSHIP OF REAL ESTATE; REAL ESTATE INVESTMENT AND REAL ESTATE MANAGEMENT (U.S. CLS. 100, 101 AND 102).

FIRST USE 6-1-2002; IN COMMERCE 11-1-2002.

CLASS 36—(Continued).

2,955,382. PULSE EFT ASSOCIATION, HOUSTON, TX. SN 76-495,511. PUB. 11-18-2003, FILED 3-7-2003.

***pulse* DebitSolutions**

OWNER OF U.S. REG. NOS. 1,225,326, 2,461,084, AND OTHERS.

NO CLAIM IS MADE TO THE EXCLUSIVE RIGHT TO USE "DEBIT SOLUTIONS", APART FROM THE MARK AS SHOWN.

FOR FINANCIAL SERVICES, NAMELY, ELECTRONIC FUNDS TRANSFER SERVICES AND PAYMENTS AT THE POINT-OF-SALE AND WHEN ORDERING GOODS AND SERVICES OVER A GLOBAL COMPUTER NETWORK; AND ELECTRONIC BANKING SERVICES (U.S. CLS. 100, 101 AND 102).

FIRST USE 2-1-2005; IN COMMERCE 2-1-2005.

2,955,425. JOSEPH S. STURNIOLO AND ASSOCIATES, INC., DENVER, CO. SN 76-521,695. PUB. 3-9-2004, FILED 6-11-2003.

THE TRANSITION FORMULA

FOR FINANCIAL PLANNING SERVICES, STOCK BROKERAGE SERVICES AND ESTATE PLANNING SERVICES FOR OTHERS (U.S. CLS. 100, 101 AND 102).

FIRST USE 1-1-2003; IN COMMERCE 1-1-2003.

2,955,428. ASSOCIATION OF BAY AREA GOVERNMENTS, OAKLAND, CA. SN 76-528,265. PUB. 9-21-2004, FILED 7-7-2003.

CALIFORNIA HOMESOURCE

NO CLAIM IS MADE TO THE EXCLUSIVE RIGHT TO USE "CALIFORNIA", APART FROM THE MARK AS SHOWN.

FOR PROVISIONS OF FINANCIAL AND HOUSING SERVICES, NAMELY, ADMINISTERING HOUSING ASSISTANCE PROGRAMS TARGETED AT LOW INCOME HOME BUYERS THAT ASSIST THEM IN ENTERING INTO LEASE/PURCHASE CONTRACTS FOR HOMES AND TO PROVIDE ASSISTANCE IN SECURING FINANCING FOLLOWING EXPIRATION OF LEASE PERIOD (U.S. CLS. 100, 101 AND 102).

FIRST USE 12-15-2002; IN COMMERCE 2-1-2003.

2,955,461. ROBERT L. STARK ENTERPRISES, INC., WOODMERE, OH. SN 76-553,940. PUB. 6-29-2004, FILED 10-22-2003.

THE BEAUTIFUL PEOPLE

FOR REAL ESTATE MANAGEMENT; LEASING OF REAL ESTATE (U.S. CLS. 100, 101 AND 102).

FIRST USE 10-21-2003; IN COMMERCE 9-1-2004.

CLASS 36—(Continued).

2,955,485. FORD MOTOR COMPANY, DEARBORN, MI. SN 78-068,620. PUB. 11-27-2001, FILED 6-12-2001.

CREDIT FOR A LIFETIME

FOR FINANCIAL SERVICES, NAMELY PROVIDING INFORMATION ON CREDIT, CREDIT TRANSACTIONS, MAINTAINING GOOD CREDIT AND USING CREDIT PROPERLY (U.S. CLS. 100, 101 AND 102).

FIRST USE 5-1-2001; IN COMMERCE 5-1-2001.

2,955,571. COLLEGEINVEST, DENVER, CO. SN 78-202,163. PUB. 1-27-2004, FILED 1-10-2003.

COLLEGEINVEST

OWNER OF U.S. REG. NOS. 2,507,904 AND 2,507,905. FOR EDUCATION FINANCING SERVICES (U.S. CLS. 100, 101 AND 102).

FIRST USE 9-1-2002; IN COMMERCE 9-1-2002.

2,955,605. MAYACAMA GOLF CLUB LLC, SANTA ROSA, CA. SN 78-222,989. PUB. 10-21-2003, FILED 3-7-2003.



OWNER OF U.S. REG. NO. 2,464,349. THE MARK CONSISTS OF THE DESIGN OF A SINGLE GRAPE LEAF WITH AN ATTACHED VINE WRAPPED AROUND A CRESCENT.

FOR REAL ESTATE TIME-SHARING; VACATION REAL ESTATE TIME-SHARING (U.S. CLS. 100, 101 AND 102).

FIRST USE 11-1-2003; IN COMMERCE 11-1-2003.

2,955,606. MAYACAMA GOLF CLUB LLC, SANTA ROSA, CA. SN 78-223,004. PUB. 10-14-2003, FILED 3-7-2003.

MAYACAMA

OWNER OF U.S. REG. NO. 2,464,349. THE MARK CONSISTS OF THE WORD "MAYACAMA". THE FOREIGN WORDING IN THE MARK TRANSLATED INTO ENGLISH AS "WATER FLOWING FROM THE SOURCE".

FOR REAL ESTATE TIME-SHARING; VACATION REAL ESTATE TIME-SHARING (U.S. CLS. 100, 101 AND 102).

FIRST USE 11-1-2003; IN COMMERCE 11-1-2003.

CLASS 36—(Continued).

2,955,673. BNY SEPARATE ACCOUNT SERVICES, INC., MALVERN, PA. SN 78-248,886. PUB. 9-7-2004, FILED 5-13-2003.

**THE BANK OF NEW YORK
SEPARATE ACCOUNT
SERVICES**

OWNER OF U.S. REG. NOS. 841,428, 1,560,124, AND OTHERS.

NO CLAIM IS MADE TO THE EXCLUSIVE RIGHT TO USE "BANK AND SEPARATE ACCOUNT SERVICES", APART FROM THE MARK AS SHOWN.

SEC. 2(F).

FOR FINANCIAL AND INVESTMENT CONSULTING SERVICES, NAMELY, INDIVIDUALLY MANAGED ACCOUNT SERVICES FOR FINANCIAL ADVISORS TO ASSIST CLIENTS IN ALLOCATING AND MANAGING INVESTMENTS WITHIN A SERIES OF INDIVIDUALLY MANAGED ACCOUNTS (U.S. CLS. 100, 101 AND 102).

FIRST USE 10-0-2002; IN COMMERCE 12-0-2002.

2,955,678. PRICE, BRADLEY C., OAK PARK, IL. SN 78-251,255. PUB. 2-10-2004, FILED 5-17-2003.

**BENEFITS SAVVY
ASSOCIATES**

NO CLAIM IS MADE TO THE EXCLUSIVE RIGHT TO USE "BENEFITS" OR "ASSOCIATES", APART FROM THE MARK AS SHOWN.

FOR EMPLOYEE BENEFITS CONSULTING AND HEALTH, LIFE AND DISABILITY INSURANCE BROKERAGE (U.S. CLS. 100, 101 AND 102).

FIRST USE 3-31-2003; IN COMMERCE 3-31-2003.

2,955,718. ICON CAPITAL CORP., NEW YORK, NY. SN 78-281,589. PUB. 5-11-2004, FILED 7-31-2003.

**A NEW LEASE ON
INVESTING**

FOR FINANCIAL SERVICES IN THE FIELD OF EQUIPMENT LEASING (U.S. CLS. 100, 101 AND 102).

FIRST USE 9-1-2003; IN COMMERCE 9-1-2003.

2,955,724. CONCORDANT PARTNERS, L.L.C., LINCOLN, NE. SN 78-286,815. PUB. 9-21-2004, FILED 8-13-2003.

CONCORDANT PARTNERS

NO CLAIM IS MADE TO THE EXCLUSIVE RIGHT TO USE "PARTNERS", APART FROM THE MARK AS SHOWN.

FOR INVESTMENT FINANCIAL SERVICES IN THE FIELD OF SECURITIES (U.S. CLS. 100, 101 AND 102).

FIRST USE 9-5-2003; IN COMMERCE 9-5-2003.

CLASS 36—(Continued).

2,955,735. BUSCH, SCOTT, KANSAS CITY, MO. SN 78-292,502. PUB. 5-25-2004, FILED 8-26-2003.

COLLECTIVE GOOD

FOR CHARITABLE FUNDRAISING SERVICES (U.S. CLS. 100, 101 AND 102).
FIRST USE 8-10-2003; IN COMMERCE 8-10-2003.

2,955,766. AMERICAN ASSOCIATION OF NEUROLOGICAL SURGEONS, ROLLING MEADOWS, IL. SN 78-323,608. PUB. 8-24-2004, FILED 11-5-2003.



FOR FUND-RAISING SERVICES, NAMELY, FUND-RAISING AND SOLICITING MONETARY DONATIONS FROM CORPORATIONS FOR THE PURPOSE OF FURTHERING THE EDUCATIONAL MISSION AND GOALS OF THE AMERICAN ASSOCIATION OF NEUROLOGICAL SURGEONS IN THE FIELD OF NEUROSURGERY (U.S. CLS. 100, 101 AND 102).
FIRST USE 1-1-2004; IN COMMERCE 1-1-2004.

2,955,777. MERCK SHARP & DOHME FEDERAL CREDIT UNION, NORTH WALES, PA. SN 78-336,213. PUB. 8-31-2004, FILED 12-4-2003.

MSDFCU

THE MARK CONSISTS OF STANDARD CHARACTERS WITHOUT CLAIM TO ANY PARTICULAR FONT, STYLE, SIZE, OR COLOR.
FOR CREDIT UNION SERVICES (U.S. CLS. 100, 101 AND 102).
FIRST USE 1-1-1980; IN COMMERCE 1-1-1980.

CLASS 36—(Continued).

2,955,781. FGIC CORPORATION, NEW YORK, NY. SN 78-340,041. PUB. 9-7-2004, FILED 12-12-2003.

STRENGTH IS OUR BOND

THE MARK CONSISTS OF STANDARD CHARACTERS WITHOUT CLAIM TO ANY PARTICULAR FONT, STYLE, SIZE, OR COLOR.

FOR FINANCIAL GUARANTY ASSURANCE UNDERWRITING SERVICES FOR BONDS AND ASSET-BACKED SECURITIES (U.S. CLS. 100, 101 AND 102).
FIRST USE 12-19-2003; IN COMMERCE 12-19-2003.

CLASS 37—CONSTRUCTION AND REPAIR

2,955,228. SUN TECH DEVELOPMENT, L.L.C., SCOTTSDALE, AZ. SN 76-084,816. PUB. 4-24-2001, FILED 7-7-2000.



FOR REAL ESTATE DEVELOPMENT; LAND DEVELOPMENT SERVICES, NAMELY, PLANNING AND LAYING OUT OF RESIDENTIAL AND/OR COMMERCIAL COMMUNITIES; AND CUSTOM CONSTRUCTION OF HOMES (U.S. CLS. 100, 103 AND 106).
FIRST USE 3-0-1998; IN COMMERCE 3-0-1998.

2,955,253. VIP INVESTMENTS, LTD., OREM, UT. SN 76-248,402. PUB. 4-1-2003, FILED 4-18-2001.

VANTAGE

FOR INSTALLATION AND REPAIR OF BUILDING AUTOMATION SYSTEMS AND DEVICES, AND BUILDING ELECTRICAL AND ELECTRONIC DEVICES, DISTRIBUTED PRIMARILY THROUGH PROFESSIONAL ELECTRICAL SERVICE DEALERS (U.S. CLS. 100, 103 AND 106).
FIRST USE 0-0-1987; IN COMMERCE 0-0-1987.

CLASS 37—(Continued).

2,955,639. WEBEMERGE, INC., NEW YORK, NY. SN 78-231,729. PUB. 6-29-2004, FILED 3-30-2003.

COOLSPOT

FOR INSTALLATION, REPAIR, AND MAINTENANCE OF COMPUTER NETWORKS FOR OTHERS, NAMELY HIGH SPEED WIRED AND WIRELESS LOCAL AREA NETWORKS (LANS), LOCATED IN RESIDENTIAL AND COMMERCIAL BUILDINGS, USED TO TRANSMIT VOICE, AUDIO, CABLE AND DATA COMMUNICATIONS, ACCESS THE GLOBAL AND LOCAL COMPUTER NETWORK, AND MONITOR AND REPORT ON THE OPERATION OF MECHANICAL COMPONENTS AND MECHANICAL SYSTEMS WITHIN THE BUILDINGS (U.S. CLS. 100, 103 AND 106).

FIRST USE 1-1-2003; IN COMMERCE 1-1-2004.

CLASS 37—(Continued).

2,955,759. SEREN INNOVATIONS, INC., MINNEAPOLIS, MN. SN 78-315,863. PUB. 10-12-2004, FILED 10-20-2003.

WIRE GUARD

NO CLAIM IS MADE TO THE EXCLUSIVE RIGHT TO USE "WIRE", APART FROM THE MARK AS SHOWN.

FOR COMPUTER NETWORK AND WIRING MAINTENANCE SERVICES, NAMELY, MAINTENANCE OF NETWORK WIRING AND WIRE MAINTENANCE SERVICE, THE MAINTENANCE OF THE NETWORK INTERFACE CARD IN THE PC, MAINTENANCE OF INSIDE TELEPHONE WIRE, INSIDE TELEVISION CABLE WIRE, INSIDE DATA WIRE AND INSIDE JACKS (U.S. CLS. 100, 103 AND 106).

FIRST USE 10-28-2003; IN COMMERCE 10-28-2003.

2,955,652. VALLEY GLASS INC., OGDEN, UT. SN 78-236,649. PUB. 1-27-2004, FILED 4-11-2003.

2,955,786. PHILIPPOU ENTERPRISES, INC., COLORADO SPRINGS, CO. SN 78-342,815. PUB. 9-21-2004, FILED 12-18-2003.



NO CLAIM IS MADE TO THE EXCLUSIVE RIGHT TO USE "CHIP", APART FROM THE MARK AS SHOWN.

FOR GLASS CHIP REPAIR SERVICES (U.S. CLS. 100, 103 AND 106).

FIRST USE 5-1-2003; IN COMMERCE 5-1-2003.

**We Don't Just
Clean ... We Really
Scrub!**

2,955,672. WASH N JOE, LLC, DESTIN, FL. SN 78-247,732. PUB. 1-13-2004, FILED 5-9-2003.

WASH N JOE

THE MARK CONSISTS OF STANDARD CHARACTERS WITHOUT CLAIM TO ANY PARTICULAR FONT, STYLE, SIZE, OR COLOR.

FOR CLEANING OF RESIDENTIAL HOUSES; MAID SERVICES (U.S. CLS. 100, 103 AND 106).

FIRST USE 11-1-1989; IN COMMERCE 11-1-1989.

FOR DRIVE THROUGH CAR WASH SERVICES (U.S. CLS. 100, 103 AND 106).

FIRST USE 9-18-2004; IN COMMERCE 9-18-2004.

CLASS 38—COMMUNICATION

CLASS 38—(Continued).

2,955,290. WILINK U.S. HOLDINGS INC., RICHMOND, VA.
SN 76-417,949. PUB. 1-14-2003, FILED 6-5-2002.

CLASS 38—(Continued).

2,955,291. WILINK U.S. HOLDINGS INC., RICHMOND, VA.
SN 76-417,974. PUB. 6-24-2003, FILED 6-5-2002.

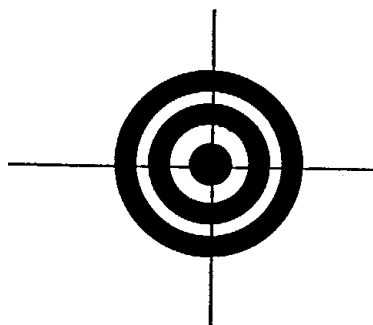

NO CLAIM IS MADE TO THE EXCLUSIVE RIGHT TO USE "IR", APART FROM THE MARK AS SHOWN.

FOR TELECOMMUNICATIONS NAMELY, ELECTRONIC TRANSMISSION OF DATA AND DOCUMENTS FEATURING INVESTOR RELATIONS EVENTS AND INFORMATION VIA A GLOBAL COMPUTER NETWORK, THE INTERNET, WIRELESS DEVICES, AND TELEPHONE DIRECTED TO BUSINESSES; ELECTRONIC TRANSMISSION OF INVESTMENT INFORMATION, BUSINESS AND FUND REPORTS AND PROSPECTUSES VIA A GLOBAL COMPUTER NETWORK, THE INTERNET AND WIRELESS DEVICES DIRECTED TO BUSINESSES; STREAMING OF VIDEO AND AUDIO CONTENT VIA A GLOBAL COMPUTER NETWORK, THE INTERNET, TELEPHONE AND WIRELESS DEVICES; INTERNET, TELEPHONE AND WIRELESS MESSAGE SERVICE, NAMELY, THE RECORDING AND SUBSEQUENT TRANSMISSION OF VOICE, TEXT AND PICTORIAL MESSAGES BY TELEPHONE AND ELECTRONIC, ELECTRIC AND DIGITAL TRANSMISSION OF MESSAGES DIRECTED TO BUSINESSES (U.S. CLS. 100, 101 AND 104).

FIRST USE 6-0-2002; IN COMMERCE 6-0-2002.

2,955,407. AMERICA ONLINE, INC., DULLES, VA. SN 76-507,423. PUB. 4-13-2004, FILED 4-16-2003.

MATCH CHAT

FOR TELECOMMUNICATIONS NAMELY, ELECTRONIC TRANSMISSION OF DATA AND DOCUMENTS FEATURING INVESTOR RELATIONS EVENTS AND INFORMATION VIA A GLOBAL COMPUTER NETWORK, THE INTERNET, WIRELESS DEVICES, AND TELEPHONE DIRECTED TO BUSINESSES; ELECTRONIC TRANSMISSION OF INVESTMENT INFORMATION, BUSINESS AND FUND REPORTS AND PROSPECTUSES VIA A GLOBAL COMPUTER NETWORK, THE INTERNET AND WIRELESS DEVICES DIRECTED TO BUSINESSES; STREAMING OF VIDEO AND AUDIO CONTENT VIA A GLOBAL COMPUTER NETWORK, THE INTERNET, TELEPHONE AND WIRELESS DEVICES; INTERNET, TELEPHONE AND WIRELESS MESSAGE SERVICES, NAMELY, THE RECORDING AND SUBSEQUENT TRANSMISSION OF VOICE, TEXT AND PICTORIAL MESSAGES BY TELEPHONE AND ELECTRONIC, ELECTRIC AND DIGITAL TRANSMISSION OF MESSAGES DIRECTED TO BUSINESSES (U.S. CLS. 100, 101 AND 104).

FIRST USE 4-0-2004; IN COMMERCE 4-0-2004.

NO CLAIM IS MADE TO THE EXCLUSIVE RIGHT TO USE CHAT, APART FROM THE MARK AS SHOWN.

FOR PROVIDING ONLINE FACILITIES FOR REAL-TIME INTERACTIONS BETWEEN COMPUTER USERS CONCERNING USER-DEFINED INTERESTS; ELECTRONIC TRANSMISSION OF DATA, IMAGES, AND DOCUMENTS VIA COMPUTER NETWORKS; ELECTRONIC MAIL SERVICES (U.S. CLS. 100, 101 AND 104).

FIRST USE 2-0-2003; IN COMMERCE 2-0-2003.

CLASS 38—(Continued).

2,955,671. MAPLE LEAF SPORTS & ENTERTAINMENT, LTD., TORONTO, ONTARIO, CANADA. SN 78-247,396. PUB. 11-25-2003, FILED 5-8-2003.



FOR AUDIO BROADCASTING; CABLE TELEVISION BROADCASTING; RADIO BROADCASTING; SUBSCRIPTION TELEVISION BROADCASTING; TELEVISION BROADCASTING; VIDEO BROADCASTING; WEBCASTING SERVICES IN THE NATURE OF PROVIDING ON-LINE CHAT ROOMS AND ON-LINE INTERACTIVE CHAT ROOMS WITH GUESTS FOR TRANSMISSION OF MESSAGES AMONG COMPUTER USERS CONCERNING THE FIELD OF BASKETBALL; BROADCASTING PROGRAMS OVER THE INTERNET PROVIDING ON-LINE ELECTRONIC BULLETIN BOARDS FOR TRANSMISSION OF MESSAGES AMONG COMPUTER USERS CONCERNING THE FIELD OF BASKETBALL (U.S. CLS. 100, 101 AND 104).

FIRST USE 10-3-2003; IN COMMERCE 10-3-2003.

2,955,782. WESTERN WIRELESS CORPORATION, BELLEVUE, WA. SN 78-340,109. PUB. 9-28-2004, FILED 12-12-2003.

HELLO2WEB

THE MARK CONSISTS OF STANDARD CHARACTERS WITHOUT CLAIM TO ANY PARTICULAR FONT, STYLE, SIZE, OR COLOR.

FOR TELECOMMUNICATIONS SERVICES, NAMELY, RADIO, TELEPHONE AND CELLULAR TELEPHONE SERVICES; WIRELESS ELECTRONIC TRANSMISSION OF VOICE AND DATA; PROVIDING USERS THE ABILITY TO ACCESS EMAIL, INTRANET AND NETWORK APPLICATIONS VIA REMOTE ACCESS; WIRELESS INTERNET ACCESS SERVICES; ELECTRONIC MESSAGING SERVICE ENABLING USERS TO RECEIVE VOICE, FAX, EMAIL AND OTHER FORMS OF MESSAGES VIA WIRELESS DEVICES OR ANY DEVICE CONNECTED TO THE TELECOMMUNICATIONS NETWORK (U.S. CLS. 100, 101 AND 104).

FIRST USE 10-0-2003; IN COMMERCE 10-0-2003.

CLASS 38—(Continued).

2,955,783. WESTERN WIRELESS CORPORATION, BELLEVUE, WA. SN 78-340,119. PUB. 9-28-2004, FILED 12-12-2003.

HELLO2TXT

THE MARK CONSISTS OF STANDARD CHARACTERS WITHOUT CLAIM TO ANY PARTICULAR FONT, STYLE, SIZE, OR COLOR.

FOR TELECOMMUNICATIONS SERVICES, NAMELY, RADIO, TELEPHONE AND CELLULAR TELEPHONE SERVICES; WIRELESS ELECTRONIC TRANSMISSION OF VOICE AND DATA; PROVIDING USERS THE ABILITY TO ACCESS EMAIL, INTRANET AND NETWORK APPLICATIONS VIA REMOTE ACCESS; WIRELESS INTERNET ACCESS SERVICES; ELECTRONIC MESSAGING SERVICE ENABLING USERS TO RECEIVE VOICE, FAX, EMAIL AND OTHER FORMS OF MESSAGES VIA WIRELESS DEVICES OR ANY DEVICE CONNECTED TO THE TELECOMMUNICATIONS NETWORK (U.S. CLS. 100, 101 AND 104).

FIRST USE 10-0-2003; IN COMMERCE 10-0-2003.

CLASS 39—TRANSPORTATION AND STORAGE

2,955,207. SJI, INC., ST. LOUIS, MO. SN 75-932,845. PUB. 11-6-2001, FILED 3-1-2000.

SJI COMPANIES

NO CLAIM IS MADE TO THE EXCLUSIVE RIGHT TO USE "COMPANIES", APART FROM THE MARK AS SHOWN.

FOR PACKAGING, STORAGE AND TRANSPORTATION VIA AIRPLANE, TRAIN, BUS OR PUBLIC OR PRIVATE MAIL/DELIVERY SERVICE OF GOODS USED AS PROMOTIONAL ITEMS AND PRODUCT SAMPLES, GIFTS AND LITERATURE IN CONNECTION WITH EXECUTION OF ADVERTISING PROGRAMS, MARKETING PROGRAMS AND PUBLIC RELATIONS PROGRAMS (U.S. CLS. 100 AND 105).

FIRST USE 5-1-2000; IN COMMERCE 5-1-2000.

2,955,292. HINSON, JAMES WILLIAM, TALLAHASSEE, FL. SN 76-419,724. PUB. 10-28-2003, FILED 6-12-2002.

VIP JETPORT

NO CLAIM IS MADE TO THE EXCLUSIVE RIGHT TO USE "JETPORT", APART FROM THE MARK AS SHOWN.

FOR PROVIDING TAKE OFF AND LANDING FACILITIES FOR JET AIRCRAFT (U.S. CLS. 100 AND 105).

FIRST USE 1-15-2004; IN COMMERCE 1-15-2004.

CLASS 39—(Continued).

2,955,344. BROG, WERNER, MUCHEN, FED REP GERMANY. SN 76-478,389. PUB. 11-18-2003, FILED 12-26-2002.

INDIMARK

FOR TRANSPORTATION CONSULTATION SERVICES TO PROMOTE THE USE OF ENVIRONMENTALLY SUSTAINABLE TRANSPORTATION, NAMELY PUBLIC TRANSPORTATION, CYCLING AND WALKING AS ALTERNATIVES TO CAR TRAVEL (U.S. CLS. 100 AND 105).

FIRST USE 4-22-2002; IN COMMERCE 4-22-2002.

2,955,660. AGNEW, DENNIS, NEW YORK, NY. SN 78-241,622. PUB. 12-16-2003, FILED 4-24-2003.

GETAWAY CRUISES

NO CLAIM IS MADE TO THE EXCLUSIVE RIGHT TO USE "CRUISES", APART FROM THE MARK AS SHOWN. FOR TRAVEL SERVICES, NAMELY ARRANGING CRUISES AND TOURS (U.S. CLS. 100 AND 105).

FIRST USE 6-30-2003; IN COMMERCE 6-30-2003.

CLASS 40—MATERIAL TREATMENT

2,955,373. GALAXY NUTRITIONAL FOODS, INC., ORLANDO, FL. SN 76-491,199. PUB. 12-2-2003, FILED 2-19-2003.



GALAXY NUTRITIONAL FOODS

OWNER OF U.S. REG. NOS. 2,314,619, 2,731,446, AND OTHERS.

NO CLAIM IS MADE TO THE EXCLUSIVE RIGHT TO USE "NUTRITIONAL FOODS", APART FROM THE MARK AS SHOWN.

FOR MANUFACTURE OF PROCESSED FOODS TO THE ORDER AND SPECIFICATIONS OF OTHERS, NAMELY CHEESE, CHEESE FOOD, CHEESE SPREADS; CHEESE SUBSTITUTES; IMITATION CHEESE; PEANUT BUTTER; DAIRY PRODUCTS EXCLUDING ICE CREAM, ICE MILK, AND FROZEN YOGURT; DAIRY-BASED BEVERAGES; PLANT-BASED FOOD BEVERAGES USED AS A SUBSTITUTE FOR MILK (U.S. CLS. 100, 103 AND 106).

FIRST USE 12-0-2000; IN COMMERCE 12-0-2000.

2,955,463. IRONCLAD PERFORMANCE WEAR CORP., LOS ANGELES, CA. SN 76-555,231. PUB. 8-24-2004, FILED 10-30-2003.

ROLLTOP

FOR CUSTOM MANUFACTURE OF GLOVES FOR OTHERS (U.S. CLS. 100, 103 AND 106).

FIRST USE 6-0-2004; IN COMMERCE 6-0-2004.

CLASS 40—(Continued).

2,955,574. BARDANI, FRANK, M., PURCHASE, NY. SN 78-203,466. PUB. 5-4-2004, FILED 1-15-2003.



NO CLAIM IS MADE TO THE EXCLUSIVE RIGHT TO USE KI 130, APART FROM THE MARK AS SHOWN.

THE MARK CONSISTS OF BLOCK LETTERS AND NUMERALS WITH A GEOMETRIC SHADED DESIGN REPRESENTING RADIATION HAZARD AS THE DOT OVER THE I.

FOR CUSTOM MANUFACTURE OF POTASSIUM IODIDE TABLETS FOR USE AS A THYROID BLOCKING AGENT IN THE EVENT OF EXPOSURE TO RADIATION (U.S. CLS. 100, 103 AND 106).

FIRST USE 8-3-2004; IN COMMERCE 8-3-2004.

CLASS 41—EDUCATION AND ENTERTAINMENT

2,955,195. REIMAN MEDIA GROUP, INC., GREENDALE, WI. SN 75-774,879. PUB. 2-22-2000, FILED 8-12-1999.

TASTE OF HOME

OWNER OF U.S. REG. NOS. 1,847,423, 2,113,908, AND OTHERS.

FOR EDUCATIONAL SERVICES, NAMELY, CONDUCTING CULINARY COURSES AND DISTRIBUTING COURSE MATERIALS IN CONNECTION THEREWITH (U.S. CLS. 100, 101 AND 107).

FIRST USE 8-31-1999; IN COMMERCE 8-31-1999.

2,955,219. MONDO MEDIA, INC., SAN FRANCISCO, CA. SN 76-043,261. PUB. 12-4-2001, FILED 5-8-2000.

MONDO MEDIA

NO CLAIM IS MADE TO THE EXCLUSIVE RIGHT TO USE "MEDIA", APART FROM THE MARK AS SHOWN.

THE ENGLISH TRANSLATION OF THE WORD "MONDO" IN THE MARK IS "WORLD" OR "EARTH". IT ALSO REFERS TO ITS SLANG MEANING OF "HUGE", "IMPORTANT" OR "VERY".

FOR ENTERTAINMENT SERVICES, NAMELY, PRODUCTION OF AN ANIMATED TELEVISION CARTOON SERIES, PRODUCTION OF LIVE-ACTION COMEDY, DRAMA AND/OR ANIMATED TELEVISION PROGRAMS, PRODUCTION OF LIVE-ACTION COMEDY, DRAMA AND/OR ANIMATED MOTION PICTURE THEATRICAL FILMS; THEATRICAL PERFORMANCES BOTH ANIMATED AND LIVE ACTION; AND PROVIDING A WEBSITE FEATURING INFORMATION ABOUT MOVIES, CARTOONS, AND RELATED ENTERTAINMENT INDUSTRY INFORMATION (U.S. CLS. 100, 101 AND 107).

FIRST USE 8-1-1991; IN COMMERCE 2-11-2005.

CLASS 41—(Continued).

2,955,220. IPROGRESS, PUTEAUX, FRANCE. SN 76-045,717.
PUB. 4-20-2004, FILED 5-4-2000.

IPROGRESS

FOR EDUCATIONAL SERVICES, NAMELY, CONDUCTING SEMINARS, CONGRESSES AND CONFERENCES FOR THE TRAINING OF LEARNERS AND ORGANIZATIONS OF ALL PROFILE TYPES AND SKILL LEVELS IN A STRUCTURED, TUTORED AND SELF-PACED INTEGRATED COURSE PROGRAM WITH INSTRUCTION IN ALL AREAS OF COMPUTER AND MULTIMEDIA CONTENT RENDERED VIA LOCAL AND GLOBAL COMPUTER NETWORKS (U.S. CLS. 100, 101 AND 107).

FIRST USE 5-0-2000; IN COMMERCE 1-0-2001.

2,955,260. GAMECOCK BOXING, INC., WESTMINSTER, CA.
SN 76-283,897. PUB. 12-4-2001, FILED 7-12-2001.

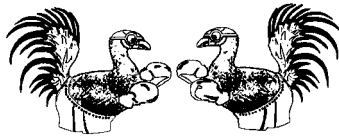

THE STIPPLING IS A FEATURE OF THE MARK AND DOES NOT INDICATE COLOR.

FOR ENTERTAINMENT AND SPORTING EVENTS IN THE NATURE OF NON-LETHAL COCK FIGHTING (U.S. CLS. 100, 101 AND 107).

FIRST USE 1-27-2005; IN COMMERCE 1-27-2005.

2,955,300. WARNER, BRIAN H., HOLLYWOOD, CA. SN 76-447,520. PUB. 12-30-2003, FILED 9-6-2002.

GROTESQUE BURLESQUE

FOR ORGANIZING ROCK FESTIVALS, CONCERTS AND MUSIC TOURS (U.S. CLS. 100, 101 AND 107).

FIRST USE 5-29-2003; IN COMMERCE 5-29-2003.

CLASS 41—(Continued).

2,955,328. MUZE INC., NEW YORK, NY. SN 76-468,053. PUB. 3-16-2004, FILED 11-19-2002.

**MUZE STORE-PLUS FOR
BODY MIND SPIRIT**

NO CLAIM IS MADE TO THE EXCLUSIVE RIGHT TO USE "BODY MIND SPIRIT", APART FROM THE MARK AS SHOWN.

FOR PROVIDING AN ONLINE COMPUTER DATABASE CONTAINING INFORMATION ABOUT VIDEO RECORDINGS, AUDIO RECORDINGS, BOOKS AND TEXTUAL WORKS OWNED BY THIRD PARTIES, RELATING TO BODY, MIND, SPIRIT, NEW AGE HEALTH AND ALTERNATIVE HEALTH AND FITNESS, TO BE DISTRIBUTED BY MEANS OF KIOSKS AND VIA A GLOBAL COMPUTER NETWORK; PROVIDING AN ONLINE COMPUTER DATABASE CONTAINING VIDEO SAMPLES AND AUDIO SAMPLES RELATING TO BODY, MIND, SPIRIT, NEW AGE HEALTH AND ALTERNATE HEALTH AND FITNESS, TO BE DISTRIBUTED BY MEANS OF KIOSKS AND VIA A COMPUTER NETWORK (U.S. CLS. 100, 101 AND 107).

FIRST USE 11-18-2002; IN COMMERCE 11-18-2002.

2,955,372. DETTMAN GROUP, LLC, THE, MISSION VIEJO, CA. SN 76-491,147. PUB. 11-4-2003, FILED 2-19-2003.

**HOUSECALLS WITH
DOCTOR GADGET**

FOR ENTERTAINMENT SERVICES FEATURING LIVE PERFORMANCES BY A TELEVISION AND RADIO PERSONALITY; EDUCATIONAL SERVICES FEATURING SEMINARS AND WORKSHOPS IN THE FIELD OF PRODUCT DEVELOPMENT (U.S. CLS. 100, 101 AND 107).

FIRST USE 11-0-2004; IN COMMERCE 11-0-2004.

2,955,439. OUTDOOR LIFE NETWORK, L.L.C., STAMFORD, CT. SN 76-535,553. PUB. 5-4-2004, FILED 8-7-2003.

MYSTERIOUS ENCOUNTERS

FOR ONGOING TELEVISION SERIES IN THE FIELD OF STRANGE PHENOMENONS (U.S. CLS. 100, 101 AND 107).

FIRST USE 9-27-2003; IN COMMERCE 9-27-2003.

CLASS 41—(Continued).

2,955,445. COYOTES HOCKEY, LLC, SCOTTSDALE, AZ. SN 76-538,279. PUB. 5-25-2004, FILED 8-19-2003.



FOR ENTERTAINMENT SERVICES IN THE NATURE OF PROFESSIONAL ICE HOCKEY EXHIBITIONS (U.S. CLS. 100, 101 AND 107).
FIRST USE 8-0-2003; IN COMMERCE 10-0-2003.

2,955,496. BFQ PRESS, FRIENDSWOOD, TX. SN 78-136,143. PUB. 10-14-2003, FILED 6-16-2002.



THE MARK CONSISTS OF THE WORDS "TOTAL RECALL" DISPLAYED AS THE SINGLE TERM "TOTALRECALL", TOGETHER WITH A GUN SIGHT DESIGN.
FOR EDUCATIONAL SERVICES, NAMELY, CONDUCTING INSTRUCTIONAL CLASSES, SEMINARS, WORKSHOPS IN THE FIELDS OF BUSINESS, COMPUTERS, COMMUNICATIONS, EDUCATION, FINANCE, INFORMATION MANAGEMENT, MEDICINE, COMPUTER NETWORKING AND INTERNET TECHNOLOGY, AND DISTRIBUTING COURSE MATERIAL CONNECTED THEREWITH (U.S. CLS. 100, 101 AND 107).
FIRST USE 1-3-2003; IN COMMERCE 1-3-2003.

CLASS 41—(Continued).

2,955,514. CHANNING BETE COMPANY, INC., SOUTH DEERFIELD, MA. SN 78-158,395. PUB. 12-2-2003, FILED 8-27-2002.

FAMILIES THAT CARE

OWNER OF U.S. REG. NOS. 1,719,908 AND 2,657,732.
NO CLAIM IS MADE TO THE EXCLUSIVE RIGHT TO USE "FAMILIES", APART FROM THE MARK AS SHOWN.
FOR CONDUCTING EDUCATIONAL PROGRAMS, WORKSHOPS, SEMINARS AND CONFERENCES, AND PROVIDING RELATED TRAINING SERVICES, INCLUDING COMPUTERIZED ONLINE EDUCATIONAL COURSES OF INSTRUCTION AND TRAINING PROGRAMS, ALL RELATING TO PARENTING, CHILDREN'S EDUCATION, AND SOCIAL ISSUES THAT FACE CHILDREN AND TEENAGERS (U.S. CLS. 100, 101 AND 107).
FIRST USE 1-24-2003; IN COMMERCE 1-24-2003.

2,955,526. DEUTSCH, STEFAN, FARMINGDALE, NY. SN 78-167,811. PUB. 1-27-2004, FILED 9-25-2002.

**THE HUMAN DEVELOPMENT COMPANY
...QUIETLY CHANGING PEOPLE'S LIVES**

THE MARK CONSISTS OF STANDARD CHARACTERS WITHOUT CLAIM TO ANY PARTICULAR FONT, STYLE, SIZE, OR COLOR.
NO CLAIM IS MADE TO THE EXCLUSIVE RIGHT TO USE "HUMAN DEVELOPMENT COMPANY", APART FROM THE MARK AS SHOWN.
FOR EDUCATIONAL SERVICES, NAMELY CONDUCTING WORKSHOPS AND SEMINARS IN THE FIELD OF PERSONAL GROWTH AND AWARENESS (U.S. CLS. 100, 101 AND 107).
FIRST USE 8-0-1998; IN COMMERCE 8-0-1998.

2,955,535. SCRIPPS NETWORKS, INC., KNOXVILLE, TN. SN 78-171,234. PUB. 5-6-2003, FILED 10-4-2002.

LIVE LIKE YOU MEAN IT

FOR TELEVISION PROGRAMMING SERVICES AND DISTRIBUTION OF TELEVISION PROGRAMMING (U.S. CLS. 100, 101 AND 107).
FIRST USE 12-30-2001; IN COMMERCE 12-30-2001.

CLASS 41—(Continued).

2,955,576. AXELROD, CHRISTOPHER G., BRATENAHL, OH. SN 78-204,429. PUB. 1-13-2004, FILED 1-17-2003.



THE NAME "CHRISTOPHER G. AXELROD" IDENTIFIES A LIVING INDIVIDUAL WHOSE CONSENT IS OF RECORD.

FOR ENTERTAINMENT SERVICES, NAMELY, MUSICAL PERFORMANCES, DRAMATIC PERFORMANCES, COMEDY PERFORMANCE, MASTER OF CEREMONY SERVICES FOR PARTIES AND SPECIAL EVENTS; PRODUCTION AND DIRECTION OF MUSICAL PERFORMANCES, DRAMATIC PERFORMANCES, AND COMEDY PERFORMANCES (U.S. CLS. 100, 101 AND 107). FIRST USE 9-30-2003; IN COMMERCE 9-30-2003.

2,955,583. EDUCATION AMERICA, INC., LITTLE ROCK, AR. SN 78-210,487. PUB. 9-21-2004, FILED 2-4-2003.



NO CLAIM IS MADE TO THE EXCLUSIVE RIGHT TO USE "COLLEGE", APART FROM THE MARK AS SHOWN. FOR EDUCATIONAL SERVICES, NAMELY, PROVIDING COURSES OF INSTRUCTION AT THE COLLEGE LEVEL (U.S. CLS. 100, 101 AND 107).

FIRST USE 7-1-2003; IN COMMERCE 7-1-2003.

2,955,585. FEDERAL EMPLOYEES NEWS DIGEST, INC., RESTON, VA. SN 78-211,521. PUB. 9-21-2004, FILED 2-6-2003.

FEDERAL DAILY

OWNER OF U.S. REG. NO. 2,887,999.

NO CLAIM IS MADE TO THE EXCLUSIVE RIGHT TO USE "FEDERAL", APART FROM THE MARK AS SHOWN.

FOR EDUCATIONAL SERVICES IN THE NATURE OF SEMINARS AND PRESENTATIONS IN THE FIELD OF GOVERNMENT EMPLOYMENT (U.S. CLS. 100, 101 AND 107).

FIRST USE 2-2-2003; IN COMMERCE 3-4-2003.

CLASS 41—(Continued).

2,955,590. THE COSMETIC, TOILETRY, AND FRAGRANCE ASSOCIATION FOUNDATION, WASHINGTON, DC. SN 78-215,018. PUB. 11-4-2003, FILED 2-14-2003.

LOOK GOOD FEEL BETTER FOR MEN

OWNER OF U.S. REG. NOS. 1,544,906, 2,249,333, AND OTHERS.

NO CLAIM IS MADE TO THE EXCLUSIVE RIGHT TO USE "FOR MEN", APART FROM THE MARK AS SHOWN.

FOR EDUCATIONAL SERVICES, NAMELY PROVIDING INSTRUCTIONAL MATERIALS ON HAIR, MAKE-UP AND SKIN CARE TECHNIQUES FOR CANCER PATIENTS AND COSMETOLOGISTS WHO PROVIDE SERVICES TO THOSE PATIENTS (U.S. CLS. 100, 101 AND 107).

FIRST USE 3-0-2004; IN COMMERCE 3-0-2004.

2,955,656. CAVS/GUND ARENA COMPANY, CLEVELAND, OH. SN 78-237,251. PUB. 11-25-2003, FILED 4-14-2003.



FOR ENTERTAINMENT AND EDUCATIONAL SERVICES IN THE NATURE OF ONGOING TELEVISION AND RADIO PROGRAMS IN THE FIELD OF BASKETBALL AND RENDERING LIVE BASKETBALL GAMES AND BASKETBALL EXHIBITIONS; THE PRODUCTION AND DISTRIBUTION OF RADIO AND TELEVISION BROADCASTS OF BASKETBALL GAMES, BASKETBALL EVENTS AND PROGRAMS IN THE FIELD OF BASKETBALL; CONDUCTING AND ARRANGING BASKETBALL CLINICS AND COACHES CLINICS AND BASKETBALL EVENTS; ENTERTAINMENT SERVICES IN THE NATURE OF PERSONAL APPEARANCES BY A COSTUMED MASCOT AND/OR DANCE TEAM AT BASKETBALL GAMES AND EXHIBITIONS, CLINICS, PROMOTIONS, AND OTHER BASKETBALL-RELATED EVENTS, SPECIAL EVENTS AND PARTIES; FAN CLUB SERVICES; ENTERTAINMENT SERVICES, NAMELY PROVIDING A WEBSITE FEATURING THE FOLLOWING CONTENT— TELEVISION HIGHLIGHTS, INTERACTIVE TELEVISION HIGHLIGHTS, VIDEO RECORDINGS, VIDEO STREAM RECORDINGS, INTERACTIVE VIDEO HIGHLIGHT SELECTIONS, RADIO PROGRAMS, RADIO HIGHLIGHTS, AND AUDIO RECORDINGS IN THE FIELD OF BASKETBALL, BASKETBALL NEWS IN THE NATURE OF INFORMATION, STATISTICS, AND TRIVIA ABOUT BASKETBALL, ON-LINE COMPUTER GAMES, VIDEO GAMES, INTERACTIVE VIDEO GAMES, ACTION SKILL GAMES, ARCADE GAMES, ADULTS' AND CHILDREN'S PARTY GAMES, BOARD GAMES, PUZZLES, AND TRIVIA GAMES, PROVIDING ON-LINE MAGAZINES, NEWSLETTERS, COLORING BOOKS, GAME SCHEDULES AND GREETING CARDS IN THE FIELD OF BASKETBALL OVER THE INTERNET, PROVIDING AN ONLINE COMPUTER DATABASE IN THE FIELD OF BASKETBALL (U.S. CLS. 100, 101 AND 107).

FIRST USE 10-9-2002; IN COMMERCE 10-9-2002.

CLASS 41—(Continued).

2,955,696. AVAYA INC., BASKING RIDGE, NJ. SN 78-265,917. PUB. 1-13-2004, FILED 6-23-2003.

ACA

FOR EDUCATIONAL SERVICES, NAMELY; CONDUCTING SEMINARS, COURSES AND WORKSHOPS IN THE FIELD OF VOICE NETWORKING, DATA NETWORKING AND THE USE OF RELATED VOICE NETWORKING AND DATA NETWORKING COMPUTER SOFTWARE APPLICATIONS AND PRINTED COURSE PREPARATION MATERIALS INCLUDED THEREWITH; PROVIDING TESTING TO DETERMINE PROFESSIONAL SKILLS ACQUIRED IN THE FIELD OF VOICE NETWORKING, DATA NETWORKING AND THE USE OF RELATED VOICE NETWORKING AND DATA NETWORKING COMPUTER SOFTWARE APPLICATIONS AND PRINTED INSTRUCTIONAL MATERIALS INCLUDED THEREWITH (U.S. CLS. 100, 101 AND 107).

FIRST USE 5-31-2003; IN COMMERCE 5-31-2003.

2,955,733. FOLKERTS, RODNEY, NEW YORK, NY. SN 78-291,927. PUB. 8-31-2004, FILED 8-25-2003.

YOU IN PICTURES

FOR PHOTOGRAPHY (U.S. CLS. 100, 101 AND 107). FIRST USE 8-15-2002; IN COMMERCE 8-15-2002.

2,955,737. IMPULSE JAPAN INC., TOKYO, JAPAN. SN 78-294,274. PUB. 6-1-2004, FILED 8-29-2003.



MAGICALGATE

THE MARK CONSISTS OF THE STYLIZED WORD MAGICALGATE IN ALL BLACK LETTERS AND A CIRCULAR DESIGN PORTION TO THE LEFT OF THE WORD MAGICALGATE. THE CIRCULAR DESIGN INCLUDES THREE WHITE OVAL SHAPES AGAINST A BLUE BACKGROUND. THE COLORS BLUE AND WHITE ARE CLAIMED AS FEATURES OF THE MARK.

FOR TRANSLATION SERVICES (U.S. CLS. 100, 101 AND 107).

FIRST USE 4-12-2001; IN COMMERCE 6-14-2001.

CLASS 41—(Continued).

2,955,755. TIME INC., NEW YORK, NY. SN 78-311,340. PUB. 7-6-2004, FILED 10-9-2003.

SPORTS ILLUSTRATED SWIMSUIT MODEL SEARCH

OWNER OF U.S. REG. NOS. 754,203, 1,969,741, AND OTHERS.

NO CLAIM IS MADE TO THE EXCLUSIVE RIGHT TO USE "SWIMSUIT MODEL SEARCH", APART FROM THE MARK AS SHOWN.

FOR ENTERTAINMENT SERVICES, NAMELY, A MODEL SEARCH CONTEST (U.S. CLS. 100, 101 AND 107).

FIRST USE 1-5-2005; IN COMMERCE 1-5-2005.

2,955,761. BUCKEYE CABLEVISION, INC., TOLEDO, OH. SN 78-318,941. PUB. 7-27-2004, FILED 10-27-2003.

BCSN

FOR CABLE TELEVISION PROGRAMMING RELATING TO SPORTS (U.S. CLS. 100, 101 AND 107).

FIRST USE 1-7-2004; IN COMMERCE 1-7-2004.

2,955,778. DUQUESNE UNIVERSITY OF THE HOLY GHOST, PITTSBURGH, PA. SN 78-336,362. PUB. 9-21-2004, FILED 12-4-2003.

LEARNING-ON-THE-GO

THE MARK CONSISTS OF STANDARD CHARACTERS WITHOUT CLAIM TO ANY PARTICULAR FONT, STYLE, SIZE, OR COLOR.

FOR PROVIDING EDUCATIONAL SERVICES AT THE UNIVERSITY LEVEL THROUGH THE USE OF DIGITAL MEDIA (U.S. CLS. 100, 101 AND 107).

FIRST USE 11-30-2004; IN COMMERCE 12-1-2004.

CLASS 42—SCIENTIFIC, COMPUTER AND LEGAL SERVICES

CLASS 42—(Continued).

2,955,206. SJI, INC, ST. LOUIS, MO. SN 75-932,268. PUB. 11-13-2001, FILED 3-1-2000.

SJI COMPANIES

NO CLAIM IS MADE TO THE EXCLUSIVE RIGHT TO USE "COMPANIES", APART FROM THE MARK AS SHOWN.

FOR PRINTING OF PUBLIC RELATIONS, ADVERTISING, AND MARKETING MATERIALS FOR THOSE INVOLVED IN THE SALE OF GOODS AND SERVICES TO THE PUBLIC (U.S. CLS. 100 AND 101).

FIRST USE 5-1-2000; IN COMMERCE 5-1-2000.

2,955,229. KABUSHIKI KAISHA HITACHI SEISAKUSHO, DBA HITACHI, LTD., CHIYODA-KU, TOKYO, JAPAN. SN 76-088,661. PUB. 8-5-2003, FILED 7-13-2000.

HITACHI CAPITAL

OWNER OF U.S. REG. NOS. 1,685,089, 2,267,606, AND OTHERS.

NO CLAIM IS MADE TO THE EXCLUSIVE RIGHT TO USE "CAPITAL" IN CLASS 42 ONLY, APART FROM THE MARK AS SHOWN.

FOR LEASING OF COMPUTER HARDWARE (U.S. CLS. 100 AND 101).

FIRST USE 10-1-2000; IN COMMERCE 10-1-2000.

2,955,268. SEXTON, RANDALL BURKS, HONOLULU, HI. SN 76-329,021. PUB. 10-15-2002, FILED 10-24-2001.

AIKI TOUCH

NO CLAIM IS MADE TO THE EXCLUSIVE RIGHT TO USE "TOUCH", APART FROM THE MARK AS SHOWN.

"AIKI" CAN BE DEFINED AS "TO BECOME ONE WITH THE ENERGY OF THE LIFE FORCE".

FOR MASSAGE (U.S. CLS. 100 AND 101).

FIRST USE 6-22-2003; IN COMMERCE 6-22-2003.

2,955,319. VERI-LOGIC, LLC, BOLINGBROOK, IL. SN 76-462,953. PUB. 10-28-2003, FILED 10-31-2002.

VERI-SYSTEMS

FOR DESIGN AND IMPLEMENTATION OF BAR CODE SOLUTIONS AND BAR CODE SYSTEMS FOR THE MANUFACTURING AND WHOLESALE DISTRIBUTION INDUSTRIES (U.S. CLS. 100 AND 101).

FIRST USE 12-0-2004; IN COMMERCE 12-0-2004.

CLASS 42—(Continued).

2,955,320. VERI-LOGIC, LLC, BOLINGBROOK, IL. SN 76-463,423. PUB. 11-25-2003, FILED 10-31-2002.

VERI-LOGIC

FOR DESIGN AND IMPLEMENTATION OF BAR CODE SOLUTIONS AND BAR CODE SYSTEMS FOR THE MANUFACTURING AND WHOLESALE DISTRIBUTION INDUSTRIES (U.S. CLS. 100 AND 101).

FIRST USE 12-0-2004; IN COMMERCE 12-0-2004.

2,955,474. ADERIS PHARMACEUTICALS, INC., HOPKINTON, MA. SN 76-976,684. PUB. 12-17-2002, FILED 8-20-2001.

**ADERIS
PHARMACEUTICALS**

NO CLAIM IS MADE TO THE EXCLUSIVE RIGHT TO USE "PHARMACEUTICALS", APART FROM THE MARK AS SHOWN.

FOR PRODUCT RESEARCH AND DEVELOPMENT SERVICES, NAMELY, DEVELOPMENT, PRODUCTION, COMMERCIALIZATION, DESIGN, AND RESEARCH OF CARDIOVASCULAR AND RENAL THERAPEUTICS FOR OTHERS (U.S. CLS. 100 AND 101).

FIRST USE 1-0-2002; IN COMMERCE 1-0-2002.

2,955,479. HOLMAN, MICHAEL J, NORTH SALT LAKE, UT. SN 78-024,772. PUB. 6-12-2001, FILED 9-7-2000.

DOCUMATIX

FOR PROVIDING TEMPORARY USE OF ON-LINE NON-DOWNLOADABLE SOFTWARE THAT ALLOWS USERS TO DOWNLOAD VARIOUS PUBLICATIONS (U.S. CLS. 100 AND 101).

FIRST USE 9-4-2001; IN COMMERCE 9-4-2001.

2,955,619. AROMAGEN CORPORATION, PLYMOUTH, MN. SN 78-225,708. PUB. 10-14-2003, FILED 3-14-2003.

AROMAGEN

FOR RESEARCH AND DEVELOPMENT SERVICES REGARDING NEW PRODUCTS AND PROCESSES FOR OTHERS IN THE FIELDS OF DISCOVERY, MANUFACTURE AND FORMULATION OF CHEMICAL COMPOUNDS, FLAVORS, FRAGRANCES, PHARMACEUTICALS, AGROCHEMICALS, POLYMERS (U.S. CLS. 100 AND 101).

FIRST USE 9-14-2004; IN COMMERCE 9-14-2004.

CLASS 42—(Continued).

2,955,689. SCHNEIDER CORPORATION, THE, INDIANAPOLIS, IN. SN 78-261,748. PUB. 4-27-2004, FILED 6-12-2003.

V.BUILDER

FOR ON-LINE SURVEYING AND ENGINEERING SERVICES (U.S. CLS. 100 AND 101).
FIRST USE 9-0-2003; IN COMMERCE 9-0-2003.

2,955,711. INCAPITAL HOLDINGS, LLC, CHICAGO, IL. SN 78-275,368. PUB. 4-13-2004, FILED 7-17-2003.

LADDERBUILDER

FOR PROVIDING ON-LINE INVESTMENT TOOLS, NAMELY, THE TEMPORARY USE OF ON-LINE NON-DOWNLOADABLE SOFTWARE (U.S. CLS. 100 AND 101).
FIRST USE 7-0-2003; IN COMMERCE 7-0-2003.

2,955,785. SEMAFORE PHARMACEUTICALS INC., INDIANAPOLIS, IN. SN 78-342,184. PUB. 9-21-2004, FILED 12-17-2003.

SEMAFORE

THE MARK CONSISTS OF STANDARD CHARACTERS WITHOUT CLAIM TO ANY PARTICULAR FONT, STYLE, SIZE, OR COLOR.
FOR PHARMACEUTICAL DRUG DEVELOPMENT SERVICES (U.S. CLS. 100 AND 101).
FIRST USE 11-0-2003; IN COMMERCE 11-0-2003.

2,955,791. LEX SOLUTIO CORPORATION, PHOENIX, AZ. SN 78-351,728. PUB. 10-19-2004, FILED 1-14-2004.

ENCORE LEX SOLUTIO

THE MARK CONSISTS OF STANDARD CHARACTERS WITHOUT CLAIM TO ANY PARTICULAR FONT, STYLE,

CLASS 42—(Continued).

SIZE, OR COLOR.

THE FOREIGN WORDING IN THE MARK TRANSLATES INTO ENGLISH AS "LEX" IS "LAW, STATUTE/COVENANT, AGREEMENT" AND THE TERM "SOLUTIO" IS "LOOSENING/PAYMENT/SOLUTION/EXPLANATION".

FOR LEGAL SUPPORT AND CONSULTING SERVICES, NAMELY, PREPARING AND PRESENTING LEGAL EXHIBITS AND ELECTRONIC PRESENTATION OF EXHIBITS, DEPOSITION TRANSCRIPTS, AND VIDEO DEPOSITIONS IN THE LEGAL FIELD; TRIAL CONSULTING SERVICES; VIDEOTAPE, VIDEO LASER DISC, CD ROM AND PHOTOGRAPHIC SLIDE PRODUCTION FOR USE AS EXHIBITS IN LEGAL PROCEEDINGS AND CONSULTING SERVICES IN CONNECTION THEREWITH; DEPOSITION DIGESTING SERVICES; COMPUTER CONSULTATION SERVICES, NAMELY DATA RECOVERY, EXTRACTION AND REPRODUCTION SERVICES (U.S. CLS. 100 AND 101).
FIRST USE 12-0-2003; IN COMMERCE 12-0-2003.

2,955,793. CYRLIN, ALAN, TARZANA, CA. SN 78-360,999. PUB. 11-2-2004, FILED 2-2-2004.

The Alacrity Advantage

THE MARK CONSISTS OF STANDARD CHARACTERS WITHOUT CLAIM TO ANY PARTICULAR FONT, STYLE, SIZE, OR COLOR.

FOR LEGAL SERVICES (U.S. CLS. 100 AND 101).
FIRST USE 3-31-2004; IN COMMERCE 3-31-2004.

CLASS 43—HOTEL AND RESTAURANT SERVICES

2,955,315. INTERSTATE OPERATING COMPANY, LP, ARLINGTON, VA. SN 76-461,106. PUB. 6-24-2003, FILED 10-24-2002.



FOR FOOD KIOSK SERVICES AT HOTELS AND RESORTS (U.S. CLS. 100 AND 101).
FIRST USE 6-3-2002; IN COMMERCE 6-3-2002.

CLASS 43—(Continued).

2,955,471. BRAR, HARINDER SINGH, SNOHOMISH, WA. SN 76-569,935. PUB. 10-26-2004, FILED 1-14-2004.

CLASS 43—(Continued).

2,955,789. SSA ENTERPRISES, INC., DULUTH, GA. SN 78-350,283. PUB. 10-5-2004, FILED 1-10-2004.

HARRY'S PEPPERED PIZZA

THE MARK CONSISTS OF STANDARD CHARACTERS WITHOUT CLAIM TO ANY PARTICULAR FONT, STYLE, SIZE, OR COLOR.

NO CLAIM IS MADE TO THE EXCLUSIVE RIGHT TO USE "PEPPERED PIZZA", APART FROM THE MARK AS SHOWN.

FOR RESTAURANT SERVICES (U.S. CLS. 100 AND 101).

FIRST USE 7-0-2004; IN COMMERCE 7-0-2004.

PAWSPA RESORT

THE MARK CONSISTS OF STANDARD CHARACTERS WITHOUT CLAIM TO ANY PARTICULAR FONT, STYLE, SIZE, OR COLOR.

OWNER OF U.S. REG. NO. 2,150,468.

NO CLAIM IS MADE TO THE EXCLUSIVE RIGHT TO USE "RESORT", APART FROM THE MARK AS SHOWN.

FOR PET BOARDING, NAMELY, KENNEL SERVICES (U.S. CLS. 100 AND 101).

FIRST USE 6-1-2004; IN COMMERCE 10-1-2004.

2,955,662. HAGGEN, INC., BELLINGHAM, WA. SN 78-242,147. PUB. 2-3-2004, FILED 4-25-2003.

TERRAVIDA COFFEE

NO CLAIM IS MADE TO THE EXCLUSIVE RIGHT TO USE "COFFEE", APART FROM THE MARK AS SHOWN.

FOR COFFEE SHOP SERVICES (U.S. CLS. 100 AND 101).

FIRST USE 2-4-2004; IN COMMERCE 2-4-2004.

CLASS 44—MEDICAL, BEAUTY AND AGRICULTURAL SERVICES

2,955,306. UNIVERSAL HEALTH SERVICES, INC., KING OF PRUSSIA, PA. SN 76-453,820. PUB. 10-28-2003, FILED 9-30-2002.

2,955,668. INTERNATIONAL RESTAURANT CONCEPTS, LLC, LAKEWOOD, CO. SN 78-245,937. PUB. 3-23-2004, FILED 5-5-2003.

**AVENIDA PAULISTA
CHURRASCARIA**



NO CLAIM IS MADE TO THE EXCLUSIVE RIGHT TO USE "CHURRASCARIA", APART FROM THE MARK AS SHOWN.

THE ENGLISH TRANSLATION OF "AVENIDA PAULISTA" IN THE MARK IS "PAULIST AVENUE".

FOR RESTAURANT SERVICES, RESTAURANT CARRY-OUT SERVICES AND CATERING SERVICES (U.S. CLS. 100 AND 101).

FIRST USE 4-2-2004; IN COMMERCE 4-2-2004.

NO CLAIM IS MADE TO THE EXCLUSIVE RIGHT TO USE "MEDICAL CENTER", APART FROM THE MARK AS SHOWN.

FOR HEALTH CARE SERVICES (U.S. CLS. 100 AND 101).

FIRST USE 9-1-2004; IN COMMERCE 9-1-2004.

CLASS 44—(Continued).

2,955,375. KIDZAAM, LLC, PRESCOTT, AZ. SN 76-492,492.
PUB. 11-11-2003, FILED 2-26-2003.



FOR COSMETIC DENTISTRY SERVICES; COSMETIC DENTISTRY SERVICES IN THE NATURE OF DENTAL RESTORATION SERVICES; DENTAL HYGIENIST SERVICES, DENTAL ORTHODONTIC SERVICES (U.S. CLS. 100 AND 101).

FIRST USE 10-9-2002; IN COMMERCE 10-9-2002.

2,955,400. SAMMONS, TROY E., PUEBLO WEST, CO. SN 76-500,073. PUB. 1-6-2004, FILED 3-24-2003.

ACUINJECTION

FOR ACUPUNCTURE SERVICES, NAMELY, INJECTION THERAPY WHEREBY ACUPUNCTURE POINTS ARE INJECTED WITH A NON-MYOTOXIC SUBSTANCE (U.S. CLS. 100 AND 101).

FIRST USE 3-0-2003; IN COMMERCE 4-0-2004.

CLASS 44—(Continued).

2,955,416. KIDZAAM, LLC, PRESCOTT, AZ. SN 76-517,827.
PUB. 11-11-2003, FILED 5-29-2003.



FOR COSMETIC DENTISTRY SERVICES; COSMETIC DENTISTRY SERVICES IN THE NATURE OF DENTAL RESTORATION SERVICES; DENTAL HYGIENIST SERVICES, DENTAL ORTHODONTIC SERVICES (U.S. CLS. 100 AND 101).

FIRST USE 10-9-2002; IN COMMERCE 10-9-2002.

2,955,417. REASY, PEGGY JOE, SAMMAMISH, WA. AND REASY, CHARLES JR., SAMMAMISH, WA. SN 76-517,843.
PUB. 5-11-2004, FILED 5-29-2003.

SORELLA SALON & SPA

NO CLAIM IS MADE TO THE EXCLUSIVE RIGHT TO USE "SALON & SPA", APART FROM THE MARK AS SHOWN.

THE ENGLISH TRANSLATION OF THE TERM SORELLA IN THE MARK IS SISTER.

FOR BEAUTY SALON SERVICES; HAIR CUTTING, COLORING AND STYLING SERVICES; HEALTH SPA SERVICES, NAMELY, COSMETIC BODY CARE SERVICES; MASSAGE SERVICES; MANICURE AND PEDICURE SERVICES; SKIN CARE SALON SERVICES; HAIR REMOVAL SERVICES; FACIAL CLEANSING AND TREATMENT SERVICES (U.S. CLS. 100 AND 101).

FIRST USE 7-12-2003; IN COMMERCE 7-12-2003.

2,955,553. EARLY WARNING HEALTHCARE, PLLC, BLOOMFIELD HILLS, MI. SN 78-185,049. PUB. 3-30-2004,
FILED 11-14-2002.



FOR MEDICAL SERVICES, NAMELY DIAGNOSIS AND TREATMENT OF EARLY STAGE HEART DISEASE (U.S. CLS. 100 AND 101).

FIRST USE 11-18-2002; IN COMMERCE 11-18-2002.

CLASS 45—(Continued).

2,955,556. BOVIGEN, LLC, METAIRIE, LA. SN 78-191,393.
PUB. 6-10-2003, FILED 12-5-2002.

BOVIGEN SOLUTIONS

FOR ANIMAL HUSBANDRY (U.S. CLS. 100 AND 101).
FIRST USE 4-1-2004; IN COMMERCE 4-1-2004.

2,955,597. CADBURY SENIOR SERVICES, INC., CHERRY
HILL, NJ. SN 78-218,063. PUB. 2-17-2004, FILED 2-24-2003.

**CONTINUING CARE THE
WAY IT SHOULD BE**

OWNER OF U.S. REG. NO. 2,585,290.
NO CLAIM IS MADE TO THE EXCLUSIVE RIGHT TO

CLASS 45—(Continued).

USE "CONTINUING CARE", APART FROM THE MARK AS
SHOWN.

FOR HEALTH CARE SERVICES, HOME HEALTH
CARE SERVICES, AND BEAUTY SALON SERVICES
(U.S. CLS. 100 AND 101).

FIRST USE 8-0-2001; IN COMMERCE 8-0-2001.

CLASS 45—PERSONAL SERVICES

2,955,758. FULL SPECTRUM TELECOMMUNICATIONS,
INC., CLEARWATER, FL. SN 78-315,707. PUB. 7-20-2004,
FILED 10-20-2003.

TALKCAFE

FOR DATING, MATCHMAKING AND SOCIAL IN-
TRODUCTION SERVICES OFFERED BY MEANS OF
TELEPHONE AND THE GLOBAL COMPUTER NET-
WORK (U.S. CLS. 100 AND 101).

FIRST USE 12-1-2004; IN COMMERCE 12-1-2004.

* * * * *

PRIOR UNITED STATES CLASSIFICATION

APPLICATION IN ONE CLASS

CERTIFICATION MARKS

CLASS B—SERVICES

2,955,310. AMERICAN BOARD OF SCIENTIFIC MEDICAL INTUITION, FAIR GROVE, MO. SN 76-455,199. PUB. 10-7-2003, FILED 9-27-2002.



NO CLAIM IS MADE TO THE EXCLUSIVE RIGHT TO USE "CERTIFIED MEDICAL INTUITIVE", APART FROM THE MARK AS SHOWN.

THE CERTIFICATION MARK, AS INTENDED TO BE USED BY AUTHORIZED PERSONS, CERTIFIES THAT AN INDIVIDUAL HAS DEMONSTRATED INTUITIVE MEDICAL DIAGNOSTIC PROFICIENCY BY SUCCESSFULLY COMPLETING TESTS, EXAMINATIONS, TRAINING PROGRAMS, AND CONTINUING EDUCATION; ADHERING TO ETHICAL STANDARDS; MEDICAL DIAGNOSING EXPERIENCE FOR SET PERIODS OF TIME; AND THAT THE INDIVIDUAL HAS BEEN RECERTIFIED FOR SUCH PROFICIENCY FROM TIME TO TIME.

FOR INTUITIVE MEDICAL DIAGNOSTIC SERVICES, NAMELY, MEDICALLY DIAGNOSING INDIVIDUALS AT A DISTANCE (U.S. CL. B).

FIRST USE 6-14-2004; IN COMMERCE 6-14-2004.

2,955,787. THE WAY TO WELLNESS, INC., NEW YORK, NY. SN 78-347,456. PUB. 10-19-2004, FILED 1-3-2004.

THE WAY TO WELLNESS

THE MARK CONSISTS OF STANDARD CHARACTERS WITHOUT CLAIM TO ANY PARTICULAR FONT, STYLE, SIZE, OR COLOR.

THIS CERTIFIES THAT THESE SERVICES ARE PERFORMED IN THE UNITED STATES AND ARE FOR THE PURPOSE OF THERAPY.

FOR HYPNOTHERAPY SERVICES, HYPNOTHERAPY TRAINING SERVICES; THERAPY AND TRAINING SERVICES, NAMELY NEURO LINGUISTIC PROGRAMMING AND REGRESSION THERAPY (U.S. CL. B).

FIRST USE 1-1-2003; IN COMMERCE 1-1-2003.

* * * * *

SUPPLEMENTAL REGISTER

These registrations are not subject to opposition.

SECTION 1.— INTERNATIONAL CLASSIFICATION

The short titles associated below with the international class numbers are terms designed merely for quick identification and are not an official part of the international classification. The full names of international classes are given in section 6.1 of the trademark rules of practice.

The designation "U.S. Cl." appearing in this section refers to the U.S. class in effect prior to Sep. 1, 1973 rather than the international class which applies to applications filed on or after that date. For adoption of international classification see notice in the OFFICIAL GAZETTE of Jun. 26, 1973 (911 O.G. TM 210).

Application in more than one class

2,955,806. FINE ARTS CENTER OF KERSHAW COUNTY, CAMDEN, SC. SN 76-283,208. FILED P.R. 7-3-2001; AM. S.R. 10-26-2004.

THE CAMDEN CUP

NO CLAIM IS MADE TO THE EXCLUSIVE RIGHT TO USE "CUP", APART FROM THE MARK AS SHOWN.

CLASS 36—INSURANCE AND FINANCIAL

FOR CHARITABLE FUND RAISING, NAMELY, SPONSORING POLO TOURNAMENTS FOR CHARITABLE PURPOSES (U.S. CLS. 100, 101 AND 102).
FIRST USE 4-0-2001; IN COMMERCE 4-0-2001.

CLASS 41—EDUCATION AND ENTERTAINMENT

FOR ENTERTAINMENT IN THE NATURE OF POLO TOURNAMENTS (U.S. CLS. 100, 101 AND 107).
FIRST USE 4-0-2001; IN COMMERCE 4-0-2001.

2,955,808. ABB AUTOMATION GROUP AG, CH-8050 ZURICH, SWITZERLAND. SN 76-314,476. FILED P.R. 9-19-2001; AM. S.R. 2-3-2005.

SIMULATE^{IT}

PRIORITY CLAIMED UNDER SEC. 44(D) ON SWITZERLAND APPLICATION NO. 02909/2001, FILED 3-22-2001, REG. NO. 489471, DATED 9-24-2001, EXPIRES 3-22-2011.

CLASS 9—ELECTRICAL AND SCIENTIFIC APPARATUS

FOR SCIENTIFIC, NAUTICAL, ELECTRICAL AND ELECTRONIC, OPTICAL, WEIGHING, MEASURING, ANALYSIS, DISPLAY, SIGNALING AND CHECKING, SUPERVISION APPARATUS AS WELL AS INSTRUMENTS AND EQUIPMENT, NAMELY FLOW METERS, AMMETERS, WATER, GAS, ELECTRICITY AND ENERGY METERS, VOLTMETERS, GAS, LIQUID AND PHYSICAL PROPERTY ANALYZERS, SPECTROMETERS, PHOTOMETERS, LOAD CELLS, SENSORS, FLOW SENSORS, TEMPERATURE SENSORS, INTEGRATORS, METAL DETECTORS FOR INDUSTRIAL PURPOSES, ACTUATORS, CONTROL VALVES FOR REGULATING THE FLOW OF GASES AND LIQUIDS, TRANSMITTERS FOR SIGNALS, ELECTROACOUSTIC TRANSDUCERS, SCANNERS, ACOUSTIC AND OPTICAL ALARMS, BURGLAR ALARMS, ELECTRONIC NOTICE BOARDS, ELECTRIC CONTROL PANELS FOR ELECTRICITY, ELECTRIC CHEMICAL CELLS; DOWNLOADABLE ELECTRONIC PUBLICATIONS IN THE NATURE OF MANUALS, TABLES, SPREADSHEETS, GRAPHIC PRINTS, FURTHER READINGS, INFORMATION BROCHURES AND ELECTRONIC NEWSLETTER IN THE FIELD OF PROCESS AND AUTOMATION INDUSTRIES, UTILITY INDUSTRY, OIL, GAS AND PETROCHEMICAL INDUSTRIES, MANUFACTURING AND CONSUMER INDUSTRIES, DATA PROCESSORS AND DATA PROCESSING COMPUTERS; MICROPROCESSORS; COMPUTER SOFTWARE, APPLICATION SOFTWARE, SOFTWARE TOOLS AND COMPUTER PROGRAMS FOR PROVIDING INTERFACES TO OPERATORS AND SETTING PARAMETERS, FOR COMPILING, ANALYZING, RECORDING, CONTROLLING, RETRIEVING, STORING, CONSOLIDATING AND MANAGING DATA SPECIALLY FAULTS DATA, FAULTS LOCATION DATA, PHYSICAL VALUES AND CHEMICAL PROPERTIES, SIGNALS AND FOR CALCULATING, REGULATING, ACTUATING, CREATING, EDITING, MODIFYING, OPTIMIZING, MONITORING, SUPPORTING, CONFIGURING, TUNING PROCESSES IN THE AUTOMOTIVE, METAL FABRICATION, FOUNDRY, PULP AND PAPER, PLASTICS, CONSUMER GOODS, CHEMICALS, PHARMACEUTICALS, MARINE, CEMENT, MINERALS, MINING, ELECTRIC UTILITIES, POWER GENERATION, WATER, OIL, AND GAS, PETROCHEMICALS AND REFINING INDUSTRIES, IN LOGISTIC SYSTEMS; COMPUTER PROGRAMS FOR PROVIDING INTERFACES TO OPERATORS AND REAL TIME INFORMATION TO BUSINESS SYSTEMS, FOR SETTING PARAMETERS, FOR CONFIGURING MEASURING FUNCTIONS, FOR ANALYZING ELECTRICAL POWER SYSTEMS, FOR COORDINATING PROCESSING, TESTING AND STATUS REPORTING TO THE PROCESSORS, ESPECIALLY TO MINIMIZE LOSSES IN THE POWER NETWORK, TO VERIFY SAFETY AND PROCESS INTERLOCKS AND ANALYZE PROCESS DYNAMICS FOR COMPILING, ANALYZING, RECORDING, CONTROLLING, RETRIEVING, STORING, CONSOLIDATING AND MANAGING DATA FROM BUSINESS, PRODUCTION AND AUTOMATION SYSTEMS, PHYSICAL VALUES, CHEMICAL PROPERTIES,

SIGNALS, FOR EXECUTING THE SAFETY CONTROL LOGIC AND FOR CALCULATING, REGULATING, ACTUATING, CREATING, EDITING, MODIFYING, MODELING, IMPROVING, MOTORING, SUPPORTING, CONFIGURING, CONTROLLING, TUNING PROCESSES AND PROCESS MODELS IN INDUSTRIAL PLANTS, IN CHEMICAL AND PHARMACEUTICAL PLANTS, IN SEMICONDUCTOR MANUFACTURING PLANTS AND SYSTEMS, IN POWER PLANTS, IN LOGISTIC SYSTEMS, IN THE MANUFACTURING AND CONSUMER INDUSTRIES, IN THE OIL, GAS AND PETROCHEMICALS INDUSTRIES, IN THE UTILITIES AND PROCESS INDUSTRIES, IN TELECOMMUNICATION SYSTEMS; ELECTRIC CABLES, ELECTRIC WIRES, SEMICONDUCTORS; ELECTRONIC AND ELECTRICAL APPARATUS, EQUIPMENT AND INSTRUMENTS AND PARTS THEREOF FOR POWER GENERATION, DISTRIBUTION AND SUPPLY AS WELL AS FOR GENERATING, DISTRIBUTING AND SUPPLYING ALTERNATIVE ENERGY, NAMELY ELECTRIC DUCTS AND LEADS, SIGNAL CABLES, STARTER CABLES FOR MOTORS, ELECTRIC CONTACTORS, ELECTRIC AND ELECTRONIC RELAYS, POWER SYSTEM PROTECTIVE RELAYS, ELECTRIC TRANSFORMERS, ELECTRIC CONVERTERS AND INVERTERS, ELECTRICAL CONNECTIONS, NAMELY, SOCKETS AND PLUGS, RESIDUAL CURRENT DEVICES, ELECTRIC INTERRUPTERS AND VACUUM INTERRUPTERS, REACTIVE POWER COMPENSATORS, ELECTRIC CAPACITORS, ELECTRIC REACTORS, ELECTRICITY LOSS METERS, ELECTRIC DISTRIBUTION CONSOLES, ELECTRICAL DISTRIBUTION BOXES, DISTRIBUTION BOARDS AND JUNCTION BOXES FOR ELECTRICITY, VOLTAGE REGULATORS, ELECTRONIC INDICATOR BOARDS, ELECTRIC INDUCTORS, ELECTRIC POSITIVE BOOSTER, ELECTRIC ACCUMULATORS, ELECTRIC SWITCHES AND CELL SWITCHES, CIRCUIT BREAKERS, CIRCUIT CLOSERS, FUSES, ELECTRIC TERMINALS, ELECTRIC ANTI-INTERFERENCE DEVICES, SEMICONDUCTOR ELEMENTS; PRERECORDED DISKETTES FEATURING DATA AND TECHNICAL INSTRUCTIONS REGARDING PRODUCTS AND SERVICES SPECIFIC TO PROCESS INDUSTRY, AUTOMATION INDUSTRY, UTILITIES INDUSTRY, OIL, GAS AND PETROCHEMICALS INDUSTRIES, MANUFACTURING AND CONSUMER INDUSTRIES; PRE-RECORDED MAGNETIC DISKS FEATURING DATA AND TECHNICAL INSTRUCTIONS REGARDING PRODUCTS AND SERVICES SPECIFIC TO PROCESS INDUSTRY, AUTOMATION INDUSTRY, UTILITIES INDUSTRY, OIL, GAS AND PETROCHEMICALS INDUSTRIES, MANUFACTURING AND CONSUMER INDUSTRIES; PRERECORDED OPTICAL DISKS FEATURING DATA AND TECHNICAL INSTRUCTIONS REGARDING PRODUCTS AND SERVICES SPECIFIC TO PROCESS INDUSTRY, AUTOMATION INDUSTRY, UTILITIES INDUSTRY, OIL, GAS AND PETROCHEMICALS INDUSTRIES, MANUFACTURING AND CONSUMER INDUSTRIES; DATA ENCRYPTION SOFTWARE (U.S. CLS. 21, 23, 26, 36 AND 38).

CLASS 42—SCIENTIFIC, COMPUTER AND LEGAL SERVICES

FOR PROVIDING TEMPORARY USE OF ONLINE NON-DOWNLOADABLE SOFTWARE FOR CONSULTING AND LOOKING UP MANUALS AND INFORMATION REGARDING PRODUCTS AND SERVICES SPECIFIC TO PROCESS INDUSTRY, AUTOMATION INDUSTRY, UTILITIES INDUSTRY, OIL, GAS AND PETROCHEMICALS INDUSTRIES, MANUFACTURING AND CONSUMER INDUSTRIES, COMMUNICATION TECHNOLOGY, FOR COMPARING, ANALYZING, CALCULATING AND BREAKING DOWN DATA, VALUES AND PROCESSES IN THE FIELD OF PROCESS INDUSTRY, AUTOMATION INDUSTRY, UTILITIES INDUSTRY, OIL, GAS AND PETROCHEMICALS INDUSTRIES, MANUFACTURING AND CONSUMER INDUSTRIES, COMMUNICATION TECHNOLOGY; TECHNICAL SUPPORT AND INFORMATION REGARDING THE USE OF COMPUTERS, COMPUTER HARDWARE, COMPUTER SOFTWARE AND COMPUTER NETWORKS ONLINE FROM A COMPUTER DATABASE OR VIA COMPUTER NETWORKS; COMPUTER PROGRAMMING FOR OTHERS; UPDATING OF COMPUTER SOFTWARE FOR OTHERS; PERFORMANCE OF CHEMICAL ANALYSIS; ANALYSIS FOR OIL EXTRACTION; CONSULTA-

TION IN THE FIELD OF ENVIRONMENTAL PROTECTION; ANALYSIS FOR OIL-FIELD EXPLOITATION; CONDUCTING OIL FIELD SURVEYS; CONSULTATION IN THE FIELD OF ARCHITECTURAL; ARCHITECTURAL DESIGN; RENTAL OF PORTABLE BUILDINGS; CONSULTANCY IN THE FIELD OF PUBLIC SAFETY; PROFESSIONAL AND TECHNICAL CONSULTANCY IN THE FIELD OF PROCESS ANALYSIS, PROCESS MODELING, PROCESS REDESIGN, PERFORMANCE ANALYSIS, ENERGY ANALYSIS, ENVIRONMENTAL ANALYSIS, COMPUTER SOFTWARE ENGINEERING, NETWORK ENGINEERING, IMPLEMENTATION OF HARDWARE, SOFTWARE AND NETWORK SYSTEMS, COMPUTER SYSTEMS ANALYSIS, REMOTE MONITORING AND CONTROLLING, QUALITY CONTROL, OF LIQUID, WATER AND GAS ANALYSIS, OF FLOW, FORCE, TORQUE, PARAMETER, LEVEL, PRESSURE, TEMPERATURE, VOLUME, PH, CONDUCTIVITY MEASUREMENT, PROFESSIONAL AND TECHNICAL CONSULTANCY RELATING TO ENERGY PRODUCTION UNITS AND ALTERNATIVE ENERGY SOLUTIONS AS WELL AS TO THE MANAGEMENT OF ELECTRICITY NETWORKS; PROFESSIONAL AND TECHNICAL CONSULTANCY RELATING TO PROGRAMMABLE ELECTRONIC SAFETY SYSTEMS WITHIN MANUFACTURING PROCESSES; RESEARCH IN THE FIELD OF CHEMISTRY; DESIGN OF COMPUTER SOFTWARE FOR OTHERS; INDUSTRIAL DESIGN; PHYSICAL RESEARCH FOR OTHERS IN THE FIELDS OF ELECTRICAL TECHNOLOGY, SUPERCONDUCTIVITY, DISTRIBUTED POWER GENERATION, CIRCUIT INTERRUPTION, INSULATION, AUTOMATION PRODUCTS, COMMUNICATION TECHNOLOGY, POWER ELECTRONICS, SENSORS, CURRENT SENSING, PRESSURE SENSING, FLOW SENSING, GAS SENSING, SPECTROSCOPY, SEMICONDUCTOR MANUFACTURING AND PACKAGING, FIBER OPTICS, SOFTWARE TECHNOLOGIES AND ARCHITECTURES, AUTOMATIC CONTROL AND OPTIMIZATION, OIL AND GAS TECHNOLOGIES; PHARMACEUTICAL CONSULTANCY; SERVICES OF A PHYSICIST, NAMELY ANALYZING, CALCULATING, OPTIMIZING DATA, VALUES, PROCESSES AND CONSULTATION RELATED TO AUTOMATION TECHNOLOGY, ENGINEERING, POWER ENGINEERING, MANUFACTURING ENGINEERING, OIL AND GAS TECHNOLOGIES, COMMUNICATION TECHNOLOGY; RENTAL AND LEASING OF PORTABLE SANITATION EQUIPMENT, NAMELY SINKS AND TOILETS; COMPUTER CONSULTATION; RECOVERY OF COMPUTER DATA; MAINTENANCE OF COMPUTER SOFTWARE; COMPUTER SYSTEM ANALYSIS, NAMELY EFFICIENCY ANALYSIS, INTEROPERABILITY ANALYSIS, SCALABILITY ANALYSIS, FAULT ANALYSIS, DRIVES ANALYSIS; RESEARCH AND DEVELOPMENT OF NEW PRODUCTS FOR OTHERS; RESEARCH IN THE FIELD OF ENGINEERING AND MACHINE CONSTRUCTION; PREPARING TECHNICAL EXPERT REPORTS; ENGINEERING; LEASING OF SOFTWARE AND DATA PROCESSING EQUIPMENT; SOFTWARE DEVELOPMENT; NETWORK TECHNOLOGY, NAMELY TECHNICAL SERVICES IN THE SETTING UP AND OPERATION OF COMPUTER NETWORKS, NETWORK ENGINEERING, DEVELOPMENT AND DESIGN ENGINEERING OF NETWORKS (U.S. CLS. 100 AND 101).

2,955,810. ABB AUTOMATION GROUP AG, CH-8050 ZURICH, SWITZERLAND. SN 76-341,544. FILED P.R. 11-26-2001; AM. S.R. 2-2-2005.

**Industrial^{IT}
enabled**

PRIORITY CLAIMED UNDER SEC. 44(D) ON SWITZERLAND APPLICATION NO. 9739/2001, FILED 10-5-2001, REG. NO. 495699, DATED 3-13-2002, EXPIRES 10-5-2011.

CLASS 9—ELECTRICAL AND SCIENTIFIC APPARATUS

FOR SCIENTIFIC, NAUTICAL, ELECTRICAL AND ELECTRONIC, OPTICAL, WEIGHING, MEASURING, ANALYSIS, DISPLAY, SIGNALING AND CHECKING, SUPERVISION APPARATUS AS WELL AS INSTRUMENTS AND EQUIPMENT, NAMELY FLOW METERS, AMMETERS, WATER, GAS, ELECTRICITY AND ENERGY METERS, VOLTMETERS, GAS, LIQUID AND PHYSICAL PROPERTY ANALYZERS, SPECTROMETERS, PHOTOMETERS, LOAD CELLS, SENSORS, FLOW SENSORS, TEMPERATURE SENSORS, INTEGRATORS, METAL DETECTORS FOR INDUSTRIAL PURPOSES, ACTUATORS, CONTROL VALVES FOR REGULATING THE FLOW OF GASES AND LIQUIDS, TRANSMITTERS FOR SIGNALS, ELECTROACOUSTIC TRANSDUCERS, SCANNERS, DATA DISPLAY APPARATUS, ACOUSTIC AND OPTICAL ALARMS, BURGLAR ALARMS, ELECTRONIC NOTICE BOARDS, ELECTRIC CONTROL PANELS FOR ELECTRICITY, ELECTRIC CHEMICAL CELLS; DOWNLOADABLE ELECTRONIC PUBLICATIONS IN THE NATURE OF MANUALS, TABLES, SPREADSHEETS, GRAPHIC PRINTS, FURTHER READINGS, INFORMATION BROCHURES AND ELECTRONIC NEWSLETTER IN THE FIELD OF PROCESS INDUSTRY, UTILITY INDUSTRY, OIL, GAS AND PETROCHEMICAL INDUSTRIES, MANUFACTURING AND CONSUMER INDUSTRIES; DATA PROCESSORS AND DATA PROCESSING COMPUTERS; MICROPROCESSORS; COMPUTER SOFTWARE, APPLICATION SOFTWARE, SOFTWARE TOOLS AND COMPUTER PROGRAMS FOR PROVIDING INTERFACES TO OPERATORS AND SETTING PARAMETERS, FOR COMPILING, ANALYZING, RECORDING, CONTROLLING, RETRIEVING, STORING, CONSOLIDATING AND MANAGING DATA SPECIALLY FAULTS DATA, FAULTS LOCATION DATA, PHYSICAL VALUES AND CHEMICAL PROPERTIES, SIGNALS AND FOR CALCULATING, REGULATING, ACTUATING, CREATING, EDITING, MODIFYING, OPTIMIZING, MONITORING, SUPPORTING, CONFIGURING, TUNING PROCESSES IN THE AUTOMOTIVE, METAL FABRICATION, FOUNDRY, PULP AND PAPER, PLASTICS, CONSUMER GOODS, CHEMICALS, PHARMACEUTICALS, MARINE, CEMENT, MINERALS, MINING, ELECTRIC UTILITIES, POWER GENERATION, WATER, OIL, AND GAS, PETROCHEMICALS AND REFINING INDUSTRIES, IN LOGISTIC SYSTEMS; COMPUTER PROGRAMS FOR PROVIDING INTERFACES TO OPERATORS AND REAL TIME INFORMATION TO BUSINESS SYSTEMS, FOR SETTING PARAMETERS, FOR CONFIGURING MEASURING FUNCTIONS, FOR COORDINATING PROCESSING, TESTING AND STATUS REPORTING TO THE PROCESSORS ESPECIALLY TO MINIMIZE LOSSES IN THE POWER NETWORK, FOR DEVELOPING, REGULATING, ACTUATING AND SUPPORTING PROGRAMMABLE ELECTRONIC SAFETY SYSTEMS, FOR COMPILING, ANALYZING, RECORDING, CONTROLLING, RETRIEVING, STORING, CONSOLIDATING AND MANAGING DATA, SPECIALLY FAULTS DATA, FAULTS LOCATION DATA, PHYSICAL VALUES AND CHEMICAL PROPERTIES, SIGNALS AND FOR CALCULATING, REGULATING, ACTUATING, CREATING, EDITING, MODIFYING, OPTIMIZING, MONITORING, SUPPORTING, CONFIGURING, TUNING PROCESSES IN THE AUTOMOTIVE, METAL FABRICATION, FOUNDRY, PULP AND PAPER, PLASTICS, CONSUMER GOODS, CHEMICALS, PHARMACEUTICALS, MARINE, CEMENT, MINERALS, MINING, ELECTRIC UTILITIES, POWER GENERATION, WATER, OIL AND GAS, PETROCHEMICALS AND REFINING INDUSTRIES, IN LOGISTIC SYSTEMS, IN TELECOMMUNICATION SYSTEMS; ELECTRIC CABLES, ELECTRIC WIRES, SEMICONDUCTORS; ELECTRONIC AND ELECTRICAL APPARATUS, EQUIPMENT AND INSTRUMENTS AND PARTS THEREOF FOR POWER GENERATION, DISTRIBUTION AND SUPPLY AS WELL AS FOR GENERATING, DISTRIBUTING AND SUPPLYING ALTERNATIVE ENERGY, NAMELY ELECTRIC DUCTS AND LEADS, SIGNAL CABLES, STARTER CABLES FOR MOTORS, ELECTRIC CONTACTORS, ELECTRIC AND ELECTRONIC RELAYS, POWER SYSTEM PROTECTIVE RELAYS, ELECTRIC TRANSFORMERS, ELECTRIC CONVERTERS AND INVERTERS, ELECTRICAL CONNECTIONS, NAMELY SOCKETS AND PLUGS, RESIDUAL CURRENT DEVICES, ELECTRIC INTERRUPTERS AND VACUUM INTERRUPTERS, REACTIVE POWER

COMPENSATORS, ELECTRIC CAPACITORS, ELECTRIC REACTORS, ELECTRIC LOSS METERS, ELECTRIC DISTRIBUTION CONSOLES, ELECTRICAL DISTRIBUTION BOXES, DISTRIBUTION BOARDS AND JUNCTION BOXES FOR ELECTRICITY, VOLTAGE REGULATORS, ELECTRONIC INDICATOR BOARDS, ELECTRIC INDUCTORS, ELECTRIC POSITIVE BOOSTER, ELECTRIC ACCUMULATORS, ELECTRIC SWITCHES AND CELL SWITCHES, CIRCUIT BREAKERS, CIRCUIT CLOSERS, FUSES, ELECTRICITY VALVES, SURGE ARRESTORS, ELECTRIC TERMINALS, ELECTRIC ANTI-INTERFERENCE DEVICES, SEMICONDUCTOR ELEMENTS; PRE-RECORDED DISKETTES FEATURING DATA AND TECHNICAL INSTRUCTIONS REGARDING PRODUCTS AND SERVICES SPECIFIC TO PROCESS INDUSTRY, UTILITY INDUSTRY, OIL, GAS AND PETROCHEMICALS INDUSTRIES, MANUFACTURING AND CONSUMER INDUSTRIES; PRE-RECORDED MAGNETIC DISKS FEATURING DATA AND TECHNICAL INSTRUCTIONS REGARDING PRODUCTS AND SERVICES SPECIFIC TO PROCESS INDUSTRY, UTILITIES INDUSTRY, OIL, GAS AND PETROCHEMICALS INDUSTRIES, MANUFACTURING AND CONSUMER INDUSTRIES; PRERECORDED OPTICAL DISKS FEATURING DATA AND TECHNICAL INSTRUCTIONS REGARDING SPECIFIC PRODUCTS AND SERVICES RELATING TO PROCESS INDUSTRY, UTILITY INDUSTRY, OIL, GAS AND PETROCHEMICALS INDUSTRIES, MANUFACTURING AND CONSUMER INDUSTRIES; DATA ENCRYPTION SOFTWARE (U.S. CLS. 21, 23, 26, 36 AND 38).

CLASS 42—SCIENTIFIC, COMPUTER AND LEGAL SERVICES

FOR PROVIDING TEMPORARY USE OF ONLINE NON-DOWNLOADABLE SOFTWARE FOR CONSULTING AND LOOKING UP MANUALS AND INFORMATION REGARDING PRODUCTS AND SERVICES SPECIFIC TO PROCESS INDUSTRY, UTILITIES INDUSTRY, OIL, GAS AND PETROCHEMICALS INDUSTRIES, MANUFACTURING AND CONSUMER INDUSTRIES, COMMUNICATION TECHNOLOGY, FOR COMPARING, ANALYZING, CALCULATING AND BREAKING DOWN DATA, VALUES AND PROCESSES IN THE FIELD OF PROCESS INDUSTRY, UTILITIES INDUSTRY, OIL, GAS AND PETROCHEMICALS INDUSTRIES, MANUFACTURING AND CONSUMER INDUSTRIES, COMMUNICATION TECHNOLOGY; TECHNICAL SUPPORT AND INFORMATION REGARDING THE USE OF COMPUTERS, COMPUTER HARDWARE, COMPUTER SOFTWARE AND COMPUTER NETWORKS ONLINE FROM A COMPUTER DATABASE OR VIA COMPUTER NETWORKS; COMPUTER PROGRAMMING FOR OTHERS; UPDATING OF COMPUTER SOFTWARE FOR OTHERS; PERFORMANCE OF CHEMICAL ANALYSIS; ANALYSIS FOR OIL EXTRACTION; CONSULTANCY IN THE FIELD OF ENVIRONMENTAL PROTECTION; ANALYSIS FOR OIL-FIELD EXPLOITATION; CONDUCTING OIL FIELD SURVEYS; CONSULTANCY IN THE FIELD OF ARCHITECTURE; ARCHITECTURAL DESIGN; RENTAL OF PORTABLE BUILDINGS; CONSULTANCY IN THE FIELD OF PUBLIC SAFETY; PROFESSIONAL CONSULTANCY IN THE FIELD OF DESIGNING, PLANNING, ENGINEERING, TESTING, INSTALLING AND ACTUATING PROCESS CONTROL SYSTEMS, COMPUTER SOFTWARE ENGINEERING, NETWORK ENGINEERING, IMPLEMENTATION OF HARDWARE, SOFTWARE AND NETWORK SYSTEMS, COMPUTER SYSTEMS ANALYSIS, REMOTE MONITORING AND CONTROLLING, QUALITY CONTROL OF LIQUID, WATER AND GAS ANALYSIS, OF FLOW, FORCE, TORQUE, PARAMETER, LEVEL, PRESSURE, TEMPERATURE, VOLUME, PH, CONDUCTIVITY MEASUREMENT, PROFESSIONAL AND TECHNICAL CONSULTANCY RELATING TO ENERGY PRODUCTION UNITS AND ALTERNATIVE ENERGY SOLUTIONS AS WELL AS TO THE MANAGEMENT OF ELECTRICITY NETWORKS; RESEARCH IN THE FIELD OF CHEMISTRY; DESIGN OF COMPUTER SOFTWARE FOR OTHERS; INDUSTRIAL DESIGN; PHYSICAL RESEARCH FOR OTHERS IN THE FIELDS OF ELECTRICAL TECHNOLOGY, SUPERCONDUCTIVITY, DISTRIBUTED POWER GENERATION, CIRCUIT INTERRUPTION, INSULATION, AUTOMATION PRODUCTS, COMMUNICATION TECHNOLOGY, POWER ELECTRONICS, SENSORS, CURRENT SENSING, PRES-

SURE SENSING, FLOW SENSING, GAS SENSING, SPECTROSCOPY, SEMICONDUCTOR MANUFACTURING AND PACKAGING, FIBER OPTICS, SOFTWARE TECHNOLOGIES AND ARCHITECTURES, AUTOMATIC CONTROL AND OPTIMIZATION, OIL AND GAS TECHNOLOGIES; SERVICES OF A PHYSICIST, NAMELY ANALYZING, CALCULATING, OPTIMIZING DATA, VALUES, PROCESSES AND CONSULTATION RELATED TO AUTOMATION TECHNOLOGY ENGINEERING, POWER ENGINEERING, MANUFACTURING ENGINEERING, OIL AND GAS TECHNOLOGIES, COMMUNICATION TECHNOLOGY; RENTAL AND LEASING OF PORTABLE SANITATION EQUIPMENT, NAMELY SINKS AND TOILETS; COMPUTER CONSULTATION; RECOVERY OF COMPUTER DATA; MAINTENANCE OF COMPUTER SOFTWARE; COMPUTER SYSTEM ANALYSIS, NAMELY EFFICIENCY ANALYSIS, INTEROPERABILITY ANALYSIS, SCALABILITY ANALYSIS, FAULT ANALYSIS, DRIVES ANALYSIS; RESEARCH AND DEVELOPMENT OF NEW PRODUCTS FOR OTHERS; RESEARCH IN THE FIELD OF ENGINEERING AND MACHINE CONSTRUCTION; PREPARING TECHNICAL EXPERT REPORTS; ENGINEERING LEASING OF SOFTWARE AND DATA PROCESSING EQUIPMENT; SOFTWARE DEVELOPMENT; NETWORK TECHNOLOGY, NAMELY TECHNICAL SERVICES IN THE SETTING UP AND OPERATION OF COMPUTER NETWORKS, NETWORK ENGINEERING, DEVELOPMENT AND DESIGN ENGINEERING OF NETWORKS (U.S. CLS. 100 AND 101).

2,955,816. PERFECTION FENCE CORPORATION, MARSHFIELD, MA. SN 76-452,271. FILED P.R. 9-23-2002; AM. S.R. 12-27-2004.

CUSTOM DESIGNERS AND MANUFACTURERS

CLASS 6—METAL GOODS

FOR METAL OUTDOOR BUILDING MATERIALS, NAMELY, RAILINGS, FENCING, PILLAR POSTS, ARBORS, PERGOLAS, DECKS, DECK RAILS, GAZEBOS, LAMP POSTS, MAIL BOX POSTS AND SIGN FRAMES (U.S. CLS. 2, 12, 13, 14, 23, 25 AND 50).

FIRST USE 4-0-2002; IN COMMERCE 4-0-2002.

CLASS 19—NON-METALLIC BUILDING MATERIALS

FOR NON-METALLIC OUTDOOR BUILDING MATERIALS, NAMELY, RAILINGS, FENCING, PILLAR POSTS, ARBORS, PERGOLAS, DECKS, DECK RAILS, GAZEBOS, LAMP POSTS, MAIL BOX POSTS AND SIGN FRAMES (U.S. CLS. 1, 12, 33 AND 50).

FIRST USE 4-0-2002; IN COMMERCE 4-0-2002.

2,955,822. BOSS PET PRODUCTS, INC., KEWANEE, IL. SN 76-490,831. FILED P.R. 2-13-2003; AM. S.R. 3-7-2005.

PET THERAPY

CLASS 3—COSMETICS AND CLEANING PREPARATIONS

FOR NON-MEDICATED DRY BATH POWDER FOR PETS; NON-MEDICATED GROOMING PREPARATIONS FOR PETS, NAMELY, SHAMPOOS, LOTIONS, CREAMS, EYE WASHES, DEODORANTS, COLOGNES, SHED STOPPING SPRAYS, AND HAIR REMOVAL GLOVES; PET STAIN REMOVERS; FABRIC CLEANING PREPARATIONS FOR CARPETS AND FURNITURE; NON-MEDICATED DENTAL RINSE FOR PETS (U.S. CLS. 1, 4, 6, 50, 51 AND 52).

FIRST USE 9-30-2003; IN COMMERCE 9-30-2003.

CLASS 5—PHARMACEUTICALS

FOR MEDICATED PET POWDERS, SHAMPOOS, SOLUTIONS, CREAMS, DIPS AND SPRAYS FOR THE TREATMENT OF FLEAS, TICKS, EAR MITES, FUNGUS, ODOR AND BACTERIA; PREMOISTENED MEDICATED TISSUES, PADS, TOWLETTES AND WIPES FOR PETS; MEDICATED GROOMING PREPARATIONS FOR PETS, NAMELY, SHAMPOOS, LOTIONS, CREAMS, EYE WASHES, AND SHED STOPPING SPRAYS; ANTI-FLATULANTS FOR PETS; ANIMAL FEED ADDITIVE FOR USE AS A NUTRITIONAL SUPPLEMENT; VITAMIN SUPPLEMENTS FOR PETS; MEDICATED DENTAL RINSE FOR PETS; PHARMACEUTICAL PREPARATIONS FOR PETS IN THE NATURE OF LINIMENTS, SALVES, AND LIQUID AND TABLET MEDICATION FOR THE RELIEF OF ARTHRITIS; STYPTIC POWDERS FOR PETS; ALL PURPOSE DISINFECTING AND DEODORIZING PREPARATIONS; AND FIRST AID KITS FOR PETS (U.S. CLS. 6, 18, 44, 46, 51 AND 52).

FIRST USE 9-30-2003; IN COMMERCE 9-30-2003.

CLASS 31—NATURAL AGRICULTURAL PRODUCTS

FOR NON-MEDICATED ADDITIVES FOR ANIMAL FEED; EDIBLE PET TREATS FOR CATS AND DOGS (U.S. CLS. 1 AND 46).

FIRST USE 9-30-2003; IN COMMERCE 9-30-2003.

2,955,824. SPORTS PICK INTERNATIONAL HOLDINGS, INC., BRIDGETOWN, BARBADOS. SN 76-501,108. FILED P.R. 3-26-2003; AM. S.R. 2-1-2005.

SPORTS PICK

NO CLAIM IS MADE TO THE EXCLUSIVE RIGHT TO USE "SPORTS", APART FROM THE MARK AS SHOWN.

CLASS 35—ADVERTISING AND BUSINESS

FOR CONTESTS AND INCENTIVE AWARENESS PROGRAMS TO PROMOTE THE SALE OF PRODUCTS AND SERVICES OF OTHERS; PROMOTING SPORTS COMPETITIONS AND/OR EVENTS OF OTHERS; PROMOTING THE GOODS AND SERVICES OF OTHERS BY ARRANGING FOR SPONSORS TO AFFILIATE THEIR GOODS WITH MAJOR SPORTING EVENTS (U.S. CLS. 100, 101 AND 102).

FIRST USE 10-0-2000; IN COMMERCE 10-0-2000.

CLASS 41—EDUCATION AND ENTERTAINMENT

FOR ENTERTAINMENT SERVICES, NAMELY, CONDUCTING CONTESTS AT LIQUOR LICENSED ESTABLISHMENTS, AND BY WAY OF ELECTRONIC COMMUNICATION MEDIUMS, NAMELY, WIRELESS DEVICES, CABLE, SATELLITE, INTERNET AND TELEPHONE LINES (U.S. CLS. 100, 101 AND 107).

FIRST USE 10-0-2000; IN COMMERCE 10-0-2000.

2,955,831. G. RAU GMBH & CO. KG, D-75172 PFORZHEIM, FED REP GERMANY. SN 76-519,614. FILED P.R. 5-20-2003; AM. S.R. 5-6-2004.

G. RAU

OWNER OF ERPN CMNTY TM OFC REG. NO. 002329340, DATED 2-4-2003, EXPIRES 8-3-2011.

CLASS 6—METAL GOODS

FOR COMMON METALS ALLOYS FOR FURTHER MANUFACTURING OF THE FOLLOWING—METALLIC PIPES AND TUBES, BOURDON TUBES, TUBES OF PLATED MATERIALS COATED WITH COMMON METALS, PROFILE TUBES OF COMMON METALS AND THEIR ALLOYS, COATED MATERIALS AND STAINLESS STEELS, TUBES OF EXPANSION ALLOYS, TUBES AS MELTDOWN ALLOYS FOR GLASS/METAL OR GLASS/CERAMIC/METAL COMPOUNDS AND OF IRON, NICKEL ALLOYS AND RESISTANCE ALLOYS, HOLLOW WAVEGUIDES, THIN-WALL TUBES OF COMMON METALS AND HARDENABLE COPPER/BERYLLIUM ALLOYS, REFINED TUBES OF COMMON METALS, STAINLESS STEELS AND SPECIAL MATERIALS, CAPILLARY TUBES, COMPOSITE MATERIALS, LAMINAR COMPOSITE MATERIALS, AND FIBRE COMPOSITE MATERIALS, THERMOSTATIC BIMETAL SNAP WASHERS AND SNAP ELEMENTS, THERMOSTATIC BIMETAL STRAPS AND STRIPS, STAMPED AND MOULDED PARTS OF THERMOSTATIC BIMETAL, METALLIC ASSEMBLIES, NICKEL AND NICKEL ALLOYS AN STEEL BEING STRAPS, WIRES, TUBES AND PROFILE SECTIONS, THERMOSTATIC BIMETALS OF IRON/NICKEL ALLOYS, STAINLESS STEELS AND SPECIAL MATERIALS BEING STRAPS AND STRIPS, THERMOSTATIC BIMETAL STAMPED AND MOULDED PARTS WITH DEFINED PROPERTIES AND ASSEMBLIES OF THERMOSTATIC BIMETALS, ROLL SEAM WELDED STRAPS AND PROFILE SECTIONS, ELECTROPLATED STRAPS WITH NICKEL AND TIN, SILVER, GOLD, COPPER, ZINC, PALLADIUM AND CHEMICALLY NICKEL PLATED, DEEP-DRAWN AND EXTRUDED HIGH-PRECISION PARTS IN SPECIAL SHAPES OF METALLIC MATERIALS AND TRANSPORTABLE BUILDINGS OF METAL; NON-ELECTRIC CABLES AND WIRES OF COMMON METAL; GOODS OF COMMON METAL, NAMELY, METALLIC PIPES AND TUBES, BOURDON TUBES, TUBES OF PLATES MATERIALS COATED WITH COMMON METALS, PROFILE TUBES OF COMMON METALS AND THEIR ALLOYS, COATED MATERIALS AND STAINLESS STEELS, TUBES OF EXPANSION ALLOYS, TUBES AS MELTDOWN ALLOYS FOR GLASS/METAL OR GLASS/CERAMIC/METAL COMPOUNDS AND OF IRON/NICKEL ALLOYS AND RESISTANCE ALLOYS, HOLLOW WAVEGUIDES, THIN-WALL TUBES OF COMMON METALS AND HARDENABLE COPPER/BERYLLIUM ALLOYS, REFINED TUBES OF COMMON METALS, STAINLESS STEELS AND SPECIAL MATERIALS, CA-

PILLARY TUBES, COMPOSITE MATERIALS, LAMINAR COMPOSITE MATERIALS, AND FIBRE COMPOSITE MATERIALS, THERMOSTATIC BIMETAL SNAP WASHERS AND SNAP ELEMENTS, THERMOSTATIC BIMETAL STRAPS AND STRIPS, STAMPED AND MOULDED PARTS OF THERMOSTATIC BIMETAL, METALLIC ASSEMBLIES, NICKEL AND NICKEL ALLOYS AND STEEL BEING STRAPS, WIRES, TUBES AND PROFILE SECTIONS, THERMOSTATIC BIMETALS OF IRON/NICKEL ALLOYS, STAINLESS STEELS AND SPECIAL MATERIALS BEING STRAPS AND STRIPS, THERMOSTATIC BIMETAL STAMPED AND MOULDED PARTS WITH DEFINED PROPERTIES AND ASSEMBLIES OF THERMOSTATIC BIMETALS, ROLL SEAM WELDED STRAPS AND PROFILE SECTION, ELECTROPLATED STRAPS WITH NICKEL AND TIN, SILVER, GOLD, COPPER, ZINC, PALLADIUM AND CHEMICALLY NICKEL PLATED, DEEP-DRAWN AND EXTRUDED HIGH-PRECISION PARTS IN SPECIAL SHAPES OF METALLIC MATERIALS (U.S. CLS. 2, 12, 13, 14, 23, 25 AND 50).

CLASS 9—ELECTRICAL AND SCIENTIFIC APPARATUS

FOR ELECTRICAL CONTROLLERS; HOLLOW WAVEGUIDES FOR APPLICATIONS IN HIGH FREQUENCY ENGINEERING OF THE FOLLOWING— COPPER AND COPPER ALLOYS, PRECIOUS METALS AND PRECIOUS METAL COATINGS, THIN-WALL TUBES OF COMMON METALS AND HARD ENABLE COPPER/BERYLLIUM ALLOYS, E.G; FOR FURTHER PROCESSING INTO CORRUGATED TUBES AND MEASURING SPRINGS SUBJECTED TO HIGH DYNAMIC STRESSES, REFINED TUBES OF COMMON METALS, PRECIOUS METAL, STAINLESS STEELS AND SPECIAL MATERIALS, E.G; AS GUIDE TUBES FOR TEST PINS OR PLUG-IN CONNECTIONS, CAPILLARY TUBES FOR MEASURING AND CONTROL ENGINEERING, HYDRAULICS AND PNEUMATICS OF COPPER, COPPER ALLOYS, STAINLESS STEEL AND SPECIAL ALLOYS, THERMOSTATIC BIMETAL SNAP WASHERS AND SNAP ELEMENTS, THERMOSTATIC STRAPS AND STRIPS, STAMPED AND MOULDED PARTS OF THERMOSTATIC BIMETAL, CONTACT PARTS, SOLID AND COATED, CONTACTED RIVETS, SOLID AND COATED, STAMPED FLEXIBLE PARTS OF MATERIALS COATED WITH PRECIOUS METALS, CONTACT SPRINGS, CONTACT PART ASSEMBLIES, RIVETED, TOX-JOINED, SOLDERED, RESISTANCE AND LASER, WELDED ASSEMBLIES, DEEP-DRAWN AND EXTRUDED PARTS FOR ELECTRICAL ENGINEERING AND ELECTRONICS AND FOR MEASURING AND CONTROL ENGINEERING OF PRECIOUS METALS AND THE ALLOYS, COPPER AND COPPER ALLOYS, NICKEL AND NICKEL ALLOYS, STAINLESS STEELS AND MATERIALS WITH SPECIAL PHYSICAL PROPERTIES WITH REGARD TO EXPANSION BEHAVIOR AND MAGNETISM, INCLUDING WITH ELECTROPLATED SURFACE COATS, COLD EXTRUDED PARTS AS HEAT SINKS, LOAD-BEARING AND CONNECTING ELEMENTS FOR POWER ELECTRONICS, CONTACT PARTS AND CONTACT LAMINATIONS FOR COLLECTORS, LOAD-BEARING PLATES AND CONTACTING PLATES, COMPOSITE ELECTRODES FOR SPARK PLUGS, PROTECTIVE SLEEVES, SCREENING CANS, CAPS AND A NUMBER OF SMALL HIGH-PRECISION DEEP-DRAWN PARTS IN SPECIAL SHAPES OF METALLIC MATERIALS, SEMI-FINISHED PRODUCTS AND MEMORY ELEMENTS OF SHAPE MEMORY ALLOYS FOR MEASURING AND CONTROL ENGINEERING, COATED MATERIALS WITH PRECIOUS METAL COATINGS AND SUBSTRATES OF COPPER MATERIAL, NICKEL AND NICKEL ALLOYS AND STEEL, AS STRAPS, WIRES, TUBES, AND PROFILE SECTIONS, CONTACT BIMETALS AND COATINGS OF PRECIOUS METAL AND SUBSTRATES OF

CONDUCTIVE COPPER MATERIALS AND ALL COATABLE NICKEL MATERIALS AND STEELS, ROLL SEAM WELDED STRAPS AND PROFILE SECTIONS, ELECTROPLATED STRAPS WITH NICKEL, TIN AND PRECIOUS METALS, CONTACT PARTS AND ASSEMBLIES WITH INSERTS AND COATINGS OF PRECIOUS METAL AND PRECIOUS METAL ALLOYS, WELDED, SOLDERED RIVETED, IF REQUIRED WITH ELECTROPLATED COATINGS, CONTACT RIVETS OF PRECIOUS METAL, SOLID AND COATED, COMPOSITE MATERIALS FOR ELECTRICAL CONTACTS AS FIBRE AND LAMINAR COMPOSITE MATERIALS, TUBES AS BOURDON TUBES, PROFILE TUBES, TUBES OF COATED MATERIALS, OR SPECIAL ALLOYS AND THIN-WALL, REFINED AND CAPILLARY TUBES, DEEP-DRAWN AND EXTRUDED HIGH-PRECISION PARTS IN SPECIAL SHAPES OF METALLIC MATERIALS, WIRES AND PROFILE SECTIONS OF PRECIOUS METAL, SOLID AND COATED, AND OF SPECIAL ALLOYS AND; SUPERELASTIC MATERIALS (U.S. CLS. 21, 23, 26, 36 AND 38).

CLASS 10—MEDICAL APPARATUS

FOR SUTURE MATERIALS; REFINED TUBES OF PRECIOUS METALS AND SPECIAL MATERIALS, PIPES, WIRES, BOURDON TUBES, PROFILE TUBES, TUBES OF COATED MATERIALS, OF SPECIAL ALLOYS AND THIN-WALL, REFINED AND CAPILLARY TUBES, TUBES OF SUPERELASTIC MATERIALS, ALL FOR MEDICAL PURPOSES FOR THE FURTHER MANUFACTURING OF THE FOLLOWING— STENTS, CATHETERS, CANNULAC, GUIDEWIRES, CAPILLARY DRAINAGE TUBES, CAPILLARY REAGENT TUBES, INJECTION SYRINGES, INJECTION NEEDLES, HYPODERMIC SYRINGES, HYPODERMIC NEEDLES, DISPOSABLE SYRINGES, SYRINGES, INTRAVENOUS NEEDLES, INTRAVENOUS FEEDING TUBES, CAPILLARY TUBES FOR BLOOD, CAPILLARY TUBES FOR SAMPLES, DRAINAGE TUBES, DRAINAGE APPLIANCES, ENDOSCOPIC EQUIPMENT, ENDOTRACHEAL TUBES, ENDOBRACHIAL TUBES, GASTROSCOPES, TRACHEOSTOMY TUBES, UTERINE SYRINGES, WOUND DRAINAGE APPARATUS; SEMI-FINISHED PRODUCTS AND MEMORY ELEMENTS OF SHAPE-MEMORY ALLOYS AND NICKEL/TITANIUM FOR MEDICAL PURPOSES FOR THE FURTHER MANUFACTURING OF THE FOLLOWING— TRUSSES; JOINT IMPLANTS, SPLINTS, DRILLING JIGS, IMPLANTS, GUIDEWIRES (U.S. CLS. 26, 39 AND 44).

CLASS 14—JEWELRY

FOR PRECIOUS METALS AND THEIR ALLOYS AND GOODS IN PRECIOUS METALS OR COATED THEREWITH; NAMELY, PROCESSED OR SEMI-PROCESSED PRECIOUS METALS (U.S. CLS. 2, 27, 28 AND 50).
2,955,844. USA FINANCIAL MARKETING CORPORATION, ADA, MI. SN 76-546,432. FILED P.R. 9-23-2003; AM. S.R. 3-2-2005.

ASSET-CYCLE PORTFOLIO SYSTEM

CLASS 16—PAPER GOODS AND PRINTED MATTER

FOR PRINTED INSTRUCTIONAL, EDUCATIONAL, AND TEACHING MATERIALS FOR FINANCIAL STRATEGIES, FINANCIAL PROGRAMS, AND FINANCIAL SEMINARS (U.S. CLS. 2, 5, 22, 23, 29, 37, 38 AND 50).
FIRST USE 11-0-2001; IN COMMERCE 11-0-2001.

CLASS 41—EDUCATION AND ENTERTAINMENT

FOR FINANCIAL STRATEGY PROGRAMS AND SEMINARS FOR FINANCIAL PROFESSIONALS (U.S. CLS. 100, 101 AND 107).
FIRST USE 11-0-2001; IN COMMERCE 11-0-2001.

2,955,848. COMCAST CORPORATION, PHILADELPHIA, PA. SN 76-550,405. FILED P.R. 10-8-2003; AM. S.R. 3-11-2005.

CABLELATINO

CLASS 38—COMMUNICATION

FOR CABLE TELEVISION BROADCASTING SERVICES (U.S. CLS. 100, 101 AND 104).
FIRST USE 5-5-2003; IN COMMERCE 5-5-2003.

CLASS 41—EDUCATION AND ENTERTAINMENT

FOR ENTERTAINMENT SERVICES IN THE NATURE OF DISTRIBUTION AND PROGRAMMING OF MOVIES, SPORTS, FAMILY, MUSIC AND EDUCATIONAL PROGRAMMING AND SPANISH-LANGUAGE CABLE TELEVISION CHANNELS AND PROGRAMS AND AUDIO CHANNELS FOR CABLE TELEVISION BROADCASTING, VIEWING AND LISTENING (U.S. CLS. 100, 101 AND 107).
FIRST USE 5-5-2003; IN COMMERCE 5-5-2003.

2,955,854. NACA LOGISTICS (USA) INC., CARSON, CA. SN 76-561,860. FILED P.R. 11-24-2003; AM. S.R. 1-28-2005.

BRENNAN

THE MARK CONSISTS OF STANDARD CHARACTERS WITHOUT CLAIM TO ANY PARTICULAR FONT, STYLE, SIZE, OR COLOR.

CLASS 35—ADVERTISING AND BUSINESS

FOR TRANSPORTATION LOGISTICS SERVICES, NAMELY PLANNING AND SCHEDULING SHIPMENTS FOR USERS OF TRANSPORTATION SERVICES, ARRANGING THE TRANSPORTATION OF GOODS FOR OTHERS (U.S. CLS. 100, 101 AND 102).
FIRST USE 4-0-2000; IN COMMERCE 4-0-2000.

CLASS 39—TRANSPORTATION AND STORAGE

FOR ARRANGING FOR FREIGHT TRANSPORTATION VIA SHIP (U.S. CLS. 100 AND 105).
FIRST USE 4-0-2000; IN COMMERCE 4-0-2000.

2,955,903. SAL. OPPENHEIM JR. & CIE., KOLN, FED REP GERMANY. SN 78-024,586. FILED P.R. 9-6-2000; AM. S.R. 11-6-2003.

OPPENHEIM

PRIORITY CLAIMED UNDER SEC. 44(D) ON ERPN CMNTY TM OFC APPLICATION NO. 001550532, FILED 3-10-2000, REG. NO. 001550532, DATED 7-18-2002, EXPIRES 3-10-2010.

CLASS 9—ELECTRICAL AND SCIENTIFIC APPARATUS

FOR DATA PROCESSING DEVICES, NAMELY, COMPUTERS; ACCOUNTING MACHINES, NAMELY, CALCULATORS AND ADDING MACHINES; COMPUTER PROGRAMS IN THE FIELD OF DATA PROCESSING, BANKING, ASSET, AND FINANCIAL MANAGEMENT; DATA PROCESSING SYSTEMS, NAMELY COMPUTERS AND PERIPHERALS FOR DATA PROCESSING AND BANKING, ASSET, AND FINANCIAL MANAGEMENT; COUNTERFEIT MONEY DETECTORS; MONEY COUNTING AND SORTING MACHINES; IDENTIFICATION CARDS FEATURING INTEGRATED CIRCUITRY AND MEMORY FOR IDENTIFYING THE BEARER, MAGNETICALLY CODED IDENTIFICATION CARDS; MAGNETICALLY CODED CARDS; BLANK SMART CARDS AND ENCODED SMART CARDS CONTAINING PROGRAMMING USED FOR ACCESS CONTROL; CASH REGISTERS; READING DEVICES FOR DATA PROCESSING, BANK MACHINES, BANKING, ASSET, AND FINANCIAL MANAGEMENT; BANK MACHINES, BANKING, ASSET, AND FINANCIAL MANAGEMENT; MONEY DISPENSERS (U.S. CLS. 21, 23, 26, 36 AND 38).

CLASS 14—JEWELRY

FOR PRECIOUS METALS AND METAL ALLOYS, PRECIOUS STONES, JEWELRY, GOLD, SILVER, SEMI-PRECIOUS STONES, COINS, SOLD AND RETAINED FOR PURPOSES OF FINANCIAL AND ASSET MANAGEMENT (U.S. CLS. 2, 27, 28 AND 50).

CLASS 16—PAPER GOODS AND PRINTED MATTER

FOR PRINTED INSTRUCTIONAL, EDUCATIONAL, AND TEACHING MATERIALS, NAMELY, PAMPHLETS, BROCHURES, NEWSLETTERS, JOURNALS, AND MAGAZINES, USED FOR BANKING, ASSET, AND FINANCIAL MANAGEMENT, BLANK AND PRINTED FORMS, GRAPHIC ART REPRODUCTIONS, STATIONERY FOR BANKING, ASSET, AND FINANCIAL MANAGEMENT, ACCOUNT BOOKS, STAMPS, STAMP COLLECTIONS, OLD BANK NOTES, OLD SHARE CERTIFICATES (U.S. CLS. 2, 5, 22, 23, 29, 37, 38 AND 50).

CLASS 35—ADVERTISING AND BUSINESS

FOR BUSINESS MANAGEMENT AND ADMINISTRATION FOR THIRD PARTIES, COMPUTERIZED DATABASE MANAGEMENT, SYSTEMATIZATION OF DATA IN COMPUTER DATA BASES, COMPILING, SUPPLEMENTING AND TAKING CARE OF DATA BASES FOR OUTSIDE USE, PUBLIC WORK, ACCOUNTING SERVICES, PROVIDING STATISTICAL INFORMATION, AUCTIONEERING SERVICES, ECONOMIC FORECASTING AND ANALYSIS, COMPUTERIZED ONLINE TRADING, BUSINESS CONSULTATION PROVIDED VIA MOBILE, RADIO, TELEPHONE, AND THE INTERNET, PROVIDING ONLINE DATABASES FEATURING DALES INFORMATION IN THE FIELD OF SALES VIA THE INTERNET, INTRANETS, AND EXTRANETS, COMPUTER DATABASE MANAGEMENT, NAMELY, OPERATING AND MAINTAINING DATABASES FOR OTHERS, INCLUDING FINANCIAL DATABASES (U.S. CLS. 100, 101 AND 102).

CLASS 42—SCIENTIFIC, COMPUTER AND LEGAL SERVICES

FOR COMPUTER PROGRAMMING FOR OTHERS (U.S. CLS. 100 AND 101).

2,955,906. MMMGMBH, 81369 MUNICH, FED REP GERMANY. SN 78-035,277. FILED P.R. 11-14-2000; AM. S.R. 7-21-2004.

HOSPITAL 24

CLASS 9—ELECTRICAL AND SCIENTIFIC APPARATUS

FOR APPARATUS FOR RECORDING, TRANSMITTING, AND REPRODUCING SOUNDS AND IMAGES, NAMELY, AMPLIFIERS, TAPE RECORDERS, COMPACT DISK RECORDERS AND PLAYERS, EQUALIZERS, AND AUDIO SPEAKERS; BLANK MAGNETIC DATA CARRIERS; CALCULATORS; DATA PROCESSORS; COMPUTER HARDWARE AND COMPUTER SOFTWARE FOR THE INTEGRATION OF TECHNICAL HOSPITAL APPARATUS INTO A NETWORK-BASED TRANSMISSION AND MONITORING SYSTEM; COMPUTER PRINTERS; ELECTRONIC APPARATUS FOR TESTING THE STERILITY OF MEDICAL EQUIPMENT, NAMELY, STEAM STERILIZERS; COMPUTER INTERFACE BOARDS FOR DATA TRANSFER; COMPUTER HARDWARE AND SOFTWARE FOR DETECTING TRANSMITTING, ACTIVATION, AND PROVIDING DATA FOR APPARATUS IN HOSPITALS, DOCTOR'S PRACTICES OR MEDICAL SUPPLY FACILITIES; AND LABORATORY EQUIPMENT AND SUPPLIES, NAMELY, REFRIGERATING INCUBATORS FOR THE INDUSTRY, HOSPITALS, LABORATORIES, AND PHARMACIES (U.S. CLS. 21, 23, 26, 36 AND 38).

FIRST USE 10-18-2002; IN COMMERCE 10-18-2002.

CLASS 10—MEDICAL APPARATUS

FOR STERILIZATION UNITS FOR MEDICAL INSTRUMENTS, NAMELY, STEAM STERILIZERS, GAS STERILIZERS, WASTE DISINFECTORS, AND STEAM DISINFECTION APPARATUS, FOR USE BY THE INDUSTRIES, HOSPITALS, LABORATORIES, OR PHARMACIES (U.S. CLS. 26, 39 AND 44).

FIRST USE 10-18-2002; IN COMMERCE 10-18-2002.

2,955,913. SUN 'N FUN FLY-IN, INC., LAKELAND, FL. SN 78-122,557. FILED P.R. 4-18-2002; AM. S.R. 3-4-2003.

FLORIDA AIR MUSEUM

CLASS 14—JEWELRY

FOR COSTUME JEWELRY (U.S. CLS. 2, 27, 28 AND 50).

FIRST USE 4-9-2002; IN COMMERCE 4-9-2002.

CLASS 16—PAPER GOODS AND PRINTED MATTER

FOR PRINTED MATERIAL, NAMELY, NEWSLETTERS, INFORMATIONAL BROCHURES AND PROGRAMS FEATURING INFORMATION ON AVIATION, AIR SAFETY, EXPERIMENTAL AIRCRAFT, AIR SHOWS, AND SUBJECT MATTER DIRECTED TO AVIATION ENTHUSIASTS; POSTERS, CALENDARS, AND DECALS (U.S. CLS. 2, 5, 22, 23, 29, 37, 38 AND 50).

FIRST USE 4-9-2002; IN COMMERCE 4-9-2002.

CLASS 25—CLOTHING

FOR CLOTHING, NAMELY, SHIRTS, CAPS, SWEATSHIRTS, SHORTS, SOCKS, JACKETS AND SWEATPANTS (U.S. CLS. 22 AND 39).

FIRST USE 4-9-2002; IN COMMERCE 4-9-2002.

CLASS 26—FANCY GOODS

FOR EMBROIDERED PATCHES FOR CLOTHING (U.S. CLS. 37, 39, 40, 42 AND 50).

FIRST USE 4-9-2002; IN COMMERCE 4-9-2002.

CLASS 41—EDUCATION AND ENTERTAINMENT

FOR EDUCATIONAL SERVICES, NAMELY, CONDUCTING SEMINARS AND WORKSHOPS IN THE FIELD OF AIR SAFETY AND EDUCATION, AND ENTERTAINMENT SERVICES, NAMELY, CONDUCTING AN ANNUAL AIR SHOW (U.S. CLS. 100, 101 AND 107).

FIRST USE 4-9-2002; IN COMMERCE 4-9-2002.

2,955,917. LOCAL AREA BUSINESS INTERNET LISTINGS, INC., APPLETON, WI. SN 78-134,570. FILED P.R. 6-11-2002; AM. S.R. 10-22-2002.

WEBSITE YELLOWPAGES

NO CLAIM IS MADE TO THE EXCLUSIVE RIGHT TO USE YELLOWPAGES, APART FROM THE MARK AS SHOWN.

CLASS 16—PAPER GOODS AND PRINTED MATTER

FOR PRINTED DIRECTORIES OF WEBSITE ADDRESSES, EMAIL ADDRESSES, PHYSICAL ADDRESSES, PHONE NUMBERS, FAX NUMBERS, AND TOLL FREE NUMBERS (U.S. CLS. 2, 5, 22, 23, 29, 37, 38 AND 50).

FIRST USE 8-8-1999; IN COMMERCE 9-8-1999.

CLASS 42—SCIENTIFIC, COMPUTER AND LEGAL SERVICES

FOR COMPUTER SERVICES, NAMELY, PROVIDING SEARCH ENGINES FOR OBTAINING DATA ON A GLOBAL COMPUTER NETWORK (U.S. CLS. 100 AND 101).

FIRST USE 8-8-1999; IN COMMERCE 9-8-1999.

2,955,924. APPSTREAM, INC., PALO ALTO, CA. SN 78-166,027. FILED P.R. 9-19-2002; AM. S.R. 7-12-2004.

ON-DEMAND APPLICATION DELIVERY**CLASS 9—ELECTRICAL AND SCIENTIFIC APPARATUS**

FOR COMPUTER SOFTWARE FOR DELIVERING, EXECUTING, MONITORING AND MANAGING DATA, CONTENT AND COMPUTER PROGRAMS ACROSS COMPUTER NETWORKS, THE INTERNET, AND WIRELESS COMPUTING PLATFORMS, DEVICES AND INFRASTRUCTURE (U.S. CLS. 21, 23, 26, 36 AND 38).

FIRST USE 9-3-2002; IN COMMERCE 9-3-2002.

CLASS 42—SCIENTIFIC, COMPUTER AND LEGAL SERVICES

FOR CONSULTATION SERVICES CONCERNING COMPUTER SOFTWARE, THE DELIVERY, EXECUTION, MONITORING AND MANAGEMENT OF DATA CONTENT AND COMPUTER PROGRAMS (U.S. CLS. 100 AND 101).

FIRST USE 9-3-2002; IN COMMERCE 9-3-2002.

2,955,928. TAYLOR NELSON SOFRES PLC, LONDON, UNITED KINGDOM. SN 78-177,631. FILED P.R. 10-23-2002; AM. S.R. 7-1-2004.

WORLD PANEL**CLASS 9—ELECTRICAL AND SCIENTIFIC APPARATUS**

FOR COMPUTER SOFTWARE FOR ANALYZING INFORMATION IN THE FIELD OF MARKET RESEARCH (U.S. CLS. 21, 23, 26, 36 AND 38).

FIRST USE 2-24-2004; IN COMMERCE 2-24-2004.

CLASS 35—ADVERTISING AND BUSINESS

FOR MARKET RESEARCH SERVICES; MARKET ANALYSIS SERVICES; CONDUCTING MARKETING STUDIES; COST AND/OR PRICE ANALYSIS SERVICES; BUSINESS MARKETING INFORMATION SERVICES; BUSINESS MANAGEMENT AND CONSULTING SERVICES; CONDUCTING PUBLIC OPINION POLLS; BUSINESS RESEARCH AND SURVEY SERVICES; BUSINESS INVESTIGATION SERVICES; BUSINESS MONITORING IN THE FIELD OF MARKET RESEARCH, NAMELY, AUDIENCE MONITORING SERVICES; STATISTICAL INFORMATION SERVICES; TRADE INFORMATION SERVICES; DATA PROCESSING ANALYSIS SERVICES IN THE FIELD OF MARKET AND BUSINESS INFORMATION (U.S. CLS. 100, 101 AND 102).

FIRST USE 2-24-2004; IN COMMERCE 2-24-2004.

2,955,929. IMPERIAL SHEET METAL LTD., NEW BRUNSWICK, CANADA. SN 78-179,428. FILED P.R. 10-29-2002; AM. S.R. 10-2-2003.

GREENTEK

PRIORITY CLAIMED UNDER SEC. 44(D) ON CANADA APPLICATION NO. 1138632, FILED 4-30-2002.

CLASS 11—ENVIRONMENTAL CONTROL APPARATUS

FOR AIR VENTILATION, FILTRATION, HUMIDIFICATION AND PURIFICATION EQUIPMENT, PRODUCTS AND ACCESSORIES FOR USE IN ENHANCING, MODIFYING AND MAINTAINING INDOOR AIR QUALITY NAMELY, AIR HUMIDIFIERS AND ACCESSORIES THEREFOR SOLD AS A UNIT, FURNACE HUMIDIFIERS AND ACCESSORIES THEREFOR SOLD AS A UNIT, ULTRAVIOLET AIR PURIFIERS AND ACCESSORIES THEREFOR SOLD AS A UNIT, AIR FILTRATION UNITS AND ACCESSORIES THEREFOR SOLD AS A UNIT, AND HVAC UNITS AND ACCESSORIES THEREFOR SOLD AS A UNIT, ALL FOR RESIDENTIAL, COMMERCIAL AND INDUSTRIAL USE (U.S. CLS. 13, 21, 23, 31 AND 34).

FIRST USE 3-0-2002; IN COMMERCE 10-0-2002.

CLASS 37—CONSTRUCTION AND REPAIR

FOR MAINTENANCE AND REPAIR OF AIR VENTILATION, FILTRATION, HUMIDIFICATION AND PURIFICATION EQUIPMENT (U.S. CLS. 100, 103 AND 106).

FIRST USE 3-0-2002; IN COMMERCE 10-0-2002.

2,955,933. MELLUM, LARRY L., SEATTLE, WA. SN 78-189,784. FILED P.R. 11-28-2002; AM. S.R. 2-4-2005.

PIKE PLACE CHOWDER

NO CLAIM IS MADE TO THE EXCLUSIVE RIGHT TO USE "CHOWDER", APART FROM THE MARK AS SHOWN.

CLASS 29—MEATS AND PROCESSED FOODS

FOR CHOWDER, SOUPS AND SAUCES (U.S. CL. 46).
FIRST USE 2-1-2003; IN COMMERCE 2-1-2003.

CLASS 35—ADVERTISING AND BUSINESS

FOR RESTAURANT FOOD SERVICE BUSINESS, NAMELY, A QUICK SERVICE, DINE-IN AND TAKE-OUT EATERY SPECIALIZING IN SERVING A VARIETY OF CHOWDERS (U.S. CLS. 100, 101 AND 102).
FIRST USE 2-1-2003; IN COMMERCE 2-1-2003.

2,955,934. PAVERART LLC, AUDUBON, PA. SN 78-189,807.
FILED P.R. 11-29-2002; AM. S.R. 7-8-2004.

PAVERART**CLASS 19—NON-METALLIC BUILDING MATERIALS**

FOR CONCRETE PAVERS FOR CREATING DESIGNS ON WALKWAYS, DRIVEWAYS, POOL DECKS, STREETS, PLAZAS, AND THE LIKE (U.S. CLS. 1, 12, 33 AND 50).

FIRST USE 5-1-2003; IN COMMERCE 5-1-2003.

CLASS 42—SCIENTIFIC, COMPUTER AND LEGAL SERVICES

FOR PLANNING DESIGNS TO THE ORDER AND SPECIFICATIONS OF OTHERS USING PAVERS (U.S. CLS. 100 AND 101).

FIRST USE 1-31-2003; IN COMMERCE 1-31-2003.

2,955,942. SMART DOOR SYSTEMS, INC., ARLINGTON, VA.
SN 78-209,156. FILED P.R. 1-30-2003; AM. S.R. 1-11-2005.

VIRTUAL ATTENDANT**CLASS 9—ELECTRICAL AND SCIENTIFIC APPARATUS**

FOR ELECTRONIC MONITORING, SURVEILLANCE AND PAYMENT SYSTEMS COMPRISED OF VIDEO CAMERAS, VIDEO RECORDERS, AND MACHINES FOR ACCEPTING PAYMENT FOR PARKING (U.S. CLS. 21, 23, 26, 36 AND 38).

FIRST USE 5-0-2001; IN COMMERCE 5-0-2001.

CLASS 36—INSURANCE AND FINANCIAL

FOR ELECTRONIC PAYMENT ACCEPTANCE SERVICES FOR PARKING GARAGES AND PARKING LOTS (U.S. CLS. 100, 101 AND 102).

FIRST USE 5-0-2001; IN COMMERCE 5-0-2001.

CLASS 37—CONSTRUCTION AND REPAIR

FOR INSTALLATION AND MAINTENANCE OF ELECTRONIC MONITORING, SURVEILLANCE AND PAYMENT SYSTEMS FOR PARKING GARAGES AND PARKING LOTS (U.S. CLS. 100, 103 AND 106).

FIRST USE 5-0-2001; IN COMMERCE 5-0-2001.

CLASS 42—SCIENTIFIC, COMPUTER AND LEGAL SERVICES

FOR ELECTRONIC MONITORING SURVEILLANCE SERVICES FOR PARKING GARAGES AND PARKING LOTS (U.S. CLS. 100 AND 101).

FIRST USE 5-0-2001; IN COMMERCE 5-0-2001.

2,955,945. ADVANCED BRAIN TECHNOLOGIES, LLC, OGDEN, UT. SN 78-211,946. FILED P.R. 2-6-2003; AM. S.R. 9-2-2003.

SPATIAL SURROUND

NO CLAIM IS MADE TO THE EXCLUSIVE RIGHT TO USE SURROUND, APART FROM THE MARK AS SHOWN.

CLASS 9—ELECTRICAL AND SCIENTIFIC APPARATUS

FOR MEDIA, NAMELY, DVDS, PRE-RECORDED COMPACT DISCS, CASSETTE TAPES AND FLOPPY DISKS CONTAINING MUSIC (U.S. CLS. 21, 23, 26, 36 AND 38).

FIRST USE 7-28-2003; IN COMMERCE 7-29-2003.

CLASS 41—EDUCATION AND ENTERTAINMENT

FOR RECORDING SERVICES FOR RECORDING MUSIC WHICH ENHANCES AUDITORY PROCESSING AND STIMULATES AWARENESS (U.S. CLS. 100, 101 AND 107).

FIRST USE 7-28-2003; IN COMMERCE 7-29-2003.

2,955,966. COOLBAKER'S INTERNATIONAL, LLC, LOUISVILLE, KY. SN 78-247,375. FILED P.R. 5-8-2003; AM. S.R. 1-10-2005.

THE OFFICE FOOD PROS**CLASS 39—TRANSPORTATION AND STORAGE**

FOR FOOD DELIVERY, NAMELY, DELIVERY OF DELICATESSEN AND BAKERY GOODS (U.S. CLS. 100 AND 105).

FIRST USE 9-1-2002; IN COMMERCE 9-1-2002.

CLASS 43—HOTEL AND RESTAURANT SERVICES

FOR CATERING IN THE FIELD OF DELICATESSEN AND BAKERY GOODS (U.S. CLS. 100 AND 101).

FIRST USE 9-1-2002; IN COMMERCE 9-1-2002.

2,955,967. YORKSHIRE FOOD SALES CORP., NEW HYDE PARK, NY. SN 78-250,285. FILED P.R. 5-15-2003; AM. S.R. 1-24-2005.

NYSNACKS**CLASS 29—MEATS AND PROCESSED FOODS**

FOR SALTY SNACKS, NAMELY, POTATO CHIPS, BARBEQUE FLAVORED POTATO CHIPS, SEA SALT AND VINEGAR FLAVORED POTATO CHIPS, POTATO STICKS; BANANA CHIPS; SWEET AND SOUR PROCESSED ONION RINGS; PRESERVED MEATS, NAMELY, FRIED PORK RINDS, BARBEQUE FLAVORED PORK RINDS, FRIED PORK SKINS, BEEF JERKY, BEEF SAUSAGES IN STICK FORM, BEEF PEPPERONI AND CHEESE STICKS; PIZZA FLAVORED POTATO STICKS, PIZZA FLAVORED POTATO CHIPS, PIZZA FLAVORED CHEESE, PIZZA FLAVORED BEEF JERKY; PROCESSED NUTS, NAMELY, CASHEWS, PEANUTS, AND PISTACHIOS; PROCESSED EDIBLE SEEDS, NAMELY, SUNFLOWER SEEDS, PARTY/BAR MIX CONSISTING PRIMARILY OF PROCESSED FRUITS, PROCESSED NUTS AND/OR RAISINS (U.S. CL. 46).

FIRST USE 8-9-2004; IN COMMERCE 1-13-2005.

CLASS 30—STAPLE FOODS

FOR EXTRUDED SNACKS, NAMELY, PUFFED CHEESE CURLS AND CRUNCHY NACHO CHEESE CURLS; NACHO CHEESE TORTILLA CHIPS, BAKED BLUE CORN TORTILLA CHIPS, CORN CHIPS; PRETZELS; PIZZA FLAVORED PRETZELS, CRACKERS, NAMELY, ORIGINAL, RANCH, CHEDDAR AND WHITE CHEDDAR FLAVORED CRACKERS; CRACKER COMBINATIONS, NAMELY, CHEESE-FILLED AND PEANUT BUTTER FILLED SANDWICH CRACKERS; PARTY/BAR MIX CONSISTING PRIMARILY OF CRACKERS, PRETZELS, CANDIED NUTS AND/OR POPPED POPCORN; POPPED POPCORN; MULTIGRAIN CHIPS (U.S. CL. 46).

FIRST USE 8-9-2004; IN COMMERCE 1-13-2005.

2,955,979. FASHION TRAVELLER MEDIA GROUP, S.L., BILBAO, SPAIN. SN 78-262,148. FILED P.R. 6-13-2003; AM. S.R. 2-14-2005.

FASHION TRAVELER

PRIORITY CLAIMED UNDER SEC. 44(D) ON ERP N CMNTY TM OFC APPLICATION NO. 003175031, FILED 5-20-2003, REG. NO. 003175031, DATED 5-28-2004, EXPIRES 5-20-2013.

CLASS 35—ADVERTISING AND BUSINESS

FOR PROVIDING ON-LINE DIRECTORY INFORMATION SERVICES FEATURING HYPERLINKS TO OTHER WEB SITES, PROMOTING GOODS AND SERVICES OF OTHERS BY PREPARING AND PLACING ADVERTISEMENTS IN AN ELECTRONIC MAGAZINE ACCESSED THROUGH A GLOBAL COMPUTER NETWORK, BUSINESS MARKETING INFORMATION AND SERVICES, DIRECT MARKETING SERVICES, CONDUCTING MARKETING STUDIES, COMMERCIAL INFORMATION AND DIRECTORY AGENCY (U.S. CLS. 100, 101 AND 102).

FIRST USE 12-26-2004; IN COMMERCE 12-26-2004.

CLASS 45—PERSONAL SERVICES

FOR PROVIDING FASHION INFORMATION (U.S. CLS. 100 AND 101).

FIRST USE 12-26-2004; IN COMMERCE 12-26-2004.

2,955,982. USIS EMPLOYERS INFORMATION GROUP, INC., TULSA, OK. SN 78-267,771. FILED P.R. 6-27-2003; AM. S.R. 7-12-2004.

EMPLOYERS INFORMATION GROUP**CLASS 16—PAPER GOODS AND PRINTED MATTER**

FOR PRINTED MATERIALS, NAMELY, STATIONERY, PAMPHLETS, MANUALS, QUESTIONNAIRES AND BROCHURES IN THE FIELD OF PRE-EMPLOYMENT SCREENING (U.S. CLS. 2, 5, 22, 23, 29, 37, 38 AND 50).

FIRST USE 1-31-2003; IN COMMERCE 1-31-2003.

CLASS 36—INSURANCE AND FINANCIAL

FOR FINANCIAL SERVICES, NAMELY, EVALUATION OF CREDIT BUREAU DATA FOR OTHERS IN CONJUNCTION WITH PRE-EMPLOYMENT SCREENING (U.S. CLS. 100, 101 AND 102).

FIRST USE 1-31-2003; IN COMMERCE 1-31-2003.

CLASS 45—PERSONAL SERVICES

FOR SECURITY SERVICES, NAMELY, PROVIDING PRE-EMPLOYMENT BACKGROUND SCREENING; PROVIDING A DATABASE FEATURING PRE-EMPLOYMENT SCREENING INFORMATION THROUGH A GLOBAL COMPUTER NETWORK (U.S. CLS. 100 AND 101).

FIRST USE 1-31-2003; IN COMMERCE 1-31-2003.

2,955,986. WARRANTY MANAGEMENT TECHNOLOGIES, LLC, BURNSVILLE, MN. SN 78-271,802. FILED P.R. 7-8-2003; AM. S.R. 1-5-2005.

WARRANTY MANAGEMENT TECHNOLOGIES

NO CLAIM IS MADE TO THE EXCLUSIVE RIGHT TO USE "TECHNOLOGIES", APART FROM THE MARK AS SHOWN.

CLASS 35—ADVERTISING AND BUSINESS

FOR COMMERCIAL AND RESIDENTIAL WARRANTY MANAGEMENT SERVICES, NAMELY FACILITATING COMMUNICATIONS BETWEEN COMMERCIAL AND RESIDENTIAL BUILDERS, NEW COMMERCIAL AND RESIDENTIAL PROPERTY OWNERS, AND TRADE CONTRACTORS REGARDING ISSUES RELATED TO BUILDER'S STATUTORY WARRANTY, CONDUCTING ON-SITE WARRANTY REVIEWS TO DETERMINE COMPLIANCE WITH WARRANTY, AND CREATING AND MAINTAINING ON-LINE COMPUTER DATABASES REGARDING STATUS OF WARRANTY SERVICES (U.S. CLS. 100, 101 AND 102).

FIRST USE 2-9-2001; IN COMMERCE 8-31-2002.

CLASS 36—INSURANCE AND FINANCIAL

FOR COMMERCIAL AND RESIDENTIAL WARRANTY SERVICES, NAMELY BROKERAGE IN THE FIELDS OF COMMERCIAL AND RESIDENTIAL WARRANTY REPAIRS AND MAINTENANCE (U.S. CLS. 100, 101 AND 102).

FIRST USE 2-9-2001; IN COMMERCE 8-31-2002.

2,955,997. UNITEDHEALTH GROUP INCORPORATED, MINNETONKA, MN. SN 78-277,620. FILED P.R. 7-23-2003; AM. S.R. 8-6-2004.

CONSUMER ACCOUNTS CARD

CLASS 9—ELECTRICAL AND SCIENTIFIC APPARATUS

FOR MAGNETICALLY ENCODED CREDIT CARDS, DEBIT CARDS, AND STORED VALUE CARDS; BLANK SMART CARDS; ENCODED SMART CARDS CONTAINING PROGRAMMING USED IN CONNECTION WITH MANAGED CARE SERVICES, HEALTH BENEFITS AND ANCILLARY BENEFIT PLANS AND PRODUCTS, EMPLOYEE BENEFITS SERVICES, INSURANCE ADMINISTRATION SERVICES, BANKING, CREDIT CARD, AND DEBIT CARD SERVICES (U.S. CLS. 21, 23, 26, 36 AND 38).

FIRST USE 11-1-2003; IN COMMERCE 11-1-2003.

CLASS 16—PAPER GOODS AND PRINTED MATTER

FOR CREDIT CARDS, DEBIT CARDS, AND STORED VALUE CARDS ALL WITHOUT MAGNETIC CODING (U.S. CLS. 2, 5, 22, 23, 29, 37, 38 AND 50).

FIRST USE 11-1-2003; IN COMMERCE 11-1-2003.

CLASS 35—ADVERTISING AND BUSINESS

FOR MANAGED CARE SERVICES, NAMELY, ELECTRONIC PROCESSING OF HEALTH CARE TRANSACTIONS COMPLIANT WITH THE REQUIREMENTS OF HIPAA (HEALTH INSURANCE PORTABILITY AND ACCOUNTABILITY ACT OF 1996), MEDICAL COST MANAGEMENT FOR HEALTH AND ANCILLARY BENEFIT PLANS OF GROUP AND INDIVIDUALS (U.S. CLS. 100, 101 AND 102).

FIRST USE 11-1-2003; IN COMMERCE 11-1-2003.

CLASS 36—INSURANCE AND FINANCIAL

FOR INSURANCE ADMINISTRATION SERVICES, NAMELY, DETERMINING INSURANCE ELIGIBILITY FOR INDIVIDUALS; INSURANCE BILL PAYMENT SERVICES, NAMELY, ADMINISTRATION OF INSURANCE PLAN CO-PAYMENTS; ADMINISTRATION OF EMPLOYEE AND INDIVIDUAL BENEFIT PLANS; BANKING SERVICES; CREDIT CARD SERVICES, DEBIT CARDS SERVICES; ISSUING STORED VALUE CARD SERVICES; FINANCIAL SERVICES, NAMELY PROVIDING ON-LINE STORED VALUE ACCOUNTS IN AN ELECTRONIC ENVIRONMENT; BANKING SERVICES, NAMELY, PROVIDING CHECKING AND SAVINGS DEPOSIT ACCOUNTS; CONSUMER LENDING SERVICES; ELECTRONIC FUNDS TRANSFER; ADMINISTRATION OF PRE-PAID HEALTH CARE PLANS; ADMINISTRATION OF PRE-PAID HEALTH CARE PLANS IN THE NATURE OF A DEFINED CONTRIBUTION PLAN; FINANCIAL CLEARINGHOUSES RELATED TO HEALTH CARE (U.S. CLS. 100, 101 AND 102).

FIRST USE 11-1-2003; IN COMMERCE 11-1-2003.
2,955,999. BOWTIE, INC., LOS ANGELES, CA. SN 78-278,915. FILED P.R. 7-25-2003; AM. S.R. 2-7-2005.

TRAINING SECRETS FOR BULLY BREEDS

OWNER OF U.S. REG. NO. 2,801,985.

CLASS 16—PAPER GOODS AND PRINTED MATTER

FOR PRINTED PUBLICATIONS, NAMELY, MAGAZINES, JOURNALS, BOOKS, NEWSLETTERS AND PERIODICALS, ALL IN THE FIELDS OF ANIMALS AND CANINE SPECIES (U.S. CLS. 2, 5, 22, 23, 29, 37, 38 AND 50).

FIRST USE 9-23-2004; IN COMMERCE 9-23-2004.

CLASS 41—EDUCATION AND ENTERTAINMENT

FOR COMPUTER SERVICES, NAMELY, PROVIDING ONLINE PUBLICATIONS IN THE FIELDS OF ANIMALS AND CANINE SPECIES, VIA THE INTERNET (U.S. CLS. 100, 101 AND 107).

FIRST USE 9-23-2004; IN COMMERCE 9-23-2004.

2,956,003. PRECISION WORKS, INC., OJAI, CA. SN 78-280,762. FILED P.R. 7-30-2003; AM. S.R. 3-7-2005.

DISINFECT YOUR HOME WITH HEAT

OWNER OF U.S. REG. NO. 2,796,131.

CLASS 37—CONSTRUCTION AND REPAIR

FOR TERMITE AND PEST ERADICATION SERVICES (U.S. CLS. 100, 103 AND 106).

FIRST USE 5-28-1999; IN COMMERCE 5-28-1999.

CLASS 42—SCIENTIFIC, COMPUTER AND LEGAL SERVICES

FOR EVALUATION AND TESTING OF REAL ESTATE FOR THE PRESENCE OF HAZARDOUS MATERIALS; TESTING, ANALYSIS AND EVALUATION OF THE GOODS AND SERVICES OF OTHERS FOR THE PURPOSE OF CERTIFICATION (U.S. CLS. 100 AND 101).

FIRST USE 5-28-1999; IN COMMERCE 5-28-1999.

2,956,004. PRECISION WORKS, INC., OJAI, CA. SN 78-280,769. FILED P.R. 7-30-2003; AM. S.R. 3-7-2005.

HEAT MOLD**CLASS 37—CONSTRUCTION AND REPAIR**

FOR TERMITE AND PEST ERADICATION SERVICES (U.S. CLS. 100, 103 AND 106).

FIRST USE 5-28-1999; IN COMMERCE 5-28-1999.

CLASS 42—SCIENTIFIC, COMPUTER AND LEGAL SERVICES

FOR EVALUATION AND TESTING OF REAL ESTATE FOR THE PRESENCE OF HAZARDOUS MATERIALS; TESTING, ANALYSIS AND EVALUATION OF THE GOODS AND SERVICES OF OTHERS FOR THE PURPOSE OF CERTIFICATION (U.S. CLS. 100 AND 101).

FIRST USE 5-28-1999; IN COMMERCE 5-28-1999.

2,956,005. PRECISION WORKS, INC., OJAI, CA. SN 78-280,772. FILED P.R. 7-30-2003; AM. S.R. 3-7-2005.

STOP MOLD WITH HEAT**CLASS 37—CONSTRUCTION AND REPAIR**

FOR TERMITE AND PEST ERADICATION SERVICES (U.S. CLS. 100, 103 AND 106).

FIRST USE 5-28-1999; IN COMMERCE 5-28-1999.

CLASS 42—SCIENTIFIC, COMPUTER AND LEGAL SERVICES

FOR EVALUATION AND TESTING OF REAL ESTATE FOR THE PRESENCE OF HAZARDOUS MATERIALS; TESTING, ANALYSIS AND EVALUATION OF THE GOODS AND SERVICES OF OTHERS FOR THE PURPOSE OF CERTIFICATION (U.S. CLS. 100 AND 101).

FIRST USE 5-28-1999; IN COMMERCE 5-28-1999.

2,956,014. LF, LLC, WILMINGTON, DE. SN 78-287,285. FILED P.R. 8-14-2003; AM. S.R. 4-19-2004.

BUILD IT VIRTUALLY**CLASS 37—CONSTRUCTION AND REPAIR**

FOR PROVIDING ON-LINE INFORMATION IN THE FIELD OF HOME IMPROVEMENT INSTALLATION AND MAINTENANCE SERVICES; PROVIDING ON-LINE INFORMATION IN THE FIELD OF DO-IT-YOURSELF INSTALLATION AND MAINTENANCE PROJECTS (U.S. CLS. 100, 103 AND 106).

FIRST USE 2-0-2002; IN COMMERCE 2-0-2002.

CLASS 41—EDUCATION AND ENTERTAINMENT

FOR EDUCATION SERVICES, NAMELY, PROVIDING ON-LINE INSTRUCTIONAL TRAINING IN THE FIELD OF HOME IMPROVEMENT, HOME DÉCOR, AND DO-IT-YOURSELF PROJECTS (U.S. CLS. 100, 101 AND 107).

FIRST USE 5-20-2002; IN COMMERCE 5-20-2002.

CLASS 42—SCIENTIFIC, COMPUTER AND LEGAL SERVICES

FOR PROVIDING ON-LINE INFORMATION IN THE FIELD OF HOME IMPROVEMENT DESIGNS AND HOME DÉCOR (U.S. CLS. 100 AND 101).

FIRST USE 2-0-2002; IN COMMERCE 2-0-2002.

2,956,015. PACER TECHNOLOGY, RANCHO CUCAMONGA, CA. SN 78-287,438. FILED P.R. 8-14-2003; AM. S.R. 9-7-2004.

THE ORIGINAL SUPER GLUE

NO CLAIM IS MADE TO THE EXCLUSIVE RIGHT TO USE "SUPER GLUE", APART FROM THE MARK AS SHOWN.

CLASS 1—CHEMICALS

FOR ADHESIVE BONDING AGENTS FOR USE IN THE INDUSTRIAL, COMMERCIAL, AND HOBBYIST FIELDS FOR GENERAL BONDING AND REPAIR PURPOSES (U.S. CLS. 1, 5, 6, 10, 26 AND 46).
FIRST USE 3-15-2004; IN COMMERCE 3-15-2004.

CLASS 16—PAPER GOODS AND PRINTED MATTER

FOR ADHESIVE BONDING AGENTS FOR HOUSEHOLD USE (U.S. CLS. 2, 5, 22, 23, 29, 37, 38 AND 50).
FIRST USE 3-15-2004; IN COMMERCE 3-15-2004.

2,956,021. EAST BAY IMPORT CO., ASHLAND, OH. SN 78-292,686. FILED P.R. 8-27-2003; AM. S.R. 9-16-2004.

THE MEDITERRANEAN COLLECTION

NO CLAIM IS MADE TO THE EXCLUSIVE RIGHT TO USE "COLLECTION", APART FROM THE MARK AS SHOWN.

CLASS 8—HAND TOOLS

FOR FLATWARE (U.S. CLS. 23, 28 AND 44).
FIRST USE 7-1-2003; IN COMMERCE 7-1-2003.

CLASS 21—HOUSEWARES AND GLASS

FOR GLASSWARE, DINNERWARE (U.S. CLS. 2, 13, 23, 29, 30, 33, 40 AND 50).
FIRST USE 7-1-2003; IN COMMERCE 7-1-2003.

2,956,022. BAKERS DELIGHT HOLDINGS LTD., CAMBERWELL, VICTORIA, 3124, AUSTRALIA. SN 78-293,528. FILED P.R. 8-28-2003; AM. S.R. 3-8-2005.

COBS

OWNER OF CANADA REG. NO. TMA623579, DATED 10-26-2004, EXPIRES 10-26-2019.

CLASS 30—STAPLE FOODS

FOR BREAD; ROLLS AND BUNS; CAKES; PIES; BISCUITS AND PASTRIES (U.S. CL. 46).

CLASS 35—ADVERTISING AND BUSINESS

FOR RETAIL BAKERY SERVICES (U.S. CLS. 100, 101 AND 102).

CLASS 43—HOTEL AND RESTAURANT SERVICES

FOR RESTAURANT SERVICES; FOOD PREPARATION, NAMELY, PREPARATION OF BAKERY PRODUCTS (U.S. CLS. 100 AND 101).

2,956,023. BAKERS DELIGHT HOLDINGS LTD., CAMBERWELL, VICTORIA, 3124, AUSTRALIA. SN 78-293,534. FILED P.R. 8-28-2003; AM. S.R. 3-8-2005.

COBS BREAD

OWNER OF CANADA REG. NO. TMA623295, DATED 10-22-2004, EXPIRES 10-22-2019.

NO CLAIM IS MADE TO THE EXCLUSIVE RIGHT TO USE BREAD, APART FROM THE MARK AS SHOWN.

CLASS 30—STAPLE FOODS

FOR BREAD; ROLLS AND BUNS; CAKES; PIES; BISCUITS AND PASTRIES (U.S. CL. 46).

CLASS 35—ADVERTISING AND BUSINESS

FOR RETAIL BAKERY SERVICES (U.S. CLS. 100, 101 AND 102).

CLASS 43—HOTEL AND RESTAURANT SERVICES

FOR RESTAURANT SERVICES; FOOD PREPARATION, NAMELY, PREPARATION OF BAKERY PRODUCTS (U.S. CLS. 100 AND 101).

2,956,033. P.M.B.Q. STUDIOS, SAN JOSE, CA. SN 78-306,483. FILED P.R. 9-29-2003; AM. S.R. 10-13-2004.



THE COLORS BLACK, WHITE, RED AND YELLOW ARE CLAIMED AS FEATURES OF THE MARK.

THE MARK CONSISTS OF A BLACK AND WHITE CARTOON PANDA WEARING A RED SUMO OUTFIT, LAYERED ON TOP OF A YELLOW CIRCLE WITH A RED BORDER.

CLASS 16—PAPER GOODS AND PRINTED MATTER

FOR PRINTED MATTER AND PAPER GOODS, NAMELY, COMIC BOOKS AND COMIC MAGAZINES AND STORIES IN ILLUSTRATED FORM; CHILDREN'S BOOKS, CHILDREN'S ACTIVITY BOOKS, COLORING BOOKS, STICKER BOOKS; STICKERS; BUMPER STICKERS; POSTERS; TRADING CARDS; COLLECTOR ALBUMS FOR TRADING CARDS; PLAYING CARDS; ART SUPPLIES, NAMELY CRAYONS, MARKERS, COLORED PENCILS, ART AND CRAFT PAINT KITS, PAINT BRUSHES, PRE-PRINTED SHEETS OR POSTERS FOR COLORING OR PAINTING; SLATES FOR WRITING AND DRAWING; CHALK AND CHALKBOARDS FOR HOME USE; DECALS AND HEAT TRANSFERS; SCHOOL SUPPLIES, NAMELY PENS, PENCILS, ERASERS, PENCIL CASES, PENCIL SHARPENERS, DRAWING RULERS, PAPER STAPLERS, PAPERWEIGHTS, NOTEBOOKS, FOLDERS, RING BINDERS, SPIRAL NOTEPADS, BOOK COVERS AND BOOKMARKS; PAPER DOOR KNOB HANGERS; STATIONERY, WRITING PAPER, ENVELOPES, NOTE CARDS, GREETING CARDS, POSTCARDS, NOTEPADS, MEMO PADS; APPOINTMENT BOOKS; CALENDARS; PRINTED PATTERNS FOR COSTUMES; PAPER PARTY GOODS, PAPER PLACE MATS, PAPER PARTY HATS, DECORATIVE PAPER CENTERPIECES AND PAPER TABLECLOTHS (U.S. CLS. 2, 5, 22, 23, 29, 37, 38 AND 50).

FIRST USE 8-21-2001; IN COMMERCE 8-21-2001.

CLASS 25—CLOTHING

FOR CLOTHING, NAMELY, T-SHIRTS, TANK TOPS, SWEATSHIRTS, SHIRTS, SHORTS, SWEATPANTS, SLACKS, OVERALLS, VESTS, JACKETS, COATS, RAINWEAR, UNDERWEAR, LINGERIE, SLEEPWEAR, ROBES, HATS, VISORS, SCARVES, HEADBANDS, TIES, SOCKS, SHOES, BOOTS, SNEAKERS, BEACH SHOES, SANDALS, GLOVES, SUSPENDERS, BELTS, HALLOWEEN AND MASQUERADE COSTUMES (U.S. CLS. 22 AND 39).

FIRST USE 8-21-2001; IN COMMERCE 8-21-2001.

2,956,040. CARAVAN CANOPY INTERNATIONAL, INC., COMPTON, CA. SN 78-312,793. FILED P.R. 10-13-2003; AM. S.R. 3-4-2005.



NO CLAIM IS MADE TO THE EXCLUSIVE RIGHT TO USE "SHADE", APART FROM THE MARK AS SHOWN.

CLASS 6—METAL GOODS

FOR PREFABRICATED TEMPORARY STRUCTURES, MAINLY, PREFABRICATED TEMPORARY SHEDS, GARAGES, GAZEBOS, CARPORTS, AND SHADE COVERS HAVING METALLIC FRAMES (U.S. CLS. 2, 12, 13, 14, 23, 25 AND 50).

FIRST USE 7-17-2003; IN COMMERCE 12-30-2004.

CLASS 19—NON-METALLIC BUILDING MATERIALS

FOR PREFABRICATED TEMPORARY NON-METAL STRUCTURES, NAMELY, SHEDS, GARAGES, GAZEBOS, CARPORTS AND SHADE COVERS HAVING FABRIC OR CANVAS FRAME COVERINGS (U.S. CLS. 1, 12, 33 AND 50).

FIRST USE 7-17-2003; IN COMMERCE 12-30-2004.

CLASS 22—CORDAGE AND FIBERS

FOR TENTS AND CANOPIES WITH CANVAS COVERING FOR OUTDOOR USE (U.S. CLS. 1, 2, 7, 19, 22, 42 AND 50).

FIRST USE 7-17-2003; IN COMMERCE 12-30-2004.

2,956,041. BOWTIE, INC., LOS ANGELES, CA. SN 78-314,537. FILED P.R. 10-16-2003; AM. S.R. 3-15-2005.

TRICKS & GAMES**CLASS 16—PAPER GOODS AND PRINTED MATTER**

FOR PRINTED PUBLICATIONS, NAMELY, MAGAZINES, JOURNALS, BOOKS, NEWSLETTERS AND PERIODICALS, ALL IN THE FIELDS OF ANIMALS, CANINE SPECIES AND GENERAL INTEREST (U.S. CLS. 2, 5, 22, 23, 29, 37, 38 AND 50).

FIRST USE 3-0-2003; IN COMMERCE 3-0-2003.

CLASS 41—EDUCATION AND ENTERTAINMENT

FOR COMPUTER SERVICES, NAMELY, PROVIDING ONLINE PUBLICATIONS, NAMELY, MAGAZINES, JOURNALS AND NEWSLETTERS, IN THE FIELDS OF ANIMALS CANINE SPECIES AND GENERAL INTEREST, VIA THE INTERNET (U.S. CLS. 100, 101 AND 107).

FIRST USE 3-0-2003; IN COMMERCE 3-0-2003.

2,956,043. THE MAGNUSON COMPANY LLC, SPOKANE, WA. SN 78-315,341. FILED P.R. 10-17-2003; AM. S.R. 2-6-2005.

MAGNUSON HOTELS

NO CLAIM IS MADE TO THE EXCLUSIVE RIGHT TO USE "HOTELS", APART FROM THE MARK AS SHOWN.

CLASS 35—ADVERTISING AND BUSINESS

FOR ADVERTISING SERVICES, NAMELY, PROMOTING THE AND MARKETING THE SERVICES OF HOTELS FOR OTHERS THROUGH PRINTED MATERIALS AND VIA A GLOBAL COMPUTER NETWORK (U.S. CLS. 100, 101 AND 102).

FIRST USE 5-31-2003; IN COMMERCE 5-31-2003.

CLASS 43—HOTEL AND RESTAURANT SERVICES

FOR HOTEL RESERVATION AND REGISTRATION SERVICES FOR OTHERS; HOTEL RESERVATION AND REGISTRATION SERVICES FOR OTHERS VIA A GLOBAL COMPUTER NETWORK (U.S. CLS. 100 AND 101).
FIRST USE 5-31-2003; IN COMMERCE 5-31-2003.

2,956,049. CMP MEDIA LLC, MANHASSET, NY. SN 78-317,770. FILED P.R. 10-23-2003; AM. S.R. 10-12-2004.

EMBEDDED COMPUTING SOLUTIONS

NO CLAIM IS MADE TO THE EXCLUSIVE RIGHT TO USE "EMBEDDED COMPUTING", APART FROM THE MARK AS SHOWN.

CLASS 16—PAPER GOODS AND PRINTED MATTER

FOR PRINT PUBLICATIONS IN THE FIELDS OF HIGH TECHNOLOGY, BUSINESS TECHNOLOGY AND INFORMATION TECHNOLOGY (U.S. CLS. 2, 5, 22, 23, 29, 37, 38 AND 50).
FIRST USE 12-1-2003; IN COMMERCE 12-1-2003.

CLASS 41—EDUCATION AND ENTERTAINMENT

FOR ONLINE PUBLICATIONS IN THE FIELDS OF HIGH TECHNOLOGY, BUSINESS TECHNOLOGY AND INFORMATION TECHNOLOGY (U.S. CLS. 100, 101 AND 107).
FIRST USE 12-1-2003; IN COMMERCE 12-1-2003.

2,956,073. FOOD INVESTMENTS LIMITED, LONDON, UNITED KINGDOM. SN 78-334,916. FILED P.R. 12-2-2003; AM. S.R. 3-7-2005.

GERMAIN'S

THE MARK CONSISTS OF STANDARD CHARACTERS WITHOUT CLAIM TO ANY PARTICULAR FONT, STYLE, SIZE, OR COLOR.

CLASS 1—CHEMICALS

FOR CHEMICAL PREPARATIONS AND POLYMERS FOR USE IN SEED PROCESSING, SPECIFICALLY FOR USE IN TREATING, COATING AND PELLETING SEED (U.S. CLS. 1, 5, 6, 10, 26 AND 46).
FIRST USE 0-0-1990; IN COMMERCE 0-0-2002.

CLASS 40—MATERIAL TREATMENT

FOR SEED TREATMENT SERVICES; SEED COATING SERVICES; SEED PELLETING SERVICES (U.S. CLS. 100, 103 AND 106).
FIRST USE 0-0-1990; IN COMMERCE 0-0-2002.

2,956,097. LEINSLE, PETRA, BAD WORISHOFEN, FED REP GERMANY. SN 78-348,065. FILED P.R. 1-6-2004; AM. S.R. 2-7-2005.

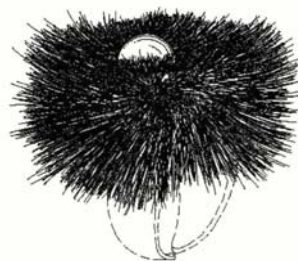

THE MARK CONSISTS OF A CONFIGURATION OF A PUFF AND GEM APPLIED IN COMBINATION TO THE GOODS.

CLASS 14—JEWELRY

FOR JEWELRY, NAMELY RINGS, NECKLACES, EARRINGS, BROACHES, BRACELETS, AND NAVEL RINGS (U.S. CLS. 2, 27, 28 AND 50).
FIRST USE 7-0-2004; IN COMMERCE 7-0-2004.

CLASS 25—CLOTHING

FOR CLOTHING, NAMELY, SHIRTS, PANTS, JACKETS, DRESSES, HATS, GLOVES, SHOES, SCARVES, SWEATERS AND SKIRTS (U.S. CLS. 22 AND 39).
FIRST USE 7-0-2004; IN COMMERCE 7-0-2004.

2,956,098. MULTI-STATE LOTTERY ASSOCIATION, DES MOINES, IA. SN 78-348,716. FILED P.R. 1-7-2004; AM. S.R. 1-31-2005.

2,956,104. CHASE CHARTERS, INC., FORT WORTH, TX. SN 78-350,220. FILED 1-9-2004.

NORTH DAKOTA LOTTERY

THE MARK CONSISTS OF STANDARD CHARACTERS WITHOUT CLAIM TO ANY PARTICULAR FONT, STYLE, SIZE, OR COLOR.

NO CLAIM IS MADE TO THE EXCLUSIVE RIGHT TO USE "LOTTERY", APART FROM THE MARK AS SHOWN.

CLASS 28—TOYS AND SPORTING GOODS

FOR LOTTERY TICKETS (U.S. CLS. 22, 23, 38 AND 50).
FIRST USE 3-25-2004; IN COMMERCE 3-25-2004.

CLASS 41—EDUCATION AND ENTERTAINMENT

FOR LOTTERY SERVICES (U.S. CLS. 100, 101 AND 107).
FIRST USE 3-25-2004; IN COMMERCE 3-25-2004.

2,956,099. OMNICOM INTERNATIONAL HOLDINGS INC., SAN FRANCISCO, NY. SN 78-348,774. FILED P.R. 1-7-2004; AM. S.R. 2-16-2005.

MED ED RESOURCE GROUP

THE MARK CONSISTS OF STANDARD CHARACTERS WITHOUT CLAIM TO ANY PARTICULAR FONT, STYLE, SIZE, OR COLOR.

CLASS 35—ADVERTISING AND BUSINESS

FOR ADVERTISING AGENCY SERVICES, PUBLIC RELATIONS, DIRECT MARKETING ADVERTISING, MARKET RESEARCH AND MARKET CONSULTING SERVICES, ALL IN THE FIELD OF HEALTHCARE AND PHARMACEUTICALS (U.S. CLS. 100, 101 AND 102).
FIRST USE 1-0-2004; IN COMMERCE 1-0-2004.

CLASS 41—EDUCATION AND ENTERTAINMENT

FOR PROVIDING MEDICAL EDUCATION AND CONTINUING MEDICAL EDUCATION PROGRAMS, TRAINING, COURSES, WORKSHOPS, SEMINARS AND COURSE MATERIALS TO PHYSICIANS AND OTHER HEALTHCARE PROVIDERS (U.S. CLS. 100, 101 AND 107).
FIRST USE 1-0-2004; IN COMMERCE 1-0-2004.

SPICE ISLAND TOURS

THE MARK CONSISTS OF STANDARD CHARACTERS WITHOUT CLAIM TO ANY PARTICULAR FONT, STYLE, SIZE, OR COLOR.

NO CLAIM IS MADE TO THE EXCLUSIVE RIGHT TO USE "TOURS", APART FROM THE MARK AS SHOWN.

CLASS 39—TRANSPORTATION AND STORAGE

FOR TRAVEL SERVICES, NAMELY ARRANGING AUTOMOBILE TRANSPORTATION, AND ARRANGING SCUBA DIVING EXCURSIONS (U.S. CLS. 100 AND 105).
FIRST USE 1-9-2004; IN COMMERCE 1-9-2004.

CLASS 41—EDUCATION AND ENTERTAINMENT

FOR SPORTING AND ENTERTAINMENT SERVICES, NAMELY ARRANGING RECREATIONAL SERVICES IN THE NATURE OF SCUBA DIVING (U.S. CLS. 100, 101 AND 107).
FIRST USE 1-9-2004; IN COMMERCE 1-9-2004.

CLASS 43—HOTEL AND RESTAURANT SERVICES

FOR TRAVEL AGENCY SERVICES, NAMELY ARRANGING MEALS AND TEMPORARY LODGING (U.S. CLS. 100 AND 101).
FIRST USE 1-9-2004; IN COMMERCE 1-9-2004.

CLASS 45—PERSONAL SERVICES

FOR CONCIERGE SERVICES FOR OTHERS COMPRISING MAKING REQUESTED PERSONAL ARRANGEMENTS AND RESERVATIONS AND PROVIDING CUSTOMER-SPECIFIC INFORMATION TO MEET INDIVIDUAL NEEDS RENDERED TOGETHER WITH TRAVEL SERVICES AND SCUBA DIVING EXCURSIONS (U.S. CLS. 100 AND 101).
FIRST USE 1-9-2004; IN COMMERCE 1-9-2004.

2,956,110. SHEPHERD & GOLDSTEIN LLP, WORCESTER, MA. SN 78-353,576. FILED P.R. 1-19-2004; AM. S.R. 10-4-2004.

2,956,111. BIG TIME PRODUCTS, LLC, ROME, GA. SN 78-353,577. FILED P.R. 1-19-2004; AM. S.R. 2-9-2005.

FIRM GRIP

Our service will
be so awesome
that we will
become your
benchmark for
measuring all other
professionals

THE MARK CONSISTS OF STANDARD CHARACTERS WITHOUT CLAIM TO ANY PARTICULAR FONT, STYLE, SIZE, OR COLOR.

CLASS 35—ADVERTISING AND BUSINESS

FOR BUSINESS DEVELOPMENT CONSULTING SERVICES, NAMELY, BUSINESS DEVELOPMENT STRATEGIES; BUSINESS MANAGEMENT IN THE FIELDS OF BUDGETING, PROJECTIONS, FINANCIAL ANALYSIS, CASH MANAGEMENT PLANNING, MANAGEMENT CONSULTING SERVICES IN CONNECTION WITH BUSINESS PROCEDURES AND OPERATIONS AND PERSONNEL AND HUMAN RELATIONS; CONSULTATION AND INVESTIGATION FOR BUSINESS ACQUISITIONS AND DISPOSITIONS, TEMPORARY CEO/CFO AND CONTROLLERS; ACCOUNTING AND TAX SERVICES, NAMELY, AUDITED OR CERTIFIED FINANCIAL STATEMENTS, REVIEW OF FINANCIAL STATEMENTS, COMPILATION OF FINANCIAL STATEMENTS, TAX PLANNING AND RETURN PREPARATION (U.S. CLS. 100, 101 AND 102).
FIRST USE 1-1-1999; IN COMMERCE 1-1-1999.

CLASS 36—INSURANCE AND FINANCIAL

FOR FINANCIAL SERVICES, NAMELY, ASSET MANAGEMENT, PERSONAL FINANCIAL AND RETIREMENT PLANNING INCLUDING 401(K), PROFIT SHARING, AND PENSION REVIEW PLANNING AND IMPLEMENTATION, ESTATE PLANNING, BUSINESS VALUATION, BUY-SELL AGREEMENT CONSULTING, LIFE AND DISABILITY INSURANCE ASSESSMENT; INVESTMENT PORTFOLIO REVIEW, AND BUSINESS WORKING CAPITAL CONSULTING (U.S. CLS. 100, 101 AND 102).
FIRST USE 1-1-2000; IN COMMERCE 1-1-2000.

THE MARK CONSISTS OF STANDARD CHARACTERS WITHOUT CLAIM TO ANY PARTICULAR FONT, STYLE, SIZE, OR COLOR.

CLASS 9—ELECTRICAL AND SCIENTIFIC APPARATUS

FOR PROTECTIVE GLOVES FOR INDUSTRIAL USE (U.S. CLS. 21, 23, 26, 36 AND 38).
FIRST USE 8-23-2004; IN COMMERCE 8-23-2004.

CLASS 21—HOUSEWARES AND GLASS

FOR DISPOSABLE LATEX GLOVES FOR GENERAL USE, HOUSEHOLD GLOVES FOR GENERAL USE (U.S. CLS. 2, 13, 23, 29, 30, 33, 40 AND 50).
FIRST USE 6-1-2004; IN COMMERCE 6-1-2004.

CLASS 25—CLOTHING

FOR WORK GLOVES (U.S. CLS. 22 AND 39).
FIRST USE 8-23-2004; IN COMMERCE 8-23-2004.

2,956,112. COMPASSTOOLS, INC., CENTENNIAL, CO. SN 78-353,769. FILED P.R. 1-19-2004; AM. S.R. 2-23-2005.

CompassTools

THE MARK CONSISTS OF STANDARD CHARACTERS WITHOUT CLAIM TO ANY PARTICULAR FONT, STYLE, SIZE, OR COLOR.

CLASS 41—EDUCATION AND ENTERTAINMENT

FOR TRAINING IN THE USE OF COMPUTER HARDWARE, SOFTWARE AND RELATED EQUIPMENT FOR USE IN GLOBAL POSITIONING SYSTEMS AND GEOGRAPHIC INFORMATION SYSTEMS (U.S. CLS. 100, 101 AND 107).

FIRST USE 1-20-2004; IN COMMERCE 1-20-2004.

CLASS 42—SCIENTIFIC, COMPUTER AND LEGAL SERVICES

FOR RENTAL AND LEASING SERVICES IN THE FIELD OF COMPUTER HARDWARE, SOFTWARE, GLOBAL POSITIONING SYSTEMS, LASER RANGE FINDERS AND AUTOMATED FIELD DATA COLLECTION EQUIPMENT FOR USE IN GLOBAL POSITIONING SYSTEMS AND GEOGRAPHIC INFORMATION SYSTEMS (U.S. CLS. 100 AND 101).

FIRST USE 1-20-2004; IN COMMERCE 1-20-2004.

2,956,125. HUMAN CAPITAL RESOURCES GROUP, LLC, THE, WALTHAM, MA. SN 78-358,746. FILED P.R. 1-28-2004; AM. S.R. 3-3-2005.

**THE HUMAN CAPITAL
RESOURCES GROUP**

THE MARK CONSISTS OF STANDARD CHARACTERS WITHOUT CLAIM TO ANY PARTICULAR FONT, STYLE, SIZE, OR COLOR.

NO CLAIM IS MADE TO THE EXCLUSIVE RIGHT TO USE "GROUP", APART FROM THE MARK AS SHOWN.

CLASS 35—ADVERTISING AND BUSINESS

FOR BUSINESS CONSULTING SERVICES IN THE FIELD OF HUMAN RESOURCES (U.S. CLS. 100, 101 AND 102).

FIRST USE 1-0-2003; IN COMMERCE 1-0-2003.

CLASS 41—EDUCATION AND ENTERTAINMENT

FOR INSURANCE SERVICES, NAMELY, EMPLOYEE BENEFITS BROKERAGE SERVICES (U.S. CLS. 100, 101 AND 107).

FIRST USE 1-0-2003; IN COMMERCE 1-0-2003.

2,956,133. LANIER WORLDWIDE, INC., ATLANTA, GA. SN 78-359,921. FILED P.R. 1-30-2004; AM. S.R. 2-14-2005.

**MANAGED DOCUMENT
SERVICES**

THE MARK CONSISTS OF STANDARD CHARACTERS WITHOUT CLAIM TO ANY PARTICULAR FONT, STYLE, SIZE, OR COLOR.

CLASS 35—ADVERTISING AND BUSINESS

FOR CONSULTATION SERVICES IN THE FIELD OF DOCUMENT REPRODUCTION EQUIPMENT AND PROCESSES; DOCUMENT REPRODUCTION AND DOCUMENT INDEXING FOR OTHERS (U.S. CLS. 100, 101 AND 102).

FIRST USE 1-0-2004; IN COMMERCE 1-0-2004.

CLASS 42—SCIENTIFIC, COMPUTER AND LEGAL SERVICES

FOR TECHNICAL SUPPORT SERVICES IN THE FIELD OF DOCUMENT-RELATED TECHNOLOGY AND PROCESSES, NAMELY, TROUBLESHOOTING OF OFFICE EQUIPMENT SUCH AS COPIERS AND FAX MACHINES; SOFTWARE INTEGRATION (U.S. CLS. 100 AND 101).

FIRST USE 1-0-2004; IN COMMERCE 1-0-2004.

2,956,166. USTER TECHNOLOGIES AG, CH-8610 USTER, SWITZERLAND. SN 78-367,496. FILED P.R. 2-13-2004; AM. S.R. 3-2-2005.

WEAVABILITY

THE MARK CONSISTS OF STANDARD CHARACTERS WITHOUT CLAIM TO ANY PARTICULAR FONT, STYLE, SIZE, OR COLOR.

PRIORITY CLAIMED UNDER SEC. 44(D) ON SWITZERLAND APPLICATION NO. 041742003, FILED 8-13-2003, REG. NO. 314803, DATED 10-9-2003, EXPIRES 8-13-2013.

CLASS 7—MACHINERY

FOR APPARATUS FOR EXAMINING RAW MATERIALS AND MATERIALS USED IN THE TEXTILE INDUSTRY, NAMELY, FIBER TESTERS, STRENGTH TESTERS FOR FIBERS AND YARNS, EVENNESS TESTERS FOR YARNS (U.S. CLS. 13, 19, 21, 23, 31, 34 AND 35).

CLASS 16—PAPER GOODS AND PRINTED MATTER

2,956,197. WNY ASSET MANAGEMENT, LLC, WILLIAMS-VILLE, NY. SN 78-375,161. FILED P.R. 2-27-2004; AM. S.R. 3-4-2005.

FOR PRINTED PRODUCTS, NAMELY, PUBLICATIONS IN THE NATURE OF SALES BROCHURES, ADVERTISEMENTS, SALES PROMOTION DOCUMENTS IN THE FIELD OF TEXTILES AND MANUFACTURE OF TEXTILE PRODUCTS (U.S. CLS. 2, 5, 22, 23, 29, 37, 38 AND 50).

CLASS 23—YARNS AND THREADS

FOR YARNS AND THREADS FOR TEXTILE USE (U.S. CL. 43).

CPA FINANCIAL NETWORK

THE MARK CONSISTS OF STANDARD CHARACTERS WITHOUT CLAIM TO ANY PARTICULAR FONT, STYLE, SIZE, OR COLOR.

NO CLAIM IS MADE TO THE EXCLUSIVE RIGHT TO USE "FINANCIAL NETWORK", APART FROM THE MARK AS SHOWN.

CLASS 35—ADVERTISING AND BUSINESS

FOR PROVIDES BUSINESS MARKETING CONSULTING FOR CERTIFIED PUBLIC ACCOUNTANTS AND ENROLLED AGENTS FOR EXPANDING THEIR SERVICES AND CAPABILITIES OFFERED AND TO PROVIDE THEIR EXISTING SERVICES AND ALL NEW SERVICES TO A WIDER AUDIENCE AND CLIENTELE (U.S. CLS. 100, 101 AND 102).

FIRST USE 6-1-2003; IN COMMERCE 6-1-2003.

CLASS 36—INSURANCE AND FINANCIAL

FOR PROVIDING FINANCIAL PLANNING AND INVESTMENT MANAGEMENT FOR THE INDIVIDUAL AND BUSINESS TAX CLIENTS OF CERTIFIED PUBLIC ACCOUNTANTS AND ENROLLED AGENTS (U.S. CLS. 100, 101 AND 102).

FIRST USE 6-1-2003; IN COMMERCE 6-1-2003.

2,956,179. ADVANCED BIOMATERIAL SYSTEMS, INC., CHATHAM, NJ. SN 78-369,322. FILED P.R. 2-17-2004; AM. S.R. 3-17-2005.

ADVANCED BIOMATERIAL SYSTEMS

THE MARK CONSISTS OF STANDARD CHARACTERS WITHOUT CLAIM TO ANY PARTICULAR FONT, STYLE, SIZE, OR COLOR.

CLASS 5—PHARMACEUTICALS

FOR BIOMATERIALS, BONE CEMENTS, BONE VOID FILLERS, BIOCOMPATIBLE MATERIALS; ALL FOR USE IN ORTHOPEDIC SURGERY, MUSCULOSKELETAL, MAXILLOFACIAL AND NEUROSURGICAL PROCEDURES (U.S. CLS. 6, 18, 44, 46, 51 AND 52).

FIRST USE 3-10-2004; IN COMMERCE 3-10-2004.

CLASS 10—MEDICAL APPARATUS

FOR SURGICAL INSTRUMENTS, NAMELY, BONE VOID FILLING SYSTEMS, MULTI-COMPONENT BONE CEMENT MIXING AND DELIVERY SYSTEMS, MULTI-COMPONENT BONE CEMENT MIXING AND DELIVERY SYSTEMS WITH A PRELOADED MIXING CHAMBER, AXIAL TORQUE LIMITERS, RATCHETING HANDLES, RATCHETING SCREW DRIVERS, NON-RATCHETING HANDLES, AND BONE CEMENT MIXER/DISPENSERS; ALL FOR USE IN ORTHOPEDIC SURGERY, MUSCULOSKELETAL, MAXILLOFACIAL AND NEUROSURGICAL PROCEDURES (U.S. CLS. 26, 39 AND 44).

FIRST USE 3-0-2004; IN COMMERCE 3-0-2004.

2,956,203. EKKOSOFT CORPORATION, NEWBURYPORT, MA. SN 78-378,767. FILED P.R. 3-4-2004; AM. S.R. 3-21-2005.

MARINE411

THE MARK CONSISTS OF STANDARD CHARACTERS WITHOUT CLAIM TO ANY PARTICULAR FONT, STYLE, SIZE, OR COLOR.

CLASS 9—ELECTRICAL AND SCIENTIFIC APPARATUS

FOR COMPUTER SOFTWARE FOR OTHERS TO UPDATE AND RECEIVE DIRECTORY INFORMATION IN THE MARINE INDUSTRY (U.S. CLS. 21, 23, 26, 36 AND 38).

FIRST USE 6-23-2004; IN COMMERCE 6-23-2004.

CLASS 35—ADVERTISING AND BUSINESS

FOR PROVIDING COMMERCIAL DIRECTORY INFORMATION IN THE MARINE INDUSTRY (U.S. CLS. 100, 101 AND 102).

FIRST USE 6-23-2004; IN COMMERCE 6-23-2004.

2,956,218. THE L.S. STARRETT COMPANY, ATHOL, MA. SN 78-385,246. FILED P.R. 3-16-2004; AM. S.R. 1-24-2005.

bi metal unique

CLASS 7—MACHINERY

FOR BLADES FOR POWER SAWS, NAMELY, JIG SAW BLADES, PORTABAND SAW BLADES, AND BAND SAWS BLADES (U.S. CLS. 13, 19, 21, 23, 31, 34 AND 35).

FIRST USE 10-18-2004; IN COMMERCE 10-18-2004.

CLASS 8—HAND TOOLS

FOR BLADES FOR HAND SAWS, NAMELY, HACK SAW BLADES (U.S. CLS. 23, 28 AND 44).

FIRST USE 3-22-2004; IN COMMERCE 3-22-2004.

2,956,235. FIRST DAKOTA TITLE LIMITED PARTNERSHIP, SIOUX FALLS, SD. SN 78-395,650. FILED P.R. 4-2-2004; AM. S.R. 1-21-2005.

THE TITLE RESOURCE NETWORK

THE MARK CONSISTS OF STANDARD CHARACTERS WITHOUT CLAIM TO ANY PARTICULAR FONT, STYLE, SIZE, OR COLOR.

NO CLAIM IS MADE TO THE EXCLUSIVE RIGHT TO USE "TITLE", APART FROM THE MARK AS SHOWN.

CLASS 36—INSURANCE AND FINANCIAL

FOR TITLE INSURANCE SERVICES; REAL ESTATE SERVICES, NAMELY, CLOSING AND SETTLEMENT SERVICES, ESCROW SERVICES (U.S. CLS. 100, 101 AND 102).

FIRST USE 5-0-2004; IN COMMERCE 5-0-2004.

CLASS 42—SCIENTIFIC, COMPUTER AND LEGAL SERVICES

FOR REAL ESTATE TITLE SERVICES, NAMELY, TITLE SEARCH AND CONDITION REPORTING (U.S. CLS. 100 AND 101).

FIRST USE 5-0-2004; IN COMMERCE 5-0-2004.

2,956,243. MANN PROPERTIES, LLP, INDIANAPOLIS, IN. SN 78-402,650. FILED P.R. 4-15-2004; AM. S.R. 3-8-2005.

MANN PROPERTIES

THE MARK CONSISTS OF STANDARD CHARACTERS WITHOUT CLAIM TO ANY PARTICULAR FONT, STYLE, SIZE, OR COLOR.

NO CLAIM IS MADE TO THE EXCLUSIVE RIGHT TO USE PROPERTIES, APART FROM THE MARK AS SHOWN.

CLASS 36—INSURANCE AND FINANCIAL

FOR REAL ESTATE MANAGEMENT AND REAL ESTATE LEASING SERVICES (U.S. CLS. 100, 101 AND 102).

FIRST USE 6-30-2001; IN COMMERCE 6-30-2001.

CLASS 37—CONSTRUCTION AND REPAIR

FOR REAL ESTATE DEVELOPMENT SERVICES (U.S. CLS. 100, 103 AND 106).

FIRST USE 6-30-2001; IN COMMERCE 6-30-2001.

2,956,255. CONNOLLY, JENNIFER, TRUMBULL, CT. SN 78-410,651. FILED P.R. 4-29-2004; AM. S.R. 3-17-2005.

BUZZ DOG FENCE

THE MARK CONSISTS OF STANDARD CHARACTERS WITHOUT CLAIM TO ANY PARTICULAR FONT, STYLE, SIZE, OR COLOR.

NO CLAIM IS MADE TO THE EXCLUSIVE RIGHT TO USE "DOG FENCE", APART FROM THE MARK AS SHOWN.

CLASS 37—CONSTRUCTION AND REPAIR

FOR INSTALLATION, SERVICING, MAINTENANCE AND REPAIR OF ELECTRICALLY CHARGED BOUNDARIES FOR USE AS FENCES FOR ENCLOSING PETS (U.S. CLS. 100, 103 AND 106).

FIRST USE 8-31-2003; IN COMMERCE 8-31-2003.

CLASS 41—EDUCATION AND ENTERTAINMENT

FOR TRAINING IN THE USE, OPERATION, SERVICING, MAINTENANCE AND REPAIR OF ELECTRICALLY CHARGED BOUNDARIES FOR USE AS FENCES FOR ENCLOSING PETS (U.S. CLS. 100, 101 AND 107).

FIRST USE 8-31-2003; IN COMMERCE 8-31-2003.

2,956,256. LOS ANGELES BIOMEDICAL RESEARCH INSTITUTE AT HARBOR-UCLA MEDICAL CENTER, TORRANCE, CA. SN 78-410,774. FILED P.R. 4-29-2004; AM. S.R. 3-15-2005.

LABIOMED

THE MARK CONSISTS OF STANDARD CHARACTERS WITHOUT CLAIM TO ANY PARTICULAR FONT, STYLE, SIZE, OR COLOR.

CLASS 36—INSURANCE AND FINANCIAL

FOR CHARITABLE FUND RAISING (U.S. CLS. 100, 101 AND 102).

FIRST USE 7-0-2004; IN COMMERCE 7-0-2004.

CLASS 41—EDUCATION AND ENTERTAINMENT

FOR EDUCATION SERVICES, NAMELY CLASSES AND TRAINING IN THE FIELD OF MEDICAL AND SCIENTIFIC RESEARCH; EDUCATION SERVICES, NAMELY CLASSES AND TRAINING IN THE FIELD OF HEALTH AND PERSONAL SAFETY (U.S. CLS. 100, 101 AND 107).

FIRST USE 7-0-2004; IN COMMERCE 7-0-2004.

CLASS 42—SCIENTIFIC, COMPUTER AND LEGAL SERVICES

FOR MEDICAL AND SCIENTIFIC RESEARCH (U.S. CLS. 100 AND 101).

FIRST USE 7-0-2004; IN COMMERCE 7-0-2004.

CLASS 44—MEDICAL, BEAUTY AND AGRICULTURAL SERVICES

FOR HEALTH CARE AND HEALTH COUNSELING (U.S. CLS. 100 AND 101).

FIRST USE 7-0-2004; IN COMMERCE 7-0-2004.

2,956,274. EZ PUBLISHING, INC., DAVIS, CA. SN 78-419,530. FILED P.R. 5-16-2004; AM. S.R. 2-14-2005.

stream send

THE MARK CONSISTS OF STANDARD CHARACTERS WITHOUT CLAIM TO ANY PARTICULAR FONT, STYLE, SIZE, OR COLOR.

CLASS 9—ELECTRICAL AND SCIENTIFIC APPARATUS

FOR COMPUTER PROGRAMS, NAMELY, COMPUTER SOFTWARE THAT ALLOWS USERS TO ORGANIZE, UPLOAD, SEND, MANAGE, AND CONFIRM ELECTRONIC MAIL CONTACTS AND UPLOAD, FORMAT, SEND, AND TRACK ELECTRONIC MESSAGES, ADVERTISING, AND MARKETING CAMPAIGNS FOR USE IN ELECTRONIC PUBLISHING, ADVERTISING, MARKETING (U.S. CLS. 21, 23, 26, 36 AND 38).

FIRST USE 8-1-2003; IN COMMERCE 8-1-2003.

CLASS 35—ADVERTISING AND BUSINESS

FOR ADVERTISING AND MARKETING SERVICES FOR PERMISSION-BASED ELECTRONIC MAIL; MARKETING SERVICES, NAMELY, TRACKING RECEIPT AND RESPONSE RATES FOR PERMISSION-BASED ELECTRONIC MAIL ADVERTISEMENTS AND MESSAGES (U.S. CLS. 100, 101 AND 102).

FIRST USE 8-1-2003; IN COMMERCE 8-1-2003.

CLASS 38—COMMUNICATION

FOR ELECTRONIC TRANSMISSION OF PERMISSION-BASED MESSAGES AND DATA (U.S. CLS. 100, 101 AND 104).

FIRST USE 8-1-2003; IN COMMERCE 8-1-2003.

2,956,287. FIRST ZURICH PRIVATE BANK, ZURICH, SWITZERLAND. SN 78-424,333. FILED P.R. 5-25-2004; AM. S.R. 1-17-2005.

2,956,297. ATHENS NEWSPAPERS, LLC, AUGUSTA, GA. SN 78-429,137. FILED P.R. 6-3-2004; AM. S.R. 3-8-2005.

BANK FREY

THE MARK CONSISTS OF STANDARD CHARACTERS WITHOUT CLAIM TO ANY PARTICULAR FONT, STYLE, SIZE, OR COLOR.

PRIORITY CLAIMED UNDER SEC. 44(D) ON SWITZERLAND APPLICATION NO. 55397/2003, FILED 12-22-2003, REG. NO. 518328, DATED 2-4-2004, EXPIRES 12-22-2013.

CLASS 9—ELECTRICAL AND SCIENTIFIC APPARATUS

FOR COMPUTER SOFTWARE FOR DATA COLLECTION, ONLINE COMMUNICATIONS AND ONLINE TRANSACTIONS IN THE FIELD OF FINANCE AND BANKING (U.S. CLS. 21, 23, 26, 36 AND 38).

CLASS 16—PAPER GOODS AND PRINTED MATTER

FOR PRINTED MATTER, NAMELY, NEWSLETTERS, BROCHURES, BOOKS IN THE FIELD OF FINANCE AND BANKING (U.S. CLS. 2, 5, 22, 23, 29, 37, 38 AND 50).

CLASS 35—ADVERTISING AND BUSINESS

FOR BUSINESS MANAGEMENT AND ORGANIZATION CONSULTING SERVICES (U.S. CLS. 100, 101 AND 102).

CLASS 36—INSURANCE AND FINANCIAL

FOR FINANCIAL SERVICES, NAMELY, FINANCIAL ELECTRONIC CASH TRANSACTIONS, FINANCIAL CONSULTATION AND BANKING SERVICES (U.S. CLS. 100, 101 AND 102).

CLASS 42—SCIENTIFIC, COMPUTER AND LEGAL SERVICES

FOR LEGAL SERVICES (U.S. CLS. 100 AND 101).

GAINESVILLE LIFE

THE MARK CONSISTS OF STANDARD CHARACTERS WITHOUT CLAIM TO ANY PARTICULAR FONT, STYLE, SIZE, OR COLOR.

CLASS 16—PAPER GOODS AND PRINTED MATTER

FOR PRINTED MATERIALS, NAMELY, MAGAZINE ABOUT ENTERTAINMENT, ART, SHOPPING, HISTORY AND DINING IN GAINESVILLE AND HALL COUNTY, GEORGIA (U.S. CLS. 2, 5, 22, 23, 29, 37, 38 AND 50).
FIRST USE 1-0-2004; IN COMMERCE 3-0-2004.

CLASS 41—EDUCATION AND ENTERTAINMENT

FOR ONLINE PUBLICATION OF A MAGAZINE CONTAINING INFORMATION ON ENTERTAINMENT, ART, SHOPPING, HISTORY AND DINING FOR RESIDENTS OF AND VISITORS TO GAINESVILLE AND HALL COUNTY, GEORGIA VIA A GLOBAL COMPUTER NETWORK (U.S. CLS. 100, 101 AND 107).
FIRST USE 1-0-2004; IN COMMERCE 3-0-2004.

2,956,299. GETZ, HARRY, LAGUNA NIGUEL, CA. SN 78-430,077. FILED P.R. 6-4-2004; AM. S.R. 1-26-2005.

ORNetwork

THE MARK CONSISTS OF STANDARD CHARACTERS WITHOUT CLAIM TO ANY PARTICULAR FONT, STYLE, SIZE, OR COLOR.

CLASS 41—EDUCATION AND ENTERTAINMENT

FOR PROVIDING ONLINE CONTINUING MEDICAL EDUCATION SERVICES IN THE NATURE OF COURSES IN THE FIELDS OF SURGERY, DIAGNOSTIC PROCEDURES, INFORMATION MANAGEMENT TO SURGEONS, STAFF PROVIDERS, ADMINISTRATORS, CONSUMERS AND OTHER PARTICIPANTS IN THE HEALTH CARE INDUSTRY (U.S. CLS. 100, 101 AND 107).

FIRST USE 6-4-2004; IN COMMERCE 8-15-2004.

CLASS 44—MEDICAL, BEAUTY AND AGRICULTURAL SERVICES

FOR PROVIDING NEWS AND INFORMATION IN THE FIELD OF HEALTH VIA AN ONLINE COMPUTER NETWORK; EXCHANGING CLINICAL AND LABORATORY INFORMATION TO CONSUMERS, PROVIDERS, ADMINISTRATORS AND OTHER PARTICIPANTS IN THE HEALTH CARE INDUSTRY (U.S. CLS. 100 AND 101).

FIRST USE 6-4-2004; IN COMMERCE 8-15-2004.

2,956,364. STOCHASTICS FINANCIAL SOFTWARE SA, PARIS, FRANCE. SN 78-975,334. FILED P.R. 9-12-2001; AM. S.R. 10-20-2003.

RISKDATA

PRIORITY CLAIMED UNDER SEC. 44(D) ON FRANCE APPLICATION NO. 013089533, FILED 3-13-2001, REG. NO. 013089533, DATED 3-13-2001, EXPIRES 3-13-2011.

CLASS 9—ELECTRICAL AND SCIENTIFIC APPARATUS

FOR COMPUTER SOFTWARE TO AUTOMATE DATA WAREHOUSING; DATABASE MANAGEMENT SOFTWARE; COMPUTER COMMUNICATIONS SOFTWARE TO ALLOW CUSTOMERS TO ACCESS DATABASE; COMPUTER SEARCH ENGINE SOFTWARE TO SELECT DATA (U.S. CLS. 21, 23, 26, 36 AND 38).

FIRST USE 8-26-2002; IN COMMERCE 8-26-2002.

CLASS 36—INSURANCE AND FINANCIAL

FOR FINANCIAL PORTFOLIO MANAGEMENT, OPTIMIZED ACCORDING TO PERFORMANCE AND RISK MANAGEMENT INDICATORS (U.S. CLS. 100, 101 AND 102).

2,956,365. TRIPLE CANOPY GROUP, INC., CHICAGO, IL. SN 78-975,479. FILED P.R. 10-3-2003; AM. S.R. 2-25-2005.

SPECIAL DEFENSE SERVICES

CLASS 41—EDUCATION AND ENTERTAINMENT

FOR EDUCATIONAL SERVICES, NAMELY, CONDUCTING CLASSES, COURSES, SEMINARS, AND WORKSHOPS LIVE AND BY MEANS OF ELECTRONIC COMMUNICATIONS NETWORKS, DEVELOPMENT OF EDUCATIONAL MATERIALS FOR OTHERS, ALL IN THE FIELDS OF LAW ENFORCEMENT, MILITARY SCIENCE AND SECURITY SERVICES, AND EDUCATIONAL TESTING OF THE PROGRESS OF PARTICIPANTS IN THE FOREGOING ACTIVITIES (U.S. CLS. 100, 101 AND 107).

FIRST USE 10-0-2003; IN COMMERCE 10-0-2003.

CLASS 42—SCIENTIFIC, COMPUTER AND LEGAL SERVICES

FOR SCIENTIFIC RESEARCH FOR MILITARY APPLICATIONS AND TECHNICAL CONSULTATION IN THE FIELDS OF LAW ENFORCEMENT, MILITARY SCIENCE AND SECURITY SERVICES (U.S. CLS. 100 AND 101).

FIRST USE 3-1-2004; IN COMMERCE 3-1-2004.

CLASS 45—PERSONAL SERVICES

FOR LAW ENFORCEMENT SERVICES; SECURITY SERVICES, NAMELY, SECURITY GUARD AND BODYGUARD; AND MILITARY SCIENCE SERVICES, NAMELY, PROVIDING MILITARY PERSONNEL IN AREAS OF POLITICAL UNREST (U.S. CLS. 100 AND 101).

FIRST USE 3-1-2004; IN COMMERCE 3-1-2004.

* * * * *

SECTION 2.— INTERNATIONAL CLASSIFICATION

The short titles associated below with the international class numbers are terms designed merely for quick identification and are not an official part of the international classification. The full names of international classes are given in section 6.1 of the trademark rules of practice.

The designation "U.S. Cl." appearing in this section refers to the U.S. class in effect prior to Sep. 1, 1973 rather than the international class which applies to applications filed on or after that date. For adoption of international classification see notice in the OFFICIAL GAZETTE of Jun. 26, 1973 (911 O.G. TM 210).

Application in one class

CLASS 1—CHEMICALS

2,955,842. ULTRA ADDITIVES INCORPORATED, BLOOMFIELD, NJ. SN 76-545,469. FILED P.R. 9-5-2003; AM. S.R. 2-22-2005.

THE ULTIMATE ADDITIVES COMPANY

FOR CHEMICAL ADDITIVES FOR USE BY MANUFACTURES IN THE PRODUCTION OF PAINTS AND COATINGS, INKS, METALWORKING LUBRICANTS, GROUTS AND MORTARS AND ADHESIVES, NAMELY, DEFOAMERS, RHEOLOGY MODIFIERS, POLYMERIC DISPERSANTS, WETTING AND LEVELING AGENTS, EMULSIFIERS, ANTISHRINKAGE AGENTS AND COALESCENTS (U.S. CLS. 1, 5, 6, 10, 26 AND 46).
FIRST USE 2-1-2004; IN COMMERCE 2-1-2004.

2,955,890. OLD WORLD INDUSTRIES, INC., NORTHBROOK, IL. SN 76-599,434. FILED P.R. 6-28-2004; AM. S.R. 12-9-2004.

LIFETIME

THE MARK CONSISTS OF STANDARD CHARACTERS WITHOUT CLAIM TO ANY PARTICULAR FONT, STYLE, SIZE, OR COLOR.
FOR ANTIFREEZE AND COOLANTS (U.S. CLS. 1, 5, 6, 10, 26 AND 46).
FIRST USE 11-1-2004; IN COMMERCE 11-1-2004.

2,955,939. BOC GROUP, INC., THE, NEW PROVIDENCE, NJ. SN 78-208,177. FILED P.R. 1-29-2003; AM. S.R. 1-20-2005.

PUREFILM

FOR CHEMICALS FOR USE IN SEMICONDUCTOR AND INTEGRATED CIRCUIT MANUFACTURING (U.S. CLS. 1, 5, 6, 10, 26 AND 46).
FIRST USE 1-31-2002; IN COMMERCE 1-31-2002.

CLASS 1—(Continued).

2,955,973. NISUS CORPORATION, ROCKFORD, TN. SN 78-260,247. FILED P.R. 6-10-2003; AM. S.R. 1-25-2005.

MOLD-CLEAN

FOR CHEMICAL COMPOSITION USED TO REMOVE STAINS CAUSED BY MICROBIAL GROWTH ON SUBSTRATES, INCLUDING WOOD AND CELLULOSIC MATERIALS (U.S. CLS. 1, 5, 6, 10, 26 AND 46).
FIRST USE 4-9-2004; IN COMMERCE 4-9-2004.

2,956,092. POOL GEL LLC, LOMA LINDA, CA. SN 78-346,316. FILED P.R. 12-29-2003; AM. S.R. 1-25-2005.

POOL GEL

THE MARK CONSISTS OF STANDARD CHARACTERS WITHOUT CLAIM TO ANY PARTICULAR FONT, STYLE, SIZE, OR COLOR.
NO CLAIM IS MADE TO THE EXCLUSIVE RIGHT TO USE "GEL", APART FROM THE MARK AS SHOWN.
FOR WATER PURIFYING CHEMICALS FOR SWIMMING POOLS AND SPAS (U.S. CLS. 1, 5, 6, 10, 26 AND 46).
FIRST USE 8-0-2003; IN COMMERCE 8-0-2003.

CLASS 1—(Continued).

2,956,280. VECTOR PRODUCTS, INC, FAIRFIELD, NJ. SN 78-422,048. FILED P.R. 5-20-2004; AM. S.R. 2-23-2005.

CLASS 3—(Continued).

2,955,828. RON ROBINSON, INC., LOS ANGELES, CA. SN 76-512,096. FILED P.R. 4-21-2003; AM. S.R. 2-7-2005.

STAYFRESH

THE MARK CONSISTS OF STANDARD CHARACTERS WITHOUT CLAIM TO ANY PARTICULAR FONT, STYLE, SIZE, OR COLOR.
FOR CHEMICALS NAMELY OXYGEN ABSORBERS FOR USE IN FOOD PRESERVATION (U.S. CLS. 1, 5, 6, 10, 26 AND 46).
FIRST USE 4-5-2003; IN COMMERCE 4-5-2003.



THE MARK CONSISTS OF THE 3-D DESIGN OF A BOTTLE HAVING A DISTINCTIVELY SHAPED SLEEVE COVERING THE CYLINDRICAL BOTTLE.
FOR PERFUMES, ESSENTIAL OILS FOR PERSONAL USE AND FRAGRANCES FOR PERSONAL USE (U.S. CLS. 1, 4, 6, 50, 51 AND 52).
FIRST USE 5-1-2001; IN COMMERCE 5-1-2001.

CLASS 2—PAINTS

2,956,189. CHOATE, EARL W. JR., FARMERSVILLE, TX. SN 78-372,652. FILED P.R. 2-23-2004; AM. S.R. 3-24-2005.

**CONCRETE
CAMOUFLAGE**

THE MARK CONSISTS OF STANDARD CHARACTERS WITHOUT CLAIM TO ANY PARTICULAR FONT, STYLE, SIZE, OR COLOR.
FOR CONCRETE COATINGS AND COLORINGS, NAMELY, CONCRETE STAINS (U.S. CLS. 6, 11 AND 16).
FIRST USE 2-10-2004; IN COMMERCE 1-3-2005.

2,955,850. PAULA AMELIA MOYNAHAN M.D., ENTERPRISES INC., WATERBURY, CT. SN 76-552,845. FILED P.R. 10-20-2003; AM. S.R. 1-13-2005.

**TO HEAL THE
ENVIRONMENTAL
WOUNDING OF THE SKIN**

CLASS 3—COSMETICS AND CLEANING PREPARATIONS

FOR COSMETICS FOR THE FACE, BODY AND SKIN, NAMELY CREAMS, LOTIONS, PADS AND MASKS (U.S. CLS. 1, 4, 6, 50, 51 AND 52).
FIRST USE 3-1-2004; IN COMMERCE 3-1-2004.

CLASS 3—(Continued).

2,955,851. BEAUTE PRESTIGE INTERNATIONAL, 75116, PARIS, FRANCE. SN 76-555,793. FILED P.R. 10-31-2003; AM. S.R. 2-18-2005.



PRIORITY CLAIMED UNDER SEC. 44(D) ON FRANCE APPLICATION NO. 033226467, FILED 5-21-2003, REG. NO. 033226467, DATED 5-21-2003, EXPIRES 5-21-2013.

THE MARK IS A THREE DIMENSIONAL REPRESENTATION OF A CONTAINER FOR THE GOODS CHARACTERIZED BY A GENERALLY SQUARE CROSS SECTION HAVING AN OPAQUE CAP AND A CLEAR BODY WITH A VISIBLE ELONGATED CYLINDER EXTENDING LONGITUDINALLY THERE WITHIN.

FOR PERFUMERY PRODUCTS, NAMELY, PERFUME, TOILET WATER AND COLOGNE (U.S. CLS. 1, 4, 6, 50, 51 AND 52).

2,955,852. BEAUTE PRESTIGE INTERNATIONAL, 75116, PARIS, FRANCE. SN 76-555,794. FILED P.R. 10-31-2003; AM. S.R. 2-18-2005.

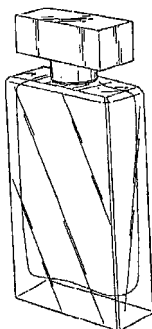

PRIORITY CLAIMED UNDER SEC. 44(D) ON FRANCE APPLICATION NO. 033226468, FILED 5-21-2003, REG. NO. 033226468, DATED 5-21-2003, EXPIRES 5-21-2013.

THE MARK IS A THREE DIMENSIONAL REPRESENTATION OF A CONTAINER FOR THE GOODS CHARACTERIZED BY OPPOSED RECTANGULAR FACES AND HAVING A T-SHAPED TOP EXTENDING ACROSS THE WIDTH OF THE CONTAINER AND CREATING THE IMPRESSION OF A BOTTLE WITHIN A BOTTLE.

FOR PERFUMERY PRODUCTS, NAMELY, PERFUME, TOILET WATER AND COLOGNE (U.S. CLS. 1, 4, 6, 50, 51 AND 52).

CLASS 3—(Continued).

2,955,869. MYSTIC TAN, INC., FARMERS BRANCH, TX. SN 76-573,881. FILED P.R. 2-4-2004; AM. S.R. 2-28-2005.

CLEARMYST

THE MARK CONSISTS OF STANDARD CHARACTERS WITHOUT CLAIM TO ANY PARTICULAR FONT, STYLE, SIZE, OR COLOR.

FOR TANNING BRONZER-FREE SPRAY FOR SKIN TREATMENT TO BE USED IN TANNING BOOTHS (U.S. CLS. 1, 4, 6, 50, 51 AND 52).

FIRST USE 1-31-2004; IN COMMERCE 1-31-2004.

2,955,870. MYSTIC TAN, INC., FARMERS BRANCH, TX. SN 76-573,886. FILED P.R. 2-4-2004; AM. S.R. 3-15-2005.

PREMIUM TANNING MYST

THE MARK CONSISTS OF STANDARD CHARACTERS WITHOUT CLAIM TO ANY PARTICULAR FONT, STYLE, SIZE, OR COLOR.

FOR TANNING BRONZING AND BRONZER-FREE SPRAY FOR SKIN TREATMENT TO BE USED IN TANNING BOOTHS (U.S. CLS. 1, 4, 6, 50, 51 AND 52).

FIRST USE 1-31-2004; IN COMMERCE 1-31-2004.

2,955,871. MYSTIC TAN, INC., FARMERS BRANCH, TX. SN 76-573,887. FILED P.R. 2-4-2004; AM. S.R. 3-1-2005.

ORIGINAL TANNING MYST

THE MARK CONSISTS OF STANDARD CHARACTERS WITHOUT CLAIM TO ANY PARTICULAR FONT, STYLE, SIZE, OR COLOR.

FOR TANNING BRONZING AND BRONZER-FREE SPRAY FOR SKIN TREATMENT TO BE USED IN TANNING BOOTHS (U.S. CLS. 1, 4, 6, 50, 51 AND 52).

FIRST USE 2-29-2004; IN COMMERCE 2-29-2004.

CLASS 3—(Continued).

2,955,969. QUIMI ROMAR, S.L., MONCADA, SPAIN. SN 78-251,844. FILED P.R. 5-20-2003; AM. S.R. 2-23-2005.

GARLEY

OWNER OF ERPN CMNTY TM OFC REG. NO. 001350172, DATED 12-7-2000, EXPIRES 10-19-2009.

FOR PERFUMES, EAU DE COLOGNE, AND COSMETIC; TOOTHPASTE; SHAMPOOS, SKINS SOAPS AND SOAPS CREMES FOR THE SKIN, BATH GELS, UPHOLSTERY SHAMPOO; HAIR LOTION, HAIR FIXING GEL, HAIR SOFTENER CREME, HAIR SOFTENER CONDITIONER, HAIR SHAPER FOAM, STYLING MOUSSE; SHAVING LATHER, AFTER SHAVE BALMSAMS; DEODORANTS; FRAGRANCED TALCUM POWDER; BODY CREAMS, BODY MILK, HAND CREAMS, SKIN CREAMS; COSMETIC OILS; NAIL POLISHES, NAIL POLISH REMOVER; EYE LINERS, EYELASH MASK, EYE SHADOW; LIP BARS, LIPSTICKS, COSMETIC CACAO CREME, PROTECTIVE LIPSTICK, AND BLUSHERS; COMPACT POWERED MAKE-UP; VARNISH REMOVER; HUMECTED BABY WIPES; LIQUID SHOE POLISH; GREASE CLEANERS; DASHBOARD CLEANERS, DISH DETERGENTS; HOUSE CLEANING PRODUCTS, NAMELY, CHEMICAL PRODUCTS USED FOR CLEANING CERAMIC, STONE OR WOOD FLOORS, WOOD FURNITURE SURFACE, GLASS, TAPESTRIES, CARPETS AND METAL SURFACES, AND DISHWASHER LIQUID SOAP; MULTIPURPOSE CLEANERS, OVEN CLEANSING SPRAYS, FURNITURE WASHES; SOAPS AND CHEMICAL PRODUCTS FOR WASHING FLOORS; MOP SPRAYS, BOTTLED CHEMICAL PRODUCTS AND SPRAY CHEMICAL PRODUCTS USED FOR IMPARTING A BRIGHTNESS TO FURNITURE, FLOOR AND CAR SURFACES; INSTANT IRONING SPRAYS, MULTIPURPOSE POLISHES, TURPENTINE SUBSTITUTE GREASE CLEANER, CAR PERFUME SPRAYS, TEXTILE CLEANING PRODUCTS, NAMELY, DISSOLVENTS AND FOAM USED FOR REMOVING SPOTS, DIRT AND THE LIKE FROM CLOTHES AND TAPESTRIES; AND GREASE REMOVER PRODUCTS, NAMELY, CHEMICAL PRODUCTS USED FOR REMOVING GREASE (U.S. CLS. 1, 4, 6, 50, 51 AND 52).

2,956,070. PRIMAL ELEMENTS, INC., GARDEN GROVE, CA. SN 78-333,868. FILED P.R. 11-26-2003; AM. S.R. 1-27-2005.

SUGAR WHIP

THE MARK CONSISTS OF STANDARD CHARACTERS WITHOUT CLAIM TO ANY PARTICULAR FONT, STYLE, SIZE, OR COLOR.
FOR BODY SOAP AND BODY CLEANSERS (U.S. CLS. 1, 4, 6, 50, 51 AND 52).
FIRST USE 12-4-2003; IN COMMERCE 12-6-2003.

CLASS 3—(Continued).

2,956,071. PRIMAL ELEMENTS, INC., GARDEN GROVE, CA. SN 78-333,871. FILED P.R. 11-26-2003; AM. S.R. 1-27-2005.

BODY WHIP

THE MARK CONSISTS OF STANDARD CHARACTERS WITHOUT CLAIM TO ANY PARTICULAR FONT, STYLE, SIZE, OR COLOR.

FOR BODY SOAP AND BODY CLEANSERS (U.S. CLS. 1, 4, 6, 50, 51 AND 52).

FIRST USE 12-4-2003; IN COMMERCE 12-6-2003.

2,956,114. PHILOSOPHY, INC., PHOENIX, AZ. SN 78-354,306. FILED P.R. 1-20-2004; AM. S.R. 2-8-2005.

MELON DAIQUIRI

THE MARK CONSISTS OF STANDARD CHARACTERS WITHOUT CLAIM TO ANY PARTICULAR FONT, STYLE, SIZE, OR COLOR.

FOR SCENTED HEAD-TO-TOE BODY WASH (U.S. CLS. 1, 4, 6, 50, 51 AND 52).

FIRST USE 4-14-2004; IN COMMERCE 4-14-2004.

CLASS 3—(Continued).

2,956,146. PRIMARY INVESTMENTS GROUP LIMITED, ROAD TOWN, TORTOLA, BR. VIRGIN ISLANDS. SN 78-363,104. FILED P.R. 2-5-2004; AM. S.R. 3-14-2005.

CLASS 3—(Continued).

2,956,248. SOURCE DIRECT, INC., IDAHO FALLS, ID. SN 78-407,410. FILED P.R. 4-23-2004; AM. S.R. 2-10-2005.

ANTI-WRINKLE INFUSION

THE MARK CONSISTS OF STANDARD CHARACTERS WITHOUT CLAIM TO ANY PARTICULAR FONT, STYLE, SIZE, OR COLOR.

FOR TOPICAL SKIN CREAM FOR COSMETIC PURPOSES (U.S. CLS. 1, 4, 6, 50, 51 AND 52).
FIRST USE 2-0-2004; IN COMMERCE 2-0-2004.

STAIN PEN

THE MARK CONSISTS OF STANDARD CHARACTERS WITHOUT CLAIM TO ANY PARTICULAR FONT, STYLE, SIZE, OR COLOR.

FOR GENERAL PURPOSE STAIN REMOVER (U.S. CLS. 1, 4, 6, 50, 51 AND 52).
FIRST USE 1-0-2003; IN COMMERCE 1-0-2003.

2,956,195. COLGATE-PALMOLIVE COMPANY, NEW YORK, NY. SN 78-374,786. FILED P.R. 2-26-2004; AM. S.R. 3-15-2005.

2,956,320. LAURA GELLER MAKE-UP STUDIOS, LTD., NEW YORK, NY. SN 78-439,272. FILED P.R. 6-22-2004; AM. S.R. 2-10-2005.

WILD FREESIA

THE MARK CONSISTS OF STANDARD CHARACTERS WITHOUT CLAIM TO ANY PARTICULAR FONT, STYLE, SIZE, OR COLOR.

FOR PERSONAL CARE PRODUCTS, NAMELY, DEODORANTS AND ANTIPERSPIRANTS (U.S. CLS. 1, 4, 6, 50, 51 AND 52).
FIRST USE 6-20-2000; IN COMMERCE 6-20-2000.

BIG APPLE BEAUTY

THE MARK CONSISTS OF STANDARD CHARACTERS WITHOUT CLAIM TO ANY PARTICULAR FONT, STYLE, SIZE, OR COLOR.

FOR COSMETICS, NAMELY, MAKE-UP KIT CONSISTING OF FOUNDATION STICKS, BLUSH STICK, BRONZER STICK, MAKE-UP APPLICATOR BRUSH AND MASCARA, SOLD AS A UNIT (U.S. CLS. 1, 4, 6, 50, 51 AND 52).
FIRST USE 7-11-2004; IN COMMERCE 7-11-2004.

CLASS 3—(Continued).

2,956,343. GOLD, STEVEN H., PALM SPRINGS, CA. SN 78-456,325. FILED P.R. 7-25-2004; AM. S.R. 3-3-2005.

ScentGels

THE MARK CONSISTS OF STANDARD CHARACTERS WITHOUT CLAIM TO ANY PARTICULAR FONT, STYLE, SIZE, OR COLOR.

FOR BODY GELS, NAMELY, FRAGRANCE OIL PREPARATIONS FOR PERSONAL USE (U.S. CLS. 1, 4, 6, 50, 51 AND 52).

FIRST USE 3-16-2004; IN COMMERCE 3-16-2004.

2,956,347. ORANGE GLO INTERNATIONAL, INC., GREENWOOD VILLAGE, CO. SN 78-461,413. FILED P.R. 8-3-2004; AM. S.R. 3-22-2005.

GRAPEFRUIT ZEST

THE MARK CONSISTS OF STANDARD CHARACTERS WITHOUT CLAIM TO ANY PARTICULAR FONT, STYLE, SIZE, OR COLOR.

FOR ALL PURPOSE CLEANING AND DEGREASING PREPARATIONS (U.S. CLS. 1, 4, 6, 50, 51 AND 52).

FIRST USE 4-12-2004; IN COMMERCE 4-12-2004.

2,956,366. BAHASH, TIMOTHY J., PHILADELPHIA, PA. SN 78-975,927. FILED P.R. 7-28-2003; AM. S.R. 2-4-2005.

4MULA

FOR BATH PRODUCTS, NAMELY, SOAPS, LOTIONS, SKIN CLEANSERS, FACIAL CLEANSERS AND ESSENTIAL OILS FOR PERSONAL USE (U.S. CLS. 1, 4, 6, 50, 51 AND 52).

FIRST USE 7-28-2003; IN COMMERCE 4-4-2004.

CLASS 4—LUBRICANTS AND FUELS

CLASS 4—(Continued).

2,956,264. WICKS N MORE INC., MANTACHIE, MS. SN 78-414,941. FILED P.R. 5-7-2004; AM. S.R. 1-26-2005.

Candle Decor

THE MARK CONSISTS OF STANDARD CHARACTERS WITHOUT CLAIM TO ANY PARTICULAR FONT, STYLE, SIZE, OR COLOR.

NO CLAIM IS MADE TO THE EXCLUSIVE RIGHT TO USE CANDLE, APART FROM THE MARK AS SHOWN.

FOR MULTI-COLORED FRAGRANCED PILLAR CANDLES (U.S. CLS. 1, 6 AND 15).

FIRST USE 2-2-2003; IN COMMERCE 2-2-2003.

CLASS 5—PHARMACEUTICALS

2,955,858. OMS INVESTMENTS, INC., LOS ANGELES, CA. SN 76-568,154. FILED P.R. 12-22-2003; AM. S.R. 12-22-2004.



THE COLOR(S) SILVER, BLACK AND WHITE IS/ARE CLAIMED AS A FEATURE OF THE MARK.

THE MARK CONSISTS OF THE SHAPE AND COLOR OF A SILVER BOTTLE WITH A BLACK CAP AND BLACK AND WHITE SPRAY GUN.

FOR HERBICIDES FOR DOMESTIC USE (U.S. CLS. 6, 18, 44, 46, 51 AND 52).

FIRST USE 12-15-2003; IN COMMERCE 12-15-2003.

CLASS 5—(Continued).

2,955,859. GLOBAL HEALTH TRAX, INC., VISTA, CA. SN 76-568,651. FILED P.R. 12-22-2003; AM. S.R. 2-1-2005.

OXYGEN ELEMENTS

THE MARK CONSISTS OF STANDARD CHARACTERS WITHOUT CLAIM TO ANY PARTICULAR FONT, STYLE, SIZE, OR COLOR.

FOR DIETARY SUPPLEMENTS EXCLUDING SKIN CARE PREPARATIONS AND ACNE PREPARATIONS (U.S. CLS. 6, 18, 44, 46, 51 AND 52).
FIRST USE 6-0-2003; IN COMMERCE 6-0-2003.

2,955,949. BIOSYNTRX, INC., LEXINGTON, SC. SN 78-221,645. FILED P.R. 3-4-2003; AM. S.R. 7-9-2004.

MACULA COMPLETE

NO CLAIM IS MADE TO THE EXCLUSIVE RIGHT TO USE "MACULA", APART FROM THE MARK AS SHOWN.

FOR VITAMINS AND NUTRACEUTICALS TO BE USED AS A DIETARY SUPPLEMENT TO ENHANCE MACULAR AND OVERALL HEALTH (U.S. CLS. 6, 18, 44, 46, 51 AND 52).

FIRST USE 10-1-2002; IN COMMERCE 10-1-2002.

2,956,121. NATURE'S HEALTH SUPPLY, INC., SANTA BARBARA, CA. SN 78-357,094. FILED P.R. 1-24-2004; AM. S.R. 8-31-2004.

**Cholesterol
Metabolizer**

THE MARK CONSISTS OF STANDARD CHARACTERS WITHOUT CLAIM TO ANY PARTICULAR FONT, STYLE, SIZE, OR COLOR.

NO CLAIM IS MADE TO THE EXCLUSIVE RIGHT TO USE "CHOLESTEROL", APART FROM THE MARK AS SHOWN.

FOR DIETARY SUPPLEMENT FOR USE IN TREATING CHOLESTEROL (U.S. CLS. 6, 18, 44, 46, 51 AND 52).
FIRST USE 8-0-2004; IN COMMERCE 8-0-2004.

CLASS 5—(Continued).

2,956,127. GAIA HERBS, INC., BREVARD, NC. SN 78-358,787. FILED P.R. 1-28-2004; AM. S.R. 2-9-2005.

ADRENAL HEALTH

THE MARK CONSISTS OF STANDARD CHARACTERS WITHOUT CLAIM TO ANY PARTICULAR FONT, STYLE, SIZE, OR COLOR.

FOR HERBAL, NUTRITIONAL AND DIETARY SUPPLEMENTS (U.S. CLS. 6, 18, 44, 46, 51 AND 52).
FIRST USE 2-1-2005; IN COMMERCE 2-1-2005.

2,956,128. GAIA HERBS, INC., BREVARD, NC. SN 78-358,789. FILED P.R. 1-28-2004; AM. S.R. 2-9-2005.

LACTATE SUPPORT

THE MARK CONSISTS OF STANDARD CHARACTERS WITHOUT CLAIM TO ANY PARTICULAR FONT, STYLE, SIZE, OR COLOR.

FOR HERBAL, NUTRITIONAL AND DIETARY SUPPLEMENTS (U.S. CLS. 6, 18, 44, 46, 51 AND 52).
FIRST USE 3-1-2004; IN COMMERCE 3-1-2004.

2,956,129. GAIA HERBS, INC., BREVARD, NC. SN 78-358,793. FILED P.R. 1-28-2004; AM. S.R. 2-9-2005.

GLYCEMIC HEALTH

THE MARK CONSISTS OF STANDARD CHARACTERS WITHOUT CLAIM TO ANY PARTICULAR FONT, STYLE, SIZE, OR COLOR.

FOR HERBAL, NUTRITIONAL AND DIETARY SUPPLEMENTS (U.S. CLS. 6, 18, 44, 46, 51 AND 52).
FIRST USE 2-1-2005; IN COMMERCE 2-1-2005.

CLASS 5—(Continued).

2,956,187. MYDAILYDOSE INC., SAIPAN, N. MARIANA ISLAND. SN 78-372,551. FILED P.R. 2-23-2004; AM. S.R. 1-11-2005.

MYDAILYDOSE

THE MARK CONSISTS OF STANDARD CHARACTERS WITHOUT CLAIM TO ANY PARTICULAR FONT, STYLE, SIZE, OR COLOR.

FOR DIETARY SUPPLEMENT (U.S. CLS. 6, 18, 44, 46, 51 AND 52).

FIRST USE 4-1-2001; IN COMMERCE 4-1-2001.

CLASS 5—(Continued).

2,956,249. XTREME INTERNET INC, DENVER, CO. SN 78-408,310. FILED P.R. 4-26-2004; AM. S.R. 2-7-2005.

SAVE ON SUPPLEMENTS

THE MARK CONSISTS OF STANDARD CHARACTERS WITHOUT CLAIM TO ANY PARTICULAR FONT, STYLE, SIZE, OR COLOR.

FOR MINERAL AND NUTRITIONAL SUPPLEMENTS FOR SPORTS AND VITAMINS FOR SALE IN RETAIL STORES (U.S. CLS. 6, 18, 44, 46, 51 AND 52).

FIRST USE 12-1-1999; IN COMMERCE 1-1-2000.

2,956,261. AGION TECHNOLOGIES, INC., WAKEFIELD, MA. SN 78-413,277. FILED P.R. 5-5-2004; AM. S.R. 2-9-2005.

Clene Seal

2,956,207. MEEKS, JOSEPH A., CORONA, CA. AND MEEKS, MARY GROSSMAN, CORONA, CA. SN 78-380,553. FILED P.R. 3-8-2004; AM. S.R. 1-31-2005.

KENNEL KLEAN

THE MARK CONSISTS OF STANDARD CHARACTERS WITHOUT CLAIM TO ANY PARTICULAR FONT, STYLE, SIZE, OR COLOR.

NO CLAIM IS MADE TO THE EXCLUSIVE RIGHT TO USE "CLEAN", APART FROM THE MARK AS SHOWN.

FOR ALL-PURPOSE DISINFECTANT, ALL-PURPOSE DEODORIZERS AND FUNGICIDES FOR COMMERCIAL AND DOMESTIC USE, ALL FOR USE IN KENNEL AREAS, PET GROOMING FACILITIES, DOG AND CAT BEDS (U.S. CLS. 6, 18, 44, 46, 51 AND 52).

FIRST USE 2-1-1999; IN COMMERCE 2-1-1999.

THE MARK CONSISTS OF STANDARD CHARACTERS WITHOUT CLAIM TO ANY PARTICULAR FONT, STYLE, SIZE, OR COLOR.

NO CLAIM IS MADE TO THE EXCLUSIVE RIGHT TO USE "SEAL", APART FROM THE MARK AS SHOWN.

FOR ANTIMICROBIAL COATINGS TO PREVENT THE GROWTH OF MOLD, MILDEW, BACTERIA AND FUNGUS ON VARIOUS SURFACES (U.S. CLS. 6, 18, 44, 46, 51 AND 52).

FIRST USE 3-25-2004; IN COMMERCE 3-25-2004.

CLASS 5—(Continued).

2,956,262. AGION TECHNOLOGIES, INC., WAKEFIELD, MA. SN 78-413,286. FILED P.R. 5-5-2004; AM. S.R. 2-9-2005.

Clene Wax

THE MARK CONSISTS OF STANDARD CHARACTERS WITHOUT CLAIM TO ANY PARTICULAR FONT, STYLE, SIZE, OR COLOR.

NO CLAIM IS MADE TO THE EXCLUSIVE RIGHT TO USE "WAX", APART FROM THE MARK AS SHOWN.

FOR ANTIMICROBIAL COATINGS FOR INDUSTRIAL, COMMERCIAL AND RESIDENTIAL BUILDINGS TO PREVENT THE GROWTH OF MOLD, MILDEW, BACTERIA AND FUNGUS ON VARIOUS SURFACES (U.S. CLS. 6, 18, 44, 46, 51 AND 52).

FIRST USE 3-25-2004; IN COMMERCE 3-25-2004.

2,956,276. PH SCIENCES, INC., SEATTLE, WA. SN 78-420,048. FILED P.R. 5-17-2004; AM. S.R. 1-13-2005.

PH BALANCE

THE MARK CONSISTS OF STANDARD CHARACTERS WITHOUT CLAIM TO ANY PARTICULAR FONT, STYLE, SIZE, OR COLOR.

NO CLAIM IS MADE TO THE EXCLUSIVE RIGHT TO USE "PH", APART FROM THE MARK AS SHOWN.

FOR PHARMACEUTICALS, NAMELY, DIETARY FOOD SUPPLEMENTS (U.S. CLS. 6, 18, 44, 46, 51 AND 52).

FIRST USE 1-23-2004; IN COMMERCE 1-23-2004.

CLASS 5—(Continued).

2,956,362. LIPPMAN, RICHARD D., HONOLULU, HI. SN 78-481,039. FILED P.R. 9-9-2004; AM. S.R. 2-15-2005.

Digestif

THE MARK CONSISTS OF STANDARD CHARACTERS WITHOUT CLAIM TO ANY PARTICULAR FONT, STYLE, SIZE, OR COLOR.

FOR FOOD SUPPLEMENT (U.S. CLS. 6, 18, 44, 46, 51 AND 52).

FIRST USE 8-28-2004; IN COMMERCE 8-28-2004.

CLASS 6—METAL GOODS

2,955,899. PEWAG AUSTRIA GMBH, GRAZ, AUSTRIA. SN 76-976,869. FILED P.R. 5-27-2003; AM. S.R. 5-24-2004.

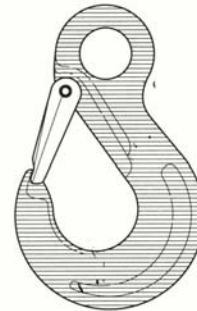

THE COLOR(S) BLUE IS/ARE CLAIMED AS A FEATURE OF THE MARK.

THE MARK IS LINED FOR THE COLOR BLUE, NAMELY PANTONE 299.

THE MARK CONSISTS OF THE COLOR BLUE AS APPLIED TO THE ENTIRETY OF THE GOODS. THE DOTTED OUTLINE OF THE GOODS IS INTENDED TO SHOW THE POSITION OF THE MARK AND IS NOT A PART OF THE MARK. THE MARK IS LINED FOR THE COLOR BLUE, NAMELY PANTONE 299.

FOR METAL GOODS, NAMELY HOOKS, SHORTENING HOOKS, GRAB HOOKS, EYHOOKS AND PARALLEL HOOKS (U.S. CLS. 2, 12, 13, 14, 23, 25 AND 50).

FIRST USE 1-3-1990; IN COMMERCE 1-3-1997.

CLASS 6—(Continued).

2,955,951. AUTOSAFE INTERNATIONAL LIMITED, PENTWORTH, WEST SUSSEX, UNITED KINGDOM. SN 78-224,776. FILED P.R. 3-12-2003; AM. S.R. 2-17-2004.

AUTOSAFE

FOR METAL SAFE LOCK BOXES FOR VALUABLE ITEMS (U.S. CLS. 2, 12, 13, 14, 23, 25 AND 50).
FIRST USE 4-0-2000; IN COMMERCE 4-0-2000.

2,956,045. PREMIER CUSTOM DESIGN, INC., OAKVILLE, ONTARIO, CANADA. SN 78-316,525. FILED P.R. 10-21-2003; AM. S.R. 1-24-2005.

THE NO SAG

PRIORITY CLAIMED UNDER SEC. 44(D) ON CANADA APPLICATION NO. 1175304, FILED 5-1-2003.
FOR METAL BRACKETS FOR CONSTRUCTING, ASSEMBLING AND SUPPORTING GATES AS A MEANS FOR ENTRANCE AND EXIT IN FENCING (U.S. CLS. 2, 12, 13, 14, 23, 25 AND 50).
FIRST USE 1-31-1997; IN COMMERCE 3-31-1997.

CLASS 7—MACHINERY

2,955,820. WEINGARTNER MASCHINENBAU GESELLSCHAFT M.B.H., A-4656 KIRCHHAM 29, AUSTRIA. SN 76-481,272. FILED P.R. 1-9-2003; AM. S.R. 8-23-2004.

**MULTI PRODUCT
MACHINING CENTER**

NO CLAIM IS MADE TO THE EXCLUSIVE RIGHT TO USE "MACHINING CENTER", APART FROM THE MARK AS SHOWN.

FOR MILLING MACHINES; BORING MACHINES; DRILLING MACHINES AND PARTS THEREFOR; LATHES; AND MACHINES AND MACHINE TOOLS FOR CUTTING, GRINDING, FINISHING, AND FORMING OF MATERIALS (U.S. CLS. 13, 19, 21, 23, 31, 34 AND 35).
FIRST USE 1-20-2003; IN COMMERCE 7-1-2004.

CLASS 7—(Continued).

2,955,856. VULCAN ENGINEERING COMPANY, HELENA, AL. SN 76-565,238. FILED P.R. 12-15-2003; AM. S.R. 2-28-2005.

FOXALL

FOR AUTOMATED CASTING AND FINISHING MACHINE FOR FOUNDRY USE (U.S. CLS. 13, 19, 21, 23, 31, 34 AND 35).
FIRST USE 6-23-2003; IN COMMERCE 6-23-2003.

2,955,931. RIVERDALE COLOR MANUFACTURING, INC., PERTH AMBOY, NJ. SN 78-181,666. FILED P.R. 11-5-2002; AM. S.R. 12-28-2004.

PUMP-IN-A-DRUM

FOR MACHINES, NAMELY APPARATUS FOR DELIVERING CONTROLLED AMOUNTS OF LIQUID COLOR FOR MIXING WITH PLASTIC RESIN MATERIALS PRIOR TO MOLDING, EXTRUSION OR OTHER PROCESSING (U.S. CLS. 13, 19, 21, 23, 31, 34 AND 35).
FIRST USE 4-30-2002; IN COMMERCE 4-30-2002.

2,956,009. CREDO TECHNOLOGY CORPORATION, BROADVIEW, IL. SN 78-283,470. FILED P.R. 8-5-2003; AM. S.R. 11-23-2004.

**LITHIUM-ION
CORLESS**

THE STIPPLING IS FOR SHADING PURPOSES ONLY.
FOR POWER-OPERATED ROTARY TOOLS, NAMELY, HAND-MANIPULABLE, ROTATING CHUCK TYPE FOR GRINDING, DRILLING, ROUTING, POLISHING, ENGRAVING, SANDING, SAWING, MARKING, DEBURRING, CARVING, SHARPENING, SHAPING, AND CUTTING; HAND-MANIPULABLE RECIPROCATING SANDERS, POLISHERS, AND ENGRAVERS; HAND-MANIPULABLE AND MOUNTED JIG SAWS, SANDERS, GRINDERS, AND BUFFERS; HAND-MANIPULABLE SCROLL SAWS; AND, ACCESSORIES FOR THE FOREGOING, NAMELY, SANDPAPER, POLISHING PADS, DRILLS, SAW BLADES, BRUSHES, CARVING CUTTERS, ROUTING CUTTERS, COLLETS, EMERY WHEELS, DRESSING STONES, POLISHING WHEELS, CUT-OFF WHEELS, BUFFING WHEELS, GRINDING WHEELS, WIRE WHEELS, ENGRAVING POINTS AND MANDRELS (U.S. CLS. 13, 19, 21, 23, 31, 34 AND 35).
FIRST USE 7-30-2003; IN COMMERCE 7-30-2003.

CLASS 7—(Continued).

2,956,130. KODAK POLYCHROME GRAPHICS LLC, NORWALK, CT. SN 78-358,860. FILED P.R. 1-28-2004; AM. S.R. 2-28-2005.

THERMALDIRECT

THE MARK CONSISTS OF STANDARD CHARACTERS WITHOUT CLAIM TO ANY PARTICULAR FONT, STYLE, SIZE, OR COLOR.

FOR PRINTING PLATES (U.S. CLS. 13, 19, 21, 23, 31, 34 AND 35).

FIRST USE 1-31-2004; IN COMMERCE 4-30-2004.

CLASS 7—(Continued).

2,956,245. ASHLAND CROSSING, INC., REDMOND, WA. SN 78-403,682. FILED P.R. 4-18-2004; AM. S.R. 2-22-2005.

StemGrip

THE MARK CONSISTS OF STANDARD CHARACTERS WITHOUT CLAIM TO ANY PARTICULAR FONT, STYLE, SIZE, OR COLOR.

FOR DISHWASHER ACCESSORY FOR SECURING DISHES AND GLASSES ON THE RACK OF A DISHWASHER (U.S. CLS. 13, 19, 21, 23, 31, 34 AND 35).

FIRST USE 12-0-2003; IN COMMERCE 4-0-2004.

2,956,253. TOP INNOVATIONS, INC., RIVERSIDE, MO. SN 78-410,507. FILED P.R. 4-29-2004; AM. S.R. 3-10-2005.

**KILLS GERMS WHERE
BRUSHES CAN'T
REACH**

THE MARK CONSISTS OF STANDARD CHARACTERS WITHOUT CLAIM TO ANY PARTICULAR FONT, STYLE, SIZE, OR COLOR.

FOR MULTI-PURPOSE STEAM CLEANERS (U.S. CLS. 13, 19, 21, 23, 31, 34 AND 35).

FIRST USE 8-1-2004; IN COMMERCE 8-1-2004.

2,956,188. MCGUIRE TOOLS, LLC, COLUMBIA, MD. SN 78-372,635. FILED P.R. 2-23-2004; AM. S.R. 3-7-2005.

MCGUIRE TOOLS

THE MARK CONSISTS OF STANDARD CHARACTERS WITHOUT CLAIM TO ANY PARTICULAR FONT, STYLE, SIZE, OR COLOR.

NO CLAIM IS MADE TO THE EXCLUSIVE RIGHT TO USE "TOOLS", APART FROM THE MARK AS SHOWN.

FOR ELECTRICAL HAND TOOLS NAMELY PLIERS, SCREWDRIVERS, WRENCHES (U.S. CLS. 13, 19, 21, 23, 31, 34 AND 35).

FIRST USE 8-1-2003; IN COMMERCE 8-1-2003.

CLASS 8—HAND TOOLS

2,956,031. MAG CLIP CORPORATION, NAPLES, FL. SN 78-301,970. FILED P.R. 9-18-2003; AM. S.R. 1-10-2005.

SOCKET CADDY

FOR MAGNETIC WRENCH SOCKET AND TOOL HOLDER (U.S. CLS. 23, 28 AND 44).

FIRST USE 8-19-2003; IN COMMERCE 8-19-2003.

CLASS 8—(Continued).

2,956,185. IDEAVILLAGE PRODUCTS CORP., FAIRFIELD, NJ. SN 78-371,672. FILED P.R. 2-20-2004; AM. S.R. 2-28-2005.

CLASS 8—(Continued).

2,956,345. RODGERS, WM. GAYLE, MADRAS, OR. SN 78-457,312. FILED 7-27-2004.

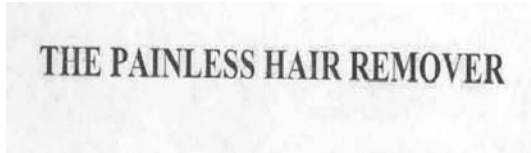

Big Game Tool Company

THE MARK CONSISTS OF STANDARD CHARACTERS WITHOUT CLAIM TO ANY PARTICULAR FONT, STYLE, SIZE, OR COLOR.

FOR APPLIANCES FOR BEAUTY CARE PURPOSES, NAMELY ELECTRIC SHAVERS, HAIR TRIMMERS AND DEPILATORY APPLIANCES (U.S. CLS. 23, 28 AND 44). FIRST USE 5-0-2004; IN COMMERCE 5-0-2004.

THE MARK CONSISTS OF STANDARD CHARACTERS WITHOUT CLAIM TO ANY PARTICULAR FONT, STYLE, SIZE, OR COLOR.

NO CLAIM IS MADE TO THE EXCLUSIVE RIGHT TO USE TOOL COMPANY, APART FROM THE MARK AS SHOWN.

FOR HAND TOOL FOR ANIMAL FIELD DRESSING (U.S. CLS. 23, 28 AND 44). FIRST USE 4-30-2004; IN COMMERCE 4-30-2004.

2,956,312. MISTY MATE, INC., GILBERT, AZ. SN 78-436,488. FILED P.R. 6-16-2004; AM. S.R. 2-2-2005.

CLASS 9—ELECTRICAL AND SCIENTIFIC APPARATUS

2,955,812. UNIVERSAL UNDERWRITERS INSURANCE COMPANY, OVERLAND PARK, KS. SN 76-374,943. FILED P.R. 2-26-2002; AM. S.R. 1-17-2005.

VSC RATECALC

FOR COMPUTER SOFTWARE, NAMELY, A CALCULATOR PROGRAM FOR USE ON PERSONAL COMPUTERS TO CALCULATE AND QUOTE RATES FOR VEHICLE SERVICE CONTRACTS (U.S. CLS. 21, 23, 26, 36 AND 38).

FIRST USE 2-28-2002; IN COMMERCE 2-28-2002.

FLORAMIST

2,955,814. UVIEW ULTRAVIOLET SYSTEMS, INC., MISSISSAUGA, ONTARIO L4Y 1M5, CANADA. SN 76-438,649. FILED P.R. 8-8-2002; AM. S.R. 9-7-2004.

SMART GAUGE

THE MARK CONSISTS OF STANDARD CHARACTERS WITHOUT CLAIM TO ANY PARTICULAR FONT, STYLE, SIZE, OR COLOR.

FOR HAND-OPERATED MISTING SPRAYERS FOR PLANTS AND FLOWERS (U.S. CLS. 23, 28 AND 44). FIRST USE 6-14-2004; IN COMMERCE 6-14-2004.

NO CLAIM IS MADE TO THE EXCLUSIVE RIGHT TO USE GAUGE, APART FROM THE MARK AS SHOWN.

FOR SCIENTIFIC APPARATUS, NAMELY, A DIAGNOSTIC TOOL USED FOR IDENTIFYING AIR CONDITIONING SYSTEM PROBLEMS (U.S. CLS. 21, 23, 26, 36 AND 38).

FIRST USE 12-12-2002; IN COMMERCE 12-12-2002.

CLASS 9—(Continued).

2,955,832. INNOTEK, INC., GARRETT, IN. SN 76-524,075. FILED P.R. 6-12-2003; AM. S.R. 2-7-2005.

ZONES

FOR ELECTRICAL AREA AVOIDANCE AND TRAINING SYSTEM FOR PETS, CONSISTING OF AT LEAST ONE WIRELESS TRANSMITTER AND A RECEIVER COLLAR, SOLD AS A UNIT (U.S. CLS. 21, 23, 26, 36 AND 38).

FIRST USE 12-0-2003; IN COMMERCE 12-0-2003.

2,955,855. ALL COMPONENTS, INC., FARMERS BRANCH, TX. SN 76-564,191. FILED P.R. 12-9-2003; AM. S.R. 1-12-2005.

PREMIUM PERFORMANCE MEMORY UPGRADE

THE MARK CONSISTS OF STANDARD CHARACTERS WITHOUT CLAIM TO ANY PARTICULAR FONT, STYLE, SIZE, OR COLOR.

NO CLAIM IS MADE TO THE EXCLUSIVE RIGHT TO USE "MEMORY UPGRADE", APART FROM THE MARK AS SHOWN.

FOR COMPUTER HARDWARE, NAMELY COMPUTER MEMORIES AND COMPUTER MEMORY MODULES, COMPUTER MEMORY CARDS, MODULES AND CHIPS, FLASH MEMORY CARDS, DIGITAL MEMORY DEVICES, AND USB FLASH MEMORY DEVICES (U.S. CLS. 21, 23, 26, 36 AND 38).

FIRST USE 12-20-2003; IN COMMERCE 12-20-2003.

2,955,863. SONY KABUSHIKI KAISHA, TA SONY CORPORATION, SHINAGAWA-KU, TOKYO, JAPAN. SN 76-572,132. FILED P.R. 1-21-2004; AM. S.R. 3-16-2005.

WIDE DIRECTIONAL CONVEX SPEAKERS

THE MARK CONSISTS OF STANDARD CHARACTERS WITHOUT CLAIM TO ANY PARTICULAR FONT, STYLE, SIZE, OR COLOR.

NO CLAIM IS MADE TO THE EXCLUSIVE RIGHT TO USE "CONVEX SPEAKERS", APART FROM THE MARK AS SHOWN.

FOR AUDIO TAPE PLAYERS AND/OR RECORDERS; AUDIO DISC PLAYERS AND/OR RECORDERS; RADIO TUNERS; AUDIO RECEIVERS; AUDIO AMPLIFIERS; AUDIO SPEAKERS (U.S. CLS. 21, 23, 26, 36 AND 38).

FIRST USE 4-30-2004; IN COMMERCE 4-30-2004.

CLASS 9—(Continued).

2,955,900. MAGALLAN, PHILLIP, DALLAS, TX. SN 76-977,005. FILED P.R. 8-27-2001; AM. S.R. 2-15-2005.

DJ COOL ROC

NO CLAIM IS MADE TO THE EXCLUSIVE RIGHT TO USE "DJ", APART FROM THE MARK AS SHOWN.

FOR PRERECORDED AUDIO AND VIDEO, NAMELY AUDIO TAPES, AUDIO DISCS, AUDIO CASSETTES, AUDIO DIGITAL TAPES, AUDIO RECORDINGS, VIDEO CASSETTES, VIDEO TAPES AND VIDEO DISCS, FEATURING MUSIC BY A RAP OR HIP-HOP MUSICAL GROUP OR ARTIST (U.S. CLS. 21, 23, 26, 36 AND 38).

FIRST USE 7-26-2004; IN COMMERCE 7-26-2004.

2,955,914. UNIVERSAL CONTROL SOLUTIONS CORP., SYLMAR, CA. SN 78-126,374. FILED P.R. 5-5-2002; AM. S.R. 7-20-2004.

FLEX CONTROL NETWORK

NO CLAIM IS MADE TO THE EXCLUSIVE RIGHT TO USE "NETWORK", APART FROM THE MARK AS SHOWN.

FOR ELECTRONIC CONTROL DEVICES NAMELY, ELECTROMECHANICAL CURSORS FOR USE IN INDUSTRIAL CONTROL, VIDEO GRAPHIC CONTROL, AND AUDIO CONTROL, USING ETHERNET TECHNOLOGY (U.S. CLS. 21, 23, 26, 36 AND 38).

FIRST USE 4-0-2002; IN COMMERCE 10-29-2003.

2,955,919. XENON LIGHT GMBH, GRAZ, AUSTRIA. SN 78-143,960. FILED P.R. 7-15-2002; AM. S.R. 5-14-2003.

xenonLIGHT

PRIORITY CLAIMED UNDER SEC. 44(D) ON ERPNTY TM OFC APPLICATION NO. 2543841, FILED 1-21-2002, REG. NO. 2543841, DATED 5-7-2003, EXPIRES 1-21-2012.

NO CLAIM IS MADE TO THE EXCLUSIVE RIGHT TO USE "XENON LIGHT", APART FROM THE MARK AS SHOWN.

THE MARK CONSISTS OF THE STYLIZED WORDING XENONLIGHT IN COLOR. THE WORD XENON IS IN BLUE AND LIGHT IS IN GRAY.

FOR ELECTRIC LIGHTING FIXTURES (U.S. CLS. 21, 23, 26, 36 AND 38).

FIRST USE 12-31-2000; IN COMMERCE 5-29-2001.

CLASS 9—(Continued).

2,955,920. NANOPTO CORPORATION, SOMMERSET, NJ. SN 78-144,406. FILED P.R. 7-16-2002; AM. S.R. 4-14-2003.

SUBWAVE

FOR OPTICS AND OPTICAL COMMUNICATIONS PRODUCTS, NAMELY, TRANSMITTERS, RECEIVERS, SWITCHES, ROUTERS, LASERS FOR OPTICAL TRANSMISSION OF DATA, DETECTORS, FIBER OPTICS, LIGHT EMITTING DIODES, OPTICAL ISOLATORS, OPTICAL CIRCULATORS, TUNABLE CHROMATIC DISPERSION COMPENSATORS, POLARIZERS, WAVEPLATES, MULTIPLEXERS, DEMULTIPLEXERS, AND OPTICAL FILTERS; LIGHTWAVE DATA LINKS, NAMELY OPTICAL RECEIVERS, OPTICAL TRANSMITTERS, OPTICAL CABLES AND SWITCHES, INTEGRATED CIRCUITS; COMPUTER PROGRAMS FOR MANAGING OPTICAL COMMUNICATIONS; ELECTRONIC CIRCUITS FOR CONTROLLING OPTICAL COMMUNICATION PRODUCTS AND LIGHTWAVE DATA LINKS (U.S. CLS. 21, 23, 26, 36 AND 38).

FIRST USE 6-0-2002; IN COMMERCE 6-0-2002.

2,955,925. ESI CASES & ACCESSORIES, INC., BROOKLYN, NY. SN 78-166,222. FILED P.R. 9-20-2002; AM. S.R. 1-20-2005.

WIRELESS GEAR

NO CLAIM IS MADE TO THE EXCLUSIVE RIGHT TO USE WIRELESS, APART FROM THE MARK AS SHOWN.

FOR WIRELESS CELLULAR TELEPHONE ACCESSORIES CONSISTING OF CAR CHARGERS, AC ADAPTORS/TRAVEL CHARGERS, RAPID CHARGERS, HANDS-FREE KITS COMPRISED OF AN EARPHONE-TYPE SPEAKER, A MICROPHONE AND A JACK TO PLUG INTO THE PHONE; AND CRADLE UNITS THAT PLUG INTO A CAR CIGARETTE LIGHTER, BATTERIES, AND REPLACEMENT PARTS FOR PAGERS, NAMELY CIRCUIT BOARDS AND HOUSINGS; WIRELESS TELEPHONE ACCESSORIES CONSISTING OF LEATHER CASES, VINYL CASES, PLASTIC CASES, AND REPLACEMENT HOUSINGS FOR CELLULAR TELEPHONES, AND PAGER ACCESSORIES CONSISTING OF REPLACEMENT HOUSINGS FOR PAGERS (U.S. CLS. 21, 23, 26, 36 AND 38).

FIRST USE 11-10-2002; IN COMMERCE 11-10-2002.

2,955,930. CHILI SYSTEMS, INC., NORWALK, CT. SN 78-180,194. FILED P.R. 10-30-2002; AM. S.R. 8-27-2004.

NETWORK TOOLBOX

FOR COMPUTER HARDWARE AND SOFTWARE USED TO PROVIDE LANS (LOCAL AREA NETWORKS) INTERNET BASED SERVICES, NAMELY, FIREWALLS, PROXY, REMOTE BACKUP, INSTANT MESSAGING AND REMOTE MONITORING (U.S. CLS. 21, 23, 26, 36 AND 38).

FIRST USE 8-10-2002; IN COMMERCE 8-15-2002.

CLASS 9—(Continued).

2,955,932. SONIC SOLUTIONS, NOVATO, CA. SN 78-181,711. FILED P.R. 11-5-2002; AM. S.R. 8-18-2004.

DVD PRODUCER

FOR COMPUTER SOFTWARE FOR CREATING, EDITING, AUTHORIZING, FORMATTING OR PRODUCING AUDIO, VIDEO AND MULTIMEDIA PRODUCTION FILES AND APPLICATIONS, AND ACCOMPANYING USER MANUALS, SOLD AS A UNIT (U.S. CLS. 21, 23, 26, 36 AND 38).

FIRST USE 5-0-1997; IN COMMERCE 5-0-1997.

2,955,953. SENTILLION, INC., ANDOVER, MA. SN 78-227,008. FILED P.R. 3-18-2003; AM. S.R. 11-1-2004.

SIGNON MANAGER

FOR COMPUTER SOFTWARE FOR COORDINATING AND MANAGING CONTEXT INFORMATION TO ENABLE USERS TO ACCESS MULTIPLE APPLICATIONS, NAMELY, ALL DATA RELATED TO PATIENT/CLIENT HISTORIES, DIAGNOSES, PHYSICIAN ORDERS AND ADMINISTRATIVE ISSUES (U.S. CLS. 21, 23, 26, 36 AND 38).

FIRST USE 10-8-2002; IN COMMERCE 10-8-2002.

2,955,954. IRON GRIP BARBELL COMPANY, INC., SANTA ANA, CA. SN 78-227,134. FILED P.R. 3-18-2003; AM. S.R. 2-28-2005.

EWEIGHT PLANNER

FOR COMPUTER PROGRAM TO BE USED TO CALCULATE THE NUMBER OF PLATES AND/OR BARS NECESSARY FOR PROPER FACILITY UTILIZATION OF COMMERCIAL EXERCISE AND TRAINING EQUIPMENT (U.S. CLS. 21, 23, 26, 36 AND 38).

FIRST USE 2-26-2003; IN COMMERCE 2-26-2003.

2,955,960. AVANEX CORPORATION, FREMONT, CA. SN 78-234,785. FILED P.R. 4-7-2003; AM. S.R. 1-10-2005.

POWEREQUALIZER

FOR TELECOMMUNICATIONS AND DATA NETWORKING HARDWARE, NAMELY OPTICAL HARDWARE USED FOR FIBER OPTIC TRANSMISSION (U.S. CLS. 21, 23, 26, 36 AND 38).

FIRST USE 9-13-2002; IN COMMERCE 9-13-2002.

CLASS 9—(Continued).

2,955,981. OEM SYSTEMS COMPANY, INC., SPARKS, NV. SN 78-266,068. FILED P.R. 6-23-2003; AM. S.R. 1-8-2005.

VAPOR DOME

FOR ROUGH-IN BOXES FOR LOUDSPEAKERS (U.S. CLS. 21, 23, 26, 36 AND 38).

FIRST USE 11-12-2003; IN COMMERCE 11-12-2003.

2,955,989. FILESTREAM, INC., OLD BROOKVILLE, NY. SN 78-272,669. FILED P.R. 7-10-2003; AM. S.R. 10-18-2004.

PIXEL STUDIO

FOR COMPUTER PROGRAMS FOR CREATING, REPRODUCING, EDITING AND MANIPULATING GRAPHIC IMAGES, PHOTOGRAPHS, ANIMATION, AND TEXT, AND MANUALS FOR USE THEREWITH, SOLD AS A UNIT OR AS PART OF A SYSTEM (U.S. CLS. 21, 23, 26, 36 AND 38).

FIRST USE 7-9-2003; IN COMMERCE 7-9-2003.

2,955,995. ALLY CORPORATION, CHESAPEAKE, VA. SN 78-276,771. FILED P.R. 7-21-2003; AM. S.R. 2-3-2005.

LTC MANAGER

FOR COMPUTER SOFTWARE FOR USE IN DATABASE MANAGEMENT OF INFORMATION OF LONG TERM CARE BUSINESSES INCLUDING, BUT NOT LIMITED TO, CONTINUING CARE RETIREMENT COMMUNITIES, ASSISTED LIVING FACILITIES, RESIDENTIAL CARE BUSINESSES, REST HOMES, AND NURSING HOMES (U.S. CLS. 21, 23, 26, 36 AND 38).

FIRST USE 8-4-2003; IN COMMERCE 8-4-2003.

2,956,006. KARSYAN, MICHAEL, TAGANROG, RUSSIAN FED. AND SHELUDKO, IGOR, TAGANROG, RUSSIAN FED.. SN 78-282,001. FILED P.R. 8-1-2003; AM. S.R. 2-13-2005.

HIDE FOLDERS

NO CLAIM IS MADE TO THE EXCLUSIVE RIGHT TO USE "FOLDERS", APART FROM THE MARK AS SHOWN.

FOR COMPUTER SOFTWARE FOR PREVENTING UNAUTHORIZED USERS FROM ACCESSING THE COMPUTER DATA, FILES AND FOLDERS LOCATED ON STORAGE DEVICES (U.S. CLS. 21, 23, 26, 36 AND 38).

FIRST USE 3-6-2001; IN COMMERCE 3-6-2001.

CLASS 9—(Continued).

2,956,016. HON HAI PRECISION INDUSTRY CO., LTD., TUCHENG CITY, TAIWAN. SN 78-287,519. FILED P.R. 8-14-2003; AM. S.R. 2-1-2005.

EVMI SYSTEM

NO CLAIM IS MADE TO THE EXCLUSIVE RIGHT TO USE SYSTEM, APART FROM THE MARK AS SHOWN.

FOR WAREHOUSE STORAGE SERVICES FOR CAPACITORS, RESISTORS, INDUCTORS, MEMORY UNITS, HARD DISC DRIVES, CD-ROM DISCS, FLOPPY DRIVE DISCS AND PACKAGING MATERIAL THEREFORE; DISPATCHING SERVICES FOR CAPACITORS, RESISTORS, INDUCTORS, MEMORY UNITS, HARD DISC DRIVES, CD-ROM DISCS, FLOPPY DRIVE DISCS AND PACKAGING MATERIALS THEREFORE (U.S. CLS. 21, 23, 26, 36 AND 38).

FIRST USE 5-3-2003; IN COMMERCE 5-3-2003.

2,956,018. ZOOM EYEWORKS, INC., BERKELEY, CA. SN 78-288,494. FILED P.R. 8-18-2003; AM. S.R. 1-24-2005.

TITANIUM SERIES

FOR READING GLASSES AND ACCESSORIES, NAMELY, CASES, CHAINS, AND LEASHES (U.S. CLS. 21, 23, 26, 36 AND 38).

FIRST USE 7-1-2003; IN COMMERCE 1-1-2004.

2,956,024. RGA TECHNOLOGY PARTNERS, INC., CHESTERFIELD, MO. SN 78-293,618. FILED P.R. 8-28-2003; AM. S.R. 9-20-2004.

AUTOMATED UNDERWRITING & RISK ANALYSIS

FOR COMPUTER SOFTWARE FOR ASSESSING INSURABILITY CHARACTERISTICS OF APPLICANTS AND ISSUING POLICIES, IN THE FIELD OF LIFE INSURANCE (U.S. CLS. 21, 23, 26, 36 AND 38).

FIRST USE 11-0-2000; IN COMMERCE 11-0-2000.

2,956,027. BLUE TITAN SOFTWARE, SAN FRANCISCO, CA. SN 78-296,867. FILED P.R. 9-5-2003; AM. S.R. 2-7-2005.

SOA FABRIC

FOR ENTERPRISE COMPUTER SOFTWARE FOR USE IN OPTIMIZING AND SECURING COMPUTER NETWORKS (U.S. CLS. 21, 23, 26, 36 AND 38).

FIRST USE 2-7-2005; IN COMMERCE 2-7-2005.

CLASS 9—(Continued).

2,956,037. THE COLEMAN COMPANY, INC., WICHITA, KS. SN 78-309,735. FILED P.R. 10-6-2003; AM. S.R. 2-8-2005.

DYNAMIC AIR FLOW

FOR ELECTRONIC TRAPS FOR ATTRACTING AND KILLING INSECTS (U.S. CLS. 21, 23, 26, 36 AND 38).
FIRST USE 4-16-2004; IN COMMERCE 4-16-2004.

2,956,042. SMITH, CHAR, K. LA MESA, CA. SN 78-314,765. FILED P.R. 10-16-2003; AM. S.R. 11-1-2004.

BLACK BOOT CD

NO CLAIM IS MADE TO THE EXCLUSIVE RIGHT TO USE "CD", APART FROM THE MARK AS SHOWN.
FOR COMPUTER SOFTWARE FOR BOOT PURPOSES (U.S. CLS. 21, 23, 26, 36 AND 38).
FIRST USE 12-0-1992; IN COMMERCE 12-0-1992.

2,956,044. TAMARA TECHNOLOGIES, INC., OCOEE, FL. SN 78-315,427. FILED P.R. 10-17-2003; AM. S.R. 1-26-2005.

FLYTETyme

FOR COMPUTER SOFTWARE BASED LOGBOOK FOR PILOTS; TRACKS FLYING TIME, RECENT EXPERIENCE OF INSTRUMENT APPROACHES AND LANDINGS, AND EXPIRATION OF MEDICAL EXAMS AND INSTRUCTOR CERTIFICATES (U.S. CLS. 21, 23, 26, 36 AND 38).
FIRST USE 9-1-2000; IN COMMERCE 9-1-2000.

2,956,065. HENION, JAMES, DBA COOPERATIVE LEARNING SOLUTIONS, ITHACA, NY. SN 78-329,661. FILED P.R. 11-18-2003; AM. S.R. 12-27-2004.

**Agri-
Marketing/Live**

THE MARK CONSISTS OF STANDARD CHARACTERS WITHOUT CLAIM TO ANY PARTICULAR FONT, STYLE, SIZE, OR COLOR.

FOR PRE-RECORDED CD'S AND DVD'S FEATURING TRAINING MATERIALS IN FIELD OF MARKETING OF AGRICULTURAL PRODUCTS (U.S. CLS. 21, 23, 26, 36 AND 38).
FIRST USE 1-1-2003; IN COMMERCE 1-1-2003.

CLASS 9—(Continued).

2,956,080. DIRECT SOURCE SPECIAL PRODUCTS INC., LASALLE, QUEBEC, CANADA. SN 78-339,687. FILED P.R. 12-11-2003; AM. S.R. 2-1-2005.

DANCE MIX

THE MARK CONSISTS OF STANDARD CHARACTERS WITHOUT CLAIM TO ANY PARTICULAR FONT, STYLE, SIZE, OR COLOR.

FOR VIDEO RECORDINGS AND SOUND RECORDINGS FEATURING MUSIC (U.S. CLS. 21, 23, 26, 36 AND 38).
FIRST USE 12-12-1995; IN COMMERCE 10-20-2003.

2,956,086. COGENTWORKS, LLC, DENVER, CO. SN 78-342,412. FILED P.R. 12-17-2003; AM. S.R. 1-14-2005.

Digital Memoirs

THE MARK CONSISTS OF STANDARD CHARACTERS WITHOUT CLAIM TO ANY PARTICULAR FONT, STYLE, SIZE, OR COLOR.

FOR PRE-RECORDED CDS, VIDEO TAPES, LASER DISKS AND DVDS FEATURING INDIVIDUAL, PERSONAL, ORAL HISTORIES, NAMELY, DOCUMENTARIES ABOUT INDIVIDUALS (U.S. CLS. 21, 23, 26, 36 AND 38).
FIRST USE 6-16-2003; IN COMMERCE 9-15-2003.

CLASS 9—(Continued).

2,956,091. LINCOLN GLOBAL, INC., MONTEREY PARK, CA. SN 78-345,907. FILED P.R. 12-29-2003; AM. S.R. 1-31-2005.

CLASS 9—(Continued).

WITHOUT CLAIM TO ANY PARTICULAR FONT, STYLE, SIZE, OR COLOR.

FOR ELECTROCHEMICAL REMOVEABLE FUEL CELL FOR USE IN POWER TOOLS AND RELATED APPLIANCES (U.S. CLS. 21, 23, 26, 36 AND 38).
FIRST USE 9-17-2002; IN COMMERCE 9-17-2002.

E-CELL

THE MARK CONSISTS OF STANDARD CHARACTERS WITHOUT CLAIM TO ANY PARTICULAR FONT, STYLE, SIZE, OR COLOR.

FOR ROBOTIC CELL INCORPORATING ELECTRIC ARC WELDING (U.S. CLS. 21, 23, 26, 36 AND 38).
FIRST USE 11-30-2004; IN COMMERCE 11-30-2004.

MEMOCVD

THE MARK CONSISTS OF STANDARD CHARACTERS WITHOUT CLAIM TO ANY PARTICULAR FONT, STYLE, SIZE, OR COLOR.

FOR SEMICONDUCTORS, SEMICONDUCTOR WAFERS, LIGHT EMITTING DIODES, ELECTRICAL CONDUCTORS, ELECTRICAL CONTROLLERS, ELECTRICAL CIRCUIT BOARDS, ELECTRICAL CIRCUITS FOR USE IN RADIO FREQUENCY APPLICATIONS, ELECTRONIC AND COMMUNICATIONS INSTRUMENTS AND COMPONENTS, NAMELY, RADIO TRANSMITTERS, RECEIVERS, DATA LINKS, TRANSCEIVERS, AND COMMUNICATION LINK TESTERS; WAFERS MADE FROM ONE OR A COMBINATION OF NITRIDES, ALUMINUM, GALLIUM (U.S. CLS. 21, 23, 26, 36 AND 38).

FIRST USE 6-1-2002; IN COMMERCE 6-1-2002.

2,956,100. SOWELU ENTERTAINMENT, LTD., SANTA MONICA, CA. SN 78-348,789. FILED P.R. 1-7-2004; AM. S.R. 1-26-2005.

MYTHSTORY MUSIC

THE MARK CONSISTS OF STANDARD CHARACTERS WITHOUT CLAIM TO ANY PARTICULAR FONT, STYLE, SIZE, OR COLOR.

NO CLAIM IS MADE TO THE EXCLUSIVE RIGHT TO USE MUSIC, APART FROM THE MARK AS SHOWN.

FOR PRERECORDED AUDIO COMPACT DISCS FEATURING MUSIC AND STORIES (U.S. CLS. 21, 23, 26, 36 AND 38).

FIRST USE 5-6-2002; IN COMMERCE 5-6-2002.

2,956,107. PRO-IRODA USA, INC., CHAGRIN FALLS, OH. SN 78-351,203. FILED P.R. 1-13-2004; AM. S.R. 1-31-2005.

LIQUID ENERGY CELL

THE MARK CONSISTS OF STANDARD CHARACTERS

CLASS 9—(Continued).

2,956,122. ROTHSCHILD, SHIMON, KARNEY SHOMRON, ISRAEL. SN 78-357,274. FILED P.R. 1-26-2004; AM. S.R. 3-8-2005.

CLASS 9—(Continued).

2,956,143. RED WING SHOE COMPANY, INC., RED WING, MN. SN 78-362,599. FILED P.R. 2-4-2004; AM. S.R. 3-3-2005.

**Great Budget
Software**

RIMS

THE MARK CONSISTS OF STANDARD CHARACTERS WITHOUT CLAIM TO ANY PARTICULAR FONT, STYLE, SIZE, OR COLOR.

NO CLAIM IS MADE TO THE EXCLUSIVE RIGHT TO USE SOFTWARE, APART FROM THE MARK AS SHOWN. FOR SOFTWARE FOR BUDGETING AND PROJECT MANAGEMENT (U.S. CLS. 21, 23, 26, 36 AND 38). FIRST USE 12-17-2001; IN COMMERCE 12-17-2001.

THE MARK CONSISTS OF STANDARD CHARACTERS WITHOUT CLAIM TO ANY PARTICULAR FONT, STYLE, SIZE, OR COLOR.

FOR COMPUTER SOFTWARE PROGRAM FOR PROVIDING A RETAIL INFORMATION MANAGEMENT SYSTEM FOR RETAIL FOOTWEAR STORES (U.S. CLS. 21, 23, 26, 36 AND 38). FIRST USE 3-7-2002; IN COMMERCE 3-7-2002.

2,956,139. IMPACT SOFTWARE SOLUTIONS, INC., ATLANTA, GA. SN 78-361,933. FILED P.R. 2-3-2004; AM. S.R. 2-2-2005.

2,956,150. COMARCO WIRELESS TECHNOLOGIES, INC., IRVINE, CA. SN 78-364,165. FILED P.R. 2-6-2004; AM. S.R. 2-15-2005.

ITOOOLS

SMARTTIP

THE MARK CONSISTS OF STANDARD CHARACTERS WITHOUT CLAIM TO ANY PARTICULAR FONT, STYLE, SIZE, OR COLOR.

FOR COMPUTER SOFTWARE, NAMELY TRANSPORTATION LOGISTICS SOFTWARE (U.S. CLS. 21, 23, 26, 36 AND 38). FIRST USE 6-1-2002; IN COMMERCE 6-1-2002.

THE MARK CONSISTS OF STANDARD CHARACTERS WITHOUT CLAIM TO ANY PARTICULAR FONT, STYLE, SIZE, OR COLOR.

FOR CONNECTOR ADAPTORS FOR USE WITH PROGRAMMABLE POWER SUPPLIES (U.S. CLS. 21, 23, 26, 36 AND 38). FIRST USE 9-0-1999; IN COMMERCE 9-0-1999.

CLASS 9—(Continued).

2,956,157. MIDKNIGHT CREATIONS, LLC, JACKSON, CA.
SN 78-366,164. FILED P.R. 2-11-2004; AM. S.R. 2-9-2005.

K9 OPTIX

THE MARK CONSISTS OF STANDARD CHARACTERS
WITHOUT CLAIM TO ANY PARTICULAR FONT, STYLE,
SIZE, OR COLOR.

FOR DOG SUNGLASSES, DOG SUN GOGGLES (U.S.
CLS. 21, 23, 26, 36 AND 38).

FIRST USE 10-15-2003; IN COMMERCE 10-15-2003.

CLASS 9—(Continued).

2,956,163. LE JACQ LTD., DARIEN, CT. SN 78-367,335. FILED
P.R. 2-12-2004; AM. S.R. 2-3-2005.

THE JOURNAL OF CLINICAL HYPERTENSION

THE MARK CONSISTS OF STANDARD CHARACTERS
WITHOUT CLAIM TO ANY PARTICULAR FONT, STYLE,
SIZE, OR COLOR.

NO CLAIM IS MADE TO THE EXCLUSIVE RIGHT TO
USE JOURNAL, APART FROM THE MARK AS SHOWN.

FOR DOWNLOADABLE ELECTRONIC PUBLICA-
TIONS IN THE NATURE OF ARTICLES ON THE
TREATMENT OF HYPERTENSION IN THE FIELD OF
CLINICAL HYPERTENSION (U.S. CLS. 21, 23, 26, 36
AND 38).

FIRST USE 4-0-2002; IN COMMERCE 4-0-2002.

2,956,162. BOSE CORPORATION, FRAMINGHAM, MA. SN
78-366,850. FILED P.R. 2-12-2004; AM. S.R. 3-17-2005.

CYLINDRICAL RADIATOR

THE MARK CONSISTS OF STANDARD CHARACTERS
WITHOUT CLAIM TO ANY PARTICULAR FONT, STYLE,
SIZE, OR COLOR.

FOR LOUDSPEAKER SYSTEMS (U.S. CLS. 21, 23, 26,
36 AND 38).

FIRST USE 10-15-2003; IN COMMERCE 10-15-2003.

2,956,169. BEST SOFTWARE, INC., IRVINE, CA. SN 78-
368,222. FILED P.R. 2-14-2004; AM. S.R. 2-21-2005.

CPAPRACTICE

THE MARK CONSISTS OF STANDARD CHARACTERS
WITHOUT CLAIM TO ANY PARTICULAR FONT, STYLE,
SIZE, OR COLOR.

FOR COMPUTER SOFTWARE FOR USE IN THE
INTEGRATION OF TIME AND OFFICE MANAGE-
MENT IN THE FIELD OF ACCOUNTING, FINANCIAL
MANAGEMENT AND DOCUMENT STORAGE COMPU-
TER SOFTWARE PROGRAMS (U.S. CLS. 21, 23, 26, 36
AND 38).

FIRST USE 7-14-2004; IN COMMERCE 7-14-2004.

CLASS 9—(Continued).

2,956,170. BEST SOFTWARE, INC., IRVINE, CA. SN 78-368,224. FILED P.R. 2-14-2004; AM. S.R. 2-21-2005.

CLASS 9—(Continued).

2,956,226. LANGUAGE ANALYSIS SYSTEMS, INC., HERN-DON, VA. SN 78-390,426. FILED P.R. 3-25-2004; AM. S.R. 2-2-2005.

CPADOCUMENT

NAMEPARSER

THE MARK CONSISTS OF STANDARD CHARACTERS WITHOUT CLAIM TO ANY PARTICULAR FONT, STYLE, SIZE, OR COLOR.

OWNER OF U.S. REG. NO. 2,699,001.
FOR COMPUTER SOFTWARE FOR INTEGRATED PRACTICE MANAGEMENT IN THE FIELD OF AC-COUNTING, FINANCIAL MANAGEMENT, AND DATA STORAGE COMPUTER SOFTWARE PROGRAMS (U.S. CLS. 21, 23, 26, 36 AND 38).
FIRST USE 7-14-2004; IN COMMERCE 7-14-2004.

THE MARK CONSISTS OF STANDARD CHARACTERS WITHOUT CLAIM TO ANY PARTICULAR FONT, STYLE, SIZE, OR COLOR.

OWNER OF U.S. REG. NOS. 2,454,259 AND 2,574,744.
FOR SOFTWARE FOR MANIPULATING PERSONAL NAME DATA (U.S. CLS. 21, 23, 26, 36 AND 38).
FIRST USE 2-20-2004; IN COMMERCE 2-20-2004.

2,956,171. BEST SOFTWARE, INC., IRVINE, CA. SN 78-368,225. FILED P.R. 2-14-2004; AM. S.R. 2-21-2005.

2,956,227. LANGUAGE ANALYSIS SYSTEMS, INC., HERN-DON, VA. SN 78-390,435. FILED P.R. 3-25-2004; AM. S.R. 2-14-2005.

CPAACOUNTING

NAMESTATS

THE MARK CONSISTS OF STANDARD CHARACTERS WITHOUT CLAIM TO ANY PARTICULAR FONT, STYLE, SIZE, OR COLOR.

OWNER OF U.S. REG. NO. 2,699,001.
FOR COMPUTER SOFTWARE FOR INTEGRATED PRACTICE MANAGEMENT IN THE FILED OF AC-COUNTING, FINANCIAL MANAGEMENT AND DOCU-MENT AND DATA STORAGE (U.S. CLS. 21, 23, 26, 36 AND 38).
FIRST USE 7-14-2004; IN COMMERCE 7-14-2004.

THE MARK CONSISTS OF STANDARD CHARACTERS WITHOUT CLAIM TO ANY PARTICULAR FONT, STYLE, SIZE, OR COLOR.

OWNER OF U.S. REG. NOS. 2,454,259 AND 2,574,744.
FOR SOFTWARE FOR MANIPULATING PERSONAL NAME DATA (U.S. CLS. 21, 23, 26, 36 AND 38).
FIRST USE 11-11-2004; IN COMMERCE 11-11-2004.

CLASS 9—(Continued).

2,956,229. VOXAS LLC, EVANSTON, IL. SN 78-390,842. FILED P.R. 3-25-2004; AM. S.R. 3-1-2005.

EARLYSOUNDS

THE MARK CONSISTS OF STANDARD CHARACTERS WITHOUT CLAIM TO ANY PARTICULAR FONT, STYLE, SIZE, OR COLOR.

FOR DIGITAL AUDIO RECORDER AND PLAYER FOR RECORDING AND PLAYING BACK BABY SOUNDS (U.S. CLS. 21, 23, 26, 36 AND 38).

FIRST USE 12-18-2004; IN COMMERCE 12-18-2004.

2,956,244. MORLAND, D. VERNE, KETTERING, OH. SN 78-403,167. FILED P.R. 4-16-2004; AM. S.R. 1-12-2005.

Digital Stationery

THE MARK CONSISTS OF STANDARD CHARACTERS WITHOUT CLAIM TO ANY PARTICULAR FONT, STYLE, SIZE, OR COLOR.

NO CLAIM IS MADE TO THE EXCLUSIVE RIGHT TO USE DIGITAL, APART FROM THE MARK AS SHOWN.

FOR COMPUTER SOFTWARE USED FOR PROCESSING DIGITIZED IMAGES AND GRAPHIC DESIGN ELEMENTS FOR USE AS PERSONAL, PROFESSIONAL, AND COMMERCIAL STATIONERY IN ELECTRONIC MAIL, SLIDE PRESENTATIONS, AND WEB SITE LAYOUT AND CONTENT (U.S. CLS. 21, 23, 26, 36 AND 38).

FIRST USE 4-12-2004; IN COMMERCE 4-12-2004.

CLASS 9—(Continued).

2,956,250. NEBRASKA DEPARTMENT OF REVENUE, LOTTERY DIVISION, LINCOLN, NE. SN 78-408,778. FILED P.R. 4-27-2004; AM. S.R. 2-3-2005.

CHECK A TICKET

THE MARK CONSISTS OF STANDARD CHARACTERS WITHOUT CLAIM TO ANY PARTICULAR FONT, STYLE, SIZE, OR COLOR.

FOR LOTTERY TICKET VALIDATION MACHINES (U.S. CLS. 21, 23, 26, 36 AND 38).

FIRST USE 5-4-1999; IN COMMERCE 5-4-1999.

2,956,252. MANAGESOFT CORPORATION PTY. LTD., BOX HILL, AUSTRALIA. SN 78-409,697. FILED P.R. 4-28-2004; AM. S.R. 1-10-2005.

**THE SOFTWARE
MANAGEMENT
COMPANY**

THE MARK CONSISTS OF STANDARD CHARACTERS WITHOUT CLAIM TO ANY PARTICULAR FONT, STYLE, SIZE, OR COLOR.

NO CLAIM IS MADE TO THE EXCLUSIVE RIGHT TO USE "COMPANY", APART FROM THE MARK AS SHOWN.

FOR COMPUTERS; COMPUTER HARDWARE; COMPUTER SOFTWARE TO AUTOMATE SOFTWARE AND DATA WAREHOUSING; COMPUTER SOFTWARE FOR ADMINISTRATION, DISTRIBUTION, INSTALLATION, DEPLOYMENT AND UPDATING OF SOFTWARE APPLICATIONS; COMPUTER SOFTWARE TO AUTOMATE THE ADMINISTRATION OF INFORMATION TECHNOLOGY ASSET INVENTORY, REPORTING, LICENSING, AND PERFORMANCE ANALYSIS; COMPUTER SOFTWARE TO AUTOMATE SOFTWARE APPLICATION MAINTENANCE AND INTEGRITY; PRERECORDED CD-ROMS AND INSTRUCTIONAL MANUALS THEREFOR, IN THE FIELD OF COMPUTER SOFTWARE; ELECTRONIC PUBLICATIONS, NAMELY, DOWNLOADABLE NEWSLETTERS IN THE FIELD OF COMPUTER SOFTWARE; APPARATUS, NAMELY, COMPUTER SOFTWARE APPLICATIONS THAT ENABLE CONNECTIONS TO DATABASES AND THE INTERNET; ELECTRONIC APPARATUS, NAMELY, COMPUTER SOFTWARE APPLICATIONS TO ENABLE SEARCHING OF DATA (U.S. CLS. 21, 23, 26, 36 AND 38).

FIRST USE 4-28-2004; IN COMMERCE 5-0-2004.

CLASS 9—(Continued).

2,956,268. TADAA TECHNOLOGIES, INC., NEW BALTIMORE, MI. SN 78-416,243. FILED P.R. 5-10-2004; AM. S.R. 2-24-2005.

CLASS 9—(Continued).

2,956,286. SUN, LIANCHAO, ACTON, MA. SN 78-423,564. FILED P.R. 5-24-2004; AM. S.R. 2-10-2005.

VideoTribute

THE MARK CONSISTS OF STANDARD CHARACTERS WITHOUT CLAIM TO ANY PARTICULAR FONT, STYLE, SIZE, OR COLOR.

FOR COMPUTER SOFTWARE, NAMELY, SOFTWARE FOR USE IN ENABLING IMAGE, AUDIO AND TEXT DATA TO BE WRITTEN ON MAGNETIC AND/OR OPTICAL STORAGE UNITS; ALLOWS STORED DATA TO BE VIEWED IN A VIDEO FORMAT WITH OR WITHOUT AUDIO AND TEXT, AND VIDEO AND/OR AUDIO CAN BE PLAYED FROM A COMPUTER, TELEVISION OR INTERNET VIEWING DEVICE; AND USER MANUALS ARE PROVIDED THEREWITH (U.S. CLS. 21, 23, 26, 36 AND 38).

FIRST USE 4-20-2004; IN COMMERCE 4-20-2004.

TFProbe

2,956,284. ROMAINE PIERSON PUBLISHERS, INC., JAMESBURG, NJ. SN 78-422,496. FILED P.R. 5-20-2004; AM. S.R. 3-3-2005.

PHARMACEUTICAL BUSINESS STRATEGIES

THE MARK CONSISTS OF STANDARD CHARACTERS WITHOUT CLAIM TO ANY PARTICULAR FONT, STYLE, SIZE, OR COLOR.

FOR PROVIDING DOWNLOADABLE ONLINE MAGAZINES, JOURNALS, NEWSLETTERS, FEATURE REPORTS, SUPPLEMENTS, AND WEB SITES THAT PROVIDE GENERAL INFORMATION AND BUSINESS ADVICE IN THE FIELDS OF PHARMACEUTICAL PRODUCTS, PRODUCTION, PLANNING, INVESTMENT, PROCESSING, MANUFACTURING, LOGISTICS, SUPPLY CHAIN SOLUTIONS, INFORMATION TECHNOLOGY, WHOLESALING, DISTRIBUTION, DELIVERY, VENDORS, SUPPLIERS, AND PACKAGING AND DELIVERY SYSTEMS (U.S. CLS. 21, 23, 26, 36 AND 38).

FIRST USE 4-23-2004; IN COMMERCE 4-23-2004.

THE MARK CONSISTS OF STANDARD CHARACTERS WITHOUT CLAIM TO ANY PARTICULAR FONT, STYLE, SIZE, OR COLOR.

FOR THIN FILM THICKNESS MEASUREMENT SYSTEM COMPRISED OF A SPECTROPHOTOMETER, MICROSPECTROPHOTOMETER, NANOSPECTROPHOTOMETER, SPECTROMETER, REFLECTOMETER, ELLIPSOMETER, SPECTROSCOPIC ELLIPSOMETER; MICROSCOPE, IMAGING SYSTEM, MONOCHROMATOR, AND SOFTWARE FOR DATA ACQUISITION, SIMULATION AND REGRESSION PROVIDED THEREWITH; STRESS MEASUREMENT SYSTEM COMPRISED OF LASER BEAMS, MOTOR CONTROLLERS AND SOFTWARE FOR DATA ACQUISITION, SIMULATION AND REGRESSION PROVIDED THEREWITH (U.S. CLS. 21, 23, 26, 36 AND 38).

FIRST USE 3-0-2004; IN COMMERCE 5-1-2004.

CLASS 9—(Continued).

2,956,301. PROTOKRAFT, LLC, KINGSPORT, TN. SN 78-430,974. FILED P.R. 6-7-2004; AM. S.R. 1-25-2005.

CLASS 9—(Continued).

2,956,316. NEWSSTAND, INC., AUSTIN, TX. SN 78-438,314. FILED P.R. 6-21-2004; AM. S.R. 2-1-2005.

FACILITATING
SECURE
COMMUNICATIONS IN
HARSH
ENVIRONMENTS

IBROWSE

THE MARK CONSISTS OF STANDARD CHARACTERS WITHOUT CLAIM TO ANY PARTICULAR FONT, STYLE, SIZE, OR COLOR.

FOR HARSH-ENVIRONMENT ELECTRONIC COMMUNICATIONS PRODUCTS, NAMELY, OPTICAL FIBER OPTIC TRANSCEIVERS, FIBER OPTIC CABLES, JUNCTION BOXES AND CABLE CONNECTORS; FIBER OPTIC CHANNEL SWITCHES; FIBER OPTIC CHANNEL INTERFACES; AND OPTOELECTRIC LINE CARDS AND CIRCUITS; ALL FOR USE IN CONNECTION WITH MILITARY, AEROSPACE AND OTHER HARSH-ENVIRONMENT COMMUNICATIONS INDUSTRIES (U.S. CLS. 21, 23, 26, 36 AND 38).
FIRST USE 1-4-2005; IN COMMERCE 1-5-2005.

THE MARK CONSISTS OF STANDARD CHARACTERS WITHOUT CLAIM TO ANY PARTICULAR FONT, STYLE, SIZE, OR COLOR.

FOR COMPUTER APPLICATION SOFTWARE FOR DISPLAYING ELECTRONIC VERSIONS OF THE PRINT VERSION FORMAT OF MAGAZINES AND NEWSPAPERS (U.S. CLS. 21, 23, 26, 36 AND 38).
FIRST USE 7-26-2004; IN COMMERCE 7-26-2004.

2,956,307. NAGHI, DAVID, BEVERLY HILLS, CA. SN 78-434,228. FILED P.R. 6-11-2004; AM. S.R. 3-3-2005.

2,956,332. CALDWELL COMMUNICATIONS, INC., TROY, MI. SN 78-447,118. FILED P.R. 7-7-2004; AM. S.R. 3-1-2005.

DataSense

ROAD & TRAVEL

THE MARK CONSISTS OF STANDARD CHARACTERS WITHOUT CLAIM TO ANY PARTICULAR FONT, STYLE, SIZE, OR COLOR.

FOR UNIVERSAL USB EXTENSION CABLE (U.S. CLS. 21, 23, 26, 36 AND 38).
FIRST USE 8-0-2003; IN COMMERCE 8-0-2003.

THE MARK CONSISTS OF STANDARD CHARACTERS WITHOUT CLAIM TO ANY PARTICULAR FONT, STYLE, SIZE, OR COLOR.

FOR DOWNLOADABLE ELECTRONIC PUBLICATIONS, NAMELY, MAGAZINES FEATURING NEWS AND SPECIAL INTEREST INFORMATION REGARDING NAMELY BUSINESS, AUTOMOTIVE, SAFETY AND VACATION DESTINATIONS (U.S. CLS. 21, 23, 26, 36 AND 38).
FIRST USE 8-31-2002; IN COMMERCE 8-31-2002.

CLASS 9—(Continued).

2,956,339. EBERLE DESIGN, INC., PHOENIX, AZ. SN 78-451,562. FILED P.R. 7-15-2004; AM. S.R. 2-23-2005.

SmartMonitor

THE MARK CONSISTS OF STANDARD CHARACTERS WITHOUT CLAIM TO ANY PARTICULAR FONT, STYLE, SIZE, OR COLOR.
FOR INTERSECTION MONITOR FOR VEHICULAR TRAFFIC CONTROL (U.S. CLS. 21, 23, 26, 36 AND 38).
FIRST USE 7-6-2004; IN COMMERCE 7-6-2004.

2,956,357. KIRLIN INDUSTRIES, INC., ONTARIO, CA. SN 78-472,176. FILED P.R. 8-23-2004; AM. S.R. 3-28-2005.

Kirlin

THE MARK CONSISTS OF STANDARD CHARACTERS WITHOUT CLAIM TO ANY PARTICULAR FONT, STYLE, SIZE, OR COLOR.
FOR ELECTRONIC GOODS, NAMELY, AUDIO/VIDEO PLUGS AND JACKS, AUDIO/VIDEO ADAPTERS, AND AUDIO/VIDEO CABLES (U.S. CLS. 21, 23, 26, 36 AND 38).
FIRST USE 5-1-2003; IN COMMERCE 6-1-2003.

CLASS 9—(Continued).

2,956,359. WINTERNALS SOFTWARE, L.P., AUSTIN, TX. SN 78-473,920. FILED P.R. 8-26-2004; AM. S.R. 3-30-2005.

DEFRAG MANAGER

THE MARK CONSISTS OF STANDARD CHARACTERS WITHOUT CLAIM TO ANY PARTICULAR FONT, STYLE, SIZE, OR COLOR.
FOR COMPUTER SOFTWARE FOR USE IN ANALYZING AND ARRANGING COMPUTER DATA (U.S. CLS. 21, 23, 26, 36 AND 38).
FIRST USE 7-15-2002; IN COMMERCE 7-15-2002.

CLASS 10—MEDICAL APPARATUS

2,955,805. KARL STORZ GMBH & CO. KG, D-78532 TUTTLINGEN, FED REP GERMANY. SN 76-185,258. FILED P.R. 12-22-2000; AM. S.R. 1-4-2005.

SMART SCOPE

OWNER OF FED REP GERMANY REG. NO. 30109713, DATED 12-4-2001, EXPIRES 2-28-2011.
FOR MEDICAL DEVICES, NAMELY, ENDOSCOPES AND ILLUMINATORS AND THEIR POWER SUPPLIES SOLD THEREWITH; CAMERAS, NAMELY, CCD CAMERAS, FOR USE IN ENDOSCOPIC PROCEDURES; DIGITAL IMAGE PROCESSORS AND IMAGE RECORDING AND REPRODUCTION APPARATUS FOR ENDOSCOPIC PROCEDURES; COMPUTER SOFTWARE SOLD WITH THE AFOREMENTIONED DEVICES FOR OPERATING ENDOSCOPIC OR SURGICAL EQUIPMENT AND FOR TRAINING, TEACHING AND INSTRUCTING PHYSICIANS ON USE OF ENDOSCOPIC APPARATUS IN MEDICAL PROCEDURES; ADAPTERS AND CABLES FOR CONNECTING THE AFOREMENTIONED APPARATUS AND INSTRUMENTS (U.S. CLS. 26, 39 AND 44).

2,955,963. LASERSCOPE, SAN JOSE, CA. SN 78-241,823. FILED P.R. 4-24-2003; AM. S.R. 2-11-2005.

GREENLIGHT PV

NO CLAIM IS MADE TO THE EXCLUSIVE RIGHT TO USE "PV", APART FROM THE MARK AS SHOWN.
FOR MEDICAL APPARATUS, NAMELY A SURGICAL LASER DEVICE FOR USE IN THE TREATMENT OF MEDICAL CONDITIONS (U.S. CLS. 26, 39 AND 44).
FIRST USE 4-0-2003; IN COMMERCE 4-0-2003.

CLASS 10—(Continued).

2,955,985. INTERACTIVE HEALTH, LLC, LONG BEACH, CA. SN 78-271,233. FILED P.R. 7-7-2003; AM. S.R. 1-31-2005.

OTTOMAN

FOR ROBOTIC CALF AND FOOT MASSAGER (U.S. CLS. 26, 39 AND 44).
FIRST USE 12-6-2002; IN COMMERCE 12-6-2002.

2,956,010. ULTRADENT PRODUCTS, INC., SOUTH JORDAN, UT. SN 78-284,441. FILED P.R. 8-7-2003; AM. S.R. 2-28-2005.

THE ONE WITH THE STRIPE

FOR DENTAL PRODUCTS, NAMELY DENTAL RE-TRACTION CORDS (U.S. CLS. 26, 39 AND 44).
FIRST USE 10-29-2003; IN COMMERCE 10-29-2003.

2,956,329. REPROCESSING PRODUCTS CORP (RPC), TUCSON, AZ. SN 78-443,596. FILED P.R. 6-30-2004; AM. S.R. 2-8-2005.

E-Z Grip

THE MARK CONSISTS OF STANDARD CHARACTERS WITHOUT CLAIM TO ANY PARTICULAR FONT, STYLE, SIZE, OR COLOR.
FOR PORT CAPS FOR CLOSING THE PORTS OF HEMODIALYZERS (U.S. CLS. 26, 39 AND 44).
FIRST USE 12-3-2003; IN COMMERCE 12-17-2004.

CLASS 11—ENVIRONMENTAL CONTROL APPARATUS**CLASS 11—(Continued).**

2,955,821. PANASONIC CORPORATION OF NORTH AMERICA, SECAUCUS, NJ. SN 76-484,440. FILED P.R. 1-21-2003; AM. S.R. 6-16-2004.



NO CLAIM IS MADE TO THE EXCLUSIVE RIGHT TO USE "HOME & OUTDOOR LIGHTING", APART FROM THE MARK AS SHOWN.
FOR FLASHLIGHTS (U.S. CLS. 13, 21, 23, 31 AND 34).
FIRST USE 10-1-2003; IN COMMERCE 10-1-2003.

2,955,833. THERMOSPAS, INC., WALLINGFORD, CT. SN 76-524,649. FILED P.R. 6-23-2003; AM. S.R. 3-1-2005.

THE HEALING SPA

NO CLAIM IS MADE TO THE EXCLUSIVE RIGHT TO USE "SPA", APART FROM THE MARK AS SHOWN.
FOR SPA HOT TUBS (U.S. CLS. 13, 21, 23, 31 AND 34).
FIRST USE 5-1-2003; IN COMMERCE 5-1-2003.

2,955,846. FISHER CONTROLS INTERNATIONAL LLC, ST. LOUIS, MO. SN 76-547,022. FILED P.R. 9-25-2003; AM. S.R. 1-10-2005.

BORE SEAL

NO CLAIM IS MADE TO THE EXCLUSIVE RIGHT TO USE "SEAL", APART FROM THE MARK AS SHOWN.
FOR VALVE TRIM FOR INDUSTRIAL PROCESS CONTROL PUMPS AND VALVES (U.S. CLS. 13, 21, 23, 31 AND 34).
FIRST USE 7-15-2003; IN COMMERCE 7-15-2003.

CLASS 11—(Continued).

2,955,857. VENT RITE VALVE CORPORATION, BENTON HARBOR, MI. SN 76-567,709. FILED P.R. 12-17-2003; AM. S.R. 3-7-2005.

SMITH'S ENVIRONMENTAL PRODUCTS

THE MARK CONSISTS OF STANDARD CHARACTERS WITHOUT CLAIM TO ANY PARTICULAR FONT, STYLE, SIZE, OR COLOR.

NO CLAIM IS MADE TO THE EXCLUSIVE RIGHT TO USE "ENVIRONMENTAL PRODUCTS", APART FROM THE MARK AS SHOWN.

FOR HEATING PRODUCTS, NAMELY FAN CONVECTORS, KICKSPACE HEATERS, HOT WATER BOOSTER COILS, AIR FILTRATION UNITS FOR HOT AIR HEATING SYSTEMS AND AIR HANDLING UNITS FOR HYDRONIC HEATING AND COOLING SYSTEMS (U.S. CLS. 13, 21, 23, 31 AND 34).

FIRST USE 9-24-2001; IN COMMERCE 12-0-2003.

2,955,908. CONAIR CORPORATION, STAMFORD, CT. SN 78-044,731. FILED P.R. 1-24-2001; AM. S.R. 12-18-2001.

ION SHINE

FOR HAIR DRYER (U.S. CLS. 13, 21, 23, 31 AND 34).
FIRST USE 4-1-2001; IN COMMERCE 4-1-2001.

2,955,922. RABBIT TANAKA CORPORATION LIMITED, SIU SAI WAN, HONG KONG. SN 78-165,006. FILED P.R. 9-17-2002; AM. S.R. 10-19-2004.

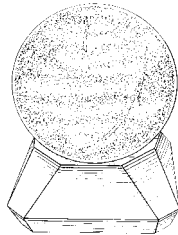

THE STIPPLING AND LINING IN THE DRAWING ARE FOR SHADING PURPOSES ONLY.

THE MARK CONSISTS OF A THREE-DIMENSIONAL CONFIGURATION OF A NOVELTY LAMP, WHICH CONSISTS OF A ROUND GLOBE AND A BASE. COLOR IS NOT A FEATURE OF THE MARK.

FOR NOVELTY LAMPS (U.S. CLS. 13, 21, 23, 31 AND 34).

FIRST USE 4-24-2001; IN COMMERCE 8-0-2001.

CLASS 11—(Continued).

2,955,927. MIRACLE SUN, INC., WESTLAKE VILLAGE, CA. SN 78-172,925. FILED P.R. 10-10-2002; AM. S.R. 1-27-2005.

360° HP

FOR TANNING EQUIPMENT, NAMELY, SUN TANNING BEDS WITH ULTRAVIOLET LAMPS; ELECTRIC LIGHT BULBS FOR TANNING SKIN USING ULTRAVIOLET LIGHT (U.S. CLS. 13, 21, 23, 31 AND 34).

FIRST USE 2-28-2003; IN COMMERCE 2-28-2003.

2,956,154. EUROSTOVES, INC., WESTLAKE VILLAGE, CA. SN 78-365,753. FILED P.R. 2-10-2004; AM. S.R. 3-4-2005.

EUROSTOVES

THE MARK CONSISTS OF STANDARD CHARACTERS WITHOUT CLAIM TO ANY PARTICULAR FONT, STYLE, SIZE, OR COLOR.

FOR LARGE DOMESTIC APPLIANCES, NAMELY, GAS STOVES, ELECTRIC STOVES, INDUCTION OVENS, GAS RANGES, ELECTRIC RANGES, REFRIGERATORS AND FREEZERS (U.S. CLS. 13, 21, 23, 31 AND 34).

FIRST USE 3-26-2004; IN COMMERCE 3-26-2004.

CLASS 11—(Continued).

2,956,155. EUROSTOVES, INC., WESTLAKE VILLAGE, CA. SN 78-365,761. FILED P.R. 2-10-2004; AM. S.R. 3-4-2005.



FOR LARGE DOMESTIC APPLIANCES, NAMELY, GAS STOVES, ELECTRIC STOVES, INDUCTION OVENS, GAS RANGES, ELECTRIC RANGES, REFRIGERATORS AND FREEZERS (U.S. CLS. 13, 21, 23, 31 AND 34).
FIRST USE 3-26-2004; IN COMMERCE 3-26-2004.

CLASS 12—VEHICLES

2,955,918. MDG MEDICAL, INC., ENGLEWOOD, NJ. SN 78-141,142. FILED P.R. 7-3-2002; AM. S.R. 2-23-2004.

SMART CART

FOR MEDICATION DISPENSING SYSTEM, NAMELY A MEDICATION STORAGE AND DISPENSING CABINET AND MOBILE CART COMPRISING COMPARTMENTS FOR STORING MEDICATION, A PROCESSOR AND DISPLAY FOR STORING AND DISPLAYING MEDICATION DOSAGES, AND A MEDICATION DELIVERY DEVICE (U.S. CLS. 19, 21, 23, 31, 35 AND 44).
FIRST USE 12-1-2001; IN COMMERCE 12-1-2001.

2,955,958. FERRARI S.P.A., MODENA, ITALY. SN 78-231,199. FILED P.R. 3-28-2003; AM. S.R. 1-24-2005.

Quattroporte

PRIORITY CLAIMED UNDER SEC. 44(D) ON ITALY APPLICATION NO. TO2003C00070, FILED 3-13-2003, REG. NO. 902864, DATED 8-4-2003, EXPIRES 3-13-2013.
THE ENGLISH TRANSLATION OF THE MARK IS FOUR DOOR.

FOR LAND MOTOR VEHICLES, NAMELY, AUTOMOBILES AND SPORTS CARS, STRUCTURAL PARTS AND ACCESSORIES THEREOF, NAMELY, ENGINES, TRANSMISSIONS, SUSPENSIONS, BRAKES, AND AUTOMOBILE BODY PANELS; MOTORBIKES, BICYCLES; BODY FRAMES FOR MOTORBIKES AND BICYCLES (U.S. CLS. 19, 21, 23, 31, 35 AND 44).

CLASS 12—(Continued).

2,955,961. CALIFORNIA MOTORS LLC, CAMARILLO, CA. SN 78-238,406. FILED P.R. 4-16-2003; AM. S.R. 8-6-2004.

CALIFORNIA MOTORS

NO CLAIM IS MADE TO THE EXCLUSIVE RIGHT TO USE "MOTORS", APART FROM THE MARK AS SHOWN.
FOR MANUFACTURED AUTOMOBILES AND STRUCTURAL PARTS THEREFOR (U.S. CLS. 19, 21, 23, 31, 35 AND 44).
FIRST USE 1-4-2003; IN COMMERCE 1-27-2003.

2,956,046. SDS ENTERPRISES, L.L.C., PIEDMONT, OK. SN 78-316,633. FILED P.R. 10-21-2003; AM. S.R. 11-4-2004.

THE COLLAR

FOR METAL LOCKING DEVICE FOR TRAILER HITCH COUPLERS (U.S. CLS. 19, 21, 23, 31, 35 AND 44).
FIRST USE 6-4-2002; IN COMMERCE 6-4-2002.

2,956,048. TOWMASTER, INC., LITCHFIELD, MN. SN 78-317,443. FILED P.R. 10-23-2003; AM. S.R. 1-13-2005.

AUTO-LATCH

FOR FLATBED UTILITY TRAILERS, AND RAMPS AND RAMP HOLD-UP MECHANISMS THEREFOR, SOLD AS A UNIT (U.S. CLS. 19, 21, 23, 31, 35 AND 44).
FIRST USE 10-0-2000; IN COMMERCE 10-0-2000.

2,956,068. BUGATTI INTERNATIONAL S.A., LUXEMBOURG, LUXEMBOURG. SN 78-333,646. FILED P.R. 11-26-2003; AM. S.R. 11-26-2003.

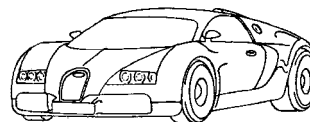

THE MARK CONSISTS OF THE CONFIGURATION OF AN AUTOMOBILE.
FOR AUTOMOBILES (U.S. CLS. 19, 21, 23, 31, 35 AND 44).
FIRST USE 1-31-2000; IN COMMERCE 1-31-2000.

CLASS 12—(Continued).

2,956,069. BUGATTI INTERNATIONAL S.A., LUXEMBOURG, LUXEMBOURG. SN 78-333,658. FILED 11-26-2003.

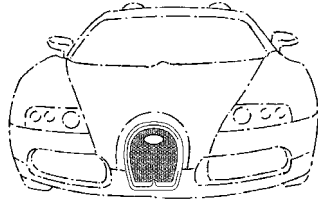

THE LINING SHOWN IN THE DRAWING IS A FEATURE OF THE MARK.

THE MARK CONSISTS OF THE CONFIGURATION OF THE GRILL OF AN AUTOMOBILE.

FOR AUTOMOBILES (U.S. CLS. 19, 21, 23, 31, 35 AND 44).

FIRST USE 1-31-2000; IN COMMERCE 1-31-2000.

2,956,254. TRACKER MARINE, L.L.C., SPRINGFIELD, MO. SN 78-410,557. FILED P.R. 4-29-2004; AM. S.R. 2-8-2005.

AMERICA'S FAVORITE BOATS

THE MARK CONSISTS OF STANDARD CHARACTERS WITHOUT CLAIM TO ANY PARTICULAR FONT, STYLE, SIZE, OR COLOR.

NO CLAIM IS MADE TO THE EXCLUSIVE RIGHT TO USE "BOATS", APART FROM THE MARK AS SHOWN.

FOR BOATS (U.S. CLS. 19, 21, 23, 31, 35 AND 44).

FIRST USE 5-1-2002; IN COMMERCE 5-1-2002.

CLASS 13—FIREARMS

2,955,823. CLAY CARTRIDGE COMPANY, LLC, CAMDEN, SC. SN 76-493,012. FILED P.R. 1-27-2003; AM. S.R. 9-30-2004.

CLAY CARTRIDGE COMPANY

NO CLAIM IS MADE TO THE EXCLUSIVE RIGHT TO USE "CARTRIDGE COMPANY", APART FROM THE MARK AS SHOWN.

FOR AMMUNITION FOR SHOTGUNS (U.S. CLS. 2 AND 9).

FIRST USE 4-1-2003; IN COMMERCE 4-1-2003.

CLASS 13—(Continued).

2,955,915. FIRST SAMCO INC., SOUTHAMPTON, PA. SN 78-127,542. FILED P.R. 5-9-2002; AM. S.R. 1-19-2005.

SAFE-T-STIX

FOR BRIGHTLY COLORED PLASTIC STICK THAT IS INSERTED IN AND PROTRUDES FROM THE BARREL OF A FIREARM INDICATING THE CHAMBER IS EMPTY (U.S. CLS. 2 AND 9).

FIRST USE 7-31-2002; IN COMMERCE 7-31-2002.

2,955,957. GRIZZLY CARTRIDGE CO., RAINIER, OR. SN 78-229,287. FILED P.R. 3-24-2003; AM. S.R. 3-29-2005.

GRIZZLY CARTRIDGE

NO CLAIM IS MADE TO THE EXCLUSIVE RIGHT TO USE CARTRIDGE, APART FROM THE MARK AS SHOWN.

FOR CARTRIDGES AND AMMUNITION, NAMELY METALLIC CARTRIDGE AMMUNITION FOR MULTIPLE USES, INCLUDING TARGET-SHOOTING AND HUNTING, SUCH AMMUNITION OF VARIOUS SIZES INCLUDING; 357-CALIBER AMMUNITION TO; 50-CALIBER AMMUNITION (U.S. CLS. 2 AND 9).

FIRST USE 4-1-2003; IN COMMERCE 4-1-2003.

CLASS 14—JEWELRY

2,956,208. MICHAEL C. FINA COMPANY, NEW YORK, NY. SN 78-381,421. FILED P.R. 3-10-2004; AM. S.R. 1-28-2005.

DORSET

THE MARK CONSISTS OF STANDARD CHARACTERS WITHOUT CLAIM TO ANY PARTICULAR FONT, STYLE, SIZE, OR COLOR.

FOR WATCHES (U.S. CLS. 2, 27, 28 AND 50).

FIRST USE 12-1-2004; IN COMMERCE 12-1-2004.

CLASS 14—(Continued).

2,956,267. TAN, HOWARD H. S., LAS VEGAS, NV. SN 78-416,225. FILED P.R. 5-10-2004; AM. S.R. 3-1-2005.

POKER CARD-GUARD

THE MARK CONSISTS OF STANDARD CHARACTERS WITHOUT CLAIM TO ANY PARTICULAR FONT, STYLE, SIZE, OR COLOR.

NO CLAIM IS MADE TO THE EXCLUSIVE RIGHT TO USE "POKER", APART FROM THE MARK AS SHOWN.

FOR COLLECTIBLE COIN THAT CAN ALSO BE USED TO PROTECT HAND CARDS WHILE PLAYING THE CARD GAME POKER (U.S. CLS. 2, 27, 28 AND 50).

FIRST USE 3-1-2004; IN COMMERCE 3-1-2004.

CLASS 15—MUSICAL INSTRUMENTS

2,955,962. PIANOVA GMBH, MULHEIM, FED REP GERMANY. SN 78-239,016. FILED P.R. 4-17-2003; AM. S.R. 2-2-2004.

FENNER

OWNER OF FED REP GERMANY REG. NO. 30031018, DATED 9-11-2000, EXPIRES 4-30-2010.

FOR MUSICAL INSTRUMENTS, PARTICULARLY PIANOS AND GRAND PIANOS AND THEIR ACCESSORIES, NAMELY KEYBOARDS, SOUNDING BOARDS WITH STRINGS AND PEGS, PIANO AND GRAND PIANO HOUSINGS WITH LEGS (U.S. CLS. 2, 21 AND 36).

2,956,087. GA MEINL MUSIKMARKETING GMBH, GERTSRIED, FED REP GERMANY. SN 78-344,608. FILED P.R. 12-23-2003; AM. S.R. 1-26-2005.

GEBR. SCHUSTER

THE MARK CONSISTS OF STANDARD CHARACTERS WITHOUT CLAIM TO ANY PARTICULAR FONT, STYLE, SIZE, OR COLOR.

PRIORITY CLAIMED UNDER SEC. 44(D) ON FED REP GERMANY APPLICATION NO. 30331471.0, FILED 6-26-2003, REG. NO. 30331471, DATED 9-29-2003, EXPIRES 6-30-2013.

FOR MUSICAL INSTRUMENTS; SPARE PARTS FOR MUSICAL INSTRUMENTS, NAMELY BOXES, CASES, BAGS AND COVERS (U.S. CLS. 2, 21 AND 36).

FIRST USE 3-29-2002; IN COMMERCE 3-29-2002.

CLASS 15—(Continued).

2,956,303. ASHER, WILLIAM, DBA GUITAR TRADITIONS, VENICE, CA. SN 78-433,160. FILED P.R. 6-10-2004; AM. S.R. 2-4-2005.

ELECTRO HAWAIIAN

THE MARK CONSISTS OF STANDARD CHARACTERS WITHOUT CLAIM TO ANY PARTICULAR FONT, STYLE, SIZE, OR COLOR.

NO CLAIM IS MADE TO THE EXCLUSIVE RIGHT TO USE "HAWAIIAN", APART FROM THE MARK AS SHOWN. FOR MUSICAL INSTRUMENTS, NAMELY GUITARS (U.S. CLS. 2, 21 AND 36).

FIRST USE 12-0-2002; IN COMMERCE 12-0-2002.

CLASS 16—PAPER GOODS AND PRINTED MATTER

2,955,847. AMERICA 001 MEDIA, LLC, NEW YORK, NY. SN 76-548,888. FILED P.R. 9-12-2003; AM. S.R. 9-15-2004.

AMERICA

FOR MAGAZINE IN THE FIELDS OF FASHION, MUSIC, LIFESTYLE, ENTERTAINMENT, HEALTH AND BEAUTY, TECHNOLOGY, ARTS, SPORTS AND CURRENT EVENTS (U.S. CLS. 2, 5, 22, 23, 29, 37, 38 AND 50).

FIRST USE 3-1-2004; IN COMMERCE 3-1-2004.

2,955,877. CHEER COACH & ADVISOR PUBLISHING CO., LLC, NORTH PALM BEACH, FL. SN 76-592,131. FILED P.R. 5-13-2004; AM. S.R. 2-15-2005.

Cheer
COACH & ADVISOR

FOR PUBLICATION, NAMELY MAGAZINE WHICH EQUIPS ALL LEVEL COACHES, ADVISORS AND DIRECTORS WITH THE LATEST IN CHEER TRAINING, PROBLEM SOLVING, COACHES CERTIFICATION, SAFETY GUIDELINES AND REFERENCE MATERIALS TO RUN AN EFFICIENT PROGRAM (U.S. CLS. 2, 5, 22, 23, 29, 37, 38 AND 50).

FIRST USE 5-28-2004; IN COMMERCE 8-20-2004.

CLASS 16—(Continued).

2,955,888. NATIONAL RAILROAD PASSENGER CORPORATION, WASHINGTON, DC. SN 76-596,875. FILED P.R. 6-10-2004; AM. S.R. 2-7-2005.

NEW YORK BY RAIL

FOR TRAVEL MAGAZINES (U.S. CLS. 2, 5, 22, 23, 29, 37, 38 AND 50).
FIRST USE 5-0-2004; IN COMMERCE 5-0-2004.

2,955,895. GRUNER + JAHR PRINTING & PUBLISHING CO., NEW YORK, NY. SN 76-603,588. FILED P.R. 7-22-2004; AM. S.R. 3-23-2005.

HOW I DID IT

THE MARK CONSISTS OF STANDARD CHARACTERS WITHOUT CLAIM TO ANY PARTICULAR FONT, STYLE, SIZE, OR COLOR.

FOR MAGAZINE COLUMN FEATURING PROFILES OF INNOVATORS (U.S. CLS. 2, 5, 22, 23, 29, 37, 38 AND 50).

FIRST USE 12-0-2003; IN COMMERCE 12-0-2003.

2,955,898. ALM PROPERTIES, INC., NEWARK, DE. SN 76-976,444. FILED P.R. 10-14-2003; AM. S.R. 9-13-2004.

GC MID-ATLANTIC

FOR LEGAL AND BUSINESS PUBLICATIONS, NAMELY, MAGAZINES, NEWSPAPERS AND NEWSLETTERS PERTAINING TO THE LEGAL AND BUSINESS FIELD (U.S. CLS. 2, 5, 22, 23, 29, 37, 38 AND 50).

FIRST USE 11-0-2003; IN COMMERCE 11-0-2003.

2,955,901. HUDSON, SUZAN J., HENDERSON, NV. SN 76-977,456. FILED P.R. 2-27-2003; AM. S.R. 3-3-2005.

HAVE A PEACEFUL HEART

FOR BUMPER STICKERS, DECALS, CALENDARS, POSTERS, NOTE BOOKS, GREETING CARDS, DAILY PLANNERS, PERSONAL ORGANIZERS, STATIONERY, NOTE PADS, DESIGNER BANK CHECKS, INK PENS, PENCILS, PENCIL AND PEN HOLDERS, PAPERWEIGHTS (U.S. CLS. 2, 5, 22, 23, 29, 37, 38 AND 50).
FIRST USE 9-12-2001; IN COMMERCE 9-12-2001.

CLASS 16—(Continued).

2,955,947. SPA FINDER, INC, NEW YORK, NY. SN 78-218,844. FILED P.R. 2-25-2003; AM. S.R. 2-8-2005.

SPA ENTHUSIAST

FOR NEWSLETTER DEALING WITH INFORMATION REGARDING SPAS AND HOTELS (U.S. CLS. 2, 5, 22, 23, 29, 37, 38 AND 50).
FIRST USE 3-20-2002; IN COMMERCE 3-20-2002.

2,955,964. INTERNATIONAL DATA GROUP, INC., FRAMINGHAM, MA. SN 78-243,324. FILED P.R. 4-29-2003; AM. S.R. 2-1-2005.

IT EXECUTIVE SUMMIT

NO CLAIM IS MADE TO THE EXCLUSIVE RIGHT TO USE "EXECUTIVE SUMMIT", APART FROM THE MARK AS SHOWN.

FOR ARRANGING AND CONDUCTING SEMINARS, CONFERENCES, SYMPOSIUMS, COLLOQUIUMS AND DISCUSSION GROUPS IN THE FIELDS OF COMPUTERS, COMPUTER SOFTWARE, HIGH TECHNOLOGY, INFORMATION TECHNOLOGY AND INFORMATION SERVICES (U.S. CLS. 2, 5, 22, 23, 29, 37, 38 AND 50).

FIRST USE 9-23-2003; IN COMMERCE 9-23-2003.

2,956,039. HESTERMAN, MICHAEL L., MORTON, IL. SN 78-312,756. FILED P.R. 10-13-2003; AM. S.R. 2-17-2005.

JESUS IS

FOR BUMPER STICKERS; BUSINESS CARDS; PRINTED INSTRUCTIONAL, EDUCATIONAL, AND TEACHING MATERIALS FOR CHRISTIAN WORSHIP AND STUDIES (U.S. CLS. 2, 5, 22, 23, 29, 37, 38 AND 50).
FIRST USE 9-30-2002; IN COMMERCE 9-30-2002.

CLASS 16—(Continued).

2,956,072. HEINRICH BAUER PUBLISHING, LP, ENGLEWOOD, NJ. SN 78-334,796. FILED P.R. 12-1-2003; AM. S.R. 3-21-2005.

SOAP OPERA PREVIEWS

THE MARK CONSISTS OF STANDARD CHARACTERS WITHOUT CLAIM TO ANY PARTICULAR FONT, STYLE, SIZE, OR COLOR.

FOR MAGAZINE PROVIDING INFORMATION CONCERNING TELEVISED AND OTHER BROADCAST SERIAL DRAMAS (U.S. CLS. 2, 5, 22, 23, 29, 37, 38 AND 50). FIRST USE 3-1-2004; IN COMMERCE 3-1-2004.

2,956,101. WARNER-LAMBERT COMPANY LLC, MORRIS PLAINS, NJ. SN 78-349,489. FILED P.R. 1-8-2004; AM. S.R. 1-31-2005.

THE HEARTBURN CHRONICLES

THE MARK CONSISTS OF STANDARD CHARACTERS WITHOUT CLAIM TO ANY PARTICULAR FONT, STYLE, SIZE, OR COLOR.

NO CLAIM IS MADE TO THE EXCLUSIVE RIGHT TO USE "CHRONICLES", APART FROM THE MARK AS SHOWN.

FOR NEWSLETTERS AND PERIODICALS REGARDING HEARTBURN INFORMATION AND MEDICATION (U.S. CLS. 2, 5, 22, 23, 29, 37, 38 AND 50). FIRST USE 3-14-2004; IN COMMERCE 3-14-2004.

CLASS 16—(Continued).

2,956,109. JOHNSON, TERRI LYNNE, CONCORD, CA. SN 78-353,103. FILED P.R. 1-16-2004; AM. S.R. 2-10-2005.

CRAFT GRASS

THE MARK CONSISTS OF STANDARD CHARACTERS WITHOUT CLAIM TO ANY PARTICULAR FONT, STYLE, SIZE, OR COLOR.

FOR NATURAL FIBER PAPER AND PAPER ACCESSORIES NAMELY, SCRAPBOOK PAGES, DECORATIVE PAPER EMBELLISHMENTS AND STICKERS FOR USE WITH SCRAPBOOKING AND MEMORY ALBUMS (U.S. CLS. 2, 5, 22, 23, 29, 37, 38 AND 50).

FIRST USE 9-1-2002; IN COMMERCE 9-1-2002.

2,956,113. SMITH, TERRY DON, POWAY, CA. SN 78-353,829. FILED P.R. 1-19-2004; AM. S.R. 2-13-2005.

AMERICA'S FINEST KIDS

THE MARK CONSISTS OF STANDARD CHARACTERS WITHOUT CLAIM TO ANY PARTICULAR FONT, STYLE, SIZE, OR COLOR.

FOR PRINTED MATERIALS AND PUBLICATIONS, NAMELY, PHOTO-ESSAYS, ESSAYS, BOOKS, COLLECTIONS OF PHOTOS, ART PRINTS, POSTERS, POSTCARDS, GREETING CARDS, BEVERAGE COASTERS, BROCHURES, BUMPER STICKERS, AND STICKERS REGARDING THE DOCUMENTATION OF YOUTH CULTURE (U.S. CLS. 2, 5, 22, 23, 29, 37, 38 AND 50).

FIRST USE 4-28-2004; IN COMMERCE 12-11-2004.

CLASS 16—(Continued).

2,956,131. RADIO & RECORDS, INC., LOS ANGELES, CA. SN 78-359,082. FILED P.R. 1-28-2004; AM. S.R. 2-10-2005.

CLASS 16—(Continued).

2,956,160. SATER DESIGN COLLECTION, INC., BONITA SPRINGS, FL. SN 78-366,298. FILED P.R. 2-11-2004; AM. S.R. 2-15-2005.

GOING FOR ADDS

THE MARK CONSISTS OF STANDARD CHARACTERS WITHOUT CLAIM TO ANY PARTICULAR FONT, STYLE, SIZE, OR COLOR.

FOR MAGAZINE AND NEWSLETTER COLUMNS AND SECTIONS IN THE FIELD OF RADIO, MUSIC AND ENTERTAINMENT (U.S. CLS. 2, 5, 22, 23, 29, 37, 38 AND 50).

FIRST USE 6-25-1999; IN COMMERCE 6-25-1999.

2,956,135. QARMOUT, ELIAS, DALY CITY, CA. SN 78-360,326. FILED P.R. 1-30-2004; AM. S.R. 2-10-2005.

**UNO CALIFORNIA
TARJETA TELEFONICA
PREPAGADA**

THE MARK CONSISTS OF STANDARD CHARACTERS WITHOUT CLAIM TO ANY PARTICULAR FONT, STYLE, SIZE, OR COLOR.

NO CLAIM IS MADE TO THE EXCLUSIVE RIGHT TO USE "TARJETA TELEFONICA PREPAGADA", APART FROM THE MARK AS SHOWN.

THE FOREIGN WORDING IN THE MARK TRANSLATES INTO ENGLISH AS ONE CALIFORNIA PREPAID TELEPHONE CARD.

FOR NON-MAGNETICALLY ENCODED TELEPHONE CALLING CARDS (U.S. CLS. 2, 5, 22, 23, 29, 37, 38 AND 50).

FIRST USE 1-28-2004; IN COMMERCE 1-28-2004.

2,956,151. MANZANITA MEDIA, INC., DEWEY, AZ. SN 78-364,519. FILED P.R. 2-8-2004; AM. S.R. 3-14-2005.

**Professional
BUILDING Review**
A Trade Publication Focusing On The Local Building and Contracting Industry

NO CLAIM IS MADE TO THE EXCLUSIVE RIGHT TO USE "REVIEW", APART FROM THE MARK AS SHOWN.

FOR TRADE MAGAZINES CONCERNING THE UNITED STATES BUILDING INDUSTRY (U.S. CLS. 2, 5, 22, 23, 29, 37, 38 AND 50).

FIRST USE 2-0-2004; IN COMMERCE 3-0-2004.

**FLORIDA FLOOR
PLANS**

THE MARK CONSISTS OF STANDARD CHARACTERS WITHOUT CLAIM TO ANY PARTICULAR FONT, STYLE, SIZE, OR COLOR.

FOR PRINTED PUBLICATIONS, NAMELY, PERIODICALS FEATURING HOME PLANS AND HOME INTERIOR DESIGN (U.S. CLS. 2, 5, 22, 23, 29, 37, 38 AND 50).

FIRST USE 9-30-2001; IN COMMERCE 9-30-2001.

2,956,164. LE JACQ LTD., DARIEN, CT. SN 78-367,348. FILED P.R. 2-12-2004; AM. S.R. 2-3-2005.

**THE JOURNAL OF
CLINICAL
HYPERTENSION**

THE MARK CONSISTS OF STANDARD CHARACTERS WITHOUT CLAIM TO ANY PARTICULAR FONT, STYLE, SIZE, OR COLOR.

NO CLAIM IS MADE TO THE EXCLUSIVE RIGHT TO USE "JOURNAL", APART FROM THE MARK AS SHOWN.

FOR SERIES OF JOURNALS ON THE SUBJECT OF THE TREATMENT OF HYPERTENSION (U.S. CLS. 2, 5, 22, 23, 29, 37, 38 AND 50).

FIRST USE 7-0-1999; IN COMMERCE 7-0-1999.

CLASS 16—(Continued).

2,956,172. ROTHERMEL, CHARLES E., ASHBURN, VA. SN 78-368,318. FILED P.R. 2-15-2004; AM. S.R. 3-26-2005.

PicturePaper

THE MARK CONSISTS OF STANDARD CHARACTERS WITHOUT CLAIM TO ANY PARTICULAR FONT, STYLE, SIZE, OR COLOR.

FOR PAPER FOR WRAPPING AND PACKING (U.S. CLS. 2, 5, 22, 23, 29, 37, 38 AND 50).

FIRST USE 12-6-2004; IN COMMERCE 12-16-2004.

CLASS 16—(Continued).

2,956,181. CANCER COMFORT KIT, LLC, NORMAN, OK. SN 78-369,759. FILED P.R. 2-18-2004; AM. S.R. 9-12-2004.

Cancer Comfort Kit

THE MARK CONSISTS OF STANDARD CHARACTERS WITHOUT CLAIM TO ANY PARTICULAR FONT, STYLE, SIZE, OR COLOR.

FOR BROCHURE ABOUT CANCER SUPPORT ITEMS (U.S. CLS. 2, 5, 22, 23, 29, 37, 38 AND 50).

FIRST USE 6-12-2002; IN COMMERCE 6-18-2002.

2,956,177. MORRIS, JAMES, HITCHENS & WILLIAMS LLP, WILMINGTON, DE. SN 78-368,669. FILED P.R. 2-16-2004; AM. S.R. 12-22-2004.

PIP TIPS

THE MARK CONSISTS OF STANDARD CHARACTERS WITHOUT CLAIM TO ANY PARTICULAR FONT, STYLE, SIZE, OR COLOR.

FOR PERIODIC PUBLICATIONS, NAMELY NEWSLETTERS IN THE LEGAL FIELD (U.S. CLS. 2, 5, 22, 23, 29, 37, 38 AND 50).

FIRST USE 2-15-2002; IN COMMERCE 2-15-2002.

2,956,190. HARCOURT ASSESSMENT INC., AUSTIN, TX. SN 78-372,896. FILED P.R. 2-24-2004; AM. S.R. 1-12-2005.

SHORT EMPLOYMENT TESTS

THE MARK CONSISTS OF STANDARD CHARACTERS WITHOUT CLAIM TO ANY PARTICULAR FONT, STYLE, SIZE, OR COLOR.

OWNER OF U.S. REG. NO. 1,824,400.

NO CLAIM IS MADE TO THE EXCLUSIVE RIGHT TO USE EMPLOYMENT TESTS, APART FROM THE MARK AS SHOWN.

FOR PRINTED MATERIALS NAMELY, PRINTED TESTS, ANSWER BOOKLETS AND MANUALS FOR MEASURING ABILITIES OF JOB APPLICANTS (U.S. CLS. 2, 5, 22, 23, 29, 37, 38 AND 50).

FIRST USE 4-16-1993; IN COMMERCE 4-16-1993.

CLASS 16—(Continued).

2,956,191. COASTAL PRINTING CORPORATION, NEW YORK, NY. SN 78-372,958. FILED P.R. 2-24-2004; AM. S.R. 3-2-2005.

THE COASTAL HOME

THE MARK CONSISTS OF STANDARD CHARACTERS WITHOUT CLAIM TO ANY PARTICULAR FONT, STYLE, SIZE, OR COLOR.

FOR BUSINESS TO BUSINESS MAGAZINE AND CATALOG FEATURING INFORMATION ON THE LATEST TRENDS AND STYLES IN HOME PRODUCTS AND FASHION, CONNECTIONS TO DIRECT HOME FASHION RESOURCES, AND INFORMATION REGARDING ORDERING OF HOME FASHIONS AND CATALOGS (U.S. CLS. 2, 5, 22, 23, 29, 37, 38 AND 50).

FIRST USE 5-1-2003; IN COMMERCE 5-1-2003.

CLASS 16—(Continued).

2,956,219. WILLS, THOMAS E., WAPAKONETA, OH. SN 78-385,716. FILED P.R. 3-17-2004; AM. S.R. 1-27-2005.

The Doggie Screen

THE MARK CONSISTS OF STANDARD CHARACTERS WITHOUT CLAIM TO ANY PARTICULAR FONT, STYLE, SIZE, OR COLOR.

FOR PORTABLE, FOLDING PET BARRIERS MADE OF PAPER AND CARDBOARD FOR USE A PASSIVE PET RESTRAINT AND DOG TRAINING DEVICE (U.S. CLS. 2, 5, 22, 23, 29, 37, 38 AND 50).

FIRST USE 1-9-2004; IN COMMERCE 3-4-2004.

2,956,193. MILFORD, FRANCINE M., VENICE, FL. SN 78-373,951. FILED P.R. 2-25-2004; AM. S.R. 1-21-2005.

**Tuning Fork
Therapy**

THE MARK CONSISTS OF STANDARD CHARACTERS WITHOUT CLAIM TO ANY PARTICULAR FONT, STYLE, SIZE, OR COLOR.

FOR SERIES OF NON-FICTION BOOKS ABOUT USING TUNING FORKS IN A THERAPY SESSION (U.S. CLS. 2, 5, 22, 23, 29, 37, 38 AND 50).

FIRST USE 1-2-2002; IN COMMERCE 1-2-2002.

2,956,230. IMAGINE INVESTMENT GROUP, INC., SAN ANTONIO, TX. SN 78-391,714. FILED P.R. 3-26-2004; AM. S.R. 1-13-2005.

HOLY HOUSES

THE MARK CONSISTS OF STANDARD CHARACTERS WITHOUT CLAIM TO ANY PARTICULAR FONT, STYLE, SIZE, OR COLOR.

FOR PRINTS AND PRINTED MATERIALS, NAMELY PHOTOGRAPHIC PRINTS, POSTERS, PICTURE BOOKS, AND CALENDARS (U.S. CLS. 2, 5, 22, 23, 29, 37, 38 AND 50).

FIRST USE 1-1-2004; IN COMMERCE 3-25-2004.

CLASS 16—(Continued).

2,956,242. SENIOR HEALTH & WELFARE CONSULTANTS, INC., PALOS HILLS, IL. SN 78-402,370. FILED P.R. 4-15-2004; AM. S.R. 3-3-2005.

The Prescription Assistance Program

THE MARK CONSISTS OF STANDARD CHARACTERS WITHOUT CLAIM TO ANY PARTICULAR FONT, STYLE, SIZE, OR COLOR.

FOR MEDICAL IDENTIFICATION CARD (U.S. CLS. 2, 5, 22, 23, 29, 37, 38 AND 50).
FIRST USE 4-14-2004; IN COMMERCE 4-14-2004.

CLASS 16—(Continued).

2,956,308. GREAT DINING, INC., BELLEAIR, FL. SN 78-434,788. FILED P.R. 6-14-2004; AM. S.R. 2-8-2005.

GREAT DINING

THE MARK CONSISTS OF STANDARD CHARACTERS WITHOUT CLAIM TO ANY PARTICULAR FONT, STYLE, SIZE, OR COLOR.

FOR PRINTED GUIDES FOR RESTAURANTS (U.S. CLS. 2, 5, 22, 23, 29, 37, 38 AND 50).
FIRST USE 3-24-2004; IN COMMERCE 3-24-2004.

2,956,309. HOLLOWAY, STEVEN H., CARMEL, IN. SN 78-435,005. FILED P.R. 6-14-2004; AM. S.R. 1-24-2005.

2,956,266. MEREDITH CORPORATION, DES MOINES, IA. SN 78-416,164. FILED P.R. 5-10-2004; AM. S.R. 1-16-2005.

DIABETIC LIVING

THE MARK CONSISTS OF STANDARD CHARACTERS WITHOUT CLAIM TO ANY PARTICULAR FONT, STYLE, SIZE, OR COLOR.

FOR PERIODIC PUBLICATION, NAMELY A MAGAZINE PROVIDING ARTICLES, INFORMATION AND RECIPES DESIGNED FOR CONSUMERS WITH DIABETES (U.S. CLS. 2, 5, 22, 23, 29, 37, 38 AND 50).
FIRST USE 8-10-2004; IN COMMERCE 8-10-2004.

EXECUTIVE HOMES

THE MARK CONSISTS OF STANDARD CHARACTERS WITHOUT CLAIM TO ANY PARTICULAR FONT, STYLE, SIZE, OR COLOR.

FOR PRINTED PUBLICATIONS, NAMELY, MAGAZINES FEATURING REAL ESTATE, HOMES, LAND AND REAL ESTATE RELATED SERVICES (U.S. CLS. 2, 5, 22, 23, 29, 37, 38 AND 50).
FIRST USE 1-1-1994; IN COMMERCE 1-1-1994.

CLASS 16—(Continued).

2,956,322. MEREDITH CORPORATION, DES MOINES, IA. SN 78-439,900. FILED P.R. 6-23-2004; AM. S.R. 2-10-2005.

HOW THEY MET

THE MARK CONSISTS OF STANDARD CHARACTERS WITHOUT CLAIM TO ANY PARTICULAR FONT, STYLE, SIZE, OR COLOR.

FOR PERIODIC PUBLICATIONS, NAMELY A SECTION OF A MAGAZINE FEATURING ENTERTAINING ARTICLES ABOUT THE UNIQUE AND UNUSUAL WAYS COUPLES MEET (U.S. CLS. 2, 5, 22, 23, 29, 37, 38 AND 50).

FIRST USE 2-15-2003; IN COMMERCE 2-15-2003.

CLASS 16—(Continued).

2,956,333. REED ELSEVIER INC., NEWTON, MA. SN 78-448,907. FILED P.R. 7-11-2004; AM. S.R. 2-28-2005.

CONSTRUCTION FORECAST MONTHLY

THE MARK CONSISTS OF STANDARD CHARACTERS WITHOUT CLAIM TO ANY PARTICULAR FONT, STYLE, SIZE, OR COLOR.

NO CLAIM IS MADE TO THE EXCLUSIVE RIGHT TO USE "MONTHLY", APART FROM THE MARK AS SHOWN.

FOR PRINTED PUBLICATIONS NAMELY NEWSLETTERS RELATING TO ECONOMIC FORECAST (U.S. CLS. 2, 5, 22, 23, 29, 37, 38 AND 50).

FIRST USE 6-0-2004; IN COMMERCE 6-0-2004.

2,956,330. RODALE INC., EMMAUS, PA. SN 78-444,625. FILED P.R. 7-1-2004; AM. S.R. 2-15-2005.

THE QUICK COOK

THE MARK CONSISTS OF STANDARD CHARACTERS WITHOUT CLAIM TO ANY PARTICULAR FONT, STYLE, SIZE, OR COLOR.

NO CLAIM IS MADE TO THE EXCLUSIVE RIGHT TO USE COOK, APART FROM THE MARK AS SHOWN.

FOR SERIES OF BOOKS IN THE FIELD OF COOKING (U.S. CLS. 2, 5, 22, 23, 29, 37, 38 AND 50).

FIRST USE 1-0-2004; IN COMMERCE 1-0-2004.

2,956,336. CORIMAX, INC., TALLAHASSEE, FL. SN 78-450,173. FILED P.R. 7-13-2004; AM. S.R. 2-25-2005.

HOMES

NO CLAIM IS MADE TO THE EXCLUSIVE RIGHT TO USE "HOMES", APART FROM THE MARK AS SHOWN.

FOR PERIODIC PUBLICATIONS NAMELY MAGAZINES REGARDING REAL ESTATE LISTINGS (U.S. CLS. 2, 5, 22, 23, 29, 37, 38 AND 50).

FIRST USE 6-8-2003; IN COMMERCE 6-8-2003.

CLASS 16—(Continued).

2,956,346. PRINT-LOCK CORP., LAS VEGAS, NV. SN 78-461,104. FILED P.R. 8-3-2004; AM. S.R. 3-23-2005.

DNA PRINT-KIT

THE MARK CONSISTS OF STANDARD CHARACTERS WITHOUT CLAIM TO ANY PARTICULAR FONT, STYLE, SIZE, OR COLOR.

NO CLAIM IS MADE TO THE EXCLUSIVE RIGHT TO USE "PRINT-KIT", APART FROM THE MARK AS SHOWN. FOR KITS FOR LABELING OBJECTS WITH A PERSON'S FINGERPRINT WHICH IS PERCEPTIBLE ONLY WITH ULTRA-VIOLET (UV) RADIATION, FEATURING, A PRINT PAD, UV DETECTION LAMP, MAGNIFYING GLASS, AND INVENTORY LIST (U.S. CLS. 2, 5, 22, 23, 29, 37, 38 AND 50).

FIRST USE 7-0-2004; IN COMMERCE 7-0-2004.

CLASS 17—RUBBER GOODS

2,956,079. TYSON FENCE CO., INC., HARRISBURG, PA. SN 78-339,383. FILED P.R. 12-11-2003; AM. S.R. 1-21-2005.

BEESTOP

THE MARK CONSISTS OF STANDARD CHARACTERS WITHOUT CLAIM TO ANY PARTICULAR FONT, STYLE, SIZE, OR COLOR.

FOR PLASTIC PLUGS FOR INSERTION INTO A FENCE RAIL TO BLOCK AN OPENING IN A FENCE POST (U.S. CLS. 1, 5, 12, 13, 35 AND 50).

FIRST USE 1-19-2004; IN COMMERCE 1-19-2004.

CLASS 18—LEATHER GOODS**CLASS 18—(Continued).**

2,955,941. L. L. BEAN, INC., FREEPORT, ME. SN 78-208,928. FILED P.R. 1-30-2003; AM. S.R. 2-16-2005.

CLASSIC FIELD TOTE

NO CLAIM IS MADE TO THE EXCLUSIVE RIGHT TO USE TOTE, APART FROM THE MARK AS SHOWN. FOR TOTE BAGS (U.S. CLS. 1, 2, 3, 22 AND 41). FIRST USE 1-25-2004; IN COMMERCE 1-25-2004.

CLASS 19—NON-METALLIC BUILDING MATERIALS

2,955,911. SIMPSON TIMBER COMPANY, SEATTLE, WA. SN 78-092,795. FILED P.R. 11-12-2001; AM. S.R. 8-19-2004.

CALIFORNIA PREMIUM

FOR LUMBER (U.S. CLS. 1, 12, 33 AND 50). FIRST USE 4-24-2002; IN COMMERCE 4-24-2002.

2,955,912. SIMPSON TIMBER COMPANY, SEATTLE, WA. SN 78-092,796. FILED P.R. 11-12-2001; AM. S.R. 8-19-2004.

CALIFORNIA HEART

FOR LUMBER (U.S. CLS. 1, 12, 33 AND 50). FIRST USE 4-24-2002; IN COMMERCE 4-24-2002.

2,955,935. WPW INDUSTRIES, INC., DBA STREATOR BRICK COMPANY, STREATOR, IL. SN 78-190,113. FILED P.R. 12-2-2002; AM. S.R. 10-27-2004.

GREENBRICK

FOR BRICKS FOR USE IN CONSTRUCTION, NOT INCLUDING REFRACTORY BRICKS (U.S. CLS. 1, 12, 33 AND 50). FIRST USE 7-15-2003; IN COMMERCE 7-15-2003.

CLASS 19—(Continued).

2,956,123. DAYTON SUPERIOR SPECIALTY CHEMICAL CORP., DAYTON, OH. SN 78-358,043. FILED P.R. 1-27-2004; AM. S.R. 1-21-2005.

SPECIAL PATCH

THE MARK CONSISTS OF STANDARD CHARACTERS WITHOUT CLAIM TO ANY PARTICULAR FONT, STYLE, SIZE, OR COLOR.

FOR POLYMER-MODIFIED, CEMENTIOUS, TWO-COMPOUND CONCRETE REPAIR MORTAR (U.S. CLS. 1, 12, 33 AND 50).

FIRST USE 7-31-1991; IN COMMERCE 7-31-1991.

2,956,210. GLEN OAK LUMBER & MILLING, INC., MONTELLO, WI. SN 78-381,916. FILED P.R. 3-10-2004; AM. S.R. 3-10-2005.

SCULPTURED WOODS

THE MARK CONSISTS OF STANDARD CHARACTERS WITHOUT CLAIM TO ANY PARTICULAR FONT, STYLE, SIZE, OR COLOR.

NO CLAIM IS MADE TO THE EXCLUSIVE RIGHT TO USE "WOODS", APART FROM THE MARK AS SHOWN.

FOR DECORATIVE WOOD MOULDINGS, CARVINGS AND ACCESSORIES, NAMELY, INTERIOR AND EXTERIOR WOOD TRIM AND WOOD MOULDINGS, NAMELY, DENTIL CROWNS, EMBOSSED CROWNS, ROPE TRIM, BASEBOARDS, CASINGS, CROWNS, CHAIR RAILS, EMBOSSED CARVINGS, CORNER BLOCKS, BASE BLOCKS, PLINTH BLOCKS, ROSETTES, CHAIR RAIL CORNER BEADS, BASE CORNER BEADS, CROWN CORNERS, EMBOSSED MOULDINGS, CORBELS, AND MANTELS (U.S. CLS. 1, 12, 33 AND 50).

FIRST USE 2-28-2005; IN COMMERCE 2-28-2005.

2,956,232. ZICKGRAF ENTERPRISES, INC., FRANKLIN, NC. SN 78-393,368. FILED P.R. 3-30-2004; AM. S.R. 1-13-2005.

ZICKGRAF HARDWOOD FLOORING**CLASS 19—(Continued).**

THE MARK CONSISTS OF STANDARD CHARACTERS WITHOUT CLAIM TO ANY PARTICULAR FONT, STYLE, SIZE, OR COLOR.

OWNER OF U.S. REG. NOS. 243,701, 2,516,579, AND OTHERS.

NO CLAIM IS MADE TO THE EXCLUSIVE RIGHT TO USE "HARDWOOD FLOORING", APART FROM THE MARK AS SHOWN.

FOR LUMBER, WOOD FLOORING AND WOOD MOLDING (U.S. CLS. 1, 12, 33 AND 50).

FIRST USE 6-1-1933; IN COMMERCE 6-1-1933.

CLASS 20—FURNITURE AND ARTICLES NOT OTHERWISE CLASSIFIED

2,955,876. ROYAL MOULDINGS LIMITED, MARION, VA. SN 76-583,447. FILED P.R. 3-29-2004; AM. S.R. 2-15-2005.

OVERLAYS

THE MARK CONSISTS OF STANDARD CHARACTERS WITHOUT CLAIM TO ANY PARTICULAR FONT, STYLE, SIZE, OR COLOR.

FOR NON-METAL CARRIAGE AND GARAGE DOOR TRIM (U.S. CLS. 2, 13, 22, 25, 32 AND 50).

FIRST USE 3-0-2004; IN COMMERCE 4-0-2004.

2,956,240. LARIN CORPORATION, ONTARIO, CA. SN 78-400,275. FILED P.R. 4-12-2004; AM. S.R. 12-27-2004.

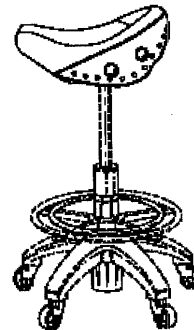

THE MARK CONSISTS OF THE CURVATURE OF THE SEAT, THE SIDE PANELING OF THE SEAT, THE SECOND INNER RING ON THE FOOT REST, AND THE DECORATIVE VERTICAL LINES ON THE BOTTOM OF THE POST. THE MATTER SHOWN IN DOTTED LINES IN THE DRAWING IS NOT A PART OF THE MARK AND SERVES ONLY TO SHOW THE POSITION OF THE MARK.

FOR FURNITURE, NAMELY PORTABLE BAR STOOLS (U.S. CLS. 2, 13, 22, 25, 32 AND 50).

FIRST USE 10-18-2002; IN COMMERCE 10-18-2002.

CLASS 20—(Continued).

2,956,295. LEO INTERNATIONAL, INC., BROOKLYN, NY. SN 78-428,396. FILED P.R. 6-2-2004; AM. S.R. 3-2-2005.

CLASSIC CABINETS

THE MARK CONSISTS OF STANDARD CHARACTERS WITHOUT CLAIM TO ANY PARTICULAR FONT, STYLE, SIZE, OR COLOR.

NO CLAIM IS MADE TO THE EXCLUSIVE RIGHT TO USE "CABINETS", APART FROM THE MARK AS SHOWN, FOR KITCHEN AND BATHROOM WOOD VANITIES AND CABINETS (U.S. CLS. 2, 13, 22, 25, 32 AND 50).
FIRST USE 0-0-2004; IN COMMERCE 0-0-2004.

CLASS 21—(Continued).

2,955,866. CHOKSHI, SAURABH, TAMPA, FL. SN 76-573,367. FILED P.R. 2-2-2004; AM. S.R. 12-8-2004.

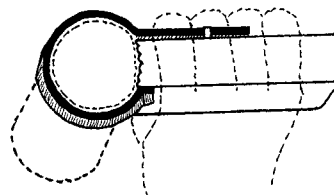

THE MARK CONSISTS OF AJAR OPENER. THE OUTLINE OF THE HAND DEPICTED IN BROKEN LINES IS INTENDED TO SHOW THE LOCATION OF THE HANDLE OF THE MARK WHEN GRASPED AND IS NOT A PART OF THE MARK. THE OUTLINE OF THE CAP AND BODY OF THE JAR ALSO DEPICTED IN BROKEN LINES IS INTENDED TO SHOW THE LOCATION OF THE STRAP PORTION OF THE JAR OPENER WHEN PLACED AROUND THE CAP OF THE JAR AND IS ALSO NOT PART OF THE MARK.

FOR JAR OPENER (U.S. CLS. 2, 13, 23, 29, 30, 33, 40 AND 50).

FIRST USE 1-11-2004; IN COMMERCE 1-11-2004.

2,955,907. FRESH PRODUCTS, INC., TOLEDO, OH. SN 78-042,771. FILED P.R. 1-11-2001; AM. S.R. 4-7-2003.

FRESH SCENTS

FOR COMBINED DISPENSERS FOR BOTH LIQUID SOAP AND AIR FRESHENERS (U.S. CLS. 2, 13, 23, 29, 30, 33, 40 AND 50).

FIRST USE 11-0-2002; IN COMMERCE 11-0-2002.

CLASS 21—HOUSEWARES AND GLASS

2,955,843. WESLEY DEVELOPMENT INC., CHICAGO, IL. SN 76-545,715. FILED P.R. 9-22-2003; AM. S.R. 2-18-2005.

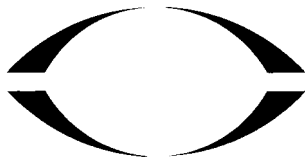

FOR PLASTIC CONTAINER FOR FOOD STORAGE (U.S. CLS. 2, 13, 23, 29, 30, 33, 40 AND 50).
FIRST USE 1-0-2003; IN COMMERCE 1-0-2003.

2,956,032. TAVERNTOOLS, JUNEAU, AK. SN 78-303,927. FILED P.R. 9-23-2003; AM. S.R. 6-21-2004.

THE BAR HOOK

NO CLAIM IS MADE TO THE EXCLUSIVE RIGHT TO USE "HOOK", APART FROM THE MARK AS SHOWN.

FOR BOTTLE OPENERS (U.S. CLS. 2, 13, 23, 29, 30, 33, 40 AND 50).

FIRST USE 3-10-2003; IN COMMERCE 8-11-2003.

2,956,051. HARVEY, KIM, INDIANAPOLIS, IN. SN 78-319,731. FILED P.R. 10-28-2003; AM. S.R. 3-1-2005.

THE BUN WARMER

FOR COOKWARE, NAMELY, CONTAINERS FOR MICROWAVE OVENS (U.S. CLS. 2, 13, 23, 29, 30, 33, 40 AND 50).

FIRST USE 8-24-2004; IN COMMERCE 8-24-2004.

CLASS 21—(Continued).

2,956,327. PUCCI, MICHAEL A., SIMI VALLEY, CA. AND UNDERWOOD, DEBRA L., ALTADENA, CA. SN 78-443,226. FILED P.R. 6-29-2004; AM. S.R. 2-14-2005.

PETSTOOTHBRUSH

THE MARK CONSISTS OF STANDARD CHARACTERS WITHOUT CLAIM TO ANY PARTICULAR FONT, STYLE, SIZE, OR COLOR.

FOR HAND-WORN ARTICLE, NAMELY, A GLOVE, MITT OR MITTEN HAVING BRISTLES FOR CLEANING THE TEETH OF ANIMALS (U.S. CLS. 2, 13, 23, 29, 30, 33, 40 AND 50).

FIRST USE 5-2-2004; IN COMMERCE 5-2-2004.

2,956,328. PUCCI, MICHAEL A., SIMI VALLEY, CA. AND UNDERWOOD, DEBRA L., ALTADENA, CA. SN 78-443,236. FILED P.R. 6-29-2004; AM. S.R. 2-23-2005.

GLOVEBRUSH

THE MARK CONSISTS OF STANDARD CHARACTERS WITHOUT CLAIM TO ANY PARTICULAR FONT, STYLE, SIZE, OR COLOR.

FOR CLEANING AND MASSAGING ARTICLE, NAMELY, A HAND-WORN GLOVE, MITT OR MITTEN HAVING RAISED SURFACES FOR CLEANING OR MASSAGING (U.S. CLS. 2, 13, 23, 29, 30, 33, 40 AND 50).

FIRST USE 5-2-2004; IN COMMERCE 5-2-2004.

CLASS 21—(Continued).

2,956,356. WELLS LAMONT CORPORATION, NILES, IL. SN 78-470,480. FILED P.R. 8-19-2004; AM. S.R. 1-24-2005.

TIME FLIES WHEN YOU'RE GARDENING

THE MARK CONSISTS OF STANDARD CHARACTERS WITHOUT CLAIM TO ANY PARTICULAR FONT, STYLE, SIZE, OR COLOR.

FOR GARDENING GLOVES (U.S. CLS. 2, 13, 23, 29, 30, 33, 40 AND 50).

FIRST USE 12-0-2003; IN COMMERCE 12-0-2003.

CLASS 22—CORDAGE AND FIBERS

2,955,830. MCGRATH, DONALD, COSTA MESA, CA. SN 76-515,527. FILED P.R. 5-19-2003; AM. S.R. 5-5-2004.

PLANCARRIER.COM

FOR DETACHABLE SECURED TEXTILE WRAP AROUND DEVICE FOR TRANSPORTING LARGE ROLLABLE PLANAR OBJECTS SUCH AS DOCUMENTS, PICTURES, PORTFOLIOS AND BLUEPRINTS (U.S. CLS. 1, 2, 7, 19, 22, 42 AND 50).

FIRST USE 8-15-2003; IN COMMERCE 8-15-2003.

2,956,060. AER-FLO CANVAS PRODUCTS, INC., DBA AER-FLO, INC., BRADENTON, FL. SN 78-326,025. FILED P.R. 11-11-2003; AM. S.R. 2-24-2005.

WIND WEIGHTED

THE MARK CONSISTS OF STANDARD CHARACTERS WITHOUT CLAIM TO ANY PARTICULAR FONT, STYLE, SIZE, OR COLOR.

FOR PROTECTIVE TARPULINS FOR THE GROUND, EQUIPMENT, WOOD PILES, AND THE LIKE (U.S. CLS. 1, 2, 7, 19, 22, 42 AND 50).

FIRST USE 10-30-2002; IN COMMERCE 11-3-2002.

CLASS 24—FABRICS

CLASS 24—(Continued).

2,955,956. PAMANI, ASHOK, MOONACHIE, NJ. SN 78-229,133. FILED 3-24-2003.

HUDSON VALLEY

FOR TEXTILE GOODS, NAMELY, HOUSEHOLD LINEN, BED LINEN, BATH LINEN, PLACE MATS, BLANKET TROWS, TOWELS, BED COVERS, NAMELY, BED SPREADS, TABLE COVERS, NAMELY, TABLE LINEN, FABRIC TABLE TOPPERS, FABRIC TABLE RUNNERS; AND FABRIC TABLE MATS; TABLE LINEN, NAMELY, NAPKINS; WASH CLOTHS; FABRIC KITCHEN NAPKINS (U.S. CLS. 42 AND 50).

FIRST USE 3-24-2003; IN COMMERCE 3-24-2003.

2,956,028. QVC, INC., WEST CHESTER, PA. SN 78-299,025. FILED P.R. 9-11-2003; AM. S.R. 1-25-2005.

CROSSTRETCH

FOR COTTON AND SPANDEX FABRICS FOR THE MANUFACTURE OF CLOTHING (U.S. CLS. 42 AND 50). FIRST USE 10-1-2003; IN COMMERCE 10-1-2003.

2,956,239. MARKS, ROBIN LURYNE, DALLAS, TX. SN 78-399,843. FILED P.R. 4-10-2004; AM. S.R. 3-21-2005.

Baby Bath Blanket

THE MARK CONSISTS OF STANDARD CHARACTERS WITHOUT CLAIM TO ANY PARTICULAR FONT, STYLE, SIZE, OR COLOR.

OWNER OF U.S. REG. NO. 2,794,153.

NO CLAIM IS MADE TO THE EXCLUSIVE RIGHT TO USE "BLANKET", APART FROM THE MARK AS SHOWN. FOR BLANKETS FOR BABIES (U.S. CLS. 42 AND 50). FIRST USE 1-30-2002; IN COMMERCE 9-21-2002.

CLASS 25—CLOTHING**CLASS 25—(Continued).**

2,955,804. CONWAY STORES, INC., DBA NYC JEAN CO., NEW YORK, NY. SN 74-715,474. FILED P.R. 8-14-1995; AM. S.R. 8-13-1996.

NYC JEANSWEAR

NO CLAIM IS MADE TO THE EXCLUSIVE RIGHT TO USE "JEANSWEAR", APART FROM THE MARK AS SHOWN.

FOR CLOTHING, NAMELY SWEATSHIRTS, SWEAT-PANTS, JEANS, TOPS, SHIRTS, T-SHIRTS, BLOUSES, PANTS, DRESSES, SKIRTS, SOCKS, HOSIERY AND UNDERWEAR (U.S. CLS. 22 AND 39).

FIRST USE 7-15-1995; IN COMMERCE 7-15-1995.

2,955,948. KMJ L.L.C., TULSA, OK. SN 78-218,966. FILED P.R. 2-26-2003; AM. S.R. 8-2-2004.

KAPPA MAMMA JAMMA

FOR CLOTHING, NAMELY SHIRTS, SWEATSHIRTS, HATS, T-SHIRTS AND OVERALLS (U.S. CLS. 22 AND 39).

FIRST USE 9-1-2000; IN COMMERCE 7-1-2002.

2,956,029. JETTY LIFE, LLC, MANAHAWKIN, NJ. SN 78-300,005. FILED P.R. 9-12-2003; AM. S.R. 3-4-2005.

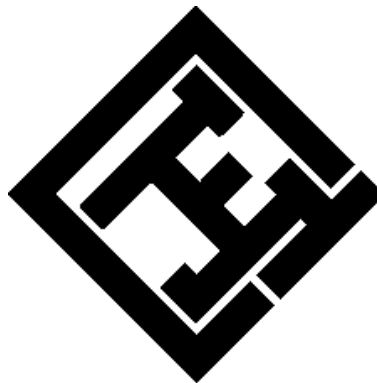

THE MARK CONSISTS OF AN INVERTED SQUARE OR DIAMOND CONTAINING THE INTERLOCKING AND OVERLAPPING LETTERS J, E, T, AND Y, SO AS TO SPELL THE WORD JETTY.

FOR MEN'S AND WOMEN'S CLOTHING, NAMELY, T-SHIRTS, HATS, SWEATSHIRTS, LONG SLEEVE SHIRTS, BELTS, JACKETS, BATHING SUITS, TANK TOPS, SHORTS, PANTS, SHOES, FLIP FLOPS, SOCKS, UNDERWEAR, HEADWEAR, HEADBANDS, WRISTBANDS, PONCHOS, RAINWEAR AND RASH GUARDS (U.S. CLS. 22 AND 39).

FIRST USE 7-5-2003; IN COMMERCE 7-15-2003.

CLASS 25—(Continued).

2,956,052. KIDS RAGS, INC., RIVERSIDE, CA. SN 78-320,520.
FILED P.R. 10-29-2003; AM. S.R. 11-1-2004.

KIDS RAGS

FOR CHILDREN'S CLOTHES, NAMELY, TUXEDOS
(U.S. CLS. 22 AND 39).
FIRST USE 2-1-2004; IN COMMERCE 2-1-2004.

2,956,076. GUDGEL, DAVID E., ALBUQUERQUE, NM. AND
GUDGEL, ASHLEY F., ALBUQUERQUE, NM. SN 78-
335,983. FILED P.R. 12-3-2003; AM. S.R. 12-16-2004.



THE COLOR(S) SILVER AND PINK IS/ARE CLAIMED AS
A FEATURE OF THE MARK.

THE MARK CONSISTS OF SILVER ABSTRACT MOTOR-
CYCLE RIDDEN BY AN ABSTRACT PINK WOMAN WITH
HAIR BLOWN BACK. WORDS "RIDIN' SOLO" IN LOWER
CASE, SAME PINK AS LADY RIDER, BETWEEN MOTOR-
CYCLE TIRES WITH SECOND "O" IN SOLO BEING THE
INSIDE OF REAR TIRE.

FOR LADIES MOTORCYCLE APPAREL NAMELY
SHIRTS, PANTS, SCARVES, SWEATERS, SWEAT-
SHIRTS, T-SHIRTS, SOCKS, BELTS, VESTS, JACKETS,
AND UNDERGARMENTS (U.S. CLS. 22 AND 39).
FIRST USE 2-1-2004; IN COMMERCE 2-1-2004.

2,956,082. BOUTELLE, RODGER W., MIAMI, FL. SN 78-
341,429. FILED P.R. 12-16-2003; AM. S.R. 2-16-2005.

AIR MANGO

THE MARK CONSISTS OF STANDARD CHARACTERS
WITHOUT CLAIM TO ANY PARTICULAR FONT, STYLE,
SIZE, OR COLOR.

FOR CLOTHING, NAMELY, T-SHIRT, TOPS AND
HATS (U.S. CLS. 22 AND 39).
FIRST USE 10-1-1998; IN COMMERCE 10-1-1998.

CLASS 25—(Continued).

2,956,083. BOUTELLE, RODGER W., MIAMI, FL. SN 78-
341,445. FILED P.R. 12-16-2003; AM. S.R. 2-8-2005.

**LAST MANGO IN
PARADISE**

THE MARK CONSISTS OF STANDARD CHARACTERS
WITHOUT CLAIM TO ANY PARTICULAR FONT, STYLE,
SIZE, OR COLOR.

FOR CLOTHING, NAMELY, T-SHIRTS, TOPS, AND
HATS (U.S. CLS. 22 AND 39).

FIRST USE 9-1-1994; IN COMMERCE 9-1-1994.

2,956,084. CGS INDUSTRIES INC., LONG ISLAND CITY,
NY. SN 78-341,700. FILED P.R. 12-16-2003; AM. S.R. 11-18-
2004.

A. KURTZ

THE MARK CONSISTS OF STANDARD CHARACTERS
WITHOUT CLAIM TO ANY PARTICULAR FONT, STYLE,
SIZE, OR COLOR.

THE NAME "A. KURTZ" DOES NOT IDENTIFY A
PARTICULAR LIVING INDIVIDUAL.

FOR CLOTHING AND APPAREL ITEMS, NAMELY,
JEANS, SWEATERS, SHIRTS, SHORTS, PANTS, JACK-
ETS, AND HATS (U.S. CLS. 22 AND 39).

FIRST USE 5-1-2004; IN COMMERCE 5-1-2004.

CLASS 25—(Continued).

2,956,089. TOMMY BAHAMA GROUP, INC., NEW YORK, NY. SN 78-344,925. FILED P.R. 12-23-2003; AM. S.R. 1-26-2005.

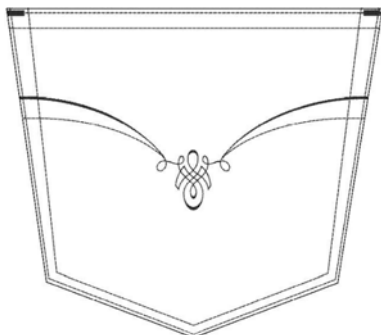

THE MARK CONSISTS OF A STITCHING PATTERN APPEARING ON THE BACK POCKET OF THE GOODS. THE MATTER SHOWN BY THE DOTTED LINES IS NOT A PART OF THE MARK AND SERVES ONLY TO SHOW THE POSITION OF THE MARK.

FOR WOMEN'S CLOTHING; NAMELY, PANTS, JEANS, SHORTS AND SKIRTS (U.S. CLS. 22 AND 39).
FIRST USE 7-1-2003; IN COMMERCE 11-1-2003.

2,956,140. AYER, PETER M, SAN LUIS OBISPO, CA. SN 78-362,058. FILED P.R. 2-3-2004; AM. S.R. 2-24-2005.

**AYER CLOTHING
COMPANY**

THE MARK CONSISTS OF STANDARD CHARACTERS WITHOUT CLAIM TO ANY PARTICULAR FONT, STYLE, SIZE, OR COLOR.

NO CLAIM IS MADE TO THE EXCLUSIVE RIGHT TO USE "CLOTHING COMPANY", APART FROM THE MARK AS SHOWN.

FOR CLOTHING, NAMELY, T-SHIRTS (U.S. CLS. 22 AND 39).

FIRST USE 12-1-2004; IN COMMERCE 12-1-2004.

2,956,141. ELEGANT FOOTWEAR, INC., CITY OF INDUSTRY, CA. SN 78-362,337. FILED P.R. 2-4-2004; AM. S.R. 1-18-2005.

ELEGANT COLLECTION

CLASS 25—(Continued).

THE MARK CONSISTS OF STANDARD CHARACTERS WITHOUT CLAIM TO ANY PARTICULAR FONT, STYLE, SIZE, OR COLOR.

NO CLAIM IS MADE TO THE EXCLUSIVE RIGHT TO USE "COLLECTION", APART FROM THE MARK AS SHOWN.

FOR SHOES (U.S. CLS. 22 AND 39).

FIRST USE 4-0-2004; IN COMMERCE 4-0-2004.

2,956,199. VAN ART DESIGNS, INC., ST. THOMAS, US VIRGIN ISLANDS. SN 78-376,712. FILED P.R. 3-2-2004; AM. S.R. 2-11-2005.



THE APPLICANT'S MARK CONSISTS OF THE STYLIZED WORDING SAINT THOMAS VIRGIN ISLANDS AND A SQUARE BACKGROUND DESIGN.

FOR CLOTHING, NAMELY, SKIRTS, SHIRTS, DRESSES, HATS, PANTS, BATHING SUITS (U.S. CLS. 22 AND 39).

FIRST USE 12-1-2003; IN COMMERCE 12-1-2003.

2,956,238. ROCKAWAY BEACH APPAREL, NEW YORK, NY. SN 78-398,870. FILED P.R. 4-8-2004; AM. S.R. 3-18-2005.

**ROCKAWAY BEACH
APPAREL**

THE MARK CONSISTS OF STANDARD CHARACTERS WITHOUT CLAIM TO ANY PARTICULAR FONT, STYLE, SIZE, OR COLOR.

NO CLAIM IS MADE TO THE EXCLUSIVE RIGHT TO USE "APPAREL", APART FROM THE MARK AS SHOWN.

FOR CLOTHING, NAMELY SWIMWEAR, BIKINI TOPS, BIKINI BOTTOMS, ONE PIECE SWIMSUITS (U.S. CLS. 22 AND 39).

FIRST USE 12-1-2003; IN COMMERCE 1-1-2004.

CLASS 25—(Continued).

2,956,241. WOLPA, STEVE, OMAHA, NE. SN 78-402,035.
FILED P.R. 4-14-2004; AM. S.R. 1-14-2005.

the original
strapless
footwear

THE MARK CONSISTS OF STANDARD CHARACTERS WITHOUT CLAIM TO ANY PARTICULAR FONT, STYLE, SIZE, OR COLOR.

NO CLAIM IS MADE TO THE EXCLUSIVE RIGHT TO USE STRAPLESS FOOTWEAR, APART FROM THE MARK AS SHOWN.

FOR STRAPLESS FOOTWEAR (U.S. CLS. 22 AND 39).
FIRST USE 11-29-2003; IN COMMERCE 11-29-2003.

CLASS 25—(Continued).

2,956,358. BOWLES, DAVID, BROOKLYN, NY. SN 78-472,304.
FILED P.R. 8-24-2004; AM. S.R. 3-25-2005.

poop

THE MARK CONSISTS OF STANDARD CHARACTERS WITHOUT CLAIM TO ANY PARTICULAR FONT, STYLE, SIZE, OR COLOR.

FOR T-SHIRTS, SWEATSHIRTS, JACKETS AND HATS (U.S. CLS. 22 AND 39).

FIRST USE 3-17-2003; IN COMMERCE 4-1-2003.

2,956,335. KRAUTER, SHERRY, CAMPBELL HALL, NY. SN 78-449,304. FILED P.R. 7-12-2004; AM. S.R. 3-14-2005.

Leitz

THE MARK CONSISTS OF THE WORD "LEITZ" IN STYLIZED FORM.

FOR CLOTHING, NAMELY HATS, VISORS, T-SHIRTS AND JACKETS (U.S. CLS. 22 AND 39).

FIRST USE 10-30-2001; IN COMMERCE 10-30-2001.

CLASS 26—FANCY GOODS

2,956,144. UNIVERSAL TRIM SUPPLY CO., LTD., WU KU SHIANG, TAIWAN. SN 78-362,808. FILED P.R. 2-5-2004; AM. S.R. 2-24-2005.

Micro-teeth

THE MARK CONSISTS OF STANDARD CHARACTERS WITHOUT CLAIM TO ANY PARTICULAR FONT, STYLE, SIZE, OR COLOR.

FOR BUTTONS; ZIPPERS, AND PARTS OF ZIPPERS, NAMELY, SLIDERS FOR ZIPPERS, TABS FOR ZIPPERS, CORDLOCKS FOR ZIPPERS, AND ZIPPER PULLS AND FASTENERS; SNAP BUTTONS FOR CLOTHING; CLOTHING BUCKLES; ORNAMENTS FOR ATTACHMENT TO ZIPPER PULLS; AND DRAW CORDS SOLD AS INTEGRAL COMPONENTS OF ZIPPERS (U.S. CLS. 37, 39, 40, 42 AND 50).

FIRST USE 1-15-2004; IN COMMERCE 1-15-2004.

CLASS 26—(Continued).

2,956,198. MASTER MFG. CO., INC., DBA MASTER CASTER COMPANY, CLEVELAND, OH. SN 78-375,190. FILED P.R. 2-27-2004; AM. S.R. 12-29-2004.

CLASS 27—(Continued).

2,956,275. MOHAWK BRANDS, INC., WILMINGTON, DE. SN 78-419,703. FILED P.R. 5-17-2004; AM. S.R. 1-27-2005.

SHOULDER CUSHION

THE MARK CONSISTS OF STANDARD CHARACTERS WITHOUT CLAIM TO ANY PARTICULAR FONT, STYLE, SIZE, OR COLOR.

NO CLAIM IS MADE TO THE EXCLUSIVE RIGHT TO USE "SHOULDER", APART FROM THE MARK AS SHOWN.

FOR SHOULDER STRAP HOLDERS USED TO DISPERSE LOAD AND TO HELP HOLD A SHOULDER STRAP IN PLACE AND TO REDUCE SLIPPING (U.S. CLS. 37, 39, 40, 42 AND 50).

FIRST USE 4-20-2004; IN COMMERCE 4-20-2004.

STAY-PUT

THE MARK CONSISTS OF STANDARD CHARACTERS WITHOUT CLAIM TO ANY PARTICULAR FONT, STYLE, SIZE, OR COLOR.

FOR PAD USED FOR CARPET NAMELY, RUGS (U.S. CLS. 19, 20, 37, 42 AND 50).

FIRST USE 9-12-2004; IN COMMERCE 9-12-2004.

CLASS 27—FLOOR COVERINGS

2,956,106. A.T.G. SPORTS INDUSTRIES, INC., WICHITA, KS. SN 78-350,971. FILED P.R. 1-13-2004; AM. S.R. 2-9-2005.

CLASS 28—TOYS AND SPORTING GOODS

2,955,811. LEVEN INDUSTRIES, CANOGA PARK, CA. SN 76-352,862. FILED P.R. 12-19-2001; AM. S.R. 3-18-2005.

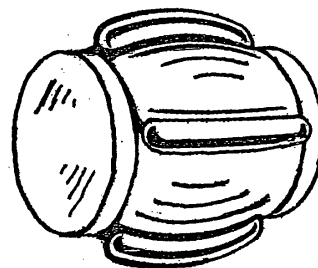
SuperTurf

THE MARK CONSISTS OF STANDARD CHARACTERS WITHOUT CLAIM TO ANY PARTICULAR FONT, STYLE, SIZE, OR COLOR.

FOR SYNTHETIC OR ARTIFICIAL GRASS FOR USE ON ATHLETIC FIELDS AND LAWNS (U.S. CLS. 19, 20, 37, 42 AND 50).

FIRST USE 8-22-2004; IN COMMERCE 8-22-2004.

THE BROKEN LINES ARE TO INDICATE SHADING AND CONTOUR AND ARE NOT MEANT TO INDICATE COLOR.

THE MARK CONSISTS OF A THREE-DIMENSIONAL CONFIGURATION OF A ROOT BARRELED SHAPE.

FOR ARCHERY ACCESSORIES, NAMELY BOW STABILIZERS, V-BARS, V-BAR MOUNTS, EXTENSION BARS, ADJUSTMENT WEIGHTS, VIBRATION ABSORBERS AND BURLEY BARS (U.S. CLS. 22, 23, 38 AND 50).

FIRST USE 2-0-1997; IN COMMERCE 2-0-1997.

CLASS 28—(Continued).

2,955,834. OLIVA, RICHARD A., JR., CHARLOTTESVILLE, VA. SN 76-525,320. FILED P.R. 6-17-2003; AM. S.R. 3-22-2005.



FOR STORAGE RACK BOARDS FOR FISHING RIGS AND LURES (U.S. CLS. 22, 23, 38 AND 50).
FIRST USE 8-26-2003; IN COMMERCE 8-26-2003.

CLASS 28—(Continued).

2,956,085. RUOCCHIO, ALBERT C., RALEIGH, NC. SN 78-342,355. FILED P.R. 12-17-2003; AM. S.R. 1-14-2005.

NYC

2,955,952. KUSCHNIR, ARI, SUNNY ISLES, FL. AND THRIFT, SCOTT, SUNNY ISLES, FL. SN 78-226,210. FILED P.R. 3-17-2003; AM. S.R. 11-1-2004.

SOMETHING

THE MARK CONSISTS OF STANDARD CHARACTERS WITHOUT CLAIM TO ANY PARTICULAR FONT, STYLE, SIZE, OR COLOR.

FOR TOYS, NAMELY, MODEL TOY TRAINS AND MODEL TOY TRAIN LAYOUT ACCESSORIES (U.S. CLS. 22, 23, 38 AND 50).

FIRST USE 2-1-1989; IN COMMERCE 2-1-1989.

FOR NOVELTY ITEMS, NAMELY TOY BLOCKS (U.S. CLS. 22, 23, 38 AND 50).
FIRST USE 7-10-2002; IN COMMERCE 7-10-2002.

2,956,119. DAVID & GOLIATH, INC., CLEARWATER, FL. SN 78-356,646. FILED P.R. 1-23-2004; AM. S.R. 2-14-2005.

BEAR IN UNDERWEAR

2,955,968. TAB-AUSTRIA INDUSTRIE- UND UNTERHALTUNGSELEKTRONIK GMBH & CO. KG, A-4052 ANSFELDEN, AUSTRIA. SN 78-251,503. FILED P.R. 5-19-2003; AM. S.R. 6-14-2004.

VIRTUAL PINBALL

NO CLAIM IS MADE TO THE EXCLUSIVE RIGHT TO USE PINBALL, APART FROM THE MARK AS SHOWN.

FOR PINBALL GAMES OR PINBALL LIKE GAMES EMPLOY A COMPUTER GENERATED OR SIMULATED PINBALL (U.S. CLS. 22, 23, 38 AND 50).

FIRST USE 4-18-2002; IN COMMERCE 8-29-2003.

THE MARK CONSISTS OF STANDARD CHARACTERS WITHOUT CLAIM TO ANY PARTICULAR FONT, STYLE, SIZE, OR COLOR.

FOR BENDABLE, INFLATABLE, PLASTIC CHARACTER, PLUSH, RUBBER CHARACTER, AND STUFFED TOYS (U.S. CLS. 22, 23, 38 AND 50).

FIRST USE 6-15-2004; IN COMMERCE 6-15-2004.

CLASS 28—(Continued).

2,956,167. BLACKWELL, VIRGINIA A., WHEATON, IL. AND CISON, LAURA A., ELBURN, IL. SN 78-367,745. FILED P.R. 2-13-2004; AM. S.R. 3-3-2005.

Create Your Garden

THE COLOR(S) GREEN IS/ARE CLAIMED AS A FEATURE OF THE MARK.

THE COLOR GREEN IS A FEATURE OF THE MARK. THE MARK IS RENDERED IN KRISTEN ITC TYPEFONT.

FOR PRINTED AND BONDED CARDS WITH PHOTOS OF PLANTS AND CULTIVATION INFORMATION SO A GARDENER CAN SELECT PLANTS THEY LIKE BASED ON COLOR, HEIGHT, BLOOM PERIOD, GROWING ZONE AND SOIL CONDITIONS TO CREATE A PLANT LIST FOR THEIR GARDEN (U.S. CLS. 22, 23, 38 AND 50). FIRST USE 4-1-2004; IN COMMERCE 4-1-2004.

2,956,220. HEAVY PUTTER, LLC, SOUTH SALEM, NY. SN 78-386,046. FILED P.R. 3-17-2004; AM. S.R. 1-14-2005.

HEAVY PUTTER

THE MARK CONSISTS OF STANDARD CHARACTERS WITHOUT CLAIM TO ANY PARTICULAR FONT, STYLE, SIZE, OR COLOR.

NO CLAIM IS MADE TO THE EXCLUSIVE RIGHT TO USE "PUTTER", APART FROM THE MARK AS SHOWN.

FOR GOLF EQUIPMENT, NAMELY GOLF PUTTERS (U.S. CLS. 22, 23, 38 AND 50).

FIRST USE 11-15-2004; IN COMMERCE 11-15-2004.

2,956,221. HEAVY PUTTER, LLC, SOUTH SALEM, NY. SN 78-386,073. FILED P.R. 3-17-2004; AM. S.R. 1-14-2005.

WEIGHT MANAGEMENT SYSTEM

THE MARK CONSISTS OF STANDARD CHARACTERS WITHOUT CLAIM TO ANY PARTICULAR FONT, STYLE, SIZE, OR COLOR.

FOR GOLF EQUIPMENT, NAMELY GOLF PUTTERS (U.S. CLS. 22, 23, 38 AND 50).

FIRST USE 11-15-2004; IN COMMERCE 11-15-2004.

CLASS 28—(Continued).

2,956,319. AMERICAN PRINTING HOUSE FOR THE BLIND, LOUISVILLE, KY. SN 78-439,025. FILED P.R. 6-22-2004; AM. S.R. 3-17-2005.

Talking GlowDice

THE MARK CONSISTS OF STANDARD CHARACTERS WITHOUT CLAIM TO ANY PARTICULAR FONT, STYLE, SIZE, OR COLOR.

FOR BATTERY POWERED DICE SIMULATOR WITH DIGITAL SPEECH AND LIGHT EMITTING DIODE OUTPUT DESIGNED FOR THE USE OF BLIND AND VISUALLY IMPAIRED PERSONS (U.S. CLS. 22, 23, 38 AND 50).

FIRST USE 6-1-2004; IN COMMERCE 6-1-2004.

CLASS 29—MEATS AND PROCESSED FOODS

2,955,807. STELLAR BAY SHELLFISH LTD., BOWSER, BRITISH COLUMBIA, CANADA. SN 76-285,606. FILED P.R. 7-16-2001; AM. S.R. 2-8-2005.

KUSSHI

PRIORITY CLAIMED UNDER SEC. 44(D) ON CANADA APPLICATION NO. 1107255, FILED 6-19-2001, REG. NO. TMA593082, DATED 10-27-2003, EXPIRES 10-27-2018.

FOR OYSTERS (U.S. CL. 46).

CLASS 29—(Continued).

2,955,835. CULINARY CROSSING, INC., HARLEYSVILLE, PA. SN 76-527,262. FILED P.R. 6-30-2003; AM. S.R. 2-11-2005.

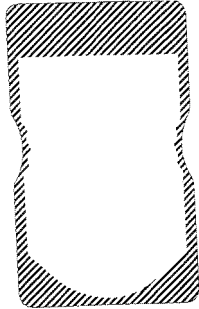

THE DIAGONAL LINING IS A FEATURE OF THE MARK AND DOES NOT INDICATE COLOR.

THE MARK CONSISTS OF A PACKAGE DESIGN WITH A LABEL SURROUNDED BY A BORDER COMPOSED OF DIAGONAL STRAIGHT LINES, THE BORDER BEING CHARACTERIZED BY A LARGE, GENERALLY RECTANGULAR UPPER PORTION, NARROW SIDE PORTIONS THE INTERMEDIATE PARTS OF WHICH ARE BENT TOWARD EACH OTHER, AND A BOTTOM PORTION HAVING A CONCAVE UPPER EDGE. THE BORDER SHAPE IS A FEATURE OF THE MARK.

FOR SOUP (U.S. CL. 46).

FIRST USE 1-5-2004; IN COMMERCE 4-28-2004.

2,955,837. CULINARY CROSSING, INC., HARLEYSVILLE, PA. SN 76-527,580. FILED P.R. 6-30-2003; AM. S.R. 2-11-2005.

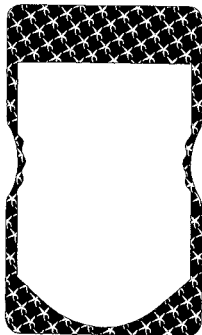

THE MARK CONSISTS OF A PACKAGE DESIGN IN WHICH A LABEL IS SURROUNDED BY A BORDER COMPOSED OF A MULTITUDE OF STARFISH, THE BEING CHARACTERIZED BY A LARGE, GENERALLY RECTANGULAR UPPER PORTION, NARROW SIDE PORTIONS THE INTERMEDIATE PARTS OF WHICH ARE BENT TOWARD EACH OTHER, AND A BOTTOM PORTION HAVE A CONCAVE UPPER EDGE.

FOR SOUP (U.S. CL. 46).

FIRST USE 1-5-2004; IN COMMERCE 4-28-2004.

CLASS 29—(Continued).

2,955,923. SOCIETE DES PRODUITS NESTLE S.A., 1800 VEVEY, SWITZERLAND. SN 78-165,766. FILED P.R. 9-19-2002; AM. S.R. 10-1-2004.

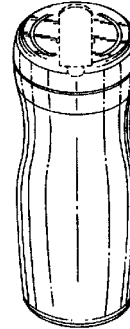

THE COLORS WHITE AND RED ARE CLAIMED AS FEATURES OF THE MARK.

THE MARK CONSISTS OF THE CONFIGURATION OF PRODUCT PACKAGING FOR THE GOODS IN THE FORM OF A WHITE CYLINDRICAL BULBOUS SHAPED CONTAINER WITH A RED TOP. THE COLORS WHITE AND RED ARE CLAIMED AS FEATURES OF THE MARK.

FOR NON-DAIRY CREAMERS (U.S. CL. 46).

FIRST USE 1-8-2001; IN COMMERCE 1-8-2001.

2,956,200. MINERVA DAIRY, INC., MINERVA, OH. SN 78-376,972. FILED P.R. 3-2-2004; AM. S.R. 3-7-2005.

AMISH GOURMET

THE MARK CONSISTS OF STANDARD CHARACTERS WITHOUT CLAIM TO ANY PARTICULAR FONT, STYLE, SIZE, OR COLOR.

FOR CHEESE (U.S. CL. 46).

FIRST USE 5-4-2004; IN COMMERCE 5-4-2004.

CLASS 29—(Continued).

2,956,258. MOUNTAIN VELVET, LTD., DEL NORTE, CO. SN 78-412,188. FILED P.R. 5-3-2004; AM. S.R. 2-1-2005.

Real Elk

THE MARK CONSISTS OF STANDARD CHARACTERS WITHOUT CLAIM TO ANY PARTICULAR FONT, STYLE, SIZE, OR COLOR.

NO CLAIM IS MADE TO THE EXCLUSIVE RIGHT TO USE ELK, APART FROM THE MARK AS SHOWN.

FOR FRESH, FROZEN AND PROCESSED ELK MEAT AND VARIETY MEATS MADE PRIMARILY FROM ELK (U.S. CL. 46).

FIRST USE 12-10-2003; IN COMMERCE 12-16-2003.

2,956,269. CLIF BAR, INC., BERKELEY, CA. SN 78-417,030. FILED P.R. 5-11-2004; AM. S.R. 2-16-2005.

**THE ENTIRELY
NATURAL PROTEIN
BAR**

THE MARK CONSISTS OF STANDARD CHARACTERS WITHOUT CLAIM TO ANY PARTICULAR FONT, STYLE, SIZE, OR COLOR.

NO CLAIM IS MADE TO THE EXCLUSIVE RIGHT TO USE PROTEIN BAR, APART FROM THE MARK AS SHOWN.

FOR PRIMARILY SOY-BASED FOOD BARS ALSO CONTAINING NUTS (U.S. CL. 46).

FIRST USE 5-17-2004; IN COMMERCE 5-17-2004.

CLASS 29—(Continued).

2,956,337. GARCIA-GUTIERREZ, REYNALDO, MONTERREY, N.L., MEXICO. SN 78-450,467. FILED 7-14-2004.

FLAT

THE MARK CONSISTS OF STANDARD CHARACTERS WITHOUT CLAIM TO ANY PARTICULAR FONT, STYLE, SIZE, OR COLOR.

OWNER OF MEXICO REG. NO. 528636, DATED 3-15-1996, EXPIRES 3-15-2006.

FOR HOTDOGS (U.S. CL. 46).

2,956,338. GARCIA-GUTIERREZ, REYNALDO, MONTERREY, N.L., MEXICO. SN 78-450,476. FILED 7-14-2004.

FLAT-DOG

THE MARK CONSISTS OF STANDARD CHARACTERS WITHOUT CLAIM TO ANY PARTICULAR FONT, STYLE, SIZE, OR COLOR.

OWNER OF MEXICO REG. NO. 257164, DATED 3-15-1996, EXPIRES 3-15-2006.

FOR HOTDOGS (U.S. CL. 46).

CLASS 30—STAPLE FOODS

CLASS 30—(Continued).

2,955,836. CULINARY CROSSING, INC., HARLEYSVILLE, PA. SN 76-527,579. FILED P.R. 6-30-2003; AM. S.R. 2-11-2005.

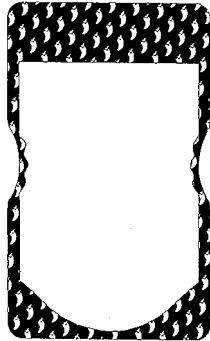

THE PEPPERS WHICH FORM PART OF THE MARK HAVE RED BODIES AND GREEN TOPS. THE RED AND GREEN COLORS ARE A FEATURE OF THE MARK. FOR SALSA (U.S. CL. 46).
FIRST USE 1-5-2004; IN COMMERCE 4-28-2004.

2,955,886. CHOCOLATES DUVIN, EL PASO, TX. SN 76-596,650. FILED P.R. 6-10-2004; AM. S.R. 2-18-2005.



NO CLAIM IS MADE TO THE EXCLUSIVE RIGHT TO USE CHOCOLATE, APART FROM THE MARK AS SHOWN. THE COLOR(S) RED AND YELLOW IS/ARE CLAIMED AS A FEATURE OF THE MARK.

THE WORDS CHOCOLATE SANTA FE ARE IN YELLOW AND WITH A RED BORDER AROUND THE LETTER. FOR INSTANT HOT CHOCOLATE IN THE FORM OF A TABLET AND POWDER (U.S. CL. 46).
FIRST USE 5-0-2004; IN COMMERCE 6-0-2004.

2,955,946. STICKY FOODS, L.L.C., HACKETTSTOWN, NJ. SN 78-212,342. FILED P.R. 2-7-2003; AM. S.R. 10-26-2004.

STICKY WINGS

FOR SAUCE USED ON CHICKEN WINGS (U.S. CL. 46).
FIRST USE 2-17-2004; IN COMMERCE 2-17-2004.

CLASS 30—(Continued).

2,955,965. AUGUST STORCK KG, BERLIN, FED REP GERMANY. SN 78-246,021. FILED P.R. 5-6-2003; AM. S.R. 9-16-2004.



PRIORITY CLAIMED UNDER SEC. 44(D) ON FED REP GERMANY APPLICATION NO. 30253782.1/3, FILED 11-6-2002, REG. NO. 30253782, DATED 1-10-2003, EXPIRES 11-30-2012.

THE COLORS ORANGE/RED, SILVER, LIGHT BROWN AND DARK BROWN ARE CLAIMED AS A FEATURE OF THE MARK.

THE MARK CONSISTS OF A CONFIGURATION OF THE GOODS AND PACKAGING THEREOF AS DEPICTED ON THE DRAWING, WHICH SHOWS AN OPEN CANDY WRAPPER AND A PARTIAL VIEW OF THE GOODS THEREIN. THE PORTION OF THE WRAPPER THAT APPEARS IN BLACK, NAMELY, THE OUTSIDE PORTION AND THE TOP INNER PORTION OF THE WRAPPER ON THE DRAWING IS ORANGE/RED, AND THE REMAINDER OF THE WRAPPER THAT APPEARS IN WHITE ON THE DRAWING PAGE IS SILVER. THE PARTIAL CONFIGURATION OF THE GOODS IS LIGHT BROWN ON TOP AND THE REMAINDER IS DARK BROWN.

FOR CANDY, CHOCOLATE, CHOCOLATES, CHOCOLATE CANDY AND PASTRIES (U.S. CL. 46).

2,955,974. SCHWAN'S IP, LLC, MARSHALL, MN. SN 78-260,341. FILED P.R. 6-10-2003; AM. S.R. 2-1-2005.

MINI EGG ROLLZ

NO CLAIM IS MADE TO THE EXCLUSIVE RIGHT TO USE MINI EGG ROLLS, APART FROM THE MARK AS SHOWN.

FOR EGG ROLLS (U.S. CL. 46).
FIRST USE 3-0-2003; IN COMMERCE 3-0-2003.

CLASS 30—(Continued).

2,956,036. CAMANO ISLAND MANAGEMENT, INC., CAMANO ISLAND, WA. SN 78-307,757. FILED P.R. 9-30-2003; AM. S.R. 12-27-2004.

CAMANO ISLAND COFFEE ROASTERS

FOR LIQUID AND POWDERED COCOA MIXES; POWDERED FLAVORING ADDITIVES FOR NON-NUTRITIONAL PURPOSES; POWDERED FOOD FLAVORINGS; BEVERAGES MADE WITH A BASE OF COFFEE; BEVERAGES MADE WITH A BASE OF ESPRESSO; READY-TO-DRINK COFFEE, READY-TO-DRINK COFFEE BASED BEVERAGES; GROUND AND WHOLE BEAN COFFEE; COCOA; HERBAL AND NON-HERBAL TEAS; COFFEE, TEA, COCOA AND ESPRESSO BEVERAGES, INSTANT COFFEE AND COFFEE SUBSTITUTES; READY-TO-DRINK COFFEE BEVERAGES; FLAVORING SYRUPS FOR BEVERAGES; BAKED GOODS, NAMELY, BAGELS, MUFFINS, SCONES, BISCUITS, COOKIES, PASTRIES AND BREADS; ICE CREAM AND FROZEN CONFECTIONS; MILKSHAKES, ICE CREAM, SHERBET, SORBET, FLAVORED ICES AND FROZEN CONFECTIONS (U.S. CL. 46).

FIRST USE 12-15-2000; IN COMMERCE 12-15-2000.

2,956,120. NATURAL CHOICE DISTRIBUTION CO. LLC, LAFAYETTE, CA. SN 78-356,792. FILED P.R. 1-23-2004; AM. S.R. 12-15-2004.

Real Wraps

THE MARK CONSISTS OF STANDARD CHARACTERS WITHOUT CLAIM TO ANY PARTICULAR FONT, STYLE, SIZE, OR COLOR.

NO CLAIM IS MADE TO THE EXCLUSIVE RIGHT TO USE "WRAPS", APART FROM THE MARK AS SHOWN.

FOR PREPARED FOODS, NAMELY, BURRITOS AND TORTILLA WRAP SANDWICHES (U.S. CL. 46).

FIRST USE 3-1-2003; IN COMMERCE 3-1-2003.

CLASS 30—(Continued).

2,956,216. THE COMFORTCAKE COMPANY, CHICAGO, IL. SN 78-384,510. FILED P.R. 3-15-2004; AM. S.R. 2-22-2005.

Sugarless Sweetness

THE MARK CONSISTS OF STANDARD CHARACTERS WITHOUT CLAIM TO ANY PARTICULAR FONT, STYLE, SIZE, OR COLOR.

FOR SUGAR SUBSTITUTES (U.S. CL. 46).

FIRST USE 5-15-2004; IN COMMERCE 5-15-2004.

2,956,247. SANISSIMO, S.A. DE C.V., MONTERREY, N.L., MEXICO. SN 78-406,290. FILED P.R. 4-22-2004; AM. S.R. 11-29-2004.

SANISSIMO

THE MARK CONSISTS OF STANDARD CHARACTERS WITHOUT CLAIM TO ANY PARTICULAR FONT, STYLE, SIZE, OR COLOR.

THE FOREIGN WORDING IN THE MARK TRANSLATES INTO ENGLISH AS VERY HEALTHY OR HEALTHIEST.

FOR BRAN COOKIES AND CORN CHIPS (U.S. CL. 46).

FIRST USE 7-23-1997; IN COMMERCE 7-23-1997.

CLASS 30—(Continued).

2,956,260. REMBRANDTS COFFEE, LLC, OCEANSIDE, NY.
SN 78-412,662. FILED P.R. 5-4-2004; AM. S.R. 3-29-2005.

Longfellow's Coffee

THE MARK CONSISTS OF STANDARD CHARACTERS
WITHOUT CLAIM TO ANY PARTICULAR FONT, STYLE,
SIZE, OR COLOR.

FOR READY TO GO COFFEE AND READY TO GO
COFFEE-BASED BEVERAGES (U.S. CL. 46).
FIRST USE 10-16-2004; IN COMMERCE 10-16-2004.

2,956,351. FRATERNITE NOTRE DAME, INC., CHICAGO,
IL. SN 78-462,622. FILED 8-5-2004.

ST ROGER ABBEY

THE MARK CONSISTS OF STANDARD CHARACTERS
WITHOUT CLAIM TO ANY PARTICULAR FONT, STYLE,
SIZE, OR COLOR.

FOR PASTRIES, CAKES, PIES, CHOUX, COOKIES,
AND BISCUITS (U.S. CL. 46).
FIRST USE 7-1-2003; IN COMMERCE 7-1-2003.

CLASS 31—NATURAL AGRICULTURAL PRODUCTS

2,955,879. AMERICAN MUSSEL HARVESTERS, INC.,
NORTH KINGSTOWN, RI. SN 76-593,792. FILED P.R. 5-
21-2004; AM. S.R. 3-10-2005.

COASTAL RESERVE OYSTERS

THE MARK CONSISTS OF STANDARD CHARACTERS
WITHOUT CLAIM TO ANY PARTICULAR FONT, STYLE,
SIZE, OR COLOR.

CLASS 31—(Continued).

NO CLAIM IS MADE TO THE EXCLUSIVE RIGHT TO USE
"OYSTERS", APART FROM THE MARK AS SHOWN.
FOR LIVE OYSTERS FOR FOOD PURPOSES (U.S. CLS.
1 AND 46).
FIRST USE 4-14-2004; IN COMMERCE 4-14-2004.

2,956,019. SUNFED PRODUCE, INC., RIO RICO, AZ. SN 78-
292,492. FILED 8-26-2003.

PERFECT HONEYDEWS

OWNER OF U.S. REG. NOS. 2,647,455, 2,655,118, AND
2,667,374.

NO CLAIM IS MADE TO THE EXCLUSIVE RIGHT TO
USE "HONEYDEWS", APART FROM THE MARK AS
SHOWN.

FOR FRESH HONEYDEW MELONS (U.S. CLS. 1 AND
46).
FIRST USE 9-1-1999; IN COMMERCE 9-1-1999.

2,956,108. FRUIT PATCH SALES, LLC, DINUBA, CA. SN 78-
351,506. FILED P.R. 1-13-2004; AM. S.R. 2-3-2005.



THE COLOR(S) BLACK, YELLOW, ORANGE, AND RED
IS/ARE CLAIMED AS A FEATURE OF THE MARK.

THE MARK CONSISTS OF THE TERM "JUICYSWEET"
OUTLINED IN BLACK, WITH THE LETTERS SHADING
FROM YELLOW AT THE BEGINNING OF THE TERM
THROUGH ORANGE IN THE MIDDLE TO RED AT THE
END.

FOR FRESH FRUITS (U.S. CLS. 1 AND 46).
FIRST USE 5-27-2004; IN COMMERCE 5-27-2004.

CLASS 32—LIGHT BEVERAGES

2,955,996. YOGURT TECHNOLOGIES, INC., GALVESTON,
TX. SN 78-277,507. FILED P.R. 7-22-2003; AM. S.R. 1-7-2005.

HURRICANE IN A BAG

FOR NON-ALCOHOLIC POWDERED COCKTAIL
MIXES (U.S. CLS. 45, 46 AND 48).
FIRST USE 1-4-2005; IN COMMERCE 1-4-2005.

CLASS 32—(Continued).

2,956,047. YOGURT TECHNOLOGIES, INC., GALVESTON, TX. SN 78-316,653. FILED P.R. 10-21-2003; AM. S.R. 2-8-2005.

CLASS 33—(Continued).

2,955,943. VINOMEX, S.A. DE C.V., DELICIAS, MEXICO. SN 78-210,336. FILED P.R. 2-3-2003; AM. S.R. 1-28-2005.

MUDSLIDE IN A BAG

NO CLAIM IS MADE TO THE EXCLUSIVE RIGHT TO USE "MUDSLIDE", APART FROM THE MARK AS SHOWN. FOR NON-ALCOHOLIC POWDERED COCKTAIL MIXES (U.S. CLS. 45, 46 AND 48).
FIRST USE 2-4-2005; IN COMMERCE 2-4-2005.

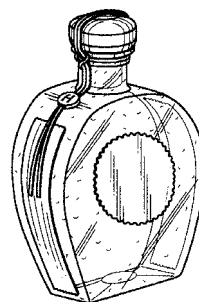

THE MARK CONSISTS OF A CONFIGURATION OF A BOTTLE HAVING A RECTANGULAR BASE WITH ARCHED LATERAL SIDES AND SUBSTANTIALLY FLAT ANTERIOR AND POSTERIOR SIDES. THE NECK OF THE BOTTLE IS CYLINDRICAL WITH A PRONOUNCED LIP AT THE BOTTLE OPENING. THE LID OF THE BOTTLE IS SMOOTH AND OVOID IN PROFILE WITH AN ATTACHED CORK EXTENDING INTO THE BOTTLE MOUTH. A LEATHER STRAP SECURED BY A LOOP KNOT EXTENDS ACROSS THE TOP OF THE LID AND AROUND THE BOTTLE NECK UNDER THE BOTTLE LIP. THE LEATHER STRAP IS AFFIXED TO ONE OF THE LATERAL SIDES OF THE BOTTLE BY A WAX SEAL HAVING AN "H" IN THE CENTER OF THE SEAL. A CIRCULAR LABEL HAVING A SCALLOPED EDGE IS AFFIXED TO THE ANTERIOR SIDE OF THE BOTTLE. A RECTANGULAR LABEL IS AFFIXED TO EACH OF THE LATERAL SIDES OF THE BOTTLE.

FOR ALCOHOLIC BEVERAGES, NAMELY, SOTOL (U.S. CLS. 47 AND 49).

FIRST USE 7-22-1996; IN COMMERCE 7-25-1998.

CLASS 33—WINES AND SPIRITS

2,955,839. SAZERAC COMPANY, INC., NEW ORLEANS, LA. SN 76-532,018. FILED P.R. 7-11-2003; AM. S.R. 2-17-2005.

**AMERICA'S ORIGINAL
COCKTAIL**

NO CLAIM IS MADE TO THE EXCLUSIVE RIGHT TO USE "COCKTAIL", APART FROM THE MARK AS SHOWN. FOR ALCOHOLIC BEVERAGES, NAMELY, WHISKIES AND MIXED DRINKS, NAMELY, PREPARED ALCOHOLIC DRINKS (U.S. CLS. 47 AND 49).
FIRST USE 9-8-2004; IN COMMERCE 9-8-2004.

CLASS 34—SMOKERS' ARTICLES

2,955,849. TROPICAL TOBACCO, INC., MIAMI, FL. SN 76-552,097. FILED P.R. 10-15-2003; AM. S.R. 3-14-2005.

CUBAN LEAF

FOR CIGARS MADE FROM TOBACCO GROWN FROM CUBAN TOBACCO SEEDS (U.S. CLS. 2, 8, 9 AND 17).

FIRST USE 3-0-2004; IN COMMERCE 3-0-2004.

CLASS 34—(Continued).

2,956,090. KAMAT GROUP LLC, LOUISVILLE, KY. SN 78-345,804. FILED P.R. 12-28-2003; AM. S.R. 2-4-2005.

Bombay Beedis

THE MARK CONSISTS OF STANDARD CHARACTERS WITHOUT CLAIM TO ANY PARTICULAR FONT, STYLE, SIZE, OR COLOR.

FOR INDIAN CIGARETTE (U.S. CLS. 2, 8, 9 AND 17). FIRST USE 1-15-2005; IN COMMERCE 1-15-2005.

SERVICE MARKS**CLASS 35—ADVERTISING AND BUSINESS**

2,955,817. PLANET EARTH FOUNDATION, SEATTLE, WA. SN 76-464,136. FILED P.R. 10-28-2002; AM. S.R. 3-11-2005.

CAMPAIGN FOR HEALTH CARE

FOR ADVERTISING SERVICES, NAMELY, CREATING, DESIGNING, AND IMPLEMENTING ADVERTISING AND PUBLIC SERVICE CAMPAIGNS, MARKETING AND DISSEMINATION OF INFORMATION ON ISSUES RELATING TO HEALTH AND HEALTH INSURANCE; PREPARING AND PLACING PRINTED, AUDIO, AUDIO-VISUAL, AND ON-LINE MATERIALS FOR USE IN ADVERTISING AND PUBLIC SERVICE CAMPAIGNS AND MARKETING; LICENSING OF SLOGANS FOR ADVERTISING AND PUBLIC SERVICE CAMPAIGNS AND MARKETING ISSUES RELATING TO HEALTH AND HEALTH INSURANCE; PREPARING AND PLACING IN ALL MEDIA INFORMATION AND ADVERTISEMENTS FOR OTHERS ON ISSUES RELATING TO HEALTH AND HEALTH INSURANCE; RENDERING ADVERTISING AND PUBLIC RELATIONS ADVICE ON ISSUES RELATING TO HEALTH AND HEALTH INSURANCE; AND RENTAL OR LICENSING OF ON-LINE ADVERTISING SPACE (U.S. CLS. 100, 101 AND 102).

FIRST USE 8-5-2002; IN COMMERCE 8-5-2002.

CLASS 35—(Continued).

2,955,825. STASZEL, MICHAEL, LAUDERDALE BY THE SEA, FL. AND OTWINOWSKA-STASZEL, KATARZYNA, LAUDERDALE BY THE SEA, FL. SN 76-508,658. FILED P.R. 4-22-2003; AM. S.R. 2-7-2005.

THE SEXUAL HEALTH STORE

NO CLAIM IS MADE TO THE EXCLUSIVE RIGHT TO USE STORE, APART FROM THE MARK AS SHOWN.

FOR RETAIL VARIETY STORES; ON-LINE RETAIL STORE SERVICES FEATURING VIDEO RECORDINGS, NAMELY, ADULT VIDEOS AND SEXUAL MANUALS AND ADULT SEXUAL AIDS, NAMELY, ARTIFICIAL PENISES, PENIS ENLARGERS, VIBRATORS, ARTIFICIAL VAGINAS, ADULT NOVELTIES, AND LINGERIE (U.S. CLS. 100, 101 AND 102).

FIRST USE 11-28-2000; IN COMMERCE 5-1-2004.

2,955,838. CSRA AIR, INC., AIKEN, SC. SN 76-529,752. FILED P.R. 7-14-2003; AM. S.R. 3-16-2005.

ACDEPOT

THE MARK CONSISTS OF STANDARD CHARACTERS WITHOUT CLAIM TO ANY PARTICULAR FONT, STYLE, SIZE, OR COLOR.

FOR WHOLESALE AND RETAIL STORES FEATURING AIR CONDITIONING APPARATUS (U.S. CLS. 100, 101 AND 102).

FIRST USE 7-30-2004; IN COMMERCE 7-30-2004.

2,955,861. BRAR, HARINDER SINGH, SNOHOMISH, WA. SN 76-571,102. FILED P.R. 1-21-2004; AM. S.R. 8-24-2004.

INDO-AMERICAN BUSINESS PAGES

THE MARK CONSISTS OF STANDARD CHARACTERS WITHOUT CLAIM TO ANY PARTICULAR FONT, STYLE, SIZE, OR COLOR.

NO CLAIM IS MADE TO THE EXCLUSIVE RIGHT TO USE "BUSINESS", APART FROM THE MARK AS SHOWN.

FOR PROVIDING ON-LINE DIRECTORY INFORMATION SERVICES ALSO FEATURING INCIDENTAL HYPERLINKS TO OTHER WEB SITES; ONLINE TELEPHONE DIRECTORY INFORMATION SERVICES; ONLINE DISSEMINATION OF ADVERTISING FOR OTHERS (U.S. CLS. 100, 101 AND 102).

FIRST USE 7-0-2004; IN COMMERCE 7-0-2004.

CLASS 35—(Continued).

2,955,867. VENVEST, INC., ST. LOUIS, MO. SN 76-573,757. FILED P.R. 2-3-2004; AM. S.R. 2-28-2005.

10 DIGIT MARKETING

THE MARK CONSISTS OF STANDARD CHARACTERS WITHOUT CLAIM TO ANY PARTICULAR FONT, STYLE, SIZE, OR COLOR.

NO CLAIM IS MADE TO THE EXCLUSIVE RIGHT TO USE MARKETING, APART FROM THE MARK AS SHOWN. FOR BUSINESS CONSULTATION AND BUSINESS MARKETING CONSULTING FOR PLUMBING, ELECTRICAL AND HVAC BUSINESS (U.S. CLS. 100, 101 AND 102).

FIRST USE 1-0-2001; IN COMMERCE 1-0-2001.

2,955,872. LATIN MARKETING AND COMMUNICATION CORP., JACKSON HEIGHTS, NY. SN 76-576,870. FILED P.R. 2-20-2004; AM. S.R. 1-19-2005.

1-800-FIND WORK

THE MARK CONSISTS OF STANDARD CHARACTERS WITHOUT CLAIM TO ANY PARTICULAR FONT, STYLE, SIZE, OR COLOR.

FOR EMPLOYMENT AGENCY SERVICES; MARKETING THE SERVICES OF EMPLOYMENT AGENCIES AND JOB PLACEMENT SPECIALISTS BY PREPARING AND PLACING ONLINE ADVERTISEMENTS, AND LEASING USE OF A NOVELTY TOLL-FREE PHONE NUMBER; PROVIDING ONLINE INFORMATION IN THE FIELD OF EMPLOYMENT (U.S. CLS. 100, 101 AND 102).

FIRST USE 2-13-2004; IN COMMERCE 2-13-2004.

CLASS 35—(Continued).

2,955,874. AGUDAT HAKORMIM HACOOPERATIVIT SHEL YEKVEI RICHON LE ZION V'ZICHRON YAAKOV B.M., DBA CARMEL WINE GROWERS COOPERATIVE, RICHON LE ZION 75100, ISRAEL. SN 76-579,275. FILED P.R. 3-5-2004; AM. S.R. 3-18-2005.

HANDCRAFTED WINES OF ISRAEL

THE MARK CONSISTS OF STANDARD CHARACTERS WITHOUT CLAIM TO ANY PARTICULAR FONT, STYLE, SIZE, OR COLOR.

NO CLAIM IS MADE TO THE EXCLUSIVE RIGHT TO USE "WINES" OR "ISRAEL", APART FROM THE MARK AS SHOWN.

FOR ADVERTISING AND MARKETING SERVICES, NAMELY, PROMOTING THE SALE OF ALCOHOLIC BEVERAGES, NAMELY, WINE, THROUGH THE DISTRIBUTION OF PRINTED MATERIAL (U.S. CLS. 100, 101 AND 102).

FIRST USE 1-30-2005; IN COMMERCE 1-30-2005.

2,955,891. BITPIPE INC., BOSTON, MA. SN 76-600,715. FILED P.R. 7-6-2004; AM. S.R. 3-21-2005.



The logo for "Analyst Views" features the word "Analyst" in a bold, black, sans-serif font. Below it, the word "Views" is written in a lighter, grey, sans-serif font. The letter "V" in "Views" is stylized, with its top bar extending to the left and overlapping the "A" in "Analyst".

FOR COMMERCIAL INFORMATION IN THE FIELD OF INFORMATION TECHNOLOGY, NAMELY PROVIDING ONLINE EDITORIAL SUMMARIES OF MARKET REPORTS IN THE INFORMATION TECHNOLOGY FIELD (U.S. CLS. 100, 101 AND 102).

FIRST USE 6-1-2004; IN COMMERCE 6-1-2004.

2,955,905. BROOKS, LINDA ROBERTSON, SHERMAN OAKS, CA. SN 78-031,938. FILED P.R. 10-23-2000; AM. S.R. 1-12-2005.

FINANCIAL JOB NET

FOR PROVIDING AN ON-LINE ELECTRONIC DATABASE ON GLOBAL COMPUTER NETWORKS FEATURING FINANCIAL JOB LISTINGS, RESUMES OF POTENTIAL CANDIDATES FOR JOBS IN FINANCE AND INFORMATION ABOUT JOBS IN FINANCE (U.S. CLS. 100, 101 AND 102).

FIRST USE 5-11-2004; IN COMMERCE 5-11-2004.

CLASS 35—(Continued).

2,955,916. BERG, JENNA, SANTA BARBARA, CA. SN 78-131,845. FILED P.R. 5-29-2002; AM. S.R. 2-23-2005.

JOBAPS.COM

FOR COMPUTER-BASED SYSTEMS AND SERVICES FOR PROCESSING ONLINE EMPLOYMENT APPLICATIONS (U.S. CLS. 100, 101 AND 102).
FIRST USE 0-0-1998; IN COMMERCE 0-0-1998.

2,955,921. BUILDING INDUSTRY ASSOCIATION OF SOUTHEASTERN MICHIGAN, FARMINGTON HILLS, MI. SN 78-145,185. FILED P.R. 7-18-2002; AM. S.R. 9-1-2004.

BIA BUILDERS & REMODELERS EXPO

FOR ARRANGING AND CONDUCTING TRADE SHOWS, EXHIBITIONS AND CONFERENCES IN THE FIELD OF CONSTRUCTION, HOME IMPROVEMENT, DECORATING, GARDENING AND LANDSCAPING (U.S. CLS. 100, 101 AND 102).
FIRST USE 1-10-2003; IN COMMERCE 1-10-2003.

2,955,971. CHINA ALLIANCE, LLC, ST. LOUIS, MO. SN 78-256,976. FILED P.R. 6-2-2003; AM. S.R. 2-2-2005.

CHINA ALLIANCE

FOR PROVIDING BUSINESS INFORMATION AND BUSINESS CONSULTATION TO OTHERS ABOUT REQUIREMENTS FOR DOING BUSINESS IN CHINA AND FACILITATING THE CONDUCTING OF BUSINESS TRANSACTIONS IN CHINA (U.S. CLS. 100, 101 AND 102).
FIRST USE 3-1-2003; IN COMMERCE 3-1-2003.

2,955,978. INDEPENDENT WAREHOUSE DISTRIBUTORS LLC, NEW HAVEN, CT. SN 78-261,980. FILED P.R. 6-13-2003; AM. S.R. 1-24-2005.

TRUCK SERVICE EXPERTS

OWNER OF U.S. REG. NOS. 1,813,985, 2,604,243, AND OTHERS.

NO CLAIM IS MADE TO THE EXCLUSIVE RIGHT TO USE TRUCK SERVICE, APART FROM THE MARK AS SHOWN.

FOR RETAIL STORE SERVICES FEATURING AUTOMOBILE AND TRUCK PARTS (U.S. CLS. 100, 101 AND 102).
FIRST USE 1-14-2005; IN COMMERCE 1-14-2005.

CLASS 35—(Continued).

2,955,983. LILLIAN JONES, TROY, MI. SN 78-268,346. FILED P.R. 6-28-2003; AM. S.R. 2-27-2005.

THE WORKSHOP STORE

NO CLAIM IS MADE TO THE EXCLUSIVE RIGHT TO USE "STORE", APART FROM THE MARK AS SHOWN.

FOR LICENSING OF TRAINING MANUALS USED IN THE FIELDS OF EMPLOYEE DEVELOPMENT AND INCREASED WORK PRODUCTIVITY (U.S. CLS. 100, 101 AND 102).
FIRST USE 7-1-2001; IN COMMERCE 7-1-2001.

2,955,987. PAUL F. MAHONEY, MILTON, MA. SN 78-271,928. FILED P.R. 7-9-2003; AM. S.R. 10-20-2004.

VALUE BASED CAPITAL

NO CLAIM IS MADE TO THE EXCLUSIVE RIGHT TO USE "CAPITAL", APART FROM THE MARK AS SHOWN.

FOR BUSINESS CONSULTATION IN THE FIELD OF RAISING CAPITAL (U.S. CLS. 100, 101 AND 102).
FIRST USE 2-15-2003; IN COMMERCE 2-15-2003.

2,956,008. AMERICAN PUBLIC MEDIA GROUP, ST. PAUL, MN. SN 78-283,093. FILED P.R. 8-5-2003; AM. S.R. 12-30-2004.

RADIO MUSICSOURCE

OWNER OF U.S. REG. NOS. 1,875,645 AND 2,521,749.
FOR ONLINE ORDERING SERVICES FEATURING AUDIO AND VIDEO MUSIC RECORDINGS BY MEANS OF A GLOBAL COMPUTER NETWORK (U.S. CLS. 100, 101 AND 102).

FIRST USE 7-25-2003; IN COMMERCE 7-25-2003.

2,956,011. INTEGRATED SYSTEMS EVENTS LLC, FAIRFAX, VA. SN 78-284,518. FILED P.R. 8-7-2003; AM. S.R. 3-3-2005.

INTEGRATED SYSTEMS EUROPE

NO CLAIM IS MADE TO THE EXCLUSIVE RIGHT TO USE "EUROPE", APART FROM THE MARK AS SHOWN.

FOR ORGANIZING, PROMOTING AND CONDUCTING CONFERENCES AND TRADE SHOWS CONCERNING THE PRODUCTS AND SERVICES OF AND TOPICS OF INTEREST TO THOSE IN THE AUDIO/VIDEO, PROJECTION, PRESENTATION AND AUDIOVISUAL COMMUNICATIONS INDUSTRIES (U.S. CLS. 100, 101 AND 102).

FIRST USE 2-3-2004; IN COMMERCE 2-3-2004.

CLASS 35—(Continued).

2,956,012. LWIN FAMILY CO., CHARLOTTE, NC. SN 78-286,697. FILED P.R. 8-13-2003; AM. S.R. 8-27-2004.

PURVEYOR OF QUALITY SUSHI TO MARKETS AND CAFES

FOR BUSINESS CONSULTING AND MANAGEMENT IN THE OPERATION OF SUSHI IN MARKETS AND CAFES (U.S. CLS. 100, 101 AND 102).

FIRST USE 1-1-2003; IN COMMERCE 1-1-2003.

2,956,026. SUNCOAST ROOFERS SUPPLY, INC., TAMPA, FL. SN 78-295,938. FILED P.R. 9-4-2003; AM. S.R. 2-23-2005.

ROOF DESIGN CENTERS OF AMERICA

NO CLAIM IS MADE TO THE EXCLUSIVE RIGHT TO USE "ROOF", APART FROM THE MARK AS SHOWN.

FOR PROVIDING SHOWROOMS FEATURING COMMERCIAL AND RESIDENTIAL ROOFING PRODUCTS AND SUPPLIES MANUFACTURED BY OTHERS (U.S. CLS. 100, 101 AND 102).

FIRST USE 5-1-2002; IN COMMERCE 5-1-2002.

2,956,030. ROLLER, KERRY LEE, MORGAN HILL, CA. SN 78-300,090. FILED P.R. 9-14-2003; AM. S.R. 4-22-2004.

SALES ANALYTICS

NO CLAIM IS MADE TO THE EXCLUSIVE RIGHT TO USE "SALES", APART FROM THE MARK AS SHOWN.

FOR BUSINESS CONSULTANT IN THE FIELD OF SALES (U.S. CLS. 100, 101 AND 102).

FIRST USE 11-1-2003; IN COMMERCE 1-22-2004.

2,956,035. BIRMINGHAM AREA TECHNOLOGY LEADERSHIP ALLIANCE, BIRMINGHAM, AL. SN 78-307,631. FILED P.R. 9-30-2003; AM. S.R. 11-8-2004.

TECHBIRMINGHAM

FOR PROMOTING TECHNOLOGY GROWTH AND ECONOMIC DEVELOPMENT IN THE BIRMINGHAM METROPOLITAN AREA (U.S. CLS. 100, 101 AND 102).

FIRST USE 3-1-2002; IN COMMERCE 3-1-2002.

CLASS 35—(Continued).

2,956,038. ARROWHEAD PROMOTION AND FULFILLMENT CO., INC., GRAND RAPIDS, MN. SN 78-312,254. FILED P.R. 10-10-2003; AM. S.R. 1-12-2005.

DESKTOP SAVINGS

FOR ELECTRONIC ADVERTISING AND PROMOTIONAL SERVICES FOR OTHERS, NAMELY, ELECTRONIC DELIVERY VIA COMPUTER OF CUSTOMER-SPECIFIC COUPONS AND SPECIAL OFFERS (U.S. CLS. 100, 101 AND 102).

FIRST USE 1-10-2005; IN COMMERCE 1-10-2005.

2,956,053. CAIAZZO, JILL TIFFANY, NEW YORK, NY. SN 78-320,669. FILED P.R. 10-30-2003; AM. S.R. 11-19-2004.

BANKNOTE CONFERENCE

NO CLAIM IS MADE TO THE EXCLUSIVE RIGHT TO USE CONFERENCE, APART FROM THE MARK AS SHOWN.

FOR ARRANGING BUSINESS CONFERENCES (U.S. CLS. 100, 101 AND 102).

FIRST USE 11-1-1999; IN COMMERCE 11-1-1999.

2,956,055. CAIAZZO, JILL TIFFANY, NEW YORK, NY. SN 78-321,320. FILED P.R. 10-30-2003; AM. S.R. 11-19-2004.

BANKNOTE 2005

NO CLAIM IS MADE TO THE EXCLUSIVE RIGHT TO USE 2005, APART FROM THE MARK AS SHOWN.

FOR ARRANGING AND CONDUCTING BUSINESS CONFERENCES (U.S. CLS. 100, 101 AND 102).

FIRST USE 2-1-2003; IN COMMERCE 2-1-2003.

CLASS 35—(Continued).

2,956,059. NEW SECTOR ALLIANCE, INC., CAMBRIDGE, MA. SN 78-325,656. FILED P.R. 11-10-2003; AM. S.R. 2-9-2005.

**NEW SECTOR
ALLIANCE**

THE MARK CONSISTS OF STANDARD CHARACTERS WITHOUT CLAIM TO ANY PARTICULAR FONT, STYLE, SIZE, OR COLOR.

NO CLAIM IS MADE TO THE EXCLUSIVE RIGHT TO USE ALLIANCE, APART FROM THE MARK AS SHOWN.

FOR BUSINESS CONSULTING SERVICES TO DEVELOP SOCIAL-PURPOSE ORGANIZATIONS, NAMELY, CONSULTING WITH RELATION TO STRATEGY, MARKETING AND PERSONNEL MATTERS (U.S. CLS. 100, 101 AND 102).

FIRST USE 11-3-2003; IN COMMERCE 11-3-2003.

CLASS 35—(Continued).

2,956,062. MULHOLLAND BROTHERS, SAN FRANCISCO, CA. SN 78-326,850. FILED P.R. 11-12-2003; AM. S.R. 3-11-2005.

MULHOLLAND

THE MARK CONSISTS OF STANDARD CHARACTERS WITHOUT CLAIM TO ANY PARTICULAR FONT, STYLE, SIZE, OR COLOR.

OWNER OF U.S. REG. NOS. 2,242,225, 2,265,833, AND OTHERS.

FOR RETAIL STORE SERVICES AND ON-LINE RETAIL SERVICES FEATURING LEATHER GOODS, SPORTING ACCESSORIES, CLOTHING AND FURNITURE (U.S. CLS. 100, 101 AND 102).

FIRST USE 11-0-2002; IN COMMERCE 11-0-2002.

2,956,061. BAYER CROSCIENCE LP, RESEARCH TRIANGLE PARK, NC. SN 78-326,730. FILED P.R. 11-12-2003; AM. S.R. 12-27-2004.

PAPERLESS POINTS

THE MARK CONSISTS OF STANDARD CHARACTERS WITHOUT CLAIM TO ANY PARTICULAR FONT, STYLE, SIZE, OR COLOR.

FOR PROMOTING THE GOODS AND SERVICES OF OTHERS BY MEANS OF AN INCENTIVE AWARDS PROGRAM FOR PEST CONTROL PRODUCT CUSTOMERS (U.S. CLS. 100, 101 AND 102).

FIRST USE 7-31-2003; IN COMMERCE 10-1-2003.

2,956,066. ADVANCED RESEARCH TECHNOLOGIES, INC., CAMBRIDGE, MA. SN 78-330,224. FILED P.R. 11-19-2003; AM. S.R. 8-5-2004.

**ADVANCED RESEARCH
TECHNOLOGIES**

THE MARK CONSISTS OF STANDARD CHARACTERS WITHOUT CLAIM TO ANY PARTICULAR FONT, STYLE, SIZE, OR COLOR.

FOR BUSINESS SERVICES, NAMELY, BUSINESS RESEARCH, CONDUCTING SURVEYS, BUSINESS CONSULTATION, ECONOMIC FORECASTING AND ANALYSIS, DEVELOPING STRATEGIC BUSINESS PLANS AND PROVIDING STATISTICAL INFORMATION TO GOVERNMENTAL AGENCIES, REGIONAL ASSOCIATIONS, INDUSTRIES, AND BUSINESSES FOR THE PURPOSE OF FOSTERING GROWTH, ENTREPRENEURSHIP, INNOVATION AND COLLABORATION BETWEEN BUSINESSES (U.S. CLS. 100, 101 AND 102).

FIRST USE 4-27-2002; IN COMMERCE 4-27-2002.

CLASS 35—(Continued).

2,956,067. CALPASC, DBA PROFESSIONAL ASSOCIATION OF SPECIALTY CONTRACTORS, SAN DIEGO, CA. SN 78-331,143. FILED P.R. 11-20-2003; AM. S.R. 12-30-2004.

PROFESSIONAL
ASSOCIATION OF
SPECIALTY
CONTRACTORS

THE MARK CONSISTS OF STANDARD CHARACTERS WITHOUT CLAIM TO ANY PARTICULAR FONT, STYLE, SIZE, OR COLOR.

FOR TRADE ASSOCIATION SERVICES, NAMELY, PROMOTING, REPRESENTING, ADVOCATING, AND LOBBYING THE INTERESTS OF RESIDENTIAL TRADE CONTRACTORS, SUPPLIERS, AND RELATED BUSINESSES (U.S. CLS. 100, 101 AND 102).

FIRST USE 6-9-2000; IN COMMERCE 6-9-2000.

2,956,077. FONTAINE MODIFICATION COMPANY, CHARLOTTE, NC. SN 78-338,896. FILED P.R. 12-10-2003; AM. S.R. 1-12-2005.

TRUCK TRAK

THE MARK CONSISTS OF STANDARD CHARACTERS WITHOUT CLAIM TO ANY PARTICULAR FONT, STYLE, SIZE, OR COLOR.

FOR ONLINE VEHICLE QUOTATION, ORDERING, AND ORDER STATUS DETERMINATION SERVICES (U.S. CLS. 100, 101 AND 102).

FIRST USE 9-30-2003; IN COMMERCE 9-30-2003.

CLASS 35—(Continued).

2,956,088. LUTHER'S SMOKEHOUSE, INC., LEROY, KS. SN 78-344,795. FILED P.R. 12-23-2003; AM. S.R. 3-17-2005.

JERKYUSA.COM

THE MARK CONSISTS OF STANDARD CHARACTERS WITHOUT CLAIM TO ANY PARTICULAR FONT, STYLE, SIZE, OR COLOR.

FOR COMPUTERIZED ON-LINE RETAIL STORE SERVICES FEATURING SMOKED MEATS AND MEAT SNACKS (U.S. CLS. 100, 101 AND 102).

FIRST USE 1-25-1999; IN COMMERCE 1-25-1999.

2,956,102. MORARI SPECIALTIES, INC., MIAMI, FL. SN 78-349,501. FILED P.R. 1-8-2004; AM. S.R. 1-13-2005.

MORARI

THE MARK CONSISTS OF STANDARD CHARACTERS WITHOUT CLAIM TO ANY PARTICULAR FONT, STYLE, SIZE, OR COLOR.

FOR WHOLESALE DISTRIBUTORSHIP SERVICES FEATURING FRESH PRODUCE (U.S. CLS. 100, 101 AND 102).

FIRST USE 10-29-2003; IN COMMERCE 10-29-2003.

CLASS 35—(Continued).

2,956,103. BILLETS AMERICA, LLC, TARRYTOWN, NY. SN 78-350,115. FILED P.R. 1-9-2004; AM. S.R. 2-8-2005.

**MEDIA PERFORMANCE
MONITOR AMERICA**

THE MARK CONSISTS OF STANDARD CHARACTERS WITHOUT CLAIM TO ANY PARTICULAR FONT, STYLE, SIZE, OR COLOR.
FOR BUSINESS MANAGEMENT CONSULTING SERVICES FOR THE PURPOSE OF ENHANCING MARKETING COMMUNICATIONS EFFECTIVENESS (U.S. CLS. 100, 101 AND 102).
FIRST USE 9-23-2003; IN COMMERCE 9-23-2003.

CLASS 35—(Continued).

2,956,126. AFFORDABLE KIOSKS, INC., PHOENIX, AZ. SN 78-358,759. FILED P.R. 1-28-2004; AM. S.R. 3-1-2005.

AFFORDABLEKIOSKS

THE MARK CONSISTS OF STANDARD CHARACTERS WITHOUT CLAIM TO ANY PARTICULAR FONT, STYLE, SIZE, OR COLOR.
FOR ONLINE RETAIL STORE FEATURING KIOSKS, KIOSK HARDWARE, AND KIOSK-RELATED ACCESSORIES (U.S. CLS. 100, 101 AND 102).
FIRST USE 4-15-2002; IN COMMERCE 4-20-2002.

2,956,132. LANIER WORLDWIDE, INC., ATLANTA, GA. SN 78-359,675. FILED P.R. 1-29-2004; AM. S.R. 2-14-2005.

**MANAGED DOCUMENT
PRODUCTIVITY**

THE MARK CONSISTS OF STANDARD CHARACTERS WITHOUT CLAIM TO ANY PARTICULAR FONT, STYLE, SIZE, OR COLOR.
FOR CONSULTATION SERVICES IN THE FIELD OF DOCUMENT MANAGEMENT AND DOCUMENT PRODUCTION (U.S. CLS. 100, 101 AND 102).
FIRST USE 1-0-2004; IN COMMERCE 1-0-2004.

2,956,116. RANGER ENTERPRISES, INC., ROCKFORD, IL. SN 78-355,492. FILED P.R. 1-22-2004; AM. S.R. 3-4-2005.



THE COLOR(S) YELLOW, RED, ORANGE AND BLUE IS/ ARE CLAIMED AS A FEATURE OF THE MARK.
THE MARK CONSISTS OF COMPRISES HORIZONTAL STRIPES OF YELLOW, RED, ORANGE AND BLUE ARRANGED VERTICALLY IN SEQUENCE.
FOR RETAIL STORE SERVICES FEATURING CONVENIENCE STORE ITEMS, GASOLINE AND DIESEL (U.S. CLS. 100, 101 AND 102).
FIRST USE 7-31-2003; IN COMMERCE 7-31-2003.

2,956,142. EPLEY MARKETING SERVICES, INC., NORTH LIBERTY, IA. SN 78-362,492. FILED P.R. 2-4-2004; AM. S.R. 2-18-2005.

SUPERINTERVIEW

THE MARK CONSISTS OF STANDARD CHARACTERS WITHOUT CLAIM TO ANY PARTICULAR FONT, STYLE, SIZE, OR COLOR.
FOR MARKET AND PUBLIC OPINION POLLING FOR BUSINESS AND ADVERTISING SERVICES BY WAY OF TELEPHONE (U.S. CLS. 100, 101 AND 102).
FIRST USE 3-4-2004; IN COMMERCE 3-4-2004.

CLASS 35—(Continued).

2,956,152. **PODIATRIC THERAPY AMERICA, LLC, TARRY-TOWN, NY.** SN 78-364,671. FILED P.R. 2-9-2004; AM. S.R. 3-1-2005.

**PODIATRIC THERAPY
AMERICA**

THE MARK CONSISTS OF STANDARD CHARACTERS WITHOUT CLAIM TO ANY PARTICULAR FONT, STYLE, SIZE, OR COLOR.

NO CLAIM IS MADE TO THE EXCLUSIVE RIGHT TO USE "THERAPY", APART FROM THE MARK AS SHOWN.

FOR BUSINESS MANAGEMENT AND ADVICE, NAMELY, PROVIDING START-UP SUPPORT, OPERATIONAL PLANNING AND MANAGEMENT FOR THE BUSINESSES OF OTHERS IN THE FIELD OF PHYSICAL THERAPY SERVICES AND OTHER DESIGNATED HEALTH SERVICES (DHS), FOR PODIATRISTS AND MEDICAL DOCTORS (U.S. CLS. 100, 101 AND 102).

FIRST USE 10-1-2003; IN COMMERCE 10-1-2003.

2,956,161. **OPTOMETRIC PHYSICIANS OF WASHINGTON, BELLEVUE, WA.** SN 78-366,738. FILED P.R. 2-12-2004; AM. S.R. 3-7-2005.

EyeExpo Northwest

THE MARK CONSISTS OF STANDARD CHARACTERS WITHOUT CLAIM TO ANY PARTICULAR FONT, STYLE, SIZE, OR COLOR.

FOR ARRANGING AND CONDUCTING TRADE SHOW EXHIBITIONS IN THE FIELD OF EYE CARE (U.S. CLS. 100, 101 AND 102).

FIRST USE 7-1-2003; IN COMMERCE 7-1-2003.

2,956,180. **INSTORECARD, INC., SAN FRANCISCO, CA.** SN 78-369,693. FILED P.R. 2-18-2004; AM. S.R. 3-21-2005.

INSTORECARD

CLASS 35—(Continued).

THE MARK CONSISTS OF STANDARD CHARACTERS WITHOUT CLAIM TO ANY PARTICULAR FONT, STYLE, SIZE, OR COLOR.

FOR MERCHANDISING AND MARKETING SERVICES FOR INDUCING THE PURCHASING PUBLIC TO BUY THE GOODS OF OTHERS THROUGH AN ONLINE PROMOTIONAL PRODUCT DISCOUNT AND AWARD REDEMPTION PROGRAM (U.S. CLS. 100, 101 AND 102).

FIRST USE 3-1-2004; IN COMMERCE 3-1-2004.

2,956,183. **NATIONAL MED NETWORK, LLC, ROCKFORD, IL.** SN 78-369,939. FILED P.R. 2-18-2004; AM. S.R. 2-28-2005.

**National Med
Network**

THE MARK CONSISTS OF STANDARD CHARACTERS WITHOUT CLAIM TO ANY PARTICULAR FONT, STYLE, SIZE, OR COLOR.

NO CLAIM IS MADE TO THE EXCLUSIVE RIGHT TO USE "MED", APART FROM THE MARK AS SHOWN.

FOR PROCUREMENT SERVICES, NAMELY, PURCHASING LARGE QUANTITIES OF MEDICAL SUPPLIES AND MEDICAL DEVICES FOR RESALE TO OTHERS (U.S. CLS. 100, 101 AND 102).

FIRST USE 4-2-2003; IN COMMERCE 4-2-2003.

2,956,184. **CHG MANAGEMENT, INC., SALT LAKE CITY, UT.** SN 78-370,253. FILED P.R. 2-18-2004; AM. S.R. 3-11-2005.

RN NETWORK

THE MARK CONSISTS OF STANDARD CHARACTERS WITHOUT CLAIM TO ANY PARTICULAR FONT, STYLE, SIZE, OR COLOR.

FOR HEALTHCARE RECRUITING AND STAFFING SERVICES (U.S. CLS. 100, 101 AND 102).

FIRST USE 6-19-1998; IN COMMERCE 9-4-1998.

CLASS 35—(Continued).

2,956,204. TOLL FREE YELLOW PAGES, CORP., AKA TOLL FREE YELLOW PAGES - 1-877-YELLOWPAGES - TFYP - YELLOWPAGES BY TELEPHONE, BEVERLY HILLS, CA. SN 78-379,258. FILED P.R. 3-5-2004; AM. S.R. 1-31-2005.

CLASS 35—(Continued).

2,956,214. HARLEY'S HOUSE OF HARLEYS, OCEANSIDE, CA. SN 78-383,575. FILED P.R. 3-12-2004; AM. S.R. 3-16-2005.

1-877-YELLOWPAGES

BIGGS

THE MARK CONSISTS OF STANDARD CHARACTERS WITHOUT CLAIM TO ANY PARTICULAR FONT, STYLE, SIZE, OR COLOR.

NO CLAIM IS MADE TO THE EXCLUSIVE RIGHT TO USE "YELLOW PAGES", APART FROM THE MARK AS SHOWN.

FOR TOLL-FREE TELEPHONE DIRECTORY INFORMATION SERVICES, WHEREBY CONSUMERS CAN CALL AND REQUEST FOR A CATEGORY OR PRODUCT AND BE GIVEN A LIST OF BUSINESSES THAT PROVIDE THOSE SERVICES AND/OR PRODUCTS (U.S. CLS. 100, 101 AND 102).

FIRST USE 1-1-2004; IN COMMERCE 1-1-2004.

THE MARK CONSISTS OF STANDARD CHARACTERS WITHOUT CLAIM TO ANY PARTICULAR FONT, STYLE, SIZE, OR COLOR.

FOR RETAIL STORE SERVICES IN CONNECTION WITH MOTORCYCLES AND MOTORCYCLE ACCESSORIES (U.S. CLS. 100, 101 AND 102).

FIRST USE 8-22-2003; IN COMMERCE 8-22-2003.

2,956,215. SOUTHERN STRATEGY GROUP, INC., TALLAHASSEE, FL. SN 78-384,033. FILED P.R. 3-14-2004; AM. S.R. 2-24-2005.

2,956,205. TMW MARKETING COMPANY, INC., FREMONT, CA. SN 78-379,421. FILED P.R. 3-5-2004; AM. S.R. 9-17-2004.

U.S. Strategy Group



NO CLAIM IS MADE TO THE EXCLUSIVE RIGHT TO USE REWARDS PROGRAM, APART FROM THE MARK AS SHOWN.

THE COLOR(S) RED AND BROWN IS/ARE CLAIMED AS A FEATURE OF THE MARK.

THE WORD PERFECT IS IN BROWN, THE WORD FIT IS IN RED.

FOR CUSTOMER LOYALTY PROGRAM, NAMELY A BONUS INCENTIVE PROGRAM FOR RETAIL CLOTHING CUSTOMERS (U.S. CLS. 100, 101 AND 102).

FIRST USE 9-1-2004; IN COMMERCE 9-1-2004.

THE MARK CONSISTS OF STANDARD CHARACTERS WITHOUT CLAIM TO ANY PARTICULAR FONT, STYLE, SIZE, OR COLOR.

NO CLAIM IS MADE TO THE EXCLUSIVE RIGHT TO USE "STRATEGY GROUP", APART FROM THE MARK AS SHOWN.

FOR PUBLIC RELATIONS CONSULTING SERVICES AND BUSINESS CONSULTING SERVICES IN THE FIELDS OF BUSINESS STRATEGIES, CORPORATE POSITIONING, LEGISLATIVE AFFAIRS, PUBLIC AFFAIRS, COMMUNITY AFFAIRS, MEDIA RELATIONS; AND GOVERNMENT RELATIONS SERVICES FOR OTHERS, NAMELY, PROVIDING LOBBYING SERVICES, NAMELY, PROMOTING THE INTERESTS OF INTERNATIONAL, REAL ESTATE AND NONPROFIT COMPANIES IN THE FIELDS OF POLITICS, LEGISLATION, AND REGULATION (U.S. CLS. 100, 101 AND 102).

FIRST USE 3-1-2004; IN COMMERCE 11-1-2004.

CLASS 35—(Continued).

2,956,224. INFOSPACE, INC., BELLEVUE, WA. SN 78-389,177.
FILED P.R. 3-23-2004; AM. S.R. 2-18-2005.

CLASS 35—(Continued).

2,956,263. SHANOWER, LISA, MILL VALLEY, CA. SN 78-
414,624. FILED P.R. 5-6-2004; AM. S.R. 3-18-2005.

LocalCalls

THE MARK CONSISTS OF STANDARD CHARACTERS WITHOUT CLAIM TO ANY PARTICULAR FONT, STYLE, SIZE, OR COLOR.

NO CLAIM IS MADE TO THE EXCLUSIVE RIGHT TO USE "CALLS", APART FROM THE MARK AS SHOWN.

FOR ADVERTISING SERVICES, NAMELY, TRACKING AND MONITORING THE EFFECTIVENESS OF AN INTERNET ADVERTISING CAMPAIGN BY AUTOMATICALLY TRACING TELEPHONE CALLS BACK TO A SPECIFIC ADVERTISING SOURCE ON THE INTERNET (U.S. CLS. 100, 101 AND 102).

FIRST USE 8-19-2004; IN COMMERCE 8-19-2004.

Back Cover Media

THE MARK CONSISTS OF STANDARD CHARACTERS WITHOUT CLAIM TO ANY PARTICULAR FONT, STYLE, SIZE, OR COLOR.

NO CLAIM IS MADE TO THE EXCLUSIVE RIGHT TO USE "MEDIA", APART FROM THE MARK AS SHOWN.

FOR INDEPENDENT SALES REPRESENTATIVES IN THE FIELD OF PRINT, ON-LINE, AND BROADCAST MEDIA; CONSULTATION IN THE FIELD OF ADVERTISING (U.S. CLS. 100, 101 AND 102).

FIRST USE 2-9-2004; IN COMMERCE 3-1-2004.

2,956,270. IN THE SWIM, WEST CHICAGO, IL. SN 78-417,120.
FILED P.R. 5-12-2004; AM. S.R. 1-6-2005.

2,956,233. MZ CONSULT SERVICOS E NEGOCIOS S/C LTDA, SAO PAULO, BRAZIL. SN 78-394,128. FILED P.R. 3-31-2004; AM. S.R. 1-18-2005.



PRIORITY CLAIMED UNDER SEC. 44(D) ON BRAZIL APPLICATION NO. 826243304, FILED 3-29-2004.

NO CLAIM IS MADE TO THE EXCLUSIVE RIGHT TO USE RANKINGS, APART FROM THE MARK AS SHOWN.

FOR RANKING OF INVESTOR RELATIONS WEBSITES AND PREPARING BUSINESS RANKING REPORTS REGARDING COMMUNICATION MEANS BETWEEN PUBLIC COMPANIES AND THE CAPITAL MARKET SUCH AS DEBT AND EQUITY INSTITUTIONAL INVESTORS, RETAIL INVESTORS, ANALYSTS AND RATING AGENCIES (U.S. CLS. 100, 101 AND 102).

FIRST USE 0-0-1999; IN COMMERCE 0-0-1999.

America's #1 Direct Source for Pool Supplies

THE MARK CONSISTS OF STANDARD CHARACTERS WITHOUT CLAIM TO ANY PARTICULAR FONT, STYLE, SIZE, OR COLOR.

NO CLAIM IS MADE TO THE EXCLUSIVE RIGHT TO USE "POOL SUPPLIES", APART FROM THE MARK AS SHOWN.

FOR MAIL ORDER CATALOG SERVICES FEATURING SWIMMING POOL CHEMICALS AND SUPPLIES (U.S. CLS. 100, 101 AND 102).

FIRST USE 3-1-2002; IN COMMERCE 3-1-2002.

CLASS 35—(Continued).

2,956,273. TWO WEST, INC., KANSAS CITY, MO. SN 78-418,298. FILED P.R. 5-13-2004; AM. S.R. 2-8-2005.

CLASS 35—(Continued).

2,956,279. HENDON PUBLISHING CO., DEERFIELD, IL. SN 78-422,045. FILED P.R. 5-20-2004; AM. S.R. 2-9-2005.

RAPID RESEARCH

**TACTICAL
PROCUREMENT**

THE MARK CONSISTS OF STANDARD CHARACTERS WITHOUT CLAIM TO ANY PARTICULAR FONT, STYLE, SIZE, OR COLOR.

NO CLAIM IS MADE TO THE EXCLUSIVE RIGHT TO USE "RESEARCH", APART FROM THE MARK AS SHOWN, FOR PROVIDING BUSINESS RESEARCH SERVICES IN THE FIELDS OF MARKETING AND BRANDING (U.S. CLS. 100, 101 AND 102).

FIRST USE 12-1-2003; IN COMMERCE 1-1-2004.

THE MARK CONSISTS OF STANDARD CHARACTERS WITHOUT CLAIM TO ANY PARTICULAR FONT, STYLE, SIZE, OR COLOR.

FOR ORGANIZING, PROMOTING AND CONDUCTING TRADE SHOW EXHIBITIONS AND CONFERENCES RELATING TO TACTICAL UNIT LAW ENFORCEMENT (U.S. CLS. 100, 101 AND 102).

FIRST USE 9-11-2002; IN COMMERCE 9-11-2002.

2,956,277. PEDRAZA , MILTON, F., WYCKOFF, NJ. SN 78-420,892. FILED P.R. 5-18-2004; AM. S.R. 1-17-2005.

2,956,282. HENDON PUBLISHING CO., DEERFIELD, IL. SN 78-422,181. FILED P.R. 5-20-2004; AM. S.R. 2-9-2005.

LUXURY INSTITUTE

HENDON EXPO GROUP

THE MARK CONSISTS OF STANDARD CHARACTERS WITHOUT CLAIM TO ANY PARTICULAR FONT, STYLE, SIZE, OR COLOR.

NO CLAIM IS MADE TO THE EXCLUSIVE RIGHT TO USE "INSTITUTE", APART FROM THE MARK AS SHOWN, FOR BUSINESS RESEARCH AND ADVICE IN AREAS SUCH AS MARKETING, BRANDING, ADVERTISING, CONSUMER SPENDING AND BUSINESS PRACTICES IN THE LUXURY CONSUMER SERVICES AND PRODUCTS SECTORS (U.S. CLS. 100, 101 AND 102).

FIRST USE 5-17-2004; IN COMMERCE 5-17-2004.

THE MARK CONSISTS OF STANDARD CHARACTERS WITHOUT CLAIM TO ANY PARTICULAR FONT, STYLE, SIZE, OR COLOR.

NO CLAIM IS MADE TO THE EXCLUSIVE RIGHT TO USE "EXPO GROUP", APART FROM THE MARK AS SHOWN.

FOR ORGANIZING, PROMOTING AND CONDUCTING TRADE SHOW EXHIBITIONS AND BUSINESS CONFERENCES RELATING TO LAW ENFORCEMENT (U.S. CLS. 100, 101 AND 102).

FIRST USE 9-9-2002; IN COMMERCE 9-9-2002.

CLASS 35—(Continued).

2,956,283. HENDON PUBLISHING CO., DEERFIELD, IL. SN 78-422,281. FILED P.R. 5-20-2004; AM. S.R. 2-9-2005.

CLASS 35—(Continued).

2,956,291. AQUANTIVE, INC., SEATTLE, WA. SN 78-426,459. FILED P.R. 5-27-2004; AM. S.R. 2-14-2005.

POLICE FLEET EXPO

THE MARK CONSISTS OF STANDARD CHARACTERS WITHOUT CLAIM TO ANY PARTICULAR FONT, STYLE, SIZE, OR COLOR.

NO CLAIM IS MADE TO THE EXCLUSIVE RIGHT TO USE "EXPO", APART FROM THE MARK AS SHOWN.

FOR ORGANIZING, PROMOTING AND CONDUCTING TRADE SHOW EXHIBITIONS AND BUSINESS CONFERENCES RELATING TO LAW ENFORCEMENT, NAMELY POLICE FLEET MANAGEMENT AND OPERATIONS (U.S. CLS. 100, 101 AND 102).

FIRST USE 3-7-2003; IN COMMERCE 3-7-2003.

BIDMANAGER

THE MARK CONSISTS OF STANDARD CHARACTERS WITHOUT CLAIM TO ANY PARTICULAR FONT, STYLE, SIZE, OR COLOR.

FOR BUSINESS AND ADVERTISING SERVICES, NAMELY, DISSEMINATING OF ADVERTISING, DIRECT ADVERTISING, MARKETING AND PROMOTING THE SERVICES OF ON-LINE ADVERTISERS VIA A GLOBAL COMPUTER NETWORK (U.S. CLS. 100, 101 AND 102).

FIRST USE 9-30-2001; IN COMMERCE 9-30-2001.

2,956,285. ROMAINE PIERSON PUBLISHERS, INC., JAMESBURG, NJ. SN 78-422,503. FILED P.R. 5-20-2004; AM. S.R. 3-1-2005.

2,956,292. LAWRENCE MUSIC, INC., PITTSBURGH, PA. SN 78-426,574. FILED P.R. 5-27-2004; AM. S.R. 1-28-2005.

**PHARMACEUTICAL
BUSINESS STRATEGIES**

THE MARK CONSISTS OF STANDARD CHARACTERS WITHOUT CLAIM TO ANY PARTICULAR FONT, STYLE, SIZE, OR COLOR.

FOR ADVERTISING SERVICES, NAMELY, PROVIDING ADVERTISING SPACE IN MAGAZINES, JOURNALS, NEWSLETTERS, FEATURE REPORTS, SUPPLEMENTS, AND WEB SITES THAT PROVIDE GENERAL INFORMATION AND BUSINESS ADVICE IN THE FIELDS OF PHARMACEUTICAL PRODUCTS, PRODUCTION, PLANNING, INVESTMENT, PROCESSING, MANUFACTURING, LOGISTICS, SUPPLY CHAIN SOLUTIONS, INFORMATION TECHNOLOGY, WHOLESALE, DISTRIBUTION, DELIVERY, VENDORS, SUPPLIERS, AND PACKAGING AND DELIVERY SYSTEMS (U.S. CLS. 100, 101 AND 102).

FIRST USE 4-23-2004; IN COMMERCE 4-23-2004.

THE MARK CONSISTS OF STANDARD CHARACTERS WITHOUT CLAIM TO ANY PARTICULAR FONT, STYLE, SIZE, OR COLOR.

FOR ONLINE RETAIL SERVICES FEATURING MUSICAL INSTRUMENTS, AND PARTS AND ACCESSORIES THEREFORE (U.S. CLS. 100, 101 AND 102).

FIRST USE 8-1-2004; IN COMMERCE 8-1-2004.

JUSTPICKUPS.COM

CLASS 35—(Continued).

2,956,294. WTC-TRADE MART, L.P., DALLAS, TX. SN 78-428,092. FILED P.R. 6-1-2004; AM. S.R. 2-4-2005.

HOLIDAY & HOME EXPO

THE MARK CONSISTS OF STANDARD CHARACTERS WITHOUT CLAIM TO ANY PARTICULAR FONT, STYLE, SIZE, OR COLOR.

NO CLAIM IS MADE TO THE EXCLUSIVE RIGHT TO USE "EXPO", APART FROM THE MARK AS SHOWN.

FOR ARRANGING AND CONDUCTING TRADE SHOWS IN THE FIELDS OF PERMANENT BOTANICAL, SEASONAL DÉCOR AND GIFTS AND DECORATIVE ACCESSORIES (U.S. CLS. 100, 101 AND 102).

FIRST USE 3-0-2004; IN COMMERCE 3-0-2004.

2,956,296. GOURMET APPLIANCE OUTLET, OAKLAND, CA. SN 78-428,835. FILED P.R. 6-2-2004; AM. S.R. 2-2-2005.

Gourmet Appliance Outlet

THE MARK CONSISTS OF STANDARD CHARACTERS WITHOUT CLAIM TO ANY PARTICULAR FONT, STYLE, SIZE, OR COLOR.

NO CLAIM IS MADE TO THE EXCLUSIVE RIGHT TO USE "OUTLET", APART FROM THE MARK AS SHOWN.

FOR RETAIL LIQUIDATION CENTER FOR LARGE KITCHEN APPLIANCES AND INCIDENTAL MERCHANDISE (U.S. CLS. 100, 101 AND 102).

FIRST USE 2-1-2003; IN COMMERCE 5-27-2003.

2,956,298. FEP, INC., SANTA MONICA, CA. SN 78-429,483. FILED P.R. 6-3-2004; AM. S.R. 2-16-2005.

Cupones y Muestras

THE MARK CONSISTS OF STANDARD CHARACTERS WITHOUT CLAIM TO ANY PARTICULAR FONT, STYLE, SIZE, OR COLOR.

CLASS 35—(Continued).

THE FOREIGN WORDING IN THE MARK TRANSLATES INTO ENGLISH AS COUPONS AND SAMPLES.

FOR ADVERTISING SERVICES, NAMELY, PROMOTING THE GOODS AND SERVICES OF OTHERS THROUGH DISTRIBUTION OF COUPONS AND SAMPLES OF NATIONAL BRAND PRODUCTS VIA AN INTERNET WEB SITE (U.S. CLS. 100, 101 AND 102).

FIRST USE 3-7-2000; IN COMMERCE 3-7-2000.

2,956,304. COBB ENTERPRISES, INC., DBA HI-TECH HOME, CLOVIS, CA. SN 78-433,602. FILED P.R. 6-11-2004; AM. S.R. 3-22-2005.

HI-TECH HOME

THE MARK CONSISTS OF STANDARD CHARACTERS WITHOUT CLAIM TO ANY PARTICULAR FONT, STYLE, SIZE, OR COLOR.

FOR ONLINE AND OFFLINE RETAIL STORE SERVICES FEATURING ELECTRONIC AUDIO, VIDEO, NETWORKING, SECURITY, AND AUTOMATION EQUIPMENT FOR THE HOME (U.S. CLS. 100, 101 AND 102).

FIRST USE 10-0-2003; IN COMMERCE 10-0-2003.

2,956,305. GRETER BOSTON CONVENTION & VISITORS BUREAU, BOSTON, MA. SN 78-433,668. FILED P.R. 6-11-2004; AM. S.R. 3-22-2005.

Restaurant Week Boston

THE MARK CONSISTS OF STANDARD CHARACTERS WITHOUT CLAIM TO ANY PARTICULAR FONT, STYLE, SIZE, OR COLOR.

FOR NAME OF A PROMOTIONAL EVENT FOR RESTAURANTS IN BOSTON WHO OFFER LUNCHEAS AND/OR DINNERS AT PRIX FIX PRICES (U.S. CLS. 100, 101 AND 102).

FIRST USE 8-15-2000; IN COMMERCE 8-15-2000.

CLASS 35—(Continued).

2,956,313. KELLEY, LYNN, SCOTTSDALE, AZ. SN 78-436,814.
FILED P.R. 6-17-2004; AM. S.R. 2-9-2005.

**US MANGALARGA
MARCHADOR
ASSOCIATION**

THE MARK CONSISTS OF STANDARD CHARACTERS WITHOUT CLAIM TO ANY PARTICULAR FONT, STYLE, SIZE, OR COLOR.

NO CLAIM IS MADE TO THE EXCLUSIVE RIGHT TO USE "ASSOCIATION", APART FROM THE MARK AS SHOWN.

FOR ASSOCIATION SERVICES, NAMELY PROMOTING THE INTERESTS OF MANGALARGA MARCHADOR HORSE OWNERS AND BREEDERS; PROVIDING AND MAINTAINING A REGISTRY OF CERTIFIED MANGALARGA MARCHADOR HORSES (U.S. CLS. 100, 101 AND 102).

FIRST USE 6-3-2004; IN COMMERCE 6-3-2004.

2,956,317. FIZER, STEPHEN, LAS VEGAS, NV. SN 78-438,815.
FILED P.R. 6-21-2004; AM. S.R. 1-31-2005.

LASVEGASREALTY.BIZ

THE MARK CONSISTS OF STANDARD CHARACTERS WITHOUT CLAIM TO ANY PARTICULAR FONT, STYLE, SIZE, OR COLOR.

FOR REAL ESTATE ADVERTISING (U.S. CLS. 100, 101 AND 102).

FIRST USE 6-11-2004; IN COMMERCE 6-11-2004.

CLASS 35—(Continued).

2,956,326. MOFFLY PUBLICATIONS, INC., GREENWICH, CT. SN 78-442,968. FILED P.R. 6-29-2004; AM. S.R. 2-17-2005.



NO CLAIM IS MADE TO THE EXCLUSIVE RIGHT TO USE "MAGAZINES", APART FROM THE MARK AS SHOWN.

FOR ADVERTISING AND BUSINESS SERVICES, NAMELY, ADVERTISING THE GOODS AND SERVICES OF OTHERS THROUGH THE PLACEMENT OF ADVERTISEMENTS IN PRINTED PUBLICATIONS AND ON A SEPARATELY MAINTAINED WEBSITE (U.S. CLS. 100, 101 AND 102).

FIRST USE 11-1-2003; IN COMMERCE 11-1-2003.

2,956,331. LE, BRUCE, HUNTERSVILLE, NC. SN 78-446,643.
FILED P.R. 7-6-2004; AM. S.R. 2-8-2005.

EAR RX

THE MARK CONSISTS OF STANDARD CHARACTERS WITHOUT CLAIM TO ANY PARTICULAR FONT, STYLE, SIZE, OR COLOR.

NO CLAIM IS MADE TO THE EXCLUSIVE RIGHT TO USE "RX", APART FROM THE MARK AS SHOWN.

FOR RETAIL STORE SERVICES IN THE FIELD OF HEARING AIDS AND RELATED ACCESSORIES (U.S. CLS. 100, 101 AND 102).

FIRST USE 7-1-2004; IN COMMERCE 7-1-2004.

CLASS 35—(Continued).

2,956,340. AYAMON, LLC, SAINT PAUL, MN. SN 78-453,035. FILED P.R. 7-19-2004; AM. S.R. 3-19-2005.

findopensourceupp
ort.com

THE MARK CONSISTS OF STANDARD CHARACTERS WITHOUT CLAIM TO ANY PARTICULAR FONT, STYLE, SIZE, OR COLOR.

FOR ONLINE REFERRAL, ADVERTISING AND MARKETING SERVICES IN THE FIELDS OF COMPUTER SOFTWARE SUPPORT AND RELATED CONSULTING SERVICES (U.S. CLS. 100, 101 AND 102).

FIRST USE 10-15-2003; IN COMMERCE 3-25-2004.

CLASS 35—(Continued).

2,956,363. AYAMON, LLC, SAINT PAUL, MN. SN 78-533,270. FILED P.R. 12-15-2004; AM. S.R. 3-19-2005.

findnetworkmonitori
ng.com

THE MARK CONSISTS OF STANDARD CHARACTERS WITHOUT CLAIM TO ANY PARTICULAR FONT, STYLE, SIZE, OR COLOR.

FOR ON-LINE REFERRAL, ADVERTISING, AND MARKETING SERVICES CONCERNING COMPUTER NETWORK MONITORING PRODUCTS AND SERVICES (U.S. CLS. 100, 101 AND 102).

FIRST USE 10-15-2003; IN COMMERCE 3-2-2004.

CLASS 36—INSURANCE AND FINANCIAL

2,955,819. WALLACE, JERRY L., DESTIN, FL. SN 76-480,631. FILED P.R. 1-7-2003; AM. S.R. 12-7-2004.

KEYLESS MANAGEMENT

NO CLAIM IS MADE TO THE EXCLUSIVE RIGHT TO USE "MANAGEMENT", APART FROM THE MARK AS SHOWN.

FOR REAL ESTATE RENTAL MANAGEMENT SERVICES (U.S. CLS. 100, 101 AND 102).

FIRST USE 12-1-2002; IN COMMERCE 12-1-2002.

2,956,342. JAY-ROC MARKETING INC., WOODSIDE, NY. SN 78-456,156. FILED P.R. 7-24-2004; AM. S.R. 3-10-2005.

Condoms Of The
Month Club

THE MARK CONSISTS OF STANDARD CHARACTERS WITHOUT CLAIM TO ANY PARTICULAR FONT, STYLE, SIZE, OR COLOR.

NO CLAIM IS MADE TO THE EXCLUSIVE RIGHT TO USE CONDOM AND CLUB, APART FROM THE MARK AS SHOWN.

FOR MAIL ORDER SERVICES FEATURING CONDOMS AVAILABLE ON A MONTHLY BASIS (U.S. CLS. 100, 101 AND 102).

FIRST USE 1-26-2001; IN COMMERCE 1-26-2001.

2,955,827. NICHE SOLUTIONS GROUP, ARLINGTON HEIGHTS, VA. SN 76-510,602. FILED P.R. 4-14-2003; AM. S.R. 3-25-2004.

**THE INSURANCE AND
BENEFITS NICHE MARKET
SPECIALISTS**

NO CLAIM IS MADE TO THE EXCLUSIVE RIGHT TO USE INSURANCE AND BENEFITS NICHE MARKET, APART FROM THE MARK AS SHOWN.

FOR INSURANCE SERVICES, NAMELY, INSURANCE UNDERWRITING AND ADMINISTRATION, BROKERAGE SERVICES, AND CLAIMS ADJUSTMENT IN THE FIELD OF SPECIAL RISK ACCIDENT AND PROPERTY AND CASUALTY INSURANCE; ADMINISTRATION OF EMPLOYEE BENEFIT PLANS FEATURING TRADITIONAL INSURANCE AND NON-INSURANCE PROGRAMS FOR EMPLOYEES ON A PAYROLL DEDUCTION BASIS (U.S. CLS. 100, 101 AND 102).

FIRST USE 6-1-2003; IN COMMERCE 6-1-2003.

CLASS 36—(Continued).

2,955,829. CHAPDELAIN & CO., NEW YORK, NY. SN 76-514,594. FILED P.R. 5-14-2003; AM. S.R. 2-8-2005.

TOP 3

FOR PROVIDING BROKERAGE AND INVESTMENT SERVICES IN THE FIELD OF SECURITIES (U.S. CLS. 100, 101 AND 102).

FIRST USE 2-0-2002; IN COMMERCE 2-0-2002.

2,955,853. EUROPEAN VILLAGE, LLC., PALM COAST, FL. SN 76-561,433. FILED P.R. 11-24-2003; AM. S.R. 1-10-2005.

EUROPEAN VILLAGE

THE MARK CONSISTS OF STANDARD CHARACTERS WITHOUT CLAIM TO ANY PARTICULAR FONT, STYLE, SIZE, OR COLOR.

FOR REAL ESTATE MANAGEMENT (U.S. CLS. 100, 101 AND 102).

FIRST USE 12-1-2001; IN COMMERCE 5-0-2002.

2,955,868. GENERAL RE CORPORATION, STAMFORD, CT. SN 76-573,838. FILED P.R. 2-4-2004; AM. S.R. 2-7-2005.

ENTERPRISE BASED INVESTMENT BENCHMARKS

THE MARK CONSISTS OF STANDARD CHARACTERS WITHOUT CLAIM TO ANY PARTICULAR FONT, STYLE, SIZE, OR COLOR.

FOR FINANCIAL ANALYSIS AND FINANCIAL ADVICE; FINANCIAL MANAGEMENT SERVICES, NAMELY, PROVIDING AND UPDATING AN INDEX FOR MEASURING THE PERFORMANCE OF INVESTORS' PORTFOLIOS (U.S. CLS. 100, 101 AND 102).

FIRST USE 2-1-2004; IN COMMERCE 2-1-2004.

2,955,880. FIRST COMMAND FINANCIAL PLANNING, INC., FORT WORTH, TX. SN 76-594,221. FILED P.R. 5-24-2004; AM. S.R. 2-7-2005.

**THE #1 INDEPENDENT PROVIDER
OF FINANCIAL PLANS TO THE
PROFESSIONAL MILITARY FAMILY**

FOR FINANCIAL PLANNING SERVICES (U.S. CLS. 100, 101 AND 102).

FIRST USE 3-0-2001; IN COMMERCE 3-0-2001.

CLASS 36—(Continued).

2,955,884. PHILLIPSGARDNER, L.L.C., OREM, UT. SN 76-595,850. FILED P.R. 6-7-2004; AM. S.R. 2-18-2005.

**GUARANTEED INTEREST GENERATING
INSURED LOAN SYSTEM**

THE MARK CONSISTS OF STANDARD CHARACTERS WITHOUT CLAIM TO ANY PARTICULAR FONT, STYLE, SIZE, OR COLOR.

FOR FINANCIAL PLANNING SERVICES (U.S. CLS. 100, 101 AND 102).

FIRST USE 2-27-2004; IN COMMERCE 2-27-2004.

2,955,885. PHILLIPSGARDNER, L.L.C., OREM, UT. SN 76-595,851. FILED P.R. 6-7-2004; AM. S.R. 1-31-2005.

GIGILS

THE MARK CONSISTS OF STANDARD CHARACTERS WITHOUT CLAIM TO ANY PARTICULAR FONT, STYLE, SIZE, OR COLOR.

FOR FINANCIAL PLANNING SERVICES (U.S. CLS. 100, 101 AND 102).

FIRST USE 2-27-2004; IN COMMERCE 2-27-2004.

2,955,889. FOREX CAPITAL MARKETS LLC, NEW YORK, NY. SN 76-597,875. FILED 6-17-2004.

FOREX CAPITAL MARKETS

THE MARK CONSISTS OF STANDARD CHARACTERS WITHOUT CLAIM TO ANY PARTICULAR FONT, STYLE, SIZE, OR COLOR.

OWNER OF U.S. REG. NO. 2,905,367.

FOR INTERNATIONAL COMMODITY TRADING AND EXCHANGE SERVICES FOR OTHERS; INTEGRATION FUTURES EXCHANGE SERVICES; INTERNATIONAL STOCK EXCHANGE PRICE QUOTATION; INTERNATIONAL FINANCIAL EXCHANGE AND MONETARY SERVICES; FOREIGN CURRENCY EXCHANGE AND ADVICE; INTEGRATION FINANCIAL CLEARING HOUSE SERVICES; FINANCIAL SERVICES, NAMELY, INVESTMENT FUND TRANSFER AND TRANSACTION SERVICES (U.S. CLS. 100, 101 AND 102).

FIRST USE 7-1-1999; IN COMMERCE 7-1-1999.

CLASS 36—(Continued).

2,955,894. BLUE PLANET RUN FOUNDATION, SAN FRANCISCO, CA. SN 76-601,922. FILED P.R. 7-12-2004; AM. S.R. 3-22-2005.

THE WORLD FOOTRACE

THE MARK CONSISTS OF STANDARD CHARACTERS WITHOUT CLAIM TO ANY PARTICULAR FONT, STYLE, SIZE, OR COLOR.

FOR CHARITABLE FUND RAISING SERVICES (U.S. CLS. 100, 101 AND 102).
FIRST USE 9-23-2002; IN COMMERCE 2-4-2003.

2,955,902. IDT HORIZON GT, INC., NEWARK, NJ. SN 78-008,921. FILED P.R. 5-19-2000; AM. S.R. 1-26-2005.

ESECLEND

FOR PROVIDING FINANCIAL SERVICES BY MEANS OF A GLOBAL COMPUTER NETWORK IN THE NATURE OF A SECURITIES OFFERING AUCTION, FEATURING SECURITIES TRADING, EXECUTION, AND DISTRIBUTION (U.S. CLS. 100, 101 AND 102).
FIRST USE 1-25-2005; IN COMMERCE 1-25-2005.

2,955,926. EDUFUND INTERNATIONAL, INC., NEW YORK, NY. SN 78-168,321. FILED P.R. 9-26-2002; AM. S.R. 9-16-2003.

**GLOBAL STUDENT
LOAN**

THE MARK CONSISTS OF STANDARD CHARACTERS WITHOUT CLAIM TO ANY PARTICULAR FONT, STYLE, SIZE, OR COLOR.

NO CLAIM IS MADE TO THE EXCLUSIVE RIGHT TO USE "LOAN", APART FROM THE MARK AS SHOWN.

FOR STUDENT LOAN SERVICES, NAMELY, ARRANGING LOANS TO STUDENTS RESIDING OUTSIDE OF THE UNITED STATES WHO DESIRE TO ATTEND COLLEGES OR UNIVERSITIES, IN PERSON OR THROUGH DISTANCE LEARNING PROGRAMS, IN THE UNITED STATES OR IN THEIR COUNTRY OF ORIGIN (U.S. CLS. 100, 101 AND 102).
FIRST USE 4-1-2003; IN COMMERCE 4-1-2003.

CLASS 36—(Continued).

2,955,950. SIPES, WILLIAM H., JR., JACKSON, TN. SN 78-221,729. FILED P.R. 3-5-2003; AM. S.R. 6-21-2004.

THE TAX MINIMIZER

FOR TAX PLANNING AND PREPARATION SERVICES (U.S. CLS. 100, 101 AND 102).
FIRST USE 8-4-2002; IN COMMERCE 8-4-2002.

2,955,955. GALLERY PLACE ASSOCIATES, LLC., WASHINGTON, DC. SN 78-227,228. FILED P.R. 3-19-2003; AM. S.R. 12-8-2004.

**RESIDENCES AT GALLERY
PLACE**

OWNER OF U.S. REG. NO. 2,527,857.
NO CLAIM IS MADE TO THE EXCLUSIVE RIGHT TO USE "RESIDENCES", APART FROM THE MARK AS SHOWN.

FOR REAL ESTATE SERVICES, NAMELY, LEASING, RENTING, AND MANAGING APARTMENTS; REAL ESTATE SERVICES, NAMELY, LEASING, RENTING, AND MANAGING CONDOMINIUM UNITS; REAL ESTATE BROKERAGE SERVICES (U.S. CLS. 100, 101 AND 102).

FIRST USE 6-0-2003; IN COMMERCE 6-0-2003.

2,955,970. ECREDITGROUP.COM, INC., SANTA BARBARA, CA. SN 78-256,569. FILED P.R. 5-31-2003; AM. S.R. 4-29-2004.

ECREDITGROUP.COM

FOR PERSONAL CREDIT REMEDIATION SERVICES, NAMELY, DISPUTING CREDIT BUREAU REPORTS FOR INDIVIDUALS (U.S. CLS. 100, 101 AND 102).
FIRST USE 2-0-2003; IN COMMERCE 2-0-2003.

2,955,976. GLOBAL FOREST PARTNERS LP, WEST LEBANON, NH. SN 78-261,420. FILED P.R. 6-12-2003; AM. S.R. 6-1-2004.

**GLOBAL FOREST
PARTNERS LP**

NO CLAIM IS MADE TO THE EXCLUSIVE RIGHT TO USE "FOREST PARTNERS LP", APART FROM THE MARK AS SHOWN.

FOR INVESTMENT ADVISORY SERVICES (U.S. CLS. 100, 101 AND 102).
FIRST USE 9-30-2003; IN COMMERCE 9-30-2003.

CLASS 36—(Continued).

2,955,998. AMERICAN PIONEER FINANCIAL SERVICES, INC., OREM, UT. SN 78-277,852. FILED P.R. 7-23-2003; AM. S.R. 1-31-2005.

VIRTUAL LOAN OFFICER

FOR FINANCIAL SERVICES, NAMELY PROVIDING LOAN INFORMATION, MORTGAGE INFORMATION, UNDERWRITING AND ANNUITY CONTRACT INFORMATION, LOANS AND MORTGAGES AND FUNDING MORTGAGES TO BROKERS VIA GLOBAL COMPUTER INFORMATION NETWORKS (U.S. CLS. 100, 101 AND 102).

FIRST USE 6-1-2000; IN COMMERCE 6-1-2000.

2,956,050. CAREY & KUTAY DEVELOPMENT GROUP, LLC, LOS ANGELES, CA. SN 78-318,150. FILED P.R. 10-24-2003; AM. S.R. 11-29-2004.

PERINO'S APARTMENTS

NO CLAIM IS MADE TO THE EXCLUSIVE RIGHT TO USE APARTMENTS, APART FROM THE MARK AS SHOWN.

FOR APARTMENT HOUSE MANAGEMENT; REAL ESTATE DEVELOPMENT SERVICES; REAL ESTATE MANAGEMENT, AND LEASING OF REAL (U.S. CLS. 100, 101 AND 102).

FIRST USE 6-0-2004; IN COMMERCE 7-0-2004.

2,956,054. AMERICOR MORTGAGE, INC., TROY, MI. SN 78-320,802. FILED P.R. 10-30-2003; AM. S.R. 1-3-2005.

FREFINANCE

FOR RESIDENTIAL LOAN RE-FINANCING SERVICES (U.S. CLS. 100, 101 AND 102).

FIRST USE 3-1-1995; IN COMMERCE 3-1-1995.

2,956,057. HINSDALE BANK & TRUST COMPANY, HINSDALE, IL. SN 78-323,280. FILED P.R. 11-5-2003; AM. S.R. 1-27-2005.

**DOWNERS GROVE
ACCOUNT**

THE MARK CONSISTS OF STANDARD CHARACTERS WITHOUT CLAIM TO ANY PARTICULAR FONT, STYLE, SIZE, OR COLOR.

NO CLAIM IS MADE TO THE EXCLUSIVE RIGHT TO USE "ACCOUNT", APART FROM THE MARK AS SHOWN, FOR BANKING SERVICES (U.S. CLS. 100, 101 AND 102).

FIRST USE 1-17-2005; IN COMMERCE 1-17-2005.

CLASS 36—(Continued).

2,956,074. ABRAMS CAPITAL, LLC, BOSTON, MA. SN 78-335,205. FILED P.R. 12-2-2003; AM. S.R. 2-21-2005.

ABRAMS CAPITAL

THE MARK CONSISTS OF STANDARD CHARACTERS WITHOUT CLAIM TO ANY PARTICULAR FONT, STYLE, SIZE, OR COLOR.

NO CLAIM IS MADE TO THE EXCLUSIVE RIGHT TO USE CAPITAL, APART FROM THE MARK AS SHOWN.

FOR INVESTMENT SERVICES, NAMELY INVESTMENT MANAGEMENT SERVICES (U.S. CLS. 100, 101 AND 102).

FIRST USE 3-0-1999; IN COMMERCE 3-0-1999.

2,956,075. LOAN SHOPPER FINANCIAL, INC., DBA CALIFORNIA LENDING COMPANY, LA MESA, CA. SN 78-335,441. FILED P.R. 12-2-2003; AM. S.R. 3-8-2005.

**CALIFORNIA LENDING
COMPANY**

THE MARK CONSISTS OF STANDARD CHARACTERS WITHOUT CLAIM TO ANY PARTICULAR FONT, STYLE, SIZE, OR COLOR.

NO CLAIM IS MADE TO THE EXCLUSIVE RIGHT TO USE "LENDING COMPANY", APART FROM THE MARK AS SHOWN.

FOR BROKERING REAL ESTATE LOANS FOR CUSTOMERS (U.S. CLS. 100, 101 AND 102).

FIRST USE 10-2-2003; IN COMMERCE 12-2-2003.

CLASS 36—(Continued).

2,956,095. FMR CORP., BOSTON, MA. SN 78-346,650. FILED P.R. 12-30-2003; AM. S.R. 2-2-2005.

BROKERAGEXCHANGE

THE MARK CONSISTS OF STANDARD CHARACTERS WITHOUT CLAIM TO ANY PARTICULAR FONT, STYLE, SIZE, OR COLOR.

OWNER OF U.S. REG. NOS. 2,240,453 AND 2,759,224. FOR MUTUAL FUND INVESTMENT SERVICES; SECURITIES BROKERAGE SERVICES; FINANCIAL INFORMATION PROVIDED BY ELECTRONIC MEANS; MUTUAL FUND INVESTMENT AND SECURITIES BROKERAGE SERVICES FEATURING ONLINE ENTRY OF ORDERS AND ONLINE REPORTING OF FINANCIAL INFORMATION (U.S. CLS. 100, 101 AND 102). FIRST USE 2-0-2004; IN COMMERCE 2-0-2004.

2,956,118. HOMESERVICE OF AMERICA, INC., EDINA, MN. SN 78-356,089. FILED P.R. 1-23-2004; AM. S.R. 2-18-2005.

HOMESERVICES OF AMERICA

THE MARK CONSISTS OF STANDARD CHARACTERS WITHOUT CLAIM TO ANY PARTICULAR FONT, STYLE, SIZE, OR COLOR.

NO CLAIM IS MADE TO THE EXCLUSIVE RIGHT TO USE "HOME SERVICES", APART FROM THE MARK AS SHOWN.

FOR REAL ESTATE BROKERAGE SERVICES (U.S. CLS. 100, 101 AND 102). FIRST USE 4-1-2001; IN COMMERCE 4-1-2001.

2,956,124. EMPLOYEE BENEFIT RESEARCH INSTITUTE, WASHINGTON, DC. SN 78-358,518. FILED P.R. 1-28-2004; AM. S.R. 2-8-2005.

RETIREMENT SECURITY PROJECTION MODEL**CLASS 36—(Continued).**

THE MARK CONSISTS OF STANDARD CHARACTERS WITHOUT CLAIM TO ANY PARTICULAR FONT, STYLE, SIZE, OR COLOR.

FOR FINANCIAL PLANNING INFORMATION SERVICES, NAMELY, PROVIDING TAILORED REPORTS AND ANALYSIS TO POLICY MAKERS AND DECISION MAKERS CONCERNING RETIREMENT PLANNING WITH REGARD TO GROUPS OR CERTAIN GEOGRAPHICAL AREAS (U.S. CLS. 100, 101 AND 102). FIRST USE 11-0-2003; IN COMMERCE 11-0-2003.

2,956,134. INVESTMENT CONSULTING AND RESEARCH, INC., CENTERVILLE, OH. SN 78-359,929. FILED P.R. 1-30-2004; AM. S.R. 3-3-2005.

NORTHWEST QUADRANT ADVISORS

THE MARK CONSISTS OF STANDARD CHARACTERS WITHOUT CLAIM TO ANY PARTICULAR FONT, STYLE, SIZE, OR COLOR.

FOR INVESTMENT CONSULTING AND RESEARCH (U.S. CLS. 100, 101 AND 102). FIRST USE 12-3-2003; IN COMMERCE 12-3-2003.

2,956,138. RETIREMENT STRATEGIES, LLC, ALBUQUERQUE, NM. SN 78-360,934. FILED P.R. 2-2-2004; AM. S.R. 2-8-2005.

The Cafeteria Plan Company

THE MARK CONSISTS OF STANDARD CHARACTERS WITHOUT CLAIM TO ANY PARTICULAR FONT, STYLE, SIZE, OR COLOR.

FOR CREATION AND ADMINISTRATION OF EMPLOYEE BENEFIT PLANS (U.S. CLS. 100, 101 AND 102). FIRST USE 5-9-2003; IN COMMERCE 6-18-2003.

CLASS 36—(Continued).

2,956,153. GRACIE MARKETING LLC, ST. MICHAELS, MD.
SN 78-365,038. FILED P.R. 2-9-2004; AM. S.R. 3-4-2005.

ACCESS YOUR MLS.
COM

THE MARK CONSISTS OF STANDARD CHARACTERS WITHOUT CLAIM TO ANY PARTICULAR FONT, STYLE, SIZE, OR COLOR.

FOR PROVIDING INFORMATION IN THE FIELD OF REAL ESTATE BY MEANS OF A WEBSITE THAT FEATURES LINKS TO REAL ESTATE AGENTS' WEBSITES THAT HAVE HOMES CURRENTLY FOR SALE FROM THEIR MULTIPLE LISTING SERVICES (U.S. CLS. 100, 101 AND 102).

FIRST USE 5-1-2001; IN COMMERCE 5-1-2001.

2,956,176. BARRINGTON BANK & TRUST COMPANY, N.A.,
BARRINGTON, IL. SN 78-368,637. FILED P.R. 2-16-2004;
AM. S.R. 3-4-2005.

PALATINE BANK &
TRUST

THE MARK CONSISTS OF STANDARD CHARACTERS WITHOUT CLAIM TO ANY PARTICULAR FONT, STYLE, SIZE, OR COLOR.

NO CLAIM IS MADE TO THE EXCLUSIVE RIGHT TO USE "BANK & TRUST", APART FROM THE MARK AS SHOWN.

FOR BANKING SERVICES (U.S. CLS. 100, 101 AND 102).

FIRST USE 3-3-2005; IN COMMERCE 3-3-2005.

CLASS 36—(Continued).

2,956,202. AMERICAN INTERNATIONAL GROUP, INC.,
NEW YORK, NY. SN 78-378,078. FILED P.R. 3-3-2004;
AM. S.R. 3-22-2005.

CONCIERGE-LEVEL
CLAIMS SERVICES

THE MARK CONSISTS OF STANDARD CHARACTERS WITHOUT CLAIM TO ANY PARTICULAR FONT, STYLE, SIZE, OR COLOR.

NO CLAIM IS MADE TO THE EXCLUSIVE RIGHT TO USE "CLAIMS SERVICES", APART FROM THE MARK AS SHOWN.

FOR INSURANCE UNDERWRITING SERVICES IN THE FIELD OF PROPERTY AND CASUALTY INSURANCE COMPRISING, IN PART, OF MANAGEMENT, INVESTIGATION, ADJUSTING AND PROCESSING OF PROPERTY AND CASUALTY INSURANCE CLAIMS MADE BY POLICYHOLDERS (U.S. CLS. 100, 101 AND 102).

FIRST USE 3-1-2004; IN COMMERCE 3-1-2004.

2,956,213. SPENCE, KENT D., KIMBERLING CITY, MO. SN
78-383,433. FILED 3-12-2004.

No Limit Loans

THE MARK CONSISTS OF STANDARD CHARACTERS WITHOUT CLAIM TO ANY PARTICULAR FONT, STYLE, SIZE, OR COLOR.

FOR CHECK CASHING SERVICES (U.S. CLS. 100, 101 AND 102).

FIRST USE 12-1-2003; IN COMMERCE 5-3-2004.

CLASS 36—(Continued).

2,956,225. CONNECTICUT COMMUNITY BANK, NATIONAL ASSOCIATION, WESTPORT, CT. SN 78-390,219. FILED P.R. 3-24-2004; AM. S.R. 3-6-2005.

NORWALK BANK & TRUST

THE MARK CONSISTS OF STANDARD CHARACTERS WITHOUT CLAIM TO ANY PARTICULAR FONT, STYLE, SIZE, OR COLOR.

NO CLAIM IS MADE TO THE EXCLUSIVE RIGHT TO USE "BANK & TRUST", APART FROM THE MARK AS SHOWN.

FOR BANKING SERVICES (U.S. CLS. 100, 101 AND 102).

FIRST USE 5-3-2004; IN COMMERCE 7-12-2004.

2,956,231. FINANCIAL TOOLBOX, INC., BOGART, GA. SN 78-392,205. FILED P.R. 3-29-2004; AM. S.R. 12-16-2004.

401k Toolbox

THE MARK CONSISTS OF STANDARD CHARACTERS WITHOUT CLAIM TO ANY PARTICULAR FONT, STYLE, SIZE, OR COLOR.

FOR PROVIDING FINANCIAL SERVICES IN THE NATURE OF MONEY MANAGEMENT AND PROFESSIONAL INVESTMENT CONSULTATION (U.S. CLS. 100, 101 AND 102).

FIRST USE 2-28-2001; IN COMMERCE 4-30-2001.

2,956,259. SANDERS, PHILLIP G., ATLANTA, GA. SN 78-412,364. FILED P.R. 5-3-2004; AM. S.R. 12-27-2004.

GEORGIA ELDERCARE

THE MARK CONSISTS OF STANDARD CHARACTERS WITHOUT CLAIM TO ANY PARTICULAR FONT, STYLE, SIZE, OR COLOR.

CLASS 36—(Continued).

NO CLAIM IS MADE TO THE EXCLUSIVE RIGHT TO USE "ELDERCARE", APART FROM THE MARK AS SHOWN.

FOR CONSULTING AND INFORMATION PERTAINING TO FINANCIAL ISSUES FACING THE ELDERLY (U.S. CLS. 100, 101 AND 102).

FIRST USE 9-25-2002; IN COMMERCE 11-30-2003.

2,956,324. THE 1031 EXCHANGE EXPERTS, LLC, GREENWOOD VILLAGE, CO. SN 78-441,080. FILED P.R. 6-24-2004; AM. S.R. 2-10-2005.

THE 1031 EXCHANGE EXPERTS

THE MARK CONSISTS OF STANDARD CHARACTERS WITHOUT CLAIM TO ANY PARTICULAR FONT, STYLE, SIZE, OR COLOR.

NO CLAIM IS MADE TO THE EXCLUSIVE RIGHT TO USE "1031 EXCHANGE", APART FROM THE MARK AS SHOWN.

FOR REAL ESTATE TRUSTEE SERVICES NAMELY PERFORMING QUALIFIED INTERMEDIARY SERVICES FOR CLIENTS PERFORMING TAX-DEFERRED REAL ESTATE EXCHANGES PURSUANT TO I;R;C; SECTION 1031 (U.S. CLS. 100, 101 AND 102).

FIRST USE 6-1-2002; IN COMMERCE 7-22-2002.

2,956,341. PRODUCERS LLOYDS INSURANCE COMPANY, AMARILLO, TX. SN 78-453,860. FILED P.R. 7-21-2004; AM. S.R. 2-24-2005.

PRODUCERS AG INSURANCE GROUP

THE MARK CONSISTS OF STANDARD CHARACTERS WITHOUT CLAIM TO ANY PARTICULAR FONT, STYLE, SIZE, OR COLOR.

NO CLAIM IS MADE TO THE EXCLUSIVE RIGHT TO USE "INSURANCE GROUP", APART FROM THE MARK AS SHOWN.

FOR INSURANCE UNDERWRITING IN THE FILED OF CROP INSURANCE (U.S. CLS. 100, 101 AND 102).

FIRST USE 9-30-2003; IN COMMERCE 1-15-2004.

CLASS 36—(Continued).

2,956,344. VERMONT STUDENT DEVELOPMENT FUND, INC., WINOOSKI, VT. SN 78-457,139. FILED P.R. 7-27-2004; AM. S.R. 3-14-2005.

**THE VERMONT
SCHOLARSHIP FUND**

THE MARK CONSISTS OF STANDARD CHARACTERS WITHOUT CLAIM TO ANY PARTICULAR FONT, STYLE, SIZE, OR COLOR.

NO CLAIM IS MADE TO THE EXCLUSIVE RIGHT TO USE "SCHOLARSHIP FUND", APART FROM THE MARK AS SHOWN.

FOR PROVIDING EDUCATIONAL SCHOLARSHIPS (U.S. CLS. 100, 101 AND 102).

FIRST USE 3-15-2003; IN COMMERCE 3-15-2003.

CLASS 37—CONSTRUCTION AND REPAIR

2,955,818. CRITTER CONTROL, INC., TRAVERSE CITY, MI. SN 76-479,432. FILED P.R. 12-31-2002; AM. S.R. 1-21-2005.

1-800-CRITTER

FOR ANIMAL AND PEST CONTROL, NAMELY, WILDLIFE, RODENT, ANIMAL TRAPPING SERVICES (U.S. CLS. 100, 103 AND 106).

FIRST USE 7-31-2002; IN COMMERCE 7-31-2002.

2,955,873. WHEEL REPAIR SOLUTIONS, INC., NORCROSS, GA. SN 76-576,985. FILED P.R. 2-13-2004; AM. S.R. 2-22-2005.

**ALLOY WHEEL REPAIR
SPECIALISTS, INC. and DESIGN**

THE MARK CONSISTS OF STANDARD CHARACTERS WITHOUT CLAIM TO ANY PARTICULAR FONT, STYLE, SIZE, OR COLOR.

NO CLAIM IS MADE TO THE EXCLUSIVE RIGHT TO USE WHEEL REPAIR AND INC., APART FROM THE MARK AS SHOWN.

FOR VEHICLE WHEEL REPAIR SERVICES (U.S. CLS. 100, 103 AND 106).

FIRST USE 0-0-2000; IN COMMERCE 0-0-2000.

CLASS 37—(Continued).

2,955,881. MASTER BUILDERS OF IOWA, INC., DES MOINES, IA. SN 76-594,810. FILED P.R. 6-1-2004; AM. S.R. 1-25-2005.

**CONSTRUCTION UPDATE
ONLINE PLAN ROOM**

THE MARK CONSISTS OF STANDARD CHARACTERS WITHOUT CLAIM TO ANY PARTICULAR FONT, STYLE, SIZE, OR COLOR.

NO CLAIM IS MADE TO THE EXCLUSIVE RIGHT TO USE "CONSTRUCTION UPDATE ONLINE PLAN", APART FROM THE MARK AS SHOWN.

FOR PROVIDING INFORMATION IN THE FIELD OF BUILDING CONSTRUCTION VIA WEBSITES ON GLOBAL COMPUTER NETWORKS (U.S. CLS. 100, 103 AND 106).

FIRST USE 5-14-2004; IN COMMERCE 5-14-2004.

2,955,959. ARROWHEAD CONSTRUCTION INC., TULSA, OK. SN 78-231,495. FILED P.R. 3-28-2003; AM. S.R. 2-27-2004.



NO CLAIM IS MADE TO THE EXCLUSIVE RIGHT TO USE "ROOFING", APART FROM THE MARK AS SHOWN.

FOR CONSTRUCTION SERVICES, NAMELY INSTALLATION, REPAIR, AND MAINTENANCE OF RESIDENTIAL AND COMMERCIAL ROOFING SURFACES (U.S. CLS. 100, 103 AND 106).

FIRST USE 12-2-2002; IN COMMERCE 12-2-2002.

2,955,977. INDEPENDENT WAREHOUSE DISTRIBUTORS LLC, NEW HAVEN, CT. SN 78-261,959. FILED P.R. 6-13-2003; AM. S.R. 1-24-2005.

TRUCK SERVICE EXPERTS

OWNER OF U.S. REG. NOS. 1,813,985, 2,604,243, AND OTHERS.

NO CLAIM IS MADE TO THE EXCLUSIVE RIGHT TO USE TRUCK SERVICE, APART FROM THE MARK AS SHOWN.

FOR INSTALLATION OF AUTOMOBILE AND TRUCK PARTS (U.S. CLS. 100, 103 AND 106).

FIRST USE 1-14-2005; IN COMMERCE 1-14-2005.

CLASS 37—(Continued).

2,956,017. WANDER'S INC., KENT, WA. SN 78-288,333.
FILED P.R. 8-16-2003; AM. S.R. 11-5-2004.

ORIENTAL EXPRESS

FOR CLEANING OF ORIENTAL RUGS PROVIDED
BOTH ON-SITE AND OFF-SITE (U.S. CLS. 100, 103 AND
106).

FIRST USE 7-1-2003; IN COMMERCE 7-1-2003.

2,956,064. CENTEX CORPORATION, DALLAS, TX. SN 78-
329,018. FILED P.R. 11-17-2003; AM. S.R. 1-12-2005.

SUPERPLAN

THE MARK CONSISTS OF STANDARD CHARACTERS
WITHOUT CLAIM TO ANY PARTICULAR FONT, STYLE,
SIZE, OR COLOR.

FOR CONSTRUCTION SERVICES, NAMELY, PLAN-
NING, LAYING OUT AND CONSTRUCTION OF RESI-
DENTIAL AND COMMERCIAL COMMUNITIES (U.S.
CLS. 100, 103 AND 106).

FIRST USE 10-5-2003; IN COMMERCE 10-5-2003.

2,956,145. MARRICK PROPERTIES, INC., DUNKIRK, MD.
SN 78-362,943. FILED P.R. 2-5-2004; AM. S.R. 2-22-2005.

**THE MARK OF
EXCELLENCE**

THE MARK CONSISTS OF STANDARD CHARACTERS
WITHOUT CLAIM TO ANY PARTICULAR FONT, STYLE,
SIZE, OR COLOR.

FOR BUILDING CONSTRUCTION AND DEVELOP-
MENT-RESIDENTIAL AND COMMERCIAL; CUSTOM
CONSTRUCTION, DEVELOPMENT AND RENOVA-
TION-RESIDENTIAL AND COMMERCIAL; CONSTRU-
TION SERVICES; NAMELY, PLANNING, LAYING OUT
AND CUSTOM CONSTRUCTION OF RESIDENTIAL
COMMUNITIES; DEVELOPMENT OF SENIOR COMMU-
NITIES (U.S. CLS. 100, 103 AND 106).

FIRST USE 2-19-2000; IN COMMERCE 2-19-2000.

CLASS 37—(Continued).

2,956,315. DGA SECURITY SYSTEMS, INC., NEW YORK,
NY. SN 78-437,878. FILED P.R. 6-18-2004; AM. S.R. 2-9-2005.

HOLMES

THE MARK CONSISTS OF STANDARD CHARACTERS
WITHOUT CLAIM TO ANY PARTICULAR FONT, STYLE,
SIZE, OR COLOR.

FOR INSTALLATION AND REPAIR OF ALARM
SYSTEMS (U.S. CLS. 100, 103 AND 106).

FIRST USE 1-28-2005; IN COMMERCE 1-28-2005.

CLASS 38—COMMUNICATION

2,955,845. HC MEDIA, LLC, OMAHA, NE. SN 76-546,572.
FILED P.R. 8-25-2003; AM. S.R. 8-16-2004.

CASINO TELEVISION

NO CLAIM IS MADE TO THE EXCLUSIVE RIGHT TO
USE "TELEVISION", APART FROM THE MARK AS
SHOWN.

FOR CABLE TELEVISION BROADCASTING SER-
VICES (U.S. CLS. 100, 101 AND 104).

FIRST USE 7-21-2003; IN COMMERCE 7-21-2003.

2,955,936. LOYOLA ENTERPRISES INC., VIRGINIA BEACH,
VA. SN 78-192,372. FILED P.R. 12-9-2002; AM. S.R. 1-31-
2005.

RTK-NET

FOR GLOBAL POSITIONING SYSTEM SERVICES,
NAMELY, PRODUCING REAL TIME KINEMATICS
CORRECTION SIGNALS BY MEANS OF A NETWORK
OF HIGH PRECISION GLOBAL POSITIONING SYSTEM
REFERENCE STATIONS FOR USE BY OTHERS TO
INCREASE THE ACCURACY OF THEIR GLOBAL POSI-
TIONING SYSTEM RECEIVERS SUCH THAT ACCU-
RACY IS WITHIN ONE TO TWO CENTIMETERS
INSTEAD OF THE SEVERAL METERS OF ACCURACY
WHICH OCCURS WITHOUT THE USE OF CORREC-
TION SIGNALS (U.S. CLS. 100, 101 AND 104).

FIRST USE 9-10-2003; IN COMMERCE 9-10-2003.

CLASS 38—(Continued).

2,955,992. VOICE ACCOUNT, INC., SALT LAKE CITY, UT.
SN 78-274,176. FILED P.R. 7-15-2003; AM. S.R. 2-2-2005.

COMEDY CALL

NO CLAIM IS MADE TO THE EXCLUSIVE RIGHT TO USE "CALL", APART FROM THE MARK AS SHOWN.

FOR ENTERTAINMENT IN THE NATURE OF PRE-RECORDED GREETING, OCCASION, JOKE AND COMEDY MESSAGES PROVIDED VIA TELEPHONE AND FEATURING PERSONAL MESSAGES (U.S. CLS. 100, 101 AND 104).

FIRST USE 2-1-2004; IN COMMERCE 2-1-2004.

2,956,078. DIALPAD COMMUNICATIONS, INC., MILPITAS, CA. SN 78-339,054. FILED P.R. 12-10-2003; AM. S.R. 2-7-2005.

**THE INTERNET'S
BEST PHONE CALL**

THE MARK CONSISTS OF STANDARD CHARACTERS WITHOUT CLAIM TO ANY PARTICULAR FONT, STYLE, SIZE, OR COLOR.

FOR INTERNATIONAL, INTERSTATE, LOCAL, AND LONG DISTANCE TELEPHONE SERVICES (U.S. CLS. 100, 101 AND 104).

FIRST USE 7-0-2002; IN COMMERCE 7-0-2002.

2,956,156. FIRST INTERNATIONAL DIGITAL, INC., SCHAUMBURG, IL. SN 78-365,988. FILED P.R. 2-11-2004; AM. S.R. 1-17-2005.

Mobile Karaoke

THE MARK CONSISTS OF STANDARD CHARACTERS WITHOUT CLAIM TO ANY PARTICULAR FONT, STYLE, SIZE, OR COLOR.

FOR COMMUNICATION SERVICES, NAMELY, TRANSMITTING SOUND AND AUDIO-VISUAL RECORDINGS IN THE NATURE OF KARAOKE PRESENTATIONS VIA THE INTERNET TO CELLULAR AND MOBILE TELEPHONES (U.S. CLS. 100, 101 AND 104).

FIRST USE 2-11-2004; IN COMMERCE 2-11-2004.

CLASS 38—(Continued).

2,956,174. AMERICAPCS, MT. VERNON, OH. SN 78-368,435. FILED P.R. 2-16-2004; AM. S.R. 2-24-2005.

**Collaborative
Conversation**

THE MARK CONSISTS OF STANDARD CHARACTERS WITHOUT CLAIM TO ANY PARTICULAR FONT, STYLE, SIZE, OR COLOR.

FOR COMMUNICATION SERVICES, NAMELY, ELECTRONIC TRANSMISSION OF DATA AND DOCUMENTS AMONG USERS OF COMPUTERS (U.S. CLS. 100, 101 AND 104).

FIRST USE 6-1-2003; IN COMMERCE 6-1-2003.

2,956,217. MOBILISA, INC., PORT TOWNSEND, WA. SN 78-385,224. FILED P.R. 3-16-2004; AM. S.R. 3-1-2005.

**WIRELESS OVER
WATER**

THE MARK CONSISTS OF STANDARD CHARACTERS WITHOUT CLAIM TO ANY PARTICULAR FONT, STYLE, SIZE, OR COLOR.

FOR TELECOMMUNICATIONS SERVICES, NAMELY, PROVIDING DIGITAL DATA LINKS TO MOBILE PLATFORMS OVER WATER (U.S. CLS. 100, 101 AND 104).

FIRST USE 2-22-2003; IN COMMERCE 3-1-2003.

CLASS 39—TRANSPORTATION AND STORAGE

CLASS 39—(Continued).

2,956,228. OSUNA, RIC B., LAS VEGAS, NV. SN 78-390,567.
FILED P.R. 3-25-2004; AM. S.R. 3-14-2005.

**Millionaire
TRAVELER**

THE MARK CONSISTS OF THE WORD "MILLIONAIRE" IS OF THE FONT KNOWN AS GRADL AND HAS THE M AND E CAPITALIZED, WHILE THE WORD "TRAVELER" IS ALL CAPS AND IN THE FONT BAUHAUS 93.

FOR TRAVEL GUIDE SERVICES (U.S. CLS. 100 AND 105).

FIRST USE 2-2-2004; IN COMMERCE 2-2-2004.

2,956,293. CALIFORNIA PARKING SYSTEMS INC.,
HAWTHORNE, CA. SN 78-426,920. FILED P.R. 5-28-2004;
AM. S.R. 2-10-2005.

**California Parking
Systems**

THE MARK CONSISTS OF STANDARD CHARACTERS WITHOUT CLAIM TO ANY PARTICULAR FONT, STYLE, SIZE, OR COLOR.

NO CLAIM IS MADE TO THE EXCLUSIVE RIGHT TO USE "PARKING SYSTEMS", APART FROM THE MARK AS SHOWN.

FOR VALET PARKING (U.S. CLS. 100 AND 105).
FIRST USE 5-0-2001; IN COMMERCE 5-0-2001.

CLASS 40—MATERIAL TREATMENT

2,955,937. IMPLANT INNOVATIONS, INC., PALM BEACH
GARDENS, FL. SN 78-196,663. FILED P.R. 12-20-2002; AM.
S.R. 3-2-2005.

**PATIENT SPECIFIC
RESTORATIONS**

THE MARK CONSISTS OF STANDARD CHARACTERS WITHOUT CLAIM TO ANY PARTICULAR FONT, STYLE,

CLASS 40—(Continued).

SIZE, OR COLOR.

NO CLAIM IS MADE TO THE EXCLUSIVE RIGHT TO USE RESTORATIONS, APART FROM THE MARK AS SHOWN.

FOR PROVIDING CUSTOM MADE RESTORATIVE COMPONENTS FOR DENTAL IMPLANTS TO THE ORDER AND SPECIFICATION OF OTHERS (U.S. CLS. 100, 103 AND 106).

FIRST USE 9-1-2004; IN COMMERCE 9-1-2004.

CLASS 41—EDUCATION AND ENTERTAINMENT

2,955,815. EDUCATION MANAGEMENT CORPORATION,
PITTSBURGH, PA. SN 76-449,231. FILED P.R. 9-11-2002;
AM. S.R. 11-15-2004.

**THE ART INSTITUTE OF
TAMPA**

NO CLAIM IS MADE TO THE EXCLUSIVE RIGHT TO USE "THE ART INSTITUTE", APART FROM THE MARK AS SHOWN.

FOR EDUCATIONAL SERVICES, NAMELY, OFFERING COURSES OF INSTRUCTION AT THE POST SECONDARY LEVEL (U.S. CLS. 100, 101 AND 107).

FIRST USE 1-0-2004; IN COMMERCE 1-0-2004.

2,955,840. SHERIDAN BROADCASTING CORPORATION,
PITTSBURGH, PA. SN 76-541,047. FILED P.R. 8-29-2003;
AM. S.R. 2-18-2005.

THE HIP HOP WIRE

NO CLAIM IS MADE TO THE EXCLUSIVE RIGHT TO USE "WIRE", APART FROM THE MARK AS SHOWN.

FOR ENTERTAINMENT IN THE NATURE OF TELEVISION NEWS AND PROGRAMS IN THE FIELD OF CURRENT EVENTS; PROVIDING NEWS IN THE NATURE OF CURRENT EVENTS REPORTING (U.S. CLS. 100, 101 AND 107).

FIRST USE 9-1-2003; IN COMMERCE 9-1-2003.

CLASS 41—(Continued).

2,955,862. UNIVERSITY OF ST. THOMAS, MINNEAPOLIS, MN. SN 76-571,597. FILED P.R. 1-16-2004; AM. S.R. 2-9-2005.

The Institute for Retailing Excellence

THE MARK CONSISTS OF STANDARD CHARACTERS WITHOUT CLAIM TO ANY PARTICULAR FONT, STYLE, SIZE, OR COLOR.

NO CLAIM IS MADE TO THE EXCLUSIVE RIGHT TO USE "INSTITUTE", APART FROM THE MARK AS SHOWN.

FOR EDUCATIONAL SERVICES, NAMELY CONDUCTING PROGRAMS, SEMINARS, COURSES, WORKSHOPS AND EDUCATIONAL RESEARCH ABOUT CONSUMER TRENDS, INDUSTRY TRENDS, RETAIL INDUSTRY STRUCTURE, RETAILING STRATEGY, RETAILING STORE FORMATS, NON-STORE RETAILING, INTERNET RETAILING, SUPPLY CHAIN CHARACTERISTICS AND OPTIMIZATION, PRODUCT ASSORTMENT, RETAIL PRICING, SHELF AND FLOOR SPACE MANAGEMENT, PROMOTION PRACTICES, PROCUREMENT, STORE DESIGN, RETAIL MATH, FINANCE AND ACCOUNTING REQUIREMENTS, CUSTOMER SEGMENTATION, SITE LOCATION PLANNING, YIELD MANAGEMENT, MARKETING, MERCHANDISING, HUMAN RESOURCE MANAGEMENT FOR RETAILERS, SERVICE REQUIREMENTS FOR RETAILERS, RETAIL TECHNOLOGY, FUTURE RETAIL TRENDS, INTERNATIONAL RETAILING PRACTICES, FUTURE RETAILING TRENDS, AND RETAIL LEADERSHIP (U.S. CLS. 100, 101 AND 107).

FIRST USE 4-18-2001; IN COMMERCE 7-1-2002.

2,955,864. SIEMON, PAUL, RENO, NV. SN 76-572,385. FILED P.R. 1-26-2004; AM. S.R. 2-23-2005.

BASIX SELF DEFENSE

THE MARK CONSISTS OF STANDARD CHARACTERS WITHOUT CLAIM TO ANY PARTICULAR FONT, STYLE, SIZE, OR COLOR.

FOR MARTIAL ARTS INSTRUCTION AND EDUCATIONAL DEMONSTRATIONS (U.S. CLS. 100, 101 AND 107).

FIRST USE 2-5-2004; IN COMMERCE 10-8-2004.

2,955,865. KAZA AZTECA AMERICA, INC., GLENDALE, CA. SN 76-572,619. FILED P.R. 1-23-2004; AM. S.R. 2-17-2005.

DEPORTIVO 54**CLASS 41—(Continued).**

THE MARK CONSISTS OF STANDARD CHARACTERS WITHOUT CLAIM TO ANY PARTICULAR FONT, STYLE, SIZE, OR COLOR.

THE FOREIGN WORDING IN THE MARK TRANSLATES INTO ENGLISH AS SPORT.

FOR ONGOING TELEVISION PROGRAMS IN THE FIELDS OF NEWS AND SPORTS (U.S. CLS. 100, 101 AND 107).

FIRST USE 8-24-2003; IN COMMERCE 8-24-2003.

2,955,878. THE COMMON APPLICATION, INC., RESTON, VA. SN 76-592,478. FILED P.R. 5-17-2004; AM. S.R. 2-11-2005.

COMMON APP ONLINE

THE MARK CONSISTS OF STANDARD CHARACTERS WITHOUT CLAIM TO ANY PARTICULAR FONT, STYLE, SIZE, OR COLOR.

NO CLAIM IS MADE TO THE EXCLUSIVE RIGHT TO USE "ONLINE", APART FROM THE MARK AS SHOWN.

FOR PROVIDING ONLINE INFORMATION ABOUT COLLEGE ADMISSION FORMS (U.S. CLS. 100, 101 AND 107).

FIRST USE 5-0-1999; IN COMMERCE 5-0-1999.

2,955,882. CC & C MANAGEMENT GROUP, INC., MYRTLE BEACH, SC. SN 76-595,151. FILED P.R. 5-28-2004; AM. S.R. 3-1-2005.

YOUTH WORLD SERIES

THE MARK CONSISTS OF STANDARD CHARACTERS WITHOUT CLAIM TO ANY PARTICULAR FONT, STYLE, SIZE, OR COLOR.

FOR ORGANIZING AND CONDUCTING OF SOCCER TOURNAMENTS AND COMPETITIONS (U.S. CLS. 100, 101 AND 107).

FIRST USE 1-0-2004; IN COMMERCE 1-0-2004.

CLASS 41—(Continued).

2,955,883. RADIO SHOPPING SHOW, INC., ELGIN, IL. SN 76-595,710. FILED P.R. 6-4-2004; AM. S.R. 2-5-2005.

THE RADIO TRAVEL SHOW

THE MARK CONSISTS OF STANDARD CHARACTERS WITHOUT CLAIM TO ANY PARTICULAR FONT, STYLE, SIZE, OR COLOR.

FOR ENTERTAINMENT SERVICES, NAMELY AN ONGOING RADIO PROGRAM IN THE FIELD OF TRAVEL (U.S. CLS. 100, 101 AND 107).

FIRST USE 11-2-2000; IN COMMERCE 11-2-2000.

2,955,887. JOHN PAUL MITCHELL SYSTEMS, SAUGUS, CA. SN 76-596,670. FILED P.R. 6-7-2004; AM. S.R. 2-14-2005.

LUNCH TIME COLOR

FOR HAIRDRESSING COUNSELING, NAMELY, OFFERING ADVISE REGARDING HAIR COLOR IN SALONS (U.S. CLS. 100, 101 AND 107).

FIRST USE 9-1-2003; IN COMMERCE 9-1-2003.

2,955,892. SPORTS COACHING ACADEMY, LLC, KIRKLAND, WA. SN 76-601,642. FILED P.R. 7-9-2004; AM. S.R. 2-21-2005.

SPORTS COACHING ACADEMY

THE MARK CONSISTS OF STANDARD CHARACTERS WITHOUT CLAIM TO ANY PARTICULAR FONT, STYLE, SIZE, OR COLOR.

NO CLAIM IS MADE TO THE EXCLUSIVE RIGHT TO USE "ACADEMY", APART FROM THE MARK AS SHOWN.

FOR PROVIDING EDUCATIONAL SERVICES, NAMELY PROVIDING COURSES OF INSTRUCTION AT THE BASIC, INTERMEDIATE AND ADVANCED LEVELS IN SPORTS AND DISTRIBUTING COURSE MATERIALS IN CONNECTION THEREWITH (U.S. CLS. 100, 101 AND 107).

FIRST USE 4-20-2004; IN COMMERCE 7-5-2004.

2,955,893. STONIER, ANTHONY, NEW YORK, NY. SN 76-601,910. FILED P.R. 7-12-2004; AM. S.R. 3-1-2005.

MAMBO NYC

THE MARK CONSISTS OF STANDARD CHARACTERS

CLASS 41—(Continued).

WITHOUT CLAIM TO ANY PARTICULAR FONT, STYLE, SIZE, OR COLOR.

NO CLAIM IS MADE TO THE EXCLUSIVE RIGHT TO USE "MAMBO", APART FROM THE MARK AS SHOWN.

FOR ENTERTAINMENT SERVICES, NAMELY, RENDERING LIVE VOCAL AND MUSICAL PERFORMANCES (U.S. CLS. 100, 101 AND 107).

FIRST USE 6-13-2002; IN COMMERCE 6-13-2002.

2,955,897. NATIONAL EVALUATION SYSTEMS, INC., HADLEY, MA. SN 76-604,562. FILED P.R. 7-28-2004; AM. S.R. 3-10-2005.

VIRGINIA READING ASSESSMENT

THE MARK CONSISTS OF STANDARD CHARACTERS WITHOUT CLAIM TO ANY PARTICULAR FONT, STYLE, SIZE, OR COLOR.

NO CLAIM IS MADE TO THE EXCLUSIVE RIGHT TO USE "ASSESSMENT", APART FROM THE MARK AS SHOWN.

FOR STANDARDIZED TESTING SERVICES - NAMELY, PREPARING, ADMINISTERING AND SCORING OF STANDARDIZED TESTS OF EDUCATORS (U.S. CLS. 100, 101 AND 107).

FIRST USE 6-0-2003; IN COMMERCE 6-0-2003.

2,955,909. GARBOSKI, RICHARD, NEW YORK, NY. SN 78-068,847. FILED P.R. 6-13-2001; AM. S.R. 6-16-2003.



NO CLAIM IS MADE TO THE EXCLUSIVE RIGHT TO USE "HALL OF FAME", APART FROM THE MARK AS SHOWN.

FOR EDUCATIONAL AND ENTERTAINMENT SERVICES, NAMELY THE ESTABLISHMENT AND OPERATION OF A MUSEUM FOR RECOGNITION AND ENSHRINEMENT OF CONTRIBUTIONS IN THE FIELD OF TECHNOLOGY AND PROVIDING MUSEUM CONFERENCE CENTER FACILITIES FOR ENTERTAINMENT ACTIVITIES AND COURSES OF INSTRUCTION, WORKSHOPS, SEMINARS AND CLASSES IN THE FIELD OF TECHNOLOGY (U.S. CLS. 100, 101 AND 107).

FIRST USE 8-19-1999; IN COMMERCE 1-3-2002.

2,955,940. FINANCIAL FREEDOM THROUGH FORECLOSURES INC., BAILEY, CO. SN 78-208,637. FILED P.R. 1-29-2003; AM. S.R. 11-22-2004.

SHORT SALE

FOR EDUCATIONAL SERVICES, NAMELY, CONDUCTING WORKSHOPS AND SEMINARS IN THE FIELDS OF REAL ESTATE, BUSINESS AND FINANCING (U.S. CLS. 100, 101 AND 107).

FIRST USE 12-1-2002; IN COMMERCE 12-1-2002.

CLASS 41—(Continued).

2,955,972. NATIONAL TRUST FOR HISTORIC PRESERVATION IN THE UNITED STATES, WASHINGTON, DC. SN 78-258,716. FILED P.R. 6-5-2003; AM. S.R. 9-30-2004.

CENTER FOR PRESERVATION LEADERSHIP

NO CLAIM IS MADE TO THE EXCLUSIVE RIGHT TO USE "CENTER", APART FROM THE MARK AS SHOWN.

FOR EDUCATIONAL SERVICES, NAMELY, PROVIDING CONFERENCES AND SEMINARS ON THE SUBJECT OF HISTORIC PRESERVATION AND COMMUNITY DEVELOPMENT WITH AN EMPHASIS ON LEADERSHIP SKILLS, ORGANIZATIONAL, FUNDRAISING AND FISCAL MANAGEMENT (U.S. CLS. 100, 101 AND 107).

FIRST USE 12-31-2002; IN COMMERCE 12-31-2002.

2,955,975. INTERNATIONAL REGISTRY OF BACKSTABBERS, INC., THE, ATLANTA, GA. SN 78-260,386. FILED P.R. 6-10-2003; AM. S.R. 8-19-2004.

BACKSTABBERS

FOR ENTERTAINMENT SERVICES, NAMELY, PROVIDING AN ONLINE COMPUTER DATABASE FEATURING A LISTING OF CHEATS, SCOUNDRELS, VILLAINS, ROGUES AND OTHER MISCREANTS AS WELL AS THE PROVISION OF AN OFFICIAL CERTIFICATE TO THOSE INDIVIDUALS NOMINATED FOR INCLUSION IN THE DATABASE (U.S. CLS. 100, 101 AND 107).

FIRST USE 12-1-2003; IN COMMERCE 12-1-2003.

2,955,980. HORN ABBOT LTD., TORONTO, ONTARIO, CANADA. SN 78-263,225. FILED P.R. 6-17-2003; AM. S.R. 12-21-2004.

SILVER SCREEN

FOR ENTERTAINMENT SERVICES, NAMELY, PROVIDING AN ON-LINE INTERACTIVE TRIVIA COMPUTER GAME (U.S. CLS. 100, 101 AND 107).

FIRST USE 5-1-2003; IN COMMERCE 5-1-2003.

2,955,990. 333 LLC, EDGEWATER, NJ. SN 78-273,903. FILED P.R. 7-14-2003; AM. S.R. 2-8-2005.

WORLD ROCK CONFERENCE

NO CLAIM IS MADE TO THE EXCLUSIVE RIGHT TO USE "CONFERENCE", APART FROM THE MARK AS SHOWN.

FOR EDUCATIONAL SERVICES, NAMELY, CONDUCTING MUSIC LECTURES AND CONFERENCES; ENTERTAINMENT SERVICES, NAMELY LIVE MUSIC CONCERTS (U.S. CLS. 100, 101 AND 107).

FIRST USE 12-0-2003; IN COMMERCE 12-0-2003.

CLASS 41—(Continued).

2,955,991. 333 11C, EDGEWATER, NJ. SN 78-273,906. FILED P.R. 7-14-2003; AM. S.R. 2-8-2005.

WORLD TWINS PAGEANT

FOR ENTERTAINMENT SERVICES IN THE NATURE OF BEAUTY PAGEANTS (U.S. CLS. 100, 101 AND 107).

FIRST USE 12-0-2003; IN COMMERCE 12-0-2003.

2,955,993. SCRIPPS NETWORKS, INC., KNOXVILLE, TN. SN 78-276,131. FILED P.R. 7-18-2003; AM. S.R. 2-3-2005.

BEST KITCHEN IDEAS

FOR ENTERTAINMENT SERVICES, NAMELY, PRODUCTION OF LIVE AND ON-DEMAND TELEVISION PROGRAMS INTENDED FOR DISTRIBUTION VIA TELEVISION, SATELLITE, WIRELESS, AUDIO AND VIDEO MEDIA, AND OVER FIBER OPTIC NETWORKS, CABLE AND A GLOBAL COMPUTER NETWORK, IN THE FIELDS OF INTERIOR DESIGN AND KITCHEN REMODELING (U.S. CLS. 100, 101 AND 107).

FIRST USE 9-30-2003; IN COMMERCE 9-30-2003.

2,955,994. BRENNER, MARK L., SHERMAN OAKS, CA. SN 78-276,316. FILED P.R. 7-18-2003; AM. S.R. 2-18-2005.

PARENT FITNESS

FOR SERVICES RELATED TO PARENTING LIFESTYLES, NAMELY CONDUCTING PARENT SKILLS SEMINARS AND PROVIDING PARENT EDUCATION INFORMATION TO ADULTS, PARENTS, COMMUNITY AND SCHOOLS (U.S. CLS. 100, 101 AND 107).

FIRST USE 1-11-2004; IN COMMERCE 6-7-2004.

2,956,000. THE HCP GROUP, LTD., SKIPPACK, PA. SN 78-280,456. FILED P.R. 7-29-2003; AM. S.R. 7-12-2004.

STRATEGIC VALUE ANALYSIS

FOR TRAINING IN VALUE ANALYSIS FUNCTIONAL APPROACH FOR COST REDUCTION OF PRODUCTS, SERVICES, PROCESSES AND TECHNOLOGIES THAT CUSTOMERS UTILIZE (U.S. CLS. 100, 101 AND 107).

FIRST USE 12-1-2001; IN COMMERCE 12-1-2001.

CLASS 41—(Continued).

2,956,001. MATTEL, INC., EL SEGUNDO, CA. SN 78-280,548.
FILED P.R. 7-29-2003; AM. S.R. 2-10-2005.

FASHION DESIGNER

OWNER OF U.S. REG. NO. 2,110,118.
FOR ENTERTAINMENT SERVICES, NAMELY, PRO-
VIDING AN ONLINE COMPUTER GAME (U.S. CLS. 100,
101 AND 107).
FIRST USE 12-31-2003; IN COMMERCE 12-31-2003.

CLASS 41—(Continued).

2,956,058. MINNESOTA PUBLIC RADIO, ST. PAUL, MN. SN
78-323,541. FILED P.R. 11-5-2003; AM. S.R. 2-7-2005.

**PUBLIC INSIGHT
JOURNALISM**

2,956,002. MEDICIGROUP, INC., KING PRUSSIA, PA. SN 78-
280,603. FILED P.R. 7-29-2003; AM. S.R. 1-24-2005.

**CENTER FOR PATIENT
RECRUITMENT**

FOR EDUCATIONAL SERVICES PROVIDED TO
PHARMACEUTICAL INDUSTRY EXECUTIVES,
NAMELY PROVIDING TRAINING, EVENTS AND
WORKSHOPS FEATURING PATIENT RECRUITMENT
(U.S. CLS. 100, 101 AND 107).
FIRST USE 12-30-2004; IN COMMERCE 12-30-2004.

THE MARK CONSISTS OF STANDARD CHARACTERS
WITHOUT CLAIM TO ANY PARTICULAR FONT, STYLE,
SIZE, OR COLOR.

NO CLAIM IS MADE TO THE EXCLUSIVE RIGHT TO
USE "JOURNALISM", APART FROM THE MARK AS
SHOWN.

FOR GATHERING AND DISSEMINATION OF NEWS;
PROVIDING DATABASES FEATURING AUDIENCE IN-
FORMATION RELATED TO NEWS OR CURRENT
EVENTS (U.S. CLS. 100, 101 AND 107).

FIRST USE 11-30-2004; IN COMMERCE 11-30-2004.

2,956,025. COURTROOM TELEVISION NETWORK LLC,
NEW YORK, NY. SN 78-295,302. FILED P.R. 9-3-2003;
AM. S.R. 7-1-2004.

NIGHTLY UPDATE

FOR PROVIDING TV PROGRAMS IN THE FIELD OF
COURTROOM TRIALS AND LEGAL ISSUES (U.S. CLS.
100, 101 AND 107).

FIRST USE 10-29-2003; IN COMMERCE 10-29-2003.

2,956,063. 3CIM, INC., SANTA CLARA, CA. SN 78-327,755.
FILED P.R. 11-13-2003; AM. S.R. 7-7-2004.

SlideTour

2,956,034. AMORI, GERALDINE H., SHELBURNE, VT. SN
78-306,730. FILED P.R. 9-29-2003; AM. S.R. 9-14-2004.

PATIENT SAFETY PLAYERS

NO CLAIM IS MADE TO THE EXCLUSIVE RIGHT TO
USE "PLAYERS", APART FROM THE MARK AS SHOWN.

FOR EDUCATIONAL SERVICES, NAMELY, LIVE
PERFORMANCES THAT PRESENT AND TEACH PA-
TIENT SAFETY (U.S. CLS. 100, 101 AND 107).

FIRST USE 0-0-2001; IN COMMERCE 8-23-2003.

THE MARK CONSISTS OF STANDARD CHARACTERS
WITHOUT CLAIM TO ANY PARTICULAR FONT, STYLE,
SIZE, OR COLOR.

FOR DIGITAL IMAGING SERVICES (U.S. CLS. 100,
101 AND 107).

FIRST USE 11-4-2003; IN COMMERCE 11-4-2003.

CLASS 41—(Continued).

2,956,094. PARMENTER, JAMES R., MANOMET, MA. SN 78-346,619. FILED P.R. 12-30-2003; AM. S.R. 1-14-2005.

RCKNRLL

THE MARK CONSISTS OF STANDARD CHARACTERS WITHOUT CLAIM TO ANY PARTICULAR FONT, STYLE, SIZE, OR COLOR.

NO CLAIM IS MADE TO THE EXCLUSIVE RIGHT TO USE "ROCK AND ROLL", APART FROM THE MARK AS SHOWN.

FOR ENTERTAINMENT SERVICES IN THE NATURE OF LIVE PERFORMANCES BY A MUSICAL BAND (U.S. CLS. 100, 101 AND 107).

FIRST USE 12-21-2003; IN COMMERCE 12-29-2003.

CLASS 41—(Continued).

2,956,105. FINANCIAL KNOWLEDGE NETWORK, LLC, CUPERTINO, CA. SN 78-350,965. FILED P.R. 1-13-2004; AM. S.R. 2-11-2005.

FinancialKnowledge

THE COLOR(S) PURPLE AND GREEN IS/ARE CLAIMED AS A FEATURE OF THE MARK.

THE MARK CONSISTS OF THE WORD FINANCIAL WRITTEN IN PURPLE THE WORD KNOWLEDGE WRITTEN IN GREEN.

FOR ARRANGING AND CONDUCTING FINANCIAL EDUCATION CLASSES (U.S. CLS. 100, 101 AND 107).

FIRST USE 6-1-2004; IN COMMERCE 6-1-2004.

2,956,115. AMERICAN MEDICAL DIAGNOSTICS, INC., FAIRFAX, VA. SN 78-354,847. FILED P.R. 1-21-2004; AM. S.R. 2-2-2005.

WORKING CME

THE MARK CONSISTS OF STANDARD CHARACTERS WITHOUT CLAIM TO ANY PARTICULAR FONT, STYLE, SIZE, OR COLOR.

NO CLAIM IS MADE TO THE EXCLUSIVE RIGHT TO USE "CME", APART FROM THE MARK AS SHOWN.

FOR PROVIDING CONTINUING MEDICAL EDUCATION COURSES (U.S. CLS. 100, 101 AND 107).

FIRST USE 9-0-2002; IN COMMERCE 6-2-2003.

2,956,096. SCHMIDLIN, LAWRENCE A, CHANDLER, AZ. SN 78-347,424. FILED P.R. 1-2-2004; AM. S.R. 7-30-2004.

National Leaders

THE MARK CONSISTS OF STANDARD CHARACTERS WITHOUT CLAIM TO ANY PARTICULAR FONT, STYLE, SIZE, OR COLOR.

FOR EDUCATIONAL SERVICES, NAMELY, CONDUCTING TRAINING CLASSES AND SEMINARS IN THE FIELD OF PROVIDING BETTER CUSTOMER SERVICE AND EMPLOYEE SUPERVISION (U.S. CLS. 100, 101 AND 107).

FIRST USE 1-1-2004; IN COMMERCE 1-1-2004.

CLASS 41—(Continued).

2,956,136. ENTERTAINMENT & SPORTS INTERNATIONAL INC., DURHAM, NC. SN 78-360,673. FILED P.R. 2-1-2004; AM. S.R. 2-16-2005.

CLASS 41—(Continued).

2,956,147. HAMPEL, PHILIP, BARRINGTON, IL. SN 78-363,380. FILED P.R. 2-5-2004; AM. S.R. 2-28-2005.

FAMILY FUN FEST



THE MARK CONSISTS OF STANDARD CHARACTERS WITHOUT CLAIM TO ANY PARTICULAR FONT, STYLE, SIZE, OR COLOR.

NO CLAIM IS MADE TO THE EXCLUSIVE RIGHT TO USE FEST, APART FROM THE MARK AS SHOWN.

FOR ORGANIZING COMMUNITY SPORTING AND CULTURAL EVENTS; ENTERTAINMENT SERVICES, NAMELY, PLANNING AND CONDUCTING OF FAIRS, EXHIBITIONS AND PRESENTATIONS RELATED TO SPORTS (U.S. CLS. 100, 101 AND 107).

FIRST USE 8-1-2003; IN COMMERCE 9-1-2003.

FOR PHOTOGRAPHY SERVICES (U.S. CLS. 100, 101 AND 107).

FIRST USE 1-1-2002; IN COMMERCE 2-1-2002.

2,956,137. FINANCIAL KNOWLEDGE NETWORK, LLC, CUPERTINO, CA. SN 78-360,739. FILED P.R. 2-2-2004; AM. S.R. 3-4-2005.

2,956,148. ALTERNATIVE CANINE TRAINING, LLC, ROYAL OAK, MI. SN 78-363,475. FILED P.R. 2-5-2004; AM. S.R. 2-28-2005.

**Conflict Free
Financial
Education**

**ALTERNATIVE CANINE
TRAINING**

THE MARK CONSISTS OF STANDARD CHARACTERS WITHOUT CLAIM TO ANY PARTICULAR FONT, STYLE, SIZE, OR COLOR.

NO CLAIM IS MADE TO THE EXCLUSIVE RIGHT TO USE "FINANCIAL EDUCATION", APART FROM THE MARK AS SHOWN.

FOR ARRANGING AND CONDUCTING FINANCIAL EDUCATION CLASSES (U.S. CLS. 100, 101 AND 107).

FIRST USE 6-1-2004; IN COMMERCE 6-1-2004.

THE MARK CONSISTS OF STANDARD CHARACTERS WITHOUT CLAIM TO ANY PARTICULAR FONT, STYLE, SIZE, OR COLOR.

NO CLAIM IS MADE TO THE EXCLUSIVE RIGHT TO USE "CANINE TRAINING", APART FROM THE MARK AS SHOWN.

FOR PET EDUCATIONAL SERVICES, NAMELY, CONDUCTING CLASSES, WORKSHOPS, SEMINARS IN THE FIELD OF ANIMAL CARE, MAINTENANCE, AND INSTRUCTION (U.S. CLS. 100, 101 AND 107).

FIRST USE 11-8-2000; IN COMMERCE 11-8-2000.

CLASS 41—(Continued).

2,956,158. WHITE STALLION PRODUCTIONS, INC., OVEIDO, FL. SN 78-366,194. FILED P.R. 2-11-2004; AM. S.R. 1-26-2005.

**THE "WORLD FAMOUS"
LIPIZZANER STALLIONS**

THE MARK CONSISTS OF STANDARD CHARACTERS WITHOUT CLAIM TO ANY PARTICULAR FONT, STYLE, SIZE, OR COLOR.

NO CLAIM IS MADE TO THE EXCLUSIVE RIGHT TO USE "LIPIZZANER STALLIONS", APART FROM THE MARK AS SHOWN.

FOR ENTERTAINMENT SERVICES, NAMELY, EQUESTRIAN SHOWS (U.S. CLS. 100, 101 AND 107).
FIRST USE 12-12-2003; IN COMMERCE 12-12-2003.

2,956,159. WHITE STALLION PRODUCTIONS, INC., OVEIDO, FL. SN 78-366,213. FILED P.R. 2-11-2004; AM. S.R. 3-8-2005.

**THE DANCING WHITE
STALLIONS**

THE MARK CONSISTS OF STANDARD CHARACTERS WITHOUT CLAIM TO ANY PARTICULAR FONT, STYLE, SIZE, OR COLOR.

NO CLAIM IS MADE TO THE EXCLUSIVE RIGHT TO USE "WHITE STALLIONS", APART FROM THE MARK AS SHOWN.

FOR ENTERTAINMENT SERVICES, NAMELY, EQUESTRIAN SHOWS (U.S. CLS. 100, 101 AND 107).
FIRST USE 12-12-2003; IN COMMERCE 12-12-2003.

2,956,175. GREEN, CHARLES H., MORRISTOWN, NJ. SN 78-368,523. FILED P.R. 2-16-2004; AM. S.R. 3-17-2005.

**TRUST-BASED
SELLING**

CLASS 41—(Continued).

THE MARK CONSISTS OF STANDARD CHARACTERS WITHOUT CLAIM TO ANY PARTICULAR FONT, STYLE, SIZE, OR COLOR.

FOR TRAINING SERVICES IN THE FIELD OF SALES, IN PARTICULAR SELLING BASED ON THE PRINCIPLES OF TRUST (U.S. CLS. 100, 101 AND 107).

FIRST USE 4-30-2002; IN COMMERCE 6-30-2002.

2,956,178. RODALE INC., EMMAUS, PA. SN 78-369,275. FILED P.R. 2-17-2004; AM. S.R. 3-11-2005.

**WEIGHT LOSS
BULLETIN**

THE MARK CONSISTS OF STANDARD CHARACTERS WITHOUT CLAIM TO ANY PARTICULAR FONT, STYLE, SIZE, OR COLOR.

OWNER OF U.S. REG. NOS. 2,914,031 AND 2,920,260.

NO CLAIM IS MADE TO THE EXCLUSIVE RIGHT TO USE "BULLETIN", APART FROM THE MARK AS SHOWN.

FOR PROVIDING INFORMATION IN THE FIELDS OF PHYSICAL FITNESS, EXERCISE AND MAINTAINING A HEALTHY LIFESTYLE; PROVIDING ELECTRONIC NEWSLETTERS IN THE FIELD OF HEALTH, FITNESS, DIET, EXERCISE AND LIFESTYLE (U.S. CLS. 100, 101 AND 107).

FIRST USE 2-27-2005; IN COMMERCE 2-27-2005.

2,956,192. HAROLD E. LEMAY MUSEUM, THE, TACOMA, WA. SN 78-373,348. FILED P.R. 2-24-2004; AM. S.R. 2-3-2005.

THE LEMAY MUSEUM

THE MARK CONSISTS OF STANDARD CHARACTERS WITHOUT CLAIM TO ANY PARTICULAR FONT, STYLE, SIZE, OR COLOR.

NO CLAIM IS MADE TO THE EXCLUSIVE RIGHT TO USE "MUSEUM", APART FROM THE MARK AS SHOWN.

FOR MUSEUM SERVICES (U.S. CLS. 100, 101 AND 107).

FIRST USE 1-0-2002; IN COMMERCE 1-0-2002.

CLASS 41—(Continued).

2,956,196. RH SOLUTIONS, INC., FLEMINGTON, NJ. SN 78-375,087. FILED P.R. 2-27-2004; AM. S.R. 1-27-2005.

**FAMILY CENTERED
PARENTING**

THE MARK CONSISTS OF STANDARD CHARACTERS WITHOUT CLAIM TO ANY PARTICULAR FONT, STYLE, SIZE, OR COLOR.

FOR EDUCATION SERVICES, NAMELY: WORKSHOPS IN THE FIELD OF PARENTING, PARENTING TRAINING, AND FAMILY ADVOCACY (U.S. CLS. 100, 101 AND 107).

FIRST USE 2-13-2004; IN COMMERCE 2-14-2004.



2,956,201. CORDAIRE & PARTNERS COMPANY INC., ZONA 3, PANAMA CITY, PANAMA. SN 78-377,039. FILED P.R. 3-2-2004; AM. S.R. 1-14-2005.

BOGART'S

THE MARK CONSISTS OF STANDARD CHARACTERS WITHOUT CLAIM TO ANY PARTICULAR FONT, STYLE, SIZE, OR COLOR.

FOR BETTING SERVICES (U.S. CLS. 100, 101 AND 107).

FIRST USE 5-0-2002; IN COMMERCE 5-0-2002.

CLASS 41—(Continued).

2,956,209. BROWN, GARRETT, BROOKLYN, NY. SN 78-381,552. FILED P.R. 3-10-2004; AM. S.R. 3-7-2005.

DJ G. BROWN

THE MARK CONSISTS OF STANDARD CHARACTERS WITHOUT CLAIM TO ANY PARTICULAR FONT, STYLE, SIZE, OR COLOR.

NO CLAIM IS MADE TO THE EXCLUSIVE RIGHT TO USE "DJ", APART FROM THE MARK AS SHOWN.

FOR ENTERTAINMENT IN THE NATURE OF VISUAL AND AUDIO PERFORMANCES, NAMELY, DISC JOCKEY SERVICES FOR NIGHTCLUBS, CONCERTS AND RADIO SHOWS; MUSIC PRODUCTION; LIVE MUSIC PERFORMANCE BY AN INDIVIDUAL (U.S. CLS. 100, 101 AND 107).

FIRST USE 9-1-1994; IN COMMERCE 9-1-1994.



2,956,223. COHEN, JEREMY C., OAKLAND, CA. SN 78-388,825. FILED 3-23-2004.

**QUARTET SAN
FRANCISCO**

THE MARK CONSISTS OF STANDARD CHARACTERS WITHOUT CLAIM TO ANY PARTICULAR FONT, STYLE, SIZE, OR COLOR.

NO CLAIM IS MADE TO THE EXCLUSIVE RIGHT TO USE "QUARTET", APART FROM THE MARK AS SHOWN.

FOR COMPOSITION OF MUSIC FOR OTHERS; ENTERTAINMENT IN THE NATURE OF LIVE MUSICAL CONCERT PERFORMANCES (U.S. CLS. 100, 101 AND 107).

FIRST USE 0-0-2001; IN COMMERCE 0-0-2001.

CLASS 41—(Continued).

2,956,234. MONTANA WEST, INC., QUAKERTOWN, PA. SN 78-395,109. FILED P.R. 4-1-2004; AM. S.R. 1-20-2005.

BIKINI BULL RIDING

THE MARK CONSISTS OF STANDARD CHARACTERS WITHOUT CLAIM TO ANY PARTICULAR FONT, STYLE, SIZE, OR COLOR.

FOR ENTERTAINMENT IN THE NATURE OF MECHANICAL BULL RIDING CONTESTS (U.S. CLS. 100, 101 AND 107).

FIRST USE 2-0-2002; IN COMMERCE 2-0-2002.

2,956,237. MUSEUM OF SCIENCE, BOSTON, MA. SN 78-398,543. FILED P.R. 4-8-2004; AM. S.R. 2-8-2005.

**NATIONAL CENTER FOR
TECHNOLOGICAL LITERACY**

THE MARK CONSISTS OF STANDARD CHARACTERS WITHOUT CLAIM TO ANY PARTICULAR FONT, STYLE, SIZE, OR COLOR.

NO CLAIM IS MADE TO THE EXCLUSIVE RIGHT TO USE "NATIONAL CENTER", APART FROM THE MARK AS SHOWN.

FOR MUSEUM SERVICES; EDUCATIONAL, EXHIBITION AND ENTERTAINMENT SERVICES, NAMELY CONDUCTING DEMONSTRATIONS, COURSES OF INSTRUCTION AND SEMINARS, ORGANIZING EXHIBITIONS, AND DISTRIBUTING INFORMATIONAL MATERIALS, ALL IN THE FIELDS OF SCIENCE AND ITS APPLICATIONS, AND COMPUTERS (U.S. CLS. 100, 101 AND 107).

FIRST USE 4-15-2004; IN COMMERCE 4-15-2004.

2,956,246. PRIMEDIA BUSINESS MAGAZINES & MEDIA, INC., OVERLAND PARK, KS. SN 78-405,105. FILED 4-20-2004.

**BROADWAY LIGHTING
MASTER CLASSES**

THE MARK CONSISTS OF STANDARD CHARACTERS WITHOUT CLAIM TO ANY PARTICULAR FONT, STYLE, SIZE, OR COLOR.

CLASS 41—(Continued).

NO CLAIM IS MADE TO THE EXCLUSIVE RIGHT TO USE "CLASSES", APART FROM THE MARK AS SHOWN.

FOR EDUCATIONAL SERVICES, NAMELY, CONDUCTING CONFERENCES IN THE FIELDS OF THEATRICAL LIGHTING DESIGN AND LIGHTING DESIGN CAREER MANAGEMENT (U.S. CLS. 100, 101 AND 107).

FIRST USE 6-0-1994; IN COMMERCE 6-0-1994.

2,956,251. SUKOTAI CORPORATION, ROSWELL, GA. SN 78-409,395. FILED P.R. 4-28-2004; AM. S.R. 1-11-2005.

Extreme Kickboxing

THE MARK CONSISTS OF STANDARD CHARACTERS WITHOUT CLAIM TO ANY PARTICULAR FONT, STYLE, SIZE, OR COLOR.

FOR PROMOTING THE SPORTS COMPETITIONS AND SPORTING EVENTS OF OTHERS, NAMELY COMPETITIONS INVOLVING KICKBOXING (U.S. CLS. 100, 101 AND 107).

FIRST USE 12-0-2004; IN COMMERCE 12-0-2004.

2,956,257. LAVINE, RON S, OAK PARK, CA. SN 78-411,753. FILED P.R. 5-1-2004; AM. S.R. 3-15-2005.

**Cold Calling
System for Sales
Success LIVE Call
Sales Training
Workshops**

THE MARK CONSISTS OF STANDARD CHARACTERS WITHOUT CLAIM TO ANY PARTICULAR FONT, STYLE, SIZE, OR COLOR.

FOR SALES EDUCATIONAL WORKSHOPS AND TRAINING IN COLD CALLING SALES TECHNIQUES (U.S. CLS. 100, 101 AND 107).

FIRST USE 2-3-1997; IN COMMERCE 2-3-1997.

CLASS 41—(Continued).

2,956,272. SPEEDWAY MOTORS, INC., LINCOLN, NE. SN 78-418,216. FILED P.R. 5-13-2004; AM. S.R. 1-19-2005.

**MUSEUM OF AMERICAN
SPEED**

THE MARK CONSISTS OF STANDARD CHARACTERS WITHOUT CLAIM TO ANY PARTICULAR FONT, STYLE, SIZE, OR COLOR.

NO CLAIM IS MADE TO THE EXCLUSIVE RIGHT TO USE "MUSEUM", APART FROM THE MARK AS SHOWN.

FOR MUSEUMS FEATURING RACING AND HIGH SPEED MOTOR VEHICLES (U.S. CLS. 100, 101 AND 107). FIRST USE 6-0-2004; IN COMMERCE 6-0-2004.

CLASS 41—(Continued).

2,956,281. INSTITUTE FOR COMMUNITY PEACE, WASHINGTON, DC. SN 78-422,110. FILED 5-20-2004.

**INSTITUTE FOR
COMMUNITY PEACE**

THE MARK CONSISTS OF STANDARD CHARACTERS WITHOUT CLAIM TO ANY PARTICULAR FONT, STYLE, SIZE, OR COLOR.

NO CLAIM IS MADE TO THE EXCLUSIVE RIGHT TO USE INSTITUTE, APART FROM THE MARK AS SHOWN.

FOR CONDUCTING EDUCATIONAL PROGRAMS AND TRAINING SERVICES IN THE FIELD OF VIOLENCE PREVENTION SKILLS AND STRATEGIES; CONDUCTING EDUCATIONAL RESEARCH ON VIOLENCE PREVENTION CAUSES AND SOLUTIONS (U.S. CLS. 100, 101 AND 107).

FIRST USE 5-31-2003; IN COMMERCE 5-31-2003.

2,956,278. BIG APPLE BARBECUE BLOCK PARTY, NEW YORK, NY. SN 78-420,933. FILED P.R. 5-18-2004; AM. S.R. 3-11-2005.

**BIG APPLE BARBECUE
BLOCK PARTY**

THE MARK CONSISTS OF STANDARD CHARACTERS WITHOUT CLAIM TO ANY PARTICULAR FONT, STYLE, SIZE, OR COLOR.

NO CLAIM IS MADE TO THE EXCLUSIVE RIGHT TO USE BARBECUE, APART FROM THE MARK AS SHOWN.

FOR ENTERTAINMENT IN THE NATURE OF LIVE MUSICAL PERFORMANCES; EDUCATIONAL SEMINARS AND WORKSHOPS IN THE AREA OF FOOD AND FOOD COMPETITIONS (U.S. CLS. 100, 101 AND 107).

FIRST USE 5-31-2003; IN COMMERCE 5-31-2003.

2,956,310. GOLFTEC ENTERPRISES, LLC, GREENWOOD VILLAGE, CO. SN 78-435,278. FILED P.R. 6-15-2004; AM. S.R. 2-16-2005.

**AMERICA'S #1 GOLF
LESSON**

THE MARK CONSISTS OF STANDARD CHARACTERS WITHOUT CLAIM TO ANY PARTICULAR FONT, STYLE, SIZE, OR COLOR.

NO CLAIM IS MADE TO THE EXCLUSIVE RIGHT TO USE "GOLF LESSON", APART FROM THE MARK AS SHOWN.

FOR GOLF INSTRUCTION, FEATURING DIGITAL VIDEO AND MOTION ANALYSIS COMPUTERS WHICH UTILIZE A PROPRIETARY DATABASE OF THE SWINGS OF TOP TOUR PROFESSIONALS; CORPORATE ENTERTAINMENT SERVICES, NAMELY, CONDUCTING GOLF CONTESTS; AND CUSTOM FITTING OF GOLF CLUBS TO INDIVIDUAL USERS (U.S. CLS. 100, 101 AND 107).

FIRST USE 2-28-2002; IN COMMERCE 2-28-2002.

CLASS 41—(Continued).

2,956,325. THE 1031 EXCHANGE EXPERTS, LLC, GREENWOOD VILLAGE, CO. SN 78-441,330. FILED P.R. 6-25-2004; AM. S.R. 2-14-2005.

THE 1031 EDUCATORS

THE MARK CONSISTS OF STANDARD CHARACTERS WITHOUT CLAIM TO ANY PARTICULAR FONT, STYLE, SIZE, OR COLOR.

NO CLAIM IS MADE TO THE EXCLUSIVE RIGHT TO USE "EDUCATORS", APART FROM THE MARK AS SHOWN.

FOR EDUCATIONAL SERVICES, NAMELY CONDUCTING CLASSES AND WORKSHOPS IN THE FIELD OF TAX-DEFERRED EXCHANGES, SECTION 1031 OF THE TAX CODE, TAUGHT AT UNIVERSITIES, COLLEGES, REAL ESTATE, LEGAL AND ACCOUNTING TRADE ASSOCIATIONS, CONTINUING EDUCATION ORGANIZATIONS (U.S. CLS. 100, 101 AND 107).

FIRST USE 6-1-2002; IN COMMERCE 7-22-2002.

CLASS 41—(Continued).

2,956,350. REED ELSEVIER INC., NEWTON, MA. SN 78-462,302. FILED P.R. 8-5-2004; AM. S.R. 3-8-2005.

**CONSTRUCTION
FORECAST MONTHLY**

THE MARK CONSISTS OF STANDARD CHARACTERS WITHOUT CLAIM TO ANY PARTICULAR FONT, STYLE, SIZE, OR COLOR.

NO CLAIM IS MADE TO THE EXCLUSIVE RIGHT TO USE "MONTHLY", APART FROM THE MARK AS SHOWN. FOR PROVIDING NEWSLETTERS VIA ONLINE MEANS IN THE FIELD OF ECONOMIC FORECAST (U.S. CLS. 100, 101 AND 107).

FIRST USE 7-15-2004; IN COMMERCE 7-15-2004.

2,956,334. MINNESOTA PUBLIC RADIO, SAINT PAUL, MN. SN 78-449,200. FILED P.R. 7-12-2004; AM. S.R. 2-17-2005.

Weekend America

THE MARK CONSISTS OF STANDARD CHARACTERS WITHOUT CLAIM TO ANY PARTICULAR FONT, STYLE, SIZE, OR COLOR.

FOR RADIO PROGRAMMING; DISTRIBUTION OF RADIO PROGRAMS FOR OTHERS; ENTERTAINMENT IN THE NATURE OF ON-GOING RADIO PROGRAMS IN THE FIELD OF NEWS, INFORMATION AND ENTERTAINMENT; AND ENTERTAINMENT SERVICES, NAMELY PROVIDING RADIO PROGRAMMING AND INFORMATION IN THE FIELD OF NEWS, NEWS AND CURRENT EVENT INFORMATION AND ENTERTAINMENT VIA A GLOBAL COMPUTER NETWORK (U.S. CLS. 100, 101 AND 107).

FIRST USE 9-4-2004; IN COMMERCE 9-4-2004.

2,956,353. THOMPSON, BRIGITTE A., WILLISTON, VT. SN 78-463,767. FILED P.R. 8-6-2004; AM. S.R. 3-23-2005.

Women In Print

THE MARK CONSISTS OF STANDARD CHARACTERS WITHOUT CLAIM TO ANY PARTICULAR FONT, STYLE, SIZE, OR COLOR.

FOR PUBLISHING AND DISTRIBUTION OF BOOKS BY WOMEN WRITERS (U.S. CLS. 100, 101 AND 107).

FIRST USE 5-1-2003; IN COMMERCE 4-9-2004.

CLASS 41—(Continued).

2,956,355. KALAMAZOO PICTURES GROUP, LLC, KALAMAZOO, MI. SN 78-467,315. FILED 8-13-2004.

**KALAMAZOO PICTURES
MOBILE CINEMA**

THE MARK CONSISTS OF STANDARD CHARACTERS WITHOUT CLAIM TO ANY PARTICULAR FONT, STYLE, SIZE, OR COLOR.

FOR ENTERTAINMENT SERVICES, NAMELY, THE TEMPORARY EXHIBITION OF MOTION PICTURES AND MOVING IMAGES AT VARIED LOCATIONS (U.S. CLS. 100, 101 AND 107).

FIRST USE 10-25-2003; IN COMMERCE 10-31-2003.

CLASS 42—SCIENTIFIC, COMPUTER AND LEGAL SERVICES

2,955,809. NOODLES & COMPANY, BOULDER, CO. SN 76-334,791. FILED P.R. 10-24-2001; AM. S.R. 3-1-2005.

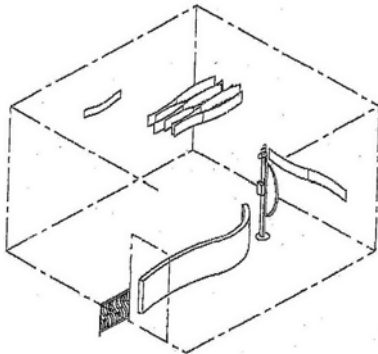

THE MARK COMPRISES THREE-DIMENSIONAL ELEMENTS FORMING A DESIGN LOCATED IN THE INTERIOR AND EXTERIOR SPACES IN WHICH THE SERVICES ARE PROVIDED, NAMELY, AN INTERIOR ROOM DIVIDER SHAPED LIKE A NOODLE, A CHAIR RAIL SHAPED LIKE A NOODLE, A FENCE WITH VERTICAL RAILS THAT ARE SHAPED LIKE NOODLES, CEILING HANGINGS THAT ARE SHAPED LIKE NOODLES, AND A MENU BOARD THAT IS SHAPED LIKE A HALF-MOON WITH A TWISTED NOODLE AT THE TOP. THE DASHED LINES SHOW THE POSITIONING OF THE ELEMENTS COMPRISING THE MARK AND ARE NOT CLAIMED AS A FEATURE OF THE MARK.

FOR RESTAURANT SERVICES (U.S. CLS. 100 AND 101).

FIRST USE 11-17-1998; IN COMMERCE 11-17-1998.

CLASS 42—(Continued).

2,955,813. BOWNE OF LOS ANGELES, INC., DOMINGUEZ HILLS, CA. SN 76-411,027. FILED P.R. 5-23-2002; AM. S.R. 7-28-2004.

ESUBMIT

FOR PROVIDING TEMPORARY USE OF ON-LINE, NON-DOWNLOADABLE GLOBAL PRODUCTION WORK FLOW TRACKING SOFTWARE FOR USE IN WORD PROCESSING, DESKTOP PUBLISHING, FACSIMILE TRANSMISSION, LITIGATION SUPPORT AND INFORMATION TECHNOLOGY IN CONJUNCTION WITH DOCUMENT HANDLING FOR OTHERS (U.S. CLS. 100 AND 101).

FIRST USE 3-11-2003; IN COMMERCE 3-11-2003.

2,955,841. CRYSTAL CRUISES, INC., LOS ANGELES, CA. SN 76-545,033. FILED P.R. 9-2-2003; AM. S.R. 3-2-2005.

WELLNESS AT SEA

FOR EDUCATIONAL PROGRAM, NAMELY CLASSES, SEMINARS AND WORKSHOPS ON THE SUBJECT OF HEALTH AND WELL-BEING (U.S. CLS. 100 AND 101).

FIRST USE 6-1-2003; IN COMMERCE 11-1-2003.

2,955,875. THE UNIVERSITY OF NORTH CAROLINA AT CHARLOTTE, CHARLOTTE, NC. SN 76-581,099. FILED P.R. 3-12-2004; AM. S.R. 2-4-2005.

CHARLOTTE RESEARCH INSTITUTE

THE MARK CONSISTS OF STANDARD CHARACTERS WITHOUT CLAIM TO ANY PARTICULAR FONT, STYLE, SIZE, OR COLOR.

NO CLAIM IS MADE TO THE EXCLUSIVE RIGHT TO USE "RESEARCH INSTITUTE", APART FROM THE MARK AS SHOWN.

FOR SCIENTIFIC RESEARCH; AND MEDICAL RESEARCH (U.S. CLS. 100 AND 101).

FIRST USE 1-0-2004; IN COMMERCE 1-0-2004.

2,955,904. BEN INC., COALDALE, ALBERTA, CANADA. SN 78-028,738. FILED P.R. 10-3-2000; AM. S.R. 2-28-2005.

AG TV

OWNER OF CANADA REG. NO. TMA605166, DATED 3-15-2004, EXPIRES 3-15-2019.

NO CLAIM IS MADE TO THE EXCLUSIVE RIGHT TO USE "TV", APART FROM THE MARK AS SHOWN.

FOR PROVIDING A WEBSITE CONTAINING INFORMATION IN THE FIELDS OF RANCHING, AGRICULTURE AND FARMING (U.S. CLS. 100 AND 101).

CLASS 42—(Continued).

2,955,910. EMEDICALFILES, INC., ATLANTA, GA. SN 78-072,422. FILED P.R. 7-5-2001; AM. S.R. 3-27-2002.

EMEDICALFILES

FOR PROVIDING ON-LINE MEDICAL INFORMATION MANAGEMENT SYSTEMS AND COMMUNICATIONS SYSTEM FOR MAINTAINING PERSONAL MEDICAL HISTORY RECORDS AND FILES ACCESSIBLE BY MEANS OF A GLOBAL COMPUTER NETWORK (U.S. CLS. 100 AND 101).

FIRST USE 3-31-2001; IN COMMERCE 3-31-2001.

2,955,984. AMERICAN LAW ON-LINE, INC., OWINGS MILLS, MD. SN 78-269,630. FILED P.R. 7-2-2003; AM. S.R. 12-27-2004.

SMARTLEGALFORMS

FOR COMPUTER INFORMATION SERVICES PROVIDED THROUGH A GLOBAL COMPUTER NETWORK, NAMELY PROVIDING ON-LINE LEGAL DOCUMENT PREPARATION, GENERATION, LEGAL FORMS EXPLANATION AND LEGAL INFORMATION FOR OTHERS (U.S. CLS. 100 AND 101).

FIRST USE 12-31-2003; IN COMMERCE 12-31-2003.

2,955,988. SUTHERLAND, WILLIAM T, EDEN PRAIRIE, MN. SN 78-272,056. FILED P.R. 7-9-2003; AM. S.R. 2-21-2005.

CERTIFY FOR SAFETY

NO CLAIM IS MADE TO THE EXCLUSIVE RIGHT TO USE SAFETY, APART FROM THE MARK AS SHOWN. FOR ENGINEERING (U.S. CLS. 100 AND 101).

FIRST USE 12-15-2000; IN COMMERCE 12-15-2000.

2,956,007. NEVADA CANCER INSTITUTE, LAS VEGAS, NV. SN 78-282,298. FILED P.R. 8-1-2003; AM. S.R. 8-23-2004.

NEVADA CANCER INSTITUTE

FOR RESEARCH, ANALYSIS, AND DEVELOPMENT OF MEDICAL TREATMENT, PROCEDURES AND PROCESSES AND DIAGNOSIS TREATMENT AND CURE OF ONCOLOGICAL DISEASES (U.S. CLS. 100 AND 101).

FIRST USE 4-1-2002; IN COMMERCE 4-1-2002.

2,956,013. TIM PETERS AND COMPANY, INC., PEAPACK, NJ. SN 78-286,989. FILED P.R. 8-13-2003; AM. S.R. 2-8-2005.

VISUAL MED SCHEDULER

NO CLAIM IS MADE TO THE EXCLUSIVE RIGHT TO

CLASS 42—(Continued).

USE "SCHEDULER", APART FROM THE MARK AS SHOWN.

FOR PROVIDING TEMPORARY USE OF ONLINE NON-DOWNLOADABLE INTERACTIVE COMPUTER APPLICATION FOR DESIGNING AND PRINTING CUSTOMIZED DRUG REGIMENS FOR PATIENTS AND FOR USE BY HEALTHCARE PROFESSIONALS (U.S. CLS. 100 AND 101).

FIRST USE 12-15-2004; IN COMMERCE 12-15-2004.

2,956,081. BODMAN, LONGLEY & DAHLING LLP, DETROIT, MI. SN 78-339,922. FILED P.R. 12-12-2003; AM. S.R. 3-3-2005.

BODMAN

THE MARK CONSISTS OF STANDARD CHARACTERS WITHOUT CLAIM TO ANY PARTICULAR FONT, STYLE, SIZE, OR COLOR.

OWNER OF U.S. REG. NO. 2,569,730.

THE NAME IN THE MARK DOES NOT IDENTIFY ANY LIVING INDIVIDUAL.

FOR LEGAL SERVICES (U.S. CLS. 100 AND 101).

FIRST USE 6-1-2004; IN COMMERCE 6-1-2004.

2,956,149. ROBERT S. HIGHTOWER, P.A., TALLAHASSEE, FL. SN 78-363,676. FILED P.R. 2-6-2004; AM. S.R. 2-28-2005.

HIGHTOWERLAW.COM

THE MARK CONSISTS OF STANDARD CHARACTERS WITHOUT CLAIM TO ANY PARTICULAR FONT, STYLE, SIZE, OR COLOR.

FOR LEGAL SERVICES (U.S. CLS. 100 AND 101).

FIRST USE 2-28-2005; IN COMMERCE 2-28-2005.

CLASS 42—(Continued).

2,956,186. ALLOY TECHNOLOGY SOLUTIONS, INC., MARINETTE, WI. SN 78-372,423. FILED P.R. 2-23-2004; AM. S.R. 3-14-2005.

CLASS 42—(Continued).

2,956,212. AQUALAW PLC, RICHMOND, VA. SN 78-382,435. FILED P.R. 3-11-2004; AM. S.R. 3-22-2005.

ALLOY TECHNOLOGY
SOLUTIONS

AquaLaw

THE MARK CONSISTS OF STANDARD CHARACTERS WITHOUT CLAIM TO ANY PARTICULAR FONT, STYLE, SIZE, OR COLOR.

NO CLAIM IS MADE TO THE EXCLUSIVE RIGHT TO USE "TECHNOLOGY SOLUTIONS", APART FROM THE MARK AS SHOWN.

FOR RESEARCH AND DEVELOPMENT IN THE FIELD OF HEAT AND WEAR RESISTANT ALLOYS (U.S. CLS. 100 AND 101).

FIRST USE 11-22-2004; IN COMMERCE 11-22-2004.

THE MARK CONSISTS OF STANDARD CHARACTERS WITHOUT CLAIM TO ANY PARTICULAR FONT, STYLE, SIZE, OR COLOR.

FOR LEGAL SERVICES (U.S. CLS. 100 AND 101).

FIRST USE 9-9-2002; IN COMMERCE 9-9-2002.

2,956,236. THE TRUSTEES OF THE ROBERT L. O'BLOCK REVOCABLE TRUST, SPRINGFIELD, MO. SN 78-398,312. FILED P.R. 4-7-2004; AM. S.R. 1-10-2005.

2,956,194. MAZZANTI, INC., HOBOKEN, NJ. SN 78-374,112. FILED P.R. 2-25-2004; AM. S.R. 12-16-2004.

MAZZANTI INC

CERTIFIED CRISIS
INTERVENER, CCI

THE MARK CONSISTS OF STANDARD CHARACTERS WITHOUT CLAIM TO ANY PARTICULAR FONT, STYLE, SIZE, OR COLOR.

NO CLAIM IS MADE TO THE EXCLUSIVE RIGHT TO USE "INC", APART FROM THE MARK AS SHOWN.

FOR CONSULTING SERVICES IN THE FIELD OF DESIGN, SELECTION, IMPLEMENTATION AND USE OF COMPUTER HARDWARE AND SOFTWARE SYSTEMS FOR OTHERS (U.S. CLS. 100 AND 101).

FIRST USE 0-0-2001; IN COMMERCE 0-0-2001.

THE MARK CONSISTS OF STANDARD CHARACTERS WITHOUT CLAIM TO ANY PARTICULAR FONT, STYLE, SIZE, OR COLOR.

NO CLAIM IS MADE TO THE EXCLUSIVE RIGHT TO USE "CERTIFIED CRISIS INTERVENER", APART FROM THE MARK AS SHOWN.

FOR TESTING, ANALYSIS, AND EVALUATION OF THE SERVICES OF OTHERS FOR THE PURPOSE OF CERTIFICATION IN THE FIELD OF CRISIS INTERVENTION (U.S. CLS. 100 AND 101).

FIRST USE 6-30-2003; IN COMMERCE 6-30-2003.

CLASS 42—(Continued).

2,956,289. 20/10 PERFECT VISION OPTISCHE GERAETE GMBH, D-69123 HEIDELBERG, FED REP GERMANY. SN 78-424,926. FILED P.R. 5-25-2004; AM. S.R. 2-22-2005.

PERSONALIZED VISION CARE

THE MARK CONSISTS OF STANDARD CHARACTERS WITHOUT CLAIM TO ANY PARTICULAR FONT, STYLE, SIZE, OR COLOR.

FOR OPHTHALMIC MEDICAL RESEARCH PROCEDURES INVOLVING THE COLLECTION OF DATA FOR THE DIAGNOSTIC EVALUATION OF THE ANATOMY OF EYES TO DETERMINE THEIR OPTICAL PROPERTIES FOR USE BY OTHER MEDICAL PROFESSIONALS (U.S. CLS. 100 AND 101).

FIRST USE 5-1-2004; IN COMMERCE 5-1-2004.

2,956,290. AQUANTIVE, INC., SEATTLE, WA. SN 78-426,456. FILED P.R. 5-27-2004; AM. S.R. 2-14-2005.

BIDMANAGER

THE MARK CONSISTS OF STANDARD CHARACTERS WITHOUT CLAIM TO ANY PARTICULAR FONT, STYLE, SIZE, OR COLOR.

FOR PROVIDING TEMPORARY USE OF AN ON-LINE NON-DOWNLOADABLE SOFTWARE FOR OTHER ON-LINE ADVERTISERS TO USE IN MANAGING, TRACKING AND MONITORING ADVERTISING, MARKETING AND PROMOTIONS VIA A GLOBAL COMPUTER NETWORK (U.S. CLS. 100 AND 101).

FIRST USE 9-30-2001; IN COMMERCE 9-30-2001.

CLASS 42—(Continued).

2,956,311. BIOPSY SCIENCES, LLC, CLEARWATER, FL. SN 78-436,224. FILED P.R. 6-16-2004; AM. S.R. 2-1-2005.

BIOPSY SCIENCES

THE MARK CONSISTS OF STANDARD CHARACTERS WITHOUT CLAIM TO ANY PARTICULAR FONT, STYLE, SIZE, OR COLOR.

NO CLAIM IS MADE TO THE EXCLUSIVE RIGHT TO USE "SCIENCES", APART FROM THE MARK AS SHOWN. FOR RESEARCH AND DEVELOPMENT FOR MEDICAL AND SURGICAL PRODUCTS (U.S. CLS. 100 AND 101).

FIRST USE 11-1-2003; IN COMMERCE 11-1-2003.

2,956,314. GÉNÉTIPORC INC., ST-BERNARD, QUEBEC, CANADA. SN 78-437,851. FILED P.R. 6-18-2004; AM. S.R. 2-25-2005.

Specialized Expertise. Hands- On Approach.

THE MARK CONSISTS OF STANDARD CHARACTERS WITHOUT CLAIM TO ANY PARTICULAR FONT, STYLE, SIZE, OR COLOR.

FOR ZOOLOGICAL CONSULTATION AND ASSISTANCE OFFERED TO PRODUCERS, NAMELY, MONITORING LIVESTOCK PRODUCTION, OFFERING BIOSECURITY AND GENETICS PROTOCOLS, PROVIDING WEIGHT AND FEEDING STRATEGY AND CUSTOMIZED EVALUATION OF LIVESTOCK (U.S. CLS. 100 AND 101).

FIRST USE 6-18-2004; IN COMMERCE 6-18-2004.

CLASS 42—(Continued).

2,956,321. LUTHER CONSULTING, LLC, INDIANAPOLIS, IN. SN 78-439,894. FILED P.R. 6-23-2004; AM. S.R. 4-3-2005.

CLASS 42—(Continued).

2,956,348. THE SIMMONS FIRM, APC, SAN DIEGO, CA. SN 78-462,101. FILED P.R. 8-4-2004; AM. S.R. 3-10-2005.

EvaluationWeb



THE MARK CONSISTS OF STANDARD CHARACTERS WITHOUT CLAIM TO ANY PARTICULAR FONT, STYLE, SIZE, OR COLOR.

FOR COMPUTER SERVICE, NAMELY, ACTING AS AN APPLICATION SERVICE PROVIDER IN THE FIELD OF KNOWLEDGE MANAGEMENT TO HOST COMPUTER APPLICATION SOFTWARE FOR THE COLLECTION, EDITING, ORGANIZING, MODIFYING, BOOK MARKING, TRANSMISSION, STORAGE AND SHARING OF DATA AND INFORMATION (U.S. CLS. 100 AND 101).

FIRST USE 11-1-1999; IN COMMERCE 11-1-1999.

NO CLAIM IS MADE TO THE EXCLUSIVE RIGHT TO USE FIRM A LAW CORPORATION, APART FROM THE MARK AS SHOWN.

THE MARK CONSISTS OF STYLIZED LETTERING OF THE WORDS "THE SIMMONS FIRM A LAW CORPORATION". THE WORDS "THE SIMMONS FIRM" ARE UNDERLINED, AND BELOW THE UNDERLINING ARE THE WORDS "A LAW CORPORATION".

FOR PROFESSIONAL LEGAL SERVICES (U.S. CLS. 100 AND 101).

FIRST USE 12-1-2003; IN COMMERCE 1-5-2004.

2,956,323. CORPORATION SERVICE COMPANY, WILMINGTON, DE. SN 78-440,394. FILED P.R. 6-23-2004; AM. S.R. 3-15-2005.

2,956,349. THE SIMMONS FIRM, APC, SAN DIEGO, CA. SN 78-462,116. FILED P.R. 8-4-2004; AM. S.R. 3-10-2005.

COMPLIANCE CALENDAR

THE SIMMONS FIRM

THE MARK CONSISTS OF STANDARD CHARACTERS WITHOUT CLAIM TO ANY PARTICULAR FONT, STYLE, SIZE, OR COLOR.

FOR PROVIDING INFORMATION IN THE FIELD OF BUSINESS AND LEGAL AFFAIRS VIA THE INTERNET, NAMELY CALCULATING DEADLINES FOR FILING DOCUMENTS RELATED TO MAINTAINING LEGAL ENTITY STATUS, FURNISHING A SEARCHABLE DATABASE OF SUCH INFORMATION AND CALCULATIONS, AND AUTOMATICALLY ADVISING CUSTOMERS OF THE UPCOMING STEPS TO TAKE (U.S. CLS. 100 AND 101).

FIRST USE 6-0-1999; IN COMMERCE 6-0-1999.

THE MARK CONSISTS OF STANDARD CHARACTERS WITHOUT CLAIM TO ANY PARTICULAR FONT, STYLE, SIZE, OR COLOR.

NO CLAIM IS MADE TO THE EXCLUSIVE RIGHT TO USE FIRM, APART FROM THE MARK AS SHOWN.

FOR PROFESSIONAL LEGAL SERVICES (U.S. CLS. 100 AND 101).

FIRST USE 12-21-2000; IN COMMERCE 1-2-2001.

CLASS 42—(Continued).

2,956,352. AMERICAN INTERNATIONAL GROUP, INC., NEW YORK, NY. SN 78-463,238. FILED P.R. 8-6-2004; AM. S.R. 2-11-2005.

**THREAT AND
VULNERABILITY RISK
ASSESSMENT**

THE MARK CONSISTS OF STANDARD CHARACTERS WITHOUT CLAIM TO ANY PARTICULAR FONT, STYLE, SIZE, OR COLOR.

FOR PROVIDING TEMPORARY USE OF AN ONLINE NON-DOWNLOADABLE SOFTWARE PLATFORM USED FOR CONDUCTING ASSESSMENTS OF A BUSINESS'S RISK EXPOSURE FOR INSURANCE UNDERWRITING PURPOSES (U.S. CLS. 100 AND 101).

FIRST USE 10-15-2002; IN COMMERCE 10-15-2002.

2,956,354. HUTCHISON & MASON PLLC, RALEIGH, NC. SN 78-466,235. FILED P.R. 8-12-2004; AM. S.R. 3-16-2005.

**COUNSEL TO THE
TECHNOLOGY
COMMUNITY**

THE MARK CONSISTS OF STANDARD CHARACTERS WITHOUT CLAIM TO ANY PARTICULAR FONT, STYLE, SIZE, OR COLOR.

FOR LEGAL SERVICES (U.S. CLS. 100 AND 101).
FIRST USE 6-1-2002; IN COMMERCE 6-1-2002.

CLASS 43—HOTEL AND RESTAURANT SERVICES

CLASS 43—(Continued).

2,955,860. WOLFE, KENNETH, DUBOIS, WY. SN 76-569,113. FILED P.R. 12-1-2003; AM. S.R. 3-17-2005.

CAFÉ WYOMING

THE MARK CONSISTS OF STANDARD CHARACTERS WITHOUT CLAIM TO ANY PARTICULAR FONT, STYLE, SIZE, OR COLOR.

NO CLAIM IS MADE TO THE EXCLUSIVE RIGHT TO USE CAFÉ, APART FROM THE MARK AS SHOWN.

FOR RESTAURANT SERVICES (U.S. CLS. 100 AND 101).

FIRST USE 2-8-2001; IN COMMERCE 2-8-2001.

2,956,056. OTG MANAGEMENT, INC., PHILADELPHIA, PA. SN 78-321,650. FILED P.R. 10-31-2003; AM. S.R. 8-27-2004.

NEW YORK SPORTS GRILL

NO CLAIM IS MADE TO THE EXCLUSIVE RIGHT TO USE "GRILL", APART FROM THE MARK AS SHOWN.
FOR RESTAURANT AND BAR SERVICES (U.S. CLS. 100 AND 101).

FIRST USE 11-7-2003; IN COMMERCE 11-7-2003.

2,956,093. MARRIOTT INTERNATIONAL, INC., BETHESDA, MD. SN 78-346,610. FILED P.R. 12-30-2003; AM. S.R. 1-12-2005.

DUPRE'S

THE MARK CONSISTS OF STANDARD CHARACTERS WITHOUT CLAIM TO ANY PARTICULAR FONT, STYLE, SIZE, OR COLOR.

FOR RESTAURANT, BAR AND CATERING SERVICES (U.S. CLS. 100 AND 101).

FIRST USE 1-15-2004; IN COMMERCE 1-15-2004.

CLASS 43—(Continued).

2,956,165. AMERICAN CLASSIC, LLC, BOSTON, MA. SN 78-367,361. FILED P.R. 2-12-2004; AM. S.R. 2-26-2005.

CLASS 43—(Continued).

2,956,306. BURNS, DONALD P., LAKELAND, FL. SN 78-433,833. FILED P.R. 6-11-2004; AM. S.R. 2-10-2005.

MENUS OF AMERICA**PB & JS**

THE MARK CONSISTS OF STANDARD CHARACTERS WITHOUT CLAIM TO ANY PARTICULAR FONT, STYLE, SIZE, OR COLOR.

NO CLAIM IS MADE TO THE EXCLUSIVE RIGHT TO USE "MENUS", APART FROM THE MARK AS SHOWN.

FOR PROVIDING A SEARCHABLE ONLINE ADVERTISING GUIDE FEATURING THE GOODS AND SERVICES OF OTHER ONLINE VENDORS ON THE INTERNET (U.S. CLS. 100 AND 101).

FIRST USE 6-3-2003; IN COMMERCE 6-3-2003.

THE MARK CONSISTS OF STANDARD CHARACTERS WITHOUT CLAIM TO ANY PARTICULAR FONT, STYLE, SIZE, OR COLOR.

FOR RESTAURANT SERVICES (U.S. CLS. 100 AND 101).

FIRST USE 11-1-2004; IN COMMERCE 11-1-2004.

CLASS 44—MEDICAL, BEAUTY AND AGRICULTURAL SERVICES

2,955,896. DMX WORKS, INC., PALM HARBOR, FL. SN 76-604,008. FILED P.R. 7-26-2004; AM. S.R. 3-11-2005.

DIGITAL MOTION X-RAY

THE MARK CONSISTS OF STANDARD CHARACTERS WITHOUT CLAIM TO ANY PARTICULAR FONT, STYLE, SIZE, OR COLOR.

OWNER OF U.S. REG. NO. 2,017,132.

NO CLAIM IS MADE TO THE EXCLUSIVE RIGHT TO USE "X-RAY", APART FROM THE MARK AS SHOWN.

FOR MEDICAL TESTING SERVICES NAMELY VIDEOFLUOROSCOPY (U.S. CLS. 100 AND 101).

FIRST USE 4-25-2001; IN COMMERCE 4-25-2001.

2,956,222. DYNAMIC MANAGEMENT COMPANY, LLC, MADISON, TN. SN 78-388,231. FILED P.R. 3-22-2004; AM. S.R. 4-1-2005.

**Planned Eating
Alternatives**

2,955,944. LEAP OF FAITH TECHNOLOGIES, INC., CRYSTAL LAEK, IL. SN 78-211,615. FILED P.R. 2-6-2003; AM. S.R. 10-29-2004.

IMMUN.COM

THE MARK CONSISTS OF STANDARD CHARACTERS WITHOUT CLAIM TO ANY PARTICULAR FONT, STYLE, SIZE, OR COLOR.

NO CLAIM IS MADE TO THE EXCLUSIVE RIGHT TO USE "EATING", APART FROM THE MARK AS SHOWN.

FOR RESTAURANT SERVICES (U.S. CLS. 100 AND 101).

FIRST USE 1-1-2004; IN COMMERCE 1-1-2004.

FOR MEDICAL AND HEALTHCARE SERVICES, NAMELY, PROVIDING MEDICAL INFORMATION ON THE SUBJECT OF IMMUNIZATIONS VIA A WEB SITE AND CREATING AND MAINTAINING AN IMMUNIZATION REGISTRY CONTAINING MEDICAL RECORDS CONCERNING THE IMMUNIZATION OF INDIVIDUALS (U.S. CLS. 100 AND 101).

FIRST USE 0-0-1998; IN COMMERCE 3-17-1999.

CLASS 44—(Continued).

2,956,020. BASIC DENTAL IMPLANT SYSTEMS, INC., ALBUQUERQUE, NM. SN 78-292,516. FILED P.R. 8-26-2003; AM. S.R. 12-20-2004.

MODEL TOMOGRAPHIC

FOR DENTAL MODEL CREATION AND FABRICATION SERVICES TO AID IN DETERMINING OPTIMAL PLACEMENT OF DENTAL IMPLANTS (U.S. CLS. 100 AND 101).

FIRST USE 1-28-2003; IN COMMERCE 1-28-2003.

2,956,168. ST. VINCENT MEDICAL CENTER, LOS ANGELES, CA. SN 78-367,967. FILED P.R. 2-13-2004; AM. S.R. 3-4-2005.

**LOS ANGELES CANCER
INSTITUTE**

THE MARK CONSISTS OF STANDARD CHARACTERS WITHOUT CLAIM TO ANY PARTICULAR FONT, STYLE, SIZE, OR COLOR.

NO CLAIM IS MADE TO THE EXCLUSIVE RIGHT TO USE "CANCER INSTITUTE", APART FROM THE MARK AS SHOWN.

FOR PROVIDING MEDICAL INFORMATION ON MEDICAL DIAGNOSIS AND TREATMENTS FOR CANCER; MEDICAL SERVICES IN THE NATURE OF TREATMENT, DIAGNOSIS AND SCREENING FOR CANCER (U.S. CLS. 100 AND 101).

FIRST USE 11-1-2003; IN COMMERCE 11-1-2003.

2,956,173. EATON, RANDI C., LEWISVILLE, NC. AND HUNT, LINDA J., WINSTON-SALEM, NC. SN 78-368,375. FILED P.R. 2-15-2004; AM. S.R. 1-20-2005.

**Cellular Memory
Repatterning**

THE MARK CONSISTS OF STANDARD CHARACTERS WITHOUT CLAIM TO ANY PARTICULAR FONT, STYLE, SIZE, OR COLOR.

FOR PSYCHOLOGICAL COUNSELING, NAMELY, INDIVIDUALIZED BODY AND ENERGY WORK AND TALK THERAPY THAT ACTS ON CELLULAR MEMORY TO REMOVE DESTRUCTIVE GENETIC AND INHERITED LIFE PATTERNS (U.S. CLS. 100 AND 101).

FIRST USE 3-4-2004; IN COMMERCE 3-4-2004.

CLASS 44—(Continued).

2,956,182. RENT A GARDENER, INC., NAPERVILLE, IL. SN 78-369,835. FILED P.R. 2-18-2004; AM. S.R. 2-24-2005.

RENT A GARDENER

THE MARK CONSISTS OF STANDARD CHARACTERS WITHOUT CLAIM TO ANY PARTICULAR FONT, STYLE, SIZE, OR COLOR.

FOR LANDSCAPE GARDENING; LANDSCAPE GARDENING DESIGN FOR OTHERS (U.S. CLS. 100 AND 101).

FIRST USE 3-1-2004; IN COMMERCE 3-1-2004.

2,956,206. NYC SMILE DESIGN, NEW YORK, NY. SN 78-379,930. FILED P.R. 3-7-2004; AM. S.R. 1-24-2005.

NYC SMILE DESIGN

THE MARK CONSISTS OF STANDARD CHARACTERS WITHOUT CLAIM TO ANY PARTICULAR FONT, STYLE, SIZE, OR COLOR.

NO CLAIM IS MADE TO THE EXCLUSIVE RIGHT TO USE "SMILE DESIGN", APART FROM THE MARK AS SHOWN.

FOR GENERAL AND COSMETIC DENTISTRY (U.S. CLS. 100 AND 101).

FIRST USE 12-0-2002; IN COMMERCE 12-0-2002.

2,956,265. RODGERS, TIMOTHY L., SANTA BARBARA, CA. AND BAKER, DENNIS H., SANTA BARBARA, CA. SN 78-415,546. FILED P.R. 5-9-2004; AM. S.R. 2-5-2005.

**Premium Care
Internal Medicine**

THE MARK CONSISTS OF STANDARD CHARACTERS WITHOUT CLAIM TO ANY PARTICULAR FONT, STYLE, SIZE, OR COLOR.

NO CLAIM IS MADE TO THE EXCLUSIVE RIGHT TO USE "INTERNAL MEDICINE", APART FROM THE MARK AS SHOWN.

FOR MEDICAL SERVICES, NAMELY, INTERNAL MEDICINE AND HEALTHCARE SERVICES FOR ADULTS (U.S. CLS. 100 AND 101).

FIRST USE 9-1-2003; IN COMMERCE 11-1-2003.

CLASS 44—(Continued).

2,956,271. NATURAL REFLEX THERAPY, PLLC, SAN ANTONIO, TX. SN 78-417,138. FILED P.R. 5-12-2004; AM. S.R. 1-14-2005.

**NATURAL REFLEX
THERAPY**

THE MARK CONSISTS OF STANDARD CHARACTERS WITHOUT CLAIM TO ANY PARTICULAR FONT, STYLE, SIZE, OR COLOR.

NO CLAIM IS MADE TO THE EXCLUSIVE RIGHT TO USE "REFLEX THERAPY", APART FROM THE MARK AS SHOWN.

FOR MASSAGE, NAMELY, HOLISTIC BODYWORK THAT WORKS BY STIMULATING REFLEX POINTS ON THE BODY (U.S. CLS. 100 AND 101).

FIRST USE 12-0-2002; IN COMMERCE 12-0-2002.

CLASS 44—(Continued).

2,956,318. HORN, RICHARD A, MURRIETA, CA. SN 78-438,991. FILED P.R. 6-22-2004; AM. S.R. 3-3-2005.

**All American
Alpacas**

THE MARK CONSISTS OF STANDARD CHARACTERS WITHOUT CLAIM TO ANY PARTICULAR FONT, STYLE, SIZE, OR COLOR.

NO CLAIM IS MADE TO THE EXCLUSIVE RIGHT TO USE ALPACAS, APART FROM THE MARK AS SHOWN.

FOR ALPACA BREEDING AND STUD SERVICES (U.S. CLS. 100 AND 101).

FIRST USE 12-30-2001; IN COMMERCE 12-30-2001.

CLASS 45—PERSONAL SERVICES

2,955,826. WORLDWIDE INVESTIGATIONS & RESEARCH, INC., DBA WIRED TECHNOLOGY SYSTEMS, WEST PALM BEACH, FL. SN 76-508,880. FILED P.R. 4-23-2003; AM. S.R. 2-18-2005.

**WIRED TECHNOLOGY
SYSTEMS**

NO CLAIM IS MADE TO THE EXCLUSIVE RIGHT TO USE "TECHNOLOGY SYSTEMS", APART FROM THE MARK AS SHOWN.

FOR SECURITY SERVICES, NAMELY INTEGRATING BIOMETRICS PROCESSES INTO SECURITY SYSTEMS FOR ENHANCING AUTHENTICATION OF INDIVIDUALS (U.S. CLS. 100 AND 101).

FIRST USE 8-0-1999; IN COMMERCE 8-0-1999.

2,956,300. 20/20 INSTITUTE, LLC, ENGLEWOOD, CO. SN 78-430,723. FILED P.R. 6-7-2004; AM. S.R. 2-24-2005.

20/20 INSTITUTE

THE MARK CONSISTS OF STANDARD CHARACTERS WITHOUT CLAIM TO ANY PARTICULAR FONT, STYLE, SIZE, OR COLOR.

NO CLAIM IS MADE TO THE EXCLUSIVE RIGHT TO USE "INSTITUTE", APART FROM THE MARK AS SHOWN.

FOR LASER EYE VISION CORRECTION SURGERY (U.S. CLS. 100 AND 101).

FIRST USE 7-18-2004; IN COMMERCE 7-18-2004.

2,955,938. SCANALERT, INC., NAPA, CA. SN 78-205,653. FILED P.R. 1-22-2003; AM. S.R. 8-13-2004.

HACKER SECURE

NO CLAIM IS MADE TO THE EXCLUSIVE RIGHT TO USE "HACKER", APART FROM THE MARK AS SHOWN.

FOR MONITORING OF COMPUTER SYSTEMS FOR SECURITY PURPOSES (U.S. CLS. 100 AND 101).

FIRST USE 5-10-2004; IN COMMERCE 5-10-2004.

CLASS 45—(Continued).

2,956,211. DINNER INTRODUCTIONS LLC, NEW YORK, NY. SN 78-381,968. FILED P.R. 3-10-2004; AM. S.R. 2-10-2005.

**DINNER
INTRODUCTIONS**

THE MARK CONSISTS OF STANDARD CHARACTERS WITHOUT CLAIM TO ANY PARTICULAR FONT, STYLE, SIZE, OR COLOR.

FOR SOCIAL INTRODUCTION AGENCY, ONLINE DATE SERVICES AND SOCIAL CLUB (U.S. CLS. 100 AND 101).

FIRST USE 7-7-2003; IN COMMERCE 7-7-2003.

2,956,302. LIFE COACHES, HAMEL, MN. SN 78-433,121. FILED P.R. 6-10-2004; AM. S.R. 2-14-2005.

Life COACHES

THE MARK CONSISTS OF STANDARD CHARACTERS WITHOUT CLAIM TO ANY PARTICULAR FONT, STYLE, SIZE, OR COLOR.

FOR MINISTERIAL AND EVANGELISTIC SERVICES (U.S. CLS. 100 AND 101).

FIRST USE 5-18-2000; IN COMMERCE 5-18-2000.

CLASS 45—(Continued).

2,956,360. NELSEN FUNERAL HOME, INC., RICHMOND, VA. SN 78-475,510. FILED 8-30-2004.

**CREMATION SOCIETY
OF VIRGINIA**

THE MARK CONSISTS OF STANDARD CHARACTERS WITHOUT CLAIM TO ANY PARTICULAR FONT, STYLE, SIZE, OR COLOR.

OWNER OF U.S. REG. NO. 2,902,524.

NO CLAIM IS MADE TO THE EXCLUSIVE RIGHT TO USE "CREMATION SOCIETY", APART FROM THE MARK AS SHOWN.

FOR FUNERAL SERVICES NAMELY, CREMATION, BURIAL AND EMBALMING (U.S. CLS. 100 AND 101).

FIRST USE 4-1-1996; IN COMMERCE 4-1-1996.

2,956,361. NELSEN FUNERAL HOME, INC., RICHMOND, VA. SN 78-475,513. FILED 8-30-2004.

Cremation Society
of
VIRGINIA

OWNER OF U.S. REG. NO. 2,902,524.

NO CLAIM IS MADE TO THE EXCLUSIVE RIGHT TO USE "CREMATION SOCIETY", APART FROM THE MARK AS SHOWN.

THE MARK CONSISTS OF FOUR WORDS IN STYLIZED FORM WITH "CREMATION SOCIETY" ON THE FIRST LINE IN ITALICS, "OF" BETWEEN DECORATIVE MARKINGS ON THE SECOND LINE IN ITALICS AND "VIRGINIA" IN ALL CAPITALS AND PRINTED FONT ON THE THIRD LINE.

FOR FUNERAL SERVICES NAMELY, CREMATION, BURIAL AND EMBALMING (U.S. CLS. 100 AND 101).

FIRST USE 4-1-1996; IN COMMERCE 4-1-1996.

* * * * *

PRIOR UNITED STATES CLASSIFICATION

APPLICATION IN ONE CLASS

COLLECTIVE MEMBERSHIP MARKS

2,956,288. ASOCIACIÓN DE PRODUCTORES Y EMPACADORES EXPORTADORES DE AGUACATE DE MICHOACÁN A.C., URUAPAN, MEXICO. SN 78-424,527. FILED P.R. 5-25-2004; AM. S.R. 3-11-2005.

The World's Finest

CLASS 200—COLLECTIVE MEMBERSHIP

THE MARK CONSISTS OF STANDARD CHARACTERS WITHOUT CLAIM TO ANY PARTICULAR FONT, STYLE, SIZE, OR COLOR.
FOR INDICATING MEMBERSHIP IN AN ASSOCIATION OF AVOCADO PRODUCERS, PACKERS AND EXPORTERS (U.S. CL. 200).
FIRST USE 9-1-2002; IN COMMERCE 3-1-2004.

* * * * *

TRADEMARK REGISTRATIONS RENEWED

The designation "U.S. Cl." appearing in this section refers to the U.S. class in effect prior to Sep. 1, 1973 rather than the international class which applies to applications filed on or after that date. For adoption of international classification see notice in the OFFICIAL GAZETTE of Jun. 26, 1973 (911 O.G. TM 210).

178,478.	ACE. U.S. CL. 32. (INT. CL. 20). REG. 1-15-1924.	793,181.	MICRO-TROL. U.S. CL. 13. (INT. CL. 6). REG. 7-27-1965.
188,958.	ECLIPSE (STYLIZED). U.S. CL. 13. (INT. CL. 6). REG. 9-9-1924.	795,156.	JIFFY. U.S. CL. 24. (INT. CL. 7). REG. 8-31-1965.
314,441.	B AND DESIGN. U.S. CL. 48. (INT. CL. 32). REG. 6-26-1934.	796,922.	ROYAL ARCANUM VMC AND DESIGN. U.S. CL. 102. (INT. CL. 36). REG. 9-28-1965.
325,862.	WHITMAN'S SAMPLER AND DESIGN. U.S. CL. 46. (INT. CL. 30). REG. 7-9-1935.	802,352.	MISCELLANEOUS DESIGN. U.S. CL. 46. (INT. CL. 29). REG. 1-18-1966.
414,660.	HULA POPPER (STYLIZED). U.S. CL. 22. (INT. CL. 28). REG. 6-19-1945.	976,710.	SIEMOSYN. U.S. CL. 21. (INT. CLS. 7 AND 9). REG. 1-15-1974.
415,755.	COKE (STYLIZED). U.S. CL. 45. (INT. CL. 32). REG. 8-14-1945.	977,874.	BUTY-WAVE. U.S. CLS. 51 AND 52. (INT. CL. 3). REG. 1-29-1974.
593,529.	KEYSTONE. U.S. CL. 13. (INT. CL. 6). REG. 8-10-1954.	981,985.	FRONTRUNNER. U.S. CL. 35. (INT. CL. 12). REG. 4-9-1974.
594,542.	DICKIES AND DESIGN. U.S. CL. 39. (INT. CL. 25). REG. 8-31-1954.	990,003.	FMC (STYLIZED). U.S. CL. 16. (INT. CL. 1). REG. 8-6-1974.
598,229.	DOWN BEAT AND DESIGN. U.S. CL. 38. (INT. CL. 16). REG. 11-16-1954.	991,120.	TITAN. INT. CL. 28. (U.S. CL. 22). REG. 8-20-1974.
599,274.	ZERO PERM (STYLIZED). U.S. CL. 12. (INT. CL. 17). REG. 12-14-1954.	991,307.	OK. U.S. CL. 23. (INT. CL. 8). REG. 8-20-1974.
601,918.	FOREMOST. U.S. CL. 46. (INT. CLS. 29, 30 AND 32). REG. 2-8-1955.	996,557.	MACALLAN. U.S. CL. 49. (INT. CL. 33). REG. 10-22-1974.
603,299.	CANON (STYLIZED). U.S. CL. 26. (INT. CL. 9). REG. 3-15-1955.	1,001,460.	BESCODYNE. INT. CL. 7. (U.S. CL. 23). REG. 1-14-1975.
604,409.	EXTENTABS. U.S. CL. 18. (INT. CL. 5). REG. 4-12-1955.	1,004,307.	TEMP-TEC. INT. CL. 25. (U.S. CL. 39). REG. 2-11-1975.
604,707.	CUSHION (STYLIZED). U.S. CL. 14. (INT. CL. 6). REG. 4-19-1955.	1,005,547.	GERSON. U.S. CL. 31 ONLY. (INT. CLS. 11 AND 21). REG. 2-25-1975.
605,321.	HYLINE. U.S. CL. 12. (INT. CL. 19). REG. 5-3-1955.	1,005,631.	RUSSIAN TEA ROOM. U.S. CL. 100. (INT. CL. 42). REG. 2-25-1975.
610,923.	PRESS SEAL AND DESIGN. U.S. CL. 13. (INT. CL. 6). REG. 8-23-1955.	1,005,655.	THE OHIO STATE UNIVERSITY. U.S. CL. 200. REG. 2-25-1975.
612,987.	GENIE. U.S. CL. 21. (INT. CL. 9). REG. 9-27-1955.	1,005,907.	WYE. INT. CLS. 31 AND 42. (U.S. CLS. 1 AND 100). REG. 3-4-1975.
738,047.	HOUSE & PLANS (STYLIZED). U.S. CL. 38. (INT. CL. 16). REG. 9-18-1962.	1,005,908.	WYE AND DESIGN. INT. CL. 42 ONLY. (U.S. CL. 100). REG. 3-4-1975.
767,658.	CHARTOR. U.S. CL. 46. (INT. CL. 30). REG. 3-31-1964.	1,006,107.	SLIDER. U.S. CL. 50. (INT. CL. 6). REG. 3-4-1975.
767,958.	OLD FITZ. U.S. CL. 49. (INT. CL. 33). REG. 4-7-1964.	1,006,193.	CLOVER. INT. CL. 3. (U.S. CL. 4). REG. 3-11-1975.
768,215.	STEDMAN. U.S. CL. 39. (INT. CLS. 10, 25 AND 26). REG. 4-14-1964.	1,006,236.	UNICRAFT. INT. CL. 8. (U.S. CL. 23). REG. 3-11-1975.
773,800.	D-C-FIX (STYLIZED). U.S. CL. 50. (INT. CL. 24). REG. 7-21-1964.	1,006,374.	GLENGARRIFF. INT. CL. 21. (U.S. CL. 33). REG. 3-11-1975.
775,325.	FF AND DESIGN. U.S. CL. 23. (INT. CL. 7). REG. 8-18-1964.	1,006,500.	KINGS AND DESIGN. INT. CL. 41. (U.S. CL. 107). REG. 3-11-1975.
775,833.	W-M (STYLIZED). U.S. CL. 34. (INT. CL. 11). REG. 8-25-1964.	1,007,546.	BONT. U.S. CL. 13. (INT. CL. 7). REG. 3-25-1975.
777,809.	GLOBE. U.S. CL. 23. (INT. CL. 1). REG. 9-29-1964.	1,008,092.	PACIFIC HIDE & LEATHER. U.S. CLS. 1, 20 AND 42. (INT. CLS. 18, 24 AND 27). REG. 4-1-1975.
779,156.	THOM MCAN (STYLIZED). U.S. CL. 50. (INT. CL. 26). REG. 10-27-1964.	1,010,334.	K-KUT. INT. CL. 7. (U.S. CL. 23). REG. 5-13-1975.
780,682.	CONTE THE ORIGINAL (STYLIZED). U.S. CL. 46. (INT. CL. 30). REG. 11-24-1964.	1,011,291.	GULF-SEAL AND DESIGN. INT. CLS. 2 AND 19. (U.S. CLS. 1, 12, 16, 33 AND 50). REG. 5-27-1975.
783,613.	BLAKESLEE. U.S. CL. 23. (INT. CLS. 6, 7, 8, 9, 11, 12, 16, 21 AND 28). REG. 1-19-1965.	1,012,512.	BIOSPERSE. U.S. CL. 6. (INT. CL. 5). REG. 6-3-1975.
785,505.	MEKTRON. U.S. CL. 21. (INT. CL. 9). REG. 2-23-1965.	1,012,530.	AMERGY. U.S. CL. 15. (INT. CL. 4). REG. 6-3-1975.
785,635.	ROMIKA. U.S. CL. 39. (INT. CL. 25). REG. 2-23-1965.	1,012,846.	PANTONE. INT. CL. 9. (U.S. CL. 26). REG. 6-10-1975.
786,260.	GIANT. U.S. CL. 12. (INT. CL. 19). REG. 3-9-1965.	1,014,777.	C COTTON CORDELL AND DESIGN. INT. CL. 28. (U.S. CL. 22). REG. 7-1-1975.
786,279.	X-10. U.S. CL. 12. (INT. CL. 19). REG. 3-9-1965.	1,016,687.	FIRMEX. INT. CL. 6. (U.S. CL. 14). REG. 7-29-1975.
786,329.	BLITZER (STYLIZED). U.S. CL. 21. (INT. CL. 9). REG. 3-9-1965.	1,018,836.	LANCEL. INT. CL. 18. (U.S. CLS. 1, 2, 3, 22 AND 41). REG. 8-26-1975.
786,427.	PENTEL. U.S. CL. 37. (INT. CL. 16). REG. 3-9-1965.	1,019,916.	RACE-TRIM. INT. CL. 12. (U.S. CLS. 19 AND 23). REG. 9-9-1975.
786,531.	RISE. U.S. CL. 51. (INT. CL. 3). REG. 3-9-1965.	1,020,931.	INSECTAPE. INT. CL. 5. (U.S. CL. 6). REG. 9-23-1975.
786,895.	WESTERN BLEND. U.S. CL. 46. (INT. CL. 29). REG. 3-16-1965.	1,021,648.	BERGKELDER. INT. CL. 33. (U.S. CL. 47). REG. 9-30-1975.
788,618.	SNAP-ON. U.S. CL. 2. (INT. CL. 6). REG. 4-27-1965.	1,021,654.	CROSSPOINT. INT. CL. 36 ONLY. (U.S. CL. 102). REG. 9-30-1975.
790,722.	KRAFTBILT (STYLIZED). U.S. CL. 37. (INT. CL. 16). REG. 6-8-1965.	1,023,884.	SALAD CRUNCHIES. INT. CL. 30. (U.S. CL. 46). REG. 10-28-1975.
790,751.	DURANGO. U.S. CL. 39. (INT. CL. 25). REG. 6-8-1965.	1,025,395.	WORLD SERIES OF POKER. INT. CL. 41. (U.S. CL. 107). REG. 11-18-1975.

- 1,025,829. CUP O' FLAVOR AND DESIGN. INT. CL. 30. (U.S. CL. 46). REG. 11-25-1975.
- 1,028,860. LA BERBERINE. INT. CL. 33. (U.S. CL. 47). REG. 12-30-1975.
- 1,031,112. PARASPERSE. INT. CL. 1. (U.S. CL. 6). REG. 1-27-1976.
- 1,033,672. SILVER KING KUTLETT. INT. CL. 8. (U.S. CL. 23). REG. 2-17-1976.
- 1,139,860. RIONET. INT. CL. 10. (U.S. CL. 44). REG. 9-23-1980.
- 1,262,845. SAFE-TURN. INT. CL. 7. (U.S. CL. 23). REG. 1-3-1984.
- 1,264,282. SLEEP-O-PEDIC. INT. CL. 20. (U.S. CL. 32). REG. 1-17-1984.
- 1,266,845. SEAL OF THE GEORGIA INSTITUTE OF TECHNOLOGY PROGRESS AND SERVICE 1885. AND DESIGN. INT. CLS. 6, 14, 16, 20, 21 AND 24 ONLY. (U.S. CLS. 2, 13, 28, 29, 32, 37, 38 AND 50). REG. 2-14-1984.
- 1,267,518. REMASIL. INT. CL. 1. (U.S. CL. 6). REG. 2-21-1984.
- 1,272,404. REMACK. INT. CLS. 7 AND 12. (U.S. CLS. 19 AND 23). REG. 4-3-1984.
- 1,276,809. POLYCORDER. INT. CL. 9. (U.S. CLS. 21, 23, 26, 36 AND 38). REG. 5-8-1984.
- 1,284,178. SPIRFLAME. INT. CL. 9. (U.S. CLS. 21 AND 34). REG. 7-3-1984.
- 1,286,668. LO-CAT. INT. CL. 1. (U.S. CL. 6). REG. 7-24-1984.
- 1,286,856. ECL. INT. CL. 7. (U.S. CLS. 19 AND 23). REG. 7-24-1984.
- 1,288,275. YAMAHA ELECTONE. INT. CL. 41. (U.S. CL. 107). REG. 7-31-1984.
- 1,289,967. LO-CAT. INT. CL. 11. (U.S. CLS. 23 AND 34). REG. 8-14-1984.
- 1,290,009. STEVENS INSTITUTE OF TECHNOLOGY. INT. CLS. 16, 41 AND 42. (U.S. CLS. 37, 38, 100 AND 107). REG. 8-14-1984.
- 1,291,300. SILVER CROSS (STYLIZED). INT. CL. 28. (U.S. CL. 22). REG. 8-21-1984.
- 1,292,635. WVN WINONA VAN NORMAN (STYLIZED). INT. CLS. 6, 7, 9 AND 35. (U.S. CLS. 2, 13, 19, 21, 23, 26 AND 101). REG. 9-4-1984.
- 1,292,814. MISCELLANEOUS DESIGN. INT. CLS. 16 AND 31. (U.S. CLS. 38 AND 46). REG. 9-4-1984.
- 1,293,368. SCHOOL HOUSE ROCK! SR AND DESIGN. INT. CL. 41. (U.S. CL. 107). REG. 9-4-1984.
- 1,294,197. BARRY (STYLIZED). INT. CL. 16. (U.S. CLS. 37 AND 38). REG. 9-11-1984.
- 1,294,831. WEYMAN & BRUTON. INT. CL. 34. (U.S. CL. 17). REG. 9-11-1984.
- 1,295,249. NATURAL SOUND. INT. CL. 9. (U.S. CLS. 21 AND 36). REG. 9-11-1984.
- 1,295,320. SEMICOFINE. INT. CL. 1. (U.S. CLS. 6 AND 21). REG. 9-18-1984.
- 1,295,658. V LOC AND DESIGN. INT. CL. 6. (U.S. CL. 13). REG. 9-18-1984.
- 1,296,347. SHOWOFF. INT. CL. 20. (U.S. CL. 32). REG. 9-18-1984.
- 1,299,478. HEALTH-WISE. INT. CL. 16. (U.S. CL. 38). REG. 10-9-1984.
- 1,299,993. ARTHUR'S GARDEN DELI (STYLIZED). INT. CL. 42. (U.S. CL. 100). REG. 10-9-1984.
- 1,301,314. ECCO. INT. CL. 9. (U.S. CL. 21). REG. 10-23-1984.
- 1,306,396. ALL NEWS ALL THE TIME. INT. CL. 38. (U.S. CL. 104). REG. 11-20-1984.
- 1,307,510. CHARLES JOURDAN. INT. CL. 42. (U.S. CL. 101). REG. 11-27-1984.
- 1,311,084. NITOHARD. INT. CL. 17. (U.S. CL. 1). REG. 12-25-1984.
- 1,312,230. NICHOLSON. INT. CLS. 12, 36, 37 AND 42. (U.S. CLS. 19, 100, 101, 102 AND 103). REG. 1-1-1985.
- 1,313,834. MERCY CORPS AND DESIGN. INT. CLS. 36 AND 42. (U.S. CLS. 100 AND 102). REG. 1-8-1985.
- 1,315,832. HIBERNATION SERIES AND DESIGN. INT. CL. 20. (U.S. CL. 32). REG. 1-22-1985.
- 1,316,140. PARK & SELL AND DESIGN. INT. CL. 39. (U.S. CL. 105). REG. 1-22-1985.
- 1,317,492. PHOSKADENT. INT. CL. 1. (U.S. CL. 6). REG. 2-5-1985.
- 1,317,628. T (STYLIZED). INT. CLS. 7 AND 8. (U.S. CL. 23). REG. 2-5-1985.
- 1,318,625. OHIO GUN COLLECTORS ASSOCIATION 1937 AND DESIGN. INT. CL. 41. (U.S. CL. 107). REG. 2-5-1985.
- 1,318,893. SCF 19. INT. CL. 6. (U.S. CL. 14). REG. 2-12-1985.
- 1,319,170. SPECTRON. INT. CL. 10. (U.S. CL. 44). REG. 2-12-1985.
- 1,319,801. MISCELLANEOUS DESIGN. INT. CL. 35. (U.S. CL. 101). REG. 2-12-1985.
- 1,320,493. BRAD HARRISON. INT. CL. 9. (U.S. CL. 21). REG. 2-19-1985.
- 1,320,494. BRAD HARRISON AND DESIGN. INT. CL. 9. (U.S. CL. 21). REG. 2-19-1985.
- 1,320,837. MOGA. INT. CL. 25. (U.S. CL. 39). REG. 2-19-1985.
- 1,321,445. THE PENINSULA GROUP AND DESIGN. INT. CL. 42. (U.S. CL. 100). REG. 2-19-1985.
- 1,321,881. TATUNG AND DESIGN. INT. CLS. 9 AND 11. (U.S. CLS. 21, 26, 31, 34 AND 36). REG. 2-26-1985.
- 1,322,072. IZVOR. INT. CL. 16. (U.S. CL. 38). REG. 2-26-1985.
- 1,322,196. THE COMPONENTS PEOPLE. INT. CL. 20. (U.S. CL. 32). REG. 2-26-1985.
- 1,322,216. GAZEBO. INT. CL. 21. (U.S. CLS. 2, 30 AND 33). REG. 2-26-1985.
- 1,322,395. DON QUIJOTE. INT. CL. 29. (U.S. CL. 46). REG. 2-26-1985.
- 1,322,520. KEY ANNUITY (STYLIZED). INT. CL. 36. (U.S. CL. 102). REG. 2-26-1985.
- 1,322,739. TACO BELL (STYLIZED). INT. CL. 42. (U.S. CL. 100). REG. 2-26-1985.
- 1,322,839. INTERFILL. INT. CL. 2. (U.S. CL. 12). REG. 3-5-1985.
- 1,322,858. SOYA SYSTEM. INT. CL. 3. (U.S. CLS. 51 AND 52). REG. 3-5-1985.
- 1,322,930. LL AND DESIGN. INT. CL. 5. (U.S. CL. 18). REG. 3-5-1985.
- 1,322,960. UNISHELP. INT. CL. 6. (U.S. CLS. 13 AND 32). REG. 3-5-1985.
- 1,322,981. OSP. INT. CL. 9. (U.S. CL. 21). REG. 3-5-1985.
- 1,323,008. SAILCOMP. INT. CL. 9. (U.S. CLS. 21 AND 26). REG. 3-5-1985.
- 1,323,133. SANDYLION AND DESIGN. INT. CL. 16. (U.S. CLS. 37 AND 38). REG. 3-5-1985.
- 1,323,232. MISCELLANEOUS DESIGN. INT. CL. 16. (U.S. CL. 38). REG. 3-5-1985.
- 1,323,276. THE COURTHOUSE CHAIR. INT. CL. 20. (U.S. CL. 32). REG. 3-5-1985.
- 1,323,280. KINNARPS. INT. CL. 20. (U.S. CLS. 2 AND 32). REG. 3-5-1985.
- 1,323,281. KINNARPS AND DESIGN. INT. CL. 20. (U.S. CLS. 2 AND 32). REG. 3-5-1985.
- 1,323,678. C FIRST COMMUNITY BANCSHARES, INC. AND DESIGN. INT. CL. 36. (U.S. CL. 102). REG. 3-5-1985.
- 1,323,679. C AND DESIGN. INT. CL. 36. (U.S. CL. 102). REG. 3-5-1985.
- 1,324,029. SKIDMORE COLLEGE. INT. CLS. 6, 20 AND 21 ONLY. (U.S. CLS. 2, 13 AND 32). REG. 3-12-1985.
- 1,324,057. PACK-STOCK. INT. CL. 7. (U.S. CL. 23). REG. 3-12-1985.
- 1,324,094. HOPPY. INT. CLS. 8, 9 AND 21. (U.S. CLS. 1, 2, 21, 23, 26 AND 29). REG. 3-12-1985.
- 1,324,188. DRAGON (STYLIZED). INT. CL. 9. (U.S. CL. 36). REG. 3-12-1985.
- 1,324,351. KING STAR. INT. CL. 12. (U.S. CL. 35). REG. 3-12-1985.
- 1,324,406. PLANT SERVICES. INT. CL. 16. (U.S. CL. 38). REG. 3-12-1985.
- 1,324,673. INFINITA. INT. CL. 25. (U.S. CL. 39). REG. 3-12-1985.
- 1,324,830. FASTRAC. INT. CL. 28. (U.S. CL. 22). REG. 3-12-1985.
- 1,325,241. NUTRASWEET AND DESIGN. INT. CLS. 1, 5 AND 30. (U.S. CLS. 6, 18, 45 AND 46). REG. 3-19-1985.
- 1,325,359. MAGIC LUBE. INT. CL. 4. (U.S. CL. 15). REG. 3-19-1985.
- 1,325,582. BERKEMANN. INT. CL. 10. (U.S. CL. 44). REG. 3-19-1985.
- 1,325,784. NORTHWESTERN UNIVERSITY 1851 QUAE-CUMQUE.SUNT.VERA AND DESIGN. INT. CLS. 16, 21, 24 AND 25. (U.S. CLS. 2, 13, 30, 33, 37, 38, 39 AND 50). REG. 3-19-1985.
- 1,325,862. CHICCO (STYLIZED). INT. CL. 20. (U.S. CL. 32). REG. 3-19-1985.
- 1,326,177. LITTLE POISON. INT. CL. 28. (U.S. CL. 22). REG. 3-19-1985.
- 1,326,256. BIOMOIST. INT. CL. 31. (U.S. CL. 46). REG. 3-19-1985.
- 1,326,991. FELCO. INT. CL. 20. (U.S. CL. 2). REG. 3-26-1985.
- 1,327,572. NAPL. INT. CL. 42. (U.S. CL. 100). REG. 3-26-1985.

- 1,328,031. SAF-T-LOK. INT. CL. 7. (U.S. CL. 23). REG. 4-2-1985.
- 1,328,620. D D'URBAN AND DESIGN. INT. CL. 25. (U.S. CL. 39). REG. 4-2-1985.
- 1,329,297. TRIONIC (STYLIZED). INT. CL. 9. (U.S. CLS. 26 AND 39). REG. 4-9-1985.
- 1,329,470. CHI AND DESIGN. INT. CL. 14. (U.S. CL. 28). REG. 4-9-1985.
- 1,329,582. CHROMATICS. INT. CL. 18. (U.S. CL. 41). REG. 4-9-1985.
- 1,330,162. ALADDIN. INT. CL. 42. (U.S. CL. 101). REG. 4-9-1985.
- 1,331,658. UNIBAR. INT. CL. 6. (U.S. CL. 13). REG. 4-23-1985.
- 1,331,905. THIN-LITE. INT. CL. 11. (U.S. CL. 21). REG. 4-23-1985.
- 1,332,166. MIRAGE (STYLIZED). INT. CL. 19. (U.S. CL. 12). REG. 4-23-1985.
- 1,332,231. E-Z SCOOP. INT. CL. 21. (U.S. CL. 23). REG. 4-23-1985.
- 1,333,853. CAN SACKS. INT. CL. 22. (U.S. CL. 2). REG. 4-30-1985.
- 1,334,311. RAMEX. INT. CL. 19. (U.S. CL. 12). REG. 5-7-1985.
- 1,336,222. NP-200. INT. CL. 3. (U.S. CL. 51). REG. 5-21-1985.
- 1,336,551. CHALLENGER. INT. CL. 13. (U.S. CL. 9). REG. 5-21-1985.
- 1,337,023. CHARSOL SUPREME. INT. CL. 30. (U.S. CL. 46). REG. 5-21-1985.
- 1,337,080. LOUIS LATOUR. INT. CL. 33. (U.S. CL. 47). REG. 5-21-1985.
- 1,337,288. CEASAR'S BAY BAZAAR. INT. CL. 42. (U.S. CL. 101). REG. 5-21-1985.
- 1,337,398. MISCELLANEOUS DESIGN. U.S. CL. 200. REG. 5-21-1985.
- 1,338,159. SWINGER. INT. CL. 28. (U.S. CL. 22). REG. 5-28-1985.
- 1,339,715. PHILEAS FOGG'S. INT. CL. 42. (U.S. CL. 101). REG. 6-4-1985.
- 1,339,873. ISOPASTE. INT. CL. 1. (U.S. CLS. 5, 6 AND 12). REG. 6-11-1985.
- 1,340,667. DUO MINDER. INT. CL. 16. (U.S. CL. 37). REG. 6-11-1985.
- 1,340,699. TY-REEL. INT. CL. 17. (U.S. CL. 7). REG. 6-11-1985.
- 1,340,989. PRO SPIRIT. INT. CL. 25. (U.S. CL. 39). REG. 6-11-1985.
- 1,341,079. LUNKER LIGHTS. INT. CL. 28. (U.S. CL. 22). REG. 6-11-1985.
- 1,342,453. FREESTYLER. INT. CL. 12. (U.S. CL. 19). REG. 6-18-1985.
- 1,343,014. G PASTA GUIDO DI NAPOLI AND DESIGN. INT. CL. 30. (U.S. CL. 46). REG. 6-18-1985.
- 1,343,540. FRESH DAILY DELI. INT. CL. 42. (U.S. CL. 101). REG. 6-18-1985.
- 1,345,458. YELLOW OUT. INT. CL. 3. (U.S. CL. 52). REG. 7-2-1985.
- 1,345,569. EFCO. INT. CL. 6. (U.S. CL. 12). REG. 7-2-1985.
- 1,346,215. HIBERNATION SERIES. INT. CL. 20. (U.S. CL. 32). REG. 7-2-1985.
- 1,348,097. SARAH LOUISE. INT. CL. 25. (U.S. CL. 39). REG. 7-9-1985.
- 1,348,373. MISCELLANEOUS DESIGN. INT. CL. 30. (U.S. CL. 46). REG. 7-9-1985.
- 1,348,810. NOVAPOL. INT. CL. 1. (U.S. CLS. 1 AND 6). REG. 7-16-1985.
- 1,349,683. RATTLIN' SPOONBILL (STYLIZED). INT. CL. 28. (U.S. CL. 22). REG. 7-16-1985.
- 1,350,259. VIP (STYLIZED). INT. CL. 5. (U.S. CLS. 6, 18, 44, 46, 51 AND 52). REG. 7-23-1985.
- 1,351,081. MARBLE SLAB CREAMERY. INT. CL. 42. (U.S. CL. 100). REG. 7-23-1985.
- 1,352,657. CEGASA AND DESIGN. INT. CL. 11. (U.S. CL. 21). REG. 8-6-1985.
- 1,353,117. TASTY BAKE PIZZA CRUSTS AND DESIGN. INT. CL. 30. (U.S. CL. 46). REG. 8-6-1985.
- 1,355,000. ATC. INT. CL. 9. (U.S. CL. 21). REG. 8-20-1985.
- 1,355,625. AXIS & ALLIES. INT. CL. 28. (U.S. CL. 22). REG. 8-20-1985.
- 1,356,590. ALPHA DELTA PI. INT. CLS. 16 AND 25. (U.S. CLS. 37 AND 39). REG. 8-27-1985.
- 1,358,422. RE/MAX AND DESIGN. INT. CL. 36. (U.S. CL. 102). REG. 9-3-1985.
- 1,360,784. ALMAR SALES CO.. INT. CL. 26. (U.S. CL. 40). REG. 9-17-1985.
- 1,361,460. CP AND DESIGN. INT. CL. 7. (U.S. CL. 23). REG. 9-24-1985.
- 1,373,219. 'NRG+' INT. CL. 1. (U.S. CL. 10). REG. 12-3-1985.
- 1,375,156. MISCELLANEOUS DESIGN. INT. CL. 41. (U.S. CL. 107). REG. 12-10-1985.
- 1,380,147. PORTA-NAILER. INT. CL. 8. (U.S. CL. 23). REG. 1-28-1986.
- 1,382,989. NEURONTIN. INT. CL. 5. (U.S. CL. 18). REG. 2-18-1986.
- 1,383,884. ALPHATINE COMPLEX. INT. CL. 3. (U.S. CLS. 1, 4, 6, 50, 51 AND 52). REG. 2-25-1986.
- 1,587,551. ULTRA-FLEX (STYLIZED). INT. CL. 9. (U.S. CL. 26). REG. 3-20-1990.
- 1,698,718. SPOT OUT. INT. CL. 5. (U.S. CLS. 6, 18, 44, 46, 51 AND 52). REG. 7-7-1992.
- 1,701,494. HAWK. INT. CL. 9. (U.S. CL. 21). REG. 7-21-1992.
- 1,756,550. HYDRO CONTROL. INT. CL. 9. (U.S. CLS. 21, 23, 26, 36 AND 38). REG. 3-9-1993.
- 1,784,080. FLAG. INT. CL. 16. (U.S. CL. 38). REG. 7-27-1993.
- 1,794,207. POLYTECH. INT. CL. 9. (U.S. CL. 26). REG. 9-21-1993.
- 1,797,404. LIGNOTECH. INT. CLS. 1, 2, 4, 19 AND 31. (U.S. CLS. 5, 6, 12, 15, 16 AND 46). REG. 10-12-1993.
- 1,819,125. BISCOTTI MEZZAMORE. INT. CL. 30. (U.S. CL. 46). REG. 2-1-1994.
- 1,823,573. SOMATOKINE. INT. CL. 5. (U.S. CL. 18). REG. 2-22-1994.
- 1,825,346. DENGIE. INT. CL. 31. (U.S. CL. 46). REG. 3-8-1994.
- 1,826,131. OA. INT. CL. 7. (U.S. CL. 23). REG. 3-15-1994.
- 1,828,182. MULTI-DOP. INT. CL. 10. (U.S. CLS. 26, 38 AND 44). REG. 3-29-1994.
- 1,829,143. FUDGE. INT. CL. 3. (U.S. CL. 51). REG. 4-5-1994.
- 1,830,060. RIBLENE. INT. CLS. 1 AND 17. (U.S. CLS. 1, 6, 10, 12, 13 AND 35). REG. 4-12-1994.
- 1,843,427. RICITOS DE ORO (STYLIZED). INT. CL. 3. (U.S. CL. 52). REG. 7-5-1994.
- 1,844,050. ARIZONA NATURAL CIRCULATION PLUS AND DESIGN. INT. CL. 5. (U.S. CL. 18). REG. 7-12-1994.
- 1,844,261. PALMCORDER (STYLIZED). INT. CL. 9. (U.S. CL. 21). REG. 7-12-1994.
- 1,844,417. TAKE STOCK. INT. CL. 16. (U.S. CL. 38). REG. 7-12-1994.
- 1,848,049. SCICLONE PHARMACEUTICALS AND DESIGN. INT. CL. 5. (U.S. CL. 18). REG. 8-2-1994.
- 1,848,723. TECH-ENERGY CO.. INT. CL. 37. (U.S. CL. 103). REG. 8-9-1994.
- 1,850,542. NAILERS. INT. CL. 8. (U.S. CLS. 23 AND 39). REG. 8-23-1994.
- 1,850,577. FINEPLACER. INT. CL. 9. (U.S. CLS. 21 AND 26). REG. 8-23-1994.
- 1,851,534. BODY SUEDE. INT. CL. 25. (U.S. CL. 39). REG. 8-30-1994.
- 1,851,748. MISCELLANEOUS DESIGN. INT. CL. 41. (U.S. CL. 107). REG. 8-30-1994.
- 1,852,873. UNICORD. INT. CL. 7. (U.S. CL. 23). REG. 9-6-1994.
- 1,853,120. BABY MORGAN AND DESIGN. INT. CL. 24. (U.S. CL. 42). REG. 9-6-1994.
- 1,853,610. PROSPERITY. INT. CL. 16. (U.S. CL. 38). REG. 9-13-1994.
- 1,853,776. LE VIGNE DI SAN PIETRO AND DESIGN. INT. CL. 33. (U.S. CL. 47). REG. 9-13-1994.
- 1,854,664. EXTOS. INT. CL. 17. (U.S. CLS. 1, 12, 19 AND 35). REG. 9-20-1994.
- 1,855,254. WHITE STAG AND DESIGN. INT. CL. 25. (U.S. CL. 39). REG. 9-20-1994.
- 1,855,271. ENDORPHIN WARRIOR. INT. CL. 25. (U.S. CL. 39). REG. 9-20-1994.
- 1,855,823. GORE-TEX. INT. CL. 25. (U.S. CL. 39). REG. 9-27-1994.
- 1,856,556. VISUALIZER. INT. CL. 9. (U.S. CL. 26). REG. 10-4-1994.
- 1,857,015. SUPERSTARS OF WRESTLING SW AND DESIGN. INT. CL. 41. (U.S. CL. 107). REG. 10-4-1994.
- 1,857,433. ECLAT D'ETE. INT. CL. 3. (U.S. CL. 51). REG. 10-11-1994.
- 1,857,480. TCS. INT. CL. 6. (U.S. CLS. 12 AND 14). REG. 10-11-1994.
- 1,858,813. ROI AND DESIGN. INT. CL. 35. (U.S. CLS. 100 AND 101). REG. 10-18-1994.
- 1,860,429. MISCELLANEOUS DESIGN. INT. CL. 25. (U.S. CL. 39). REG. 10-25-1994.

- 1,862,263. PIPE DRAGON AND DESIGN. INT. CL. 7. (U.S. CL. 23). REG. 11-15-1994.
- 1,865,246. NEFCO. INT. CL. 11. (U.S. CL. 13). REG. 11-29-1994.
- 1,871,036. GREEN POWER. INT. CL. 7. (U.S. CL. 23). REG. 1-3-1995.
- 1,872,345. EAGLEEYE. INT. CL. 9. (U.S. CL. 38). REG. 1-10-1995.
- 1,873,550. JUNGAMALS. INT. CL. 5. (U.S. CL. 18). REG. 1-17-1995.
- 1,873,604. PASTURE KING. INT. CL. 7. (U.S. CL. 23). REG. 1-17-1995.
- 1,874,099. VELTINS. INT. CL. 32. (U.S. CL. 48). REG. 1-17-1995.
- 1,874,962. ANNICK GOUTAL AND DESIGN. INT. CL. 3. (U.S. CLS. 51 AND 52). REG. 1-24-1995.
- 1,875,097. LOS IRACUNDOS. INT. CL. 9. (U.S. CL. 36). REG. 1-24-1995.
- 1,875,800. DIEMITECH (STYLIZED). INT. CL. 6. (U.S. CL. 14). REG. 1-24-1995.
- 1,876,136. GAS FOIL ROTATION. INT. CL. 7. (U.S. CL. 13). REG. 1-24-1995.
- 1,876,289. GRUNDO-OIL. INT. CL. 4. (U.S. CL. 15). REG. 1-31-1995.
- 1,876,328. TWOFISH. INT. CL. 6. (U.S. CL. 13). REG. 1-31-1995.
- 1,876,409. GTI COLORMATCHER. INT. CL. 9. (U.S. CL. 26). REG. 1-31-1995.
- 1,876,607. AMORC. INT. CLS. 16, 41 AND 42. (U.S. CLS. 38, 100 AND 107). REG. 1-31-1995.
- 1,877,142. T-FIX. INT. CL. 10. (U.S. CL. 44). REG. 1-31-1995.
- 1,877,740. MISCELLANEOUS DESIGN. INT. CL. 28. (U.S. CL. 22). REG. 2-7-1995.
- 1,877,779. GULF CLASSIC. INT. CL. 29. (U.S. CL. 46). REG. 2-7-1995.
- 1,878,046. MONSTER PATROL AND DESIGN. INT. CL. 41. (U.S. CL. 107). REG. 2-7-1995.
- 1,878,172. HUMPHREY YOGART. INT. CL. 42. (U.S. CL. 100). REG. 2-7-1995.
- 1,878,258. NINA DE SCREAMIN MIM'S AND DESIGN. INT. CL. 30. (U.S. CL. 46). REG. 2-7-1995.
- 1,878,389. TEMACOLOR. INT. CL. 2. (U.S. CL. 16). REG. 2-14-1995.
- 1,878,421. PREMIER ONE. INT. CL. 5. (U.S. CL. 46). REG. 2-14-1995.
- 1,878,431. LIDO. INT. CL. 6. (U.S. CL. 13). REG. 2-14-1995.
- 1,878,691. MOTHER GOOSE AND DESIGN. INT. CL. 21. (U.S. CLS. 2, 21, 29, 30, 33 AND 40). REG. 2-14-1995.
- 1,878,693. SATURN. INT. CL. 24. (U.S. CL. 42). REG. 2-14-1995.
- 1,878,759. OLD COURTHOUSE. INT. CL. 29. (U.S. CL. 46). REG. 2-14-1995.
- 1,878,942. KEY INSTITUTE. INT. CL. 41. (U.S. CL. 107). REG. 2-14-1995.
- 1,879,046. GRAND CANYON RAFTERS. INT. CL. 25 ONLY. (U.S. CLS. 22 AND 39). REG. 2-14-1995.
- 1,879,183. FLAVORSELECT. INT. CL. 11. (U.S. CLS. 21 AND 34). REG. 2-14-1995.
- 1,879,220. THREE T'S OF PERFECTION TOMORROW'S TECHNOLOGY TODAY AND DESIGN. INT. CL. 19. (U.S. CL. 12). REG. 2-14-1995.
- 1,879,526. MAR-10. INT. CL. 7. (U.S. CL. 23). REG. 2-21-1995.
- 1,879,573. MAGNO. INT. CL. 9. (U.S. CLS. 21, 23, 26, 36 AND 38). REG. 2-21-1995.
- 1,879,609. LIGHTCRIMP. INT. CL. 9. (U.S. CL. 21). REG. 2-21-1995.
- 1,879,770. SAFE'N SOUND. INT. CL. 19. (U.S. CL. 12). REG. 2-21-1995.
- 1,879,988. MISCELLANEOUS DESIGN. INT. CL. 33. (U.S. CL. 47). REG. 2-21-1995.
- 1,880,038. ISLAND GETAWAY. INT. CL. 36. (U.S. CLS. 101 AND 102). REG. 2-21-1995.
- 1,880,063. ABU GARCIA AND DESIGN. INT. CL. 37. (U.S. CL. 103). REG. 2-21-1995.
- 1,880,120. LIMALAMA. INT. CL. 41. (U.S. CL. 107). REG. 2-21-1995.
- 1,880,223. PRESENCE. INT. CL. 5. (U.S. CLS. 39 AND 44). REG. 2-21-1995.
- 1,880,343. ESE. INT. CLS. 5 AND 29. (U.S. CLS. 18 AND 46). REG. 2-28-1995.
- 1,880,427. Q AND DESIGN. INT. CL. 9 ONLY. (U.S. CLS. 21, 23, 26, 36 AND 38). REG. 2-28-1995.
- 1,880,619. AIRFAQS (STYLIZED). INT. CL. 16. (U.S. CL. 38). REG. 2-28-1995.
- 1,880,645. SERIES 3000. INT. CL. 19. (U.S. CL. 12). REG. 2-28-1995.
- 1,880,675. THE GREENROOM. INT. CLS. 25 AND 28. (U.S. CLS. 22 AND 39). REG. 2-28-1995.
- 1,880,696. J AND DESIGN. INT. CL. 25. (U.S. CL. 39). REG. 2-28-1995.
- 1,880,766. WESTCO (STYLIZED). INT. CLS. 29 AND 30. (U.S. CL. 46). REG. 2-28-1995.
- 1,880,863. OCTFCU ORANGE COUNTY TEACHERS FEDERAL CREDIT UNION (STYLIZED). INT. CL. 36. (U.S. CL. 102). REG. 2-28-1995.
- 1,880,864. OCTFCU ORANGE COUNTY TEACHERS FEDERAL CREDIT UNION PARTNERS IN EDUCATION SINCE 1934 (STYLIZED). INT. CL. 36. (U.S. CL. 102). REG. 2-28-1995.
- 1,880,937. ECONOMICSAMERICA. INT. CL. 41. (U.S. CL. 107). REG. 2-28-1995.
- 1,881,001. THE PHOENICIAN RESORT. INT. CL. 42. (U.S. CL. 100). REG. 2-28-1995.
- 1,881,003. COLTER'S BAR-B-Q. INT. CL. 42. (U.S. CL. 100). REG. 2-28-1995.
- 1,881,057. PAVILION. INT. CLS. 20 AND 24. (U.S. CLS. 13 AND 42). REG. 2-28-1995.
- 1,881,083. INDANTHREN. INT. CL. 2. (U.S. CL. 6). REG. 2-28-1995.
- 1,881,095. CONTOUR DU CORPS. INT. CL. 3. (U.S. CL. 51). REG. 2-28-1995.
- 1,881,124. CYPERMIST. INT. CL. 5. (U.S. CL. 6). REG. 2-28-1995.
- 1,881,187. THERMOGLAS. INT. CL. 9. (U.S. CLS. 26 AND 39). REG. 2-28-1995.
- 1,881,227. ENVIROMAX. INT. CL. 9. (U.S. CLS. 26 AND 44). REG. 2-28-1995.
- 1,881,480. ULTRABRASS. INT. CL. 21. (U.S. CLS. 2, 13 AND 29). REG. 2-28-1995.
- 1,881,559. TORTIZZA. INT. CL. 30. (U.S. CL. 46). REG. 2-28-1995.
- 1,881,565. THE REAL TASTE OF LICORICE. INT. CL. 30. (U.S. CL. 46). REG. 2-28-1995.
- 1,881,675. POLHODE. INT. CL. 42. (U.S. CL. 100). REG. 2-28-1995.
- 1,881,730. INTECH EDM (STYLIZED). INT. CLS. 1, 7 AND 9. (U.S. CLS. 1, 6, 21, 23, 26 AND 31). REG. 3-7-1995.
- 1,881,826. CAR & TRUCK MAGIC. INT. CL. 5. (U.S. CL. 6). REG. 3-7-1995.
- 1,881,877. EDWARDS. INT. CL. 7. (U.S. CL. 23). REG. 3-7-1995.
- 1,881,964. GULBRANSEN. INT. CL. 9. (U.S. CLS. 21 AND 36). REG. 3-7-1995.
- 1,881,992. SAFE T SPIN. INT. CL. 9. (U.S. CL. 26). REG. 3-7-1995.
- 1,882,097. ULTRABAND. INT. CL. 14. (U.S. CL. 27). REG. 3-7-1995.
- 1,882,129. STAMP E-Z. INT. CL. 16. (U.S. CLS. 23 AND 37). REG. 3-7-1995.
- 1,882,142. FETCO INTERNATIONAL AND DESIGN. INT. CLS. 16 AND 20. (U.S. CLS. 32 AND 37). REG. 3-7-1995.
- 1,882,181. MANIPULITE. INT. CL. 16. (U.S. CL. 38). REG. 3-7-1995.
- 1,882,208. PRINCIPLE-CENTERED LEADERSHIP. INT. CL. 16. (U.S. CL. 38). REG. 3-7-1995.
- 1,882,221. HIDEDESIGN AND DESIGN. INT. CL. 18. (U.S. CL. 3). REG. 3-7-1995.
- 1,882,539. CIA. INT. CL. 41. (U.S. CL. 107). REG. 3-7-1995.
- 1,882,544. SPEDEWORLD. INT. CL. 41. (U.S. CLS. 100 AND 107). REG. 3-7-1995.
- 1,882,641. HEALTHPARTNERS AND DESIGN. INT. CL. 42. (U.S. CL. 100). REG. 3-7-1995.
- 1,882,650. HEALTHPARTNERS DENTAL OPTIONS. INT. CL. 42. (U.S. CLS. 100 AND 101). REG. 3-7-1995.
- 1,882,681. GO TO YOUR ROOM. INT. CL. 42. (U.S. CL. 101). REG. 3-7-1995.
- 1,882,761. DERMASIL. INT. CL. 3. (U.S. CL. 51). REG. 3-7-1995.
- 1,882,770. LOTENSIN HCT. INT. CL. 5. (U.S. CL. 18). REG. 3-7-1995.
- 1,882,775. MITA-CLEAR. INT. CL. 5. (U.S. CL. 18). REG. 3-7-1995.
- 1,882,779. FAMVIR. INT. CL. 5. (U.S. CL. 18). REG. 3-7-1995.
- 1,882,782. DUSA PHARMACEUTICALS, INC. (STYLIZED). INT. CL. 5. (U.S. CL. 18). REG. 3-7-1995.
- 1,882,815. ACCUCAL. INT. CL. 9. (U.S. CL. 26). REG. 3-7-1995.

- 1,882,835. AUTOPLAN II. INT. CL. 9. (U.S. CL. 38). REG. 3-7-1995.
- 1,882,851. CASEWISE. INT. CL. 9. (U.S. CL. 38). REG. 3-7-1995.
- 1,882,856. 5390. INT. CL. 9. (U.S. CL. 26). REG. 3-7-1995.
- 1,882,896. MC-IOL. INT. CL. 10. (U.S. CL. 44). REG. 3-7-1995.
- 1,882,921. NIGHT STALKER. INT. CL. 13. (U.S. CL. 9). REG. 3-7-1995.
- 1,883,009. SMALL TREASURES. INT. CL. 25. (U.S. CL. 39). REG. 3-7-1995.
- 1,883,044. STAR FOX. INT. CL. 28. (U.S. CL. 22). REG. 3-7-1995.
- 1,883,112. EARTH SENSE. INT. CL. 37. (U.S. CL. 103). REG. 3-7-1995.
- 1,883,131. BLADE PRODUCTIONS INC. AND DESIGN. INT. CL. 41. (U.S. CL. 107). REG. 3-7-1995.
- 1,883,168. WORLD OF WHEELS AND HUBCAPS. INT. CL. 42. (U.S. CL. 101). REG. 3-7-1995.
- 1,883,210. MISCELLANEOUS DESIGN. INT. CL. 1 ONLY. (U.S. CLS. 1 AND 6). REG. 3-14-1995.
- 1,883,464. FALCON. INT. CL. 11. (U.S. CLS. 13 AND 23). REG. 3-14-1995.
- 1,883,757. HERSHEY'S. INT. CL. 30. (U.S. CL. 46). REG. 3-14-1995.
- 1,883,805. SUPREME BRAND. INT. CL. 31. (U.S. CL. 1). REG. 3-14-1995.
- 1,883,850. WILD RIVER. INT. CL. 32. (U.S. CL. 48). REG. 3-14-1995.
- 1,883,854. ROCCA CASELLI (STYLIZED). INT. CL. 33. (U.S. CL. 47). REG. 3-14-1995.
- 1,883,950. CROWN. INT. CL. 37. (U.S. CL. 103). REG. 3-14-1995.
- 1,884,196. SINUSPAX. INT. CL. 5. (U.S. CL. 18). REG. 3-14-1995.
- 1,884,197. SANTAHERBA. INT. CL. 5. (U.S. CL. 18). REG. 3-14-1995.
- 1,884,429. DRAIN-SLEEVE. INT. CL. 24. (U.S. CL. 42). REG. 3-14-1995.
- 1,884,440. PREFERRED SERVICE PLAN. INT. CL. 36. (U.S. CLS. 101 AND 102). REG. 3-14-1995.
- 1,884,451. RESEARCH CONSULTING GROUP. INT. CL. 42. (U.S. CLS. 100 AND 101). REG. 3-14-1995.
- 1,884,591. NICHROLOY. INT. CL. 6. (U.S. CLS. 13 AND 14). REG. 3-21-1995.
- 1,884,858. ACE AMERICAN COUNCIL ON EXERCISE AND DESIGN. INT. CLS. 16, 25 AND 41. (U.S. CLS. 38, 39, 100 AND 107). REG. 3-21-1995.
- 1,884,919. STOP THE WATCH. INT. CL. 16. (U.S. CL. 37). REG. 3-21-1995.
- 1,885,062. CIRQUE DU SOLEIL AND DESIGN. INT. CL. 25. (U.S. CL. 39). REG. 3-21-1995.
- 1,885,095. CIRQUE DU SOLEIL. INT. CL. 28. (U.S. CLS. 22 AND 38). REG. 3-21-1995.
- 1,885,160. VAN BOURGONDIE. INT. CLS. 31 AND 42. (U.S. CLS. 1 AND 101). REG. 3-21-1995.
- 1,885,240. 1-800 CAR-LOAN. INT. CL. 36. (U.S. CL. 102). REG. 3-21-1995.
- 1,885,256. PROPERTY TAX SOLUTIONS. INT. CL. 36. (U.S. CLS. 101 AND 102). REG. 3-21-1995.
- 1,885,318. ALITALIA AND DESIGN. INT. CL. 39. (U.S. CL. 105). REG. 3-21-1995.
- 1,885,382. CIRQUE DU SOLEIL. INT. CL. 41. (U.S. CL. 107). REG. 3-21-1995.
- 1,885,524. AFTER THE RAIN. INT. CL. 5. (U.S. CL. 6). REG. 3-21-1995.
- 1,886,256. OPERE TREVIGIANE. INT. CL. 33. (U.S. CLS. 47 AND 49). REG. 3-28-1995.
- 1,886,506. TOLERANCE TECHNOLOGY. INT. CL. 5. (U.S. CL. 18). REG. 3-28-1995.
- 1,886,903. BUILDER'S PRIDE. INT. CL. 19 ONLY. (U.S. CLS. 1, 12, 33 AND 50). REG. 4-4-1995.
- 1,886,909. PJC AND DESIGN. INT. CL. 6. (U.S. CL. 13). REG. 4-4-1995.
- 1,887,058. GLACIAL. INT. CL. 11. (U.S. CLS. 21 AND 37). REG. 4-4-1995.
- 1,887,174. PJC AND DESIGN. INT. CL. 19. (U.S. CL. 12). REG. 4-4-1995.
- 1,887,387. SPRING BLUSH. INT. CL. 33. (U.S. CL. 47). REG. 4-4-1995.
- 1,888,004. HUGS AND DESIGN. INT. CL. 30. (U.S. CL. 46). REG. 4-4-1995.
- 1,888,156. SPARKLE WASH. INT. CL. 3. (U.S. CL. 52). REG. 4-11-1995.
- 1,888,391. HC THE HEALTH CARE GROUP (STYLIZED). INT. CLS. 16, 35, 36, 41 AND 42. (U.S. CLS. 38, 100, 101, 102 AND 107). REG. 4-11-1995.
- 1,888,777. PETER VELLA AND DESIGN. INT. CL. 33. (U.S. CLS. 47 AND 49). REG. 4-11-1995.
- 1,889,018. GALBRAITH. INT. CL. 42. (U.S. CL. 100). REG. 4-11-1995.
- 1,889,317. BILL BLASS. INT. CL. 25. (U.S. CL. 39). REG. 4-11-1995.
- 1,889,599. TUFFBRAZE. INT. CL. 6. (U.S. CL. 14). REG. 4-18-1995.
- 1,889,600. ACCURLOY. INT. CL. 6. (U.S. CL. 14). REG. 4-18-1995.
- 1,889,618. ZAMA. INT. CL. 7. (U.S. CL. 23). REG. 4-18-1995.
- 1,889,975. SNAG PROOF. INT. CL. 28. (U.S. CL. 22). REG. 4-18-1995.
- 1,890,102. MISCELLANEOUS DESIGN. INT. CL. 33. (U.S. CL. 47). REG. 4-18-1995.
- 1,890,799. V-MAX. INT. CL. 6. (U.S. CL. 14). REG. 4-25-1995.
- 1,890,900. MAPWIZARD. INT. CL. 9. (U.S. CL. 38). REG. 4-25-1995.
- 1,891,021. GRAPHIC LEARNING. INT. CL. 16. (U.S. CL. 38). REG. 4-25-1995.
- 1,891,882. DREWBROM. INT. CL. 1. (U.S. CL. 6). REG. 5-2-1995.
- 1,892,076. 1011. INT. CL. 14. (U.S. CL. 28). REG. 5-2-1995.
- 1,892,276. ORANGE KRISPY. INT. CL. 30. (U.S. CL. 46). REG. 5-2-1995.
- 1,893,115. SMART PICKS. INT. CL. 16. (U.S. CL. 38). REG. 5-9-1995.
- 1,895,782. TRANS KOTE. INT. CL. 2. (U.S. CL. 16). REG. 5-30-1995.
- 1,895,877. VENTRAY. INT. CL. 6. (U.S. CL. 13). REG. 5-30-1995.
- 1,895,878. VENTRIB. INT. CL. 6. (U.S. CL. 13). REG. 5-30-1995.
- 1,895,879. ELECTRAY. INT. CL. 6. (U.S. CL. 13). REG. 5-30-1995.
- 1,895,995. SHELTER. INT. CL. 9. (U.S. CL. 36). REG. 5-30-1995.
- 1,896,376. GUMMY BEARS & FRIENDS. INT. CL. 30. (U.S. CL. 46). REG. 5-30-1995.
- 1,896,563. MYSTERIOUS PLACES. INT. CL. 41. (U.S. CL. 107). REG. 5-30-1995.
- 1,897,057. MY TWINN AND DESIGN. INT. CL. 28. (U.S. CL. 28). REG. 5-30-1995.
- 1,897,162. YELLOW RELIEF. INT. CL. 3. (U.S. CL. 32). REG. 5-30-1995.
- 1,897,386. PROVOX. INT. CL. 9. (U.S. CLS. 21, 26 AND 38). REG. 6-6-1995.
- 1,898,843. ATOMIC. INT. CL. 13. (U.S. CL. 9). REG. 6-13-1995.
- 1,898,868. ACE. INT. CLS. 16 AND 41. (U.S. CLS. 38 AND 107). REG. 6-13-1995.
- 1,899,339. WORK 'N GEAR AMERICA'S WORK WEAR STORE. INT. CL. 42. (U.S. CL. 101). REG. 6-13-1995.
- 1,899,357. BLUE BELL CAFE. INT. CL. 42. (U.S. CL. 100). REG. 6-13-1995.
- 1,900,104. EARTH SENSE HOME AND DESIGN. INT. CL. 37. (U.S. CL. 103). REG. 6-13-1995.
- 1,900,259. EPOCA. INT. CL. 2. (U.S. CL. 16). REG. 6-20-1995.
- 1,900,805. COWLOVER. INT. CL. 31. (U.S. CL. 1). REG. 6-20-1995.
- 1,900,945. DEVILBISS KIDS CLUB AND DESIGN. INT. CL. 41. (U.S. CL. 107). REG. 6-20-1995.
- 1,901,065. WOLFGANG PUCK. INT. CL. 42. (U.S. CL. 100). REG. 6-20-1995.
- 1,901,460. TRAVERS. INT. CLS. 7 AND 8. (U.S. CL. 23). REG. 6-27-1995.
- 1,901,486. CHECK-INN. INT. CLS. 9 AND 16. (U.S. CL. 38). REG. 6-27-1995.
- 1,901,643. KIENE. INT. CL. 9. (U.S. CL. 26). REG. 6-27-1995.
- 1,902,063. THE GREENROOM. INT. CL. 42. (U.S. CL. 101). REG. 6-27-1995.
- 1,902,387. SOLVKLENE. INT. CL. 7. (U.S. CL. 23). REG. 7-4-1995.
- 1,902,614. ST. CROIX EDITION. INT. CL. 12. (U.S. CLS. 19 AND 35). REG. 7-4-1995.
- 1,902,904. KOTTERIN. INT. CL. 30. (U.S. CL. 46). REG. 7-4-1995.
- 1,902,999. TRANSADVANTAGE (STYLIZED). INT. CL. 36. (U.S. CL. 102). REG. 7-4-1995.

- 1,903,192. TOMBOY'S FAMOUS CHILI HAMBURGERS AND DESIGN. INT. CL. 42. (U.S. CL. 100). REG. 7-4-1995.
- 1,903,294. WINSOME. INT. CL. 21 ONLY. (U.S. CLS. 2, 13 AND 33). REG. 7-4-1995.
- 1,903,496. AXLELESS. INT. CL. 12. (U.S. CLS. 19, 21, 23, 31, 35 AND 44). REG. 7-4-1995.
- 1,903,985. DRY CLEANING STATION. INT. CL. 37. (U.S. CL. 103). REG. 7-4-1995.
- 1,904,353. PLANET X. INT. CL. 12. (U.S. CL. 19). REG. 7-11-1995.
- 1,904,471. SMOOTH TOUCH. INT. CL. 21. (U.S. CL. 29). REG. 7-11-1995.
- 1,905,451. COMFORT CUSHION. INT. CL. 9. (U.S. CL. 26). REG. 7-18-1995.
- 1,906,460. GLORY TORCHES. INT. CL. 13. (U.S. CLS. 2 AND 9). REG. 7-18-1995.
- 1,906,578. BUCKTEX. INT. CL. 24. (U.S. CLS. 42 AND 50). REG. 7-18-1995.
- 1,906,881. NO-FOG. INT. CL. 10. (U.S. CLS. 26, 39 AND 44). REG. 7-18-1995.
- 1,907,074. SPORTSMAN. INT. CL. 7. (U.S. CL. 23). REG. 7-25-1995.
- 1,907,120. MISCELLANEOUS DESIGN. INT. CL. 9. (U.S. CL. 21). REG. 7-25-1995.
- 1,907,259. R&D RACING PRODUCTS U.S.A. AND DESIGN. INT. CL. 12. (U.S. CLS. 19, 21, 23, 31, 35 AND 44). REG. 7-25-1995.
- 1,909,687. THUMBS-UP. INT. CL. 3. (U.S. CL. 52). REG. 8-8-1995.
- 1,909,839. MUSICBANK (STYLIZED). INT. CL. 9. (U.S. CLS. 26 AND 36). REG. 8-8-1995.
- 1,911,104. MIGHTY MINI. INT. CL. 7. (U.S. CL. 23). REG. 8-15-1995.
- 1,911,893. THE INNOVATIVE TEAMWORKSHOP. INT. CL. 41. (U.S. CL. 107). REG. 8-15-1995.
- 1,912,112. TRIKOTE. INT. CL. 1. (U.S. CLS. 1, 5, 6, 10, 26 AND 46). REG. 8-15-1995.
- 1,912,355. GAP KIDS. INT. CL. 9. (U.S. CLS. 21, 23, 26, 36 AND 38). REG. 8-15-1995.
- 1,912,746. TRUST ONE. INT. CL. 36. (U.S. CLS. 100, 101 AND 102). REG. 8-15-1995.
- 1,914,105. ARISTAR. INT. CL. 9. (U.S. CLS. 21, 23, 26, 36 AND 38). REG. 8-22-1995.
- 1,914,674. ELITE. INT. CL. 9. (U.S. CLS. 21, 23, 26, 36 AND 38). REG. 8-29-1995.
- 1,915,360. DEALERNET. INT. CL. 35. (U.S. CLS. 100, 101 AND 102). REG. 8-29-1995.
- 1,915,964. TUFTS. INT. CLS. 6 AND 14. (U.S. CLS. 13, 25 AND 28). REG. 9-5-1995.
- 1,916,972. SERVING THE FINEST PRODUCTS, FOR THE LEAST COST, IN THE CLEANEST SURROUNDINGS, WITH THE MOST COURTEOUS PERSONNEL. INT. CL. 42. (U.S. CL. 100). REG. 9-5-1995.
- 1,917,738. DRAGON OPTICAL AND DESIGN. INT. CL. 9. (U.S. CL. 26). REG. 9-12-1995.
- 1,920,870. DR. WELLBOOK. INT. CL. 16. (U.S. CLS. 2, 5, 22, 23, 29, 37, 38 AND 50). REG. 9-19-1995.
- 1,921,346. POLYPHASE. INT. CLS. 1 AND 5. (U.S. CLS. 5 AND 6). REG. 9-26-1995.
- 1,921,454. CONNECT-ALL. INT. CL. 5. (U.S. CLS. 6, 18, 44, 46, 51 AND 52). REG. 9-26-1995.
- 1,922,905. HUMANATOMY. INT. CL. 16. (U.S. CLS. 2, 5, 22, 23, 29, 37, 38 AND 50). REG. 9-26-1995.
- 1,924,011. MISCELLANEOUS DESIGN. INT. CL. 35. (U.S. CLS. 100, 101 AND 102). REG. 10-3-1995.
- 1,925,614. SAILOR BRAND SUPREME QUALITY FROM USA AND DESIGN. INT. CL. 29. (U.S. CL. 46). REG. 10-10-1995.
- 1,925,631. MISCELLANEOUS DESIGN. INT. CLS. 29, 30 AND 31. (U.S. CLS. 1 AND 46). REG. 10-10-1995.
- 1,927,438. LONGWOOD. INT. CL. 8. (U.S. CL. 23). REG. 10-17-1995.
- 1,929,352. AL (STYLIZED). INT. CL. 14. (U.S. CL. 28). REG. 10-24-1995.
- 1,929,614. GOLDEN YEARS. INT. CL. 5. (U.S. CL. 18). REG. 10-24-1995.
- 1,931,003. NAKAMICHI AND DESIGN. INT. CL. 9. (U.S. CLS. 21, 23, 26, 36 AND 38). REG. 10-31-1995.
- 1,936,976. AC AND DESIGN. INT. CL. 9. (U.S. CLS. 21, 23, 26, 36 AND 38). REG. 11-21-1995.
- 1,937,147. ADVANCED MEDICAL NUTRITION, INC.. INT. CL. 5. (U.S. CLS. 6, 18, 44, 46, 51 AND 52). REG. 11-21-1995.
- 1,937,647. IPS WELD-ON HOT 'R COLD AND DESIGN. INT. CL. 1. (U.S. CL. 5). REG. 11-28-1995.
- 1,938,425. MISCELLANEOUS DESIGN. INT. CL. 41. (U.S. CLS. 100, 101 AND 107). REG. 11-28-1995.
- 1,942,363. SGMA HEROES AND DESIGN. INT. CL. 41. (U.S. CLS. 100, 101 AND 107). REG. 12-19-1995.
- 1,942,918. BEND-PAK. INT. CL. 7. (U.S. CLS. 13, 19, 21, 23, 31, 34 AND 35). REG. 12-19-1995.
- 1,942,933. JERKY SHOOTER AND DESIGN. INT. CL. 21. (U.S. CLS. 2, 13, 23, 29, 30, 33, 40 AND 50). REG. 12-19-1995.
- 1,947,111. LACOSTE. INT. CL. 14. (U.S. CLS. 2, 27, 28 AND 50). REG. 1-9-1996.
- 1,947,320. CAPTAIN BIO. INT. CL. 16. (U.S. CLS. 2, 5, 22, 23, 29, 37, 38 AND 50). REG. 1-9-1996.
- 1,947,691. DRIVEN TO SERVE YOU BETTER. INT. CL. 39. (U.S. CLS. 100 AND 105). REG. 1-9-1996.
- 1,948,464. MISCELLANEOUS DESIGN. INT. CL. 41. (U.S. CLS. 100, 101 AND 107). REG. 1-16-1996.
- 1,948,719. I AND DESIGN. INT. CLS. 38 AND 41. (U.S. CLS. 100, 101, 104 AND 107). REG. 1-16-1996.
- 1,949,301. DON NICO AND DESIGN. INT. CL. 29. (U.S. CL. 46). REG. 1-16-1996.
- 1,949,304. LA NATURA. INT. CL. 3. (U.S. CLS. 1, 4, 6, 50, 51 AND 52). REG. 1-16-1996.
- 1,949,670. FIRSTPURSUIT. INT. CL. 42. (U.S. CLS. 100 AND 101). REG. 1-16-1996.
- 1,953,691. MAGIC JOHNSON THEATRES. INT. CL. 41. (U.S. CLS. 100, 101 AND 107). REG. 1-30-1996.
- 1,953,749. POLY-DOLLY. INT. CL. 12. (U.S. CLS. 19, 21, 23, 31, 35 AND 44). REG. 1-30-1996.
- 1,954,922. CF AND DESIGN. INT. CL. 6. (U.S. CLS. 2, 12, 13, 14, 23, 25 AND 50). REG. 2-6-1996.
- 1,957,088. HARRAH'S AND DESIGN. INT. CLS. 41 AND 42. (U.S. CLS. 100 AND 107). REG. 2-20-1996.
- 1,958,408. PROFESSIONAL ICE MELTER. INT. CL. 1. (U.S. CLS. 1, 5, 6, 10, 26 AND 46). REG. 2-27-1996.
- 1,958,479. JACKAROO. INT. CL. 30. (U.S. CL. 46). REG. 2-27-1996.
- 1,960,994. FRONTIER. INT. CL. 37. (U.S. CLS. 100, 103 AND 106). REG. 3-5-1996.

* * * * *

TRADEMARK REGISTRATIONS CANCELED

The designation "U.S. Cl." appearing in this section refers to the U.S. class in effect prior to Sep. 1, 1973 rather than the international class which applies to applications filed on or after that date. For adoption of international classification see notice in the OFFICIAL GAZETTE of Jun. 26, 1973 (911 O.G. TM 210).

SECTION 7(D)

2,360,568. SUN CRUISES AND DESIGN. INT. CLS. 39 AND 42. REG. 6-20-2000.

SECTION 8

186,271. XXX WHITE DIAMOND AND DESIGN. U.S. CL. 4. REG. 7-8-1924.
186,288. DOMINANT (STYLIZED). U.S. CL. 46. REG. 7-8-1924.
186,290. ATHLETE (STYLIZED). U.S. CL. 46. REG. 7-8-1924.
186,307. S AND DESIGN. U.S. CL. 19. REG. 7-8-1924.
186,356. METEX AND DESIGN. U.S. CL. 4. REG. 7-8-1924.
186,389. JOBBER TOPICS (STYLIZED). U.S. CL. 38. REG. 7-8-1924.
186,403. POPPY BRAND AND DESIGN. U.S. CL. 46. REG. 7-8-1924.
407,888. KELCO. U.S. CL. 6. REG. 7-4-1944.
407,933. DARLING AND DESIGN. U.S. CL. 50. REG. 7-4-1944.
772,568. BEACH PAPER TABLEWARE AND DESIGN. U.S. CL. 2. REG. 7-7-1964.
772,581. RECOVER. U.S. CL. 4. REG. 7-7-1964.
772,592. SAF-SOL. U.S. CL. 6. REG. 7-7-1964.
772,618. RUGGED RED. U.S. CL. 12. REG. 7-7-1964.
772,619. FORD AND DESIGN. U.S. CL. 12. REG. 7-7-1964.
772,626. PANLFRAME (STYLIZED). U.S. CL. 12. REG. 7-7-1964.
772,642. KEY-SEAL. U.S. CL. 12. REG. 7-7-1964.
772,643. SKY-CAP. U.S. CL. 12. REG. 7-7-1964.
772,658. CAPRI. U.S. CL. 13. REG. 7-7-1964.
772,668. TOPCO. U.S. CL. 14. REG. 7-7-1964.
772,672. SKIL. U.S. CL. 15. REG. 7-7-1964.
772,690. STANTEN HALL. U.S. CL. 17. REG. 7-7-1964.
772,691. PINNACLE. U.S. CL. 17. REG. 7-7-1964.
772,697. HETRAZEEN. U.S. CL. 18. REG. 7-7-1964.
772,698. ISOPAQUE. U.S. CL. 18. REG. 7-7-1964.
772,714. SCHWINN TWINN. U.S. CL. 19. REG. 7-7-1964.
772,716. BON-TON AND DESIGN. U.S. CL. 20. REG. 7-7-1964.
772,727. MISCELLANEOUS DESIGN. U.S. CL. 21. REG. 7-7-1964.
772,763. BILLY BOY. U.S. CL. 23. REG. 7-7-1964.
772,777. ROTEX. U.S. CL. 23. REG. 7-7-1964.
772,780. BEARING BUDDY. U.S. CL. 23. REG. 7-7-1964.
772,784. BEE ZEE AND DESIGN. U.S. CL. 23. REG. 7-7-1964.
772,806. MISCELLANEOUS DESIGN. U.S. CL. 28. REG. 7-7-1964.
772,816. STRATOROCKER. U.S. CL. 32. REG. 7-7-1964.
772,820. CARILLON AND DESIGN. U.S. CL. 33. REG. 7-7-1964.
772,826. PLAZA. U.S. CL. 35. REG. 7-7-1964.
772,838. BEACH. U.S. CL. 37. REG. 7-7-1964.
772,840. HANDI-SET. U.S. CL. 37. REG. 7-7-1964.

772,851. JOHNSON CITY PRESS-CHRONICLE TENN. WHAT THE PEOPLE DON'T KNOW WILL HURT THEM AND DESIGN. U.S. CL. 38. REG. 7-7-1964.
772,852. AHP AND DESIGN. U.S. CL. 38. REG. 7-7-1964.
772,854. THE ROMPER ROOM. U.S. CL. 38. REG. 7-7-1964.
772,867. SAYLON. U.S. CL. 39. REG. 7-7-1964.
772,882. MISCELLANEOUS DESIGN. U.S. CL. 40. REG. 7-7-1964.
772,884. MISCELLANEOUS DESIGN. U.S. CL. 42. REG. 7-7-1964.
772,888. CMC (STYLIZED). U.S. CL. 42. REG. 7-7-1964.
772,890. ROYAL DIMENSION. U.S. CL. 42. REG. 7-7-1964.
772,896. SILASTIC. U.S. CL. 44. REG. 7-7-1964.
772,897. SILASTIC. U.S. CL. 44. REG. 7-7-1964.
772,909. TONE'S AND DESIGN. U.S. CL. 46. REG. 7-7-1964.
772,922. BILL CAMP'S (STYLIZED). U.S. CL. 46. REG. 7-7-1964.
772,923. LUND'S. U.S. CL. 46. REG. 7-7-1964.
772,941. RICH-PUFF. U.S. CL. 51. REG. 7-7-1964.
772,942. SHARI. U.S. CL. 51. REG. 7-7-1964.
772,944. COLENA. U.S. CL. 52. REG. 7-7-1964.
772,946. KEY. U.S. CL. 52. REG. 7-7-1964.
772,961. FBA AND DESIGN. U.S. CL. 101. REG. 7-7-1964.
772,969. MISCELLANEOUS DESIGN. U.S. CL. 106. REG. 7-7-1964.
772,977. 3 WAY. U.S. CL. 15. REG. 7-7-1964.
772,991. BROLIO BIANCO DRY WHITE WINE CASA VINICOLA BARONE RICASOLI FIRENZE-ITALY. AND DESIGN. U.S. CL. 47. REG. 7-7-1964.
987,457. HAPPY ICE. U.S. CL. 46. REG. 7-2-1974.
1,265,195. GOETZE'S PRONOUNCED "GETS" AND DESIGN. INT. CL. 30. REG. 1-24-1984.
1,266,845. SEAL OF THE GEORGIA INSTITUTE OF TECHNOLOGY PROGRESS AND SERVICE 1885. AND DESIGN. INT. CLS. 25 AND 28 UNDO. REG. 2-14-1984.
1,283,919. COAG-NORM. INT. CL. 1. REG. 7-3-1984.
1,283,921. SPLI-PREST. INT. CL. 1. REG. 7-3-1984.
1,283,926. LUBE-106. INT. CL. 1. REG. 7-3-1984.
1,283,927. RENOD. INT. CL. 1. REG. 7-3-1984.
1,283,931. CLASS A2000. INT. CL. 1. REG. 7-3-1984.
1,283,935. INDEX. INT. CL. 1. REG. 7-3-1984.
1,283,938. DREHER AND DESIGN. INT. CLS. 1, 3 AND 7. REG. 7-3-1984.
1,283,940. DISSOLVAN. INT. CL. 1. REG. 7-3-1984.
1,283,941. MOLD-EX (STYLIZED). INT. CL. 1. REG. 7-3-1984.
1,283,945. WG-100. INT. CL. 1. REG. 7-3-1984.
1,283,946. TEK TAN. INT. CL. 1. REG. 7-3-1984.
1,283,950. PER-FORM. INT. CL. 1. REG. 7-3-1984.
1,283,954. SKY. INT. CL. 1. REG. 7-3-1984.
1,283,956. ASC AND DESIGN. INT. CLS. 2 AND 12. REG. 7-3-1984.
1,283,959. LIVING COLOR. INT. CL. 2. REG. 7-3-1984.
1,283,961. RUNWAY. INT. CL. 2. REG. 7-3-1984.
1,283,964. OPAL EARTH. INT. CL. 3. REG. 7-3-1984.
1,283,967. DUAL CONTROL. INT. CL. 3. REG. 7-3-1984.
1,283,972. PERMANIZER. INT. CL. 3. REG. 7-3-1984.
1,283,983. SHAMTU. INT. CL. 3. REG. 7-3-1984.
1,283,987. STIPULATE. INT. CL. 3. REG. 7-3-1984.
1,283,997. ANNOUNCE. INT. CL. 3. REG. 7-3-1984.
1,284,004. QUASAR. INT. CL. 3. REG. 7-3-1984.

- 1,284,005. CARBOGEL. INT. CLS. 4 AND 11. REG. 7-3-1984.
 1,284,008. BLUE MAX. INT. CL. 4. REG. 7-3-1984.
 1,284,009. KEROFUEL AND DESIGN. INT. CL. 4. REG. 7-3-1984.
 1,284,013. MISCELLANEOUS DESIGN. INT. CL. 5. REG. 7-3-1984.
 1,284,014. NEURO.B-12 SL. INT. CL. 5. REG. 7-3-1984.
 1,284,019. GO "55". INT. CL. 5. REG. 7-3-1984.
 1,284,021. TRAUM-AID. INT. CL. 5. REG. 7-3-1984.
 1,284,025. CONQUER. INT. CL. 5. REG. 7-3-1984.
 1,284,027. MISCELLANEOUS DESIGN. INT. CL. 5. REG. 7-3-1984.
 1,284,033. FIRMALOSS. INT. CL. 5. REG. 7-3-1984.
 1,284,036. BUR-CELL/HVT. INT. CL. 5. REG. 7-3-1984.
 1,284,040. MISCELLANEOUS DESIGN. INT. CL. 5. REG. 7-3-1984.
 1,284,041. STERICIDE. INT. CL. 5. REG. 7-3-1984.
 1,284,043. DIVERSEY WYANDOTTE TEATCARE. INT. CL. 5. REG. 7-3-1984.
 1,284,046. PENTAC AQUAFLOW. INT. CL. 5. REG. 7-3-1984.
 1,284,048. AC AND DESIGN. INT. CL. 5. REG. 7-3-1984.
 1,284,056. DIAGLAZE. INT. CL. 5. REG. 7-3-1984.
 1,284,059. REPARIL. INT. CL. 5. REG. 7-3-1984.
 1,284,067. RAYCHEM. INT. CL. 6. REG. 7-3-1984.
 1,284,069. TEST RITE AND DESIGN. INT. CLS. 7, 8, 12 AND 21. REG. 7-3-1984.
 1,284,074. REGAL. INT. CL. 7. REG. 7-3-1984.
 1,284,077. CHETAH SYSTEMS AND DESIGN. INT. CL. 7. REG. 7-3-1984.
 1,284,079. UNIVERSAL. INT. CL. 7. REG. 7-3-1984.
 1,284,082. TSUMURA. INT. CL. 7. REG. 7-3-1984.
 1,284,084. MTI AND DESIGN. INT. CL. 7. REG. 7-3-1984.
 1,284,086. QUALITY INDUSTRIAL CONVEYORS R AND DESIGN. INT. CL. 7. REG. 7-3-1984.
 1,284,088. COLONIAL ENGRAVED. INT. CL. 8. REG. 7-3-1984.
 1,284,102. LITETOUCH AND DESIGN. INT. CL. 9. REG. 7-3-1984.
 1,284,107. MICRO/POR. INT. CL. 9. REG. 7-3-1984.
 1,284,108. DIAMOND CUT. INT. CL. 9. REG. 7-3-1984.
 1,284,112. MEGA-CON. INT. CL. 9. REG. 7-3-1984.
 1,284,124. PUMP INTELLIGENCE. INT. CL. 9. REG. 7-3-1984.
 1,284,128. SAHUARO RECORDS. INT. CL. 9. REG. 7-3-1984.
 1,284,132. MIRATROL. INT. CL. 9. REG. 7-3-1984.
 1,284,135. HW (STYLIZED). INT. CL. 9. REG. 7-3-1984.
 1,284,138. JCS. INT. CL. 9. REG. 7-3-1984.
 1,284,139. TAPEMASTER. INT. CL. 9. REG. 7-3-1984.
 1,284,140. RIMFIRE. INT. CL. 9. REG. 7-3-1984.
 1,284,142. JONES FUTUREX. INT. CL. 9. REG. 7-3-1984.
 1,284,153. GAC II. INT. CL. 9. REG. 7-3-1984.
 1,284,154. MEMOTRON AND DESIGN. INT. CL. 9. REG. 7-3-1984.
 1,284,155. TYPOTRON AND DESIGN. INT. CL. 9. REG. 7-3-1984.
 1,284,156. TONOTRON AND DESIGN. INT. CL. 9. REG. 7-3-1984.
 1,284,158. FORTY-FIVE. INT. CL. 9. REG. 7-3-1984.
 1,284,159. GUNSLINGER. INT. CL. 9. REG. 7-3-1984.
 1,284,162. DISK FINDER. INT. CL. 9. REG. 7-3-1984.
 1,284,167. TRI-SAFE. INT. CL. 9. REG. 7-3-1984.
 1,284,168. SPACE MISER. INT. CL. 9. REG. 7-3-1984.
 1,284,174. PHOTOSUN II. INT. CL. 9. REG. 7-3-1984.
 1,284,180. VESTRON VIDEO. INT. CL. 9. REG. 7-3-1984.
 1,284,182. VAL-U-CAP. INT. CL. 10. REG. 7-3-1984.
 1,284,185. SIMPLEX 2000. INT. CL. 10. REG. 7-3-1984.
 1,284,186. OSTEOPAK. INT. CL. 10. REG. 7-3-1984.
 1,284,189. DIREC-TROL. INT. CL. 10. REG. 7-3-1984.
 1,284,193. FORCE 4. INT. CL. 11. REG. 7-3-1984.
 1,284,212. TINY TOT. INT. CL. 12. REG. 7-3-1984.
 1,284,214. TRAIL-MATE. INT. CL. 12. REG. 7-3-1984.
 1,284,217. GRAZIA BILLIO. INT. CLS. 14 AND 18. REG. 7-3-1984.
 1,284,221. CHUNLEI AND DESIGN. INT. CL. 14. REG. 7-3-1984.
 1,284,231. SHENANDOAH. INT. CL. 15. REG. 7-3-1984.
 1,284,235. TOUCH MATH 1 2 3 4 5 6 7 8 9 AND DESIGN. INT. CL. 16. REG. 7-3-1984.
 1,284,239. ENGLISH STITCH AND DESIGN. INT. CL. 16. REG. 7-3-1984.
 1,284,242. MECANORMA. INT. CL. 16. REG. 7-3-1984.
 1,284,258. FUN FACTS. INT. CL. 16. REG. 7-3-1984.
 1,284,263. EPIC COMICS. INT. CL. 16. REG. 7-3-1984.
 1,284,265. CCA AND DESIGN. INT. CL. 16. REG. 7-3-1984.
 1,284,266. BRILLIANT THOUGHTS. INT. CL. 16. REG. 7-3-1984.
 1,284,267. LAVENDER & LACE. INT. CLS. 16 AND 42. REG. 7-3-1984.
 1,284,270. IMT INDUSTRIAL MACHINE TRADER (STYLIZED). INT. CL. 16. REG. 7-3-1984.
 1,284,275. OVAWIPES. INT. CLS. 16 AND 21. REG. 7-3-1984.
 1,284,277. ESTEEM. INT. CLS. 16 AND 21. REG. 7-3-1984.
 1,284,278. AGCHEK. INT. CLS. 16 AND 35. REG. 7-3-1984.
 1,284,283. METAMORPHOSES. INT. CL. 16. REG. 7-3-1984.
 1,284,288. TOP TAB. INT. CL. 16. REG. 7-3-1984.
 1,284,293. OLIVER TREADMARKS. INT. CL. 16. REG. 7-3-1984.
 1,284,300. FRESH-SHIELD. INT. CL. 16. REG. 7-3-1984.
 1,284,302. BULKSERV. INT. CL. 16. REG. 7-3-1984.
 1,284,309. MAXIMA (STYLIZED). INT. CL. 16. REG. 7-3-1984.
 1,284,317. LOOKABOUT AND DESIGN. INT. CL. 18. REG. 7-3-1984.
 1,284,322. G-71 SUPER-VUE. INT. CL. 20. REG. 7-3-1984.
 1,284,332. L AND DESIGN. INT. CL. 20. REG. 7-3-1984.
 1,284,334. CK CASKET KING AND DESIGN. INT. CL. 20. REG. 7-3-1984.
 1,284,335. FSM FUNERAL SERVICE MERCHANDISE AND DESIGN. INT. CL. 20. REG. 7-3-1984.
 1,284,340. ERGO-MATE. INT. CL. 20. REG. 7-3-1984.
 1,284,347. ASHES OF DRACULA. INT. CL. 20. REG. 7-3-1984.
 1,284,349. ASHES OF FRANKENSTEIN. INT. CL. 20. REG. 7-3-1984.
 1,284,356. JAYPOUR. INT. CL. 20. REG. 7-3-1984.
 1,284,357. BACK TALK. INT. CL. 20. REG. 7-3-1984.
 1,284,358. WE TALK BACK. INT. CL. 20. REG. 7-3-1984.
 1,284,359. TALK BACK. INT. CL. 20. REG. 7-3-1984.
 1,284,363. DREXEL HERITAGE AND DESIGN. INT. CL. 20. REG. 7-3-1984.
 1,284,371. REFLECTIONS AND DESIGN. INT. CL. 21. REG. 7-3-1984.
 1,284,378. WINDOW PRIDE (STYLIZED). INT. CL. 24. REG. 7-3-1984.
 1,284,383. MATIN-MATINES. INT. CL. 25. REG. 7-3-1984.
 1,284,384. VERA DA POZZO AND DESIGN. INT. CL. 25. REG. 7-3-1984.
 1,284,389. CHEAP SNEAKS. INT. CL. 25. REG. 7-3-1984.
 1,284,390. SARATOGA AND DESIGN. INT. CL. 25. REG. 7-3-1984.
 1,284,392. WHAT'S THE NAME?. INT. CL. 25. REG. 7-3-1984.
 1,284,398. COLORALLS. INT. CL. 25. REG. 7-3-1984.
 1,284,402. FRENCH VANILLA. INT. CL. 25. REG. 7-3-1984.
 1,284,406. FLEXTRON. INT. CL. 25. REG. 7-3-1984.
 1,284,408. FORERUNNER. INT. CL. 25. REG. 7-3-1984.
 1,284,409. COMMISSIONER. INT. CL. 25. REG. 7-3-1984.
 1,284,410. BAY AREA TRADERS. INT. CL. 25. REG. 7-3-1984.
 1,284,412. KAMA SUTRA. INT. CL. 25. REG. 7-3-1984.
 1,284,413. CAMBRIDGE DRY GOODS COMPANY AND DESIGN. INT. CL. 25. REG. 7-3-1984.
 1,284,414. BACK CREEK. INT. CL. 25. REG. 7-3-1984.
 1,284,415. STACEY DAWN. INT. CL. 25. REG. 7-3-1984.
 1,284,418. FIELD SPORT AND DESIGN. INT. CL. 25. REG. 7-3-1984.
 1,284,422. MISCELLANEOUS DESIGN. INT. CL. 25. REG. 7-3-1984.
 1,284,424. M.I.D.. INT. CL. 27. REG. 7-3-1984.
 1,284,425. MILLITEX. INT. CL. 27. REG. 7-3-1984.
 1,284,437. RAINBOW PACK. INT. CL. 28. REG. 7-3-1984.
 1,284,448. MISCELLANEOUS DESIGN. INT. CL. 28. REG. 7-3-1984.
 1,284,449. CHOPLIFTER!. INT. CL. 28. REG. 7-3-1984.
 1,284,455. KILLER. INT. CL. 28. REG. 7-3-1984.
 1,284,460. SOLARIS (STYLIZED). INT. CL. 28. REG. 7-3-1984.
 1,284,465. SUFIX. INT. CL. 28. REG. 7-3-1984.

- 1,284,469. GYRUSS. INT. CL. 28. REG. 7-3-1984.
 1,284,480. MAG TUNED. INT. CL. 28. REG. 7-3-1984.
 1,284,481. SPORTGRIP. INT. CL. 28. REG. 7-3-1984.
 1,284,484. OUR GOURMET AND DESIGN. INT. CL. 29. REG. 7-3-1984.
 1,284,488. SUPERBARRETTOS. INT. CLS. 29 AND 30. REG. 7-3-1984.
 1,284,494. RIO DEL SOL AND DESIGN. INT. CL. 29. REG. 7-3-1984.
 1,284,495. LANDBO. INT. CL. 29. REG. 7-3-1984.
 1,284,498. PIGGIE PARK. INT. CLS. 29 AND 42. REG. 7-3-1984.
 1,284,504. CHEZYER. INT. CL. 30. REG. 7-3-1984.
 1,284,505. SHAPELY SHAKE. INT. CL. 30. REG. 7-3-1984.
 1,284,507. CAROBA. INT. CL. 30. REG. 7-3-1984.
 1,284,511. RETRIEVER AND DESIGN. INT. CL. 31. REG. 7-3-1984.
 1,284,520. CARMEL (STYLIZED). INT. CL. 33. REG. 7-3-1984.
 1,284,526. TAXXPEDITE. INT. CL. 35. REG. 7-3-1984.
 1,284,538. THERIAULTS THE DOLLMASTERS. INT. CLS. 35 AND 36. REG. 7-3-1984.
 1,284,539. MISCELLANEOUS DESIGN. INT. CLS. 35 AND 36. REG. 7-3-1984.
 1,284,542. CONNECTIONS. INT. CL. 35. REG. 7-3-1984.
 1,284,544. PE AND DESIGN. INT. CLS. 35 AND 42. REG. 7-3-1984.
 1,284,549. JANNA. INT. CLS. 35 AND 41. REG. 7-3-1984.
 1,284,557. MISCELLANEOUS DESIGN. INT. CLS. 36 AND 42. REG. 7-3-1984.
 1,284,558. MUTUAL MONEY. INT. CL. 36. REG. 7-3-1984.
 1,284,559. ALLIANCE FUNDING, INCORPORATED. INT. CL. 36. REG. 7-3-1984.
 1,284,561. BETTER VACATIONS AND DESIGN. INT. CL. 36. REG. 7-3-1984.
 1,284,562. INTERNATIONAL CREDIT SERVICE. INT. CL. 36. REG. 7-3-1984.
 1,284,570. CENTRAL RESERVATIONS, INC. AND DESIGN. INT. CL. 36. REG. 7-3-1984.
 1,284,572. TELEPRAISAL. INT. CL. 36. REG. 7-3-1984.
 1,284,578. RELOCATING FAMILIES AROUND THE WORLD AND DESIGN. INT. CL. 36. REG. 7-3-1984.
 1,284,579. ASF AND DESIGN. INT. CL. 36. REG. 7-3-1984.
 1,284,580. CENTRALOCK. INT. CL. 36. REG. 7-3-1984.
 1,284,584. BNB BROAD NATIONAL BANK (STYLIZED). INT. CL. 36. REG. 7-3-1984.
 1,284,585. C AND DESIGN. INT. CL. 36. REG. 7-3-1984.
 1,284,588. COMERICARD (STYLIZED). INT. CL. 36. REG. 7-3-1984.
 1,284,590. ACADEMY LIFE. INT. CL. 36. REG. 7-3-1984.
 1,284,594. MESA. INT. CL. 36. REG. 7-3-1984.
 1,284,595. H HANOVER AND DESIGN. INT. CL. 36. REG. 7-3-1984.
 1,284,599. CANOPY. INT. CL. 36. REG. 7-3-1984.
 1,284,600. WINGS. INT. CL. 36. REG. 7-3-1984.
 1,284,602. GDS AND DESIGN. INT. CL. 37. REG. 7-3-1984.
 1,284,605. ATI AMERICAN TECHNOLOGIES AND DESIGN. INT. CL. 37. REG. 7-3-1984.
 1,284,608. KINO STARR LABORATORY (STYLIZED). INT. CL. 37. REG. 7-3-1984.
 1,284,610. TOGETHER, WE CAN FIND THE ANSWERS. INT. CL. 37. REG. 7-3-1984.
 1,284,614. THE TUBESHOTTER (STYLIZED). INT. CL. 37. REG. 7-3-1984.
 1,284,616. FOUNTAIN OF YOUTH FOR BOATS AND DESIGN. INT. CL. 37. REG. 7-3-1984.
 1,284,618. DR. DIPSTICK. INT. CL. 37. REG. 7-3-1984.
 1,284,620. VOICENET. INT. CL. 38. REG. 7-3-1984.
 1,284,621. Y YORK AND DESIGN. INT. CLS. 38, 40, 41 AND 42. REG. 7-3-1984.
 1,284,622. USA DIRECT. INT. CL. 38. REG. 7-3-1984.
 1,284,623. TCI AND DESIGN. INT. CL. 38. REG. 7-3-1984.
 1,284,624. CTN CABLE TELEVISION NETWORK OF NEW JERSEY, INC. (STYLIZED). INT. CL. 38. REG. 7-3-1984.
 1,284,634. DTX. INT. CL. 39. REG. 7-3-1984.
 1,284,635. ETS AND DESIGN. INT. CL. 39. REG. 7-3-1984.
 1,284,643. CLIP CUP. INT. CL. 40. REG. 7-3-1984.
 1,284,644. AMAX AND DESIGN. INT. CL. 40. REG. 7-3-1984.
 1,284,646. CYBERICONICS INSTITUTES AND DESIGN. INT. CL. 41. REG. 7-3-1984.
 1,284,647. PALMER VIDEO PRODUCTIONS. INT. CL. 41. REG. 7-3-1984.
 1,284,650. MISCELLANEOUS DESIGN. INT. CL. 41. REG. 7-3-1984.
 1,284,660. KING OF CLOWNS. INT. CL. 41. REG. 7-3-1984.
 1,284,661. CLAYTON JUNIOR COLLEGE UNIVERSITY SYSTEM OF GEORGIA 1969 AND DESIGN. INT. CL. 41. REG. 7-3-1984.
 1,284,664. COUNTRY CROSSROADS AND DESIGN. INT. CL. 41. REG. 7-3-1984.
 1,284,669. MICROFABRITECH. INT. CL. 41. REG. 7-3-1984.
 1,284,673. COUNTRY MUSIC FAN FAIR INTERNATIONAL NASHVILLE-TENNESSEE AND DESIGN. INT. CL. 41. REG. 7-3-1984.
 1,284,675. VISUAL IMPRESSIONS AND DESIGN. INT. CL. 41. REG. 7-3-1984.
 1,284,680. ARCA. INT. CL. 41. REG. 7-3-1984.
 1,284,684. MISCELLANEOUS DESIGN. INT. CL. 41. REG. 7-3-1984.
 1,284,686. TELESEAT AND DESIGN. INT. CL. 41. REG. 7-3-1984.
 1,284,687. NAT. INT. CL. 41. REG. 7-3-1984.
 1,284,698. VITAL VITTLES AND DESIGN. INT. CL. 42. REG. 7-3-1984.
 1,284,699. PERSNICKETY. INT. CL. 42. REG. 7-3-1984.
 1,284,702. MISCELLANEOUS DESIGN. INT. CL. 42. REG. 7-3-1984.
 1,284,703. BUILDER WAY. INT. CL. 42. REG. 7-3-1984.
 1,284,706. RAM AND DESIGN. INT. CL. 42. REG. 7-3-1984.
 1,284,708. LIQVARS. INT. CL. 42. REG. 7-3-1984.
 1,284,711. PARFUMERIE DOUGLAS. INT. CL. 42. REG. 7-3-1984.
 1,284,721. OUR PAL (STYLIZED). INT. CL. 42. REG. 7-3-1984.
 1,284,723. PUPID. INT. CL. 42. REG. 7-3-1984.
 1,284,725. PMCD. INT. CL. 42. REG. 7-3-1984.
 1,284,726. ACOS. INT. CL. 42. REG. 7-3-1984.
 1,284,727. COMPUTEC. INT. CL. 42. REG. 7-3-1984.
 1,284,741. MARKET STREET AND DESIGN. INT. CL. 42. REG. 7-3-1984.
 1,284,744. THE WEIGHT CARE CENTER AND DESIGN. INT. CL. 42. REG. 7-3-1984.
 1,284,749. MISCELLANEOUS DESIGN. INT. CL. 42. REG. 7-3-1984.
 1,284,750. S SOCOTEC AND DESIGN. INT. CL. 42. REG. 7-3-1984.
 1,284,759. LOTS OF LABELS AND DESIGN. INT. CL. 42. REG. 7-3-1984.
 1,284,761. FARMLINE. INT. CL. 42. REG. 7-3-1984.
 1,284,762. FARMLINE SPEEDY AND DESIGN. INT. CL. 42. REG. 7-3-1984.
 1,284,763. ABC FARMLINE AND DESIGN. INT. CL. 42. REG. 7-3-1984.
 1,284,767. JEFFREY'S ICE CREAM. INT. CL. 42. REG. 7-3-1984.
 1,284,771. COUNTER-INTELLIGENCE AND DESIGN. INT. CL. 42. REG. 7-3-1984.
 1,284,777. JUST KEEPS ON GETTING BETTER. INT. CL. 42. REG. 7-3-1984.
 1,284,778. MISCELLANEOUS DESIGN. INT. CL. 42. REG. 7-3-1984.
 1,284,780. MISCELLANEOUS DESIGN. INT. CL. 42. REG. 7-3-1984.
 1,284,781. MISCELLANEOUS DESIGN. INT. CL. 42. REG. 7-3-1984.
 1,284,783. MISCELLANEOUS DESIGN. INT. CL. 42. REG. 7-3-1984.
 1,284,785. ACCENTS AND DESIGN. INT. CL. 42. REG. 7-3-1984.
 1,284,787. WHEN YOU SAY TACO, SAY VIVA. INT. CL. 42. REG. 7-3-1984.
 1,284,788. MISCELLANEOUS DESIGN. INT. CL. 42. REG. 7-3-1984.
 1,284,791. RONOCOLOR. INT. CL. 42. REG. 7-3-1984.

- 1,284,799. CAPT. BENNY'S AND DESIGN. INT. CL. 42. REG. 7-3-1984.
- 1,284,802. NEXT SYSTEMS AND DESIGN. INT. CL. 42. REG. 7-3-1984.
- 1,284,805. ISA MAINTENANCE. U.S. CL. 200. REG. 7-3-1984.
- 1,284,806. ISA METALS INDUSTRIES. U.S. CL. 200. REG. 7-3-1984.
- 1,308,742. HELLY-HANSEN. INT. CL. 9 ONLY. REG. 12-11-1984.
- 1,324,029. SKIDMORE COLLEGE. INT. CL. 14 ONLY. REG. 3-12-1985.
- 1,841,560. GEIGER. INT. CL. 18. REG. 6-21-1994.
- 1,842,575. LIGHTWAVE RESEARCH. INT. CLS. 1, 7, 9 AND 11. REG. 7-5-1994.
- 1,842,583. "RAIN TURF". INT. CL. 1. REG. 7-5-1994.
- 1,842,601. CAPTYANE. INT. CL. 3. REG. 7-5-1994.
- 1,842,604. DD DIDI ROMA (STYLIZED). INT. CLS. 3, 14 AND 25. REG. 7-5-1994.
- 1,842,612. IT'S IN YOUR HANDS. INT. CL. 3. REG. 7-5-1994.
- 1,842,614. KIDFRESH. INT. CL. 3. REG. 7-5-1994.
- 1,842,628. DUAL ACTION. INT. CL. 4. REG. 7-5-1994.
- 1,842,629. ELFOLNA. INT. CL. 4. REG. 7-5-1994.
- 1,842,633. WB50. INT. CL. 4. REG. 7-5-1994.
- 1,842,642. TECHNICON H AND DESIGN. INT. CL. 5. REG. 7-5-1994.
- 1,842,643. YKK (STYLIZED). INT. CL. 6. REG. 7-5-1994.
- 1,842,650. NEW CENTURY. INT. CL. 6. REG. 7-5-1994.
- 1,842,651. MED-STOR. INT. CL. 6. REG. 7-5-1994.
- 1,842,653. STRAP-EASE. INT. CL. 6. REG. 7-5-1994.
- 1,842,654. MONODECK. INT. CL. 6. REG. 7-5-1994.
- 1,842,661. TOTAL QUALITY: A WORLD OF DIFFERENCE. INT. CL. 7. REG. 7-5-1994.
- 1,842,663. LURMARK. INT. CL. 7. REG. 7-5-1994.
- 1,842,684. THE GATOR. INT. CL. 7. REG. 7-5-1994.
- 1,842,687. O&K AND DESIGN. INT. CL. 7. REG. 7-5-1994.
- 1,842,690. CRAFTSMAN. INT. CL. 7. REG. 7-5-1994.
- 1,842,693. STRONG BACK. INT. CL. 7. REG. 7-5-1994.
- 1,842,694. GOLF LIFT. INT. CL. 7. REG. 7-5-1994.
- 1,842,695. VORTEX. INT. CL. 7. REG. 7-5-1994.
- 1,842,709. THE VIEWING WAND. INT. CL. 9. REG. 7-5-1994.
- 1,842,713. DATAPLATES. INT. CL. 9. REG. 7-5-1994.
- 1,842,731. OPTIMARK. INT. CLS. 9 AND 16. REG. 7-5-1994.
- 1,842,735. MISCELLANEOUS DESIGN. INT. CL. 9. REG. 7-5-1994.
- 1,842,742. W (STYLIZED). INT. CLS. 9 AND 42. REG. 7-5-1994.
- 1,842,743. STAR AND DESIGN. INT. CL. 9. REG. 7-5-1994.
- 1,842,744. MISCELLANEOUS DESIGN. INT. CLS. 9, 16 AND 28. REG. 7-5-1994.
- 1,842,747. LACE. INT. CL. 9. REG. 7-5-1994.
- 1,842,749. ACCU-LOK. INT. CL. 9. REG. 7-5-1994.
- 1,842,750. MAXWARE (STYLIZED). INT. CL. 9. REG. 7-5-1994.
- 1,842,753. TRIS+. INT. CL. 9. REG. 7-5-1994.
- 1,842,758. VISIONARY SHOPPER AND DESIGN. INT. CLS. 9 AND 35. REG. 7-5-1994.
- 1,842,771. BEST AND DESIGN. INT. CL. 9. REG. 7-5-1994.
- 1,842,774. GENCON. INT. CL. 9. REG. 7-5-1994.
- 1,842,777. DAN STAR. INT. CL. 9. REG. 7-5-1994.
- 1,842,778. PCI. INT. CL. 9. REG. 7-5-1994.
- 1,842,795. EARTH SCIENCE VIDEOLAB. INT. CL. 9. REG. 7-5-1994.
- 1,842,809. MY ADVANCED MAILLIST. INT. CL. 9. REG. 7-5-1994.
- 1,842,820. CIC/START. INT. CLS. 9 AND 42. REG. 7-5-1994.
- 1,842,823. KOPYKAT. INT. CL. 9. REG. 7-5-1994.
- 1,842,831. STERION. INT. CL. 10. REG. 7-5-1994.
- 1,842,838. LUMEX FOR THE QUALITY OF LIFE AND DESIGN. INT. CL. 11. REG. 7-5-1994.
- 1,842,846. COOLER COLORS. INT. CL. 11. REG. 7-5-1994.
- 1,842,847. THE NEW GENERATION. INT. CL. 11. REG. 7-5-1994.
- 1,842,848. LITTLE EAGLE. INT. CL. 11. REG. 7-5-1994.
- 1,842,850. CASCADE. INT. CL. 11. REG. 7-5-1994.
- 1,842,852. HUMI-HEAT. INT. CL. 11. REG. 7-5-1994.
- 1,842,854. PROCOMP HIGH PERFORMANCE WHEELS AND DESIGN. INT. CL. 12. REG. 7-5-1994.
- 1,842,855. HEDSTROM. INT. CLS. 12 AND 28. REG. 7-5-1994.
- 1,842,859. ARRIBA. INT. CL. 12. REG. 7-5-1994.
- 1,842,874. FLOWERS FERNS AND RAINFORESTS. INT. CL. 14. REG. 7-5-1994.
- 1,842,884. FUNKTIONAL. INT. CL. 14. REG. 7-5-1994.
- 1,842,886. M&GN. INT. CL. 14. REG. 7-5-1994.
- 1,842,887. ARTWATCH. INT. CL. 14. REG. 7-5-1994.
- 1,842,898. WILEY CPA EXAMINATION REVIEW. INT. CL. 16. REG. 7-5-1994.
- 1,842,908. MISCELLANEOUS DESIGN. INT. CL. 16. REG. 7-5-1994.
- 1,842,909. MISCELLANEOUS DESIGN. INT. CL. 16. REG. 7-5-1994.
- 1,842,916. QUICK ART AND DESIGN. INT. CL. 16. REG. 7-5-1994.
- 1,842,918. SOUND-CODED READING AND DESIGN. INT. CL. 16. REG. 7-5-1994.
- 1,842,926. AHA. INT. CLS. 16 AND 42. REG. 7-5-1994.
- 1,842,951. BOEING. INT. CL. 18. REG. 7-5-1994.
- 1,842,955. THE ULTIMATE TILE BACKER AND DESIGN. INT. CL. 19. REG. 7-5-1994.
- 1,842,977. NORTHPLAINS. INT. CL. 20. REG. 7-5-1994.
- 1,842,982. DEQUEVEDO. INT. CL. 21. REG. 7-5-1994.
- 1,842,984. THE ORIGINAL BOOK WORKS LIMITED. INT. CL. 21. REG. 7-5-1994.
- 1,842,985. LIFER JUICE (STYLIZED). INT. CL. 21. REG. 7-5-1994.
- 1,842,992. VALISERE PARIS AND DESIGN. INT. CLS. 24 AND 25. REG. 7-5-1994.
- 1,843,002. MISCELLANEOUS DESIGN. INT. CL. 25. REG. 7-5-1994.
- 1,843,019. BUFF STUFF. INT. CL. 25. REG. 7-5-1994.
- 1,843,020. IMMA COLATA AND DESIGN. INT. CL. 25. REG. 7-5-1994.
- 1,843,021. JR AND DESIGN. INT. CL. 25. REG. 7-5-1994.
- 1,843,026. EHL. INT. CL. 25. REG. 7-5-1994.
- 1,843,032. KELLY STRYKER AND DESIGN. INT. CL. 25. REG. 7-5-1994.
- 1,843,038. MY STARS. INT. CL. 25. REG. 7-5-1994.
- 1,843,048. CARPETMAX. INT. CL. 27. REG. 7-5-1994.
- 1,843,053. HUDSON GROUP HUDSON SOFT AND DESIGN. INT. CL. 28. REG. 7-5-1994.
- 1,843,055. WOOLAKINS. INT. CL. 28. REG. 7-5-1994.
- 1,843,061. DPW. INT. CL. 28. REG. 7-5-1994.
- 1,843,063. PLAY VISIONS. INT. CL. 28. REG. 7-5-1994.
- 1,843,069. ROY'S ROASTERS. INT. CL. 29. REG. 7-5-1994.
- 1,843,083. GAROTO ALO, DOCURA! AND DESIGN. INT. CL. 30. REG. 7-5-1994.
- 1,843,088. CULINAR. INT. CL. 30. REG. 7-5-1994.
- 1,843,090. MARSHALL'S BISCUITS TASTE THE DIFFERENCE AND DESIGN. INT. CL. 30. REG. 7-5-1994.
- 1,843,092. CIGARETTES RUSSES. INT. CL. 30. REG. 7-5-1994.
- 1,843,093. JAVA NOIR. INT. CL. 30. REG. 7-5-1994.
- 1,843,095. PERC AND DESIGN. INT. CL. 30. REG. 7-5-1994.
- 1,843,100. NORTHERN NECTAR. INT. CL. 30. REG. 7-5-1994.
- 1,843,107. DAKOTA SUNBURST. INT. CL. 31. REG. 7-5-1994.
- 1,843,113. ENERGIZER. INT. CL. 32. REG. 7-5-1994.
- 1,843,128. EL SUBLIMADO. INT. CL. 34. REG. 7-5-1994.
- 1,843,136. IMC (STYLIZED). INT. CL. 35. REG. 7-5-1994.
- 1,843,139. FEATUREPHONE. INT. CLS. 35, 36, 41 AND 42. REG. 7-5-1994.
- 1,843,140. MISCELLANEOUS DESIGN. INT. CLS. 35, 41 AND 42. REG. 7-5-1994.
- 1,843,141. WRIGHTERS, INK.. INT. CL. 35. REG. 7-5-1994.
- 1,843,142. THE CLEVER CLEAVER BROTHERS. INT. CL. 35. REG. 7-5-1994.
- 1,843,152. KSK (STYLIZED). INT. CL. 35. REG. 7-5-1994.
- 1,843,164. GWR (STYLIZED). INT. CLS. 35 AND 36. REG. 7-5-1994.
- 1,843,166. ASSET GUARANTY REINSURANCE. INT. CL. 36. REG. 7-5-1994.
- 1,843,177. FAST ANSWERS. RELIABLE INFORMATION. HOME SALES LINE AND DESIGN. INT. CL. 36. REG. 7-5-1994.
- 1,843,179. COMMONWEALTHRISK (STYLIZED). INT. CL. 36. REG. 7-5-1994.

- 1,843,185. F-I-R-S-T FRANKLIN AND DESIGN. INT. CL. 36. REG. 7-5-1994.
- 1,843,199. COSTWISE. INT. CL. 36. REG. 7-5-1994.
- 1,843,206. SEAT 100. INT. CL. 37. REG. 7-5-1994.
- 1,843,208. CORPORATE JETS CJ AND DESIGN. INT. CLS. 37 AND 39. REG. 7-5-1994.
- 1,843,221. CARGO ONE. INT. CL. 39. REG. 7-5-1994.
- 1,843,223. CRUISE HOLIDAYS CLUB SEAQUEL AND DESIGN. INT. CL. 39. REG. 7-5-1994.
- 1,843,225. FAST FORWARD. INT. CL. 39. REG. 7-5-1994.
- 1,843,227. PRO-M-CYCLE. INT. CL. 40. REG. 7-5-1994.
- 1,843,231. FAMILIES FOR PREVENTION. INT. CL. 41. REG. 7-5-1994.
- 1,843,234. KANSAS CITY MONARCHS. INT. CL. 41. REG. 7-5-1994.
- 1,843,236. ARI. INT. CL. 41. REG. 7-5-1994.
- 1,843,243. GATEWAY TO THE BUSINESS WORLD. INT. CL. 41. REG. 7-5-1994.
- 1,843,254. DESIGN CONNECTIONS. INT. CL. 41. REG. 7-5-1994.
- 1,843,258. EARTH CADETS. INT. CL. 41. REG. 7-5-1994.
- 1,843,263. TAEKWONDO WORLD. INT. CL. 41. REG. 7-5-1994.
- 1,843,281. OPENLINE. INT. CL. 42. REG. 7-5-1994.
- 1,843,282. STEAK FRITES. INT. CL. 42. REG. 7-5-1994.
- 1,843,295. MIRACLE OF SCIENCE BAR+GRILL AND DESIGN. INT. CL. 42. REG. 7-5-1994.
- 1,843,300. KIMSU (STYLIZED). INT. CL. 42. REG. 7-5-1994.
- 1,843,303. THE NATURE OF BEING WHOLE AND DESIGN. INT. CL. 42. REG. 7-5-1994.
- 1,843,307. MISCELLANEOUS DESIGN. INT. CL. 42. REG. 7-5-1994.
- 1,843,316. OIL LADY AROMATHERAPY. INT. CL. 42. REG. 7-5-1994.
- 1,843,317. PETS ARE INN AND DESIGN. INT. CL. 42. REG. 7-5-1994.
- 1,843,323. MEDIATION FIRST. INT. CL. 42. REG. 7-5-1994.
- 1,843,331. 1-800-PRO-TEAM. INT. CL. 42. REG. 7-5-1994.
- 1,843,334. ANNIE'S ONE STOP CRAFT SHOPPE. INT. CL. 42. REG. 7-5-1994.
- 1,843,339. SOLV-IT. INT. CL. 42. REG. 7-5-1994.
- 1,843,351. M.D. ANDERSON CANCER CENTER OUT-REACH. INT. CLS. 41 AND 42. REG. 7-5-1994.
- 1,843,360. PACKIT. INT. CLS. 39 AND 42. REG. 7-5-1994.
- 1,843,362. XAOS. INT. CLS. 9 AND 20. REG. 7-5-1994.
- 1,843,372. IT'S OK TO TALK ABOUT IT. INT. CLS. 10 AND 11. REG. 7-5-1994.
- 1,843,380. ITZ AND DESIGN. INT. CLS. 18 AND 25. REG. 7-5-1994.
- 1,843,382. MAXI-FLEX. INT. CLS. 36 AND 42. REG. 7-5-1994.
- 1,843,386. ITZ. INT. CLS. 18 AND 25. REG. 7-5-1994.
- 1,843,391. DEOFLOW. INT. CL. 1. REG. 7-5-1994.
- 1,843,398. HYDROBROM. INT. CL. 1. REG. 7-5-1994.
- 1,843,399. SERVICE-PRO. INT. CL. 1. REG. 7-5-1994.
- 1,843,411. BE BOP. INT. CL. 3. REG. 7-5-1994.
- 1,843,416. BEYOND ESSENCE. INT. CL. 3. REG. 7-5-1994.
- 1,843,421. BERIT (STYLIZED). INT. CL. 3. REG. 7-5-1994.
- 1,843,435. THROATIES. INT. CL. 5. REG. 7-5-1994.
- 1,843,437. TYROMEX. INT. CL. 5. REG. 7-5-1994.
- 1,843,438. ALTEON. INT. CL. 5. REG. 7-5-1994.
- 1,843,442. HELP-MATE. INT. CL. 5. REG. 7-5-1994.
- 1,843,444. HIRULOG. INT. CL. 5. REG. 7-5-1994.
- 1,843,450. ACTI-FORM. INT. CL. 5. REG. 7-5-1994.
- 1,843,458. RELIEV-OL. INT. CL. 5. REG. 7-5-1994.
- 1,843,459. METABA-TROL. INT. CL. 5. REG. 7-5-1994.
- 1,843,467. LITTLE LOUIE. INT. CL. 6. REG. 7-5-1994.
- 1,843,468. EZPRINT (STYLIZED). INT. CL. 7. REG. 7-5-1994.
- 1,843,475. HARMONY. INT. CL. 9. REG. 7-5-1994.
- 1,843,491. S*MMIT (STYLIZED). INT. CL. 9. REG. 7-5-1994.
- 1,843,495. MISCELLANEOUS DESIGN. INT. CL. 9. REG. 7-5-1994.
- 1,843,508. MULTIBAND PLUS. INT. CL. 9. REG. 7-5-1994.
- 1,843,511. DYNAGUIDE. INT. CL. 9. REG. 7-5-1994.
- 1,843,516. MEGADRAW. INT. CL. 9. REG. 7-5-1994.
- 1,843,523. SYSTEM DESIGN STATION. INT. CL. 9. REG. 7-5-1994.
- 1,843,534. KOOL SHADES. INT. CL. 9. REG. 7-5-1994.
- 1,843,539. EXCEL 5000 AND DESIGN. INT. CL. 9. REG. 7-5-1994.
- 1,843,541. ECLIPSE. INT. CL. 9. REG. 7-5-1994.
- 1,843,543. ML. INT. CL. 9. REG. 7-5-1994.
- 1,843,546. LAPLINK REMOTE ACCESS. INT. CL. 9. REG. 7-5-1994.
- 1,843,552. FIBRELITE. INT. CL. 9. REG. 7-5-1994.
- 1,843,554. BELLOVAC. INT. CL. 10. REG. 7-5-1994.
- 1,843,555. TOMHEY. INT. CL. 10. REG. 7-5-1994.
- 1,843,556. SILC CUP. INT. CL. 10. REG. 7-5-1994.
- 1,843,563. LAPAROLIFT. INT. CL. 10. REG. 7-5-1994.
- 1,843,566. FLEX-GUT. INT. CL. 10. REG. 7-5-1994.
- 1,843,567. IGN. INT. CL. 10. REG. 7-5-1994.
- 1,843,569. INTREPID. INT. CL. 10. REG. 7-5-1994.
- 1,843,578. HYDROX. INT. CL. 11. REG. 7-5-1994.
- 1,843,579. THE MED GROUP AND DESIGN. INT. CL. 11. REG. 7-5-1994.
- 1,843,582. ULNEX. INT. CL. 11. REG. 7-5-1994.
- 1,843,585. NORTH COAST VALVE & GATE, INC. AND DESIGN. INT. CL. 11. REG. 7-5-1994.
- 1,843,592. SECRET TREASURES. INT. CL. 12. REG. 7-5-1994.
- 1,843,596. JESSICA STEVENS. INT. CL. 14. REG. 7-5-1994.
- 1,843,600. QUICK PICK. INT. CL. 15. REG. 7-5-1994.
- 1,843,604. GAYLORD ENCOR AND DESIGN. INT. CL. 16. REG. 7-5-1994.
- 1,843,611. ADHERE-O. INT. CL. 16. REG. 7-5-1994.
- 1,843,618. INPACEL AND DESIGN. INT. CL. 16. REG. 7-5-1994.
- 1,843,623. BEST EFFORT. INT. CL. 16. REG. 7-5-1994.
- 1,843,626. IT'S TIME TO TALK. INT. CL. 16. REG. 7-5-1994.
- 1,843,634. FAMILY LIFE. INT. CL. 16. REG. 7-5-1994.
- 1,843,640. NATIONAL ALLIANCE OF MULTIAGE EDUCATORS. INT. CL. 16. REG. 7-5-1994.
- 1,843,646. FREEZERMATE. INT. CL. 17. REG. 7-5-1994.
- 1,843,649. 777. INT. CL. 18. REG. 7-5-1994.
- 1,843,654. TOTAL CONTROL SYSTEM. INT. CL. 18. REG. 7-5-1994.
- 1,843,661. HOME KAIR AND DESIGN. INT. CL. 20. REG. 7-5-1994.
- 1,843,663. AUVICASE (STYLIZED). INT. CL. 20. REG. 7-5-1994.
- 1,843,665. PRESS-BAK. INT. CL. 20. REG. 7-5-1994.
- 1,843,679. BAND-IT. INT. CL. 21. REG. 7-5-1994.
- 1,843,684. G GAGGIO AND DESIGN. INT. CL. 24. REG. 7-5-1994.
- 1,843,685. THE BLACK TIE COLLECTION AND DESIGN. INT. CL. 24. REG. 7-5-1994.
- 1,843,691. PINE ISLAND. INT. CL. 25. REG. 7-5-1994.
- 1,843,695. WINTER HIVIZ. INT. CL. 25. REG. 7-5-1994.
- 1,843,697. ASSETS LONDON AND DESIGN. INT. CL. 25. REG. 7-5-1994.
- 1,843,699. TROPICAL SPORTSWEAR NATURAL MAN. INT. CL. 25. REG. 7-5-1994.
- 1,843,705. MEKKA. INT. CL. 25. REG. 7-5-1994.
- 1,843,707. MISCELLANEOUS DESIGN. INT. CL. 25. REG. 7-5-1994.
- 1,843,710. ANIMAL X-ING. INT. CL. 25. REG. 7-5-1994.
- 1,843,721. ALLEN EDMONDS LIFE STYLES AND DESIGN. INT. CL. 25. REG. 7-5-1994.
- 1,843,723. A (STYLIZED). INT. CL. 25. REG. 7-5-1994.
- 1,843,725. ZIP-R-STRIP. INT. CL. 25. REG. 7-5-1994.
- 1,843,734. DARK SUN. INT. CL. 28. REG. 7-5-1994.
- 1,843,745. TORNADO AND DESIGN. INT. CL. 28. REG. 7-5-1994.
- 1,843,749. HIGH FIVES. INT. CL. 28. REG. 7-5-1994.
- 1,843,750. REEL GEMS. INT. CL. 28. REG. 7-5-1994.
- 1,843,751. MISCELLANEOUS DESIGN. INT. CL. 28. REG. 7-5-1994.
- 1,843,753. PREMIUM CARD. INT. CL. 28. REG. 7-5-1994.
- 1,843,756. REPTILIBOTS. INT. CL. 28. REG. 7-5-1994.
- 1,843,757. BUILDERBOTS. INT. CL. 28. REG. 7-5-1994.
- 1,843,761. MASS TRANSFER. INT. CL. 28. REG. 7-5-1994.
- 1,843,765. RASPY GLASS. INT. CL. 28. REG. 7-5-1994.
- 1,843,770. CHRISTMAS PRESENT AND PAST. INT. CL. 28. REG. 7-5-1994.
- 1,843,771. CHOICE WORDS. INT. CL. 28. REG. 7-5-1994.
- 1,843,788. JR. CAMPING. INT. CL. 28. REG. 7-5-1994.

- 1,843,792. SCREAMING SQUADRON. INT. CL. 28. REG. 7-5-1994.
- 1,843,801. SEABITES. INT. CL. 29. REG. 7-5-1994.
- 1,843,809. NOKOMIS FARMS, INC. AND DESIGN. INT. CL. 30. REG. 7-5-1994.
- 1,843,816. TOP HAT. INT. CL. 30. REG. 7-5-1994.
- 1,843,817. PRETZELS-4-U. INT. CL. 30. REG. 7-5-1994.
- 1,843,818. BLO-HO-HO. INT. CL. 30. REG. 7-5-1994.
- 1,843,824. MON CHER CHOUCYOU MY DEAR PET FRENCH DELICACIES FOR THE LOVED-AND-PAMPERED PET AND DESIGN. INT. CL. 31. REG. 7-5-1994.
- 1,843,825. MON CHER CHOUCYOU. INT. CL. 31. REG. 7-5-1994.
- 1,843,826. POTATO PRIDE. INT. CL. 31. REG. 7-5-1994.
- 1,843,829. BEAKER-KEEPER. INT. CL. 31. REG. 7-5-1994.
- 1,843,831. MORRO SANGRIA. INT. CL. 31. REG. 7-5-1994.
- 1,843,848. BR BORKUM RIFF AND DESIGN. INT. CL. 34. REG. 7-5-1994.
- 1,843,857. NVAL. INT. CL. 35. REG. 7-5-1994.
- 1,843,864. MISCELLANEOUS DESIGN. INT. CL. 36. REG. 7-5-1994.
- 1,843,869. CARE RESOURCES PROTECT A LIFETIME OF LIVING AND DESIGN. INT. CL. 36. REG. 7-5-1994.
- 1,843,870. FIRST DOWN. INT. CL. 36. REG. 7-5-1994.
- 1,843,872. WILL ROGERS BANK. INT. CL. 36. REG. 7-5-1994.
- 1,843,873. WIPE OUT DIABETES. INT. CL. 36. REG. 7-5-1994.
- 1,843,874. TOUCH & TRADE. INT. CL. 36. REG. 7-5-1994.
- 1,843,875. WINGED KEEL. INT. CL. 36. REG. 7-5-1994.
- 1,843,876. MISCELLANEOUS DESIGN. INT. CL. 36. REG. 7-5-1994.
- 1,843,878. MEDKEY AND DESIGN. INT. CL. 36. REG. 7-5-1994.
- 1,843,890. BORDERPASS. INT. CL. 39. REG. 7-5-1994.
- 1,843,896. CHURCHILL DOWNS SPORTS SPECTRUM AND DESIGN. INT. CL. 41. REG. 7-5-1994.
- 1,843,899. AMA AND DESIGN. INT. CL. 41. REG. 7-5-1994.
- 1,843,902. ONE NATION PRODUCTIONS AND DESIGN. INT. CL. 41. REG. 7-5-1994.
- 1,843,907. COOPER'S TURKEY PLACE SINCE 1938 AND DESIGN. INT. CL. 42. REG. 7-5-1994.
- 1,843,923. WE HAVE A VISION FOR YOU. INT. CL. 42. REG. 7-5-1994.
- 1,843,929. SINKIE AND DESIGN. U.S. CL. 200. REG. 7-5-1994.
- 1,843,932. QUALLOWARM. U.S. CL. A. REG. 7-5-1994.
- 1,843,941. ELECTRONIC FIELD BOOK. INT. CL. 9. REG. 7-5-1994.
- 1,843,942. IMAGEDISC (STYLIZED). INT. CL. 9. REG. 7-5-1994.
- 1,843,943. SIMULTANEOUS BIPLANE PROBE. INT. CL. 10. REG. 7-5-1994.
- 1,843,948. WAREHOUSING MANAGEMENT. INT. CL. 16. REG. 7-5-1994.
- 1,843,949. SCRIPTURE MINIATURES. INT. CL. 16. REG. 7-5-1994.
- 1,843,952. PRODUCTORES DE HORTALIZAS. INT. CL. 16. REG. 7-5-1994.
- 1,843,959. ENTERTAINMENT PREVIEW. INT. CL. 16. REG. 7-5-1994.
- 1,843,965. MAZZO. INT. CL. 25. REG. 7-5-1994.
- 1,843,966. MECHANICAL COLLECTIBLES. INT. CL. 28. REG. 7-5-1994.
- 1,843,967. HOUND DOG CHRISTMAS. INT. CL. 28. REG. 7-5-1994.
- 1,843,970. ORANGE COUNTY SWEETS. INT. CL. 31. REG. 7-5-1994.
- 1,843,972. NATIONAL VISION ASSOCIATES, LTD.. INT. CL. 35. REG. 7-5-1994.
- 1,843,973. REGIONAL FINANCIAL ASSOCIATES. INT. CL. 35. REG. 7-5-1994.
- 1,843,974. HEALTHCARE RECRUITERS. INT. CL. 35. REG. 7-5-1994.
- 1,843,977. NATIONAL PROFESSIONAL SOCCER LEAGUE. INT. CL. 41. REG. 7-5-1994.
- 1,843,980. SPECTACULAR ON-SITE SERVICES. INT. CL. 41. REG. 7-5-1994.
- 1,845,619. INTERIOR IMAGES BY SALTERINI AND DESIGN. INT. CL. 20. REG. 7-19-1994.
- 1,872,759. MISCELLANEOUS DESIGN. INT. CLS. 35, 37, 39, 41 AND 42 ONLY. REG. 1-10-1995.
- 1,879,046. GRAND CANYON RAFTERS. INT. CL. 16 ONLY. REG. 2-14-1995.
- 1,880,427. Q AND DESIGN. INT. CL. 28 ONLY. REG. 2-28-1995.
- 1,903,294. WINSOME. INT. CL. 8 ONLY. REG. 7-4-1995.
- 1,953,888. FALCON. INT. CL. 9. REG. 2-6-1996.
- 2,021,138. BRICK. INT. CL. 32. REG. 12-3-1996.
- 2,077,250. SELECT BRAND. INT. CLS. 3 AND 5. REG. 7-8-1997.
- 2,082,815. CAREER TREK AND DESIGN. INT. CLS. 9 AND 16. REG. 7-29-1997.
- 2,105,410. SPACE-SAVING INNOVATIONS TO UNCLUTTER YOUR LIFE. INT. CL. 35. REG. 10-14-1997.
- 2,107,639. MY DOC. INT. CL. 42. REG. 10-21-1997.
- 2,108,004. SPORTS AUTHORITY LTD.. INT. CLS. 35 AND 41. REG. 10-21-1997.
- 2,108,752. CHARITY BEGINS AT HOME. INT. CL. 42. REG. 10-28-1997.
- 2,125,067. GALAXSEA. INT. CL. 39. REG. 12-30-1997.
- 2,132,615. HTM-CEROS. INT. CL. 9. REG. 1-27-1998.
- 2,133,210. SURE SHOT. INT. CLS. 6 AND 9. REG. 1-27-1998.
- 2,141,822. POLICE. INT. CLS. 16 AND 18 ONLY. REG. 3-10-1998.
- 2,142,347. SKILLMASTER AND DESIGN. INT. CL. 9. REG. 3-10-1998.
- 2,160,320. RESCUE THE CHILDREN AND DESIGN. INT. CL. 42. REG. 5-26-1998.
- 2,164,900. GEORG JENSEN AND DESIGN. INT. CLS. 3, 11, 16, 18, 20, 24, 25, 28 AND 42 ONLY. REG. 6-16-1998.
- 2,170,618. CARDIAC ALLIANCE AND DESIGN. INT. CL. 42. REG. 7-7-1998.
- 2,170,619. BANDMASTER. INT. CL. 15. REG. 7-7-1998.
- 2,170,621. INFOTEC. INT. CLS. 37 AND 42. REG. 7-7-1998.
- 2,170,622. PLAY WITH A PURPOSE. INT. CL. 41. REG. 7-7-1998.
- 2,170,624. MISCELLANEOUS DESIGN. INT. CL. 36. REG. 7-7-1998.
- 2,170,627. CASANTO INTEGRAL. INT. CL. 29. REG. 7-7-1998.
- 2,170,628. AS SEEN ON TV SHOWCASE. INT. CL. 42. REG. 7-7-1998.
- 2,170,631. US CUP AND DESIGN. INT. CLS. 14, 16, 24, 25, 41 AND 42. REG. 7-7-1998.
- 2,170,632. ESCAPADE. INT. CL. 41. REG. 7-7-1998.
- 2,170,633. THE PAYROLL LEARNING CENTER AND DESIGN. INT. CL. 41. REG. 7-7-1998.
- 2,170,634. GALIL. INT. CL. 13. REG. 7-7-1998.
- 2,170,635. VIEW Z AND DESIGN. INT. CL. 9. REG. 7-7-1998.
- 2,170,636. NIRVIS (STYLIZED). INT. CLS. 9 AND 42. REG. 7-7-1998.
- 2,170,637. CARAVAN AND DESIGN. INT. CL. 9. REG. 7-7-1998.
- 2,170,641. VISTEON. INT. CL. 42. REG. 7-7-1998.
- 2,170,643. THERM-A-WELD AND DESIGN. INT. CL. 19. REG. 7-7-1998.
- 2,170,644. THE GOLDEN RULE. INT. CL. 35. REG. 7-7-1998.
- 2,170,645. LA POSTE. INT. CLS. 35 AND 42. REG. 7-7-1998.
- 2,170,646. HEALTHMARK AND DESIGN. INT. CL. 42. REG. 7-7-1998.
- 2,170,649. CIR CORPORATE INVESTOR RELATIONS AND DESIGN. INT. CL. 35. REG. 7-7-1998.
- 2,170,650. FACIM. INT. CLS. 7 AND 9. REG. 7-7-1998.
- 2,170,655. CRYSTAL CREEK. INT. CLS. 11 AND 32. REG. 7-7-1998.
- 2,170,657. DYNAMIC GLOBAL PARTNERS FUND. INT. CL. 36. REG. 7-7-1998.
- 2,170,658. DYNAMIC FUND OF CANADA LTD.. INT. CL. 36. REG. 7-7-1998.
- 2,170,659. DYNAMIC EUROPE FUND. INT. CL. 36. REG. 7-7-1998.

- 2,170,660. DEALING 2000-1. INT. CLS. 9, 35, 36, 38 AND 42. REG. 7-7-1998.
- 2,170,666. CUSTOMER CHOICE & CONTROL AND DESIGN. INT. CLS. 35, 37, 39 AND 42. REG. 7-7-1998.
- 2,170,672. MONDU (STYLIZED). INT. CL. 14. REG. 7-7-1998.
- 2,170,673. SPEED SNAP (STYLIZED). INT. CL. 26. REG. 7-7-1998.
- 2,170,677. SECOMAX. INT. CL. 7. REG. 7-7-1998.
- 2,170,678. SOUND IDEAS. INT. CL. 9. REG. 7-7-1998.
- 2,170,680. BUSINESS VISION AND DESIGN. INT. CL. 41. REG. 7-7-1998.
- 2,170,681. RAQUEL'S. INT. CL. 35. REG. 7-7-1998.
- 2,170,685. 1-800-32-TOURS. INT. CLS. 39 AND 42. REG. 7-7-1998.
- 2,170,686. DELCO ELECTRONICS AND DESIGN. INT. CL. 9. REG. 7-7-1998.
- 2,170,689. YOUR CONNECTION TO EXCELLENCE. INT. CLS. 40 AND 42. REG. 7-7-1998.
- 2,170,690. MELAVISION. INT. CLS. 9 AND 11. REG. 7-7-1998.
- 2,170,692. COMFORCE. INT. CLS. 35, 38 AND 42. REG. 7-7-1998.
- 2,170,701. MEDICAL WEIGHT LOSS 'DIET EASY' AND DESIGN. INT. CL. 42. REG. 7-7-1998.
- 2,170,704. THE TIMEPROMPT. INT. CL. 9. REG. 7-7-1998.
- 2,170,708. OSTER. INT. CL. 3. REG. 7-7-1998.
- 2,170,711. ANGEL BABIES (STYLIZED). INT. CLS. 24 AND 25. REG. 7-7-1998.
- 2,170,712. BUTTERFLY DELIGHT. INT. CL. 9. REG. 7-7-1998.
- 2,170,714. FIRST CONNECT. INT. CL. 42. REG. 7-7-1998.
- 2,170,715. TS = TECHNOLOGY SOLUTIONS AND DESIGN. INT. CL. 42. REG. 7-7-1998.
- 2,170,716. LONG DISTANCE WHOLESALE CLUB. INT. CL. 38. REG. 7-7-1998.
- 2,170,717. 10297 LONG DISTANCE WHOLESALE CLUB AND DESIGN. INT. CL. 38. REG. 7-7-1998.
- 2,170,718. CHOICENTER. INT. CL. 35. REG. 7-7-1998.
- 2,170,719. APSTAR. INT. CLS. 9 AND 42. REG. 7-7-1998.
- 2,170,722. CONSIDER THE POSSIBILITIES. INT. CL. 14. REG. 7-7-1998.
- 2,170,723. MISCELLANEOUS DESIGN. INT. CLS. 35, 36 AND 41. REG. 7-7-1998.
- 2,170,728. BROOKLYN BAGEL RESTAURANT AND DESIGN. INT. CL. 42. REG. 7-7-1998.
- 2,170,729. ULTIMATE SAILING CALENDAR. INT. CL. 16. REG. 7-7-1998.
- 2,170,730. THE WHITE RHINO AND DESIGN. INT. CL. 42. REG. 7-7-1998.
- 2,170,734. K + CARE. INT. CL. 5. REG. 7-7-1998.
- 2,170,737. AMERICAN CAPITAL LEASING. INT. CLS. 36 AND 37. REG. 7-7-1998.
- 2,170,738. NNT. INT. CL. 9. REG. 7-7-1998.
- 2,170,746. VIEWALL AND DESIGN. INT. CL. 20. REG. 7-7-1998.
- 2,170,747. @ ONCE AND DESIGN. INT. CL. 35. REG. 7-7-1998.
- 2,170,752. UNITED STATES TRIATHLON SERIES. INT. CL. 41. REG. 7-7-1998.
- 2,170,754. MOBILE CHEF AND DESIGN. INT. CLS. 8 AND 21. REG. 7-7-1998.
- 2,170,755. CONFETTI. INT. CL. 9. REG. 7-7-1998.
- 2,170,756. LIGHTBAND. INT. CLS. 35 AND 42. REG. 7-7-1998.
- 2,170,761. SKYLINER AND DESIGN. INT. CL. 7. REG. 7-7-1998.
- 2,170,762. STREETWALKER. INT. CL. 30. REG. 7-7-1998.
- 2,170,763. ONE EYE BEAR TRAP. INT. CL. 7. REG. 7-7-1998.
- 2,170,764. CTT CERTIFIED TECHNICAL TRAINER AND DESIGN. INT. CLS. 9, 16 AND 42. REG. 7-7-1998.
- 2,170,765. MOUNTAIN BLAST PAK COCA-COLA AND DESIGN. INT. CL. 32. REG. 7-7-1998.
- 2,170,767. DIAMOND. INT. CL. 6. REG. 7-7-1998.
- 2,170,768. PROMEDCO. INT. CL. 35. REG. 7-7-1998.
- 2,170,770. EXECUTIVE DRIVE. INT. CL. 3. REG. 7-7-1998.
- 2,170,771. DORNIER DISCOLENO AND DESIGN. INT. CL. 7. REG. 7-7-1998.
- 2,170,774. MISCELLANEOUS DESIGN. INT. CLS. 9 AND 25. REG. 7-7-1998.
- 2,170,779. KANGOL AND DESIGN. INT. CLS. 9 AND 28. REG. 7-7-1998.
- 2,170,783. L'AGENCE AND DESIGN. INT. CL. 35. REG. 7-7-1998.
- 2,170,787. MISCELLANEOUS DESIGN. INT. CL. 9. REG. 7-7-1998.
- 2,170,788. MARGO. INT. CL. 41. REG. 7-7-1998.
- 2,170,789. MARGO METRO. INT. CL. 41. REG. 7-7-1998.
- 2,170,790. QUOKKA SPORTS. INT. CL. 42. REG. 7-7-1998.
- 2,170,791. CREATIVE CULINARY CONCEPTS. INT. CL. 42. REG. 7-7-1998.
- 2,170,794. PLASPLUGS MULTI TASK SHARPENING SYSTEM. INT. CL. 7. REG. 7-7-1998.
- 2,170,796. MISCELLANEOUS DESIGN. INT. CLS. 1 AND 5. REG. 7-7-1998.
- 2,170,798. INTELLECTUAL. INT. CL. 5. REG. 7-7-1998.
- 2,170,802. EUROPA COMMUNICATIONS AND DESIGN. INT. CLS. 35, 38 AND 42. REG. 7-7-1998.
- 2,170,804. PROSTAR. INT. CL. 11. REG. 7-7-1998.
- 2,170,805. AIRSTAR. INT. CL. 11. REG. 7-7-1998.
- 2,170,806. CALSTAR. INT. CL. 11. REG. 7-7-1998.
- 2,170,809. Q LUBE MOBILE. INT. CL. 37. REG. 7-7-1998.
- 2,170,812. MAXILIFE PHYTONUTRIENT PROTECTOR. INT. CL. 5. REG. 7-7-1998.
- 2,170,813. INFOSTORE@WORK AND DESIGN. INT. CL. 9. REG. 7-7-1998.
- 2,170,815. VISION ADVANTAGE OPTICAL AND DESIGN. INT. CL. 42. REG. 7-7-1998.
- 2,170,816. INDIANAPOLIS NEWSPAPERS. INT. CL. 41. REG. 7-7-1998.
- 2,170,818. FROM TIME MANAGEMENT TO LIFE LEADERSHIP. INT. CL. 41. REG. 7-7-1998.
- 2,170,822. PRIVATE LABEL COMMUNITY. INT. CL. 42. REG. 7-7-1998.
- 2,170,829. CMIX AND DESIGN. INT. CL. 42. REG. 7-7-1998.
- 2,170,831. VRDN NETWORK. INT. CL. 36. REG. 7-7-1998.
- 2,170,836. PLATEAU GOLF & COUNTRY CLUB AND DESIGN. INT. CL. 41. REG. 7-7-1998.
- 2,170,837. ENTREPRENEUR'S NOTEBOOK. INT. CL. 16. REG. 7-7-1998.
- 2,170,838. MANAGING YOUR SMALL BUSINESS. INT. CL. 16. REG. 7-7-1998.
- 2,170,839. EASY TOUCH. INT. CLS. 6 AND 19. REG. 7-7-1998.
- 2,170,844. BUSINESS BALLOT. INT. CL. 16. REG. 7-7-1998.
- 2,170,845. WHERE I STAND. INT. CL. 16. REG. 7-7-1998.
- 2,170,849. SKI REFRESHERS. INT. CLS. 35 AND 41. REG. 7-7-1998.
- 2,170,852. TRANSMILLENNIUM. INT. CL. 9. REG. 7-7-1998.
- 2,170,854. RELEASE. INT. CL. 3. REG. 7-7-1998.
- 2,170,858. MILLENNIUM REAL ESTATE NETWORK. INT. CLS. 35 AND 36. REG. 7-7-1998.
- 2,170,861. TARUGOS. INT. CL. 30. REG. 7-7-1998.
- 2,170,862. ETOOLS (STYLIZED). INT. CL. 9. REG. 7-7-1998.
- 2,170,863. FAMOUS KILLER GRINDS WAHOO'S FISH TACO AND DESIGN. INT. CL. 42. REG. 7-7-1998.
- 2,170,872. PROLONGO. INT. CLS. 29 AND 30. REG. 7-7-1998.
- 2,170,873. FILTRATION SYSTEMS AND DESIGN. INT. CLS. 7 AND 11. REG. 7-7-1998.
- 2,170,874. OAK CREST. INT. CL. 11. REG. 7-7-1998.
- 2,170,876. 2 + 1. INT. CL. 11. REG. 7-7-1998.
- 2,170,877. HERCUBOND (STYLIZED). INT. CL. 6. REG. 7-7-1998.
- 2,170,882. THE FAMOUS DOOR. INT. CL. 35. REG. 7-7-1998.
- 2,170,883. COOL CHECKING. INT. CL. 36. REG. 7-7-1998.
- 2,170,885. UA PERFECT. INT. CL. 5. REG. 7-7-1998.
- 2,170,887. M MIDWEST RUBBER CUSTOM MIXING CORP. (STYLIZED). INT. CL. 42. REG. 7-7-1998.
- 2,170,891. HAWTHORNE VALLEY. INT. CLS. 16, 24, 25 AND 28. REG. 7-7-1998.
- 2,170,894. EVERAIN. INT. CL. 21. REG. 7-7-1998.
- 2,170,895. WATCH YOUR HEALTH. INT. CL. 42. REG. 7-7-1998.
- 2,170,896. HANK AARON ORIGINALS AND DESIGN. INT. CL. 25. REG. 7-7-1998.

- 2,170,897. ZS BALATA. INT. CL. 28. REG. 7-7-1998.
 2,170,898. SUPERMIX. INT. CL. 42. REG. 7-7-1998.
 2,170,902. LIME CREEK. INT. CL. 25. REG. 7-7-1998.
 2,170,904. CALGEN HEALTHY FRIEND AND DESIGN. INT. CL. 5. REG. 7-7-1998.
 2,170,907. ORIGINAL HEIRLOOM BAKEWARE AND DESIGN. INT. CL. 21. REG. 7-7-1998.
 2,170,908. HANDS 4711 AND DESIGN. INT. CL. 3. REG. 7-7-1998.
 2,170,909. GEL-24/7. INT. CL. 25. REG. 7-7-1998.
 2,170,910. NEVAMAR LAMMATES (STYLIZED). INT. CL. 17. REG. 7-7-1998.
 2,170,911. OMNIVORE. INT. CL. 9. REG. 7-7-1998.
 2,170,914. "NATURE KNOWS BEST" (STYLIZED). INT. CL. 1. REG. 7-7-1998.
 2,170,916. PCNET. INT. CLS. 9, 35, 37, 41 AND 42. REG. 7-7-1998.
 2,170,917. IDG BOOKS WORLDWIDE AND DESIGN. INT. CL. 28. REG. 7-7-1998.
 2,170,919. WINNER EVERY:PLAY. INT. CL. 9. REG. 7-7-1998.
 2,170,920. ICE OCCASIONS AND DESIGN. INT. CL. 30. REG. 7-7-1998.
 2,170,922. BLACK THUNDER (STYLIZED). INT. CL. 7. REG. 7-7-1998.
 2,170,923. HORIZON. INT. CL. 9. REG. 7-7-1998.
 2,170,924. MISCELLANEOUS DESIGN. INT. CL. 25. REG. 7-7-1998.
 2,170,926. PERSONAPLUS. INT. CLS. 9 AND 41. REG. 7-7-1998.
 2,170,927. C GYPSUM (STYLIZED). INT. CL. 19. REG. 7-7-1998.
 2,170,929. AQUASPHERE. INT. CL. 41. REG. 7-7-1998.
 2,170,930. CABLE KEEPER. INT. CL. 9. REG. 7-7-1998.
 2,170,932. ECHELON. INT. CL. 9. REG. 7-7-1998.
 2,170,933. SUISSE BOTANICUS. INT. CL. 3. REG. 7-7-1998.
 2,170,934. LUTHERAN PARENT'S WELLSRING. INT. CL. 16. REG. 7-7-1998.
 2,170,936. E-LINE. INT. CLS. 6 AND 12. REG. 7-7-1998.
 2,170,939. SOLITAR (STYLIZED). INT. CLS. 11 AND 17. REG. 7-7-1998.
 2,170,941. SOVEREIGN CHEMICAL COMPANY AND DESIGN. INT. CL. 1. REG. 7-7-1998.
 2,170,944. KEYGATEWAY. INT. CL. 36. REG. 7-7-1998.
 2,170,945. MISCELLANEOUS DESIGN. INT. CL. 6. REG. 7-7-1998.
 2,170,946. FUNTIME INC. AND DESIGN. INT. CL. 9. REG. 7-7-1998.
 2,170,947. LITTLE ROCK AND DESIGN. INT. CL. 7. REG. 7-7-1998.
 2,170,949. JANUS EQUITY INCOME FUND. INT. CL. 36. REG. 7-7-1998.
 2,170,952. EVANGELISM ON THE GO. INT. CL. 16. REG. 7-7-1998.
 2,170,954. BIG HEAVY WORLD. INT. CL. 35. REG. 7-7-1998.
 2,170,956. INVESTIGATE. INT. CL. 42. REG. 7-7-1998.
 2,170,957. MISCELLANEOUS DESIGN. INT. CL. 42. REG. 7-7-1998.
 2,170,962. AERONAUTICAL ADVENTURES. INT. CLS. 12, 35, 37, 39, 40 AND 42. REG. 7-7-1998.
 2,170,966. MOISTURESEAL LEAVE-IN CONDITIONING MIST. INT. CL. 3. REG. 7-7-1998.
 2,170,968. PIK:NIK. INT. CL. 16. REG. 7-7-1998.
 2,170,971. MUPHORAN AND DESIGN. INT. CL. 5. REG. 7-7-1998.
 2,170,973. ENSERCO ENERGY INC. AND DESIGN. INT. CL. 39. REG. 7-7-1998.
 2,170,978. MISCELLANEOUS DESIGN. INT. CL. 42. REG. 7-7-1998.
 2,170,980. ENTA. INT. CL. 16. REG. 7-7-1998.
 2,170,984. POOL AID. INT. CL. 36. REG. 7-7-1998.
 2,170,985. EHOB THE LEADER IN STATIC AIR TECHNOLOGY AND DESIGN. INT. CL. 10. REG. 7-7-1998.
 2,170,989. REBEL X AND DESIGN. INT. CL. 25. REG. 7-7-1998.
 2,170,990. ACTIVEMEDIA AND DESIGN. INT. CL. 42. REG. 7-7-1998.
 2,170,991. APS CORP (STYLIZED). INT. CLS. 11 AND 35. REG. 7-7-1998.
 2,170,994. GYRODOG. INT. CL. 29. REG. 7-7-1998.
 2,170,995. C AND DESIGN. INT. CLS. 35, 36 AND 42. REG. 7-7-1998.
 2,170,996. PARADIGM OVATION. INT. CL. 35. REG. 7-7-1998.
 2,170,998. REY ARTURO AND DESIGN. INT. CL. 30. REG. 7-7-1998.
 2,171,001. THE VACUUM WAY. INT. CL. 7. REG. 7-7-1998.
 2,171,002. FINANCIAL SOLUTIONS WITH LIFE TIME VALUE. INT. CL. 36. REG. 7-7-1998.
 2,171,006. THE HOME INSURANCE COMPANIES. INT. CL. 36. REG. 7-7-1998.
 2,171,008. GREATER BUFFALO CONVENTION & VISITORS BUREAU AND DESIGN. INT. CL. 35. REG. 7-7-1998.
 2,171,009. MISCELLANEOUS DESIGN. INT. CL. 37. REG. 7-7-1998.
 2,171,010. BOY MEETS GIRL A MATCH MADE IN HEAVEN ABOVE AND DESIGN. INT. CL. 21. REG. 7-7-1998.
 2,171,012. REGULUS NOT OG TRALVERKSTED AND DESIGN. INT. CL. 22. REG. 7-7-1998.
 2,171,013. M (STYLIZED). INT. CLS. 18 AND 25. REG. 7-7-1998.
 2,171,017. JUST FOR FANS. INT. CL. 35. REG. 7-7-1998.
 2,171,018. ALVA. INT. CL. 25. REG. 7-7-1998.
 2,171,019. INNOVA TOUCH. INT. CL. 27. REG. 7-7-1998.
 2,171,020. WESTERN DUDS AND DESIGN. INT. CL. 25. REG. 7-7-1998.
 2,171,021. HEADIE HURTLE AND DESIGN. INT. CL. 41. REG. 7-7-1998.
 2,171,022. PAC. INT. CL. 35. REG. 7-7-1998.
 2,171,023. VITO RUFOLO. INT. CL. 25. REG. 7-7-1998.
 2,171,025. CFC (STYLIZED). INT. CLS. 7 AND 12. REG. 7-7-1998.
 2,171,026. M2D2 (STYLIZED). INT. CL. 42. REG. 7-7-1998.
 2,171,027. BANCAJA. INT. CL. 36. REG. 7-7-1998.
 2,171,028. RISOLISTO. INT. CL. 30. REG. 7-7-1998.
 2,171,030. MISCELLANEOUS DESIGN. INT. CL. 25. REG. 7-7-1998.
 2,171,031. MISCELLANEOUS DESIGN. INT. CL. 25. REG. 7-7-1998.
 2,171,032. MISCELLANEOUS DESIGN. INT. CL. 25. REG. 7-7-1998.
 2,171,035. STIX. INT. CL. 25. REG. 7-7-1998.
 2,171,036. REACH MARKETING. INT. CL. 35. REG. 7-7-1998.
 2,171,037. EAT STREET. INT. CL. 42. REG. 7-7-1998.
 2,171,038. LAZZARA AND DESIGN. INT. CL. 12. REG. 7-7-1998.
 2,171,039. GIULIA. INT. CL. 12. REG. 7-7-1998.
 2,171,040. DEMCO ONLINE. INT. CL. 35. REG. 7-7-1998.
 2,171,041. CHIAMARE. INT. CL. 25. REG. 7-7-1998.
 2,171,042. RINNOVATO. INT. CL. 25. REG. 7-7-1998.
 2,171,043. ASK CITI. INT. CL. 36. REG. 7-7-1998.
 2,171,044. THE BEEF SANDWICH. INT. CL. 16. REG. 7-7-1998.
 2,171,045. YOUNG CARE AND DESIGN. INT. CL. 41. REG. 7-7-1998.
 2,171,046. THE YOUNG SCHOOL. INT. CLS. 25 AND 41. REG. 7-7-1998.
 2,171,049. ALTFIELD. INT. CLS. 16 AND 20. REG. 7-7-1998.
 2,171,050. MX (STYLIZED). INT. CL. 42. REG. 7-7-1998.
 2,171,052. NATIONAL FLORIST DIRECTORY BUYER'S GUIDE. INT. CL. 16. REG. 7-7-1998.
 2,171,055. THE FACES OF CHLORINE AND THE FACES BEHIND THEM. INT. CL. 42. REG. 7-7-1998.
 2,171,057. AVATAR. INT. CLS. 39 AND 42. REG. 7-7-1998.
 2,171,059. A.S.A.P. TAX REFUNDS AND DESIGN. INT. CL. 36. REG. 7-7-1998.
 2,171,061. 762 7.62 DESIGN AND DESIGN. INT. CL. 25. REG. 7-7-1998.
 2,171,063. HYPER PORTFOLIO AND DESIGN. INT. CLS. 9 AND 42. REG. 7-7-1998.
 2,171,064. COUNTRY CAFE (STYLIZED). INT. CL. 30. REG. 7-7-1998.

- 2,171,066. STRATEGIC PLANNING OF EMPLOYEE BENEFITS REPORT. INT. CL. 16. REG. 7-7-1998.
- 2,171,069. CYBER ESQ. (STYLIZED). INT. CL. 16. REG. 7-7-1998.
- 2,171,073. POWER TORQUE. INT. CL. 8. REG. 7-7-1998.
- 2,171,075. GONUTS GOURMET DONUT BAR (STYLIZED). INT. CL. 35. REG. 7-7-1998.
- 2,171,077. HOUSE OF ERTE (STYLIZED). INT. CL. 21. REG. 7-7-1998.
- 2,171,082. SANKTGALLEN (STYLIZED). INT. CL. 32. REG. 7-7-1998.
- 2,171,083. HAVE A DELICIOUS DAY.. INT. CL. 35. REG. 7-7-1998.
- 2,171,084. FIRST STEP. INT. CL. 41. REG. 7-7-1998.
- 2,171,085. WORLD AEROSPACE CONGRESS. INT. CL. 35. REG. 7-7-1998.
- 2,171,087. LIMIANO LACTO LIMA L.DA PONTE DO LIMA AND DESIGN. INT. CL. 29. REG. 7-7-1998.
- 2,171,088. DEMAND VARILUX LENSES. INT. CL. 9. REG. 7-7-1998.
- 2,171,089. TECHNOCOM CORPORATION AND DESIGN. INT. CLS. 35 AND 42. REG. 7-7-1998.
- 2,171,092. PONDO COMBO ENTREE BUFFET SUNDAE BAR AND DESIGN. INT. CL. 42. REG. 7-7-1998.
- 2,171,095. AS ALL STAR OUTDOOR PRODUCTS, INC. AND DESIGN. INT. CL. 28. REG. 7-7-1998.
- 2,171,096. LIGHT INDEX. INT. CL. 36. REG. 7-7-1998.
- 2,171,098. TRADELINK INC. AND DESIGN. INT. CL. 35. REG. 7-7-1998.
- 2,171,099. J C T (STYLIZED). INT. CL. 25. REG. 7-7-1998.
- 2,171,100. GONE TROPO TRAVEL, LTD.. INT. CLS. 39 AND 42. REG. 7-7-1998.
- 2,171,101. GREAT LIVING PROGRAM. INT. CL. 5. REG. 7-7-1998.
- 2,171,104. WORLD VIRTUAL CITY. INT. CL. 35. REG. 7-7-1998.
- 2,171,106. RENAISSANCE. INT. CLS. 7 AND 11. REG. 7-7-1998.
- 2,171,107. INTEGRATED INDUSTRIAL SERVICES. INT. CL. 37. REG. 7-7-1998.
- 2,171,108. TEEN WINTER SPORTS AND DESIGN. INT. CL. 39. REG. 7-7-1998.
- 2,171,109. WE - THE LIVING. INT. CL. 41. REG. 7-7-1998.
- 2,171,110. A.S.A.P. JACKSON HEWITT TAX SERVICE AND DESIGN. INT. CL. 36. REG. 7-7-1998.
- 2,171,111. PAR-CHX. INT. CL. 36. REG. 7-7-1998.
- 2,171,114. CYBER-BOWL AND DESIGN. INT. CL. 41. REG. 7-7-1998.
- 2,171,115. ROZRYWKA NOCA. INT. CL. 16. REG. 7-7-1998.
- 2,171,116. JULIANA BERNERS' ANGLERS CLUB. INT. CL. 42. REG. 7-7-1998.
- 2,171,120. YOUR CHOICE FOR ELECTRIC POWER. INT. CL. 39. REG. 7-7-1998.
- 2,171,122. ATLANTIC CRUISING CLUB. INT. CL. 16. REG. 7-7-1998.
- 2,171,123. COAST TO COAST DESIGN SOLUTIONS AND DESIGN. INT. CL. 42. REG. 7-7-1998.
- 2,171,124. MISCELLANEOUS DESIGN. INT. CL. 42. REG. 7-7-1998.
- 2,171,125. INTELICABLE (STYLIZED). INT. CL. 9. REG. 7-7-1998.
- 2,171,128. A+ COMPUTER SCHOOL AND DESIGN. INT. CLS. 41 AND 42. REG. 7-7-1998.
- 2,171,131. TAX REFUNDS A.S.A.P. AND DESIGN. INT. CL. 36. REG. 7-7-1998.
- 2,171,132. RESULTS BY DESIGN AND DESIGN. INT. CL. 41. REG. 7-7-1998.
- 2,171,134. ND (STYLIZED). INT. CL. 40. REG. 7-7-1998.
- 2,171,139. TS TOP SHAPE AND DESIGN. INT. CL. 41. REG. 7-7-1998.
- 2,171,141. VALDEOR. INT. CL. 14. REG. 7-7-1998.
- 2,171,142. JD T 21 AND DESIGN. INT. CL. 9. REG. 7-7-1998.
- 2,171,143. DIAMOND ENERGY. INT. CL. 39. REG. 7-7-1998.
- 2,171,145. BIOCAIR. INT. CL. 39. REG. 7-7-1998.
- 2,171,146. FIRST THURSDAY. INT. CL. 41. REG. 7-7-1998.
- 2,171,147. FIRST WEDNESDAY. INT. CL. 41. REG. 7-7-1998.
- 2,171,148. FIRST 2'SDAY. INT. CL. 41. REG. 7-7-1998.
- 2,171,149. MEDIA FARM AND DESIGN. INT. CL. 42. REG. 7-7-1998.
- 2,171,150. WINDOW VIEWPOINTS. INT. CL. 24. REG. 7-7-1998.
- 2,171,151. ENERGY MASTER PLUS. INT. CL. 11. REG. 7-7-1998.
- 2,171,152. ADCONFERENCE[LIVE] AND DESIGN. INT. CL. 38. REG. 7-7-1998.
- 2,171,155. SMARTI. INT. CL. 9. REG. 7-7-1998.
- 2,171,156. LYNDEN GROUP. INT. CL. 35. REG. 7-7-1998.
- 2,171,158. RAD TRACK. INT. CL. 35. REG. 7-7-1998.
- 2,171,159. SOUND SIGNATURE. INT. CL. 35. REG. 7-7-1998.
- 2,171,160. DERMA-BUFF. INT. CL. 21. REG. 7-7-1998.
- 2,171,161. PRISONLOK (STYLIZED). INT. CL. 17. REG. 7-7-1998.
- 2,171,162. INTELLIBUY. INT. CL. 35. REG. 7-7-1998.
- 2,171,164. DR. GREEN AND DESIGN. INT. CL. 42. REG. 7-7-1998.
- 2,171,166. AIMS. INT. CL. 36. REG. 7-7-1998.
- 2,171,167. AIMS LOGISTICS AND DESIGN. INT. CL. 36. REG. 7-7-1998.
- 2,171,168. BOLE (STYLIZED). INT. CL. 9. REG. 7-7-1998.
- 2,171,172. DILL'S DRILLER CUSTOMIZED BY TERRY DILL AND DESIGN. INT. CL. 28. REG. 7-7-1998.
- 2,171,173. TELEPARRANDA. INT. CLS. 16 AND 36. REG. 7-7-1998.
- 2,171,176. REDI-TUBE. INT. CL. 7. REG. 7-7-1998.
- 2,171,178. WING WAREHOUSE SPORTS BAR & GRILL AND DESIGN. INT. CL. 42. REG. 7-7-1998.
- 2,171,180. USA VOLLEYBALL TEAM AND DESIGN. INT. CL. 14. REG. 7-7-1998.
- 2,171,183. INPOD. INT. CL. 9. REG. 7-7-1998.
- 2,171,184. COMPAKBOARD. INT. CLS. 7 AND 19. REG. 7-7-1998.
- 2,171,186. CHANNELFRESH. INT. CL. 21. REG. 7-7-1998.
- 2,171,188. WELLVISION (STYLIZED). INT. CL. 9. REG. 7-7-1998.
- 2,171,191. REPUBLIC MONEY ORDERS AND DESIGN. INT. CL. 36. REG. 7-7-1998.
- 2,171,193. LITTLE BLACK PEARL WORKSHOP AND DESIGN. INT. CL. 41. REG. 7-7-1998.
- 2,171,202. WT. INT. CL. 42. REG. 7-7-1998.
- 2,171,204. PILLOW TUFF. INT. CL. 25. REG. 7-7-1998.
- 2,171,207. PHYTOMED. INT. CL. 42. REG. 7-7-1998.
- 2,171,208. TEAMWIN. INT. CL. 35. REG. 7-7-1998.
- 2,171,209. BEECHWOOD PROCESS. INT. CL. 35. REG. 7-7-1998.
- 2,171,211. ACCESS EDUCATION (STYLIZED). INT. CL. 41. REG. 7-7-1998.
- 2,171,212. PHONE TECH SEMINARS. INT. CL. 35. REG. 7-7-1998.
- 2,171,214. MR. PEELY AND DESIGN. INT. CL. 8. REG. 7-7-1998.
- 2,171,215. GAMMA FILTRATION AND DESIGN. INT. CL. 7. REG. 7-7-1998.
- 2,171,216. GAMMA REGENERATER AND DESIGN. INT. CL. 11. REG. 7-7-1998.
- 2,171,217. DOCK OF THE BAY AND DESIGN. INT. CL. 25. REG. 7-7-1998.
- 2,171,219. WINDOW TO THE WORLD ARCHIVES. INT. CL. 35. REG. 7-7-1998.
- 2,171,221. CYBERTIFICATE. INT. CL. 35. REG. 7-7-1998.
- 2,171,224. ROC XS. INT. CL. 10. REG. 7-7-1998.
- 2,171,225. COVEY LEADERSHIP CENTER. INT. CL. 25. REG. 7-7-1998.
- 2,171,226. WINTER LIGHTS. INT. CL. 11. REG. 7-7-1998.
- 2,171,227. HIST-O-FACTS. INT. CL. 36. REG. 7-7-1998.
- 2,171,230. VESTA (STYLIZED). INT. CL. 9. REG. 7-7-1998.
- 2,171,231. THE WOODBOX. INT. CL. 35. REG. 7-7-1998.
- 2,171,232. FRAMEWORX AND DESIGN. INT. CLS. 9, 20 AND 28. REG. 7-7-1998.
- 2,171,234. VR-MDS. INT. CL. 9. REG. 7-7-1998.
- 2,171,239. INTELLIVAC. INT. CL. 7. REG. 7-7-1998.
- 2,171,240. NETWARP. INT. CL. 9. REG. 7-7-1998.
- 2,171,241. HNE. INT. CL. 14. REG. 7-7-1998.
- 2,171,244. CASUAL MOOSE. INT. CL. 25. REG. 7-7-1998.
- 2,171,248. OXENFREE WRITERS' WORKSHOP. INT. CL. 41. REG. 7-7-1998.

- 2,171,249. SURVIVALNET. INT. CL. 42. REG. 7-7-1998.
 2,171,252. DR. BEACH. INT. CL. 42. REG. 7-7-1998.
 2,171,253. RADIALPRO. INT. CL. 15. REG. 7-7-1998.
 2,171,254. OXENFREE WRITERS' WORKSHOP AND DESIGN. INT. CL. 41. REG. 7-7-1998.
 2,171,255. INSTACORP. INT. CL. 35. REG. 7-7-1998.
 2,171,256. GREYWOLF. INT. CL. 35. REG. 7-7-1998.
 2,171,258. THE WHOLE HORSE JOURNAL. INT. CL. 16. REG. 7-7-1998.
 2,171,263. KEYS PRINTING UNCONDITIONAL COMMITMENT TO CUSTOMER SATISFACTION AND DESIGN. INT. CL. 42. REG. 7-7-1998.
 2,171,265. SEON NATURAL SKIN CARE. INT. CL. 3. REG. 7-7-1998.
 2,171,268. MISCELLANEOUS DESIGN. INT. CL. 25. REG. 7-7-1998.
 2,171,270. LEAKSEEKER. INT. CL. 9. REG. 7-7-1998.
 2,171,271. POWER BURRO. INT. CL. 30. REG. 7-7-1998.
 2,171,272. BACK EAST AND DESIGN. INT. CL. 25. REG. 7-7-1998.
 2,171,273. IDTC. INT. CL. 9. REG. 7-7-1998.
 2,171,275. INTELLIGENCE AT WORK. INT. CL. 35. REG. 7-7-1998.
 2,171,277. ASPIRE. INT. CL. 38. REG. 7-7-1998.
 2,171,278. SMALL CHANGE. INT. CL. 38. REG. 7-7-1998.
 2,171,279. MARLOW. INT. CL. 20. REG. 7-7-1998.
 2,171,281. QCM. INT. CL. 9. REG. 7-7-1998.
 2,171,282. SEQUEL CLUB. INT. CLS. 36 AND 38. REG. 7-7-1998.
 2,171,284. GASER AND DESIGN. INT. CLS. 9 AND 10. REG. 7-7-1998.
 2,171,285. SOLO FLY. INT. CL. 25. REG. 7-7-1998.
 2,171,286. OPEN HORIZON. INT. CL. 9. REG. 7-7-1998.
 2,171,287. PASSPORT. INT. CL. 28. REG. 7-7-1998.
 2,171,290. NETTIKS. INT. CL. 35. REG. 7-7-1998.
 2,171,291. STAGE PRESENCE. INT. CL. 41. REG. 7-7-1998.
 2,171,297. AE FACE AND DESIGN. INT. CL. 3. REG. 7-7-1998.
 2,171,299. BAD BREATH TERMINATOR (STYLIZED). INT. CL. 10. REG. 7-7-1998.
 2,171,301. HIDDEN ILLUSIONS CONCEALMENT FURNITURE. INT. CL. 20. REG. 7-7-1998.
 2,171,305. SAFE INSPEC. INT. CL. 9. REG. 7-7-1998.
 2,171,306. EQUILIO. INT. CL. 42. REG. 7-7-1998.
 2,171,308. JUSTDENTAL. INT. CL. 36. REG. 7-7-1998.
 2,171,309. AMS TECH AND DESIGN. INT. CL. 9. REG. 7-7-1998.
 2,171,313. ECONNECTICUT (STYLIZED). INT. CL. 42. REG. 7-7-1998.
 2,171,315. M AND DESIGN. INT. CL. 42. REG. 7-7-1998.
 2,171,317. MINDBRIDGE. INT. CL. 42. REG. 7-7-1998.
 2,171,320. JUAN IN A MILLION. INT. CL. 42. REG. 7-7-1998.
 2,171,321. ENVIROCHALLENGE. INT. CL. 28. REG. 7-7-1998.
 2,171,322. POLY. INT. CL. 1. REG. 7-7-1998.
 2,171,323. THE ONLY DIFFERENCE BETWEEN NEW & USED IS THE PRICE. INT. CL. 9. REG. 7-7-1998.
 2,171,324. NESBITT'S. INT. CL. 32. REG. 7-7-1998.
 2,171,329. CTA AND DESIGN. INT. CL. 42. REG. 7-7-1998.
 2,171,332. BERA BERKELEY ECONOMIC RESEARCH ASSOCIATES AND DESIGN. INT. CL. 42. REG. 7-7-1998.
 2,171,335. NAIL SEEKER. INT. CL. 9. REG. 7-7-1998.
 2,171,336. MISCELLANEOUS DESIGN. INT. CL. 9. REG. 7-7-1998.
 2,171,339. SER AND DESIGN. INT. CL. 40. REG. 7-7-1998.
 2,171,340. FRESH GREENS AND DESIGN. INT. CL. 25. REG. 7-7-1998.
 2,171,341. THE SLY FOX BREWHOUSE & EATERY AND DESIGN. INT. CL. 42. REG. 7-7-1998.
 2,171,343. HOME LINK SERVICES AND DESIGN. INT. CL. 35. REG. 7-7-1998.
 2,171,345. CARBILUX. INT. CLS. 1 AND 2. REG. 7-7-1998.
 2,171,346. ROTOMAX. INT. CL. 2. REG. 7-7-1998.
 2,171,348. MAYO HEALTH PLAN. INT. CL. 36. REG. 7-7-1998.
 2,171,349. MAYO HEALTH PLAN. INT. CL. 42. REG. 7-7-1998.
 2,171,351. ANCHORSAWAY. INT. CL. 9. REG. 7-7-1998.
 2,171,354. BIOTONIC. INT. CL. 20. REG. 7-7-1998.
 2,171,356. SYNFLUOR. INT. CL. 1. REG. 7-7-1998.
 2,171,358. LESCOL (STYLIZED). INT. CL. 5. REG. 7-7-1998.
 2,171,360. CUBANACAN CIGARS. INT. CL. 34. REG. 7-7-1998.
 2,171,363. BANETTE. INT. CL. 30. REG. 7-7-1998.
 2,171,368. BASS TICKETS. INT. CL. 35. REG. 7-7-1998.
 2,171,369. HAVE THE SUMMER OF A LIFETIME. INT. CLS. 41 AND 42. REG. 7-7-1998.
 2,171,370. MISCELLANEOUS DESIGN. INT. CL. 42. REG. 7-7-1998.
 2,171,371. A NEW ANSWER FROM AN OLD FAMILY SECRET. INT. CL. 5. REG. 7-7-1998.
 2,171,372. MAYO PHARMACY. INT. CL. 42. REG. 7-7-1998.
 2,171,373. EARTHSCENTS. INT. CL. 28. REG. 7-7-1998.
 2,171,375. COLETAYLORTOWN. INT. CL. 36. REG. 7-7-1998.
 2,171,378. MISCELLANEOUS DESIGN. INT. CL. 9. REG. 7-7-1998.
 2,171,379. DESTINATION UNLIMITED. INT. CL. 36. REG. 7-7-1998.
 2,171,380. TIPWORLD. INT. CL. 42. REG. 7-7-1998.
 2,171,390. REDIFURL. INT. CL. 10. REG. 7-7-1998.
 2,171,391. TARGETING SUCCESS THROUGH PEOPLE. INT. CL. 35. REG. 7-7-1998.
 2,171,393. RAPID REFLEX. INT. CL. 9. REG. 7-7-1998.
 2,171,397. ROBERT BRUCE. INT. CL. 37. REG. 7-7-1998.
 2,171,398. CITRALEAN AND DESIGN. INT. CL. 5. REG. 7-7-1998.
 2,171,399. CHUBBY AND DESIGN. INT. CL. 32. REG. 7-7-1998.
 2,171,400. VOOM AND DESIGN. INT. CL. 42. REG. 7-7-1998.
 2,171,404. MONEYLAW. INT. CL. 16. REG. 7-7-1998.
 2,171,405. SERVAL (STYLIZED). INT. CL. 31. REG. 7-7-1998.
 2,171,406. YOO-HOO. INT. CL. 30. REG. 7-7-1998.
 2,171,407. ONE BILL. ONE SOURCE. ONE GREAT TOOL TO HELP LOWER UTILITY COSTS. INT. CLS. 36 AND 42. REG. 7-7-1998.
 2,171,410. NITE CAP. INT. CL. 30. REG. 7-7-1998.
 2,171,414. MISCELLANEOUS DESIGN. INT. CL. 30. REG. 7-7-1998.
 2,171,417. NABISCO. INT. CL. 16. REG. 7-7-1998.
 2,171,418. FASTBALLS. INT. CL. 30. REG. 7-7-1998.
 2,171,426. PRIMESPORT INTERNATIONAL. INT. CL. 39. REG. 7-7-1998.
 2,171,429. PSI. INT. CL. 39. REG. 7-7-1998.
 2,171,430. BLACKJACK. INT. CL. 25. REG. 7-7-1998.
 2,171,431. BANK 1 ONE TO ONE. AND DESIGN. INT. CL. 36. REG. 7-7-1998.
 2,171,432. TASTE THE ONE THAT WON FOR TASTE. INT. CL. 32. REG. 7-7-1998.
 2,171,433. SCHILLING AND DESIGN. INT. CLS. 29 AND 30. REG. 7-7-1998.
 2,171,434. TRINITY BROADCASTING NETWORK. INT. CL. 38. REG. 7-7-1998.
 2,171,439. ASK DR. H. INT. CL. 16. REG. 7-7-1998.
 2,171,441. DYNAMO. INT. CL. 28. REG. 7-7-1998.
 2,171,445. MARKETACCESS. INT. CL. 42. REG. 7-7-1998.
 2,171,446. PROLIPOSOME. INT. CL. 3. REG. 7-7-1998.
 2,171,447. PROACCELERATOR. INT. CL. 3. REG. 7-7-1998.
 2,171,448. PROCOAT. INT. CL. 3. REG. 7-7-1998.
 2,171,449. ASSAULT. INT. CL. 28. REG. 7-7-1998.
 2,171,450. THERMAL ZONE. INT. CLS. 3 AND 11. REG. 7-7-1998.
 2,171,454. SCENTUALS. INT. CL. 16. REG. 7-7-1998.
 2,171,456. WESTURF DISTRIBUTORS, INC.. INT. CLS. 16, 35 AND 37. REG. 7-7-1998.
 2,171,458. NORCROSS. INT. CL. 35. REG. 7-7-1998.
 2,171,459. RTRIBE. INT. CL. 41. REG. 7-7-1998.
 2,171,460. FUNDMOR. INT. CL. 36. REG. 7-7-1998.
 2,171,461. PRIMERA WORLD. INT. CL. 31. REG. 7-7-1998.
 2,171,463. SHAKE AND TAKE (STYLIZED). INT. CL. 28. REG. 7-7-1998.
 2,171,464. PIECE-ABLE CREATURES. INT. CL. 28. REG. 7-7-1998.
 2,171,465. SPACEOPOLY. INT. CL. 28. REG. 7-7-1998.
 2,171,467. WHITE CLAY. INT. CL. 9. REG. 7-7-1998.
 2,171,468. 9 WEST (STYLIZED). INT. CL. 25. REG. 7-7-1998.

- 2,171,469. SILS. INT. CL. 28. REG. 7-7-1998.
 2,171,472. M&M'S MINIS. INT. CL. 16. REG. 7-7-1998.
 2,171,473. M&M'S MINIS AND DESIGN. INT. CL. 16. REG. 7-7-1998.
 2,171,476. FLEXCELL CELLULAR SUPPORT (STYLIZED). INT. CL. 10. REG. 7-7-1998.
 2,171,477. DR. SPERMANOVA. INT. CL. 16. REG. 7-7-1998.
 2,171,480. QUICK FIXIN' IDEAS AND DESIGN. INT. CL. 29. REG. 7-7-1998.
 2,171,482. STONE HAVEN. INT. CL. 25. REG. 7-7-1998.
 2,171,485. ACCUSITE. INT. CL. 5. REG. 7-7-1998.
 2,171,489. RUFFHIDES. INT. CL. 25. REG. 7-7-1998.
 2,171,490. MICROSCINT (STYLIZED). INT. CL. 9. REG. 7-7-1998.
 2,171,492. STERIFOAM. INT. CL. 5. REG. 7-7-1998.
 2,171,493. DAHLIAGE. INT. CL. 3. REG. 7-7-1998.
 2,171,495. ASTI (STYLIZED). INT. CLS. 9 AND 42. REG. 7-7-1998.
 2,171,496. POOH AND DESIGN. INT. CL. 21. REG. 7-7-1998.
 2,171,501. PHARMACIA LASERSCAN. INT. CL. 9. REG. 7-7-1998.
 2,171,503. WATER AND DESIGN. INT. CLS. 1 AND 3. REG. 7-7-1998.
 2,171,507. LEARNING PAD. INT. CL. 28. REG. 7-7-1998.
 2,171,508. SWEET'N LOW. INT. CL. 32. REG. 7-7-1998.
 2,171,509. PRIMARY PIECES. INT. CLS. 21, 24 AND 27. REG. 7-7-1998.
 2,171,510. CIRCLE OF BEAUTY. INT. CL. 3. REG. 7-7-1998.
 2,171,512. MDC WARE. INT. CL. 9. REG. 7-7-1998.
 2,171,513. KIDS' WHEAT AND DESIGN. INT. CL. 30. REG. 7-7-1998.
 2,171,514. BASQUE AND DESIGN. INT. CL. 29. REG. 7-7-1998.
 2,171,515. FIRST NAME IN INNOVATION. INT. CL. 7. REG. 7-7-1998.
 2,171,516. JERUSALEM 2000. INT. CLS. 41 AND 42. REG. 7-7-1998.
 2,171,517. MISCELLANEOUS DESIGN. INT. CLS. 6, 17 AND 19. REG. 7-7-1998.
 2,171,521. THERMACYL. INT. CL. 10. REG. 7-7-1998.
 2,171,522. CENTER OF THE UNIVERSE. INT. CLS. 16 AND 42. REG. 7-7-1998.
 2,171,523. A UNITED DOMINION COMPANY. INT. CLS. 6, 7, 9, 11, 17 AND 19. REG. 7-7-1998.
 2,171,524. SATCOM ELECTRONICS AND DESIGN. INT. CL. 9. REG. 7-7-1998.
 2,171,525. MPATH INTERACTIVE. INT. CL. 28. REG. 7-7-1998.
 2,171,527. ALWAYS QUALITY ALWAYS FUN. INT. CL. 24. REG. 7-7-1998.
 2,171,528. SLASH'S SNAKEPIT. INT. CL. 25. REG. 7-7-1998.
 2,171,530. SUGAROUT. INT. CL. 5. REG. 7-7-1998.
 2,171,532. LA FABULOSA. INT. CL. 38. REG. 7-7-1998.
 2,171,533. MISCELLANEOUS DESIGN. INT. CLS. 5 AND 30. REG. 7-7-1998.
 2,171,535. NOTHING BUT GREEN AND DESIGN. INT. CL. 24. REG. 7-7-1998.
 2,171,536. BOWBUCKLE. INT. CL. 6. REG. 7-7-1998.
 2,171,538. HERITAGE COLLECTION AND DESIGN. INT. CL. 42. REG. 7-7-1998.
 2,171,539. JAME-OX. INT. CL. 1. REG. 7-7-1998.
 2,171,540. JAME-ACT. INT. CL. 1. REG. 7-7-1998.
 2,171,541. MISCELLANEOUS DESIGN. INT. CLS. 35, 36 AND 42. REG. 7-7-1998.
 2,171,542. GENENTECH MANAGED DISTRIBUTION SYSTEM AND DESIGN. INT. CLS. 35, 36 AND 42. REG. 7-7-1998.
 2,171,544. CITRUSPHERE. INT. CL. 3. REG. 7-7-1998.
 2,171,547. FUELSMART. INT. CL. 11. REG. 7-7-1998.
 2,171,548. GAF COMPOSITEROOF AND DESIGN. INT. CL. 19. REG. 7-7-1998.
 2,171,549. SUTTON SELECT. INT. CLS. 20 AND 21. REG. 7-7-1998.
 2,171,551. SARAH SWEETHEART AND DESIGN. INT. CL. 25. REG. 7-7-1998.
 2,171,552. PLANNING FOR CONDUCTING EVOLVING INSPECTION AND DESIGN. INT. CL. 41. REG. 7-7-1998.
 2,171,556. CAMERON. INT. CLS. 36 AND 37. REG. 7-7-1998.
 2,171,557. FRAMERUNNER. INT. CL. 9. REG. 7-7-1998.
 2,171,560. MISCELLANEOUS DESIGN. INT. CL. 16. REG. 7-7-1998.
 2,171,564. MOREA AND DESIGN. INT. CL. 29. REG. 7-7-1998.
 2,171,568. SURF & CO (STYLIZED). INT. CLS. 18 AND 25. REG. 7-7-1998.
 2,171,569. SOLOTEC. INT. CL. 7. REG. 7-7-1998.
 2,171,572. TOC ONE HUMAN'S OF VIEW (STYLIZED). INT. CL. 16. REG. 7-7-1998.
 2,171,574. MISCELLANEOUS DESIGN. INT. CLS. 16, 25 AND 41. REG. 7-7-1998.
 2,171,577. CDG. INT. CL. 25. REG. 7-7-1998.
 2,171,578. NO BRAKES. INT. CL. 25. REG. 7-7-1998.
 2,171,580. VISUAL WORLD. INT. CL. 9. REG. 7-7-1998.
 2,171,584. DR. KENAF'S. INT. CL. 31. REG. 7-7-1998.
 2,171,585. DP AND DESIGN. INT. CL. 25. REG. 7-7-1998.
 2,171,586. DEWALT ROLLING THUNDER. INT. CL. 7. REG. 7-7-1998.
 2,171,587. DILUENT OF CHOICE.. INT. CL. 5. REG. 7-7-1998.
 2,171,590. BIG SKY WIRE. INT. CLS. 35 AND 42. REG. 7-7-1998.
 2,171,592. MADCAP CRAFTBREW AND BOTTLE WORKS. INT. CL. 32. REG. 7-7-1998.
 2,171,593. PAINWEBBER EDGE. INT. CL. 36. REG. 7-7-1998.
 2,171,594. FLEXITAG. INT. CL. 20. REG. 7-7-1998.
 2,171,595. CERDEC ON TOP AND DESIGN. INT. CL. 1. REG. 7-7-1998.
 2,171,596. ELYSE. INT. CL. 25. REG. 7-7-1998.
 2,171,597. CAMPUS COLLECT. INT. CL. 38. REG. 7-7-1998.
 2,171,600. GOLF ALMANAC AND DESIGN. INT. CL. 16. REG. 7-7-1998.
 2,171,602. SOUNDREWARDS. INT. CL. 38. REG. 7-7-1998.
 2,171,603. ENVISION. INT. CLS. 16 AND 41. REG. 7-7-1998.
 2,171,605. PAO2 (STYLIZED). INT. CLS. 9 AND 16. REG. 7-7-1998.
 2,171,606. BASICS OF GENIUS. INT. CLS. 9, 16 AND 42. REG. 7-7-1998.
 2,171,608. WESCARE. INT. CL. 42. REG. 7-7-1998.
 2,171,609. WILLIAM DOUGLASS & SONS FINE GUNS & RIFLES ENGLAND AND DESIGN. INT. CL. 13. REG. 7-7-1998.
 2,171,610. RED ASS. INT. CL. 30. REG. 7-7-1998.
 2,171,611. GEOSAFARI TALKING GLOBE. INT. CL. 9. REG. 7-7-1998.
 2,171,613. SAFETY-BUFF. INT. CL. 9. REG. 7-7-1998.
 2,171,615. COOKIE PLANET. INT. CL. 30. REG. 7-7-1998.
 2,171,616. ACTIVELITE. INT. CL. 9. REG. 7-7-1998.
 2,171,617. COLOR SURPRISE. INT. CL. 16. REG. 7-7-1998.
 2,171,619. OPTIMAX. INT. CL. 9. REG. 7-7-1998.
 2,171,621. COLDCUBE. INT. CL. 11. REG. 7-7-1998.
 2,171,623. FISHCLUB. INT. CL. 9. REG. 7-7-1998.
 2,171,624. ICE CREAM SCONE AND DESIGN. INT. CL. 30. REG. 7-7-1998.
 2,171,625. INCON AND DESIGN. INT. CLS. 3, 5, 10, 16, 21 AND 42. REG. 7-7-1998.
 2,171,627. EARTHMADE. INT. CLS. 1, 6, 8, 11, 19, 20 AND 21. REG. 7-7-1998.
 2,171,628. CALL VAL AND DESIGN. INT. CLS. 35, 38 AND 42. REG. 7-7-1998.
 2,171,630. LITTLE SMART ALPHABET PICTURE DESK. INT. CL. 28. REG. 7-7-1998.
 2,171,633. REAL CHERRY TOPPERS. INT. CL. 29. REG. 7-7-1998.
 2,171,634. WEE-TV. INT. CLS. 41 AND 42. REG. 7-7-1998.
 2,171,639. ORVIEW. INT. CL. 9. REG. 7-7-1998.
 2,171,640. THE SAM BASS "STAND ON IT!" COLLECTION. INT. CL. 16. REG. 7-7-1998.
 2,171,641. GOOD. AND GOOD FOR YOU. INT. CL. 30. REG. 7-7-1998.
 2,171,642. PRELUDE. INT. CL. 21. REG. 7-7-1998.
 2,171,643. CACTUS CAR WASH AND DESIGN. INT. CL. 37. REG. 7-7-1998.
 2,171,644. CHAC MOOL. INT. CL. 29. REG. 7-7-1998.
 2,171,646. PAXBAC. INT. CL. 12. REG. 7-7-1998.

- 2,171,648. MONARCA E-Z MELT. INT. CL. 29. REG. 7-7-1998.
- 2,171,651. SILVER SAYINGS. INT. CL. 42. REG. 7-7-1998.
- 2,171,654. NEW RULE. INT. CL. 35. REG. 7-7-1998.
- 2,171,655. FUNNELATOR. INT. CL. 21. REG. 7-7-1998.
- 2,171,657. GO CALL. INT. CL. 36. REG. 7-7-1998.
- 2,171,659. DESIGNPOINT. INT. CL. 9. REG. 7-7-1998.
- 2,171,660. MISCELLANEOUS DESIGN. INT. CL. 16. REG. 7-7-1998.
- 2,171,661. DIATRON. INT. CL. 7. REG. 7-7-1998.
- 2,171,664. FLORSHEIM GOLF. INT. CL. 25. REG. 7-7-1998.
- 2,171,665. DUCKCYCLE. INT. CL. 28. REG. 7-7-1998.
- 2,171,666. PLAY 'N CUDDLE. INT. CL. 28. REG. 7-7-1998.
- 2,171,667. GRAND GIFT. INT. CL. 36. REG. 7-7-1998.
- 2,171,668. PRICKLY PAIR. INT. CL. 29. REG. 7-7-1998.
- 2,171,669. STARWIRE BY VIASAT AND DESIGN. INT. CL. 9. REG. 7-7-1998.
- 2,171,671. 3D FAXFILE. INT. CL. 9. REG. 7-7-1998.
- 2,171,673. COMPUCRUISER (STYLIZED). INT. CL. 18. REG. 7-7-1998.
- 2,171,674. GARCIS AND DESIGN. INT. CLS. 25 AND 28. REG. 7-7-1998.
- 2,171,675. HW AND DESIGN. INT. CL. 28. REG. 7-7-1998.
- 2,171,676. JUNGLE ADVENTURE. INT. CL. 28. REG. 7-7-1998.
- 2,171,677. PI MANAGEMENT RESOURCES. INT. CLS. 16, 35 AND 41. REG. 7-7-1998.
- 2,171,680. PI MANAGEMENT RESOURCES AND DESIGN. INT. CLS. 16, 35 AND 41. REG. 7-7-1998.
- 2,171,681. SOARIN' STRAWBERRY LEMONADE. INT. CL. 32. REG. 7-7-1998.
- 2,171,682. DURASHIELD. INT. CL. 9. REG. 7-7-1998.
- 2,171,692. TRADITIONAL HOME DESIGNERFINDER. INT. CL. 35. REG. 7-7-1998.
- 2,171,693. OVENLY FRESH & GYROS. INT. CL. 35. REG. 7-7-1998.
- 2,171,695. ULTRA GRIPP (STYLIZED). INT. CL. 28. REG. 7-7-1998.
- 2,171,696. EVO AND DESIGN. INT. CL. 12. REG. 7-7-1998.
- 2,171,697. J-CON. INT. CL. 9. REG. 7-7-1998.
- 2,171,698. 13 CATS. INT. CL. 35. REG. 7-7-1998.
- 2,171,699. TREASURES. INT. CL. 42. REG. 7-7-1998.
- 2,171,701. THE "J". INT. CL. 14. REG. 7-7-1998.
- 2,171,703. ONEWAVE. INT. CLS. 9, 16, 41 AND 42. REG. 7-7-1998.
- 2,171,704. TRANSACTIONS. INT. CL. 35. REG. 7-7-1998.
- 2,171,706. GCO CREDIT PLUS AND DESIGN. INT. CL. 36. REG. 7-7-1998.
- 2,171,707. INNER-CITY GAMES AND DESIGN. INT. CLS. 14, 18 AND 25. REG. 7-7-1998.
- 2,171,708. LA CUMANESA. INT. CL. 34. REG. 7-7-1998.
- 2,171,710. VCR. INT. CL. 12. REG. 7-7-1998.
- 2,171,715. MINI SHEETS. INT. CL. 34. REG. 7-7-1998.
- 2,171,716. AMBER MORNING. INT. CL. 25. REG. 7-7-1998.
- 2,171,721. DURA-HAMMER HOLDER. INT. CL. 8. REG. 7-7-1998.
- 2,171,722. CROSSROUTE SOFTWARE. INT. CL. 42. REG. 7-7-1998.
- 2,171,724. SOLAS. INT. CL. 13. REG. 7-7-1998.
- 2,171,726. ARCTIC BLEND. INT. CL. 30. REG. 7-7-1998.
- 2,171,727. COOL GRIND. INT. CL. 30. REG. 7-7-1998.
- 2,171,729. BARLEY ROAD. INT. CL. 32. REG. 7-7-1998.
- 2,171,730. FAR WEST RODEO. INT. CL. 41. REG. 7-7-1998.
- 2,171,731. Q-GUARD. INT. CLS. 37 AND 42. REG. 7-7-1998.
- 2,171,733. ARCHIMAP. INT. CL. 41. REG. 7-7-1998.
- 2,171,735. NETROCKET. INT. CL. 9. REG. 7-7-1998.
- 2,171,736. DIACOMP. INT. CL. 9. REG. 7-7-1998.
- 2,171,737. MATROX NETWORKS AND DESIGN. INT. CL. 9. REG. 7-7-1998.
- 2,171,738. HUTECH HUMAN SERVICE TECHNOLOGIES AND DESIGN. INT. CL. 42. REG. 7-7-1998.
- 2,171,740. FRUIT & CREAM SENSATIONS. INT. CL. 30. REG. 7-7-1998.
- 2,171,741. GASFINCO. INT. CL. 36. REG. 7-7-1998.
- 2,171,742. PASTIS & CO.. INT. CLS. 21 AND 24. REG. 7-7-1998.
- 2,171,743. TRAVEL EXPO AND DESIGN. INT. CLS. 18 AND 42. REG. 7-7-1998.
- 2,171,745. COMPETITOR SERIES. INT. CL. 9. REG. 7-7-1998.
- 2,171,747. COFFEE SPEEDSTER. INT. CL. 30. REG. 7-7-1998.
- 2,171,748. CHOCOLATE SEDAN. INT. CL. 30. REG. 7-7-1998.
- 2,171,749. POLYPAVE. INT. CL. 19. REG. 7-7-1998.
- 2,171,751. VORTEX. INT. CL. 6. REG. 7-7-1998.
- 2,171,752. LATCALL. INT. CL. 38. REG. 7-7-1998.
- 2,171,753. SETTING A NEW GOLD STANDARD. INT. CL. 37. REG. 7-7-1998.
- 2,171,754. FAUX DESIGN FD AND DESIGN. INT. CL. 25. REG. 7-7-1998.
- 2,171,760. MBF. INT. CLS. 41 AND 42. REG. 7-7-1998.
- 2,171,762. MISCELLANEOUS DESIGN. INT. CL. 40. REG. 7-7-1998.
- 2,171,764. MISCELLANEOUS DESIGN. INT. CL. 3. REG. 7-7-1998.
- 2,171,766. E AND DESIGN. INT. CL. 35. REG. 7-7-1998.
- 2,171,770. SCENTMASTER. INT. CL. 35. REG. 7-7-1998.
- 2,171,772. FRESHCUP 1-2. INT. CL. 3. REG. 7-7-1998.
- 2,171,773. ACCOUNTANTS PLUS. INT. CL. 35. REG. 7-7-1998.
- 2,171,776. THE WORLD'S COOLEST ICE CREAM TRUCK AND DESIGN. INT. CL. 35. REG. 7-7-1998.
- 2,171,781. FASTEST DISTANCE BETWEEN BUYER AND SELLER. INT. CL. 38. REG. 7-7-1998.
- 2,171,784. WING TECH. INT. CL. 12. REG. 7-7-1998.
- 2,171,786. FOX SPORTS AMERICAS AND DESIGN. INT. CL. 38. REG. 7-7-1998.
- 2,171,790. MISCELLANEOUS DESIGN. INT. CL. 25. REG. 7-7-1998.
- 2,171,791. PROWLER. INT. CL. 7. REG. 7-7-1998.
- 2,171,792. AIRSET. INT. CL. 9. REG. 7-7-1998.
- 2,171,795. POCKET SPA (STYLIZED). INT. CL. 11. REG. 7-7-1998.
- 2,171,796. SMART GATE. INT. CL. 6. REG. 7-7-1998.
- 2,171,800. SDS SPECIALTY DOCUMENT SOLUTIONS AND DESIGN. INT. CL. 16. REG. 7-7-1998.
- 2,171,801. MAINSPRING. INT. CL. 16. REG. 7-7-1998.
- 2,171,802. KID'CHUP. INT. CL. 30. REG. 7-7-1998.
- 2,171,803. MAINSPRING. INT. CL. 42. REG. 7-7-1998.
- 2,171,806. XENET (STYLIZED). INT. CL. 9. REG. 7-7-1998.
- 2,171,811. VISIONCARD AND DESIGN. INT. CL. 35. REG. 7-7-1998.
- 2,171,812. GLOBALSTAND. INT. CL. 42. REG. 7-7-1998.
- 2,171,817. MACMOODY. INT. CL. 26. REG. 7-7-1998.
- 2,171,820. ROBIN. INT. CL. 24. REG. 7-7-1998.
- 2,171,822. NOKOMIS. INT. CL. 32. REG. 7-7-1998.
- 2,171,823. VIRALUBE. INT. CL. 4. REG. 7-7-1998.
- 2,171,827. STUFFABLES. INT. CL. 30. REG. 7-7-1998.
- 2,171,831. SPILL SHIELD. INT. CL. 27. REG. 7-7-1998.
- 2,171,832. SILVERVISION ENTERTAINMENT GROUP. INT. CL. 41. REG. 7-7-1998.
- 2,171,835. RICH BICH BIPLANE CO.. INT. CL. 35. REG. 7-7-1998.
- 2,171,836. RICH BICH. INT. CL. 30. REG. 7-7-1998.
- 2,171,839. INSTANT CHANGE TECHNOLOGY. INT. CL. 7. REG. 7-7-1998.
- 2,171,841. COOLEYS TROPICAL FROZEN FRUIT AND DESIGN. INT. CL. 29. REG. 7-7-1998.
- 2,171,842. EL PASO FIELD SERVICES AND DESIGN. INT. CL. 40. REG. 7-7-1998.
- 2,171,843. BLACK CAT. INT. CL. 12. REG. 7-7-1998.
- 2,171,845. EL PASO ENERGY INTERNATIONAL AND DESIGN. INT. CL. 35. REG. 7-7-1998.
- 2,171,847. VENAPORT. INT. CL. 10. REG. 7-7-1998.
- 2,171,849. JEC. INT. CLS. 38 AND 41. REG. 7-7-1998.
- 2,171,850. AFFORDACARE. INT. CL. 35. REG. 7-7-1998.
- 2,171,851. AFFORDACARE PLUS. INT. CL. 35. REG. 7-7-1998.
- 2,171,852. PAJAMA GAME. INT. CL. 25. REG. 7-7-1998.
- 2,171,853. SUNSET BEACH. INT. CL. 41. REG. 7-7-1998.
- 2,171,854. OPCENTER. INT. CL. 35. REG. 7-7-1998.
- 2,171,855. SMARTSTART PRE-RELAXER MOISTURIZER. INT. CL. 3. REG. 7-7-1998.
- 2,171,856. XILADO. INT. CL. 34. REG. 7-7-1998.
- 2,171,858. VHO/R+. INT. CL. 11. REG. 7-7-1998.
- 2,171,859. FUTURESELF. INT. CL. 35. REG. 7-7-1998.
- 2,171,860. COSMIC FIESTA. INT. CL. 31. REG. 7-7-1998.
- 2,171,861. OTAS. INT. CL. 9. REG. 7-7-1998.

- 2,171,863. BRAIN CHILLER. INT. CL. 32. REG. 7-7-1998.
 2,171,865. UPPER DECK 500. INT. CL. 16. REG. 7-7-1998.
 2,171,867. MONORAY. INT. CL. 9. REG. 7-7-1998.
 2,171,869. ULTRA MARK. INT. CL. 7. REG. 7-7-1998.
 2,171,871. PR*POWDER. INT. CL. 5. REG. 7-7-1998.
 2,171,875. DE CHINE VERONIQUE AND DESIGN. INT. CL. 3. REG. 7-7-1998.
 2,171,876. GAS POST. INT. CL. 12. REG. 7-7-1998.
 2,171,878. ABC'S TUTORING ON WHEELS AND DESIGN. INT. CL. 16. REG. 7-7-1998.
 2,171,879. COMFORT-EASE. INT. CL. 18. REG. 7-7-1998.
 2,171,880. SPUN THETICS. INT. CL. 24. REG. 7-7-1998.
 2,171,883. NO ESCAPE VACUUM SEAL. INT. CL. 11. REG. 7-7-1998.
 2,171,886. ROBBY RABBIT. INT. CL. 21. REG. 7-7-1998.
 2,171,889. CHIROPRACTIC PROTECTOR PLAN. INT. CL. 36. REG. 7-7-1998.
 2,171,891. OPTACOR. INT. CL. 36. REG. 7-7-1998.
 2,171,892. TIME TO SHARE. INT. CL. 16. REG. 7-7-1998.
 2,171,901. CERIAN. INT. CL. 3. REG. 7-7-1998.
 2,171,903. MASTER'S INSTITUTE. INT. CL. 41. REG. 7-7-1998.
 2,171,904. JAMES RIVER TRADERS. INT. CL. 25. REG. 7-7-1998.
 2,171,905. JALAPENO ROCKETS. INT. CL. 29. REG. 7-7-1998.
 2,171,908. WHERE LOVE MEETS MONEY. INT. CL. 35. REG. 7-7-1998.
 2,171,909. PRIMEYE. INT. CL. 3. REG. 7-7-1998.
 2,171,910. METALLIX GRAPPLER. INT. CL. 28. REG. 7-7-1998.
 2,171,911. IT'S THE DESIGN OF THE HAIRLINE. INT. CL. 42. REG. 7-7-1998.
 2,171,912. FLIGHTLINE. INT. CL. 36. REG. 7-7-1998.
 2,171,913. VENTREX. INT. CL. 22. REG. 7-7-1998.
 2,171,914. WORRY FREE HOUSE TO SELL CONTINGENCY PROGRAM. INT. CL. 36. REG. 7-7-1998.
 2,171,916. MORE TASTE FOR YOUR PESO. INT. CL. 42. REG. 7-7-1998.
 2,171,918. TRIPREDACUS. INT. CL. 28. REG. 7-7-1998.
 2,171,919. UP-RITE. INT. CL. 16. REG. 7-7-1998.
 2,171,920. MAGNASTATIC. INT. CL. 7. REG. 7-7-1998.
 2,171,921. MISCELLANEOUS DESIGN. INT. CLS. 14 AND 18. REG. 7-7-1998.
 2,171,922. MOOKS. INT. CLS. 14 AND 18. REG. 7-7-1998.
 2,171,923. MOOKS. INT. CL. 25. REG. 7-7-1998.
 2,171,924. MISCELLANEOUS DESIGN. INT. CL. 25. REG. 7-7-1998.
 2,171,927. NOTT US. INT. CL. 25. REG. 7-7-1998.
 2,171,928. RILADENT. INT. CL. 3. REG. 7-7-1998.
 2,171,929. TRAVEL BOX. INT. CL. 18. REG. 7-7-1998.
 2,171,934. SARGIE GUARD. INT. CL. 26. REG. 7-7-1998.
 2,171,939. MIRAGE. INT. CL. 2. REG. 7-7-1998.
 2,171,940. TORANI BARISTA CUP. INT. CL. 41. REG. 7-7-1998.
 2,171,943. LINKETS. INT. CL. 14. REG. 7-7-1998.
 2,171,944. HOLIDAY HOMECOMING COLLECTOR SERIES. INT. CL. 28. REG. 7-7-1998.
 2,171,945. CITY SLICKER. INT. CL. 28. REG. 7-7-1998.
 2,171,947. OLD WORLD ROOFING, INC. AND DESIGN. INT. CL. 37. REG. 7-7-1998.
 2,171,948. FRUIT LA MORE. INT. CL. 29. REG. 7-7-1998.
 2,171,950. PHYTOGESIC. INT. CL. 5. REG. 7-7-1998.
 2,171,952. PROVEN FOR LIFE. INT. CL. 5. REG. 7-7-1998.
 2,171,953. P (STYLIZED). INT. CL. 14. REG. 7-7-1998.
 2,171,956. PROMENADE BLEND. INT. CL. 30. REG. 7-7-1998.
 2,171,960. DREAM DANCER. INT. CL. 28. REG. 7-7-1998.
 2,171,961. CAVEWEAR. INT. CL. 25. REG. 7-7-1998.
 2,171,962. VIASYSTEMS. INT. CL. 9. REG. 7-7-1998.
 2,171,963. VIASYSTEMS AND DESIGN. INT. CL. 9. REG. 7-7-1998.
 2,171,964. BONA BONA MEANS YOGURT AND DESIGN. INT. CL. 29. REG. 7-7-1998.
 2,171,965. SWEET SENTIMENTS. INT. CL. 28. REG. 7-7-1998.
 2,171,966. IT'S ALL WITHIN YOUR REACH. INT. CL. 38. REG. 7-7-1998.
 2,171,967. NUT-HUGGER. INT. CL. 12. REG. 7-7-1998.
 2,171,968. NEGATIVE CAPABILITY. INT. CL. 25. REG. 7-7-1998.
 2,171,969. PLANET SWEETS. INT. CL. 30. REG. 7-7-1998.
 2,171,970. COUNTRY ROSE. INT. CL. 28. REG. 7-7-1998.
 2,171,971. NBA JAM SESSION AND DESIGN. INT. CL. 16. REG. 7-7-1998.
 2,171,973. TRAIPSING AROUND. INT. CL. 25. REG. 7-7-1998.
 2,171,974. PROMETHEUS. INT. CL. 11. REG. 7-7-1998.
 2,171,975. WIN4 ATHLETIC COMPANY (STYLIZED). INT. CL. 25. REG. 7-7-1998.
 2,171,976. WIN OR BE 4 GOTTEN. INT. CL. 25. REG. 7-7-1998.
 2,171,982. CALYPSO LIME. INT. CL. 30. REG. 7-7-1998.
 2,171,985. MONOBLAST. INT. CL. 28. REG. 7-7-1998.
 2,171,987. RPI. INT. CL. 42. REG. 7-7-1998.
 2,171,988. DUSDIRECT. INT. CL. 36. REG. 7-7-1998.
 2,171,989. QUIK GRIP. INT. CL. 3. REG. 7-7-1998.
 2,171,990. COMMAND & CONQUER SOLE SURVIVOR. INT. CL. 9. REG. 7-7-1998.
 2,171,991. BACKBOARD KINGS. INT. CL. 28. REG. 7-7-1998.
 2,171,993. WIRELESS DEPOT. INT. CL. 35. REG. 7-7-1998.
 2,171,996. COPPERFIELD KEEPSAKE. INT. CL. 21. REG. 7-7-1998.
 2,171,998. PETS LIM (STYLIZED). INT. CL. 5. REG. 7-7-1998.
 2,171,999. GARDEN OF JOYS AND DESIGN. INT. CL. 29. REG. 7-7-1998.
 2,172,000. PARKAY MELT IN YOUR MOUTH BUTTERY TASTE. INT. CL. 29. REG. 7-7-1998.
 2,172,002. ALL AMERICAN MONITORING. INT. CL. 42. REG. 7-7-1998.
 2,172,005. OASIS. INT. CL. 30. REG. 7-7-1998.
 2,172,006. WARM UPS. INT. CL. 30. REG. 7-7-1998.
 2,172,007. WEBPAL. INT. CL. 9. REG. 7-7-1998.
 2,172,008. BQMS (STYLIZED). INT. CL. 16. REG. 7-7-1998.
 2,172,009. BQMS (STYLIZED). INT. CL. 41. REG. 7-7-1998.
 2,172,010. CONNECTIONS IN THE WEST. INT. CL. 16. REG. 7-7-1998.
 2,172,011. RACE DAY. INT. CL. 32. REG. 7-7-1998.
 2,172,012. NOT SO SCARY TALES. INT. CL. 16. REG. 7-7-1998.
 2,172,013. SALM-WICH. INT. CL. 29. REG. 7-7-1998.
 2,172,015. KING TUT. INT. CL. 3. REG. 7-7-1998.
 2,172,016. VICE T. INT. CL. 32. REG. 7-7-1998.
 2,172,019. BUY MORE, PAYLESS. INT. CL. 35. REG. 7-7-1998.
 2,172,020. GANG OF FIVE. INT. CL. 28. REG. 7-7-1998.
 2,172,023. KATTL. INT. CL. 41. REG. 7-7-1998.
 2,172,024. YEAR 2000. INT. CL. 28. REG. 7-7-1998.
 2,172,026. DIVE! AND DESIGN. INT. CL. 21. REG. 7-7-1998.
 2,172,027. S SULKA AND DESIGN. INT. CLS. 14, 18, 24, 25, 37 AND 42. REG. 7-7-1998.
 2,172,032. ONE LESS THING TO WORRY ABOUT. INT. CL. 16. REG. 7-7-1998.
 2,172,034. MISCELLANEOUS DESIGN. INT. CLS. 16 AND 25. REG. 7-7-1998.
 2,172,035. PAPERCUFF. INT. CL. 10. REG. 7-7-1998.
 2,172,038. MISCELLANEOUS DESIGN. INT. CL. 3. REG. 7-7-1998.
 2,172,039. FEEL GOOD AND DESIGN. INT. CLS. 16, 21 AND 25. REG. 7-7-1998.
 2,172,040. UNIVERSITY OF NORTH TEXAS AND DESIGN. INT. CL. 25. REG. 7-7-1998.
 2,172,041. ABOUTSNOWBOARDING. INT. CL. 41. REG. 7-7-1998.
 2,172,046. IMMEDIATE 2-WAY PROTECTION. INT. CL. 36. REG. 7-7-1998.
 2,172,047. BETTER TREATMENT CENTERS, INC.. INT. CL. 42. REG. 7-7-1998.
 2,172,048. THERAPEUTICS INFORMATION CENTER. INT. CL. 42. REG. 7-7-1998.
 2,172,051. NO SMOKE. INT. CL. 41. REG. 7-7-1998.
 2,172,056. MOVIECD. INT. CL. 9. REG. 7-7-1998.
 2,172,058. THE ORIGINAL GUMMI WATCH. INT. CL. 30. REG. 7-7-1998.
 2,172,059. SMOKY MOUNTAIN GETAWAY. INT. CL. 16. REG. 7-7-1998.
 2,184,389. SAFESIDE. INT. CL. 6 ONLY. REG. 8-25-1998.

- 2,184,390. STAY ON THE SAFESIDE. INT. CL. 6 ONLY. REG. 8-25-1998.
- 2,187,049. HRS HOTEL RESERVATION SERVICE ROBERT RAGGE GMBH AND DESIGN. INT. CLS. 39 AND 41 ONLY. REG. 9-8-1998.
- 2,188,744. SAFFRON. INT. CL. 9. REG. 9-15-1998.
- 2,188,794. CQK MUSIC. INT. CL. 9. REG. 9-15-1998.
- 2,190,472. ELEVATOR MUSIC AND DESIGN. INT. CL. 41 ONLY. REG. 9-22-1998.
- 2,190,618. CASTLE KING. INT. CL. 36 ONLY. REG. 9-22-1998.
- 2,192,160. SLIMLINE (STYLIZED). INT. CL. 6. REG. 9-29-1998.
- 2,192,712. ENDEAVOR AND DESIGN. INT. CL. 10. REG. 9-29-1998.
- 2,196,566. MACBETH. INT. CL. 32. REG. 10-13-1998.
- 2,214,890. SUN-RYPE. INT. CL. 30 ONLY. REG. 12-29-1998.
- 2,227,579. JACKSON STATE UNIVERSITY 18 77 MISSISSIPPI EXCELLENTIA ACADEMICA INVESTIGATIO ET OFFIRIUM AND DESIGN. INT. CLS. 18 AND 28 ONLY. REG. 3-2-1999.
- 2,230,169. HYDROCER. INT. CL. 40 ONLY. REG. 3-9-1999.
- 2,231,024. LISTNET. INT. CL. 35 ONLY. REG. 3-9-1999.
- 2,268,012. YES. IT'S THAT GOOD. INT. CL. 35 ONLY. REG. 8-10-1999.
- 2,300,922. TEST THE CHEF. INT. CL. 35 ONLY. REG. 12-14-1999.
- 2,303,803. H I AND DESIGN. INT. CL. 16 ONLY. REG. 12-28-1999.
- 1,364,858. FLEX CHECKING. INT. CL. 36. REG. 10-8-1985.
- 1,370,762. METASORB. INT. CL. 1. REG. 11-19-1985.
- 1,411,650. SIGNET (STYLIZED). INT. CL. 36. REG. 9-30-1986.
- 1,412,710. TODDLER HOUSE THE GREAT AMERICAN DINER (STYLIZED). INT. CL. 42. REG. 10-7-1986.
- 1,413,793. VICTORY MARKETS. INT. CL. 42. REG. 10-14-1986.
- 1,419,547. V VICTORY MARKETS AND DESIGN. INT. CL. 42. REG. 12-2-1986.
- 1,440,737. ACCUPUTT. INT. CL. 28. REG. 5-26-1987.
- 1,448,453. TAMPA BAY TIMES. INT. CL. 16. REG. 7-21-1987.
- 1,474,049. BATH BUDDY. INT. CL. 10. REG. 1-26-1988.
- 1,488,862. SPECIAL DELIVERY AND DESIGN. INT. CL. 42. REG. 5-17-1988.
- 1,516,572. YO-FRUIT (STYLIZED). INT. CL. 30. REG. 12-13-1988.
- 1,597,972. LUGGAGE LABEL AND DESIGN. INT. CL. 18. REG. 5-22-1990.
- 2,180,379. ROMAR. INT. CLS. 3, 4 AND 5. REG. 8-11-1998.
- 2,229,750. HAWAIIAN BLENDS. INT. CL. 3. REG. 3-2-1999.
- 2,261,545. 1-800-CREDFIX. INT. CLS. 35 AND 36. REG. 7-13-1999.
- 2,298,247. THE INTEGRATOR. INT. CL. 16. REG. 12-7-1999.
- 2,334,319. E'OLA OPTIMEAL. INT. CL. 5. REG. 3-28-2000.
- 2,336,147. DEBIT-IT!. INT. CL. 36. REG. 3-28-2000.
- 2,371,918. ILLUSION INC. AND DESIGN. INT. CL. 41. REG. 8-1-2000.
- 2,371,919. ILLUSION INC. AND DESIGN. INT. CL. 9. REG. 8-1-2000.
- 2,399,180. EVERYTHING 4 LESS AND DESIGN. INT. CL. 35. REG. 10-31-2000.
- 2,464,847. CSP SLIM PLAN (STYLIZED). INT. CL. 5. REG. 7-3-2001.
- 2,576,285. CRISPAIR (STYLIZED). INT. CL. 11. REG. 6-4-2002.
- 2,589,868. LASEM, FREEZER TO OVEN. INT. CL. 30. REG. 7-2-2002.
- 2,678,117. FULLSPECTRUM LEADERSHIP. INT. CL. 35. REG. 1-21-2003.
- 2,772,342. CARO. INT. CL. 3. REG. 10-7-2003.
- 2,806,484. MILLIONAIRE REAL ESTATE MENTOR. INT. CL. 16. REG. 1-20-2004.
- 2,848,054. SFERA AND DESIGN. INT. CL. 21. REG. 6-1-2004.
- 2,856,931. H BY TRUSSARDI. INT. CL. 35. REG. 6-22-2004.
- 2,878,526. J.T.B. (STYLIZED). INT. CL. 25. REG. 8-31-2004.

SECTION 18

- 771,618. TODDLER HOUSE (STYLIZED). U.S. CL. 100. REG. 6-16-1964.
- 815,592. HOUR AFTER HOUR. U.S. CL. 51. REG. 9-20-1966.
- 816,290. PERSPIREX. U.S. CL. 51. REG. 10-4-1966.
- 1,026,446. PUSSYCATS. U.S. CL. 39. REG. 12-2-1975.
- 1,051,315. VIVID AND DESIGN. INT. CL. 25. REG. 10-26-1976.
- 1,343,936. CRAFTSMAN. INT. CL. 9. REG. 6-25-1985.
- 1,343,937. CRAFTSMAN AND DESIGN. INT. CL. 9. REG. 6-25-1985.

* * * * *

TRADEMARK REGISTRATIONS AMENDED, CORRECTED, ETC.

The designation "U.S. Cl." appearing in this section refers to the U.S. class in effect prior to Sep. 1, 1973 rather than the international class which applies to applications filed on or after that date. For adoption of international classification see notice in the OFFICIAL GAZETTE of Jun. 26, 1973 (911 O.G. TM 210).

Any change to the registration will be indicated at the bottom of each entry under ELEMENTS AMENDED, CORRECTED OR RESTRICTED. With the exception of changes to the goods and services, additions to the registration will appear in asterisks and deletions of the registration will appear in brackets. Elements which are only changed will be listed with no punctuation. As to the goods/services statement, amendments to the goods/services will appear in asterisks and deletions will appear in brackets. In addition if any change to the goods/services occurs, the element "Goods/Services" will be listed under ELEMENTS AMENDED, CORRECTED OR RESTRICTED.

767,658. REG. 3-31-1964. RED ARROW PRODUCTS COMPANY LLC (WISCONSIN LTD LIAB CO) 633 SOUTH 23TH STREET, MANITOWOC, WI, 54221, SN 72-167,164. FILED 4-19-1963. PRINCIPAL REGISTER.

FOR LIQUID FOUNDATION MAKE-UP AND SKIN MOISTURIZING LOTION WITH SUNSCREEN.
FIRST USE 2-4-1965; IN COMMERCE 2-4-1965.

CHARTOR

ELEMENTS CORRECTED
CITIZENSHIP

INT. CL. 30/U.S. CL. 46
FOR EDIBLE SMOKE-FLAVORED YEAST.
FIRST USE 2-26-1963; IN COMMERCE 2-26-1963.

ELEMENTS AMENDED
OWNER NAME
OWNER ADDRESS
CITIZENSHIP
ENTITY
MARK

1,305,320. REG. 11-13-1984. BAILEY COMPANY, INC.; THE (TENNESSEE CORPORATION) 501 COWAN STREET, NASHVILLE, TN, 37228, SN 73-430,279. FILED 6-15-1983. PRINCIPAL REGISTER.



829,881. REG. 6-6-1967. HERSHEY FOODS CORPORATION (DELAWARE CORPORATION) 100 MANSION RD., E., HERSHEY, PA, 17033, SN 72-242,914. FILED 4-7-1966. PRINCIPAL REGISTER.

TAKE5

INT. CL. 37/U.S. CL. 103
FOR REPAIR AND SERVICING OF MATERIAL HANDLING EQUIPMENT.
FIRST USE 0-0-1975; IN COMMERCE 0-0-1975.
INT. CL. 42/U.S. CLS. 100 AND 101
FOR DISTRIBUTORSHIP AND RENTAL SERVICES IN THE FIELD OF MATERIAL HANDLING EQUIPMENT, PARTS, AND SUPPLIES THEREFORE.
FIRST USE 0-0-1975; IN COMMERCE 0-0-1975.

INT. CL. 30/U.S. CL. 46
FOR CANDY.
FIRST USE 3-15-1966; IN COMMERCE 3-15-1966.

ELEMENTS AMENDED
MARK

ELEMENTS AMENDED
MARK

1,257,282. REG. 11-15-1983. PHYSICIANS FORMULA COSMETICS, INC. (DELAWARE CORPORATION) 1055 WEST EIGHTH STREET, AZUSA, CA, 91702, SN 73-295,967. FILED 2-6-1981. PRINCIPAL REGISTER.

SUN SHIELD

1,325,079. REG. 3-12-1985. NATIONAL PRONTO STORES, INC. (DELAWARE CORPORATION) 220 E. JEFFERSON ST., SPRINGFIELD, IL, 62701, SN 73-336,274. FILED 11-9-1981. PRINCIPAL REGISTER.

PRONTO

NO CLAIM IS MADE TO THE EXCLUSIVE RIGHT TO USE THE WORD "SUN", APART FROM THE MARK AS SHOWN.
INT. CL. 3/U.S. CL. 51

INT. CL. 42/U.S. CL. 101
FOR RETAIL STORE SERVICES AND DISTRIBUTORSHIP SERVICES IN THE FIELD OF AUTOMOTIVE PARTS, TOOLS AND ACCESSORIES.
FIRST USE 10-6-1977; IN COMMERCE 10-6-1977.

ELEMENTS CORRECTED
CITIZENSHIP

1,332,480. REG. 4-23-1985. REDHOOK ALE BREWERY INCORPORATED (WASHINGTON CORPORATION) 3400 PHINNEY AVENUE NORTH, SEATTLE, WA, 98103, SN 73-382,104. FILED 8-26-1982. PRINCIPAL REGISTER.



NO CLAIM IS MADE TO THE EXCLUSIVE RIGHT TO USE THE WORD "ALE", APART FROM THE MARK AS SHOWN.

INT. CL. 32/U.S. CL. 48

FOR ALE.

FIRST USE 8-11-1982; IN COMMERCE 8-11-1982.

ELEMENTS AMENDED
MARK



1,486,062. REG. 4-26-1988. RED ARROW PRODUCTS COMPANY LLC (WISCONSIN CORPORATION) SOUTH 20TH STREET, MANITOWOC, WI, 54221, SN 73-677,907. FILED 8-12-1987. PRINCIPAL REGISTER.

POWRSMOKER

INT. CL. 11/U.S. CL. 34

FOR ATOMIZING UNIT USED TO ATOMIZE A SOLUTION OF WOOD SMOKE FLAVORS INTO A SMOKE HOUSE CHAMBER TO SMOKE FLAVOR MEAT, FISH AND OTHER FOOD STUFFS THEREIN.

FIRST USE 7-22-1987; IN COMMERCE 7-22-1987.

ELEMENTS AMENDED
MARK



1,637,139. REG. 3-5-1991. NEXTEL COMMUNICATIONS, INC (DELAWARE CORPORATION) 2001 EDMUND HALLEY DRIVE, RESTON, VA, 20191, SN 74-066,566. FILED 6-7-1990. PRINCIPAL REGISTER.

NEXTEL

INT. CL. 38/U.S. CL. 104

FOR TELECOMMUNICATIONS SERVICES.

FIRST USE 11-21-1988; IN COMMERCE 11-21-1988.

ELEMENTS CORRECTED
CITIZENSHIP

1,759,042. REG. 3-16-1993. PHYSICIANS FORMULA COSMETICS, INC. (DELAWARE CORPORATION) 1055 WEST EIGHTH STREET, AZUSA, CA, 91702, SN 74-154,106. FILED 4-4-1991. PRINCIPAL REGISTER.



OWNER OF U.S. REG. NOS. 1,187,303 AND 1,479,261. NO CLAIM IS MADE TO THE EXCLUSIVE RIGHT TO USE "INTENSIVE THERAPY MOISTURE LOTION", APART FROM THE MARK AS SHOWN.

AS TO "PHYSICIANS FORMULA".

INT. CL. 3/U.S. CL. 51

FOR SKIN MOISTURIZING LOTION.

FIRST USE 5-0-1991; IN COMMERCE 5-0-1991.

ELEMENTS CORRECTED
CITIZENSHIP



1,862,694. REG. 11-15-1994. SOUTHCORP BRANDS PTY LIMITED (AUSTRALIA COMPANY) 403 PACIFIC HIGHWAY, ARTARMON, NSW 2064, AUSTRALIA., SN 74-445,519. FILED 10-12-1993. PRINCIPAL REGISTER.



OWNER OF AUSTRALIA REG. NO. A542972, DATED 9-26-1990.

THE LINING IN THE MARK IS A FEATURE OF THE MARK AND NOT INTENDED TO INDICATE COLOR.

INT. CL. 33/U.S. CLS. 47 AND 49

FOR WINES, [BRANDY AND LIQUEURS].

FIRST USE ; IN COMMERCE .

ELEMENTS AMENDED
MARK

1,949,213. REG. 1-16-1996. PHYSICIANS FORMULA COSMETICS, INC. (DELAWARE CORPORATION) 1055 WEST EIGHTH STREET, AZUSA, CA, 91702, SN 74-648,281. FILED 3-17-1995. PRINCIPAL REGISTER.

LE VELVET

OWNER OF U.S. REG. NO. 1,122,628.
 INT. CL. 3/U.S. CLS. 1, 4, 6, 50, 51 AND 52
 FOR FACIAL MAKE-UP IN STICK AND POWDER FORM.
 FIRST USE 4-0-1994; IN COMMERCE 4-0-1994.
 INT. CL. 21/U.S. CLS. 2, 13, 23, 29, 30, 33, 40 AND 50
 FOR MAKEUP SPONGES.
 FIRST USE 4-0-1994; IN COMMERCE 4-0-1994.

ELEMENTS CORRECTED
 CITIZENSHIP

1,970,596. REG. 4-23-1996. PHYSICIANS FORMULA COSMETICS, INC. (DELAWARE CORPORATION) 1055 WEST EIGHTH STREET, AZUSA, CA, 91702, SN 74-594,306. FILED 10-24-1994. PRINCIPAL REGISTER.

BEYOND MOISTURE

INT. CL. 3/U.S. CLS. 1, 4, 6, 50, 51 AND 52
 FOR LIPSTICK.
 FIRST USE 2-0-1995; IN COMMERCE 2-0-1995.

ELEMENTS CORRECTED
 CITIZENSHIP

2,003,717. REG. 9-24-1996. PHYSICIANS FORMULA COSMETICS, INC. (DELAWARE CORPORATION) 1055 WEST 8TH ST., AZUSA, CA, 91702, SN 74-655,051. FILED 4-3-1995. PRINCIPAL REGISTER.

PLENTIFULL

INT. CL. 3/U.S. CLS. 1, 4, 6, 50, 51 AND 52
 FOR MASCARA.
 FIRST USE 12-0-1995; IN COMMERCE 12-0-1995.

ELEMENTS CORRECTED
 CITIZENSHIP

2,007,889. REG. 10-15-1996. CAPITAL CITY BANK GROUP, INC. (FLORIDA CORPORATION) 217 NORTH MONROE STREET, TALLAHASSEE, FL, 323023248, SN 74-696,249. FILED 7-3-1995. PRINCIPAL REGISTER.



NO CLAIM IS MADE TO THE EXCLUSIVE RIGHT TO USE "BANK", APART FROM THE MARK AS SHOWN.
 INT. CL. 36/U.S. CLS. 100, 101 AND 102

FOR BANKING SERVICES.
 FIRST USE 1-1-1995; IN COMMERCE 1-1-1995.

ELEMENTS CORRECTED
 OWNER NAME

2,020,712. REG. 12-3-1996. KONA RESTAURANT GROUP, INC. (DELAWARE CORPORATION) 20308 HIGHWAY 71 WEST SUITE 5, SPICEWOOD, TX, 78669, SN 75-025,876. FILED 11-30-1995. PRINCIPAL REGISTER.



NO CLAIM IS MADE TO THE EXCLUSIVE RIGHT TO USE "ITALIAN", APART FROM THE MARK AS SHOWN.
 THE NAME "JOHNNY CARINO" IDENTIFIES A PARTICULAR LIVING INDIVIDUAL WHOSE CONSENT IS OF RECORD.
 INT. CL. 42/U.S. CLS. 100 AND 101
 FOR RESTAURANT SERVICES.
 FIRST USE 10-1-1995; IN COMMERCE 10-1-1995.

ELEMENTS AMENDED
 MARK
 DISCLAIMER

2,030,318. REG. 1-14-1997. PHYSICIANS FORMULA COSMETICS, INC. (DELAWARE CORPORATION) 1055 WEST EIGHTH STREET, AZUSA, CA, 91702, SN 75-066,725. FILED 3-4-1996. PRINCIPAL REGISTER.

SHINE AWAY

INT. CL. 3/U.S. CLS. 1, 4, 6, 50, 51 AND 52
 FOR FACIAL MAKEUP PRIMER.
 FIRST USE 2-0-1995; IN COMMERCE 2-0-1995.

ELEMENTS CORRECTED
 CITIZENSHIP

2,070,859. REG. 6-10-1997. PHYSICIANS FORMULA COSMETICS, INC. (DELAWARE CORPORATION) 1055 WEST EIGHTH STREET, AZUSA, CA, 91702, SN 75-066,697. FILED 3-4-1996. PRINCIPAL REGISTER.

TO ANY LENGTHS

INT. CL. 3/U.S. CLS. 1, 4, 6, 50, 51 AND 52
 FOR MASCARA.
 FIRST USE 3-12-1996; IN COMMERCE 3-12-1996.

ELEMENTS CORRECTED
 CITIZENSHIP

2,114,105. REG. 11-18-1997. UNIVERSITY RESTAURANT GROUP, INC. (CALIFORNIA CORPORATION) 3185-H AIRWAY AVENUE, COSTA MESA, CA, 92626, SN 75-197,078. FILED 11-12-1996. PRINCIPAL REGISTER.

WATER GRILL

OWNER OF U.S. REG. NO. 1,781,928.
NO CLAIM IS MADE TO THE EXCLUSIVE RIGHT TO USE "GRILL", APART FROM THE MARK AS SHOWN.
INT. CL. 42/U.S. CLS. 100 AND 101
FOR RESTAURANT SERVICES.
FIRST USE 6-0-1991; IN COMMERCE 6-0-1991.

ELEMENTS CORRECTED
OWNER NAME

2,228,941. REG. 3-2-1999. PHYSICIANS FORMULA COSMETICS, INC. (DELAWARE CORPORATION) 1055 WEST EIGHTH STREET, AZUSA, CA, 91702, SN 75-479,844. FILED 5-5-1998. PRINCIPAL REGISTER.

PEACH-TO-GLOW

INT. CL. 3/U.S. CLS. 1, 4, 6, 50, 51 AND 52
FOR FOUNDATION MAKEUP, FACE POWDERS, SKIN MOISTURIZERS, AND SUN SCREEN LOTIONS.
FIRST USE 3-27-1998; IN COMMERCE 3-27-1998.

ELEMENTS CORRECTED
CITIZENSHIP

2,230,823. REG. 3-9-1999. BWD GROUP LLC (DELAWARE CORPORATION) BWD PLAZA, P. O. BOX 9050, JERICHO, NY, 117538950, SN 75-476,763. FILED 4-29-1998. PRINCIPAL REGISTER.

BWD GROUP LLC

NO CLAIM IS MADE TO THE EXCLUSIVE RIGHT TO USE "GROUP LIMITED", APART FROM THE MARK AS SHOWN.
INT. CL. 36/U.S. CLS. 100, 101 AND 102
FOR INSURANCE BROKERAGE SERVICES.
FIRST USE 11-0-1993; IN COMMERCE 11-0-1993.

ELEMENTS AMENDED
MARK

2,255,118. REG. 6-22-1999. DR. JOHANNES RIEGL RADAR-TECHNIK & ELEKTROOPTIK GMBH (AUSTRIA CORPORATION) RIEDENBURGSTRASSE 48, A-3580 HORN, AUSTRIA., SN 75-407,647. FILED 12-18-1997. PRINCIPAL REGISTER.

LASERTAPE

INT. CL. 9/U.S. CLS. 21, 23, 26, 36 AND 38

FOR LASER RANGEFINDERS.
FIRST USE 0-0-1989; IN COMMERCE 1-0-1993.

ELEMENTS CORRECTED
OWNER NAME
OWNER ADDRESS

2,288,234. REG. 10-19-1999. PHYSICIANS FORMULA COSMETICS, INC. (DELAWARE CORPORATION) 1055 WEST EIGHTH STREET, AZUSA, CA, 91702, SN 75-426,755. FILED 1-31-1998. PRINCIPAL REGISTER.

SPORT TEAM

INT. CL. 3/U.S. CLS. 1, 4, 6, 50, 51 AND 52
FOR COSMETICS AND SKIN CARE PRODUCTS; NAMELY, MOISTURIZING CREAMS AND LOTIONS AND SUNTAN AND SUNSCREEN LOTIONS AND CREAMS.
FIRST USE 3-10-1998; IN COMMERCE 3-10-1998.

ELEMENTS CORRECTED
CITIZENSHIP

2,371,937. REG. 8-1-2000. PHYSICIANS FORMULA COSMETICS, INC. (DELAWARE CORPORATION) 1055 WEST EIGHTH STREET, AZUSA, CA, 91702, SN 75-336,312. FILED 8-5-1997. PRINCIPAL REGISTER.

TOTAL PERFECTION

INT. CL. 3/U.S. CLS. 1, 4, 6, 50, 51 AND 52
FOR LIPSTICK.
FIRST USE 9-0-1991; IN COMMERCE 9-0-1991.

ELEMENTS CORRECTED
CITIZENSHIP

2,384,341. REG. 9-5-2000. PHYSICIANS FORMULA COSMETICS, INC. (DELAWARE CORPORATION) 1055 WEST EIGHTH STREET, AZUSA, CA, 91702, SN 75-656,794. FILED P.R. 3-9-1999; AM. S.R. 5-9-2000. SUPPLEMENTAL REGISTER.

BROW CORRECTOR

NO CLAIM IS MADE TO THE EXCLUSIVE RIGHT TO USE "BROW", APART FROM THE MARK AS SHOWN.
INT. CL. 3/U.S. CLS. 1, 4, 6, 50, 51 AND 52
FOR COSMETICS, NAMELY, EYEBROW GEL.
FIRST USE 6-16-1999; IN COMMERCE 6-16-1999.

ELEMENTS CORRECTED
CITIZENSHIP

2,386,492. REG. 9-12-2000. CROSSMEDIA SERVICES, INC. (DELAWARE CORPORATION) 350 WEST ERIE, SUITE 300, CHICAGO, IL, 60610, SN 75-632,306. FILED 2-2-1999. PRINCIPAL REGISTER.

SALESHOUND

INT. CL. 35/U.S. CLS. 100, 101 AND 102

FOR PROVIDING ONLINE INFORMATION REGARDING THE PRICE AND AVAILABILITY OF GOODS AND SERVICES OFFERED [BY THIRD PARTY RETAIL STORES AND ONLINE OUTLETS, AND THE LOCATION THEREOF] *AT NON-INTERNET BASED THIRD-PARTY RETAIL STORES AND LOCATIONS THEREOF .

FIRST USE 11-8-1999; IN COMMERCE 11-8-1999.

ELEMENTS AMENDED
GOODS/SERVICES

2,398,555. REG. 10-24-2000. PHYSICIANS FORMULA COSMETICS, INC. (DELAWARE CORPORATION) 1055 WEST EIGHTH STREET, AZUSA, CA, 91702, SN 75-592,193. FILED 11-19-1998. PRINCIPAL REGISTER.

CONCEALER TWINS

NO CLAIM IS MADE TO THE EXCLUSIVE RIGHT TO USE "CONCEALER", APART FROM THE MARK AS SHOWN.

INT. CL. 3/U.S. CLS. 1, 4, 6, 50, 51 AND 52
FOR COSMETICS, NAMELY, FACIAL MAKEUP.
FIRST USE 12-11-1998; IN COMMERCE 12-11-1998.

ELEMENTS CORRECTED
CITIZENSHIP

2,400,377. REG. 10-31-2000. PHYSICIANS FORMULA COSMETICS, INC. (DELAWARE CORPORATION) 1055 WEST EIGHTH STREET, AZUSA, CA, 91702, SN 75-184,455. FILED 10-21-1996. PRINCIPAL REGISTER.

POWDER PALETTE

NO CLAIM IS MADE TO THE EXCLUSIVE RIGHT TO USE "POWDER", APART FROM THE MARK AS SHOWN.

INT. CL. 3/U.S. CLS. 1, 4, 6, 50, 51 AND 52
FOR COSMETICS, NAMELY, PRESSED POWDER FOR THE FACE.
FIRST USE 1-29-1997; IN COMMERCE 1-29-1997.

ELEMENTS CORRECTED
CITIZENSHIP

2,407,434. REG. 11-21-2000. PHYSICIANS FORMULA COSMETICS, INC. (DELAWARE CORPORATION) 1055 WEST EIGHTH STREET, AZUSA, CA, 91702, SN 75-591,426. FILED P.R. 11-18-1998; AM. S.R. 5-6-2000. SUPPLEMENTAL REGISTER.

LIP COLOR CORRECTOR

NO CLAIM IS MADE TO THE EXCLUSIVE RIGHT TO USE "LIP COLOR", APART FROM THE MARK AS SHOWN.

INT. CL. 3/U.S. CLS. 1, 4, 6, 50, 51 AND 52
FOR COSMETICS, NAMELY, LIPSTICK.
FIRST USE 1-6-1999; IN COMMERCE 1-6-1999.

ELEMENTS CORRECTED
CITIZENSHIP

2,413,065. REG. 12-12-2000. PHYSICIANS FORMULA COSMETICS, INC. (DELAWARE CORPORATION) 1055 WEST EIGHTH STREET, AZUSA, CA, 91702, SN 75-641,040. FILED 2-16-1999. PRINCIPAL REGISTER.

DROPS OF BRONZE

NO CLAIM IS MADE TO THE EXCLUSIVE RIGHT TO USE "BRONZE", APART FROM THE MARK AS SHOWN.

INT. CL. 3/U.S. CLS. 1, 4, 6, 50, 51 AND 52
FOR LOTIONS AND FOUNDATION FOR THE FACE AND BODY.
FIRST USE 4-8-1999; IN COMMERCE 4-8-1999.

ELEMENTS CORRECTED
CITIZENSHIP

2,422,061. REG. 1-16-2001. PHYSICIANS FORMULA COSMETICS, INC. (DELAWARE CORPORATION) 1055 WEST EIGHTH STREET, AZUSA, CA, 91702, SN 75-640,668. FILED 2-16-1999. PRINCIPAL REGISTER.

DUST OF BRONZE

NO CLAIM IS MADE TO THE EXCLUSIVE RIGHT TO USE "BRONZE", APART FROM THE MARK AS SHOWN.

INT. CL. 3/U.S. CLS. 1, 4, 6, 50, 51 AND 52
FOR COSMETICS AND SKIN CARE PRODUCTS; NAMELY, POWDERS AND FOUNDATION FOR THE FACE AND BODY.
FIRST USE 4-8-1999; IN COMMERCE 4-8-1999.

ELEMENTS CORRECTED
CITIZENSHIP

2,460,119. REG. 6-12-2001. PHYSICIANS FORMULA COSMETICS, INC. (DELAWARE CORPORATION) 1055 WEST EIGHTH STREET, AZUSA, CA, 91702, SN 75-591,427. FILED 11-18-1998. PRINCIPAL REGISTER.

PEARLS OF PERFECTION

INT. CL. 3/U.S. CLS. 1, 4, 6, 50, 51 AND 52

FOR COSMETICS; NAMELY, FACE POWDER, BLUSH, FOUNDATION BRONZER AND HIGHLIGHTER FOR THE FACE.
FIRST USE 12-12-1998; IN COMMERCE 12-12-1998.

ELEMENTS CORRECTED
CITIZENSHIP

2,464,337. REG. 6-26-2001. PHYSICIANS FORMULA COSMETICS, INC. (DELAWARE CORPORATION) 1055 WEST EIGHTH STREET, AZUSA, CA, 91702, SN 75-641,038. FILED 2-16-1999. PRINCIPAL REGISTER.

DUST OF GOLD

NO CLAIM IS MADE TO THE EXCLUSIVE RIGHT TO USE "GOLD", APART FROM THE MARK AS SHOWN.
INT. CL. 3/U.S. CLS. 1, 4, 6, 50, 51 AND 52
FOR COSMETICS AND SKIN CARE PRODUCTS; NAMELY, POWDERS AND FOUNDATION FOR THE FACE AND BODY.
FIRST USE 4-8-1999; IN COMMERCE 4-8-1999.

ELEMENTS CORRECTED
CITIZENSHIP

2,475,987. REG. 8-7-2001. PHYSICIANS FORMULA COSMETICS, INC. (DELAWARE CORPORATION) 1055 WEST EIGHTH STREET, AZUSA, CA, 91702, SN 75-066,698. FILED 3-4-1996. PRINCIPAL REGISTER.

SELF DEFENSE

INT. CL. 3/U.S. CLS. 1, 4, 6, 50, 51 AND 52
FOR SKIN MOISTURIZING LOTION.
FIRST USE 1-31-1996; IN COMMERCE 1-31-1996.

ELEMENTS CORRECTED
CITIZENSHIP

2,489,120. REG. 9-11-2001. PHYSICIANS FORMULA COSMETICS, INC. (DELAWARE CORPORATION) 1055 WEST EIGHTH STREET, AZUSA, CA, 91702, SN 75-874,200. FILED 12-18-1999. PRINCIPAL REGISTER.

PLANET EYES

NO CLAIM IS MADE TO THE EXCLUSIVE RIGHT TO USE "EYES", APART FROM THE MARK AS SHOWN.
INT. CL. 3/U.S. CLS. 1, 4, 6, 50, 51 AND 52
FOR COSMETICS, NAMELY, EYE SHADOWS.
FIRST USE 8-18-2000; IN COMMERCE 8-18-2000.

ELEMENTS CORRECTED
CITIZENSHIP

2,493,092. REG. 9-25-2001. PHYSICIANS FORMULA COSMETICS, INC. (DELAWARE CORPORATION) 1055 WEST EIGHTH STREET, AZUSA, CA, 91702, SN 75-609,934. FILED 12-17-1998. PRINCIPAL REGISTER.

SUMMER SHIMMER

NO CLAIM IS MADE TO THE EXCLUSIVE RIGHT TO USE "SHIMMER", APART FROM THE MARK AS SHOWN.
INT. CL. 3/U.S. CLS. 1, 4, 6, 50, 51 AND 52
FOR COSMETICS AND SKIN CARE PRODUCTS; NAMELY, POWDER, LOTION AND FOUNDATION FOR THE FACE AND BODY.
FIRST USE 4-7-1999; IN COMMERCE 4-7-1999.

ELEMENTS CORRECTED
CITIZENSHIP

2,520,797. REG. 12-18-2001. PACIFIC LIFE INSURANCE COMPANY (CALIFORNIA CORPORATION) PACIFIC LIFE INSURANCE COMPANY, 700 NEWPORT CENTER DRIVE, NEWPORT BEACH, CA, 92660, SN 75-741,937. FILED 7-1-1999. PRINCIPAL REGISTER.



THE LINING SHOWN IN THE DRAWING IS A FEATURE OF THE MARK AND NOT INTENDED TO INDICATE COLOR.

INT. CL. 36/U.S. CLS. 100, 101 AND 102
FOR INSURANCE UNDERWRITING AND ADMINISTRATION SERVICES IN THE FIELDS OF LIFE, DISABILITY, HEALTH, AND LOSS PREVENTION; ANNUITY UNDERWRITING AND ADMINISTRATION SERVICES; INSURANCE CLAIMS ADMINISTRATION AND PROCESSING; REINSURANCE UNDERWRITING; ADMINISTRATION OF EMPLOYEE BENEFIT PLANS; INVESTMENT CONSULTATION AND MANAGEMENT; PENSION PLAN SERVICES, NAMELY, ADMINISTRATION OF EMPLOYEE PENSION PLANS; PENSION PLAN REVIEW AND ANALYSIS; INVESTMENT OF EMPLOYEE PENSION PLANS; FINANCIAL AND INVESTMENT SERVICES, NAMELY, FUNDING AGREEMENTS, PROVIDING VENTURE CAPITAL FOR ESTABLISHMENT, OPERATION, AND EXPANSION OF BUSINESS; ASSET MANAGEMENT FOR OTHERS, INVESTMENT BROKERAGE; INVESTMENT, ADMINISTRATIVE, AND BROKER-DEALER SERVICES FINANCIAL INVESTMENT IN THE FIELD OF SECURITIES, DERIVATIVES, REAL ESTATE, MUTUAL FUNDS, AND PRIVATE PLACEMENT; MAINTAINING ESCROW ACCOUNTS FOR INVESTMENTS; MUTUAL FUND MANAGEMENT; INVESTMENT OF FUNDS FOR OTHERS; INVESTMENT CONSULTATION AND MANAGEMENT; FINANCIAL AND INVESTMENT SERVICES, NAMELY, PROVIDING TO CLIENTS; REAL ESTATE INVESTMENT ADVISORY; AND FINANCIAL SERVICES, NAMELY, MORTGAGE SERVICING; FUND INVESTMENT CONSULTATION; CAPITAL INVESTMENT CONSULTATION; MUTUAL FUND BROKERAGE INVESTMENT AND DISTRIBUTION; REAL ESTATE INVESTMENT AND MANAGEMENT; AND MORTGAGE LENDING AND LOAN SERVICING.
FIRST USE 6-1-1999; IN COMMERCE 6-1-1999.

ELEMENTS CORRECTED
OWNER NAME

2,526,119. REG. 1-1-2002. PHYSICIANS FORMULA COSMETICS, INC. (DELAWARE CORPORATION) 1055 WEST EIGHTH STREET, AZUSA, CA, 91702, SN 76-069,887. FILED 6-14-2000. PRINCIPAL REGISTER.

VIRTUAL EYES

NO CLAIM IS MADE TO THE EXCLUSIVE RIGHT TO USE "EYES", APART FROM THE MARK AS SHOWN.
INT. CL. 3/U.S. CLS. 1, 4, 6, 50, 51 AND 52

FOR COSMETICS AND SKIN CARE PRODUCTS; NAMELY EYE SHADOW, EYE COLORING PENCILS AND MASCARA.

FIRST USE 1-26-2001; IN COMMERCE 1-26-2001.

ELEMENTS CORRECTED
CITIZENSHIP

2,547,162. REG. 3-12-2002. PHYSICIANS FORMULA COSMETICS, INC. (DELAWARE CORPORATION) 1055 WEST 8TH STREET, AZUSA, CA, 91702, SN 76-254,830. FILED 5-8-2001. PRINCIPAL REGISTER.

BEAUTY SPIRAL

OWNER OF U.S. REG. NO. 2,352,779.

NO CLAIM IS MADE TO THE EXCLUSIVE RIGHT TO USE "BEAUTY", APART FROM THE MARK AS SHOWN.

INT. CL. 3/U.S. CLS. 1, 4, 6, 50, 51 AND 52

FOR COSMETICS, NAMELY, MOISTURIZERS, EYE SHADOW AND LIP COLOR.

FIRST USE 7-18-2000; IN COMMERCE 7-18-2000.

ELEMENTS CORRECTED
CITIZENSHIP

2,560,084. REG. 4-9-2002. CAPITAL CITY BANK GROUP, INC. (FLORIDA CORPORATION) 217 NORTH MONROE STREET, TALLAHASSEE, FL, 32301, SN 76-041,514. FILED 5-5-2000. PRINCIPAL REGISTER.



OWNER OF U.S. REG. NOS. 2,007,889, 2,165,466 AND 2,283,071.

NO CLAIM IS MADE TO THE EXCLUSIVE RIGHT TO USE "BANK ONLINE FOR BUSINESS", APART FROM THE MARK AS SHOWN.

THE LINING IS A FEATURE OF THE MARK AND DOES NOT INDICATE COLOR.

INT. CL. 9/U.S. CLS. 21, 23, 26, 36 AND 38

FOR COMMERCIAL BANKING SERVICES PROVIDED VIA AN ONLINE ELECTRONIC COMMUNICATIONS NETWORK.

FIRST USE 7-27-2000; IN COMMERCE 7-27-2000.

ELEMENTS CORRECTED
OWNER NAME

2,583,857. REG. 6-18-2002. PHYSICIANS FORMULA COSMETICS, INC. (DELAWARE CORPORATION) 1055 WEST EIGHTH STREET, AZUSA, CA, 91702, SN 78-033,024. FILED 10-30-2000. PRINCIPAL REGISTER.

SENSITIVE SKIN ? BE SENSIBLE !

INT. CL. 3/U.S. CLS. 1, 4, 6, 50, 51 AND 52

FOR SKIN CARE PRODUCTS, NAMELY, CLEANSERS, TONERS, MOISTURIZERS, CREAMS, LOTIONS, EYE MAKEUP REMOVER PADS AND LOTIONS, EYE MOISTURIZERS AND SKIN CARE PREPARATIONS; COSMETICS, NAMELY, FOUNDATIONS, FACE POWDERS, BLUSHES, EYE SHADOW, MASCARA, EYE PENCILS, CONCEALERS, LIP BALM, EYE BROW GEL, EYE BROW PENCILS, AND LIP COLOR.

FIRST USE 1-4-2001; IN COMMERCE 1-4-2001.

ELEMENTS CORRECTED
CITIZENSHIP

2,596,062. REG. 7-16-2002. PHYSICIANS FORMULA COSMETICS, INC. (DELAWARE CORPORATION) 1055 WEST EIGHTH STREET, AZUSA, CA, 91702, SN 78-032,179. FILED 10-24-2000. PRINCIPAL REGISTER.

PLANET BLUSH

NO CLAIM IS MADE TO THE EXCLUSIVE RIGHT TO USE "BLUSH", APART FROM THE MARK AS SHOWN.

INT. CL. 3/U.S. CLS. 1, 4, 6, 50, 51 AND 52

FOR COSMETICS; NAMELY, BLUSH, POWDER, HIGHLIGHTER AND BRONZER.

FIRST USE 12-29-2000; IN COMMERCE 12-29-2000.

ELEMENTS CORRECTED
CITIZENSHIP

2,598,226. REG. 7-23-2002. PHYSICIANS FORMULA COSMETICS, INC. (DELAWARE CORPORATION) 1055 WEST EIGHTH STREET, AZUSA, CA, 91702, SN 75-404,651. FILED 12-12-1997. PRINCIPAL REGISTER.

VIRTUAL GLOVE

INT. CL. 3/U.S. CLS. 1, 4, 6, 50, 51 AND 52

FOR SKIN CARE PREPARATIONS; NAMELY, CREAMS AND LOTIONS FOR THE HANDS AND BODY.

FIRST USE 9-21-2001; IN COMMERCE 9-21-2001.

ELEMENTS CORRECTED
CITIZENSHIP

2,599,366. REG. 7-23-2002. PHYSICIANS FORMULA COSMETICS, INC. (DELAWARE CORPORATION) 1055 WEST EIGHTH STREET, AZUSA, CA, 91702, SN 76-262,741. FILED 5-24-2001. PRINCIPAL REGISTER.

AQUA COVER

NO CLAIM IS MADE TO THE EXCLUSIVE RIGHT TO USE "COVER", APART FROM THE MARK AS SHOWN. INT. CL. 3/U.S. CLS. 1, 4, 6, 50, 51 AND 52

FOR COSMETICS, NAMELY, FACE MAKEUP, CONCEALERS, FACE POWDERS, FOUNDATION, BLUSH, EYE SHADOW, EYE PENCILS, EYELINERS, LOTIONS AND GELS FOR THE FACE.

FIRST USE 12-17-2001; IN COMMERCE 12-17-2001.

ELEMENTS CORRECTED
CITIZENSHIP

2,599,557. REG. 7-23-2002. PHYSICIANS FORMULA COSMETICS, INC. (DELAWARE CORPORATION) 1055 WEST EIGHTH STREET, AZUSA, CA, 91702, SN 78-035,676. FILED 11-16-2000. PRINCIPAL REGISTER.

CINNAMON ROLL

INT. CL. 3/U.S. CLS. 1, 4, 6, 50, 51 AND 52

FOR COSMETICS AND SKIN CARE PRODUCTS, NAMELY, LIP GLOSS, EYE MAKEUP, BLUSH, MASCARA, EYE PENCIL.

FIRST USE 6-1-2000; IN COMMERCE 6-1-2000.

ELEMENTS CORRECTED
CITIZENSHIP

2,613,511. REG. 8-27-2002. PHYSICIANS FORMULA COSMETICS, INC. (DELAWARE CORPORATION) 1055 WEST EIGHTH STREET, AZUSA, CA, 91702, SN 76-289,237. FILED 7-20-2001. PRINCIPAL REGISTER.

AQUACHEEKS

INT. CL. 3/U.S. CLS. 1, 4, 6, 50, 51 AND 52

FOR BLUSH, FACE POWDER, HIGHLIGHTER, BRONZER, FACE MAKEUP, FOUNDATION.

FIRST USE 12-21-2001; IN COMMERCE 12-21-2001.

ELEMENTS CORRECTED
CITIZENSHIP

2,619,015. REG. 9-10-2002. PHYSICIANS FORMULA COSMETICS, INC. (DELAWARE CORPORATION) 1055 WEST EIGHTH STREET, AZUSA, CA, 91702, SN 78-035,674. FILED 11-16-2000. PRINCIPAL REGISTER.

CLEAR WATER

INT. CL. 3/U.S. CLS. 1, 4, 6, 50, 51 AND 52

FOR COSMETICS AND SKIN CARE PRODUCTS, NAMELY, MASCARA, LIPSTICK AND LIP COLOR AND LIP GLOSS.

FIRST USE 5-4-2000; IN COMMERCE 5-4-2000.

ELEMENTS CORRECTED
CITIZENSHIP

2,622,305. REG. 9-17-2002. PHYSICIANS FORMULA COSMETICS, INC. (DELAWARE CORPORATION) 1055 WEST EIGHTH STREET, AZUSA, CA, 91702, SN 78-035,555. FILED 10-26-2000. PRINCIPAL REGISTER.

SEDUCER

INT. CL. 3/U.S. CLS. 1, 4, 6, 50, 51 AND 52

FOR COSMETICS AND SKIN CARE; NAMELY, FACIAL MOISTURIZERS.

FIRST USE 12-15-2000; IN COMMERCE 12-15-2000.

ELEMENTS CORRECTED
CITIZENSHIP

2,626,623. REG. 9-24-2002. PHYSICIANS FORMULA COSMETICS, INC. (DELAWARE CORPORATION) 1055 WEST EIGHTH STREET, AZUSA, CA, 91702, SN 78-035,913. FILED 11-17-2000. PRINCIPAL REGISTER.

SILVER MOON

INT. CL. 3/U.S. CLS. 1, 4, 6, 50, 51 AND 52

FOR COSMETICS AND SKIN CARE PRODUCTS; NAMELY, LIP GLOSS, EYE COLOR, BLUSH, MASCARA, EYELINER AND FACE POWDER.

FIRST USE 6-13-2000; IN COMMERCE 6-13-2000.

ELEMENTS CORRECTED
CITIZENSHIP

2,640,888. REG. 10-22-2002. PHYSICIANS FORMULA COSMETICS, INC. (DELAWARE CORPORATION) 1055 WEST 8TH STREET, AZUSA, CA, 91702, SN 76-262,740. FILED 5-24-2001. PRINCIPAL REGISTER.

VIRTUAL FOUNDATION

NO CLAIM IS MADE TO THE EXCLUSIVE RIGHT TO USE "FOUNDATION", APART FROM THE MARK AS SHOWN.

INT. CL. 3/U.S. CLS. 1, 4, 6, 50, 51 AND 52

FOR COSMETICS, NAMELY FOUNDATION, BLUSH, POWDER AND CONCEALERS FOR THE FACE.

FIRST USE 12-23-2001; IN COMMERCE 12-23-2001.

ELEMENTS CORRECTED
CITIZENSHIP

2,644,431. REG. 10-29-2002. PHYSICIANS FORMULA COSMETICS, INC. (DELAWARE CORPORATION) 1055 W. EIGHTH STREET, AZUSA, CA, 91702, SN 76-316,484. FILED 9-24-2001. PRINCIPAL REGISTER.

LIEUTENANT LASH

INT. CL. 3/U.S. CLS. 1, 4, 6, 50, 51 AND 52
FOR COSMETICS AND SKIN CARE PRODUCTS;
NAMESLY, MASCARA, EYE COLOR, EYE LINERS.
FIRST USE 4-26-2002; IN COMMERCE 4-26-2002.

ELEMENTS CORRECTED
CITIZENSHIP

2,644,432. REG. 10-29-2002. PHYSICIANS FORMULA COSMETICS, INC. (DELAWARE CORPORATION) 1055 W. EIGHTH STREET, AZUSA, CA, 91702, SN 76-316,485. FILED 9-24-2001. PRINCIPAL REGISTER.

SERGEANT SHADOW

INT. CL. 3/U.S. CLS. 1, 4, 6, 50, 51 AND 52
FOR COSMETICS AND SKIN CARE PRODUCTS;
NAMESLY, EYE COLOR, EYE SHADOW, EYE COLOR
PENCILS, EYE COLOR CREAMS, EYE COLOR POW-
DERS, EYE COLOR STICKS, EYE LINERS, MASCARA.
FIRST USE 4-26-2002; IN COMMERCE 4-26-2002.

ELEMENTS CORRECTED
CITIZENSHIP

2,650,551. REG. 11-12-2002. PHYSICIANS FORMULA COSMETICS, INC. (DELAWARE CORPORATION) 1055 WEST EIGHTH STREET, AZUSA, CA, 91702, SN 76-265,895. FILED 6-1-2001. PRINCIPAL REGISTER.

PEARLS OF PERFECTION

OWNER OF U.S. REG. NO. 2,460,119.
INT. CL. 3/U.S. CLS. 1, 4, 6, 50, 51 AND 52
FOR COSMETICS AND TOILETRIES, NAMESLY, EYE
MAKEUP, CONCEALER, MOISTURIZER, CLEANSER,
TONER, GEL AND LOTION FOR THE FACE.
FIRST USE 1-26-2001; IN COMMERCE 1-26-2001.

ELEMENTS CORRECTED
CITIZENSHIP

2,659,956. REG. 12-10-2002. PHYSICIANS FORMULA COSMETICS, INC. (DELAWARE CORPORATION) 1055 WEST EIGHTH STREET, AZUSA, CA, 91702, SN 75-783,896. FILED 8-25-1999. PRINCIPAL REGISTER.

DUST OF CRYSTAL

INT. CL. 3/U.S. CLS. 1, 4, 6, 50, 51 AND 52

FOR COSMETICS AND SKIN CARE PRODUCTS,
NAMESLY, FACE LOTIONS AND MAKE-UP FOUNDA-
TION FOR THE FACE AND BODY.
FIRST USE 4-13-2000; IN COMMERCE 4-13-2000.

ELEMENTS CORRECTED
CITIZENSHIP

2,664,520. REG. 12-17-2002. PHYSICIANS FORMULA COSMETICS, INC. (DELAWARE CORPORATION) 1055 WEST EIGHTH STREET, AZUSA, CA, 91702, SN 76-314,607. FILED 9-18-2001. PRINCIPAL REGISTER.

RETRO GLOW

OWNER OF U.S. REG. NO. 2,228,941.
INT. CL. 3/U.S. CLS. 1, 4, 6, 50, 51 AND 52
FOR FACE MAKEUP, FACE POWDER, FOUNDA-
TION, BLUSH, EYE COLOR PENCILS, EYE SHADOW,
EYE LINER, CONCEALERS, MASCARAS, BROW MA-
KEUP, SKIN CLEANSER, TONER, SKIN MOISTURIZER,
EYE MAKEUP REMOVER, SUN CARE LOTIONS, NON-
MEDICATED LIP BALM, LIP COLOR.
FIRST USE 12-23-2001; IN COMMERCE 12-23-2001.

ELEMENTS CORRECTED
CITIZENSHIP

2,673,075. REG. 1-7-2003. PHYSICIANS FORMULA COSMETICS, INC. (DELAWARE CORPORATION) 1055 WEST EIGHTH STREET, AZUSA, CA, 91702, SN 76-266,428. FILED 6-4-2001. PRINCIPAL REGISTER.

SKINSITIVE

INT. CL. 3/U.S. CLS. 1, 4, 6, 50, 51 AND 52
FOR FACE MAKEUP, FACE POWDER, FOUNDA-
TION, BLUSH, EYE SHADOW, EYE PENCILS, EYE
LINER, CONCEALERS, MASCARA, BROW MAKEUP,
SKIN CLEANSER, TONER, SKIN MOISTURIZER, EYE
MAKEUP REMOVER PADS, EYE MAKEUP REMOVER
LOTIONS, SUN CARE LOTIONS, NON-MEDICATED LIP
BALM, LIPSTICK, LIP LINERS.
FIRST USE 12-27-2001; IN COMMERCE 12-27-2001.

ELEMENTS CORRECTED
CITIZENSHIP

2,679,606. REG. 1-28-2003. UPSOLUT MICHAEL VEITH MARKETING GMBH (FED REP GERMANY CORPORATION) BIRKENLEITEN 33, MUNICH, FED REP GERMANY, 81543, SN 76-108,891. FILED 8-14-2000. PRINCIPAL REGISTER.

RACE BEYOND BORDERS

PRIORITY CLAIMED UNDER SEC. 44(D) ON FED REP
GERMANY APPLICATION NO. 3001197.525, FILED 2-15-
2000, REG. NO. 3001197, DATED 3-20-2000.
INT. CL. 25/U.S. CLS. 22 AND 39

FOR CLOTHING, NAMELY, COATS, TOPCOATS, OVERALLS, PANTS, SHIRTS, PULLOVERS, SKIRTS, SWEATERS, SUITS, SOCKS, ANORAKS, ATHLETIC UNIFORMS, PARKAS, BLAZERS, SHORTS, LEOTARDS, SWEAT SUITS, SWEAT BANDS, BODY SUITS, CARDIGANS, UNDERWEAR, VISORS, BLOUSES, T-SHIRTS, SWEATSHIRTS, TRACK SUITS, LEGGINGS, FOOTWEAR AND HEADWEAR.

FIRST USE ; IN COMMERCE .

INT. CL. 28/U.S. CLS. 22, 23, 38 AND 50

FOR PUPPETS; PLUSH TOYS; PLAYING BALLS, NAMELY, FOOTBALLS, BASKETBALLS, VOLLEYBALLS; PARLOR GAMES; BOARD GAMES; CARD GAMES; TOSS GAMES, NAMELY, DARTS; ARCADE GAMES; PUZZLES; TOY MOBILES; TOY MODEL VEHICLES; TOY FIGURES; TOY MODEL BICYCLES; AND [GYMNASTIC] * GYMNASTICS * AND SPORTING ARTICLES, NAMELY, STATIONARY EXERCISE BICYCLES, ROLLERS FOR STATIONARY EXERCISE BICYCLES, SKIS, SURFBOARDS, AEROBIC STEPS, ELBOW GUARDS FOR ATHLETIC USE, BICYCLING GLOVES, BICYCLE TAGS, EXERCISE MACHINES, HANDLE GRIPS FOR SPORTING EQUIPMENT, SPORT GOGGLES FOR USE IN BIKING.

FIRST USE ; IN COMMERCE .

INT. CL. 41/U.S. CLS. 100, 101 AND 107

FOR EDUCATIONAL SERVICES, NAMELY, CONDUCTING CLASSES, SEMINARS AND WORKSHOPS IN THE FIELD OF [GYMNASTIC] * GYMNASTICS * , BIKE RACES AND SPORTS; AND ENTERTAINMENT SERVICES IN THE NATURE OF BICYCLE RACES, BIKE COMPETITIONS, ARRANGING AND CONDUCTING ATHLETIC COMPETITIONS, ORGANIZING SPORTING AND CULTURAL EVENTS.

FIRST USE ; IN COMMERCE .

ELEMENTS AMENDED
GOODS/SERVICES

2,715,740. REG. 5-13-2003. PROCTER & GAMBLE COMPANY, THE (OHIO CORPORATION) ONE PROCTER & GAMBLE PLAZA, CINCINNATI, OH, 45202, SN 78-017,460. FILED P.R. 7-19-2000; AM. S.R. 7-2-2001. SUPPLEMENTAL REGISTER.

SPRAY, TUG AND SMOOTH AWAY WRINKLES

INT. CL. 3/U.S. CLS. 1, 4, 6, 50, 51 AND 52

FOR SPRAY TREATMENT FOR THE CARE AND DEWRINKLING OF CLOTHING AND FABRICS, NAMELY FABRIC SOFTENERS.

FIRST USE 8-14-2000; IN COMMERCE 8-14-2000.

ELEMENTS CORRECTED
AMENDED REGISTER
REGISTER
AMENDED REGISTER

2,721,774. REG. 6-3-2003. PHYSICIANS FORMULA COSMETICS, INC. (DELAWARE CORPORATION) 1055 WEST EIGHTH STREET, AZUSA, CA, 91702, SN 75-886,756. FILED 1-4-2000. PRINCIPAL REGISTER.

SUMMER ECLIPSE

OWNER OF U.S. REG. NO. 2,550,786.

INT. CL. 3/U.S. CLS. 1, 4, 6, 50, 51 AND 52

FOR COSMETICS; NAMELY, POWDER FOR THE FACE AND BODY.

FIRST USE 7-6-2000; IN COMMERCE 7-6-2000.

ELEMENTS CORRECTED
CITIZENSHIP

2,738,659. REG. 7-15-2003. HI-VAC CORPORATION (OHIO CORPORATION) 117 INDUSTRY ROAD, MARIETTA, OH, 457509355, SN 76-361,426. FILED 1-22-2002. PRINCIPAL REGISTER.

X-VAC

INT. CL. 7/U.S. CLS. 13, 19, 21, 23, 31, 34 AND 35

FOR WATER AND VACUUM POWERED TRENCH DIGGER.

FIRST USE 12-3-2002; IN COMMERCE 12-3-2002.

ELEMENTS CORRECTED
MARK

2,741,925. REG. 7-29-2003. PHYSICIANS FORMULA COSMETICS, INC. (DELAWARE CORPORATION) 1055 WEST EIGHTH STREET, AZUSA, CA, 91702, SN 78-141,244. FILED 7-3-2002. PRINCIPAL REGISTER.

VIRTUAL LIPS

OWNER OF U.S. REG. NOS. 2,526,119, 2,598,226 AND 2,640,888.

NO CLAIM IS MADE TO THE EXCLUSIVE RIGHT TO USE "LIPS", APART FROM THE MARK AS SHOWN.

INT. CL. 3/U.S. CLS. 1, 4, 6, 50, 51 AND 52

FOR LIP GLOSS, LIP LINER, LIP COLOR.

FIRST USE 5-23-2002; IN COMMERCE 5-23-2002.

ELEMENTS CORRECTED
CITIZENSHIP

2,745,344. REG. 7-29-2003. VINA ERRAZURIZ S.A. (CHILE CORPORATION) EDIF. WORLD TRADE CENTER, AV. NUEVA TAJMAR N 481, OF. N 503, TORRE SUR, 5 PISO, LAS CONDES, SANTIAGO, CHILE., SN 76-189,638. FILED P.R. 1-4-2001; AM. S.R. 4-2-2003. SUPPLEMENTAL REGISTER.

VIÑEDO CHADWICK

OWNER OF CHILE REG. NO. 586586, DATED 12-29-2000, EXPIRES 12-29-2010.

NO CLAIM IS MADE TO THE EXCLUSIVE RIGHT TO USE "VINEDO", APART FROM THE MARK AS SHOWN.

THE ENGLISH TRANSLATION OF "VINEDO" IS "VINEYARD".

INT. CL. 33/U.S. CLS. 47 AND 49

FOR WINES.

ELEMENTS CORRECTED
OWNER ADDRESS

2,752,160. REG. 8-19-2003. VERDERA OY (FINLAND COMPANY INCORPORATED IN FINLAND) RIIHITONTUNTIE 14 A, ESPOO, FINLAND, 02200, SN 76-396,841. FILED 4-17-2002. PRINCIPAL REGISTER.

VERDERA

PRIORITY CLAIMED UNDER SEC. 44(D) ON FINLAND APPLICATION NO. T200103495, FILED 11-22-2001, REG. NO. 225288, DATED 9-30-2002, EXPIRES 9-30-2012.

INT. CL. 1/U.S. CLS. 1

FOR PLANT GROWTH PROMOTERS OF BIOLOGICAL ORIGIN FOR USE IN AGRICULTURE, HORTICULTURE [OF] *OR* FORESTRY.

FIRST USE ; IN COMMERCE .

INT. CL. 5/U.S. CLS. 6, 18, 44, 46, 51 AND 52

FOR BIOPESTICIDES, BIOFUNGICIDES, BIOINSECTICIDES, BIOACARICIDES AND BIOHERBICIDES FOR PREVENTING OR CONTROLLING DISEASES, INSECTS, MITES AND WEEDS AND PROMOTING HEALTH AND VIGOR FOR DOMESTIC AND COMMERCIAL USE IN AGRICULTURE, HORTICULTURE OR FORESTRY.

FIRST USE ; IN COMMERCE .

ELEMENTS CORRECTED
CITIZENSHIP
GOODS/SERVICES

2,754,830. REG. 8-26-2003. AESCULAPIAN INCORPORATED (MINNESOTA CORPORATION) 1446 BELL OAKS LN. SW, ROCHESTER, MN, 55902, SN 76-009,063. FILED 3-24-2000. PRINCIPAL REGISTER.



THE CROSS DESIGN PORTION OF THE MARK IS NOT DISPLAYED IN RED OR ORANGE OR IN WHOLE OR IN PART IN WHITE ON A BACKGROUND SOLELY OF SHADES OF RED OR ORANGE, OR IN ANY COMBINATION THEREOF.

INT. CL. 42/U.S. CLS. 100 AND 101

FOR PROVIDING HEALTH CARE INFORMATION AND CONSULTATION VIA VIDEO CONFERENCE, TELEPHONE AND THE INTERNET.

FIRST USE 1-12-2000; IN COMMERCE 1-12-2000.

ELEMENTS AMENDED
DESCRIPTION OF MARK

2,766,046. REG. 9-23-2003. TRANSTECHNOLOGY CORPORATION (DELAWARE CORPORATION) 700 LIBERTY AVENUE, P.O. BOX 3300, UNION, NJ, 070838198, SN 76-038,427. FILED 5-2-2000. PRINCIPAL REGISTER.

TRANSTECHNOLOGY

INT. CL. 6/U.S. CLS. 2, 12, 13, 14, 23, 25 AND 50

FOR METAL FASTENING DEVICES, NAMELY, SINGLE AND MULTI-THREADED FASTENERS; ASSEMBLY FASTENERS; LOCK NUTS; PUSH-NUTS; U-NUTS; EXTERNALLY THREADED FASTENERS; SOLID RIVETS; NUTS AND BOLTS; NUTS FOR SCREWS AND BOLTS; HOSE, WIRE, TUBE AND CABLE CLAMPS; LOCKING CLIPS; ELECTRICAL COIL TUBE CLIPS OR FASTENERS; ELECTRICAL COIL TUBE CAPS; COLD HEADED FASTENERS.

FIRST USE 9-8-1993; IN COMMERCE 9-8-1993.

INT. CL. 20/U.S. CLS. 2, 13, 22, 25, 32 AND 50

FOR NON-METAL HARDWARE, NAMELY, PLASTIC NUTS.

FIRST USE 9-0-1999; IN COMMERCE 9-0-1999.

ELEMENTS CORRECTED
OWNER ADDRESS

2,770,397. REG. 9-30-2003. PHYSICIANS FORMULA COSMETICS, INC. (DELAWARE CORPORATION) 1055 WEST EIGHTH STREET, AZUSA, CA, 91702, SN 78-135,953. FILED 6-14-2002. PRINCIPAL REGISTER.

LASH-IN-A-TUBE

INT. CL. 3/U.S. CLS. 1, 4, 6, 50, 51 AND 52
FOR COSMETICS.

FIRST USE 12-10-2002; IN COMMERCE 12-10-2002.

ELEMENTS CORRECTED
CITIZENSHIP

2,772,149. REG. 10-7-2003. NATIONAL APERTURE, INC. (NEW HAMPSHIRE CORPORATION) 26 KEEMAYDIN DRIVE, SUITE B, SALEM, NH, 03079, SN 76-197,147. FILED 1-12-2001. PRINCIPAL REGISTER.

NAI

INT. CL. 7/U.S. CLS. 13, 19, 21, 23, 31, 34 AND 35

FOR MULTI-DIRECTIONAL WORK PLATFORMS FOR MICRO-POSITIONING, AND PARTS FOR MICRO-POSITIONING PLATFORMS, NAMELY, MINIATURE POSITIONERS AND PRECISION MICRO-APERTURES.

FIRST USE 5-31-2003; IN COMMERCE 5-31-2003.

INT. CL. 9/U.S. CLS. 21, 23, 26, 36 AND 38

FOR COMPUTER SOFTWARE PROGRAMS FOR USE WITH MOTION CONTROL AND MICRO-POSITIONING PLATFORMS.

FIRST USE 12-31-2002; IN COMMERCE 12-31-2002.

INT. CL. 42/U.S. CLS. 100 AND 101

FOR ENGINEERING SERVICES IN THE FIELDS OF MICRO-APERTURES, MINIATURES, MINIATURE POSITIONERS AND MOTION CONTROL.

FIRST USE 0-0-1998; IN COMMERCE 0-0-1998.

ELEMENTS CORRECTED
DATE OF FIRST USE
DATE OF FIRST USE IN COMMERCE

2,801,528. REG. 12-30-2003. PHYSICIANS FORMULA COSMETICS, INC. (DELAWARE CORPORATION) 1055 WEST EIGHTH STREET, AZUSA, CA, 91702, SN 78-203,188. FILED 1-14-2003. PRINCIPAL REGISTER.

BAKED BRONZER

NO CLAIM IS MADE TO THE EXCLUSIVE RIGHT TO USE "BRONZER", APART FROM THE MARK AS SHOWN.
INT. CL. 3/U.S. CLS. 1, 4, 6, 50, 51 AND 52
FOR COSMETICS.
FIRST USE 3-1-2003; IN COMMERCE 3-1-2003.

ELEMENTS CORRECTED
CITIZENSHIP

FOR CLEANING MACHINE, AND CHEMICAL AGENTS SOLD AS A UNIT THEREWITH, FOR CLEANING UV FLUID TREATMENT EQUIPMENT FOR INDUSTRIAL, COMMERCIAL AND MUNICIPAL USE .
FIRST USE 3-1-2002; IN COMMERCE 3-1-2002.

ELEMENTS CORRECTED
[FOREIGN COUNTRY OF ORIGIN]
[FOREIGN APPLICATION NO.]
[FOREIGN APPLICATION FILING DATE]
[PRIORITY CLAIMED STATEMENT]

2,803,685. REG. 1-6-2004. PHYSICIANS FORMULA COSMETICS, INC. (DELAWARE CORPORATION) 1055 WEST EIGHTH STREET, AZUSA, CA, 91702, SN 78-143,505. FILED 7-12-2002. PRINCIPAL REGISTER.

CHAR-KOHL

NO CLAIM IS MADE TO THE EXCLUSIVE RIGHT TO USE "CHARCOAL ", APART FROM THE MARK AS SHOWN.
INT. CL. 3/U.S. CLS. 1, 4, 6, 50, 51 AND 52
FOR COSMETICS.
FIRST USE 12-30-2002; IN COMMERCE 12-30-2002.

ELEMENTS CORRECTED
CITIZENSHIP

2,818,418. REG. 2-24-2004. PHYSICIANS FORMULA COSMETICS, INC. (DELAWARE CORPORATION) 1055 WEST EIGHTH STREET, AZUSA, CA, 91702, SN 78-146,709. FILED 7-23-2002. PRINCIPAL REGISTER.

LOOSE-TO-GO

INT. CL. 3/U.S. CLS. 1, 4, 6, 50, 51 AND 52
FOR COSMETICS.
FIRST USE 12-30-2002; IN COMMERCE 12-30-2002.

2,805,872. REG. 1-13-2004. PHYSICIANS FORMULA COSMETICS, INC. (DELAWARE CORPORATION) 1055 WEST EIGHTH STREET, AZUSA, CA, 91702, SN 78-163,453. FILED 9-12-2002. PRINCIPAL REGISTER.

VIRTUAL FACE POWDER

OWNER OF U.S. REG. NOS. 2,526,119 AND 2,598,226.
NO CLAIM IS MADE TO THE EXCLUSIVE RIGHT TO USE "FACE POWDER", APART FROM THE MARK AS SHOWN.
INT. CL. 3/U.S. CLS. 1, 4, 6, 50, 51 AND 52
FOR COSMETICS.
FIRST USE 12-28-2002; IN COMMERCE 12-28-2002.

ELEMENTS CORRECTED
CITIZENSHIP

ELEMENTS CORRECTED
CITIZENSHIP

2,824,286. REG. 3-23-2004. SIMPSON, CHRISTOPHER (UNITED KINGDOM INDIVIDUAL) 61 CLAPHAM COMMON NORTHSIDE, LONDON, ENGLAND, UNITED KINGDOM, SW4 9SA, SN 76-068,327. FILED 6-12-2000. PRINCIPAL REGISTER.

2,806,954. REG. 1-20-2004. TROJAN TECHNOLOGIES INC. (CANADA CORPORATION) 3020 GORE ROAD, LONDON, ONTARIO, CANADA, N5V 4T7, SN 76-177,300. FILED 12-7-2000. PRINCIPAL REGISTER.

ACTICLEAN

PRIORITY CLAIMED UNDER SEC. 44(D) ON CANADA APPLICATION NO. 1085216, FILED 12-6-2000.
INT. CL. 7/U.S. CLS. 13, 19, 21, 23, 31, 34 AND 35

ITSFRIDAY

PRIORITY CLAIMED UNDER SEC. 44(D) ON ERPNTY TM OFC APPLICATION NO. 1,425,446, FILED 12-10-1999, REG. NO. 1425446, DATED 6-17-2003, EXPIRES 6-17-2013.
INT. CL. 9/U.S. CLS. 21, 23, 26, 36 AND 38

FOR SCIENTIFIC, NAUTICAL, SURVEYING, ELECTRIC, PHOTOGRAPHIC, CINEMATOGRAPHIC, OPTICAL, WEIGHING, SIGNALING AND TEACHING APPARATUS AND INSTRUMENTS, NAMELY, COMPUTERS, HANDHELD PERSONAL COMPUTERS, LAPTOP COMPUTERS, NOTEBOOK COMPUTERS; PERSONAL DIGITAL ASSISTANT COMPUTERS; APPARATUS FOR RECORDING, TRANSMISSION OR REPRODUCTION OF SOUND, IMAGES AND/OR DATA NAMELY, RADIO PAGERS, PERSONAL RADIO SETS; TELEVISION SETS AND CELLULAR TELEPHONES; MAGNETIC DATA CARRIERS FEATURING INFORMATION ABOUT ENTERTAINMENT AND RECREATION; COMPUTER DISCS FEATURING INFORMATION ABOUT ENTERTAINMENT AND RECREATION; CALCULATORS, DATA PROCESSORS; COMPUTER SOFTWARE[:] *AND* COMPUTER PROGRAMS *FOR SEARCHING AND RETRIEVING INFORMATION, SITES AND OTHER RESOURCES ON COMPUTER NETWORKS; COMPUTER SOFTWARE AND COMPUTER PROGRAMS CONTAINING A DIRECTORY OF INFORMATION, SITES AND OTHER RESOURCES ON COMPUTER NETWORKS; PUBLICATIONS IN ELECTRONIC FORM ON THE TOPIC OF CATERING SERVICES, DINING OUT, DRINKING OUT, BAR SERVICES, PUBLIC HOUSE SERVICES, DRINKING AND/OR DRINKING ESTABLISHMENTS;* ; COMPUTER SOFTWARE AND PUBLICATIONS IN ELECTRONIC FORM; COMPUTER SOFTWARE AND PUBLICATIONS IN ELECTRONIC FORM SUPPLIED ONLINE FROM DATABASES OR FROM FACILITIES PROVIDED ON THE INTERNET FEATURING INFORMATION ABOUT ENTERTAINMENT AND RECREATION; COMPUTER SOFTWARE USED FOR CONNECTING TO DATABASES AND THE INTERNET; COMPUTER SOFTWARE TO ENABLE SEARCHING OF DATA; COMPUTER SOFTWARE FOR USE IN LOCATING, RETRIEVING AND RECEIVING TEXT, ELECTRONIC DOCUMENTS, GRAPHICS AND AUDIO VISUAL INFORMATION; PRE-RECORDED AUDIO CASSETTES AND VIDEO TAPES, COMPACT DISCS, CD-ROMS, INTERACTIVE CD-ROMS AND DVDS FEATURING INFORMATION ABOUT ENTERTAINMENT AND RECREATION.

FIRST USE ; IN COMMERCE .

INT. CL. 35/U.S. CLS. 100, 101 AND 102

FOR DISSEMINATION OF ADVERTISING MATTER FOR OTHERS; ADVERTISING AGENCIES, NAMELY, PROMOTING THE SERVICES OF INDIVIDUALS AND COMPANIES IN THE ENTERTAINMENT AND RECREATION INDUSTRY THROUGH THE DISTRIBUTION OF PRINTED AND AUDIO PROMOTIONAL [MATERIAL] *MATERIALS* AND BY RENDERING SALES PROMOTION ADVICE; ORGANIZING EXHIBITIONS FOR ENTERTAINMENT AND RECREATION; PUBLICITY AGENTS; EMPLOYMENT AND PERSONNEL RECRUITMENT AND INFORMATION SERVICES RELATING THERETO, NAMELY THE AFOREMENTIONED SERVICES PROVIDED ONLINE FROM A COMPUTER [A COMPUTER] DATABASE OR THE INTERNET; BUSINESS INFORMATION IN RELATION TO ENTERTAINMENT AND RECREATION; PREPARING AND PLACING ADVERTISEMENTS FOR OTHERS *FOR USE ON WEB PAGES ON THE INTERNET; BUSINESS INFORMATION IN RELATION TO ENTERTAINMENT AND RECREATION AND DISSEMINATION OF ADVERTISING FOR OTHERS* VIA THE INTERNET; ONLINE ORDERING SERVICES FEATURING ENTERTAINMENT AND RECREATION; AUCTIONEERING SERVICES PROVIDED ON THE INTERNET; ELECTRONIC BILLBOARD ADVERTISING; PROVIDING ADVERTISING SPACE IN ELECTRONIC PUBLICATIONS AND ON WEB SITES; PROVIDING ADVERTISING SPACE ON THE INTERNET; MARKET RESEARCH SERVICES; CONSULTING, INFORMATION AND ADVISORY SERVICES RELATING TO THE AFORESAID; PROVIDING ONLINE DIRECTORY INFORMATION SERVICES ALSO FEATURING HYPERLINKS TO OTHER WEBSITES; PROVIDING SPACE AT A WEB SITE FOR THE ADVERTISEMENT OF THE GOODS AND SERVICES OF OTHERS.

FIRST USE ; IN COMMERCE .

INT. CL. 36/U.S. CLS. 100, 101 AND 102

FOR INSURANCE CONSULTATION, FINANCIAL INFORMATION PROVIDED BY ELECTRONIC MEANS, MONETARY EXCHANGE SERVICES AND PROVIDING INFORMATION IN THE FIELD OF REAL ESTATE BY MEANS OF LINKING THE WEB SITE TO OTHER WEB SITES FEATURING REAL ESTATE INFORMATION.

FIRST USE ; IN COMMERCE .

INT. CL. 38/U.S. CLS. 100, 101 AND 104

FOR [ROVIDING] *PROVIDING* TELECOMMUNICATIONS CONNECTIONS TO A GLOBAL COMPUTER NETWORK; ELECTRONIC MAIL SERVICES; ELECTRONIC TRANSMISSION OF DATA VIA COMPUTER AND COMMUNICATION NETWORKS; ELECTRONIC ORDER TRANSMISSION SERVICES ELECTRONIC TRANSMISSION OF DATA VIA THE INTERNET; COMPUTER AIDED TRANSMISSION OF MESSAGES AND IMAGES; PROVIDING TELECOMMUNICATION ACCESS AND LINKS TO COMPUTER DATABASES AND THE INTERNET; PROVIDING ACCESS TO THE INTERNET; PROVIDING ACCESS TO DATA, INCLUDING TEXT, GRAPHICS, ELECTRONIC DOCUMENTS, DATABASES, GRAPHICS AND AUDIO VISUAL INFORMATION, VIA THE INTERNET; NEWS GROUP SERVICES, NAMELY, PROVIDING ACCESS TO AN AREA OF A GLOBAL COMPUTER NETWORK, ESPECIALLY THE INTERNET, DEVOTED TO THE DISCUSSION OF ENTERTAINMENT AND RECREATION; CONSULTING SERVICES, INFORMATION AND ADVISORY SERVICES RELATING TO THE AFORESAID; PROVIDING ACCESS TO AND LEASING ACCESS TIME TO A COMPUTER DATABASE.

FIRST USE ; IN COMMERCE .

INT. CL. 39/U.S. CLS. 100 AND 105

FOR TRANSPORTATION RESERVATION SERVICES; PROVIDING TRAVEL INFORMATION SERVICES.

FIRST USE ; IN COMMERCE .

INT. CL. 41/U.S. CLS. 100, 101 AND 107

FOR EDUCATIONAL SERVICES, NAMELY, CONDUCTING CLASSES, SEMINARS, CONFERENCES AND WORKSHOPS IN THE FIELD OF ENTERTAINMENT AND RECREATION AND THE DISTRIBUTION OF COURSE MATERIALS IN CONNECTION THEREWITH; ENTERTAINMENT SERVICES, NAMELY **PROVIDING A WEBSITE FEATURING MUSICAL PERFORMANCES, MUSICAL VIDEOS, RELATED FILM CLIPS, PHOTOGRAPHS AND OTHER MULTIMEDIA MATERIALS; ENTERTAINMENT SERVICES, NAMELY ** PROVIDING ONLINE LISTINGS AND REVIEWS OF GEOGRAPHICAL LOCATIONS, PLACES OF INTEREST, SHOPS, MARKETS, TRAINING, EVENTS, HOLIDAYS, THE ARTS, CONFERENCES, EXHIBITIONS,[COMPLETIONS] *COMPETITIONS,* CONTESTS, CARNIVALS, PAGEANTS, DISPLAYS, CULTURAL EVENTS, SHOWS, FASHION SHOWS, PROGRAMS, SPORTING EVENTS, RADIO AND TELEVISION PROGRAMS, PERFORMANCES AND CONSUMER NEWS; PROVIDING INFORMATION RELATING TO EDUCATION AS A [SERVICES] *SERVICE* TO OTHERS; PROVIDING RESERVATION SERVICES FOR OTHERS, ONLINE FROM A COMPUTER DATABASE OR THE INTERNET IN RESPECT OF EDUCATION SERVICES, ENTERTAINMENT, RECREATION, CULTURE, CINEMA, CONCERT, THEATRE; MOTION PICTURE FILM PRODUCTION; AUDIO RECORDING AND PRODUCTION; RECORDING STUDIO SERVICES; *PUBLICATION OF BOOKS, BROCHURES, JOURNALS, LEAFLETS, MAGAZINES, MANUALS, PUBLICITY TEXTS AND TEXT BOOKS; ELECTRONIC PUBLISHING SERVICES, NAMELY,* PUBLICATION OF TEXT AND GRAPHIC WORKS OF OTHERS ON CD-ROMS FEATURING ENTERTAINMENT AND RECREATION.

FIRST USE ; IN COMMERCE .

INT. CL. 42/U.S. CLS. 100 AND 101

FOR COMPUTER SERVICES, NAMELY PROVIDING SEARCH ENGINES FOR OBTAINING DATA ON A GLOBAL COMPUTER NETWORK; COMPUTER SERVICES, NAMELY, DESIGNING AND IMPLEMENTING WEBSITES FOR OTHERS; TRAVEL AGENCY SERVICES, NAMELY, MAKING RESERVATIONS AND BOOKINGS FOR TRANSPORTATION; MAKING HOTEL RESERVATIONS FOR OTHERS; COMPUTER SERVICES, NAMELY PROVIDING DATABASES FEATURING GENERAL AND LOCAL NEWS, AND INFORMATION OF INTEREST TO SPECIFIC GEOGRAPHICAL AREAS; INFORMATION SERVICES, NAMELY, PROVIDING ONLINE LISTINGS AND LISTINGS REVIEWS OF HEALTH SERVICES INSTITUTIONS, ACCOMMODATIONS, HOTELS, CATERING SERVICES, RESTAURANTS, BARS, PUBLIC HOUSES, FASHION NEWS, PERSONAL SERVICES AND HAIRDRESSING SALONS; COMPUTER PROGRAMMING FOR OTHERS; COMPUTER NETWORK DESIGN FOR OTHERS AND COMPUTER SITE AND WEB DESIGN.

FIRST USE ; IN COMMERCE .

ELEMENTS CORRECTED
GOODS/SERVICES

2,829,068. REG. 4-6-2004. PINSKE, LOTHAR (FED REP GERMANY INDIVIDUAL) WILHELMSHOHER STRASSE 36B, VELBERT, FED REP GERMANY, 42555, AND AMERSHLAGER, THOMAS (FED REP GERMANY INDIVIDUAL) LEBZELTER STRASSE 4B, MUNCHEN, FED REP GERMANY, 81827, SN 76-350,723. FILED 12-19-2001. PRINCIPAL REGISTER.

The logo for V8STAR features the word "V8STAR" in a bold, black, sans-serif font. The number "8" is stylized with two white stars on either side, and the "V" has a white star on its right side.

PRIORITY CLAIMED UNDER SEC. 44(D) ON FED REP GERMANY APPLICATION NO. 30138215.8, FILED 6-25-2001, REG. NO. 30138215, DATED 8-29-2001.

INT. CL. 9/U.S. CLS. 21, 23, 26, 36 AND 38

FOR VIDEO GAME DISCS AND CARTRIDGES.

FIRST USE ; IN COMMERCE .

INT. CL. 12/U.S. CLS. 19, 21, 23, 31, 35 AND 44

FOR FOUR-WHEELED VEHICLES FOR CAR-RACING AND THEIR COMPONENTS, NAMELY SPACE FRAME FOR THE BODY STRUCTURE, PARTS OF SUCH SPACE FRAME, BODY SHELL, DRIVE TRAIN INCLUDING ENGINE, CLUTCH, GEARBOX, SHAFTS, DIFFERENTIAL GEAR, WHEELS, TIRES, STEERING WHEELS, GEARSHIFT KNOBS AND SUSPENSIONS COMPONENTS, NAMELY SHOCKS, SPRINGS, TORSION BARS, SUSPENSION ARMS, SUSPENSION STRUTS .

FIRST USE ; IN COMMERCE .

INT. CL. 16/U.S. CLS. 2, 5, 22, 23, 29, 37, 38 AND 50

FOR PAPER FLAGS * AND PLAYING CARDS*.

FIRST USE ; IN COMMERCE .

INT. CL. 18/U.S. CLS. 1, 2, 3, 22 AND 41

FOR UMBRELLAS, PARASOLS AND WALKING STICKS.

FIRST USE ; IN COMMERCE .

INT. CL. 21/U.S. CLS. 2, 13, 23, 29, 30, 33, 40 AND 50

FOR GLASSWARE, PORCELAIN AND EARTHENWARE, NAMELY PLATES, CUPS, BOWLS, VASES, DISHES AND MUGS.

FIRST USE ; IN COMMERCE .

INT. CL. 25/U.S. CLS. 22 AND 39

FOR CLOTHING, NAMELY HEADWEAR, NAMELY HATS AND CAPS; FOOTWEAR, NAMELY SHOES, SOCKS AND STOCKINGS; AND BODYWEAR, NAMELY SHIRTS, PANTS, PULLOVERS, TROUSERS, SCARVES, ANORAKS, JACKETS, PARKAS, BLOUSES, VESTS AND UNDERWEAR.

FIRST USE ; IN COMMERCE .

INT. CL. 28/U.S. CLS. 22, 23, 38 AND 50

FOR GAMES AND PLAYTHINGS, NAMELY MODEL [AUTOMOBILES] * CARS OF EXISTING RACING CARS TAKING PART OR HAVING TAKEN PART IN RACES WITH AN EMBLEM INCLUDING THE EXPRESSIONS V8 AND STAR *, YO-YOS, PLAYGROUND BALLS, BOARD GAMES, [AND PLAYING CARDS].

FIRST USE ; IN COMMERCE .
INT. CL. 41/U.S. CLS. 100, 101 AND 107

FOR ENTERTAINMENT IN THE NATURE OF CAR RACING AND SPORTING ACTIVITIES IN CONNECTION WITH CAR RACING; REPORTING ON SPORTING ACTIVITIES INCLUDING REPORTING VIA THE GLOBAL COMPUTER NETWORK; AND ORGANIZING AND CONDUCTING CULTURAL ACTIVITIES IN CONNECTION WITH CAR RACING, NAMELY CAR EXHIBITIONS, SHOWS, ORCHESTRA PERFORMANCES AND COMMUNITY FESTIVALS.

FIRST USE ; IN COMMERCE .
INT. CL. 42/U.S. CLS. 100 AND 101

FOR LEASING RADIO AND TELEVISION RIGHTS FOR THE COVERAGE OF SPORTING ACTIVITIES; LICENSING REPORTING RIGHTS ON SPORTING ACTIVITIES INCLUDING RIGHTS ON REPORTING VIA THE GLOBAL NETWORK.

FIRST USE ; IN COMMERCE .

ELEMENTS AMENDED
GOODS/SERVICES

2,830,906. REG. 4-6-2004. PHYSICIANS FORMULA COSMETICS, INC. (DELAWARE CORPORATION) 1055 WEST EIGHTH STREET, AZUSA, CA, 91702, SN 78-203,185. FILED 1-14-2003. PRINCIPAL REGISTER.

**YOUR EYES WON'T BELIEVE
YOUR FACE**

INT. CL. 3/U.S. CLS. 1, 4, 6, 50, 51 AND 52
FOR COSMETICS.

FIRST USE 4-14-2003; IN COMMERCE 4-14-2003.

ELEMENTS CORRECTED
CITIZENSHIP

2,833,112. REG. 4-13-2004. PHYSICIANS FORMULA COSMETICS, INC. (DELAWARE CORPORATION) 1055 WEST EIGHTH STREET, AZUSA, CA, 91702, SN 78-125,514. FILED 5-1-2002. PRINCIPAL REGISTER.

WANDERFUL WAND

INT. CL. 3/U.S. CLS. 1, 4, 6, 50, 51 AND 52
FOR COSMETICS.

FIRST USE 12-14-2002; IN COMMERCE 12-14-2002.

ELEMENTS CORRECTED
CITIZENSHIP

2,837,152. REG. 4-27-2004. FRS TECHNOLOGIES LLC (DELAWARE LIMITED LIABILITY COMPANY) 51 LOCUST AVENUE, SUITE 302A, NEW CANAAN, CT, 06840, SN 78-046,118. FILED 2-1-2001. PRINCIPAL REGISTER.

2,852,079. REG. 6-8-2004. PHYSICIANS FORMULA COSMETICS, INC. (DELAWARE CORPORATION) 1055 WEST EIGHTH STREET, AZUSA, CA, 91702, SN 78-228,978. FILED 3-24-2003. PRINCIPAL REGISTER.

NEW SUN

FACE LACE

INT. CL. 5/U.S. CLS. 6, 18, 44, 46, 51 AND 52
FOR FOOD SUPPLEMENTS.
FIRST USE 1-0-2002; IN COMMERCE 1-0-2002.

INT. CL. 3/U.S. CLS. 1, 4, 6, 50, 51 AND 52
FOR COSMETICS.
FIRST USE 12-17-2003; IN COMMERCE 12-17-2003.

INT. CL. 32/U.S. CLS. 45, 46 AND 48
FOR BEVERAGES, NAMELY, [CARBONATED AND NON-CARBONATED MINERAL WATER AND TABLE WATER;] ISOTONIC DRINKS,[HYPERTONIC DRINKS AND HYPOTONIC DRINKS, NON-ALCOHOLIC CORDIALS; SMOOTHIES, FRUIT JUICES, FRUIT NECTARS,] FRUIT DRINKS, [SHANDIES,] SOFT DRINKS,[COLAS, POP, LEMONADE,] ENERGY DRINKS, AND SPORT DRINKS; [NON-ALCOHOLIC PREPARED COCKTAIL MIXES; BEER-BASED COOLERS; FLAVORED BREWED MALT-BASED ALCOHOLIC BEVERAGES IN THE NATURE OF BEER].
FIRST USE 8-0-2001; IN COMMERCE 8-0-2001.

ELEMENTS CORRECTED
CITIZENSHIP

ELEMENTS AMENDED
GOODS/SERVICES
OWNER ADDRESS

2,852,080. REG. 6-8-2004. PHYSICIANS FORMULA COSMETICS, INC. (DELAWARE CORPORATION) 1055 WEST EIGHTH STREET, AZUSA, CA, 91702, SN 78-230,386. FILED 3-26-2003. PRINCIPAL REGISTER.

CONCEALER 101

2,846,865. REG. 5-25-2004. PHYSICIANS FORMULA COSMETICS, INC. (DELAWARE CORPORATION) 1055 W. EIGHTH STREET, AZUSA, CA, 91702, SN 78-221,206. FILED 3-4-2003. PRINCIPAL REGISTER.

NO CLAIM IS MADE TO THE EXCLUSIVE RIGHT TO USE "CONCEALER", APART FROM THE MARK AS SHOWN.
INT. CL. 3/U.S. CLS. 1, 4, 6, 50, 51 AND 52
FOR COSMETICS.
FIRST USE 11-24-2003; IN COMMERCE 11-24-2003.

ELEMENTS CORRECTED
CITIZENSHIP

MAGIC CUBE

INT. CL. 3/U.S. CLS. 1, 4, 6, 50, 51 AND 52
FOR COSMETICS.
FIRST USE 12-17-2003; IN COMMERCE 12-17-2003.

ELEMENTS CORRECTED
CITIZENSHIP

2,862,536. REG. 7-13-2004. DESIGN DIVISION, INC. (CALIFORNIA CORPORATION) 1454 3RD STREET PROMENADE, SANTA MONICA, CA, 90401, SN 78-187,718. FILED 11-21-2002. PRINCIPAL REGISTER.

AROMAPHARMACY

2,852,078. REG. 6-8-2004. PHYSICIANS FORMULA COSMETICS, INC. (DELAWARE CORPORATION) 1055 WEST EIGHTH STREET, AZUSA, CA, 91702, SN 78-228,976. FILED 3-24-2003. PRINCIPAL REGISTER.

INT. CL. 3/U.S. CLS. 1, 4, 6, 50, 51 AND 52
FOR PERSONAL CARE PRODUCTS FOR MEN AND FOR WOMEN, NAMELY SHAVING CREAM, SHAVING GEL, PRE-SHAVING PREPARATIONS, NAMELY, OIL; NON-MEDICATED ASTRINGENT AFTER-SHAVE FOR COSMETIC PURPOSES, AFTER-SHAVE BALM, TOOTH-PASTE, PERSONAL DEODORANT, FACIAL AND BODY SCRUB, FACIAL CLEANSER, ANTI-WRINKLE CREAM, BODY CLEANSING GEL, BODY SCRUB, FACIAL SCRUB, SKIN TONER, HAND SOAP, HAND AND BODY LOTION, FACIAL LOTION, FACIAL MOISTURIZER, DEEP-PORE CLEANSING CLAY FACIAL MASK, LIP CREAM, EYE CREAM, SHAMPOO, HAIR CONDITIONER, HAIR SELF-TANNING LOTION, NON-MEDICATED MUSCLE RUB, COLOGNE, BRONZER, LIPSTICK, EYE LINER, AND MASCARA.
FIRST USE 9-27-2000; IN COMMERCE 9-27-2000.

STAR PERFECTION

OWNER OF U.S. REG. NOS. 2,371,937, 2,460,119 AND 2,650,551.
INT. CL. 3/U.S. CLS. 1, 4, 6, 50, 51 AND 52
FOR COSMETICS.
FIRST USE 12-29-2003; IN COMMERCE 12-29-2003.

ELEMENTS CORRECTED
CITIZENSHIP

ELEMENTS CORRECTED
ASSIGNMENT/NAME CHANGE

2,866,276. REG. 7-27-2004. LEVANTE S.P.A. (ITALY CORPORATION) VIALE AVIS 32 46042 CASTEL GOFFREDO, MANTOVA, ITALY., SN 76-515,604. FILED 5-20-2003. PRINCIPAL REGISTER.

LEVANTE

THE FOREIGN WORDING IN THE MARK TRANSLATES INTO ENGLISH AS "EAST OR RAISE".

INT. CL. 25/U.S. CLS. 22 AND 39

FOR PANTYHOSE, STOCKINGS, SOCK ANKLETS, KNEE HIGHS, KNEE SOCKS, LINGERIE, PANTIES, BRASSIERES, SOCKS, UNDERWEAR THONGS, TIGHTS, UNDERGARMENTS, UNDERPANTS, UNDERWEAR, BRIEFS, CAMISOLES, BODYWEAR, NAMELY, LEOTARDS AND TIGHTS AND HOSIERY.

FIRST USE 12-31-1969; IN COMMERCE 12-31-1999.

ELEMENTS CORRECTED
OWNER ADDRESS

FOR EDUCATION SERVICES, NAMELY, CLASSES, SEMINARS, CONFERENCES AND WORKSHOPS IN THE FIELD OF COMPUTER AND SOFTWARE TRAINING, WORD AND DATA PROCESSING.

FIRST USE ; IN COMMERCE .

INT. CL. 42/U.S. CLS. 100 AND 101

FOR PROFESSIONAL CONSULTATION IN THE FIELD OF INFORMATION TECHNOLOGY; COMPUTER CONSULTATION; COMPUTER PROGRAMMING FOR OTHERS.

FIRST USE ; IN COMMERCE .

ELEMENTS AMENDED
FOREIGN REG. EXPIRATION DATE

2,868,064. REG. 7-27-2004. FABASOFT AG (AUSTRIA JOINT STOCK CORPORATION) KARL LEITL STRASSE 1, 4040 PUCHNAU, AUSTRIA., SN 76-368,304. FILED P.R. 2-7-2002; AM. S.R. 3-24-2004. SUPPLEMENTAL REGISTER.

EGOV.NET

PRIORITY CLAIMED UNDER SEC. 44(D) ON AUSTRIA APPLICATION NO. AM6342/2001, FILED 9-5-2001, REG. NO. 201143, DATED 12-20-2001.

OWNER OF U.S. REG. NO. 2,596,167.

INT. CL. 9/U.S. CLS. 21, 23, 26, 36 AND 38

FOR COMPUTER SOFTWARE FOR BUSINESS PROCESS MANAGEMENT AND WORKFLOW MANAGEMENT, NAMELY, AUTOMATING, SYSTEMATIZING AND STRUCTURING THE ADMINISTRATION AND MANAGEMENT OF LARGE INDUSTRIAL ENTERPRISES AND PUBLIC AUTHORITIES, TELECOMMUNICATION ENTERPRISES, AND THE SERVICES INVOLVED WITH FINANCIAL AND PLANNING SERVICES; COMPUTER SOFTWARE FOR DOCUMENT AND INFORMATION MANAGEMENT, STORAGE, ARCHIVING AND RETRIEVAL; DATA PROCESSING EQUIPMENT, NAMELY, COMPUTER HARDWARE, KEYBOARDS, MONITORS, MOUSE, PRINTERS, SCANNERS AND COMPUTER PERIPHERALS; MAGNETIC DATA CARRIERS, NAMELY, PRE-RECORDED COMPACT DISCS FEATURING SOFTWARE FOR BUSINESS PROCESS MANAGEMENT AND WORKFLOW MANAGEMENT, NAMELY, AUTOMATING, SYSTEMATIZING AND STRUCTURING THE ADMINISTRATION AND MANAGEMENT OF LARGE INDUSTRIAL ENTERPRISES AND PUBLIC AUTHORITIES, TELECOMMUNICATION ENTERPRISES, AND THE SERVICES INVOLVED WITH FINANCIAL AND PLANNING SERVICES; COMPACT DISCS AND DVDS FOR DATA PROCESSING; COMPUTERS; COMPUTER SOFTWARE FOR USE IN DATABASE MANAGEMENT AND FOR WORD PROCESSING IN THE FIELDS OF BUSINESS PROCESS MANAGEMENT AND WORKFLOW MANAGEMENT, NAMELY, AUTOMATING, SYSTEMATIZING AND STRUCTURING THE ADMINISTRATION AND MANAGEMENT OF LARGE INDUSTRIAL ENTERPRISES AND PUBLIC AUTHORITIES, TELECOMMUNICATION ENTERPRISES, AND THE SERVICES INVOLVED WITH FINANCIAL AND PLANNING SERVICES.

FIRST USE ; IN COMMERCE .

INT. CL. 37/U.S. CLS. 100, 103 AND 106

FOR MAINTENANCE AND REPAIR OF COMPUTER HARDWARE.

FIRST USE ; IN COMMERCE .

INT. CL. 41/U.S. CLS. 100, 101 AND 107

2,868,391. REG. 8-3-2004. LANBOSS SOFTWARE LIMITED (UNITED KINGDOM LIMITED LIABILITY COMPANY) LANGROUP HOUSE, 14-16 MULFORDS HILL, TADLEY, HANTS RG26 3JA, ENGLAND., SN 76-423,514. FILED 6-18-2002. PRINCIPAL REGISTER.

LANboss

PRIORITY CLAIMED UNDER SEC. 44(D) ON UNITED KINGDOM APPLICATION NO. 2302118, FILED 6-1-2002, REG. NO. 2302118, DATED 6-1-2002, EXPIRES 6-1-2012.

INT. CL. 9/U.S. CLS. 21, 23, 26, 36 AND 38

FOR COMPUTER SOFTWARE AND DOWNLOADABLE SOFTWARE USED FOR REMOTE, CENTRAL MANAGEMENT CONTROL AND ADMINISTRATION OF IT NETWORK MANAGEMENT SYSTEMS DESIGNED TO MAKE MANAGING NETWORKED SYSTEMS EASIER, LESS TIME CONSUMING AND MORE COST EFFECTIVE; COMPACT DISCS FEATURING EXECUTABLE SOFTWARE, TECHNICAL REQUISITES FOR THE OPERATION AND LICENSING OF THE SOFTWARE, RESELLER AND DISTRIBUTOR GUIDANCE MATERIAL, INSTRUCTIONS AND AGREEMENTS, SOFTWARE LICENSING REQUISITES, TECHNICAL DOCUMENTATION, (NAMELY SOFTWARE SPECIFICATIONS, FUNCTIONAL SPECIFICATIONS, MINIMUM PLATFORM REQUIREMENTS, REPORTS, NOTES, EXTRACTS OR SCRIPTS OF TECHNICAL CODE AND TABLES, EXTRACTS OR SCRIPTS OF TECHNICAL PROCEDURES AND PROCESSES, TECHNICAL SPREADSHEETS, TECHNICAL USAGE INFORMATION, TECHNICAL LIBRARIES, UNIVERSAL NAMING CONVENTIONS AND TECHNICAL MANUALS), USER DOCUMENTATION (NAMELY GUIDANCE MATERIAL, HELP DOCUMENTS AND SCREEN LAYOUTS, EXAMPLE USAGE DESCRIPTIONS AND DEFINITIONS, EXTRACTS OR LISTS, FAQ'S, AND USER MANUALS) PRESENTATIONS, TRAINING COURSE MATERIAL, SALES, MARKETING AND PROMOTIONAL MATERIAL IN RESPECT OF THE SOFTWARE FOR USE BY THE SALES AND MARKETING PERSONNEL OF ITS THIRD PARTY RESELLERS AND DISTRIBUTORS, ALL RELATING TO THE ABOVE MENTIONED COMPUTER SOFTWARE AND DOWNLOADABLE SOFTWARE; PRE-RECORDED VIDEOS, AUDIO CASSETTES AND DVDS FEATURING TECHNICAL AND USER GUIDANCE MATERIAL (NAMELY SOFTWARE SPECIFICATIONS, FUNCTIONAL SPECIFICATIONS, MINIMUM PLATFORM REQUIREMENTS, REPORTS, NOTES, EXTRACTS OR SCRIPTS OF TECHNICAL CODE AND TABLES, EXTRACTS OR SCRIPTS OF TECHNICAL PROCEDURES AND PROCESSES, TECHNICAL SPREADSHEETS, TECHNICAL USAGE INFORMATION, TECHNICAL LIBRARIES, UNIVERSAL NAMING CONVENTIONS AND TECHNICAL MANUALS), HELP DOCUMENTS AND SCREEN LAYOUTS, EXAMPLE USAGE DESCRIPTIONS AND DEFINITIONS, EXTRACTS OR LISTS, FAQ'S, AND USER MANUALS, RESELLER AND DISTRIBUTOR GUIDANCE MATERIAL, PRESENTATIONS, TRAINING COURSE MATERIAL, SALES, MARKETING AND PROMOTIONAL MATERIAL, NAMELY VIDEOS, CD'S, DVD'S, AUDIO CASSETTES, DEMONSTRATION COPIES OF SOFTWARE AND EVALUATION COPIES OF SOFTWARE AND MOUSE PADS FOR USE BY THE SALES AND MARKETING PERSONNEL OF ITS THIRD PARTY RESELLERS AND DISTRIBUTORS, ALL RELATING TO THE ABOVE-MENTIONED COMPUTER SOFTWARE AND DOWNLOADABLE SOFTWARE.

FIRST USE ; IN COMMERCE .

INT. CL. 16/U.S. CLS. 2, 5, 22, 23, 29, 37, 38 AND 50

FOR MAGAZINES CONTAINING NEWSLETTERS, USER-GROUP MATERIAL, RESELLER AND DISTRIBUTOR GUIDANCE MATERIAL, TECHNICAL GUIDANCE, USER GUIDANCE, PRESENTATIONS, TRAINING COURSE MATERIAL, SALES, MARKETING AND PROMOTIONAL MATERIAL IN RESPECT OF THE SOFTWARE FOR USE BY THE SALES AND MARKETING PERSONNEL OF ITS THIRD PARTY RESELLERS AND DISTRIBUTORS, ALL IN RELATION TO COMPUTER SOFTWARE AND DOWNLOADABLE SOFTWARE; NON-FICTION BOOKS CONTAINING TECHNICAL DOCUMENTATION, USER DOCUMENTATION, TRAINING, SALES, MARKETING AND PROMOTIONAL MATERIAL IN RESPECT OF THE SOFTWARE FOR USE BY THE SALES AND MARKETING PERSONNEL OF ITS THIRD PARTY RESELLERS AND DISTRIBUTORS, ALL IN RELATION TO COMPUTER SOFTWARE AND DOWNLOADABLE SOFTWARE; PRINTED MATTER, NAMELY TECHNICAL AND USER DOCUMENTATION (NAMELY SOFTWARE SPECIFICATIONS, FUNCTIONAL SPECIFICATIONS, MINIMUM PLATFORM REQUIREMENTS, REPORTS, NOTES, EXTRACTS OR SCRIPTS OF TECHNICAL CODE AND TABLES, EXTRACTS OR SCRIPTS OF TECHNICAL PROCEDURES AND PROCESSES, TECHNICAL SPREADSHEETS, TECHNICAL USAGE INFORMATION, TECHNICAL LIBRARIES, UNIVERSAL NAMING CONVENTIONS AND TECHNICAL (MANUALS), GUIDANCE MATERIAL, HELP DOCUMENTS AND SCREEN LAYOUTS, EXAMPLE USAGE DESCRIPTIONS AND DEFINITIONS,

EXTRACTS OR LISTS, FAQ'S, AND USER MANUALS), CASE STUDIES, INFORMATION CARDS, NAMELY DATA SHEETS COMPRISING PRE-SALES TECHNICAL PRODUCT INFORMATION FOR USE BY THE SALES AND MARKETING PERSONNEL OF THIRD PARTY RESELLERS AND DISTRIBUTORS, AND TRAINING, SALES, MARKETING AND PROMOTIONAL MATERIAL, NAMELY MANUALS, BOOKS, BROCHURES, PRESS RELEASES, PAPER FOLDERS, INFORMATION CARDS, CASE STUDIES, PRINTED AUDIO-VISUAL AIDS, PENS, STATIONERY, COMPANY PROFILES, PLASTIC SLEEVE BINDERS, PAPER AND PLASTIC LAMINATED REPORT COVERS AND PAPER BADGES IN RELATION TO THE AFOREMENTIONED COMPUTER SOFTWARE AND DOWNLOADABLE SOFTWARE; PHOTOGRAPHS; USER MANUALS FOR USE IN THE GENERATION OF SALES OF COMPUTER SOFTWARE AND DOWNLOADABLE SOFTWARE AND TO DESCRIBE HOW OR WHAT TO DO FOR USERS WISHING TO BENEFIT FROM FULL AND PROPER USE OF THE SOFTWARE.

FIRST USE ; IN COMMERCE .

INT. CL. 42/U.S. CLS. 100 AND 101

FOR DESIGN AND DEVELOPMENT OF COMPUTER SOFTWARE FOR OTHERS; INSTALLATION, MAINTENANCE, UPGRADING AND REPAIR OF COMPUTER SOFTWARE; WEBSITE DESIGN FOR OTHERS, NAMELY DRAWING AND COMMISSIONED WRITING FOR THE COMPILATION OF WEBSITES; CREATING, MAINTAINING AND HOSTING WEBSITES OF OTHERS; TECHNICAL SUPPORT SERVICES, NAMELY THE PROVISION OF SUPPORT IN THE FORM OF TROUBLESHOOTING OF COMPUTER SOFTWARE AND HARDWARE PROBLEMS IN EXISTING SYSTEMS, PROVISION OF TECHNICAL ADVICE IN RELATION TO SOFTWARE, PROVISION OF TECHNICAL ADVICE IN RELATION TO COMPUTER ENGINEERING SERVICES, PROVISION OF TECHNICAL ADVICE IN RELATION TO TECHNICAL DOCUMENTATION AND PRESENTATIONS, PROVISION OF TECHNICAL ADVICE IN RELATION TO UPGRADES TO SOFTWARE, AND PROVISION OF TECHNICAL ADVICE IN RELATION TO SUPPORT AND MAINTENANCE AGREEMENTS FOR EXISTING AND YET-TO-BE-RELEASED SOFTWARE, CONSULTANCY AND ENGINEERING SERVICES RELATING TO ALL THE AFORESAID SERVICES.

FIRST USE ; IN COMMERCE .

ELEMENTS CORRECTED
GOODS/SERVICES

2,870,556. REG. 8-3-2004. AMINACH BEDDING & FURNITURE MANUFACTURERS & DISTRIBUTORS LTD. (ISRAEL CORPORATION) NIR-TZVI, P.O.B. 215, RAMLA, ISRAEL, 72101, SN 78-198,916. FILED 12-31-2002. PRINCIPAL REGISTER.

ספפא

THE transliteration of the Hebrew letters IS "SAPAPA" WHICH IS TRANSLATED INTO ENGLISH TO MEAN "SAPAPA".

INT. CL. 20/U.S. CLS. 2, 13, 22, 25, 32 AND 50

FOR SOFA BEDS.
FIRST USE 3-30-2003; IN COMMERCE 3-30-2003.

ELEMENTS CORRECTED
OWNER ADDRESS
CITIZENSHIP

FOR COMPUTER HARDWARE, NAMELY, PRINTED
CIRCUIT BOARDS AND INTEGRATED CIRCUIT CAR-
RIERS.
FIRST USE 9-0-2003; IN COMMERCE 9-0-2003.

ELEMENTS CORRECTED
OWNER ADDRESS

2,872,782. REG. 8-10-2004. MARINA DISTRICT DEVELOP-
MENT COMPANY, LLC (NEW JERSEY LTD LIAB CO),
DBA BORGATA HOTEL, CASINO & SPA, ONE BORGATA
WAY, ATLANTIC CITY, NJ, 08401, SN 78-206,794. FILED 1-
24-2003. PRINCIPAL REGISTER.

BORGATA

THE ENGLISH TRANSLATION OF THE WORD "BORGATA"
IN THE MARK IS "VILLAGE".

INT. CL. 41/U.S. CLS. 100, 101 AND 107

FOR HEALTH CLUB SERVICES; CASINO SERVICES;
ENTERTAINMENT SERVICES, NAMELY, MUSICAL
AND COMEDY NIGHTCLUB PERFORMANCES, LIVE
SPORTING EVENTS, CONCERTS; LIVE PERFORM-
ANCES FEATURING MUSICIANS, SINGERS, AND
COMEDIANS; [EDUCATIONAL SERVICES, NAMELY,
CLASSROOM INSTRUCTION IN THE CULINARY ARTS;
PROVIDING ON-LINE COMPUTER NON-WAGERING
GAMES;] PROVIDING ON-LINE INFORMATION IN
THE FIELDS OF HEALTH CLUB SERVICES, CASINO
SERVICES, ENTERTAINMENT SERVICES, AND EDU-
CATIONAL SERVICES VIA A GLOBAL COMPUTER
NETWORK.

FIRST USE 7-2-2003; IN COMMERCE 7-2-2003.

ELEMENTS CORRECTED
GOODS/SERVICES

2,878,084. REG. 8-31-2004. ALBERTSON'S, INC. (DELAWARE
CORPORATION) 250 PARKCENTER BOULEVARD,
BOISE, ID. 83736, SN 75-028,456. FILED 12-6-1995. PRINCIPAL
REGISTER.

SAV-ON

INT. CL. 42/U.S. CLS. 100 AND 101
FOR RETAIL DRUG STORES.

FIRST USE 7-31-1945; IN COMMERCE 6-18-1968.

ELEMENTS CORRECTED
ASSIGNMENT/NAME CHANGE
OWNER NAME

2,879,782. REG. 8-31-2004. KYOCERA CORPORATION (JAPAN
CORPORATION) 6 TAKEDA TOBADONO-CHO,
FUSHIMI-KU, KYOTO, 6128501, JAPAN, 612-8501, SN 75-
778,964. FILED 8-19-1999. PRINCIPAL REGISTER.

SLC

INT. CL. 9/U.S. CLS. 21, 23, 26, 36 AND 38

2,882,211. REG. 9-7-2004. P.T. BINTANG TOEDJOE (INDO-
NESIA CORPORATION) Jl. RAWA SUMUR BARAT II K-9,
KAWASAN INDUSTRI PULOGADUNG, JAKARTA, IN-
DONESIA, 13930, SN 76-285,734. FILED 7-16-2001. PRINCIPAL
REGISTER.



NO CLAIM IS MADE TO THE EXCLUSIVE RIGHT TO
USE "EXTRA", APART FROM THE MARK AS SHOWN.

THE LINES IN THE DRAWING EXTENDING FROM THE
FIST ARE A FEATURE OF THE MARK AND NOT
INTENDED TO INDICATE COLOR.

THE DRAWING DEPICTS A FIST IN A CIRCULAR
DESIGN RISING FROM SPLASHING LIQUID AND THE
TERM "EXTRA JOSS". THE FIST IS RUST/DARK RED IN
COLOR; THE SPLASHING LIQUID IS YELLOW/GOLD; THE
CIRCLE CONTAINS VARIOUS SHADES OF YELLOW/
GOLD; AND THE LETTERS IN THE TERMS "EXTRA JOSS"
ARE RUST/DARK RED COLORED AT THE TOP OF EACH
LETTER CHANGING TO YELLOW/GOLD IN THE MIDDLE
OF EACH LETTER AND WHITE AT THE BOTTOM OF
EACH LETTER. THE COLORS IN THE MARK ARE
CLAIMED AS A FEATURE OF THE MARK.

INT. CL. 32/U.S. CLS. 45, 46 AND 48

FOR CONCENTRATES, SYRUPS OR POWDERS USED
IN THE PREPARATION OF SOFT DRINKS; NON-ALCO-
HOLIC SOFT DRINKS; CONCENTRATES, SYRUPS OR
POWDERS USED IN THE PREPARATION OF NON-
ALCOHOLIC SOFT DRINKS.

FIRST USE 8-1-2003; IN COMMERCE 8-1-2003.

ELEMENTS CORRECTED
OWNER ADDRESS

2,886,790. REG. 9-21-2004. VALSOIA S.P.A. (ITALY COR-
PORATION) VIA I. BAROZZI, 4+40126 BOLOGNA,
ITALY., SN 75-874,541. FILED 12-17-1999. PRINCIPAL
REGISTER.



THE ENGLISH TRANSLATION OF THE WORDS "BON-
TA' E SALUTE" IN THE MARK IS "GOODNESS AND
HEALTH".

INT. CL. 29/U.S. CL. 46

FOR MILK PRODUCTS EXCLUDING ICE CREAM, ICE MILK AND FROZEN YOGURT.
FIRST USE 1-15-1991; IN COMMERCE 3-15-2003.
INT. CL. 30/U.S. CL. 46
FOR COFFEE SUBSTITUTES AND FLAVORED ICES.
FIRST USE 1-15-1991; IN COMMERCE 3-15-2003.

ELEMENTS CORRECTED
OWNER ADDRESS

2,888,545. REG. 9-28-2004. GIESSDORF INC. (TAIWAN CORPORATION) 5F-1, NO. 98, SEC. 2, TUN-HWA S. RD., TA-AN DIST., TAIPEI, TAIWAN., SN 76-520,750. FILED 5-27-2003. PRINCIPAL REGISTER.



INT. CL. 11/U.S. CLS. 13, 21, 23, 31 AND 34
FOR TOILETS, TOILET SEATS, BATH TUBS, LAVATORY BASINS, SHOWER ENCLOSURES, SINKS, SHOWER FAUCET EXTENSIONS, FAUCETS, WATER PURIFICATION UNITS.
FIRST USE 5-0-1990; IN COMMERCE 1-0-1997.
INT. CL. 21/U.S. CLS. 2, 13, 23, 29, 30, 33, 40 AND 50
FOR BATHROOM ACCESSORIES, NAMELY, TOWEL BARS, TOWEL HOLDERS, DISPENSER FOR CUPS, TOOTH BRUSH HOLDERS AND SOAP HOLDERS.
FIRST USE 5-0-1990; IN COMMERCE 1-0-1997.

ELEMENTS CORRECTED
OWNER NAME

2,888,940. REG. 9-28-2004. NATURAL THOUGHTS, INC. (CALIFORNIA CORPORATION) 4757 OLD CLIFFS ROAD, SAN DIEGO, CA, 92120, SN 78-219,440. FILED 2-26-2003. PRINCIPAL REGISTER.

MICRO-BUFF BODY

NO CLAIM IS MADE TO THE EXCLUSIVE RIGHT TO USE BODY, APART FROM THE MARK AS SHOWN.
INT. CL. 3/U.S. CLS. 1, 4, 6, 50, 51 AND 52
FOR SKIN PREPARATIONS, NAMELY, BODY LOTIONS, CREMES.
FIRST USE 1-14-2003; IN COMMERCE 1-14-2003.

ELEMENTS CORRECTED
GOODS/SERVICES

2,890,610. REG. 10-5-2004. CHANNEL M, INC. (CALIFORNIA CORPORATION) 11734 GATEWAY BOULEVARD, LOS ANGELES, CA, 90064, SN 75-192,629. FILED 11-4-1996. PRINCIPAL REGISTER.

CHANNEL M

NO CLAIM IS MADE TO THE EXCLUSIVE RIGHT TO USE "CHANNEL", APART FROM THE MARK AS SHOWN.
INT. CL. 35/U.S. CLS. 100, 101 AND 102

FOR PROVIDING TELEVISION ADVERTISING FOR OTHERS VIA CLOSED-CIRCUIT TELEVISION WHICH IS NOT AVAILABLE FOR HOME VIEWING OR VIEWING IN EDUCATIONAL INSTITUTIONS; PRODUCTION AND DISTRIBUTION OF TELEVISION COMMERCIALS FOR CLOSED-CIRCUIT TELEVISION WHICH ARE NOT AVAILABLE FOR HOME VIEWING OR VIEWING IN EDUCATIONAL INSTITUTIONS; SERVICES RELATING TO PROMOTIONAL CAMPAIGNS AND EVENTS, NAMELY, DEVELOPMENT AND DISSEMINATION OF ADVERTISING MATTER, SAMPLES AND PROMOTIONAL PRODUCTS FOR OTHERS.
FIRST USE 12-0-1988; IN COMMERCE 12-0-1989.

ELEMENTS CORRECTED
ASSIGNMENT/NAME CHANGE

2,892,025. REG. 10-5-2004. INDIA HOUSE OF MASS, INC. (MASSACHUSETTS CORPORATION) 57 JFK STREET, CAMBRIDGE, MA, 02138, SN 78-975,546. FILED 4-28-2002. PRINCIPAL REGISTER.

MASALA ART

NO CLAIM IS MADE TO THE EXCLUSIVE RIGHT TO USE "MASALA", APART FROM THE MARK AS SHOWN.
THE WORD "MASALA" IN THE INDIAN LANGUAGE HINDI IS "SPICE".
INT. CL. 29/U.S. CL. 46
FOR PROCESSED FRUITS AND VEGETABLES; FROZEN, PREPARED, AND PACKAGED MEALS CONSISTING PRIMARILY OF MEAT, FISH, POULTRY, OR *VEGETABLES;* TOMATO PUREE; VEGETABLE-BASED FOOD BEVERAGES; VEGETABLE SALADS; CHEESE FOODS; FRUIT SALADS; FRUITS, FRUIT TOPPINGS; FRUIT SAUCES.
FIRST USE 8-1-2003; IN COMMERCE 8-11-2003.

INT. CL. 30/U.S. CL. 46
FOR RICE SALAD; RISOTTO; SANDWICHES; SHERBET; TOMATO SAUCE; FOOD PACKAGE COMBINATIONS CONSISTING PRIMARILY OF BREAD, CRACKERS, AND/OR COOKIES; FROZEN YOGURT; CURRY.
FIRST USE 8-1-2003; IN COMMERCE 8-11-2003.
INT. CL. 43/U.S. CLS. 100 AND 101
FOR FOOD PACKAGING SERVICES; PREPARED FOOD PACKAGING SERVICES; FROZEN FOOD PACKAGING SERVICES.
FIRST USE 8-1-2003; IN COMMERCE 8-11-2003.

ELEMENTS CORRECTED
GOODS/SERVICES

2,892,225. REG. 10-12-2004. TRI-TECH INTERNET SERVICES, INC. (CALIFORNIA CORPORATION) 425 EAST COLORADO BLVD., SUITE 560, GLENDALE, CA, 91205, SN 76-169,606. FILED 11-21-2000. PRINCIPAL REGISTER.

CYBERAGE

INT. CL. 41/U.S. CLS. 100, 101 AND 102

FOR PROVIDING ON-LINE INFORMATION IN THE FIELD OF ENTERTAINMENT; PROVIDING ENTERTAINMENT INFORMATION ON A COMPUTER NETWORK, NAMELY, PHOTOGRAPHS, COMPUTER GAMES, SOUND RECORDINGS, MUSIC PROGRAMS AND AUDIOVISUAL WORKS; PROVIDING AN ON-LINE SEARCHABLE COMPUTER DATABASE IN THE FIELD OF ENTERTAINMENT.

FIRST USE 11-22-2000; IN COMMERCE 11-22-2000.

ELEMENTS CORRECTED
OWNER ADDRESS

2,894,187. REG. 10-19-2004. ECI TELECOM LTD. (ISRAEL COMPANY) 30 HASIVIM STREET, PETACH-TIKVA, ISRAEL., SN 76-428,641. FILED 7-2-2002. PRINCIPAL REGISTER.

LIGHTPLAN

PRIORITY CLAIMED UNDER SEC. 44(D) ON ISRAEL APPLICATION NO. 155151, FILED 2-4-2002, REG. NO. 155151, DATED 4-3-2003, EXPIRES 2-4-2009.

INT. CL. 9/U.S. CLS. 21, 23, 26, 36 AND 38

FOR COMPUTER SOFTWARE AND INSTRUCTION MANUALS THEREFOR SOLD AS A UNIT THEREWITH, FOR DEVELOPING, DESIGNING AND RE-DESIGNING COMMUNICATION NETWORKS.

FIRST USE ; IN COMMERCE .

ELEMENTS CORRECTED
ASSIGNMENT/NAME CHANGE

2,894,643. REG. 10-19-2004. GIESSDORF INC. (TAIWAN CORPORATION) 5F-1, NO.98, SEC. 2, TUN-HWA S. RD, TA-AN DIST., TAIPEI, TAIWAN., SN 76-520,751. FILED 5-27-2003. PRINCIPAL REGISTER.



INT. CL. 11/U.S. CLS. 13, 21, 23, 31 AND 34

FOR TOILETS, TOILET SEATS, BATH TUBS, LAVATORY BASINS, SHOWER ENCLOSURES, SINKS, SHOWER FAUCET EXTENSIONS, FAUCETS WATER PURIFICATION UNITS.

FIRST USE 5-0-1990; IN COMMERCE 1-0-1997.

INT. CL. 21/U.S. CLS. 2, 13, 23, 29, 30, 33, 40 AND 50

FOR BATHROOM ACCESSORIES, NAMELY, TOWEL BARS, TOWEL HOLDERS, DISPENSER FOR CUPS, TOOTH BRUSH HOLDERS AND SOAP HOLDERS.

FIRST USE 5-0-1990; IN COMMERCE 1-0-1997.

ELEMENTS CORRECTED
OWNER NAME

2,896,338. REG. 10-19-2004. EURO-PRO OPERATING LLC (DELAWARE LTD LIAB CO) 1210 WASHINGTON STREET, WEST NEWTON, MA, 02465, SN 78-151,013. FILED 8-5-2002. PRINCIPAL REGISTER.

THUNDERBOLT

OWNER OF U.S. REG. NOS. 2,090,404 AND 2,322,894.
INT. CL. 7/U.S. CLS. 13, 19, 21, 23, 31, 34 AND 35
FOR VACUUM CLEANERS [AND MULTI-PURPOSE STEAM CLEANING MACHINES].
FIRST USE 7-31-2003; IN COMMERCE 7-31-2003.

ELEMENTS CORRECTED
GOODS/SERVICES
OWNER NAME
OWNER ADDRESS
CITIZENSHIP
ENTITY

2,896,769. REG. 10-26-2004. MINEBEA CO., LTD. (JAPAN CORPORATION) 4106-73 OAZA MIYOTA, MIYOTA-MACHI KITASAKU-GUN, NAGANO-KEN, JAPAN., SN 76-521,887. FILED 6-12-2003. PRINCIPAL REGISTER.

KKRO

OWNER OF JAPAN REG. NO. 4619160, DATED 11-8-2002, EXPIRES 11-8-2012.

OWNER OF U.S. REG. NO. 2,714,993.

INT. CL. 12/U.S. CLS. 19, 21, 23, 31, 35 AND 44

FOR WHEEL AND AXLE BEARINGS FOR LAND VEHICLES; AC AND/OR DC MOTORS FOR LAND VEHICLES.

FIRST USE ; IN COMMERCE .

ELEMENTS CORRECTED
GOODS/SERVICES

2,896,773. REG. 10-26-2004. MINEBEA CO., LTD. (JAPAN CORPORATION) 4106-73 OAZA MIYOTA, MIYOTA-MACHI KITASAKU-GUN, NAGANO-KEN, JAPAN., SN 76-522,223. FILED 6-12-2003. PRINCIPAL REGISTER.

KKL

OWNER OF JAPAN REG. NO. 4630100, DATED 12-13-2002, EXPIRES 12-13-2012.

OWNER OF U.S. REG. NO. 2,676,421.

INT. CL. 12/U.S. CLS. 19, 21, 23, 31, 35 AND 44

FOR WHEEL AND AXLE BEARINGS FOR LAND VEHICLES; AC AND/OR DC MOTORS FOR LAND VEHICLES.

FIRST USE ; IN COMMERCE .

ELEMENTS CORRECTED
GOODS/SERVICES

2,896,775. REG. 10-26-2004. MINEBEA CO., LTD. (JAPAN CORPORATION) 4106-73 OAZA MIYOTA, MIYOTA-MACHI KITASAKU-GUN, NAGANO-KEN, JAPAN., SN 76-522,230. FILED 6-12-2003. PRINCIPAL REGISTER.

KJR

OWNER OF JAPAN REG. NO. 4637122, DATED 1-17-2003, EXPIRES 1-17-2013.

OWNER OF U.S. REG. NO. 2,774,397.
 INT. CL. 12/U.S. CLS. 19, 21, 23, 31, 35 AND 44
 FOR WHEEL AND AXLE BEARINGS FOR LAND VEHICLES; AC AND/OR DC MOTORS FOR LAND VEHICLES.
 FIRST USE ; IN COMMERCE .

ELEMENTS CORRECTED
 GOODS/SERVICES

2,899,307. REG. 11-2-2004. SANARUS MEDICAL, INC. (DELAWARE CORPORATION) 5880 W. LAS POSITAS, BLVD., STE. 52, PLEASANTON, CA, 94588, SN 78-126,992. FILED 5-7-2002. PRINCIPAL REGISTER.



NO CLAIM IS MADE TO THE EXCLUSIVE RIGHT TO USE ""SCREENING" AND "DIAGNOSIS" AND "TREATMENT" AND "FOLLOW-UP"", APART FROM THE MARK AS SHOWN.

INT. CL. 16/U.S. CLS. 2, 5, 22, 23, 29, 37, 38 AND 50
 FOR BOOKS, BROCHURES, MANUALS, PRINTED INSTRUCTIONAL, EDUCATIONAL AND TEACHING MATERIALS, MAGAZINES, JOURNALS, AND NEWSLETTERS, IN THE MEDICAL FIELD RELATING TO WOMEN'S HEALTH ISSUES; SPECIFICALLY, INFORMATION ON BREAST CARE; STATIONERY.
 FIRST USE 4-24-2002; IN COMMERCE 4-24-2002.

ELEMENTS CORRECTED
 GOODS/SERVICES

2,900,985. REG. 11-9-2004. NORTH ATLANTIC OPERATING COMPANY, INC. (DELAWARE CORPORATION) 257 PARK AVENUE SOUTH, NEW YORK, NY, 10010, SN 76-042,035. FILED 5-5-2000. PRINCIPAL REGISTER.

ZIGARETTES

NO CLAIM IS MADE TO THE EXCLUSIVE RIGHT TO USE "CIGARETTE", APART FROM THE MARK AS SHOWN.
 INT. CL. 34/U.S. CLS. 2, 8, 9 AND 17

FOR CIGARETTE TOBACCO.
 FIRST USE 4-19-2000; IN COMMERCE 4-19-2000.

ELEMENTS CORRECTED
 ASSIGNMENT/NAME CHANGE

2,901,777. REG. 11-9-2004. JOHN RICH & SONS INVESTMENT HOLDING COMPANY (DELAWARE CORPORATION) SUITE 900, 300 DELAWARE AVENUE, WILMINGTON, DE, 19801, SN 78-318,378. FILED 10-24-2003. PRINCIPAL REGISTER.

WOOLRICH

OWNER OF U.S. REG. NOS. 515,304, 2,428,744 AND OTHERS.

INT. CL. 9/U.S. CLS. 21, 23, 26, 36 AND 38
 FOR EYEWEAR, NAMELY, SUNGLASSES AND EYEGLASSES.
 FIRST USE 10-31-2001; IN COMMERCE 10-31-2001.
 INT. CL. 18/U.S. CLS. 1, 2, 3, 22 AND 41
 FOR HANDBAGS, TOTE BAGS, LUGGAGE.
 FIRST USE 1-31-1999; IN COMMERCE 1-31-1999.
 INT. CL. 20/U.S. CLS. 2, 13, 22, 25, 32 AND 50
 FOR WOODEN BOXES.
 FIRST USE 7-31-2002; IN COMMERCE 7-31-2002.
 INT. CL. 21/U.S. CLS. 2, 13, 23, 29, 30, 33, 40 AND 50
 FOR COASTERS NOT MADE OF *PAPER* [PAPER] AND NOT BEING TABLE LINEN.
 FIRST USE 7-31-2002; IN COMMERCE 7-31-2002.

ELEMENTS CORRECTED
 GOODS/SERVICES

2,902,012. REG. 11-9-2004. LIFEMARQUE LIMITED (UNITED KINGDOM CORPORATION) UNITS 1 & 8 BACCHUS HOUSE, CALLEVA PARK, ALDERMASTON, BERKSHIRE RG7 8PN, UNITED KINGDOM., SN 76-434,690. FILED 7-26-2002. PRINCIPAL REGISTER.

LIFEVENTURE

INT. CL. 6/U.S. CLS. 2, 12, 13, 14, 23, 25 AND 50
 FOR LOCKS AND PADLOCKS; COMBINATION LOCKS AND PADLOCKS, ALL BEING METALLIC.
 FIRST USE 2-0-1998; IN COMMERCE 3-25-2003.

INT. CL. 18/U.S. CLS. 1, 2, 3, 22 AND 41
 FOR ALL PURPOSE BAGS, ATTACHE CASES, HOLLERS, CARRYALLS, RUCKSACKS, BACKPACKS, HIPSACKS, BUMBAGS, DITTY BAGS, WALLETS, PURSES, MONEY BELTS, TOILETRY BAGS SOLD EMPTY, TRAVELING BAGS SOLD EMPTY; PARTS AND FITTINGS FOR ALL THE AFORESAID GOODS; NONE BEING FOR USE WITH GOLFING EQUIPMENT OR APPARATUS.
 FIRST USE 2-0-1998; IN COMMERCE 3-24-2003.

INT. CL. 20/U.S. CLS. 2, 13, 22, 25, 32 AND 50
 FOR SLEEPING BAGS, SLEEPING BAG LINERS, SLEEPING MATS, PILLOWS, INFLATABLE PILLOWS, NECK SUPPORT CUSHIONS; INFLATABLE NECK SUPPORT CUSHIONS; LOCKS AND PADLOCKS; COMBINATION LOCKS AND PADLOCKS; ALL BEING NON-METALLIC.
 FIRST USE 2-0-1998; IN COMMERCE 3-24-2003.
 INT. CL. 21/U.S. CLS. 2, 13, 23, 29, 30, 33, 40 AND 50

FOR CONTAINERS FOR FOOD AND BEVERAGES, BOTTLES SOLD EMPTY, FLASKS, PLATES, BOWLS, MUGS, CUPS; THERMALLY INSULATED CONTAINERS FOR FOOD AND BEVERAGES, THERMALLY INSULATED BOTTLES SOLD EMPTY; THERMALLY INSULATED FLASKS; THERMALLY INSULATED PLATES; THERMALLY INSULATED BOWLS; THERMALLY INSULATED MUGS; THERMALLY INSULATED CUPS.

FIRST USE 2-0-1998; IN COMMERCE 3-24-2003.
INT. CL. 25/U.S. CLS. 22 AND 39

FOR ARTICLES OF CLOTHING AND FOOTWEAR, NAMELY, PANTS, TROUSERS, SHORTS, SWEATPANTS, OVERALLS, SHIRTS, TEE-SHIRTS, SWEATSHIRTS, JUMPERS, FLEECE JUMPERS, SWEATERS, BLOUSES, SKIRTS, DRESSES, JACKETS, WIND-RESISTANT JACKETS, RAIN JACKETS, FLEECE JACKETS, VESTS, FLEECE VESTS, COATS, RAINCOATS, UNDERWEAR, THERMAL UNDERWEAR, LINGERIE, SLEEPWEAR, SWIMWEAR, WET SUITS, GLOVES, SOCKS, HOSIERY, BELTS, SCARVES, HATS, CAPS, TIES, SHOES, BOOTS, GALOSHES, SNEAKERS, SANDALS, SLIPPERS.

FIRST USE 2-0-1998; IN COMMERCE 3-24-2003.

ELEMENTS CORRECTED
OWNER NAME
ENTITY

2,902,614. REG. 11-16-2004. MONDO S.P.A. (ITALY JOINT STOCK COMPANY) VIA GARIBADI 192, 12060 GALLO D'ALBA, CUNEO, ITALY., SN 76-166,007. FILED 11-14-2000. PRINCIPAL REGISTER.

Kaleidos

PRIORITY CLAIMED UNDER SEC. 44(D) ON ITALY APPLICATION NO. T02000C00270, FILED 8-8-2000, REG. NO. 910706, DATED 10-1-2003, EXPIRES 8-8-2010.

INT. CL. 28/U.S. CLS. 22, 23, 38 AND 50

FOR SPORTING BALLS, BOTH FOR COMPETITION AND TRAINING, FOR DIFFERENT SPORTS INCLUDING SOCCER, VOLLEYBALL, BASKETBALL, RUGBY, FOOTBALL, CALCETTO, BEACH BALL, FITNESS; PLAY BALLS; PLAYGROUND BALLS.

FIRST USE : IN COMMERCE .

ELEMENTS CORRECTED
OWNER ADDRESS

2,902,797. REG. 11-16-2004. STE MAISON A. TESSERON (FRANCE SOCIETE ANONYME) BOULEVARD DE PELISSE, 16120 CHATTEAUNEUF SUR CHARENTE, FRANCE., SN 76-511,304. FILED 5-2-2003. PRINCIPAL REGISTER.

COGNAC TESSERON

PRIORITY CLAIMED UNDER SEC. 44(D) ON FRANCE APPLICATION NO. 023201664, FILED 12-20-2002, REG. NO. 023201664, DATED 12-20-2002, EXPIRES 12-20-2012.

NO CLAIM IS MADE TO THE EXCLUSIVE RIGHT TO USE "COGNAC", APART FROM THE MARK AS SHOWN.

INT. CL. 33/U.S. CLS. 47 AND 49
FOR COGNAC.

ELEMENTS CORRECTED
ENTITY

2,904,855. REG. 11-23-2004. WATER-VEND, INC. (MASSACHUSETTS CORPORATION) 30 MAIN STREET, ASHLAND, MA, 01721, SN 78-258,220. FILED 6-4-2003. PRINCIPAL REGISTER.

WATER-VEND

INT. CL. 32/U.S. CLS. 45, 46 AND 48
FOR DRINKING WATER.

FIRST USE 11-0-1988; IN COMMERCE 11-0-1988.

INT. CL. 35/U.S. CLS. 100, 101 AND 102

FOR RETAIL VENDING MACHINE SERVICES IN THE FIELD OF DRINKING WATER AND MACHINES FOR DISPENSING DRINKING WATER.

FIRST USE 11-0-1988; IN COMMERCE 11-0-1988.

ELEMENTS CORRECTED
DATE OF FIRST USE

2,905,041. REG. 11-23-2004. BLUE RHINO GLOBAL SOURCING, LLC (DELAWARE LIMITED LIABILITY COMPANY) 104 CAMBRIDGE PLAZA DRIVE, WINSTON-SALEM, NC, 27104, SN 78-312,032. FILED 10-10-2003. PRINCIPAL REGISTER.

WAVEDRAWER

INT. CL. 21/U.S. CLS. 2, 13, 23, 29, 30, 33, 40 AND 50
FOR COLLECTION UNIT SOLD AS A COMPONENT PART OF INSECT TRAPS FOR ATTRACTING AND DESTROYING INSECTS.

FIRST USE 2-9-2004; IN COMMERCE 2-9-2004.

ELEMENTS CORRECTED
GOODS/SERVICES

2,905,375. REG. 11-30-2004. METASTORM (MARYLAND CORPORATION) 836 RITCHIE HIGHWAY - SUITE 16, SEVERNA PARK, MD, 21146, SN 75-244,442. FILED 2-20-1997. PRINCIPAL REGISTER.

E-WORK

NO CLAIM IS MADE TO THE EXCLUSIVE RIGHT TO USE "WORK", APART FROM THE MARK AS SHOWN.

INT. CL. 9/U.S. CLS. 21, 23, 26, 36 AND 38

FOR COMPUTER SOFTWARE, NAMELY, BUSINESS WORKFLOW APPLICATION SOFTWARE DESIGNED TO AUTOMATE AND CONTROL BUSINESS PROCEDURES SUCH AS INTERNAL ADMINISTRATION, PURCHASE REQUESTS AND PRODUCTION TRACKING.

FIRST USE 12-1-1996; IN COMMERCE 1-17-1997.

ELEMENTS CORRECTED
MARK

2,905,518. REG. 11-30-2004. BARILLA G. E. R. FRATELLI - SOCIETA PERAZIONI (ITALY CORPORATION) VALE RICCARDO E. PIETRO BARILLA 3/A, PARMA, ITALY., SN 76-401,504. FILED 4-29-2002. PRINCIPAL REGISTER.

2,908,456. REG. 12-7-2004. IFSA, LLC (DELAWARE CORPORATION) P.O. BOX 39 322 WASHINGTON AVENUE, NEWTOWN, PA, 18940, SN 78-276,873. FILED 7-21-2003. PRINCIPAL REGISTER.



PRIORITY CLAIMED UNDER SEC. 44(D) ON ITALY APPLICATION NO. MI2002C00134, FILED 2-11-2002, REG. NO. 00875574, DATED 9-20-2002, EXPIRES 2-11-2012. INT. CL. 29/U.S. CL. 46

FOR MEAT, FISH, POULTRY AND GAME; MEAT EXTRACTS; PRESERVED, DRIED AND COOKED FRUITS AND VEGETABLES; JELLIES, JAMS, FRUIT COMPOTES; EGGS, MILK AND MILK- BASED PRODUCTS, NAMELY, DAIRY PRODUCTS, EXCLUDING ICE CREAM, ICE MILK AND FROZEN YOGURT; EDIBLE OILS AND FATS.

FIRST USE ; IN COMMERCE .
INT. CL. 30/U.S. CL. 46

FOR COFFEE, TEA, COCOA, SUGAR, RICE, TAPIOCA, SAGO, GRAIN-BASED AND CHICORY-BASED COFFEE SUBSTITUTES; FLOUR AND PREPARATIONS MADE FROM CEREALS, BREAD, PASTRY AND CONFECTIONERY, NAMELY, CANDY; FLAVORED ICES; HONEY, TREACLE; YEAST, BAKING POWDER; SALT, MUSTARD; VINEGAR, SAUCES, NAMELY CONDIMENTS; SPICES; ICE.

FIRST USE ; IN COMMERCE .
INT. CL. 32/U.S. CLS. 45, 46 AND 48

FOR BEERS; MINERAL AND AERATED WATERS AND OTHER NON-ALCOHOLIC DRINKS, NAMELY LEMONADES AND ORANGE JUICES; FRUIT DRINKS AND FRUIT JUICES; SYRUPS AND OTHER PREPARATIONS FOR MAKING BEVERAGES.

FIRST USE ; IN COMMERCE .
INT. CL. 33/U.S. CLS. 47 AND 49

FOR ALCOHOLIC BEVERAGES, NAMELY WINES AND DISTILLED LIQUORS.

FIRST USE ; IN COMMERCE .

ELEMENTS CORRECTED

- *OWNER NAME*
- *OWNER ADDRESS*
- *CITIZENSHIP*
- *ENTITY*

NO CLAIM IS MADE TO THE EXCLUSIVE RIGHT TO USE "INTERNATIONAL FINANCIAL SERVICES ASSOCIATES", APART FROM THE MARK AS SHOWN.

INT. CL. 36/U.S. CLS. 100, 101 AND 102

FOR FINANCIAL SERVICES, NAMELY STRUCTURING AND MODELLING OF CORPORATE STRUCTURE, DEPLOYMENT OF CAPITAL, GLOBAL CASH MANAGEMENT AND FOREIGN EXCHANGE STRATEGIES, STRUCTURING OF GLOBAL WORKING CAPITAL MANAGEMENT SOLUTIONS, ASSISTANCE WITH NEGOTIATIONS WITH FINANCIAL INTERMEDIARIES, STRUCTURED NOTE PREPARATION, ADVISING ON GLOBAL TREASURY MANAGEMENT AND RISK MANAGEMENT INCLUDING CASH, DEBT INVESTMENT AND [FOREING] * FOREIGN * EXCHANGE STRATEGIES, AND STRUCTURING OF SECURITIZATION AND MONETIZATION TRANSACTIONS OF ASSET CLASSES INCLUDING TRADE RECEIVABLES AND INVENTORY; FINANCIAL AND MANAGEMENT SOLUTIONS PROVIDERS TO BUSINESS ENTERPRISES AROUND THE WORLD IN THE FIELD OF BANKING, CORPORATE FINANCE, TREASURY, ACCOUNTING, AUDITING, STRATEGIC PLANNING, RISK MANAGEMENT, PUBLIC RELATIONS, INTELLECTUAL PROPERTY RIGHTS, STRUCTURED FINANCE AND CROSS BORDER TAXATION, DIRECTORSHIP SERVICES, CAPITAL MARKET-ADVISING SERVICES (LONG TERM DEBT AND EQUITY), AND ACQUISITIONING DIVESTITURE AND RELATED DILIGENCE SERVICES, NAMELY PROVIDING ADVICE WITH [RESECTS] * RESPECT * TO MERGERS AND ACQUISITION STRATEGY, NEGOTIATION AND EXECUTION, TRANSACTION MODELLING AND CAPITAL STRUCTURE, AND DUE DILIGENCE ON FINANCIAL COMPONENTS OF TARGET COMPANIES.

FIRST USE 7-8-2003; IN COMMERCE 7-8-2003.

ELEMENTS CORRECTED
GOODS/SERVICES

2,908,884. REG. 12-7-2004. FREIGHTLINER LLC (DELAWARE LTD LIAB CO) 4747 N. CHANNEL AVENUE, PORTLAND, OR, 97208, SN 75-713,404. FILED 5-25-1999. PRINCIPAL REGISTER.

2,909,383. REG. 12-14-2004. SANCHEZ, MAYA (FRANCE INDIVIDUAL) LA SOURCE, 9 QUAI DES PLATRERIES, 7290 SAMOIS SUR SEINE, FRANCE., AND SANCHEZ, THIERRY (FRANCE INDIVIDUAL) LA SOURCE, 9 QUAI DES PLATRERIES, 7290 SAMOIS SUR SEINE, FRANCE., SN 76-020,166. FILED 4-7-2000. PRINCIPAL REGISTER.

HUMAN SPIRIT



INT. CL. 1/U.S. CLS. 1

FOR ANTIFREEZE, COOLANT FOR VEHICLES.

FIRST USE 8-0-1998; IN COMMERCE 8-0-1998.

INT. CL. 6/U.S. CLS. 2, 12, 13, 14, 23, 25 AND 50

FOR METAL APPLIQUES FOR USE *ON* VEHICLES MUD FLAPS AND OTHER VEHICLE COMPONENTS.

FIRST USE 8-0-1998; IN COMMERCE 8-0-1998.

INT. CL. 7/U.S. CLS. 13, 19, 21, 23, 31, 34 AND 35

FOR ALTERNATORS FOR LAND VEHICLES, STARTER MOTORS FOR LAND VEHICLES, BELTS FOR MOTORS AND FOR ENGINES FOR LAND VEHICLES, FILTER KITS CONSISTING PRIMARILY OF OIL FILTERS, FUEL FILTERS AND AIR FILTERS FOR LAND VEHICLE ENGINES.

FIRST USE 8-0-1998; IN COMMERCE 8-0-1998.

INT. CL. 9/U.S. CLS. 21, 23, 26, 36 AND 38

FOR BATTERIES.

FIRST USE 8-0-1998; IN COMMERCE 8-0-1998.

INT. CL. 11/U.S. CLS. 13, 21, 23, 31 AND 34

FOR FANS; AIR CONDITIONERS FOR VEHICLES, VEHICLE HEATERS AND AIR CONDITIONING COMPONENT PARTS, NAMELY, BLOWER MOTORS, BLOWER WHEELS, CLUTCHES, COMPRESSORS, FITTINGS, VALVES FOR GASES AND LIQUID, CONDENSER AND EVAPORATOR COILS, FAN BLADES*, AIR CONDITIONING AND REFRIGERANT HOSES; GASKETS, HEATER CORES, CONTROL KNOBS, AIR DIFFUSERS AND LOUVERS, PRESSURE SWITCHES, DRIERS, RELAYS, RESISTORS, ELECTRICAL SWITCHES AND THERMOSTATIC SWITCHES, FUEL-WATER SEPARATORS FOR THE CLEANING AND PURIFICATION OF FUEL; LIGHTS FOR VEHICLES, HEADLIGHTS FOR VEHICLES AND ANTIGLARE LIGHTS FOR VEHICLES; LENSES AND LAMP BULBS FOR VEHICLE BUMPER GUIDES.

FIRST USE 7-15-2002; IN COMMERCE 7-15-2002.

INT. CL. 12/U.S. CLS. 19, 21, 23, 31, 35 AND 44

FOR VEHICLE TIRE AND WHEEL ACCESSORIES, NAMELY, BOLT AND LUG NUT CAPS; REFLECTIVE LUGNUT COVERS; HUB CAPS; AXLE AND WHEEL COVERS AND RINGS; WHEEL SIMULATORS AND WHEEL COVERS FOR [VEHICLE] *VEHICLES*; LAND VEHICLE PARTS, NAMELY, MUD FLAP HOLDERS, ANTI-SAIL BRACKETS FOR MUD FLAPS, TOP AND BOTTOM FENDER PLATES, QUARTER FENDERS, QUARTER FENDER MOUNTING BARS, QUARTER FENDER PLUGS, SPLASH GUARDS, LICENSE PLATE FRAMES AND LICENSE PLATE HOLDERS, PERMIT AND LICENSE HOLDERS FOR ATTACHMENT TO VEHICLES, BUMPER GUIDES, CLAMPS FOR BUMPER GUIDES, VEHICLE HORN COVERS, RAIN CAPS FOR VEHICLE EXHAUST PIPES*, ROCK, LENS AND FOG GUARDS FOR VEHICLE LIGHTS; LAND VEHICLE PARTS, NAMELY, VISORS FOR LAND VEHICLES, HEADLIGHT SHIELDS; REMANUFACTURED DIESEL ENGINES, MUFFLER CLAMPS, AIR CLEANER SHIELDS, MOUNTING BRACKETS FOR VEHICLES, THROTTLE STICKS, WINDOW VENT LOCKS, BRAKE CHAMBERS FOR LAND VEHICLES AND PNEUMATIC HOSES FOR LAND VEHICLES.

FIRST USE 8-0-1998; IN COMMERCE 8-0-1998.

ELEMENTS CORRECTED
GOODS/SERVICES

PRIORITY CLAIMED UNDER SEC. 44(D) ON FRANCE APPLICATION NO. 99817960, FILED 10-13-1999, REG. NO. 99/817960, DATED 10-13-1999, EXPIRES 10-13-2009.

INT. CL. 9/U.S. CLS. 21, 23, 26, 36 AND 38

FOR EYEGLASSES; SUNGLASSES; CASES AND CORDS FOR GLASSES; BINOCULARS; MAGNETS; APPARATUS FOR RECORDING, TRANSMITTING AND REPRODUCING OF SOUND AND IMAGES, NAMELY, TELEVISIONS, RADIOS, SLIDE PROJECTORS, FILM STRIP VIEWERS, MOVIE PROJECTORS, TAPE, CASSETTE AND COMPACT DISC AUDIO RECORDERS AND PLAYERS, PHOTOGRAPHIC CAMERAS; MOTORCYCLE HELMET; BLANK SOUND CARRIERS, NAMELY, BLANK AUDIO AND VIDEO TAPES, BLANK VIDEO CASSETTES; BLANK COMPACT DISCS FOR AUDIO AND VIDEO, DIGITAL AUDIO TAPES, COMPUTER TAPES, MAGNETIC COMPUTER TAPES, AUDIOCASSETTES, COMPUTER DISCS, FLOPPY DISCS FOR COMPUTERS, HARD COMPUTER DISCS FOR COMPUTERS; PRERECORDED SOUND CARRIERS, NAMELY, AUDIOTAPES, DIGITAL AUDIO TAPES, VIDEO TAPES, VIDEOCASSETTES, AUDIO CASSETTES, COMPACT DISCS, CD-ROMS, VIDEO DISCS, MAGNETIC TAPES, MAGNETIC DISCS, OPTICAL DISCS AND DVDS FEATURING MUSIC, ANIMATION, MOVIES FEATURING COMEDY AND DRAMA AND MUSIC; BLANK AUDIO AND VIDEO DISCS AND CASSETTES FOR RECORDING STILL IMAGES, MOVING IMAGES AND SOUNDS; COMPUTERS; MODEMS; ELECTRONIC POCKET TRANSLATORS; ELECTRONIC AGENDAS; OPTICAL SCANNERS; COMPUTER PRINTERS; CALCULATORS AND DATA PROCESSORS; CREDIT CARD READERS; CASH EXCHANGING MACHINES, ANTI-INTRUSION ALARMS AND PERSONAL SECURITY ALARMS; LOUDSPEAKERS; VIDEO CAMERAS; CAMCORDERS; FACSIMILE TRANSMISSION MACHINES; TELEPHONES; TELEPHONE ANSWERING MACHINES; VIDEO PHONES; PHOTOCOPY MACHINES; PHOTOGRAPHIC EQUIPMENT, NAMELY, CAMERAS, PROJECTORS, EXPOSED FILMS, FLASHBULBS, CAMERA CASES, BATTERIES AND PARTS THEREFOR; WINDSOCKS FOR INDICATING WIND DIRECTION AND INTENSITY; HAND-HELD ELECTRONIC GAMES ADAPTED FOR USE WITH TELEVISION RECEIVERS ONLY; VIDEO GAME CARTRIDGES; PRE-RECORDED COMPUTER SOFTWARE, NAMELY, COMPUTER GAME SOFTWARE; ELECTRONIC VENDING MACHINES, DIRECTIONAL COMPASSES; MEMORY CARDS; MICROCHIP CARDS; AND MAGNETICALLY ENCODED CARDS, NAMELY, CREDIT CARDS, PREPAID PHONE CARDS, DEBIT CARDS, TRAVEL AND ENTERTAINMENT CARDS AND CHECK GUARANTEE CARDS.

FIRST USE ; IN COMMERCE .

INT. CL. 16/U.S. CLS. 2, 5, 22, 23, 29, 37, 38 AND 50

FOR HOLOGRAMS; GIFT AND PARTY SUPPLIES MADE OF PAPER, NAMELY, NAPKINS, TABLE CLOTHS, BAGS, INVITATIONS, GIFT WRAP, COASTERS, PLACE MATS; PAPER TABLE LINEN AND CREPE PAPER; GARBAGE BAGS OF PAPER OR PLASTIC, FOOD STORAGE WRAPPERS, BLANK OR PARTIALLY PRINTED LABELS NOT OF TEXTILES; FLAGS OF PAPER; PENNANTS OF PAPER; HANDKERCHIEFS OF PAPER; TYPEWRITER PAPER; COPYING PAPER; PAPER COFFEE FILTERS; TOWELS OF PAPER; DISPOSABLE WIPES NOT IMPREGNATED WITH CHEMICALS OR COMPOUNDS; TOILET PAPER; ENVELOPES; BABIES' DIAPERS OF PAPER; STATIONERY AND NOTE PADS; NOTEBOOKS; NOTE PAPER; BINDERS; WRITING INSTRUMENTS, NAMELY, PENS, PENCILS, BALL-POINT PENS, PEN AND PENCIL KITS, POROUS-POINT PENS, ROLLING BALL PENS AND BROAD-TIP MARKERS; PRINTING BLOCKS; CORRECTION FLUIDS; RUBBER ERASERS; BOOKENDS; PENCIL SHARPENERS; CALENDARS; ADHESIVE NOTE PAPER; POSTERS; GREETING CARDS, DECALS; HEAT TRANSFERS; COLORING BOOKS AND CHILDREN'S ACTIVITY BOOKS; MAGAZINES, NEWSPAPERS,

BOOKS AND JOURNALS IN THE FIELD OF ATHLETES OR SPORT EVENTS; *ROADMAPS* PLAYING CARDS; PRINTED TICKETS; BANK CHECKS; PRINTED TIME-TABLES; COLLECTABLE PLAYER'S CARDS; BUMPER STICKERS; MOUNTED AND UNMOUNTED PHOTOGRAPHS; PHOTOGRAPH ALBUMS; STAMPS; CREDIT, PHONE, ATM, TRAVEL AND ENTERTAINMENT DISCOUNT, CHECK GUARANTEE AND DEBIT CARDS MADE OF PAPER OR CARDBOARD AND NOT MAGNETICALLY ENCODED; AUTOGRAPH BOOKS; TISSUE PAPER; BINDER PAPER; BOOK COVERS; BOOK STANDS; CONFETTI; CHALK; DOCUMENT HOLDERS; PAPER CLIPS; WRITING INK; PAINT BOXES, KITCHEN TOWELS OF PAPER; WRITING PAPER; SCRIBBLE PADS; CLIP BOARDS; NOTEPAD HOLDERS; ADDRESS BOOKS; DECORATIONS FOR PENCILS; STANDS FOR WRITING IMPLEMENTS; INK PADS; RUBBER STAMPS; PRINTED SCHEDULES FOR RECORDING TEST, SPORTS AND GAME RESULTS; ADHESIVE TAPE FOR STATIONERY USE AND OFFICE DISPENSERS FOR ADHESIVE TAPE FOR STATIONERY USE; STAPLERS; STENCILS; LUMINOUS PAPER; PRINTED SOUVENIR EVENT PROGRAMS FOR FUNDRAISING EVENTS; EVENT ALBUMS; BOXED TISSUES; PAPER BADGES; AND PASSPORT HOLDERS.

FIRST USE ; IN COMMERCE .

INT. CL. 18/U.S. CLS. 1, 2, 3, 22 AND 41

FOR LEATHER AND IMITATIONS OF LEATHER SOLD IN BULK; UMBRELLAS; PARASOLS; ALL PURPOSE SPORT BAGS; TRAVELLING BAGS; BACKPACKS; TOTE BAGS; SCHOOL BAGS; BELT BAGS; HAND BAGS; BEACH BAGS; SUITCASES; VANITY CASES SOLD EMPTY; KEY CASES; GARMENT BAGS FOR TRAVEL; WALLETS; PURSES; AND BRIEF-CASES.

FIRST USE ; IN COMMERCE .

INT. CL. 25/U.S. CLS. 22 AND 39

FOR CLOTHING, NAMELY, SHIRTS; KNIT SHIRTS; JERSEYS AND TANK TOPS; T-SHIRTS; DRESSES; SKIRTS; UNDERWEAR; SWIMWEAR; SHORTS; PANTS; SWEATERS; CAPS; HATS; SCARVES; VISORS; WARM-UP SUITS; SWEATSHIRTS; JACKETS; FOOTWEAR; BELTS; GLOVES; AND HEADWEAR.

FIRST USE ; IN COMMERCE .

INT. CL. 28/U.S. CLS. 22, 23, 38 AND 50

FOR GAMES AND PLAYTHINGS, NAMELY, SPORT BALLS, BOARD GAMES, STUFFED DOLLS AND ANIMALS, TOY VEHICLES, JIGSAW PUZZLES, BALLOONS, INFLATABLE TOYS, SPORT AND GYMNASIAC EQUIPMENT, NAMELY, GYMNASIAC PARALLEL BARS, SOCCER EQUIPMENT, NAMELY, BALLS, GLOVES, KNEE PADS, ELBOW PADS AND SHOULDER PADS; HAND-HELD ELECTRONIC GAMES OTHER THAN THOSE ADAPTED FOR USE WITH TELEVISION RECEIVERS ONLY; TOY FOAM HANDS; AND SPORTS BAGS FOR HOLDING HOCKEY, TENNIS, AND SOCCER EQUIPMENT.

FIRST USE ; IN COMMERCE .

INT. CL. 35/U.S. CLS. 100, 101 AND 102

FOR EMPLOYMENT AGENCIES; PERSONNEL RECRUITMENT SERVICES; PUBLICATION ADVERTISEMENT SERVICES, NAMELY, PLACING ADVERTISEMENTS IN MAGAZINES AND NEWSPAPERS; ADVERTISING AGENCY SERVICES; INTERNET ADVERTISING SERVICES; DISSEMINATION OF ADVERTISING FOR OTHERS, BILLBOARD LEASING SERVICES; ADVERTISING SPACE RENTAL SERVICES; OUTDOOR ADVERTISING SERVICES; TV ADVERTISING SERVICES; PROMOTION AGENCY SERVICES, NAMELY, PROMOTING THE GOODS AND SERVICES OF OTHERS THROUGH THE DISTRIBUTION OF PRINTED MATERIAL AND CONTESTS; PUBLIC RELATION AGENCY SERVICES; MARKETING RESEARCH SERVICES; PUBLIC OPINION POLLING FOR ADVERTISING AND BUSINESS PURPOSES; PROMOTING THE EXHIBITIONS OF OTHERS BY PLACING ADVERTISEMENTS IN MAGAZINES AND TELEVISION; AND DATABASE MANAGEMENT SERVICES.

FIRST USE ; IN COMMERCE .

INT. CL. 38/U.S. CLS. 100, 101 AND 104

FOR TELECOMMUNICATION SERVICES, NAMELY, PROVIDING TELECOMMUNICATIONS CONNECTIONS TO THE INTERNET; COMMUNICATIONS BY MOBILE PHONES; LOCAL AND LONG DISTANCE TELEPHONE COMMUNICATION SERVICES FOR HEARING IMPAIRED PEOPLE; ELECTRONIC TRANSMISSION OF DATA AND DOCUMENTS VIA COMPUTER TERMINAL OVER LOCAL AND GLOBAL COMPUTER NETWORKS; COMMUNICATIONS BY TELEGRAPH; COMMUNICATION BY TELEPHONE; COMMUNICATIONS BY FACSIMILE; PAGING BY RADIO; VIDEO TELECONFERENCING; TELEVISION BROADCASTING; CABLE TELEVISION BROADCASTING; RADIO BROADCASTING; AND LEASING OF TELEPHONE SETS, FACSIMILE MACHINES AND TELECOMMUNICATIONS EQUIPMENT.

FIRST USE ; IN COMMERCE .

INT. CL. 41/U.S. CLS. 100, 101 AND 107

FOR PROVIDING RECORD AND STATISTICAL INFORMATION IN THE FIELD OF SPORTS; EDUCATIONAL SERVICES, NAMELY, CONDUCTING CLASSES, CONFERENCES, SEMINARS AND WORKSHOPS IN THE FIELD OF FUNDRAISING EVENTS; PROVIDING TRAINING IN THE USE AND OPERATION OF COMPUTERS, TELEVISIONS, RADIOS; AND CONDUCTING SPORTING COMPETITIONS IN THE FIELD OF HOCKEY, TENNIS AND SOCCER AND CULTURAL ACTIVITIES, NAMELY, LIVE MUSIC CONCERTS, DANCE PERFORMANCES, AND ETHNIC FESTIVALS FOR FUNDRAISING PURPOSES.

FIRST USE ; IN COMMERCE .

ELEMENTS CORRECTED
GOODS/SERVICES

2,909,828. REG. 12-14-2004. FILTRE-EXPERT INC (CANADA CORPORATION) 580 ALPHONSE DESJARDINS, LEVIS (QUEBEC), CANADA, G6V 5T2, SN 76-531,160. FILED 7-22-2003. PRINCIPAL REGISTER.



The logo for Agrivolt features the word "Agrivolt" in a bold, sans-serif font. The letter "A" is stylized with a lightning bolt shape extending downwards from its base.

INT. CL. 9/U.S. CLS. 21, 23, 26, 36 AND 38

FOR EQUIPMENT FOR USE IN NEUTRALIZING STRAY-VOLTAGE PRODUCED BY ELECTRICAL NETWORKS IN THE FARMING AND AGRICULTURAL INDUSTRIES, FOR MAINTAINING STRAY-VOLTAGE LEVELS BELOW THE ACCEPTED ANIMAL SENSITIVITY THRESHOLD AND FOR DETECTING LEAKAGE FROM FARM EQUIPMENT DUE TO FAULTY INSULATION, ON GROUND NETWORKS, AND BONDING IN HERD ENVIRONMENTS.

FIRST USE 10-10-1999; IN COMMERCE 10-10-1999.

ELEMENTS CORRECTED
DATE OF FIRST USE
DATE OF FIRST USE IN COMMERCE

2,910,588. REG. 12-14-2004. BEAUTE CREATEURS (SOCIETE ANONYME) (FRANCE CORPORATION) 10 RUE DE LA PAIX, PARIS, FRANCE, 75002, SN 78-267,351. FILED 6-26-2003. PRINCIPAL REGISTER.

2,911,202. REG. 12-14-2004. JANE & COMPANY, LLC (DELAWARE LTD LIAB CO) 9611 PULASKI PARK DRIVE, BALTIMORE, MD, 21220, SN 78-342,347. FILED 12-17-2003. PRINCIPAL REGISTER.

MANGANOX

STAY CALM

PRIORITY CLAIMED UNDER SEC. 44(D) ON FRANCE APPLICATION NO. 033206884, FILED 1-29-2003, REG. NO. 033206884, DATED 1-29-2003, EXPIRES 1-29-2013.
PRIORITY CLAIMED UNDER SEC. 44(D) ON FRANCE APPLICATION NO. 033206038, FILED 1-24-2003, REG. NO. 033206038, DATED 1-24-2003, EXPIRES 1-24-2013.

THE MARK CONSISTS OF STANDARD CHARACTERS WITHOUT CLAIM TO ANY PARTICULAR FONT, STYLE, SIZE, OR COLOR.
INT. CL. 3/U.S. CLS. 1, 4, 6, 50, 51 AND 52
FOR COSMETICS.
FIRST USE 1-15-2001; IN COMMERCE 3-15-2001.

ELEMENTS CORRECTED
OWNER NAME
OWNER ADDRESS
CITIZENSHIP
ENTITY

INT. CL. 3/U.S. CLS. 1, 4, 6, 50, 51 AND 52
FOR NON-MEDICATED SKIN CARE AND CLEANING PREPARATIONS, NAMELY, CREAM, MILK, LOTION, SERUM, GEL, FLUID, AND OIL FOR MOISTURIZING THE BODY, FACE AND EYES; NON-MEDICATED CELLULITE-REDUCING SKIN LOTIONS AND SKIN GELS; CLEANSING, MOISTURIZING, ANTI-AGING, AND NON-MEDICATED ANTI-WRINKLE FACIAL MASKS; NON-MEDICATED MOISTURIZING LIP MASKS; ANTI-WRINKLE CREAM FOR EYES; MASSAGE OIL; TALCUM POWDER; SUN PRODUCTS, NAMELY, SUN SCREEN, SUN TANNING OILS AND LOTIONS, SUN BLOCK, AFTER-SUN CREAM, SELF-TANNING MILK AND CREAM, ACCELERATED TANNING CREAM; COSMETICS, NAMELY, SKIN SOAP, MAKE-UP REMOVER, LIP AND EYE MAKE-UP REMOVER, NAIL POLISH, DENTIFRICES, DEPILATORIES, LIQUID FOUNDATION, TINTED SKIN CREAMS, MAKE-UP, POWDER AND CREAM BLUSHER, LIPSTICK, MASCARA, EYE SHADOW, EYELINER PENCIL; PERFUMES, NAMELY, PERFUMED WATER, TOILET WATER, COLOGNE WATER, SCENTED WATER, PERFUMED TALCUM POWDER, PERFUMED SKIN CREAM, PERFUMED BODY OILS, PERFUMED SKIN CLEANSING FOAM, ESSENTIAL OILS FOR PERSONAL USE; PERFUMED BATH PRODUCTS, NAMELY, BODY LOTIONS, BODY POWDER, BODY OILS AND PERSONAL DEODORANTS; HAIR CARE PREPARATIONS, NAMELY, SHAMPOO, CONDITIONERS, SPRAYS, LOTIONS, HAIR GELS, MOUSSE, MASKS, FOAMS, SUN SCREEN AND HAIR COLOR.
FIRST USE ; IN COMMERCE .

2,911,332. REG. 12-14-2004. ERMENEGILDO ZEGNA CORPORATION (NEW YORK CORPORATION) 100 WEST FOREST AVENUE, UNIT A, ENGLEWOOD, NJ, 07631, SN 75-922,286. FILED 2-18-2000. PRINCIPAL REGISTER.

ERMENEGILDO ZEGNA

THE NAME "ERMENEGILDO ZEGNA" SHOWN IN THE MARK DOES NOT IDENTIFY A PARTICULAR LIVING INDIVIDUAL, HOWEVER, IT DOES IDENTIFY THE NOW-DECEASED BUSINESS FOUNDER OF APPLICANT.
INT. CL. 9/U.S. CLS. 21, 23, 26, 36 AND 38
FOR [EYEGLOSS FRAMES, EYEGASSES.] SUNGLASSES.
FIRST USE 3-0-2003; IN COMMERCE 3-0-2003.

ELEMENTS CORRECTED
GOODS/SERVICES

INT. CL. 5/U.S. CLS. 6, 18, 44, 46, 51 AND 52
FOR DIETETIC SUBSTANCES ADAPTED FOR MEDICAL USE, NAMELY, DIET PILLS, AND DIETARY FOOD SUPPLEMENTS; ACTIVE PHARMACEUTICAL SUBSTANCES FOR COSMETIC PRODUCTS, NAMELY, MAGNESIUM AND MANGANESE.
FIRST USE ; IN COMMERCE .

2,911,405. REG. 12-14-2004. PROCORDE GMBH (FED REP GERMANY CORPORATION) FRAUNHOFERSTR. 9, 82152 MARTINSRIED, FED REP GERMANY., SN 76-415,508. FILED 6-5-2002. PRINCIPAL REGISTER.

SIGSCREEN

PRIORITY CLAIMED UNDER SEC. 44(D) ON FED REP GERMANY, REG. NO. 30169877.5, DATED 10-16-2002, EXPIRES 12-31-2011.
INT. CL. 42/U.S. CLS. 100 AND 101

ELEMENTS CORRECTED
GOODS/SERVICES

FOR SCIENTIFIC AND INDUSTRIAL RESEARCH; GENOME RESEARCH; ANIMAL AND MAMMALIAN CELLULAR RESEARCH; *TESTING* [TEATING] OF NEW PRODUCTS ON ANIMALS; GENE THERAPY.
FIRST USE 0-0-2000; IN COMMERCE 0-0-2000.

ELEMENTS CORRECTED
GOODS/SERVICES
PRIORITY CLAIMED STATEMENT

2,911,951. REG. 12-21-2004. DOLPHIAN (FRANCE PUBLIC LIMITED LIABILITY) 3 RUE DE PARADIS, PARIS, FRANCE., SN 76-321,969. FILED 10-4-2001. PRINCIPAL REGISTER.

DOLPHIAN

2,911,630. REG. 12-14-2004. SERTA, INC. (DELAWARE CORPORATION) 325 SPRING LAKE DRIVE, ITASCA, IL, 60143, SN 78-157,916. FILED 8-26-2002. PRINCIPAL REGISTER.

WHISPER FOAM

NO CLAIM IS MADE TO THE EXCLUSIVE RIGHT TO USE "FOAM", APART FROM THE MARK AS SHOWN.
INT. CL. 20/U.S. CLS. 2, 13, 22, 25, 32 AND 50
FOR MATTRESSES.
FIRST USE 12-1-2003; IN COMMERCE 12-1-2003.

ELEMENTS CORRECTED
OWNER NAME
OWNER ADDRESS
CITIZENSHIP
ENTITY

2,911,689. REG. 12-14-2004. AC NIELSEN (US), INC. (DELAWARE CORPORATION) 150 NORTH MARTINGALE ROAD, SCHAUMBURG, IL, 60173, SN 78-196,771. FILED 12-20-2002. PRINCIPAL REGISTER.

MYCBP

INT. CL. 35/U.S. CLS. 100, 101 AND 102
FOR BUSINESS AND MARKET RESEARCH SERVICES AND RETAIL MARKETING AND SALES INFORMATION SERVICES; PROVIDING AN ON-LINE COMPUTER DATABASE IN THE FIELD OF MARKET RESEARCH AND PRODUCT RETAILER AND MANUFACTURER INFORMATION; SALES VOLUME TRACKING FOR OTHERS, NAMELY THE COLLECTION AND DISSEMINATION OF PRODUCT AND MANUFACTURER SALES DATA.
FIRST USE 10-15-2002; IN COMMERCE 1-31-2003.

INT. CL. 42/U.S. CLS. 100 AND 101
FOR PROVIDING TEMPORARY USE OF ONLINE NONDOWNLOADABLE COMPUTER SOFTWARE, NAMELY, ELECTRONIC DATABASE AND COMPUTER SOFTWARE FOR CREATING, ACCESSING, VIEWING, MANIPULATING, AND PREPARING REPORTS FROM SAID ELECTRONIC DATABASE IN THE AREAS OF MARKET RESEARCH AND PRODUCT RETAILER AND MANUFACTURER INFORMATION VIA A GLOBAL COMPUTER NETWORK, DIALUP COMPUTER OR OTHER COMPUTER NETWORK.
FIRST USE 10-15-2002; IN COMMERCE 1-31-2003.

ELEMENTS CORRECTED
OWNER NAME

PRIORITY CLAIMED UNDER SEC. 44(D) ON FRANCE APPLICATION NO. 013093752, FILED 4-5-2001, REG. NO. 013093752, DATED 4-5-2001, EXPIRES 4-5-2010.
INT. CL. 9/U.S. CLS. 21, 23, 26, 36 AND 38

FOR SCIENTIFIC, NAUTICAL, SURVEYING, PHOTOGRAPHIC, CINEMATOGRAFICAL, OPTICAL, WEIGHING, MEASURING, SIGNAL, AND INSPECTION EQUIPMENT, NAMELY, SURVEYOR'S LEVELS, PHOTOGRAPHIC CAMERAS; APPARATUS AND INSTRUMENTS FOR CONDUCTING, DISTRIBUTING, TRANSFORMING, ACCUMULATING, REGULATING OR COMMANDING ELECTRICAL CURRENT, NAMELY, RECTIFIERS; ELECTRONIC DECODERS; ELECTRONIC DATA PROCESSORS; MEASURING AND ELECTRONIC CONTROL APPARATUS, NAMELY ELECTRICAL CONTROLLERS; ELECTRONIC SOUND AMPLIFIERS; TEACHING APPARATUS AND INSTRUMENTS, NAMELY VIDEO PROJECTORS, AUDIO AND VIDEO TAPE PLAYERS; APPARATUS AND INSTRUMENTS FOR RECORDING, TRANSMITTING, REPRODUCING, STORING, CODING, DECODING, TRANSFORMING, AND PROCESSING SOUND AND IMAGES, NAMELY ENCRYPTERS, DECRYPTERS, ELECTRONIC SIGNAL DATA DECODERS, BAR CODE READERS, PRINTED AND INTEGRATED CIRCUIT BOARDS; AUDIOVISUAL, TELECOMMUNICATION, AND TELEPROCESSING APPARATUS AND INSTRUMENTS, NAMELY TELEVISION RECEIVERS, VIDEO CASSETTE RECORDERS, RADIOS, REMOTE CONTROLS THEREFOR; SLIDE AND MOVIE PROJECTORS; AUTOMOBILE RADIOS; RADIO-CONTROLLED MINIATURE AERIAL TARGETS; PRE-RECORDED VIDEO DISCS, OPTICAL DISCS, COMPACT DISCS, CD-ROMS, MAGNETIC DISCS AND PHONOGRAPH RECORDS FEATURING NEWS, SPORTS, CULTURE, REVIEWS OF MOTION PICTURES AND TELEVISION PROGRAMS, MUSIC, GAMES, ACTION FILMS, HISTORY, GEOGRAPHY, ART, ANIMALS, FASHION, COMEDY VARIETY, SCIENCE, DRAMA, COMICS, SCIENTIFIC INSTRUCTION, AND SCIENTIFIC RESEARCH; ANTENNAS; AUDIO SPEAKERS; SPEAKERPHONES; AUDIO AMPLIFIERS; HIGH FIDELITY STEREO SETS; COMPUTERS; COMPUTER KEYBOARDS; MODEMS; PRE-RECORDED COMPUTER SOFTWARE FEATURING NEWS, SPORTS, CULTURE, COMEDY, VARIETY, MUSIC, REVIEWS OF MOTION PICTURE FILMS AND PROTECTION OF PRIVACY ON THE INTERNET; IDENTIFICATION DEVICES FOR TELECOMMUNICATION NETWORKS, NAMELY CALLER IDENTIFICATION BOXES; SCRAMBLING AND UNSCRAMBLING DEVICES FOR COMPUTER AND TELEPHONE SIGNALS AND TRANSMISSIONS; MICROPHONES; COMPUTER TERMINALS; EXPOSED CAMERA FILMS, MAGNETIC TAPES AND VIDEO RECORDINGS AND SOUND RECORDINGS FEATURING NEWS, SPORTS, CULTURE, REVIEWS OF MOTION PICTURES AND TELEVISION PROGRAMS, MUSIC, GAMES, ACTION FILMS, HISTORY, GEOGRAPHY, ART, ANIMALS, FASHION, COMEDY VARIETY, SCIENCE, DRAMA, COMICS, SCIENTIFIC INSTRUCTION, AND SCIENTIFIC RESEARCH; ANTENNAS; TELEPHONES; BLANK MAGNETIC CODED CARDS, BLANK ELECTRONIC CHIP CARDS; MAGNETIC CODED CARD READERS; COMPUTER MONITORS FOR RECEIVING DATA ON WORLD INFORMATION SYSTEMS AND SERVERS; CASH REGISTERS; DATA PROCESSORS; CALCULATORS; SATELLITES FOR SCIENTIFIC AND TELECOMMUNICATION USE; COMPUTER SOFTWARE FOR PROVIDING ACCESS TO COMPUTER NETWORKS AND DATA TRANSMISSION NETWORKS AND TO THE INTERNET AND INTRANET.
FIRST USE ; IN COMMERCE .

INT. CL. 38/U.S. CLS. 100, 101 AND 104

FOR RADIO, TELEGRAPH, TELEPHONE AND VISIOPHONIC COMMUNICATION; TELEVISION BROADCASTING; ELECTRONIC TRANSMISSION OF MESSAGES; TRANSMISSION OF TELEGRAMS; ELECTRONIC TRANSMISSION OF DATA AND DOCUMENTS VIA COMPUTER TERMINALS; RENTAL OF TELECOMMUNICATION EQUIPMENT FOR TRANSMITTING MESSAGES; COMMUNICATION BY COMPUTER TERMINALS NAMELY, ELECTRONIC MAIL SERVICES AND COMMUNICATIONS VIA OPEN AND CLOSED WORLD INFORMATION NETWORKS; PROVIDING INFORMATION IN THE FIELD OF TELECOMMUNICATIONS; SERVICES OF PROVIDING TELECOMMUNICATION CONNECTIONS TO INFORMATION-SYSTEM NETWORKS; PROVIDING MULTIPLE-USER ACCESS TO A GLOBAL COMPUTER INFORMATION NETWORKS.

FIRST USE ; IN COMMERCE .
INT. CL. 42/U.S. CLS. 100 AND 101

FOR SCIENTIFIC RESEARCH; ENGINEERING; TECHNICAL CONSULTATION IN THE FIELD OF PRIVACY PROTECTION OF THE INTERNET; GEOLOGICAL PROSPECTING; MATERIAL TESTING; PRINTING, DESIGN, UPDATING AND RENTAL OF COMPUTER SOFTWARE FOR OTHERS; COMPUTER PRIVACY PROTECTION, HEALTH SECURITY, CONSTRUCTION, TELECOMMUNICATION, AUDIOVISUAL INFORMATION-SYSTEM TECHNICAL CONSULTATION; COMPUTER PROGRAMMING, RENTAL OF COMPUTERS; DESIGN OF SYSTEMS OF CODING, DECODING, ACCESS CONTROL TO DATA AND TO ANY TRANSMISSION OF INFORMATION; DESIGN OF INTERACTIVE PROGRAMMING AND APPARATUS; TECHNICAL COMPUTER NORMALIZATION SERVICES; TECHNICAL RESEARCH IN THE FIELD OF PRIVACY PROTECTION; RESEARCH AND DEVELOPMENT OF ELECTRONIC, COMPUTER AND AUDIOVISUAL, SCRAMBLING AND ACCESS-CONTROL SYSTEMS IN THE FIELD OF PRIVACY PROTECTION ON THE INTERNET, RELATING TO COMPUTER, TELECOMMUNICATION, AUDIOVISUAL; SERVICES OF AUTHENTICATION OF ELECTRONIC MESSAGES.

FIRST USE ; IN COMMERCE .

ELEMENTS CORRECTED

OWNER NAME
OWNER ADDRESS
CITIZENSHIP
ENTITY

2,912,420. REG. 12-21-2004. AMERICAN PSYCHOLOGICAL ASSOCIATION (D.C. INC. ASSOCIATION) 750 FIRST STREET, N.E., WASHINGTON, DC, 200024242, SN 76-555,790. FILED 10-31-2003. PRINCIPAL REGISTER.

APA MONITOR

OWNER OF U.S. REG. NOS. 1,860,897, 2,624,488 AND OTHERS.

INT. CL. 9/U.S. CLS. 21, 23, 26, 36 AND 38

FOR DOWNLOADABLE ELECTRONIC JOURNAL PERTAINING TO PSYCHOLOGICAL TOPICS, PERIODICALLY PUBLISHED AND DISTRIBUTED TO MEMBERS AND TO OTHER PERSONS IN THE PSYCHOLOGICAL AND SOCIAL SCIENCE COMMUNITIES.

FIRST USE 3-0-1995; IN COMMERCE 3-0-1995.

ELEMENTS CORRECTED
ENTITY

2,912,673. REG. 12-21-2004. M-REAL CORPORATION (FINLAND JOINT STOCK COMPANY) REVONTULENTIE 6, ESPOO, FINLAND, 02100, SN 78-190,190. FILED 12-2-2002. PRINCIPAL REGISTER.

CARTA INTEGRA

PRIORITY CLAIMED UNDER SEC. 44(D) ON FINLAND APPLICATION NO. T200201846, FILED 6-24-2002, REG. NO. 227990, DATED 8-15-2003, EXPIRES 8-15-2013.

NO CLAIM IS MADE TO THE EXCLUSIVE RIGHT TO USE CARTA, APART FROM THE MARK AS SHOWN.

THE ENGLISH TRANSLATION OF "CARTA" IS "CARD".
INT. CL. 16/U.S. CLS. 2, 5, 22, 23, 29, 37, 38 AND 50
FOR PAPERBOARD, IN PARTICULAR FOR PACKAGES AND GRAPHICAL PURPOSES.

FIRST USE ; IN COMMERCE .

ELEMENTS CORRECTED
DISCLAIMER

2,912,783. REG. 12-21-2004. BRITISH SKY BROADCASTING GROUP PLC (UNITED KINGDOM COMPANY) GRANT WAY, ISLESWORTH, MIDDLESEX, UNITED KINGDOM, TW7 5QD, SN 78-256,450. FILED 5-30-2003. PRINCIPAL REGISTER.

SKY NEWS

OWNER OF UNITED KINGDOM REG. NO. B1348024, DATED 9-6-1991, EXPIRES 6-15-2005.

NO CLAIM IS MADE TO THE EXCLUSIVE RIGHT TO USE "NEWS", APART FROM THE MARK AS SHOWN.

INT. CL. 41/U.S. CLS. 100, 101 AND 107

FOR TELEVISION AND RADIO NEWS REPORTING SERVICES; PRODUCTION OF RADIO AND TELEVISION NEWS PROGRAMMES; RENTAL OF FILMS, AUDIO TAPES AND VIDEO TAPES, ALL RELATING TO NEWS.

FIRST USE ; IN COMMERCE .

ELEMENTS CORRECTED
GOODS/SERVICES

2,913,474. REG. 12-21-2004. NCL CORPORATION LTD. (BERMUDA CORPORATION) 7665 CORPORATE CENTER DRIVE, MIAMI, FL, 33126, SN 76-235,167. FILED 4-4-2001. PRINCIPAL REGISTER.

ROYAL CRUISE LINE

OWNER OF U.S. REG. NO. 1,150,644.

NO CLAIM IS MADE TO THE EXCLUSIVE RIGHT TO USE "CRUISE LINE", APART FROM THE MARK AS SHOWN.

INT. CL. 39/U.S. CLS. 100 AND 105

FOR ARRANGING AND CONDUCTING TRANSPORTATION FOR OCEAN CRUISES.

FIRST USE 3-1-2003; IN COMMERCE 3-1-2003.

ELEMENTS CORRECTED
OWNER NAME

2,913,568. REG. 12-21-2004. KABUSHIKI KAISHA FOUR SEEDS (JAPAN CORPORATION) ZENKAREN BLDG., 5TH FLOOR, 5-12-4, MINAMI AOYAMA, MINATO-KU, TOKYO, JAPAN., SN 76-430,124. FILED 7-10-2002. PRINCIPAL REGISTER.



THE MARK ILLUSTRATES AN OLD STYLE JAPANESE RICE COOKER.
INT. CL. 43/U.S. CLS. 100 AND 101
FOR RESTAURANTS.
FIRST USE 11-24-2000; IN COMMERCE 2-28-2003.

ELEMENTS CORRECTED
DATE OF FIRST USE

2,913,657. REG. 12-21-2004. ALEXIA FOODS, INC. (DELAWARE CORPORATION) 37 GREENPOINT AVE, BROOKLYN, NY, 11222, SN 76-493,132. FILED 2-20-2003. PRINCIPAL REGISTER.

MORNING FRIES

NO CLAIM IS MADE TO THE EXCLUSIVE RIGHT TO USE "FRIES", APART FROM THE MARK AS SHOWN.
INT. CL. 29/U.S. CL. 46
FOR FROZEN PROCESSED POTATOES.
FIRST USE 7-13-2004; IN COMMERCE 7-13-2004.

ELEMENTS CORRECTED
OWNER NAME
OWNER ADDRESS
CITIZENSHIP
ENTITY

2,913,990. REG. 12-21-2004. WORLD WIDE ORDNANCE, INC. C/O DAVID A. CHENKIN, ESQUIRE (FLORIDA CORPORATION) LAW OFFICES OF DAVID A. CHENKIN, ESQ. P.A., 8551 WEST SUNRISE BLVD, SUITE 208, PLANTATION, FL, 33322, SN 76-498,238. FILED P.R. 3-17-2003; AM. S.R. 8-31-2004. SUPPLEMENTAL REGISTER.

WORLD WIDE ORDNANCE

INT. CL. 35/U.S. CLS. 100, 101 AND 102

FOR RETAIL DISTRIBUTORSHIPS FEATURING AUTOMATIC WEAPONS, BULLET MAGAZINE LOADING DEVICES AND GUN HOOKS, MAIL ORDER SERVICES FEATURING AUTOMATIC WEAPONS, BULLET MAGAZINE LOADING DEVICES AND GUN HOOKS; ON-LINE RETAIL STORE SERVICES FEATURING AUTOMATIC WEAPONS, BULLET MAGAZINE LOADING DEVICES AND GUN HOOKS.
FIRST USE 2-12-2003; IN COMMERCE 2-12-2003.

ELEMENTS CORRECTED
OWNER ADDRESS

2,914,598. REG. 12-28-2004. BLUE RHINO GLOBAL SOURCING, LLC (DELAWARE LIMITED LIABILITY COMPANY) 104 CAMBRIDGE PLAZA DRIVE, WINSTON-SALEM, NC, 27104, SN 78-312,031. FILED 10-10-2003. PRINCIPAL REGISTER.

VAC & TAC

INT. CL. 21/U.S. CLS. 2, 13, 23, 29, 30, 33, 40 AND 50
FOR INSECT TRAPPING SYSTEM COMPRISING A VACUUM AND STICKY PAPER TRAPS THAT IS SOLD AS A COMPONENT OF INSECT TRAPS FOR ATTRACTING AND DESTROYING[INSECT] * INSECTS".
FIRST USE 2-9-2004; IN COMMERCE 2-9-2004.

ELEMENTS CORRECTED
GOODS/SERVICES

2,916,729. REG. 1-4-2005. MARSH SUPERMARKETS, INC. (INDIANA CORPORATION) 9800 CROSSPOINT BOULEVARD, INDIANAPOLIS, IN, 462563350, SN 78-238,399. FILED 4-16-2003. PRINCIPAL REGISTER.

TRIOS DI TUSCANOS

THE ENGLISH TRANSLATION OF THE WORDING "DI" IS "OF".
INT. CL. 43/U.S. CLS. 100 AND 101
FOR RESTAURANT, COFFEE HOUSE, CAFE AND CATERING SERVICES, CARRY-OUT RESTAURANT AND CAFE SERVICES.
FIRST USE 4-1-2004; IN COMMERCE 4-1-2004.

ELEMENTS AMENDED
MARK

2,918,033. REG. 1-11-2005. GENERAL ELECTRIC COMPANY (NEW YORK CORPORATION) 1 RIVER ROAD, SCHE-
NECTADY, NY, 12345, SN 78-183,604. FILED 11-11-2002.
PRINCIPAL REGISTER.

FOR PRINTED MATTER, NAMELY, BROCHURES
RELATING TO HEALTH AND WELLNESS, PARENT-
ING, YOUTH DEVELOPMENT, EDUCATION, SOCIAL
ISSUES, COGNITIVE AND BEHAVIORAL CHANGE,
ELDER ISSUES, SAFETY, ENERGY AND CONSERVA-
TION, EMERGENCY PREPAREDNESS, RECREATION
AND LEISURE, AND RELIGION AND PAMPHLETS
RELATING TO HEALTH AND WELLNESS, PARENT-
ING, YOUTH DEVELOPMENT, EDUCATION, SOCIAL
ISSUES, COGNITIVE AND BEHAVIORAL CHANGE,
ELDER ISSUES, SAFETY, ELECTRICITY, ENERGY
AND CONSERVATION, EMERGENCY PREPAREDNESS,
RECREATION AND LEISURE, ANIMAL WELFARE,
AND RELIGION, BROCHURES AND PAMPHLETS RE-
LATING TO STAFF TRAINING IN THE AREAS OF
SAFETY, HEALTH, PERSONAL DEVELOPMENT, AND
COGNITIVE AND BEHAVIORAL CHANGE, COLORING
BOOKS RELATING TO HEALTH AND WELLNESS,
PARENTING, YOUTH DEVELOPMENT, EDUCATION,
SOCIAL ISSUES, SAFETY, ELECTRICITY, ENERGY
AND CONSERVATION, EMERGENCY PREPAREDNESS,
RECREATION AND LEISURE, ANIMAL WELFARE,
COGNITIVE AND BEHAVIORAL CHANGE, AND RELI-
GION, LEADER'S GUIDES RELATING TO HEALTH
AND WELLNESS, PARENTING, YOUTH DEVELOP-
MENT, EDUCATION, SOCIAL ISSUES, COGNITIVE
AND BEHAVIORAL CHANGE, SAFETY, EMERGENCY
PREPAREDNESS, RECREATION AND LEISURE, AND
RELIGION, POSTERS RELATING TO HEALTH AND
WELLNESS, PARENTING, YOUTH DEVELOPMENT,
EDUCATION, SOCIAL ISSUES, COGNITIVE AND BE-
HAVIORAL CHANGE, SAFETY, ELECTRICITY AND
ENERGY AND CONSERVATION, AND CALENDARS
RELATING TO HEALTH AND WELLNESS, PARENT-
ING, YOUTH DEVELOPMENT, EDUCATION, SOCIAL
ISSUES, COGNITIVE AND BEHAVIORAL CHANGE,
SAFETY, EMERGENCY PREPAREDNESS, AND RELI-
GION; CURRICULUM COURSE MATERIALS, NAMELY,
BOOKS IN THE AREAS OF HEALTH, SAFETY, PERSONAL
DEVELOPMENT, AND COGNITIVE AND BEHA-
VIORAL CHANGE, BROCHURES IN THE AREAS OF
HEALTH AND WELLNESS, YOUTH DEVELOPMENT,
SOCIAL ISSUES, AND COGNITIVE AND BEHAVIORAL
CHANGE, PARENTING, AND SAFETY, PAMPHLETS IN
THE AREAS OF HEALTH AND WELLNESS, YOUTH
DEVELOPMENT, SOCIAL ISSUES, PARENTING, PERSONAL
DEVELOPMENT, SAFETY COGNITIVE AND
BEHAVIORAL CHANGE, AND CLASSROOM MANAGE-
MENT, AND POSTERS IN THE AREAS OF YOUTH
DEVELOPMENT, SOCIAL ISSUES AND COGNITIVE
AND BEHAVIORAL CHANGE, AND HEALTH AND
WELLNESS.

FIRST USE 1-7-2002; IN COMMERCE 1-7-2002.

e-Speed

INT. CL. 10/U.S. CLS. 26, 39 AND 44
FOR COMPUTED TOMOGRAPHY (CT) APPARATUS
AND PARTS THEREFOR.
FIRST USE 10-28-2002; IN COMMERCE 10-28-2002.

ELEMENTS CORRECTED
MARK

INT. CL. 35/U.S. CLS. 100, 101 AND 102
FOR ADVERTISING SERVICES FOR OTHERS,
NAMELY, CONDUCTING DIRECT MAIL CAMPAIGNS
FOR OTHERS; TELEMARKETING SERVICES.
FIRST USE 1-10-2002; IN COMMERCE 1-10-2002.

2,918,225. REG. 1-11-2005. CHANNING BETE COMPANY,
INC. (MASSACHUSETTS CORPORATION) ONE COMMU-
NITY PLACE, SOUTH DEERFIELD, MA, 01373, SN 78-
975,556. FILED 11-7-2001. PRINCIPAL REGISTER.

INT. CL. 42/U.S. CLS. 100 AND 101
FOR ONLINE INFORMATION SERVICES, NAMELY,
PROVIDING INFORMATION RELATING TO HEALTH,
WELLNESS, PARENTING, YOUTH DEVELOPMENT,
SOCIAL ISSUES, COGNITIVE AND BEHAVIORAL
CHANGE, ELDER ISSUES, CHILD SAFETY, HOME
SAFETY, PERSONAL SAFETY, AND EMERGENCY
PREPAREDNESS; DESIGNING AND IMPLEMENTING
WEB PAGES FOR OTHERS, CONSULTING SERVICES IN
THE AREA OF COGNITIVE AND BEHAVIORAL
CHANGE; AND LANGUAGE TRANSLATION SER-
VICES.
FIRST USE 1-1-2002; IN COMMERCE 1-1-2002.

CHANNING BETE COMPANY

NO CLAIM IS MADE TO THE EXCLUSIVE RIGHT TO
USE "COMPANY", APART FROM THE MARK AS SHOWN.
THE NAME "CHANNING BETE" DOES NOT IDENTIFY A
LIVING INDIVIDUAL.
INT. CL. 16/U.S. CLS. 2, 5, 22, 23, 29, 37, 38 AND 50

ELEMENTS CORRECTED
CITIZENSHIP
ENTITY
OWNER NAME
OWNER ADDRESS

2,918,230. REG. 1-11-2005. CHANNING BETE COMPANY, INC. (MASSACHUSETTS CORPORATION) ONE COMMUNITY PLACE, SOUTH DEERFIELD, MA, 01373, SN 78-975,687. FILED 11-7-2001. PRINCIPAL REGISTER.



THE MARK CONSISTS OF A FANCIFUL DEPICTION OF A PERSON RUNNING.

INT. CL. 16/U.S. CLS. 2, 5, 22, 23, 29, 37, 38 AND 50

FOR PRINTED MATTER, NAMELY, BROCHURES RELATING TO HEALTH AND WELLNESS, PARENTING, YOUTH DEVELOPMENT, EDUCATION, SOCIAL ISSUES, COGNITIVE AND BEHAVIORAL CHANGE, ELDER ISSUES, SAFETY, ENERGY AND CONSERVATION, EMERGENCY PREPAREDNESS, RECREATION AND LEISURE, AND RELIGION AND PAMPHLETS RELATING TO HEALTH AND WELLNESS, PARENTING, YOUTH DEVELOPMENT, EDUCATION, SOCIAL ISSUES, COGNITIVE AND BEHAVIORAL CHANGE, ELDER ISSUES, SAFETY, ELECTRICITY, ENERGY AND CONSERVATION, EMERGENCY PREPAREDNESS, RECREATION AND LEISURE, ANIMAL WELFARE, AND RELIGION, BROCHURES AND PAMPHLETS RELATING TO STAFF TRAINING IN THE AREAS OF SAFETY, HEALTH, PERSONAL DEVELOPMENT, AND COGNITIVE AND BEHAVIORAL CHANGE, COLORING BOOKS RELATING TO HEALTH AND WELLNESS, PARENTING, YOUTH DEVELOPMENT, EDUCATION, SOCIAL ISSUES, SAFETY, ELECTRICITY, ENERGY AND CONSERVATION, EMERGENCY PREPAREDNESS, RECREATION AND LEISURE, ANIMAL WELFARE, COGNITIVE AND BEHAVIORAL CHANGE, AND RELIGION, LEADER'S GUIDES RELATING TO HEALTH AND WELLNESS, PARENTING, YOUTH DEVELOPMENT, EDUCATION, SOCIAL ISSUES, COGNITIVE AND BEHAVIORAL CHANGE, SAFETY, EMERGENCY PREPAREDNESS, RECREATION AND LEISURE, AND RELIGION, POSTERS RELATING TO HEALTH AND WELLNESS, PARENTING, YOUTH DEVELOPMENT, EDUCATION, SOCIAL ISSUES, COGNITIVE AND BEHAVIORAL CHANGE, SAFETY, ELECTRICITY AND ENERGY AND CONSERVATION, AND CALENDARS RELATING TO HEALTH AND WELLNESS, PARENTING, YOUTH DEVELOPMENT, EDUCATION, SOCIAL ISSUES, COGNITIVE AND BEHAVIORAL CHANGE, SAFETY, EMERGENCY PREPAREDNESS, AND RELIGION; CURRICULUM COURSE MATERIALS, NAMELY, BOOKS IN THE AREAS OF HEALTH, SAFETY, PERSONAL DEVELOPMENT, AND COGNITIVE AND BEHAVIORAL CHANGE, BROCHURES IN THE AREAS OF HEALTH AND WELLNESS, YOUTH DEVELOPMENT, SOCIAL ISSUES, AND COGNITIVE AND BEHAVIORAL CHANGE, PARENTING, AND SAFETY, PAMPHLETS IN THE AREAS OF HEALTH AND WELLNESS, YOUTH DEVELOPMENT, SOCIAL ISSUES, PARENTING, PERSONAL DEVELOPMENT, SAFETY COGNITIVE AND BEHAVIORAL CHANGE, AND CLASSROOM MANAGEMENT, AND POSTERS IN THE AREAS OF YOUTH DEVELOPMENT, SOCIAL ISSUES AND COGNITIVE AND BEHAVIORAL CHANGE, AND HEALTH AND WELLNESS.

FIRST USE 1-7-2002; IN COMMERCE 1-7-2002.
INT. CL. 35/U.S. CLS. 100, 101 AND 102

FOR ADVERTISING SERVICES FOR OTHERS, NAMELY, CONDUCTING DIRECT MAIL CAMPAIGNS FOR OTHERS; TELEMARKETING SERVICES.

FIRST USE 1-10-2002; IN COMMERCE 1-10-2002.
INT. CL. 42/U.S. CLS. 100 AND 101

FOR ONLINE INFORMATION SERVICES, NAMELY, PROVIDING INFORMATION RELATING TO HEALTH, WELLNESS, PARENTING, YOUTH DEVELOPMENT, SOCIAL ISSUES, COGNITIVE AND BEHAVIORAL CHANGE, ELDER ISSUES, CHILD SAFETY, HOME SAFETY, PERSONAL SAFETY, AND EMERGENCY PREPAREDNESS; DESIGNING AND IMPLEMENTING WEB PAGES FOR OTHERS, CONSULTING SERVICES IN THE AREA OF COGNITIVE AND BEHAVIORAL CHANGE; AND LANGUAGE TRANSLATION SERVICES.

FIRST USE 1-1-2002; IN COMMERCE 1-1-2002.

ELEMENTS CORRECTED

CITIZENSHIP

ENTITY

OWNER NAME

OWNER ADDRESS

2,918,231. REG. 1-11-2005. CHANNING BETE COMPANY, INC. (MASSACHUSETTS CORPORATION) ONE COMMUNITY PLACE, SOUTH DEERFIELD, MA, 01373, SN 78-975,692. FILED 11-7-2001. PRINCIPAL REGISTER.



NO CLAIM IS MADE TO THE EXCLUSIVE RIGHT TO USE "COMPANY", APART FROM THE MARK AS SHOWN. THE NAME "CHANNING BETE" DOES NOT IDENTIFY A LIVING INDIVIDUAL.

THE MARK CONSISTS OF A FANCIFUL DEPICTION OF A PERSON RUNNING WITHIN TEXT.

INT. CL. 16/U.S. CLS. 2, 5, 22, 23, 29, 37, 38 AND 50

FOR PRINTED MATTER, NAMELY, BROCHURES RELATING TO HEALTH AND WELLNESS, PARENTING, YOUTH DEVELOPMENT, EDUCATION, SOCIAL ISSUES, COGNITIVE AND BEHAVIORAL CHANGE, ELDER ISSUES, SAFETY, ENERGY AND CONSERVATION, EMERGENCY PREPAREDNESS, RECREATION AND LEISURE, AND RELIGION AND PAMPHLETS RELATING TO HEALTH AND WELLNESS, PARENTING, YOUTH DEVELOPMENT, EDUCATION, SOCIAL ISSUES, COGNITIVE AND BEHAVIORAL CHANGE, ELDER ISSUES, SAFETY, ELECTRICITY, ENERGY AND CONSERVATION, EMERGENCY PREPAREDNESS, RECREATION AND LEISURE, ANIMAL WELFARE, AND RELIGION, BROCHURES AND PAMPHLETS RELATING TO STAFF TRAINING IN THE AREAS OF SAFETY, HEALTH, PERSONAL DEVELOPMENT, AND COGNITIVE AND BEHAVIORAL CHANGE, COLORING BOOKS RELATING TO HEALTH AND WELLNESS, PARENTING, YOUTH DEVELOPMENT, EDUCATION, SOCIAL ISSUES, SAFETY, ELECTRICITY, ENERGY AND CONSERVATION, EMERGENCY PREPAREDNESS, RECREATION AND LEISURE, ANIMAL WELFARE, COGNITIVE AND BEHAVIORAL CHANGE, AND RELIGION, LEADER'S GUIDES RELATING TO HEALTH AND WELLNESS, PARENTING, YOUTH DEVELOPMENT, EDUCATION, SOCIAL ISSUES, COGNITIVE AND BEHAVIORAL CHANGE, SAFETY, EMERGENCY PREPAREDNESS, RECREATION AND LEISURE, AND RELIGION, POSTERS RELATING TO HEALTH AND WELLNESS, PARENTING, YOUTH DEVELOPMENT, EDUCATION, SOCIAL ISSUES, COGNITIVE AND BEHAVIORAL CHANGE, SAFETY, ELECTRICITY AND ENERGY AND CONSERVATION, AND CALENDARS RELATING TO HEALTH AND WELLNESS, PARENTING, YOUTH DEVELOPMENT, EDUCATION, SOCIAL ISSUES, COGNITIVE AND BEHAVIORAL CHANGE, SAFETY, EMERGENCY PREPAREDNESS, AND RELIGION; CURRICULUM COURSE MATERIALS, NAMELY, BOOKS IN THE AREAS OF HEALTH, SAFETY, PERSONAL DEVELOPMENT, AND COGNITIVE AND BEHAVIORAL CHANGE, BROCHURES IN THE AREAS OF HEALTH AND WELLNESS, YOUTH DEVELOPMENT, SOCIAL ISSUES, AND COGNITIVE AND BEHAVIORAL CHANGE, PARENTING, AND SAFETY, PAMPHLETS IN THE AREAS OF HEALTH AND WELLNESS, YOUTH DEVELOPMENT, SOCIAL ISSUES, PARENTING, PERSONAL DEVELOPMENT, SAFETY COGNITIVE AND BEHAVIORAL CHANGE, AND CLASSROOM MANAGEMENT, AND POSTERS IN THE AREAS OF YOUTH DEVELOPMENT, SOCIAL ISSUES AND COGNITIVE AND BEHAVIORAL CHANGE, AND HEALTH AND WELLNESS.

FIRST USE 1-7-2002; IN COMMERCE 1-7-2002.
 INT. CL. 35/U.S. CLS. 100, 101 AND 102

FOR ADVERTISING SERVICES FOR OTHERS, NAMELY, CONDUCTING DIRECT MAIL CAMPAIGNS FOR OTHERS; TELEMARKETING SERVICES.
 FIRST USE 1-10-2002; IN COMMERCE 1-10-2002.

INT. CL. 42/U.S. CLS. 100 AND 101
 FOR ONLINE INFORMATION SERVICES, NAMELY, PROVIDING INFORMATION RELATING TO HEALTH, WELLNESS, PARENTING, YOUTH DEVELOPMENT, SOCIAL ISSUES, COGNITIVE AND BEHAVIORAL CHANGE, ELDER ISSUES, CHILD SAFETY, HOME SAFETY, PERSONAL SAFETY, AND EMERGENCY PREPAREDNESS; DESIGNING AND IMPLEMENTING WEB PAGES FOR OTHERS, CONSULTING SERVICES IN THE AREA OF COGNITIVE AND BEHAVIORAL CHANGE; AND LANGUAGE TRANSLATION SERVICES.
 FIRST USE 1-1-2002; IN COMMERCE 1-1-2002.

ELEMENTS CORRECTED
 CITIZENSHIP
 ENTITY
 OWNER NAME
 OWNER ADDRESS

* * * * *

TRADEMARK REGISTRATIONS—NEW CERTIFICATES

New Certificates issued under section 7(d) of the Trademark Act of 1946 for the unexpired term of the original registrations.

983,624. THE NORTH FACE. U.S. CLS. 3, 22 AND 39. NORTH FACE, THE, BERKELEY, CA. REG. 5-14-1974. NEW CERT. SEC. 7(D) TO REGISTRANT.

NEW CERT. SEC. 7(D) TO THE NORTH FACE APPAREL CORP., WILMINGTON, DE.

1,102,407. MISCELLANEOUS DESIGN. INT. CL. 42. NORTH FACE, THE, BERKELEY, CA. REG. 9-12-1978. NEW CERT. SEC. 7(D) TO NORTH FACE APPAREL CORP., THE, WILMINGTON, DE.

2,097,715. THE NORTH FACE AND DESIGN. INT. CLS. 18, 20, 22 AND 25. NORTH FACE, INC., THE, SAN LEANDRO, CA. REG. 9-16-1997. NEW CERT. SEC. 7(D) TO NORTH FACE APPAREL CORP., THE, WILMINGTON, DE.

1,283,449. EXTREME. INT. CL. 25. NORTH FACE, THE, BERKELEY, CA. REG. 6-26-1984. NEW CERT. SEC. 7(D) TO REGISTRANT.

2,109,256. A5 AND DESIGN. INT. CL. 28. NORTH FACE, INC., THE, SAN LEANDRO, CA. REG. 10-28-1997. NEW CERT. SEC. 7(D) TO REGISTRANT.

1,762,096. APART. INT. CL. 25. OTTO-VERSAND (GMBH & CO), 22179 HAMBURG, FED REP GERMANY. REG. 3-30-1993. NEW CERT. SEC. 7(D) TO REGISTRANT.

2,300,758. THE NORTH FACE AND DESIGN. INT. CL. 25. NORTH FACE, INC., THE, SAN LEANDRO, CA. REG. 12-14-1999. NEW CERT. SEC. 7(D) TO REGISTRANT.

2,067,763. VAPORWICK. INT. CL. 1. NORTH FACE, INC., THE, BERKELEY, CA. REG. 6-3-1997. NEW CERT. SEC. 7(D) TO NORTH FACE APPAREL CORP., THE, WILMINGTON, DE.

2,660,558. CONVERSATILE. INT. CL. 22. NORTH FACE, INC., THE, SAN LEANDRO, CA. REG. 12-10-2002. NEW CERT. SEC. 7(D) TO REGISTRANT.

2,096,011. REMOTE TERRAIN GEAR. INT. CL. 25. NORTH FACE, INC., THE, SAN LEANDRO, CA. REG. 9-9-1997.

2,901,129. PANDA FARMS. INT. CL. 31. CRECES, HENRI, GOSHEN, NY. REG. 11-9-2004. NEW CERT. SEC. 7(D) TO REGISTRANT.

* * * * *

INDEX OF REGISTRANTS

MAY 24, 2005

(Registered; Renewed; Canceled; Amended, Corrected, etc.; New Certificates; 12c Publications.)

The designation "U.S. Cl." appearing in this section refers to the U.S. class in effect prior to Sep. 1, 1973 rather than the international class which applies to applications filed on or after that date. For adoption of international classification see notice in the OFFICIAL GAZETTE of Jun. 26, 1973 (911 O.G. TM 210).

"JAGUAR" STAHLWARENFABRIK GMBH & CO. KG, SOLINGEN, FED REP GERMANY:
2,954,719, PUB. 3-1-2005. INT. CL. 8.

A. DAIGGER & COMPANY, INC., VERNON HILLS, IL:
1,882,181. REN. 4-15-05. INT. CL. 16.

A. SCHULMAN, INC., AKRON, OH:
2,955,313, INT. CL. 1.

A.A. TRUCK RENTING CORP., LONG ISLAND CITY, NY:
1,947,691. REN. 4-15-05. INT. CL. 39.

A.S.A.P. PERSONNEL SERVICES, INC., SMITHTOWN, NY:
2,954,265, PUB. 3-1-2005. INT. CL. 35.

A.T. WEST 16TH ENTERPRISES, LTD., NEW YORK, NY:
1,843,282, CANC. INT. CL. 42.

A.T.G. SPORTS INDUSTRIES, INC., WICHITA, KS:
2,956,106, INT. CL. 27.

AAA TENT & AWNING COMPANY, SALT LAKE CITY, UT:
2,954,773, PUB. 3-1-2005. INT. CL. 35.
2,954,774, PUB. 3-1-2005. INT. CL. 22.

AAR CORP., ELK GROVE VILLAGE, IL:
2,171,791, CANC. INT. CL. 7.

AB VACUUM EXTRACTOR, 400 60 GOTEBOG, SWEDEN:
1,843,556, CANC. INT. CL. 10.

AB VOLVO, 405 08 GOTEBOG, SWEDEN:
1,843,511, CANC. INT. CL. 9.

ABANAKI CORPORATION, CHAGRIN FALLS, OH:
1,911,104. REN. 4-13-05. INT. CL. 7.

ABB AUTOMATION GROUP AG, CH-8050 ZURICH, SWITZERLAND:
2,955,808, MULTIPLE CLASS, INT. CLS. 9 AND 42.
2,955,810, MULTIPLE CLASS, INT. CLS. 9 AND 42.

ABBOTT LABORATORIES, ABBOTT PARK, IL:
1,843,437, CANC. INT. CL. 5.

ABBYSON CORPORATION, CALABASAS, CA:
2,954,451, PUB. 3-1-2005. INT. CL. 18.

ABELL, MARTHA S., BLAINE, WA:
2,955,050, PUB. 3-1-2005. INT. CL. 16.

ABLEMARLE CORPORATION, BATON ROUGE, LA:
2,954,450, PUB. 3-1-2005. MULTIPLE CLASS, INT. CLS. 1 AND 3.

ABRAMS & COMPANY PUBLISHERS, INC., WATERBURY, CT:
1,891,021. REN. 4-11-05. INT. CL. 16.

ABRAMS CAPITAL, LLC, BOSTON, MA:
2,956,074, INT. CL. 36.

ABU AB, SVANGSTA, SWEDEN, ABU AB, SVANGSTA, SWEDEN:
1,880,063. REN. 4-11-05. INT. CL. 37.

AC NIELSEN (US), INC., SCHAUMBURG, IL TO A.C. NIELSEN COMPANY, SCHAUMBURG, IL:
2,911,689, COR. MULTIPLE CLASS, INT. CLS. 35 AND 42.

ACADEMY LIFE INSURANCE COMPANY, VALLEY FORGE, PA:
1,284,590, CANC. INT. CL. 36.

ACCELA COMMUNICATIONS INC, SOUTHBOROUGH, MA FROM INTERNATIONAL DATA GROUP, INC., FRAMINGHAM, MA:
2,955,509, MULTIPLE CLASS, INT. CLS. 35, 38, 41 AND 42.

ACCESS EDUCATION CORPORATION, HOUSTON, TX:
2,171,211, CANC. INT. CL. 41.

ACCU PERSONNEL, INC., PENNSAUKEN, NJ:
2,953,994, PUB. 3-1-2005. INT. CL. 35.

ACCU-WEATHER, INC., STATE COLLEGE, PA:
1,843,139, CANC. MULTIPLE CLASS, INT. CLS. 35, 36, 41 AND 42.

ACCURATE AUTOMATION CORPORATION, CHATTAHOOGA, TN:
2,170,738, CANC. INT. CL. 9.

ACE BED CO., LTD., KYONGGI-DO, REPUBLIC OF KOREA:
178,478. REN. 4-11-05. U.S. CL. 32 (INT. CL. 20).

ACECOOK VIETNAM COMPANY LIMITED, HO CHI MINH CITY, VIETNAM:
2,954,788, PUB. 3-1-2005. INT. CL. 30.

ACRI.TEC GESELLSCHAFT FUER OPHTHALMOLOGISCHE PRODUKTE, D-16761 HENNIGSDORF, FED REP GERMANY:
2,954,424, PUB. 3-1-2005. INT. CL. 10.

ACTI-FORM LTD., MARKHAM, ONTARIO L3R 9W9, CANADA:
1,843,450, CANC. INT. CL. 5.

ACTIVATOR METHODS INTERNATIONAL, LTD., PHOENIX, AZ:
2,955,780, INT. CL. 10.

ACTIVE, INC., MILFORD, OH:
2,170,990, CANC. INT. CL. 42.

ADAMS ENTERPRISES, INC., CARSON CITY, NV:
2,954,124, PUB. 3-1-2005. INT. CL. 35.

ADC TELECOMMUNICATIONS, INC., EDEN PRAIRIE, MN:
2,955,236, INT. CL. 9.
2,955,257, INT. CL. 9.

ADCONFERENCE[LIVE], INC., HOUSTON, TX:
2,171,152, CANC. INT. CL. 38.

ADDA CORP., PING TUNG CITY, TAIWAN:
2,954,417, PUB. 10-26-2004. MULTIPLE CLASS, INT. CLS. 9 AND 11.

ADDISON, GARY L., ANDERSON, IN:
2,954,749, PUB. 3-1-2005. INT. CL. 41.

ADERDEEN ROAD COMPANY, EMIGSVILLE, PA, HEALTH-CHEM CORPORATION, NEW YORK, NY:
1,020,931. REN. 4-13-05. INT. CL. 5.

ADERIS PHARMACEUTICALS, INC., HOPKINTON, MA FROM DISCOVERY THERAPEUTICS, INC., HOPKINTON, MA:
2,955,474, INT. CL. 42.

ADIDAS AG, D-91072, FED REP GERMANY:
2,171,660, CANC. INT. CL. 16.

ADJUNCT LLC, SAN FRANCISCO, CA:
2,954,850, PUB. 3-1-2005. INT. CL. 35.
2,954,851, PUB. 3-1-2005. INT. CL. 35.

ADLER LEATHER SPORTSWEAR MANUFACTURING CO., INC., SYLMAR, CA:
2,954,323, PUB. 3-1-2005. INT. CL. 25.

ADS TECHNOLOGIES, INC., CERRITOS, CA:
1,914,674. REN. 4-14-05. INT. CL. 9.

ADVANCE MAGAZINE PUBLISHERS INC., NEW YORK, NY:
2,171,908, CANC. INT. CL. 35.

ADVANCED BIOMATERIAL SYSTEMS, INC., CHATHAM, NJ:
2,956,179, MULTIPLE CLASS, INT. CLS. 5 AND 10.

- ADVANCED BRAIN TECHNOLOGIES, LLC, OGDEN, UT:
2,955,945, MULTIPLE CLASS, INT. CLS. 9 AND 41.
- ADVANCED COMPOSITES GROUP LIMITED, HEANOR,
DERBYSHIRE, UNITED KINGDOM:
2,954,610, PUB. 3-1-2005. MULTIPLE CLASS, INT. CLS. 1
AND 17.
- ADVANCED INFORMATION MANAGEMENT SYSTEMS
L.L.C., COLLIERVILLE, TN:
2,171,166, CANC. INT. CL. 36.
2,171,167, CANC. INT. CL. 36.
- ADVANCED LIGHTING TECHNOLOGIES, INC., TWINS-
BURG, OH:
2,171,151, CANC. INT. CL. 11.
- ADVANCED MEDICAL NUTRITION, INC., PITTSBURGH,
PA:
1,937,147, REN. 4-12-05. INT. CL. 5.
- ADVANCED MODERN TECHNOLOGIES CORPORATION,
LOS ANGELES, CA:
2,954,348, PUB. 3-1-2005. INT. CL. 11.
- ADVANCED PUMPING SYSTEMS, INC., LAFAYETTE, CO:
1,284,079, CANC. INT. CL. 7.
- ADVANCED RESEARCH TECHNOLOGIES, INC., CAM-
BRIDGE, MA:
2,956,066, INT. CL. 35.
- AEL LEASING CO., INC., READING, PA:
2,170,737, CANC. MULTIPLE CLASS, INT. CLS. 36 AND
37.
- AER-FLO CANVAS PRODUCTS, INC., BRADENTON, FL,
DBA AER-FLO, INC.:
2,956,060, INT. CL. 22.
- AERATION INDUSTRIES INTERNATIONAL, INC., CHAS-
KA, MN:
2,955,262, INT. CL. 7.
- AERONAUTICAL ADVENTURES, INC., CHESTERFIELD,
MO:
2,170,962, CANC. MULTIPLE CLASS, INT. CLS. 12, 35, 37,
39, 40 AND 42.
- AESCULAPIAN INCORPORATED, ROCHESTER, MN:
2,754,830, AM. INT. CL. 42.
- AFFILIATED FOODS, INC., AMARILLO, TX:
1,843,826, CANC. INT. CL. 31.
- AFFORDABLE KIOSKS, INC., PHOENIX, AZ:
2,956,126, INT. CL. 35.
- AG MEDIA, INC., GREENWICH, CT:
2,171,258, CANC. INT. CL. 16.
- AGA ENTERPRISES, INC., AKRON, OH:
2,170,730, CANC. INT. CL. 42.
- AGC, INC., CLEVELAND, OH:
2,171,965, CANC. INT. CL. 28.
- AGF MANAGEMENT LIMITED, TORONTO, ONTARIO,
CANADA:
2,954,035, PUB. 9-7-2004. INT. CL. 36.
- AGIO SIGARENFABRIEKEN N.V., NL-5525 AR DUIZEL,
NETHERLANDS:
2,955,174, PUB. 3-1-2005. INT. CL. 34.
- AGION TECHNOLOGIES, INC., WAKEFIELD, MA:
2,956,261, INT. CL. 5.
2,956,262, INT. CL. 5.
- AGL, PARIS, 75008, FRANCE:
2,954,922, PUB. 3-1-2005. INT. CL. 38.
- AGNEW, DENNIS, NEW YORK, NY:
2,955,660, INT. CL. 39.
- AGRICULTURAL EXCESS AND SURPLUS INSURANCE
COMPANY, CINCINNATI, OH:
1,284,599, CANC. INT. CL. 36.
- AGRIGENIC FOOD CORPORATION, HUNTINGTON
BEACH, CA:
2,954,980, PUB. 3-1-2005. INT. CL. 5.
- AGRILINK FOODS, INC., ROCHESTER, NY:
2,171,633, CANC. INT. CL. 29.
- AGRILINK HOLDINGS PTY LTD., HILTON, SOUTH AUS-
TRALIA 5033, AUSTRALIA:
2,955,280, MULTIPLE CLASS, INT. CLS. 35, 36 AND 44.
2,955,281, MULTIPLE CLASS, INT. CLS. 35, 36 AND 44.
- AGROPUR COOPERATIVE, GRANBY, QUEBEC, CANADA:
2,954,201, PUB. 9-28-2004. MULTIPLE CLASS, INT. CLS. 5
AND 32.
- AGUDAT HAKORMIM HACOOPERATIVIT SHEL YEKVEI
RICHON LE ZION V'ZICHRON YAAKOV B.M., RICHON
LE ZION, ISRAEL, DBA CARMEL WINE GROWERS
COOPERATIVE:
1,284,520, CANC. INT. CL. 33.
- AGUDAT HAKORMIM HACOOPERATIVIT SHEL YEKVEI
RICHON LE ZION V'ZICHRON YAAKOV B.M., RICHON
LE ZION 75100, ISRAEL, DBA CARMEL WINE GROWERS
COOPERATIVE:
2,955,874, INT. CL. 35.
- AHOLA CORPORATION, BRECKSVILLE, OH:
2,954,777, PUB. 3-1-2005. INT. CL. 35.
- AIDS PROJECT LOS ANGELES, LOS ANGELES, CA:
2,170,984, CANC. INT. CL. 36.
- AIR QUALITY SCIENCES, INC., ATLANTA, GA:
1,880,619, REN. 4-14-05. INT. CL. 16.
- AIR RIDE TECHNOLOGIES, INC., JASPER, IN:
2,954,373, PUB. 3-1-2005. INT. CL. 9.
- AIRCRAFT GEAR CORPORATION, ROCKFORD, IL:
2,955,594, INT. CL. 12.
- AIREL WEST INC., HALLENDALE, FL:
1,843,567, CANC. INT. CL. 10.
- AIRO-SERIES, INC., SANTEE, CA:
2,955,028, PUB. 3-1-2005. INT. CL. 12.
- AIRTOURS PLC, MANCHESTER, ENGLAND:
2,360,568, CANC. MULTIPLE CLASS, INT. CLS. 39 AND
42.
- AIS MEDIA, INC., ATLANTA, GA:
2,954,283, PUB. 3-1-2005. INT. CL. 42.
- AIXTRON AG, AACHEN, FED REP GERMANY, AIXTRON
SEMICONDUCTOR TECHNOLOGIES GMBH, D 5100
AACHEN, FED REP GERMANY:
1,876,136, REN. 4-15-05. INT. CL. 7.
- AJR BEAUTY INDUSTRY SERVICES, LLC, NEW YORK,
NY:
2,955,695, INT. CL. 3.
- AKTIEBOLAGET SCANIAINVENTOR, HELSINGBORG,
SWEDEN:
1,284,005, CANC. MULTIPLE CLASS, INT. CLS. 4 AND
11.
- ALADDIN EQUIPMENT COMPANY, SARASOTA, FL:
1,325,359, REN. 4-13-05. INT. CL. 4.
- ALADDIN EQUIPMENT COMPANY, SARASOTA, FL,
ALADDIN SWIMMING POOL SERVICE AND SUPPLY
COMPANY, HUNTINGTON BEACH, CA, DBA ALADDIN
EQUIPMENT COMPANY:
1,330,162, REN. 4-13-05. INT. CL. 42.
- ALADDIN EQUIPMENT COMPANY, SARASOTA, FL:
1,332,231, REN. 4-13-05. INT. CL. 21.
- ALAMO GROUP INC., SEGUIN, TX:
2,954,439, PUB. 3-1-2005. INT. CL. 35.
- ALAN I. ROSENBLATT, MD, SC, CHICAGO, IL:
2,954,533, PUB. 3-1-2005. INT. CL. 44.
- ALARM SPECIALIST CORPORATION, SARASOTA, FL:
2,172,002, CANC. INT. CL. 42.
- ALARON, INC., AUBURN HILLS, MI:
1,843,534, CANC. INT. CL. 9.
- ALASKA TRAVEL INDUSTRY ASSOCIATION, ANCHO-
RAGE, AK:
2,954,702, PUB. 3-1-2005. INT. CL. 39.
- ALBERTO-CULVER COMPANY, MELROSE PARK, IL:
2,955,688, INT. CL. 3.
- ALBERTSON'S INC., BOISE, ID:
2,171,480, CANC. INT. CL. 29.
- ALBERTSON'S, INC., BOISE, ID TO AMERICAN STORES
COMPANY, SALT LAKE CITY, UT:
2,878,084, COR. INT. CL. 42.
- ALCHEMY GLASS & LIGHT, INC., LOS ANGELES, CA:
2,954,606, PUB. 3-1-2005. INT. CL. 21.
- ALDEN LEEDS, INC., SOUTH KEARNY, NJ:
1,843,398, CANC. INT. CL. 1.
- ALDERSON, STEPHEN J., LAGUNA NIGUEL, CA:
2,954,311, PUB. 3-1-2005. MULTIPLE CLASS, INT. CLS. 12
AND 36.
- ALEF STANDARD PACKAGING COMPANY, PHILADEL-
PHIA, PA:
2,954,313, PUB. 3-1-2005. MULTIPLE CLASS, INT. CLS. 6,
9, 14, 16, 20, 21 AND 22.

- ALFRED DUNHILL LIMITED, UNITED KINGDOM:
2,955,186, PUB. 3-1-2005. INT. CL. 14.
- ALITALIA LINEE AEREE ITALIANE S.P.A., ROMA, ITALY:
1,885,318. REN. 4-13-05. INT. CL. 39.
- ALL COMPONENTS, INC., FARMERS BRANCH, TX:
2,955,855, INT. CL. 9.
- ALL NATURAL FMG, INC., NORTH PALM BEACH, FL:
2,955,413, INT. CL. 5.
- ALL PLUMBERS SUPPLY CORP., ROCHESTER, NY:
2,170,991, CANC. MULTIPLE CLASS, INT. CLS. 11 AND 35.
- ALL PURPOSE, INC., SALT LAKE CITY, UT:
2,954,811, PUB. 3-1-2005. INT. CL. 25.
- ALLEN-EDMONDS SHOE CORPORATION, PORT WASHINGTON, WI:
1,843,721, CANC. INT. CL. 25.
- ALLIANCE FUNDING, INCORPORATED, ALEXANDRIA, VA:
1,284,559, CANC. INT. CL. 36.
- ALLIANCE OF CANADIAN CINEMA TELEVISION AND RADIO ARTISTS, TORONTO ONTARIO, CANADA:
2,954,042, PUB. 6-8-2004. MULTIPLE CLASS, INT. CLS. 35, 36, 41 AND 42.
- ALLOY TECHNOLOGY SOLUTIONS, INC., MARINETTE, WI:
2,956,186, INT. CL. 42.
- ALLTECH ASSOCIATES, INC., COLUMBIA, MD:
2,955,363, MULTIPLE CLASS, INT. CLS. 1 AND 9.
- ALLY CORPORATION, CHESAPEAKE, VA:
2,955,995, INT. CL. 9.
- ALM PROPERTIES, INC., NEWARK, DE:
2,955,898, INT. CL. 16.
- ALMAR SALES COMPANY, INC., NEW YORK, NY:
1,360,784. REN. 4-15-05. INT. CL. 26.
- ALOE FARMS, INC., HARLINGEN, TX:
2,955,057, PUB. 3-1-2005. INT. CL. 32.
- ALPA LUMBER INC., MISSISSAUGA, ONTARIO, CANADA:
2,954,098, PUB. 9-7-2004. INT. CL. 19.
- ALPHA DELTA PI SORORITY, ATLANTA, GA:
1,356,590. REN. 4-14-05. MULTIPLE CLASS, INT. CLS. 16 AND 25.
- ALPHA INNOTECH CORPORATION, SAN LEANDRO, CA:
2,955,090, PUB. 3-1-2005. INT. CL. 1.
- ALPHA OMEGA PUBLICATIONS, INC., CHANDLER, AZ:
2,955,340, INT. CL. 16.
2,955,341, INT. CL. 16.
2,955,342, INT. CL. 16.
2,955,343, INT. CL. 16.
2,955,347, INT. CL. 16.
2,955,348, INT. CL. 16.
2,955,349, INT. CL. 16.
2,955,350, INT. CL. 16.
- ALPHA OMICRON PI FOUNDATION, BRENTWOOD, TN:
2,954,847, PUB. 3-1-2005. INT. CL. 36.
- ALPHONSE CAPONE ENTERPRISES, INC., ST. CHARLES, IL:
2,955,440, INT. CL. 33.
- ALPINE OVERHEAD DOORS, INC., BROOKLYN, NY:
2,171,176, CANC. INT. CL. 7.
- ALPINESTARS RESEARCH SRL, 31010 COSTE DI MASER (TREVISO), ITALY:
2,954,101, PUB. 8-24-2004. INT. CL. 25.
- ALRA LABORATORIES, INC., GURNEE, IL:
2,170,734, CANC. INT. CL. 5.
- ALS SCAN, INC., COLUMBIA, MD:
2,954,954, PUB. 3-1-2005. INT. CL. 41.
- ALTEON INC., NORTHVALE, NJ:
1,843,438, CANC. INT. CL. 5.
- ALTERNATIVE CANINE TRAINING, LLC, ROYAL OAK, MI:
2,956,148, INT. CL. 41.
- ALTFIELD ENTERPRISES LTD., CENTRAL, HONG KONG:
2,171,049, CANC. MULTIPLE CLASS, INT. CLS. 16 AND 20.
- ALTICOR INC., ADA, MI:
2,955,489, INT. CL. 5.
- ALUMA SHIELD INDUSTRIES, INC., DAYTONA BEACH, FL:
1,842,654, CANC. INT. CL. 6.
- ALUMISEAL CORPORATION, STAMFORD, CT:
599,274. REN. 4-13-05. U.S. CL. 12 (INT. CL. 17).
- ALVARADO DYE & KNITTING MILLS, UNION CITY, CA:
2,954,988, PUB. 3-1-2005. INT. CL. 25.
- AMAX PLATING, INC., ELGIN, IL:
1,284,644, CANC. INT. CL. 40.
- AMBRION, INC., BLOOMINGTON, MN:
2,955,003, PUB. 3-1-2005. INT. CL. 35.
- AMERICA ONLINE, INC., DULLES, VA:
2,955,407, INT. CL. 38.
- AMERICA 001 MEDIA, LLC, NEW YORK, NY:
2,955,847, INT. CL. 16.
- AMERICA'S DRIVE-IN CORP., WICHITA, KS:
2,955,000, PUB. 3-1-2005. INT. CL. 43.
- AMERICAAT.COM, LLC, LAS VEGAS, NV:
2,955,226, INT. CL. 36.
- AMERICAN APPAREL & FOOTWEAR ASSOCIATION, ARLINGTON, VA:
2,954,520, PUB. 3-1-2005. INT. CL. 35.
2,954,521, PUB. 3-1-2005. INT. CL. 35.
- AMERICAN APPAREL, INC., LOS ANGELES, CA:
2,954,280, PUB. 3-1-2005. INT. CL. 25.
- AMERICAN ASSOCIATION OF NEUROLOGICAL SURGEONS, ROLLING MEADOWS, IL:
2,955,766, INT. CL. 36.
- AMERICAN AUTOMOBILE ASSOCIATION, INC., HEATHROW, FL:
2,171,057, CANC. MULTIPLE CLASS, INT. CLS. 39 AND 42.
- AMERICAN BOARD OF SCIENTIFIC MEDICAL INTUITION, FAIR GROVE, MO:
2,955,310, U.S. CL. B.
- AMERICAN BRANDS, INC., NEW YORK, NY:
772,691, CANC. U.S. CL. 17.
- AMERICAN BROADCASTING COMPANIES, INC., NEW YORK, NY:
1,293,368. REN. 4-11-05. INT. CL. 41.
- AMERICAN CASH FLOW ASSOCIATION, INC., ORLANDO, FL:
2,954,086, PUB. 1-28-2003. INT. CL. 35.
- AMERICAN CLASSIC, LLC, BOSTON, MA:
2,956,165, INT. CL. 43.
- AMERICAN COUNCIL ON EXERCISE, SAN DIEGO, CA:
1,884,858. REN. 4-12-05. MULTIPLE CLASS, INT. CLS. 16, 25 AND 41.
1,898,868. REN. 4-12-05. MULTIPLE CLASS, INT. CLS. 16 AND 41.
- AMERICAN DIABETES ASSOCIATION, INC., ALEXANDRIA, VA:
1,843,873, CANC. INT. CL. 36.
- AMERICAN FAMILY LIFE ASSURANCE COMPANY OF COLUMBUS, COLUMBUS, GA:
1,842,926, CANC. MULTIPLE CLASS, INT. CLS. 16 AND 42.
- AMERICAN FELT & FILTER COMPANY, NEWBURGH, NY:
2,170,804, CANC. INT. CL. 11.
2,170,805, CANC. INT. CL. 11.
2,170,806, CANC. INT. CL. 11.
- AMERICAN FUTURE TECHNOLOGY CORP., MONTEREY PARK, CA, DBA IBUYPOWER:
2,955,109, PUB. 3-1-2005. INT. CL. 9.
- AMERICAN GAS ASSOCIATION, ARLINGTON, VA:
2,171,741, CANC. INT. CL. 36.
- AMERICAN HOME PRODUCTS CORPORATION, NEW YORK, NY:
772,852, CANC. U.S. CL. 38.
- AMERICAN INDOOR SOCCER ASSOCIATION, INC., CANTON, OH, DBA NATIONAL PROFESSIONAL SOCCER LEAGUE:
1,843,977, CANC. INT. CL. 41.

- AMERICAN INTERNATIONAL CONCESSION PRODUCTS CORP., FARMINGDALE, NY:
2,171,726, CANC. INT. CL. 30.
2,171,727, CANC. INT. CL. 30.
2,171,969, CANC. INT. CL. 30.
- AMERICAN INTERNATIONAL GROUP, INC., NEW YORK, NY:
2,955,062, PUB. 3-1-2005. INT. CL. 36.
2,955,063, PUB. 3-1-2005. INT. CL. 36.
2,955,156, PUB. 3-1-2005. INT. CL. 36.
2,955,157, PUB. 3-1-2005. INT. CL. 36.
2,955,158, PUB. 3-1-2005. INT. CL. 36.
2,955,159, PUB. 3-1-2005. INT. CL. 35.
2,956,202, INT. CL. 36.
2,956,352, INT. CL. 42.
- AMERICAN INTERNATIONAL INDUSTRIES, LOS ANGELES, CA:
2,954,720, PUB. 12-9-2003. INT. CL. 3.
- AMERICAN LAW ON-LINE, INC., OWINGS MILLS, MD:
2,955,984, INT. CL. 42.
- AMERICAN MANAGEMENT ASSOCIATION, NEW YORK, NY TO AMERICAN MANAGEMENT ASSOCIATION INTERNATIONAL, NEW YORK, NY:
1,843,899, CANC. INT. CL. 41.
- AMERICAN MEDICAL DIAGNOSTICS, INC., FAIRFAX, VA:
2,956,115, INT. CL. 41.
- AMERICAN MEGACOM, INC., LIVONIA, MI:
2,955,356, MULTIPLE CLASS, INT. CLS. 35 AND 42.
- AMERICAN MUSSEL HARVESTERS, INC., NORTH KINGSTOWN, RI:
2,955,879, INT. CL. 31.
- AMERICAN OPTICAL IP CORPORATION, GREENWICH, CT:
2,954,568, PUB. 3-1-2005. INT. CL. 9.
- AMERICAN PIONEER FINANCIAL SERVICES, INC., OREM, UT:
2,955,998, INT. CL. 36.
- AMERICAN PRINTING HOUSE FOR THE BLIND, LOUISVILLE, KY:
2,956,319, INT. CL. 28.
- AMERICAN PSYCHOLOGICAL ASSOCIATION, WASHINGTON, DC:
2,912,420, COR. INT. CL. 9.
- AMERICAN PUBLIC MEDIA GROUP, ST. PAUL, MN:
2,956,008, INT. CL. 35.
- AMERICAN SOCIETY FOR CLINICAL PATHOLOGY, INC., CHICAGO, IL:
2,954,208, PUB. 3-1-2005. INT. CL. 16.
- AMERICAN SOCO, INC., MIDDLESEX, NJ:
1,284,495, CANC. INT. CL. 29.
- AMERICAN SOUTHWEST FINANCIAL CORPORATION, PHOENIX, AZ:
1,284,579, CANC. INT. CL. 36.
- AMERICAN SPORTING GOODS CORPORATION, IRVINE, CA:
2,955,404, INT. CL. 25.
- AMERICAN TECHNICAL CERAMICS CORP., HUNTINGTON STATION, NY, PHASE INDUSTRIES, INC., HUNTINGTON STATION, NY:
1,355,000, REN. 4-12-05. INT. CL. 9.
- AMERICAN TECHNOLOGIES, INC., BELLEVILLE, IL:
1,284,605, CANC. INT. CL. 37.
- AMERICAN VETERINARY MEDICAL ASSOCIATION, SCHAUMBURG, IL:
2,954,456, PUB. 3-1-2005. INT. CL. 35.
- AMERICAN WOODMARK CORPORATION, WINCHESTER, VA:
2,171,279, CANC. INT. CL. 20.
- AMERICAPCS, MT. VERNON, OH:
2,956,174, INT. CL. 38.
- AMERICOR MORTGAGE, INC., TROY, MI:
2,956,054, INT. CL. 36.
- AMERINET, INC., LAKE OSWEGO, OR:
2,336,147, CANC. INT. CL. 36.
- AMERIVEST PARTNERS, LLC, NEW YORK, NY:
2,954,718, PUB. 8-17-2004. INT. CL. 36.
- AMERON INTERNATIONAL CORPORATION, PASADENA, CA, SOUTHERN PIPE & CASING CO., AZUSA, CA:
610,923, REN. 4-15-05. U.S. CL. 13 (INT. CL. 6).
- AMES TRUE TEMPER PROPERTIES, INC., WILMINGTON, DE:
2,955,775, INT. CL. 8.
- AMI AGROLINZ MELAMINE INTERNATIONAL; GMBH, AUSTRIA:
2,955,184, PUB. 3-1-2005. MULTIPLE CLASS, INT. CLS. 1 AND 4.
- AMINA RUBINACCI S.R.L., 80121 NAPOLI, ITALY:
2,954,803, PUB. 3-1-2005. MULTIPLE CLASS, INT. CLS. 18, 24 AND 25.
- AMINACH BEDDING & FURNITURE MANUFACTURERS & DISTRIBUTORS LTD., RAMAL, ISRAEL, ISRAEL:
2,870,556, COR. INT. CL. 20.
- AMOREPACIFIC CORPORATION, SEOUL, REPUBLIC OF KOREA:
2,955,369, INT. CL. 3.
2,955,617, INT. CL. 3.
- AMORI, GERALDINE H., SHELBURNE, VT:
2,956,034, INT. CL. 41.
- AMREP, INC., MARIETTA, GA:
2,955,123, PUB. 3-1-2005. INT. CL. 4.
- AMS FRANCHISE CORPORATION, SANTA BARBARA, CA:
2,954,952, PUB. 3-1-2005. INT. CL. 41.
- AMY'S KITCHEN, INC., SANTA ROSA, CA:
2,954,885, PUB. 3-1-2005. MULTIPLE CLASS, INT. CLS. 29 AND 30.
- ANALYTIC RESEARCH ASSOCIATES, INC., ANN ARBOR, MI:
2,171,859, CANC. INT. CL. 35.
- ANDAMIRO CO., LTD., MAPO-GU, SEOUL, REPUBLIC OF KOREA:
2,954,043, PUB. 6-29-2004. MULTIPLE CLASS, INT. CLS. 3, 8, 9, 14, 15, 16, 18, 20, 21, 24, 25, 28 AND 41.
- ANDERMAC, INC., YUBA CITY, CA:
1,843,372, CANC. MULTIPLE CLASS, INT. CLS. 10 AND 11.
- ANDERSON UNIVERSITY, INC., ANDERSON, IN:
2,955,046, PUB. 3-1-2005. INT. CL. 9.
- ANDERSON, JAMES D., LONGWOOD, FL:
2,955,679, INT. CL. 14.
- ANDIGILOG, INC., TEMPE, AZ:
2,954,331, PUB. 3-1-2005. INT. CL. 9.
- ANGEL TOES, INC., EDINA, MN:
2,954,671, PUB. 3-1-2005. INT. CL. 16.
- ANGLES BEAUTY CARE GROUP, INC., SAN DIEGO, CA:
2,171,297, CANC. INT. CL. 3.
- ANHEUSER-BUSCH EMPLOYEES' CREDIT UNION, SAINT LOUIS, MO:
2,954,541, PUB. 3-1-2005. INT. CL. 36.
2,954,542, PUB. 3-1-2005. INT. CL. 36.
- ANKONY LAND, INC., CLARKESVILLE, GA:
2,954,835, PUB. 3-1-2005. INT. CL. 44.
- ANNICK GOUTAL, 75001 PARIS, FRANCE:
1,874,962, REN. 4-14-05. INT. CL. 3.
- ANNIE'S ATTIC, INC., IRVING, TX TO DRG TEXAS LP, BERNE, IN:
1,843,334, CANC. INT. CL. 42.
- ANNUITY BOARD OF THE SOUTHERN BAPTIST CONVENTION, DALLAS, TX:
2,954,597, PUB. 3-1-2005. INT. CL. 36.
- ANOMET INC., BRAMPTON, ONTARIO, L7A 1C2, CANADA:
2,954,143, PUB. 9-21-2004. MULTIPLE CLASS, INT. CLS. 6 AND 35.
- ANP, INC., PHOENIX, AZ, DBA ARIZONA NATURAL PRODUCTS:
1,844,050, REN. 4-13-05. INT. CL. 5.
- ANSCOTT CHEMICAL INDUSTRIES, INC., WAYNE, NJ, DBA CALED SIGNAL CHEMICAL:
1,283,987, CANC. INT. CL. 3.
- ANSELL EDMONT INDUSTRIAL INC., COSHOCTON, OH TO ANSELL PROTECTIVE PRODUCTS INC., COSHOCTON, OH:
1,843,695, CANC. INT. CL. 25.

- ANSELL HEALTHCARE PRODUCTS, LLC, RED BANK, NJ, DBA ANSELL HEALTHCARE:
2,954,914, PUB. 3-1-2005. INT. CL. 10.
- ANSOFT CORPORATION, PITTSBURGH, PA:
2,954,407, PUB. 10-19-2004. INT. CL. 9.
- ANSUL, INCORPORATED, MARINETTE, WI:
2,955,091, PUB. 3-1-2005. MULTIPLE CLASS, INT. CLS. 1 AND 9.
- ANTIGUA WINDS, INC., SAN ANTONIO, TX:
2,954,562, PUB. 3-1-2005. INT. CL. 15.
- ANTIOCH COMPANY, THE, YELLOW SPRINGS, OH:
2,955,600, INT. CL. 21.
- ANTRACO INC., LIVINGSTON, NJ:
1,284,056, CANC. INT. CL. 5.
- AOIS TRANSACTION TRACKING, INC., DOWNERS GROVE, IL:
2,170,624, CANC. INT. CL. 36.
- APAN WINE COMPANY LLC, PT. RICHMOND, CA:
2,955,036, PUB. 3-1-2005. INT. CL. 33.
- APEMA S.R.L., MUGNANO DI NAPOLI (NA), ITALY:
2,955,438, INT. CL. 25.
- APEX ENTERPRISES, MURFREESBORO, TN:
2,171,114, CANC. INT. CL. 41.
- API FUND FOR PAYROLL EDUCATION, NEW YORK, NY:
2,170,633, CANC. INT. CL. 41.
- APPLERA CORPORATION, ROCKVILLE, MD FROM PE CORPORATION, ROCKVILLE, MD:
2,954,031, PUB. 9-24-2002. INT. CL. 42.
- APPLIED SPECIALTIES, INC., AVON LAKE, OH:
2,955,687, INT. CL. 1.
- APPLIED SYSTEMS TECHNOLOGIES, INC., BELLEVUE, NE:
2,171,495, CANC. MULTIPLE CLASS, INT. CLS. 9 AND 42.
- APPSTAR SOFTWARE INC., MARKHAM, ONTARIO L3R 4G9, CANADA:
2,170,719, CANC. MULTIPLE CLASS, INT. CLS. 9 AND 42.
- APPSTREAM, INC., PALO ALTO, CA:
2,955,924, MULTIPLE CLASS, INT. CLS. 9 AND 42.
- APREBIC INDUSTRY CO. LTD., TACHIA TOWN, TAI-CHUNG HSIEN, TAIWAN:
2,171,696, CANC. INT. CL. 12.
- AQUAHAB, L.P., CHERRY HILL, NJ:
2,954,444, PUB. 3-1-2005. INT. CL. 44.
- AQUALAW PLC, RICHMOND, VA:
2,956,212, INT. CL. 42.
- AQUANTIVE, INC., SEATTLE, WA:
2,956,290, INT. CL. 42.
2,956,291, INT. CL. 35.
- ARABELLA TEXTILES, LLC, NEW YORK, NY FROM DEBORAH CONNOLLY & ASSOCIATES, LLC, NEW YORK, NY:
2,955,316, INT. CL. 20.
- ARAMARK EDUCATIONAL RESOURCES, INC., GOLDEN, CO:
2,171,369, CANC. MULTIPLE CLASS, INT. CLS. 41 AND 42.
- ARBORWOOD HOMES, INC., SPRING ARBOR, MI:
2,954,956, PUB. 3-1-2005. INT. CL. 37.
- ARBY'S IP HOLDER TRUST, A DELAWARE BUSINESS TRUST, THE TRUSTEES COMPRISING THE CORPORATE TRUST ADMINISTRATOR, WILMINGTON TRUST COMPANY, A DELAWARE CORPORATION, THE, FT. LAUDERDALE, FL:
2,954,806, PUB. 3-1-2005. INT. CL. 29.
- ARCHIPELAGO HOLDINGS, LLC, CHICAGO, IL:
2,955,233, MULTIPLE CLASS, INT. CLS. 16 AND 36.
- ARIELA & ASSOCIATES, INC., NEW YORK, NY:
1,843,020, CANC. INT. CL. 25.
- ARIO DATA NETWORKS, INC., SAN JOSE, CA:
2,955,408, INT. CL. 9.
- ARISTOCRAT LEISURE INDUSTRIES PTY LTD, ROSEBURY, NEW SOUTH WALES, AUSTRALIA:
2,170,712, CANC. INT. CL. 9.
- ARISTOCRAT TECHNOLOGIES AUSTRALIA PTY LTD, NEW SOUTH WALES 2066, AUSTRALIA:
2,955,436, INT. CL. 9.
- ARISTOCRAT TECHNOLOGIES AUSTRALIA PTY LTD, LANE COVE, NEW SOUTH WALES 2066, AUSTRALIA:
2,955,437, INT. CL. 9.
- ARIZONA FALL LEAGUE, INC., THE, NEW YORK, NY:
1,879,046, REN. 4-13-05. INT. CL. 25.
1,879,046, CANC. INT. CL. 16.
- ARLUY, S.L., LOGRONO (LA RIOJA), SPAIN:
2,170,998, CANC. INT. CL. 30.
- ARMANDINO'S SALUMI, INC., SEATTLE, WA:
2,954,721, PUB. 3-1-2005. INT. CL. 29.
- AROMAGEN CORPORATION, PLYMOUTH, MN:
2,955,619, INT. CL. 42.
- ARREDI TECNICI VILLA S.P.A., 21042 CARONNO PERTUSSELLA (VA), ITALY:
2,955,351, INT. CL. 9.
- ARROWHEAD CONSTRUCTION INC., TULSA, OK:
2,955,959, INT. CL. 37.
- ARROWHEAD PROMOTION AND FULFILLMENT CO., INC., GRAND RAPIDS, MN:
2,956,038, INT. CL. 35.
- ART A. S. A. P. KIDS INC., NEW YORK, NY:
2,954,218, PUB. 3-1-2005. INT. CL. 35.
- ART WATCH INTERNATIONAL, INC., LARCHMONT, NY:
1,842,887, CANC. INT. CL. 14.
- ARTEMIS CONSULTING SERVICES, INC., RANDOLPH, NJ:
2,954,977, PUB. 3-1-2005. INT. CL. 9.
- ARTHREX, INC., NAPLES, FL:
2,955,009, PUB. 3-1-2005. INT. CL. 10.
- ARTHUR'S GARDEN DELI, INC., ROCK FALLS, IL:
1,299,993, REN. 4-15-05. INT. CL. 42.
- ARTIFICIAL MIND AND MOVEMENT/PENSEE ET MOUVEMENT ARTIFICIEL INC., MONTREAL, QUEBEC, CANADA FROM MEGATOON STUDIOS INC., STE-FOY, QUEBEC, CANADA:
2,953,998, PUB. 8-24-2004. INT. CL. 28.
- ARTSANA S.P.A., GRANDATE, COMO, ITALY:
1,325,862, REN. 4-13-05. INT. CL. 20.
- ASANA ENTERPRISES, LLC, DALLAS, TX:
2,954,591, PUB. 3-1-2005. INT. CL. 3.
- ASC INCORPORATED, SOUTHGATE, MI:
1,283,956, CANC. MULTIPLE CLASS, INT. CLS. 2 AND 12.
- ASCEND COMMUNICATIONS, INC., ALAMEDA, CA:
1,843,508, CANC. INT. CL. 9.
2,171,240, CANC. INT. CL. 9.
- ASCENT TECHNOLOGY, INC., CAMBRIDGE, MA:
2,955,088, PUB. 3-1-2005. INT. CL. 9.
- ASHER, WILLIAM, VENICE, CA, DBA GUITAR TRADITIONS:
2,956,303, INT. CL. 15.
- ASHLAND CROSSING, INC., REDMOND, WA:
2,956,245, INT. CL. 7.
- ASHLAND INC., COVINGTON, KY:
1,012,512, REN. 4-12-05. U.S. CL. 6 (INT. CL. 5).
1,012,530, REN. 4-13-05. U.S. CL. 15 (INT. CL. 4).
1,339,873, REN. 4-14-05. INT. CL. 1.
- ASHLAND INC., COVINGTON, KY, DREW CHEMICAL CORPORATION, BOONTON, NJ:
1,891,882, REN. 4-14-05. INT. CL. 1.
- ASI IMPORTS, INC., ROSEVILLE, CA:
2,954,583, PUB. 3-1-2005. INT. CL. 14.
- ASIA PACIFIC FUEL CELL TECHNOLOGIES, LTD., TAIPEI, TAIWAN:
2,954,707, PUB. 11-2-2004. MULTIPLE CLASS, INT. CLS. 6, 7, 9, 12 AND 42.
- ASICS CORPORATION, CHUO-KU, KOBE CITY, HYOGO PREFECTURE, JAPAN:
1,843,723, CANC. INT. CL. 25.
- ASICS CORPORATION, 7-CHOME CHUO-KU, KOBE 650, JAPAN:
2,170,909, CANC. INT. CL. 25.
- ASICS CORPORATION, KOBE 650-8555, JAPAN:
2,954,359, PUB. 3-1-2005. INT. CL. 25.
- ASIJA; SATYA PAL, SHELTON, CT:
1,284,721, CANC. INT. CL. 42.

- ASOCIACIÓN DE PRODUCTORES Y EMPACADORES EXPORTADORES DE AGUACATE DE MICHOACÁN A.C., URUAPAN, MEXICO:
2,956,288, U.S. CL. 200.
- ASOTV CORPORATION, PALM BEACH, FL:
2,170,628, CANC. INT. CL. 42.
- ASSA ABLOY AB, STOCKHOLM, SWEDEN:
2,954,625, PUB. 3-1-2005. MULTIPLE CLASS, INT. CLS. 6, 9 AND 45.
- ASSET GUARANTY REINSURANCE COMPANY INC., NEW YORK, NY TO ENHANCE FINANCIAL SERVICES GROUP INC., NEW YORK, NY:
1,843,166, CANC. INT. CL. 36.
- ASSETS LONDON (USA) CORP., NEW YORK, NY:
1,843,697, CANC. INT. CL. 25.
- ASSOCIATED BEARINGS COMPANY, KANSAS CITY, MO:
1,284,761, CANC. INT. CL. 42.
1,284,762, CANC. INT. CL. 42.
1,284,763, CANC. INT. CL. 42.
- ASSOCIATED RETAILERS GROUP, INC., LANCASTER, TX:
2,170,718, CANC. INT. CL. 35.
- ASSOCIATES MEGA SUB-SYSTEM, INC., IRWINDALE, CA, DBA AMS TECH:
2,171,309, CANC. INT. CL. 9.
- ASSOCIATION OF AMERICAN MEDICAL COLLEGES, WASHINGTON, DC:
2,954,225, PUB. 3-1-2005. INT. CL. 41.
- ASSOCIATION OF BAY AREA GOVERNMENTS, OAKLAND, CA:
2,955,428, INT. CL. 36.
- ASSOCIATION OF UNIVERSITY TECHNOLOGY MANAGERS, NORTHBROOK, IL:
2,954,992, PUB. 3-1-2005. INT. CL. 35.
- ASSOCIATION TELECOM VALLEY, 06560 VALBONNE, FRANCE:
2,954,049, PUB. 6-8-2004. MULTIPLE CLASS, INT. CLS. 38, 39, 41 AND 42.
- ASTRA TECH AKTIEBOLAG, MOLNDAL, SWEDEN:
1,843,554, CANC. INT. CL. 10.
- ASTRO DYE WORKS, INC., CALHOUN, GA:
772,969, CANC. U.S. CL. 106.
- AT&T CORP., NEW YORK, NY:
2,171,966, CANC. INT. CL. 38.
- ATHENS NEWSPAPERS, LLC, AUGUSTA, GA:
2,956,297, MULTIPLE CLASS, INT. CLS. 16 AND 41.
- ATLANTA RHYTHM SECTION, MADISON, GA:
2,954,324, PUB. 3-1-2005. INT. CL. 41.
- ATLANTIC CRUISING CLUB, INC., RYE, NY:
2,171,122, CANC. INT. CL. 16.
- ATLANTIC PAPER & FOIL, LLC, HAUPPAUGE, NY:
2,955,522, INT. CL. 16.
- ATLAS CRYSTAL WORKS, COVINGTON, TN, DBA WORLD WIDE ART STUDIOS:
1,284,643, CANC. INT. CL. 40.
- ATLAS MEDIA CORP., NEW YORK, NY:
1,896,563, REN. 4-9-05. INT. CL. 41.
- AUGUST STORCK KG, BERLIN, FED REP GERMANY:
2,955,965, INT. CL. 30.
- AURARIAN CAPITAL MANAGEMENT, LLC, NEW YORK, NY:
2,954,998, PUB. 3-1-2005. INT. CL. 36.
- AURUM CERAMIC DENTAL LABORATORIES LTD., CALGARY, ALBERTA, CANADA:
2,954,102, PUB. 9-21-2004. MULTIPLE CLASS, INT. CLS. 5 AND 10.
- AUSTRALIA MEAT HOLDINGS PTY LIMITED, DINMORE, QUEENSLAND, AUSTRALIA:
2,954,972, PUB. 3-1-2005. INT. CL. 42.
- AUTOBYTEL INC., IRVINE, CA:
2,954,836, PUB. 3-1-2005. INT. CL. 35.
- AUTOMATION AND CONTROL TECHNOLOGY, INC., COLUMBUS, OH:
2,955,601, INT. CL. 9.
2,955,602, INT. CL. 9.
- AUTOMOBILE RACING CLUB OF AMERICA, INC., TEMPERANCE, MI:
1,284,680, CANC. INT. CL. 41.
- AUTOMOTIVE COMPONENTS LIMITED, MELBOURNE, 3000, VIC, AUSTRALIA:
2,954,128, PUB. 11-9-2004. MULTIPLE CLASS, INT. CLS. 19 AND 27.
- AUTOSAFE INTERNATIONAL LIMITED, PENTWORTH, WEST SUSSEX, UNITED KINGDOM:
2,955,951, INT. CL. 6.
- AUTUMN LIGHT ENTERTAINMENT, INC., ALBUQUERQUE, NM:
2,955,188, INT. CL. 9.
- AVANEX CORPORATION, FREMONT, CA:
2,955,960, INT. CL. 9.
- AVARUA SYSTEMS AND SERVICES, INC., BOISE, ID:
2,954,804, PUB. 3-1-2005. INT. CL. 9.
- AVAYA INC., BASKING RIDGE, NJ:
2,955,696, INT. CL. 41.
- AVCJ HOLDINGS LIMITED, WANCHAI, HONG KONG:
2,955,197, MULTIPLE CLASS, INT. CLS. 9, 41 AND 42.
- AVENTINE RENEWABLE ENERGY, INC., PEKIN, IL:
2,954,378, PUB. 3-1-2005. MULTIPLE CLASS, INT. CLS. 1 AND 31.
- AVENTIS (IRELAND) LIMITED, DUBLIN, IRELAND:
2,954,262, PUB. 3-1-2005. INT. CL. 5.
- AVENTIS PHARMA S.A., ANTONY, FRANCE:
2,954,823, PUB. 3-1-2005. INT. CL. 5.
- AVERY DENNISON CORPORATION, PASADENA, CA:
1,878,693, REN. 4-13-05. INT. CL. 24.
- AVIATION LAW CENTER, WILLIAMSBURG, VA:
2,171,124, CANC. INT. CL. 42.
- AVID CENTER, SAN DIEGO, CA:
2,954,667, PUB. 6-1-2004. INT. CL. 41.
2,954,668, PUB. 6-1-2004. INT. CL. 41.
- AVON PRODUCTS, INC., NEW YORK, NY:
2,954,939, PUB. 3-1-2005. INT. CL. 3.
- AW INDUSTRIES, INC., LANDOVER, MD, FOAM INDUSTRIES, INC., NORFOLK, VA:
1,264,282, REN. 4-14-05. INT. CL. 20.
- AXCESS INC., CARROLLTON, TX:
2,955,190, INT. CL. 9.
- AXELROD, CHRISTOPHER G., BRATENAHL, OH:
2,955,576, INT. CL. 41.
- AXONWAVE SOFTWARE, INC., BURNABY, BC V5G 4C9, CANADA:
2,954,825, PUB. 3-1-2005. INT. CL. 42.
- AYAMON, LLC, SAINT PAUL, MN:
2,956,340, INT. CL. 35.
2,956,363, INT. CL. 35.
- AYER, PETER M, SAN LUIS OBISPO, CA:
2,956,140, INT. CL. 25.
- B & F PLASTICS, INC., RICHMOND, IN:
2,955,278, INT. CL. 17.
- B'NAI B'RITH, WASHINGTON, DC, DBA B'NAI B'RITH INTERNATIONAL:
1,843,236, CANC. INT. CL. 41.
- BACK EAST, INC., SANTA BARBARA, CA:
2,171,272, CANC. INT. CL. 25.
- BACON PRODUCTS CORPORATION, CHATTANOOGA, TN:
2,955,242, MULTIPLE CLASS, INT. CLS. 3 AND 5.
- BAD NEWS TRAVELS FAST, INC., FRANKLIN, NC:
2,955,304, MULTIPLE CLASS, INT. CLS. 25 AND 28.
- BADER, SHAWN EDWARD, WACCABUC, NY:
2,955,205, MULTIPLE CLASS, INT. CLS. 35 AND 42.
- BAE SYSTEMS INFORMATION AND ELECTRONIC SYSTEMS INTEGRATION INC., NASHUA, NH FROM LOCKHEED MARTIN CORPORATION, BETHESDA, MD:
2,955,202, INT. CL. 9.
- BAGELS-4-U, INC., SPRINGFIELD, NJ:
1,843,817, CANC. INT. CL. 30.
- BAHASH, TIMOTHY J., PHILADELPHIA, PA:
2,956,366, INT. CL. 3.
- BAILEY COMPANY, INC.; THE, NASHVILLE, TN:
1,305,320, AM. MULTIPLE CLASS, INT. CLS. 37 AND 42.
- BAKERS DELIGHT HOLDINGS LTD., CAMBERWELL, VICTORIA, 3124, AUSTRALIA:
2,956,022, MULTIPLE CLASS, INT. CLS. 30, 35 AND 43.
2,956,023, MULTIPLE CLASS, INT. CLS. 30, 35 AND 43.

BALBIRNIE, ROBERT BRUCE, WEST CHESTER, PA:
2,171,397, CANC. INT. CL. 37.

BALENCIAGA, 75006 PARIS, FRANCE:
2,954,289, PUB. 3-1-2005. INT. CL. 3.

BALLET MAKERS, INC., TOTOWA, NJ:
1,324,673. REN. 4-15-05. INT. CL. 25.

BALLY GAMING INTERNATIONAL, INC., LAS VEGAS, NV:
1,843,749, CANC. INT. CL. 28.
1,843,750, CANC. INT. CL. 28.

BAMAIL! CORP., MENLO PARK, CA:
2,955,567, INT. CL. 9.

BANC ONE CAPITAL FUNDING CORPORATION, COLUMBUS, OH:
2,171,988, CANC. INT. CL. 36.

BANC ONE CORPORATION, COLUMBUS, OH:
2,171,431, CANC. INT. CL. 36.

BANDERA CONNECTION, INC., BEAUMONT, TX:
2,172,023, CANC. INT. CL. 41.

BANIF - SGPS, S.A., 9004-509 FUNCHAL CODEX, PORTUGAL:
2,954,761, PUB. 3-1-2005. INT. CL. 36.
2,954,762, PUB. 3-1-2005. INT. CL. 36.

BANK FOR INVESTMENT AND DEVELOPMENT OF VIETNAM (BIDV), HA NOI, VIETNAM, DBA VIETINDEBANK:
2,954,728, PUB. 3-1-2005. INT. CL. 36.

BANK, MORT, BISMARCK, ND:
2,171,905, CANC. INT. CL. 29.

BANNER ASSOCIATES, INC., CHEVY CHASE, MD:
2,954,475, PUB. 3-1-2005. INT. CL. 35.
2,954,476, PUB. 3-1-2005. INT. CL. 35.

BARCANA, INC., NEW CITY, NY:
2,171,226, CANC. INT. CL. 11.

BARDANI, FRANK, M., PURCHASE, NY:
2,955,574, INT. CL. 40.

BARILLA ALIMENTARE S.P.A., PARMA PR, ITALY:
2,905,518, COR. MULTIPLE CLASS, INT. CLS. 29, 30, 32 AND 33.

BARONE; GEORGE A., WILLIAMSVILLE, NY:
1,284,744, CANC. INT. CL. 42.

BARRETTO DE ARAUJO PRODUCTOS DE CACAU S.A., SALVADOR BAHIA, BRAZIL:
1,284,488, CANC. MULTIPLE CLASS, INT. CLS. 29 AND 30.

BARRINGTON BANK & TRUST COMPANY, N.A., BARRINGTON, IL:
2,956,176, INT. CL. 36.

BARRY SANDERS, INC., MIAMI, FL:
2,954,299, PUB. 7-6-2004. INT. CL. 25.

BASF AKTIENGESELLSCHAFT, LUDWIGSHAFEN, FED REP GERMANY:
2,954,400, PUB. 3-1-2005. INT. CL. 1.

BASIC DENTAL IMPLANT SYSTEMS, INC., ALBUQUERQUE, NM:
2,956,020, INT. CL. 44.

BASIC RESOURCES, INC., DALLAS, TX:
2,171,407, CANC. MULTIPLE CLASS, INT. CLS. 36 AND 42.

BATEMAN, III; EARLE W., FISCHER, TX, DBA E. W. BATEMAN & CO.:
1,338,159. REN. 4-15-05. INT. CL. 28.

BATES MANUFACTURING COMPANY, THE, HACKETTS-TOWN, NJ:
1,284,162, CANC. INT. CL. 9.

BATTLE MOUNTAIN GOLD COMPANY, HOUSTON, TX:
2,171,753, CANC. INT. CL. 37.

BAUMAN, LINDA, HOLDEN, MA:
2,171,244, CANC. INT. CL. 25.

BAXTER INTERNATIONAL INC., DEERFIELD, IL:
2,171,521, CANC. INT. CL. 10.

BAXTER INTERNATIONAL, INC.:
1,284,182, CANC. INT. CL. 10.

BAY AREA COFFEE, INC., SUISUN, CA:
2,954,306, PUB. 3-1-2005. INT. CL. 30.

BAY AREA SEATING SERVICES, INC., CONCORD, CA:
2,171,368, CANC. INT. CL. 35.

BAY SHORE DEVELOPMENT CORPORATION, OCEAN CITY, MD:
1,882,544. REN. 4-9-05. INT. CL. 41.

BAYER CROPSCIENCE LP, RESEARCH TRIANGLE PARK, NC:
2,956,061, INT. CL. 35.

BAYERISCHE MOTOREN WERKE AKTIENGESELLSCHAFT, 80809 MUNICH, FED REP GERMANY:
2,954,341, PUB. 3-1-2005. INT. CL. 12.

BE'COZZ INTERNATIONAL, INC., SAN DIEGO, CA:
2,954,270, PUB. 3-1-2005. INT. CL. 28.

BEACON SWEETS, INC., MOORESVILLE, NC:
2,172,058, CANC. INT. CL. 30.

BEAR CREEK GARDENS, INC., MEDFORD, OR:
2,171,860, CANC. INT. CL. 31.

BEAR STEARNS COMPANIES INC., THE, NEW YORK, NY:
1,844,417. REN. 4-15-05. INT. CL. 16.

BEARD, TODD, HUNTINGTON BEACH, CA:
2,954,555, PUB. 3-1-2005. INT. CL. 25.

BEARDOG PRODUCTS INC., SCOTTSDALE, AZ:
2,955,736, INT. CL. 3.

BEARING BUDDY, INC., PATILLAS, PUERTO RICO:
772,780, CANC. U.S. CL. 23.

BEAUCHAMP COLLECTION, PARIS, TX:
2,171,651, CANC. INT. CL. 42.

BEAUTE CREATEURS (SOCIETE ANONYME), PARIS, FRANCE:
2,910,588, COR. MULTIPLE CLASS, INT. CLS. 3 AND 5.

BEAUTE PRESTIGE INTERNATIONAL, 75008 PARIS, FRANCE:
2,172,038, CANC. INT. CL. 3.

BEAUTE PRESTIGE INTERNATIONAL, 75116, PARIS, FRANCE:
2,955,851, INT. CL. 3.
2,955,852, INT. CL. 3.

BEECHAM INC., BRISTOL, TN:
816,290, CANC. U.S. CL. 51.

BEKO CONDENSATE SYSTEMS CORPORATION, MOORESVILLE, NORTH CAROLINA, OH, DBA BEKO TECHNOLOGIES CORPORATION:
2,954,943, PUB. 3-1-2005. INT. CL. 7.

BELKIN CORPORATION, COMPTON, CA:
2,955,675, INT. CL. 9.

BELL ATLANTIC CORPORATION, PHILADELPHIA, PA:
2,171,602, CANC. INT. CL. 38.

BELL MOTORSPORTS, OAKLAND, CA:
2,954,734, PUB. 3-1-2005. INT. CL. 9.

BELLSOUTH CORPORATION, ATLANTA, GA:
2,171,628, CANC. MULTIPLE CLASS, INT. CLS. 35, 38 AND 42.

BELSNICKEL ENTERPRISES, INC., LANCASTER, PA:
2,954,278, PUB. 3-1-2005. INT. CL. 6.

BEMCO ASSOCIATES, INC., DES PLAINES, IL:
1,284,357, CANC. INT. CL. 20.
1,284,358, CANC. INT. CL. 20.
1,284,359, CANC. INT. CL. 20.

BEN INC., COALDALE, ALBERTA, CANADA:
2,955,904, INT. CL. 42.

BENCOM S.R.L., TREVISO, ITALY:
2,954,179, PUB. 6-22-2004. INT. CL. 14.

BEND-PAK, MOORPARK, CA:
1,942,918. REN. 4-12-05. INT. CL. 7.

BENDIX COMMERCIAL VEHICLE SYSTEMS LLC, ELYRIA, OH:
2,955,142, PUB. 3-1-2005. INT. CL. 12.

BENGAL PRODUCTS INC., BATON ROUGE, LA:
2,954,845, PUB. 8-3-2004. INT. CL. 5.

BENJAMIN MOORE & CO., MONTVALE, NJ:
2,954,403, PUB. 3-1-2005. INT. CL. 2.

BENSUSAN RESTAURANT CORPORATION, NEW YORK, NY:
2,954,511, PUB. 3-1-2005. INT. CL. 26.

BERENTZEN BRENNEREIEN GMBH + CO. KG, HASELUENNE, FED REP GERMANY:
2,954,736, PUB. 9-28-2004. INT. CL. 33.

BERG, JENNA, SANTA BARBARA, CA:
2,955,916, INT. CL. 35.

- BERKSHIRE HATHAWAY INC., OMAHA, NE:
772,977, CANC. U.S. CL. 15.
- BERNARD FOOD INDUSTRIES, INC., EVANSTON, IL:
1,284,505, CANC. INT. CL. 30.
- BERNER INTERNATIONAL CORPORATION, NEW CASTLE, PA:
2,955,378, INT. CL. 11.
- BESSER COMPANY, ALPENA, MI:
1,001,460, REN. 4-9-05. INT. CL. 7.
- BEST FOODS INC., MASPEETH, NY:
2,954,765, PUB. 3-1-2005. MULTIPLE CLASS, INT. CLS. 29 AND 30.
2,954,766, PUB. 3-1-2005. MULTIPLE CLASS, INT. CLS. 29 AND 30.
- BEST PICTURE SHOW COMPANY PTY. LTD., THE, BRISBANE QUEENSLAND 4000, AUSTRALIA:
2,955,222, INT. CL. 28.
- BEST SEA-PACK OF TEXAS, INC., DANBURY, TX:
2,955,366, INT. CL. 29.
- BEST SOFTWARE, INC., IRVINE, CA:
2,955,444, INT. CL. 9.
2,956,169, INT. CL. 9.
2,956,170, INT. CL. 9.
2,956,171, INT. CL. 9.
- BEST TELEPRODUKTER AKTIEBOLAG, S-421 76 VASTRA FROLUNDA, SWEDEN:
1,842,771, CANC. INT. CL. 9.
- BETTER LEARNING TECHNIQS, INC., HIGHLAND PARK, IL, DBA THE BETTER READING PROGRAM, INC.:
1,856,556, REN. 4-13-05. INT. CL. 9.
- BETTER TREATMENT CENTERS, INC., WASHINGTON, DC:
2,172,047, CANC. INT. CL. 42.
- BEVERAGE MARKETING OF COLORADO, FORT COLLINS, CO:
2,171,610, CANC. INT. CL. 30.
- BFQ PRESS, FRIENDSWOOD, TX:
2,955,496, INT. CL. 41.
- BIEDERMANN MOTECHE GMBH, SCHWENNINGEN, FED REP GERMANY:
2,954,731, PUB. 3-1-2005. MULTIPLE CLASS, INT. CLS. 5 AND 10.
- BIG APPLE BARBECUE BLOCK PARTY, NEW YORK, NY:
2,956,278, INT. CL. 41.
- BIG BEAUTIFUL HOLDINGS INC., SHAWNIGAN LAKE, BRITISH COLUMBIA, CANADA:
2,955,588, INT. CL. 16.
- BIG O TIRES, INC., ENGLEWOOD, CO:
1,842,854, CANC. INT. CL. 12.
- BIG SUR WATERBEDS, INC., LAKEWOOD, CO:
1,315,832, REN. 4-14-05. INT. CL. 20.
1,346,215, REN. 4-14-05. INT. CL. 20.
- BIG TIME PRODUCTS, LLC, ROME, GA:
2,956,111, MULTIPLE CLASS, INT. CLS. 9, 21 AND 25.
- BIGI CO., LTD., MINATO-KU, TOKYO, JAPAN:
1,320,837, REN. 4-12-05. INT. CL. 25.
- BIKESTER INC., PACIFIC PALISADES, CA:
2,955,353, INT. CL. 35.
- BILL BLOSS INTERNATIONAL LLC, NEW YORK, NY, BILL BLOSS, LTD., NEW YORK, NY:
1,889,317, REN. 4-14-05. INT. CL. 25.
- BILLETS AMERICA, LLC, TARRYTOWN, NY:
2,956,103, INT. CL. 35.
- BILLIO; GRAZIA, MILAN, ITALY:
1,284,217, CANC. MULTIPLE CLASS, INT. CLS. 14 AND 18.
- BIO THERAPEUTICS, INC., DANIA BEACH, FL:
2,171,492, CANC. INT. CL. 5.
- BIO-MICROBICS INCORPORATED, SHAWNEE, KS:
2,954,345, PUB. 3-1-2005. INT. CL. 7.
- BIO-OREGON, INC., WARRENTON, OR, BIOPRODUCTS INCORPORATED, WARRENTON, OR:
1,326,256, REN. 4-15-05. INT. CL. 31.
- BIO-OREGON, INC., WARRENTON, OR:
2,954,893, PUB. 3-1-2005. INT. CL. 5.
- BIOCAIR INTERNATIONAL, CAMBRIDGE, UNITED KINGDOM:
2,171,145, CANC. INT. CL. 39.
- BIOENERGIMED, L.L.C., SCHUYLKILL HAVEN, PA:
2,954,527, PUB. 3-1-2005. INT. CL. 5.
- BIOGEN, INC., CAMBRIDGE, MA TO MEDICINES COMPANY, THE, CAMBRIDGE,, MA:
1,843,444, CANC. INT. CL. 5.
- BIOLAB SERVICES, INC., WILMINGTON, DE:
2,955,134, PUB. 3-1-2005. INT. CL. 1.
2,955,136, PUB. 3-1-2005. INT. CL. 3.
2,955,139, PUB. 3-1-2005. INT. CL. 3.
- BIOELECTRON, INC., HACKENSACK, NJ:
1,284,186, CANC. INT. CL. 10.
- BIOLITEC, INC., EAST LONGMEADOW, MA:
2,954,663, PUB. 3-1-2005. INT. CL. 3.
- BIOMEGA, INC., GOODYEAR, AZ:
2,170,914, CANC. INT. CL. 1.
- BIOPSY SCIENCES, LLC, CLEARWATER, FL:
2,956,311, INT. CL. 42.
- BIOSYNTRX, INC., LEXINGTON, SC:
2,955,949, INT. CL. 5.
- BIOVERSE, INC., BLOOMINGTON, MN:
2,954,205, PUB. 3-1-2005. MULTIPLE CLASS, INT. CLS. 1, 16 AND 40.
- BIRCH, JOHN N. JR., NEW YORK, NY:
2,954,120, PUB. 6-1-2004. MULTIPLE CLASS, INT. CLS. 11, 16, 20, 21 AND 34.
- BIRD TECHNOLOGIES GROUP INC., MAYFIELD HEIGHTS, OH:
2,954,795, PUB. 3-1-2005. INT. CL. 9.
- BIRMINGHAM AREA TECHNOLOGY LEADERSHIP ALLIANCE, BIRMINGHAM, AL:
2,956,035, INT. CL. 35.
- BISON ADVERTISING, INC., EDEN PRAIRIE, MN:
2,954,909, PUB. 3-1-2005. INT. CL. 35.
- BITPIPE INC., BOSTON, MA:
2,955,891, INT. CL. 35.
- BITTERLICH, R/TERRY, PUEBLO WEST, CO AND BITTERLICH, KRISTINE, PUEBLO WEST, CO:
2,954,826, PUB. 3-1-2005. INT. CL. 41.
- BIXBY-ZIMMER ENGINEERING COMPANY, GALESBURG, IL:
772,784, CANC. U.S. CL. 23.
- BK GULINI GMBH, D-67065 LUDWIGSHAFEN, FED REP GERMANY:
1,317,492, REN. 4-15-05. INT. CL. 1.
- BKI HOLDING CORPORATION, WILMINGTON, DE:
2,954,321, PUB. 3-1-2005. INT. CL. 22.
- BLACK & DECKER CORPORATION, THE, TOWSON, MD:
2,171,586, CANC. INT. CL. 7.
- BLACK CAT DECISIONS, LLC, FAIRFIELD, CT:
2,954,422, PUB. 3-1-2005. INT. CL. 9.
- BLACKJACK, INC., STERLING HEIGHTS, MI:
2,171,430, CANC. INT. CL. 25.
- BLACKWELL, VIRGINIA A., WHEATON, IL AND CISON, LAURA A., ELBURN, IL:
2,956,167, INT. CL. 28.
- BLADE PRODUCTIONS, INC., GAINESVILLE, FL:
1,883,131, REN. 4-10-05. INT. CL. 41.
- BLAINE BROOKE PHOTOGRAPHY, INC., LOUISVILLE, KY:
2,955,406, INT. CL. 25.
- BLAIREX LABORATORIES, INC., COLUMBUS, IN:
2,171,587, CANC. INT. CL. 5.
- BLAKE BROS. INTERNATIONAL, INC., AMHERST, NH:
2,954,873, PUB. 3-1-2005. INT. CL. 35.
- BLAKO, INC., CHICAGO, IL, G. S. BLAKESLEE & CO., CHICAGO, IL:
783,613, REN. 4-13-05. U.S. CL. 23 (INT. CLS. 6, 7, 8, 9, 11, 12, 16, 21 AND 28).
- BLENDEX GMBH, MAINZ, FED REP GERMANY:
1,283,983, CANC. INT. CL. 3.
- BLIA CORPORATION, STUART, FL, TA BLIACO:
2,171,754, CANC. INT. CL. 25.
- BLIEVERT, DENISE, NEW YORK, NY:
2,171,268, CANC. INT. CL. 25.
- BLUE BANNER COMPANY, INC., RIVERSIDE, CA:
1,843,831, CANC. INT. CL. 31.
- BLUE BELL INN, BLUE BELL, PA:
1,899,357, REN. 4-12-05. INT. CL. 42.

BLUE CROSS AND BLUE SHIELD OF NORTH CAROLINA, DURHAM, NC:
 1,843,199, CANC. INT. CL. 36.

BLUE PLANET RUN FOUNDATION, SAN FRANCISCO, CA:
 2,955,894, INT. CL. 36.

BLUE RHINO GLOBAL SOURCING, LLC, WINSTON-SALEM, NC:
 2,905,041, COR. INT. CL. 21.
 2,914,598, COR. INT. CL. 21.

BLUE RIDGE NETWORKS, INC., CHANTILLY, VA:
 2,954,505, PUB. 3-1-2005. INT. CL. 9.
 2,954,506, PUB. 3-1-2005. INT. CL. 42.

BLUE TITAN SOFTWARE, SAN FRANCISCO, CA:
 2,956,027, INT. CL. 9.

BLUE VISTA CAPITAL PARTNERS, LLC, CHICAGO, IL:
 2,954,319, PUB. 3-1-2005. INT. CL. 36.

BLUESTREAM WATER SYSTEMS, INC., WAHPETON, ND:
 2,170,655, CANC. MULTIPLE CLASS, INT. CLS. 11 AND 32.

BNY SEPARATE ACCOUNT SERVICES, INC., MALVERN, PA:
 2,955,673, INT. CL. 36.

BOARD OF REGENTS OF THE UNIVERSITY SYSTEM OF GEORGIA, ATLANTA, GA, DBA GEORGIA INSTITUTE OF TECHNOLOGY:
 1,266,845, CANC. MULTIPLE CLASS, INT. CLS. 25 AND 28.
 1,266,845, REN. 4-14-05. MULTIPLE CLASS, INT. CLS. 6, 14, 16, 20, 21 AND 24.

BOARD OF REGENTS OF THE UNIVERSITY SYSTEM OF GEORGIA, ATLANTA, GA:
 1,284,661, CANC. INT. CL. 41.

BOARD OF REGENTS, THE UNIVERSITY OF TEXAS SYSTEM, AUSTIN, TX:
 1,843,351, CANC. MULTIPLE CLASS, INT. CLS. 41 AND 42.

BOARD OF TRUSTEES OF NORTH KANSAS CITY MEMORIAL HOSPITAL, THE, NORTH KANSAS CITY, MO, DBA NORTH KANSAS CITY MEMORIAL HOSPITAL:
 1,284,542, CANC. INT. CL. 35.

BOC GROUP, INC., THE, NEW PROVIDENCE, NJ:
 2,955,939, INT. CL. 1.

BODEGAS VALSACRO, SA, LA RIOJA, SPAIN:
 2,955,269, INT. CL. 33.

BODMAN, LONGLEY & DAHLING LLP, DETROIT, MI:
 2,956,081, INT. CL. 42.

BOEING COMPANY, THE, SEATTLE, WA:
 1,842,951, CANC. INT. CL. 18.

BOGNAR AND COMPANY, INC., PITTSBURGH, PA:
 1,334,311, REN. 4-13-05. INT. CL. 19.

BOHLIN INSTRUMENTS LIMITED, CIRENCESTER, GLOUCESTER, GREAT BRITAIN:
 2,954,100, PUB. 3-1-2005. INT. CL. 9.

BOLAND TRANE SERVICES, INC., ROCKVILLE, MD, DBA BOLAND SERVICES:
 2,954,358, PUB. 3-1-2005. INT. CL. 37.

BON-TON VINYL FOR WALLS, INC., DARBY, PA:
 772,716, CANC. U.S. CL. 20.

BONAKEMI USA, INC., AURORA, CO:
 2,954,590, PUB. 3-1-2005. INT. CL. 2.

BONFIGLIO, BARBARA, WASHINGTON, DC:
 2,955,355, MULTIPLE CLASS, INT. CLS. 9 AND 25.

BOOKER, FELISHA A., NEW YORK, NY, DBA DYNAMIC PRODUCER:
 2,954,819, PUB. 3-1-2005. INT. CL. 41.

BOOTH RANCHES, ORANGE COVE, CA:
 2,955,464, INT. CL. 31.

BOOTS COMPANY USA HOLDINGS INC., THE, WILMINGTON, DE:
 2,955,634, INT. CL. 3.

BORGES USA, INC., FRESNO, CA, DBA STAR FINE FOODS:
 2,954,094, PUB. 1-13-2004. INT. CL. 29.

BORGES, ELIANA, SANTA BARBARA, CA:
 2,171,812, CANC. INT. CL. 42.

BORLIND GESELLSCHAFT FUR KOSMETISCHE ERZEUGNISSE MBH, D-75365 CALW, FED REP GERMANY:
 2,954,333, PUB. 8-17-2004. INT. CL. 3.

BORON MANAGEMENT B.V., ZEIST, NETHERLANDS:
 2,954,640, PUB. 10-5-2004. MULTIPLE CLASS, INT. CLS. 35 AND 36.

2,954,641, PUB. 10-5-2004. MULTIPLE CLASS, INT. CLS. 35 AND 36.

BORREGAARD INDUSTRIES LIMITED, N-1701 SARPSBORG, NORWAY:
 1,797,404, REN. 4-14-05. MULTIPLE CLASS, INT. CLS. 1, 2, 4, 19 AND 31.

BOSE CORPORATION, FRAMINGHAM, MA:
 2,956,162, INT. CL. 9.

BOSS & CO. LIMITED, LONDON W1K 2RH, UNITED KINGDOM:
 2,954,023, PUB. 3-2-2004. MULTIPLE CLASS, INT. CLS. 9, 13 AND 37.

2,954,024, PUB. 3-16-2004. MULTIPLE CLASS, INT. CLS. 9, 13 AND 37.

BOSS PET PRODUCTS, INC., KEWANEE, IL:
 2,955,822, MULTIPLE CLASS, INT. CLS. 3, 5 AND 31.

BOUTELLE, RODGER W., MIAMI, FL:
 2,956,082, INT. CL. 25.
 2,956,083, INT. CL. 25.

BOVIGEN, LLC, METAIRIE, LA:
 2,955,556, INT. CL. 44.

BOWLES, DAVID, BROOKLYN, NY:
 2,956,358, INT. CL. 25.

BOWNE OF LOS ANGELES, INC., DOMINGUEZ HILLS, CA:
 2,955,813, INT. CL. 42.

BOWTIE, INC., LOS ANGELES, CA:
 2,955,208, INT. CL. 16.
 2,955,999, MULTIPLE CLASS, INT. CLS. 16 AND 41.
 2,956,041, MULTIPLE CLASS, INT. CLS. 16 AND 41.

BOYD GAMING CORPORATION, LAS VEGAS, NV:
 2,954,559, PUB. 3-1-2005. INT. CL. 41.

BP INTERNATIONAL RIGHTS HOLDINGS INC., RICHMOND, BRITISH COLUMBIA, CANADA:
 2,955,801, INT. CL. 30.

BP PRODUCTS NORTH AMERICA INC., CHICAGO, IL:
 2,954,032, PUB. 4-23-2002. MULTIPLE CLASS, INT. CLS. 21, 30 AND 35.

BPE, INC., EMPORIA, KS:
 1,942,933, REN. 4-11-05. INT. CL. 21.

BPS INFO SOLUTIONS, INC., TUCKER, GA:
 2,955,073, PUB. 3-1-2005. INT. CL. 9.

BRADFORD WHITE CORPORATION, AMBLER, PA:
 2,955,654, INT. CL. 11.

BRAIN INJURY ASSOCIATION, THE, JACKSON, MS:
 2,171,021, CANC. INT. CL. 41.

BRAND DESIGN COMPANY, INC., YORKLYN, DE, DBA HOUSE INDUSTRIES:
 2,954,565, PUB. 3-1-2005. INT. CL. 9.

BRAR, HARINDER SINGH, SNOHOMISH, WA:
 2,955,471, INT. CL. 43.
 2,955,861, INT. CL. 35.

BRAUN CORPORATION, THE, WINAMAC, IN:
 2,955,641, INT. CL. 12.

BRAUN GMBH, D-61476 KRONBERG IM TANAUS, FED REP GERMANY, BRAUN AKTIENGESELLSCHAFT, D-6242 KRONBERG IM TAUNUS, FED REP GERMANY:
 1,879,183, REN. 4-14-05. INT. CL. 11.

BREEZWAY AUSTRALIA PTY LTD, QUEENSLAND, AUSTRALIA:
 2,954,392, PUB. 3-1-2005. INT. CL. 6.

BREMERS, ROBERT C, LOUISVILLE, CO:
 2,954,860, PUB. 3-1-2005. INT. CL. 9.

BRENNER, MARK L., SHERMAN OAKS, CA:
 2,955,994, INT. CL. 41.

BRICK BREWING CO. LIMITED, WATERLOO, ONTARIO, CANADA:
 2,021,138, CANC. INT. CL. 32.

BRIDGER COMMERCIAL FUNDING LLC, MILL VALLEY, CA:
 2,955,308, INT. CL. 36.

BRIGHT STATION LIMITED, LONDON, UNITED KINGDOM:
 2,954,857, PUB. 3-1-2005. MULTIPLE CLASS, INT. CLS. 9, 35, 36, 38 AND 42.

- BRILLIANT; ASHLEIGH, SANTA BARBARA, CA:
1,284,266, CANC. INT. CL. 16.
- BRINK'S NETWORK, INC., WILMINGTON, DE:
2,954,674, PUB. 3-1-2005. INT. CL. 36.
- BRINKER RESTAURANT CORPORATION, DALLAS, TX
TO KONA RESTAURANT GROUP, INC., SPICEWOOD,
TX:
2,020,712, AM. INT. CL. 42.
- BRISCIANI, ROBERTO, 46700, GANDIA, VALENICA,
SPAIN:
2,954,254, PUB. 3-1-2005. INT. CL. 30.
- BRITISH SKY BROADCASTING GROUP PLC, MIDDLE-
SEX, UNITED KINGDOM:
2,912,783, COR. INT. CL. 41.
- BROAD NATIONAL BANCORPORATION, NEWARK, NJ:
1,284,584, CANC. INT. CL. 36.
- BROADCAST ELECTRONICS, INC., QUINCY, IL:
2,171,155, CANC. INT. CL. 9.
- BROADWAY BANCSHARES, INC., SAN ANTONIO, TX:
2,954,464, PUB. 3-1-2005. INT. CL. 36.
- BROD & MCCLUNG-PACE CO., PORTLAND, OR:
772,643, CANC. U.S. CL. 12.
- BRODERBUND SOFTWARE, INC., SAN RAFAEL, CA:
1,284,448, CANC. INT. CL. 28.
1,284,449, CANC. INT. CL. 28.
- BROG, WERNER, MUCHEN, FED REP GERMANY:
2,955,344, INT. CL. 39.
- BROMINE COMPOUNDS LTD., BEER SHEVA, 84101, IS-
RAEL:
2,954,099, PUB. 3-1-2005. INT. CL. 1.
- BRONNER SLOSBERG HUMPHREY, INC., BOSTON, MA:
2,171,281, CANC. INT. CL. 9.
- BROOKLYN BAGEL RESTAURANT, INC., THE, JUPITER,
FL:
2,170,728, CANC. INT. CL. 42.
- BROOKS, LINDA ROBERTSON, SHERMAN OAKS, CA:
2,955,905, INT. CL. 35.
- BROWN & COLE STORES, LLC, BELLINGHAM, WA:
2,955,359, INT. CL. 35.
- BROWN & HALEY, TACOMA, WA:
2,955,505, INT. CL. 30.
- BROWN & WILLIAMSON TOBACCO CORPORATION,
LOUISVILLE, KY, DBA KOHL'S DEPARTMENT STORES
TO KOHL'S DEPARTMENT STORES, INC., MENOMO-
NEE FALLS, WI:
1,284,410, CANC. INT. CL. 25.
- BROWN, GARRETT, BROOKLYN, NY:
2,956,209, INT. CL. 41.
- BROWNE & CO. LTD., MARKHAM, ONTARIO, CANADA:
2,954,356, PUB. 3-1-2005. MULTIPLE CLASS, INT. CLS. 11
AND 21.
- BRUNSWICK BOWLING & BILLIARDS CORPORATION,
MUSKEGON, MI:
2,171,232, CANC. MULTIPLE CLASS, INT. CLS. 9, 20
AND 28.
2,955,287, INT. CL. 28.
- BSH PROFILO ELEKTRIKLI GERECLER SANAYI A.S.,
MECIDIYEKÖY, ISTANBUL, TURKEY:
2,954,222, PUB. 3-1-2005. MULTIPLE CLASS, INT. CLS. 7
AND 11.
- BUCKEYE CABLEVISION, INC., TOLEDO, OH:
2,955,761, INT. CL. 41.
- BUDD COMPANY, THE, TROY, MI:
1,283,931, CANC. INT. CL. 1.
- BUDDHIST COMPASSION RELIEF TZU-CHI FOUNDA-
TION, HUALIEN COUNTY, TAIWAN:
2,955,578, MULTIPLE CLASS, INT. CLS. 36, 38, 41 AND
44.
- BUGATTI INTERNATIONAL S.A., LUXEMBOURG, LUX-
EMBOURG:
2,956,068, INT. CL. 12.
2,956,069, INT. CL. 12.
- BUHLER AG, CH-9240 UZWIL, SWITZERLAND:
2,170,636, CANC. MULTIPLE CLASS, INT. CLS. 9 AND
42.
- BUILDERWAY, INC., GREENVILLE, SC:
1,284,702, CANC. INT. CL. 42.
1,284,703, CANC. INT. CL. 42.
- BUILDING INDUSTRY ASSOCIATION OF SOUTHEAST-
ERN MICHIGAN, FARMINGTON HILLS, MI:
2,955,921, INT. CL. 35.
- BULGARI S.P.A., ROME, ITALY:
2,954,459, PUB. 3-1-2005. INT. CL. 25.
- BULLY HILL VINEYARDS, INC., HAMMONDSPORT, NY:
1,887,387, REN. 4-10-05. INT. CL. 33.
- BUNTE, BRADY, IRVINE, CA:
1,912,746, REN. 4-12-05. INT. CL. 36.
- BUONGIORNO PIZZA AND PASTA, INC., PALM BEACH
GARDENS, FL:
2,954,556, PUB. 3-1-2005. INT. CL. 43.
- BURLWOOD FINANCIAL GROUP, INC., MINNEAPOLIS,
MN:
2,955,772, MULTIPLE CLASS, INT. CLS. 35 AND 36.
- BURLWOOD GROUP, INC., BURBANK, CA:
2,955,655, INT. CL. 34.
- BURNHAM SERVICES, INC., WILMINGTON, DE:
2,954,411, PUB. 3-1-2005. INT. CL. 11.
- BURNS, DONALD P., LAKELAND, FL:
2,956,306, INT. CL. 43.
- BUSCH, SCOTT, KANSAS CITY, MO:
2,955,735, INT. CL. 36.
- BUSINESS & QUALITY MANAGEMENT SYSTEMS, INC.,
FREMONT, CA:
2,172,008, CANC. INT. CL. 16.
- BUSINESS RESULTS, INC., DALLAS, TX:
2,954,569, PUB. 3-1-2005. INT. CL. 41.
- BUTLER MANUFACTURING COMPANY, KANSAS CITY,
MO:
772,626, CANC. U.S. CL. 12.
- BUTTE, FAWN CHANETTE, MESA, AZ:
2,954,708, PUB. 3-1-2005. INT. CL. 9.
- BUTY-WAVE PRODUCTS CO., INC., LOS ANGELES, CA:
977,874, REN. 4-15-05. MULTIPLE CLASS, U.S. CLS. 51
(INT. CL. 3) AND 52 (INT. CL. 3).
- BWD GROUP LLC, JERICHO, NY:
2,230,823, AM. INT. CL. 36.
- BYRNE SPECIALTY GASES, INC., SEATTLE, WA:
2,955,749, INT. CL. 10.
- BYTE SIZE TOOLS LLC, ARGYLE, TX:
2,954,337, PUB. 3-1-2005. INT. CL. 42.
- C & D HIT, INC., LARGO, FL:
1,284,108, CANC. INT. CL. 9.
- C J WILDBIRD FOODS LIMITED, UNITED KINGDOM:
2,955,162, PUB. 3-1-2005. MULTIPLE CLASS, INT. CLS. 6,
9, 16, 19, 20, 21 AND 31.
- C P MEDICAL, PORTLAND, OR:
1,843,566, CANC. INT. CL. 10.
- C. & A. VELTINS GMBH & CO., 59872 MESCHDEDE, FED REP
GERMANY:
1,874,099, REN. 4-12-05. INT. CL. 32.
- C. & J. CLARK INTERNATIONAL LIMITED, SOMERSET,
UNITED KINGDOM:
2,954,724, PUB. 11-30-2004. INT. CL. 25.
- C. F. MARTIN & CO., INC., NAZARETH, PA:
1,284,231, CANC. INT. CL. 15.
- C.A.S. IBERIA, INC., SALE CREEK, TN:
2,954,350, PUB. 3-1-2005. INT. CL. 8.
- C.B. FLEET COMPANY, INCORPORATED, LYNCHBURG,
VA:
2,954,598, PUB. 3-1-2005. INT. CL. 5.
- C.B. FLEET INVESTMENT CORPORATION, WILMING-
TON, DE:
2,955,477, INT. CL. 3.
- C.P. INTERNATIONAL CORPORATION, ENGLEWOOD, NJ:
2,955,334, INT. CL. 25.
- C.R. BARD, MURRAY HILL, NJ:
2,171,390, CANC. INT. CL. 10.
- C.R.A.C. LTD., MONTREAL, QUEBEC, CANADA:
2,954,661, PUB. 9-21-2004. INT. CL. 35.
- C-LITE INTERNATIONAL, INC., SAN ANTONIO, TX:
2,955,547, INT. CL. 31.
- CABLE TELEVISION LABORATORIES, INC., LOUISVILLE,
CO:
2,955,237, INT. CL. 16.

- CABLE TELEVISION NETWORK OF NEW JERSEY, INC., THE, TRENTON, NJ:
1,284,624, CANC. INT. CL. 38.
- CADBURY SENIOR SERVICES, INC., CHERRY HILL, NJ:
2,955,597, INT. CL. 44.
- CAFE CUMBRE, S.A. DE C. V., JALISCO, MEXICO:
2,954,224, PUB. 7-27-2004. INT. CL. 43.
- CAGAN, LEIGH D., SAN JOSE, CA:
2,955,653, INT. CL. 9.
- CAIAZZO, JILL TIFFANY, NEW YORK, NY:
2,956,053, INT. CL. 35.
2,956,055, INT. CL. 35.
- CAJA DE AHORROS DE VALENCIA, CASTELLON Y ALICANTE, BANCAJA, 46002 VALENCIA, SPAIN:
2,171,027, CANC. INT. CL. 36.
- CAL FARLEY'S BOYS RANCH, AMARILLO, TX, DBA CAL FARLEY'S:
2,954,423, PUB. 3-1-2005. MULTIPLE CLASS, INT. CLS. 41, 43 AND 44.
- CAL-GEN INTERNATIONAL TRADING INC., WU FENG HSIANG, TAICHUNG HSIEN, TAIWAN:
2,170,904, CANC. INT. CL. 5.
- CALDWELL COMMUNICATIONS, INC., TROY, MI:
2,956,332, INT. CL. 9.
- CALIFORNIA MOTORS LLC, CAMARILLO, CA:
2,955,961, INT. CL. 12.
- CALIFORNIA PARKING SYSTEMS INC., HAWTHORNE, CA:
2,956,293, INT. CL. 39.
- CALIFORNIA TEACHERS ASSOCIATION, BURLINGAME, CA:
2,171,329, CANC. INT. CL. 42.
- CALIPER CORPORATION, NEWTON, MA:
1,890,900, REN. 4-9-05. INT. CL. 9.
- CALLAWAY GOLF COMPANY, CARLSBAD, CA:
1,326,177, REN. 4-14-05. INT. CL. 28.
- CALPASC, SAN DIEGO, CA, DBA PROFESSIONAL ASSOCIATION OF SPECIALTY CONTRACTORS:
2,956,067, INT. CL. 35.
- CALTON HOMES, INC., MANALAPAN, NJ:
2,171,914, CANC. INT. CL. 36.
- CAMANO ISLAND MANAGEMENT, INC., CAMANO ISLAND, WA:
2,956,036, INT. CL. 30.
- CAMBRIDGE INSTITUTE FOR BETTER VISION, INC., TOPSFIELD, MA:
2,954,149, PUB. 3-1-2005. MULTIPLE CLASS, INT. CLS. 9 AND 16.
- CAMCO INTERNATIONAL INC., HOUSTON, TX:
2,171,188, CANC. INT. CL. 9.
- CAMCO, INC., LAS VEGAS, NV:
2,954,362, PUB. 3-1-2005. INT. CL. 36.
- CAMDEN EXTRUSION TOOL & DESIGN, INC., CAMDEN, NY:
1,842,695, CANC. INT. CL. 7.
- CAMPBELL T. GERRISH AND MICHAEL B. LIEBESKIND JOINT VENTURE, THE, NEW YORK, NY, DBA THE WINGED KEEL GROUP:
1,843,875, CANC. INT. CL. 36.
- CAMPER & NICHOLSONS (DESIGNS) LIMITED, GO-SPORT, HAMPSHIRE PO12 1 AH, ENGLAND, J. C. MANN & ASSOCIATES, INC., ANNAPOLIS, MD, AKA CAMPER & NICHOLSONS OF NORTH AMERICA:
1,312,230, REN. 4-15-05. MULTIPLE CLASS, INT. CLS. 12, 36, 37 AND 42.
- CANADIAN CENTRE FOR HIGH PERFORMANCE INC., COLLINGWOOD, ONTARIO, CANADA:
2,954,160, PUB. 5-25-2004. MULTIPLE CLASS, INT. CLS. 16 AND 41.
- CANADIAN EGG MARKETING AGENCY, OTTAWA CANADA, ONTARIO:
2,954,611, PUB. 7-6-2004. INT. CL. 35.
- CANADIAN HOME PUBLISHERS, TORONTO, ONTARIO M5V 2Z4, CANADA:
2,954,006, PUB. 3-1-2005. MULTIPLE CLASS, INT. CLS. 16 AND 41.
- CANCER COMFORT KIT, LLC, NORMAN, OK:
2,956,181, INT. CL. 16.
- CANNA B.V., 4817 LE BRED, NETHERLANDS:
2,954,231, PUB. 9-14-2004. INT. CL. 25.
- CANNON RUBBER LIMITED, TOTTENHAM, LONDON, UNITED KINGDOM:
2,954,690, PUB. 3-1-2005. INT. CL. 10.
- CANON KABUSHIKI KAISHA, OHTA-KU, TOKYO, JAPAN, CANON CAMERA KABUSHIKI KAISHA, OHTA-KU, TOKYO, JAPAN:
603,299, REN. 4-15-05. U.S. CL. 26 (INT. CL. 9).
- CANON KABUSHIKI KAISHA, OHTA-KU, TOKYO, JAPAN:
2,955,303, INT. CL. 9.
- CAP GEMINI AMERICA, INC., NEW YORK, NY:
2,170,852, CANC. INT. CL. 9.
- CAPITAL CITY BANK GROUP, TALLAHASSEE, FL:
2,007,889, COR. INT. CL. 36.
- CAPITAL CITY BANK GROUP, INC., TALLAHASSEE, FL:
2,560,084, COR. INT. CL. 9.
- CAPITOL RECORDS, INC., NEW YORK, NY, CAPITOL RECORDS, INC., NEW YORK, NY:
1,895,995, REN. 4-12-05. INT. CL. 9.
- CAPT'N BENNY'S HALF SHELL, INC., HOUSTON, TX:
1,284,799, CANC. INT. CL. 42.
- CARAVAN CANOPY INTERNATIONAL, INC., COMPTON, CA:
2,956,040, MULTIPLE CLASS, INT. CLS. 6, 19 AND 22.
- CARBOLOY INC., WARREN, MI:
2,170,677, CANC. INT. CL. 7.
- CARDIAC ALLIANCE, INC., NORTHBROOK, IL:
2,170,618, CANC. INT. CL. 42.
- CARDIMA, INC., FREMONT, CA:
2,171,847, CANC. INT. CL. 10.
- CARDIOPUL MEDICAL, INC., DECATUR, GA:
1,284,788, CANC. INT. CL. 42.
- CARDONI, JOE, CLARKS SUMMIT, PA:
2,954,216, PUB. 3-1-2005. INT. CL. 42.
- CAREER COMMUNICATIONS, OVERLAND PARK, KS:
2,954,276, PUB. 3-1-2005. INT. CL. 16.
- CAREER IMAGING, BRENTWOOD, TN:
2,955,006, PUB. 3-1-2005. INT. CL. 41.
- CAREING FOUNDATION, INC., THE, WEST PALM BEACH, FL:
2,171,109, CANC. INT. CL. 41.
- CAREY & KUTAY DEVELOPMENT GROUP, LLC, LOS ANGELES, CA:
2,956,050, INT. CL. 36.
- CARGILL, INCORPORATED, WAYZATA, MN:
2,955,557, INT. CL. 30.
- CARGO ONE, INC., GREAT NECK, NY:
1,843,221, CANC. INT. CL. 39.
- CARIBE TOBACCO, LTD., INC., MIAMI, FL:
2,171,856, CANC. INT. CL. 34.
- CARIME LTD., SMITHVILLE, ONTARIO, CANADA:
2,954,125, PUB. 10-26-2004. INT. CL. 21.
- CARING AMBASSADORS PROGRAM, INC., DUNWOODY, GA:
2,954,141, PUB. 3-1-2005. MULTIPLE CLASS, INT. CLS. 35 AND 44.
- CARL-ZEISS-STIFTUNG, 73446 OBERKOCHEN, FED REP GERMANY, DBA CARL ZEISS:
2,171,736, CANC. INT. CL. 9.
- CARL-ZEISS-STIFTUNG, FED REP GERMANY, DBA CARL ZEISS:
2,954,246, PUB. 3-1-2005. INT. CL. 9.
- CARLBERG GRAFIX, INC., SPRINGFIELD, IL:
2,955,628, INT. CL. 25.
- CARO USA., INC., LAKE TAHOE, NV:
2,772,342, CANC. INT. CL. 3.
- CAROLINA MILLWRIGHT SERVICE CORPORATION, FU-QUAY-VARINA, NC:
2,171,107, CANC. INT. CL. 37.
- CARON FOUNDATION OF NEW YORK, INC., NEW YORK, NY:
2,954,515, PUB. 3-1-2005. INT. CL. 44.
- CARPENTER, DALE F, TRAVERSE CITY, MI:
2,954,612, PUB. 7-13-2004. INT. CL. 41.
- CARRANZA Y RUIZ ARQUITECTOS, S.A. DE C.V., 11850 MEXICO, D.F., MEXICO:
2,171,600, CANC. INT. CL. 16.

- CARRAWAY, RUSSELL D, RALEIGH, NC:
2,955,731, INT. CL. 9.
- CARRIER, JIM, MOUNTAIN LAKES, NJ:
2,171,578, CANC. INT. CL. 25.
- CARRIFF CORPORATION INC., MIDLAND, NC:
1,884,429, REN. 4-14-05. INT. CL. 24.
- CARROLL MCENTEE & MCGINLEY INCORPORATED,
NEW YORK, NY:
1,843,874, CANC. INT. CL. 36.
- CARROLL, TRACI, JOHNSON CITY, TN:
2,954,315, PUB. 3-1-2005. INT. CL. 41.
- CARSON PRODUCTS COMPANY, SAVANNAH, GA:
2,170,966, CANC. INT. CL. 3.
2,171,855, CANC. INT. CL. 3.
- CARVEL CORPORATION, ATLANTA, GA:
2,954,989, PUB. 3-1-2005. INT. CL. 35.
- CAS MEDICAL SYSTEMS, INC., BRANFORD, CT:
2,172,035, CANC. INT. CL. 10.
- CASEWISE SYSTEMS LIMITED, WATFORD HERTFORD-
SHIRE, ENGLAND, CASEWARE LIMITED, LONDON
NW3 1TL, ENGLAND:
1,882,851, REN. 4-10-05. INT. CL. 9.
- CASHFAC LIMITED, LONDON, ENGLAND:
2,954,026, PUB. 3-1-2005. MULTIPLE CLASS, INT. CLS. 9,
16, 35, 36, 38, 41 AND 42.
- CASKET SHELLS, INC., EYNON, PA:
1,284,334, CANC. INT. CL. 20.
1,284,335, CANC. INT. CL. 20.
- CASSLAC, INC., MALIBU, CA:
2,955,385, INT. CL. 14.
2,955,386, INT. CL. 14.
- CASSLEE CORPORATION, SAN DIEGO, CA, DBA CLEVER
CLEAVER PRODUCTIONS:
1,843,142, CANC. INT. CL. 35.
- CASTLE KING CORPORATION, MINNETONKA, MN:
2,190,618, CANC. INT. CL. 36.
- CAT MBX, SACRAMENTO, CA:
2,954,123, PUB. 3-1-2005. INT. CL. 37.
- CATERPILLAR INC., PEORIA, IL:
2,954,660, PUB. 7-6-2004. INT. CL. 42.
- CAUDWELL HOLDINGS LIMITED, STAFFORDSHIRE,
UNITED KINGDOM:
2,954,636, PUB. 8-10-2004. MULTIPLE CLASS, INT. CLS.
11, 28 AND 35.
- CAVS/GUND ARENA COMPANY, CLEVELAND, OH:
2,955,656, INT. CL. 41.
- CC & C MANAGEMENT GROUP, INC., MYRTLE BEACH,
SC:
2,955,882, INT. CL. 41.
- CEASAR'S BAZAAR LIMITED, BROOKLYN, NY:
1,337,288, REN. 4-12-05. INT. CL. 42.
- CECCHI E CECCHI TESSITURE S.R.L., 50041 CALENZANO -
FIRENZE, ITALY:
2,954,827, PUB. 3-1-2005. MULTIPLE CLASS, INT. CLS. 24
AND 25.
- CELAYA EMPARANZA Y GALDOS, S. A., VITORIA, SPAIN:
1,352,657, REN. 4-13-05. INT. CL. 11.
- CELEBRATION OF LIGHT CHURCH, INC., SAN FRANCIS-
CO, CA:
2,954,890, PUB. 3-1-2005. INT. CL. 45.
- CELLECTIS S.A., 75724, PARIS CEDEX 15, FRANCE:
2,954,070, PUB. 5-4-2004. MULTIPLE CLASS, INT. CLS. 1,
5 AND 42.
- CELLEX-C INTERNATIONAL INC., TORONTO, ONTARIO,
CANADA:
2,954,982, PUB. 3-1-2005. INT. CL. 3.
- CENTER FOR DANCE EDUCATION, LLC, CLARK, NJ:
2,955,161, PUB. 6-1-2004. INT. CL. 9.
- CENTER FOR GLOBAL MINISTRIES, PLANO, TX:
2,954,965, PUB. 3-1-2005. INT. CL. 45.
- CENTER FOR LEADERSHIP IN SCHOOL REFORM INC.,
LOUISVILLE, KY:
2,954,897, PUB. 3-1-2005. INT. CL. 41.
- CENTEX CORPORATION, DALLAS, TX:
2,956,064, INT. CL. 37.
- CENTRA SOFTWARE, INC., LEXINGTON, MA:
2,954,842, PUB. 10-26-2004. MULTIPLE CLASS, INT. CLS.
38, 41 AND 42.
- CENTRAL AND SOUTH WEST CORPORATION, DALLAS,
TX:
2,170,666, CANC. MULTIPLE CLASS, INT. CLS. 35, 37, 39
AND 42.
- CENTRAL FALLS INCORPORATED, GARLAND, TX:
1,843,032, CANC. INT. CL. 25.
- CENTRAL FIDELITY BANKS, INC., RICHMOND, VA:
1,284,580, CANC. INT. CL. 36.
- CENTRAL NEWSPAPERS, INC., INDIANAPOLIS, IN:
2,170,816, CANC. INT. CL. 41.
2,170,978, CANC. INT. CL. 42.
- CENTRAL RESERVATIONS, INC.:
1,284,570, CANC. INT. CL. 36.
- CEPHALON, INC., WEST CHESTER, PA:
2,955,150, PUB. 3-1-2005. INT. CL. 42.
2,955,151, PUB. 3-1-2005. INT. CL. 42.
- CERDEC AG, D-60327 FRANKFURT, FED REP GERMANY:
2,171,595, CANC. INT. CL. 1.
- CERVECERIA MODELO, S.A. DE C.V., 11320 MEXICO, D.F.,
MEXICO:
2,954,586, PUB. 3-1-2005. INT. CL. 32.
- CERVITECH, INC., ROCKAWAY, NJ:
2,954,198, PUB. 8-17-2004. MULTIPLE CLASS, INT. CLS.
9, 10, 16, 42 AND 44.
- CESARE BONETTI S.P.A., 20024 GARBAGNATE MILA-
NESE, ITALY:
1,007,546, REN. 4-11-05. U.S. CL. 13 (INT. CL. 7).
- CESPA S.R.L., CIVITANOVA MARCHE (MACERATA),
ITALY:
2,954,370, PUB. 10-26-2004. INT. CL. 14.
- CFC SYSTEMES AUTOMATISES, 92130 ISSY-LES-MOLI-
NEAUX, FRANCE:
2,171,025, CANC. MULTIPLE CLASS, INT. CLS. 7 AND
12.
- CGS INDUSTRIES INC., LONG ISLAND CITY, NY:
2,956,084, INT. CL. 25.
- CHABOUD, GEORGES GASTON, LONDON W1Y 7RF,
UNITED KINGDOM:
2,170,755, CANC. INT. CL. 9.
- CHAFFEE, ROBERT B., BOSTON, MA:
2,955,270, MULTIPLE CLASS, INT. CLS. 20 AND 28.
- CHALABI, RIFAT AL., FANWOOD, NJ AND PERRY,
OPHNEIL H., NOTTINGHAM, UNITED KINGDOM:
2,955,632, INT. CL. 11.
- CHALLENGER MANUFACTURING, INC., ST. CHARLES,
IL:
1,843,399, CANC. INT. CL. 1.
- CHAMBER OF COMMERCE OF THE UNITED STATES,
THE, WASHINGTON, DC:
2,170,837, CANC. INT. CL. 16.
2,170,838, CANC. INT. CL. 16.
2,170,844, CANC. INT. CL. 16.
2,170,845, CANC. INT. CL. 16.
- CHAMBERLAIN GROUP, LLC, THE, CHESAPEAKE, VA:
2,172,048, CANC. INT. CL. 42.
- CHAMPION PARKING CORP., NEW YORK, NY:
2,954,447, PUB. 3-1-2005. INT. CL. 39.
- CHANNEL VANTAGE, INC., DETROIT, MI:
2,955,272, MULTIPLE CLASS, INT. CLS. 9, 16, 35 AND 42.
- CHANNING BETE COMPANY, INC., SOUTH DEERFIELD,
MA:
2,918,225, COR. MULTIPLE CLASS, INT. CLS. 16, 35
AND 42.
2,918,230, COR. MULTIPLE CLASS, INT. CLS. 16, 35
AND 42.
2,918,231, COR. MULTIPLE CLASS, INT. CLS. 16, 35
AND 42.
- 2,955,514, INT. CL. 41.
- CHAPA, TATIANA PALACIOS, GARZA GARCIA, N.L. CP
66256, MEXICO:
2,955,274, MULTIPLE CLASS, INT. CLS. 9 AND 41.
2,955,275, MULTIPLE CLASS, INT. CLS. 9 AND 41.
- CHAPDELAINE & CO., NEW YORK, NY:
2,955,829, INT. CL. 36.
- CHARLES GRAY LONDON LIMITED, LONDON, UNITED
KINGDOM:
2,954,828, PUB. 3-1-2005. INT. CL. 25.

- CHARLES JOURDAN HOLDING AG, GLARUS 8750, SWITZERLAND:
1,307,510. REN. 4-15-05. INT. CL. 42.
- CHARMANT INC., FUKUI-KEN, JAPAN, CHARMANT INC., USA, MORRIS PLAINS, NJ:
1,914,105. REN. 4-13-05. INT. CL. 9.
- CHASE CHARTERS, INC., FORT WORTH, TX:
2,956,104, MULTIPLE CLASS, INT. CLS. 39, 41, 43 AND 45.
- CHATTEM, INC., CHATTANOOGA, TN:
1,283,945, CANC. INT. CL. 1.
- CHAUNCEY GROUP INTERNATIONAL LTD., THE, PRINCETON, NJ:
2,170,764, CANC. MULTIPLE CLASS, INT. CLS. 9, 16 AND 42.
- CHECKS IN THE MAIL, INC., IRWINDALE, CA:
2,171,538, CANC. INT. CL. 42.
- CHEER COACH & ADVISOR PUBLISHING CO., LLC, NORTH PALM BEACH, FL:
2,955,877, INT. CL. 16.
- CHEMICAL MANUFACTURERS ASSOCIATION, ARLINGTON, VA:
2,171,055, CANC. INT. CL. 42.
- CHEMICAL SPECIALTIES MANUFACTURING CORPORATION, BALTIMORE, MD:
1,284,481, CANC. INT. CL. 28.
- CHEMICAL SPECIALTIES, INC., CHARLOTTE, NC:
1,283,941, CANC. INT. CL. 1.
- CHEMISCHES LABORATORIUM DR. KURT RICHTER GMBH, 12159 BERLIN, FED REP GERMANY:
2,954,279, PUB. 3-1-2005. INT. CL. 1.
- CHESTER COUNTY BREWING COMPANY, INC., PHOENIXVILLE, PA:
2,171,341, CANC. INT. CL. 42.
- CHG MANAGEMENT, INC., SALT LAKE CITY, UT:
2,956,184, INT. CL. 35.
- CHIANUCCI MAURIZIO S.R.L., 52100 AREZZO, ITALY:
1,329,470. REN. 4-15-05. INT. CL. 14.
- CHILD HEALTH CORPORATION OF AMERICA, SHAWNEE MISSION, KS:
2,954,434, PUB. 3-1-2005. INT. CL. 41.
- CHILDREN'S HOSPITAL, COLUMBUS, OH:
2,954,419, PUB. 3-1-2005. INT. CL. 42.
- CHILI SYSTEMS, INC., NORWALK, CT:
2,955,930, INT. CL. 9.
- CHILTON COMPANY, RADNOR, PA TO REED ELSEVIER INC., NEWTON, MA:
1,843,948, CANC. INT. CL. 16.
- CHIMERA RESEARCH & CHEMICAL, INC., TAMPA, FL:
2,170,885, CANC. INT. CL. 5.
- CHINA ALLIANCE, LLC, ST. LOUIS, MO:
2,955,971, INT. CL. 35.
- CHINA MOBILE (HONG KONG) LIMITED, HONG KONG:
2,954,064, PUB. 3-1-2005. MULTIPLE CLASS, INT. CLS. 9, 16, 35, 38 AND 42.
- CHINA NATIONAL LIGHT INDUSTRIAL PRODUCTS IMPORT AND EXPORT CORPORATION, SHANGHAI BRANCH, SHANGHAI, CHINA:
1,284,221, CANC. INT. CL. 14.
- CHISCO, INC., SALT LAKE CITY, UT, DBA CHISCO SPORTS ACCESSORIES:
1,882,097. REN. 4-10-05. INT. CL. 14.
- CHOATE, EARL W. JR., FARMERSVILLE, TX:
2,956,189, INT. CL. 2.
- CHOCOLATES DUVIN, EL PASO, TX:
2,955,886, INT. CL. 30.
- CHOCOLATES GAROTO S.A., VILA VELHA, ESPIRITO SANTO, BRAZIL:
1,843,083, CANC. INT. CL. 30.
- CHOKSHI, SAURABH, TAMPA, FL:
2,955,866, INT. CL. 21.
- CHRISTINA HAN, INC., MEGURO-KU TOKYO, JAPAN:
2,954,309, PUB. 3-1-2005. MULTIPLE CLASS, INT. CLS. 14, 18, 24 AND 25.
- CHROME HEARTS, INC., HOLLYWOOD, CA:
2,954,539, PUB. 3-1-2005. INT. CL. 14.
- CHRONICLE PUBLISHING COMPANY, THE, SAN FRANCISCO, CA:
1,843,002, CANC. INT. CL. 25.
- CHUNG HWA BOOK COMPANY, LIMITED, TAIPEI, TAIWAN:
2,171,560, CANC. INT. CL. 16.
- CHURCH AND CHAPEL FUNERAL SERVICES, INC., WAUKESHA, WI:
2,955,116, PUB. 3-1-2005. INT. CL. 45.
- CHURCH HEALTH CENTER OF MEMPHIS, INC. HOPE & HEALING PROGRAM, MEMPHIS, TN:
2,171,370, CANC. INT. CL. 42.
- CHURCHILL COATINGS CORPORATION, GRAFTON, MA:
2,954,327, PUB. 3-1-2005. INT. CL. 19.
- CHURCHILL DOWNS INCORPORATED, LOUISVILLE, KY:
1,843,896, CANC. INT. CL. 41.
- CIBELLIS, MICHAEL J., PARSIPPANY, NJ:
2,955,323, INT. CL. 25.
- CIELO LTD., NEW YORK, NY:
2,954,706, PUB. 10-26-2004. MULTIPLE CLASS, INT. CLS. 41 AND 43.
- CIENA CORPORATION, LINTHICUM, MD:
2,955,580, INT. CL. 9.
- CIGNA INTELLECTUAL PROPERTY, INC., CLAYMONT, DE:
2,954,448, PUB. 3-1-2005. INT. CL. 36.
- CIP CORPORATION, TAIPEI, TAIWAN:
2,888,545, COR. MULTIPLE CLASS, INT. CLS. 11 AND 21.
- CIPER INVESTMENT MANAGEMENT COMPANY, INC., CORAL GABLES, FL:
2,954,065, PUB. 3-1-2005. INT. CL. 36.
- CIPRICO INC., PLYMOUTH, MN:
1,284,139, CANC. INT. CL. 9.
- CIRCLE OF BEAUTY, INC., NEW YORK, NY:
2,171,510, CANC. INT. CL. 3.
- CIRRUS TECHNOLOGY, INC., HUNTSVILLE, AL:
2,954,322, PUB. 3-1-2005. INT. CL. 42.
- CITGO PETROLEUM CORPORATION, TULSA, OK:
2,955,768, INT. CL. 4.
- CITICORP, NEW YORK, NY:
2,171,043, CANC. INT. CL. 36.
- 2,954,363, PUB. 3-1-2005. MULTIPLE CLASS, INT. CLS. 35, 39 AND 43.
- CITIZENS COMMUNICATIONS COMPANY, STAMFORD, CT, FRONTIER CORPORATION, RICHESTER, NY:
1,960,994. REN. 4-14-05. INT. CL. 37.
- CITRA-SOLV LLC, RIDGEFIELD, CT:
2,955,252, INT. CL. 3.
- CITYLIT PROJECT, INC., BALTIMORE, MD:
2,954,534, PUB. 3-1-2005. INT. CL. 41.
- CLABER S.P.A., I-33080 FIUME VENETO (PN), ITALY:
2,954,156, PUB. 9-7-2004. INT. CL. 11.
- CLAMPIT, SHELLEY A., MONTICELLO, AR, DBA THE GIFT SHAKER:
2,954,552, PUB. 3-1-2005. INT. CL. 16.
- CLARKE MOSQUITO CONTROL PRODUCTS, INC., ROSELLE, IL:
1,881,124. REN. 4-13-05. INT. CL. 5.
- CLASSIC THERMOGRAPHERS LIMITED, HICKORY HILLS, IL:
1,284,267, CANC. MULTIPLE CLASS, INT. CLS. 16 AND 42.
- CLASSNOTES, INC., SACRAMENTO, CA:
2,955,191, INT. CL. 36.
- CLAY CARTRIDGE COMPANY, LLC, CAMDEN, SC:
2,955,823, INT. CL. 13.
- CLAYBURN INDUSTRIES LTD., ABBOTSFORD, BRITISH COLUMBIA, CANADA, CLAYBURN-HARBISON LTD., VANCOUVER, BRITISH COLUMBIA, CANADA:
786,260. REN. 4-10-05. U.S. CL. 12 (INT. CL. 19).
- CLEAR CHANNEL IDENTITY, L.P., SAN ANTONIO, TX:
2,955,473, INT. CL. 35.

- CLEMENT COMMUNICATIONS INCORPORATED, CONCORDVILLE, PA:
1,843,623, CANC. INT. CL. 16.
- CLEVELAND MILLS COMPANY, LAWNSDALE, NC:
772,888, CANC. U.S. CL. 42.
- CLEVELAND PROCESS CORPORATION, HOMESTEAD, FL:
2,954,532, PUB. 3-1-2005. INT. CL. 11.
- CLIF BAR, INC., BERKELEY, CA:
2,956,269, INT. CL. 29.
- CLIMATE CARE, LEAWOOD, KS:
2,954,863, PUB. 3-1-2005. INT. CL. 37.
- CLIPPER BELT LACER COMPANY, GRAND RAPIDS, MI:
1,331,658, REN. 4-15-05. INT. CL. 6.
- CLUBCORP, INC., DALLAS, TX:
1,843,140, CANC. MULTIPLE CLASS, INT. CLS. 35, 41 AND 42.
- CMP MEDIA LLC, MANHASSET, NY:
2,956,049, MULTIPLE CLASS, INT. CLS. 16 AND 41.
- CMS PRODUCTS, INC., COSTA MESA, CA:
2,954,436, PUB. 12-21-2004. INT. CL. 9.
- CNF INC., PALO ALTO, CA FROM CNF TRANSPORTATION INC., PALO ALTO, CA:
2,954,004, PUB. 7-31-2001. INT. CL. 39.
- CNF TRANSPORTATION INC.:
See— CNF INC..
- CNS VITAL SIGNS, LLC, CHAPEL HILL, NC:
2,955,697, MULTIPLE CLASS, INT. CLS. 9 AND 44.
- COACH-NET SERVICES GROUP, INC., LAKE HAVASU CITY, AZ:
2,954,950, PUB. 3-1-2005. MULTIPLE CLASS, INT. CLS. 37 AND 39.
- COASTAL PRINTING CORPORATION, NEW YORK, NY:
2,956,191, INT. CL. 16.
- COASTAL TECHNOLOGIES GROUP, INC., BOCA RATON, FL:
2,955,331, INT. CL. 9.
- COATEC GESELLSCHAFT FUR OBERFLACHENVEREDLUNG MBH, 36381 SCHLUCHTERN, FED REP GERMANY:
2,230,169, CANC. INT. CL. 40.
- COATEX S.A.S., GENAY, FRANCE:
2,954,632, PUB. 5-25-2004. MULTIPLE CLASS, INT. CLS. 1 AND 42.
- COBALT GROUP, INC., THE, SEATTLE, WA, DEALER INTERNET SERVICES CORPORATION, LYNNWOOD, WA:
1,915,360, REN. 4-12-05. INT. CL. 35.
- COBB ENTERPRISES, INC., CLOVIS, CA, DBA HI-TECH HOME:
2,956,304, INT. CL. 35.
- COCA-COLA COMPANY, THE, ATLANTA, GA:
415,755, REN. 4-15-05. U.S. CL. 45 (INT. CL. 32).
2,170,765, CANC. INT. CL. 32.
- CODECORRECT, YAKIMA, WA:
2,954,798, PUB. 3-1-2005. INT. CL. 42.
- COFCO FUJIAN (NEW YORK) CORPORATION, NEW YORK, NY:
2,171,999, CANC. INT. CL. 29.
- COFFEE PEOPLE, INC., PORTLAND, CA:
1,843,093, CANC. INT. CL. 30.
- COGENTWORKS, LLC, DENVER, CO:
2,956,086, INT. CL. 9.
- COHEN, JEREMY C., OAKLAND, CA:
2,956,223, INT. CL. 41.
- COHN, GARRETT, BUFFALO GROVE, IL:
1,343,936, CANC. INT. CL. 9.
- COLE TAYLOR BANK, WHEELING, IL:
2,171,375, CANC. INT. CL. 36.
- COLE-PARMER INSTRUMENT COMPANY, VERNON HILLS, IL:
1,882,815, REN. 4-12-05. INT. CL. 9.
- COLEMAN, CHARLES M., PITTSBURGH, PA:
2,955,295, INT. CL. 10.
- COLGATE-PALMOLIVE COMPANY, NEW YORK, NY:
815,592, CANC. U.S. CL. 51.
2,955,534, INT. CL. 3.
2,956,195, INT. CL. 3.
- COLL. FRANCISCO, WASHINGTON, DC:
1,843,243, CANC. INT. CL. 41.
- COLLEGEINVEST, DENVER, CO:
2,955,571, INT. CL. 36.
- COLLICUTT ENERGY SERVICES, LTD., ALBERTA T4P 3R2, CANADA:
2,954,260, PUB. 3-1-2005. INT. CL. 7.
- COLLINS, HEYWARD, NEW YORK, NY AND LEONETTI, CLAUDE M., NEW YORK, NY:
2,171,742, CANC. MULTIPLE CLASS, INT. CLS. 21 AND 24.
- COLONIAL REALTY LIMITED PARTNERSHIP, BIRMINGHAM, AL:
2,954,286, PUB. 3-1-2005. MULTIPLE CLASS, INT. CLS. 35 AND 36.
- COLOPLAST A/S, DK-3050 HUMLEBAEK, DENMARK:
2,954,159, PUB. 9-21-2004. MULTIPLE CLASS, INT. CLS. 38 AND 44.
- COLOSSUS INT'L TRADING(USA), INC., UPLAND, CA:
2,954,177, PUB. 3-1-2005. INT. CL. 30.
- COLUMBIA ATHLETIC CLUBS, INC., KIRKLAND, WA:
2,954,271, PUB. 3-1-2005. INT. CL. 41.
2,954,272, PUB. 3-1-2005. INT. CL. 41.
- COLUMBIA INSURANCE COMPANY, OMAHA, NE, SEE'S CANDY SHOPS, INC., SO. SAN FRANCISCO, CA, AKA SEE'S CANDIES, AKA SEE'S CANDY AND AKA SEE'S:
1,892,276, REN. 4-15-05. INT. CL. 30.
- COMARCO WIRELESS TECHNOLOGIES, INC., IRVINE, CA:
2,956,150, INT. CL. 9.
- COMCAST CORPORATION, PHILADELPHIA, PA:
2,955,848, MULTIPLE CLASS, INT. CLS. 38 AND 41.
- COMERICA INCORPORATED, DETROIT, MI:
1,284,588, CANC. INT. CL. 36.
- COMFORCE CORPORATION, LAKE SUCCESS, NY:
2,170,692, CANC. MULTIPLE CLASS, INT. CLS. 35, 38 AND 42.
- COMMONWEALTH RISK SERVICES, L.P., PHILADELPHIA, PA:
1,843,179, CANC. INT. CL. 36.
- COMPAGNIE GERVAIS DANONE, LEVALLOIS-PERRET, FRANCE:
2,954,820, PUB. 3-1-2005. INT. CL. 29.
- COMPAK SYSTEMS LIMITED, GAINSBOROUGH, LINCOLNSHIRE DN21 2EX, ENGLAND:
2,171,184, CANC. MULTIPLE CLASS, INT. CLS. 7 AND 19.
- COMPASSTOOLS, INC., CENTENNIAL, CO:
2,956,112, MULTIPLE CLASS, INT. CLS. 41 AND 42.
- COMPFIRST, INC., DALTON, GA:
2,170,995, CANC. MULTIPLE CLASS, INT. CLS. 35, 36 AND 42.
- COMPUMEDICS GERMANY GMBH, SINGEN, FED REP GERMANY:
1,828,182, REN. 4-15-05. INT. CL. 10.
- COMPUSERVE INCORPORATED, COLUMBUS, OH:
2,170,822, CANC. INT. CL. 42.
- COMPUTING SOLUTIONS, INC., MONROE, NC:
2,171,305, CANC. INT. CL. 9.
- COMPUWARE CORPORATION, DETROIT, MI:
2,955,379, INT. CL. 9.
- CONAIR CORPORATION, STAMFORD, CT:
2,955,599, INT. CL. 3.
2,955,694, INT. CL. 11.
2,955,752, INT. CL. 11.
2,955,908, INT. CL. 11.
- CONCEPTIS TECHNOLOGIES INC., MONTREAL, QUEBEC, CANADA:
2,954,732, PUB. 3-1-2005. INT. CL. 41.
- CONCEPTS CONTINENTAL CORP., GOLDEN, CO:
2,171,973, CANC. INT. CL. 25.
- CONCHITA FOODS, INC., MIAMI, FL:
2,954,609, PUB. 3-1-2005. MULTIPLE CLASS, INT. CLS. 29, 30, 32 AND 33.
- CONCORDANT PARTNERS, L.L.C., LINCOLN, NE:
2,955,724, INT. CL. 36.
- CONDUIT CAPITAL PARTNERS, LLC, NEW YORK, NY:
2,955,074, PUB. 3-1-2005. INT. CL. 36.

CONGOLEUM CORPORATION, KEARNY, NJ:
 772,618, CANC. U.S. CL. 12.
 CONJUGON, INC., MADISON, WI:
 2,955,144, PUB. 3-1-2005. INT. CL. 42.
 CONNECTICUT COMMUNITY BANK, NATIONAL ASSO-
 CIATION, WESTPORT, CT:
 2,956,225, INT. CL. 36.
 CONNER HOMES COMPANY, BELLEVUE, WA, CONNER
 DEVELOPMENT COMPANY, BELLEVUE, WA:
 1,883,112, REN. 4-14-05. INT. CL. 37.
 CONNER HOMES COMPANY, BELLEVUE, WA:
 1,900,104, REN. 4-14-05. INT. CL. 37.
 CONNMART INCORPORATED, STAMFORD, CT:
 2,171,313, CANC. INT. CL. 42.
 CONNOLLY, JENNIFER, TRUMBULL, CT:
 2,956,255, MULTIPLE CLASS, INT. CLS. 37 AND 41.
 CONOCOPHILLIPS COMPANY, HOUSTON, TX:
 2,955,764, INT. CL. 9.
 CONOPCO, INC., GREENWICH, CT, DBA CHESEBROUGH-
 POND'S USA CO.:
 1,882,761, REN. 4-12-05. INT. CL. 3.
 CONSEIL INTERPROFESSIONNEL DU VIN DE BOR-
 DEAUX, BORDEAUX CEDEX, FRANCE:
 2,954,657, PUB. 1-6-2004. INT. CL. 35.
 CONSOLIDATED BISCUIT CO., MCCOMB, OH:
 2,955,799, INT. CL. 29.
 CONSOLIDATED FREIGHTWAYS, INC., PALO ALTO, CA
 TO CONSOLIDATED FREIGHTWAYS CORPORATION,
 MENLO PARK, CA:
 1,843,890, CANC. INT. CL. 39.
 CONSOLIDATED NUTRITION, L.C., OMAHA, NE:
 2,170,898, CANC. INT. CL. 42.
 2,171,461, CANC. INT. CL. 31.
 CONSTRUCTION FORMS, INC., PORT WASHINGTON, WI:
 1,954,922, REN. 4-15-05. INT. CL. 6.
 CONSTRUCTION RESEARCH & TECHNOLOGY GMBH,
 TROSTBERG, FED REP GERMANY:
 2,954,793, PUB. 3-1-2005. MULTIPLE CLASS, INT. CLS. 1
 AND 19.
 CONTACTMUSIC.COM.LIMITED, ILKLEY, WEST YORK-
 SHIRE, ENGLAND:
 2,955,235, MULTIPLE CLASS, INT. CLS. 9, 35 AND 41.
 CONTAINER CORPORATION OF AMERICA, CHICAGO,
 IL:
 1,284,265, CANC. INT. CL. 16.
 CONTEC, INC., SPARTANBURG, SC:
 2,954,349, PUB. 3-1-2005. INT. CL. 21.
 CONTINENTAL GYPSUM COMPANY, PORT NEWARK, NJ:
 2,170,927, CANC. INT. CL. 19.
 CONTROL DATA CORPORATION, MINNEAPOLIS, MN:
 1,284,278, CANC. MULTIPLE CLASS, INT. CLS. 16 AND
 35.
 CONWAY STORES, INC., NEW YORK, NY, DBA NYC JEAN
 CO.:
 2,955,804, INT. CL. 25.
 COOK, CARL A., AGUA DULCE, CA:
 2,170,829, CANC. INT. CL. 42.
 COOKIE ISLAND INC., NEW YORK, NY:
 2,171,615, CANC. INT. CL. 30.
 COOLBAKER'S INTERNATIONAL, LLC, LOUISVILLE, KY:
 2,955,966, MULTIPLE CLASS, INT. CLS. 39 AND 43.
 COOLEY'S TROPICAL FRUIT, INC., LOS GATOS, CA:
 2,171,841, CANC. INT. CL. 29.
 COOLTOUCH INCORPORATED, ROSEVILLE, CA:
 2,954,338, PUB. 3-1-2005. INT. CL. 10.
 2,954,339, PUB. 3-1-2005. INT. CL. 10.
 COOMES, NANCY, ATLANTA, GA:
 2,955,103, PUB. 3-1-2005. INT. CL. 31.
 COONEY, MICHAEL J., GRANT JUNCTION, CO:
 2,954,510, PUB. 3-1-2005. INT. CL. 42.
 COOPER, BARRY, P. W., KINGSHILL, US VIRGIN IS-
 LANDS:
 2,955,708, INT. CL. 30.
 COOPER'S TURKEY PLACE, INC., OAKWOOD, OH:
 1,843,907, CANC. INT. CL. 42.
 COORS GLOBAL PROPERTIES, INC., LAKEWOOD, CO:
 2,171,432, CANC. INT. CL. 32.
 COPPLEY APPAREL GROUP LIMITED, HAMILTON, CA-
 NADA:
 2,955,698, INT. CL. 25.
 CORAL CHEMICAL COMPANY, WAUKEGAN, IL, CORAL,
 INC., WAUKEGAN, IL:
 1,345,458, REN. 4-15-05. INT. CL. 3.
 CORAL CHEMICAL COMPANY, WAUKEGAN, IL, CORAL
 INTERNATIONAL (INC.), WAUKEGAN, IL:
 1,897,162, REN. 4-14-05. INT. CL. 3.
 CORDAIRE & PARTNERS COMPANY INC., ZONA 3,
 PANAMA CITY, PANAMA:
 2,955,008, PUB. 3-1-2005. INT. CL. 41.
 2,956,201, INT. CL. 41.
 CORE INDUSTRIES, INC., ST. PAULS, NC:
 2,133,210, CANC. MULTIPLE CLASS, INT. CLS. 6 AND 9.
 CORE NAP, L.P., AUSTIN, TX:
 2,955,608, MULTIPLE CLASS, INT. CLS. 38 AND 42.
 CORIMAX, INC., TALLAHASSEE, FL:
 2,956,336, INT. CL. 16.
 CORNELL RESEARCH FOUNDATION, INC., ITHACA, NY:
 2,954,546, PUB. 3-1-2005. INT. CL. 31.
 CORNERSTONE LOGIC, INC., NEW SMYRNA BEACH, FL:
 2,954,991, PUB. 3-1-2005. INT. CL. 42.
 CORNING INCORPORATED, CORNING, NY:
 1,284,174, CANC. INT. CL. 9.
 CORONA-COLLEGE HEIGHTS ORANGE & LEMON ASSO-
 CIATION, RIVERSIDE, CA:
 186,290, CANC. U.S. CL. 46.
 CORPORATE AGENTS, INC., WILMINGTON, DE:
 2,171,255, CANC. INT. CL. 35.
 CORPORATE CHEFS, INC., HAVERHILL, MA:
 1,924,011, REN. 4-11-05. INT. CL. 35.
 CORPORATE EXPRESS DOCUMENT & PRINT MANAGE-
 MENT, INC., BROOMFIELD, CO, ROSS-MARTIN COM-
 PANY, TULSA, OK:
 790,722, REN. 4-14-05. U.S. CL. 37 (INT. CL. 16).
 CORPORATE FINANCIAL VENTURES, INC., ORLANDO,
 FL:
 2,954,497, PUB. 3-1-2005. INT. CL. 36.
 2,954,498, PUB. 3-1-2005. INT. CL. 36.
 CORPORATE JETS, INC., WEST MIFFLIN, PA:
 1,843,208, CANC. MULTIPLE CLASS, INT. CLS. 37 AND
 39.
 CORPORATION SERVICE COMPANY, WILMINGTON, DE:
 2,956,323, INT. CL. 42.
 CORSER, TROY, MONTECARLO, MONACO:
 2,955,209, INT. CL. 25.
 COSMODA CONCEPT CORPORATION, DOWNSVIEW, ON-
 TARIO, CANADA:
 2,953,999, PUB. 7-27-2004. INT. CL. 9.
 COST PLUS MARKETING SERVICES, INC., OAKLAND,
 CA:
 2,955,107, PUB. 3-1-2005. INT. CL. 9.
 COSTANZIA CORPORATION, NEWPORT BEACH, CA:
 2,171,306, CANC. INT. CL. 42.
 COTTING, STEVEN R., ATLANTA, GA:
 2,954,787, PUB. 3-1-2005. INT. CL. 7.
 COURTAULDS TEXTILES (HOLDINGS) LIMITED, MAN-
 CHESTER M28 5WR, ENGLAND:
 2,171,596, CANC. INT. CL. 25.
 COURTROOM TELEVISION NETWORK LLC, NEW YORK,
 NY:
 2,956,025, INT. CL. 41.
 COUSIN CORPORATION OF AMERICA, LARGO, FL:
 2,954,924, PUB. 3-1-2005. INT. CL. 14.
 COVENANT RETIREMENT PLANNING, LLC, NASHVILLE,
 TN:
 2,955,317, INT. CL. 36.
 COVEX S.A., 28770-COLMENAR VIEJO, MADRID, SPAIN:
 2,170,796, CANC. MULTIPLE CLASS, INT. CLS. 1 AND 5.
 2,170,798, CANC. INT. CL. 5.
 COVEY LEADERSHIP CENTER, INC., PROVO, UT:
 2,170,818, CANC. INT. CL. 41.
 2,171,225, CANC. INT. CL. 25.
 COYOTES HOCKEY, LLC, SCOTTSDALE, AZ:
 2,955,445, INT. CL. 41.
 CP MANUFACTURING, INC., NATIONAL CITY, CA:
 1,361,460, REN. 4-13-05. INT. CL. 7.

- CPS COLOR GROUP OY, VANTAA, FINLAND:
1,878,389. REN. 4-15-05. INT. CL. 2.
- CRANBROOK EDUCATIONAL COMMUNITY, BLOOMFIELD HILLS, MI:
1,938,425. REN. 4-15-05. INT. CL. 41.
1,948,464. REN. 4-15-05. INT. CL. 41.
- CREATIVE CULINARY CONCEPTS, INC., HYDE PARK, NY:
2,170,791. CANC. INT. CL. 42.
- CRECES, HENRI, GOSHEN, NY AND COOSEMANS, DANNY, MIAMI, FL AND CRECES, EDDY, SANDS POINT, NY:
2,901,129 NEW CERT. 5-24-2005. INT. CL. 31.
- CREDO TECHNOLOGY CORPORATION, BROADVIEW, IL:
772,672. CANC. U.S. CL. 15.
2,171,073. CANC. INT. CL. 8.
2,956,009. INT. CL. 7.
- CREME PROPERTIES, L.P., ATLANTA, GA:
2,171,634. CANC. MULTIPLE CLASS, INT. CLS. 41 AND 42.
- CRISTALL U.S.A., INC., BOCA RATON, FL:
2,954,053. PUB. 3-4-2003. INT. CL. 33.
- CRITTER CONTROL, INC., TRAVERSE CITY, MI:
2,955,818. INT. CL. 37.
- CROCCO S.P.A., ITALY:
2,955,175. PUB. 3-1-2005. INT. CL. 16.
- CROSMAN CORPORATION, EAST BLOOMFIELD, NY, COLEMAN COMPANY, INC.; THE, WICHITA, KS:
1,336,551. REN. 4-11-05. INT. CL. 13.
- CROSS COUNTRY PAPER PRODUCTS, CORP., HAUPPAUGE, NY, CROSS COUNTRY PAPER PRODUCTS, CORP., HAUPPAUGE, NY:
1,905,451. REN. 4-9-05. INT. CL. 9.
- CROSSMEDIA SERVICES, INC., CHICAGO, IL:
2,386,492. AM. INT. CL. 35.
- CROSSPOINT CORPORATION, WOODSIDE, CA, CROSSPOINT LEASING CORPORATION, LOS ALTOS, CA:
1,021,654. REN. 4-15-05. INT. CL. 36.
- CROSSROUTE SOFTWARE, INC., REDWOOD CITY, CA:
2,171,722. CANC. INT. CL. 42.
- CROSSTEX INTERNATIONAL, INC., HAUPPAUGE, NY, CROSS COUNTRY PAPER PRODUCTS, CORP., HAUPPAUGE, NY:
1,906,881. REN. 4-9-05. INT. CL. 10.
- CROTTY CORPORATION, QUINCY, MI:
772,763. CANC. U.S. CL. 23.
- CROWN FINANCIAL MINISTRIES, INC., GAINESVILLE, GA:
2,955,250. INT. CL. 9.
- CROWN LINEN SERVICE, INC., NASHUA, NH, CROWN SERVICE SYSTEMS, INC., WATERTOWN, MA:
1,883,950. REN. 4-13-05. INT. CL. 37.
- CRS HOLDINGS, INC., WILMINGTON, DE:
1,318,893. REN. 4-12-05. INT. CL. 6.
- CRUISE HOLIDAYS INTERNATIONAL, INC., SAN DIEGO, CA, DBA CRUISE HOLIDAYS:
1,843,223. CANC. INT. CL. 39.
- CRYSTAL CRUISES, INC., LOS ANGELES, CA:
2,955,841. INT. CL. 42.
- CSC INTELICOM, INC., BETHESDA, MD TO ITDS INTELICOM SERVICES, INC., STAMFORD, CT:
1,842,753. CANC. INT. CL. 9.
- CSM SUBHOLDING INC., PICO RIVERA, CA, WESTCO PRODUCTS, INC., PICO RIVERA, CA:
1,880,766. REN. 4-13-05. MULTIPLE CLASS, INT. CLS. 29 AND 30.
- CSRA AIR, INC., AIKEN, SC:
2,955,838. INT. CL. 35.
- CUBANACAN CIGARS, INC., MIAMI, FL:
2,171,360. CANC. INT. CL. 34.
- CULINAR INC., MONTREAL, QUEBEC, CANADA:
1,843,088. CANC. INT. CL. 30.
- CULINARY CROSSING, INC., HARLEYSVILLE, PA:
2,955,835. INT. CL. 29.
2,955,836. INT. CL. 30.
2,955,837. INT. CL. 29.
- CULTURE CLASH, LOS ANGELES, CA:
2,954,296. PUB. 3-1-2005. INT. CL. 41.
- CULTURE STRATEGIES, INC., HUNTINGTON STATION, NY:
2,171,391. CANC. INT. CL. 35.
- CUMBERLAND PACKING CORP., BROOKLYN, NY:
2,171,508. CANC. INT. CL. 32.
- CURRY, AUDREY, SANTA FE, NM, DBA BARE KISS LTD.:
2,955,704. INT. CL. 3.
- CURTICE-BURNS FOODS, INC., ROCHESTER, NY:
2,171,064. CANC. INT. CL. 30.
- CURTIS; EUGENE E., TOLEDO, OH, DBA CURTIS ENTERPRISES LIMITED:
1,284,660. CANC. INT. CL. 41.
- CURVES INTERNATIONAL, WACO, TX:
2,954,936. PUB. 3-1-2005. INT. CL. 16.
- CUSTOM BUILDING SYSTEMS, MUSKOGEE, OK:
2,170,877. CANC. INT. CL. 6.
- CUSTOM FABRICATORS, INC., WATERTOWN, SD:
2,954,273. PUB. 3-1-2005. MULTIPLE CLASS, INT. CLS. 37 AND 40.
- CUSTOM OUTDOOR PRODUCTS, INC., THOMASVILLE, GA:
2,171,373. CANC. INT. CL. 28.
- CYRLIN, ALAN, TARZANA, CA:
2,955,793. INT. CL. 42.
- CZINGULA, JOHN, DENVER, CO:
2,954,578. PUB. 3-1-2005. INT. CL. 29.
- D & N WOODWORKING, INC., HUDSON, FL:
2,171,301. CANC. INT. CL. 20.
- D. M. CAMP & SONS, BAKERSFIELD, CA:
772,922. CANC. U.S. CL. 46.
- D.O.G. DEUTSCHE OELFABRIK GESELLSCHAFT FUR CHEMISCHE ERZEUGNISSE MBH & CO. KG, D-2000 HAMBURG 11, FED REP GERMANY:
1,843,391. CANC. INT. CL. 1.
- D.R. HORTON MANAGEMENT COMPANY, LTD., ARLINGTON, TX:
2,954,395. PUB. 3-1-2005. INT. CL. 37.
- D.R.M. STAKOR AND ASSOCIATES, INC., ROCHESTER, MI:
2,171,066. CANC. INT. CL. 16.
- D'SAN CORPORATION, FLUSHING, NY:
2,170,704. CANC. INT. CL. 9.
- D'URBAN, INC., SHINAGAWA—KU, TOKYO, JAPAN, D'URBAN, INC., SHINAGAWA—KU, TOKYO, JAPAN:
1,328,620. REN. 4-13-05. INT. CL. 25.
- DAHL, ARLENE, SPARKILL, NY:
2,171,493. CANC. INT. CL. 3.
- DAILY JOURNAL CORPORATION, LOS ANGELES, CA:
2,171,069. CANC. INT. CL. 16.
- DAISY GROUP, LTD., WHITESTONE, NY:
1,284,415. CANC. INT. CL. 25.
- DAKOCYTOMATION DENMARK A/S, 2600 GLOSTRUP, DENMARK:
2,954,145. PUB. 3-1-2005. MULTIPLE CLASS, INT. CLS. 1, 5, 9, 10, 42 AND 44.
- DALCO INDUSTRIES, INC., BRIDGETON, MO:
2,170,643. CANC. INT. CL. 19.
- DALE OF NORWAY AS, NORWAY:
2,954,095. PUB. 3-1-2005. INT. CL. 23.
- DALE, THOMAS E., MINNEAPOLIS, MN:
1,843,725. CANC. INT. CL. 25.
- DALLAS SMITH CORPORATION, GREENCASTLE, IN, DBX ENGINEERING CORPORATION, INDIANAPOLIS, IN:
1,903,496. REN. 4-10-05. INT. CL. 12.
- DALLOYAU, PARIS, 75008, FRANCE:
2,954,933. PUB. 12-14-2004. MULTIPLE CLASS, INT. CLS. 29, 30 AND 43.
- DANA ALEXANDER, INC., MELVILLE, NY:
2,955,624. INT. CL. 29.
2,955,648. INT. CL. 29.
- DANIEL COHEN, ITHACA, NY:
2,954,938. PUB. 3-1-2005. INT. CL. 30.
- DANIEL INDUSTRIES, INC., HOUSTON, TX:
1,842,777. CANC. INT. CL. 9.
- DANIELAD S.R.L., 00044 FRASCATI (PROV. OF ROME), ITALY:
1,842,604. CANC. MULTIPLE CLASS, INT. CLS. 3, 14

- AND 25.
DANNY UDELL, INC., LOS ANGELES, CA:
1,843,770, CANC. INT. CL. 28.
DATA BROADCASTING CORPORATION, MIDVALE, UT:
2,170,680, CANC. INT. CL. 41.
DATA CONTROL CORPORATION, GRANITE BAY, CA:
2,955,039, PUB. 3-1-2005. MULTIPLE CLASS, INT. CLS.
35, 36, 37 AND 42.
DATA HO, INC., ALHAMBRA, CA:
2,170,787, CANC. INT. CL. 9.
DATAMATIC, INC., RICHARDSON, TX:
2,170,637, CANC. INT. CL. 9.
DAVEWORLD INC., FAIRFAX, AK:
2,955,104, PUB. 3-1-2005. INT. CL. 3.
DAVID & GOLIATH, INC., CLEARWATER, FL:
2,956,119, INT. CL. 28.
DAVID HALSALL (HK) LIMITED, KOWLOON, HONG
KONG, LAWRENCE WILSON & SON, LIMITED, GUISE-
LEY, LEEDS, WEST YORKSHIRE, ENGLAND:
1,291,300, REN. 4-13-05. INT. CL. 28.
DAVID J. DIVOZZO, WESTLAND, MI:
1,283,954, CANC. INT. CL. 1.
DAVID KESSLER & ASSOCIATES, INC., DEERFIELD, IL:
2,171,704, CANC. INT. CL. 35.
DAVIS, RUSSELL P., PORTLAND, OR:
1,440,737, CANC. INT. CL. 28.
DAVIS, SHEANA JUSTINE, SONOMA, CA:
2,955,495, INT. CL. 35.
DAVIS, WAYNE, KENT, WA:
1,843,019, CANC. INT. CL. 25.
DAVISON OIL COMPANY, INC., MOBILE, AL:
2,954,526, PUB. 3-1-2005. MULTIPLE CLASS, INT. CLS. 1
AND 4.
DAY, JAMES EDWARD, BAY VILLAGE, OH:
1,893,115, REN. 4-13-05. INT. CL. 16.
DAYTON SUPERIOR SPECIALTY CHEMICAL CORP.,
DAYTON, OH:
2,956,123, INT. CL. 19.
DB-TECH, INC., SOUTH BRUNSWICK, NJ:
2,188,744, CANC. INT. CL. 9.
DC WEB WOMEN, WASHINGTON, DC:
2,955,106, PUB. 3-1-2005. MULTIPLE CLASS, INT. CLS. 35
AND 41.
DDB NEEDHAM CHICAGO INC., CHICAGO, IL:
2,171,285, CANC. INT. CL. 25.
DE RIGO S.P.A. LONGARONE (BL), ITALY:
2,141,822, CANC. MULTIPLE CLASS, INT. CLS. 16 AND
18.
DECKER CAR WASH, INC., NORTH CHARLESTON, SC:
2,171,643, CANC. INT. CL. 37.
DEE CEE LABORATORIES, INC., WHITE HOUSE, TN:
2,954,414, PUB. 3-1-2005. INT. CL. 35.
DEER, RICHARD A., INDIANAPOLIS, IN:
2,171,715, CANC. INT. CL. 34.
DEFENDERS OF WILDLIFE, WASHINGTON, DC, DC:
2,955,276, MULTIPLE CLASS, INT. CLS. 30, 35 AND 36.
DEFENSE DISCOVERY COMPANY, COLUMBUS, GA:
1,284,771, CANC. INT. CL. 42.
DEFOYD, MARK L., SANTA CLARA, CA:
2,171,735, CANC. INT. CL. 9.
DEJA VU CONSULTING, INC., LANSING, MI:
2,954,553, PUB. 3-1-2005. INT. CL. 41.
DEL LABORATORIES, INC., UNIONDALE, NY:
2,954,913, PUB. 10-19-2004. INT. CL. 5.
DEL MONTE CORPORATION, PITTSBURGH, PA FROM
PROMARK INTERNATIONAL, INC., BOISE, ID:
2,955,512, INT. CL. 31.
DELAWARE CAPITAL FORMATION, INC., WILMINGTON,
DE, O.K. MACHINE AND TOOL CORPORATION,
BRONX, NY:
991,307, REN. 4-13-05. U.S. CL. 23 (INT. CL. 8).
DELICIAS FOODS LTD., CHICAGO, IL:
2,170,861, CANC. INT. CL. 30.
DELIVERY TECHNOLOGIES, LLC, NORTH HAVEN, CT:
2,955,367, INT. CL. 9.
DELL COMPUTER CORPORATION, AUSTIN, TX:
1,843,281, CANC. INT. CL. 42.
DELMARVA PAINTBALL, SALISBURY, MD:
2,955,137, PUB. 3-1-2005. INT. CL. 41.
DELTA ENTERTAINMENT CORPORATION, LOS AN-
GELES, CA:
2,955,377, INT. CL. 9.
DEMCO, INC., MADISON, WI:
2,171,040, CANC. INT. CL. 35.
DENGIE CROPS LIMITED, ASHELDHAM, SOUTHMIN-
STER, ESSEX CM0 7JF, ENGLAND:
1,825,346, REN. 4-15-05. INT. CL. 31.
DENTACLEAN, LLC, PALISADES PARK, NJ:
2,955,309, INT. CL. 31.
DENTAL DISPOSABLES INTERNATIONAL, INC., MARL-
BORO, NJ:
2,954,502, PUB. 3-1-2005. INT. CL. 10.
DENTSPLY RESEARCH & DEVELOPMENT CORP., MIL-
FORD, DE:
1,284,185, CANC. INT. CL. 10.
DEPARTMENT OF VETERANS AFFAIRS, WASHINGTON,
DC:
2,954,953, PUB. 3-1-2005. INT. CL. 41.
DEREK WEAVER COMPANY, INC., FORT WORTH, TX:
1,842,694, CANC. INT. CL. 7.
DEROSIER, MELISSA, CARY, NC:
2,954,580, PUB. 3-1-2005. MULTIPLE CLASS, INT. CLS. 9,
16 AND 45.
DESA IP, LLC, MIAMI, FL:
2,954,449, PUB. 3-1-2005. INT. CL. 11.
DESIGNS, INC., NEEDHAM, MA:
2,171,790, CANC. INT. CL. 25.
DESLOGES, ROGER, TORONTO, ONTARIO M4Y 2C7,
CANADA, TA CORPORATE INVESTOR RELATIONS:
2,170,649, CANC. INT. CL. 35.
DESTINATION IMAGINATION, INC., GLASSBORO, NJ:
2,955,629, MULTIPLE CLASS, INT. CLS. 9, 14, 16, 18, 20,
24, 25 AND 41.
DESTINY BAY VINEYARDS LIMITED, AUCKLAND, NEW
ZEALAND:
2,954,621, PUB. 3-1-2005. INT. CL. 33.
DETROIT NEWSPAPER AGENCY, DETROIT, MI:
2,954,581, PUB. 3-1-2005. INT. CL. 35.
2,954,582, PUB. 3-1-2005. INT. CL. 35.
DETROIT PISTONS BASKETBALL COMPANY, AUBURN
HILLS, MI:
2,171,585, CANC. INT. CL. 25.
DETTMAN GROUP, LLC, THE, MISSION VIEJO, CA:
2,955,372, INT. CL. 41.
DEUTREL INDUSTRIES, INC., LANCASTER, CA:
2,955,581, INT. CL. 1.
DEUTSCH, STEFAN, FARMINGDALE, NY:
2,955,526, INT. CL. 41.
DEUTSCHE TELEKOM AG, 53113 BONN, FED REP GER-
MANY:
2,954,025, PUB. 9-21-2004. MULTIPLE CLASS, INT. CLS.
9, 16, 35, 38 AND 42.
2,954,037, PUB. 9-14-2004. MULTIPLE CLASS, INT. CLS.
9, 14, 16, 18, 25, 28, 35, 36, 37, 38, 39, 41 AND 42.
DEVELOPING RESOURCES FOR EDUCATION IN AMER-
ICA, INC., JACKSON, MS:
1,842,908, CANC. INT. CL. 16.
DEVICEIQ, INC., NEW YORK, NY:
2,954,496, PUB. 3-1-2005. INT. CL. 42.
DEWITT STERN GROUP, INC., NEW YORK, NY:
2,954,987, PUB. 3-1-2005. INT. CL. 36.
DFA CAPITAL MANAGEMENT, INC., PURCHASE, NY:
2,955,507, INT. CL. 9.
DGA SECURITY SYSTEMS, INC., NEW YORK, NY:
2,956,315, INT. CL. 37.
DHARMA LEATHER CORP., MIAMI, FL:
2,954,584, PUB. 3-1-2005. INT. CL. 25.
DIAGEO NORTH AMERICA, INC., NORWALK, CT:
2,955,047, PUB. 3-1-2005. INT. CL. 33.
DIAGNOSTICA STAGO, 92600 ASNIERES (HAUTS-DE-
SEINE), FRANCE:
1,283,919, CANC. INT. CL. 1.
DIAGNOSTICA STAGO, ASNIERES (HAUT-DE-SEINE),
FRANCE:
1,283,921, CANC. INT. CL. 1.

- DIAL BRANDS, INC., SCOTTSDALE, AZ, DIAL CORP., THE, PHOENIX, AZ:
1,885,524, REN. 4-13-05. INT. CL. 5.
- DIALPAD COMMUNICATIONS, INC., MILPITAS, CA:
2,956,078, INT. CL. 38.
- DIAMANTE, ALEX, BRONX, NY:
2,954,741, PUB. 3-1-2005. INT. CL. 25.
- DICKEY-JOHN CORPORATION, AUBURN, IL:
1,284,153, CANC. INT. CL. 9.
- DICKINSON, RUDY G., SANTA FE SPRINGS, CA:
1,907,259, REN. 4-15-05. INT. CL. 12.
- DIDDE CORPORATION, OVERLAND PARK, KS:
2,171,839, CANC. INT. CL. 7.
- DIE BERGKELDER BEPERK, STELLENBOSCH, SOUTH AFRICA, DIE BERGKELDER (EIENDOMS) BERPERK, STELLENBOSCH, CAPE PROVINCE, SOUTH AFRICA:
1,021,648, REN. 4-15-05. INT. CL. 33.
- DIETERLE, NANETTE, OXFORD, CT:
2,955,019, PUB. 3-1-2005. INT. CL. 41.
- DIFRANCESCO, JOSEPH, LONGWOOD, FL AND DIFRANCESCO, BERNADETTE, LONGWOOD, FL:
2,954,551, PUB. 3-1-2005. MULTIPLE CLASS, INT. CLS. 28 AND 41.
- DIGITIMES PUBLICATION INC., TAIPEI 114, TAIWAN:
2,954,557, PUB. 3-1-2005. INT. CL. 41.
- DIMILLE'S, INC., SAN DIEGO, CA:
2,954,639, PUB. 9-28-2004. INT. CL. 43.
- DINNER INTRODUCTIONS LLC, NEW YORK, NY:
2,956,211, INT. CL. 45.
- DIRECT COMMUNICATIONS, INCORPORATED, DES MOINES, IA:
1,284,302, CANC. INT. CL. 16.
- DIRECT SOURCE SPECIAL PRODUCTS INC., LASALLE, QUEBEC, CANADA:
2,956,080, INT. CL. 9.
- DISCOVERY COLLEGIATE ADVISORS, INC., TOMS RIVER, NJ:
2,954,585, PUB. 3-1-2005. INT. CL. 36.
- DISICK, JEFFREY, NEW YORK, NY:
2,170,902, CANC. INT. CL. 25.
- DISNEY ENTERPRISES, INC., BURBANK, CA:
2,171,496, CANC. INT. CL. 21.
- DISTRIBUTION ARCHITECTS INTERNATIONAL, INC., TEMPE, AZ:
2,171,234, CANC. INT. CL. 9.
- DIVALICIOUS, INC., LOS ANGELES, CA:
2,955,247, INT. CL. 25.
- DIVERSEY WYANDOTTE CORPORATION, WYANDOTTE, MI:
772,581, CANC. U.S. CL. 4.
772,592, CANC. U.S. CL. 6.
772,946, CANC. U.S. CL. 52.
1,284,043, CANC. INT. CL. 5.
- DIVERSIFIED DYNAMICS CORPORATION, MINNEAPOLIS, MN:
2,955,569, INT. CL. 8.
- DIVERSIFIED SYSTEMS RESOURCES, LTD., BARTLESVILLE, OK:
1,842,820, CANC. MULTIPLE CLASS, INT. CLS. 9 AND 42.
- DIVIDELLA AG, 9472 GRABS, SWITZERLAND:
2,955,429, INT. CL. 16.
- DIVISION OF CHRISTIAN EDUCATION OF THE NATIONAL COUNCIL OF THE CHURCHES OF CHRIST IN THE UNITED STATES OF AMERICA, NEW YORK, NY:
1,842,909, CANC. INT. CL. 16.
- DMX WORKS, INC., PALM HARBOR, FL:
2,955,896, INT. CL. 44.
- DOALL COMPANY, DES PLAINES, IL:
2,955,089, PUB. 3-1-2005. INT. CL. 4.
- DOBBS HOUSES, INC., MEMPHIS, TN:
771,618, CANC. U.S. CL. 100.
- DOGSTAR RECORDS, INC., BETHESDA, MD:
2,955,258, INT. CL. 9.
- DOLL ACQUISITION CORP., DENVER, CO, DBA, MY TWINN, MY TWINN, AGOURA, CA:
1,897,057, REN. 4-12-05. INT. CL. 28.
- DOLLAR TREE STORES, INC., CHESAPEAKE, VA:
2,954,482, PUB. 3-1-2005. MULTIPLE CLASS, INT. CLS. 8, 21 AND 24.
- DONGAH ALUMINUM CORPORATION, INCHON, REPUBLIC OF KOREA:
2,954,928, PUB. 3-1-2005. INT. CL. 9.
- DORINT HOLDING S.A., 1855 LUXEMBOURG-KIRCHBERG, LUXEMBOURG:
2,954,090, PUB. 11-19-2002. INT. CL. 3.
- DOTS, LLC, SOLON, OH:
2,955,189, INT. CL. 25.
- DOW CHEMICAL COMPANY, THE, MIDLAND, MI:
1,843,646, CANC. INT. CL. 17.
- DOW CORNING CORPORATION, MIDLAND, MI:
772,896, CANC. U.S. CL. 44.
772,897, CANC. U.S. CL. 44.
- DOWBRANDS, INC., INDIANAPOLIS, IN:
1,283,972, CANC. INT. CL. 3.
1,284,004, CANC. INT. CL. 3.
- DOWTY, MICHAEL SCOTT, TORONTO, ONTARIO M5V 3N5, CANADA:
2,954,122, PUB. 8-10-2004. INT. CL. 3.
- DR PEPPER/SEVEN UP, INC., PLANO, TX:
2,954,633, PUB. 2-10-2004. INT. CL. 32.
- DR. GREEN LAWNS, WATERBURY, CT:
2,171,164, CANC. INT. CL. 42.
- DR. JOHANNES RIEGL RADARTECHNIK & ELEKTROOPTIK GMBH, A-3580 HORN, AUSTRIA:
2,255,118, COR. INT. CL. 9.
- DR.-ING. MANFRID DREHER GMBH & CO. KG, ENGELSBRAND 1, FED REP GERMANY:
1,283,938, CANC. MULTIPLE CLASS, INT. CLS. 1, 3 AND 7.
- DRAGON OPTICAL, INC., CARLSBAD, CA:
1,917,738, REN. 4-13-05. INT. CL. 9.
- DRAGSTER S.R.L., 20145 MILANO, ITALY:
2,954,112, PUB. 12-30-2003. INT. CL. 9.
- DREAM HEALTH L.L.C., OLYMPIA, WA:
2,954,934, PUB. 3-1-2005. MULTIPLE CLASS, INT. CLS. 5 AND 35.
- DREAMWELL, LTD., LAS VEGAS, NV:
2,955,318, INT. CL. 20.
- DRESSER INDUSTRIES, INC., DALLAS, TX:
186,307, CANC. U.S. CL. 19.
- DREXEL HERITAGE FURNISHINGS INC., DREXEL, NC:
1,284,363, CANC. INT. CL. 20.
- DRIVER, ANNIE, HOUSTON, TX:
2,955,357, INT. CL. 9.
- DRY CLEANING STATION, INC., GOLDEN VALLEY, MN:
1,903,985, REN. 4-13-05. INT. CL. 37.
- DSI TOYS, INC., HOUSTON, TX:
2,171,960, CANC. INT. CL. 28.
- DTX INC., MASON, MI:
1,284,634, CANC. INT. CL. 39.
- DUALIT LIMITED, LONDON SE15 ITU, ENGLAND:
2,170,876, CANC. INT. CL. 11.
- DUCK CREEK RESOURCES, INC., CLEVELAND, OH:
2,954,467, PUB. 3-1-2005. INT. CL. 1.
- DUMANEE, LLC, AUGUSTA, GA:
2,954,519, PUB. 3-1-2005. INT. CL. 35.
- DUNLOP SLAZENGER CORPORATION, GREENVILLE, SC TO DUNLOP MAXFIL SPORTS CORPORATION, GREENVILLE, SC:
1,843,061, CANC. INT. CL. 28.
- DUNLOP SLAZENGER CORPORATION, GREENVILLE, SC TO DUNLOP MAXFLI SPORTS CORPORATION, GREENVILLE, SC:
1,843,761, CANC. INT. CL. 28.
- DUPONT NUTRITION, INC., LOUISVILLE, KY, AKA DOWN TO EARTH NUTRITION:
1,284,698, CANC. INT. CL. 42.
- DUQUESNE UNIVERSITY OF THE HOLY GHOST, PITTSBURGH, PA:
2,955,778, INT. CL. 41.
- DURA-LOC ROOFING SYSTEMS LIMITED, COURTLAND, NOJ 1E0, 01 ONTARIO, CANADA:
2,954,902, PUB. 3-1-2005. INT. CL. 2.

DURASAMY, PERUNDURAI CHENNIMALAI GOUNDER, ERODE - 638 004, INDIA, DBA SAKTHI TRADING COMPANY:
2,955,398, INT. CL. 29.
2,955,399, INT. CL. 30.

DURLING, C. CORRELL, WHITEHOUSE, NJ:
2,171,964, CANC. INT. CL. 29.

DURVET, INC., BLUE SPRINGS, MO:
1,284,013, CANC. INT. CL. 5.

DUSA PHARMACEUTICALS, INC., WILMINGTON, MA,
DUSA PHARMACEUTICALS, INC., WILMINGTON, MA:
1,882,782, REN. 4-15-05, INT. CL. 5.

DYNAMIC COOKING SYSTEMS, INC., HUNTINGTON BEACH, CA:
2,954,887, PUB. 3-1-2005, INT. CL. 11.

DYNAMIC MANAGEMENT COMPANY, LLC, MADISON, TN:
2,956,222, INT. CL. 43.

DYSTAR TEXTILFARBEN GMBH & CO DEUTSCHLAND KG, D-60318 FRANKFURT AM MAIN, FED REP GERMANY:
1,881,083, REN. 4-13-05, INT. CL. 2.

DYSTAR TEXTILFARBEN GMBH & CO. DEUTSCHLAND KG, FRANKFURT AM MAIN, FED REP GERMANY:
2,955,566, INT. CL. 9.

E. & J. GALLO WINERY, MODESTO, CA, DBA PETER VELLA WINES:
1,888,777, REN. 4-12-05, INT. CL. 33.

E. I. DU PONT DE NEMOURS AND COMPANY, WILMINGTON, DE:
1,843,932, CANC. U.S. CL. A.

E.D. BULLARD COMPANY, LOUISVILLE, KY:
1,881,187, REN. 4-13-05, INT. CL. 9.

E.J. BOGNAR, INC., PITTSBURGH, PA, INTERNATIONAL MINERALS & CHEMICAL CORPORATION, CHICAGO, IL:
605,321, REN. 4-13-05, U.S. CL. 12 (INT. CL. 19).

E'OLA INTERNATIONAL, ST. GEORGE, UT:
2,334,319, CANC. INT. CL. 5.

EADS DEUTSCHLAND GMBH, OTTOBRUNN, FED REP GERMANY:
2,954,029, PUB. 3-1-2005, MULTIPLE CLASS, INT. CLS. 9, 13, 37 AND 42.

EAGLE SPRING FILTRATION, INC., HOLLY HILL, FL:
1,842,847, CANC. INT. CL. 11.
1,842,848, CANC. INT. CL. 11.

EARLY WARNING HEALTHCARE, PLLC, BLOOMFIELD HILLS, MI:
2,955,553, INT. CL. 44.

EARVIN JOHNSON, JR. AND LON ROSEN, BOTH U.S. CITIZENS, AS TRUSTEES OF JUNE BUG LIFETIME TRUST, BEVERLY HILLS, CA:
1,953,691, REN. 4-13-05, INT. CL. 41.

EAST BAY IMPORT CO., ASHLAND, OH:
2,956,021, MULTIPLE CLASS, INT. CLS. 8 AND 21.

EASTERDAY SUPPLY COMPANY OF CALIFORNIA, SAN FRANCISCO, CA:
772,944, CANC. U.S. CL. 52.

EASTERN AIR LINES, INC., NEW YORK, NY:
1,284,600, CANC. INT. CL. 36.

EASTERN GROUP, INC., THE, ALEXANDRIA, VA:
2,171,143, CANC. INT. CL. 39.

EASYFINE ASIA, LTD., PHILADELPHIA, PA, GOOD LAD CO., PHILADELPHIA, PA:
1,883,009, REN. 4-13-05, INT. CL. 25.

EASYGROUP IP LICENSING LIMITED, LONDON, ENGLAND:
2,954,691, PUB. 10-26-2004, MULTIPLE CLASS, INT. CLS. 9, 37, 38 AND 42.

EATON, RANDI C., LEWISVILLE, NC AND HUNT, LINDA J., WINSTON-SALEM, NC:
2,956,173, INT. CL. 44.

EBCO MANUFACTURING COMPANY, COLUMBUS, OH TO OASIS CORPORATION, COLUMBUS, OH:
1,842,846, CANC. INT. CL. 11.

EBERLE DESIGN, INC., PHOENIX, AZ:
2,956,339, INT. CL. 9.

EBI, L.P., PARSIPPANY, NJ:
2,955,049, PUB. 3-1-2005, INT. CL. 10.

EBSCO INDUSTRIES INC., BIRMINGHAM, AL:
2,955,067, PUB. 3-1-2005, INT. CL. 28.

EBSCO INDUSTRIES, INC., BIRMINGHAM, AL, ARBOGAST, FRED, AKRON, OH:
414,660, REN. 4-15-05, U.S. CL. 22 (INT. CL. 28).

EBSCO INDUSTRIES, INC., BIRMINGHAM, AL, CORDELL TACKLE, INC., HOT SPRINGS, AR:
1,014,777, REN. 4-15-05, INT. CL. 28.

EBSCO INDUSTRIES, INC., BIRMINGHAM, AL:
1,324,830, REN. 4-15-05, INT. CL. 28.
1,349,683, REN. 4-13-05, INT. CL. 28.

EC RESEARCH CORP., CHADDS FORD, PA:
2,954,921, PUB. 10-19-2004, INT. CL. 3.

ECC INTERNATIONAL INC., ROSWELL, GA:
2,171,345, CANC. MULTIPLE CLASS, INT. CLS. 1 AND 2.

ECHELON MINISTRIES, ROBBINSDALE, MN:
2,170,932, CANC. INT. CL. 9.

ECKEL MANUFACTURING CO., INC., ODESSA, TX:
2,954,593, PUB. 3-1-2005, INT. CL. 7.

ECOLAB INC., ST. PAUL, MN:
1,284,041, CANC. INT. CL. 5.
2,170,770, CANC. INT. CL. 3.

ECOMPEX, INC., MCLEAN, VA:
2,954,969, PUB. 3-1-2005, INT. CL. 35.

ECONOMY CONTROLS CORPORATION, ST. LOUIS, MO:
1,284,124, CANC. INT. CL. 9.

ECOPHON AB, 260 61 HYLLINGE, SWEDEN:
2,171,517, CANC. MULTIPLE CLASS, INT. CLS. 6, 17 AND 19.

ECREDITGROUP.COM, INC., SANTA BARBARA, CA:
2,955,970, INT. CL. 36.

ECS HOLDINGS, INC., WILMINGTON, DE:
2,170,723, CANC. MULTIPLE CLASS, INT. CLS. 35, 36 AND 41.

EDB MAXWARE AS, TRONDHEIM, NORWAY:
1,842,750, CANC. INT. CL. 9.

EDDIE HAGGAR LIMITED, INC., DALLAS, TX TO NYGARD, INC., GARDENA, CA:
1,843,026, CANC. INT. CL. 25.

EDDIE JACOBS, LTD., BALTIMORE, MD:
772,806, CANC. U.S. CL. 28.
772,882, CANC. U.S. CL. 40.
772,884, CANC. U.S. CL. 42.

EDGE COMPANY, INC., INDIANAPOLIS, IN:
2,171,693, CANC. INT. CL. 35.

EDITIONS PROSVETA, FRANCE, PROSVETA-SOCIETE D'EDITION ET DE DIFFUSION DE L'ENSEIGNEMENT DE LA FRATERNITE BLANCHE UNIVERSELLE, FREJUS (VAR), FRANCE, DBA EDITIONS PROSVETA:
1,322,072, REN. 4-12-05, INT. CL. 16.

EDITORIAL PRENSA IBERICA, S.A., BARCELONA, SPAIN:
2,955,135, PUB. 3-1-2005, INT. CL. 41.

EDUCATION AMERICA, INC., LITTLE ROCK, AR:
2,955,583, INT. CL. 41.

EDUCATION MANAGEMENT CORPORATION, PITTSBURGH, PA:
2,955,815, INT. CL. 41.

EDUCATIONAL INSIGHTS, INC., CARSON, CA:
2,171,611, CANC. INT. CL. 9.

EDUFUND INTERNATIONAL, INC., NEW YORK, NY:
2,955,926, INT. CL. 36.

EFCO CORPORATION, MONETT, MO:
1,345,569, REN. 4-12-05, INT. CL. 6.

EFFICIENT LABORATORIES, INC., SAN JUAN, PUERTO RICO:
1,698,718, REN. 4-13-05, INT. CL. 5.

EHEALTHCARE SYSTEMS, INC., TORRANCE, CA:
2,955,549, INT. CL. 9.

EHOB, INC., INDIANAPOLIS, IN:
2,170,985, CANC. INT. CL. 10.

EHRREICH, GEORGE B., HUNTINGTON BEACH, CA:
2,955,794, INT. CL. 9.

EIKOH, INC., SAN FRANCISCO, CA:
2,171,082, CANC. INT. CL. 32.

EIKOS INC., FRANKLIN, MA:
2,954,409, PUB. 3-1-2005, MULTIPLE CLASS, INT. CLS. 1

- AND 2.
 EKKOSOFT CORPORATION, NEWBURYPORT, MA:
 2,956,203, MULTIPLE CLASS, INT. CLS. 9 AND 35.
- EL MESON DE FELIPE INC., MAYAGUEZ, PUERTO RICO:
 2,955,068, PUB. 3-1-2005. INT. CL. 43.
- EL PASO ENERGY CORPORATION, EL PASO, TX:
 2,171,762, CANC. INT. CL. 40.
 2,171,766, CANC. INT. CL. 35.
 2,171,842, CANC. INT. CL. 40.
 2,171,845, CANC. INT. CL. 35.
- ELECTROLUX HOME CARE PRODUCTS LTD., CLEVELAND, OH:
 2,955,448, INT. CL. 7.
- ELECTROMAGNETIC RESOURCES CORPORATION, HOUSTON, TX:
 2,955,285, INT. CL. 10.
- ELECTRONIC CONTROLS COMPANY, BOISE, ID:
 1,301,314, REN. 4-13-05. INT. CL. 9.
- ELECTRONIC SENSOR TECHNOLOGY LP, NEWBURY PARK, CA:
 2,954,997, PUB. 3-1-2005. INT. CL. 16.
- ELEGANT FOOTWEAR, INC., CITY OF INDUSTRY, CA:
 2,956,141, INT. CL. 25.
- ELEPHANT & CASTLE GROUP, INC., VANCOUVER, BRITISH COLUMBIA, CANADA:
 2,955,122, PUB. 3-1-2005. INT. CL. 43.
- ELKEM METALS COMPANY, NIAGARA FALLS, NY:
 1,283,927, CANC. INT. CL. 1.
- ELLSWORTH SYSTEMS, LLC, FRANKLIN, TN:
 2,954,401, PUB. 3-1-2005. INT. CL. 9.
- ELVIS PRESLEY ENTERPRISES, INC., MEMPHIS, TN:
 2,955,078, PUB. 3-1-2005. INT. CL. 26.
- EMEDICALFILES, INC., ATLANTA, GA:
 2,955,910, INT. CL. 42.
- EMMETROPIA, INC., PRINCETON, WV:
 1,882,896, REN. 4-14-05. INT. CL. 10.
- EMPACADORA SAN MARCOS, S.A. DE C.V., NOPALUCAN-PUEBLA, MEXICO:
 1,949,301, REN. 4-15-05. INT. CL. 29.
- EMPEX PRODUCTIONS LIMITED, UXBRIDGE, ONTARIO, CANADA:
 2,954,091, PUB. 6-15-2004. MULTIPLE CLASS, INT. CLS. 11 AND 28.
- EMPI, INC., ANAHEIM, CA, ROSEVEAR ENTERPRISES, INC., BUENA PARK, CA, DBA RACE-TRIM PRODUCTS:
 1,019,916, REN. 4-15-05. INT. CL. 12.
- EMPIRE BEAUTY SCHOOL, INC., POTTSVILLE, PA:
 2,955,118, PUB. 3-1-2005. INT. CL. 41.
- EMPIRE GLASS COMPANIES, INC., PHOENIX, AZ:
 2,954,624, PUB. 3-1-2005. INT. CL. 37.
- EMPIRE TRANSPORT SERVICE, INC., WESTWOOD, NJ:
 1,284,635, CANC. INT. CL. 39.
- EMPLOYEE BENEFIT RESEARCH INSTITUTE, WASHINGTON, DC:
 2,956,124, INT. CL. 36.
- ENDORPHIN WARRIORS, LAGUNA NIGUEL, CA:
 1,855,271, REN. 4-12-05. INT. CL. 25.
- ENERGEX, INC., WEST LEBANON, NH:
 2,171,974, CANC. INT. CL. 11.
- ENERGY CRANES LLC, HOUSTON, TX:
 2,954,753, PUB. 3-1-2005. INT. CL. 9.
 2,954,754, PUB. 3-1-2005. INT. CL. 37.
 2,954,755, PUB. 3-1-2005. INT. CL. 7.
 2,954,756, PUB. 3-1-2005. INT. CL. 7.
 2,954,757, PUB. 3-1-2005. INT. CL. 7.
- ENSERCO ENERGY INC., LAKEWOOD, CO:
 2,170,973, CANC. INT. CL. 39.
- ENTERTAINMENT & SPORTS INTERNATIONAL INC., DURHAM, NC:
 2,956,136, INT. CL. 41.
- ENTERTAINMENT PUBLICATIONS, INC., TROY, MI:
 2,300,922, CANC. INT. CL. 35.
- ENVIRONMENTAL LIGHTING CONCEPTS, INC., TAMPA, FL:
 2,954,135, PUB. 3-1-2005. INT. CL. 11.
- ENXNET, INC., TULSA, OK:
 2,954,529, PUB. 3-1-2005. INT. CL. 40.
- EPHESIANS 4 NETWORK, INC., BELPRE, OH:
 2,954,473, PUB. 3-1-2005. INT. CL. 41.
- EPHESIANS 4:12 MINISTRIES, INC., HIGHLAND VILLAGE, TX:
 2,188,794, CANC. INT. CL. 9.
- EPLEY MARKETING SERVICES, INC., NORTH LIBERTY, IA:
 2,956,142, INT. CL. 35.
- EPOCH CORPORATION, THE, MIAMI, FL:
 2,954,295, PUB. 3-1-2005. INT. CL. 37.
- ERGO CREATIVE, INC., AURORA, IL:
 2,955,381, INT. CL. 9.
- ERIN H. WEIK, LANCASTER, VA:
 2,955,034, PUB. 3-1-2005. INT. CL. 14.
- ERMENEGILDO ZEGNA CORPORATION, ENGLEWOOD, NJ:
 2,911,332, COR. INT. CL. 9.
- ERNEST JACKSON & CO. LIMITED, CREDITON, DEVON, ENGLAND:
 1,843,435, CANC. INT. CL. 5.
- ESCHENBACH OPTIK GMBH + CO., W-8500 NURNBERG 10, FED REP GERMANY:
 1,879,573, REN. 4-13-05. INT. CL. 9.
- ESI CASES & ACCESSORIES, INC., BROOKLYN, NY:
 2,955,925, INT. CL. 9.
- ESQUIBEL COMMUNICATIONS COMPANY, CORAL GABLES, FL:
 2,955,803, INT. CL. 16.
- ESSILOR OF AMERICA, INC., ST. PETERSBURG, FL:
 2,171,088, CANC. INT. CL. 9.
- ETABLISSEMENTS JOSE ALVAREZ S.A., 32020 AUCH, FRANCE:
 2,954,620, PUB. 8-10-2004. MULTIPLE CLASS, INT. CLS. 12, 25 AND 28.
- ETHOS INTERNATIONAL, NEW YORK, NY:
 2,955,625, INT. CL. 32.
- ETRAUMA.COM CORP., DEERFIELD BEACH, FL:
 2,955,297, INT. CL. 35.
- EURO ISEKI LIMITED, WARWICKSHIRE CV37 9LQ, ENGLAND:
 2,171,001, CANC. INT. CL. 7.
- EURO-CAN MANUFACTURING INC., NEW HAMBURG, ONTARIO N3E 2K5, CANADA:
 2,954,206, PUB. 7-27-2004. INT. CL. 31.
- EURO-CAN PRODUCTS, INC., GRENLOCH, NJ TO SPECIALTY BRANDS OF AMERICA, INC., NEW CANAAN, CT:
 1,843,100, CANC. INT. CL. 30.
- EURO-PRO CORPORATION, QUEBEC, CANADA:
 2,896,338, COR. INT. CL. 7.
- EURONET SERVICES INC.:
See—EURONET WORLDWIDE, INC.
- EURONET WORLDWIDE, INC., LEAWOOD, KS FROM EURONET SERVICES INC., LEAWOOD, KS:
 2,954,046, PUB. 12-2-2003. MULTIPLE CLASS, INT. CLS. 9, 36 AND 38.
- EUROPA COMMUNICATIONS, INC., PORTLAND, OR:
 2,170,802, CANC. MULTIPLE CLASS, INT. CLS. 35, 38 AND 42.
- EUROPEAN VILLAGE, LLC., PALM COAST, FL:
 2,955,853, INT. CL. 36.
- EUROSTOVES, INC., WESTLAKE VILLAGE, CA:
 2,956,154, INT. CL. 11.
 2,956,155, INT. CL. 11.
- EUTECTIC CORPORATION, FLUSHING, NY:
 1,284,167, CANC. INT. CL. 9.
- EVANS, STEVEN W., ORLANDO, FL:
 2,955,066, PUB. 3-1-2005. INT. CL. 39.
- EVEREST & JENNINGS, INC., CAMARILLO, CA:
 1,284,212, CANC. INT. CL. 12.
- EVERSPRING PRODUCTIONS, LLC, CITY OF INDUSTRY, CA:
 2,955,296, INT. CL. 9.
- EXCLUSIVE DOOR HANDLES, INC., DALLAS, TX:
 2,954,442, PUB. 3-1-2005. INT. CL. 6.
- EXECUTOR OF THE FORREST R. DRUDGE ESTATE:
 1,284,214, CANC. INT. CL. 12.
- EXO INC., QUEBEC, CANADA:
 2,954,790, PUB. 3-1-2005. INT. CL. 18.

EXPERIENCE EDUCATION, OMAHA, NE:
1,843,231, CANC. INT. CL. 41.

EXPRESS MORTGAGE BANKERS, INC., ANNANDALE, VA:
2,171,460, CANC. INT. CL. 36.

EXTREME AUTO & TRUCK INC, POMPANO BEACH, FL:
2,954,468, PUB. 3-1-2005. INT. CL. 35.

EZ PUBLISHING, INC., DAVIS, CA:
2,954,962, PUB. 3-1-2005. INT. CL. 42.
2,956,274, MULTIPLE CLASS, INT. CLS. 9, 35 AND 38.

EZM, INC., NORWALK, CT:
2,955,659, INT. CL. 18.

E4L, INC., ENCINO, CA:
2,399,180, CANC. INT. CL. 35.

F.D.R. TACO VIVA, INC., FT. LAUDERDALE, FL:
1,284,787, CANC. INT. CL. 42.

F.N.B. CORPORATION, HERMITAGE, PA:
2,954,012, PUB. 6-8-2004. INT. CL. 36.

F&C MANAGEMENT LIMITED, LONDON, EC2A 2NY, UNITED KINGDOM:
2,954,182, PUB. 7-20-2004. INT. CL. 36.

FABASOFT AG, 4040 PUCHNAU, AUSTRIA:
2,868,064, AM. MULTIPLE CLASS, INT. CLS. 9, 37, 41 AND 42.

FABRICA DE TABACOS LA CUMANESA, JUAN FRANCISCO CABRERA E HIJO, SUCESOR, C.A., CUMANA, ESTADO SUCRE, VENEZUELA TO FABRICA DE TABACOS LA CUMANESA, JUAN FRANCISCO CABRERA E HIJO, SUCESOR, C.A., CUMANA, ESTADO SUCRE, VENEZUELA:
2,171,708, CANC. INT. CL. 34.

FAIRTRON CORPORATION, DES MOINES, IA TO DAKTRONICS, INC., BROOKINGS, SD:
1,843,552, CANC. INT. CL. 9.

FAITHFUL FRIENDS HOMEOPATHIC COMPANY, BRYN MAWR, PA:
2,955,200, INT. CL. 3.

FALCON SYSTEMS, INC., PROSPECT HEIGHTS, IL:
1,953,888, CANC. INT. CL. 9.

FAMILY LIFE COMPANY, L.P., NEW YORK, NY TO PARENTING GROUP, INC., INC, NEW YORK, NY:
1,843,634, CANC. INT. CL. 16.

FAMOUS DOOR, L.L.C., SCOTTSDALE, AZ:
2,170,882, CANC. INT. CL. 35.

FANTASY PRODUCTIONS INC., SEATTLE, WA, DBA PLAY VISIONS:
1,843,063, CANC. INT. CL. 28.

FANUC KABUSHIKI KAISHA (FANUC LTD.), YAMANASHI, JAPAN:
2,170,650, CANC. MULTIPLE CLASS, INT. CLS. 7 AND 9.

FARLAN ENTERTAINMENT, PORT LOUIS, MAURITIUS:
2,955,691, MULTIPLE CLASS, INT. CLS. 9 AND 41.

FARLEY'S & SATHERS CANDY COMPANY, ROUND LAKE, MN, HOMESTEAD, INC., NEWARK, DE:
1,896,376, REN. 4-14-05. INT. CL. 30.

FARMACEUTICA RODIM S. A. DE C.V., ANTIGUO CUSCATLAN, LA LIBERTAD, EL SALVADOR:
2,954,941, PUB. 11-9-2004. INT. CL. 5.

FARMER BROS. CO., TORRANCE, CA:
1,025,829, REN. 4-14-05. INT. CL. 30.

FASHION TRAVELLER MEDIA GROUP, S.L., BILBAO, SPAIN:
2,955,979, MULTIPLE CLASS, INT. CLS. 35 AND 45.

FAST FORWARD, INC., LAKEVIEW, AZ:
1,843,225, CANC. INT. CL. 39.

FAT KAT LLC, KEYPORT, NJ:
2,954,513, PUB. 3-1-2005. INT. CL. 25.

FAT PAT PRODUCTIONS, LLC, TAMPA, FL:
2,955,788, INT. CL. 16.

FAVOLOSA, WARREN, RI AND CHRISTOPHER TONE STORER AND DONNA ANN GAMBARDELLA PARTNERSHIP, THE, WARREN, RI:
2,955,052, PUB. 3-1-2005. INT. CL. 25.

FDN ENTERPRISES, INC., OPA LOCKA, FL:
2,955,216, INT. CL. 3.

FDS, INC., FORT WORTH, TX:
2,955,038, PUB. 3-1-2005. INT. CL. 45.

FEATHERWIND PRODUCTIONS, LLC, MUNCIE, IN:
2,171,336, CANC. INT. CL. 9.
2,171,378, CANC. INT. CL. 9.

FEDERAL EMPLOYEES NEWS DIGEST, INC., RESTON, VA:
2,955,585, INT. CL. 41.

FEDERATED MUTUAL INSURANCE COMPANY, OWATONNA, MN:
2,955,041, PUB. 3-1-2005. INT. CL. 36.

FEDMET INTERNATIONAL CORPORATION, SOLON, OH, CURTIS NOLL CORPORATION, CLEVELAND, OH, DBA INTERNATIONAL ALLOY STEEL CO.:
1,016,687, REN. 4-15-05. INT. CL. 6.

FEDMET INTERNATIONAL CORPORATION, SOLON, OH:
1,879,526, REN. 4-15-05. INT. CL. 7.
1,884,591, REN. 4-15-05. INT. CL. 6.
1,889,599, REN. 4-15-05. INT. CL. 6.
1,889,600, REN. 4-15-05. INT. CL. 6.
1,890,799, REN. 4-15-05. INT. CL. 6.

FEES & BURGESS, P. C., HUNTSVILLE, AL:
2,954,697, PUB. 1-13-2004. INT. CL. 42.

FELDMAN, CARY SCOTT, BIRMINGHAM, MI:
2,171,911, CANC. INT. CL. 42.

FELL-FAB PRODUCTS, LAWRENCE FELL LIMITED, EAST HAMILTON, ONTARIO, CANADA, DBA FELL-FAB PRODUCTS:
1,326,991, REN. 4-13-05. INT. CL. 20.

FELLOWSHIP OF COMPANIES FOR CHRIST, INTERNATIONAL, INC., ATLANTA, GA:
2,171,903, CANC. INT. CL. 41.

FENDER MUSICAL INSTRUMENTS CORPORATION, SCOTTSDALE, AZ:
2,954,226, PUB. 3-16-2004. INT. CL. 15.
2,954,228, PUB. 3-16-2004. INT. CL. 15.
2,954,229, PUB. 3-16-2004. INT. CL. 15.

FENDERLIMITATORS, INC., MERRITT ISLAND, FL:
2,955,010, PUB. 3-1-2005. INT. CL. 12.

FEP, INC., SANTA MONICA, CA:
2,956,298, INT. CL. 35.

FERGUSON, ROGER, SACRAMENTO, CA:
1,284,347, CANC. INT. CL. 20.
1,284,349, CANC. INT. CL. 20.

FERLAND, DONALD F., SEEKONK, MA:
2,954,927, PUB. 3-1-2005. INT. CL. 41.

FERRARI S.P.A., MODENA, ITALY:
2,955,958, INT. CL. 12.

FETCO HOME DECOR, RANDOLPH, MA:
1,882,142, REN. 4-10-05. MULTIPLE CLASS, INT. CLS. 16 AND 20.

FGIC CORPORATION, NEW YORK, NY:
2,955,781, INT. CL. 36.

FIAT AUTO S.P.A., 10135 TORINO, ITALY:
2,171,039, CANC. INT. CL. 12.

FIB GMBH, CH-3902 GLIS, SWITZERLAND:
2,954,150, PUB. 6-22-2004. MULTIPLE CLASS, INT. CLS. 16, 25, 32, 35 AND 43.

FIELD, KAREN A., FAIR OAKS, CA:
1,882,681, REN. 4-13-05. INT. CL. 42.

FIELDSTONE CABINETRY INC., SIOUX FALLS, SD:
1,842,977, CANC. INT. CL. 20.

FIGI, LLC, SAN DIEGO, CA:
2,171,642, CANC. INT. CL. 21.

FIGUEROA DE LIPPE, CARLOS-FRANCISCO, F-95210 SAINT-CLOUD, FRANCE:
2,171,802, CANC. INT. CL. 30.

FILESTREAM, INC., OLD BROOKVILLE, NY:
2,955,989, INT. CL. 9.

FILTRE-EXPERT INC, LEVIS (QUEBEC), CANADA:
2,909,828, COR. INT. CL. 9.

FINANCIAL FREEDOM THROUGH FORECLOSURES INC., BAILEY, CO:
2,955,940, INT. CL. 41.

FINANCIAL KNOWLEDGE NETWORK, LLC, CUPERTINO, CA:
2,956,105, INT. CL. 41.
2,956,137, INT. CL. 41.

FINANCIAL TOOLBOX, INC., BOGART, GA:
2,956,231, INT. CL. 36.

- FINDWHAT.COM, INC., FT. MYERS, FL:
2,954,712, PUB. 3-1-2005. MULTIPLE CLASS, INT. CLS. 35 AND 38.
- FINE ARTS CENTER OF KERSHAW COUNTY, CAMDEN, SC:
2,955,806, MULTIPLE CLASS, INT. CLS. 36 AND 41.
- FINETECH GMBH & CO. KG, D-1268 BERLIN, FED REP GERMANY:
1,850,577, REN. 4-13-05. INT. CL. 9.
- FINGERHUT CORPORATION, MINNETONKA, MN:
1,284,622, CANC. INT. CL. 38.
- FIRMENICH S.A., GENEVE 8, SWITZERLAND:
2,954,743, PUB. 8-3-2004. MULTIPLE CLASS, INT. CLS. 3 AND 30.
2,955,525, MULTIPLE CLASS, INT. CLS. 1, 3 AND 30.
- FIRST BANCORP OF KANSAS, WICHITA, KS TO INTRUST FINANCIAL CORPORATION, WICHITA, KS:
1,843,872, CANC. INT. CL. 36.
- FIRST COMMAND FINANCIAL PLANNING, INC., FORT WORTH, TX:
2,955,880, INT. CL. 36.
- FIRST COMMUNITY BANCSHARES, INC., BLUEFIELD, VA, FIRST COMMUNITY BANCSHARES, INC., PRINCETON, WV:
1,323,678, REN. 4-13-05. INT. CL. 36.
- FIRST COMMUNITY BANCSHARES, INC., BLUEFIELD, VA:
1,323,679, REN. 4-13-05. INT. CL. 36.
- FIRST DAKOTA TITLE LIMITED PARTNERSHIP, SIOUX FALLS, SD:
2,956,235, MULTIPLE CLASS, INT. CLS. 36 AND 42.
- FIRST DATA INTEGRATED SERVICES INC., OMAHA, NE:
1,949,670, REN. 4-15-05. INT. CL. 42.
- FIRST FRANKLIN FINANCIAL CORPORATION, SAN JOSE, CA:
1,843,185, CANC. INT. CL. 36.
- FIRST INTERNATIONAL DIGITAL, INC., SCHAUMBURG, IL:
2,956,156, INT. CL. 38.
- FIRST LIGHT TECHNOLOGY, INC., SACO, ME:
2,170,714, CANC. INT. CL. 42.
- FIRST SAMCO INC., SOUTHAMPTON, PA:
2,955,915, INT. CL. 13.
- FIRST ZURICH PRIVATE BANK, ZURICH, SWITZERLAND:
2,956,287, MULTIPLE CLASS, INT. CLS. 9, 16, 35, 36 AND 42.
- FIRST-CITIZENS BANK & TRUST COMPANY, RALEIGH, NC:
2,954,889, PUB. 3-1-2005. INT. CL. 36.
- FIRST-CITIZENS BANK AND TRUST COMPANY OF SOUTH CAROLINA, COLUMBIA, SC:
2,955,338, INT. CL. 36.
- FISHER CONTROLS INTERNATIONAL LLC, ST. LOUIS, MO:
1,897,386, REN. 4-12-05. INT. CL. 9.
2,955,846, INT. CL. 11.
- FISHING SPIRIT INC. (FKA, CENTURY DIVESTITURE CO.), SPIRIT LAKE, IA, SAFARILAND LTD., INC., ONTARIO, CA:
1,877,740, REN. 4-11-05. INT. CL. 28.
- FISKARS BRANDS, INC., MADISON, WI:
2,955,051, PUB. 3-1-2005. MULTIPLE CLASS, INT. CLS. 8 AND 11.
- FIVE STAR, INC., BELMAR, NJ:
2,954,298, PUB. 3-1-2005. MULTIPLE CLASS, INT. CLS. 39 AND 43.
- FIVE-STAR BASKETBALL CAMP, YONKERS, NY:
2,170,774, CANC. MULTIPLE CLASS, INT. CLS. 9 AND 25.
- FIZER, STEPHEN, LAS VEGAS, NV:
2,956,317, INT. CL. 35.
- FKI PLC, LONDON, EC4A 1LY, UNITED KINGDOM:
2,954,074, PUB. 3-1-2005. INT. CL. 7.
- FLAME STOP INC., FT. WORTH, TX:
2,954,147, PUB. 3-1-2005. INT. CL. 1.
- FLAMMANG, HEIDI A, PARKER, CO:
2,954,646, PUB. 6-8-2004. INT. CL. 43.
- FLATIRON INFORMATION SERVICES INC., TORONTO, CANADA:
2,954,630, PUB. 3-1-2005. MULTIPLE CLASS, INT. CLS. 16 AND 35.
2,954,631, PUB. 3-1-2005. MULTIPLE CLASS, INT. CLS. 16 AND 35.
- FLEER CORP., MOUNT LAUREL, NJ TO CONCORD CONFECTIONS INC, CONCORD ONTARIO, CANADA:
1,843,818, CANC. INT. CL. 30.
- FLEET ENGINEERS, INCORPORATED, MUSKEGON, MI:
2,955,767, INT. CL. 12.
- FLEX SERVICES INC., WARWICK, RI:
1,364,858, CANC. INT. CL. 36.
- FLIGHT OF IDEAS, INC., WALTHAM, MA:
2,955,193, INT. CL. 28.
- FLOPPY DISC ROYALTY CORP., BOULDER, CO:
2,955,119, PUB. 3-1-2005. INT. CL. 28.
2,955,120, PUB. 3-1-2005. INT. CL. 28.
2,955,128, PUB. 3-1-2005. INT. CL. 28.
- FLORES, RAYMON C., JR., TUCSON, AZ:
2,171,271, CANC. INT. CL. 30.
- FLORIDA ATLANTIC UNIVERSITY, BOCA RATON, FL:
2,954,233, PUB. 3-1-2005. MULTIPLE CLASS, INT. CLS. 16, 18, 25 AND 28.
- FLORSHEIM GROUP INC., CHICAGO, IL:
2,171,664, CANC. INT. CL. 25.
- FMC CORPORATION, PHILADELPHIA, PA:
990,003, REN. 4-15-05. U.S. CL. 16 (INT. CL. 1).
- FMR CORP., BOSTON, MA:
2,956,095, INT. CL. 36.
- FOAMEX L.P., LINWOOD, PA:
2,955,677, INT. CL. 20.
- FOLKERTS, RODNEY, NEW YORK, NY:
2,955,733, INT. CL. 41.
- FONTAINE MODIFICATION COMPANY, CHARLOTTE, NC:
2,956,077, INT. CL. 35.
- FONTTECH LIMITED, BEER-SHEVA 84224, ISRAEL:
2,171,671, CANC. INT. CL. 9.
- FOOD INVESTMENTS LIMITED, LONDON, UNITED KINGDOM:
2,956,073, MULTIPLE CLASS, INT. CLS. 1 AND 40.
- FOODCRAFT, LLC, NEW YORK, NY:
2,954,368, PUB. 3-1-2005. INT. CL. 43.
- FOOTSTAR CORPORATION, MAHWAH, NJ:
779,156, REN. 4-13-05. U.S. CL. 50 (INT. CL. 26).
- FORD MOTOR COMPANY, DEARBORN, MI:
2,955,485, INT. CL. 36.
- FORD PRODUCTS COMPANY, PAWTUCKET, RI:
772,619, CANC. U.S. CL. 12.
- FORD, KRISTEN C., PHOENIX, AZ:
2,955,700, INT. CL. 14.
- FOREMOST FARMS USA, COOPERATIVE, BARABOO, WI, FOREMOST DAIRIES, INC., JACKSONVILLE, FL:
601,918, REN. 4-15-05. U.S. CL. 46 (INT. CLS. 29, 30 AND 32).
- FOREX CAPITAL MARKETS LLC, NEW YORK, NY:
2,955,889, INT. CL. 36.
- FORKLIFT SAFETY TRAINING SERVICES, INC., BOULDER CITY, NV:
2,955,058, PUB. 3-1-2005. INT. CL. 41.
- FORMOE, TERJE, KRISTIANSAND, NORWAY:
2,954,733, PUB. 10-26-2004. MULTIPLE CLASS, INT. CLS. 8, 9, 14, 16, 18, 21, 24, 25, 26, 28 AND 41.
- FORSAKRINGSBOLAGET SPP:
See—HANDELSBANKEN VARUMARKES AB.
- FORTE SYSTEMS, INC., TROY, MI:
2,170,926, CANC. MULTIPLE CLASS, INT. CLS. 9 AND 41.
- FORTRESS GROUP LIMITED, LARKSPUR, CO:
2,955,143, PUB. 3-1-2005. INT. CL. 33.
- FOSS A/S, 3400 HILLERØD, DENMARK:
2,954,618, PUB. 3-1-2005. MULTIPLE CLASS, INT. CLS. 1, 5, 9, 10 AND 42.
- FOUNDATION TO SUPPORT ANIMAL PROTECTION, NORFOLK, VA:
2,954,310, PUB. 3-1-2005. MULTIPLE CLASS, INT. CLS. 16, 35 AND 41.

FOUNTAIN PARK ACADEMY, INC., LAWRENCEVILLE, GA:
2,954,158, PUB. 3-1-2005. INT. CL. 35.

FOUR J'S DEVELOPMENT TOOLS LTD., DUBLIN, IRELAND:
2,955,264, INT. CL. 9.

FOUR PAWS PRODUCTS, LTD., HAUPPAUGE, NY:
1,904,471. REN. 4-14-05. INT. CL. 21.

FOWLER, JULIA S., GREENVILLE, SC:
2,954,354, PUB. 3-1-2005. MULTIPLE CLASS, INT. CLS. 35 AND 42.

FOXFALES, INC., NOKOMIS, FL:
2,954,929, PUB. 3-1-2005. INT. CL. 9.

FOXWORTHY, JEFF, LOS ANGELES, CA:
2,954,489, PUB. 3-1-2005. INT. CL. 25.

FRAKE PETEROLEUM COMPANY, INC., NORTH GROSVENORDALE, CT:
2,955,591, INT. CL. 35.

FRANCE EXCELLENCE S.A.R.L., 75017 PARIS, FRANCE:
1,843,411, CANC. INT. CL. 3.

FRANK BLOCK ASSOCIATES, ST. LOUIS, MO:
772,961, CANC. U.S. CL. 101.

FRANKLIN CONNECTIONS, L.P., EL PASO, TX:
2,954,209, PUB. 3-1-2005. INT. CL. 29.
2,955,450, INT. CL. 30.

FRANKLIN COVEY CO, SALT LAKE CITY, UT, COVEY LEADERSHIP CENTER, PROVO, UT:
1,882,208. REN. 4-14-05. INT. CL. 16.

FRANKLIN ELECTRIC CO., INC., BLUFFTON, IN:
2,171,239, CANC. INT. CL. 7.

FRANZ, JEFFREY, OWINGS MILLS, MD:
2,171,418, CANC. INT. CL. 30.

FRATELLI BRANCA-DISTILLERIE S.R.L., MILANO, ITALY:
2,954,110, PUB. 8-24-2004. MULTIPLE CLASS, INT. CLS. 30, 32 AND 33.

FRATERNITE NOTRE DAME, INC., CHICAGO, IL:
2,956,351, INT. CL. 30.

FRED W. GRETSCH ENTERPRISES, LTD., RIDGELAND, SC, DBA FG ENTERPRISES:
2,170,619, CANC. INT. CL. 15.

FREEMON, RICHARD D., SAN FRANCISCO, CA:
1,842,982, CANC. INT. CL. 21.

FREIGHTLINER LLC, PORTLAND, OR:
2,908,884, COR. MULTIPLE CLASS, INT. CLS. 1, 6, 7, 9, 11 AND 12.

FREMANTLEMEDIA NORTH AMERICA, INC., SANTA MONICA, CA:
2,955,077, PUB. 3-1-2005. INT. CL. 41.

FRESH PRODUCTS, INC., TOLEDO, OH:
2,955,907, INT. CL. 21.

FRESHCUP SYSTEM LLC, EASTCHESTER, NY:
2,171,772, CANC. INT. CL. 3.

FREUDENBERG HOUSEHOLD PRODUCTS LP, NORTH LAKE, IL:
2,955,633, INT. CL. 21.

FREY, ERIC, ROCHESTER, NY:
2,954,253, PUB. 3-1-2005. INT. CL. 9.

FREY, MARK, J, OCEANO, CA:
2,954,637, PUB. 3-1-2005. INT. CL. 39.

FREY, RUSSELL E., ALEXANDRIA, VA, DBA EDHELPER:
2,955,044, PUB. 3-1-2005. INT. CL. 41.

FRIEDMAN BAG COMPANY, LOS ANGELES, CA, DBA FRIEDMAN BAG CO.:
2,171,913, CANC. INT. CL. 22.

FRIEDMAN, NEIL, WESTPORT, CT:
2,955,335, INT. CL. 4.

FRIESLAND BRANDS B.V., MEPEL, NETHERLANDS:
2,954,687, PUB. 6-15-2004. INT. CL. 29.

FRITSCHNET, INC., CORONA, CA, DBA HOSTGO.COM:
2,954,183, PUB. 8-3-2004. INT. CL. 42.

FRS TECHNOLOGIES LLC, NEW CANAAN, CT:
2,837,152, AM. MULTIPLE CLASS, INT. CLS. 5 AND 32.

FRUIT PATCH SALES, LLC, DINUBA, CA:
2,956,108, INT. CL. 31.

FTTH COMMUNICATIONS, L.L.C., ROSEMOUNT, MN:
2,954,219, PUB. 3-1-2005. INT. CL. 38.

FULL SPECTRUM TELECOMMUNICATIONS, INC., CLEARWATER, FL:
2,955,758, INT. CL. 45.

FULL-O-PEP APPLIANCES, INC., BLOOMINGTON, IN:
2,954,908, PUB. 3-1-2005. INT. CL. 35.

FULLER BRUSH COMPANY, THE, EAST HARTFORD, CT:
772,941, CANC. U.S. CL. 51.

FUNTIME, INC., CERRITOS, CA:
2,170,946, CANC. INT. CL. 9.

FURMAN FOODS, INC., NORTHUMBERLAND, PA, CONTE & SONS PACKING CO., PALM, PA:
780,682. REN. 4-13-05. U.S. CL. 46 (INT. CL. 30).

FURNERVE, INC., HIGH POINT, NC:
2,954,214, PUB. 3-1-2005. MULTIPLE CLASS, INT. CLS. 9 AND 35.
2,954,215, PUB. 3-1-2005. MULTIPLE CLASS, INT. CLS. 9 AND 35.

FUTURE MEDIA ARCHITECTS, INC, ROAD TOWN, TORTOLA, BR.VIRGIN ISLANDS:
2,955,539, MULTIPLE CLASS, INT. CLS. 35, 38, 41 AND 42.

G. RAU GMBH & CO. KG, D-75172 PFORZHEIM, FED REP GERMANY:
2,955,831, MULTIPLE CLASS, INT. CLS. 6, 9, 10 AND 14.

G.K. INDEXABLE, INC., CRYSTAL LAKE, IL:
1,843,206, CANC. INT. CL. 37.

GA MEINL MUSIKMARKETING GMBH, GERETSRIED, FED REP GERMANY:
2,956,087, INT. CL. 15.

GAF CHEMICALS CORPORATION, WAYNE, NJ:
2,171,548, CANC. INT. CL. 19.

GAGGIO, EMMA, 30100 VENEZIA, ITALY:
1,843,684, CANC. INT. CL. 24.

GAHRY, BETTY, CANYON COUNTRY, CA:
2,171,878, CANC. INT. CL. 16.

GAIA HERBS, INC., BREVARD, NC:
2,956,127, INT. CL. 5.
2,956,128, INT. CL. 5.
2,956,129, INT. CL. 5.

GALAN, JESUS MARIA FEBRERO, STATEN ISLAND, NY:
1,875,097. REN. 4-11-05. INT. CL. 9.

GALAXSEA CRUISES AND TOURS, INC., TULSA, OK:
2,125,067, CANC. INT. CL. 39.

GALAXY NUTRITIONAL FOODS, INC., ORLANDO, FL:
2,955,373, INT. CL. 40.

GALBRAITH LABORATORIES, INC., KNOXVILLE, TN:
1,889,018. REN. 4-15-05. INT. CL. 42.

GALIL MEDICAL LTD., 20 692 YOKNEAM, ISRAEL:
2,955,426, INT. CL. 10.

GALLANT INDUSTRIES CO., LTD., TA-YA HSIANG, TAI-CHUNG HSIEN, TAIWAN:
1,597,972, CANC. INT. CL. 18.

GALLERY ONE, LTD., COMPANY, MENTOR, OH:
2,955,131, PUB. 3-1-2005. INT. CL. 35.

GALLERY PLACE ASSOCIATES, LLC., WASHINGTON, DC:
2,955,955, INT. CL. 36.

GAMBLIN ARTISTS COLORS CO., PORTLAND, OR:
2,954,942, PUB. 3-1-2005. INT. CL. 2.

GAMBRO LUNDIA AB, LUND, SWEDEN:
2,954,984, PUB. 3-1-2005. INT. CL. 37.

GAME TRACKER, INC., FLUSHING, MI:
2,954,531, PUB. 3-1-2005. INT. CL. 6.

GAMECOCK BOXING, INC., WESTMINSTER, CA:
2,955,260, INT. CL. 41.

GANCIA S.P.A. CANELLI (PROVINCE OF ASTI), ITALY:
2,954,662, PUB. 8-17-2004. INT. CL. 33.

GAP (APPAREL), LLC, SAN FRANCISCO, CA, GPS (DELAWARE), INC., SAN BRUNO, CA:
1,912,355. REN. 4-15-05. INT. CL. 9.

GARBOSKI, RICHARD, NEW YORK, NY:
2,955,909, INT. CL. 41.

GARCIA-GUTIERREZ, REYNALDO, MONTERREY, N.L., MEXICO:
2,956,337, INT. CL. 29.
2,956,338, INT. CL. 29.

GARCIS, S.A. DE C.V., 15500 MEXICO, D.F., MEXICO:
2,171,674, CANC. MULTIPLE CLASS, INT. CLS. 25 AND 28.

- GARCO BUILDING SYSTEMS, INC., AIRWAY HEIGHTS, WA:
2,955,644, INT. CL. 6.
- GARY D. NELSON ASSOCIATES, INC., SONOMA, CA:
2,171,773, CANC. INT. CL. 35.
- GAS TECHNOLOGY PRODUCTS LLC, HOUSTON, TX:
1,286,668, REN. 4-15-05, INT. CL. 1.
1,289,967, REN. 4-15-05, INT. CL. 11.
- GAUCHO IMPORTS LLC, ALBUQUERQUE, NM:
2,954,615, PUB. 8-3-2004, INT. CL. 33.
- GAUGHEN HOLDINGS LLC, OXNARD, CA:
2,954,742, PUB. 3-1-2005, INT. CL. 30.
- GAYLORD CONTAINER CORPORATION, DEERFIELD, IL:
1,843,604, CANC. INT. CL. 16.
- GC SERVICES, LP, HOUSTON, TX:
2,954,357, PUB. 3-1-2005, INT. CL. 36.
- GCO INC., MONTGOMERY, AL:
2,171,706, CANC. INT. CL. 36.
- GEA BUCK VALVE GMBH, MULLHEIM, FED REP GERMANY:
2,954,651, PUB. 8-10-2004, INT. CL. 7.
- GEEHAN ADVISORY GROUP, INC., DAYTON, OH:
2,954,421, PUB. 3-1-2005, INT. CL. 35.
- GEIGER INTERNATIONAL, INC., ATLANTA, GA:
1,841,560, CANC. INT. CL. 18.
- GEIGER, KRAIG, NORTH MIAMI BEACH, FL:
2,954,888, PUB. 3-1-2005, INT. CL. 41.
- GEMSMETICS, INC., OLD TAPPAN, NJ:
2,955,110, PUB. 3-1-2005, INT. CL. 3.
- GEN CORP INC., AKRON, OH:
772,826, CANC. U.S. CL. 35.
- GENENTECH, INC., SOUTH SAN FRANCISCO, CA:
2,171,541, CANC. MULTIPLE CLASS, INT. CLS. 35, 36 AND 42.
2,171,542, CANC. MULTIPLE CLASS, INT. CLS. 35, 36 AND 42.
- GENERAL BUSINESS FORMS, INC., SKOKIE, IL:
2,171,800, CANC. INT. CL. 16.
- GENERAL ELECTRIC COMPANY, SCHENECTADY, NY:
2,918,033, COR. INT. CL. 10.
2,954,352, PUB. 3-1-2005, INT. CL. 36.
2,955,676, INT. CL. 9.
- GENERAL FIBER COMMUNICATIONS, INC., PHOENIX, AZ:
2,954,107, PUB. 9-2-2003, MULTIPLE CLASS, INT. CLS. 37 AND 42.
- GENERAL MEDIA COMMUNICATIONS, INC., NEW YORK, NY:
1,323,232, REN. 4-15-05, INT. CL. 16.
- GENERAL MOTORS CORPORATION, DETROIT, MI:
1,936,976, REN. 4-13-05, INT. CL. 9.
2,170,686, CANC. INT. CL. 9.
2,954,605, PUB. 10-2-2001, INT. CL. 25.
- GENERAL NUTRITION INVESTMENT COMPANY, PITTSBURGH, PA:
2,171,770, CANC. INT. CL. 35.
- GENERAL RE CORPORATION, STAMFORD, CT:
2,955,868, INT. CL. 36.
- GENERAL THORACIC SURGICAL CLUB, ROCHESTER, MN:
2,954,379, PUB. 3-1-2005, MULTIPLE CLASS, INT. CLS. 35 AND 41.
2,954,380, PUB. 3-1-2005, MULTIPLE CLASS, INT. CLS. 35 AND 41.
- GEOMETRIE CONCERN VERWALTUNGS-UND BETEILIGUNGSGESELLSCHAFT MBH, D-97232 GIEBELSTADT, FED REP GERMANY:
2,954,045, PUB. 9-21-2004, MULTIPLE CLASS, INT. CLS. 9, 12, 35, 36, 38, 40, 41 AND 42.
- GEORGIA BOOT LLC, FRANKLIN, TN, GEORGIA SHOE MANUFACTURING COMPANY, INC., FLOWERY BRANCH, GA:
790,751, REN. 4-15-05, U.S. CL. 39 (INT. CL. 25).
- GEORGIA BREAST CANCER COALITION FUND, ATLANTA, GA:
2,954,238, PUB. 3-1-2005, INT. CL. 36.
2,954,239, PUB. 3-1-2005, INT. CL. 35.
- GEORGIA-PACIFIC CORPORATION, ATLANTA, GA:
1,842,955, CANC. INT. CL. 19.
- GERVASONI S.P.A., 33050 PAVIA DI UDINE (UD), ITALY:
2,954,117, PUB. 5-25-2004, INT. CL. 20.
- GESCO INDUSTRIES INC., BRAMPTON, ONTARIO, CANADA:
2,954,036, PUB. 3-1-2005, MULTIPLE CLASS, INT. CLS. 19, 27 AND 35.
- GETZ, HARRY, LAGUNA NIGUEL, CA:
2,956,299, MULTIPLE CLASS, INT. CLS. 41 AND 44.
- GIANFRANCO, DE PAOLI AMBROSI, SALO' (BRESCIA), ITALY:
2,954,040, PUB. 7-6-2004, INT. CL. 3.
- GIBSON, GREGORY R., COUNCIL BLUFF, IA:
2,954,433, PUB. 3-1-2005, INT. CL. 25.
- GIMBORN US, INC., ATLANTA, GA:
2,171,886, CANC. INT. CL. 21.
- GINGERBREAD CONSTRUCTION CO., INC., WAKEFIELD, MA:
2,954,944, PUB. 3-1-2005, INT. CL. 30.
- GINSBERG, MINDY, ENGLEWOOD, NJ:
2,171,551, CANC. INT. CL. 25.
- GIRLS & SPORTS, LLC, LOS ANGELES, CA:
2,955,094, PUB. 3-1-2005, MULTIPLE CLASS, INT. CLS. 16 AND 25.
- GÉNÉTIPORC INC., ST-BERNARD, QUEBEC, CANADA:
2,956,314, INT. CL. 42.
- GLEN OAK LUMBER & MILLING, INC., MONTELO, WI:
2,956,210, INT. CL. 19.
- GLJ LLC, CHICAGO, IL:
2,171,795, CANC. INT. CL. 11.
- GLOBAL FOREST PARTNERS LP, WEST LEBANON, NH:
2,955,976, INT. CL. 36.
- GLOBAL HEALTH TRAX, INC., VISTA, CA:
2,955,859, INT. CL. 5.
- GLOBAL HORIZONS LTD., LLC, GREENSBORO, NC:
2,171,321, CANC. INT. CL. 28.
- GLOBAL INVESTIMENTI S.P.A., CROCETTA DEL MONTELLO (TREVISO), ITALY, OPERE TREVIGIANE S.I.F.A.T. - VILLA DEL BARCO - S.P.A., CROCETTA DEL MONTELLO (TREVISO), ITALY:
1,886,256, REN. 4-13-05, INT. CL. 33.
- GLOBAL SPAN PRODUCTS, INC., CAMPBELL, CA:
2,954,589, PUB. 3-1-2005, INT. CL. 9.
- GLOBE INTERNATIONAL NOMINEES PTY LTD, PORT MELBOURNE, VICTORIA, AUSTRALIA:
2,171,921, CANC. MULTIPLE CLASS, INT. CLS. 14 AND 18.
2,171,922, CANC. MULTIPLE CLASS, INT. CLS. 14 AND 18.
2,171,923, CANC. INT. CL. 25.
2,171,924, CANC. INT. CL. 25.
- GLOBE PRODUCTS INC., HUBER HIEGHTS, OH:
777,809, REN. 4-15-05, U.S. CL. 23 (INT. CL. 1).
- GLOBMAN'S OF MARTINSVILLE, INC., MARTINSVILLE, VA:
1,284,759, CANC. INT. CL. 42.
- GLUCKMAN, GEOFFREY M., SAN DIEGO, CA, DBA DYNAMICS OF PHYSICAL DEVELOPMENT:
2,171,760, CANC. MULTIPLE CLASS, INT. CLS. 41 AND 42.
- GLUSTITCH INC., DELTA, BC V4G 1M6, CANADA:
2,955,685, INT. CL. 5.
- GMI HOLDINGS, INC., ALLIANCE, OH, ALLIANCE MANUFACTURING COMPANY, THE, ALLIANCE, OH:
612,987, REN. 4-15-05, U.S. CL. 21 (INT. CL. 9).
- GO PHONE, INC., CARSON CITY, NV:
2,171,657, CANC. INT. CL. 36.
- GO SCORE, LLC, HARTFORD, CT:
2,955,187, INT. CL. 35.
- GOAMERICA COMMUNICATIONS CORPORATION, HACKENSACK, NJ:
2,954,010, PUB. 3-1-2005, INT. CL. 38.
- GOETZE'S CANDY COMPANY, INC., BALTIMORE, MD:
1,265,195, CANC. INT. CL. 30.
- GOJO INDUSTRIES, INC., CUYAHOGA FALLS, OH:
1,842,612, CANC. INT. CL. 3.

GOLD, STEVEN H., PALM SPRINGS, CA:
2,956,343, INT. CL. 3.

GOLDBERG, ALICIA, SANTA CRUZ, CA, DBA PHYTOMED INTERNATIONAL:
2,171,207, CANC. INT. CL. 42.

GOLDBRICK GAMES, LLC, MASON, NH:
2,955,622, MULTIPLE CLASS, INT. CLS. 25, 28 AND 41.

GOLDEN BOOKS PUBLISHING COMPANY, INC., RACINE, WI:
2,171,617, CANC. INT. CL. 16.

GOLDSTEIN, IRA, RALEIGH, NC AND GOLDSTEIN, DAVID, RALEIGH, NC:
2,954,494, PUB. 3-1-2005. INT. CL. 16.

GOLFTEC ENTERPRISES, LLC, GREENWOOD VILLAGE, CO:
2,956,310, INT. CL. 41.

GONUTS, L.L.C., TULSA, OK:
2,171,075, CANC. INT. CL. 35.

GOODMAN & COMPANY LTD., TORONTO, ONTARIO, CANADA:
2,170,657, CANC. INT. CL. 36.
2,170,658, CANC. INT. CL. 36.
2,170,659, CANC. INT. CL. 36.

GOODYEAR TIRE & RUBBER COMPANY, THE, AKRON, OH:
981,985, REN. 4-13-05. U.S. CL. 35 (INT. CL. 12).
2,955,642, INT. CL. 17.

GOOGLE INC., MOUNTAIN VIEW, CA:
2,954,071, PUB. 7-6-2004. MULTIPLE CLASS, INT. CLS. 9, 11, 12, 16, 18, 21, 25, 28 AND 35.

GOTTBETTER & PARTNERS, LLP, NEW YORK, NY:
2,954,437, PUB. 3-1-2005. MULTIPLE CLASS, INT. CLS. 35, 36 AND 42.

GOULDS PUMPS, INCORPORATED, SENECA FALLS, NY:
1,842,661, CANC. INT. CL. 7.

GOURMET APPLIANCE OUTLET, OAKLAND, CA:
2,956,296, INT. CL. 35.

GOWAY TRAVEL LIMITED, TORONTO ONTARIO, CANADA:
2,954,132, PUB. 7-20-2004. INT. CL. 39.

GOYA FOODS, INC., SECAUCUS, NJ:
1,322,395, REN. 4-11-05. INT. CL. 29.

GRABER INDUSTRIES, INC., MIDDLETON, WI:
1,284,322, CANC. INT. CL. 20.

GRACIE MARKETING LLC, ST. MICHAELS, MD:
2,956,153, INT. CL. 36.

GRAHAM-FIELD TEMCO, INC., PASSAIC, NJ:
1,474,049, CANC. INT. CL. 10.

GRANDOE CORPORATION, THE, GLOVERSVILLE, NY:
2,954,458, PUB. 12-21-2004. INT. CL. 25.

GRANT MEDIA, LLC, SAN FRANCISCO, CA:
2,954,312, PUB. 3-1-2005. MULTIPLE CLASS, INT. CLS. 35 AND 42.

GRAVNING, PATRICIA M., ENCINO, CA:
2,955,031, PUB. 3-1-2005. INT. CL. 16.
2,955,032, PUB. 3-1-2005. INT. CL. 16.

GRAY MATTER HOLDINGS, LLC, BALTIMORE, MD FROM GORGONZ GROUP, INC., THE, BALTIMORE, MD:
2,955,198, INT. CL. 25.

GREAT BRANDS OF EUROPE, INC., GREENWICH, CT:
2,170,849, CANC. MULTIPLE CLASS, INT. CLS. 35 AND 41.

GREAT DINING, INC., BELLEAIR, FL:
2,956,308, INT. CL. 16.

GREAT LAKES PULP COMPANY, MENOMINEE, MI:
2,954,413, PUB. 3-1-2005. INT. CL. 1.

GREAT WESTERN CHEMICAL COMPANY, PORTLAND, OR:
1,370,762, CANC. INT. CL. 1.

GREATER BUFFALO CONVENTION AND VISITORS BUREAU, INC., BUFFALO, NY:
2,171,008, CANC. INT. CL. 35.

GREEN, CHARLES H., MORRISTOWN, NJ:
2,956,175, INT. CL. 41.

GREEN, JAMES SR., NEW CUMBERLAND, PA:
2,171,613, CANC. INT. CL. 9.

GREENA, INC., LOS ANGELES, CA:
2,878,526, CANC. INT. CL. 25.

GREENBALL CORPORATION, LONG BEACH, CA:
2,171,843, CANC. INT. CL. 12.

GREENHOUSE PRODUCTS, INC., LOS ANGELES, CA:
1,872,345, REN. 4-15-05. INT. CL. 9.

GREENS & POWDER, LTD., COLORADO SPRINGS, CO:
1,843,307, CANC. INT. CL. 42.

GRETER BOSTON CONVENTION & VISITORS BUREAU, BOSTON, MA:
2,956,305, INT. CL. 35.

GREYWOLF CONSULTING SERVICES, INC., AUSTIN, TX:
2,171,256, CANC. INT. CL. 35.

GRILL, SARA, APPLETON, WI:
2,955,015, PUB. 3-1-2005. INT. CL. 43.

GRINBERG, JULIO GERARDO, BUENOS AIRES, ARGENTINA AND GRINBERG, ALEJANDRO JAVIER, BUENOS AIRES, ARGENTINA:
2,955,563, INT. CL. 2.

GRIFF CO., THE, NEW YORK, NY:
2,171,695, CANC. INT. CL. 28.

GRISI HNOS., S.A. DE C.V., COLONIA DEL VALLE, MEXICO:
1,843,427, REN. 4-11-05. INT. CL. 3.

GRIZZLY CARTRIDGE CO., RAINIER, OR:
2,955,957, INT. CL. 13.

GROSS, GABRIEL, 75116 PARIS, FRANCE:
2,911,951, COR. MULTIPLE CLASS, INT. CLS. 9, 38 AND 42.

GROUNDWATER DECONTAMINATION SYSTEMS, INC., WALDWICK, NJ:
1,284,602, CANC. INT. CL. 37.

GROUPE COSSETTE COMMUNICATION INC., QUEBEC, CANADA:
2,954,092, PUB. 9-7-2004. INT. CL. 35.

GROUPE HENRI HEULIEZ, 79140 CERIZAY, FRANCE:
2,954,744, PUB. 3-1-2005. INT. CL. 12.

GRUNER + JAHR PRINTING & PUBLISHING CO., NEW YORK, NY:
2,954,390, PUB. 3-1-2005. INT. CL. 16.
2,955,895, INT. CL. 16.

GRUP LASEM GESTIO SL, 08226 BARCELONA, SPAIN:
2,589,868, CANC. INT. CL. 30.

GRUPO BIMBO, S.A. DE C.V., DELEGACION ALVARO OBREGON, D.F., MEXICO:
2,954,906, PUB. 10-19-2004. INT. CL. 30.

GTI GRAPHIC TECHNOLOGY, INC., NEWBURGH, NY:
1,876,409, REN. 4-11-05. INT. CL. 9.

GUDGEL, DAVID E., ALBUQUERQUE, NM AND GUDGEL, ASHLEY F., ALBUQUERQUE, NM:
2,956,076, INT. CL. 25.

GUESS ?, INC., LOS ANGELES, CA:
1,284,392, CANC. INT. CL. 25.

GUIDESOFT, INC., INDIANAPOLIS, IN, DBA KNOWLEDGE SERVICES:
2,955,002, PUB. 3-1-2005. INT. CL. 35.

GUIDO IMPORTER & WHOLESALE, INC., NEW ROCHELLE, NY, GUIDO IMPORTER & WHOLESALE, INC., NEW ROCHELLE, NY:
1,343,014, REN. 4-15-05. INT. CL. 30.

GUM TECH INTERNATIONAL, INC., PHOENIX, AZ:
2,171,641, CANC. INT. CL. 30.

GUNLOCKE COMPANY, THE, WAYLAND, NY, GUNLOCKE COMPANY, THE, WAYLAND, NY:
1,323,276, REN. 4-13-05. INT. CL. 20.

GYM-MARK, INC., SAN FRANCISCO, CA:
2,170,622, CANC. INT. CL. 41.

GYRODOGS LLC, SALT LAKE CITY, UT:
2,170,994, CANC. INT. CL. 29.

GYRUS GROUP PLC, BERKS RG41 5RA, UNITED KINGDOM:
2,954,429, PUB. 3-1-2005. INT. CL. 10.

H & W COMPUTER SYSTEMS, INC., BOISE, ID:
1,284,135, CANC. INT. CL. 9.

H. E. BUTT GROCERY COMPANY, SAN ANTONIO, TX:
2,171,740, CANC. INT. CL. 30.

H-D MICHIGAN, INC., ANN ARBOR, MI:
2,955,705, INT. CL. 34.

- HACHETTE RUSCONI S.P.A., MILANO, ITALY FROM RUSCONI EDITORE SPA. 20126 MILANO, ITALY: 2,954,039, PUB. 12-30-2003. MULTIPLE CLASS, INT. CLS. 16 AND 41.
- HADDOCK; PAUL THOMAS, RESTON, VA: 1,284,561, CANC. INT. CL. 36.
- HAGGEN, INC., BELLINGHAM, WA: 2,955,662, INT. CL. 43. 2,955,663, INT. CL. 30.
- HAKKAI-JYOZO SAKE BREWING CO., LTD., NIIGATA, JAPAN: 2,954,220, PUB. 3-1-2005. INT. CL. 33. 2,954,221, PUB. 3-1-2005. INT. CL. 33.
- HALE, JANE D., NEW YORK, NY: 2,955,592, INT. CL. 28.
- HALL, KATHLEEN, EAST PROVIDENCE, RI: 2,955,480, INT. CL. 3.
- HALLIBURTON COMPANY, CARROLLTON, TX, DBA HALLIBURTON SERVICES: 1,031,112, REN. 4-15-05. INT. CL. 1.
- HALLIBURTON ENERGY SERVICES, INC., CARROLLTON, TX: 2,955,684, INT. CL. 7.
- HALO MANAGEMENT, LLC, LOS ALTOS, CA: 2,954,607, PUB. 2-17-2004. INT. CL. 42.
- HAMBLET & HAYES CO., SALEM, MA: 1,283,946, CANC. INT. CL. 1.
- HAMILTON COMPANY, RENO, NV: 2,954,111, PUB. 8-24-2004. MULTIPLE CLASS, INT. CLS. 9 AND 42.
- HAMILTON THORNE RESEARCH ASSOCIATES, BEVERLY, MA: 2,132,615, CANC. INT. CL. 9.
- HAMPEL, PHILIP, BARRINGTON, IL: 2,956,147, INT. CL. 41.
- HAMPTON INDUSTRIES, INC., KINSTON, NC: 2,171,204, CANC. INT. CL. 25.
- HANDELSBANKEN VARUMARKES AB, STOCKHOLM, SWEDEN FROM FORSAKRINGSBOLAGET SPP, 103 73 STOCKHOLM, SWEDEN: 2,954,019, PUB. 3-1-2005. MULTIPLE CLASS, INT. CLS. 36, 41 AND 42.
- HANKOOK TIRE MFG. CO., LTD., KOORO-KU, SEOUL, REPUBLIC OF KOREA: 1,324,351, REN. 4-14-05. INT. CL. 12.
- HANNAH ROSE CORPORATION, DALLAS, TX: 2,954,649, PUB. 3-1-2005. INT. CL. 14.
- HANOUN MEDICAL, (II) U.S., INC., GREENWOOD VILLAGES, CO: 2,954,895, PUB. 3-1-2005. INT. CL. 38.
- HANOVER EXCESS & SURPLUS, INC., WILMINGTON, NC: 1,284,595, CANC. INT. CL. 36.
- HANOVER TOOL, INC., ASHLAND, VA: 2,955,762, MULTIPLE CLASS, INT. CLS. 7 AND 8.
- HANSEN; ELMER H., FRESNO, CA, DBA RANCHO RIO DEL SOL: 1,284,494, CANC. INT. CL. 29.
- HANSEN'S TREE, LAWN AND LANDSCAPING SERVICES, INC., O'FALLON, MO: 2,954,523, PUB. 3-1-2005. INT. CL. 44.
- HAPPY JOE'S FRANCISING, INC., BETTENDORF, IA: 1,881,559, REN. 4-12-05. INT. CL. 30.
- HARCOURT ASSESSMENT INC., AUSTIN, TX: 2,956,190, INT. CL. 16.
- HARCOURT, INC., ORLANDO, FL: 2,955,420, INT. CL. 9.
- HARDEE'S FOOD SYSTEMS, INC., ROCKY MOUNT, NC TO MRO MID-ATLANTIC CORP, PEARL RIVER, NY: 1,843,069, CANC. INT. CL. 29.
- HARDMAN, KIM A., SAN FRANCISCO, CA: 2,955,133, PUB. 3-1-2005. INT. CL. 18.
- HARLEY'S HOUSE OF HARLEYS, OCEANSIDE, CA: 2,956,214, INT. CL. 35.
- HARNDEN, GLEN MACK, STILLWELL, KS: 2,171,516, CANC. MULTIPLE CLASS, INT. CLS. 41 AND 42.
- HARO BICYCLE CORPORATION, VISTA, CA: 1,342,453, REN. 4-13-05. INT. CL. 12.
- HAROLD E. LEMAY MUSEUM, THE, TACOMA, WA: 2,956,192, INT. CL. 41.
- HARPO SPA, TRIESTE, ITALY, SANDTEX ITALIANA S.P.A., 34123 TRIESTE, ITALY: 1,900,259, REN. 4-14-05. INT. CL. 2.
- HARRAH'S LICENSE COMPANY, LLC, LAS VEGAS, NV: 1,025,395, REN. 4-15-05. INT. CL. 41.
- HARRAH'S LICENSE COMPANY, LLC, LAS VEGAS, NV, HARRAH'S CLUB, RENO, NV: 1,957,088, REN. 4-13-05. MULTIPLE CLASS, INT. CLS. 41 AND 42.
- HARRY WINSTON ULTIMATE TIMEPIECE S.A., 1204 GENEVA, SWITZERLAND: 2,954,011, PUB. 7-27-2004. INT. CL. 14.
- HART, DANIELLE, REDONDO BEACH, CA AND PUGH, SONJA, REDONDO BEACH, CA AND GUTH, SHYANNE, REDONDO BEACH, CA: 2,955,504, INT. CL. 3.
- HARTMAN, WADE, WAYNE, NJ: 2,955,004, PUB. 3-1-2005. INT. CL. 16.
- HARUN, KARA, LOS ANGELES, CA: 2,955,511, INT. CL. 14.
- HARVEST MOON BREWING, MONTANA CITY, MT: 2,954,881, PUB. 3-1-2005. INT. CL. 32.
- HARVEY, KIM, INDIANAPOLIS, IN: 2,956,051, INT. CL. 21.
- HARWELL DOSIMETERS LTD, DIDCOT, OXFORDSHIRE, OX11 0RA, UNITED KINGDOM: 2,954,203, PUB. 7-27-2004. INT. CL. 1.
- HASBRO INC., PAWTUCKET, RI: 1,355,625, REN. 4-9-05. INT. CL. 28.
- HASBRO INDUSTRIES, INC., PAWTUCKET, RI: 772,854, CANC. U.S. CL. 38.
- HASBRO, INC., PAWTUCKET, RI: 2,171,918, CANC. INT. CL. 28. 2,171,985, CANC. INT. CL. 28. 2,171,991, CANC. INT. CL. 28. 2,954,461, PUB. 3-1-2005. INT. CL. 28.
- HASTINGS, CLAYTON & TUCKER, INC., INGLEWOOD, CA: 1,294,197, REN. 4-15-05. INT. CL. 16.
- HAVANA GROUP, INC., THE, NORTH CANTON, OH: 2,900,985, COR. INT. CL. 34.
- HAVE A TUDE, INC., PHOENIX, AZ: 2,172,034, CANC. MULTIPLE CLASS, INT. CLS. 16 AND 25.
- HAW-DI-I FOODS CO., LTD., TAINAN, TAIWAN: 2,954,275, PUB. 3-1-2005. MULTIPLE CLASS, INT. CLS. 29 AND 30.
- HAWK WING INDUSTRIAL CO., LTD., LU CHOU HSIANG, TAIPEI HSIEN, TAIWAN: 2,171,675, CANC. INT. CL. 28.
- HAYDEN INDUSTRIES INC., ONTARIO, CANADA: 2,954,834, PUB. 3-1-2005. INT. CL. 7.
- HBD INDUSTRIES, INC., DUBLIN, OH: 1,852,873, REN. 4-12-05. INT. CL. 7.
- HC MEDIA, LLC, OMAHA, NE: 2,955,845, INT. CL. 38.
- HEADWALL VENTURES, INC., HOUSTON, TX: 2,171,961, CANC. INT. CL. 25.
- HEALTH CARE GROUP, INC., THE, PLYMOUTH MEETING, PA, DBA THE HEALTH CARE GROUP: 1,888,391, REN. 4-13-05. MULTIPLE CLASS, INT. CLS. 16, 35, 36, 41 AND 42.
- HEALTH RESEARCH PTY LTD, ADELAIDE, SOUTH AUSTRALIA, AUSTRALIA: 2,954,904, PUB. 3-1-2005. INT. CL. 5.
- HEALTHPARTNERS, INC., BLOOMINGTON, MN: 1,882,641, REN. 4-13-05. INT. CL. 42. 1,882,650, REN. 4-12-05. INT. CL. 42.
- HEALTHSTAR, INC., CHICAGO, IL: 2,171,850, CANC. INT. CL. 35. 2,171,851, CANC. INT. CL. 35.
- HEALTHWISE, INCORPORATED, BOISE, ID: 1,299,478, REN. 4-13-05. INT. CL. 16.
- HEALTHY GRAINFOODS LLC, NORTHBROOK, IL: 2,954,388, PUB. 9-28-2004. INT. CL. 30.

HEARST MAGAZINES PROPERTY, INC., GREENWICH, CT:
738,047. REN. 4-9-05. U.S. CL. 38 (INT. CL. 16).

HEARST-ARGYLE STATIONS, INC., NEW YORK, NY:
2,954,317. PUB. 3-1-2005. INT. CL. 43.

HEARTLAND COMMUNICATIONS GROUP, INC., FORT DODGE, IA:
1,284,270. CANC. INT. CL. 16.

HEARTLAND CORPORATION, OLATHE, KS:
2,954,912. PUB. 10-19-2004. INT. CL. 3.

HEARTS ON FIRE COMPANY LLC, BOSTON, MA:
2,955,029. PUB. 3-1-2005. INT. CL. 41.
2,955,037. PUB. 3-1-2005. INT. CL. 41.

HEATWAY SYSTEMS, INC., SPRINGFIELD, MO:
1,756,550. REN. 4-9-05. INT. CL. 9.

HEAVEN HILL DISTILLERIES, INC., BARDSTOWN, KY:
767,958. REN. 4-15-05. U.S. CL. 49 (INT. CL. 33).

HEAVENLY VALLEY, SOUTH LAKE TAHOE, CA:
1,284,650. CANC. INT. CL. 41.

HEAVY PUTTER, LLC, SOUTH SALEM, NY:
2,956,220. INT. CL. 28.
2,956,221. INT. CL. 28.

HECHT, MITCHELL W., ROSWELL, GA:
2,171,439. CANC. INT. CL. 16.

HEDSTROM CORPORATION, BEDFORD, PA:
1,842,855. CANC. MULTIPLE CLASS, INT. CLS. 12 AND 28.

HEFTEL BROADCASTING CORPORATION, LAS VEGAS, NV:
2,171,532. CANC. INT. CL. 38.

HEINRICH AD. BERKEMANN (GMBH & CO), HAMBURG 54, FED REP GERMANY:
1,325,582. REN. 4-15-05. INT. CL. 10.

HEINRICH BAUER PUBLISHING, LP, ENGLEWOOD, NJ:
2,956,072. INT. CL. 16.

HELEN OF TROY LIMITED, EL PASO, TX:
2,955,330. INT. CL. 21.

HELEN OF TROY LIMITED, BRIDGETOWN, BARBADOS:
2,955,332. INT. CL. 3.
2,955,339. INT. CL. 3.

HELENE CURTIS, INC., CHICAGO, IL:
1,283,967. CANC. INT. CL. 3.

HELLAS INTERNATIONAL INC., SALEM, MA:
2,171,564. CANC. INT. CL. 29.

HELLY HANSEN ASA, NO-1599 MOSS, NORWAY:
1,308,742. CANC. INT. CL. 9.

HELMUT GUENSCHER, INC., BALTIMORE, MD:
2,170,746. CANC. INT. CL. 20.

HENDON PUBLISHING CO., DEERFIELD, IL:
2,955,030. PUB. 3-1-2005. MULTIPLE CLASS, INT. CLS. 16 AND 41.
2,956,279. INT. CL. 35.
2,956,282. INT. CL. 35.
2,956,283. INT. CL. 35.

HENGSTONE HOLDINGS, INC., GEORGETOWN, ONTARIO L7G 4X6, CANADA:
1,880,645. REN. 4-14-05. INT. CL. 19.

HENION, JAMES, ITHACA, NY, DBA COOPERATIVE LEARNING SOLUTIONS:
2,956,065. INT. CL. 9.

HENKEL CORPORATION, GULPH MILLS, PA, CLOVER MANUFACTURING COMPANY, THE, NORWALK, CT:
1,006,193. REN. 4-10-05. INT. CL. 3.

HENNESSY INDUSTRIES, INC., LAVERGNE, TN:
1,262,845. REN. 4-11-05. INT. CL. 7.

HENRY DUNAY DESIGNS, INC., NEW YORK, NY:
2,954,396. PUB. 3-1-2005. INT. CL. 14.

HENRY-AARON, INC., ATLANTA, GA:
2,170,896. CANC. INT. CL. 25.

HENSON, CHRISTOPHER, LAKEWOOD, CO:
2,954,425. PUB. 3-1-2005. INT. CL. 9.

HERBERT STANLEY COMPANY L.L.C., THE, GURNEE, IL, HERBERT STANLEY COMPANY, THE, GURNEE, IL, DBA BURNISHINE PRODUCTS:
1,909,687. REN. 4-12-05. INT. CL. 3.

HERCULES INCORPORATED, WILMINGTON, DE:
1,284,504. CANC. INT. CL. 30.

HERRING, DEXTER R., DURANGO, CO, DBA BUCK HERRING PRODUCTIONS:
2,954,725. PUB. 3-1-2005. INT. CL. 9.

HERSHEY CHOCOLATE & CONFECTIONERY CORPORATION, WHEAT RIDGE, CO, HOMESTEAD, INC., NEWARK, DE:
1,888,004. REN. 4-13-05. INT. CL. 30.

HERSHEY CREAMERY COMPANY, HARRISBURG, PA:
1,883,757. REN. 4-15-05. INT. CL. 30.

HERSHEY FOODS CORPORATION, HERSHEY, PA:
829,881. AM. U.S. CL. 46.

HERSHEY, CARA, PELICAN ISLAND, NJ:
2,955,638. INT. CL. 18.

HESS, JOHN E., TULSA, OK:
2,955,702. INT. CL. 1.

HESTERMAN, MICHAEL L., MORTON, IL:
2,956,039. INT. CL. 16.

HET FRIESCH PAARDEN-STAMBOEK, 9205 BZ DRACHTEN, NETHERLANDS:
2,954,197. PUB. 3-1-2005. MULTIPLE CLASS, INT. CLS. 35, 41 AND 42.

HETEROCHEMICAL CORPORATION, VALLEY STREAM, NY:
772,697. CANC. U.S. CL. 18.

HI-FIVE PRODUCTS DEVELOPING CO., LTD., TAICHUNG, TAIWAN:
2,954,920. PUB. 10-19-2004. INT. CL. 8.

HI-VAC CORPORATION, MARIETTA, OH:
2,738,659. COR. INT. CL. 7.

HICKEY, JAMES W., LEXINGTON, KY, DBA BIOTONIC:
2,171,354. CANC. INT. CL. 20.

HIDESIGN INDIA, PONDICHERRY, IN, HIDE DESIGN OF AMERICA INC., SAN FRANCISCO, CA:
1,882,221. REN. 4-9-05. INT. CL. 18.

HIGGINS COMPANY, LINEVILLE, AL:
1,284,406. CANC. INT. CL. 25.

HIGH END SYSTEMS, INC., AUSTIN, TX:
1,842,575. CANC. MULTIPLE CLASS, INT. CLS. 1, 7, 9 AND 11.

HIGHLAND CAPITAL PARTNERS, INC., BOSTON, MA:
2,954,013. PUB. 3-1-2005. INT. CL. 36.

HIKARI SALES USA, INC., HAYWARD, CA:
2,955,614. INT. CL. 1.

HILGRAEVE, INCORPORATED, MONROE, MI:
1,842,823. CANC. INT. CL. 9.

HILL DESIGN PRODUCTS, INC., MCHENRY, IL:
2,170,839. CANC. MULTIPLE CLASS, INT. CLS. 6 AND 19.

HILTON HOSPITALITY, INC., BEVERLY HILLS, CA:
2,954,994. PUB. 3-1-2005. INT. CL. 43.

HINSDALE BANK & TRUST COMPANY, HINSDALE, IL:
2,956,057. INT. CL. 36.

HINSON, JAMES WILLIAM, TALLAHASSEE, FL:
2,955,292. INT. CL. 39.

HITACHI HOME ELECTRONICS (AMERICA), INC, NORCROSS, GA:
2,171,393. CANC. INT. CL. 9.

HITACHI MEDICAL CORPORATION, CHIYODA-KU, TOKYO, JAPAN:
1,843,943. CANC. INT. CL. 10.

HITEC GROUP INTERNATIONAL, INC., BURR RIDGE, IL:
2,955,405. INT. CL. 9.

HITT, MICHAEL D., ABILENE, TX:
1,843,771. CANC. INT. CL. 28.

HIWAY FEDERAL CREDIT UNION, ST. PAUL, MN:
2,954,332. PUB. 3-1-2005. INT. CL. 36.

HMS NATIONAL, INC., FT. LAUDERDALE, FL:
2,954,486. PUB. 3-1-2005. INT. CL. 35.

HOANG, MAUREEN DAO, NEWPORT BEACH, CA:
2,954,818. PUB. 8-10-2004. INT. CL. 16.

HOBART BROTHERS COMPANY, TROY, OH:
1,284,112. CANC. INT. CL. 9.

HOCHTIEF AKTIENGESELLSCHAFT, 45128 ESSEN, FED REP GERMANY:
2,954,647. PUB. 6-8-2004. MULTIPLE CLASS, INT. CLS. 35, 36, 38 AND 39.

HODGMAN, INC., MONTGOMERY, IL:
2,955,453. INT. CL. 25.

- HOECHST AKTIENGESELLSCHAFT, D-6230 FRANKFURT AM MAIN 80, FED REP GERMANY:
1,283,940, CANC. INT. CL. 1.
- HOFFER, PETER, MONTREAL, QUEBEC, CANADA:
2,954,536, PUB. 3-1-2005. INT. CL. 16.
- HOIST FITNESS SYSTEMS, INC., SAN DIEGO, CA:
2,955,061, PUB. 3-1-2005. INT. CL. 28.
- HOLLANDER GLASS TEXAS, INC., HOUSTON, TX:
2,955,498, INT. CL. 19.
- HOLLOWAY, STEVEN H., CARMEL, IN:
2,956,309, INT. CL. 16.
- HOLMAN, MICHAEL J, NORTH SALT LAKE, UT:
2,955,479, INT. CL. 42.
- HOLMES PRODUCTS CORP., MILFORD, MA:
2,171,883, CANC. INT. CL. 11.
- HOM FURNITURE, INC., COON RAPIDS, MN:
2,954,983, PUB. 12-21-2004. INT. CL. 35.
- HOME DISCOVERE REAL ESTATE SERVICES CORPORATION, TAMPA, FL:
2,954,347, PUB. 3-1-2005. INT. CL. 36.
- HOME INSURANCE COMPANY, THE, NEW YORK, NY:
2,171,006, CANC. INT. CL. 36.
- HOME LINK SERVICES, INC., DALLAS, TX:
2,171,343, CANC. INT. CL. 35.
- HOMESERVICE OF AMERICA, INC., EDINA, MN:
2,956,118, INT. CL. 36.
- HON HAI PRECISION INDUSTRY CO., LTD., TU-CHENG CITY, TAIWAN:
2,956,016, INT. CL. 9.
- HONDA MOTOR CO., LTD., MINATO-KU, TOKYO 107-8556, JAPAN:
2,954,443, PUB. 3-1-2005. INT. CL. 16.
- HONEYWELL INC., MINNEAPOLIS, MN:
1,284,610, CANC. INT. CL. 37.
1,843,539, CANC. INT. CL. 9.
- HOOD, DREW D., PINE GROVE, CA:
2,955,283, INT. CL. 9.
- HOOKS, LEROY, CHICAGO, IL, DBA BROTHER KAH-NIYAH PEDICURE AND REFLEXOLOGY:
2,954,340, PUB. 3-1-2005. INT. CL. 3.
- HOPKINS MANUFACTURING CORPORATION, EMPORIA, KS:
1,324,094, REN. 4-14-05. MULTIPLE CLASS, INT. CLS. 8, 9 AND 21.
- HORICON BANK, HORICON, WI:
2,954,258, PUB. 3-1-2005. INT. CL. 36.
- HORIZON GLOBAL TRADING, LLC:
See— IDT HORIZON GT, INC.
- HORIZON INTERNATIONAL INC., KYOTO 601, JAPAN:
1,843,468, CANC. INT. CL. 7.
- HORN ABBOT LTD., TORONTO, ONTARIO, CANADA:
2,955,980, INT. CL. 41.
- HORN, RICHARD A, MURRIETA, CA:
2,956,318, INT. CL. 44.
- HORNBRUCH, FREDERICK W., III, OAKLAND, CA, PHILEAS FOGG'S, PALO ALTO, CA:
1,339,715, REN. 4-13-05. INT. CL. 42.
- HOTEL RESERVATION SERVICE ROBERT RAGGE GMBH, D-50667 COLOGNE, FED REP GERMANY:
2,187,049, CANC. MULTIPLE CLASS, INT. CLS. 39 AND 41.
- HOUSE OF BORKUM, RIFF AB, THE, S-118 84 STOCKHOLM, SWEDEN TO SWEDISH MATCH NORTH EUROPE AB, S-118 85 STOCKHOLM, SWEDEN:
1,843,848, CANC. INT. CL. 34.
- HOUSE OF HARLEY-DAVIDSON, INC., MILWAUKEE, WI:
2,954,259, PUB. 10-26-2004. INT. CL. 41.
- HOUSTON NUMISMATIC EXCHANGE, INC., HOUSTON, TX:
2,171,241, CANC. INT. CL. 14.
- HOUSTON RADIOLOGY, HOUSTON, TX AND RMI PHYSICIAN SERVICES CORPORATION, HOUSTON, TX:
2,954,190, PUB. 3-1-2005. INT. CL. 44.
2,954,191, PUB. 3-1-2005. INT. CL. 44.
2,954,192, PUB. 3-1-2005. INT. CL. 44.
2,954,193, PUB. 3-1-2005. INT. CL. 44.
2,954,194, PUB. 3-1-2005. INT. CL. 44.
2,954,195, PUB. 3-1-2005. INT. CL. 44.
- HSU LI, HSIU CHU, CHU PEI CITY, TAIWAN:
2,954,308, PUB. 12-28-2004. INT. CL. 9.
- HUANG, PATRICK, BURNABY, BRITISH COLUMBIA, CANADA, KESSLER MARKETING GROUP, INC., OWINGS MILLS, MD:
1,878,691, REN. 4-15-05. INT. CL. 21.
- HUCKABEE & ASSOCIATES, INC., FORT WORTH, TX:
2,955,035, PUB. 3-1-2005. INT. CL. 42.
- HUDGINS, GARY A., BRUNSWICK, GA:
2,954,325, PUB. 3-1-2005. INT. CL. 35.
- HUDSON CASTLE GROUP INC., TARRYTOWN, NY:
2,954,848, PUB. 3-1-2005. INT. CL. 36.
- HUDSON FOODS, INC., ROGERS, AR:
1,284,484, CANC. INT. CL. 29.
- HUDSON SOFT CO., LTD., HIRAGISHISANJO, TOYOHIRA, SAPPORO-SHI, JAPAN:
1,843,053, CANC. INT. CL. 28.
- HUDSON, SAUL, SHERMAN OAKS, CA:
2,171,528, CANC. INT. CL. 25.
- HUDSON, SUZAN J., HENDERSON, NV:
2,955,901, INT. CL. 16.
- HUFF INDUSTRIES, INC., CORINTH, MS:
1,881,826, REN. 4-9-05. INT. CL. 5.
- HUFFY CORPORATION, MIAMISBURG, OH:
1,843,592, CANC. INT. CL. 12.
- HUGFUN INTERNATIONAL, INC., LOS ANGELES, CA:
2,171,287, CANC. INT. CL. 28.
- HUGHES AIRCRAFT COMPANY, EL SEGUNDO, CA:
1,284,154, CANC. INT. CL. 9.
1,284,155, CANC. INT. CL. 9.
1,284,156, CANC. INT. CL. 9.
- HUMAN CAPITAL RESOURCES GROUP, LLC, THE, WALTHAM, MA:
2,956,125, MULTIPLE CLASS, INT. CLS. 35 AND 41.
- HUMAN SERVICE TECHNOLOGIES, CHICAGO, IL:
2,171,738, CANC. INT. CL. 42.
- HUME GROUP, INC., THE, ATLANTA, GA:
2,171,044, CANC. INT. CL. 16.
- HUMPHREY YOGART INTERNATIONAL, INC., LOS ANGELES, CA:
1,878,172, REN. 4-11-05. INT. CL. 42.
- HUNT IMAGING, LLC, STAMFORD, CT:
2,303,803, CANC. INT. CL. 16.
- HUNTSMAN ADVANCED MATERIALS AMERICAS INC., AUBURN HILLS, MI:
2,954,970, PUB. 3-1-2005. INT. CL. 1.
- HURLY BURLY PARTNERSHIP, SIMI VALLEY, CA:
2,954,985, PUB. 3-1-2005. INT. CL. 41.
- HUSKER AUTO GROUP, INC., LINCOLN, NE:
2,954,285, PUB. 3-1-2005. INT. CL. 35.
- HUSKY INJECTION MOLDING SYSTEMS LTD., BOLTON, ONTARIO, CANADA:
2,954,055, PUB. 3-1-2005. INT. CL. 7.
- HUTCHINS, CORRINE C., VICTORVILLE, CA:
2,954,372, PUB. 3-1-2005. INT. CL. 9.
- HUTCHINSON & GEBHARDT, INC., LILBURN, GA:
2,954,971, PUB. 3-1-2005. INT. CL. 6.
- HUTCHISON & MASON PLLC, RALEIGH, NC:
2,956,354, INT. CL. 42.
- HYDRODYNAMICS USA, INC., WELLINGTON, FL:
2,955,728, INT. CL. 12.
- HYE WEB PRODUCTIONS, LLC, GLENDALE, CA:
2,892,225, COR. INT. CL. 41.
- HYPRO CORPORATION, ST. PAUL, MN, EDWARDS MANUFACTURING, INC., MILWAUKIE, OR:
1,881,877, REN. 4-10-05. INT. CL. 7.
- I CAN'T BELIEVE IT'S YOGURT, LTD., DALLAS, TX:
1,284,749, CANC. INT. CL. 42.
- I.B.E. CO., LTD., HAZU-GUN, AICHI 444-07, JAPAN:
2,171,503, CANC. MULTIPLE CLASS, INT. CLS. 1 AND 3.
- ICE OCCASIONS PTY LTD, QUEENSLAND 4226, AUSTRALIA:
2,170,920, CANC. INT. CL. 30.
- ICICI INFOTECH LTD., VASHI NAVI MUMBAI 400 705, INDIA:
2,955,482, INT. CL. 9.

ICN PHARMACEUTICALS, INC., COSTA MESA, CA, DBA DARTELL LABORATORIES:
 1,284,014, CANC. INT. CL. 5.
 ICON CAPITAL CORP., NEW YORK, NY:
 2,955,718, INT. CL. 36.
 ICON IP, INC., LOGAN, UT:
 2,955,760, MULTIPLE CLASS, INT. CLS. 5, 9 AND 16.
 IDEAVILLAGE PRODUCTS CORP., FAIRFIELD, NJ:
 2,956,185, INT. CL. 8.
 IDEE & GESTALT SA, CH 8033 ZURICH, SWITZERLAND:
 2,954,153, PUB. 6-1-2004. INT. CL. 3.
 IDELIX SOFTWARE INC., VANCOUVER, BRITISH COLUMBIA V6B 5L1, CANADA:
 2,954,151, PUB. 11-23-2004. MULTIPLE CLASS, INT. CLS. 9 AND 42.
 IDETIX, INC., AUBURN HILLS, MI:
 2,954,760, PUB. 3-1-2005. INT. CL. 9.
 IDT HORIZON GT, INC., NEWARK, NJ FROM HORIZON GLOBAL TRADING, LLC, NEW YORK, NY:
 2,955,902, INT. CL. 36.
 IFSA, LLC, NEWTOWN, PA:
 2,908,456, COR. INT. CL. 36.
 IGIA SPECIALTY IMPORTS, INC., WEST HILLS, CA:
 2,955,325, INT. CL. 29.
 IGT, RENO, NV:
 2,955,621, INT. CL. 9.
 2,955,714, INT. CL. 9.
 2,955,717, INT. CL. 9.
 IKO INDUSTRIES LTD., TORONTO, ONTARIO M6A 3A1, CANADA:
 2,954,130, PUB. 6-29-2004. INT. CL. 19.
 ILIGHT TECHNOLOGIES, INC., EVANSTON, IL:
 2,955,146, PUB. 3-1-2005. INT. CL. 11.
 ILLINOIS INSTITUTE OF TECHNOLOGY, CHICAGO, IL:
 2,954,748, PUB. 3-1-2005. INT. CL. 35.
 ILLINOIS TOOL WORKS INC., GLENVIEW, IL:
 2,955,727, INT. CL. 1.
 ILLUSION, INC., WESTLAKE VILLAGE, CA:
 2,371,918, CANC. INT. CL. 41.
 2,371,919, CANC. INT. CL. 9.
 IMAGE PREMASTERING SERVICES, LTD., MINNEAPOLIS, MN TO MOSBY, INC., ST. LOUIS, MO:
 1,843,942, CANC. INT. CL. 9.
 IMAGEBUILDER SOFTWARE, INC., PORTLAND, OR:
 2,171,351, CANC. INT. CL. 9.
 IMAGEMASTER, INC., ANN ARBOR, MI:
 2,955,155, PUB. 3-1-2005. INT. CL. 40.
 IMAGINE INVESTMENT GROUP, INC., SAN ANTONIO, TX:
 2,956,230, INT. CL. 16.
 IMEDEX, INC., ALPHARETTA, GA:
 2,954,684, PUB. 3-1-2005. INT. CL. 41.
 IMI MARSTON LIMITED, FORDHOUSES, WOLVERHAMPTON, WV10 6QJ, ENGLAND:
 2,171,621, CANC. INT. CL. 11.
 IMI NORGREN, INC., LITTLETON, CO:
 793,181, REN. 4-13-05. U.S. CL. 13 (INT. CL. 6).
 IMLOGIC INC., WALTHAM, MA:
 2,954,841, PUB. 3-1-2005. INT. CL. 9.
 IMMTEC, INC., GOLDEN, CO:
 2,955,218, INT. CL. 9.
 IMPACT SOFTWARE SOLUTIONS, INC., ATLANTA, GA:
 2,956,139, INT. CL. 9.
 IMPERIAL SHEET METAL LTD., NEW BRUNSWICK, CANADA:
 2,955,929, MULTIPLE CLASS, INT. CLS. 11 AND 37.
 IMPLANT INNOVATIONS, INC., PALM BEACH GARDENS, FL:
 2,955,937, INT. CL. 40.
 IMPULSE JAPAN INC., TOKYO, JAPAN:
 2,955,737, INT. CL. 41.
 IMS SOFTWARE SERVICES, LTD., WILMINGTON, DE:
 2,954,623, PUB. 3-1-2005. MULTIPLE CLASS, INT. CLS. 9, 35 AND 42.
 IN THE SWIM, WEST CHICAGO, IL:
 2,956,270, INT. CL. 35.
 INAX CORPORATION, TOKONAME-SHI, AICHI, JAPAN:
 2,954,763, PUB. 9-28-2004. INT. CL. 11.
 INCAPITAL HOLDINGS, LLC, CHICAGO, IL:
 2,955,711, INT. CL. 42.
 INCHORD COMMUNICATIONS, INC., WESTERVILLE, OH:
 2,955,443, INT. CL. 35.
 INCISIVE SURGICAL, INC., PLYMOUTH, MN:
 2,954,503, PUB. 3-1-2005. INT. CL. 10.
 INCOM, INC., SOUTHBRIDGE, MA:
 1,843,516, CANC. INT. CL. 9.
 INCON DEVELOPMENT, INC., HUDSON, NY:
 2,171,625, CANC. MULTIPLE CLASS, INT. CLS. 3, 5, 10, 16, 21 AND 42.
 INDEPENDENT WAREHOUSE DISTRIBUTORS LLC, NEW HAVEN, CT:
 2,955,977, INT. CL. 37.
 2,955,978, INT. CL. 35.
 INDIA HOUSE OF MASS, INC., CAMBRIDGE, MA:
 2,892,025, COR. MULTIPLE CLASS, INT. CLS. 29, 30 AND 43.
 INDIANA MILLS & MANUFACTURING, INC., WESTFIELD, IN:
 2,171,536, CANC. INT. CL. 6.
 INDIGO CAPITAL, LLC, NEW YORK, NY:
 2,954,027, PUB. 3-1-2005. INT. CL. 36.
 INDOPCO, INC., BRIDGEWATER, NJ, DBA NATIONAL STARCH AND CHEMICAL COMPANY:
 2,955,070, PUB. 3-1-2005. INT. CL. 1.
 INDUSTRIAL MEDICAL CORPORATION, JACKSONVILLE, FL:
 1,843,136, CANC. INT. CL. 35.
 INDUSTRIAS TUGAL, S.A. DE C.V., OCOYOACAC, EDO. DE MEXICO C.P. 52740, MEXICO:
 2,954,204, PUB. 9-7-2004. INT. CL. 9.
 INDUSTRIES JARO INC., ST-CHARLES-DE-DRUMMOND, QUEBEC, CANADA:
 2,170,767, CANC. INT. CL. 6.
 INDUSTRYSUITE, INC., WARREN, NJ:
 2,954,069, PUB. 3-4-2003. INT. CL. 42.
 INET ACCESS, ATLANTA, GA:
 2,954,648, PUB. 3-1-2005. INT. CL. 9.
 INFAST S.R.L., 20143 - MILANO, ITALY:
 2,170,945, CANC. INT. CL. 6.
 INFINEON TECHNOLOGIES AG, MUNICH, FED REP GERMANY:
 2,954,735, PUB. 3-1-2005. MULTIPLE CLASS, INT. CLS. 9 AND 38.
 INFINITY BROADCASTING CORPORATION, NEW YORK, NY, WESTINGHOUSE BROADCASTING AND CABLE, INC., NEW YORK, NY:
 1,306,396, REN. 4-13-05. INT. CL. 38.
 INFINITY INTERNATIONAL HEALTH & BEAUTY, INC., ANAHEIM, CA:
 2,954,932, PUB. 3-1-2005. INT. CL. 3.
 INFOCUS CORPORATION, WILSONVILLE, OR:
 2,955,710, INT. CL. 9.
 INFORMATICA CORPORATION, REDWOOD CITY, CA:
 2,954,574, PUB. 3-1-2005. INT. CL. 9.
 INFORMATION ET DEVELOPPEMENT SOCIAL, PARIS, FRANCE:
 2,954,875, PUB. 3-1-2005. MULTIPLE CLASS, INT. CLS. 16, 35 AND 41.
 INFOSPACE, INC., BELLEVUE, WA:
 2,956,224, INT. CL. 35.
 INFOTEC DEVELOPMENT, INCORPORATED, SANTA ANA, CA:
 2,170,621, CANC. MULTIPLE CLASS, INT. CLS. 37 AND 42.
 INGRAM ENTERPRISES, INC., SPRINGFIELD, MO:
 1,906,460, REN. 4-13-05. INT. CL. 13.
 INGRAM INDUSTRIES INC., NASHVILLE, TN TO INGRAM ENTERTAINMENT INC., LA VERGNE, TN:
 1,843,959, CANC. INT. CL. 16.
 INNER-CITY GAMES FOUNDATION, SANTA MONICA, CA:
 2,171,707, CANC. MULTIPLE CLASS, INT. CLS. 14, 18 AND 25.
 INNOTEK, INC., GARRETT, IN:
 2,955,832, INT. CL. 9.

- INNOVASIVE DEVICES, INC., MARLBOROUGH, MA:
2,171,224, CANC. INT. CL. 10.
- INNSOFT, INC., BEAVERTON, OR, INNSOFT LP, BEAVERTON, OR:
1,901,486. REN. 4-10-05. MULTIPLE CLASS, INT. CLS. 9 AND 16.
- INPACEL INDUSTRIA DE PAPEL ARAPOTI S/A, STATE OF PARANA, BRAZIL:
1,843,618, CANC. INT. CL. 16.
- INPHO, INC., BOSTON, MA:
1,843,177, CANC. INT. CL. 36.
- INPOD, INC., AUSTIN, TX:
2,171,183, CANC. INT. CL. 9.
- INPUT-EZ CORPORATION, DENVER, CO:
1,284,340, CANC. INT. CL. 20.
- INSL-X PRODUCTS CORPORATION, STONY POINT, NY:
2,955,457, INT. CL. 2.
- INSMED INCORPORATED, GLEN ALLEN, VA:
1,823,573. REN. 4-11-05. INT. CL. 5.
- INSPIRATIONAL NETWORK, INC., THE, CHARLOTTE, NC:
2,955,210, MULTIPLE CLASS, INT. CLS. 16 AND 41.
2,955,217, MULTIPLE CLASS, INT. CLS. 16, 38 AND 41.
- INSTAGARDEN CORPORATION, FORT COLLINS, CO:
2,955,506, MULTIPLE CLASS, INT. CLS. 19 AND 21.
- INSTITUTE FOR COMMUNITY PEACE, WASHINGTON, DC:
2,956,281, INT. CL. 41.
- INSTITUTE OF INTERNAL AUDITORS, ALTAMONTE SPRINGS, FL:
1,882,539. REN. 4-15-05. INT. CL. 41.
- INSTORECARD, INC., SAN FRANCISCO, CA:
2,956,180, INT. CL. 35.
- INSTRUMENT SOCIETY OF AMERICA, RESEARCH TRIANGLE PARK, NC:
1,284,723, CANC. INT. CL. 42.
1,284,725, CANC. INT. CL. 42.
1,284,726, CANC. INT. CL. 42.
1,284,727, CANC. INT. CL. 42.
1,284,805, CANC. U.S. CL. 200.
1,284,806, CANC. U.S. CL. 200.
- INTECH TECHNOLOGY CORPORATION, BROADVIEW, IL, DBA INTECH EDM:
1,881,730. REN. 4-10-05. MULTIPLE CLASS, INT. CLS. 1, 7 AND 9.
- INTEGRATED MANAGEMENT SOLUTIONS, INC., HUNTSVILLE, AL:
2,954,898, PUB. 3-1-2005. INT. CL. 9.
- INTEGRATED SYSTEMS EVENTS LLC, FAIRFAX, VA:
2,956,011, INT. CL. 35.
- INTELLIGENT INSTRUMENTATION, INC., TUCSON, AZ:
2,171,659, CANC. INT. CL. 9.
- INTELLISEEK, INC., CINCINNATI, OH:
2,954,935, PUB. 3-1-2005. INT. CL. 35.
- INTELLITEK, INC., OMAHA, NE:
2,171,162, CANC. INT. CL. 35.
- INTER-IMAGES PARTNERS, LP, FORT WORTH, TX:
2,954,802, PUB. 3-1-2005. INT. CL. 9.
- INTER-STATE ASSURANCE COMPANY, DES MOINES, IA:
2,171,002, CANC. INT. CL. 36.
- INTERACTIVE HEALTH, LLC, LONG BEACH, CA:
2,955,985, INT. CL. 10.
- INTERBATH, INC., CITY OF INDUSTRY, CA:
2,954,722, PUB. 3-1-2005. INT. CL. 11.
- INTERCO GESELLSCHAFT FUR DIE PLANUNG UND DEN VERTRIEB VON REHA HILFEN MBH, 53783 EITORF, FED REP GERMANY:
2,954,142, PUB. 6-1-2004. MULTIPLE CLASS, INT. CLS. 10 AND 12.
- INTERCOOKIES GEBÄCK-; UND KUCHENSPEZIALITÄTEN GMBH, FED REP GERMANY:
2,955,182, PUB. 3-1-2005. INT. CL. 30.
- INTERMIX MEDIA, INC., LOS ANGELES, CA:
2,955,231, MULTIPLE CLASS, INT. CLS. 9 AND 41.
- INTERNATIONAL COATINGS LIMITED, LONDON, UNITED KINGDOM, INTERNATIONAL PAINT COMPANY, INC., UNION, NJ:
1,322,839. REN. 4-13-05. INT. CL. 2.
- INTERNATIONAL COMMERCIAL TELEVISION, INC., BAINBRIDGE ISLAND, WA:
2,955,693, INT. CL. 1.
- INTERNATIONAL DATA GROUP, INC., FRAMINGHAM, MA:
2,170,917, CANC. INT. CL. 28.
2,171,380, CANC. INT. CL. 42.
2,954,858, PUB. 3-1-2005. INT. CL. 35.
2,955,964, INT. CL. 16.
- INTERNATIONAL FROZEN FOODS, LLC., CASTROVILLE, CA:
2,954,301, PUB. 3-1-2005. INT. CL. 29.
- INTERNATIONAL GEM & JEWELRY SHOW, INC., ROCKVILLE, MD:
2,954,355, PUB. 3-1-2005. INT. CL. 35.
- INTERNATIONAL MASTERS PUBLISHERS AB, MALMO, SWEDEN:
2,955,071, PUB. 3-1-2005. INT. CL. 16.
2,955,651, INT. CL. 16.
- INTERNATIONAL MERCHANDISE COMPANY OF ILLINOIS, INC., CHICAGO, IL:
1,343,937, CANC. INT. CL. 9.
- INTERNATIONAL NETWORKS, LLC, PHILADELPHIA, PA:
1,948,719. REN. 4-14-05. MULTIPLE CLASS, INT. CLS. 38 AND 41.
- INTERNATIONAL NEWS, INC., KENT, WA:
1,843,705, CANC. INT. CL. 25.
- INTERNATIONAL PACIFIC SEAFOODS, INC., SOUTH EL MONTE, CA:
1,843,801, CANC. INT. CL. 29.
- INTERNATIONAL PAPER COMPANY, STAMFORD, CT:
1,284,300, CANC. INT. CL. 16.
2,170,910, CANC. INT. CL. 17.
2,172,032, CANC. INT. CL. 16.
- INTERNATIONAL PAPER TRADEMARK COMPANY, TUXEDO, NY:
2,954,738, PUB. 10-26-2004. INT. CL. 16.
- INTERNATIONAL REGISTRY OF BACKSTABBERS, INC., THE, ATLANTA, GA:
2,955,975, INT. CL. 41.
- INTERNATIONAL RESTAURANT CONCEPTS, LLC, LAKEWOOD, CO:
2,955,668, INT. CL. 43.
- INTERNATIONAL ROTEX, INC., SPARKS, NV:
772,777, CANC. U.S. CL. 23.
- INTERNATIONAL TRADING HOUSE, LLC, ALPHARETTA, GA:
2,955,734, INT. CL. 9.
- INTERNATIONAL WOMEN'S APPAREL, INC., NEW YORK, NY:
2,955,147, PUB. 3-1-2005. INT. CL. 24.
- INTERNUTRIA, INC., FRAMINGHAM, MA:
2,172,011, CANC. INT. CL. 32.
- INTERSTATE BAKERIES CORPORATION, KANSAS CITY, MO:
2,954,041, PUB. 3-1-2005. INT. CL. 30.
- INTERSTATE MEAT DIST., INC., CLACKAMAS, OR:
2,954,500, PUB. 3-1-2005. INT. CL. 29.
- INTERSTATE OPERATING COMPANY, LP, ARLINGTON, VA:
2,955,315, INT. CL. 43.
- INTERVET, INC., MILLSBORO, DE:
1,843,442, CANC. INT. CL. 5.
- INTEX DIY, INC., VILLA RICA, GA:
2,955,627, INT. CL. 21.
- INTIMATE BEAUTY CORPORATION, NEW YORK, NY, DBA VICTORIA'S SECRET BEAUTY:
2,955,743, INT. CL. 30.
- INVACARE CORPORATION, ELYRIA, OH:
2,171,646, CANC. INT. CL. 12.
- INVERSIONES HOSPITALARIAS SOCIEDAD ANONIMA DE CAPITAL VARIABLE, SANTA ANA, EL SALVADOR:
2,954,791, PUB. 8-31-2004. INT. CL. 5.
- INVESTMENT CONSULTING AND RESEARCH, INC., CLEVELAND, OH:
2,956,134, INT. CL. 36.
- IPFLEX INC., TOKYO 141-0021, JAPAN:
2,954,351, PUB. 3-1-2005. INT. CL. 9.

IPROGRESS, PUTEAUX, FRANCE:
2,955,220, INT. CL. 41.

IPS CORPORATION, GARDENA, CA:
1,937,647. REN. 4-12-05. INT. CL. 1.

IRON AGE CORPORATION, PITTSBURGH, PA:
2,171,489, CANC. INT. CL. 25.

IRON GRIP BARBELL COMPANY, INC., SANTA ANA, CA:
2,955,954, INT. CL. 9.

IRONCLAD PERFORMANCE WEAR CORP., LOS ANGELES, CA:
2,954,213, PUB. 8-24-2004. INT. CL. 25.
2,955,463, INT. CL. 40.

IRVING-CLOUD PUBLISHING COMPANY, THE, CHICAGO, IL:
186,389, CANC. U.S. CL. 38.

IRWIN PRODUCTIONS, INC., CARLSBAD, CA:
2,170,632, CANC. INT. CL. 41.

ISAACSON, RICH, TARRYTOWN, NY AND COOKMAN, TOMAS, TARRYTOWN, NY AND BLAIR, JERRY, TARRYTOWN, NY:
2,955,352, INT. CL. 9.

ISG TECHNOLOGIES INC., TORONTO, ONTARIO L4V 1S8, CANADA TO SURGICAL NAVIGATION SPECIALISTS INC., MISSISSAUGA, ONTARIO, CANADA:
1,842,709, CANC. INT. CL. 9.

ISI BRANDS INC., GRAND RAPIDS, MI:
2,170,812, CANC. INT. CL. 5.

ISLAND GETAWAY, LTD., HILTON HEAD ISLAND, SC:
1,880,038. REN. 4-14-05. INT. CL. 36.

ISLAS, AARON PEDRAZA, COLONIA EJIDO DE SAN JUAN DE ARUGON, MEXICO:
2,954,210, PUB. 3-1-2005. INT. CL. 41.

IT CORPORATION, MONROEVILLE, PA:
1,843,360, CANC. MULTIPLE CLASS, INT. CLS. 39 AND 42.

IT PAYS, INC., GRAND HAVEN, MI:
2,954,622, PUB. 3-1-2005. INT. CL. 16.

ITALIAN TRADE COMMISSION, LOS ANGELES, CA:
2,955,072, PUB. 3-1-2005. INT. CL. 35.

IZ TECHNOLOGY CORPORATION, NEW WESTMINSTER, BRITISH COLUMBIA, CANADA:
2,955,214, INT. CL. 9.

IZUMI PRODUCTS COMPANY, MATSUMOTO, NAGANO, JAPAN:
2,955,434, INT. CL. 8.
2,955,435, INT. CL. 8.

J & B DISTRIBUTING CO., CHICAGO, IL:
2,171,115, CANC. INT. CL. 16.

J & M APPLIED TECHNOLOGY, INC., VALENCIA, CA, DBA APTEK LABORATORIES, INC.:
2,954,514, PUB. 3-1-2005. INT. CL. 1.

J BOATS INC., NEWPORT, RI:
1,880,696. REN. 4-14-05. INT. CL. 25.

J. EDWARD CONNELLY ASSOCIATES, INC., PITTSBURGH, PA:
2,171,699, CANC. INT. CL. 42.

J. FRANK SCHMIDT & SON CO., BORING, OR:
2,955,466, INT. CL. 31.

J.D. CALATO MANUFACTURING CO., INC., NIAGARA FALLS, NY:
2,954,328, PUB. 3-1-2005. INT. CL. 15.

J.E. MORGAN KNITTING MILLS, INC., HOMETOWN, PA:
1,853,120. REN. 4-10-05. INT. CL. 24.

J.K. JEWELRY, INC., ROCHESTER, NY:
1,892,076. REN. 4-9-05. INT. CL. 14.

JÜRGENS FINE JEWELRY, INC., NORTH BEND, OR:
2,954,814, PUB. 3-1-2005. INT. CL. 14.

JACKSON HEWITT INC., VIRGINIA BEACH, VA:
2,171,059, CANC. INT. CL. 36.
2,171,110, CANC. INT. CL. 36.
2,171,131, CANC. INT. CL. 36.

JACKSON STATE UNIVERSITY, JACKSON, MS:
2,227,579, CANC. MULTIPLE CLASS, INT. CLS. 18 AND 28.

JADO BATHROOM AND HARDWARE MANUFACTURING CORPORATION, SCOTTSDALE, AZ:
1,881,480. REN. 4-12-05. INT. CL. 21.

JAJA GOLD INTERNATIONAL, LTD., HOLON, ISRAEL:
2,171,701, CANC. INT. CL. 14.

JAMAICA JOE'S, INC., FT. WALTON BEACH, FL:
1,284,422, CANC. INT. CL. 25.

JAMBA JUICE COMPANY, SAN FRANCISCO, CA:
2,954,776, PUB. 3-1-2005. INT. CL. 32.

JAME FINE CHEMICALS, INC., BOUND BROOK, NJ:
2,171,539, CANC. INT. CL. 1.
2,171,540, CANC. INT. CL. 1.

JANUS CAPITAL CORPORATION, DENVER, CO:
2,170,949, CANC. INT. CL. 36.

JAS. D. EASTON, INC., VAN NUYS, CA:
2,954,769, PUB. 5-4-2004. INT. CL. 28.

JASPER PRODUCTIONS, INC., SADDLE RIVER, NJ:
2,954,603, PUB. 10-5-2004. INT. CL. 41.

JAY-ROC MARKETING INC., WOODSIDE, NY:
2,956,342, INT. CL. 35.

JAYSIX USA, FREDERICKSBURG, VA:
2,955,771, INT. CL. 25.

JCB CO., LTD., JAPAN:
2,955,176, PUB. 3-1-2005. INT. CL. 36.

JEFFREY S. BROOKS, INC., CREVE COEUR, MO:
2,955,559, INT. CL. 25.

JEFFREY'S, INC., WASHINGTON, DC:
1,284,767, CANC. INT. CL. 42.

JEL SERT COMPANY, THE, WEST CHICAGO, IL:
987,457, CANC. U.S. CL. 46.

JENNIE-O TURKEY STORE, LLC, WILLMAR, MN:
2,954,277, PUB. 3-1-2005. INT. CL. 29.

JENOPTIK LASER, OPTIK, SYSTEME GMBH, D-07745 JENA, FED REP GERMANY:
2,954,771, PUB. 3-1-2005. INT. CL. 9.

JESCO INDUSTRIES, INC., LITCHFIELD, MI:
2,170,936, CANC. MULTIPLE CLASS, INT. CLS. 6 AND 12.

JESSICA MCCLINTOCK, INC., SAN FRANCISCO, CA:
2,955,201, INT. CL. 25.

JETTY LIFE, LLC, MANAHAWKIN, NJ:
2,956,029, INT. CL. 25.

JIFFY STEAMER COMPANY, LLC, UNION CITY, TN, SIMRELL, JOHN B., FULTON, KY, DBA JIFFY STEAMER CO.:
795,156. REN. 4-15-05. U.S. CL. 24 (INT. CL. 7).

JJI INTERNATIONAL, INC., WARWICK, RI:
2,955,536, INT. CL. 14.

JKA, INC, WOONSOCKET, RI:
2,955,415, INT. CL. 21.

JLB CORPORATION, HONOLULU, HI:
2,954,613, PUB. 3-1-2005. INT. CL. 25.

JOHANNA FOODS, INC., FLEMINGTON, NJ:
2,171,948, CANC. INT. CL. 29.

JOHN BODGER & SONS COMPANY, SOUTH EL MONTE, CA:
2,954,978, PUB. 3-1-2005. INT. CL. 31.
2,954,979, PUB. 3-1-2005. INT. CL. 31.

JOHN E. BARRY PLUMBING & HEATING CORP., CAPITOL HEIGHTS, MD:
2,954,491, PUB. 3-1-2005. INT. CL. 37.

JOHN LUND AND COMPANY, DENVER, CO:
772,923, CANC. U.S. CL. 46.

JOHN PAUL MITCHELL SYSTEMS, SAUGUS, CA:
2,955,887, INT. CL. 41.

JOHN RICH & SONS INVESTMENT HOLDING COMPANY, WILMINGTON, DE:
2,901,777, COR. MULTIPLE CLASS, INT. CLS. 9, 18, 20 AND 21.

JOHN T. DAVIS OIL CO., INC., ANNISTON, AL:
2,171,215, CANC. INT. CL. 7.
2,171,216, CANC. INT. CL. 11.

JOHN WILEY & SONS, INC., NEW YORK, NY:
1,842,898, CANC. INT. CL. 16.

JOHNSEN & JORGENSEN (PLASTICS) LIMITED, LONDON, ENGLAND:
1,284,356, CANC. INT. CL. 20.

JOHNSON & JOHNSON, NEW BRUNSWICK, NJ:
1,842,831, CANC. INT. CL. 10.
2,954,255, PUB. 3-1-2005. INT. CL. 3.
2,954,257, PUB. 3-1-2005. MULTIPLE CLASS, INT. CLS. 5

- AND 16.
 JOHNSON, LEWIS WALLACE, OROVILLE, CA:
 2,954,493, PUB. 3-1-2005. INT. CL. 29.
- JOHNSON, ROYA, AUSTIN, TX:
 2,170,645, CANC. MULTIPLE CLASS, INT. CLS. 35 AND 42.
- JOHNSON, TERRI LYNNE, CONCORD, CA:
 2,956,109, INT. CL. 16.
- JOHNSTON, LOUISE D., HENDERSONVILLE, NC:
 1,842,918, CANC. INT. CL. 16.
- JONES INTERNATIONAL, LTD., ENGLEWOOD, CO:
 1,284,142, CANC. INT. CL. 9.
 2,171,849, CANC. MULTIPLE CLASS, INT. CLS. 38 AND 41.
- JONES, GREGORY, MACON, GA, DBA PHOENIX SOUND RECORDING:
 2,171,467, CANC. INT. CL. 9.
- JONES, HARVEY N., SEATTLE, WA:
 2,955,800, INT. CL. 25.
- JONES, M. LEE, ATLANTA, GA:
 2,184,389, CANC. INT. CL. 6.
 2,184,390, CANC. INT. CL. 6.
- JONESHEIRS, INC., ATLANTA, GA:
 2,955,055, PUB. 3-1-2005. INT. CL. 25.
- JORDAN OUTDOOR ENTERPRISES, LTD., COLUMBUS, GA:
 2,954,152, PUB. 3-1-2005. MULTIPLE CLASS, INT. CLS. 9 AND 41.
- JOSEPH S. STURNIOLO AND ASSOCIATES, INC., DENVER, CO:
 2,955,425, INT. CL. 36.
- JOSS PRODUCTIONS, INC., ALBANY, NY:
 2,954,784, PUB. 3-1-2005. INT. CL. 16.
- JOYMASTER, INC., NEIHU CHIU, TAIPEI, TAIWAN:
 2,954,292, PUB. 3-1-2005. INT. CL. 9.
- JOYRIGGS CORPORATION, LAS VEGAS, NV:
 2,954,430, PUB. 3-1-2005. INT. CL. 25.
- JSR CORPORATION, TOKYO, JAPAN:
 2,954,678, PUB. 1-6-2004. MULTIPLE CLASS, INT. CLS. 1 AND 7.
 2,954,698, PUB. 6-1-2004. MULTIPLE CLASS, INT. CLS. 1 AND 7.
- JT INTERNATIONAL DISTRIBUTORS, INC., INDIANAPOLIS, IN:
 2,954,801, PUB. 3-1-2005. INT. CL. 18.
- JULIEN FAREL LLC, NEW YORK, NY:
 2,954,115, PUB. 3-1-2005. INT. CL. 44.
- JULIEN, NEAL B., PHOENIX, AZ:
 2,171,624, CANC. INT. CL. 30.
- JUMPNASTICS, LLC, MT. PLEASANT, SC:
 2,954,892, PUB. 3-1-2005. INT. CL. 41.
- JUNKER, BETH, MARIETTA, GA:
 2,171,248, CANC. INT. CL. 41.
 2,171,254, CANC. INT. CL. 41.
- JUST THE THING, INC., ATLANTA, GA:
 2,954,386, PUB. 3-1-2005. INT. CL. 35.
- JUSTRITE MANUFACTURING COMPANY, INC., DES PLAINES, IL, DBA HAZ-STOR COMPANY:
 1,842,651, CANC. INT. CL. 6.
- K. VAN BOURGONDEN & SONS, INC., BABYLON, NY:
 1,885,160, REN. 4-13-05. MULTIPLE CLASS, INT. CLS. 31 AND 42.
- K.L.H. DIAMONDS INC., NEW YORK, NY:
 2,954,524, PUB. 3-1-2005. INT. CL. 14.
- K-WAY, INC., TEMPE, AZ, DBA KLEIN ENGINE DEVELOPMENT:
 2,171,661, CANC. INT. CL. 7.
- KABUSHIKI KAISHA FOUR SEEDS, MINATO-KU, TOKYO, JAPAN:
 2,913,568, COR. INT. CL. 43.
- KABUSHIKI KAISHA HITACHI SEISAKUSHO, CHIYODAKU, TOKYO, JAPAN, DBA HITACHI, LTD.:
 2,955,229, INT. CL. 42.
- KABUSHIKI KAISHA HITACHI SEISAKUSHO, TOKYO, JAPAN, DBA HITACHI, LTD.:
 2,955,230, INT. CL. 36.
- KABUSHIKI KAISHA RED ENTERTAINMENT, TOKYO, JAPAN:
 2,955,199, MULTIPLE CLASS, INT. CLS. 9 AND 16.
- KABUSHIKI KAISHA SEGA, TOKYO, JAPAN, DBA SEGA CORPORATION:
 2,955,447, INT. CL. 28.
- KABUSHIKI KAISHA SQUARE ENIX, TOKYO, JAPAN, TA SQUARE ENIX CO., LTD.:
 2,955,682, INT. CL. 28.
- KABUSHIKI KAISHA VILLAGE RECORD, TOKYO 150-0011, JAPAN:
 2,954,163, PUB. 12-28-2004. MULTIPLE CLASS, INT. CLS. 9, 16, 41 AND 43.
- KAHALA FRANCHISE CORP., SCOTTSDALE, AZ:
 2,171,916, CANC. INT. CL. 42.
- KALAMAZOO PICTURES GROUP, LLC, KALAMAZOO, MI:
 2,956,355, INT. CL. 41.
- KALMUS, FRED, MARCO ISLAND, FL, DBA BEECHWOOD INTERNATIONAL:
 2,171,208, CANC. INT. CL. 35.
 2,171,209, CANC. INT. CL. 35.
- KAMAN AEROSPACE CORPORATION, BLOOMFIELD, CT:
 1,843,543, CANC. INT. CL. 9.
- KAMAT GROUP LLC, LOUISVILLE, KY:
 2,956,090, INT. CL. 34.
- KAMAX-WERKE RUDOLF KELLENNANN GMBH & CO. KG, D-37520 OSTERODE, FED REP GERMANY:
 2,954,103, PUB. 8-31-2004. MULTIPLE CLASS, INT. CLS. 6 AND 7.
- KAMSUT, INC., WESTLAKE VILLAGE, CA, AKA THE KAMA SUTRA COMPANY:
 1,284,412, CANC. INT. CL. 25.
- KAMSUT, INC., WESTLAKE VILLAGE, CA:
 2,954,252, PUB. 5-18-2004. INT. CL. 5.
- KANGOL LIMITED, CLEATOR, CUMBRIA CA23 3DJ, UNITED KINGDOM:
 2,170,779, CANC. MULTIPLE CLASS, INT. CLS. 9 AND 28.
- KAPLAN HIGHER EDUCATION CORPORATION, ROSWELL, GA:
 2,954,967, PUB. 3-1-2005. INT. CL. 41.
- KAPPA KAPPA GAMMA FRATERNITY, COLUMBUS, OH:
 2,955,476, MULTIPLE CLASS, INT. CLS. 14, 16, 25, 41 AND 42.
- KAPRO INDUSTRIES LTD., HAKERAM, 12390, ISRAEL:
 2,954,477, PUB. 3-1-2005. INT. CL. 9.
- KARL STORZ GMBH & CO. KG, D-78532 TUTTLINGEN, FED REP GERMANY:
 2,954,118, PUB. 9-21-2004. MULTIPLE CLASS, INT. CLS. 9 AND 10.
 2,954,131, PUB. 10-5-2004. MULTIPLE CLASS, INT. CLS. 9 AND 10.
 2,954,144, PUB. 11-9-2004. MULTIPLE CLASS, INT. CLS. 9 AND 10.
- KARL STORZ GMBH & CO. KG, TUTTLINGEN, FED REP GERMANY:
 2,954,683, PUB. 5-25-2004. INT. CL. 10.
- KARL STORZ GMBH & CO. KG, D-78532 TUTTLINGEN, FED REP GERMANY:
 2,955,805, INT. CL. 10.
- KARLEN MANUFACTURING, INC, ST. CHARLES, MI:
 2,171,160, CANC. INT. CL. 21.
- KARSTEN MANUFACTURING CORPORATION, PHOENIX, AZ:
 2,955,610, INT. CL. 28.
- KARSYAN, MICHAEL, TAGANROG, RUSSIAN FED. AND SHELUDKO, IGOR, TAGANROG, RUSSIAN FED.:
 2,956,006, INT. CL. 9.
- KAYLA FOODS, INC., CARROLLTON, TX:
 2,171,083, CANC. INT. CL. 35.
- KAYSER-ROTH CORPORATION, NEW YORK, NY:
 1,284,408, CANC. INT. CL. 25.
 1,284,409, CANC. INT. CL. 25.
- KAZA AZTECA AMERICA, INC., GLENDALE, CA:
 2,955,865, INT. CL. 41.
- KBS INCORPORATED, DEERFIELD BEACH, FL:
 2,170,689, CANC. MULTIPLE CLASS, INT. CLS. 40 AND 42.

KEDA, LLC, CARSON, CA:
2,954,723, PUB. 9-28-2004. INT. CL. 25.

KEENEY, TOMMY W., JR., KNOXVILLE, TN:
2,171,231, CANC. INT. CL. 35.

KEITH, CARLTON L., CHESTERFIELD, VA:
2,171,697, CANC. INT. CL. 9.

KELLEY, LYNN, SCOTTSDALE, AZ:
2,956,313, INT. CL. 35.

KELLNER, RICHARD S., NEW YORK, NY:
2,172,039, CANC. MULTIPLE CLASS, INT. CLS. 16, 21 AND 25.

KELSENBISCA A/S, NORRE-SNEDE, DENMARK:
2,954,852, PUB. 3-1-2005. INT. CL. 30.

KEMIRA AGRO OY, 00180 HELSINKI, FINLAND:
2,752,160, COR. MULTIPLE CLASS, INT. CLS. 1 AND 5.

KEMRITE COMPANY, INC., CHANNAHON, IL:
2,954,455, PUB. 3-1-2005. INT. CL. 19.

KEN-CO INDUSTRIES, INC., ORLANDO, FL:
2,954,974, PUB. 3-1-2005. INT. CL. 11.

KENAF PRODUCT MARKETING INC., ATLANTA, GA:
2,171,584, CANC. INT. CL. 31.

KENDAL INTERNATIONAL COMPANY, MASPETH, NY:
2,955,561, MULTIPLE CLASS, INT. CLS. 7 AND 11.

KENDALL MCGAW LABORATORIES, INC., IRVINE, CA:
1,284,021, CANC. INT. CL. 5.

KENOVER MARKETING CORP., BROOKLYN, NY:
2,955,478, INT. CL. 21.

KERR-MCGEE REFINING CORPORATION, OKLAHOMA CITY, OK:
1,284,008, CANC. INT. CL. 4.

KESSLER, CRAIG, IRVING, TX:
2,954,861, PUB. 3-1-2005. INT. CL. 45.

KESTREL TECHNOLOGIES, INC., NEW YORK, NY:
2,954,050, PUB. 5-21-2002. MULTIPLE CLASS, INT. CLS. 9 AND 42.

KEY INSTITUTE FOR LEARNING STRATEGIES, INC., CORTLANDT MANOR, NY:
1,878,942, REN. 4-15-05. INT. CL. 41.

KEY-TRAK, INC., HOUSTON, TX:
2,955,112, PUB. 3-1-2005. INT. CL. 9.

KEYCORP, CLEVELAND, OH:
2,170,944, CANC. INT. CL. 36.

KEYPORT LIFE INSURANCE COMPANY, BOSTON, MA:
1,322,520, REN. 4-12-05. INT. CL. 36.

KEYS FEDERAL CREDIT UNION, KEY WEST, FL:
2,954,543, PUB. 3-1-2005. INT. CL. 36.

KEYS PRINTING COMPANY, INC., GREENVILLE, SC:
2,171,263, CANC. INT. CL. 42.

KEYTOUCH CORPORATION, WALNUT, CA:
2,955,647, INT. CL. 9.

KG INTERNATIONAL FZCO, DUBAI, ARAB EMIRATES:
2,954,616, PUB. 3-1-2005. INT. CL. 7.

KHF SPORTS OY, 30100 FORSSA, FINLAND, TITAN ICE TIME PRODUCTS, STE. ADELE, QUEBEC, CANADA:
991,120, REN. 4-13-05. INT. CL. 28.

KHWY, INC., LOS ANGELES, CA:
2,955,042, PUB. 3-1-2005. INT. CL. 38.

KIDS RAGS, INC., RIVERSIDE, CA:
2,956,052, INT. CL. 25.

KIDZAAM, LLC, PRESCOTT, AZ:
2,955,375, INT. CL. 44.
2,955,416, INT. CL. 44.

KIENE DIESEL ACCESSORIES, INC., ADDISON, IL:
1,901,643, REN. 4-15-05. INT. CL. 9.

KIKKOMAN CORPORATION, NODA CITY, CHIBA, JAPAN:
1,902,904, REN. 4-15-05. INT. CL. 30.

KIM SU SEAFOOD RESTAURANT, INC., WESTMINSTER, CA:
1,843,300, CANC. INT. CL. 42.

KIM, JONG GILL, SUCHO-KU, SEOUL, REPUBLIC OF KOREA:
1,871,036, REN. 4-13-05. INT. CL. 7.

KIMBERTON ENTERPRISES, INC., WILMINGTON, DE:
1,011,291, REN. 4-13-05. MULTIPLE CLASS, INT. CLS. 2 AND 19.

KINETIC CONCEPTS, INC., SAN ANTONIO, TX:
1,843,661, CANC. INT. CL. 20.
2,171,605, CANC. MULTIPLE CLASS, INT. CLS. 9 AND 16.

KING OF KINGS LUTHERAN CHURCH, U.A.C., OMAHA, NE:
2,954,162, PUB. 3-1-2005. INT. CL. 9.

KING PHARMACEUTICALS, INC., BRISTOL, TN:
2,954,783, PUB. 3-1-2005. INT. CL. 5.

KING PLASTIC CORPORATION, NORTH PORT, FL:
2,954,297, PUB. 3-1-2005. INT. CL. 20.

KINGPIN PRODUCTIONS, LTD., NEW YORK, NY:
2,170,924, CANC. INT. CL. 25.

KINGSLEY, TODD, STANTON ISLAND, NY:
2,955,212, INT. CL. 35.

KINNARPS AKTIEBOLAG, FALKOPING, SWEDEN:
1,323,280, REN. 4-12-05. INT. CL. 20.
1,323,281, REN. 4-12-05. INT. CL. 20.

KIP MCGRATH EDUCATION CENTRES CORPORATION, NEWCASTLE, NSW, AUSTRALIA:
2,954,831, PUB. 3-1-2005. INT. CL. 41.

KIRLIN INDUSTRIES, INC., ONTARIO, CA:
2,956,357, INT. CL. 9.

KLC LAND COMPANY, LLC, HONOLULU, HI, AMFAC/JMB HAWAII, INC., HONOLULU, HI:
1,851,748, REN. 4-15-05. INT. CL. 41.

KLEINMAN, KELLY, WESTLAKE VILLAGE, CA:
2,954,446, PUB. 3-1-2005. INT. CL. 25.

KLEMTNER ADVERTISING, INC., NEW YORK, NY:
2,171,146, CANC. INT. CL. 41.
2,171,147, CANC. INT. CL. 41.
2,171,148, CANC. INT. CL. 41.

KLUTZ, PALO ALTO, CA:
1,884,919, REN. 4-15-05. INT. CL. 16.

KMD MEDIA, L.L.C., MCLEAN, VA:
2,954,445, PUB. 3-1-2005. INT. CL. 16.

KMJ L.L.C., TULSA, OK:
2,955,948, INT. CL. 25.

KNOXVILLE NEWS-SENTINEL COMPANY, INC., THE, KNOXVILLE, TN:
2,172,059, CANC. INT. CL. 16.

KOCHEM, HANS-GUENTER, D-45134 ESSEN, FED REP GERMANY:
2,954,695, PUB. 3-1-2005. INT. CL. 5.

KODAK POLYCHROME GRAPHICS LLC, NORWALK, CT:
2,956,130, INT. CL. 7.

KOHR BROTHERS, INC., CHARLOTTESVILLE, VA:
2,171,747, CANC. INT. CL. 30.
2,171,748, CANC. INT. CL. 30.

KOPE CORPORATION, S.L., GUIPUZCOA, SPAIN:
2,955,016, PUB. 3-1-2005. INT. CL. 29.

KOMATSU SEIREN KABUSHIKI KAISHA (KOMATSU SEIREN CO., LTD.), ISHIKAWA, JAPAN:
2,954,786, PUB. 3-1-2005. INT. CL. 24.

KONAMI INDUSTRY CO., LTD., CHUO-KU, KOBE, JAPAN:
1,284,469, CANC. INT. CL. 28.

KONISHI SHUZO KABUSHIKI KAISHA, HYOGO, JAPAN, DBA KONISHI BREWING CO., LTD:
1,879,988, REN. 4-13-05. INT. CL. 33.
1,890,102, REN. 4-13-05. INT. CL. 33.

KONRAD HORNSCHUCH AKTIENGESELLSCHAFT, WEISSBACH, FED REP GERMANY:
773,800, REN. 4-15-05. U.S. CL. 50 (INT. CL. 24).

KOON CHUN HING KEE SOY & SAUCE FACTORY LIMITED, 19-25 MERCER STREET, HONG KONG:
2,954,751, PUB. 3-1-2005. INT. CL. 30.
2,954,752, PUB. 3-1-2005. INT. CL. 30.

KOOPNAUTIC HOLLAND B.V., 6411 RP HEERLEN, NETHERLANDS:
2,954,227, PUB. 3-1-2005. MULTIPLE CLASS, INT. CLS. 7, 9 AND 12.

KOPP, GUILLERMO ARTURO, DARIEN, CT AND SORIA DE KOPP, GABRIELA MARIA, DARIEN, CT:
2,955,488, INT. CL. 35.

KORD PRODUCTS LIMITED, ONTARIO L6T 1G8, CANADA:
2,171,549, CANC. MULTIPLE CLASS, INT. CLS. 20 AND 21.

- KP SPORTS, INC., BALTIMORE, MD:
2,954,369, PUB. 3-1-2005. INT. CL. 25.
- KRAFT FOODS HOLDINGS, INC., NORTHFIELD, IL:
2,955,774, INT. CL. 30.
- KRAFT FOODS, INC., NORTHFIELD, IL:
2,171,681, CANC. INT. CL. 32.
- KRAUTER, SHERRY, CAMPBELL HALL, NY:
2,956,335, INT. CL. 25.
- KRESKY, PETER M., FALLS CHURCH, VA:
1,284,389, CANC. INT. CL. 25.
- KRICH; CLAUDIA A., WOODLAND, CA:
1,284,317, CANC. INT. CL. 18.
- KRIST, RENE, R. YOUNGSTOWN, NY:
2,678,117, CANC. INT. CL. 35.
- KSK COMMUNICATIONS, LTD., VIENNA, VA:
1,843,152, CANC. INT. CL. 35.
- KUHN KNIGHT INCORPORATED, BRODHEAD, WI:
2,955,414, INT. CL. 7.
- KUKLA, WILLIAM J., PLANO, TX, DBA RISK FREE MANAGEMENT:
2,171,212, CANC. INT. CL. 35.
- KUSCHNIR, ARI, SUNNY ISLES, FL AND THRIFT, SCOTT, SUNNY ISLES, FL:
2,955,952, INT. CL. 28.
- KUSTOMWERKS, INC., GREENSBORO, NC:
2,954,269, PUB. 7-27-2004. INT. CL. 12.
- KVH INDUSTRIES, INC., MIDDLETOWN, RI, SAILCOMP INDUSTRIES, INC., NEWPORT, RI:
1,323,008, REN. 4-13-05. INT. CL. 9.
- KYOCERA CORPORATION, FUSHIMI-KU, KYOTO, 6128501, JAPAN:
2,879,782, COR. INT. CL. 9.
- KÖLNMESSE GMBH, 50679 KÖLN, FED REP GERMANY:
2,954,093, PUB. 3-1-2005. MULTIPLE CLASS, INT. CLS. 16, 35, 37, 38, 41 AND 42.
- L & P PROPERTY MANAGEMENT COMPANY, SOUTH GATE, CA:
2,954,234, PUB. 3-1-2005. INT. CL. 27.
- L. L. BEAN, INC., FREEPORT, ME:
2,954,709, PUB. 3-1-2005. INT. CL. 25.
2,955,604, INT. CL. 24.
2,955,941, INT. CL. 18.
- L. W. LOYD COMPANY, INC., SOUTH PITTSBURG, TN:
1,898,843, REN. 4-12-05. INT. CL. 13.
- L.A. FITNESS DESIGN, INC., WHITEFISH BAY, WI TO L.A. CONSULTING INC, WHITEFISH BAY, WI:
1,843,303, CANC. INT. CL. 42.
- L&P PROPERTY MANAGEMENT COMPANY, SOUTH GATE, CA:
1,322,196, REN. 4-13-05. INT. CL. 20.
- L'AGENCE, INC., NEW YORK, NY:
2,170,783, CANC. INT. CL. 35.
- L'OREAL, PARIS, FRANCE:
2,955,472, INT. CL. 3.
- LA CORNUE SA, SAINT-OUEN L'AUMONE, FRANCE:
2,954,700, PUB. 3-1-2005. INT. CL. 20.
- LA INVERSORA S.A., PROVINCIA DE NEUQUEN, ARGENTINA:
2,955,337, INT. CL. 33.
- LA JOLLA PHARMACEUTICAL COMPANY, SAN DIEGO, CA:
1,886,506, REN. 4-14-05. INT. CL. 5.
- LA MONTERRATINA C.A., MARACAY, ESTADO ARAGUA, VENEZUELA:
2,954,382, PUB. 3-1-2005. INT. CL. 29.
- LA RURAL VIÑEDOS Y BODEGAS S.A. LTDA, PROV. DE MENDOZA, ARGENTINA:
2,955,598, INT. CL. 33.
- LA TEMPESTA BAKERY CONFECTIONS, INC., PORTLAND, OR:
1,819,125, REN. 4-14-05. INT. CL. 30.
- LAB-VOLT SYSTEMS, INC., FARMINGDALE, NJ:
2,954,545, PUB. 3-1-2005. INT. CL. 9.
- LABJACK CORPORATION, LAKEWOOD, CO:
2,954,949, PUB. 1-18-2005. INT. CL. 9.
- LABOR SOLUTIONS INTERNATIONAL, INC., SANDY, UT:
2,955,548, INT. CL. 35.
- LABORATOIRE GARNIER & CIE, PARIS, FRANCE:
2,954,282, PUB. 3-1-2005. INT. CL. 3.
- LABORATOIRE PRIMATECH INC., QUEBEC (QUEBEC), CANADA:
2,170,922, CANC. INT. CL. 7.
- LABS OF ADVANCED TECHNOLOGY INTERNATIONAL CORPORATION, ROCKVILLE, MD:
2,171,752, CANC. INT. CL. 38.
- LACOSTE ALLIGATOR S.A., GENEVA 3, SWITZERLAND:
1,947,111, REN. 4-11-05. INT. CL. 14.
- LACTO IBERICA, INDUSTRIA DE LACTICINIOS E QUEIJO, S.A., ACORES, PORTUGAL:
2,171,087, CANC. INT. CL. 29.
- LAKE RESTORATION, INC., ROGERS, MN:
2,955,460, INT. CL. 7.
- LAKIN, DOUGLAS M., PARADISE VALLEY, AZ:
2,170,895, CANC. INT. CL. 42.
- LAM, JOSEPH, SAN JOSE, CA:
2,160,320, CANC. INT. CL. 42.
- LAMKONE RESTAURANTS, INC., SANTA ANA, CA:
2,170,863, CANC. INT. CL. 42.
- LANBOSS SOFTWARE LIMITED, TADLEY, HANTS RG26 3JA, ENGLAND:
2,868,391, COR. MULTIPLE CLASS, INT. CLS. 9, 16 AND 42.
- LANCE MFG. LLC, CHARLOTTE, NC, DBA SOUTH STREET BAKERY CO.:
2,955,582, INT. CL. 35.
- LANCEL SOGEDI, 75008 PARIS, FRANCE, SOCIETE DES ETABLISSEMENTS LANCEL, PARIS (3E), FRANCE:
1,018,836, REN. 4-13-05. INT. CL. 18.
- LANCOME PARFUMS ET BEAUTE & CIE, PARIS, FRANCE:
2,954,288, PUB. 3-1-2005. INT. CL. 3.
2,955,294, INT. CL. 3.
- LANGUAGE ANALYSIS SYSTEMS, INC., HERNDON, VA:
2,956,226, INT. CL. 9.
2,956,227, INT. CL. 9.
- LANIER WORLDWIDE, INC., ATLANTA, GA:
2,956,132, INT. CL. 35.
2,956,133, MULTIPLE CLASS, INT. CLS. 35 AND 42.
- LAPIDUS-SALTZ, WENDY, CHICAGO, IL:
2,955,683, INT. CL. 9.
- LARIN CORPORATION, ONTARIO, CA:
2,956,240, INT. CL. 20.
- LARKIN INDUSTRIES, INC., BIRMINGHAM, AL:
2,954,078, PUB. 3-1-2005. MULTIPLE CLASS, INT. CLS. 7, 9 AND 11.
- LAS VINAS WINERY, INC., LODI, CA:
2,954,014, PUB. 11-21-2000. INT. CL. 33.
- LASAL LABORATORIES, LLC, PROVO, UT:
2,954,164, PUB. 3-1-2005. INT. CL. 5.
- LASERSCOPE, SAN JOSE, CA:
2,955,963, INT. CL. 10.
- LATIN MARKETING AND COMMUNICATION CORP., JACKSON HEIGHTS, NY:
2,955,872, INT. CL. 35.
- LATINA MEDIA VENTURES LLC, NEW YORK, NY:
2,955,732, INT. CL. 16.
- LAURA GELLER MAKE-UP STUDIOS, LTD., NEW YORK, NY:
2,956,320, INT. CL. 3.
- LAVELLE INDUSTRIES, INC., BURLINGTON, WI:
2,955,431, MULTIPLE CLASS, INT. CLS. 11 AND 21.
- LAVI INDUSTRIES, VALENCIA, CA:
1,878,431, REN. 4-10-05. INT. CL. 6.
- LAVINE, RON S. OAK PARK, CA:
2,956,257, INT. CL. 41.
- LAW, DONALD, SAINT PAUL, MN:
2,170,756, CANC. MULTIPLE CLASS, INT. CLS. 35 AND 42.
- LAWRENCE MUSIC, INC., PITTSBURGH, PA:
2,956,292, INT. CL. 35.
- LAWRENCE, DONALD H. POMPANNO BEACH, FL:
2,171,270, CANC. INT. CL. 9.
- LAWSON INDUSTRIES, INC., MEDLEY, FL:
2,955,757, INT. CL. 6.

LAZAR, ANDREA FROELICH, SANTA MONICA, CA, DBA FRESH GREENS:
2,171,340, CANC. INT. CL. 25.

LAZZARA YACHT CORPORATION, TAMPA, FL:
2,171,038, CANC. INT. CL. 12.

LCI INTERNATIONAL TELECOM CORP., MCLEAN, VA:
2,171,597, CANC. INT. CL. 38.

LE JACQ LTD., DARIEN, CT:
2,956,163, INT. CL. 9.
2,956,164, INT. CL. 16.

LE, BRUCE, HUNTERSVILLE, NC:
2,956,331, INT. CL. 35.

LEAF, INC., BANNOCKBURN, IL TO HUHTAMAKI FINANCE B.V., 1180 AMSTELREEN, NETHERLANDS:
1,843,021, CANC. INT. CL. 25.

LEANIN' TREE INC., BOULDER, CO:
2,171,892, CANC. INT. CL. 16.

LEAP OF FAITH TECHNOLOGIES, INC., CRYSTAL LAEK, IL:
2,955,944, INT. CL. 44.

LEASECOMM CORPORATION, WOBURN, MA:
2,954,726, PUB. 3-1-2005. INT. CL. 36.
2,954,727, PUB. 3-1-2005. INT. CL. 36.

LEATHERMAN, STEPHEN P., MIAMI, FL:
2,171,252, CANC. INT. CL. 42.

LEBANESE ARAK CORPORATION, GLENDALE, CA:
2,955,368, INT. CL. 33.

LEBLOND MAKINO MACHINE TOOL COMPANY, CINCINNATI, OH:
1,284,074, CANC. INT. CL. 7.

LEDESMA, RICK, HARLINGEN, TX:
2,171,230, CANC. INT. CL. 9.

LEE ENTERPRISES, INCORPORATED, DAVENPORT, IA:
2,171,590, CANC. MULTIPLE CLASS, INT. CLS. 35 AND 42.

LEGACY FOR LIFE, LLC, MELBOURNE, FL:
2,955,011, PUB. 3-1-2005. INT. CL. 5.

LEGACY MULTIMEDIA, LLC, KATY, TX:
2,955,538, MULTIPLE CLASS, INT. CLS. 40 AND 42.

LEHMAN TRIKES, INC., WESTLOCK, ALBERTA, CANADA:
2,954,854, PUB. 3-1-2005. INT. CL. 12.

LEHNING ENTREPRISE, SAINTE BARBE 57640 VIGY, FRANCE:
1,884,196, REN. 4-14-05. INT. CL. 5.
1,884,197, REN. 4-14-05. INT. CL. 5.

LEINSLER, PETRA, BAD WORISHOFEN, FED REP GERMANY:
2,956,097, MULTIPLE CLASS, INT. CLS. 14 AND 25.

LEISTER GAME CO., INC., TOLEDO, OH:
1,284,332, CANC. INT. CL. 20.

LELAND INTERNATIONAL, ANN ARBOR, MI:
2,955,665, INT. CL. 20.

LEMELSON WINERY LLC, CARLTON, OR:
2,955,092, PUB. 3-1-2005. INT. CL. 33.

LENORA, SUZANNE, NEW YORK, NY:
2,171,323, CANC. INT. CL. 9.

LEO INTERNATIONAL, INC., BROOKLYN, NY:
2,956,295, INT. CL. 20.

LEPUS GROUP, L.L.C., THE, PRINCETON, NJ:
2,171,168, CANC. INT. CL. 9.

LES VIGNERONS DU SIEUR D'ARQUES; SOCIETE COOPERATIVE AGRICOLE, FRANCE:
2,955,180, PUB. 3-1-2005. INT. CL. 33.

LESCO TECHNOLOGIES, LLC, CLEVELAND, OH:
2,955,744, INT. CL. 5.

LEVANT TECHNOLOGIES, LLC., NORMAN, OK:
2,955,020, PUB. 3-1-2005. INT. CL. 42.

LEVANTE S.P.A., MANTOVA, ITALY:
2,866,276, COR. INT. CL. 25.

LEVEN INDUSTRIES, CANOGA PARK, CA:
2,955,811, INT. CL. 28.

LEVY CAFE, INC., PHILADELPHIA, PA:
2,954,361, PUB. 9-21-2004. INT. CL. 34.

LEWIN, JAMIE P., NEW YORK, NY:
2,954,426, PUB. 3-1-2005. INT. CL. 25.

LEWIS GALOOB TOYS, INC., SOUTH SAN FRANCISCO, CA TO ODDZON, INC., PAWTUCKETT, RI:
1,843,745, CANC. INT. CL. 28.

LEWISTON ROUNDUP ASSOCIATION, INC., LEWISTON, ID:
2,954,658, PUB. 3-1-2005. INT. CL. 41.

LEX SOLUTIO CORPORATION, PHOENIX, AZ:
2,955,790, INT. CL. 35.
2,955,791, INT. CL. 42.

LF, LLC, WILMINGTON, DE:
2,956,014, MULTIPLE CLASS, INT. CLS. 37, 41 AND 42.

LIBERTY BELL EQUIPMENT CORPORATION, PHILADELPHIA, PA, TA MEDCO:
2,955,475, INT. CL. 2.

LIBRA SECURITIES HOLDINGS, LLC, LOS ANGELES, CA FROM U.S. BANCORP, MINNEAPOLIS, MN:
2,954,003, PUB. 1-20-2004. INT. CL. 36.

LICHTWER PHARMA U.S., INC., PITTSBURGH, PA:
2,171,952, CANC. INT. CL. 5.

LICO BRANDS, INC., STOCKTON, CA:
2,955,374, MULTIPLE CLASS, INT. CLS. 29 AND 30.

LIDL STIFTUNG & CO. KG, D-74167 NECKARSULM, FED REP GERMANY:
2,955,164, PUB. 3-1-2005. INT. CL. 29.

LIDL STIFTUNG & CO. KG, FED REP GERMANY:
2,955,170, PUB. 3-1-2005. INT. CL. 3.

LIFE COACHES, HAMEL, MN:
2,956,302, INT. CL. 45.

LIFE INDUSTRIES CORPORATION, CHARLESTON, SC:
2,954,917, PUB. 3-1-2005. MULTIPLE CLASS, INT. CLS. 1, 2, 3 AND 17.

LIFEFORMS INTERNATIONAL, INC., ROHNERT PARK, CA TO BIG DOG HOLDINGS, INC., SANTA BARBARA, CA:
1,843,710, CANC. INT. CL. 25.

LIFESYSTEMS LIMITED, BERKSHIRE RG7 8PN, UNITED KINGDOM:
2,902,012, COR. MULTIPLE CLASS, INT. CLS. 6, 18, 20, 21 AND 25.

LIGHT INDEX INVESTMENT COMPANY, TACOMA, WA:
2,171,096, CANC. INT. CL. 36.

LIGHTSCAPE NETWORKS LTD., PETACH TIKVA 49517, ISRAEL:
2,894,187, COR. INT. CL. 9.

LIGHTSTONE PRODUCTIONS, LLC, MINNEAPOLIS, MN:
2,171,454, CANC. INT. CL. 16.

LILLIAN JONES, TROY, MI:
2,955,983, INT. CL. 35.

LINCOLN BREWING COMPANY, WAYZATA, MN, DBA MALTERNATIVE BREWING COMPANY:
2,172,016, CANC. INT. CL. 32.

LINCOLN GLOBAL, INC., MONTEREY PARK, CA:
2,956,091, INT. CL. 9.

LINDAUER DORNIER GESELLSCHAFT MBH, D 88129 LINDAU, FED REP GERMANY:
2,170,771, CANC. INT. CL. 7.

LINDEN RESEARCH, INC., SAN FRANCISCO, CA:
2,954,675, PUB. 5-25-2004. MULTIPLE CLASS, INT. CLS. 9, 38 AND 41.

LINDSAY MANUFACTURING COMPANY, LINDSAY, NE:
2,955,739, INT. CL. 11.

LIPPMAN, RICHARD D., HONOLULU, HI:
2,956,362, INT. CL. 5.

LIPSON ASSOCIATES, INC., NORTHBROOK, IL, DBA LIPSON-ALPORT-GLASS & ASSOCIATES:
2,954,816, PUB. 3-1-2005. INT. CL. 41.

LIQUIDMETAL TECHNOLOGIES, TAMPA, FL:
2,955,613, INT. CL. 28.

LISA FRANK, INC., TUCSON, AZ:
2,955,740, INT. CL. 18.

LISCO, INC., TAMPA, FL:
2,170,897, CANC. INT. CL. 28.
2,171,449, CANC. INT. CL. 28.

LISTON SCIENTIFIC CORPORATION, IRVINE, CA:
1,881,227, REN. 4-12-05. INT. CL. 9.

LITE TOUCH, INC., SALT LAKE CITY, UT:
1,284,102, CANC. INT. CL. 9.

- LITTLE BEAR ORGANIC FOODS, INC., CARSON, CA:
2,955,568, INT. CL. 30.
- LITTLE BLACK PEARL WORKSHOP, INC., CHICAGO, IL:
2,171,193, CANC. INT. CL. 41.
- LITTLE ROCK CO., LTD., CHIBA-CITY, CHIBA-PREF., JAPAN:
2,170,947, CANC. INT. CL. 7.
- LIWAYWAY MARKETING CORPORATION, PASAY CITY, PHILIPPINES:
2,955,251, INT. CL. 30.
- LOAN SHOPPER FINANCIAL, INC., LA MESA, CA, DBA CALIFORNIA LENDING COMPANY:
2,956,075, INT. CL. 36.
- LOBLAWS INC., TORONTO, ONTARIO M4T 2S7, CANADA:
1,843,816, CANC. INT. CL. 30.
- LOCAL AREA BUSINESS INTERNET LISTINGS, INC., APPLETON, WI:
2,955,917, MULTIPLE CLASS, INT. CLS. 16 AND 42.
- LOCATION3 MEDIA, INC., DENVER, CO:
2,955,712, INT. CL. 35.
- LOCKHEED MARTIN CORPORATION, BETHESDA, MD:
2,171,273, CANC. INT. CL. 9.
2,955,607, INT. CL. 6.
- LOCKRIDGE, JAMES E., BURLINGTON, VT:
2,170,954, CANC. INT. CL. 35.
- LODGE MANUFACTURING COMPANY, SOUTH PITTSBURGH, TN:
2,170,907, CANC. INT. CL. 21.
- LOFTS, ANDREW A., JULIAN, CA:
2,170,933, CANC. INT. CL. 3.
- LOGICAL INFORMATION MACHINES, INC., CHICAGO, IL:
2,171,227, CANC. INT. CL. 36.
- LOIK, JAMES B, KINGSTON, NH:
2,954,883, PUB. 3-1-2005. INT. CL. 8.
- LOIS SAPIENZA AND DEBORAH SAPIENZA PARTNERSHIP, THE, NANUET, NY:
2,170,701, CANC. INT. CL. 42.
- LONG AN FOOD PROCESSING EXPORT JOINT STOCK COMPANY (LAFOOCO), LONG AN PROVINCE, VIETNAM:
2,954,807, PUB. 3-1-2005. INT. CL. 29.
- LONGFELLOW STAFFING, INC., BOSTON, MA:
2,955,101, PUB. 3-1-2005. INT. CL. 35.
- LONGSHIP ALTERNATIVE ASSET MANAGEMENT LLC, WILMINGTON, DE:
2,954,855, PUB. 3-1-2005. INT. CL. 36.
- LORD & SONS, INC., SAN JOSE, CA:
2,955,376, INT. CL. 6.
- LORD'S COMPANY OF ORLANDO, THE, WINTER SPRINGS, FL, DBA KELLYCO:
2,954,550, PUB. 3-1-2005. INT. CL. 9.
- LOREAL USA CREATIVE, INC., NEW YORK, NY:
1,383,884, REN. 4-14-05. INT. CL. 3.
- LOS ANGELES BIOMEDICAL RESEARCH INSTITUTE AT HARBOR-UCLA MEDICAL CENTER, TORRANCE, CA:
2,956,256, MULTIPLE CLASS, INT. CLS. 36, 41, 42 AND 44.
- LOUGHRAN, DAVID ANTHONY, SHEFFIELD, UNITED KINGDOM, VII OF CALIFORNIA, INC., TORRANCE, CA, DBA AVITAR SPORTS INTERNATIONAL:
1,904,353, REN. 4-12-05. INT. CL. 12.
- LOUIS BERKMAN COMPANY, THE, STUEBENVILLE, OH:
1,842,653, CANC. INT. CL. 6.
1,857,480, REN. 4-13-05. INT. CL. 6.
- LOUIS M. GERSON CO., INC., MIDDLEBORO, ME:
1,005,547, REN. 4-13-05. U.S. CL. 31 (INT. CLS. 11 AND 21).
- LOUISVILLE LADDER CORP., LOUISVILLE, KY TO LOUISVILLE LADDER GROUP LLC, LOUISVILLE, KY:
1,843,467, CANC. INT. CL. 6.
- LOVE'S TRAVEL STOPS & COUNTRY STORES, INC., OKLAHOMA CITY, OK:
1,343,540, REN. 4-11-05. INT. CL. 42.
- LOWE OIL COMPANY, CLINTON, MO:
1,284,009, CANC. INT. CL. 4.
- LOWER MANHATTAN DEVELOPMENT CORPORATION, NEW YORK, NY:
2,954,236, PUB. 3-1-2005. MULTIPLE CLASS, INT. CLS. 25, 35 AND 37.
- LOWERY, BOYCE F., DRAPER, UT:
2,955,666, MULTIPLE CLASS, INT. CLS. 35 AND 36.
- LOYOLA ENTERPRISES INC., VIRGINIA BEACH, VA:
2,955,936, INT. CL. 38.
- LOYOLA UNIVERSITY OF CHICAGO, CHICAGO, IL:
2,954,865, PUB. 3-1-2005. INT. CL. 44.
2,954,866, PUB. 3-1-2005. INT. CL. 44.
- LTl WHOLESALE, INC., SCHUYLKILL HAVEN, PA, DBA LTl HOME PRODUCTS, INC.:
2,954,703, PUB. 3-1-2005. INT. CL. 40.
- LUBEPRO'S INTERNATIONAL, INC., SCHAUMBURG, IL:
1,284,618, CANC. INT. CL. 37.
- LUCAS COUNTY CREDIT BUREAU, INC., HOLLAND, OH:
1,284,562, CANC. INT. CL. 36.
- LUCKEY, WARREN LLOYD, AUGUSTA, GA:
2,954,900, PUB. 11-30-2004. INT. CL. 4.
- LUDBROOK, TIMOTHY VIVIAN, LONDON, UNITED KINGDOM:
2,954,715, PUB. 10-26-2004. INT. CL. 42.
- LULO, EDWARD K., LEAWOOD, KS, DBA TOC PRODUCTIONS:
2,171,572, CANC. INT. CL. 16.
- LUMEX, INC., BAY SHORE, NY TO MUL ACQUISITION CORP. II, WILMINGTON, DE:
1,842,838, CANC. INT. CL. 11.
- LUMITEX PTY LTD., SOUTH PERTH, WESTERN AUSTRALIA, AUSTRALIA:
2,955,380, INT. CL. 9.
- LUNA, RAQUEL, CITY OF INDUSTRY, CA:
2,170,681, CANC. INT. CL. 35.
- LURMARK LIMITED, LONGSTANTON, CAMBRIDGE, ENGLAND:
1,842,663, CANC. INT. CL. 7.
- LUSTER LEAF PRODUCTS, INC., WOODSTOCK, IL:
2,955,053, PUB. 3-1-2005. INT. CL. 9.
- LUTHER CONSULTING, LLC, INDIANAPOLIS, IN:
2,956,321, INT. CL. 42.
- LUTHER'S SMOKEHOUSE, INC., LEROY, KS:
2,956,088, INT. CL. 35.
- LUTHERANS AT MISSION BODY AND SOUL (LAMBS), INC., ELK GROVE, CA:
2,954,880, PUB. 3-1-2005. INT. CL. 41.
- LWIN FAMILY CO., CHARLOTTE, NC:
2,956,012, INT. CL. 35.
- LYNDEN GROUP, INC., MAPLE GROVE, MN:
2,171,156, CANC. INT. CL. 35.
- L2B ENVIRONMENTAL SYSTEMS INC., BARRIE, ONTARIO, CANADA:
2,954,097, PUB. 3-1-2005. INT. CL. 11.
- M. GRUMBACHER, INC., CRANBURY, NJ:
1,284,309, CANC. INT. CL. 16.
- M.E.R.I.T. HOME HEALTH AGENCY, INC., BOSTON, MA:
2,108,752, CANC. INT. CL. 42.
- M&G NATIONAL JEWELRY, INC., NEW YORK, NY:
1,842,886, CANC. INT. CL. 14.
- M-I DRILLING FLUIDS COMPANY, HOUSTON, TX:
1,283,926, CANC. INT. CL. 1.
- M-REAL CORPORATION, ESPOO, FINLAND:
2,912,673, COR. INT. CL. 16.
- MAC MULCH, INCORPORATED, LEWISVILLE, IN:
2,171,315, CANC. INT. CL. 42.
- MACALLAN DISTILLERS LIMITED, THE, BANFFSHIRE, AB38 9RX, SCOTLAND:
996,557, REN. 4-15-05. U.S. CL. 49 (INT. CL. 33).
- MACBETH, DANIEL D., PARADISE VALLEY, AZ:
2,196,566, CANC. INT. CL. 32.
- MACDERMID INCORPORATED, WATERBURY, CT:
186,356, CANC. U.S. CL. 4.
- MACK TRUCKS, INC., ALLENTOWN, PA:
1,272,404, REN. 4-13-05. MULTIPLE CLASS, INT. CLS. 7 AND 12.
- MACKMYRA SVENSK WHISKY AB, SE-818 32 VALBO, SWEDEN:
2,954,121, PUB. 5-11-2004. INT. CL. 33.

MACRO INTERNATIONAL INC., CALVERTON, MD:
2,171,158, CANC. INT. CL. 35.
2,171,159, CANC. INT. CL. 35.

MADAUS AG:
1,284,059, CANC. INT. CL. 5.

MADISON, ROBERT B., MILWAUKEE, WI:
2,955,054, PUB. 3-1-2005. INT. CL. 41.

MADURA, RONALD M. SR., GOSHEN, NY:
1,843,970, CANC. INT. CL. 31.

MAG CLIP CORPORATION, NAPLES, FL:
2,956,031, INT. CL. 8.

MAGALLAN, PHILLIP, DALLAS, TX:
2,955,900, INT. CL. 9.

MAGLINE, INC., PINCONNING, MI:
1,006,107. REN. 4-13-05. U.S. CL. 50 (INT. CL. 6).

MAGNUM INTEGRATED TECHNOLOGIES INC., BRAMP-
TON, ONTARIO L4W 4T5, CANADA:
2,954,431, PUB. 3-1-2005. INT. CL. 7.

MAGOTTEAUX INTERNATIONAL, B-4051 VAU X-SOUS-
CHEVREMONT, BELGIUM:
2,954,629, PUB. 9-21-2004. INT. CL. 7.

MAHER PUBLICATIONS, INC., ELMHURST, IL, DOWN
BEAT, INCORPORATED, CHICAGO, IL:
598,229. REN. 4-10-05. U.S. CL. 38 (INT. CL. 16).

MAID TO PERFECTION CORPORATION, HAGERSTOWN,
MD:
2,954,453, PUB. 3-1-2005. INT. CL. 37.

MAIN STREET INDUSTRIES, INC., MENOMONEE FALLS,
WI:
2,955,459, INT. CL. 10.

MAINSRING COMMUNICATIONS, INC., CAMBRIDGE,
MA:
2,171,801, CANC. INT. CL. 16.
2,171,803, CANC. INT. CL. 42.

MAISON LOUIS LATOUR, S.R.L., BEAUNE (COTE D'OR),
FRANCE:
1,337,080. REN. 4-14-05. INT. CL. 33.

MAISON TARRIDE LEDROIT & CIE, 33000 BORDEAUX,
FRANCE:
1,028,860. REN. 4-15-05. INT. CL. 33.

MAJESTIC INDUSTRIES (CANADA) LTD., MONTREAL,
QUEBEC, CANADA:
2,171,568, CANC. MULTIPLE CLASS, INT. CLS. 18 AND
25.

MAJOR LEAGUE PROFESSIONAL SOCCER, INC., NEW
YORK, NY:
2,171,574, CANC. MULTIPLE CLASS, INT. CLS. 16, 25
AND 41.

MAJOR TOM HOLDING B.V., DEN HAAG, NETHER-
LANDS:
2,954,680, PUB. 8-24-2004. INT. CL. 21.

MALLINCKRODT INC., ST. LOUIS, MO:
2,955,513, INT. CL. 10.

MALONE, RICHARD W., RESTON, VA:
2,955,081, PUB. 3-1-2005. INT. CL. 41.

MALOUF, DIAN, DALLAS, TX:
1,842,874, CANC. INT. CL. 14.

MAMAC SYSTEMS, INC., EDEN PRAIRIE, MN:
2,954,394, PUB. 3-1-2005. INT. CL. 9.

MANAGESOFT CORPORATION PTY. LTD., BOX HILL,
AUSTRALIA:
2,956,252, INT. CL. 9.

MANGANARO'S HERO BOY INC., NEW YORK, NY:
2,954,116, PUB. 3-1-2005. INT. CL. 43.

MANLEY PERFORMANCE PRODUCTS, INC., LAKE-
WOOD, NJ:
1,907,074. REN. 4-13-05. INT. CL. 7.

MANN PROPERTIES, LLP, INDIANAPOLIS, IN:
2,956,243, MULTIPLE CLASS, INT. CLS. 36 AND 37.

MANN, DOUGLAS G, VENICE, FL:
2,955,646, INT. CL. 5.

MANNING, DIANE, KINGWOOD, TX:
2,954,114, PUB. 5-25-2004. INT. CL. 25.

MANNY'S BASEBALL LAND, INC., PALM CITY, FL TO
GENESIS DIRECT, INC., SECAUCUS, NJ:
1,843,331, CANC. INT. CL. 42.

MANZANITA MEDIA, INC., DEWEY, AZ:
2,956,151, INT. CL. 16.

MAPA SPONTEX, INC., COLUMBIA, TN, SHERWOOD
MEDICAL INDUSTRIES INC., ST. LOUIS, MO:
1,004,307. REN. 4-15-05. INT. CL. 25.

MAPA SPONTEX, INC., COLUMBIA, TN, PIONEER INDUS-
TRIAL COMPANY, WILLARD, OH:
1,329,297. REN. 4-15-05. INT. CL. 9.

MAPLE LEAF SPORTS & ENTERTAINMENT, LTD., TOR-
ONTO, CANADA:
2,955,670, INT. CL. 35.

MAPLE LEAF SPORTS & ENTERTAINMENT, LTD., TOR-
ONTO, ONTARIO, CANADA:
2,955,671, INT. CL. 38.

MAQUET CRITICAL CARE AB, SWEDEN:
2,955,173, PUB. 3-1-2005. INT. CL. 10.

MARBLE SLAB CREAMERY, INC., HOUSTON, TX:
1,351,081. REN. 4-14-05. INT. CL. 42.

MARCHON EYEWEAR, INC., MELVILLE, NY:
2,955,609, INT. CL. 9.

MARIA, WELCH, Y., BALTIMORE, MD:
2,954,946, PUB. 3-1-2005. INT. CL. 44.

MARIALL APPAREL, INC.:
1,284,402, CANC. INT. CL. 25.

MARINA DISTRICT DEVELOPMENT COMPANY, LLC,
ATLANTIC CITY, NJ, DBA BORGATA HOTEL, CASINO
& SPA:
2,872,782, COR. INT. CL. 41.

MARINERS ESCROW CORPORATION, NEWPORT BEACH,
CA:
2,954,717, PUB. 5-25-2004. INT. CL. 36.

MARKET DATA CORPORATION, RYE BROOK, NY:
2,171,512, CANC. INT. CL. 9.

MARKETFIRST SOFTWARE, INC., MOUNTAIN VIEW, CA:
2,954,048, PUB. 3-1-2005. MULTIPLE CLASS, INT. CLS.
35, 41 AND 42.

MARKETING SYSTEMS OF AMERICA INC., WEST PALM
BEACH, FL:
2,955,273, INT. CL. 3.

MARKETWARE CORPORATION, NORCROSS, GA TO SI-
MULATION RESEARCH, INC., MARIETTA, GA:
1,842,758, CANC. MULTIPLE CLASS, INT. CLS. 9 AND
35.

MARKS, ROBIN LURYNE, DALLAS, TX:
2,956,239, INT. CL. 24.

MARKS, SHELDON H., TUCSON, AZ:
2,955,021, PUB. 3-1-2005. INT. CL. 44.

MARLEY-WYLAIN COMPANY, THE, CHARLOTTE, NC,
WEIL-MCLAIN COMPANY, INC., MICHIGAN CITY, IN:
775,833. REN. 4-13-05. U.S. CL. 34 (INT. CL. 11).

MARMON GROUP, INC., THE, PARAGOULD, AR:
407,933, CANC. U.S. CL. 50.

MARNLEN MANAGEMENT LTD., MARKHAM, ONTARIO,
CANADA, DBA SANDYLION:
1,323,133. REN. 4-13-05. INT. CL. 16.

MARRICK PROPERTIES, INC., DUNKIRK, MD:
2,956,145, INT. CL. 37.

MARRIOTT INTERNATIONAL, INC., BETHESDA, MD:
2,956,093, INT. CL. 43.

MARS, INCORPORATED, MCLEAN, VA:
1,292,814. REN. 4-9-05. MULTIPLE CLASS, INT. CLS. 16
AND 31.
2,171,472, CANC. INT. CL. 16.
2,171,473, CANC. INT. CL. 16.
2,955,311, INT. CL. 30.
2,955,430, INT. CL. 30.

MARSH SUPERMARKETS, INC., INDIANAPOLIS, IN:
2,916,729, AM. INT. CL. 43.

MARSHALL HOUSE, SUNSET BEACH, CA:
2,955,765, INT. CL. 16.

MARSHALL INDUSTRIES, EL MONTE, CA:
2,170,747, CANC. INT. CL. 35.

MARTIN YALE INDUSTRIES, INC., WABASH, IN, DATA-
LINK CORPORATION, SANTEE, CA:
1,882,129. REN. 4-10-05. INT. CL. 16.

MARTIN, CHRISTOPHER, BRONX, NY:
2,955,667, MULTIPLE CLASS, INT. CLS. 9, 25, 35, 38 AND
41.

MARTIN, WILLIAM, SANTA BARBARA, CA:
2,955,024, PUB. 3-1-2005. INT. CL. 31.

- MARTOCCI, MARK V., CARDIFF BY THE SEA, CA:
2,170,989, CANC. INT. CL. 25.
- MARTY, JEAN CLAUDE, MIAMI BEACH, FL:
1,843,128, CANC. INT. CL. 34.
- MARVEL ENTERTAINMENT GROUP, INC., NEW YORK, NY:
1,284,263, CANC. INT. CL. 16.
- MARVIN MILLER MANUFACTURING, INC., WHITTIER, CA:
1,284,077, CANC. INT. CL. 7.
- MASCOT METROPOLITAN INC., SO. SAN FRANCISCO, CA:
2,171,673, CANC. INT. CL. 18.
- MASONITE INTERNATIONAL CORPORATION, MISSAISAUGA, ONTARIO:
1,879,770, REN. 4-14-05, INT. CL. 19.
- MASTELLONE HNOS S.A., PROVINCIA DE BUENOS AIRES, ARGENTINA:
2,170,627, CANC. INT. CL. 29.
- MASTER BUILDERS OF IOWA, INC., DES MOINES, IA:
2,955,881, INT. CL. 37.
- MASTER HOUSEHOLD, INC., ALHAMBRA, CA:
2,954,937, PUB. 3-1-2005, INT. CL. 9.
- MASTER MFG. CO., INC., CLEVELAND, OH, DBA MASTER CASTER COMPANY:
2,956,198, INT. CL. 26.
- MASTERX CORPORATION, MIDDLETOWN, CT:
2,171,050, CANC. INT. CL. 42.
- MASX ENERGY SERVICES GROUP, INC., TAYLOR, MI:
1,324,057, REN. 4-14-05, INT. CL. 7.
- MATADEROS INDUSTRIALES SOLER, S.A., CARTAM-ESTACION (MALAGA), SPAIN:
2,170,872, CANC. MULTIPLE CLASS, INT. CLS. 29 AND 30.
- MATCHLESS METAL POLISH CO., THE, CHICAGO, IL:
186,271, CANC. U.S. CL. 4.
- MATERIAUX A BAS PRIX LTEE/ BARGAIN BUILDING MATERIALS LTD., QUEBEC, G0L 2J0, CANADA:
2,954,342, PUB. 10-12-2004, MULTIPLE CLASS, INT. CLS. 19 AND 35.
- MATRIX PHARMACEUTICAL, INC., MENLO PARK, CA:
2,171,485, CANC. INT. CL. 5.
- MATROX ELECTRONIC SYSTEMS LTD., DORVAL, QUEBEC, CANADA:
2,171,737, CANC. INT. CL. 9.
- MATSUSHITA ELECTRIC INDUSTRIAL CO., LTD., OSAKA PREFECTURE, JAPAN:
1,844,261, REN. 4-15-05, INT. CL. 9.
- MATTEL, INC., EL SEGUNDO, CA:
2,171,665, CANC. INT. CL. 28.
2,171,666, CANC. INT. CL. 28.
2,171,676, CANC. INT. CL. 28.
2,171,944, CANC. INT. CL. 28.
2,171,945, CANC. INT. CL. 28.
2,171,970, CANC. INT. CL. 28.
2,955,194, MULTIPLE CLASS, INT. CLS. 9, 14, 16, 18, 20, 21, 24 AND 25.
2,955,483, INT. CL. 28.
2,955,499, INT. CL. 28.
2,955,500, INT. CL. 28.
2,955,529, INT. CL. 28.
2,955,530, INT. CL. 28.
2,955,531, INT. CL. 28.
2,955,532, INT. CL. 28.
2,955,543, INT. CL. 28.
2,955,546, INT. CL. 28.
2,955,551, INT. CL. 28.
2,955,626, INT. CL. 28.
2,955,635, INT. CL. 28.
2,955,657, INT. CL. 28.
2,955,658, INT. CL. 28.
2,955,664, INT. CL. 28.
2,955,726, INT. CL. 28.
2,956,001, INT. CL. 41.
- MATTHEWS, ROBERT C., ORANGE, CA:
2,955,080, PUB. 3-1-2005, INT. CL. 42.
- MAX-PLANCK-GESELLSCHAFT, 14476 GOLM, FED REP GERMANY:
2,954,016, PUB. 3-1-2005, MULTIPLE CLASS, INT. CLS. 9, 16 AND 42.
- MAXICARE HEALTH PLANS, INC., LOS ANGELES, CA:
1,843,382, CANC. MULTIPLE CLASS, INT. CLS. 36 AND 42.
- MAXIM GROUP, INC., THE, MARIETTA, GA TO FLOORING AMERICA FRANCHISING, LP, KENNESAW, GA:
1,843,048, CANC. INT. CL. 27.
- MAYACAMA GOLF CLUB LLC, SANTA ROSA, CA:
2,955,605, INT. CL. 36.
2,955,606, INT. CL. 36.
- MAYER, LUDOVIC, 57420 POURNOY-LA-GRASSE, FRANCE:
2,954,108, PUB. 6-1-2004, INT. CL. 28.
- MAYO FOUNDATION, ROCHESTER, MN:
2,171,348, CANC. INT. CL. 36.
2,171,349, CANC. INT. CL. 42.
2,171,372, CANC. INT. CL. 42.
- MAYONE, KIMBERLY A, SOUTH PORTLAND, ME:
2,954,815, PUB. 10-26-2004, INT. CL. 41.
- MAZZANTI, INC., HOBOKEN, NJ:
2,956,194, INT. CL. 42.
- MAZZO, INC., HONOLULU, HI:
1,843,965, CANC. INT. CL. 25.
- MCCORMICK DELAWARE, INC., WILMINGTON, DE:
2,171,433, CANC. MULTIPLE CLASS, INT. CLS. 29 AND 30.
- MCCUBBIN, STACEY L., HOUSTON, TX, DBA FROZEN 2 PERFECTION:
2,955,026, PUB. 3-1-2005, INT. CL. 43.
- MCDONALD'S CORPORATION, OAK BROOK, IL:
1,843,876, CANC. INT. CL. 36.
2,171,527, CANC. INT. CL. 24.
- MCGRATH, DONALD, COSTA MESA, CA:
2,955,830, INT. CL. 22.
- MCGUIRE FINANCIAL MANAGEMENT, INC., DALLAS, TX:
1,881,003, REN. 4-15-05, INT. CL. 42.
- MCGUIRE TOOLS, LLC, COLUMBIA, MD:
2,956,188, INT. CL. 7.
- MCINTYRE, RONALD L., MESA, AZ, DBA CYBERIONICS INSTITUTES:
1,284,646, CANC. INT. CL. 41.
- MCKESSON CORPORATION, SAN FRANCISCO, CA:
2,954,824, PUB. 3-1-2005, INT. CL. 35.
- MCLELLAN PRODUCTS & SERVICES, INC., JUPITER, FL, DBA THE CANDLEMEISTER:
2,955,130, PUB. 3-1-2005, INT. CL. 4.
- MCMULLEN, MICHAEL, CUMBERLAND, RI:
2,954,805, PUB. 3-1-2005, INT. CL. 36.
- MDG MEDICAL, INC., ENGLEWOOD, NJ:
2,955,918, INT. CL. 12.
- ME & MY KIDS, LLC., HOLLAND, OH:
2,955,491, INT. CL. 10.
- MEADOWCRAFT, INC., BIRMINGHAM, AL:
1,845,619, CANC. INT. CL. 20.
- MEADWESTVACO CORPORATION, STAMFORD, CT, KEITH CLARK, INC., SIDNEY, NY:
1,340,667, REN. 4-14-05, INT. CL. 16.
- MECANORMA INTERNATIONAL S.A.:
1,284,242, CANC. INT. CL. 16.
- MECHANICAL MANUFACTURING CORPORATION, SUNRISE, FL:
2,170,873, CANC. MULTIPLE CLASS, INT. CLS. 7 AND 11.
- MEDAIRE, INC., TEMPE, AZ:
2,955,277, MULTIPLE CLASS, INT. CLS. 44 AND 45.
- MEDIA FARM, LLC, NEW YORK, NY:
2,171,149, CANC. INT. CL. 42.
- MEDIA INDUSTRIES, INC.:
1,284,390, CANC. INT. CL. 25.
- MEDIA 3 LTD., NEW YORK, NY:
2,954,799, PUB. 3-1-2005, INT. CL. 38.
- MEDIA-TECH E.V., 60325 FRANKFURT, FED REP GERMANY:
2,954,134, PUB. 11-2-2004, MULTIPLE CLASS, INT. CLS.

- 16, 35 AND 41.
 MEDIARAZZI, INC., DELRAY BEACH, FL:
 2,954,896, PUB. 3-1-2005. INT. CL. 41.
 MEDICAL EDUCATION DEVELOPMENT SERVICES, INC.,
 BURTONSVILLE, MD:
 2,954,408, PUB. 3-1-2005. INT. CL. 41.
 MEDICAL EQUIPMENT DISTRIBUTORS, INC., LUBBOCK,
 TX:
 1,843,579, CANC. INT. CL. 11.
 MEDICAL EXPRESS (UK) LIMITED, HORSHAM, WEST
 SUSSEX, UNITED KINGDOM:
 2,954,608, PUB. 3-1-2005. INT. CL. 3.
 MEDICIGROUP, INC., KING PRUSSIA, PA:
 2,956,002, INT. CL. 41.
 MEDKEY, INC., ROANOKE, VA:
 1,843,878, CANC. INT. CL. 36.
 MEDLINE INDUSTRIES, INC., MUNDELEIN, IL:
 2,955,699, INT. CL. 10.
 MEEKS, JOSEPH A., CORONA, CA AND MEEKS, MARY
 GROSSMAN, CORONA, CA:
 2,956,207, INT. CL. 5.
 MEGATOON STUDIOS INC.:
*See— ARTIFICIAL MIND AND MOVEMENT/PENSEE
 ET MOUVEMENT ARTIFICIEL INC..*
 MEISTER MEDIA WORLDWIDE INC., WILLOUGHBY, OH:
 1,843,952, CANC. INT. CL. 16.
 MELAMED, SHANA, BEVERLY HILLS, CA:
 2,954,389, PUB. 3-1-2005. INT. CL. 35.
 MELITTA HAUSHALTSPRODUKTE GMBH & CO. KG,
 MINDEN, FED REP GERMANY:
 2,268,012, CANC. INT. CL. 35.
 MELLUM, LARRY L., SEATTLE, WA:
 2,955,933, MULTIPLE CLASS, INT. CLS. 29 AND 35.
 MELNOR INC., WINCHESTER, VA:
 2,170,894, CANC. INT. CL. 21.
 MEME, MASIFA, MIRAMAR, FL:
 2,954,643, PUB. 3-1-2005. INT. CL. 25.
 MEMORY SOLUTION GMBH, FED REP GERMANY:
 2,955,177, PUB. 3-1-2005. INT. CL. 9.
 MENTOR GRAPHICS CORPORATION, WILSONVILLE, OR:
 1,843,523, CANC. INT. CL. 9.
 MERCANTILE BANCORPORATION, INC., ST. LOUIS, MO:
 1,284,594, CANC. INT. CL. 36.
 MERCK & CO., INC., RAHWAY, NJ:
 407,888, CANC. U.S. CL. 6.
 MERCK KGAA, D-64293 DARMSTADT, FED REP GER-
 MANY:
 2,954,665, PUB. 3-1-2005. INT. CL. 1.
 MERCK SHARP & DOHME FEDERAL CREDIT UNION,
 NORTH WALES, PA:
 2,955,777, INT. CL. 36.
 MERCY CORPS, PORTLAND, OR:
 1,313,834, REN. 4-14-05. MULTIPLE CLASS, INT. CLS. 36
 AND 42.
 MEREDITH CORPORATION, DES MOINES, IA:
 2,171,692, CANC. INT. CL. 35.
 2,956,266, INT. CL. 16.
 2,956,322, INT. CL. 16.
 MERIDICA LTD., HERTFORDSHIRE, UNITED KINGDOM:
 2,954,067, PUB. 3-23-2004. MULTIPLE CLASS, INT. CLS.
 5, 9, 42 AND 44.
 MERLIN DATA PUBLISHING CORPORATION, KALIS-
 PELL, MT, DBA MERLIN INFORMATION SERVICES:
 2,954,096, PUB. 11-12-2002. INT. CL. 42.
 MERZ & DICKINSON, INCORPORATED, ESSEX, CT:
 1,284,040, CANC. INT. CL. 5.
 MESA ANALYTICS & COMPUTING, LLC, SANTA FE, NM:
 2,954,891, PUB. 3-1-2005. INT. CL. 9.
 MESSER ENTERPRISES, INC., SAN DIEGO, CA:
 2,171,221, CANC. INT. CL. 35.
 METAL BUILDING COMPONENTS, INC., HOUSTON, TX:
 2,192,160, CANC. INT. CL. 6.
 METALTECH, INC., HIALEAH, FL:
 2,171,751, CANC. INT. CL. 6.
 METAPLUS, S.A. DE C.V., 97000 MERIDA, YUCATAN,
 MEXICO:
 1,887,058, REN. 4-13-05. INT. CL. 11.
 METASTORM, SEVERNA PARK, MD:
 2,905,375, COR. INT. CL. 9.
 METRIS DIRECT, INC., ST. LOUIS PARK, MN:
 2,955,196, INT. CL. 36.
 METROMEDIA STEAKHOUSES COMPANY, L.P., DALLAS,
 TX:
 2,171,092, CANC. INT. CL. 42.
 METRONICS, INC., BEDFORD, NH:
 2,954,484, PUB. 3-1-2005. INT. CL. 9.
 METROPOLITAN LIFE INSURANCE COMPANY, NEW
 YORK, NY:
 2,954,778, PUB. 3-1-2005. INT. CL. 36.
 MEZA, JUAN P., AUSTIN, TX, DBA JUAN IN A MILLION:
 2,171,320, CANC. INT. CL. 42.
 MFI ASSOCIATES, INC., ROCHESTER, NY:
 2,171,594, CANC. INT. CL. 20.
 MGA ENTERTAINMENT, INC., VAN NUYS, CA:
 2,955,745, INT. CL. 28.
 MHB SALES, INC., CORPUS CHRISTI, TX:
 2,170,711, CANC. MULTIPLE CLASS, INT. CLS. 24 AND
 25.
 MI-TECH METALS, INC., INDIANAPOLIS, IN:
 1,875,800, REN. 4-13-05. INT. CL. 6.
 MICHAEL BEAUDRY, INC., BEVERLY HILLS, CA:
 2,170,722, CANC. INT. CL. 14.
 MICHAEL C. FINA COMPANY, NEW YORK, NY:
 2,956,208, INT. CL. 14.
 MICOM COMMUNICATIONS CORP., SIMI VALLEY, CA:
 2,171,557, CANC. INT. CL. 9.
 MICRO ESSENTIAL LABORATORY, INC., BROOKLYN,
 NY:
 2,954,381, PUB. 3-1-2005. INT. CL. 1.
 MICROBRUSH CORPORATION, ORLANDO, FL:
 2,955,266, INT. CL. 10.
 MICROMEDEX, INC., ENGLEWOOD, CO:
 2,171,026, CANC. INT. CL. 42.
 MICRUS CORPORATION, SUNNYVALE, CA:
 2,955,661, INT. CL. 10.
 MIDKNIGHT CREATIONS, LLC, JACKSON, CA:
 2,956,157, INT. CL. 9.
 MIDWESCO RELOCATION SERVICES, INC., DENVER, CO:
 1,284,578, CANC. INT. CL. 36.
 MIDWEST RUBBER CUSTOM MIXING CORP., BEDFORD,
 VA:
 2,170,887, CANC. INT. CL. 42.
 MIDWESTERN ENTERTAINMENT, INC., CHICAGO, IL:
 2,172,010, CANC. INT. CL. 16.
 MIELKE, LARRY, PORTAGE, MI:
 2,955,763, INT. CL. 28.
 MILES INC., ELKHART, IN TO BAYER CORPORATION,
 ELKHART, IN:
 1,842,642, CANC. INT. CL. 5.
 MILFORD, FRANCINE M., VENICE, FL:
 2,956,193, INT. CL. 16.
 MILKY WAY INTERNATIONAL TRADING CORPORA-
 TION, NORWALK, CA:
 2,954,033, PUB. 9-21-2004. INT. CL. 29.
 2,954,034, PUB. 9-21-2004. INT. CL. 29.
 MILL CREEK CELLARS LLC, WALLA WALLA, WA:
 2,955,279, INT. CL. 33.
 MILLENNIUM MARKETPLACE, INC, NEW YORK, NY:
 2,171,968, CANC. INT. CL. 25.
 MILLENNIUM PHARMACEUTICALS, INC., CAMBRIDGE,
 MA:
 2,955,244, INT. CL. 1.
 MILLENNIUM REAL ESTATE NETWORK, INC., ALBU-
 QUERQUE, NM:
 2,170,858, CANC. MULTIPLE CLASS, INT. CLS. 35 AND
 36.
 MILLER, JULIUS D., CLARKESVILLE, GA:
 1,843,055, CANC. INT. CL. 28.
 MILLER, KEITH J., SEBASTOPOL, CA AND MILLER,
 KAREN, SEBASTOPOL, CA:
 2,171,100, CANC. MULTIPLE CLASS, INT. CLS. 39 AND
 42.
 MILLER, VINCENT P., BERKELEY, CA:
 2,171,332, CANC. INT. CL. 42.

- MILLER'S SHADY OAKS, INC., CAVE JUNCTION, OR:
1,883,850. REN. 4-13-05. INT. CL. 32.
- MILLIKEN & COMPANY, NEW YORK, NY:
1,284,425, CANC. INT. CL. 27.
2,171,831, CANC. INT. CL. 27.
2,171,939, CANC. INT. CL. 2.
- MILLS PAINT SALES LTD., DELTA, BRITISH COLUMBIA,
CANADA:
2,954,138, PUB. 6-29-2004. INT. CL. 2.
- MILOSKY, LARRY THOMAS, FT. LAUDERDALE, FL, DBA
LIFFER JUICE:
1,842,985, CANC. INT. CL. 21.
- MINATAUR PROMOTIONS ENTERPRISES, INC., CHICA-
GO, IL:
2,890,610, COR. INT. CL. 35.
- MINDBRIDGE.COM, INC., BLUE BELL, PA:
2,171,317, CANC. INT. CL. 42.
- MINDPOWER, INC., REDMOND, WA:
2,171,275, CANC. INT. CL. 35.
- MINE SAFETY APPLIANCES COMPANY, PITTSBURGH,
PA:
2,954,397, PUB. 3-1-2005. INT. CL. 9.
2,955,686, INT. CL. 9.
- MINEBEA CO., LTD., NAGANO-KEN, JAPAN:
2,896,769, COR. INT. CL. 12.
2,896,773, COR. INT. CL. 12.
2,896,775, COR. INT. CL. 12.
- MINERVA DAIRY, INC., MINERVA, OH:
2,956,200, INT. CL. 29.
- MINITUBE OF AMERICA, INC., VERONA, WI:
2,171,477, CANC. INT. CL. 16.
- MINNESOTA PUBLIC RADIO, ST. PAUL, MN:
2,956,058, INT. CL. 41.
- MINNESOTA PUBLIC RADIO, SAINT PAUL, MN:
2,956,334, INT. CL. 41.
- MINUTE MAN PRODUCTS, INC., EAST FLAT ROCK, NC:
2,954,059, PUB. 3-1-2005. INT. CL. 6.
- MIPS DATALINE TECHNOLOGIES, GMBH, NIEDERHAU-
SEN/TANUS, FED REP GERMANY:
2,954,052, PUB. 12-24-2002. INT. CL. 36.
- MIRACHEM CORPORATION LTD./LTEE, BROSSARD,
QUEBEC, CANADA:
1,284,132, CANC. INT. CL. 9.
- MIRACLE SUN, INC., GOSHEN, IN:
2,955,746, INT. CL. 11.
- MIRACLE SUN, INC., WESTLAKE VILLAGE, CA:
2,955,927, INT. CL. 11.
- MIRAGE GRANITO CERAMICO S.P.A., PAVULLO NEL
FRIGNANO (MO), ITALY:
1,332,166. REN. 4-14-05. INT. CL. 19.
- MIS AG, 64293 DARMSTADT, FED REP GERMANY:
2,954,072, PUB. 7-13-2004. MULTIPLE CLASS, INT. CLS.
9, 35 AND 42.
- MISS UNIVERSE L.P., LLLP, NEW YORK, NY:
2,955,153, PUB. 3-1-2005. INT. CL. 41.
2,955,154, PUB. 3-1-2005. INT. CL. 41.
- MISSION CONTROL, CHICAGO, IL:
2,172,026, CANC. INT. CL. 21.
- MISSOURI SOUTHERN SEED CORPORATION, ROLLA,
MO:
1,900,805. REN. 4-15-05. INT. CL. 31.
- MISTIX CORP.:
1,284,686, CANC. INT. CL. 41.
- MISTY MATE, INC., GILBERT, AZ:
2,956,312, INT. CL. 8.
- MITCHELL & NESS NOSTALGIA COMPANY, PHILADEL-
PHIA, PA:
2,955,065, PUB. 2-15-2005. INT. CL. 25.
- MITRE SPORTS INTERNATIONAL LTD., HUDDERS-
FIELD, WEST YORKSHIRE, ENGLAND:
1,843,707, CANC. INT. CL. 25.
1,843,751, CANC. INT. CL. 28.
- mitsubishi electric corporation, CHIYODA-KU,
TOKYO, JAPAN:
2,954,063, PUB. 3-1-2005. INT. CL. 9.
- MITSUBISHI JIDOSHA KOGYO KABUSHIKI KAISHA,
MINATO-KU, TOKYO, JAPAN:
1,286,856. REN. 4-15-05. INT. CL. 7.
- MITSUBISHI MATERIALS CORPORATION, TOKYO 100,
JAPAN:
2,954,030, PUB. 8-3-2004. MULTIPLE CLASS, INT. CLS. 9,
16 AND 40.
- MITSUI SUMITOMO KAIJO KASAI HOKEN KABUSHIKI
KAISHA, TOKYO, JAPAN:
2,954,054, PUB. 11-9-2004. INT. CL. 36.
- MIZUNO USA, INC., NORCROSS, GA:
2,954,638, PUB. 3-1-2005. INT. CL. 35.
- MKT FASTENING, LLC, LONOKE, AR, DIAMOND EX-
PANSION BOLT CO., INC., GARWOOD, NJ:
593,529. REN. 4-15-05. U.S. CL. 13 (INT. CL. 6).
- MKT, INC., CHAGRIN FALLS, OH:
2,171,967, CANC. INT. CL. 12.
- MMMGBMH, 81369 MUNICH, FED REP GERMANY:
2,955,906, MULTIPLE CLASS, INT. CLS. 9 AND 10.
- MOBILISA, INC., PORT TOWNSEND, WA:
2,956,217, INT. CL. 38.
- MOBILITY ELECTRONICS, INC., SCOTTSDALE, AZ:
2,954,599, PUB. 3-1-2005. INT. CL. 9.
2,954,600, PUB. 3-1-2005. INT. CL. 9.
2,954,601, PUB. 3-1-2005. INT. CL. 9.
2,954,602, PUB. 3-1-2005. INT. CL. 9.
- MODULAR DISPLAY SYSTEMS, INC., BROOKLYN, NY:
2,954,472, PUB. 3-1-2005. INT. CL. 20.
- MOFFLY PUBLICATIONS, INC., GREENWICH, CT:
2,956,326, INT. CL. 35.
- MOGOL, MATTHEW, LOS ANGELES, CA:
2,862,536, COR. INT. CL. 3.
- MOHASCO UPHOLSTERED FURNITURE CORPORATION,
AMSTERDAM, NY:
772,816, CANC. U.S. CL. 32.
- MOHAWK BRANDS, INC., WILMINGTON, DE:
2,955,748, INT. CL. 27.
2,956,275, INT. CL. 27.
- MOHR, RANDALL J., FORT MYERS, FL:
1,284,616, CANC. INT. CL. 37.
- MOJAVE FOODS CORPORATION, COMMERCE, CA:
1,925,631. REN. 4-13-05. MULTIPLE CLASS, INT. CLS. 29,
30 AND 31.
- MON CHER CHOUCHOU, INC., CANTON, OH:
1,843,824, CANC. INT. CL. 31.
1,843,825, CANC. INT. CL. 31.
- MONARCH COMPANY, INC., THE, ATLANTA, GA:
2,171,324, CANC. INT. CL. 32.
- MONDE M.Y. SAN CORPORATION, CAINTA RIZAL,
PHILIPPINES:
2,955,007, PUB. 3-1-2005. INT. CL. 30.
- MONDO MEDIA, INC., SAN FRANCISCO, CA FROM
MONDO MEDIA, SAN FRANCISCO, CA:
2,955,219, INT. CL. 41.
- MONDO S.P.A., CUNEO, ITALY:
2,902,614, COR. INT. CL. 28.
- MONIQUE MATHIEU, INC., MIAMI BEACH, FL:
2,171,013, CANC. MULTIPLE CLASS, INT. CLS. 18 AND
25.
- MONTANA SILVER SPRINGS, INC., PHILIPSBURG, MT:
2,171,822, CANC. INT. CL. 32.
- MONTANA WEST, INC., QUAKERTOWN, PA:
2,956,234, INT. CL. 41.
- MONTEFIORE MEDICAL CENTER, BRONX, NY:
2,954,894, PUB. 3-1-2005. INT. CL. 42.
- MONTGOMERY WARD & CO., INCORPORATED, CHICA-
GO, IL TO MONTGOMERY WARD LLC, CHICAGO, IL:
1,843,038, CANC. INT. CL. 25.
- MOORE NORTH AMERICA, INC., STAMFORD, CT:
2,954,329, PUB. 3-1-2005. INT. CL. 35.
- MOOSEJAW MOUNTAINEERING AND BACKCOUNTRY
TRAVEL, INC., CHICAGO, IL:
2,955,083, PUB. 3-1-2005. INT. CL. 25.
- MOQUETTE INDUSTRIE DEVENTER B.V., DEVENTER,
NETHERLANDS:
1,284,424, CANC. INT. CL. 27.
- MORARI SPECIALTIES, INC., MIAMI, FL:
2,956,102, INT. CL. 35.
- MORETZ, INC., NEWTON, NC:
2,954,083, PUB. 5-4-2004. INT. CL. 25.

MORGAN STANLEY, NEW YORK, NY:
2,954,438, PUB. 3-1-2005. INT. CL. 36.

MORI, KEN, SHINJUKU-KU, TOKYO, JAPAN:
1,051,315, CANC. INT. CL. 25.

MORLAND, D. VERNE, KETTERING, OH:
2,956,244, INT. CL. 9.

MORRIS, JAMES, HITCHENS & WILLIAMS LLP, WIL-
MINGTON, DE:
2,956,177, INT. CL. 16.

MOTOROLA, INC., SCHAUMBURG, IL:
2,171,619, CANC. INT. CL. 9.

MOTT'S INC., STAMFORD, CT:
2,955,141, PUB. 3-1-2005. MULTIPLE CLASS, INT. CLS. 29
AND 32.

MOUNTAIN STATES EMPLOYERS COUNCIL, INC., DEN-
VER, CO:
2,954,930, PUB. 3-1-2005. MULTIPLE CLASS, INT. CLS.
35, 41 AND 42.

MOUNTAIN VELVET, LTD., DEL NORTE, CO:
2,956,258, INT. CL. 29.

MPATH INTERACTIVE, INC., MOUNTAIN VIEW, CA:
2,171,525, CANC. INT. CL. 28.

MPF MANAGEMENT, LLC., HOUSTON, TX:
2,954,768, PUB. 3-1-2005. INT. CL. 43.

MPHUSKY CORPORATION, GREENVILLE, SC:
1,895,877. REN. 4-15-05. INT. CL. 6.
1,895,878. REN. 4-15-05. INT. CL. 6.
1,895,879. REN. 4-15-05. INT. CL. 6.

MR. CHRISTMAS, INC., NEW YORK, NY:
1,843,966, CANC. INT. CL. 28.

MUELHENS GMBH & CO. KG, 50823 KOLN, FED REP
GERMANY:
2,170,908, CANC. INT. CL. 3.

MULHOLLAND BROTHERS, SAN FRANCISCO, CA:
2,956,062, INT. CL. 35.

MULLIGAN, TIMOTHY JOSEPH, TURNEY, MO:
2,171,776, CANC. INT. CL. 35.

MULTI-STATE LOTTERY ASSOCIATION, DES MOINES, IA:
2,956,098, MULTIPLE CLASS, INT. CLS. 28 AND 41.

MUSCLETECH RESEARCH AND DEVELOPMENT INC.,
MISSISSAUGA, ONTARIO, CANADA:
2,954,018, PUB. 3-1-2005. INT. CL. 5.

MUSEUM OF SCIENCE, BOSTON, MA:
2,956,237, INT. CL. 41.

MUTUAL SAVINGS AND LOAN ASSOCIATION, BAY CITY,
MI:
1,284,558, CANC. INT. CL. 36.

MUZE INC., NEW YORK, NY:
2,955,328, INT. CL. 41.

MY SOFTWARE CO., PALO ALTO, CA:
1,842,809, CANC. INT. CL. 9.

MYDAILYDOSE INC., SAIPAN, N. MARIANA ISLAND:
2,956,187, INT. CL. 5.

MYDOCONLINE, INC., ROUND ROCK, TX:
2,107,639, CANC. INT. CL. 42.

MYRIAD SOFTWARE, LLC, SAN DIEGO, CA:
2,955,227, INT. CL. 9.

MYSTIC TAN, INC., FARMERS BRANCH, TX:
2,955,869, INT. CL. 3.
2,955,870, INT. CL. 3.
2,955,871, INT. CL. 3.

MZ CONSULT SERVICOS E NEGOCIOS S/C LTDA, SAO
PAULO, BRAZIL:
2,956,233, INT. CL. 35.

N & N HOME FURNISHINGS CORPORATION, EDGE-
WATER, NJ:
2,856,931, CANC. INT. CL. 35.

N.H. ASSOCIATES, SANTA ROSA, CA:
1,843,929, CANC. U.S. CL. 200.

N.V. BISCUITS DELACRE S.A., ZAVENTEM, BELGIUM:
1,843,092, CANC. INT. CL. 30.

N-RICH PLANT FOOD, INC., HUMBOLT, SD:
1,373,219. REN. 4-9-05. INT. CL. 1.

NABISCO BRANDS COMPANY, WILMINGTON, DE:
2,171,417, CANC. INT. CL. 16.

NABISCO, INC., PARSIPPANY, NJ:
2,171,982, CANC. INT. CL. 30.
2,172,000, CANC. INT. CL. 29.

NACA LOGISTICS (USA) INC., CARSON, CA:
2,955,854, MULTIPLE CLASS, INT. CLS. 35 AND 39.

NAGHI, DAVID, BEVERLY HILLS, CA:
2,956,307, INT. CL. 9.

NAILERS, INC., SANTEE, CA:
1,850,542. REN. 4-11-05. INT. CL. 8.

NAK CORPORATION, HAYWARD, CA:
2,171,041, CANC. INT. CL. 25.
2,171,042, CANC. INT. CL. 25.

NANOCARRIER CO., LTD., CHIBA 277-0882, JAPAN:
2,954,068, PUB. 3-1-2005. INT. CL. 42.

NANOOPTO CORPORATION, SOMMERSET, NJ:
2,955,920, INT. CL. 9.

NAP, INC., NEW YORK, NY:
2,955,441, INT. CL. 25.

NATIONAL APERTURE, INC., SALEM, NH:
2,772,149, COR. MULTIPLE CLASS, INT. CLS. 7, 9 AND
42.

NATIONAL ASSOCIATION FOR PRINTING LEADERSHIP,
INC., PARAMUS, NJ:
1,327,572. REN. 4-12-05. INT. CL. 42.

NATIONAL ASSOCIATION FOR STOCK CAR AUTO RA-
CING, INC., DAYTONA BEACH, FL:
2,955,795, INT. CL. 35.

NATIONAL BEDDING COMPANY L.L.C., HOFFMAN ES-
TATES, IL:
2,911,630, COR. INT. CL. 20.

NATIONAL COLLEGIATE ATHLETIC ASSOCIATION, THE,
INDIANAPOLIS, IN:
2,954,402, PUB. 3-1-2005. INT. CL. 25.

NATIONAL COUNCIL OF YOUNG MEN'S CHRISTIAN
ASSOCIATIONS OF THE UNITED STATES OF AMERICA,
CHICAGO, IL:
2,954,588, PUB. 3-1-2005. INT. CL. 41.

NATIONAL COUNCIL ON ECONOMIC EDUCATION, INC.,
NEW YORK, NY:
1,880,937. REN. 4-13-05. INT. CL. 41.

NATIONAL COUNCIL ON YOUTH LEADERSHIP, WEST
LIBERTY, IA:
2,954,767, PUB. 3-1-2005. INT. CL. 41.

NATIONAL E COMMERCE, IRVING, TX, DBA E CHEX:
2,954,740, PUB. 3-1-2005. MULTIPLE CLASS, INT. CLS. 36
AND 40.

NATIONAL EVALUATION SYSTEMS, INC., HADLEY, MA:
2,955,897, INT. CL. 41.

NATIONAL FLORIST DIRECTORY, INC., PARAGOULD,
AR, DBA REDBOOK FLORIST SERVICES:
2,171,052, CANC. INT. CL. 16.

NATIONAL FOOTBALL LEAGUE, NEW YORK, NY:
2,954,420, PUB. 3-1-2005. INT. CL. 25.

NATIONAL INSTITUTE FOR TRUTH VERIFICATION LLC,
WEST PALM BEACH, FL:
2,954,383, PUB. 3-1-2005. INT. CL. 9.

NATIONAL INSURANCE CRIME BUREAU, PALOS HILLS,
IL:
2,170,956, CANC. INT. CL. 42.

NATIONAL MED NETWORK, LLC, ROCKFORD, IL:
2,956,183, INT. CL. 35.

NATIONAL OIL AND GAS SCHOOLS:
1,284,684, CANC. INT. CL. 41.

NATIONAL PATENT DEVELOPMENT CORPORATION,
NEW YORK, NY:
1,284,048, CANC. INT. CL. 5.

NATIONAL PORK BOARD, CLIVE, IA:
2,954,249, PUB. 3-1-2005. MULTIPLE CLASS, INT. CLS.
16, 35 AND 41.
2,954,250, PUB. 3-1-2005. MULTIPLE CLASS, INT. CLS.
16, 35 AND 41.

NATIONAL PREARRANGED SERVICES, INC., ST. LOUIS,
MO:
2,954,642, PUB. 3-1-2005. MULTIPLE CLASS, INT. CLS.
35, 36, 41 AND 45.

NATIONAL PRONTO STORES, INC., SPRINGFIELD, IL:
1,325,079, COR. INT. CL. 42.

NATIONAL RAILROAD PASSENGER CORPORATION,
WASHINGTON, DC:
2,955,888, INT. CL. 16.

- NATIONAL STARCH AND CHEMICAL CORPORATION, BRIDGEWATER, NJ:
1,283,950, CANC. INT. CL. 1.
- NATIONAL TECHNOLOGY TRANSFER, INC., ENGLEWOOD, CO:
2,954,810, PUB. 3-1-2005. INT. CL. 41.
- NATIONAL TELEPHONE EXCHANGE, INC., HARRISBURG, PA:
2,171,379, CANC. INT. CL. 36.
- NATIONAL TRUST FOR HISTORIC PRESERVATION IN THE UNITED STATES, WASHINGTON, DC:
2,955,972, INT. CL. 41.
- NATIONAL VISION ASSOCIATES, LTD., LAWRENCEVILLE, GA TO VISTA EYECARE, INC., LAWRENCEVILLE, GA:
1,843,857, CANC. INT. CL. 35.
1,843,972, CANC. INT. CL. 35.
- NATIONAL VISION ASSOCIATES, LTD., LAWRENCEVILLE, GA:
2,171,616, CANC. INT. CL. 9.
2,171,682, CANC. INT. CL. 9.
- NATIONSBANK CORPORATION, CHARLOTTE, NC:
2,170,883, CANC. INT. CL. 36.
- NATURAL CHOICE DISTRIBUTION CO. LLC, LAFAYETTE, CA:
2,956,120, INT. CL. 30.
- NATURAL ENERGY LABORATORY OF HAWAII AUTHORITY (NELHA), KAILUA-KONA, HI:
2,954,232, PUB. 3-1-2005. INT. CL. 35.
- NATURAL ORGANICS INC., MELVILLE, NY:
2,171,950, CANC. INT. CL. 5.
- NATURAL ORGANICS, INC., MELVILLE, NY:
1,921,454, REN. 4-13-05. INT. CL. 5.
1,929,614, REN. 4-13-05. INT. CL. 5.
- NATURAL REFLEX THERAPY, PLLC, SAN ANTONIO, TX:
2,956,271, INT. CL. 44.
- NATURAL THOUGHTS, INC., SAN DIEGO, CA:
2,888,940, COR. INT. CL. 3.
- NATURALLY FRESH, INC., ATLANTA, GA:
1,958,479, REN. 4-15-05. INT. CL. 30.
- NATURE'S DESIGN, LTD., BROOKLYN, NY:
2,171,410, CANC. INT. CL. 30.
- NATURE'S HEALTH SUPPLY, INC., SANTA BARBARA, CA:
2,956,121, INT. CL. 5.
- NATURE'S THERAPY, INC., LUTZ, FL:
2,171,544, CANC. INT. CL. 3.
- NAUTICO VENTURES, L.L.C., MIAMI BEACH, FL:
2,954,560, PUB. 3-1-2005. INT. CL. 39.
- NAVITRAK INTERNATIONAL CORPORATION, OAKVILLE, ONTARIO, CANADA:
2,171,522, CANC. MULTIPLE CLASS, INT. CLS. 16 AND 42.
- NBA PROPERTIES, INC., NEW YORK, NY:
2,171,971, CANC. INT. CL. 16.
2,954,264, PUB. 3-1-2005. INT. CL. 25.
- NCA MED INT'L, SEATTLE, WA:
2,464,847, CANC. INT. CL. 5.
- NCL CORPORATION, LTD., MIAMI, FL:
2,913,474, COR. INT. CL. 39.
- NEBRASKA DEPARTMENT OF REVENUE, LOTTERY DIVISION, LINCOLN, NE:
2,956,250, INT. CL. 9.
- NEERUAM, INCORPORATED, GRANITE BAY, CA:
2,954,485, PUB. 3-1-2005. INT. CL. 3.
- NEFCO, INC., PALM BEACH GARDENS, FL:
1,865,246, REN. 4-11-05. INT. CL. 11.
- NEGRO LEAGUES BASEBALL MUSEUM, INC., KANSAS CITY, MO:
1,843,234, CANC. INT. CL. 41.
- NEHA TRAINING LLC, DENVER, CO:
2,954,903, PUB. 3-1-2005. MULTIPLE CLASS, INT. CLS. 16 AND 41.
- NELOSTUOTE OY, PORI, FINLAND:
2,955,586, INT. CL. 28.
- NELSEN FUNERAL HOME, INC., RICHMOND, VA:
2,956,360, INT. CL. 45.
2,956,361, INT. CL. 45.
- NEODATA SERVICES, INC., LOUISVILLE, CO:
2,171,445, CANC. INT. CL. 42.
- NEROZZI, CARLO, 37066 SOMMACAMPAGNA (VERONA), ITALY, DBA AZIENDA AGRICOLA LE VIGNE DI SAN PIETRO DI CARLO NEROZZI:
1,853,776, REN. 4-15-05. INT. CL. 33.
- NESAK INTERNATIONAL, BOCA RATON, FL:
2,172,012, CANC. INT. CL. 16.
- NESTLER, CARLOS W., JR., FARGO, ND AND KLEIN, TERRILL, FARGO, ND:
2,955,056, PUB. 3-1-2005. INT. CL. 21.
- NETLINK REALTY ONLINE MAGAZINE, LLC, PHOENIX, AZ:
2,954,441, PUB. 3-1-2005. INT. CL. 35.
- NETWORK COMMUNICATIONS, INC., LAWRENCEVILLE, GA:
2,954,180, PUB. 3-1-2005. INT. CL. 36.
- NEVADA CANCER INSTITUTE, LAS VEGAS, NV:
2,956,007, INT. CL. 42.
- NEW AMERICAN THEATER, INC., ROCKFORD, IL:
1,284,687, CANC. INT. CL. 41.
- NEW BALANCE ATHLETIC SHOE, INC., BOSTON, MA:
2,955,394, INT. CL. 28.
2,955,395, INT. CL. 28.
- NEW CENTURY BEVERAGE COMPANY, SAN FRANCISCO, CA:
2,171,863, CANC. INT. CL. 32.
- NEW DIMENSIONS PRECISION MACHINING, INC., FRANKLIN PARK, IL:
2,171,134, CANC. INT. CL. 40.
- NEW ERA LIFESTYLE SYSTEMS, LLC, LEESBURG, VA:
2,954,376, PUB. 3-1-2005. INT. CL. 11.
- NEW FRAGRANCE CONTINENTAL, INC., LOS ANGELES, CA:
1,949,304, REN. 4-10-05. INT. CL. 3.
- NEW HORIZONS FITNESS CENTER, INC., DAYTON, OH TO TAEKWONDO WORLD, INC., MARIETTA, GA:
1,843,263, CANC. INT. CL. 41.
- NEW PRODUCTS INC., PORTLAND, OR:
2,955,215, INT. CL. 16.
- NEW SECTOR ALLIANCE, INC., CAMBRIDGE, MA:
2,956,059, INT. CL. 35.
- NEW YORK SUB, INC., DALLAS, TX:
2,954,833, PUB. 3-1-2005. MULTIPLE CLASS, INT. CLS. 35 AND 43.
- NEWAYS, INC., SPRINGVILLE, UT:
2,954,957, PUB. 3-1-2005. INT. CL. 5.
2,954,958, PUB. 3-1-2005. INT. CL. 5.
2,954,959, PUB. 3-1-2005. INT. CL. 5.
2,954,960, PUB. 3-1-2005. INT. CL. 5.
2,954,961, PUB. 3-1-2005. INT. CL. 5.
- NEWCOM, INC., WESTLAKE VILLAGE, CA:
2,172,007, CANC. INT. CL. 9.
- NEWPORT NEWS, INC., NEW YORK, NY:
2,171,904, CANC. INT. CL. 25.
- NEWSSTAND, INC., AUSTIN, TX:
2,956,316, INT. CL. 9.
- NEWSTAR COLLABORATIVE TECHNOLOGIES, INC., ST. LOUIS, MO:
2,170,678, CANC. INT. CL. 9.
- NEXT, INC., PALO ALTO, CA:
1,284,802, CANC. INT. CL. 42.
- NEXTEL, INC., LAS VEGAS, NV TO NEXTEL, INC., LAS VEGAS, NV:
1,637,139, COR. INT. CL. 38.
- NEXUS HEALTH SYSTEMS, LTD., HOUSTON, TX:
2,954,307, PUB. 3-1-2005. INT. CL. 44.
- NICHE SOLUTIONS GROUP, ARLINGTON HEIGHTS, VA:
2,955,827, INT. CL. 36.
- NICHOLS, DEBORAH L., CRESTWOOD, IL:
2,955,515, INT. CL. 35.
- NICOLAS STARK COMPUTING, AB, 521 93 FALKOPING, SWEDEN:
2,954,155, PUB. 5-18-2004. INT. CL. 9.
- NIKE, INC., BEAVERTON, OR:
2,954,673, PUB. 3-1-2005. MULTIPLE CLASS, INT. CLS. 19 AND 27.

NINACLIP, PLC, LEEDS, WEST YORKSHIRE, UNITED KINGDOM:
2,954,656, PUB. 3-1-2005. MULTIPLE CLASS, INT. CLS. 20 AND 22.

NINE WEST DEVELOPMENT CORPORATION, STAMFORD, CT:
2,171,468, CANC. INT. CL. 25.

NINTENDO CO., LTD., KYOTO, JAPAN:
2,954,619, PUB. 4-20-2004. MULTIPLE CLASS, INT. CLS. 9 AND 41.

NINTENDO OF AMERICA INC., REDMOND, WA:
1,883,044, REN. 4-10-05. INT. CL. 28.

NIPPON DENKI KABUSHIKI KAISHA, TOKYO, JAPAN, DBA NEC CORPORATION:
2,171,623, CANC. INT. CL. 9.

NISUS CORPORATION, ROCKFORD, TN:
2,955,973, INT. CL. 1.

NITRO ICE CREAM, LLC, BOONE, IA:
2,955,282, INT. CL. 35.

NITSCHKE, ALETA A., GARFIELD, MN:
2,955,102, PUB. 3-1-2005. INT. CL. 16.

NITTO DENKO CORPORATION, IBARAKI-, OSAKA-FU, JAPAN, NITTO ELECTRIC INDUSTRIAL CO., LTD., IBARAKI-SHI, OSAKA-FU, JAPAN:
1,311,084, REN. 4-13-05. INT. CL. 17.

NO LIMIT LACROSSE, INC., MANHASSETT, NY:
2,954,242, PUB. 3-16-2004. INT. CL. 41.

NO STINK, INC., PHOENIX, AZ:
2,954,469, PUB. 3-1-2005. INT. CL. 5.

NOBBY'S ABF EQUIPMENT CORP., INC., WICHITA FALLS, TX:
2,171,934, CANC. INT. CL. 26.

NODINE, SAMANTHA L, RANDOLPH, NJ:
2,954,968, PUB. 3-1-2005. INT. CL. 16.

NOKOMIS FARMS, INC., EAST TROY, WI:
1,843,809, CANC. INT. CL. 30.

NOLAN, PHILIP, WAUPACA, WI:
2,955,516, INT. CL. 9.

NOODLES & COMPANY, BOULDER, CO:
2,955,809, INT. CL. 42.

NORAM, INC., TUSCALOOSA, AL:
2,954,899, PUB. 3-1-2005. INT. CL. 6.

NORCRAFT COMPANIES, L.L.C., EAGAN, MN:
2,955,754, MULTIPLE CLASS, INT. CLS. 20 AND 40.

NORDEA BANK FINLAND ABP, HELSINKI, FINLAND:
2,954,047, PUB. 3-1-2005. MULTIPLE CLASS, INT. CLS. 9, 35, 36 AND 38.

NORDSON CORPORATION, WESTLAKE, OH:
2,171,920, CANC. INT. CL. 7.

NORDSON CORPORATION, WESTLAEK, OH:
2,955,521, INT. CL. 9.

NORITA PRECISION, INC., PORTLAND, OR TO SECO MANUFACTURING CO., INC., REDDING,, CA:
1,843,541, CANC. INT. CL. 9.

NORRELL ASSET MANAGEMENT COMPANY, RENO, NV:
2,171,458, CANC. INT. CL. 35.

NORSK HYDRO ASA, NORWAY:
2,954,137, PUB. 3-1-2005. INT. CL. 1.

NORSKE SKOG CANADA LIMITED, VANCOUVER, CANADA:
2,954,759, PUB. 9-28-2004. INT. CL. 16.

NORTH AMERICAN ACCEPTANCE CORPORATION, COSTA MESA, CA:
2,954,812, PUB. 3-1-2005. INT. CL. 36.

NORTH AMERICAN DECORATIVE PRODUCTS INC., BRAMPTON, ONTARIO L6T 3W4, CANADA:
2,171,019, CANC. INT. CL. 27.

NORTH AMERICAN FROZEN DESSERT DISPENSING SYSTEMS, INC., BROOKLYN HEIGHTS, NY:
1,516,572, CANC. INT. CL. 30.

NORTH AMERICAN PHILIPS CORPORATION, NEW YORK, NY:
1,284,168, CANC. INT. CL. 9.

NORTH DAKOTA STATE UNIVERSITY RESEARCH FOUNDATION, FARGO, ND:
1,843,107, CANC. INT. CL. 31.

NORTH FACE APPAREL CORP., THE, WILMINGTON, DE:
983,624 NEW CERT. 5-24-2005. MULTIPLE CLASS, U.S. CLS. 3, 22 AND 39.
2,109,256 NEW CERT. 5-24-2005. INT. CL. 28.
2,300,758 NEW CERT. 5-24-2005. INT. CL. 25.
2,660,558 NEW CERT. 5-24-2005. INT. CL. 22.

NORTH FACE, INC., THE, BERKELEY, CA TO NORTH FACE APPAREL CORP., THE, WILMINGTON, DE:
2,067,763 NEW CERT. 5-24-2005. INT. CL. 1.

NORTH FACE, INC., THE, SAN LEANDRO, CA TO THE NORTH FACE APPAREL CORP., WILMINGTON, DE:
2,096,011 NEW CERT. 5-24-2005. INT. CL. 25.

NORTH FACE, INC., THE, SAN LEANDRO, CA TO NORTH FACE APPAREL CORP., THE, WILMINGTON, DE:
2,097,715 NEW CERT. 5-24-2005. MULTIPLE CLASS, INT. CLS. 18, 20, 22 AND 25.

NORTH FACE, THE, BERKELEY, CA TO NORTH FACE APPAREL CORP., THE, WILMINGTON, DE:
1,102,407 NEW CERT. 5-24-2005. INT. CL. 42.

NORTHCOAST VALVE AND GATE INC., EASTLAKE, OH:
1,843,585, CANC. INT. CL. 11.

NORTHCUTT, WAYNE E., CROCKETT, TX, DBA NORTHCUTT ENTERPRISES:
1,843,679, CANC. INT. CL. 21.

NORTHROP GRUMMAN CORPORATION, LOS ANGELES, CA:
2,954,314, PUB. 3-1-2005. INT. CL. 9.

NORTHWEST EDUCATION TECHNOLOGY, INC., TUALATIN, OR:
2,171,861, CANC. INT. CL. 9.

NORTHWESTERN PUBLISHING HOUSE, MILWAUKEE, WI:
2,170,934, CANC. INT. CL. 16.

NORTHWESTERN UNIVERSITY, EVANSTON, IL:
1,325,784, REN. 4-15-05. MULTIPLE CLASS, INT. CLS. 16, 21, 24 AND 25.

NOTHING BUT GREEN, INC., PLACENTIA, CA:
2,171,535, CANC. INT. CL. 24.

NOVA BRANDS LTD., CALGARY, ALBERTA, CANADA, NOVA, AN ALBERTA CORPORATION, CALGARY, ALBERTA, CANADA:
1,348,810, REN. 4-12-05. INT. CL. 1.

NOVA GAMING, LLC, GREENVILLE, SC:
2,955,389, INT. CL. 9.
2,955,397, INT. CL. 9.

NOVAMEDICS HEALTH PRODUCTS, INC., SANTA MONICA, CA:
2,955,345, INT. CL. 5.

NOVANARY, INC., STANTON, NJ:
2,955,259, MULTIPLE CLASS, INT. CLS. 9 AND 42.

NOVARTIS AG, 4002 BASLE, SWITZERLAND:
2,171,358, CANC. INT. CL. 5.

NOVARTIS AG, SWITZERLAND:
2,955,172, PUB. 3-1-2005. INT. CL. 5.

NOVARTIS CORPORATION, SUMMIT, NJ, CIBA-GEIGY CORPORATION, ARDSLEY, NY:
1,882,770, REN. 4-13-05. INT. CL. 5.

NOVARTIS INTERNATIONAL PHARMA, LTD., EAST HANOVER, NJ:
1,882,779, REN. 4-13-05. INT. CL. 5.

NOVO NORDISK A/S, DK-2880 BAGSVAERD, DENMARK:
2,170,854, CANC. INT. CL. 3.

NSI ENTERPRISES, INC., ATLANTA, GA:
2,170,874, CANC. INT. CL. 11.

NTI AG, ZURICH, SWITZERLAND:
2,955,575, INT. CL. 7.

NU SKIN INTERNATIONAL, INC., PROVO, UT:
1,873,550, REN. 4-10-05. INT. CL. 5.

NUCCI INTERNATIONAL CORP., NEW YORK, NY:
2,955,329, INT. CL. 25.

NUCLETRON B.V., 3905 TH VEENENDAAL, NETHERLANDS:
2,954,822, PUB. 3-1-2005. INT. CL. 9.

NUUESTRA CASA, LLC, EVANSTON, IL:
2,955,784, INT. CL. 16.

NUHAD KHOURY CONMETICS & PERFUMERY, INC., NASHVILLE, TN, NAISSANCE, INC., NASHVILLE, TN:
1,881,095, REN. 4-12-05. INT. CL. 3.

NUTEK, INC., TYLER, TX:
2,576,285, CANC. INT. CL. 11.

- NUTRASWEET PROPERTY HOLDINGS, INC., CHICAGO, IL, G. D. SEARLE & CO., SKOKIE, IL:
1,325,241. REN. 4-13-05. MULTIPLE CLASS, INT. CLS. 1, 5 AND 30.
- NUTRAVITAL INC., SILLERY, (QUEBEC) G1T 1V7, CANADA:
2,954,140. PUB. 11-16-2004. MULTIPLE CLASS, INT. CLS. 29 AND 30.
- NUTRI/SYSTEM IPHC, INC., WILMINGTON, DE:
2,954,800. PUB. 3-1-2005. INT. CL. 5.
- NYC SMILE DESIGN, NEW YORK, NY:
2,956,206. INT. CL. 44.
- O&K ORENSTEIN & KOPPEL AKTIENGESELLSCHAFT, D-44149 DORTMUND, FED REP GERMANY:
1,842,687. CANC. INT. CL. 7.
- O'ROURKE, ROBERT H., CREAMRIDGE, NJ:
2,171,817. CANC. INT. CL. 26.
- OAK FURNITURE WAREHOUSE, INC., NEW CASTLE, DE:
1,843,362. CANC. MULTIPLE CLASS, INT. CLS. 9 AND 20.
- OAKHURST TRADING CORPORATION, GRAND PRAIRIE, TX:
2,171,784. CANC. INT. CL. 12.
- OASIS INTERNATIONAL, L.L.C., OOLTEWAH, TN:
2,172,005. CANC. INT. CL. 30.
- OCEAN TO OCEAN SEAFOOD LLC, CAMBRIDGE, MA:
1,877,779. REN. 4-14-05. INT. CL. 29.
- OCHS, BEVERLY, CENTERVILLE, OH:
2,955,681. MULTIPLE CLASS, INT. CLS. 21 AND 25.
- OCHS, MICHAEL, NASHVILLE, TN:
2,955,449. MULTIPLE CLASS, INT. CLS. 9 AND 41.
- ODAWARA AUTOMATION, INC., TIPP CITY, OH, DBA OA INC.:
1,826,131. REN. 4-15-05. INT. CL. 7.
- ODYSSEY PAINTBALL PRODUCTS, L.L.C., GARLAND, TX:
2,955,501. INT. CL. 28.
- OEM SYSTEMS COMPANY, INC., SPARKS, NV:
2,955,981. INT. CL. 9.
- OERI, GISELA, CH-4052 BASEL, SWITZERLAND, INDUSTRIEWIRKE LEMM & COMPANY, G.M.B.H., GUSTERATH-TAL, KREIS TRIER, FED REP GERMANY:
785,635. REN. 4-13-05. U.S. CL. 39 (INT. CL. 25).
- OFF-CAMPUS DINING NETWORK, KING OF PRUSSIA, PA:
2,954,809. PUB. 3-1-2005. MULTIPLE CLASS, INT. CLS. 9, 16 AND 36.
- OFFICIAL PILLOWTEX LLC, COLUMBUS, OH:
772,890. CANC. U.S. CL. 42.
- OHIO GUN COLLECTORS ASSOCIATION; THE, CINCINNATI, OH:
1,318,625. REN. 4-13-05. INT. CL. 41.
- OHIO STATE UNIVERSITY, THE, COLUMBUS, OH:
1,005,655. REN. 4-11-05. U.S. CL. 200.
- OHIO VALLEY BAG AND BURLAP CO., INC., LOUISVILLE, KY:
1,284,275. CANC. MULTIPLE CLASS, INT. CLS. 16 AND 21.
- OKASAWARA, MAURICIO SUSSUMU, SAO JOSE DO RIO PRETO, SAO PAULO, BRAZIL:
2,955,232. INT. CL. 5.
- OKLAHOMA PUBLISHING COMPANY, THE, OKLAHOMA CITY, OK:
2,954,537. PUB. 3-1-2005. INT. CL. 35.
- OLD CHARLESTON JOGGING BOARD CO., INC., CHARLESTON, SC:
2,954,864. PUB. 3-1-2005. INT. CL. 20.
- OLD MOTHER HUBBARD, INC., LOWELL, MA:
2,955,421. INT. CL. 5.
2,955,422. INT. CL. 5.
- OLD NAVY (APPARAL), LLC, SAN FRANCISCO, CA:
2,171,764. CANC. INT. CL. 3.
- OLD WORLD INDUSTRIES, INC., NORTHBROOK, IL:
2,955,890. INT. CL. 1.
- OLD WORLD ROOFING, INC., KALAMAZOO, MI:
2,171,947. CANC. INT. CL. 37.
- OLIVA, RICHARD A., JR., CHARLOTTESVILLE, VA:
2,955,834. INT. CL. 28.
- OLIVER RUBBER COMPANY, OAKLAND, CA:
1,284,293. CANC. INT. CL. 16.
- OLSON, A. WAYNE, LAS VEGAS, NV, DBA UNICACHE, LTD.:
2,955,221. INT. CL. 36.
- OLTERSDFORF, MICHAEL W., FORT COLLINS, CO:
2,171,606. CANC. MULTIPLE CLASS, INT. CLS. 9, 16 AND 42.
- OLYMPIC SALES CLUB, INC., ENFIELD, CT:
1,284,785. CANC. INT. CL. 42.
- OMEGA IP CO., WATERLOO, IA:
2,954,867. PUB. 3-1-2005. INT. CL. 20.
- OMG AMERICAS, INC., CLEVELAND, OH:
2,955,703. INT. CL. 1.
- OMI INTERNATIONAL CORPORATION, WARREN, MI:
1,283,935. CANC. INT. CL. 1.
- OMNI HOTELS MANAGEMENT CORPORATION, HAMPTON, NH:
1,284,778. CANC. INT. CL. 42.
1,284,780. CANC. INT. CL. 42.
1,284,781. CANC. INT. CL. 42.
1,284,783. CANC. INT. CL. 42.
- OMNICOM INTERNATIONAL HOLDINGS INC., SAN FRANCISCO, NY:
2,956,099. MULTIPLE CLASS, INT. CLS. 35 AND 41.
- OMNIGLOW CORPORATION, WEST SPRINGFIELD, MA:
1,341,079. REN. 4-15-05. INT. CL. 28.
- OMNIVORE CONSULTING INC, VANCOUVER, BRITISH COLUMBIA, CANADA:
2,170,957. CANC. INT. CL. 42.
- OMNIVORE CONSULTING INC., VANCOUVER, BRITISH COLUMBIA, CANADA:
2,170,911. CANC. INT. CL. 9.
- OMP, INC., LONG BEACH, CA:
2,955,085. PUB. 3-1-2005. MULTIPLE CLASS, INT. CLS. 3 AND 5.
- OMS INVESTMENTS, INC., LOS ANGELES, CA:
2,955,858. INT. CL. 5.
- ON SITE SANITATION, INC., ST. PAUL, MN:
2,954,990. PUB. 3-1-2005. INT. CL. 11.
- ON TOP OF THE WORLD COMMUNITIES, INC., OCALA, FL:
2,955,213. MULTIPLE CLASS, INT. CLS. 36 AND 37.
- ONE ECONOMY CORP., WASHINGTON, DC:
2,955,611. INT. CL. 35.
- ONE EYE INDUSTRIES, INC., CALGARY, ALBERTA, CANADA:
2,170,763. CANC. INT. CL. 7.
- ONE NATION PRODUCTIONS, NEW YORK, NY:
1,843,902. CANC. INT. CL. 41.
- ONE WORLD TECHNOLOGIES LIMITED, HAMILTON, BERMUDA:
2,955,692. INT. CL. 7.
- ONEWAVE, INC., WATERTOWN, MA:
2,171,703. CANC. MULTIPLE CLASS, INT. CLS. 9, 16, 41 AND 42.
- OPAL EARTH COMPANY, BOURNE, MA:
1,283,964. CANC. INT. CL. 3.
- OPCENTER, LLC, NEW YORK, NY:
2,171,854. CANC. INT. CL. 35.
- OPDEX, INC., MOUNTAIN VIEW, CA:
2,955,486. INT. CL. 9.
- OPEN HORIZON, INC., SOUTH SAN FRANCISCO, CA:
2,171,286. CANC. INT. CL. 9.
- OPEN JOINT-STOCK COMPANY "TVEL", MOSCOW, RUSSIAN FED.:
2,954,737. PUB. 9-21-2004. INT. CL. 11.
- OPI PRODUCTS, INC., NORTH HOLLYWOOD, CA:
1,336,222. REN. 4-11-05. INT. CL. 3.
- OPRYLAND USA, INC., NASHVILLE, TN:
1,284,673. CANC. INT. CL. 41.
- OPTACOR FINANCIAL SERVICES COMPANY, RICHMOND, VA:
2,171,891. CANC. INT. CL. 36.
2,171,912. CANC. INT. CL. 36.
- OPTCAPITAL, LLC, CHARLOTTE, NC:
2,954,746. PUB. 3-1-2005. INT. CL. 36.

- OPTIMARK CORPORATION, TAMPA, FL:
1,842,731, CANC. MULTIPLE CLASS, INT. CLS. 9 AND 16.
- OPTOMETRIC PHYSICIANS OF WASHINGTON, BELLEVUE, WA:
2,956,161, INT. CL. 35.
- OPTOSCINT, INC., MESA, AZ:
2,171,490, CANC. INT. CL. 9.
- OPTYS CORPORATION, TORONTO, ONTARIO, CANADA:
2,955,245, INT. CL. 9.
- ORANGE COUNTY TEACHERS FEDERAL CREDIT UNION, SANTA ANA, CA:
1,880,863, REN. 4-13-05, INT. CL. 36.
1,880,864, REN. 4-13-05, INT. CL. 36.
- ORANGE GLO INTERNATIONAL, INC., GREENWOOD VILLAGE, CO:
2,956,347, INT. CL. 3.
- ORBIT IRRIGATION PRODUCTS, INC., BOUNTIFUL, UT:
2,954,905, PUB. 3-1-2005, INT. CL. 21.
- ORBIT IRRIGATION PRODUCTS, INC., NORTH SALT LAKE, UT:
2,955,446, INT. CL. 21.
- ORCHESTRA PARENTS/PATRONS' UNITED SUPPORT ASSOCIATION, NAPERVILLE, IL:
2,954,859, PUB. 3-1-2005, INT. CL. 41.
- ORCKIT COMMUNICATIONS, INC., SHELTON, CT:
2,171,639, CANC. INT. CL. 9.
- OREGON TILTH, INC., SALEM, OR:
2,954,316, PUB. 3-1-2005, U.S. CL. A.
- ORIGIN MEDSYSTEMS, INC., SAN CARLOS, CA TO SHERWOOD SERVICES AG, SCHAFFHAUSEN, SWITZERLAND:
1,843,563, CANC. INT. CL. 10.
- ORIGINAL BOOK WORKS LIMITED, THE, CIRENCESTER, GLOS. GL7 1YT, UNITED KINGDOM:
1,842,984, CANC. INT. CL. 21.
- ORIGINAL CALIFORNIA CAR DUSTER COMPANY, INC., CHATSWORTH, CA:
2,954,066, PUB. 10-26-2004, INT. CL. 21.
- ORIGINAL SMOOTHIE COMPANY, INC., NEW ORLEANS, LA:
1,843,113, CANC. INT. CL. 32.
- ORION CORPORATION, FINLAND:
2,955,181, PUB. 3-1-2005, INT. CL. 5.
- ORION GENOMICS, LLC, ST. LOUIS, MO:
2,955,211, INT. CL. 1.
- ORSEM, S.A.R.L., 92200 NEUILLY-SUR-SEINE, FRANCE:
2,170,971, CANC. INT. CL. 5.
- ORTON, MARK B., MIMBRES, NM:
2,955,084, PUB. 3-1-2005, INT. CL. 19.
- OSBORNE, ROBERT E., BRADLEY, WV:
2,955,469, INT. CL. 11.
- OSMOND FOUNDATION, FOR THE CHILDREN OF THE WORLD, SALT LAKE CITY, UT, DBA CHILDREN'S MIRACLE NETWORK:
2,954,516, PUB. 3-1-2005, INT. CL. 41.
2,954,517, PUB. 3-1-2005, INT. CL. 38.
2,954,518, PUB. 3-1-2005, INT. CL. 36.
- OSSUR HF, REYKJAVIK, ICELAND:
2,955,544, INT. CL. 10.
- OSUNA, RIC B., LAS VEGAS, NV:
2,956,228, INT. CL. 39.
- OTG MANAGEMENT, INC., PHILADELPHIA, PA:
2,956,056, INT. CL. 43.
- OTKRYTOE AKTSIONERNOE OBSHESTVO KIROVO-CHEPETSKY KHIMICHESKY KOMBINAT, 613020 KIROVO-CHEPETSK, RUSSIAN FED., KIROVO-CHEPETSKY KHIMICHESKY KOMBINAT, 613020 KIROVO-CHEPETSK, RUSSIAN FED.:
1,883,210, REN. 4-12-05, INT. CL. 1.
- OTT, A. TRUE, NORTH OGDEN, UT, DBA MOTHER EARTH MINERALS:
2,954,808, PUB. 3-1-2005, INT. CL. 32.
- OTTO (GMBH & CO KG), HAMBURG, FED REP GERMANY:
1,762,096 NEW CERT. 5-24-2005, INT. CL. 25.
- OUTBACK SOFTWARE PTY LIMITED, A.C.N., THIRROUL, NEW SOUTH WALES, 2515, AUSTRALIA:
2,954,750, PUB. 3-1-2005, INT. CL. 9.
- OUTDOOR LIFE NETWORK, L.L.C., STAMFORD, CT:
2,955,439, INT. CL. 41.
- OUTDOOR TECHNOLOGIES INC., MACON, MS:
2,954,243, PUB. 3-1-2005, INT. CL. 19.
- OUTLAW BAKING, INC., MOBILE, AL, DBA MARSHALL BISCUIT COMPANY TO MARSHALL BISCUIT COMPANY INC, SARALAND, AL:
1,843,090, CANC. INT. CL. 30.
- OVERSEAS DIRECT IMPORT CO., LTD., NEW YORK, NY:
2,955,565, INT. CL. 25.
- OWENS-CORNING FIBERGLASS TECHNOLOGY INC., SUMMIT, IL:
1,886,903, REN. 4-15-05, INT. CL. 19.
- OXFORD BIOSIGNALS LIMITED, OXFORD OX4 4GA, UNITED KINGDOM:
2,954,677, PUB. 6-1-2004, MULTIPLE CLASS, INT. CLS. 9 AND 10.
- OXIDATION SYSTEMS, INC., ARCADIA, CA TO OXIDATION SYSTEMS, INC., ARCADIA, CA:
1,843,578, CANC. INT. CL. 11.
- OXYMORONICS, LLC, DANVILLE, IN:
2,171,716, CANC. INT. CL. 25.
- OY PANDA AB, 40800 VAAJAKOSKI, FINLAND:
1,881,565, REN. 4-12-05, INT. CL. 30.
- OZEKI CORPORATION, HYOGO, JAPAN:
2,954,844, PUB. 3-1-2005, INT. CL. 33.
- P. C. WOO, INC., LOS ANGELES, CA, DBA MEGATOYS:
2,954,849, PUB. 3-1-2005, INT. CL. 28.
- P.M.B.Q. STUDIOS, SAN JOSE, CA:
2,956,033, MULTIPLE CLASS, INT. CLS. 16 AND 25.
- P.T. BINTANG TOEDJOE, JAKARATA, INDONESIA:
2,882,211, COR. INT. CL. 32.
- P&H METAL PRODUCTS, INC., VALENCIA, CA:
2,171,721, CANC. INT. CL. 8.
- P-E COMPUTER SERVICES, INC., HOUSTON, TX:
1,284,544, CANC. MULTIPLE CLASS, INT. CLS. 35 AND 42.
- PABST BREWING COMPANY, MILL VALLEY, CA, PREMIER-PABST CORPORATION, PEORIA HEIGHTS, IL:
314,441, REN. 4-15-05, U.S. CL. 48 (INT. CL. 32).
- PACER TECHNOLOGY, RANCHO CUCAMONGA, CA:
2,956,015, MULTIPLE CLASS, INT. CLS. 1 AND 16.
- PACIFIC CORNETTA, INC., BEAVERTON, OR:
2,170,754, CANC. MULTIPLE CLASS, INT. CLS. 8 AND 21.
- PACIFIC LIFE INSURANCE COMPANY, NEWPORT BEACH, CA:
2,520,797, COR. INT. CL. 36.
- PACIFIC RIM FOODS, INC., SCOTTSDALE, AZ:
2,955,322, INT. CL. 29.
- PACIFIC WIRELESS MANUFACTURING INC, DRAPER, UT:
2,955,129, PUB. 3-1-2005, INT. CL. 9.
- PAGOSA TECHNOLOGIES, INC., DALLAS, TX:
2,954,576, PUB. 3-1-2005, INT. CL. 35.
- PAINT FAIR STORES, INC., MASPEETH, NY:
1,283,959, CANC. INT. CL. 2.
- PAINT N POTTERY, INC., DOYLESTOWN, PA:
2,954,217, PUB. 3-1-2005, INT. CL. 41.
- PAISLEY PARK ENTERPRISES, CHANHASSEN, MN:
1,860,429, REN. 4-13-05, INT. CL. 25.
- PAL MFG. CORP. OF NEW YORK, HICKSVILLE, NY:
1,879,220, REN. 4-12-05, INT. CL. 19.
- PALANZA, FRANCIS E., PALM BEACH GARDENS, FL AND SAVARESE, CAROLYN J., PALM BEACH GARDENS, FL:
2,955,523, INT. CL. 3.
- PALMER COMMUNICATIONS INCORPORATED, DAVENPORT, IA:
1,284,647, CANC. INT. CL. 41.
- PALMER, DIANE L., SAN MARCOS, TX:
2,954,871, PUB. 3-1-2005, INT. CL. 41.
- PAM RAMSAIER, BETTIE NEWBY, LYNNE RUFFIN, CORONA DEL MAR, CA:
2,171,123, CANC. INT. CL. 42.

- PAMANI, ASHOK, MOONACHIE, NJ:
2,955,956, INT. CL. 24.
- PAMECO CORP., NORCROSS, GA:
2,171,450, CANC. MULTIPLE CLASS, INT. CLS. 3 AND 11.
- PANASONIC CORPORATION OF NORTH AMERICA, SECAUCUS, NJ:
2,955,821, INT. CL. 11.
- PANIKOWSKI, LINDA M., SOUTHTON, CT:
2,954,821, PUB. 3-1-2005. INT. CL. 4.
- PANTONE, INC., CARLSTADT, NJ:
1,012,846, REN. 4-15-05. INT. CL. 9.
- PAPER CONVERTING OF AMERICA, INC., BROOKLYN, NY:
2,954,688, PUB. 3-1-2005. INT. CL. 16.
- PAR ENTERPRISES, INC., STAMFORD, CT:
2,171,111, CANC. INT. CL. 36.
- PARADIGM COMMUNICATIONS, INC., TAMPA, FL:
2,170,996, CANC. INT. CL. 35.
- PARFUMERIE DOUGLAS, INC., WESTPORT, CT:
1,284,711, CANC. INT. CL. 42.
- PARK & SELL OF CANADA LIMITED, TORONTO, ONTARIO, CANADA:
1,316,140, REN. 4-13-05. INT. CL. 39.
- PARK LI MANAGEMENT SIMULATIONS, INC., NORTHFIELD, IL, DBA MANAGEMENT SIMULATIONS:
2,954,173, PUB. 3-1-2005. MULTIPLE CLASS, INT. CLS. 9, 41 AND 42.
2,954,174, PUB. 3-1-2005. MULTIPLE CLASS, INT. CLS. 9, 41 AND 42.
- PARK PLACE MOTORCARS OF TEXAS, INC., DALLAS, TX:
2,954,266, PUB. 8-10-2004. INT. CL. 35.
2,954,268, PUB. 8-10-2004. MULTIPLE CLASS, INT. CLS. 35, 36, 37 AND 39.
- PARKER GAS SEPARATION B.V., AA 4878 ETTEN-LEUR, NETHERLANDS:
2,955,298, INT. CL. 11.
- PARKER, MELVIN C., BOCA RATON, FL:
2,171,929, CANC. INT. CL. 18.
- PARKSIDE MEDICAL SERVICES CORPORATION, PARK RIDGE, IL:
1,284,557, CANC. MULTIPLE CLASS, INT. CLS. 36 AND 42.
- PARMALAT DAIRY & BAKERY INC., ETOBICOKE, ONTARIO, CANADA:
2,954,076, PUB. 10-26-2004. INT. CL. 29.
- PARMENTER, JAMES R., MANOMET, MA:
2,956,094, INT. CL. 41.
- PARTNERSHIP FOR INNOVATION, LLC, OWENSVILLE, MO:
1,296,347, REN. 4-11-05. INT. CL. 20.
- PASCUA YAQUI TRIBE, TUCSON, AZ:
2,955,086, PUB. 3-1-2005. INT. CL. 41.
- PASSOFF, MICHELLE, NEW YORK, NY:
2,954,274, PUB. 3-1-2005. MULTIPLE CLASS, INT. CLS. 41 AND 45.
- PASSPORT HEALTH COMMUNICATIONS, INC., FRANKLIN, TN:
2,954,530, PUB. 3-1-2005. INT. CL. 36.
- PATRIOT HARLEY-DAVIDSON, INC., FAIRFAX, VA:
2,954,572, PUB. 3-1-2005. INT. CL. 41.
- PATTERSON, ALBERT P., MILWAUKEE, WI, DBA WWA SUPERSTARS OF WRESTLING:
1,857,015, REN. 4-15-05. INT. CL. 41.
- PATTERSON, PILAR, BELMONT SHORE, CA:
2,954,157, PUB. 3-1-2005. INT. CL. 42.
- PATTON BOGGS LLP, WASHINGTON, DC:
2,954,747, PUB. 3-1-2005. INT. CL. 42.
- PAUL F. MAHONEY, MILTON, MA:
2,955,987, INT. CL. 35.
- PAUL'S AUTO YARD, INC., WESTVILLE, IN:
1,878,046, REN. 4-13-05. INT. CL. 41.
- PAULA AMELIA MOYNAHAN M.D., ENTERPRISES INC., WATERBURY, CT:
2,955,850, INT. CL. 3.
- PAVEL, RICH, LA JOLLA, CA:
1,880,675, REN. 4-12-05. MULTIPLE CLASS, INT. CLS. 25 AND 28.
1,902,063, REN. 4-14-05. INT. CL. 42.
- PAVERART LLC, AUDUBON, PA:
2,955,934, MULTIPLE CLASS, INT. CLS. 19 AND 42.
- PAVILION TEXTILES LIMITED, NORTHAMPTON, ENGLAND, TEXTILE INNOVATIONS LIMITED, ST. HELIER JERSEY, CHANNEL ISLANDS:
1,881,057, REN. 4-12-05. MULTIPLE CLASS, INT. CLS. 20 AND 24.
- PAWS DOWN, VANCOUVER, WA:
2,955,518, INT. CL. 21.
2,955,519, INT. CL. 21.
- PAYEFF, BEVERLY, BROOKLINE, NH:
2,171,733, CANC. INT. CL. 41.
- PAYKEY USA, INC., GREENVILLE, SC:
2,954,127, PUB. 3-1-2005. INT. CL. 9.
- PAYLESS SHOESOURCE WORLDWIDE, INC., TOPEKA, KS:
2,172,019, CANC. INT. CL. 35.
- PC HELP!, GREENBRAE, CA:
2,171,580, CANC. INT. CL. 9.
- PCCW-HKT DATACOM SERVICES LIMITED, QUARRY BAY, HONG KONG:
2,954,604, PUB. 3-1-2005. INT. CL. 36.
- PCI REMOTE SENSING CORP., ARLINGTON, VA:
1,842,778, CANC. INT. CL. 9.
- PCNET, INC., SHELTON, CT:
2,170,916, CANC. MULTIPLE CLASS, INT. CLS. 9, 35, 37, 41 AND 42.
- PE CORPORATION:
See—APPLERA CORPORATION.
- PEAVEY ELECTRONICS CORPORATION, MERIDIAN, MS:
2,171,253, CANC. INT. CL. 15.
2,955,533, INT. CL. 9.
- PEDERSEN, LISA M., HERMOSA BEACH, CA:
2,955,302, INT. CL. 25.
- PEDRAZA, MILTON, F., WYCKOFF, NJ:
2,956,277, INT. CL. 35.
- PENBASE, 31312 LABEGE CEDEX, FRANCE:
2,954,087, PUB. 6-15-2004. MULTIPLE CLASS, INT. CLS. 9 AND 42.
- PENINSULA INTERNATIONAL (USA) LIMITED, WILMINGTON, DE:
1,321,445, REN. 4-12-05. INT. CL. 42.
- PENN CORPORATION, KALAMAZOO, MI:
772,568, CANC. U.S. CL. 2.
772,838, CANC. U.S. CL. 37.
772,840, CANC. U.S. CL. 37.
- PENN FISHING TACKLE MFG. CO., PHILADELPHIA, PA:
1,284,480, CANC. INT. CL. 28.
- PENNINGTON SEED, INC. OF NEBRASKA, MADISON, GA:
2,954,535, PUB. 3-1-2005. INT. CL. 31.
- PENNZOIL-QUAKER STATE COMPANY, HOUSTON, TX:
2,955,098, PUB. 3-1-2005. INT. CL. 12.
- PENROD COMPANY, THE, VIRGINIA BEACH, VA:
1,886,909, REN. 4-12-05. INT. CL. 6.
1,887,174, REN. 4-12-05. INT. CL. 19.
- PENTEL KABUSHIKI KAISHA, CHUO-KU, TOKYO, JAPAN, DBA PENTEL CO., LTD., YASUTOMO, BEN N., SAN FRANCISCO, CA, DBA YASUTOMO & CO.:
786,427, REN. 4-13-05. U.S. CL. 37 (INT. CL. 16).
- PENTHOUSE INTERNATIONAL LTD., NEW YORK, NY:
1,284,027, CANC. INT. CL. 5.
- PERFECT FIT GLOVE CO., LLC, BUFFALO, NY:
2,954,509, PUB. 3-1-2005. INT. CL. 9.
- PERFECT TIME INC., LOS ANGELES, CA:
2,170,672, CANC. INT. CL. 14.
- PERFECTION FENCE CORPORATION, MARSHFIELD, MA:
2,955,816, MULTIPLE CLASS, INT. CLS. 6 AND 19.
- PERFORMANCE MOTORSPORTS, INC., HUNTINGTON BEACH, CA, DBA JE PISTONS, INC.:
2,955,572, INT. CL. 7.
- PERI, CHARLES E., NOVATO, CA:
2,954,579, PUB. 3-1-2005. INT. CL. 44.
- PERKINTON, ANN M., LEXINGTON, NE:
2,170,788, CANC. INT. CL. 41.
2,170,789, CANC. INT. CL. 41.

PERMAQUIK CORPORATION, MISSISSAUGA, ONTARIO, CANADA:
2,954,247, PUB. 11-9-2004. INT. CL. 19.

PERSNICKETY INC., GREAT FALLS, VA:
1,284,699, CANC. INT. CL. 42.

PERSONAL AUTO CONSULTANTS, INC., FLORISSANT, MO:
2,171,022, CANC. INT. CL. 35.

PETIT BATEAU, USINE SAINT JOSEPH, TROYES (AUBES), FRANCE:
1,284,383, CANC. INT. CL. 25.

PETKIN, INC., MARINA DEL REY, CA:
2,171,998, CANC. INT. CL. 5.

PETOSKEY PLASTICS, INC., PETOSKEY, MI:
1,333,853, REN. 4-11-05. INT. CL. 22.

PETROTECHNICAL OPEN SOFTWARE CORPORATION, HOUSTON, TX:
1,843,495, CANC. INT. CL. 9.

PETS ARE INN, INC., MINNEAPOLIS, MN:
1,843,317, CANC. INT. CL. 42.

PEWAG AUSTRIA GMBH, GRAZ, AUSTRIA:
2,955,899, INT. CL. 6.

PFALTZGRAFF INVESTMENT CO., YORK, PA, SUSQUEHANNA BROADCASTING CO., YORK, PA:
1,322,216, REN. 4-11-05. INT. CL. 21.

PFAUTER-MAAG CUTTING TOOLS LIMITED PARTNERSHIP, LOVES PARK, IL:
1,010,334, REN. 4-15-05. INT. CL. 7.

PFIZER INC., NEW YORK, NY, SMITHKLINE BEECHAM CORPORATION, PHILADELPHIA, PA:
1,882,775, REN. 4-13-05. INT. CL. 5.

PH SCIENCES, INC., SEATTLE, WA:
2,956,276, INT. CL. 5.

PHARMACIA & UPJOHN COMPANY, KALAMOAZOO, MI:
2,171,501, CANC. INT. CL. 9.

PHARMED STAFFING, LLC, NEW YORK, NY:
2,954,398, PUB. 3-1-2005. INT. CL. 35.
2,954,399, PUB. 3-1-2005. INT. CL. 35.

PHARMOS CORPORATION, ISELIN, NJ:
2,955,267, INT. CL. 1.

PHENOMENOME DISCOVERIES INC., SASKATOON, CANADA:
2,954,782, PUB. 3-1-2005. INT. CL. 42.

PHENOMENOME DISCOVERIES, INC., SASKATOON, CANADA:
2,954,781, PUB. 3-1-2005. INT. CL. 42.

PHI GAMMA DELTA EDUCATIONAL FOUNDATION, INC., LEXINGTON, KY:
2,954,689, PUB. 3-1-2005. INT. CL. 35.

PHILADELPHIA FINANCIAL GROUP, INC., BLUE BELL, PA:
2,171,667, CANC. INT. CL. 36.

PHILIPPOU ENTERPRISES, INC., COLORADO SPRINGS, CO:
2,955,786, INT. CL. 37.

PHILIPS ELECTRONICS HONG KONG LIMITED, NEW TERRITORIES, HONG KONG:
2,954,020, PUB. 4-16-2002. INT. CL. 11.

PHILLIPS PETROLEUM COMPANY, BARTLESVILLE, OK:
2,171,037, CANC. INT. CL. 42.

PHILLIPSGARDNER, L.L.C., OREM, UT:
2,955,884, INT. CL. 36.
2,955,885, INT. CL. 36.

PHILOSOPHY, INC., PHOENIX, AZ:
2,956,114, INT. CL. 3.

PHOENIX COLOR CORP., HAGERSTOWN, MD:
2,954,154, PUB. 3-1-2005. INT. CL. 40.

PHOENIX X-RAY SYSTEMS + SERVICES GMBH, WUNSTORF, FED REP GERMANY:
2,954,119, PUB. 3-1-2005. MULTIPLE CLASS, INT. CLS. 9 AND 10.

PHONAK HOLDING AG, CH-8712 STAEFA, SWITZERLAND:
2,954,478, PUB. 3-1-2005. MULTIPLE CLASS, INT. CLS. 9 AND 10.

PHOTOPROTECTIVE TECHNOLOGIES, INC., SAN ANTONIO, TX:
2,170,690, CANC. MULTIPLE CLASS, INT. CLS. 9 AND 11.

PHYSICIANS FORMULA COSMETICS, INC, AZUSA, CA:
2,489,120, COR. INT. CL. 3.

PHYSICIANS FORMULA COSMETICS, INC., CITY OF INDUSTRY, CA:
1,257,282, COR. INT. CL. 3.
1,759,042, COR. INT. CL. 3.

PHYSICIANS FORMULA COSMETICS, INC., IRWINDALE, CA:
1,949,213, COR. MULTIPLE CLASS, INT. CLS. 3 AND 21.
1,970,596, COR. INT. CL. 3.
2,003,717, COR. INT. CL. 3.

PHYSICIANS FORMULA COSMETICS, INC., AZUSA, CA:
2,030,318, COR. INT. CL. 3.
2,070,859, COR. INT. CL. 3.
2,228,941, COR. INT. CL. 3.
2,288,234, COR. INT. CL. 3.
2,371,937, COR. INT. CL. 3.
2,384,341, COR. INT. CL. 3.
2,398,555, COR. INT. CL. 3.
2,400,377, COR. INT. CL. 3.
2,407,434, COR. INT. CL. 3.
2,413,065, COR. INT. CL. 3.
2,422,061, COR. INT. CL. 3.
2,460,119, COR. INT. CL. 3.
2,464,337, COR. INT. CL. 3.
2,475,987, COR. INT. CL. 3.
2,493,092, COR. INT. CL. 3.
2,526,119, COR. INT. CL. 3.
2,547,162, COR. INT. CL. 3.
2,583,857, COR. INT. CL. 3.
2,596,062, COR. INT. CL. 3.
2,598,226, COR. INT. CL. 3.
2,599,366, COR. INT. CL. 3.
2,599,557, COR. INT. CL. 3.
2,613,511, COR. INT. CL. 3.
2,619,015, COR. INT. CL. 3.
2,622,305, COR. INT. CL. 3.
2,626,623, COR. INT. CL. 3.
2,640,888, COR. INT. CL. 3.
2,644,431, COR. INT. CL. 3.
2,644,432, COR. INT. CL. 3.
2,650,551, COR. INT. CL. 3.
2,659,956, COR. INT. CL. 3.
2,664,520, COR. INT. CL. 3.
2,673,075, COR. INT. CL. 3.
2,721,774, COR. INT. CL. 3.
2,741,925, COR. INT. CL. 3.
2,770,397, COR. INT. CL. 3.
2,801,528, COR. INT. CL. 3.
2,803,685, COR. INT. CL. 3.
2,805,872, COR. INT. CL. 3.
2,818,418, COR. INT. CL. 3.
2,830,906, COR. INT. CL. 3.
2,833,112, COR. INT. CL. 3.
2,846,865, COR. INT. CL. 3.
2,852,078, COR. INT. CL. 3.
2,852,079, COR. INT. CL. 3.
2,852,080, COR. INT. CL. 3.

PHYSICIANS MUTUAL INSURANCE COMPANY, OMAHA, NE:
2,172,046, CANC. INT. CL. 36.

PHYTOCELL RESEARCH, INC., SAN ANTONIO, TX:
2,171,530, CANC. INT. CL. 5.

PIANOVA GMBH, MULHEIM, FED REP GERMANY:
2,955,962, INT. CL. 15.

PICTURE THE CURE, INC., SAN FRANCISCO, CA:
2,955,419, INT. CL. 20.

PIECEFUL SOLUTIONS, MALVERN, PA:
2,171,464, CANC. INT. CL. 28.

PIERRE FABRE COSMETIQUE, 92100 BOULOGNE, FRANCE TO PIERRE FABRE DERMOCOSMETIQUE, 92100 BOULOGNE, FRANCE:
1,842,601, CANC. INT. CL. 3.

PIERRE FOODS, INC., CINCINNATI, OH:
2,954,775, PUB. 3-1-2005. INT. CL. 29.

PIEZOMOTOR UPPSALA AB, UPPSALA, SWEDEN:
2,954,669, PUB. 3-1-2005. INT. CL. 9.

- PIGGIE PARK ENTERPRISES, INC., WEST COLUMBIA, SC:
1,284,498, CANC. MULTIPLE CLASS, INT. CLS. 29 AND 42.
- PIK:NIK L.L.C., LOS ANGELES, CA:
2,170,968, CANC. INT. CL. 16.
- PILATES BY THE SEA, BALBOA ISLAND, CA:
2,954,907, PUB. 3-1-2005. INT. CL. 41.
- PILATES CENTER OF NEW YORK, INC., NEW YORK, NY:
2,954,561, PUB. 3-1-2005. INT. CL. 41.
- PINCHECK, L.C., DES MOINES, IA:
2,954,973, PUB. 3-1-2005. INT. CL. 45.
- PINE ISLAND SPORTSWEAR, LTD., MONROE, NC:
1,843,691, CANC. INT. CL. 25.
- PINNACLE GROUP, INC., DALLAS, TX:
1,843,974, CANC. INT. CL. 35.
- PINNACLE TEXTILE INDUSTRIES LLC, KING OF PRUSSIA, PA:
2,955,358, INT. CL. 25.
- PINSKE, LOTHAR, VELBERT, FED REP GERMANY AND AMMERSHLAGER, THOMAS, MUNCHEN, FED REP GERMANY:
2,829,068, AM. MULTIPLE CLASS, INT. CLS. 9, 12, 16, 18, 21, 25, 28, 41 AND 42.
- PINTO, FERNANDO, NEW HAVEN, CT:
2,190,472, CANC. INT. CL. 41.
- PIO CESARE S.R.L., 12051 ALBA (CUNEO), ITALY:
2,954,528, PUB. 3-1-2005. INT. CL. 33.
- PIPE DRAGON, INC., BAYARD, NE, WAUGH, DOUGLAS J., BERTHOUD, CO AND WAUGH, CATHY A., BERTHOUD, CO:
1,862,263, REN. 4-15-05. INT. CL. 7.
- PITTS, JIM, TUCSON, AZ:
2,954,596, PUB. 3-1-2005. MULTIPLE CLASS, INT. CLS. 16 AND 41.
- PITTSWAY CORPORATION, CHICAGO, IL:
2,171,806, CANC. INT. CL. 9.
- PIVOT DESIGN, INC., CHICAGO, IL:
2,954,869, PUB. 3-1-2005. MULTIPLE CLASS, INT. CLS. 35 AND 42.
- PLACEMENTS CONTEMPORAINS, INC., CHATEAUGUAY, QUEBEC, CANADA:
2,954,729, PUB. 3-1-2005. INT. CL. 17.
- PLANAR SYSTEMS, INC., BEAVERTON, OR:
2,955,117, PUB. 3-1-2005. INT. CL. 9.
- PLANET EARTH FOUNDATION, SEATTLE, WA:
2,955,817, INT. CL. 35.
- PLANET MARKETING INC., NEW YORK, NY:
2,172,024, CANC. INT. CL. 28.
- PLANTEC INC., NISHI-KU, OSAKA-SHI, OSAKA, 550-0003, JAPAN:
2,954,294, PUB. 3-1-2005. INT. CL. 11.
- PLANTRONICS, INC., SANTA CRUZ, CA:
2,171,792, CANC. INT. CL. 9.
2,954,964, PUB. 3-1-2005. INT. CL. 9.
- PLASPLUGS LIMITED, STAFFORDSHIRE, DE14 1SD, ENGLAND:
2,170,794, CANC. INT. CL. 7.
- PLATEAU GOLF & COUNTRY CLUB, ISSAQUAH, WA:
2,170,836, CANC. INT. CL. 41.
- PLAYBOY ENTERPRISES INTERNATIONAL, INC., CHICAGO, IL:
2,955,127, PUB. 3-1-2005. MULTIPLE CLASS, INT. CLS. 38 AND 41.
- PLAYTEX PRODUCTS, INC., WESTPORT, CT:
2,955,612, INT. CL. 3.
- PNC MORTGAGE CORP. OF AMERICA, VERNON HILLS, IL TO PNC MORTGAGE CORP. OF AMERICA, VERNON HILLS, IL:
1,843,870, CANC. INT. CL. 36.
- PNEUMATIC TECHNOLOGY, INC., TROPHY CLUB, TX:
2,955,508, INT. CL. 35.
- POCKET TESTAMENT LEAGUE, THE, LITIZ, PA:
2,170,952, CANC. INT. CL. 16.
- PODIATRICAL THERAPY AMERICA, LLC, TARRYTOWN, NY:
2,956,152, INT. CL. 35.
- POE & BROWN, INC., TAMPA, FL:
2,171,889, CANC. INT. CL. 36.
- POGUE, MELODIE, WOOLWINE, VA:
2,955,121, PUB. 3-1-2005. INT. CL. 43.
- POHL CORPORATION, READING, PA:
1,842,650, CANC. INT. CL. 6.
- POINT BLANK BODY ARMOR, INC. OLD WESTBURY, NY:
2,954,005, PUB. 10-19-2004. INT. CL. 9.
- POLA CHEMICAL INDUSTRIES, INC., SHIZUOKA-KEN, JAPAN:
2,171,901, CANC. INT. CL. 3.
- POLARIS INDUSTRIES INC., MEDINA, MN:
2,955,540, INT. CL. 11.
2,955,541, INT. CL. 24.
- POLHODE, INC., BURR RIDGE, IL:
1,881,675, REN. 4-13-05. INT. CL. 42.
- POLIMERI EUROPA S.P.A., 20097 S. DONATO MILANESE, ITALY, ECP ENICHEM POLIMERI S.R.L., MILAN, ITALY:
1,830,060, REN. 4-15-05. MULTIPLE CLASS, INT. CLS. 1 AND 17.
- POLLAN, STEPHEN M., NEW YORK, NY:
2,954,465, PUB. 3-1-2005. INT. CL. 41.
- POLY/LITE W/R SUPPLIES, INC., YORK, PA, DBA POLY/LITE:
2,171,322, CANC. INT. CL. 1.
- POLYMER & STEEL TECHNOLOGIES, INC., EASTLAKE, OH, ENPAC CORPORATION, CHARDON, OH:
1,953,749, REN. 4-11-05. INT. CL. 12.
- POLYTITE MANUFACTURING CORPORATION, CAMBRIDGE, MA:
2,171,161, CANC. INT. CL. 17.
- POOL GEL LLC, LOMA LINDA, CA:
2,956,092, INT. CL. 1.
- PORTA-NAILS, INC., WILMINGTON, NC, PORTA-TOOLS, INC., WILMINGTON, NC:
1,380,147, REN. 4-13-05. INT. CL. 8.
- PORTER-CABLE CORPORATION, JACKSON, TN:
2,955,305, INT. CL. 7.
- PORTICOS, INC., MORRISVILLE, NC:
2,954,507, PUB. 3-1-2005. INT. CL. 42.
2,954,508, PUB. 3-1-2005. INT. CL. 42.
- PORTMAN SECURITY SYSTEM (USA) LTD., WOBURN, MA:
2,955,014, PUB. 3-1-2005. INT. CL. 12.
- POWER DECK COMPANY, LLC, STANTON, KY:
2,955,593, INT. CL. 13.
- PR NUTRITION, INC., SAN DIEGO, CA:
2,171,871, CANC. INT. CL. 5.
- PRAENDEX INCORPORATED, WELLESLEY HILLS, MA:
2,171,677, CANC. MULTIPLE CLASS, INT. CLS. 16, 35 AND 41.
2,171,680, CANC. MULTIPLE CLASS, INT. CLS. 16, 35 AND 41.
- PRECISION MULTIPLE CONTROLS, INC., RIDGEWOOD, NJ:
772,727, CANC. U.S. CL. 21.
- PRECISION WORKS, INC., OJAI, CA:
2,956,003, MULTIPLE CLASS, INT. CLS. 37 AND 42.
2,956,004, MULTIPLE CLASS, INT. CLS. 37 AND 42.
2,956,005, MULTIPLE CLASS, INT. CLS. 37 AND 42.
- PRECISPORT, S.L., SANT QUIRZE DEL VALLÉS (BARCELONA), SPAIN:
2,955,502, INT. CL. 25.
- PREMEIR ONE PRODUCTS, INC., PARK CITY, UT, PREMIER ONE PRODUCTS, INC., PARK CITY, UT:
1,878,421, REN. 4-15-05. INT. CL. 5.
- PREMERA BLUE CROSS, SEATTLE, WA:
2,955,263, INT. CL. 36.
- PREMIER BANCSHARES, INC., JEFFERSON CITY, MO:
2,955,093, PUB. 3-1-2005. INT. CL. 36.
- PREMIER CUSTOM DESIGN, INC., OAKVILLE, ONTARIO, CANADA:
2,956,045, INT. CL. 6.
- PRESS, INC., JOHNSON CITY, TN:
772,851, CANC. U.S. CL. 38.
- PRESTOLITE WIRE CORPORATION, SOUTHFIELD, MI:
2,955,517, INT. CL. 7.
- PRICE, BRADLEY C., OAK PARK, IL:
2,955,678, INT. CL. 36.

PRICE, CATHY, LOS ANGELES, CA:
2,954,241, PUB. 3-1-2005. INT. CL. 35.

PRICE, KIM N., ALEXANDER CITY, AL AND PRICE, TIM L., ALEXANDER CITY, AL:
2,955,584, INT. CL. 25.

PRIMAL ELEMENTS, INC., GARDEN GROVE, CA:
2,956,070, INT. CL. 3.
2,956,071, INT. CL. 3.

PRIMARY INVESTMENTS GROUP LIMITED, ROAD TOWN, TORTOLA, BR. VIRGIN ISLANDS:
2,956,146, INT. CL. 3.

PRIME RESOURCES CORPORATION, BRIDGEPORT, CT:
2,171,919, CANC. INT. CL. 16.

PRIME SITES, INC., COCONUT GROVE, FL:
2,954,571, PUB. 3-1-2005. INT. CL. 36.

PRIMEDIA BUSINESS MAGAZINES & MEDIA, INC., OVERLAND PARK, KS:
2,956,246, INT. CL. 41.

PRIMESPORT INTERNATIONAL, INC., MARIETTA, GA:
2,171,426, CANC. INT. CL. 39.
2,171,429, CANC. INT. CL. 39.

PRINCE LIONHEART, INC., SANTA MARIA, CA:
2,954,666, PUB. 3-1-2005. MULTIPLE CLASS, INT. CLS. 3 AND 11.

PRINT-LOCK CORP., LAS VEGAS, NV:
2,956,346, INT. CL. 16.

PRINTERS' SERVICE, INC., NEWARK, NJ:
1,902,387, REN. 4-13-05. INT. CL. 7.

PRO DESIGN ELECTRONIC & CAD-LAYOUT GMBH, BRUCKMUHL, FED REP GERMANY:
2,955,427, INT. CL. 9.

PRO FISH CO., BRIELLE, NJ:
2,955,779, INT. CL. 28.

PRO-IRODA USA, INC., CHAGRIN FALLS, OH:
2,956,107, INT. CL. 9.

PROCACCI BROTHERS SALES CORP., PHILADELPHIA, PA:
2,954,567, PUB. 3-1-2005. INT. CL. 31.

PROCESS COMBUSTION CORPORATION, PITTSBURGH, PA:
1,843,582, CANC. INT. CL. 11.

PROCORDE GMBH, 82152 MARTINSRIED, FED REP GERMANY:
2,911,405, COR. INT. CL. 42.

PROCTER & GAMBLE COMPANY, THE, CINCINNATI, OH:
2,171,989, CANC. INT. CL. 3.
2,715,740, COR. INT. CL. 3.

PROCYCLE OIL, INC., SPRINGTOWN, TX, DBA PRO-CYCLE METALS, INC.:
1,843,227, CANC. INT. CL. 40.

PROCYTE CORPORATION, REDMOND, WA:
2,955,075, PUB. 3-1-2005. INT. CL. 3.

PRODUCE PARTNERS, INC., COMMERCE, CA, NAGLE, SPILLMAN & BERGMAN, INC., LOS ANGELES, CA, DBA NSB FOODS:
1,023,884, REN. 4-13-05. INT. CL. 30.

PRODUCERS LLOYDS INSURANCE COMPANY, AMARILLO, TX:
2,956,341, INT. CL. 36.

PRODUCTLAB, INC., CARDIFF, CA:
2,954,075, PUB. 3-1-2005. INT. CL. 35.

PRODUCTS CAROUSEL INCORPORATED, SANGER, CA:
1,843,829, CANC. INT. CL. 31.

PROFESSIONAL LACROSSE PLAYERS' ASSOCIATION, NEWPORT, RI:
2,954,488, PUB. 3-1-2005. INT. CL. 25.

PROFESSIONAL MEDICAL MANAGEMENT COMPANY, FT. WORTH, TX:
2,170,768, CANC. INT. CL. 35.

PROFESSIONAL SERVICES ADVERTISING, INC., IRVINE, CA:
2,171,101, CANC. INT. CL. 5.

PROGRESS SOFTWARE CORPORATION, BEDFORD, MA:
2,955,484, INT. CL. 9.

PROJECT INNOVATIONS, INC., FARMINGTON HILLS, MI:
2,954,371, PUB. 3-1-2005. INT. CL. 35.

PROJECT RENEWAL, INC., NEW YORK, NY:
2,954,696, PUB. 3-1-2005. MULTIPLE CLASS, INT. CLS. 36, 41, 43 AND 44.

PROLYSIS LIMITED, OXFORDSHIRE OX5 1PF, UNITED KINGDOM:
2,954,009, PUB. 3-1-2005. MULTIPLE CLASS, INT. CLS. 1, 5, 35 AND 42.

PROPERTY TAX SOLUTIONS, HOUSTON, TX:
1,885,256, REN. 4-10-05. INT. CL. 36.

PROSTRONG, INC., OAKVILLE, CT:
2,171,446, CANC. INT. CL. 3.
2,171,447, CANC. INT. CL. 3.
2,171,448, CANC. INT. CL. 3.

PROTIVERIS, INC., ROCKVILLE, MD:
2,955,256, MULTIPLE CLASS, INT. CLS. 9 AND 10.

PROTOKRAFT, LLC, KINGSPORT, TN:
2,956,301, INT. CL. 9.

PROTOMASTRO, MICHAEL, LYNDHURST, NJ AND JOOP! GMBH, D-20148 HAMBURG, FED REP GERMANY:
2,954,002, PUB. 2-1-2000. INT. CL. 25.

PRUFTECHNIK DIETER BUSCH AG, D-85737 ISMANING, FED REP GERMANY:
2,954,146, PUB. 3-1-2005. INT. CL. 9.

PUBLIC SAFETY EQUIPMENT, INC.:
1,284,193, CANC. INT. CL. 11.

PUBLIC COMPANY ACCOUNTING OVERSIGHT BOARD, WASHINGTON, DC:
2,954,181, PUB. 1-13-2004. MULTIPLE CLASS, INT. CLS. 35 AND 42.

PUBLIUS PRESS, INC., LOOKOUT MOUNTAIN, TN:
2,954,418, PUB. 3-1-2005. INT. CL. 41.

PUCCI, MICHAEL A., SIMI VALLEY, CA AND UNDERWOOD, DEBRA L., ALTADENA, CA:
2,956,327, INT. CL. 21.
2,956,328, INT. CL. 21.

PULSE EFT ASSOCIATION, HOUSTON, TX:
2,955,382, INT. CL. 36.

PURE GOLD, INC., REDLANDS, CA:
186,403, CANC. U.S. CL. 46.

PURETAN INTERNATIONAL, INCORPORATED, DALLAS, TX:
2,171,858, CANC. INT. CL. 11.

PURSUIT REAL ESTATE SERVICE, INC., CARSON CITY, NV:
2,954,577, PUB. 3-1-2005. INT. CL. 37.

PUTMAN MEDIA, INC., ITASCA, IL:
1,324,406, REN. 4-14-05. INT. CL. 16.

Q LUBE, INC., SALT LAKE CITY, UT:
2,170,809, CANC. INT. CL. 37.

QARMOUT, ELIAS, DALY CITY, CA:
2,956,135, INT. CL. 16.

QOVIA, INC., FERDERICK, MD:
2,954,779, PUB. 3-1-2005. INT. CL. 9.

QRS MUSIC TECHNOLOGIES, INC., NAPLES, FL:
1,881,964, REN. 4-15-05. INT. CL. 9.

QSOUND LABS, INC., CALGARY, ALBERTA, CANADA:
1,880,427, REN. 4-11-05. INT. CL. 9.
1,880,427, CANC. INT. CL. 28.

QUADSIL, INC., MIDLAND, MI:
2,954,235, PUB. 9-7-2004. INT. CL. 1.

QUANTITATIVE DECISION SUPPORT INC., ONTARIO K1V 9L1, CANADA:
2,954,080, PUB. 10-26-2004. MULTIPLE CLASS, INT. CLS. 9 AND 36.

QUEBIT CONSULTING LLC, SCARSDALE, NY:
2,954,692, PUB. 3-1-2005. INT. CL. 35.

QUEST FOUNDATION, INC., TALLAHASSEE, FL:
2,954,377, PUB. 3-1-2005. INT. CL. 9.

QUIMI ROMAR, S.L., MONCADA, SPAIN:
2,954,714, PUB. 8-31-2004. INT. CL. 3.
2,955,969, INT. CL. 3.

QUINETTE GALLAY, MONTRUEIL-SOUS-BOIS, FRANCE:
2,954,745, PUB. 9-21-2004. MULTIPLE CLASS, INT. CLS. 20 AND 37.

QUINTANA ROO, INC., SAN MARCOS, CA:
2,170,752, CANC. INT. CL. 41.

QUOKKA SPORTS, INC., SAN FRANCISCO, CA:
2,170,790, CANC. INT. CL. 42.

- QVC, INC., WEST CHESTER, PA:
2,955,637, INT. CL. 24.
2,956,028, INT. CL. 24.
- R & B REALTY GROUP, LOS ANGELES, CA, DBA OAKWOOD WORLDWIDE:
2,954,457, PUB. 3-1-2005. INT. CL. 35.
- R AND K SALES, INC., KELLER, TX:
2,954,594, PUB. 3-1-2005. INT. CL. 40.
- R. HIRT JR. CO., DETROIT, MI:
1,284,741, CANC. INT. CL. 42.
- R. LOPEZ DE HEREDIA, VIÑA TONDONIA, S.A., SPAIN:
2,955,171, PUB. 3-1-2005. INT. CL. 33.
- R. TORRE & COMPANY, SOUTH SAN FRANCISCO, CA:
2,171,940, CANC. INT. CL. 41.
- R.K. MASSENGILL, M.D., A MEDICAL CORPORATION, ESCONDIDO, CA:
1,843,923, CANC. INT. CL. 42.
- RABBI'S DAUGHTERS, CULVER CITY, CA:
2,954,300, PUB. 3-1-2005. INT. CL. 25.
- RABBIT TANAKA CORPORATION LIMITED, SIU SAI WAN, HONG KONG:
2,955,922, INT. CL. 11.
- RADIAN GROUP INC., PHILADELPHIA, PA:
2,954,133, PUB. 7-20-2004. MULTIPLE CLASS, INT. CLS. 36 AND 42.
- RADIO & RECORDS, INC., LOS ANGELES, CA:
2,956,131, INT. CL. 16.
- RADIO AND TELEVISION COMMISSION OF THE SOUTHERN BAPTIST CONVENTION, FT. WORTH, TX:
1,284,664, CANC. INT. CL. 41.
- RADIO SHOPPING SHOW, INC., ELGIN, IL:
2,955,883, INT. CL. 41.
- RAFAEL ARMAMENT DEVELOPMENT AUTHORITY LTD., HAIFA 31021, ISRAEL:
2,954,237, PUB. 3-1-2005. INT. CL. 9.
- RAG DOLL MERCHANDISING, INC., LOS ANGELES, CA:
2,954,199, PUB. 3-1-2005. INT. CL. 9.
- RAGAN AND MASSEY, INC., PONCHATOULA, LA:
2,955,558, INT. CL. 31.
- RAHMEY INTERNATIONAL, INC., NEW YORK, NY:
2,171,852, CANC. INT. CL. 25.
- RAIN BIRD CORPORATION, GLENDORA, CA:
1,883,464, REN. 4-15-05. INT. CL. 11.
- RALPH D. SEABROOK, GREENWICH, CT:
2,955,729, INT. CL. 35.
- RALPH MALTBY ENTERPRISES, INC., NEWARK, OH:
2,955,640, INT. CL. 28.
- RAMPAGE VENTURES INC., GEORGE TOWN, GRAND CAYMAN, CAYMAN ISLANDS:
2,954,634, PUB. 3-1-2005. INT. CL. 9.
- RAMPARTS, INC., LAS VEGAS, NV:
2,172,015, CANC. INT. CL. 3.
- RANGER ENTERPRISES, INC., ROCKFORD, IL:
2,956,116, INT. CL. 35.
- RAYCHEM CORPORATION, MENLO PARK, CA:
1,284,067, CANC. INT. CL. 6.
- RAYMOND V. NORTHCUTT, KANSAS CITY, MO, DBA VAN NOR ENTERPRISES:
1,284,460, CANC. INT. CL. 28.
- RDA INC., MANASSAS, VA:
2,954,079, PUB. 7-8-2003. INT. CL. 35.
- RE/MAX INTERNATIONAL, INC., GREENWOOD VILLAGE, CO, RE/MAX OF AMERICA, INC., ENGLEWOOD, CO:
1,358,422, REN. 4-13-05. INT. CL. 36.
- REACH MARKETING, INC., WESTPORT, CT:
2,171,036, CANC. INT. CL. 35.
- REACTOR SERVICES INTERNATIONAL, INC., ALVIN, TX:
1,284,614, CANC. INT. CL. 37.
- READ, DONNA, BOCA RATON, FL AND CAFOLLA, RALPH, BOCA RATON, FL:
2,171,063, CANC. MULTIPLE CLASS, INT. CLS. 9 AND 42.
- REALTY VIEWING NETWORK CORPORATION, LAKE SUCCESS, NY:
2,231,024, CANC. INT. CL. 35.
- REASY, PEGGY JOE, SAMMAMISH, WA AND REASY, CHARLES JR., SAMMAMISH, WA:
2,955,417, INT. CL. 44.
- REBACK BOOTS USA, ESCONDIDO, CA:
2,954,862, PUB. 3-1-2005. MULTIPLE CLASS, INT. CLS. 18 AND 25.
- RECKITT & COLMAN SUBSIDIARY CORPORATION, WILMINGTON, DE:
2,954,797, PUB. 3-1-2005. INT. CL. 3.
- RECREATIONAL EQUIPMENT, INC., SUMNER, WA, DBA REI:
1,842,859, CANC. INT. CL. 12.
- RECYCLING WORKS, LLC, DECATUR, GA:
2,955,631, INT. CL. 25.
- RED APPLE SCHOOL SUPPLY, INC., SALT LAKE CITY, UT:
2,955,082, PUB. 3-1-2005. INT. CL. 35.
- RED ARROW PRODUCTS COMPANY LLC, MANITOWOC, WI:
767,658, AM. U.S. CL. 46.
767,658, REN. 4-14-05. U.S. CL. 46 (INT. CL. 30).
1,486,062, AM. INT. CL. 11.
- RED ARROW PRODUCTS COMPANY, INC., MANITOWOC, WI:
1,337,023, REN. 4-14-05. INT. CL. 30.
- RED BULL GMBH, 5330 FUSCHL AM SEE, AUSTRIA:
2,954,008, PUB. 10-5-2004. MULTIPLE CLASS, INT. CLS. 33 AND 42.
- RED HEAD, INC., NOVATO, CA, DBA CABO WABO ENTERPRISES:
2,954,062, PUB. 3-1-2005. INT. CL. 25.
- RED WING SHOE COMPANY, INC., RED WING, MN:
2,956,143, INT. CL. 9.
- REDEEM THE VOTE, INC., MONTGOMERY, AL:
2,955,001, PUB. 3-1-2005. INT. CL. 35.
- REDHOOK ALE BREWERY INCORPORATED, SEATTLE, WA:
1,332,480, AM. INT. CL. 32.
- REED AND BARTON CORPORATION, TAUNTON, MA:
1,927,438, REN. 4-12-05. INT. CL. 8.
- REED ELSEVIER INC., NEWTON, MA:
2,956,333, INT. CL. 16.
2,956,350, INT. CL. 41.
- REEDHYCALOG, L.P., HOUSTON, TX:
2,954,846, PUB. 3-1-2005. INT. CL. 7.
- REGALO INTERNATIONAL, LLC, GOLDEN VALLEY, MN:
2,171,796, CANC. INT. CL. 6.
- REGENT PRODUCTS, INC., VIRGINIA BEACH, VA:
2,954,886, PUB. 3-1-2005. INT. CL. 35.
- REGIONAL FINANCIAL ASSOCIATES, INC., WEST CHESTER, PA TO DISMAL SCIENCES, INC., WEST CHESTER, PA:
1,843,973, CANC. INT. CL. 35.
- REGULUS NOT OG TRAAALVERKSTED AS, N-8301 SVOLVAER, NORWAY:
2,171,012, CANC. INT. CL. 22.
- REIMAN MEDIA GROUP, INC., GREENDALE, WI FROM REIMAN PUBLICATIONS, LLC, GREENDALE, WI:
2,955,195, INT. CL. 41.
- RELIANT ENERGY, INC., HOUSTON, TX FROM RELIANT ENERGY, INCORPORATED, HOUSTON, TX:
2,955,241, INT. CL. 16.
- RELIGIOUS TECHNOLOGY CENTER, LOS ANGELES, CA:
1,784,080, REN. 4-15-05. INT. CL. 16.
- REMBRANDTS COFFEE, LLC, OCEANSIDE, NY:
2,956,260, INT. CL. 30.
- REMET CORPORATION, UTICA, NY:
1,267,518, REN. 4-15-05. INT. CL. 1.
- REMY BATTERY COMPANY, MILWAUKEE, WI:
2,954,785, PUB. 7-6-2004. MULTIPLE CLASS, INT. CLS. 9 AND 35.
- RENAISSANCE INTERNATIONAL, INC., POMPTON PLAINS, NJ:
2,171,106, CANC. MULTIPLE CLASS, INT. CLS. 7 AND 11.
- RENATURE SKIN CARE INC., NEW YORK, NY:
2,954,925, PUB. 3-1-2005. INT. CL. 3.
- RENT A GARDENER, INC., NAPERVILLE, IL:
2,956,182, INT. CL. 44.

REPROCESSING PRODUCTS CORP (RPC), TUCSON, AZ:
2,956,329, INT. CL. 10.

RESEARCH INDUSTRIES, INC., PORTLAND, OR TO CAMERON GREAT LAKES, INC., PORTLAND, OR:
1,842,850, CANC. INT. CL. 11.

RESILIENT WORLDWIDE LLC, MELVILLE, NY:
2,954,058, PUB. 3-1-2005. INT. CL. 35.

RESOURCE BANK, NATIONAL ASSOCIATION (N. A.), DEKALB, IL:
2,954,021, PUB. 10-30-2001. INT. CL. 36.

RETAIL SOLUTIONS PROVIDERS ASSOCIATION, INC., CHARLOTTE, NC:
2,954,993, PUB. 3-1-2005. INT. CL. 35.
2,955,111, PUB. 3-1-2005. U.S. CL. 200.

RETIREMENT STRATEGIES, LLC, ALBUQUERQUE, NM:
2,956,138, INT. CL. 36.

REUTERS LIMITED, LONDON EC4P 4AJ, ENGLAND:
2,170,660, CANC. MULTIPLE CLASS, INT. CLS. 9, 35, 36, 38 AND 42.

REUTERS S.A., GENEVA, SWITZERLAND:
2,954,061, PUB. 3-1-2005. MULTIPLE CLASS, INT. CLS. 9, 35 AND 36.

REVIEW AND HERALD PUBLISHING ASSOCIATION, HAGERSTOWN, MD:
2,954,367, PUB. 3-1-2005. INT. CL. 41.

REVISION EYEWEAR INC., MONTREAL, CANADA:
2,954,304, PUB. 3-1-2005. INT. CL. 42.

REXALL CORPORATION, ST. LOUIS, MO:
772,942, CANC. U.S. CL. 51.

REXALL SUNDOWN, INC., BOCA RATON, FL TO REXALL SUNDOWN, INC., BOCA RATON, FL:
1,843,458, CANC. INT. CL. 5.
1,843,459, CANC. INT. CL. 5.

REYNOLDS, PAUL, VISTA, CA:
2,955,099, PUB. 3-1-2005. INT. CL. 26.

REZAI, LAILA, SAN ANSELMO, CA:
2,955,045, PUB. 3-1-2005. INT. CL. 16.

RFD INSIGHT, INC., ANN ARBOR, MI:
2,955,022, PUB. 3-1-2005. INT. CL. 35.

RG DELAWARE, INC., WILMINGTON, DE:
2,954,189, PUB. 3-1-2005. INT. CL. 11.

RGA TECHNOLOGY PARTNERS, INC., CHESTERFIELD, MO:
2,956,024, INT. CL. 9.

RH SOLUTIONS, INC., FLEMINGTON, NJ:
2,956,196, INT. CL. 41.

RHINO IMPORT EXPORT INC., WOODLAND HILLS, CA:
2,171,879, CANC. INT. CL. 18.

RHODES, DANIEL M. "DUSTY", SAN FRANCISCO, CA:
1,843,980, CANC. INT. CL. 41.

RICE LAKE WEIGHING SYSTEMS, INC., RICE LAKE, WI:
2,955,616, INT. CL. 9.

RICH BICH BIPLANE CO., MAGGIE VALLEY, NC:
2,171,835, CANC. INT. CL. 35.
2,171,836, CANC. INT. CL. 30.

RICHARD A. GANGNES M.D., INC., SAN CLEMENTE, CA:
2,954,999, PUB. 3-1-2005. INT. CL. 44.

RICHARDSON ELECTRONICS, LTD., LAFOX, IL:
2,171,867, CANC. INT. CL. 9.

RICHEMONT INTERNATIONAL SA, VILLARS-SUR-GLANE, SWITZERLAND:
2,954,001, PUB. 3-1-2005. INT. CL. 14.

RIDE LABORATORIES, INC., TUCSON, AZ:
1,284,608, CANC. INT. CL. 37.

RILAR, INC., SAN DIEGO, CA:
2,171,928, CANC. INT. CL. 3.

RION CO., LTD., TOKYO, JAPAN:
1,139,860, REN. 4-12-05. INT. CL. 10.

RISE INTERNATIONAL GROUP, L.L.C., LODI, NJ, CARTER PRODUCTS, INC., NEW YORK, NY:
786,531, REN. 4-9-05. U.S. CL. 51 (INT. CL. 3).

RISTANO, MICHAEL A., SR., NEWARK, DE:
2,954,211, PUB. 3-1-2005. INT. CL. 41.

RITIBOON INTERNATIONAL LIMITED, TORTOLA, BR. VIRGIN ISLANDS:
2,848,054, CANC. INT. CL. 21.

RIVERDALE COLOR MANUFACTURING, INC., PERTH AMBOY, NJ:
2,955,931, INT. CL. 7.

RIVERWOOD CHURCH, CORPUS CHRISTI, TX:
2,955,087, PUB. 3-1-2005. INT. CL. 16.

RIVOLTA ENGINEERING AND MARKETING, INC., SARASOTA, FL:
2,955,741, INT. CL. 12.

RJ LEE GROUP, INCORPORATED, MONROEVILLE, PA:
2,954,385, PUB. 3-1-2005. INT. CL. 42.

RLC TECHNOLOGIES, L.L.C., SYLACAUGA, AL, PURSELL INDUSTRIES, INC., SYLACAUGA, AL:
1,912,112, REN. 4-13-05. INT. CL. 1.

ROACH MANUFACTURING CORPORATION, TRUMANN, AR:
1,284,086, CANC. INT. CL. 7.

ROBERT ALLEN FABRICS, INC., MANSFIELD, MA:
2,171,880, CANC. INT. CL. 24.

ROBERT GOOD ASSOCIATES, LLC, SALEM, NH:
2,954,705, PUB. 9-21-2004. INT. CL. 35.

ROBERT L. STARK ENTERPRISES, INC., WOODMERE, OH:
2,955,461, INT. CL. 36.

ROBERT S. HIGHTOWER, P.A., TALLAHASSEE, FL:
2,956,149, INT. CL. 42.

ROBERT'S AMERICAN GOURMET, SEA CLIFF, NY:
2,954,230, PUB. 3-1-2005. INT. CL. 29.

ROBIN MARIETON, 69500 AMPLEPUIS, FRANCE:
2,171,820, CANC. INT. CL. 24.

ROCKAWAY BEACH APPAREL, NEW YORK, NY:
2,956,238, INT. CL. 25.

ROCKET U.S.A., INC., OAK PARK, IL:
2,172,020, CANC. INT. CL. 28.

ROCKHURST UNIVERSITY, KANSAS CITY, MO:
2,954,829, PUB. 3-1-2005. MULTIPLE CLASS, INT. CLS. 16, 25 AND 41.

RODALE INC., EMMAUS, PA:
2,954,876, PUB. 3-1-2005. INT. CL. 16.
2,956,178, INT. CL. 41.
2,956,330, INT. CL. 16.

RODEO TEXMEX, SOCIEDAD ANONIMA DE CAPITAL VARIABLE, NUEVO LEON, MEXICO:
2,171,730, CANC. INT. CL. 41.

RODGERS, TIMOTHY L., SANTA BARBARA, CA AND BAKER, DENNIS H., SANTA BARBARA, CA:
2,956,265, INT. CL. 44.

RODGERS, WM. GAYLE, MADRAS, OR:
2,956,345, INT. CL. 8.

ROGER A. FARRARA & KENNETH E. JONES PARTNERSHIP, THE, CHICO, CA:
2,955,402, INT. CL. 7.

ROGERS LTD., MIDDLETOWN, OH:
1,929,352, REN. 4-12-05. INT. CL. 14.

ROGERS, LUNT & BOWLEN COMPANY, GREENFIELD, MA, DBA LUNT:
1,284,088, CANC. INT. CL. 8.

ROHO, INC., BELLEVILLE, IL:
2,955,719, INT. CL. 12.

ROI VENTURES, L.P., HOUSTON, TX:
1,858,813, REN. 4-14-05. INT. CL. 35.

ROLLER, KERRY LEE, MORGAN HILL, CA:
2,956,030, INT. CL. 35.

ROMAINE PIERSON PUBLISHERS, INC., JAMESBURG, NJ:
2,956,284, INT. CL. 9.
2,956,285, INT. CL. 35.

ROMANCO LLC, SOMERSET, CA, DBA HAPPY VALLEY BREWING CO.:
2,954,175, PUB. 3-1-2005. INT. CL. 32.

RON ROBINSON, INC., LOS ANGELES, CA:
2,955,828, INT. CL. 3.

RONO GRAPHIC COMMUNICATIONS CO., PORTLAND, OR:
1,284,791, CANC. INT. CL. 42.

ROOSEVELT UNIVERSITY, CHICAGO, IL:
2,954,148, PUB. 10-26-2004. INT. CL. 41.

ROSENBLUM, PARISH & ISAACS, SAN JOSE, CA:
2,171,987, CANC. INT. CL. 42.

- ROSS ARMSTRONG MANUFACTURING LIMITED, MISSISSAUGA, ONTARIO L4Y 1Y7, CANADA:
2,180,379, CANC. MULTIPLE CLASS, INT. CLS. 3, 4 AND 5.
- ROST, INC., ST. PETERSBURG, FL:
2,171,823, CANC. INT. CL. 4.
- ROTHERMEL, CHARLES E., ASHBURN, VA:
2,956,172, INT. CL. 16.
- ROTHMANS LIMITED, ZURICH, SWITZERLAND:
772,690, CANC. U.S. CL. 17.
- ROTHSCHILD, SHIMON, KARNEY SHOMRON, ISRAEL:
2,956,122, INT. CL. 9.
- ROTHSCHILD'S CONTINUATION HOLDINGS AG, ZUG, SWITZERLAND:
2,955,362, INT. CL. 36.
- ROTOBEC INC., SAINTE-JUSTINE, QUEBEC, CANADA:
2,954,129, PUB. 11-9-2004, INT. CL. 7.
- ROUND ROCK BASEBALL, INC, ROUND ROCK, TX:
2,955,027, PUB. 3-1-2005, INT. CL. 25.
- ROUSE IP, LLC, COLUMBIA, MD:
2,954,320, PUB. 3-1-2005, MULTIPLE CLASS, INT. CLS. 36 AND 41.
- ROYAL COPENHAGEN A/S, 2000 FREDERIKSBERG, DENMARK:
2,164,900, CANC. MULTIPLE CLASS, INT. CLS. 3, 11, 16, 18, 20, 24, 25, 28 AND 42.
- ROYAL MOULDINGS LIMITED, MARION, VA:
2,955,876, INT. CL. 20.
- ROYAL PRECISION, INC., TORRINGTON, CT:
2,955,707, INT. CL. 28.
- ROYAL PURPLE, INC., HUMBLE, TX:
2,953,996, PUB. 2-4-2003, INT. CL. 4.
- RPMC, INC., CALABASAS, CA:
2,954,185, PUB. 3-1-2005, INT. CL. 35.
- RRI FINANCIAL, INC., LAS VEGAS, NV:
2,954,176, PUB. 3-1-2005, INT. CL. 43.
- RTJ ASSOCIATES, WESTON, MA TO CLINICAL NETWORK, INC., IRVING, TX:
1,842,713, CANC. INT. CL. 9.
- RTR FUNDING GROUP INC., NEW YORK, NY:
1,005,631, REN. 4-12-05, U.S. CL. 100 (INT. CL. 42).
- RUBICON SOFTWARE UND DESIGN GMBH, W-5800 HAGEN 1, FED REP GERMANY:
1,842,747, CANC. INT. CL. 9.
- RUBIN, JEROME M., SAN GERONIMO, CA:
2,954,202, PUB. 3-1-2005, INT. CL. 21.
- RUFOLO, VITO, 14-22100 COMO, ITALY:
2,171,023, CANC. INT. CL. 25.
- RUGGIERO SEAFOOD, INC., NEWARK, NJ:
2,954,492, PUB. 3-1-2005, INT. CL. 29.
- RUIZ MEXICAN FOODS, INC., ONTARIO, CA:
2,172,006, CANC. INT. CL. 30.
- RUOCCHIO, ALBERT C., RALEIGH, NC:
2,956,085, INT. CL. 28.
- RUSCONI EDITORE SPA:
See—HACHETTE RUSCONI S.P.A.
- RVS-TEC OY, FINLAND:
2,955,167, PUB. 3-1-2005, MULTIPLE CLASS, INT. CLS. 4, 40 AND 42.
- RYSHCO MEDIA INC., LONGUEUIL, QUEBEC, H2X 2T2, CANADA:
2,954,171, PUB. 3-1-2005, INT. CL. 9.
- S. FREEDMAN & SONS, INC., LANDOVER, MD, DBA THE PAPER STORE:
1,284,277, CANC. MULTIPLE CLASS, INT. CLS. 16 AND 21.
- S. LICHTENBERG & CO., INC., NEW YORK, NY:
1,284,378, CANC. INT. CL. 24.
- S.H. BROOKS CO., INC., WALTHAM, MA:
2,170,862, CANC. INT. CL. 9.
- S.M. JALEEL & COMPANY LIMITED, TRINIDAD, TRINIDAD/TOBAGO:
2,171,399, CANC. INT. CL. 32.
- SABAN ENTERTAINMENT, INC., LOS ANGELES, CA:
2,171,910, CANC. INT. CL. 28.
- SABATH, ANNA, GILROY, CA AND REYNOLDS, CHARLES H., GILROY, CA:
2,955,246, INT. CL. 29.
- SABINE GRANDKE-BAYER, SAN RAFAEL, CA:
2,954,981, PUB. 3-1-2005, INT. CL. 44.
- SABRE CORPORATION PTY LTD, DEE WHY, NSW, AUSTRALIA:
1,829,143, REN. 4-15-05, INT. CL. 3.
- SACRAMENTO KINGS LIMITED PARTNERSHIP, L.P., SACRAMENTO, CA:
1,006,500, REN. 4-15-05, INT. CL. 41.
2,955,503, INT. CL. 28.
- SAERA CO., LTD., SEOUL, DEM REP OF KOREA:
2,955,152, PUB. 3-1-2005, INT. CL. 25.
- SAFE-TECH PRODUCTS, INC., PHOENIX, AZ:
2,955,301, INT. CL. 9.
- SAFETY & ENVIRONMENTAL RESOURCES, INC., MISHAWAKA, IN:
2,171,339, CANC. INT. CL. 40.
- SAFT AMERICA INC., VALDOSTA, GA:
2,171,745, CANC. INT. CL. 9.
- SAINT LUKE'S HOSPITAL OF KANSAS CITY, KANSAS CITY, MO:
2,172,051, CANC. INT. CL. 41.
- SAL. OPPENHEIM JR. & CIE., KOLN, FED REP GERMANY:
2,955,903, MULTIPLE CLASS, INT. CLS. 9, 14, 16, 35 AND 42.
- SALLY GEE, INC., RIDGEFIELD, NJ:
772,867, CANC. U.S. CL. 39.
- SALOMON S.A., 74370 METZ-TESSY, FRANCE:
2,171,469, CANC. INT. CL. 28.
- SALOT, STANLEY H., JR., FREMONT, CA:
2,172,009, CANC. INT. CL. 41.
- SAM BASS ILLUSTRATION & DESIGN, INC., CONCORD, NC:
2,171,640, CANC. INT. CL. 16.
- SAMMONS, TROY E., PUEBLO WEST, CO:
2,955,400, INT. CL. 44.
- SAMSONITE CORPORATION, DENVER, CO:
2,171,743, CANC. MULTIPLE CLASS, INT. CLS. 18 AND 42.
- SAMSUNG ELECTRO-MECHANICS CO., LTD., KYUNGKIDO, REPUBLIC OF KOREA:
2,955,587, INT. CL. 9.
- SANARUS MEDICAL, INC., PLEASANTON, CA:
2,899,307, COR. INT. CL. 16.
- SANCHEZ, MAYA, 7290 SAMOIS SUR SEINE, FRANCE AND SANCHEZ, THIERRY, 7290 SAMOIS SUR SEINE, FRANCE:
2,909,383, COR. MULTIPLE CLASS, INT. CLS. 9, 16, 18, 25, 28, 35, 38 AND 41.
- SANCHEZ, VINCENT F., LAKE ELSINORE, CA:
2,955,542, INT. CL. 35.
- SANDERS, PHILLIP G., ATLANTA, GA:
2,956,259, INT. CL. 36.
- SANDOZ, LTD. (SANDOZ AG), BASLE, SWITZERLAND:
1,284,046, CANC. INT. CL. 5.
- SANISSIMO, S.A. DE C.V., MONTERREY, N.L., MEXICO:
2,956,247, INT. CL. 30.
- SANKOM SARL, SWITZERLAND:
2,955,179, PUB. 3-1-2005, INT. CL. 5.
- SANKYO LIFETECH COMPANY, LIMITED, JAPAN:
2,955,168, PUB. 3-1-2005, MULTIPLE CLASS, INT. CLS. 1 AND 5.
- SANRIO COMPANY, LTD., TOKYO 141, JAPAN:
2,955,383, INT. CL. 6.
2,955,384, INT. CL. 5.
2,955,391, INT. CL. 16.
2,955,392, INT. CL. 14.
2,955,393, INT. CL. 11.
2,955,409, INT. CL. 24.
2,955,410, INT. CL. 27.
2,955,411, INT. CL. 28.
2,955,412, INT. CL. 26.
- SANTANDREA, CARMINE, OJAI, CA, TA SANTANDREA PRODUCTIONS:
2,170,929, CANC. INT. CL. 41.
- SANTEE COOPER, MONCK'S CORNER, SC:
2,171,120, CANC. INT. CL. 39.
- SANTIAGO IJALBA, S.A., SPAIN:
2,955,183, PUB. 3-1-2005, INT. CL. 33.

SAP PORTALS, INC., SAN JOSE, CA FROM TOPTIER SOFTWARE CORPORATION, SAN JOSE, CA:
2,954,028, PUB. 10-19-2004. INT. CL. 9.

SARA LEE CORPORATION, WINSTON SALEM, NC:
768,215. REN. 4-15-05. U.S. CL. 39 (INT. CLS. 10, 25 AND 26).

SARA LEE CORPORATION, WINSTON-SALEM, NC:
1,284,398, CANC. INT. CL. 25.

SARA LEE FOODS, INC., CINCINNATI, OH:
2,171,827, CANC. INT. CL. 30.

SARAH LOUISE LTD., ORMSKIRK, LANCASHIRE, ENGLAND:
1,348,097. REN. 4-12-05. INT. CL. 25.

SARALEGUI, FERNANDO, NEW YORK, NY:
2,171,018, CANC. INT. CL. 25.

SARAMAR CORPORATION, DOVER, DE:
2,171,648, CANC. INT. CL. 29.

SARAMAR, L.L.C., CHICAGO, IL:
2,955,493, INT. CL. 25.
2,955,596, INT. CL. 30.
2,955,623, INT. CL. 25.
2,955,643, INT. CL. 25.
2,955,753, INT. CL. 25.

SARGEANT, DANIEL, BAGNALL, STOKE-ON-TRENT, ST9 9LP, ENGLAND:
2,171,609, CANC. INT. CL. 13.

SASSABY, INC., NEW YORK, NY:
2,911,202, COR. INT. CL. 3.

SATCOM ELECTRONICS, INC., POWAY, CA:
2,171,524, CANC. INT. CL. 9.

SATER DESIGN COLLECTION, INC., BONITA SPRINGS, FL:
2,956,160, INT. CL. 16.

SATO PHARMACEUTICAL CO., LTD., TOKYO, JAPAN:
2,955,738, INT. CL. 32.

SAUCONY, INC., PEABODY, MA:
2,955,680, INT. CL. 25.

SAVE-A-LOT FOOD STORES, LTD., EARTH CITY, MO:
2,955,776, INT. CL. 32.

SAZERAC COMPANY, INC., NEW ORLEANS, LA:
2,955,839, INT. CL. 33.

SBJR RESTAURANT'S INC., RIVER VALE, NJ:
2,170,762, CANC. INT. CL. 30.

SCANALERT, INC., NAPA, CA:
2,955,938, INT. CL. 45.

SCHACHTER, MICHAEL, SHORT HILLS, NJ:
2,955,261, INT. CL. 14.

SCHELLING, CHRISTIANNE, THREE RIVERS, CA:
2,954,868, PUB. 3-1-2005. INT. CL. 5.

SCHERING AKTIENGESELLSCHAFT, BERLIN, FED REP GERMANY:
2,954,256, PUB. 8-17-2004. INT. CL. 5.
2,954,281, PUB. 10-26-2004. INT. CL. 5.

SCHIFFER, HARRIET, SAN FRANCISCO, CA:
2,171,291, CANC. INT. CL. 41.

SCHMIDLIN, LAWRENCE A, CHANDLER, AZ:
2,956,096, INT. CL. 41.

SCHNADER HARRISON SEGAL & LEWIS LLP, PHILADELPHIA, PA:
2,171,404, CANC. INT. CL. 16.

SCHNEDLER, DAVID E., PALO ALTO, CA:
2,955,552, INT. CL. 9.

SCHNEIDER CORPORATION, THE, INDIANAPOLIS, IN:
2,955,689, INT. CL. 42.

SCHNEIDER ELECTRIC INDUSTRIES SA, RUEIL-MALMAISON, FRANCE:
2,954,077, PUB. 3-1-2005. MULTIPLE CLASS, INT. CLS. 9, 37, 38 AND 42.

SCHNEIDER ELECTRIC INDUSTRIES SAS, RUEIL-MALMAISON, FRANCE:
2,954,017, PUB. 7-27-2004. INT. CL. 9.

SCHNEIDER, CARL M., WHITE PLAINS, NY:
2,171,655, CANC. INT. CL. 21.

SCHOLASTIC INC., NEW YORK, NY:
2,955,462, INT. CL. 16.

SCHOTT ZWIESEL AG, FED REP GERMANY:
2,955,165, PUB. 3-1-2005. INT. CL. 21.

SCHUMAN, JESSICA, PACIFIC PALISADES, CA:
2,954,452, PUB. 3-1-2005. INT. CL. 41.

SCHWAN'S IP, LLC, MARSHALL, MN:
2,955,537, INT. CL. 32.
2,955,974, INT. CL. 30.

SCHWARTZ, JOLENE, MT. LAUREL, NJ:
2,955,487, INT. CL. 3.

SCHWINN BICYCLE COMPANY, CHICAGO, IL:
772,714, CANC. U.S. CL. 19.

SCICLONE PHARMACEUTICALS, INC., SAN MATEO, CA:
1,848,049. REN. 4-13-05. INT. CL. 5.

SCIENCE PARTNERS INCORPORATED, BOSTON, MA:
1,843,295, CANC. INT. CL. 42.

SCIENTEUR CORPORATION, GREENFIELD, IN:
2,954,832, PUB. 3-1-2005. MULTIPLE CLASS, INT. CLS. 42 AND 44.

SCOTT PAPER COMPANY, DELAWARE COUNTY, PA TO THE PROCTOR & GAMBLE COMPANY, CINCINNATI, OH:
1,842,614, CANC. INT. CL. 3.

SCOTT RESOURCES, INC., FORT COLLINS, CO:
1,842,795, CANC. INT. CL. 9.

SCRANTON LACE COMPANY, SCRANTON, PA:
1,843,685, CANC. INT. CL. 24.

SCRATCH-ART COMPANY, INC., AVON, MA:
1,843,611, CANC. INT. CL. 16.

SCREAMIN' MIM'S SALSA, INC., LEXINGTON, KY:
1,878,258. REN. 4-14-05. INT. CL. 30.

SCRIPPS NETWORKS, INC., KNOXVILLE, TN:
2,955,535, INT. CL. 41.
2,955,993, INT. CL. 41.

SDE, INC., PETERBOROUGH, NH:
1,843,640, CANC. INT. CL. 16.

SDS ENTERPRISES, L.L.C., PIEDMONT, OK:
2,956,046, INT. CL. 12.

SEARS, ROEBUCK AND CO., HOFFMAN ESTATES, IL:
1,842,690, CANC. INT. CL. 7.
2,171,150, CANC. INT. CL. 24.

SEB, FRANCE:
2,955,166, PUB. 3-1-2005. INT. CL. 7.

SECUREFLIGHT, INC., WEST CHESTER, PA:
2,954,817, PUB. 3-1-2005. INT. CL. 39.

SECURIAN FINANCIAL GROUP, INC., ST. PAUL, MN:
2,954,360, PUB. 3-1-2005. INT. CL. 36.

SECURITY ASSOCIATES, INC., HUNT VALLEY, MD:
2,954,522, PUB. 3-1-2005. MULTIPLE CLASS, INT. CLS. 37 AND 45.

SECURITY CAPITAL ATLANTIC, INCORPORATED, ATLANTA, GA:
2,171,556, CANC. MULTIPLE CLASS, INT. CLS. 36 AND 37.

SEECURITY.COM, LLC, WEST ISLIP, NY:
2,955,550, MULTIPLE CLASS, INT. CLS. 38 AND 40.

SEIKO EPSON KABUSHIKI KAISHA, SHINJUKU-KU, TOKYO, JAPAN, DBA SEIKO EPSON CORPORATION:
2,954,261, PUB. 3-1-2005. INT. CL. 9.

SEITZ, RICHARD T., INDIAN SPRINGS, OH AND DECKER, JEROME L., INDIAN SPRINGS, OH:
2,171,592, CANC. INT. CL. 32.

SELECT LABORATORIES, INC., GAINESVILLE, GA:
1,284,036, CANC. INT. CL. 5.

SELLNER MANUFACTURING CO., INC., FARIBAULT, MN:
2,955,364, INT. CL. 28.

SEM-CHI RICE PRODUCTS CORP., PALM BEACH, FL:
2,171,414, CANC. INT. CL. 30.

SEMAFORE PHARMACEUTICALS INC., INDIANAPOLIS, IN:
2,955,785, INT. CL. 42.

SEMCO ENTERPRISES, INC., CASSELBERRY, FL:
2,954,480, PUB. 3-1-2005. INT. CL. 42.

SENECA, ELAINE, STATEN ISLAND, NY:
1,843,416, CANC. INT. CL. 3.

SENIOR HEALTH & WELFARE CONSULTANTS, INC., PALOS HILLS, IL:
2,956,242, INT. CL. 16.

SENS FURNITURE, INC., SAN FRANCISCO, CA:
2,955,630, MULTIPLE CLASS, INT. CLS. 11 AND 20.

- SENSITIVITY LIMITED, LONDON N3 1LF, UNITED KINGDOM:
2,954,626, PUB. 8-31-2004. MULTIPLE CLASS, INT. CLS. 9, 11 AND 35.
- SENSOR ELECTRONIC TECHNOLOGY, INC., COLUMBIA, SC:
2,956,117, INT. CL. 9.
- SENSORY ARTS & SCIENCE, LLC, LEDERACH, PA:
2,955,725, INT. CL. 10.
- SENTEN, INC., DESTIN, FL:
2,954,466, PUB. 3-1-2005. INT. CL. 16.
- SENTILLION, INC., ANDOVER, MA:
2,955,953, INT. CL. 9.
- SEON, INC., NEW YORK, NY:
2,171,265, CANC. INT. CL. 3.
- SEQUEL COMMUNICATIONS, INC., SOUTH PLAINFIELD, NJ:
2,171,282, CANC. MULTIPLE CLASS, INT. CLS. 36 AND 38.
- SEREN INNOVATIONS, INC., MINNEAPOLIS, MN:
2,955,759, INT. CL. 37.
- SERV-TECH, INC., HOUSTON, TX:
2,171,547, CANC. INT. CL. 11.
- SERVAL, 79800 SAINTE EANNE, FRANCE:
2,171,405, CANC. INT. CL. 31.
- SEVEN-UP BOTTLING OF LA CROSSE, INC., LACROSSE, WI:
1,284,706, CANC. INT. CL. 42.
- SEVENARTS LIMITED, LONDON W1XA 3HA, UNITED KINGDOM:
2,171,077, CANC. INT. CL. 21.
- SEXTON, RANDALL BURKS, HONOLULU, HI:
2,955,268, INT. CL. 42.
- SEYCHELLES IMPORTS, LLC, EL SEGUNDO, CA:
2,954,106, PUB. 3-1-2005. INT. CL. 25.
- SGS SOCIETE GENERALE DE SURVEILLANCE S.A., 1211 GENEVA 1, CANTON OF GENEVA, SWITZERLAND:
2,170,646, CANC. INT. CL. 42.
- SHAFFER, JAMES, STUART, FL:
2,954,387, PUB. 3-1-2005. INT. CL. 9.
- SHAKER ADVERTISING AGENCY, INC., OAK PARK, IL:
2,955,043, PUB. 3-1-2005. INT. CL. 35.
- SHAKESPEARE ALL STAR ACQUISITION LLC, COLUMBIA, SC:
2,171,095, CANC. INT. CL. 28.
- SHANNON, BETHANN, BETHESDA, MD:
2,171,010, CANC. INT. CL. 21.
- SHANOWER, LISA, MILL VALLEY, CA:
2,956,263, INT. CL. 35.
- SHARP IMAGE GAMING, INC., CHATSWORTH, CA:
2,955,265, INT. CL. 9.
- SHARP IMPACT, INC., NEW YORK, NY:
2,955,097, PUB. 3-1-2005. INT. CL. 42.
- SHARP, GLORIA A., CLEVELAND, MO:
2,954,758, PUB. 3-1-2005. INT. CL. 25.
- SHEPHERD & GOLDSTEIN LLP, WORCESTER, MA:
2,956,110, MULTIPLE CLASS, INT. CLS. 35 AND 36.
- SHEPLERS, INC., WICHITA, KS:
2,171,020, CANC. INT. CL. 25.
- SHEPLEY WOOD PRODUCTS, INC., HYANNIS, MA:
2,954,840, PUB. 3-1-2005. MULTIPLE CLASS, INT. CLS. 35 AND 37.
- SHERATON CORPORATION, THE, WHITE PLAINS, NY, PHOENIX RESORT CORPORATION, THE, SCOTTSDALE, AZ:
1,881,001, REN. 4-13-05. INT. CL. 42.
- SHERIDAN BROADCASTING CORPORATION, PITTSBURGH, PA:
2,955,840, INT. CL. 41.
- SHERWOOD MEDICAL COMPANY, ST. LOUIS, MO:
1,284,189, CANC. INT. CL. 10.
- SHIRLO, INC., MEMPHIS, TN, DBA PET CHEMICALS, RIVIANA FOODS INC., HOUSTON, TX:
1,350,259, REN. 4-15-05. INT. CL. 5.
- SHOPKO STORES, INC., GREEN BAY, WI:
2,170,815, CANC. INT. CL. 42.
- SHOW OF THE MONTH CLUB, LLC, BOSTON, MA:
2,955,203, MULTIPLE CLASS, INT. CLS. 35 AND 41.
- SHUBERT ORGANIZATION, INC., THE, NEW YORK, NY:
2,171,290, CANC. INT. CL. 35.
- SIBERIAN SALMON EGG CO., KENT, WA:
1,284,455, CANC. INT. CL. 28.
- SIEMENS AKTIENGESELLSCHAFT, D-8000 MUNICH 2, FED REP GERMANY:
976,710, REN. 4-12-05. U.S. CL. 21 (INT. CLS. 7 AND 9).
- SIEMENS AKTIENGESELLSCHAFT, FED REP GERMANY:
2,955,163, PUB. 3-1-2005. MULTIPLE CLASS, INT. CLS. 9, 35 AND 42.
- SIEMON, PAUL, RENO, NV:
2,955,864, INT. CL. 41.
- SIGNET BANKING CORPORATION, RICHMOND, VA:
1,411,650, CANC. INT. CL. 36.
- SILICON LABORATORIES, INC., AUSTIN, TX:
2,955,064, PUB. 3-1-2005. INT. CL. 9.
- SILKO FASHIONS, INC., SAN FRANCISCO, CA:
2,171,099, CANC. INT. CL. 25.
- SILL & SONS SERVICES, GAINESVILLE, FL:
2,955,005, PUB. 3-1-2005. INT. CL. 28.
- SILSTAR CORPORATION OF AMERICA, INC., WEST COLUMBIA, SC:
2,955,017, PUB. 3-1-2005. INT. CL. 28.
- SILVER KING REFRIGERATION, INC., MINNEAPOLIS, MN:
1,033,672, REN. 4-15-05. INT. CL. 8.
- SILVERMAN, LORI L., MADISON, WI:
2,954,374, PUB. 3-1-2005. INT. CL. 35.
- SILVERMAN, MARTIN D., NASHVILLE, TN:
1,843,600, CANC. INT. CL. 15.
- SILVERVISION ENTERTAINMENT GROUP, LLC, MALIBU, CA:
2,171,832, CANC. INT. CL. 41.
- SIMMONS, HERBERT D., JACKSONVILLE, FL:
2,954,947, PUB. 11-16-2004. INT. CL. 25.
- SIMONSWERK, GESELLSCHAFT MIT BESCHRANKTER HAFTUNG, D-33378 RHEDA-WIEDENBRUCK, FED REP GERMANY:
2,954,172, PUB. 3-1-2005. INT. CL. 6.
- SIMPSON LAWRENCE USA, INC., BRADENTON, FL:
2,171,724, CANC. INT. CL. 13.
- SIMPSON PAPER COMPANY, SEATTLE, WA:
1,284,239, CANC. INT. CL. 16.
- SIMPSON TIMBER COMPANY, SEATTLE, WA:
2,955,911, INT. CL. 19.
2,955,912, INT. CL. 19.
- SIMPSON, CHRISTOPHER, LONDON, ENGLAND, UNITED KINGDOM:
2,824,286, COR. MULTIPLE CLASS, INT. CLS. 9, 35, 36, 38, 39, 41 AND 42.
- SINUTKO, MICHAEL JR., GLEN BURNIE, MD, DBA THE RESEARCH CONSULTING GROUP:
1,884,451, REN. 4-12-05. INT. CL. 42.
- SIPES, WILLIAM H., JR., JACKSON, TN:
2,955,950, INT. CL. 36.
- SIRDAR, LLC, DURANGO, CO:
2,954,184, PUB. 4-27-2004. MULTIPLE CLASS, INT. CLS. 9, 16, 25 AND 41.
- SIRIUS PUBLISHING, INC., SCOTTSDALE, AZ:
2,172,056, CANC. INT. CL. 9.
- SIS DESIGNS, LLC, VIRGINIA BEACH, VA:
2,954,996, PUB. 3-1-2005. INT. CL. 14.
- SISON-JONES, DOY, LONDON, UNITED KINGDOM:
2,954,105, PUB. 6-1-2004. INT. CL. 14.
- SITCORE, COPENHAGEN K, DENMARK:
2,954,856, PUB. 3-1-2005. INT. CL. 9.
- SITEMAN A/S, 5300 KERTEMINDE, DENMARK:
2,954,672, PUB. 6-1-2004. MULTIPLE CLASS, INT. CLS. 9, 35 AND 42.
- SJ BERWIN, LONDON, WC1X 8XF, UNITED KINGDOM:
2,954,188, PUB. 3-1-2005. MULTIPLE CLASS, INT. CLS. 16 AND 42.
- SJI, INC, ST. LOUIS, MO:
2,955,206, INT. CL. 42.
- SJI, INC., ST. LOUIS, MO:
2,955,207, INT. CL. 39.
- SKIDMORE COLLEGE, SARATOGA SPRINGS, NY:
1,324,029, REN. 4-11-05. MULTIPLE CLASS, INT. CLS. 6,

- 20 AND 21.
1,324,029, CANC. INT. CL. 14.
SKILLMASTER, INC., LAKE ZURICH, IL:
2,142,347, CANC. INT. CL. 9.
SKIMTECH, INCORPORATED, POLAND, OH:
2,955,520, INT. CL. 17.
SKINNY SCHOOLS MEDICAL CLINIC, INC., INGLEWOOD,
CA:
1,284,019, CANC. INT. CL. 5.
SKY ROBOTICS, INC., ST PAUL, MN:
2,170,761, CANC. INT. CL. 7.
SL MONTEVIDEO TECHNOLOGY, INC.:
1,284,084, CANC. INT. CL. 7.
SLEEP COUNTRY USA, INC., KENT, WA:
2,955,701, MULTIPLE CLASS, INT. CLS. 35, 39 AND 42.
SMART & FINAL STORES CORPORATION, COMMERCE,
CA:
2,954,882, PUB. 3-1-2005. INT. CL. 21.
SMART DOOR SYSTEMS, INC., ARLINGTON, VA:
2,955,942, MULTIPLE CLASS, INT. CLS. 9, 36, 37 AND 42.
SMITH & NEPHEW DONJOY, INC., CARLSBAD, CA TO DJ
ORTHOPEDICS, LLC, VISTA, CA:
1,843,569, CANC. INT. CL. 10.
SMITH & NEPHEW, INC., MEMPHIS, TN:
1,319,170, REN. 4-11-05. INT. CL. 10.
SMITH & NEPHEW, INC., MEMPHIS, TN, ACUFEX MICRO-
SURGICAL, INC., MANSFIELD, MA:
1,877,142, REN. 4-11-05. INT. CL. 10.
SMITH, CHAR, K, LA MESA, CA:
2,956,042, INT. CL. 9.
SMITH, JOSEPH, WELLINGTON, FL:
2,954,263, PUB. 3-1-2005. INT. CL. 3.
SMITH, SHERYL, ROCHESTER, NY:
2,171,644, CANC. INT. CL. 29.
SMITH, TERRY DON, POWAY, CA:
2,956,113, INT. CL. 16.
SMITHKLINE BEECHAM CORPORATION, PHILADEL-
PHIA, PA:
2,955,713, MULTIPLE CLASS, INT. CLS. 16 AND 44.
SMITHS MEDICAL INTERNATIONAL LIMITED, LONDON
NW11 8DS, UNITED KINGDOM:
2,955,618, INT. CL. 10.
SNAG PROOF MANUFACTURING, INC., CINCINNATI,
OH:
1,889,975, REN. 4-15-05. INT. CL. 28.
SNAP AUCTIONS, INC., AUSTIN, TX:
2,954,427, PUB. 3-1-2005. INT. CL. 35.
2,954,428, PUB. 3-1-2005. INT. CL. 35.
SNAP-ON INCORPORATED, PLEASANT PRAIRIE, WI:
788,618, REN. 4-13-05. U.S. CL. 2 (INT. CL. 6).
SNOWSHOE RESORT, INC., SNOWSHOE, WV:
2,170,891, CANC. MULTIPLE CLASS, INT. CLS. 16, 24, 25
AND 28.
SOAP GARDEN, THE, BERKELEY, CA:
2,955,387, INT. CL. 3.
SOCIETA PER AZIONI CASA VINICOLA BARONE RICA-
SOLI, FLORENCE, ITALY:
772,991, CANC. U.S. CL. 47.
SOCIETE DE CONTROLE TECHNIQUE (SOCOTEC), PARIS
CEDEX 15, FRANCE:
1,284,750, CANC. INT. CL. 42.
SOCIETE DES PRODUITS NESTLE S. A., VEVEY, SWITZER-
LAND:
2,955,674, INT. CL. 31.
SOCIETE DES PRODUITS NESTLE S.A., 1800 VEVEY,
SWITZERLAND:
2,955,923, INT. CL. 29.
SOCIETE NATIONALE ELF AQUITAINE, LA DEFENSE 6,
92400 COURBEVOIE, FRANCE TO ELF AQUITAINE,
92400 COURBEVOIE, FRANCE:
1,842,629, CANC. INT. CL. 4.
SOCIETY OF AUTOMOTIVE ENGINEERS, INC., WARREN-
DALE, PA, DBA SAE:
2,171,085, CANC. INT. CL. 35.
SODEXHO OPERATIONS, LLC, GAITHERSBURG, MD:
2,954,948, PUB. 3-1-2005. INT. CL. 41.
SODIM, 45490 FLEURY-LES-AUBRAIS, FRANCE:
2,955,333, INT. CL. 9.
SOHO FASHION, INC., LOS ANGELES, CA:
2,954,501, PUB. 3-1-2005. INT. CL. 26.
SOKKIA TECHNOLOGY, INC., OVERLAND PARK, KS:
1,843,941, CANC. INT. CL. 9.
SOLIDSAIRE, INC., HOUSTON, TX:
775,325, REN. 4-13-05. U.S. CL. 23 (INT. CL. 7).
SOLIDWORKS CORPORATION, CONCORD, MA:
2,954,951, PUB. 3-1-2005. INT. CL. 9.
SOLOTEC CORPORATION, PITTSBURGH, PA:
2,171,569, CANC. INT. CL. 7.
SOLVAY (SOCIÉTÉ ANONYME), B-1050 BRUSSELS, BEL-
GIUM:
2,954,346, PUB. 3-1-2005. MULTIPLE CLASS, INT. CLS. 1
AND 17.
SOMANTEC GMBH, D70173 STUTTGART, FED REP GER-
MANY:
2,954,073, PUB. 6-1-2004. MULTIPLE CLASS, INT. CLS. 11
AND 20.
SOMMER SOLSTICE DESIGNS, INC., NEW YORK, NY:
2,955,555, INT. CL. 14.
SONATEX INC., BURLINGTON ONTARIO, CANADA, SO-
NATEX LAMINATING CANADA INC., STONEY CREEK,
ONTARIO, CANADA:
1,906,578, REN. 4-14-05. INT. CL. 24.
SONIC SOLUTIONS, NOVATO, CA:
2,955,932, INT. CL. 9.
SONNE, INC., WAHPETON, ND:
2,955,747, INT. CL. 29.
SONOSITE, INC., BOTHELL, WA:
2,955,570, INT. CL. 10.
SONY KABUSHIKI KAISHA, SHINAGAWA-KU, TOKYO,
JAPAN, TA SONY CORPORATION:
2,955,863, INT. CL. 9.
SONY MUSIC ENTERTAINMENT INC., NEW YORK, NY
TO SONY MUSIC ENTERTAINMENT INC., NEW YORK,
NY:
1,843,475, CANC. INT. CL. 9.
SOS ARANA ALIMENTACION, S.A., 46680 ALGEMESI
(VALENCIA), SPAIN:
2,171,028, CANC. INT. CL. 30.
SOUND SCENERIES CORPORATION, REPENTIGNY, CA-
NADA:
2,954,770, PUB. 9-28-2004. INT. CL. 9.
SOUNDLINE, LLC, RANDOLPH, NJ:
2,954,318, PUB. 3-1-2005. MULTIPLE CLASS, INT. CLS. 9,
16, 35 AND 41.
SOURCE DIRECT, INC., IDAHO FALLS, ID:
2,956,248, INT. CL. 3.
SOUTH CAROLINA RESEARCH AUTHORITY, N. CHAR-
LESTON, SC:
2,171,142, CANC. INT. CL. 9.
SOUTH DAKOTA STATE UNIVERSITY, BROOKINGS, SD:
2,954,940, PUB. 3-1-2005. INT. CL. 41.
SOUTHCORP BRANDS PTY LIMITED, ARTARMON, NSW
2064, AUSTRALIA:
1,862,694, AM. INT. CL. 33.
SOUTHEASTERN DEVELOPMENT, INC., LOUISVILLE,
KY:
2,954,512, PUB. 3-1-2005. INT. CL. 8.
SOUTHERN SMOKE LLC, ATLANTA, GA:
2,955,492, INT. CL. 34.
SOUTHERN STRATEGY GROUP, INC., TALLAHASSEE,
FL:
2,956,215, INT. CL. 35.
SOUTHSTAR ENERGY SERVICES LLC, ATLANTA, GA,
DBA GEORGIA NATURAL GAS AND GEORGIA NAT-
URAL GAS SERVICES:
2,954,575, PUB. 3-1-2005. INT. CL. 16.
SOUTHTEC, INC., FAIRHOPE, AL:
2,171,217, CANC. INT. CL. 25.
SOUTHWEST FEED PRODUCT, INC., JULESBURG, CO:
1,842,583, CANC. INT. CL. 1.
SOUTHWIRE COMPANY, CARROLLTON, GA:
2,955,124, PUB. 3-1-2005. INT. CL. 9.
SOVEREIGN CHEMICAL COMPANY, AKRON, OH:
2,170,941, CANC. INT. CL. 1.
SOWELU ENTERTAINMENT, LTD., SANTA MONICA, CA:
2,956,100, INT. CL. 9.

- SOY BASICS, LLC, NEW HAMPTON, IA:
2,955,802, INT. CL. 4.
- SOYA SYSTEM, INC., CLAYTON, MO:
1,322,858, REN. 4-9-05, INT. CL. 3.
- SPA FINDER, INC, NEW YORK, NY:
2,955,947, INT. CL. 16.
- SPAGNOL'S WINE & BEER MAKING SUPPLIES LTD.,
NIAGARA FALLS, ONTARIO, CANADA:
2,955,716, INT. CL. 33.
- SPARKLE INTERNATIONAL, INC., BEDFORD HEIGHTS,
OH:
1,888,156, REN. 4-11-05, INT. CL. 3.
- SPATIAL DATA ANALYTICS CORPORATION, MCLEAN,
VA:
2,954,470, PUB. 3-1-2005, INT. CL. 42.
- SPEC CERAMICS, INC., ANAHEIM, CA:
2,955,013, PUB. 3-1-2005, INT. CL. 19.
2,955,018, PUB. 3-1-2005, INT. CL. 19.
- SPECIALIZED BICYCLE COMPONENTS, INC., CONCORD,
CA:
2,955,025, PUB. 3-1-2005, INT. CL. 12.
- SPECIALIZED BICYCLE COMPONENTS, INC., MORGAN
HILL, CA:
2,955,370, INT. CL. 12.
- SPECTRUM MEDICAL INDUSTRIES, INC., LOS ANGELES,
CA:
1,284,107, CANC. INT. CL. 9.
- SPEED SNAP AUSTRALIA PTY LIMITED, MANLY, NEW
SOUTH WALES, 2095, AUSTRALIA:
2,170,673, CANC. INT. CL. 26.
- SPEEDPLAY, INC., SAN DIEGO, CA:
2,954,336, PUB. 3-1-2005, INT. CL. 12.
- SPEEDWAY MOTORS, INC., LINCOLN, NE:
2,956,272, INT. CL. 41.
- SPEEDWAY SUPERAMERICA LLC, ENON, OH:
2,955,490, INT. CL. 35.
- SPELLING ENTERTAINMENT INC., LOS ANGELES, CA:
2,171,853, CANC. INT. CL. 41.
- SPENCE, KENT D., KIMBERLING CITY, MO:
2,956,213, INT. CL. 36.
- SPICE ENTERTAINMENT, INC., CHICAGO, IL:
2,954,223, PUB. 3-1-2005, INT. CL. 41.
- SPIESS-URANIA CHEMICALS GMBH, G-20097 HAMBURG,
FED REP GERMANY:
2,954,084, PUB. 10-26-2004, MULTIPLE CLASS, INT. CLS.
1, 2, 3, 4, 5, 16, 17, 35, 37, 38, 39, 40, 41 AND 42.
- SPIN MASTER LTD, TORONTO, ONTARIO M5V 1B6,
CANADA:
2,955,371, INT. CL. 28.
- SPIRIG; DIPL. ING. ERNEST, RAPPERSWIL, SWITZER-
LAND:
1,284,178, REN. 4-9-05, INT. CL. 9.
- SPLASHES INC., NORWALK, CT:
2,955,465, INT. CL. 5.
- SPLENDID SALMON CORP., GLOUCESTER, MA:
2,172,013, CANC. INT. CL. 29.
- SPM TECHNOLOGIES DEUTSCHLAND GMBH, BERLIN,
FED REP GERMANY:
2,954,614, PUB. 12-30-2003, MULTIPLE CLASS, INT. CLS.
9, 35, 36, 38 AND 42.
- SPORTING GOODS MANUFACTURERS ASSOCIATION,
INC., NORTH PALM BEACH, FL:
1,942,363, REN. 4-15-05, INT. CL. 41.
- SPORTS COACHING ACADEMY, LLC, KIRKLAND, WA:
2,955,892, INT. CL. 41.
- SPORTS PICK INTERNATIONAL HOLDINGS, INC.,
BRIDGETOWN, BARBADOS:
2,955,824, MULTIPLE CLASS, INT. CLS. 35 AND 41.
- SPORTS, INC., PORTLAND, OR TO VENATOR GROUP
RETAIL, INC, NEW YORK, NY:
1,843,380, CANC. MULTIPLE CLASS, INT. CLS. 18 AND
25.
- SPORTS, INC., PORTLAND, OR TO VENATOR GROUP
RETAIL, INC., NEW YORK, NY:
1,843,386, CANC. MULTIPLE CLASS, INT. CLS. 18 AND
25.
- SPORTSPRAY EQUIPMENT, INC., ST. LOUIS, MO:
2,954,635, PUB. 3-1-2005, INT. CL. 28.
- SPRAYING SYSTEMS COMPANY, WHEATON, IL:
2,955,060, PUB. 3-1-2005, INT. CL. 7.
2,955,069, PUB. 3-1-2005, INT. CL. 7.
- SPRINGBOARD ORTHOPAEDICS LLC, MT. STERLING,
KY:
2,954,699, PUB. 3-1-2005, INT. CL. 10.
- SPRINGS INDUSTRIES, INC., FORT MILL, SC:
2,171,509, CANC. MULTIPLE CLASS, INT. CLS. 21, 24
AND 27.
- SPS TECHNOLOGIES, INC., NEWTOWN, PA:
1,284,138, CANC. INT. CL. 9.
- SPX CORPORATION, CHARLOTTE, NC:
2,171,523, CANC. MULTIPLE CLASS, INT. CLS. 6, 7, 9, 11,
17 AND 19.
- SPYKER CARS N.V., 3899 AZ ZEEWOLDE, NETHERLANDS:
2,954,060, PUB. 8-24-2004, INT. CL. 12.
- SSA ENTERPRISES, INC., DULUTH, GA:
2,955,789, INT. CL. 43.
- ST. VINCENT MEDICAL CENTER, LOS ANGELES, CA:
2,956,168, INT. CL. 44.
- STABAR ENTERPRISES, INC., FARMINGTON, CT:
2,171,371, CANC. INT. CL. 5.
- STANDARD TEXTILE CO., INC., CINCINNATI, OH:
2,954,410, PUB. 3-1-2005, INT. CL. 10.
- STAR MICRONICS AMERICA, INC., EDISON, NJ:
1,842,743, CANC. INT. CL. 9.
- STAR STRUCK, INC., BETHEL, CT:
2,955,023, PUB. 3-1-2005, MULTIPLE CLASS, INT. CLS. 16
AND 35.
- STARBUCKS U.S. BRANDS, LLC, MINDEN, NV:
2,171,956, CANC. INT. CL. 30.
- STARFIRE MEDICAL, INC., MAPLE GROVE, MN:
2,192,712, CANC. INT. CL. 10.
- STARKIE, MICHAEL CHARLES, MORRISTOWN, NJ:
2,955,721, MULTIPLE CLASS, INT. CLS. 41 AND 42.
- STARMARK HOLDINGS, LLC, DENVER, CO:
2,955,040, PUB. 3-1-2005, INT. CL. 41.
- STASZEL, MICHAEL, LAUDERDALE BY THE SEA, FL
AND OTWINOWSKA-STASZEL, KATARZYNA, LAU-
DERDALE BY THE SEA, FL:
2,955,825, INT. CL. 35.
- STATE FAIR OF TEXAS, DALLAS, TX:
1,375,156, REN. 4-15-05, INT. CL. 41.
- STATE OF OREGON ACTING BY AND THROUGH THE
STATE BOARD OF HIGHER EDUCATION ON BEHALF
OF OREGON STATE UNIVERSITY, CORVALLIS, OR:
2,955,249, INT. CL. 16.
- STE MAISON A. TESSERON, 16120 CHATTEAUNEUF SUR
CHARENTE, FRANCE:
2,902,797, COR. INT. CL. 33.
- STEIN, MARK, LOUISVILLE, KY:
1,843,323, CANC. INT. CL. 42.
- STELLAR BAY SHELLFISH LTD., BOWSER, BRITISH
COLUMBIA, CANADA:
2,955,807, INT. CL. 29.
- STEPHEN L. LAFRANCE HOLDINGS, INC., PINE BLUFF,
AR:
2,077,250, CANC. MULTIPLE CLASS, INT. CLS. 3 AND 5.
- STERLING DRUG INC., NEW YORK, NY:
772,698, CANC. U.S. CL. 18.
- STERLING METS, L.P., FLUSHING, NY:
2,955,239, INT. CL. 28.
- STERLING METS, L.P., FLUSHING, NY FROM STERLING
DOUBLEDAY ENTERPRISES, L.P., FLUSHING, NY:
2,955,240, INT. CL. 25.
- STICKY FOODS, L.L.C., HACKETTSTOWN, NJ:
2,955,946, INT. CL. 30.
- STILLWATER DESIGNS & AUDIO, INC., STILLWATER,
OK:
1,907,120, REN. 4-14-05, INT. CL. 9.
- STILLWATER MOTOR COMPANY, STILLWATER, MN:
1,902,614, REN. 4-12-05, INT. CL. 12.
- STOCHASTICS FINANCIAL SOFTWARE SA, PARIS,
FRANCE:
2,956,364, MULTIPLE CLASS, INT. CLS. 9 AND 36.
- STOLLER WHOLESALE WINES & SPIRITS, INC., FRANK-
LIN PARK, IL, DBA MARSALLE COMPANY:
2,955,468, INT. CL. 33.

STONE MOUNTAIN CARPET MILLS, INC., EARTH CITY, MO:
2,955,560, INT. CL. 35.

STONER ASSOCIATES, INC., CARLISLE, PA:
1,284,708, CANC. INT. CL. 42.

STONIER, ANTHONY, NEW YORK, NY:
2,955,893, INT. CL. 41.

STOUT TOOL CORP., WIXOM, MI:
2,954,837, PUB. 3-1-2005. INT. CL. 7.

STRAIGHT, CHRISTIAN, PALO ALTO, CA:
2,171,943, CANC. INT. CL. 14.

STRATAMED, LLC, CHARLOTTE, NC:
2,954,566, PUB. 3-1-2005. INT. CL. 35.

STRATHMORE PARTNERS LP, CONCORD, NH:
2,954,499, PUB. 3-1-2005. INT. CL. 35.

STRATO TRADING GROUP, INC., NEW YORK, NY:
2,955,470, INT. CL. 33.

STRATTON CORPORATION, STRATTON MOUNTAIN, VT:
2,955,573, INT. CL. 25.

STREETSMART STRATEGIES, INC., CHICAGO, IL:
2,955,365, INT. CL. 35.

STRUCTURAL GROUP, INC., HANOVER, MD:
2,955,361, INT. CL. 19.

STUDIO MODERNA SA, LUGANO, SWITZERLAND:
2,954,628, PUB. 12-16-2003. MULTIPLE CLASS, INT. CLS. 24 AND 25.

SUCCESSFUL MONEY MANAGEMENT SEMINARS, INC., PORTLAND, OR:
2,171,603, CANC. MULTIPLE CLASS, INT. CLS. 16 AND 41.

SUEHIRO SEIKO KABUSHIKI KAISHA, MIKI CITY, HYOGO PREFECTURE, JAPAN, DBA SUEHIRO SEIKO CO., LTD.:
1,284,082, CANC. INT. CL. 7.

SUGAR CREEK PACKING CO., LOVELAND, OH:
1,878,759, REN. 4-14-05. INT. CL. 29.

SUHM, RICHARD R., AVON LAKE, OH:
1,881,992, REN. 4-12-05. INT. CL. 9.

SUKAN INVESTMENTS, INC., NORTH LITTLE ROCK, AR:
2,954,838, PUB. 3-1-2005. INT. CL. 43.

SUKOTAI CORPORATION, ROSWELL, GA:
2,956,251, INT. CL. 41.

SUKUP MANUFACTURING COMPANY, SHEFFIELD, IA:
1,873,604, REN. 4-13-05. INT. CL. 7.

SULKA TRADING LTD., TORTOLA, BR. VIRGIN ISLANDS:
2,172,027, CANC. MULTIPLE CLASS, INT. CLS. 14, 18, 24, 25, 37 AND 42.

SUMITOMO CHEMICAL CO., LTD., CHUO-KU, OSAKA, JAPAN:
2,954,405, PUB. 3-1-2005. INT. CL. 5.
2,954,406, PUB. 3-1-2005. INT. CL. 5.

SUMMIT FOUNDATION, REDWOOD CITY, CA:
1,284,283, CANC. INT. CL. 16.

SUN 'N FUN FLY-IN, INC., LAKELAND, FL:
2,955,913, MULTIPLE CLASS, INT. CLS. 14, 16, 25, 26 AND 41.

SUN CHEMICAL CORPORATION, FORT LEE, NJ:
2,171,346, CANC. INT. CL. 2.

SUN CHEMICAL CORPORATION, PARSIPPANY, NJ:
2,955,388, INT. CL. 9.

SUN DRILLING PRODUCTS CORPORATION, BELLE CHASSE, LA:
2,954,877, PUB. 3-1-2005. INT. CL. 4.
2,954,878, PUB. 3-1-2005. INT. CL. 4.
2,954,879, PUB. 3-1-2005. INT. CL. 4.

SUN ON INTERNATIONAL, LLC, NEW YORK, NY:
2,955,773, INT. CL. 25.

SUN TECH DEVELOPMENT, L.L.C., SCOTTSDALE, AZ:
2,955,228, INT. CL. 37.

SUN-RYPE PRODUCTS LTD., KELOWNA, BRITISH COLUMBIA, CANADA:
2,214,890, CANC. INT. CL. 30.

SUN, LIANCHAO, ACTON, MA:
2,956,286, INT. CL. 9.

SUNBEAM PRODUCTS, INC., FT. LAUDERDALE, FL:
2,170,708, CANC. INT. CL. 3.

SUNBELT CORPORATION, ROCK HILL, SC:
2,955,390, INT. CL. 2.

SUNCOAST ROOFERS SUPPLY, INC., TAMPA, FL:
2,956,026, INT. CL. 35.

SUNFED PRODUCE, INC., RIO RICO, AZ:
2,956,019, INT. CL. 31.

SUNHEALTH SOLUTIONS, LLC, NAPLES, FL:
2,955,138, PUB. 3-1-2005. INT. CL. 10.

SUNLAND PACKING HOUSE COMPANY, PORTERVILLE, CA:
186,288, CANC. U.S. CL. 46.

SUNLIGHT FOODS, INC., SAN LEANDRO, CA:
1,284,507, CANC. INT. CL. 30.

SUNNY BROOK FARMS, INC., HEBRON, KY:
2,954,375, PUB. 3-1-2005. INT. CL. 30.

SUNRIDER CORPORATION, THE, TORRANCE, CA, DBA SUNRIDER, INTERNATIONAL:
1,880,343, REN. 4-13-05. MULTIPLE CLASS, INT. CLS. 5 AND 29.

SUNRISE MEDICAL HHG INC., LONGMONT, CO, DEVIL-BISS HEALTH CARE, INC., SOMERSET, PA:
1,900,945, REN. 4-14-05. INT. CL. 41.

SUNSHINEMLS, LLC, NAPLES, FL:
2,954,212, PUB. 9-21-2004. MULTIPLE CLASS, INT. CLS. 36 AND 41.

SUPER MARKETING ASSOCIATES, LENEXA, KS:
1,843,753, CANC. INT. CL. 28.

SUPER SAGLESS CORPORATION, TUPELO, MS TO L & P PROPERTY MANAGEMENT COMPANY, CHICAGO, IL:
1,843,665, CANC. INT. CL. 20.

SUPREME COUNCIL OF THE ROYAL ARCANUM, BOSTON, MA, DBA ROYAL ARCANUM:
796,922, REN. 4-15-05. U.S. CL. 102 (INT. CL. 36).

SUPREME GRAND LODGE OF THE ANCIENT AND MYSTICAL ORDER ROSAE CRUCIS, THE, SAN JOSE, CA:
1,876,607, REN. 4-11-05. MULTIPLE CLASS, INT. CLS. 16, 41 AND 42.

SUPREME INTERNATIONAL, MIAMI, FL:
2,171,035, CANC. INT. CL. 25.

SUPREME OIL COMPANY, ENGLEWOOD, NJ:
2,955,125, PUB. 3-1-2005. INT. CL. 29.

SURFACE SCIENCES, INC., CHICAGO, IL:
2,955,243, MULTIPLE CLASS, INT. CLS. 4 AND 37.

SURVIVAL NETWORK, INC., VILLANOVA, PA:
2,171,249, CANC. INT. CL. 42.

SUTHERLAND, WILLIAM T, EDEN PRAIRIE, MN:
2,955,988, INT. CL. 42.

SUTTER HOME WINERY, INC., ST. HELENA, CA:
2,954,843, PUB. 3-1-2005. INT. CL. 33.

SUTTON CREATIONS, INC., NEW YORK, NY:
2,171,927, CANC. INT. CL. 25.

SVENDSEN, MARK G., SANTA BARBARA, CA:
2,171,876, CANC. INT. CL. 12.

SWANSON HEALTH PRODUCTS, INCORPORATED, FARGO, ND:
2,954,587, PUB. 3-1-2005. INT. CL. 5.

SWEET COCESSIONS, INC., NEW YORK, NY:
2,955,115, PUB. 3-1-2005. INT. CL. 35.

SWEET, SHELLEY, SAN FRANCISCO, CA, DBA A+ COMPUTER SCHOOL:
2,171,128, CANC. MULTIPLE CLASS, INT. CLS. 41 AND 42.

SWEETWATER HOSIERY MILLS, INC., SWEETWATER, TN:
1,026,446, CANC. U.S. CL. 39.

SWIFT BRANDS COMPANY (, GREELEY, CO, ARMOUR AND COMPANY, CHICAGO, IL:
802,352, REN. 4-13-05. U.S. CL. 46 (INT. CL. 29).

SWX SWISS EXCHANGE, SWITZERLAND:
2,955,169, PUB. 3-1-2005. MULTIPLE CLASS, INT. CLS. 9, 16, 35, 36, 41 AND 42.

SYNBIOTICS CORPORATION, SAN DIEGO, CA:
2,954,910, PUB. 10-5-2004. INT. CL. 9.

SYNDICATE SALES, INC., KOKOMO, IN:
1,284,371, CANC. INT. CL. 21.

SYNETICS, INC., CAMBRIDGE, MA:
1,911,893, REN. 4-12-05. INT. CL. 41.

- SYNERGISTIC SOFTWARE SYSTEMS, INC., NEPTUNE BEACH, FL:
2,955,076, PUB. 3-1-2005. INT. CL. 9.
- SYNERGY COMPUTING BUSINESS GROUP, INC., LAGUNA HILLS, CA:
2,954,955, PUB. 3-1-2005. INT. CL. 35.
- SYNOPSIS, INC., MOUNTAIN VIEW, CA:
1,843,339, CANC. INT. CL. 42.
- SYNQUEST LABORATORIES, INC., ALACHUA, FL:
2,171,356, CANC. INT. CL. 1.
- SYSTEM SCHULTHEIS AG, RAPPERSWIL, SWITZERLAND:
2,955,481, MULTIPLE CLASS, INT. CLS. 6 AND 20.
- SYSTEMS ASSOCIATES, INC., CHARLOTTE, NC:
1,284,549, CANC. MULTIPLE CLASS, INT. CLS. 35 AND 41.
- T-MOBILE USA, INC., BELLEVUE, WA:
2,954,676, PUB. 7-6-2004. INT. CL. 38.
- TAAS-ISRAEL INDUSTRIES LTD., RAMAT HASHARON 47100, ISRAEL:
2,170,634, CANC. INT. CL. 13.
- TAB-AUSTRIA INDUSTRIE- UND UNTERHALTUNGSELEKTRONIK GMBH & CO. KG, A-4052 ANSFELDEN, AUSTRIA:
2,955,968, INT. CL. 28.
- TACO BELL CORP., IRVINE, CA, TACO BELL, IRVINE, CA:
1,322,739, REN. 4-13-05. INT. CL. 42.
- TACTIX LLC, MILL VALLEY, CA:
2,955,798, INT. CL. 35.
- TADAA TECHNOLOGIES, INC., NEW BALTIMORE, MI:
2,956,268, INT. CL. 9.
- TAFCO EQUIPMENT CO., INC., BLUE EARTH, MN:
2,954,353, PUB. 3-1-2005. MULTIPLE CLASS, INT. CLS. 7 AND 12.
- TAMARA TECHNOLOGIES, INC., OCOEE, FL:
2,956,044, INT. CL. 9.
- TAMPA MAID FOODS, INC., LAKELAND, FL:
2,171,668, CANC. INT. CL. 29.
- TAN, HOWARD H. S., LAS VEGAS, NV:
2,956,267, INT. CL. 14.
- TANANBAUM, AMY JUDITH, BELMONT, MA:
2,171,132, CANC. INT. CL. 41.
- TANG, BRIAN, MOUNTAIN VIEW, CA:
2,954,986, PUB. 3-1-2005. INT. CL. 10.
- TANGS DEPARTMENT LIMITED, CENTRAL, HONG KONG:
2,954,945, PUB. 12-28-2004. MULTIPLE CLASS, INT. CLS. 16, 20, 21, 24, 25 AND 28.
- TANKE, WILLIAM B., WALNUT, CA:
2,954,483, PUB. 3-1-2005. MULTIPLE CLASS, INT. CLS. 3 AND 5.
2,954,595, PUB. 3-1-2005. INT. CL. 3.
- TANNER COMPANIES, LLC, RUTHERFORDTON, NC:
2,955,223, INT. CL. 25.
- TANU U.S.A., INC., NEW YORK, NY:
2,954,911, PUB. 10-19-2004. INT. CL. 25.
- TARA TOY CORP., HAUPPAUGE, NY:
1,843,788, CANC. INT. CL. 28.
- TARALAN CORPORATION, BUFFALO, MN:
2,955,148, PUB. 3-1-2005. INT. CL. 44.
- TARANTINO, JOSEPH V., CARMEL, CA, DBA TARANTINO'S CANNED FOODS, TARANTINO, FRANK, CARMEL, CA, DBA TARANTINO'S CANNED FOODS:
1,925,614, REN. 4-12-05. INT. CL. 29.
- TARGET BRANDS, INC., MINNEAPOLIS, MN:
1,340,989, REN. 4-11-05. INT. CL. 25.
2,954,200, PUB. 3-1-2005. MULTIPLE CLASS, INT. CLS. 29, 30 AND 32.
- TARO PHARMACEUTICALS NORTH AMERICA, INC., GRAND CAYMAN, CAYMAN ISLANDS:
2,955,564, INT. CL. 5.
- TARRE, FRANCISCO GUILLERMO MENDOZA, JALISCO, MEXICO:
2,954,196, PUB. 7-27-2004. INT. CL. 33.
- TASTY BAKE, INC., BAKER, OR:
1,353,117, REN. 4-10-05. INT. CL. 30.
- TATAMI SCHUH GMBH, 53604 BAD HONNEF, FED REP GERMANY:
2,954,161, PUB. 6-8-2004. MULTIPLE CLASS, INT. CLS. 10, 18 AND 25.
- TATUNG COMPANY, TAIPEI, TAIWAN:
1,321,881, REN. 4-14-05. MULTIPLE CLASS, INT. CLS. 9 AND 11.
- TAVERNTOOLS, JUNEAU, AK:
2,956,032, INT. CL. 21.
- TAYLOR GIFTS, INC., PAOLI, PA:
2,105,410, CANC. INT. CL. 35.
- TAYLOR NELSON SOFRES PLC, LONDON, UNITED KINGDOM:
2,955,928, MULTIPLE CLASS, INT. CLS. 9 AND 35.
- TAZMO CO., LTD., OKAYAMA, JAPAN:
2,954,644, PUB. 10-26-2004. MULTIPLE CLASS, INT. CLS. 7, 9 AND 42.
- TCC ACQUISITION CORP., PLEASANTON, CA, SODERBERG OPHTHALMIC SERVICES, INC., ST. PAUL, MN:
1,587,551, REN. 4-9-05. INT. CL. 9.
- TCC ACQUISITION CORP., PLEASANTON, CA, O.S.I. CORPORATION, SOUTH SAN FRANCISCO, CA:
1,794,207, REN. 4-15-05. INT. CL. 9.
- TCC, LLC, BIRMINGHAM, AL:
2,954,839, PUB. 3-1-2005. INT. CL. 35.
- TCHOLAKOV, MIROSLAV, IVANOV, CLOVERDALE, CA:
2,955,577, INT. CL. 33.
- TECH-ENERGY CO., CIBOLO, TX:
1,848,723, REN. 4-12-05. INT. CL. 37.
- TECHNICAL RESEARCH CENTRE OF FINLAND, 02044 VTT, FINLAND:
2,954,089, PUB. 3-1-2005. MULTIPLE CLASS, INT. CLS. 9, 16, 35, 41 AND 42.
- TECHNOCOM CORPORATION, WOODLAND HILLS, CA:
2,171,089, CANC. MULTIPLE CLASS, INT. CLS. 35 AND 42.
- TECHNOLOGY DEVELOPMENT SUPPORTING COMPANY, HANOI, VIETNAM, DBA DETECH CO.:
2,954,136, PUB. 5-11-2004. INT. CL. 12.
- TECRA INTERNATIONAL PTY LTD, NEW SOUTH WALES, AUSTRALIA:
2,955,554, INT. CL. 9.
- TEE-PEE CLEANERS INC., WALL, NJ:
2,171,009, CANC. INT. CL. 37.
- TEEN SKI ADVENTURES LTD., FAIRFAX, VA:
2,171,108, CANC. INT. CL. 39.
- TEETZEL, JAMES W., YORK, ME:
1,882,921, REN. 4-15-05. INT. CL. 13.
- TEIJIN KABUSHIKI KAISHA (TEIJIN LIMITED), CHUOKU, OSAKA 541-8574, JAPAN AND NISSAN JIDOSHA KABUSHIKI KAISHA, KANAGAWA-KEN, JAPAN, TA NISSAN MOTOR CO., LTD. AND TANAKA KINKINZOKU KOGYO K.K., TOKYO, 103-8206, JAPAN:
2,954,187, PUB. 3-1-2005. INT. CL. 2.
- TEKGRAF CORPORATION, GREENVILLE, SC:
2,954,051, PUB. 3-1-2005. INT. CL. 35.
- TELCO COMMUNICATIONS GROUP, INC., CHANTILLY, VA:
2,170,716, CANC. INT. CL. 38.
2,170,717, CANC. INT. CL. 38.
- TELE-COMMUNICATIONS, INC., DENVER, CO:
1,284,623, CANC. INT. CL. 38.
- TELEFLORA LLC, LOS ANGELES, CA, TELEFLORA INC., LOS ANGELES, CA:
1,319,801, REN. 4-15-05. INT. CL. 35.
- TELEPARRANDA #6 COMMUNICATIONS CORP., KEW GARDENS, NY:
2,171,173, CANC. MULTIPLE CLASS, INT. CLS. 16 AND 36.
- TELEPRAISAL, INC., ROSLYN, NY:
1,284,572, CANC. INT. CL. 36.
- TELLURIDE CLOTHING CO., INC., NATICK, MA:
1,284,413, CANC. INT. CL. 25.
2,171,577, CANC. INT. CL. 25.
- TENNESSEE EDUCATION LOTTERY CORPORATION, NASHVILLE, TN:
2,954,330, PUB. 3-1-2005. MULTIPLE CLASS, INT. CLS. 25 AND 28.

- TENUTA DI CASTELGIOCONDO SOCIETA AGRICOLA S.P.A., MONTALCINO (SIENA), ITALY, AI CASELLI S.R.L., SIENA, ITALY:
1,883,854. REN. 4-13-05. INT. CL. 33.
- TEQUILA TAPATIO, S.A., ARANDAS, JAILSCO, MEXICO:
2,955,336. INT. CL. 33.
- TERRA COTTAGE INC., MEMPHIS, TN:
2,171,996. CANC. INT. CL. 21.
- TERRY DILL CUSTOM CLUB SHAFTING, INC., SAN ANTONIO, TX:
2,171,172. CANC. INT. CL. 28.
- TEST RITE PRODUCTS CORPORATION, CLIFTON, NJ:
1,284,069. CANC. MULTIPLE CLASS, INT. CLS. 7, 8, 12 AND 21.
- TEVA PHARMACEUTICAL INDUSTRIES LTD., JERUSALEM 91010, ISRAEL:
2,954,650. PUB. 3-1-2005. INT. CL. 5.
- TEWARI DE-OX SYSTEMS, INC., SAN ANTONIO, TX AND TEWARI, GAURAV, SAN ANTONIO, TX:
2,954,963. PUB. 3-1-2005. INT. CL. 16.
- TEXAS DAIRY QUEEN OPERATORS COUNCIL, DALLAS, TX:
1,284,777. CANC. INT. CL. 42.
- TEXAS INSTRUMENTS INCORPORATED, DALLAS, TX:
2,171,552. CANC. INT. CL. 41.
- TEXTILE INC., TORTOLA BRTHISH, BR.VIRGIN ISLANDS:
2,171,482. CANC. INT. CL. 25.
- THALES, SOCIÉTÉ ANONYME, PARIS, FRANCE:
2,954,679. PUB. 10-19-2004. INT. CL. 9.
- THE AGENCY GROUP LIMITED, LONDON, UNITED KINGDOM:
2,954,772. PUB. 3-1-2005. INT. CL. 35.
- THE AUTOMATION PARTNERSHIP (CAMBRIDGE) LIMITED, HERTFORDSHIRE, ENGLAND:
2,954,710. PUB. 9-14-2004. INT. CL. 9.
- THE BEAR STEARNS COMPANIES INC., NEW YORK, NY:
2,954,471. PUB. 3-1-2005. INT. CL. 36.
- THE BERGQUIST COMPANY, CHANHASSEN, MN:
2,955,730. INT. CL. 9.
- THE BETTIS CORPORATION, WALLER, TX:
2,954,627. PUB. 8-3-2004. INT. CL. 9.
- THE BLONDER COMPANY, CLEVELAND, OH:
2,955,346. MULTIPLE CLASS, INT. CLS. 9, 11, 20, 21, 24 AND 27.
- THE BOEING COMPANY, SEATTLE, WA:
1,843,649. CANC. INT. CL. 18.
- THE CHUBB CORPORATION, WARREN, NJ:
2,955,113. PUB. 3-1-2005. INT. CL. 36.
2,955,114. PUB. 3-1-2005. INT. CL. 36.
- THE COASTAL BANK, SAVANNAH, GA:
2,955,149. PUB. 3-1-2005. INT. CL. 36.
- THE COCA-COLA COMPANY, ATLANTA, GA:
2,955,467. INT. CL. 32.
- THE COLEMAN COMPANY, INC., WICHITA, KS:
2,956,037. INT. CL. 9.
- THE COLUMBIA HOUSE COMPANY, NEW YORK, NY:
2,954,711. PUB. 3-1-2005. INT. CL. 35.
- THE COMFORTCAKE COMPANY, CHICAGO, IL:
2,956,216. INT. CL. 30.
- THE COMMON APPLICATION, INC., RESTON, VA:
2,955,878. INT. CL. 41.
- THE COSMETIC, TOILETRY, AND FRAGRANCE ASSOCIATION FOUNDATION, WASHINGTON, DC:
2,955,590. INT. CL. 41.
- THE DALLAS CONVENTION & VISITORS BUREAU, DALLAS, TX:
2,954,563. PUB. 3-1-2005. INT. CL. 35.
- THE DREAM MERCHANT COMPANY KFT., DOHANY UTCA 12, 2ND FLOOR, HUNGARY, CREATIONS MEANDRES INC., MONTREAL, QUEBEC, CANADA:
1,885,062. REN. 4-15-05. INT. CL. 25.
- THE DREAM MERCHANT COMPANY KFT., DUHANY UTCA 12, 2ND FLOOR, HUNGARY, CREATIONS MEANDRES INC., MONTREAL, QUEBEC, CANADA:
1,885,095. REN. 4-15-05. INT. CL. 28.
- THE DREAM MERCHANT COMPANY KFT., DOHANY UTCA 12, 12TH FLOOR, HUNGARY, CREATIONS MEANDRES INC., MONTREAL, QUEBEC H2L 2R3, CANADA:
1,885,382. REN. 4-15-05. INT. CL. 41.
- THE EDIBLE SCHOOLYARD, BERKELEY, CA:
2,955,079. PUB. 3-1-2005. INT. CL. 41.
- THE EXTENDIT COMPANY, YOUNGSTOWN, OH:
786,279. REN. 4-10-05. U.S. CL. 12 (INT. CL. 19).
- THE GATES CORPORATION, DENVER, CO:
2,955,645. INT. CL. 7.
- THE GCRH CORPORATION, MIDLAND, MI:
2,954,344. PUB. 3-1-2005. INT. CL. 42.
- THE GRAND LODGE RETIREMENT COMMUNITY, INC., DES MOINES, IA:
2,954,931. PUB. 3-1-2005. INT. CL. 43.
- THE HCP GROUP, LTD., SKIPPACK, PA:
2,956,000. INT. CL. 41.
- THE HESS COLLECTION WINERY, NAPA, CA:
2,954,454. PUB. 3-1-2005. INT. CL. 33.
- THE JOFFREY BALLET OF CHICAGO, INC., CHICAGO, IL:
2,954,504. PUB. 3-1-2005. INT. CL. 41.
- THE KENNA GROUP, LLC, DALY CITY, CA:
2,955,690. MULTIPLE CLASS, INT. CLS. 35 AND 36.
- THE KROGER CO. OF MICHIGAN, CINCINNATI, OH:
2,954,919. PUB. 10-26-2004. INT. CL. 29.
- THE L.S. STARRETT COMPANY, ATHOL, MA:
2,956,218. MULTIPLE CLASS, INT. CLS. 7 AND 8.
- THE LAREDO NATIONAL BANK, LAREDO, TX:
2,954,540. PUB. 3-1-2005. INT. CL. 36.
- THE MAGNUSON COMPANY LLC, SPOKANE, WA:
2,956,043. MULTIPLE CLASS, INT. CLS. 35 AND 43.
- THE MAY DEPARTMENT STORES COMPANY, ST. LOUIS, MO:
1,284,418. CANC. INT. CL. 25.
- THE NEW YORK TIMES COMPANY, NEW YORK, NY:
2,954,432. PUB. 3-1-2005. MULTIPLE CLASS, INT. CLS. 16 AND 41.
2,955,140. PUB. 3-1-2005. INT. CL. 16.
- THE NORTH FACE APPAREL CORP., WILMINGTON, DE:
1,283,449. NEW CERT. 5-24-2005. INT. CL. 25.
- THE OKLAHOMA PUBLISHING COMPANY, OKLAHOMA CITY, OK:
2,954,538. PUB. 3-1-2005. INT. CL. 41.
- THE OPEN ENVELOPE, LLC, GREENVILLE, SC:
2,954,245. PUB. 3-1-2005. INT. CL. 35.
- THE PUTMAN GROUP, INCORPORATED, SHERIDAN, WY:
2,955,012. PUB. 3-1-2005. INT. CL. 9.
- THE SIMMONS FIRM, APC, SAN DIEGO, CA:
2,956,348. INT. CL. 42.
2,956,349. INT. CL. 42.
- THE SPORTS SECTION, INC., SUWANEE, GA:
2,954,343. PUB. 7-27-2004. MULTIPLE CLASS, INT. CLS. 16 AND 41.
- THE ST. LOUIS TRUST COMPANY, ST. LOUIS, MO:
2,954,780. PUB. 3-1-2005. MULTIPLE CLASS, INT. CLS. 35 AND 36.
- THE TICKET RESERVE, INC., CHICAGO, IL:
2,954,186. PUB. 3-1-2005. INT. CL. 36.
- THE TRUSTEE OF THE WILLIAM A. ROSTINE REVOCABLE TRUST UNDER AGREEMENT DATED NOVEMBER 9, 2001, SPRINGFIELD, MO:
2,954,487. PUB. 3-1-2005. INT. CL. 1.
- THE TRUSTEES OF FOREMOST LABS, COMPRISING LAWRENCE M. LOGSDON AND NORMA JO LOGSDON BOTH U.S. CITIZEN, LAGUNA NIGUEL, CA:
2,954,495. PUB. 3-1-2005. INT. CL. 5.
- THE TRUSTEES OF THE ROBERT L. O'BLOCK REVOCABLE TRUST, SPRINGFIELD, MO:
2,956,236. INT. CL. 42.
- THE UNIVERSITY OF HARTFORD, WEST HARTFORD, CT:
2,954,416. PUB. 3-1-2005. INT. CL. 41.
- THE UNIVERSITY OF NORTH CAROLINA AT CHARLOTTE, CHARLOTTE, NC:
2,955,875. INT. CL. 42.
- THE WAY TO WELLNESS, INC., NEW YORK, NY:
2,955,787. U.S. CL. B.

- THE 1031 EXCHANGE EXPERTS, LLC, GREENWOOD VILLAGE, CO:
2,956,324, INT. CL. 36.
2,956,325, INT. CL. 41.
- THEORY3, INC., ORLANDO, FL:
2,955,792, INT. CL. 11.
- THEOSABRATA, YOS S., WEST JAKARTA 11460, INDONESIA:
1,843,663, CANC. INT. CL. 20.
- THERIAULT'S, ANNAPOLIS, MD:
1,284,538, CANC. MULTIPLE CLASS, INT. CLS. 35 AND 36.
1,284,539, CANC. MULTIPLE CLASS, INT. CLS. 35 AND 36.
- THERMABOOT, STATEN ISLAND, NY:
2,954,384, PUB. 3-1-2005. INT. CL. 10.
- THERMOSPAS, INC., WALLINGFORD, CT:
2,955,833, INT. CL. 11.
- THIEN PO JEWELRY LTD., BANGKOK 10500, THAILAND:
2,171,953, CANC. INT. CL. 14.
- THIN-LITE CORPORATION, CAMARILLO, CA, REC SPECIALTIES, INC., CAMARILLO, CA:
1,331,905, REN. 4-12-05. INT. CL. 11.
- THOMAS & BETTS INTERNATIONAL, INC., WILMINGTON, DE:
1,340,699, REN. 4-13-05. INT. CL. 17.
- THOMAS & BETTS INTERNATIONAL, INC., SPARKS, NV:
1,701,494, REN. 4-9-05. INT. CL. 9.
- THOMAS & THOMAS RODMAKERS, INC., TURNER FALLS, MA:
2,955,234, INT. CL. 28.
- THOMAS COOK GROUP LIMITED, THE, LONDON W1A 1EB, UNITED KINGDOM:
2,170,715, CANC. INT. CL. 42.
- THOMAS COOK UK LIMITED, PETERBOROUGH PE3 8SB, UNITED KINGDOM:
2,954,139, PUB. 3-1-2005. MULTIPLE CLASS, INT. CLS. 16, 35, 36, 39 AND 43.
- THOMAS INDUSTRIES, INC., LOUISVILLE, KY:
2,171,515, CANC. INT. CL. 7.
- THOMAS NELSON, INC., NASHVILLE, TN:
1,843,949, CANC. INT. CL. 16.
- THOMAS, BORIS, CHICAGO, IL:
2,954,926, PUB. 3-1-2005. INT. CL. 44.
- THOMPSON, BRIGITTE A., WILLISTON, VT:
2,956,353, INT. CL. 41.
- THOMSON LICENSING CORPORATION, WILMINGTON, DE:
2,170,831, CANC. INT. CL. 36.
- THOR TECH, INC., SAGINAW, MI:
2,955,796, INT. CL. 12.
2,955,797, INT. CL. 12.
- THREE C'S DESIGN, LLC, NEW YORK, NY:
2,954,544, PUB. 3-1-2005. INT. CL. 18.
- THUNDER TIGER CORPORATION, TAICHUNG, TAIWAN:
2,954,057, PUB. 12-23-2003. INT. CL. 28.
- TIBA SOLUTIONS, LLC, GREENVILLE, SC:
2,954,293, PUB. 3-1-2005. MULTIPLE CLASS, INT. CLS. 35 AND 42.
- TICKETSAGE, INC., FAYETTEVILLE, AR:
2,954,558, PUB. 3-1-2005. INT. CL. 35.
- TIDEWATER PHYSICAL THERAPY AND REHABILITATION ASSOCIATION, P.A., EASTON, MD:
2,954,113, PUB. 3-1-2005. INT. CL. 35.
- TIERRA INTERNATIONAL, L.L.C., JASPER, IN:
2,171,627, CANC. MULTIPLE CLASS, INT. CLS. 1, 6, 8, 11, 19, 20 AND 21.
- TIM PETERS AND COMPANY, INC., PEAPACK, NJ:
1,920,870, REN. 4-15-05. INT. CL. 16.
1,922,905, REN. 4-15-05. INT. CL. 16.
1,947,320, REN. 4-15-05. INT. CL. 16.
2,956,013, INT. CL. 42.
- TIME INC., NEW YORK, NY:
2,955,755, INT. CL. 41.
- TIME MACHINE, INC., THE, LAWRENCE, KS:
1,843,626, CANC. INT. CL. 16.
- TIMMERMAN, WARREN M., SIMPSONVILLE, SC, DBA LOCKWOOD LEADERSHIP INTERNATIONAL AND BLECHA, DIANE L., SIMPSONVILLE, SC, DBA LOCKWOOD LEADERSHIP INTERNATIONAL:
2,954,302, PUB. 3-1-2005. INT. CL. 35.
- TIODIZE COMPANY, INC., HUNTINGTON BEACH, CA:
1,842,633, CANC. INT. CL. 4.
- TIRE PRESSURE CONTROL INTERNATIONAL LTD., EDMONTON, ALBERTA, CANADA:
2,954,044, PUB. 3-1-2005. INT. CL. 9.
- TIVOLI A/S, 1630 COPENHAGEN V, DENMARK:
2,954,000, PUB. 3-1-2005. INT. CL. 41.
- TM ACQUISITION CORP., LAS VEGAS, NV:
2,955,715, INT. CL. 35.
- TMC GROUP, INC., DERRY, NH:
1,488,862, CANC. INT. CL. 42.
- TMW MARKETING COMPANY, INC., FREMONT, CA:
2,956,205, INT. CL. 35.
- TOBEK, INC., ST. CHARLES, MO, DBA NEW RULE PRODUCTS, INC.:
2,171,654, CANC. INT. CL. 35.
- TODD CHRISTOPHER INTERNATIONAL, INC., OLDSMAR, FL, DBA VOGUE INTERNATIONAL, INC.:
2,954,481, PUB. 3-1-2005. INT. CL. 3.
- TODD'S SNAX, INC., HANOVER, PA, DBA SHULTZ FOODS COMPANY:
2,955,108, PUB. 3-1-2005. INT. CL. 30.
- TODDLE HOUSE RESTAURANTS, INC., MEMPHIS, TN:
1,412,710, CANC. INT. CL. 42.
- TOLL FREE YELLOW PAGES, CORP., BEVERLY HILLS, CA, AKA TOLL FREE YELLOW PAGES - 1-877-YELLOW-PAGES - TFYP - YELLOWPAGES BY TELEPHONE:
2,956,204, INT. CL. 35.
- TOME' PROFESSIONAL PRODUCTS, INC., SARATOGA, CA:
2,229,750, CANC. INT. CL. 3.
- TOMEY CORPORATION, NISHI-KU, NAGOYA-SHI, AICHIKEN, JAPAN:
1,843,555, CANC. INT. CL. 10.
- TOMMY BAHAMA GROUP, INC., NEW YORK, NY:
2,956,089, INT. CL. 25.
- TONE BROTHERS, INC., DES MOINES, IA:
772,909, CANC. U.S. CL. 46.
- TONE BROTHERS, INC., OAKLAND, CA:
1,843,095, CANC. INT. CL. 30.
- TONELERIA NACIONAL LTDA., SANTIAGO, CHILE:
2,955,524, INT. CL. 31.
- TONI & GUY (USA) LIMITED, LONDON, ENGLAND:
2,955,204, INT. CL. 21.
- TONKA CORPORATION:
1,284,437, CANC. INT. CL. 28.
- TONS CONSOLIDATORS, INC., LOS ANGELES, CA:
2,954,704, PUB. 3-1-2005. INT. CL. 39.
- TOP INNOVATIONS, INC., RIVERSIDE, MO:
2,956,253, INT. CL. 7.
- TOP SHAPE PERSONAL FITNESS, WOODLAND HILLS, CA:
2,171,139, CANC. INT. CL. 41.
- TOPCO ASSOCIATES, INC. (COOPERATIVE), SKOKIE, IL:
772,668, CANC. U.S. CL. 14.
- TOPTIER SOFTWARE CORPORATION:
See— SAP PORTALS, INC..
- TORAY KABUSHIKI KAISHA, NIHONBASHI-MUROMACHI, CHUO-KU, TOKYO, JAPAN, T.A. TORAY INDUSTRIES, INC.:
1,295,320, REN. 4-15-05. INT. CL. 1.
- TOSHIBA MEDICAL SYSTEMS CORPORATION, OTAWARA-SHI, TOCHIGI 324-8550, JAPAN:
2,954,440, PUB. 3-1-2005. INT. CL. 10.
- TOSHIBA TEC KABUSHIKI KAISHA, CHIYODA-KU, TOKYO 101-8442, JAPAN:
2,955,286, INT. CL. 9.
- TOSOH CORPORATION, YAMAGUCHI, JAPAN:
1,854,664, REN. 4-15-05. INT. CL. 17.
- TOTAL FITNESS, INC., SOUTH WINDSOR, CT:
2,954,085, PUB. 3-1-2005. INT. CL. 35.
- TOTES ISOTONER CORPORATION, CINCINNATI, OH:
1,329,582, REN. 4-13-05. INT. CL. 18.

- TOUCH LEARNING CONCEPTS, INC., COLORADO SPRINGS, CO:
1,284,235, CANC. INT. CL. 16.
- TOUCHNET, INC., BELLEVUE, WA:
2,171,104, CANC. INT. CL. 35.
- TOWMASTER, INC., LITCHFIELD, MN:
2,956,048, INT. CL. 12.
- TOWNSENDS, INC., WILMINGTON, DE:
2,954,284, PUB. 3-1-2005. INT. CL. 29.
- TOY STATE INDUSTRIAL LTD., KOWLOON, HONG KONG:
2,955,742, INT. CL. 28.
- TP ORTHODONTICS, INC., LAPORTE, IN:
2,954,412, PUB. 3-1-2005. INT. CL. 10.
- TRACKER MARINE, L.L.C., SPRINGFIELD, MO:
2,956,254, INT. CL. 12.
- TRADELINK, INC., ROANOKE, TX:
2,171,098, CANC. INT. CL. 35.
- TRADES PUBLISHING, INC., LAMBERTVILLE, NJ:
2,954,207, PUB. 3-1-2005. INT. CL. 16.
- TRAFFIC AND PARKING CONTROL CO., INC., WANWATOSA, WI:
1,295,658, REN. 4-13-05. INT. CL. 6.
- TRAIL BLAZERS INC., PORTLAND, OR:
1,842,744, CANC. MULTIPLE CLASS, INT. CLS. 9, 16 AND 28.
- TRANSACTION PROCESSING PERFORMANCE COUNCIL, SAN FRANCISCO, CA:
2,954,681, PUB. 3-1-2005. U.S. CL. A.
2,954,682, PUB. 3-1-2005. U.S. CL. A.
- TRANSAMERICA CORPORATION, LOS ANGELES, CA:
1,872,759, CANC. MULTIPLE CLASS, INT. CLS. 35, 37, 39, 41 AND 42.
1,902,999, REN. 4-12-05. INT. CL. 36.
- TRANSNEXUS, INC., ATLANTA, GA:
2,954,884, PUB. 10-26-2004. INT. CL. 9.
- TRANSPACIFIC TRADING CO. LIMITED, ISLE OF MAN, UNITED KINGDOM:
2,171,398, CANC. INT. CL. 5.
- TRANSTECHNOLOGY CORPORATION, LIBERTY CORNER, NJ:
2,766,046, COR. MULTIPLE CLASS, INT. CLS. 6 AND 20.
- TRAVEL AND SPORTS, INC., BOULDER, CO:
2,955,756, INT. CL. 16.
- TRAVELERS EXPRESS COMPANY, INC., ST. LOUIS PARK, MN:
2,171,191, CANC. INT. CL. 36.
- TRAVELING SOFTWARE, INC., BOTHELL, WA TO LAPLINK.COM, INC., BOTHELL, WA:
1,843,546, CANC. INT. CL. 9.
- TRAVERS TOOL CO., INC., FLUSHING, NY:
1,901,460, REN. 4-12-05. MULTIPLE CLASS, INT. CLS. 7 AND 8.
- TREE CARE INDUSTRY ASSOCIATION, INC., MANCHESTER, NH:
2,954,764, PUB. 3-1-2005. INT. CL. 35.
- TRENDMASTERS, INC., ST. LOUIS, MO:
1,843,756, CANC. INT. CL. 28.
1,843,757, CANC. INT. CL. 28.
1,843,792, CANC. INT. CL. 28.
1,843,967, CANC. INT. CL. 28.
- TRIBUNE COMPANY, THE, TAMPA, FL:
1,448,453, CANC. INT. CL. 16.
- TRILLIUM CREATIVE LLC, CHICAGO, IL:
2,954,915, PUB. 3-1-2005. INT. CL. 42.
- TRIM SYSTEMS OPERATING CORP., NEW ALBANY, OH:
2,171,710, CANC. INT. CL. 12.
- TRINITY CHRISTIAN CENTER OF SANTA ANA, INC., TUSTIN, CA, DBA TRINITY BROADCASTING NETWORK:
2,171,434, CANC. INT. CL. 38.
- TRIPLE CANOPY GROUP, INC., CHICAGO, IL:
2,956,365, MULTIPLE CLASS, INT. CLS. 41, 42 AND 45.
- TRIPLE FIVE SOUL, INC., BROOKLYN, NY:
2,955,401, INT. CL. 25.
- TRISTAR PRODUCTS, INC., FAIRFIELD, NJ:
2,955,095, PUB. 3-1-2005. INT. CL. 25.
- TRIUMPH TWIST DRILL CO., CRYSTAL LAKE, IL:
1,317,628, REN. 4-13-05. MULTIPLE CLASS, INT. CLS. 7 AND 8.
- TROJAN TECHNOLOGIES INC., LONDON, ONTARIO, CANADA:
2,806,954, COR. INT. CL. 7.
- TROPHY NUT CORPORATION, TRIPP CITY, OH:
2,954,415, PUB. 10-26-2004. INT. CL. 30.
- TROPICAL GARMENT MANUFACTURING CO., TAMPA, FL TO TROPICAL SPORTSWEAR INTERNATIONAL CORPORATION, TAMPA, FL:
1,843,699, CANC. INT. CL. 25.
- TROPICAL TOBACCO, INC., MIAMI, FL:
2,955,849, INT. CL. 34.
- TROPICCOOL LTD., GREENVILLE, MS:
2,955,432, INT. CL. 20.
- TROUBLE, AGNES, PARIS, FRANCE:
2,954,670, PUB. 12-14-2004. MULTIPLE CLASS, INT. CLS. 3, 14, 18, 24 AND 25.
- TROY TECHNOLOGY CORPORATION INC, WILMINGTON, DE, TROY CORPORATION, EAST HANOVER, NJ:
1,921,346, REN. 4-13-05. MULTIPLE CLASS, INT. CLS. 1 AND 5.
- TRUCK ACCESSORIES GROUP, INC., ELKHART, IN:
2,954,460, PUB. 3-1-2005. INT. CL. 12.
- TRUCO PUREX INDUSTRIAL CORP., LAKEWOOD, CA:
1,283,961, CANC. INT. CL. 2.
- TRUNKS BATHING, INC., JACKSONVILLE, FL:
2,954,393, PUB. 10-26-2004. MULTIPLE CLASS, INT. CLS. 18, 24 AND 25.
- TRUSERV CORPORATION, CHICAGO, IL:
2,955,100, PUB. 3-1-2005. INT. CL. 35.
- TRUSTEES OF THE STEVENS INSTITUTE OF TECHNOLOGY, THE, HOBOKEN, NJ, AKA STEVENS INSTITUTE OF TECHNOLOGY:
1,290,009, REN. 4-13-05. MULTIPLE CLASS, INT. CLS. 16, 41 AND 42.
- TRUSTMARK INSURANCE COMPANY, LAKE FOREST, IL:
2,954,462, PUB. 3-1-2005. INT. CL. 45.
- TRUWARIER RECORDS, LLC, CARMEL, IN:
2,955,723, INT. CL. 9.
- TSA CORPORATE SERVICES, INC., ENGLEWOOD, CO:
2,108,004, CANC. MULTIPLE CLASS, INT. CLS. 35 AND 41.
- TSC INDUSTRIES, INC., NASHVILLE, TN:
1,284,511, CANC. INT. CL. 31.
- TSR, INC., RENTON, WA:
1,843,734, CANC. INT. CL. 28.
- TT TECHNOLOGIES, INC., AURORA, IL:
1,876,289, REN. 4-14-05. INT. CL. 4.
- TTI TESTRON, INC., WOONSOCKET, RI:
2,171,335, CANC. INT. CL. 9.
- TUB PRODUCTIONS, LLC, ROSEMONT, PA:
2,954,326, PUB. 3-1-2005. INT. CL. 16.
- TUFAN, INC., MOUNTAIN VIEW, CA, DIGITAL TOOLS, INC., CUPERTINO, CA:
1,882,835, REN. 4-12-05. INT. CL. 9.
- TUFTS UNIVERSITY, MEDFORD, MA, AKA TRUSTEES OF TUFTS COLLEGE:
1,915,964, REN. 4-15-05. MULTIPLE CLASS, INT. CLS. 6 AND 14.
- TUIOLOSEGA, TINO, HUNTINGTON BEACH, CA:
1,880,120, REN. 4-12-05. INT. CL. 41.
- TURBINE END-USER SERVICES, INC., SEABROOK, TX:
2,955,527, MULTIPLE CLASS, INT. CLS. 37 AND 40.
- TURF-SEED, INC., HUBBARD, OR:
2,954,474, PUB. 3-1-2005. INT. CL. 31.
- TURNILS (UK) LIMITED, RENFREW, UNITED KINGDOM:
188,958, REN. 4-11-05. U.S. CL. 13 (INT. CL. 6).
- TVI CORPORATION, GLEN DALE, MD:
2,954,303, PUB. 3-1-2005. INT. CL. 21.
- TWD INDUSTRIAL COMPANY, LIMITED, ROAD TOWN, TORTOLA, BR. VIRGIN ISLANDS:
1,324,188, REN. 4-15-05. INT. CL. 9.
1,909,839, REN. 4-15-05. INT. CL. 9.
1,931,003, REN. 4-15-05. INT. CL. 9.

- TWENTIETH CENTURY FOX FILM CORPORATION, LOS ANGELES, CA:
2,171,786, CANC. INT. CL. 38.
2,955,494, INT. CL. 25.
2,955,589, INT. CL. 9.
- TWENTY AND SEVEN, LLC, NEW YORK, NY:
2,955,510, INT. CL. 16.
- TWO WEST, INC., KANSAS CITY, MO:
2,956,273, INT. CL. 35.
- TWOFISH UNLIMITED, BERKELEY, CA:
1,876,328, REN. 4-11-05, INT. CL. 6.
- TXX, INC., METAIRIE, JEFFERSON PARISH, LA:
1,284,526, CANC. INT. CL. 35.
- TYCO HEALTHCARE GROUP LP, MANSFIELD, MA, INBRAND CORPORATION, MARIETTA, GA:
1,880,223, REN. 4-14-05, INT. CL. 5.
- TYR SPORT, INC., HUNTINGTON BEACH, CA:
2,954,547, PUB. 3-1-2005, INT. CL. 28.
- TYSON FENCE CO., INC., HARRISBURG, PA:
2,956,079, INT. CL. 17.
- TYSON, JAMES, PENNSAUKEN, NJ:
2,954,334, PUB. 3-1-2005, INT. CL. 9.
- U.S. BANCORP:
See—LIBRA SECURITIES HOLDINGS, LLC.
- U.S. GRAPHICS, INC., VIRGINIA BEACH, VA:
2,953,997, PUB. 10-22-1996, INT. CL. 25.
- U.S. SMOKELESS TOBACCO COMPANY, GREENWICH, CT, UNITED STATES TOBACCO COMPANY, GREENWICH, CT:
1,294,831, REN. 4-15-05, INT. CL. 34.
- U.S. TSUBAKI, INC., WHEELING, IL:
2,955,324, INT. CL. 17.
- U.S.A. ZAMA INC., FRANKLIN, TN:
1,889,618, REN. 4-11-05, INT. CL. 7.
- UBS FINANCIAL SERVICES INC., WEHAWKEN, NJ:
2,171,593, CANC. INT. CL. 36.
- ULTRA ADDITIVES INCORPORATED, BLOOMFIELD, NJ:
2,955,842, INT. CL. 1.
- ULTRA MARK L.L.C., CHESTERFIELD, MO:
2,171,869, CANC. INT. CL. 7.
- ULTRACHEM, INC., NEW CASTLE, DE:
2,954,525, PUB. 3-1-2005, INT. CL. 4.
- ULTRADENT PRODUCTS, INC., SOUTH JORDAN, UT:
2,956,010, INT. CL. 10.
- UNICRAFT NAGURA CO., LTD., SHIZUOKA, JAPAN:
1,006,236, REN. 4-14-05, INT. CL. 8.
- UNIMIE, F-45250 BRIARE, FRANCE:
2,171,363, CANC. INT. CL. 30.
- UNITED AIR LINES, INC., CHICAGO, IL:
2,170,685, CANC. MULTIPLE CLASS, INT. CLS. 39 AND 42.
- UNITED AMERICAN MORTGAGE CORPORATION, IRVINE, CA:
2,954,693, PUB. 3-1-2005, INT. CL. 36.
- UNITED COMMUNICATIONS GROUP LIMITED PARTNERSHIP, ROCKVILLE, MD:
2,954,564, PUB. 3-1-2005, INT. CL. 35.
- UNITED CONCORDIA DENTAL PLANS, INC., TOWSON, MD:
2,171,308, CANC. INT. CL. 36.
- UNITED FABRICS, INC., PENNSAUKEN, NJ, PACIFIC HIDE & LEATHER CO., INC., LOS ANGELES, CA:
1,008,092, REN. 4-15-05, MULTIPLE CLASS, U.S. CLS. 1 (INT. CL. 18), 20 (INT. CL. 27) AND 42 (INT. CL. 24).
- UNITED FEDERATION OF DOLL CLUBS, INC., KANSAS CITY, MO:
1,337,398, REN. 4-15-05, U.S. CL. 200.
- UNITED GUARANTY CORPORATION, GREENSBORO, NC:
2,955,105, PUB. 3-1-2005, INT. CL. 36.
- UNITED HEALTHCARE CORPORATION, MINNEAPOLIS, MN TO U. S. CARE, INC., SANTA MONICA, CA:
1,843,869, CANC. INT. CL. 36.
- UNITED JERSEY BANK, HACKENSACK, NJ:
2,953,995, PUB. 3-23-2004, MULTIPLE CLASS, INT. CLS. 35 AND 39.
- UNITED SITE SERVICES, INC., MANSFIELD, MA:
2,954,364, PUB. 3-1-2005, INT. CL. 44.
2,954,365, PUB. 3-1-2005, INT. CL. 44.
2,954,366, PUB. 3-1-2005, INT. CL. 44.
- UNITED STATES FOUNDRY & MANUFACTURING CORPORATION, HIALEAH, FL:
2,954,645, PUB. 4-27-2004, INT. CL. 6.
- UNITED STATES LUGE ASSOCIATION, LAKE PLACID, NY:
2,955,326, MULTIPLE CLASS, INT. CLS. 16 AND 25.
- UNITED STATES ROWING ASSOCIATION, INDIANAPOLIS, IN:
2,954,287, PUB. 3-1-2005, INT. CL. 25.
- UNITED STATES SOCCER FEDERATION, INC., CHICAGO, IL:
2,170,631, CANC. MULTIPLE CLASS, INT. CLS. 14, 16, 24, 25, 41 AND 42.
- UNITED STATES TILE CO., CORONA, CA:
2,955,456, INT. CL. 19.
- UNITED STATES VOLLEYBALL ASSOCIATION, COLORADO SPRINGS, CO:
2,171,180, CANC. INT. CL. 14.
- UNITED TECHNOLOGIES MICROELECTRONICS CENTER, INC., COLORADO SPRINGS, CO TO AEROFLEX UTMC MICROELECTRONICS SYSTEMS, INC, COLORADO SPRINGS, CO:
1,843,491, CANC. INT. CL. 9.
- UNITED WAY INVESTMENTS LIMITED, ROAD TOWN, TORTOLA, BR.VIRGIN ISLANDS:
2,954,652, PUB. 9-7-2004, INT. CL. 37.
2,954,653, PUB. 12-14-2004, INT. CL. 38.
2,954,654, PUB. 12-14-2004, INT. CL. 39.
2,954,655, PUB. 12-14-2004, INT. CL. 42.
2,954,664, PUB. 12-14-2004, MULTIPLE CLASS, INT. CLS. 35 AND 36.
- UNITEDHEALTH GROUP INCORPORATED, MINNETONKA, MN:
2,955,997, MULTIPLE CLASS, INT. CLS. 9, 16, 35 AND 36.
- UNITE2HELP HOLDING A/S, DK-2100 COPENHAGEN O, DENMARK:
2,954,088, PUB. 8-31-2004, MULTIPLE CLASS, INT. CLS. 9, 28, 35, 36, 41 AND 42.
- UNITRON INDUSTRIES LTD., KITCHENER, ONTARIO, CANADA:
2,954,104, PUB. 10-26-2004, INT. CL. 10.
- UNIVERSAL CONTROL SOLUTIONS CORP., SYLMAR, CA:
2,955,914, INT. CL. 9.
- UNIVERSAL HEALTH SERVICES, INC., KING OF PRUSSIA, PA:
2,955,306, INT. CL. 44.
- UNIVERSAL SECURITY INSTRUMENTS, INC., OWINGS MILLS, MD:
2,955,403, INT. CL. 9.
- UNIVERSAL SUPPLY COMPANY, INC., HAMMONTON, NJ:
2,955,615, INT. CL. 19.
- UNIVERSAL TRIM SUPPLY CO., LTD., WU KU SHIANG, TAIWAN:
2,956,144, INT. CL. 26.
- UNIVERSAL UNDERWRITERS INSURANCE COMPANY, OVERLAND PARK, KS:
2,955,812, INT. CL. 9.
- UNIVERSITY OF FLORIDA, GAINESVILLE, FL:
1,284,669, CANC. INT. CL. 41.
- UNIVERSITY OF MARYLAND FOUNDATION, INC., ADELPHI, MD, HOUGHTON, ARTHUR A. JR., QUEENSTOWN, MD, DBA WYE PLANTATIONS:
1,005,907, REN. 4-13-05, MULTIPLE CLASS, INT. CLS. 31 AND 42.
- UNIVERSITY OF MARYLAND FOUNDATION, INC., ADELPHI, MD:
1,005,908, REN. 4-13-05, INT. CL. 42.
- UNIVERSITY OF NORTH TEXAS, DENTON, TX:
2,172,040, CANC. INT. CL. 25.
- UNIVERSITY OF OREGON, A MEMBER OF THE OREGON STATE SYSTEM OF HIGHER EDUCATION, THE, EUGENE, OR:
2,082,815, CANC. MULTIPLE CLASS, INT. CLS. 9 AND

16.
UNIVERSITY OF ST. THOMAS, MINNEAPOLIS, MN:
2,955,862, INT. CL. 41.
- UNIWEB, INC., CORONA, CA:
1,322,960, REN. 4-14-05, INT. CL. 6.
- UPPER DECK COMPANY, LLC, THE, CARLSBAD, CA:
2,171,865, CANC. INT. CL. 16.
- UPPER SKAGIT INDIAN TRIBE, THE, BOW, WA, DBA
SKAGIT VALLEY CASINO RESORT:
2,955,649, MULTIPLE CLASS, INT. CLS. 41 AND 43.
- UPSIDE SOFTWARE INC., EDMONTON, ALBERTA, CA-
NADA:
2,954,056, PUB. 10-28-2003, INT. CL. 42.
- UPSOLUT MICHAEL VEITH MARKETING GMBH, MU-
NICH, FED REP GERMANY:
2,679,606, AM. MULTIPLE CLASS, INT. CLS. 25, 28 AND
41.
- UPTIN, INC., LAS VEGAS, NV, DBA BENSON-PENDANT:
2,954,251, PUB. 3-1-2005, INT. CL. 5.
- URBAN ELECTRIC COMPANY, THE, CHARLESTON, SC:
2,955,458, INT. CL. 11.
- URBAN PUPPY INC., TORONTO, ONTARIO, CANADA:
2,955,299, INT. CL. 16.
- URSUS, LLC, NEW YORK, NY:
2,913,657, COR. INT. CL. 29.
- USA FINANCIAL MARKETING CORPORATION, ADA, MI:
2,955,844, MULTIPLE CLASS, INT. CLS. 16 AND 41.
- USA SERVICES, INC., AUSTIN, TX:
2,171,781, CANC. INT. CL. 38.
- USIS EMPLOYERS INFORMATION GROUP, INC, TULSA,
OK:
2,955,982, MULTIPLE CLASS, INT. CLS. 16, 36 AND 45.
- USTER TECHNOLOGIES AG, CH-8610 USTER, SWITZER-
LAND:
2,956,166, MULTIPLE CLASS, INT. CLS. 7, 16 AND 23.
- USWEBQUOTE, INC., QUARTZ HILL, CA:
2,171,299, CANC. INT. CL. 10.
- UVIEW ULTRAVIOLET SYSTEMS, INC., MISSISSAUGA,
ONTARIO L4Y 1M5, CANADA:
2,955,814, INT. CL. 9.
- V. PATEL AND SONS, INC., CHICAGO, IL, DBA PATEL
BROTHERS, AND RAJA FOODS:
2,955,255, INT. CL. 35.
- VALDIOR, S.L., 46920 MISLATA (VALENCIA), SPAIN:
2,171,141, CANC. INT. CL. 14.
- VALEN BROST GAME CO., INCLINE VILLAGE, NV:
2,171,465, CANC. INT. CL. 28.
- VALENTINE HORSE FARM INC., SORRENTO, FL:
2,955,096, PUB. 3-1-2005, INT. CL. 35.
- VALIDY, INC., SHERWOOD, OR FROM CALIFORNIA
INTERNATIONAL VENTURE CAPITAL CORP, SHER-
WOOD, OR:
2,955,192, INT. CL. 9.
- VALISERE PARIS S.A., F-67210 OBERNAI, FRANCE TO
TRIUMPH INTERNATIONAL SPIESSHOFER & BRAUN,
CH-6437 ZURICH, SWITZERLAND:
1,842,992, CANC. MULTIPLE CLASS, INT. CLS. 24 AND
25.
- VALLEY GLASS INC., OGDEN, UT:
2,955,652, INT. CL. 37.
- VALSOIA S.P.A., 4+40126 BOLOQNA, ITALY:
2,886,790, COR. MULTIPLE CLASS, INT. CLS. 29 AND
30.
- VAN ART DESIGNS, INC., ST. THOMAS, US VIRGIN
ISLANDS:
2,956,199, INT. CL. 25.
- VANDERSHACK ENTERPRISES, LLC, PULASKI, TN:
2,954,335, PUB. 3-1-2005, INT. CL. 16.
- VANITY FAIR, INC., WILMINGTON, DE:
2,955,603, INT. CL. 25.
- VARIETY PLASTIC PRODUCTS, CORONA, CA:
2,171,441, CANC. INT. CL. 28.
- VARTEC TELECOM, INC., LANCASTER, TX:
2,171,277, CANC. INT. CL. 38.
2,171,278, CANC. INT. CL. 38.
- VECTOR PRODUCTS, INC, FAIRFIELD, NJ:
2,956,280, INT. CL. 1.
- VENT RITE VALVE CORPORATION, BENTON HARBOR,
MI:
2,955,857, INT. CL. 11.
- VENTANA MEDICAL SYSTEMS, INC., TUCSON, AZ:
2,954,739, PUB. 3-23-2004, INT. CL. 5.
- VENTIV HEALTH, INC., SOMERSET, NJ:
2,955,433, INT. CL. 35.
- VENTURA FOODS, LLC, BREA, CA:
786,895, REN. 4-15-05, U.S. CL. 46 (INT. CL. 29).
- VENTURE STORES, INC., O'FALLON, MO:
1,843,596, CANC. INT. CL. 14.
- VENVEST, INC., ST. LOUIS, MO:
2,955,312, INT. CL. 35.
2,955,867, INT. CL. 35.
- VERA DA POZZO SPA:
1,284,384, CANC. INT. CL. 25.
- VEREX LABORATORIES, INC., ENGLEWOOD, CO:
1,284,025, CANC. INT. CL. 5.
- VERI-LOGIC, LLC, BOLINGBROOK, IL:
2,955,319, INT. CL. 42.
2,955,320, INT. CL. 42.
- VERITAS OPERATING CORPORATION, MOUNTAIN
VIEW, CA:
2,955,248, INT. CL. 16.
- VERMEER MANUFACTURING COMPANY, PELLA, IA:
1,842,684, CANC. INT. CL. 7.
- VERMONT STUDENT DEVELOPMENT FUND, INC., WI-
NOOSKI, VT:
2,956,344, INT. CL. 36.
- VERONIQUE, INC., NEW YORK, NY:
2,171,875, CANC. INT. CL. 3.
- VESTRON, INC., STAMFORD, CT:
1,284,180, CANC. INT. CL. 9.
- VIÑA DASSAULT-SAN PEDRO S.A., SANTIAGO, CHILE:
2,955,706, INT. CL. 33.
- VIAMEDIC, INC., TEMPE, AZ:
2,954,463, PUB. 3-1-2005, INT. CL. 35.
- VIASAT, INC., CARLSBAD, CA:
2,171,669, CANC. INT. CL. 9.
- VIASYSTEMS GROUP, INC., ST. LOUIS, MO:
2,171,962, CANC. INT. CL. 9.
2,171,963, CANC. INT. CL. 9.
- VICTORIA VOGUE, INC., BETHLEHEM, PA:
2,171,909, CANC. INT. CL. 3.
- VICTORY HEATING & AIR CONDITIONING, INC., BEL-
LINGHAM, MA:
2,954,435, PUB. 3-1-2005, INT. CL. 37.
- VICTORY MARKETS, INC., NORWICH, NY:
1,413,793, CANC. INT. CL. 42.
1,419,547, CANC. INT. CL. 42.
- VIDEO TREATS INC., POUGHKEEPSIE, NY:
2,954,796, PUB. 3-1-2005, INT. CL. 44.
- VIDEONICS, INC., CAMPBELL, CA:
1,842,735, CANC. INT. CL. 9.
- VIET HUONG FISHSAUCE COMPANY INC., SAN FRAN-
CISCO, CA, CHUNG, KHIEU, SAN FRANCISCO, CA, DBA
VIET HUONG COMPANY:
1,348,373, REN. 4-15-05, INT. CL. 30.
- VIEWSTAR CORPORATION, ALAMEDA, CA:
2,170,813, CANC. INT. CL. 9.
- VILLARREAL-SALAZAR, ING. PEDRO RAUL, NUEVO
LEON, MEXICO:
1,843,421, CANC. INT. CL. 3.
- VILLEROY & BOCH AG, METTLACH, FED REP GER-
MANY:
2,954,713, PUB. 3-1-2005, INT. CL. 11.
- VINA ERRAZURIZ S.A., SANTIAGO, CHILE:
2,745,344, COR. INT. CL. 33.
- VINA MORANDÉ S.A., SANTIAGO, CHILE:
2,954,792, PUB. 3-1-2005, INT. CL. 33.
- VINOMEX, S.A. DE C.V., DELICIAS, MEXICO:
2,955,943, INT. CL. 33.
- VIP INVESTMENTS, LTD., OREM, UT:
2,955,253, INT. CL. 37.
- VIRGINIA APPAREL CORP., ROCKY MOUNT, VA:
1,284,414, CANC. INT. CL. 25.
- VIRTOOLS, PARIS, FRANCE:
2,954,617, PUB. 6-22-2004, MULTIPLE CLASS, INT. CLS.

- 9, 35, 38 AND 42.
 VIRTUAL INTEGRATION TECHNOLOGY, CUPERTINO, CA:
 2,170,980, CANC. INT. CL. 16.
 VIRTUAL REALITY MEDICAL CENTER, SAN DIEGO, CA:
 2,955,750, INT. CL. 16.
 VISA INTERNATIONAL SERVICE ASSOCIATION, SAN FRANCISCO, CA:
 1,284,585, CANC. INT. CL. 36.
 VISA INTERNATIONAL SERVICE ASSOCIATION, FOSTER CITY, CA:
 1,843,864, CANC. INT. CL. 36.
 VISIONCARD, INC., COPPELL, TX:
 2,171,811, CANC. INT. CL. 35.
 VISIONEX, INC., WARNER ROBINS, GA:
 2,171,284, CANC. MULTIPLE CLASS, INT. CLS. 9 AND 10.
 VISTEON CORPORATION, MAITLAND, FL:
 2,170,641, CANC. INT. CL. 42.
 VISUAL IMPRESSIONS, LTD., ROCHESTER, NY:
 1,284,675, CANC. INT. CL. 41.
 VITA CRAFT CORPORATION, SHAWNEE, KS:
 772,820, CANC. U.S. CL. 33.
 VITA ZAHNFABRIK H. RAUTER GMBH & CO. KG, D-79713 BAD SACKINGEN, FED REP GERMANY:
 2,954,165, PUB. 3-1-2005. MULTIPLE CLASS, INT. CLS. 5 AND 10.
 2,954,166, PUB. 3-1-2005. MULTIPLE CLASS, INT. CLS. 5 AND 10.
 2,954,167, PUB. 3-1-2005. MULTIPLE CLASS, INT. CLS. 5 AND 10.
 2,954,168, PUB. 3-1-2005. INT. CL. 5.
 2,954,169, PUB. 3-1-2005. MULTIPLE CLASS, INT. CLS. 5 AND 10.
 2,954,170, PUB. 3-1-2005. MULTIPLE CLASS, INT. CLS. 5 AND 10.
 VITECH AMERICA CORPORATION, INC., KENT, WA:
 2,955,271, INT. CL. 30.
 VMX INC., RICHARDSON, TX:
 1,284,620, CANC. INT. CL. 38.
 VOGEL SEED & FERTILIZER, INC., JACKSON, WI:
 1,958,408, REN. 4-15-05. INT. CL. 1.
 VOICE ACCOUNT, INC., SALT LAKE CITY, UT:
 2,955,992, INT. CL. 38.
 VOLK, THOMAS, SANTA PAULA, CA:
 2,955,418, INT. CL. 12.
 VOLTAIX, INC., NORTH BRANCH, NJ:
 2,954,404, PUB. 3-1-2005. INT. CL. 1.
 VOLVO CAR CORPORATION, GOTEBORG, SWEDEN, AKA VOLVO PERSONVAGNAR AB:
 2,954,789, PUB. 3-1-2005. INT. CL. 16.
 VOOM, INC., SUNNYVALE, CA:
 2,171,400, CANC. INT. CL. 42.
 VOXAS LLC, EVANSTON, IL:
 2,956,229, INT. CL. 9.
 VTECH INDUSTRIES, INC., WHEELING, IL:
 2,171,507, CANC. INT. CL. 28.
 VTECH INDUSTRIES, L.L.C., WHEELING, IL:
 2,171,630, CANC. INT. CL. 28.
 VULCAN ENGINEERING COMPANY, HELENA, AL:
 2,955,856, INT. CL. 7.
 W WING YIP AND BROTHERS (HOLDINGS) LIMITED, BIRMINGHAM, UNITED KINGDOM:
 2,954,701, PUB. 3-1-2005. MULTIPLE CLASS, INT. CLS. 16, 21, 29, 30, 31, 32, 33, 35, 36, 37, 39 AND 43.
 W. L. GORE & ASSOCIATES, INC., NEWARK, DE:
 1,855,823, REN. 4-15-05. INT. CL. 25.
 W.E. LONG CO. - INDEPENDENT BAKERS' COOPERATIVE, THE, CHICAGO, IL:
 2,171,513, CANC. INT. CL. 30.
 WACHOVIA CORPORATION, CHARLOTTE, NC:
 2,955,145, PUB. 3-1-2005. INT. CL. 36.
 WACOAL AMERICA, INC., NEW YORK, NY:
 1,851,534, REN. 4-15-05. INT. CL. 25.
 WAGNER MINING AND CONSTRUCTION EQUIPMENT CO., PORTLAND, OR TO ATLAS COPCO WAGNER INC., PORTLAND, OR:
 1,842,693, CANC. INT. CL. 7.
 WAHL, KARL, CHINCOTEAGUE, VA:
 1,842,884, CANC. INT. CL. 14.
 WAKEFERN FOOD CORP., ELIZABETH, NJ:
 2,955,327, INT. CL. 32.
 WAL-MART STORES, INC., BENTONVILLE, AR:
 1,855,254, REN. 4-15-05. INT. CL. 25.
 2,955,451, INT. CL. 20.
 2,955,452, INT. CL. 20.
 2,955,454, INT. CL. 20.
 2,955,455, INT. CL. 20.
 WALDEMAR LINK GMBH & CO. KG, 22339 HAMBURG, FED REP GERMANY:
 2,954,240, PUB. 8-24-2004. MULTIPLE CLASS, INT. CLS. 9, 10, 16, 42 AND 44.
 WALDWICK PLASTICS CORPORATION, WALDWICK, NJ:
 2,954,872, PUB. 3-1-2005. INT. CL. 40.
 WALKER ENTERTAINMENT GROUP, FRESNO, CA:
 2,954,918, PUB. 3-1-2005. INT. CL. 41.
 WALLACE COMPUTER SERVICES, INC., HILLSIDE, IL:
 1,284,288, CANC. INT. CL. 16.
 WALLACE, JERRY L., DESTIN, FL:
 2,955,819, INT. CL. 36.
 WALLACH SURGICAL DEVICES, INC., ORANGE, CT:
 2,954,995, PUB. 3-1-2005. INT. CL. 10.
 WALLINGFORD'S, INC., OAKLAND, ME:
 2,954,730, PUB. 8-24-2004. INT. CL. 12.
 WALTER'S PUBLISHING, WASECA, MN:
 2,954,813, PUB. 3-1-2005. MULTIPLE CLASS, INT. CLS. 36 AND 41.
 WANDER'S INC., KENT, WA:
 2,956,017, INT. CL. 37.
 WANG, LIONEL, RIVERSIDE, CT:
 2,955,770, INT. CL. 9.
 WAREHOUSE HOME FURNISHING DISTRIBUTORS, INC., DUBLIN, GA:
 2,955,321, INT. CL. 35.
 WARNER-LAMBERT COMPANY LLC, MORRIS PLAINS, NJ:
 1,382,989, REN. 4-11-05. INT. CL. 5.
 2,956,101, INT. CL. 16.
 WARNER, BRIAN H., HOLLYWOOD, CA:
 2,955,300, INT. CL. 41.
 WARRANTECH CORPORATION, STAMFORD, CT:
 1,884,440, REN. 4-13-05. INT. CL. 36.
 WARRANTY MANAGEMENT TECHNOLOGIES, LLC, BURNSVILLE, MN:
 2,955,986, MULTIPLE CLASS, INT. CLS. 35 AND 36.
 WARRIOR LACROSSE, INC., WARREN, MI:
 2,955,620, INT. CL. 28.
 WASH N JOE, LLC, DESTIN, FL:
 2,955,672, INT. CL. 37.
 WASHINGTON-TONEY, GLENDA FAYE, LOUISVILLE, KY:
 2,954,923, PUB. 3-1-2005. INT. CL. 20.
 WASHINGTON, LENDA P., WASHINGTON, DC:
 2,954,592, PUB. 3-1-2005. INT. CL. 29.
 WASN'T THAT A PARTY INC., BRAMPTON, ONTARIO, CANADA:
 2,954,248, PUB. 3-1-2005. INT. CL. 28.
 WASTE MANAGEMENT OF NORTH AMERICA, INC., OAK BROOK, IL TO WASTE MANAGEMENT HOLDINGS, INC., HOUSTON, TX:
 1,843,258, CANC. INT. CL. 41.
 WASTE PROCESSING EQUIPMENT, INC., RAINSVILLE, AL:
 2,954,267, PUB. 3-1-2005. INT. CL. 7.
 WATER-VEND, INC., ASHLAND, MA:
 2,904,855, COR. MULTIPLE CLASS, INT. CLS. 32 AND 35.
 WATERFORD WEDGWOOD PLC, KILBARRY, WATERFORD, IRELAND, WATERFORD GLASS LIMITED, KILBARRY, WATERFORD, IRELAND:
 1,006,374, REN. 4-15-05. INT. CL. 21.
 WATERS INSTRUMENTS, INC., PLYMOUTH, MN, FLOTRONICS, INC., MINNEAPOLIS, MN, DBA NORTHERN SIGNAL CO.,:
 786,329, REN. 4-13-05. U.S. CL. 21 (INT. CL. 9).

WATSON FURNITURE SYSTEMS, BAINBRIDGE ISLAND, WA:
2,170,930, CANC. INT. CL. 9.

WATTYL (US) LIMITED, EDGEWATER, FL:
2,955,528, INT. CL. 2.

WAX COMPANY, INC., THE, AMORY, MS:
1,883,805, REN. 4-13-05, INT. CL. 31.

WD VENTURES, INC., OKLAHOMA CITY, OK:
2,955,048, PUB. 3-1-2005, INT. CL. 25.

WE R. FUN, INC., PIERZ, MN:
2,171,463, CANC. INT. CL. 28.

WEBEMERGE, INC., NEW YORK, NY:
2,955,639, INT. CL. 37.

WEBOLUTION CORP., ANNAPOLIS, MD:
2,171,125, CANC. INT. CL. 9.

WEBSTER, GLENN DAVID, SURBITON, SURREY KT6 6JD, UNITED KINGDOM:
2,954,081, PUB. 3-1-2005, MULTIPLE CLASS, INT. CLS. 9, 16, 25, 28, 31 AND 41.

WEBSTER, GLENN DAVID, SURREY KT6 6JD, UNITED KINGDOM:
2,954,082, PUB. 3-1-2005, MULTIPLE CLASS, INT. CLS. 9, 16, 25, 28, 31 AND 41.

WEC COMPANY, OREGON, IL:
1,328,031, REN. 4-11-05, INT. CL. 7.

WEEKS, JOHN, SEATTLE, WA, DBA INTEGRATION STRATEGIES FOR NATURAL HEALTHCARE:
2,298,247, CANC. INT. CL. 16.

WEIDER HEALTH AND FITNESS, WOODLAND HILLS, CA:
1,284,033, CANC. INT. CL. 5.

WEINGARDEN, MARSHALL L., HAWORTH, NJ:
2,954,479, PUB. 3-1-2005, INT. CL. 17.

WEINGARTNER MASCHINENBAU GESELLSCHAFT M.B.H., A-4656 KIRCHHAM 29, AUSTRIA:
2,955,820, INT. CL. 7.

WEISLEDER ASSOCIATES, INC., KEY LARGO, FL, WEISLEDER, BROOKE R., BAY HEAD, NJ:
1,885,240, REN. 4-10-05, INT. CL. 36.

WELDON CAPITAL FUNDS, INC., LEAWOOD, KS:
2,954,554, PUB. 3-1-2005, INT. CL. 36.

WELLA CORPORATION, THE, ENGLEWOOD, NJ:
1,283,997, CANC. INT. CL. 3.
1,843,254, CANC. INT. CL. 41.

WELLS LAMONT CORPORATION, NILES, IL:
2,956,356, INT. CL. 21.

WELSH, CANDACE T., NAPLES, FL:
1,843,316, CANC. INT. CL. 42.

WENDY WRIGHT, ST. PAUL, MN, DBA WRIGHTERS INK:
1,843,141, CANC. INT. CL. 35.

WENTZ, ERIC, NEEDHAM, MA:
2,171,729, CANC. INT. CL. 32.

WENZHOU CHENGBO GOOR SHOES CO., LTD., CHINA:
2,955,178, PUB. 3-1-2005, INT. CL. 25.

WERNER KAUFMANN, SWITZERLAND:
2,955,185, PUB. 3-1-2005, MULTIPLE CLASS, INT. CLS. 3, 16 AND 21.

WERNER-ROBERTSON, GAIL, OMAHA, NE:
1,843,164, CANC. MULTIPLE CLASS, INT. CLS. 35 AND 36.

WESCARE INTEGRATED HEALTH SOLUTION, LTD., CINCINNATI, OH:
2,171,608, CANC. INT. CL. 42.

WESCOR, INC., LOGAN, UT:
1,276,809, REN. 4-11-05, INT. CL. 9.

WESLEY DEVELOPMENT INC., CHICAGO, IL:
2,955,843, INT. CL. 21.

WEST COAST COMPETITION SHOOTING SUPPLIES, INC., SAN DIMAS, CA:
1,284,158, CANC. INT. CL. 9.
1,284,159, CANC. INT. CL. 9.

WESTERN CAROLINA PRODUCTIONS, INCORPORATED, FAIRVIEW, NC:
2,954,549, PUB. 3-1-2005, INT. CL. 41.

WESTERN INVENTORY SERVICE LTD., TORONTO, ONTARIO, CANADA:
2,954,178, PUB. 3-1-2005, INT. CL. 9.

WESTERN TEL CON, INC., NORTHRIDGE, CA, DBA PACHINKO PALACE:
2,170,919, CANC. INT. CL. 9.

WESTERN WIRELESS CORPORATION, BELLEVUE, WA:
2,954,870, PUB. 3-1-2005, INT. CL. 38.
2,955,782, INT. CL. 38.
2,955,783, INT. CL. 38.

WESTERN-CULLEN-HAYES, INC., CHICAGO, IL, HAYES TRACK APPLIANCE COMPANY, RICHMOND, IN:
604,707, REN. 4-14-05, U.S. CL. 14 (INT. CL. 6).

WESTINGHOUSE ELECTRIC CORPORATION, PITTSBURGH, PA:
2,171,731, CANC. MULTIPLE CLASS, INT. CLS. 37 AND 42.

WESTLAKE PLASTICS COMPANY, LENNI, PA:
2,954,853, PUB. 3-1-2005, INT. CL. 17.

WESTPORT BAY LLC, GREENSBORO, NC:
2,954,685, PUB. 3-1-2005, INT. CL. 20.
2,954,686, PUB. 3-1-2005, INT. CL. 20.

WESTRIDGE LABORATORIES, INC., SANTA, CA:
2,955,769, INT. CL. 3.

WESTURF DISTRIBUTORS, INC., COMMERCE CITY, CO:
2,171,456, CANC. MULTIPLE CLASS, INT. CLS. 16, 35 AND 37.

WESTWOOD STUDIOS, INC., LAS VEGAS, NV:
2,171,990, CANC. INT. CL. 9.

WEXLER-COMPUTER SYSTEMS DEVELOPMENT LTD., RISHON LE-ZION, ISRAEL:
1,842,774, CANC. INT. CL. 9.

WHEEL REPAIR SOLUTIONS, INC., NORCROSS, GA:
2,955,873, INT. CL. 37.

WHEELER, STEPHEN PAUL, CHAMPAIGN, IL, DBA WHEELER ARTS, INC.:
1,842,916, CANC. INT. CL. 16.

WHIRLPOOL PROPERTIES, INC., ST. JOSEPH, MI:
2,955,751, INT. CL. 11.

WHITAKER CORPORATION, THE, WILMINGTON, DE, M/A-COM OMNI SPECTRA, INC., MERRIMACK, NH:
1,322,981, REN. 4-13-05, INT. CL. 9.

WHITAKER CORPORATION, THE, WILMINGTON, DE:
1,879,609, REN. 4-15-05, INT. CL. 9.

WHITE CASTLE MANAGEMENT CO., COLUMBUS, OH, WHITE CASTLE SYSTEM, INC., COLUMBUS, OH:
1,916,972, REN. 4-15-05, INT. CL. 42.

WHITE CONSOLIDATED INDUSTRIES, INC., CLEVELAND, OH:
2,171,214, CANC. INT. CL. 8.

WHITE STALLION PRODUCTIONS, INC., OVEIDO, FL:
2,956,158, INT. CL. 41.
2,956,159, INT. CL. 41.

WHITE, WILLIAM T., JR., ABBEVILLE, AL:
1,843,765, CANC. INT. CL. 28.

WHITMAN'S CANDIES, INC., KANSAS CITY, MO, STEPHEN F. WHITMAN & SON, INC., PHILADELPHIA, PA:
325,862, REN. 4-10-05, U.S. CL. 46 (INT. CL. 30).

WHITNEY EDUCATION GROUP, INC., CAPE CORAL, FL:
2,806,484, CANC. INT. CL. 16.

WHITNEY, DANIEL D., SANFORD, FL:
2,954,490, PUB. 3-1-2005, INT. CL. 25.

WICKS N MORE INC., MANTACHIE, MS:
2,956,264, INT. CL. 4.

WILDER MFG. CO., INC., PORT JERVIS, NY:
1,842,852, CANC. INT. CL. 11.

WILFER, HANS-PETER, MARKNEUKIRCHEN, FED REP GERMANY:
2,954,694, PUB. 11-9-2004, MULTIPLE CLASS, INT. CLS. 9 AND 15.

WILHELM WERKE AG, 35633 LAHNAU, FED REP GERMANY:
2,170,939, CANC. MULTIPLE CLASS, INT. CLS. 11 AND 17.

WILINK U.S. HOLDINGS INC., RICHMOND, VA:
2,955,288, INT. CL. 35.
2,955,289, INT. CL. 36.
2,955,290, INT. CL. 38.
2,955,291, INT. CL. 38.

WILLIAM ALEXANDER'S, LLC, MCLEAN, VA:
2,955,595, INT. CL. 35.

- WILLIAMS PRODUCTS, INC., TROY, MI:
772,642, CANC. U.S. CL. 12.
- WILLIAMSON-DICKIE MANUFACTURING COMPANY,
FORT WORTH, TX:
594,542, REN. 4-9-05. U.S. CL. 39 (INT. CL. 25).
- WILLS, THOMAS E., WAPAKONETA, OH:
2,956,219, INT. CL. 16.
- WILMINGTON INSTITUTE, INC., DALLAS, TX:
2,171,202, CANC. INT. CL. 42.
- WILSON; FLOYD G., PHOENIX, AZ, DBA SAHUARO
RECORDS:
1,284,128, CANC. INT. CL. 9.
- WIN FOUR ATHLETIC COMPANY, ELKINS PARK, PA:
2,171,975, CANC. INT. CL. 25.
2,171,976, CANC. INT. CL. 25.
- WINDOW TO THE WORLD COMMUNICATIONS, INC.,
CHICAGO, IL:
2,171,219, CANC. INT. CL. 35.
- WINDQUEST COMPANIES, INC., HOLLAND, MI:
2,955,650, INT. CL. 20.
- WINDSOR DIGITAL DESIGN, INC., SCHAUMBURG, IL TO
WINDSOR D2, INC., ARLINGTON HEIGHTS, IL:
1,842,742, CANC. MULTIPLE CLASS, INT. CLS. 9 AND
42.
- WINDSOR QUALITY FOOD COMPANY LTD., HOUSTON,
TX:
2,955,545, INT. CL. 30.
- WINDWARD PRODUCTIONS, INC., SOUTHPORT, CT:
2,170,729, CANC. INT. CL. 16.
- WINERY ASSOCIATES OF SONOMA COUNTY, INC.,
HEALDSBURG, CA:
2,955,160, PUB. 3-1-2005. INT. CL. 33.
- WING FUNG TAI GINSENG INC., LOS ANGELES, CA:
2,171,533, CANC. MULTIPLE CLASS, INT. CLS. 5 AND
30.
- WING WAREHOUSE, AKRON, OH:
2,171,178, CANC. INT. CL. 42.
- WINONA VAN NORMAN, INC., WICHITA, KS:
1,292,635, REN. 4-14-05. MULTIPLE CLASS, INT. CLS. 6,
7, 9 AND 35.
- WINPLUS COMPANY, LTD., SHATIN, HONG KONG:
2,955,238, INT. CL. 12.
- WINSOME TRADING, INC., WOODINVILLE, WA:
1,903,294, REN. 4-13-05. INT. CL. 21.
1,903,294, CANC. INT. CL. 8.
- WINTER, DEBORAH A., WASHINGTON, DC:
2,955,284, INT. CL. 3.
- WINTERNALS SOFTWARE, L.P., AUSTIN, TX:
2,956,359, INT. CL. 9.
- WIRB, INC., SPOKANE, WA:
2,954,716, PUB. 3-1-2005. INT. CL. 36.
- WIRELESS DEPOT, INC., LAS VEGAS, NV:
2,171,993, CANC. INT. CL. 35.
- WIRE21, INC., LAS VEGAS, NV:
2,955,314, INT. CL. 9.
- WIRTH MASCHINENBAU GMBH, D-88074 MECKENBEU-
REN-REUTE, FED REP GERMANY:
2,954,022, PUB. 3-1-2005. INT. CL. 12.
- WISCONSIN LIFT TRUCK CORP., BROOKFIELD, WI:
2,954,975, PUB. 3-1-2005. INT. CL. 37.
- WITCO CORPORATION, NEW YORK, NY TO SUNMARKS,
INC., CLAYMONT, DE:
1,842,628, CANC. INT. CL. 4.
- WITNESS MEDCO LLC, KINGMAN, KS:
2,955,360, INT. CL. 5.
- WM. WRIGLEY JR. COMPANY, CHICAGO, IL:
1,284,258, CANC. INT. CL. 16.
- WMS GAMING INC., WAUKEGAN, IL:
2,955,636, INT. CL. 9.
- WNA COMET EAST, INC., CHELMSFORD, MA:
2,171,186, CANC. INT. CL. 21.
- WNY ASSET MANAGEMENT, LLC, WILLIAMSVILLE, NY:
2,956,197, MULTIPLE CLASS, INT. CLS. 35 AND 36.
- WOLCOTTVILLE SAND AND GRAVEL CORP., MAUMEE,
OH:
2,171,749, CANC. INT. CL. 19.
- WOLF, OLLECH, B-2018 ANTWERPEN, BELGIUM:
2,954,244, PUB. 3-1-2005. INT. CL. 14.
- WOLFCRAFT, INC., ADDISON, IL:
2,955,254, INT. CL. 6.
- WOLFE, KENNETH, DUBOIS, WY:
2,955,860, INT. CL. 43.
- WOLFGANG, PUCK, LOS ANGELES, CA, WOLFGANG
PUCK FOOD COMPANY, INC., SANTA MONICA, CA:
1,901,065, REN. 4-13-05. INT. CL. 42.
- WOLFORD, KATHLEEN A., OVERLAND PARK, KS:
2,171,017, CANC. INT. CL. 35.
- WOLPA, STEVE, OMAHA, NE:
2,954,976, PUB. 3-1-2005. INT. CL. 25.
2,956,241, INT. CL. 25.
- WOMAN'S HOSPITAL FOUNDATION, BATON ROUGE, LA:
2,170,644, CANC. INT. CL. 35.
- WOMEN OF WRESTLING, INC., INDIANAPOLIS, IN:
2,954,038, PUB. 9-2-2003. INT. CL. 41.
- WOOD KOTE PRODUCTS, INC., PORTLAND, OR:
1,895,782, REN. 4-15-05. INT. CL. 2.
- WOODBURY, MARTHA, J., GLENS FALLS, NY:
2,955,669, INT. CL. 35.
- WOODHEAD INDUSTRIES, INC., NORTHBROOK, IL, DA-
NIEL WOODHEAD, INC., NORTHBROOK, IL:
1,320,493, REN. 4-13-05. INT. CL. 9.
- WOODHEAD INDUSTRIES, INC., NORTHBROOK, IL:
1,320,494, REN. 4-13-05. INT. CL. 9.
- WOOSTER PRODUCTS, INC, WOOSTER, OH:
2,954,573, PUB. 3-1-2005. INT. CL. 28.
- WORK'N GEAR, LLC, WEYMOUTH, MA:
1,899,339, REN. 4-15-05. INT. CL. 42.
- WORKPLACE ESSENTIALS, INC., WOBURN, MA:
2,954,391, PUB. 3-1-2005. INT. CL. 37.
- WORLD INSTITUTE OF SCIENTOLOGY ENTERPRISES,
LOS ANGELES, CA:
1,853,610, REN. 4-15-05. INT. CL. 16.
- WORLD OF WHEELS AND HUBCAPS, DECATUR, GA:
1,883,168, REN. 4-10-05. INT. CL. 42.
- WORLD PROPERTIES, INC., LINCOLNWOOD, IL:
785,505, REN. 4-12-05. U.S. CL. 21 (INT. CL. 9).
- WORLD VISION, INC., FEDERAL WAY, WA:
2,954,794, PUB. 3-1-2005. MULTIPLE CLASS, INT. CLS.
35, 36 AND 41.
- WORLD WIDE ORDNANCE, INC., PLANTATION, FL:
2,913,990, COR. INT. CL. 35.
- WORLDWIDE INVESTIGATIONS & RESEARCH, INC.,
WEST PALM BEACH, FL, DBA WIRED TECHNOLOGY
SYSTEMS:
2,955,826, INT. CL. 45.
- WORLDWIDE TRANSMISSION CORE SUPPLY, INCORPO-
RATED, LAKE ZURICH, IL:
2,955,126, PUB. 3-1-2005. INT. CL. 12.
- WPI ACQUISITION LLC, BALTIMORE, MD:
2,955,442, INT. CL. 9.
- WPL GROUP, LLC, BIRMINGHAM, AL:
2,955,354, INT. CL. 35.
- WPW INDUSTRIES, INC., STREATOR, IL, DBA STREATOR
BRICK COMPANY:
2,955,935, INT. CL. 19.
- WREN ASSOCIATES, LTD., JEFFERSON CITY, MO:
2,955,224, INT. CL. 9.
2,955,225, INT. CL. 9.
- WRIGHT, PAUL DAVID, SCHERERVILLE, IN, DBA IDK
ATHLETICS:
2,171,030, CANC. INT. CL. 25.
2,171,031, CANC. INT. CL. 25.
2,171,032, CANC. INT. CL. 25.
- WTC-TRADE MART, L.P., DALLAS, TX:
2,956,294, INT. CL. 35.
- WYETH, MADISON, NJ, A. H. ROBINS COMPANY, INC.,
RICHMOND, VA:
604,409, REN. 4-15-05. U.S. CL. 18 (INT. CL. 5).
- WYETH HOLDINGS CORPORATION, MADISON, NJ:
1,322,930, REN. 4-11-05. INT. CL. 5.
- XCAD VALVE & IRRIGATION CORPORATION, PAUL, ID:
2,955,423, INT. CL. 11.
- XENON LIGHT GMBH, GRAZ, AUSTRIA:
2,955,919, INT. CL. 9.

XEROX CORPORATION, STAMFORD, CT:
1,882,856, REN. 4-10-05. INT. CL. 9.
2,955,722, INT. CL. 9.

XM INTERNATIONAL INC., EAST RUTHERFORD, NJ:
2,954,305, PUB. 3-1-2005. INT. CL. 6.

XNERGY, CARLSBAD, CA:
2,954,830, PUB. 3-1-2005. INT. CL. 37.

XOD, LLC, WARMINSTER, PA:
2,954,916, PUB. 3-1-2005. INT. CL. 38.

XTREME INTERNET INC, DENVER, CO:
2,956,249, INT. CL. 5.

XYRON INCORPORATED, SCOTTSDALE, AZ:
2,955,709, INT. CL. 16.

YAMAHA CORPORATION, HAMAMATSU-SHI, SHIZUOKA, JAPAN, NIPPON GAKKI SEIZO KABUSHIKI KAISHA, HAMAMATSU-SHI, SHIZUOKA-KEN, JAPAN, DBA NIPPON GAKKI CO., LTD.:
1,288,275, REN. 4-15-05. INT. CL. 41.
1,295,249, REN. 4-15-05. INT. CL. 9.

YAMAHA CORPORATION, SHIZUOKA, JAPAN:
2,955,307, INT. CL. 9.

YAMAHA HATSUDOKI KABUSHIKI KAISHA, SHIZUOKA-KEN, JAPAN:
2,955,720, INT. CL. 12.

YANNI PARTNERS, INC., PITTSBURGH, PA:
2,955,293, MULTIPLE CLASS, INT. CLS. 16 AND 36.

YAO I FABRIC CO., LTD., HOMEI, CHANGHUA HSIEN, R.O.C., TAIWAN:
1,284,465, CANC. INT. CL. 28.

YASMINA INC., NEW YORK, NY:
2,955,059, PUB. 3-1-2005. INT. CL. 18.

YEH, JOSEPH, OSPREY, FL:
2,955,579, INT. CL. 35.

YELLOW STROM VERWALTUNGSGESELLSCHAFT MBH, 76131 KARLSRUHE, FED REP GERMANY:
2,954,007, PUB. 3-1-2005. MULTIPLE CLASS, INT. CLS. 7, 9, 11, 12, 21, 28, 35, 39 AND 42.

YLARREGUI, RAYMOND, MADERA, CA:
2,171,514, CANC. INT. CL. 29.

YMCA OF THE GREATER HOUSTON AREA, THE, HOUSTON, TX:
2,171,084, CANC. INT. CL. 41.

YOGURT TECHNOLOGIES, INC., GALVESTON, TX:
2,955,996, INT. CL. 32.
2,956,047, INT. CL. 32.

YOO-HOO CHOCOLATE BEVERAGE CORP., CARLSTADT, NJ:
2,171,406, CANC. INT. CL. 30.

YORK GRAPHIC SERVICES CO., YORK, PA:
1,284,621, CANC. MULTIPLE CLASS, INT. CLS. 38, 40, 41 AND 42.

YORK PARTNERS, L.P., LAMBERTVILLE, NJ, TA YORK LUGGAGE COMPANY TO GROUP III INTERNATIONAL LTD., FORT LAUDERDALE, FL:
1,843,654, CANC. INT. CL. 18.

YORK TELECOM CORPORATION, EATONTOWN, NJ:
2,954,570, PUB. 3-1-2005. INT. CL. 9.

YORKSHIRE FOOD SALES CORP., NEW HYDE PARK, NY:
2,955,967, MULTIPLE CLASS, INT. CLS. 29 AND 30.

YOSHIDA KOGYO K.K., CHIYODA-KU, TOKYO 101, JAPAN TO YKK CORPORATION, TOKYO, JAPAN:
1,842,643, CANC. INT. CL. 6.

YOUNG CARE CHILD DEVELOPMENT CENTER, INC., COLUMBIA, MD:
2,171,045, CANC. INT. CL. 41.

YOUNG SCHOOL, THE, COLUMBIA, MD:
2,171,046, CANC. MULTIPLE CLASS, INT. CLS. 25 AND 41.

YOUNG, JAMES, AARON, STEPHENVILLE, TX:
2,955,132, PUB. 3-1-2005. INT. CL. 41.

YUASA EXIDE, INC., READING, PA:
2,170,923, CANC. INT. CL. 9.

YUEQING PUQI ELECTRICAL PLASTIC FACTORY, ZHEJIANG, CHINA:
2,954,659, PUB. 3-1-2005. INT. CL. 9.

YVES SAINT LAURENT PARFUMS S.A., NEUILLY-SUR-SEINE, FRANCE:
1,857,433, REN. 4-15-05. INT. CL. 3.

Z "K" CONCEPT, PARIS, FRANCE:
2,955,497, MULTIPLE CLASS, INT. CLS. 16 AND 35.

ZACH & DAN'S, LLC, GREENWOOD VILLAGE, CO:
2,954,874, PUB. 3-1-2005. INT. CL. 7.

ZAK'S SPORTS PRODUCTS, LLC, NORTHBROOK, IL:
2,955,424, INT. CL. 28.

ZAKON, NANCY, NEW YORK, NY:
2,171,116, CANC. INT. CL. 42.

ZELESKEY, CORNELIUS, HALLMARK, ROPER & HICKS, L.L.P., LUFKIN, TX:
2,955,033, PUB. 3-1-2005. INT. CL. 42.

ZEPHYR THERAPEUTICS, INC., LAGUNA HILLS, CA:
2,171,476, CANC. INT. CL. 10.

ZETA SIGMA PHI SORORITY, GLENDALE, CA:
2,954,290, PUB. 3-1-2005. INT. CL. 35.
2,954,291, PUB. 3-1-2005. INT. CL. 35.

ZEVGARAS, ANTHANASIOS, MANHATTAN BEACH, CA AND ZEVGARAS, VERA, MANHATTAN BEACH, CA, DBA TOMBOY'S FAMOUS CHILI HAMBURGERS:
1,903,192, REN. 4-15-05. INT. CL. 42.

ZICKGRAF ENTERPRISES, INC., FRANKLIN, NC:
2,956,232, INT. CL. 19.

ZIEBART INTERNATIONAL CORPORATION, TROY, MI:
2,955,396, MULTIPLE CLASS, INT. CLS. 37 AND 40.

ZIERICK MANUFACTURING CORPORATION, MOUNT KISCO, NY:
1,842,749, CANC. INT. CL. 9.

ZIN-PLAS CORPORATION, COMSTOCK PARK, MI:
772,658, CANC. U.S. CL. 13.

ZIZZO, THOMAS F, JERSEY CITY, NJ:
2,954,966, PUB. 3-1-2005. INT. CL. 41.

ZONE NETWORK, INC., THE, SEATTLE, WA:
2,172,041, CANC. INT. CL. 41.

ZOOM EYEWORKS, INC., BERKELEY, CA:
2,956,018, INT. CL. 9.

ZYDAS TECHNOLOGY CORPORATION, HSINCHU, TAIWAN:
2,954,901, PUB. 3-1-2005. MULTIPLE CLASS, INT. CLS. 9 AND 42.

1-800-CREDFIX, DANVILLE, CA:
2,261,545, CANC. MULTIPLE CLASS, INT. CLS. 35 AND 36.

1ST COMMUNITY FEDERAL CREDIT UNION, SAN ANGELO, TX:
2,954,548, PUB. 3-1-2005. INT. CL. 36.

1106677 ONTARIO LTD., DOWNSVIEW, ONTARIO M3J 3C1, CANADA, DBA VIEWZ:
2,170,635, CANC. INT. CL. 9.

13 CATS, INC., NATICK, MA:
2,171,698, CANC. INT. CL. 35.

2NDEDISON, INC., REDWOOD CITY, CA:
2,955,562, MULTIPLE CLASS, INT. CLS. 16, 25 AND 28.

20/10 PERFECT VISION OPTISCHE GERAETE GMBH, D-69123 HEIDELBERG, FED REP GERMANY:
2,956,289, INT. CL. 42.

20/20 INSTITUTE, LLC, ENGLEWOOD, CO:
2,956,300, INT. CL. 44.

3CIM, INC., SANTA CLARA, CA:
2,956,063, INT. CL. 41.

3NET COMMUNICATIONS CORPORATION, SAN JOSE, CA:
2,954,015, PUB. 7-25-2000. MULTIPLE CLASS, INT. CLS. 37 AND 42.

333 LLC, EDGEWATER, NJ:
2,955,990, INT. CL. 41.

333 11C, EDGEWATER, NJ:
2,955,991, INT. CL. 41.

4 EVER PETS NATURAL PRODUCTS LTD., KELOWNA, BRITISH COLUMBIA, CANADA:
2,954,109, PUB. 9-21-2004. INT. CL. 5.

4LIFE RESEARCH, L.C., SANDY, UT:
2,954,126, PUB. 3-1-2005. INT. CL. 9.

523 6TH CORPORATION, LONG BEACH, CA:
2,114,105, COR. INT. CL. 42.

7.62 DESIGN, LA JOLLA, CA:
2,171,061, CANC. INT. CL. 25.

911 ENTERTAINMENT, SAN FRANCISCO, CA:
2,171,459, CANC. INT. CL. 41.

* * * * *